

SSC-348

**CORROSION EXPERIENCE
DATA REQUIREMENTS**



This document has been approved
for public release and sale; its
distribution is unlimited

SHIP STRUCTURE COMMITTEE

1991

SHIP STRUCTURE COMMITTEE

The SHIP STRUCTURE COMMITTEE is constituted to prosecute a research program to improve the hull structures of ships and other marine structures by an extension of knowledge pertaining to design, materials, and methods of construction.

RADM J. D. Sipes, USCG, (Chairman)
Chief, Office of Marine Safety, Security
and Environmental Protection
U. S. Coast Guard

Mr. H. T. Haller
Associate Administrator for Ship-
building and Ship Operations
Maritime Administration

Mr. Alexander Malakhoff
Director, Structural Integrity
Subgroup (SEA 55Y)
Naval Sea Systems Command

Mr. Thomas W. Allen
Engineering Officer (N7)
Military Sealift Command

Dr. Donald Liu
Senior Vice President
American Bureau of Shipping

CDR Michael K. Parmelee, USCG,
Secretary, Ship Structure Committee
U. S. Coast Guard

CONTRACTING OFFICER TECHNICAL REPRESENTATIVES

Mr. William J. Siekierka
SEA 55Y3
Naval Sea Systems Command

Mr. Greg D. Woods
SEA 55Y3
Naval Sea Systems Command

SHIP STRUCTURE SUBCOMMITTEE

The SHIP STRUCTURE SUBCOMMITTEE acts for the Ship Structure Committee on technical matters by providing technical coordination for determining the goals and objectives of the program and by evaluating and interpreting the results in terms of structural design, construction, and operation.

AMERICAN BUREAU OF SHIPPING

Mr. Stephen G. Arntson (Chairman)
Mr. John F. Conlon
Dr. John S. Spencer
Mr. Glenn M. Ashe

NAVAL SEA SYSTEMS COMMAND

Mr. Robert A. Sielski
Mr. Charles L. Null
Mr. W. Thomas Packard
Mr. Allen H. Engle

MILITARY SEALIFT COMMAND

Mr. Albert J. Altermeyer
Mr. Michael W. Touma
Mr. Jeffery E. Beach

U. S. COAST GUARD

CAPT T. E. Thompson
CAPT Donald S. Jensen
CDR Mark E. Noll

MARITIME ADMINISTRATION

Mr. Frederick Seibold
Mr. Norman O. Hammer
Mr. Chao H. Lin
Dr. Walter M. Maclean

SHIP STRUCTURE SUBCOMMITTEE LIAISON MEMBERS

U. S. COAST GUARD ACADEMY

LT Bruce Mustain

NATIONAL ACADEMY OF SCIENCES - MARINEBOARD

Mr. Alexander B. Stavovy

U. S. MERCHANT MARINE ACADEMY

Dr. C. B. Kim

NATIONAL ACADEMY OF SCIENCES - COMMITTEE ON MARINE STRUCTURES

Mr. Stanley G. Stiansen

U. S. NAVAL ACADEMY

Dr. Ramswar Bhattacharyya

SOCIETY OF NAVAL ARCHITECTS AND MARINE ENGINEERS - HYDRODYNAMICS COMMITTEE

Dr. William Sandberg

STATE UNIVERSITY OF NEW YORK MARITIME COLLEGE

Dr. W. R. Porter

AMERICAN IRON AND STEEL INSTITUTE

WELDING RESEARCH COUNCIL

Dr. Martin Prager

Mr. Alexander D. Wilson

Member Agencies:

*United States Coast Guard
Naval Sea Systems Command
Maritime Administration
American Bureau of Shipping
Military Sealift Command*



Ship Structure Committee

An Interagency Advisory Committee
Dedicated to the Improvement of Marine Structures

Address Correspondence to:

Secretary, Ship Structure Committee
U.S. Coast Guard (G-MTH)
2100 Second Street S.W.
Washington, D.C. 20593-0001
PH: (202) 267-0003
FAX: (202) 267-0025

January 31, 1991

SSC-348
SR-1306

CORROSION EXPERIENCE DATA REQUIREMENTS

The detrimental effect of corrosion on marine structures is well known. Assessing the extent of corrosion damage and predicting corrosion rates, however, can be difficult. The purpose of this project was to develop a corrosion survey methodology that could be used in assessing vessel structures. This report contains the methodology and data collection requirements that could be used to assess corrosion rates, damage, and margins.

J. D. SIPES

Rear Admiral, U.S. Coast Guard
Chairman, Ship Structure Committee

Technical Report Documentation Page

1. Report No. SSC-348	2. Government Accession No.	3. Recipient's Catalog No.	
4. Title and Subtitle CORROSION EXPERIENCE DATA REQUIREMENTS		5. Report Date 1988	
		6. Performing Organization Code	
7. Author(s) Karl A. Stambaugh, John C. Knecht		8. Performing Organization Report No. SR-1306	
9. Performing Organization Name and Address Giannotti & Associates, Inc. 703 Giddings Avenue, Suite U-3 Annapolis, Maryland 21401		10. Work Unit No. (TRAIS)	
		11. Contract or Grant No. DTCG23-86-C-20064	
12. Sponsoring Agency Name and Address U.S. Coast Guard Office of Merchant Marine Safety Washington, DC 20593		13. Type of Report and Period Covered Technical Report 10/86 - 5/88	
		14. Sponsoring Agency Code G-M	
15. Supplementary Notes The USCG acts as the contracting office for the Ship Structure Committee.			
16. Abstract A corrosion survey methodology is presented to obtain corrosion data from ships. The corrosion data will be used to develop a rational method for assessing corrosion margins. The project included a survey of ship operators for corrosion data to define data collection and analysis requirements to characterize the corrosion rates that affect structural integrity of ships. The techniques used to predict corrosion rates and assess the strength of corroded structure were also reviewed to determine data requirements. The methodology consists of a data collection procedure, with recommended instrumentation. Forms were developed for documenting the measurements. Finally, an outline of the database was developed that includes an Expert System interface for data input, analysis and retrieval.			
17. Key Words corrosion ship structures corrosion data		18. Distribution Statement This document is available to the U.S. public through the National Technical Information Service, Springfield, VA, 22161	
19. Security Classif. (of this report) UNCLASSIFIED	20. Security Classif. (of this page) UNCLASSIFIED	21. No. of Pages 102	22. Price

METRIC CONVERSION FACTORS

Approximate Conversions to Metric Measures

Symbol	When You Know	Multiply by	To Find	Symbol
LENGTH				
in	inches	2.5	centimeters	cm
ft	feet	30	centimeters	cm
yd	yards	0.9	meters	m
mi	miles	1.6	kilometers	km
AREA				
in ²	square inches	6.5	square centimeters	cm ²
ft ²	square feet	0.09	square meters	m ²
yd ²	square yards	0.8	square meters	m ²
mi ²	square miles	2.6	square kilometers	km ²
	acres	0.4	hectares	ha
MASS (weight)				
oz	ounces	28	grams	g
lb	pounds	0.45	kilograms	kg
	short tons (2000 lb)	0.9	tonnes	t
VOLUME				
tsp	teaspoons	5	milliliters	ml
Tbsp	tablespoons	15	milliliters	ml
fl oz	fluid ounces	30	milliliters	ml
c	cups	0.24	liters	l
pt	pints	0.47	liters	l
qt	quarts	0.96	liters	l
gal	gallons	3.8	liters	l
ft ³	cubic feet	0.03	cubic meters	m ³
yd ³	cubic yards	0.76	cubic meters	m ³
TEMPERATURE (exact)				
°F	Fahrenheit temperature	5/9 (after subtracting 32)	Celsius temperature	°C

Approximate Conversions from Metric Measures

Symbol	When You Know	Multiply by	To Find	Symbol
LENGTH				
mm	millimeters	0.04	inches	in
cm	centimeters	0.4	inches	in
m	meters	3.3	feet	ft
m	meters	1.1	yards	yd
km	kilometers	0.6	miles	mi
AREA				
cm ²	square centimeters	0.16	square inches	in ²
m ²	square meters	1.2	square yards	yd ²
km ²	square kilometers	0.4	square miles	mi ²
ha	hectares (10,000 m ²)	2.5	acres	acres
MASS (weight)				
g	grams	0.035	ounces	oz
kg	kilograms	2.2	pounds	lb
t	tonnes (1000 kg)	1.1	short tons	short tons
VOLUME				
ml	milliliters	0.03	fluid ounces	fl oz
l	liters	2.1	pints	pt
l	liters	1.06	quarts	qt
l	liters	0.26	gallons	gal
m ³	cubic meters	36	cubic feet	ft ³
m ³	cubic meters	1.3	cubic yards	yd ³
TEMPERATURE (exact)				
°C	Celsius temperature	9/5 (then add 32)	Fahrenheit temperature	°F

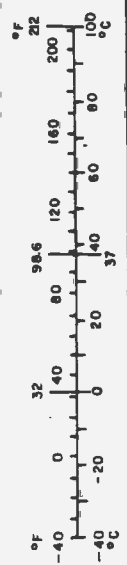
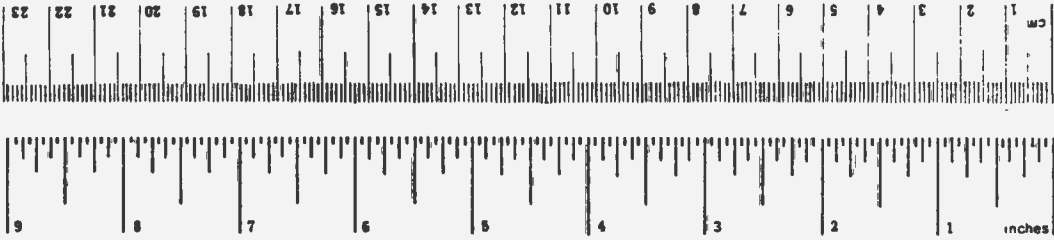

* 1 in = 2.54 (exact) in. For other exact conversions and unabbreviated tables, see NBS Mon. Publ. 286, Units of Weights and Measures, Part 2, 25, SD Catalog No. C11.10-78b.

TABLE OF CONTENTS

1.0	INTRODUCTION.	1
2.0	BACKGROUND AND PREVIOUS CORROSION SURVEY.	2
2.1	Corrosion Surveys of Ship Structure.	2
2.2	Corrosion Survey Results	3
3.0	CORROSION DATA REQUIREMENTS	13
3.1	Corrosion Margin Assessment.	13
3.2	Corrosion Rate Prediction and Survey Techniques.	16
3.3	Summary of Data Requirements and Recommended Corrosion Rate Survey Technique.	22
4.0	DATA COLLECTION REQUIREMENTS.	25
4.1	Types of Corrosion to Survey	25
4.2	Corrosion Locations.	28
4.3	Correlation Parameters	32
4.4	Sample Size and Accuracy	34
4.5	Instrumentation Requirements	39
5.0	CORROSION SURVEY METHODOLOGY.	40
5.1	Data Acquisition	40
5.2	Data Recording	54
5.3	Data Analysis.	70
5.4	Program Implementation	84
6.0	CONCLUSIONS AND RECOMMENDATIONS	87
7.0	REFERENCES.	88

LIST OF FIGURES

2-1	Gauging Measurement History for the M/V CHESTER Poling Before & After Hull Failure	7
2-2	Ultrasonic Measurements of a Transversely Framed Containership with Corrosion Fatigue Cracks.	9
2-3	Weld Detail Used on the Converted Containership Showing Corrosion Fatigue Cracks	10
2-4	Result of Plate Thickness Gauging and Corrosion Distribution of Girder Web Slot.	12
2-5	Number of Cases of Damage by Ship Type Broken-Down into Types of Damage Between 1976-1984.	12
4-1	Simplified Schematic of Uniform Corrosion.	26
4-2	Schematic of Formation of a Pit.	27
4-3	Typical Bottom Shell Loss Patterns	29
4-4	Typical Bottom Structure Defects	31
4-5	Normal Distribution Curve.	36
5-1	CRT Display Equipment.	44
5-2	Thickness Measurement Through a Coating Layer.	45
5-3	Digital Display Equipment.	46
5-4	Single Transducer Pulse Echo-Pattern	49
5-5	Twin Transducer Pulse-Echo Pattern	50
5-6	Focused Transducer Concept Showing the Diverging Beam from the Point of Focus as it Enters Parallel into the Steel Plate	51
5-7	Spurious Signal S1 Caused by a Sidelobe	52
5-8	Effect of Acoustic Mask.	53

LIST OF FIGURES (continued)

5-9	Pitting Intensity Diagrams55
5-10	Ship Designations.58
5-11	List of Compartment Designations60
5-12	List of Ship Structures.61
5-13	Ship Information Sheet65
5-14	Compartment Correlation Parameter Sheet.66
5-15	Panel Data Sheet69
5-16	Example Panel Gauging Patterns71
5-17	Database Configuration72
5-18	Data Input Sequence.74
5-19	Sample Data Input Sequence76
5-20	Data Editing Sequence.81
5-21	Sample Data Analysis Output.83
5-22	Data Analysis Sequence85

LIST OF TABLES

2-1	Corrosion Rates.	4
3-1	Correlation of Corrosion Data Requirements and Failure Modes Relevant to Structural Integrity23

1.0 INTRODUCTION

Ship structure design involves a thorough application of scientific and engineering approaches. In many instances where there are no rational theories or methods, it becomes necessary to develop this knowledge as an extrapolation of existing technology. Most often, new techniques and methods are developed from survey of structural systems to obtain empirical data. This approach would improve the analysis of corrosion in ship structures. Currently, corrosion margins are applied based on past experience and most maintenance efforts are guided by trial and error experiences.

To improve on current practice and develop a rational method for assessing corrosion margins, it is necessary to survey corrosion in ship structures, develop a corrosion rate data base to predict corrosion rates accurately and determine the time frame a given corrosion margin will be depleted.

This report presents a corrosion survey methodology that will obtain corrosion data to develop rational methods for predicting corrosion rates and assessing corrosion margins. The corrosion survey methodology is based on the review of corrosion data, data analysis requirements, data collection requirements for characterizing corrosion that affects structural integrity. The methodology presented consists of a data collection procedure with recommended instrumentation. The methodology's applicability ranges from specific problem areas to ship hull girder-structural systems. Data collection forms are presented for recording measurements. An outline database was developed that uses an Expert system for data input, analysis, and retrieval. A list of recommended research is presented to support development of rationally based corrosion margins.

2.0 BACKGROUND AND PREVIOUS CORROSION SURVEYS

To develop the corrosion survey methodology it was necessary to review corrosion data and determine the types of corrosion affecting the integrity of ship structures, the locations where corrosion occurs, the parameters that apply, and the survey techniques used. A number of ship owners, regulatory bodies, and industry representatives were surveyed to obtain corrosion data. The following describes the corrosion data, as it impacts the requirements for a corrosion rate survey methodology.

2.1 Corrosion Surveys of Ship Structure

Traditionally, corrosion surveys fall into two categories: those required by classification societies or regulatory bodies and those conducted by ship owners to determine the general condition, effectiveness of corrosion prevention systems, corrosion rates, and repair assessments. Each survey has specific requirements, objectives, and survey resources.

Classification society and regulatory body surveys include annual and intermediate surveys, drydocking surveys, special periodical surveys, and occasional surveys. Special surveys are generally required at four-year intervals. The scope of the special survey varies according to the age of the ship. Generally, the surveys are conducted during drydocking. Depending on the accessibility of structural components and the extent of corrosion, surveys are conducted at sea to minimize time spent in drydock.

While the classification societies and regulatory bodies are concerned with compliance to standards and for overall structural strength, the ship owners require information on structural condition that affects operating and repair costs. This information may be obtained at the time of annual or special surveys. Generally, the ship owner will require surveys of:

1. the present state and estimated corrosion rates of the various structural components;
2. the present condition and expected rate of deterioration of existing corrosion control systems;
3. the existence, severity, and potential for further development of structural defects due to expected corrosion patterns;
4. the potential for cargo contamination or pollution incidents due to corrosion and structural problems.

As evidence by the previous discussions the type of survey performed depends on the information required. A corrosion rate survey is a derivative of the classification and owners survey.

2.2 Corrosion Survey Results

The results of previous surveys were reviewed to highlight corrosion data collection techniques and requirements. A brief description of each survey is presented below.

During the time frame between 1981 and 1982, a tanker operator (2-1, 2-2) surveyed 32 VLCCs. The survey was conducted on internal structure. Eighty-five (85) to ninety (90) percent of the internal tank structure was surveyed including under bellmouths and flume openings.

Inspections were conducted using ultrasonic instruments. Data was recorded on forms for data analysis at a later time. For each structural member, information was collected on scale, pitting, visible thickness loss, fractures, and general wastage. Ultrasonic measurement patterns varied depending on the extent and location of corrosion. However, a detailed record of gauging locations was a key part of the data acquisition process. Tank characteristics (i.e. contents, cathodic protection, coating type) were recorded for each set of data.

The majority of general wastage occurred on internal tank structures subject to two-sided corrosion, including horizontal stringer platforms and webs and bottom plating, particularly in unprotected cargo/dirty ballast tanks. Generally main deck, side shell, and bulkhead plating had much lower corrosion rates. In segregated ballast tanks, wastage was most severe in the splash zone. Ships with flume tanks showed heavy wastage on stiffening in way of flume openings and side shell stiffening opposite the flume openings. Heavy wastage was also found on horizontal surfaces in cargo/clean and cargo/dirty tanks where tank washing machines help remove protective wax or oil films.

Pitting and grooving on coal tar epoxy coated tank structure was a common problem. Plating under bellmouths was vulnerable to pitting in both coated and uncoated tanks due to added effects of high fluid velocity. Several cases of bottom penetration occurred. The corrosion rate data derived from the survey is presented in Table 2-1.

During 1980 to 1981 a tanker operator conducted internal tank surveys (2-3). The surveys included visual checking for cracks and patterns of wastage and pitting. Periodic thickness gauging was conducted. In cargo-only tanks, uncoated surfaces showed only moderate corrosion wastage of .1 - .15 mm (4-6 mils) per year. Corrosion was noticeable primarily on structural members adjacent to connections with the bulkhead and side shell plating. No problems existed in coated areas except minor deterioration around sharp edges. Epoxy coated tank bottoms in all cargo tanks displayed severe pitting, which was greater in tanks that were

**TABLE 2-1
CORROSION RATES**

(a) SEGREGATED BALLAST TANKS (ballast factor = 50%)			
	<i>Zone</i>	<i>Unprotected</i>	<i>Protected with anodes</i>
Ullage	- 1 sided	0.20 mm/yr	Not applicable
	2 sided	0.30	Not applicable
Splash	- 1 sided	0.60	Not applicable
	2 sided	0.85	Not applicable
Immersed	- 1 sided	0.60	0.18 mm/yr
	2 sided	0.85	0.25

(b) CARGO CLEAN BALLAST TANKS (ballast factor = 45%)			
	<i>Zone</i>	<i>Unprotected</i>	<i>Protected with anodes</i>
Ullage	- 1 sided	0.10 mm/yr	Not applicable
	2 sided	0.15	Not applicable
Splash	- 1 sided	0.45	Not applicable
	2 sided	0.65	Not applicable
Immersed	- 1 sided	0.45	0.15 mm/yr
	2 sided	0.65	0.20

(c) CARGO DIRTY BALLAST TANKS (ballast factor = 5%)			
	<i>Zone</i>	<i>Unprotected</i>	<i>Protected with anodes</i>
Ullage	- 1 sided	0.10 mm yr	Not applicable
	2 sided	0.15	Not applicable
Splash	- 1 sided	0.15	Not applicable
	2 sided	0.20	Not applicable
Immersed	- 1 sided	0.15 ^a	0.15 mm yr ^b
	2 sided	0.20	0.20 ^b

^a Except for bottom plating of aft two bays where corrosion rate is assumed to be 0.45 mm yr. (Water residue increases the ballast factor)

^b Anodes not effective due to low residence time

(d) CARGO ONLY TANKS			
Corrosion is assumed to be extremely low unless ultrasonics indicate otherwise			

cleaned with salt water washing. Several penetrations occurred in bottom shell plating under bellmouths.

In cargo/ballast tanks fitted with fixed tank washing machines with no anodes, uncoated surfaces had higher corrosion rates than cargo-only tanks. Corrosion occurred extensively on horizontal girder surfaces. The operator felt that a change from seawater to crude oil for tank washing would reduce corrosion.

All significant hull corrosion occurred in permanent water ballast tanks. Corrosion problems on ships six to ten years old concentrated in the following areas:

1. oil tight bulkhead stiffeners;
2. transverse web plating at bulkhead attachments;
3. side shell longitudinal stiffeners;
4. horizontal girders, plating, and supporting structure.

Corrosion rates were as high as 1.0 mm (40 mils) per year in upper sections and .5 to .6 mm (20-24 mils) per year in remaining parts of tanks. Higher corrosion rates were found in locally high stressed areas. Zinc anodes did not provide necessary protection for uncoated ballast tank surfaces. The operators did not see traditional grooving effects but rather large amounts of general wastage.

Munger (2-4) separately reported results of a pitting corrosion survey of four VLCCs carrying sour crude. The pitting corrosion was found primarily on horizontal surfaces of internal tank structure. Visual inspections were conducted with gauging to obtain pit depth and diameter. Munger reported the survey results for each ship.

1. A Japanese tanker (250 KDWT), in service for one year, experienced extensive pitting in its oil/ballast tanks. In tanks fitted with zinc anodes, pits developed on all horizontal surfaces from the highest stiffener to the bottom shell. Anodes had no effect on pitting pattern. The density of pits increased with increasing tank depth. Pitting occurred on the horizontal surfaces with the pitting density of four to 16 per square foot, diameter of $\frac{1}{4}$ to $1\frac{1}{2}$ inches, and depth of 80 to 160 mils.
2. A European tanker (250 KDWT), in service for three years in Persian Gulf trade, experienced pitting in the cargo ballast tanks with no anodes or coating. The pitting occurred on all upper horizontal surfaces, longitudinals, and upper flanges of the center vertical keel. Pits were severe, actually growing into each other with diameters ranging from one-half inch to six

inches. Pits increased in size from upper horizontal to the bottom.

3. A U.S.-owned tanker (265 KDWT) in Persian Gulf service for 28 months experienced pitting corrosion in cargo/ballast tanks. The tanks had no anodes and pitting was located on the bottom and underside of the deck. Pitting corrosion was observed on horizontal surfaces between upper and lower coated areas with an estimated 25% of the horizontal surface corroded. Pit depth occurred between 1/16 inch and 1/4 inch.
4. A U.S.-owned tanker (250 KDWT) in Mideast to Europe trade route for 18 months experienced pitting corrosion in its cargo/ballast tanks with no anodes. All horizontal surfaces were coated with one coat of inorganic zinc primer. Vertical surfaces were in good condition with some corrosion starting. The two top horizontal stiffeners showed pitting, of 3/16 inch to one inch in diameter and 1/16 inch in depth. Horizontal stiffeners showed pitting up to two inches in diameter, depth 1/16 inch to 1/8 inch and frequency of one to 10 per square foot.

The pitting action in all four tankers reported above was aggravated by hydrogen sulfide in the sour crude oil. Sulphur dissolved in crude and available from hydrogen sulfide, oxygen from sprayed seawater used to clean tanks and from air entering the tanks, reducing environments existing during part of the crude-seawater cycle and unfavorable area relationships between the active pits (anodes) and the surrounding areas covered by the corrosion products acting as the cathode, contributed to the pitting corrosion.

During a winter storm in 1977, a coastal tanker foundered and sank (2-5). Corrosion wastage was identified as a major cause of the casualty. Ultrasonic gauging of plates were compared for 1968, 1972, 1976, and salvaged plates, as shown in Figure 2-1. When results were compared there were some discrepancies noted. Metal thickness readings were greater at later dates for many readings. However, general trends did show the hull thickness was reduced by corrosion and structural failure resulted.

A class of containerships (2-6.) sustained corrosion fatigue cracks and ultrasonic gauging was conducted to determine the extent of wastage in the shell plating. Figure 2-2 shows the results of the gauging for the bottom and side shell. The minimum thickness of the bottom shell shown in Figure 2-2 is 17.5 mm (.70 inches). The original thickness was .8175 inches. Additionally, severe local pitting was identified inside the double-bottom tank. The observed corrosion fatigue cracking is shown in Figure 2-3.

Orig Tks.	Plate	1968		1972		1976		Salvaged Plate			
		Port	Stbd	Port	Stbd	Port	Stbd	Port	Stbd		
.625	5	.490	.490	.430	.420	---	---	.392			
				.450	.415						
	6	.460	.440	.420	.415	.410	.420				
				.430	.420						
	7	.480	.500	.425	.430	---	---				
				.440	.430						
	8	.480	.500	.425	.430	.420	.430				
				.415	.450						
	9	.470	.480	.440	.440	---	---				
		D3	.570	.580	.540	.550	.570			.580	
			.550	.560	.570	.580					
			.560								
.50	4	.580	.600	.575	.580	.590	.580	.502			
				.600	.590	.570	.590				
	5	.605	.595	.600	.590	.570	.590				
		6	.670	.605	.590	.590	.570			.570	
				.580	.600	.580	.580				
	7	.590	.605	.580	.595	.580	.580				
				.575	.585	.590	.600				
	8	.595	.605	.580	.590	.600	.600				
				.580	.585						
	9	.585	.605	.600	.600	.550	.580				
E4		.460	.470	.420	.410	.480	.480				
			.415	.415		.470					
.625	5	.480	.480	.480	.440	.480	.470	.430			
				.470	.445	.470	.470				
	6	.500	.480	.470	.445	.470	.470				
		7	.500	.490	.460	.450	.470			.470	
				.460	.440						
	8	.500	.490	.450	.435	.480	.480				
				.460	.450						
	9	.490	.490	.460	.430	.470	.460				
				.440	.450						
	10	.480	.470	.450	.440	.470	.470				
F4		.590	.570	.440	.430	---	---				
	5	.600	.580	.460	.450	.460	.450				
			.465								
6	.600	.585	.465	.465	---	---					
			.445	.475							
7	.610	.600	.445	.480	.470	.470					
			.460	.465							
8	.600	.610	.460	.475	---	---					
			.465	.470							
9	.580	.590	.470	.465	.470	.470					
			.450	.470							
17	.570	.590	.460	.470	---	---					

FIGURE 2-1
GAUGING MEASUREMENT HISTORY FOR THE
M/V CHESTER POLING BEFORE & AFTER HULL FAILURE

Orig Tks.	Plate	1968		1972		1976		Salvaged Plate	
		Port	Stbd	Port	Stbd	Port	Stbd	Port	Stbd
.750	FK1	.500	.500	.685	.690	.600	.600		
	2	.500	.490	.620		.640	.640		
	3	.500	.500	.600-615-610		.630	.660	.586	
	4	.500	.480	.610-670-675		.650	.660		
	5	.460	.480	.650-660-595		.660	.680		
						.590	.580		
						.460	.450		
.50	A4	.475	.480	.380	.390				
				.430	.410				
	5	.470	.500	.445	.425	---	---		
				.445	.435				
	6	.500	.470	.450	.445	.450	.460	.413	.407
				.435	.430				
	7	.490	.495	.435	.435	---	---		
				.430	.440				
	8	.415	.475	.430	.435	.460	.460		
				.450	.435				
	C3	.435	.445	.380	.380	---	---		
	4	.460	.460	.390	.370	.420	.420		

FIGURE 2-1 (continued)
GAUGING MEASUREMENT HISTORY FOR THE
M/V CHESTER POLING BEFORE AND AFTER HULL FAILURE

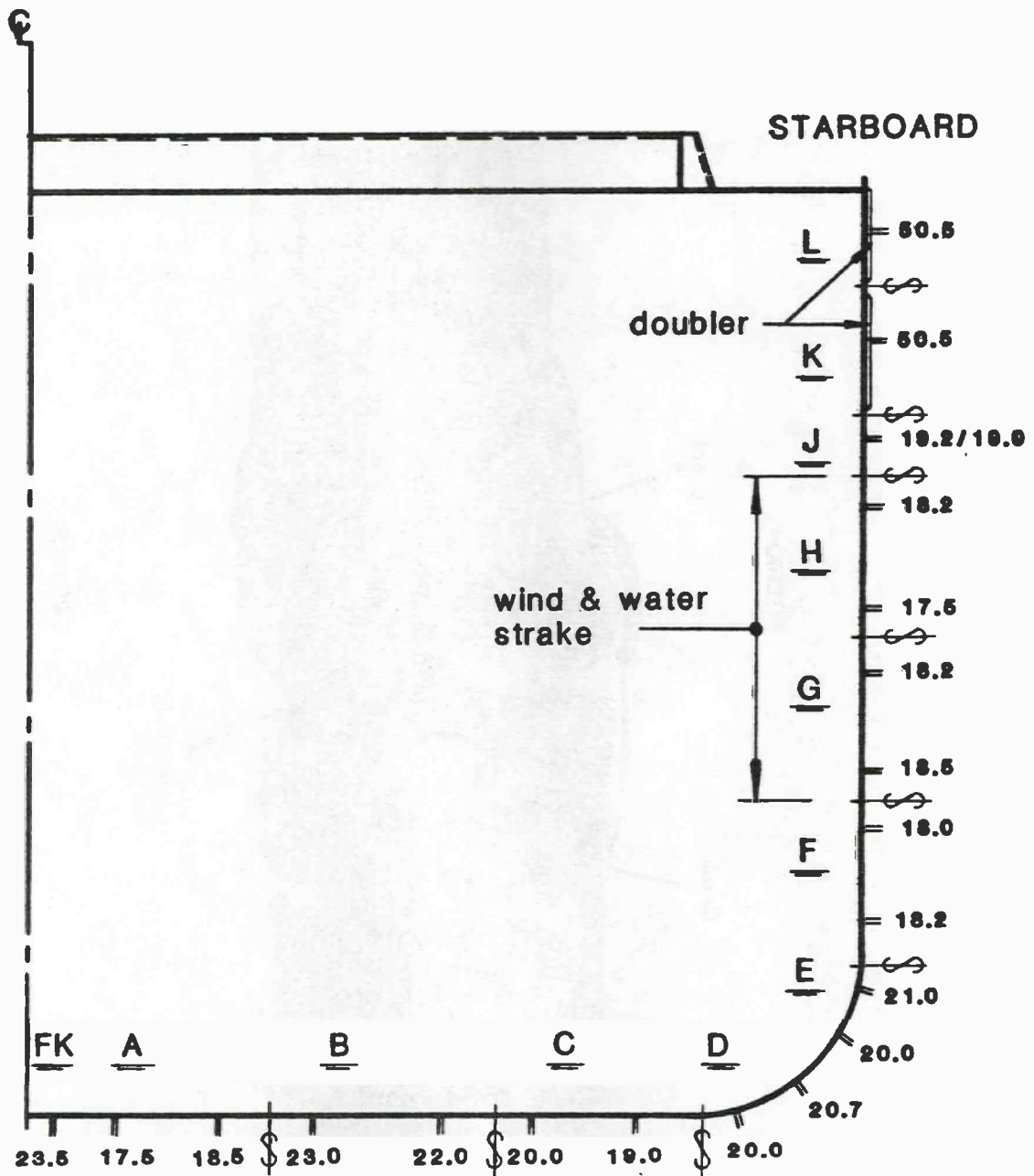

FIGURE 2-2
 ULTRASONIC MEASUREMENTS OF A TRANSVERSELY FRAMED
 CONTAINERSHIP WITH CORROSION FATIGUE CRACKS.
 (MEASUREMENTS ARE IN MM.)

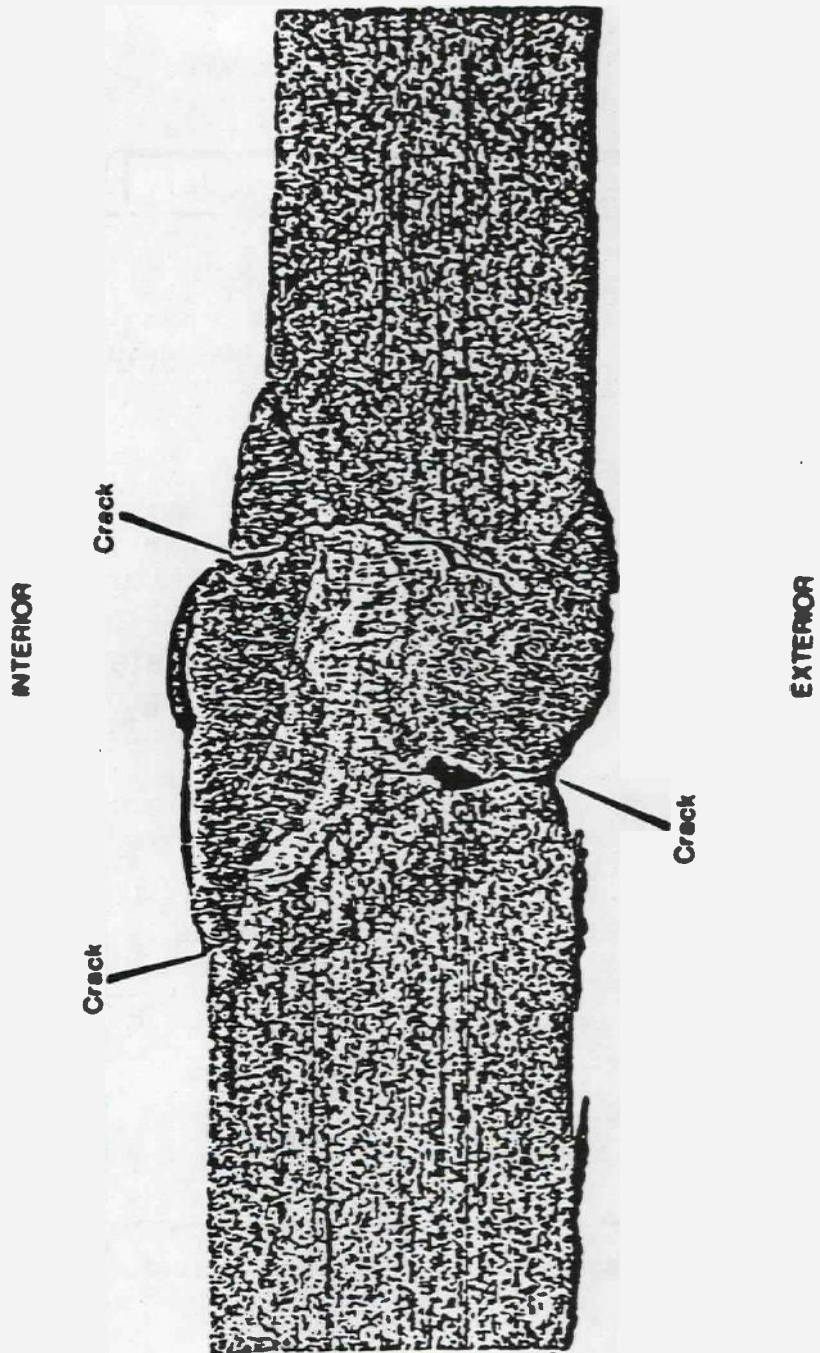

FIGURE 2-3

WELD DETAIL USED ON THE CONVERTED CONTAINERSHIP SHOWING CORROSION FATIGUE CRACKS

A Japanese organization (2-7) sponsored a research project to survey corrosion in ship structures. The surveys were conducted between 1976 and 1984. Corrosion was observed in areas of stress concentration. They observed that corrosion product (rust) is not as strong as paint coats and the product breaks down faster in high stressed areas. The corrosion pattern around a longitudinal cutout shown in Figure 2-4 illustrates this finding. The report also presented the results of a survey of corrosion aggravated by (physical) wear. This corrosion/wear phenomenon was ship type dependent as illustrated in Figure 2-5. The investigators found the corrosion wear was also dependent on ship age. In general cargo ships, corrosion wear occurs up to .5 mm (20 mils)/year. Similar corrosion/wear was observed in lumber carriers, bulk carriers, and ore carriers.

A containership operator (2-8) reported pitting corrosion in salt water ballast tanks. In worst cases the ballast tanks were coated, yet as the coating systems reached their respective life expectancies, the corrosion commenced. The ballast tanks were usually of the inner bottom type, therefore shell plating, longitudinal bulkheads, girders, floors, shell and tank top stiffeners, and tank top plating were all affected by the corrosion. These areas were all affected by pitting which in the operators opinion creates the most detrimental effect on containership structural integrity. Another area where accelerated corrosion occurred was in the bottom of the container holds. The hold plating was subjected to a somewhat hostile environment due to containerized tank leakage, difficulty in gaining access for maintenance, and the damp/wet environment generally found. The corrosion principally affects the tank top plating and the boundary longitudinal and transverse bulkheads. Corrosion wastage in these areas tends to be compounded because the plating involved is affected by corrosion from salt water ballast as described above.

Residual plate thickness

- 2.9mm or less
- 3.0~3.9
- 4.0~4.9
- 5.0~5.9
- 6.0 mm or more

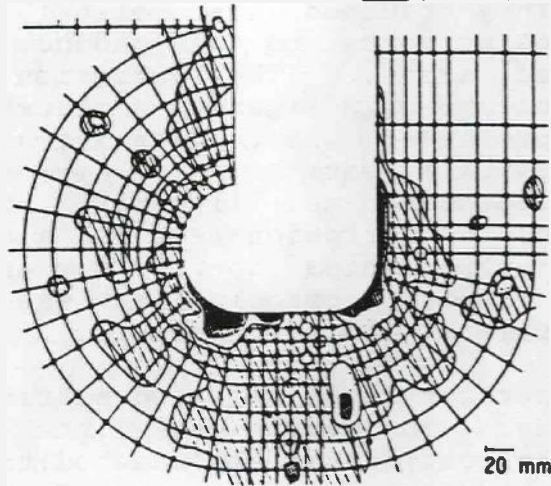

Result of Plate Thickness Gauging and Corrosion Distribution of Girder Web Slot
(3 years after construction original plate thickness 9 mm)

FIGURE 2-4

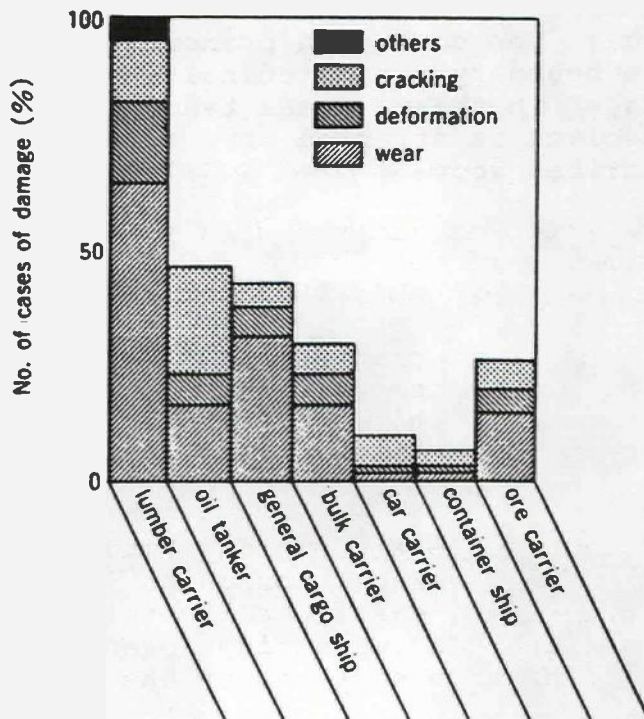

Number of Cases of Damage by Ship Type Broken-down into Types of Damage Between 1976-1984

FIGURE 2-5

3.0 CORROSION DATA REQUIREMENTS

Corrosion data collected by the methodology must be based on the requirements of the structural engineer or surveyor. These individuals must be able to determine the geometric characteristics of the remaining, unwasted structure. Knowing this information, they will be able to analyze the intact structure and determine the margin of strength remaining. The corrosion rate data will permit them to determine when the margin of strength will be depleted.

3.1 Corrosion Margin Assessment

Existing corrosion margin parameters were examined to determine the corrosion characteristics required by the structural engineer and the parameters needed to perform a structural analysis of the remaining plate. The parameters were identified considering the failure modes most important to structural integrity: yielding, buckling, fatigue and fracturing.

3.1.1 Review of Existing Corrosion Margins

Classification societies and the regulatory bodies include corrosion margins in design and inspection standards. Although the ABS rules for building and classing steel vessels do not mention explicitly the allowances adopted, they have on several occasions made known its views on wastage allowances (3-1). Other corrosion allowances were inferred by inspection of the rules as presented by Evans (3-2). Here the key point is that margins are directly additive to thickness requirements.

For example:

$$\text{Strength decks on longitudinal beams } t = .0069 S_b + .16$$

Where: t = the required minimum deck plate thickness
 S_b = spacing of deck beams
and .16 is presumably the corrosion allowance.

The extent of reduction in practice is treated as a percentage of the required plate thickness; the allowable reduction depends on several factors, such as ship type and age, frame spacing, and structural component. The range of allowable wastage ranges from 15 to 30 percent.

Similarly, the U.S. Coast Guard wastage limits are a function of plate thickness. The "average" corrosion limit of 20 percent is allowable. In practice, wastage allowances are evaluated from belt gauging, defined as measuring plate thicknesses around several complete transverse sections of the hull, including deck, sides and bottom.

Plate and structural member thicknesses are obviously key parameters in assessing corrosion margins. Other important factors include location, local extent and global extent.

3.1.2 Evaluating the Strength of Corroded Structure

Beyond existing corrosion margin assessments additional information is required to rigorously assess the strength of corroded structure.

As presented by Evans (3-2) individual panel failure by instability or plate stress (yielding) is approximately a function of the square of the thickness as illustrated in the following relationships:

$$\sigma_{cr} = \frac{\pi^2 E}{12(1-M^2)} \left(\frac{t}{b}\right)^2 K \quad \sigma = \frac{1}{2} K' p h \left(\frac{b}{t}\right)^2$$

Where: K and K' are functions of the panel aspect ratio, P is the unit weight of the loading medium and h is the pressure head. The panel dimension is given by b.

It is obvious that thickness (or predicted corrosion wastage subtracted from a known thickness) is the dominant parameter. However, to perform a thorough structural analysis of a panel plate or stiffener member the extent of wastage must be known. For example, if the corrosion wastage is generally uniform and covers the entire plate, an average thickness can be used to analyze the plate strength. However, if the wastage covers a percentage of the plate (say 50%) then the plate buckling analysis is more complex and simplified techniques have not been developed to date, for general wastage. This situation becomes more complex for analysis of the reduction in panel strength due to pitting, which occurs in a non-uniform manner.

The effects of pitting on panel strength have been investigated and techniques developed for estimating the strength of a pitted plate (3-3). Again thickness of structure in way of pits is important and the percent of remaining structure must be estimated. The authors of reference 3-3 proposed a method to determine an equivalent thickness of a panel by estimating an equivalent volume of wasted material and subtracting the volume of material wasted from the panel. Using this technique an average pit depth and frequency must be obtained. Thus, pitting data must include depth and frequency of pitting (representative of panel area covered by a given depth of pit). This is difficult in practice because pitting occurs at different rates within the same panel and an average pit depth must be derived from numerous pit measurements.

Structural yielding in corroded panels is a function of remaining plate thickness. Similar to general wastage, the extent of wastage must be determined to analyze the strength of the plate. Very localized general wastage or pitting does not reduce the overall yielding strength of a plate. But again, the extent of corrosion must be known to determine when the plate is corroded to a point where strength is sacrificed. To assess structural integrity, the key parameters are thickness (average) and extent of wastage.

Corrosion also affects the integrity of structure by forming locations where fatigue cracks initiate and subsequently accelerates fatigue crack growth. Corrosion wastage and pitting have the effect of reducing plate thickness and decreasing panel or member strength for a given load. This decrease in strength can be determined by fatigue life estimates for each stress range. Corrosion fatigue is a term that describes the behavior when a material is subjected to fluctuating forces in a non-benign environment. The factors that contribute to this failure mode are characteristic of corrosive environments as described in section 2.0. From a structural strength view point, corrosion fatigue is characterized by the widely used crack growth law given by:

$$\frac{da}{dN} = C(\Delta k)^m$$

Where: a is the characteristic dimension of the crack, its depth and width for example, and N is the number of cycles. Δk is the stress intensity range at the tip of the crack. C and M are related constants that depend on the material and the environment.

Bokalrad (3-4) presented an approach for assessing fatigue and corrosion margins using ultrasonic inspection of ship structures. Bokalrad shows the effects of a corrosive environment on crack growth of ship steel in terms of the probability of failure. The results indicate that corrosion is a critical element to consider in assessment of corrosion effects on fatigue and structural failure.

The global structural response must be evaluated to assess structural integrity. Globally, corrosion wastage reduces the ships section modulus. The number of panels and stiffeners and girders affected by corrosion must be determined and the overall hull girder section modulus reduction and net strength must be evaluated to assess corrosion margins.

According to the IACS Unified Requirement S.2 (3-5), the minimum section modulus must generally be maintained throughout .4L amidships. However, the section modulus may be reduced away from

the midships area provided that the stresses due to combined vertical still water and wave bending moments are not in excess of midships stress levels.

In ships where the longitudinal strength material in the deck or bottom area are forming boundaries of tanks for ballast or oil cargo, reductions in scantlings are permitted providing that an effective corrosion protection system is used, certain reductions in scantlings are allowed by classification societies. However the minimum hull girder section modulus reduction must not exceed 10% depending on coating.

Section modulus requirements indicate additional key areas to survey. Corroded structures most important in assessing corrosion margins are located in the deck and bottom areas at the greatest distance from the neutral axis of the ship hull girder.

3.2 CORROSION RATE PREDICTION AND SURVEY TECHNIQUES

To assess corrosion margins, the engineer or structural surveyor must be able to predict the rate of corrosion or hence the timeframe in which the margin will be depleted. Traditionally, corrosion rate predictions have been based on service monitoring, trial-and-error case studies or sample exposure tests. Each method has an impact on user requirements and recommended survey technique.

3.2.1 Analytical Methods

Early efforts to predict corrosion rates analytically involved solving the LaPlace equation (the governing equation for potential distributions in electrochemical cells). These efforts were successful but limited to cases of simple geometries and constant material properties. However, simple geometries seldom appear in real-world structures, and the electrochemical and mechanical properties are not constant with changing potential and current. Solutions can be applied to general geometries using numerical methods. These can accommodate varying inhomogeneous, nonlinear properties for electrolyte and constituent metals. Numerical methods have recently been employed in various levels of sophistication to solve the galvanic potential distribution problem. These methods include the finite element method, the finite difference method, and the boundary integral method.

3.2.1.1 Finite Element Method

The finite element method is a powerful tool for solving physical problems governed by a partial differential equation or an energy theorem using a numerical procedure. This method has been applied to a number of galvanic corrosion problems. One application was for the solution of the electric potential

distribution and current fluxes near a multimetallic system submerged in an electrolyte. The model could handle general and arbitrary geometries and the effects of nonlinear polarization behavior (3-4).

Another application of this method uses the principle of energy conservation to determine the strength and distribution of the energy field within a finite element model. It calculates the required current to maintain the minimum energy balance of each electrolyte element. The energy that enters the model at anode elements must leave at cathode elements. The advantages of this application are that shielding effects in nodes and other critical areas can be detected and, moreover, time-dependent polarization characteristics can be represented.

3.2.1.2 Finite Difference Method

The finite difference method is a numerical discretization procedure for the approximate analysis of complex boundary value problems. This method has been used for theoretical treatments of electrode systems, but lately is being used in offshore cathodic protection. Computerized finite difference analysis is useful in simulation and design of cathodic protection systems for offshore structures. It is also useful in analyzing electric field strengths, current density, and potential readings. This method has also been used to solve the Poisson equation for the electrochemical potential distribution in an electrolyte containing an array of fixed-potential electrodes and electrodes with activation, passivation, and diffusion-controlled polarization kinetics. The results were presented as a display of the potentials at selected coordinates or as a printed listing of the potentials at all nodal points in the electrolyte.

3.2.1.3 Boundary Integral Method

The boundary integral method is similar to the finite element and finite difference methods in that it solves the Laplace equation to obtain the potential distributions in electrochemical cells. However, this numerical method is more efficient than the others because it does not require modeling the electrolyte bodies to obtain the potential distribution on the surface of the structure. This saves computer time. One application of this method utilizes nonlinear and dynamic cathodic boundary conditions to simulate real polarization conditions during the formation of calcareous deposits. Applications include determining corrosion rates in offshore structures.

3.2.2 Empirical Rate Prediction Methods

Empirical techniques are also used to predict corrosion rates. They include correlating laboratory data to field measurements and field surveys.

3.2.2.1 Polarization Potential Rate Prediction Methods

Another method used to calculate metal corrosion rates is based on the use of the metal polarization curves depending on local polarization of the surface. This method is commonly referred to as the polarization resistance technique. The term polarization, as it applies to corrosion studies, is defined by ASTM as "the change from the open-circuit electrode potential as the result of the passage of current" (3-4). Simply stated, polarization is the changing of a metals natural potential (voltage), as defined on the Galvanic Scale, in either a positive or negative direction due to the fluctuation of corrosion current resulting from the introduction of electrolytes, metals, or protective systems to the base metal. Potentials referenced on a Galvanic Scale as shown in Figure 3-1 are based on a metal-water interaction. During a corrosion process, any deviation of a metals potential from that referenced in the galvanic series is known as polarization. Every corrosion process, (i.e. metal-electrolyte connection), has an associated corrosion potential (e) and current (i) which are measurable quantities. The polarization resistance technique involves the use of the developed i/e curve for a given corrosion process. An example i/e curve, or Tafel curve as often termed, is shown in Figure 3-2. The assumption is that once the shape of the Tafel curve is known in a potential range such as ± 50 mV around the corrosion potential of the system under study, the corrosion rate is equal to the inverse slope of the curve. The following relationship is generally observed:

$$i = i_c [10^{-P/B_c} - 10^{P/B_a}] \quad (1)$$

Where: i is the applied current density;
 i_c is the corrosion rate expressed as current density;
 B_c and B_a are the Cathodic and Anodic Tafel (or beta) constants;
and P is the overpotential equal to $(E_c - E)$, where E_c is the corrosion or open circuit potential and E is the polarized potential.

At low values of P , Equation (1) may be approximated by:

$$R = \frac{\Delta P}{\Delta i} = \frac{(B_a)(B_c)}{2.303 i_c (B_a + B_c)} \quad (2)$$

Where: R is the slope obtained from a linear plot of E vs i . R has the units of resistance and is inversely proportional to the corrosion rate, i_c . However, there are some problems associated with this method. One lies in the way R is measured: one wants the slope over a very narrow potential interval (to ensure reasonable linearity) but must compromise in order to get usable signals. The most serious disadvantage of this technique

PRACTICAL GALVANIC SERIES	
Metal	Volts*
Commercially pure magnesium	-1.75
Magnesium alloy (6% Al, 3% Zn, 0-15% Mn)	-1.6
Aluminum-Zinc-Indium (a)	-1.16
Aluminum-Zinc-Mercury (a)	-1.1
Zinc	-1.1
Commercially pure aluminum	-0.8
Mild steel (clean and shiny)	-0.5 to -0.8
Mild steel (rusty)	-0.2 to -0.5
Cast iron (not graphitized)	-0.5
Lead	-0.5
Mild steel in concrete	-0.2
Copper, brass, bronze	-0.2
High silicon cast iron	-0.2
Mill scale on steel	-0.2
Carbon, graphite, coke	+0.3

*Typical potential normally observed in neutral soils and water, measured with respect to copper sulfate reference electrode.

(a) added to original reference

FIGURE 3-1

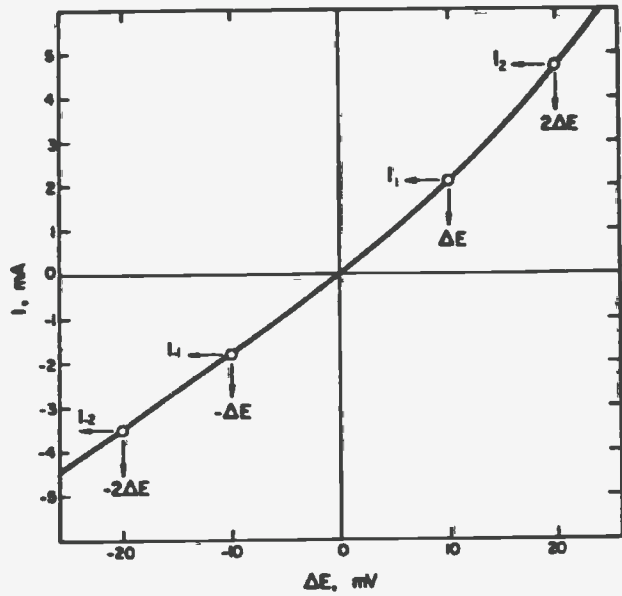

FIGURE 3-2
EXAMPLE POLARIZATION (TAFEL) CURVE

is the Tafel constants that describe the shape of the medium-range i/e curve are assumed constant, they are not. Corrosion takes place in a variety of uncontrolled solutions and is thereby notoriously unreproducible.

At large negative values of P , the second exponential in equation (1) approaches zero. Thus, a plot of E vs the logarithm of i yields a straight line under these conditions. The slope of this line is B_c and its extrapolated value at $E = 0$ is equal to i_c . B_a can similarly be obtained for large positive values of E . This is known as the Tafel Extrapolation Method.

Both of the above methods have been successfully used to determine corrosion rates in a variety of industrial systems, but not without limitations. It is often difficult to obtain a sufficiently long region of linearity to permit accurate Tafel extrapolation. Deviations from linearity are caused by resistance effects and concentration polarization, especially at high values of overvoltage. Unfortunately, Tafel extrapolation is only valid at high overvoltages (+ 50 mV). Polarization resistance is usually not affected by resistance or concentration polarization effects since it is performed at low overvoltages. However, equation (2) is an approximation which is valid at overvoltages of 10 mV or less. Experimental errors become significant in this range since the sensitivity of electrode potential measurements is ± 0.5 mV at best. Also, accurate calculations of the corrosion current density by equation (2) requires prior knowledge of the Tafel constants. These values are sometimes difficult to obtain for the reasons mentioned previously. Tafel extrapolation and polarization resistance have additional limitations. Both methods are only valid for a limited range. Tafel extrapolation cannot utilize data obtained at overvoltages less than about 50 mV, while polarization resistance is limited to the first 10 mV or less. Historically, both methods have used graphical calculations which are both cumbersome and often inaccurate. The majority of corrosion calculations carried out to date have been done in terms of direct problems of mathematical physics. Formulation of such problems have enabled, using a given distribution of the electrochemical activity over the metal surface, the calculation of the electric state of the medium near the corroding surface and estimation of the corrosion rates at different points on the surface.

3.2.2.2 Statistical Rate Prediction Methods

Statistical methods provide an alternative to analytical and empirical methods for predicting corrosion rates. The use of analytical methods are very limited, such as for controllable, laboratory-reproducible corrosion processes. Statistical methods have widespread use in virtually every industrial, commercial and even laboratory process that is characterized by complex, ever-

changing corrosion reactions. Statistical methods are concerned only with the end result of corrosion loss whereas the analytical techniques are concerned with the understanding and modeling of the corrosion reactions that produce an end result.

The American Society of Testing Materials (ASTM) has issued guidelines for applying statistics to the analysis of corrosion data (3-6). The guideline addresses the subjects of errors, sample sizes, confidence limits, mean and variance comparisons, and standard deviations as they pertain to a set of corrosion wastage data. Details associated with the application and adaptation of this guideline will be discussed in section 4-4. The general application of this guideline is aimed at the development of true means and standard deviations in addition to the recognition of errors associated with a quantity of measurable corrosion data. The corrosion rate is equal to the averaged metal loss/time between measurements for a given location or specimen. This method will produce a statistical database, for a structure that experiences many different corrosion reactions over a period of time, that includes the average corrosion rate and associated errors.

The statistical rate prediction method has been applied to ship structures by a ship operator and the method refined by the Tanker Structure Cooperative Forum (3-4).

3.3 SUMMARY OF DATA REQUIREMENTS AND RECOMMENDED CORROSION RATE SURVEY TECHNIQUE

The preceding sections discuss the parameters that must be obtained to characterize corrosion wastage to assess corrosion margins. The parameters are summarized in Table 3-1 for various failure modes. These characteristics must be determined for each panel surveyed and in specific belt and survey patterns to determine the extent of hull girder wastage.

Additional work is required in this area. Specifically, development of simple methods for assessing strength of wasted or pitted plates other than conducting detailed finite element analysis.

A mathematical model may be developed which accurately describes the contribution of each variable to the overall corrosion of a closed system such as a pipeline. However, in the case of internal ship structures, which encounter many environments, it is virtually impossible to analytically model the corrosion process because of the irregular contribution of a large number of variables. The interaction of variables constantly changes the corrosive environment making it very difficult to separate the true contribution of each variable.

TABLE 3-1

CORRELATION OF CORROSION DATA REQUIREMENTS AND
FAILURE MODES RELEVANT TO STRUCTURAL INTEGRITY

TYPE OF CORROSION	FAILURE MODE			
	YIELDING	BUCKLING	FATIGUE	FRACTURE
GENERAL WASTAGE	T, A	T, A	T	T
PITTING	N, D1, D2	N, D1, D2	D1, D2	D1, D2
GROOVING	W, D1, L	W, D1, L	W, D1, L	W, D1, L

KEY:

T = THICKNESS
L = LENGTH
D1 = DEPTH
A = AREA
D2 = DIAMETER
N = NUMBER/UNIT AREA
W = WIDTH

The statistical approach remains the only alternative for the quantitative treatment of corrosion allowances in ship structure. The usual procedure of introducing an additional safety factor (for example, in the determination of allowable stress) is inadequate. The statistical approach will indicate the possible deviation from an expected value, i.e., it indicates the dispersion about the mean of the "distribution function".

4.0 DATA COLLECTION REQUIREMENTS

In addition to users requirements presented in previous sections, there are data collection requirements that must be met to ensure that the required data is obtained. This section presents the data collection requirements including types of corrosion, locations, supporting parameters, accuracy, and instrumentation required for the survey.

4.1 Types of Corrosion to Survey

Traditionally there have been eight classifications of corrosion:

- | | |
|----------------------|------------------------------|
| 1. General (Uniform) | 5. Intergranular |
| 2. Galvanic | 6. Selective Leaching |
| 3. Crevice | 7. Velocity Corrosion |
| 4. Pitting/Grooving | 8. Stress Corrosion Cracking |

A certain degree of overlap exists among them. As discussed in Section 2.0, two types of corrosion have been found to commonly exist within ships: General and Pitting/Grooving.

General corrosion is the most common of the types of corrosion in ship structures. The corrosion product appears as a non-protective rust which can uniformly occur on uncoated, internal surfaces of a ship. The rust scale continually breaks-off, exposing fresh metal to corrosive attack. The rust scale also appears to have a constant depth and similar consistency over the surface. The mechanism of general corrosion is illustrated in Figure 4-1.

There are micro cathodic and anodic areas caused by variations in grain structure, impurities in the metal, alloying elements, and other inhomogeneities. For general corrosion, the cathodic and anodic areas constantly switch back and forth due to a difference in potential or degree of polarization, thus accounting for the uniform corrosion of the surface.

Pitting corrosion is often described as a cavity whose diameter is the same or less than its depth. Pitting is a localized form of corrosion and usually grows in the direction of gravity. It is also self-generating, i.e. autocatalytic, starting from impurities in the metal, scale or other deposits, or some inhomogeneity in the metal. Figure 4-2 shows a progressive pit being formed.

A specialized form of pitting corrosion known as grooving corrosion also occurs frequently within ships. This corrosion, sometimes referred to as "in-line pitting attack", is a linear corrosion occurring at structural intersections where water collects or flows. Grooving can also occur on vertical members and flush sides of bulkheads in way of flexing.

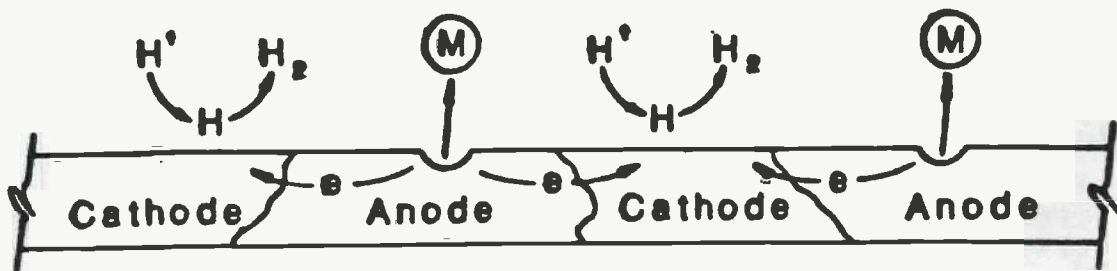

Figure 4-1
SIMPLIFIED SCHEMATIC OF UNIFORM CORROSION

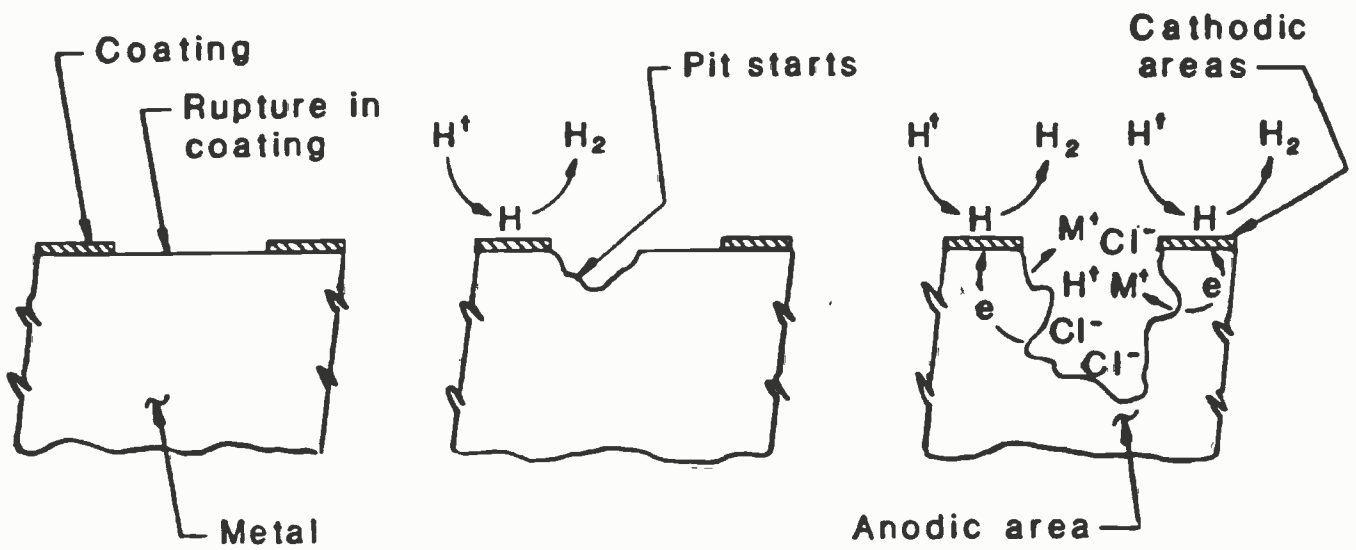

Figure 4-2
 SCHEMATIC OF FORMATION OF A PIT

4.2 Corrosion Locations

Generally stated, corrosion of structural steel will occur wherever salt water is present. However, corrosion also occurs in areas that are not directly exposed to salt water. This is evidenced by the fact that many factors contribute to the corrosion process in ships and often combine to create corrosive environments within ships.

The majority of internal structure within a ship usually experiences corrosion to a certain extent. However, it is the horizontal structural members as mentioned herein that encounter the greatest corrosive attack simply due to the ability to collect and trap water and to facilitate pit growth. The corrosion patterns discussed have generally been descriptive of the results found for tanker surveys. However, it is important to note that all cargo ships experience corrosion, the extent and severity depending on such factors as cargo, temperature, humidity, and protection system. Ballast tanks in all ships will have similar corrosive patterns but dry cargo compartments will not suffer the same amount of corrosion wastage as liquid cargo compartments. The common finding from the review of data has been that ballast tanks experience the highest corrosion rate. This is due to the fact that greater exposure of metal to salt water increases the corrosion rate. The following are locations where corrosion is found and are important to structural integrity.

4.2.1 Bottom Plating

The bottom plating within a ship typically experiences the greatest amount of corrosion wastage. As a result of water collecting and settling on the bottom, pitting, grooving, and general wastage occur frequently. For coated plating, wastage will take the form of localized pitting and grooving in way of coating failure. For inorganic zinc coating, the wastage will tend to be patches of scaly areas with only minimal thickness loss. For coal tar epoxy coated plating, wastage will tend to be deep pits of limited area which present a definite risk of bottom penetration if not repaired.

For uncoated tanks, bottom wastage is more general, affecting the higher velocity flow paths of the drainage patterns to a greater extent than stagnant areas. Thus, wastage is highest in way of cutouts in transverse web frames and bottom longitudinals, and lowest just forward and aft of web frames outside the line of the cutouts. Figure 4-3 illustrates an example of this loss pattern. Bottom wastage generally increases from forward to aft, most likely due to water wedges caused by the normal trim patterns by the stern, both in full load and ballast. However, this can be reversed on some ships where the tendency is to trim slightly by the bow in the full load condition. The water wedges are a

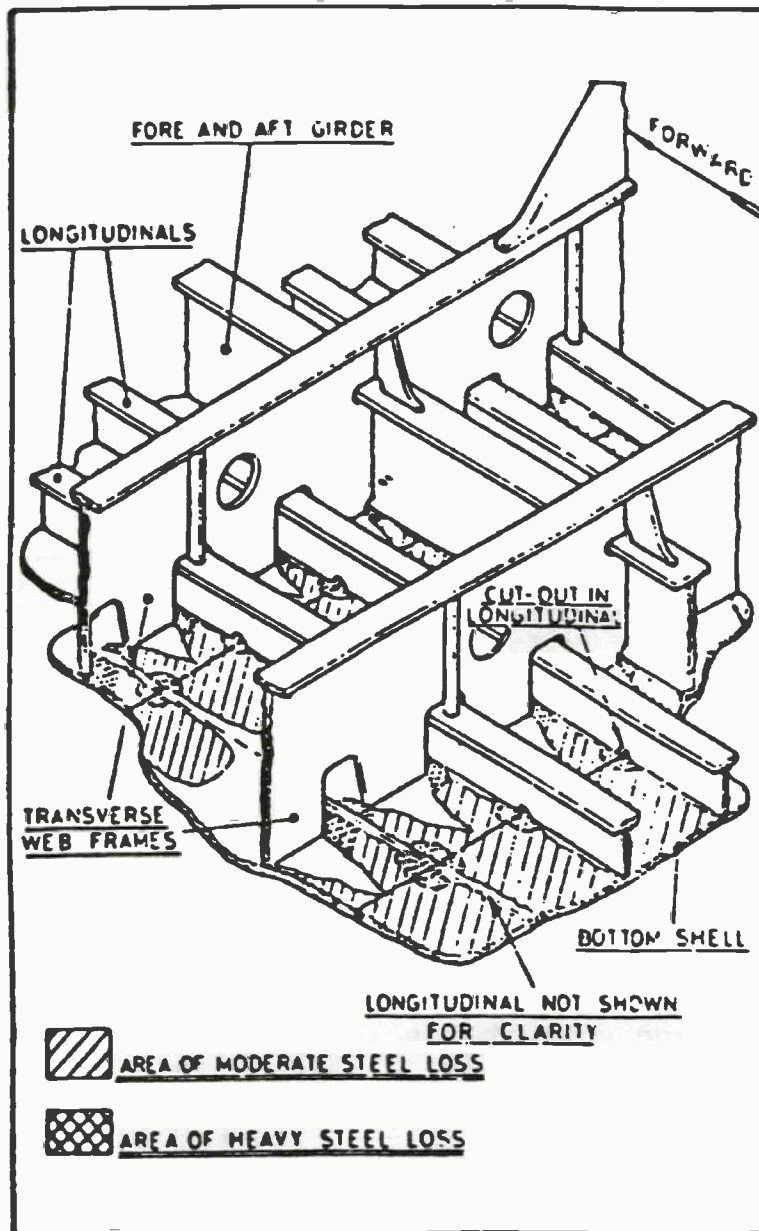

FIGURE 4-3
TYPICAL BOTTOM SHELL LOSS PATTERNS

combination of unstrippable ballast water and water settling out from cargo within certain compartments. Thus, aft bays of liquid cargo and ballast tanks can experience corrosion almost continuously. Also occurring on bottom plating and often on other typical areas of bottom structure are grooving of the welds of bilge longitudinals and thinning and cracking at the toes of longitudinal girder brackets. These are shown in Figure 4-4.

The bottom structure is an important area to survey because it is where corrosion is most prevalent and a location that is critical to structural integrity.

4.2.2 Side Shell and Bulkhead Stiffeners

Wastage patterns on the side shell and the stiffened sides of bulkheads are usually limited to the horizontal webs of the stiffening. In coated tanks, wastage occurs in way of coating failures which generally start at welds, cutouts and sharp edges. In uncoated tanks, wastage is more general and usually increases toward the bottom of the tank. Deep pitting is often found on lower stiffening, usually near web frames. On ship's with fabricated longitudinals where the face flat extends above the web, wastage can be rather severe due to the trapping of water on the web.

4.2.3 Deckheads

For coated deckhead structure, general wastage usually occurs at connections of deck longitudinals to deck plating in way of coating failure. Uncoated compartments suffer more uniform corrosion both when empty or full of either liquid cargo or ballast. When the compartment is empty, the area is subject to a highly corrosive, moist, salt-laden atmosphere. Oxygen is readily available high in the compartment from hatches, vents and deck openings and contributes greatly to the uniform corrosion process. When a compartment is full of ballast or liquid cargo, general wastage results from the same causes in this ullage space area because the deckhead is not protected by an oil film. Deckheads are important structural locations to survey because they are strength decks that contribute to structural integrity.

4.2.4 Special Locations

There are other special locations that should be surveyed where local corrosion is prevalent. Wastage can occur in high stress areas where coatings break down and corrosion attack begins. These locations include longitudinal cut-outs in frames. The plating under bellmouths is vulnerable to general wastage in both coated and uncoated tanks due to the added effects of high velocity during ballast discharge. Other special locations should be surveyed where structural integrity is reduced or areas where watertight integrity is reduced.

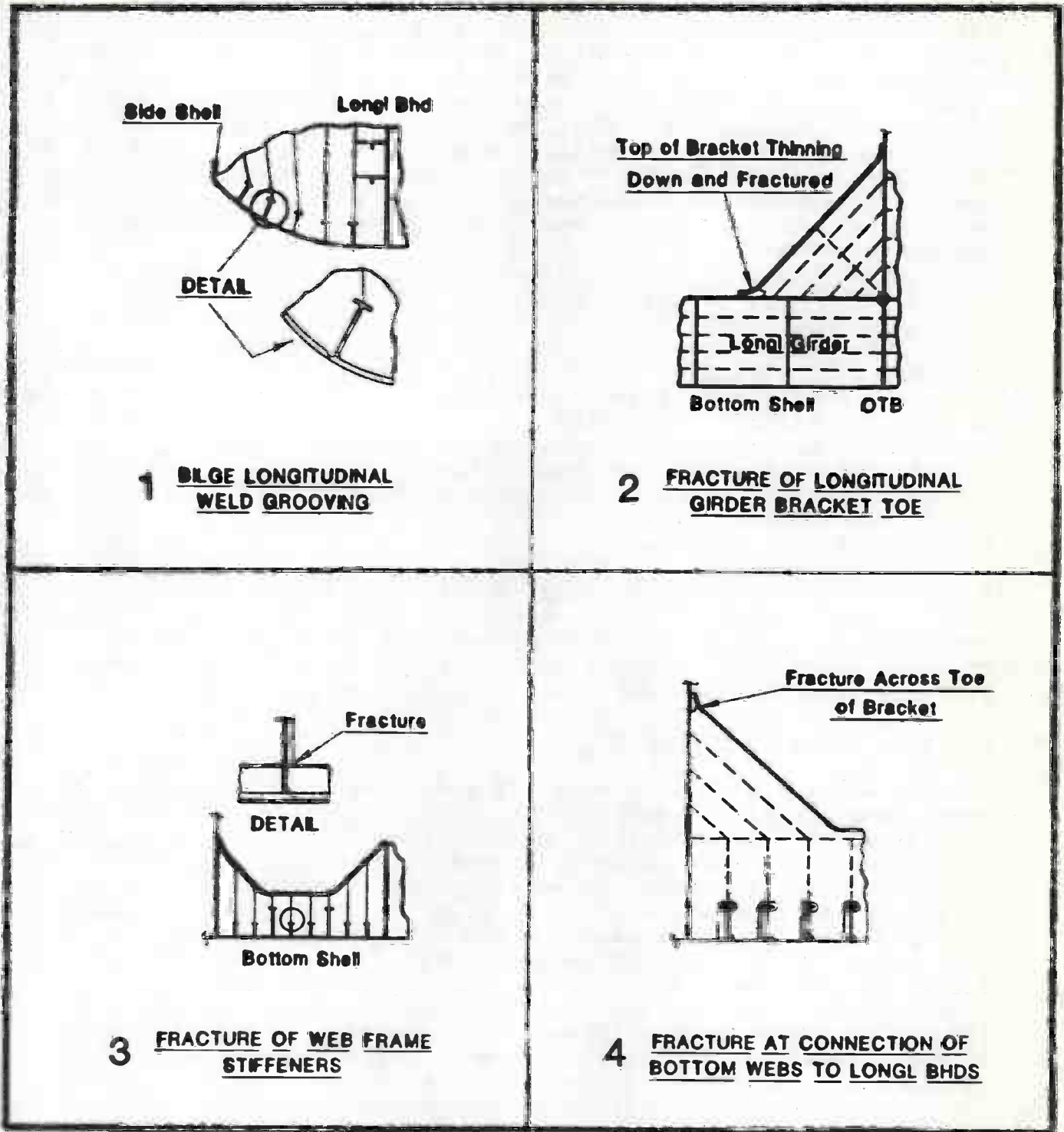

FIGURE 4-4
TYPICAL BOTTOM STRUCTURE DEFECTS

4.3 Correlation Parameters

Similar compartments within the same ship and certainly among different ships often experience different and varying rates of corrosion. This can be attributed to different operating, climatic and protective conditions that exist within a compartment throughout the duration of a voyage. These conditions are called correlation parameters. Knowledge of these conditions are important and direct decisions to analyze combinations of compartment data. Nine correlation parameters have been identified as exerting the greatest influence on corrosion rates:

1. time in ballast;
2. cargo content;
3. coating system;
4. anode system;
5. vessel navigational routes;
6. compartment humidity;
7. tank washing medium (tankers only);
8. tank washing frequency (tankers only);
9. tank inerting medium (tankers only).

4.3.1 Time in Ballast

Typically, the longer the duration of salt water exposure, the greater the corrosion rate of steel. If a compartment is not protected by coatings or anodes, the time in ballast represents the most corrosive condition. As a result, ballast tanks typically experience the highest corrosion rates.

4.3.2 Cargo Content

There are generally three types of cargo carried aboard vessels; bulk, containerized and liquid. Depending on whether the cargo compartments also function as ballast tanks, the highest corrosion rates are usually associated with liquid cargo. A limited amount of water or moisture may accumulate in bulk or container holds which would lead to localized corrosion. Corrosion within liquid cargo tanks is generally widespread and is related to the type of cargo carried. Sour crude oil is more corrosive than sweet crude oil. Acidic cargos and high-oxygen cargos, such as gasoline, typically lead to high corrosion rates. Liquid cargos can also temporarily render anodic protective systems inert through the presence of residual films. Where liquid cargo is involved, careful attention must be paid to composition and properties so as to avoid possible erroneous group analysis of data.

4.3.3 Coating System

Well-maintained coating systems offer the best protection against corrosion. However, coating breakdown due to depletion, deterioration or damage can result in high corrosion rates and pitting in way of the breakdown. It is important to know the extent and type of coating protection provided so as to develop an understanding of the protection system.

From a corrosion margin assessment standpoint coating effectiveness is an important parameter. Effective coatings can prolong corrosion initiation and hence minimize the margin required. The white coating condition assessment is not specifically addressed by the survey methodology, it is a by-product of the surveys. The absence of corrosion should be documented for each panel inspected and the coating breakdown rate determined. The time frame between re-coating must also be determined. A re-coated area becomes a new set of corrosion data.

4.3.4 Anode System

Next to coatings, anodes provide the best protection against corrosion in seawater. However, anodes only function when immersed in an electrolytic solution. Therefore, only compartments containing electrolytes such as seawater ballast tanks benefit from anode protection. The location and density of anodes play a major role in the deterrence of corrosion. Certain locations, such as underdeck structure, do not benefit from anode protection. High current densities generally afford greater protection against corrosion but can damage coatings.

4.3.5 Ship Navigational Routes

Navigational routes can have an effect on corrosion rates due primarily to two factors; temperature and voyage length. Preferential solar heating of one side of a ship due to the navigational route can lead to increased corrosion of affected wing tanks. In addition, voyages of short duration can lead to increased corrosion of anode-protected compartments due to insufficient anode activation period.

4.3.6 Compartment Humidity

High humidity within a compartment may lead to the accumulation of moisture which in turn can lead to increased atmospheric general corrosion. The level of humidity can be closely tied to the navigational route.

4.3.7 Tank Washing Medium

Compartments containing petroleum cargos can exhibit increased corrosion rates based on the washing medium used. Typical mediums used are: hot seawater, ambient seawater, and crude oil. Seawater washings introduce corrosive seawater which can lead to increased corrosion rates. Hot seawater is more damaging than ambient seawater. All washing mediums can deteriorate coatings and remove protective oily films residing from crude oil carriage.

4.3.8 Tank Washing Frequency

Increased frequency has been found to increase the corrosion rate of liquid-cargo compartments (see 4.3.7).

4.3.9 Tank Inerting Medium

Gas inerting of liquid-cargo tanks can help to increase or reduce corrosion rates. Sulfuric oxides resulting from flue gas inerting can lead to accelerated corrosion due to the formation of sulfuric acid. Gas inerting also may reduce corrosion rates of ullage areas due to a reduction in oxygen content. However, air (oxygen) leakage into a tank via deck openings can lead to increased corrosion of surfaces adjacent to the leakage site.

4.4 Sample Size and Accuracy

The number of data points required for measurement must be determined during the planning stage. The size of the data set for a given location is very important, as it is directly proportional to the resulting accuracy associated with that data set. The procedure used to determine the required data size is specified in ASTM guidelines(4-1). According to ASTM, the sample size is dependent on two parameters: Standard deviation and level of accuracy. The following relationship is used:

$$N = (Z \sigma)^2 / \Delta^2$$

Where: N = Number of samples,
Z = Level of confidence statistic (= 2, for 95% of the normal distribution),
 σ = Standard deviation, which represents the error associated with individual measurements,
 Δ = Level of accuracy associated with the mean value of a set of N data points.

In order to determine N, we must know Δ , Z , and σ . For normal distributive systems, the quantity ($Z\sigma$) represents deviation from the expected value, or mean, and corresponds to the area under the normal bell curve. Statistical theory reveals that $\pm 2\sigma$ is equal to 95% of the area under the normal curve as shown in Figure 4-5, as applied to corrosion data analysis. The quantity 2σ is equal to the maximum expected error associated with each individual data measurement. Therefore, 2σ is equal to the associated instrument/operator error. The instrument/operator error is composed of all possible errors contributing to a single measurement. These include, expected instrument error and operator systematic error. The instrument error is usually specified by the manufacturer. The operator systematic error is technique related and is influenced by gauging environment, experience and surface condition. The error value will be different for different instrument/operator combinations and must be determined prior to survey. The TSCF conducted a series of tests aimed at determining instrument/operator error and found that accuracy varied from $\pm 0.5\text{mm}$ (20 mils) to $\pm 3.0\text{mm}$ (120 mils) (4-2). The best possible accuracy attainable for a given measurement was $\pm 0.5\text{mm}$ (20 mils). Continuous increases in instrument technology and operator training ultimately will provide for better accuracy levels however, for illustrative purposes a value of 20 mils will be used herein. In addition to individual measurement error, there is also an error associated with the mean or average value of a data set. This value, Δ , will be less than 2σ and is dependent on the sample size, N. Therefore, sample size is determined based on a desired level of accuracy associated with the average corrosion rate of a data set. A large sample size will afford a small error value, while a small sample size will have a larger error value approaching, but never exceeding, the instrument/operator error. Understanding of the relationship that exists between these variables is best provided through an example.

Example

Given: $2\sigma = 0.5\text{mm}$

$$N = (2\sigma)^2 / \Delta^2$$

<u>N</u>	<u>2σ</u>	<u>Δ</u>
1	20 mils	20 mils
10	20 mils	6.4 mils
25	20 mils	4 mils
50	20 mils	2.8 mils
100	20 mils	2 mils

Notice the relationship that exists between Δ and N. As the number of samples increases, the accuracy of the average value also increases.

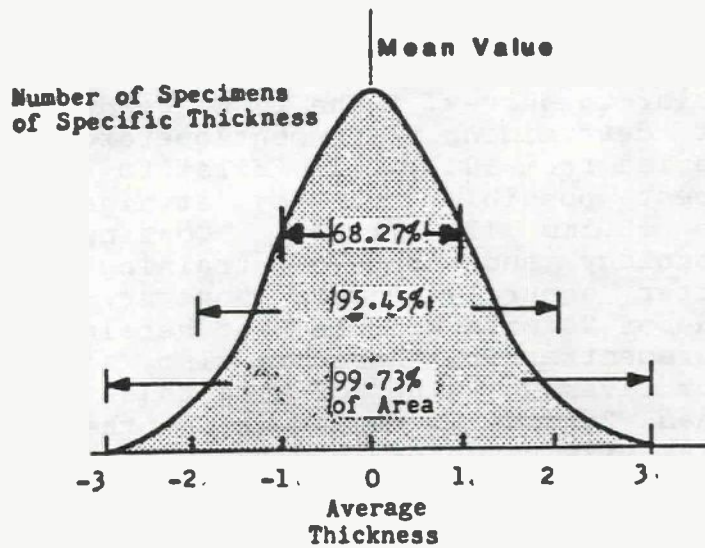

FIGURE 4-5
NORMAL DISTRIBUTION CURVE

An example that illustrates this application to the corrosion survey methodology is as follows:

Example

- Expected corrosion loss for a given location for one year = 15 mils
- Assume 3 year gap between surveys

$$\Delta t = 3 \times 15 = 45 \text{ mils}$$

$$\Delta t = \bar{t}_0 - \bar{t}_3 \quad \begin{array}{l} t_0 = \text{thickness at year zero} \\ t_3 = \text{thickness at year 3} \end{array}$$

- Assume $2\sigma = \pm 2$ mils

For $\Delta t = 45$ mils, assume desired level of accuracy of 95% ($2\sigma = 2$ mils). But, $\Delta = \Delta_0 + \Delta_3$

where

Δ_0 = error associated with year zero average,

Δ_3 = error associated with year 3 average

Assuming desired accuracy levels are constant, $\Delta_0 = \Delta_3 = 1$ mil.

$$\begin{aligned} \text{Therefore: } N &= (2\sigma)^2 / \Delta^2 \\ N_3 &= (2\sigma)^2 / \Delta_3^2 = (2)^2 / (1)^2 = 4 \\ N_3 &= 4 \end{aligned}$$

This shows that a sample size of four in year three is required to ensure a level of accuracy of ± 1 mil for the year three average thickness value, with the individual measurement error equaling ± 2 mils. The error associated with the difference in thicknesses (corrosion rate) is $2 \times \Delta_3 = 2$ mils. Note that since the operator/instrument error (2σ) is small, a small sample size is needed for 95% accuracy. This example demonstrates several important points:

1. Corrosion rate is the difference of two calculated means;
2. Associated error of the corrosion rate is the sum of the associated errors of the individual means ($\bar{t}_a - \bar{t}_b$);
3. The value of the actual average thickness (t) is not important, rather it is the value of the difference between average thicknesses that governs the selection of Δ , thus Δ_a and Δ_b ;
4. Errors are additive when comparing differences;
5. Error a of year i mean is equal to one-half the desired error of a corrosion rate (i - datum);
6. Error of a mean (Δ) cannot exceed the error of a measurement (2σ).

One final example is included taking a slightly different approach to determining sample size and error.

Example: First implementation of survey, given prior data.

Statement: If the average thickness of side shell plating measured four years ago is 200 mils, how many samples should I measure and what is the best practical accuracy I can achieve for the corrosion rate?

Given:	<u>Datum Year</u>	<u>Year Four</u>
	$t_0 = 200$ mils	$t_4 = ?$
	$\Delta_0 = \pm 10$ mils	$2\sigma = 4$ mils (assume known)
	$2\sigma =$ unknown	$\Delta_4 = ?$
	$N_0 =$ unknown	$N_4 = ?$

Solution: Assume $\bar{x}_0 - \bar{x}_4 = 30-40$ mils (must determine approximate magnitude of corrosion loss based on historical data or trial measurements) Say $\bar{x}_0 - \bar{x}_4 = 40$ mils
 $= \Delta_0 + \Delta_4 = 10 + \Delta_4$

$$\text{Best Accuracy} = \Delta / (\bar{x}_0 - \bar{x}_4) - 1 = \frac{(10 + \Delta_4)}{40} - 1$$

<u>N₄</u>	<u>2σ</u>	<u>Δ₄</u>	<u>Δ</u>	<u>Best Accuracy</u>
1	4	4	14	65.0%
10	4	1.26	11.26	71.8%
25	4	.80	10.8	73.0%
50	4	.56	10.56	73.6%
100	4	.40	10.4	74.0%
200	4	.28	10.28	74.3%

Results of best accuracy vs. practical sample size are determined for several values of N₄. For this case, the accuracy is directly related to the associated accuracy at the datum year. Recent advances in instrumentation allow for errors as low as 1-2 mils which correspond to mean accuracies (Δ) less than 1-2 mils. Therefore, it is highly recommended that this survey be initially implemented to establish a datum year with a minimum accuracy of 95% and all parameters recorded. Thereafter, practical sample sizes can be determined that correspond to 5% error values. Depending on instrument/operator error, mean accuracies may be greater than 95% for relatively small sample sizes.

When reviewing corrosion data, careful consideration must be given to the analysis due to the large and varying number of influential factors contributing to corrosion. Corrosion data in its raw form, is a massive compilation of ultrasonic thickness readings generally expressed in mm or mils. Usual practice consists of averaging a group of readings for a given location

and then converting the corrosion loss into a rate based on the time between surveys.

4.5 Instrumentation Requirements

Corrosion surveys in ships are conducted in holds, compartments or tanks that are accessed through hatches or manholes. The survey team must climb structure to measure thickness and visually inspect the structure. This type of survey requires instrumentation that is portable, easy to read accurate in field applications and operable by qualified users. This means light weight instruments typically carried by one person. The instruments must have internal power supplies or operate from ships power with light cabling. The instruments must have displays that are easy to obtain data without extensive fine adjustments. The display should be bright enough so the operator can read the display in dimly lit spaces. The instrumentation must be rugged and not affected by occasional impacts. The instrument must operate in humid, damp, environments where temperature varies between 30 to 100 degrees F.

Skilled operators are required to ensure accurate results. The level of experience and the degree of training of the survey team has a significant influence on the accuracy of the survey data. The survey technicians should be qualified in the operation of the ultrasonic measuring equipment. Initial training can be on-the-job learning from a more experienced operator or a formal training program offered by a non-destructive testing society. A formal program is recommended because the operator learns the concept as well as the skills and is certified to a specific level of skill and experience. An operator can be certified as a level I, II, or III technician as quoted in The American Society Of Non-Destructive Testing (ASNT) standard, with level I being the initial certification. The gauging team should have at least one of the operators qualified to level II to ensure that the equipment will be operated by an experienced technician. In addition, the survey team should be familiar with the shipboard gauging environment. An operator experienced only in land-based environments may find it difficult to adjust to shipboard surveys.

5.0 CORROSION SURVEY METHODOLOGY

This section details the methodology developed to survey corrosion loss and ultimately to predict corrosion rates of ship structures. The method is intended for use on any ship where corrosion exists. Efforts are aimed at establishing a highly standardized procedure covering the acquisition, recording, and analysis of data that will ensure acceptable accuracy. Accordingly, this section is broken down into four main subsections: Data Acquisition, Data Recording, Data Analysis, and Program Implementation.

5.1 Data Acquisition

Data Acquisition consists of defining, measuring and recording data parameters that will accurately describe the corrosion pattern within a given ship. The intent of the survey is collecting information on corrosion rates in specific ship structural components and general information on corrosion rates of the entire ship. The extent of the survey is determined by the needs of the user and may vary from ship to ship. The need for accuracy and practical results is of paramount importance and thus requires a thoroughly standardized procedure encompassing the entire data acquisition process. Aspects of this process include:

- Planning and Coordination
- Safety and Access
- Instrumentation
- Gauging patterns.

Prior to surveying a ship and before actual data can be obtained, a thorough planning strategy must be developed and followed to ensure consistency, completeness and accuracy.

5.1.1 Planning

Prior to beginning a survey it is necessary to ensure that the scope of work is fully defined. This involves careful identification of all structural components to be surveyed throughout the ship so as to expedite the survey and obtain a representative assessment of a ship's corrosion rates. A Naval Architect should meet with the steel inspector that will lead the survey team to review any past history and data available for the vessel to determine the ship's structural arrangement, corrosion control systems and potential problem areas. A complete determination of the types of structure and identification of exact locations consisting of panels, stiffeners, etc., should be noted on the structural plans of the ship. A detailed discussion of locations to survey is contained in section 5.1.3.4. After the survey locations have been determined, the survey team must coordinate with the ship operator. The time between surveys will

generally be determined by the ship's owner and for commercial ships will typically fall between the four/five year drydocking survey required by regulatory bodies. Therefore, the corrosion survey will typically be accomplished while the ship is underway or at pierside so as to minimize interference with the ship's operating schedule. If the time allotted for the survey will not be sufficient to enable completion of the entire ship, a priority list should be established indicating the locations that should be surveyed first. Coordination with the master of the ship is necessary to develop the timeframe, inspection route, and priority list that the survey team will follow. In addition, the master of the ship should be responsible for ensuring that all necessary safety precautions and access requirements are fulfilled.

5.1.2 Safety and Access

During the planning stage, considerations must be given to location safety and access. The considerations must involve the preparation and acceptance of safety procedures and agreement of means to access the various structural locations to be surveyed.

Safety procedure and standards vary among owners and ships and the survey team must be aware of the practices. Typical items of importance to survey personnel may include:

- Suitable Atmosphere (Oxygen Content, Hazardous Gases...)
- Temperature Extremes
- Lighting
- Climbing
- Equipment
- Rescue Procedures.

The International Safety Guide for Oil Tankers and Terminals (ISGOTT) contains basic requirements and sets minimum standards regarding tank entry of oil tankers (5-2). Depending on the owner and vessel, these safety guidelines may or may not be applicable. However, safety is an important issue of any survey and a set of procedures and practices should be recognized and adopted prior to commencement of the survey.

In addition to safety awareness, and indeed an integral part of safety procedures, is the consideration of accessing internal structural locations. The easiest and most straight-forward approach is to simply climb about the existing structural members using ladders, walkways, stiffener platforms, etc. However, the majority of internal locations that will be surveyed cannot be reached via the permanent structure. Safety precautions will generally restrict the height above bottom or height above water that survey personnel may climb. Therefore, additional means of mobility are required to access vertical members and deckheads.

During at-sea surveys, rafting has become the most common technique for allowing surveyors to move about within a tank.

In tank ships, the use of inflatable or rigid rafts maneuvering over a ballasted surface within a tank permits close-up inspection of bulkheads and deckheads. Adjustments to the height of ballast levels allows surveyors access to virtually the entire internal surface of a tank. Mobility within compartments that cannot accommodate ballast may be accomplished via temporary staging or mobile platforms. The use of temporary staging is often restrictive to repair yard or pierside surveys and generally does not facilitate an at-sea survey. Mobile platforms are a form of temporary staging but differ from conventional scaffolding in that they have freedom of movement. The most common type of mobile platform consists of a portable, self-elevating platform suspended from wires through holes drilled in the upper deck which allows access to deckhead areas. Other types consist of articulated or telescopic arms that can position platforms throughout a compartment. Mobile platforms are highly susceptible to the motions of the vessel and therefore, are often used in drydock or sheltered conditions as opposed to at-sea. As evidenced, there are several methods that can be employed to access locations in addition to numerous safety considerations that may apply under given conditions.

It is the responsibility of the survey team, ship owner and master to determine the exact procedures that will be used to ensure safety and allow access to survey locations. Upon accessing the proper locations, the survey team is ready to begin measuring.

5.1.3 Instrumentation

Ultrasonic devices are currently the most common type of instrument used to measure structural steel thickness in ships. A complete ultrasonic instrument is composed of a display and transducer (probe). The method ultrasonic instruments use to measure thickness is commonly termed the pulse-echo technique. In this technique, the instrument generates an ultrasonic signal which is transmitted to the structure via a connecting coaxial cable and special probe which is placed in contact with the structural surface. The pulse (sound waves) travels through the structure to the far side and then reflects back to the instrument via the probe and cable. Thus, thickness is obtained by measuring the elapsed time between signal entrance and exit from the structure.

5.1.3.1 Displays

There are three types of displays available that allow an operator to acquire thickness readings:

- CRT DISPLAYS
- DIGITAL DISPLAY
- COMBINATION CRT-DIGITAL DISPLAY

The CRT display resembles an oscilloscope in that the ultrasonic signal generated is displayed on a screen. An example CRT display is shown in Figure 5-1. Thickness is measured on the screen as the distance between leading edges of peaks, as shown in Figure 5-2. This feature permits interpretation of back wall scatter and coating thickness effects. The accuracy associated with a CRT unit typically ranges from $\pm 0.010"$ to $\pm 0.020"$.

The digital display is a compact, hand-held unit that records thickness directly in the form of a numerical LCD display. An example digital unit is shown in Figure 5-3. The accuracy associated with a digital display unit typically ranges from $\pm 0.005"$ to $\pm 0.020"$. The main advantage is the digital unit is in its compactness. The main disadvantage is that impurities in the steel or surface coatings or scale that reflect sound energy also create misleading echoes and influence the sound wave pattern and cannot be discriminated as such by digital units. The CRT unit can discriminate between these echoes and true backwall echoes because the operator can observe the echo pattern and pick out false echoes.

Combination units are larger and more expensive than the other types (4-2). For these reasons they are not commonly used in hull survey work. CRT display and digital display units are the most commonly used by inspection and non-destructive testing (NDT) companies for structural inspection. It is generally agreed upon in the inspection industry that digital display units are rapidly becoming the favorite for measurement ease and accuracy. However, CRT units are still widely used because they permit interpretation of back wall scatter. Marked differences exist between the display units and must be addressed accordingly.

While the CRT and digital units exhibit a difference in operation and versatility, the performance and accuracy are similar. CRT units require a greater skill level to operate than the digital units but operators typically spend an equal amount of time to obtain a clear thickness reading. If the surface has been prepared prior to gauging (i.e., removal of coating, scale...etc.) a reading can be taken every 10-20 seconds. If the inspector must prepare the surface on the spot, readings can take three to four times longer. Generally, surfaces with intact coating do not require survey. Surfaces with scale or

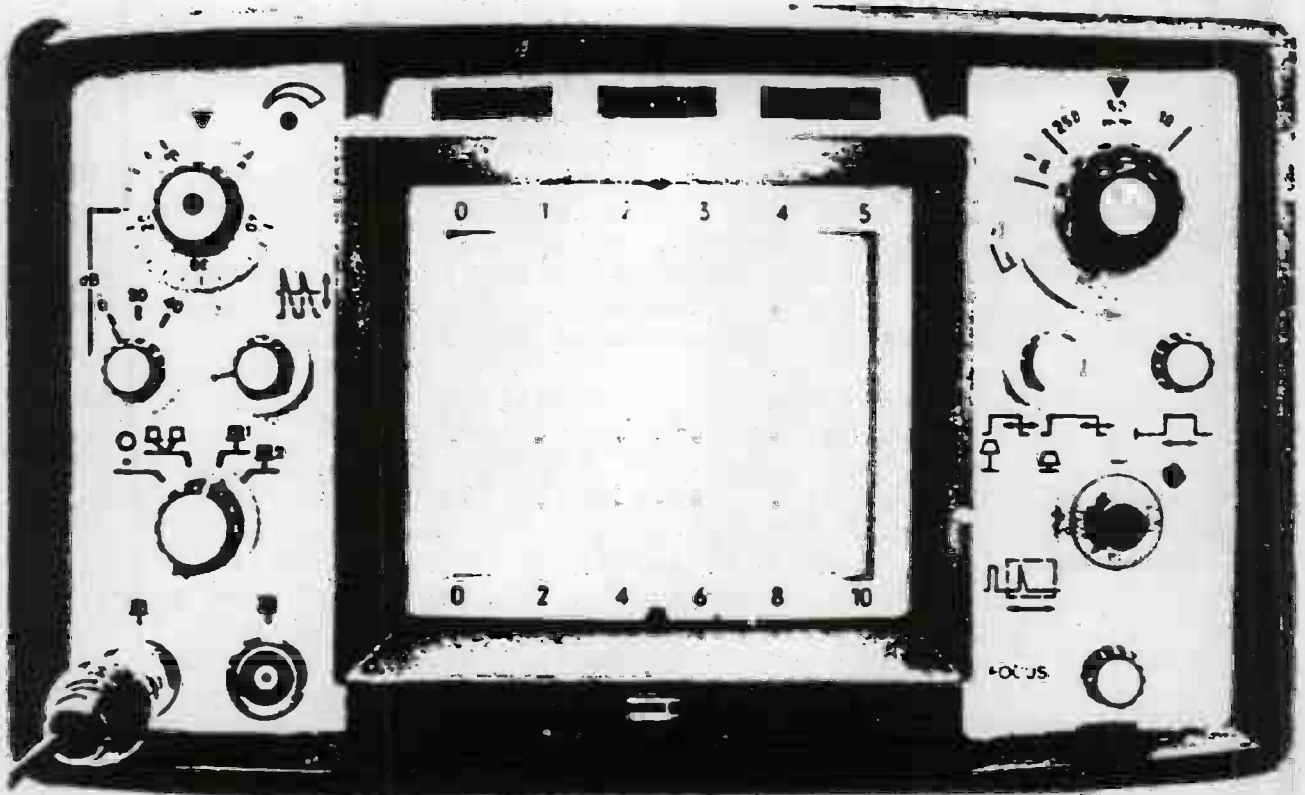

FIGURE 5-1
CRT DISPLAY EQUIPMENT

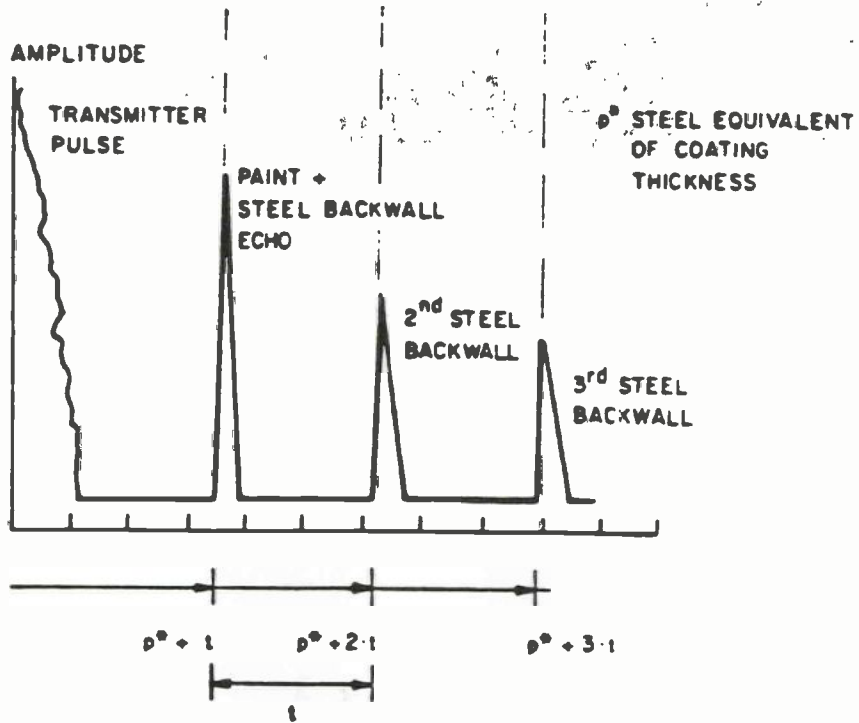
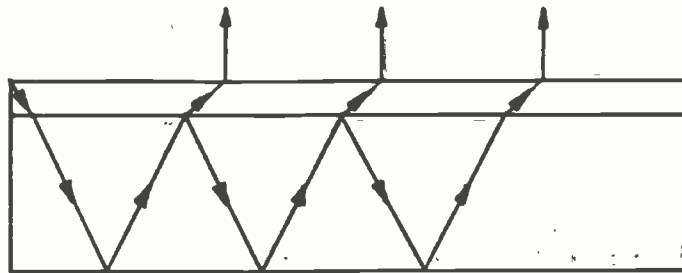
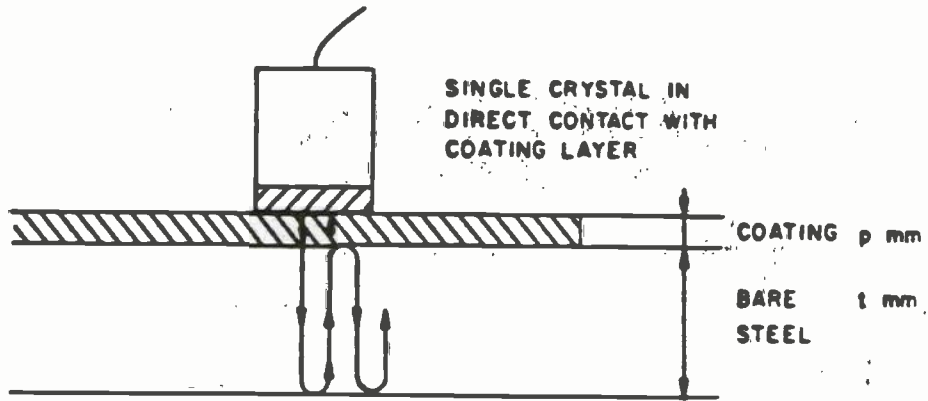

FIGURE 5-2
THICKNESS MEASUREMENT THROUGH A COATING LAYER

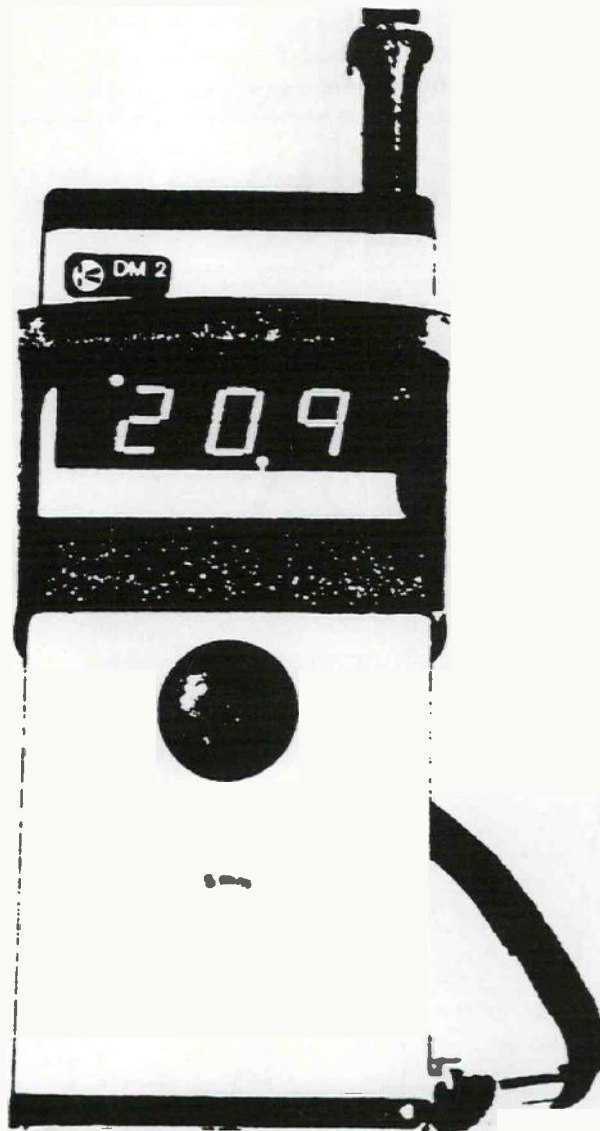

FIGURE 5-3
DIGITAL DISPLAY EQUIPMENT

failed coating should be prepared prior to gauging, otherwise the coating thickness must be determined and often the coating is not of constant thickness. If a digital display is used, surfaces must be prepared since the operator cannot observe the sound wave pattern and distinguish coating effects. Recent advances in digital equipment offer the ability to read multiple echoes, thus enabling the distinction between steel and coating thicknesses. However, regardless of the equipment used, inspectors prefer to measure bare surfaces. This practice helps to reduce possible errors due to coating and scale. In addition, the presence of scale or roughened surfaces may cause a scattering of sound energy and adversely affect the echo pattern resulting in erroneous measurements.

Current indications from the inspection industry reveal that both CRT and digital units are used with equal preference. However, digital units are rapidly becoming the favorite as accuracy and flexibility increase, thus overcoming the advantage of actual wave pattern visualization as afforded by CRT units. As technology advances, so does the reliability of digital units. Flexibility increases through the use of several different probes coupled with the ability of recent digital units to read multiple echoes. Multiple echo processing allows digital units to distinguish faulty readings and thus improve accuracy beyond the CRT level without requiring wave visualization. The most recent advances in digital units include:

- 1 Microprocessor-based design,
- 2 Internal Datalogger allowing the storing and sorting of up to 1000 readings,
- 3 Ability to off-load stored readings directly to a computer or printer via a two-way communications port,
- 4 Interfacing ability with a host computer to run most statistical processing control software packages.

The ability of digital units to interface directly with computers is a tremendous advantage which could ultimately eliminate the need to hand-record every reading. Digital units will clearly become the choice of the future however, CRT units are not to be neglected. The corrosion survey methodology warrants the need for consistency and standardization and equal success can be achieved with several display-probe combinations. Once a display-probe combination is selected, inspectors should complete a survey using the same instruments and vary probe types only where special conditions necessitate this practice. In addition, subsequent surveys of the same vessel should be conducted with the same instruments (make and model). Regardless of whether instrument consistency is indeed adhered to, careful calibration and instrument error must be established. Instrument error is the single largest source of error associated with statistical

sampling and greatly influences the amount of data required for a corrosion survey.

5.1.3.2 Transducers

In addition to the display units, a probe must also be chosen. There are two types of thickness-measuring probes; single and twin. The single probe uses the same crystal for both transmitting and receiving while the twin probe has the transmitting signal electrically and acoustically separated from the receiving signal. Figures 5-4 and 5-5 illustrate the method used by both probes. Two characteristics of transducers must also be addressed: frequency and diameter. Frequency affects the sound transmission characteristics and under conditions where echo strength is marginal, the selection of a probe with a different frequency may improve the echo strength. Typical frequencies used range from 2.25 MHZ to 5.0 MHZ. The probe diameter affects the shape of the sound beam and therefore the signal strength. The smaller the diameter the narrower the beam. Typical diameters used range from 10mm (.4 in) to 25mm (1 in). Corroded surfaces often present difficulty in keeping the transducer face parallel to the plate. Changing diameters afford operators the flexibility of ensuring a parallel probe-surface contact.

In addition to thickness measurements, depth and diameter must also be measured when examining pitting and grooving corrosion. The most common method of measuring depth is through the a micrometer device or "pit-gauge". This is a simple mechanical instrument that when placed over a pit allows a depth measurement to be read off of a marked reference rule. Depth can be measured either ultrasonically or mechanically, while diameter is easily measured with a rule or scale. Ultrasonically gauging pit depth is accomplished through the use of a focused probe. The concept of the focused probe is illustrated in Figure 5-6. When the focal point of the beam is placed above the center of the pit, the pit curvature acts as a lens and the beam diverging from the focal point will tend to converge as it enters the steel. Under this condition a significant backwall reflection can be obtained. This technique requires the use of a sharply focused transducer whose focal point is aligned over the center of the pit. The stand-off distance from the transducer and the plate is kept equal to or slightly greater than the focal length. Spurious signals can result from sidelobes generated by the focused transducer thus creating a false backwall echo as shown in Figure 5-7. Placing an acoustic mask at the focal point of the probe acts to shield any sidelobe pulses as shown on the wave patterns in Figure 5-8. This probe should be used with CRT displays only because it is necessary to see the wave pattern and account for possible false echoes.

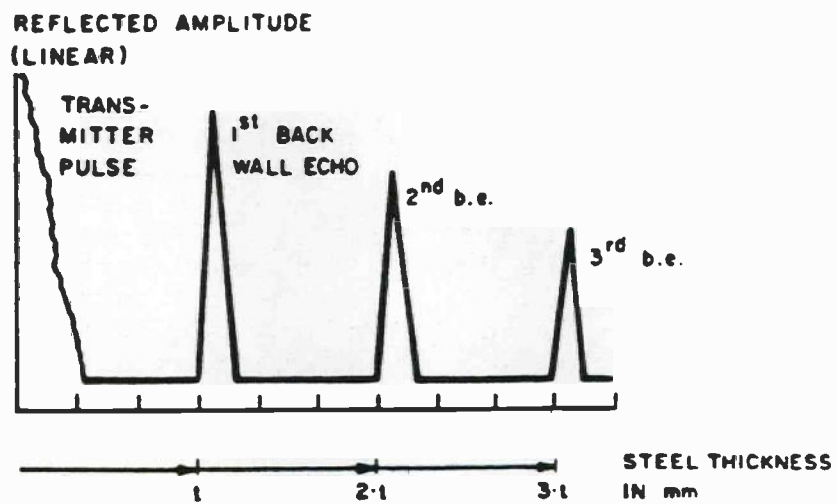
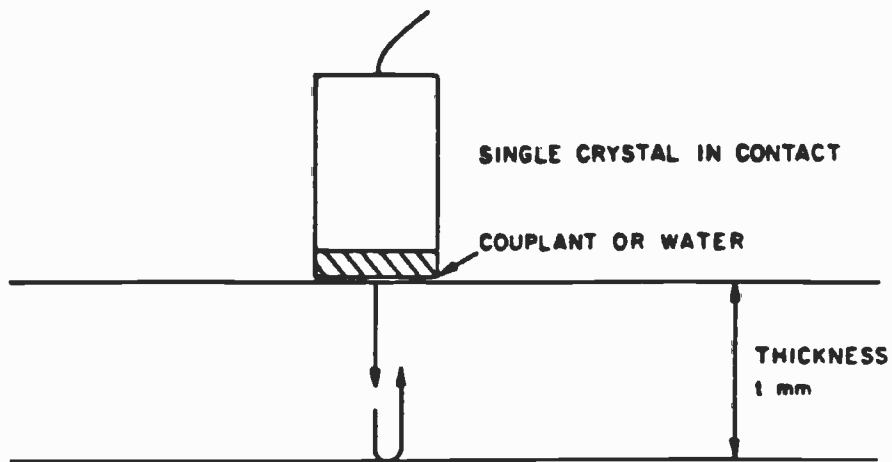

FIGURE 5-4
SINGLE TRANSDUCER PULSE ECHO-PATTERN

- ① ACOUSTIC BARRIER
- ② TRANSMITTER } CRYSTAL
- ③ RECEIVER
- ④ DELAY PIECE
- ⑤ COUPLING FLUID
- α TOP ANGLE
- g WIDTH OF BARRIER

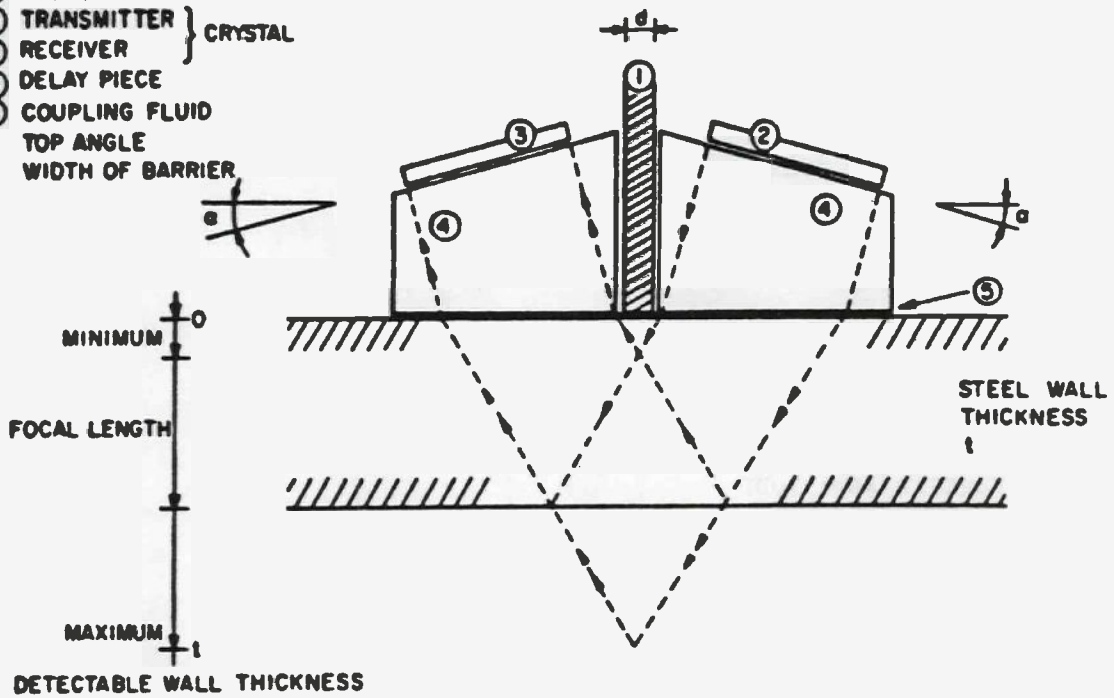

FIGURE 5-5
TWIN TRANSDUCER PULSE-ECHO PATTERN

TABLE 1. THICKNESS MEASUREMENT OF PITTED PLATES USING 10-MHZ, 19-mm DIA, 50-mm FOCUSED TRANSDUCER

<u>Calculated Average Thickness (mm)</u>	<u>Average Thickness (Using Archimedes Principle) (mm)</u>	<u>Percentage Difference</u>
6.1	6.6	-8
8.3	7.2	+15
11.2	10.2	+10
14.7	13.6	+8
12.1	11.0	+10
13.5	11.8	+14
3.7	4.0	-7
3.9	3.6	+8

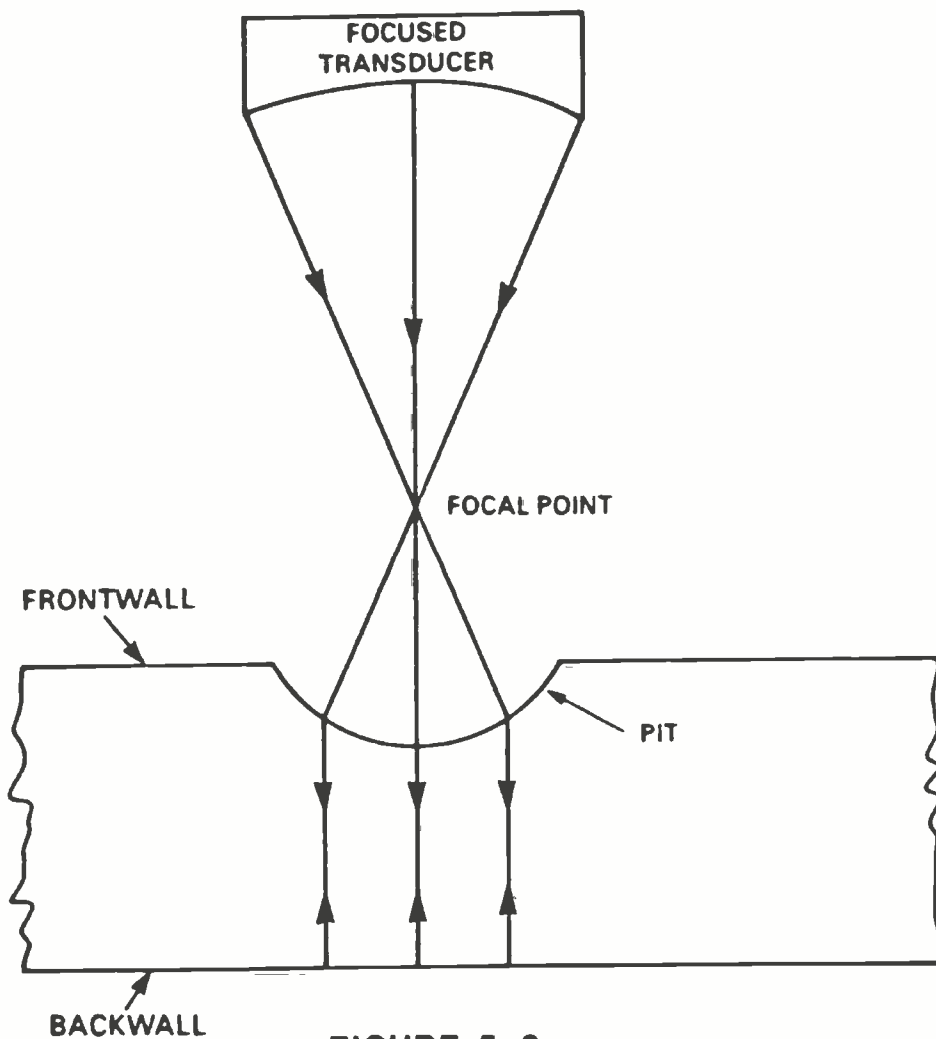
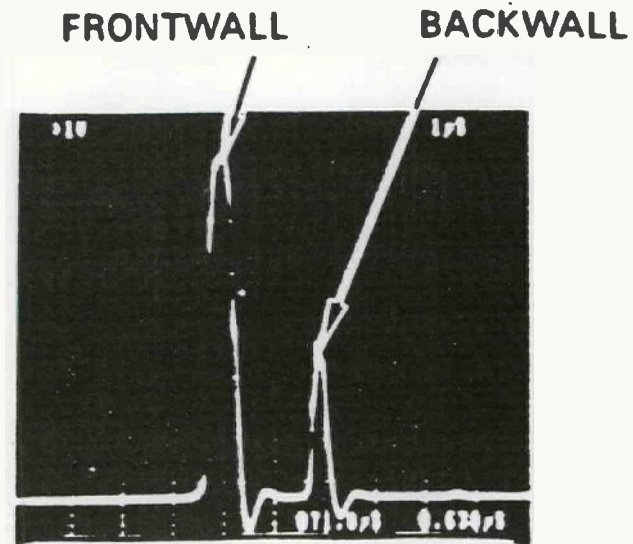
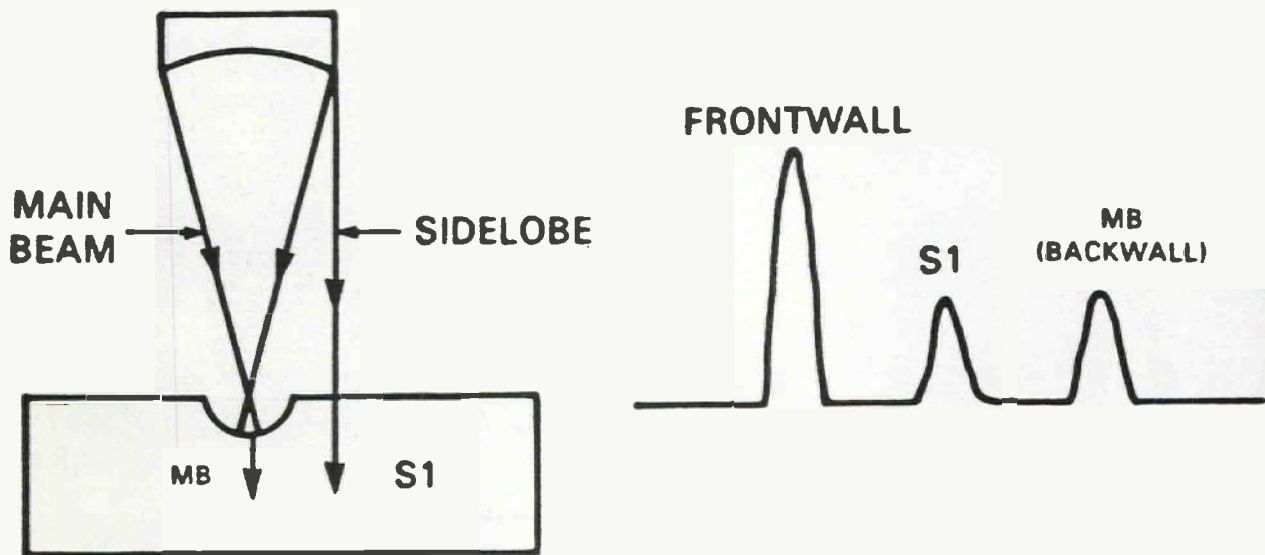

FIGURE 5-6

Focused transducer concept showing the diverging beam from the point of focus as it enters parallel into the steel plate



Reflected ultrasonic signal (video)
from a pit in a corroded plate



Spurious signal S1 caused by a sidelobe: (a) sidelobe signal S1 travels more in steel than the main beam (MB); (b) S1 arrives earlier than the backwall from MB

FIGURE 5-7

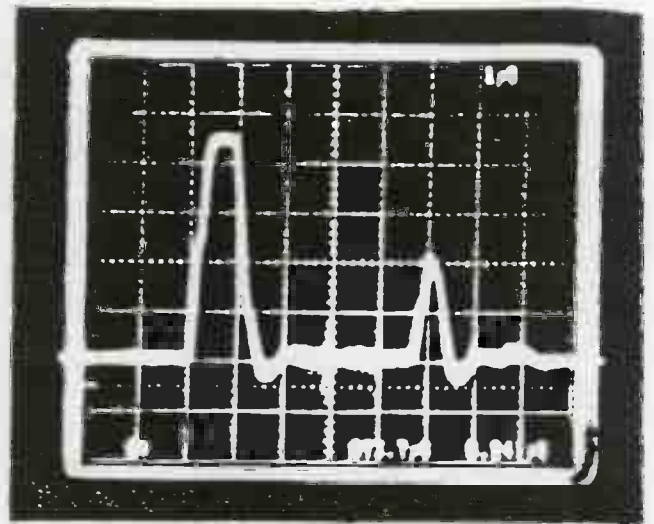
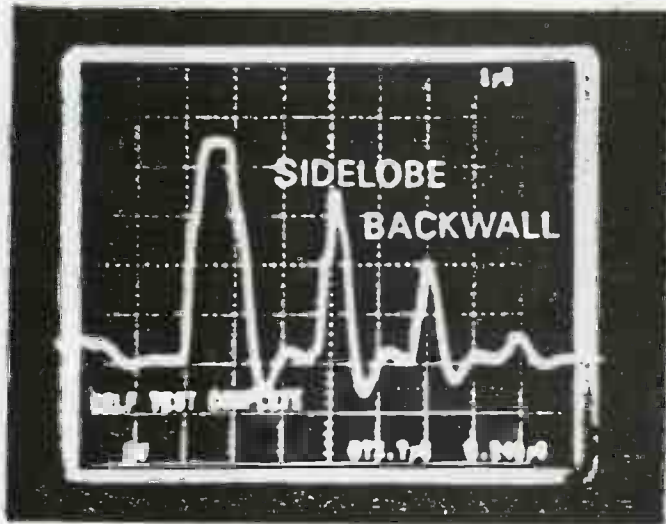

Effect of acoustic mask — removes S1 caused by sidelobes: (a) Signal w/o acoustic mask;

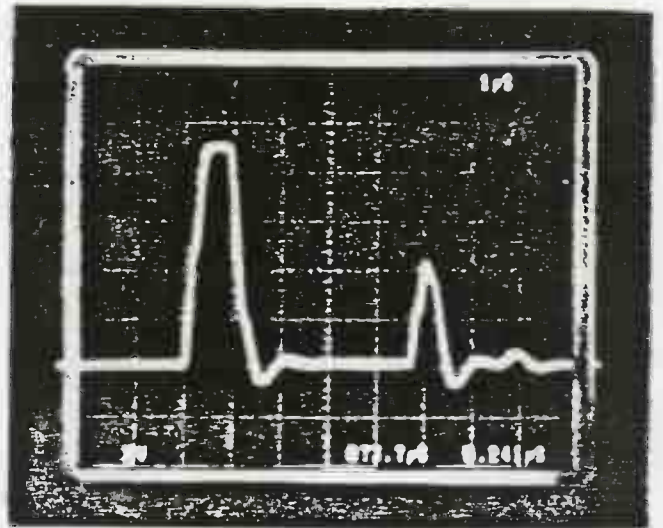
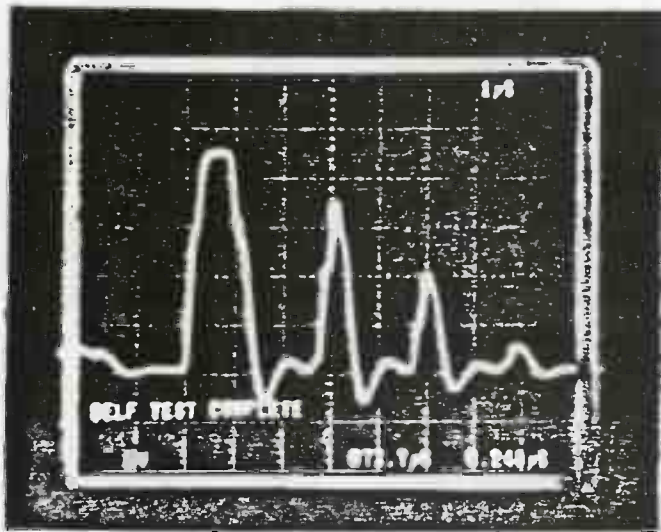

(b) signal with acoustic mask

FIGURE 5-8

5.1.4 Gauging Patterns

The precision with which a set of gauging data accurately reflects the wastage levels in a particular location will be a function of the number of readings taken. The minimum number of readings required is based on desired accuracy. In an effort to gain an understanding of vessel corrosion rates, readings must be taken that accurately describe the pattern of wastage on a given structural component. As a result, it is likely that the size of a location will govern the number readings required for a definitive corrosion pattern. The measurements should be sufficiently distributed over the subject location to obtain the average corrosion rates. Similarly gauge belting should be conducted of the longitudinally effective structure to obtain corrosion rates affecting the hull girder.

A corrosion survey will provide required information only if the same general area of gauging locations are consistently tracked in subsequent surveys. This requires careful planning to define required gauge locations that will remain unchanged throughout the overall survey duration of the vessel.

A grid pattern should be used for gauging pitting on a panel with a single depth and diameter reading taken at each pit on the grid. The grid should be sized to provide complete panel-area coverage with minimum sample size (grid density) governed by accuracy requirements. Frequency diagrams similar to those shown in Figure 5-9 should be used to estimate the percent of pitting. For grooving, gauge patterns should be evenly distributed along the length of the groove.

Gauge areas should be marked on plans or diagrams (section 5.2.2.3) so they can be relocated in future surveys. The actual measurement sequence is not important, since all the data for a specific area should be averaged. Therefore, gauge points do not need to be numbered, rather just located for future reference.

Special locations other than general hull structure will require customized gauging patterns to determine corrosion rates for the specific location.

5.2 Data Recording

After locations have been selected and appropriate gauging patterns determined, the next step is to measure and record data. This section presents data classification and correlation parameters, and the actual standardized forms used to record all necessary data information. Each data point, or gauge location, is unique and must be identifiable for subsequent corrosion surveys. Accordingly, each data point must have an associated classification code describing ship structural location and

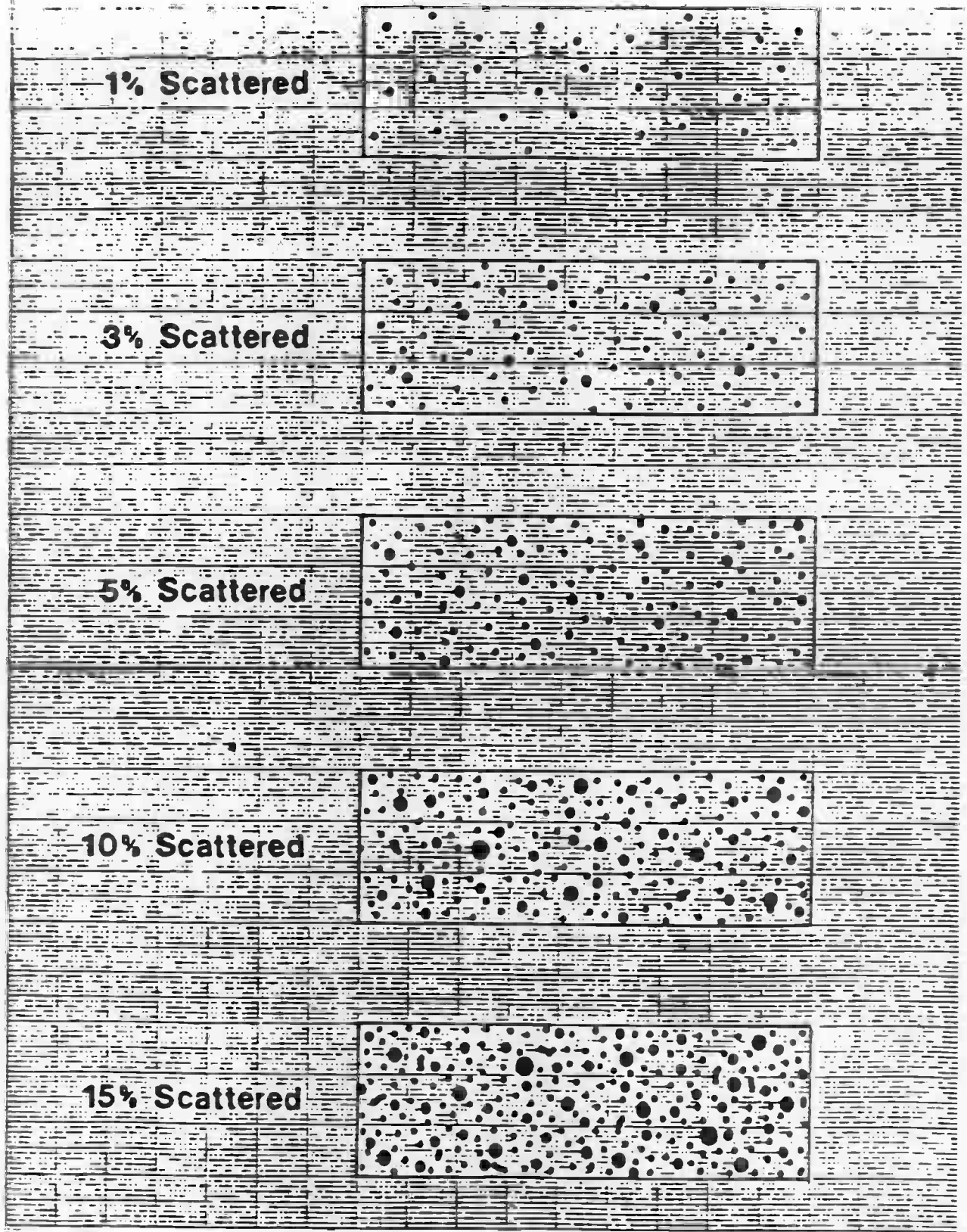
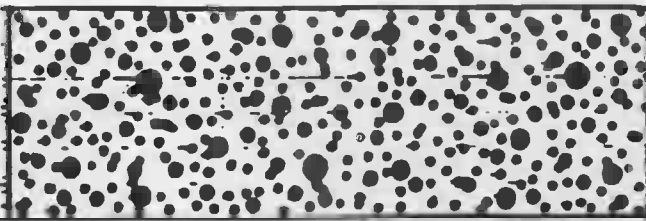
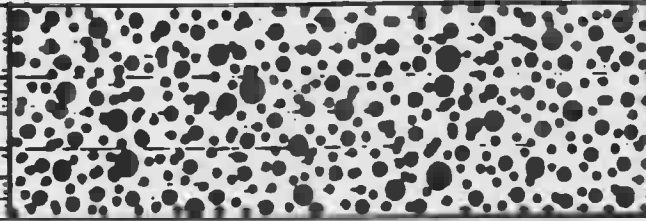

FIGURE 5-9
PITTING INTENSITY DIAGRAMS

20% Scattered



25% Scattered



30% Scattered

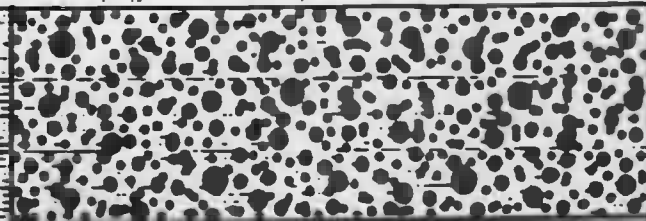

40% Scattered

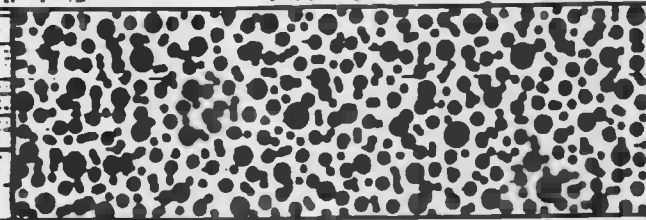

50% Scattered

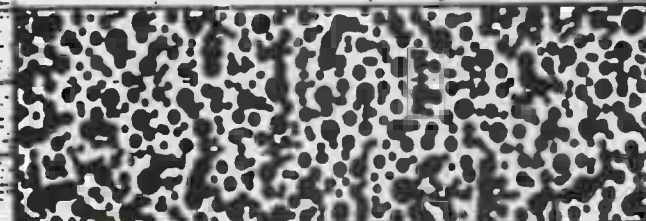

FIGURE 5-9 (CONT.)

associated correlation parameters to ensure acquired analysis (described in section 5.3)

5.2.1 Data Classification Codes

To facilitate standardization, organization and flexibility of the database, each data entry will have an associated alphanumeric code. Each classification code is composed of nine characters that represent:

- ship type
- ship number
- compartment
- structure
- panel number

Use of the classification code permits quick and easy ship and location identification of the data. A single code will have many associated data entries depending on the gauging pattern used for a particular location. Since each code represents a group of data points, there will be an associated average or mean value along with a corresponding error value. An organized database can then permit statistical combining of any number of codes depending on user preference and correlation parameters.

5.2.1.1 Ship Type

The first character of the data classification code represents the type of ship being surveyed. This character is a single letter that is keyed to an established list of ship types. An example of such a list is shown in Figure 5-10. This list is representative of all major ship types currently in the U.S. oceangoing fleet. The list is divided into two main categories of ship classification: Merchant/Commercial and Naval/Military. This suggests the development of two separate databases. Corrosion information acquired from U.S. Naval ships is likely to be classified or restricted information subject to limited distribution, thus warranting the need for separate compilation and analysis. Generally, this applies only to combatant craft. Naval auxiliaries and Military Sealift Command ships can be incorporated into the commercial database if the mission of these ships typically involves the transportation of cargo and can be classified as one of the commercial types listed. Classification of ships should be based upon the major internal cargo carried or general functional requirement. Every ships subjected to a corrosion survey should fall into one of the types shown. Several types may be broken down into further detail based on specific cargo and functional characteristics.

Merchant/Commercial/Naval/Military

1.	Breakbulk	-B	Battleship	-B
2.	Container	-C	Cruiser	-C
3.	Drybulk	-D	Destroyer	-D
4.	LNG	-G	Frigate	-F
5.	Heavylift	-H	Carrier	-V
6.	ITB	-I		
7.	LASH	-L	T-AO	
8.	Chemical Tanker	-M	T-AKR	
9.	Products Tanker	-P	T-AKX	
10.	RO/RO	-R	T-AGOS	
11.	Semisubmersibles	-S	AGOR	
12.	ULCC	-U		
13.	VLCC	-V		
14.	Workboats	-W		
15.	Other	-O		

Figure 5-10
Ship Designations

For example, drybulk ships can be subdivided into ore and grain ships. However, this increased detailed subdivision of ship type is considered unnecessary and impractical at this level of data coding. Individual ships within a category may have significantly varying corrosion rates and this fact is recognized in the second code parameter. The categorical breakdown of ship types shown in Figure 5-10 represents a sufficient and necessary level of detail that will allow combining and analysis of data for a general ship type. This is a desirable feature that owners and classification societies may wish to exercise.

5.2.1.2 Ship Number

The second and third characters of the data classification code represent the sequential number of an individual ship of a given ship type entered into the data base.

5.2.1.3 Compartment

The fourth and fifth characters of the data classification code represent the particular ship compartment that the data point lies in. Compartments must be identified and coded on a set of ships plans prior to the survey. The compartment code follows a letter-digit format. For example, B2 would correspond to the number two ballast tank. Figure 5-11 shows a list of general compartments types with letter designations. The actual numbering of compartments within a ship is subject to owner or surveyor preference. Compartments are defined according to their functional usage. A general compartment description is convenient to use and satisfies data coding requirements. Detailed descriptions of compartment characteristics are addressed as correlation parameters which are discussed in Section 5.2.2.

5.2.1.4 Structure

The sixth, seventh and eighth characters of the data classification code represent the type of structure wherein the data point lies. The structural code is composed of three letters that reference structural locations commonly experiencing corrosion within a ship. A standardized list of structures has been developed and is shown in Figure 5-12. This list represents the minimum breakdown of structural locations that is recommended for standardized usage. Marine classification societies have developed minimum requirements for vessel scantling sizing either explicitly (thickness) or implicitly (section modulus). Example scantling types are shown in Figure 5-12. Additional specialized locations, or locations associated with select ship types not currently defined, may easily be added.

<u>Compartment Type</u>	<u>Designations</u>
Ballast	B
Dry Cargo	D
Liquid Cargo	L
Liquid Cargo/Ballast	X
Dry Cargo/Ballast	Y

Figure 5-11

List of Compartment Designations

1. BGF - Bottom Girder Face Flat
2. BGP - Bottom Girder Plating
3. BLF - Bottom Longitudinal Face Flat
4. BLW - Bottom Longitudinal Web
5. BPL - Bottom plating
6. BRK - Bracket
7. BTF - Bottom Transverse Face Flat
8. BTW - Bottom Transverse Web
9. DGF - Deckgirder Face Flat
10. DGP - Deck Girder Plating
11. DLF - Deck Longitudinal Face Flat
12. DLW - Deck Longitudinal Web
13. DPL - Deck Plating
14. IBP - Inner Bottom Plating
15. IFP - Inner Bottom Floor Plating
16. ILF - Inner Bottom Longitudinal Face Flat
17. ILW - Inner Bottom Longitudinal Web
18. ITF - Inner Bottom Transverse Face Flat
19. ITW - Inner Bottom Transverse Web
20. LBF - Longitudinal Bulkhead Longitudinal Face Flat
21. LBP - Longitudinal Bulkhead Plating
22. LBW - Longitudinal Bulkhead Longitudinal Web
23. OTH - Other
24. SBF - Swash Bulkhead Stiffener Face Flat
25. SBP - Swash Bulkhead Plating
26. SBW - Swash Bulkhead Stiffener Web
27. SLF - Side Shell Longitudinal Face Flat
28. SLW - Side Shell Longitudinal Web
29. SSP - Side Shell Plating
30. STF - Side Shell Transverse Face Flat
31. STW - Side Shell Transverse Web
32. SPF - Stringer Platform Face Flat
33. SPP - Stringer Platform Plating
34. TBF - Transverse Bulkhead Stiffener Face Flat
35. TBP - Transverse Bulkhead Plating
36. TBW - Transverse Bulkhead Stiffener Web
37. TTP - Tank Top Plating
38. VGF - Vertical Girder Face Flat
39. VGP - Vertical Girder Plating
40. WFF - Web Frame Face Flat
41. WFP - Web Frame Plating

Figure 5-12

List of Ship Structures

5.2.1.5 Panel Number

The ninth character of the data classification code represents the individual panel. Here, the term panel is used as a generic term for plate, stiffener flat, or web of a particular structure. Each structure will have one to nine associated panels with each panel containing a number of gauge readings.

5.2.1.6 Summary

An example of the data classification code as described above may resemble the following:

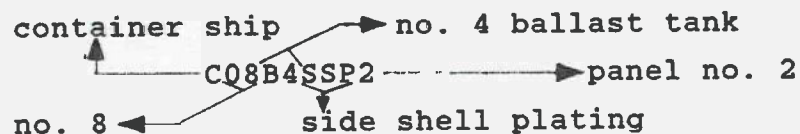

It is convenient to define each data point as a function of these five parameters for two reasons:

1. Each data point is a unique member of a data group. A successful corrosion survey warrants the need for subsequent measurements at the same locations to ensure consistency and statistical accuracy. A corrosion survey report for a single ship may contain thousands of data points and each needs to be relocated in future surveys. These five parameters accurately describe each data group and when used in conjunction with pre-survey, mark-up plans and reporting forms, pinpoints locations within a given ship.
2. Within a database structure, a user has the ability to quickly group and analyze data in several parametric combinations. For example, corrosion data can be grouped according to ship types, compartment types, or structure types, or any combination thereof. Multi-parametric classification enables users to easily combine data sets for comparative analyses regarding loss rates and errors.

The guidelines required for appropriate parametric combining are in the form of correlation parameters. Each ship and, more importantly, each compartment, have associated operating/environment characteristics that greatly influence rates of corrosion. Database operators must be knowledgeable of these correlation parameters so that similar ships and compartments can be analyzed rather than dissimilar ones which would provide inaccurate comparisons. This would be analogous to comparing apples and oranges.

5.2.2 Documenting Corrosion Parameters

As presented previously, corrosion is affected by the environment surrounding the ship structure. The parameters describing this varying environment include:

1. time in ballast;
2. coating system;
3. anode system if applicable;
4. vessel navigation routes;
5. compartment humidity;
6. tank washing medium;
7. tank washing frequency;
8. tank inerting medium;
9. cargo carried if applicable.

It may be obvious that there exists a certain degree of overlap or interdependency among the correlation parameters. Each parameter, in its own right, can influence corrosion rates. However, as is often the case, several parameters exist and interface simultaneously, thus affecting corrosion rates in a manner different from individual influence. Data analysis will involve the calculation of average corrosion rates for varying locations within a given compartment. Determining corrosion rates for a general structural location will involve data from several compartments. In order to accurately facilitate a broader calculation of corrosion rates involving several compartments, a strong correlation must exist between compartments. The reasons for differing rates can easily be obtained through an identification of dissimilar correlation parameters. Data for several compartments should be analyzed together only if all correlation parameters are similar.

Data is recorded by completing a standardized set of survey forms aimed at correlating and organizing the data for statistical analysis. Accordingly, three types of forms have been developed that contain all the information needed for data entry and analysis via a database program. The three forms are defined as follows:

1. Ship Information Sheet;
2. Compartment Correlation Parameter Sheet;
3. Panel Data Sheet.

Every ship that is surveyed will require a completed set of survey forms.

5.2.2.1 Ship Information Sheet

The first type of survey form is the Ship Information Sheet and is shown in Figure 5-13. A single complete set of survey forms will contain one Ship Information Sheet. The purpose of this form is to record general information pertaining to the ship and survey. Accordingly, the form is divided into two sections. The first section asks for typical ship characteristics and is self-explanatory. The ship database number corresponds to the ship number part of the data classification code and will generally not be known prior to the survey. Once the survey is completed and the data is ready for database entry, the next available number will be assigned depending on vessel type.

The second section of the Ship Information Sheet describes survey-related information including names, dates and instrumentation information. Also included is a space for typical navigation routes which has been previously identified as a correlation parameter. This particular parameter is ship-oriented as opposed to compartment-oriented and therefore is included in this form rather than the compartment correlation parameter form.

5.2.2.2 Compartment Correlation Parameter Sheet

The second type of survey form is the Compartment Correlation Parameter Sheet and is shown in Figure 5-14. This is a two-page form. Each independent compartment surveyed within a ship will require a completed form regardless of the number of locations and readings surveyed within that compartment. If a total number of eight independent compartments, tanks, or holds are surveyed to varying extents within a ship, then the completed survey report package will contain eight Compartment Correlation Parameter Sheets.

The form is divided into two parts: general and correlation parameters. General information contains those parameters that form part of the data classification code. They are included for reference purposes and serve to ensure consistency among the forms.

The second section contains information regarding the eight remaining correlation parameters that are compartment-oriented. The last three parameters apply strictly to tanker vessels and only need to be completed if applicable.

These forms should also be completed by knowledgeable owner representatives and prior to actual survey. The locations to be surveyed will be identified during the pre-survey planning stage.

SHIP INFORMATION SHEET

NAME: _____	OWNER: _____
TYPE: _____	DELIVERY DATE: _____
CLASS: _____	HULL NO.: _____
BUILDER: _____	DEPTH: _____
LOA: _____	DRAFT: _____
LBP: _____	SUMMER DWT: _____
BEAM: _____	DATABASE NO. _____ (SHIP NO.)

SURVEY INFORMATION

NAME(S) AND COMPANY OF INSPECTOR(S): _____

NAME(S) AND COMPANY OF ULTRASONIC TECHNICIAN(S): _____

MAKE AND MODEL OF ULTRASONIC EQUIPMENT: _____

INSTRUMENT ERROR _____

OPERATOR-INSTRUMENT SYSTEMATIC ERROR (IF KNOWN) _____

DATE OF SURVEY: _____

DATE OF PREVIOUS SURVEY: _____

DATE OF LAST DRYDOCK: _____

AVG TIME BETWEEN DRYDOCKS: _____

TYPICAL NAVIGATIONAL ROUTES _____

FIGURE 5-13

4. ANODES:

- A. MATERIAL OF ANODES: ZINC _____ ALUMINUM _____ OTHER _____
- B. SIZE: _____ lbs
- C. DESIGN CURRENT DENSITY: _____ mA
- D. ESTIMATED WASTAGE: _____ %
- E. DATE OF LAST RENEWAL: _____

5. COMPARTMENT HUMIDITY: _____ %

6. TANK WASHING MEDIUM:

- A. SEAWATER _____ : TEMPERATURE IS _____ °C (OR _____ °F)
- B. CRUDE OIL WASH _____
- C. OTHER (SPECIFY) _____
- D. COMBINATION (SPECIFY) _____

7. TANK WASHING FREQUENCY:

- A. EVERY VOYAGE _____
- B. MORE THAN EVERY VOYAGE _____ (AVG. NO. PER VOYAGE _____)
- C. LESS THAN EVERY VOYAGE _____ (AVG. NO. PER VOYAGE _____)
- D. DRYDOCK ONLY _____

8. TANK INERTING MEDIUM:

- A. FLUE GAS _____ (% TOTAL S, _____% CO₂, _____% N₂, _____% O₂, _____% SO₂, _____% SO₃, IF KNOWN)
- B. INDEPENDENT GENERATOR _____ (% TOTAL S, _____% CO₂, _____% N₂, _____% O₂, _____% SO₂, _____% SO₃, IF KNOWN)
- C. NOT REQUIRED _____
- D. OTHER (SPECIFY) _____
- E. INERTING PERIOD _____

COMMENTS: _____

FIGURE 5-14 (CONT.)

Therefore, the compartment correlation parameters can be addressed where applicable as indicated on the form.

5.2.2.3 Panel Data Sheet

The third and final type of survey form is the Panel Data Sheet and is shown in Figure 5-15. This form is used to record the data readings obtained from the survey. Every panel surveyed will have a single corresponding data sheet containing the raw data measured for the three types of corrosion encountered. The majority of the survey report package for any ship will be composed of panel data sheets. Data sheets will be grouped according to compartment and then structure type.

The format of the data sheet is divided into three sections: general, panel and data. The general section contains four data classification code parameters plus the survey date and ship name. Responses to the code parameters are keyed to the list of structures, ship types, and compartments previously shown in section 5.2.1.

The panel section contains the panel number, location references within the ship, panel correlation parameters, and space provided to illustrate the gauge pattern used. The panel number is the fifth parameter (ninth character) of the data classification code. Panel location references are included to allow for identification within the ship by users of the data sheet. Typical users would be surveyors and data analysts. Each panel surveyed should be identified and labeled on a master set of ship drawings during the pre-survey, planning stage. However, future survey teams must be able to identify and locate previously surveyed panels. Requiring location references on data sheets ensures that locations are recorded in at least two places.

In addition to the panel location several panel correlation parameters are required. These parameters indicate whether a panel is in an often-liquid-immersed area such as the aft location in a compartment. A ship normally trims aft, thus forcing any residual liquid to the after end of compartment. Corrosion rates are typically higher for aft panels than forward panels within a compartment.

A space is also provided in the panel section and should be used to illustrate the particular gauging pattern selected for that panel number. A successful corrosion survey program requires the gauging of identical locations in subsequent surveys. These locations can be marked on the structure, but the markings may vanish in following years due to overhaul or repair. An illustrative gauging pattern on a data sheet will allow future surveyors to gauge points in close proximity to prior surveys.

PANEL DATA SHEET

SHT _____ OF _____

<u>GENERAL</u>	
SHIP NAME: _____	COMPARTMENT DESIGNATION: _____
SHIP TYPE: _____	STRUCTURE DESIGNATION: _____
SHIP NO.: _____	DATE: _____

PANEL NO.: _____	FRAMES _____	LONG'LS _____	STRGRS _____
RESIDUAL ZONE (Y/N)	ULLAGE ZONE (Y/N)	SPLASH ZONE (Y/N)	WET ZONE (Y/N)
COATING PROTECTION (Y/N)		ANODE PROTECTION (Y/N)	
SPACE PROVIDED FOR GAUGE PATTERN ILLUSTRATION			

THICKNESS (mils/mm)	<u>GENERAL CORROSION DATA</u>					
ERROR: _____	AREA OF PANEL EXPERIENCING WASTAGE: _____					
1. _____	6. _____	11. _____	16. _____	21. _____	26. _____	
2. _____	7. _____	12. _____	17. _____	22. _____	27. _____	
3. _____	8. _____	13. _____	18. _____	23. _____	28. _____	
4. _____	9. _____	14. _____	19. _____	24. _____	29. _____	
5. _____	10. _____	15. _____	20. _____	25. _____	30. _____	

DEPTH (mils/mm)	<u>PITTING DATA</u>			DIAMETER (mils/mm)
ERROR: _____	INTENSITY _____ %			ERROR: _____
1. _____	6. _____	11. _____	1. _____	6. _____
2. _____	7. _____	12. _____	2. _____	7. _____
3. _____	8. _____	13. _____	3. _____	8. _____
4. _____	9. _____	14. _____	4. _____	9. _____
5. _____	10. _____	15. _____	5. _____	10. _____

LENGTH: _____		<u>GROOVING DATA</u>				LENGTH: _____	
DEPTH (mils/mm)	WIDTH (mils/mm)	DEPTH (mils/mm)	WIDTH (mils/mm)	DEPTH (mils/mm)	WIDTH (mils/mm)	DEPTH (mils/mm)	WIDTH (mils/mm)
ERROR: _____	ERROR: _____	ERROR: _____	ERROR: _____	ERROR: _____	ERROR: _____	ERROR: _____	ERROR: _____
1. _____	5. _____	1. _____	5. _____	1. _____	5. _____	1. _____	5. _____
2. _____	6. _____	2. _____	6. _____	2. _____	6. _____	2. _____	6. _____
3. _____	7. _____	3. _____	7. _____	3. _____	7. _____	3. _____	7. _____
4. _____	8. _____	4. _____	8. _____	4. _____	8. _____	4. _____	8. _____

FIGURE 5-15

Example gauge pattern illustrations are shown in Figure 5-16. Note the useful reference dimensions in describing gauge distribution.

The third section of the data sheet is the actual data recording section. Measurements for thickness, pitting, and grooving are recorded in the spaces provided. The panels should be sized so that all gauge points will fit on one data sheet. If this proves impossible or impractical, certain panels may require two data sheets.

The surveyors will be responsible for completing these forms. However, the general section and panel references should be completed during the pre-survey planning stage. It is recommended that all the forms be completed to the extent possible during the planning stage. The survey will flow smoothly and quickly if surveyors are responsible for only data recording and gauge illustration.

5.3 Data Analysis

Once the survey team has completed their recording responsibilities, the next step is to computerize the data and conduct subsequent analyses. All of the raw data will be entered into a master database, from which users can calculate and compare corrosion rates, perform trade-off studies and predict outcomes for various conditions. The intent of this section is to describe the database configuration and application, and also to discuss how an expert system may be utilized.

5.3.1 DataBase Configuration

The use of a database for the corrosion survey methodology serves two purposes:

1. Allows for standardized data storage and retrieval;
2. Able to interface with customized statistical analysis programs and expert systems.

The database must be configured to facilitate easy data entry and provide flexible data analysis.

Data is stored within three separate subgroups according to corrosion type. Each type of corrosion likewise has associated data parameters that receive independent analysis (i.e., thickness, pit depth, groove diameter, etc.). Figure 5-17 illustrates how the database is subdivided. The database is essentially divided according to classification codes within each ship (Section 5.2.1). Each classification code has associated compartment and panel correlation parameters in addition to eight

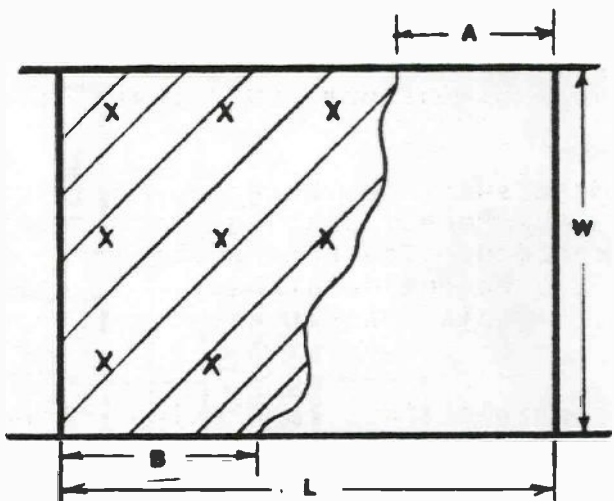

X = THICKNESS GAUGE READING

EVEN AREA COVERAGE OF WASTAGE PATTERN

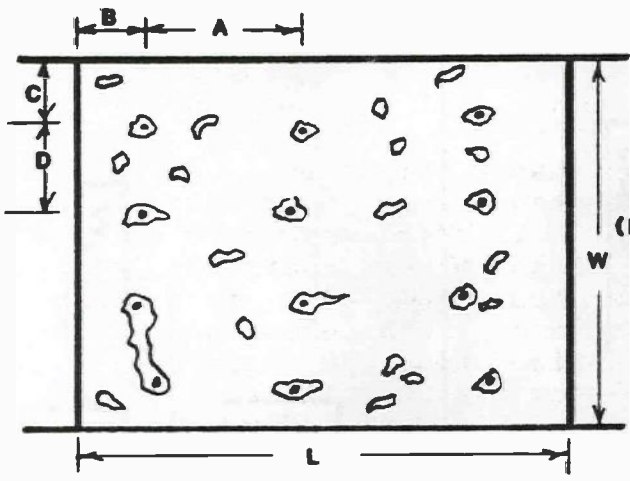

⊙ = PIT DEPTH READING
(DIAMETERS TAKEN AT SAME PITS)

(4x3) MATRIX PATTERN COVERAGE

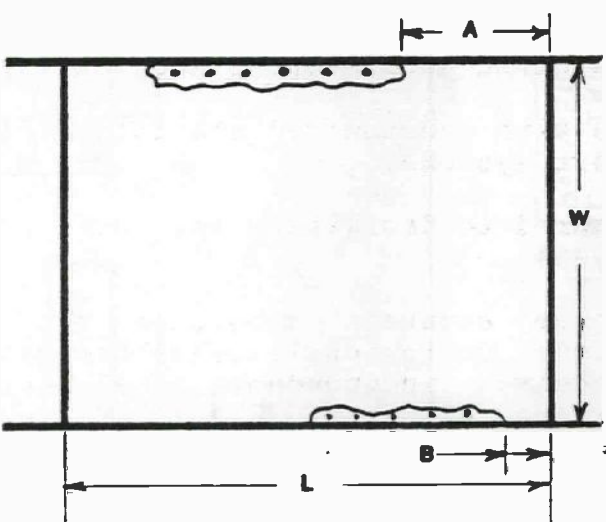

• = GROOVE DEPTH READING
(DIAMETERS TAKEN AT SAME POINTS)

EVENLY DISTRIBUTED PATTERN ALONG GROOVE LENGTH

FIGURE 5-16
EXAMPLE PANEL GAUGING PATTERNS

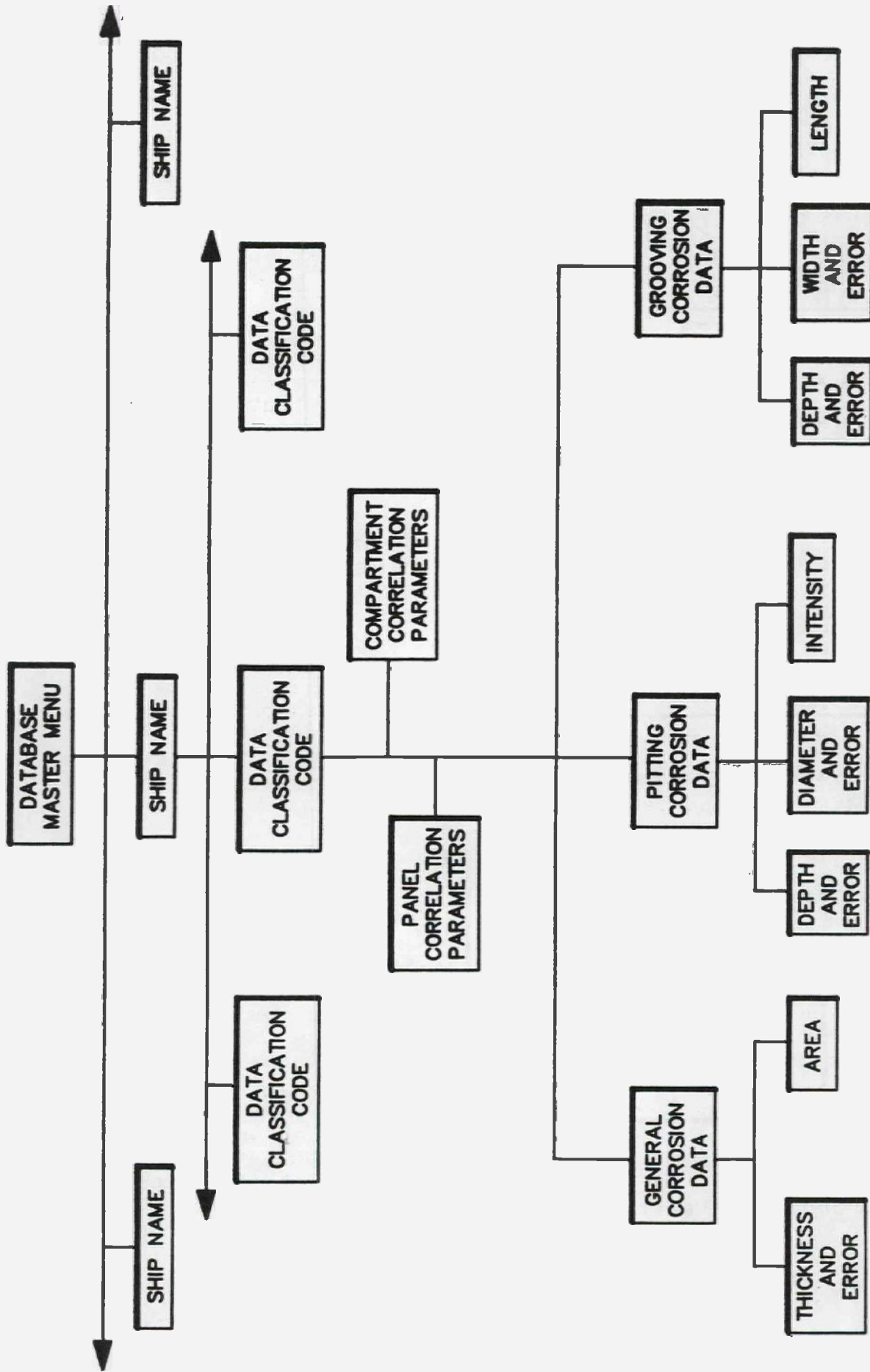

FIGURE 5-17 DATABASE CONFIGURATION

data requirements. Organization of the database in this format allows for easy data entry, code isolation and/or grouping. The database offers three functions that are controlled through a master menu: data input, editing and analysis.

After the corrosion database is formed, the data must be readily accessible to users. The users must be able to enter new data, maintain existing data, and analyze data to predict corrosion rates. Database systems are used routinely in business however, the corrosion database would be most accessible by the maximum amount of people if it were combined with an expert system.

An expert system performs a task that specially trained people can perform but other people cannot. The goal of an expert system is to enable a user to obtain a solution for a problem through an interactive session with a computer. The computer expert system first asks the user questions about his problem. This interface system facilitates access to data, performs the necessary computations, and presents the results in a summarized format.

There are several expert system shells (5-3) that could be modified to provide the interface between the user and the corrosion database. They consist of "if, then" statements that provide the working mechanism. Additional explanation is available to provide backup information for the analysis results. The advantages of using existing shells is that the shell is easy to modify and custom-designed features, such as graphic displays, enhanced help and explanation facilities, further documentation, and maintenance options can be added by the experienced system developer as needed.

Thus, it is highly recommended that the expert system be employed to interface with the corrosion database.

5.3.2 Data Input

Data input consists of all the necessary information needed for accurate corrosion rate determination. In addition to raw data, the database must store codes, dates, correlation parameters and measurement errors. It is envisioned that the data input procedure be highly interactive and user friendly, allowing for expediency and simplicity. Figure 5-18 illustrates the proposed data input sequence. Once access to the database is established, a master menu must be used to input data. Information from all three form types will be required by the database.

After selecting the input option, the user is prompted for the ship name followed by interactive entry of the particular data classification code. Each parameter of the classification code is entered individually through a sequence of interactive prompts. A list of code parameters is displayed on the screen

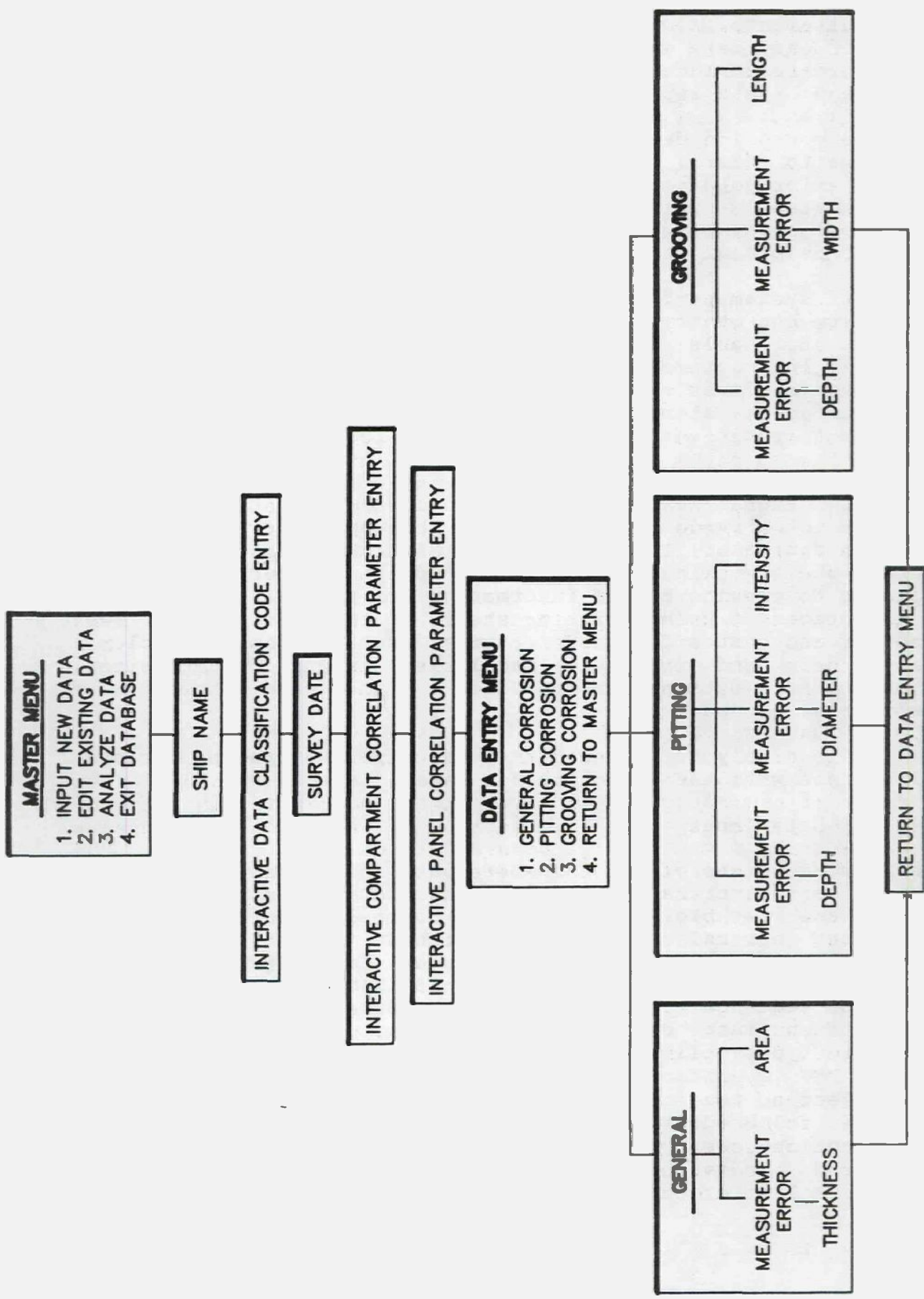

FIGURE 5-18 DATA INPUT SEQUENCE

for ship type, compartment type and structure type. The user is asked to select the appropriate code parameter. Panel number is entered as the last parameter directly from the data sheets. Ship number is automatically assigned to the classification code by the database program in accordance with ship type.

Following the classification code is the survey date, compartment correlation parameters and panel correlation parameters. The date is entered directly in "Month,Year" format. All correlation parameters are interactively entered in similar fashion to the classification code.

Corrosion type identification follows parameter input. After which, measurement effort and actual data are entered. Data input should be a quick and easy process that is read right off of the survey report forms. A sample data input sequence is shown in Figure 5-19.

After completing input of data for a particular corrosion type, the user is prompted to enter data for another corrosion type (still within the same code). After completing entry of all data for a given code, the user is returned to the master menu and may start the input sequence all over again. However, if the same compartment is still being used, then compartment correlation parameters will remain the same as before and do not have to be entered a second time. The database program will automatically recognize this and not prompt the user for compartment correlation parameters. If a compartment, thus code, is entered that differs from the preceding one, then new correlation parameters must be input.

5.3.3 Data Editing

The second function the database is data editing. In addition to the input of new data, a user may wish to edit existing data or correlation parameters. Data editing is an option that appears in the database master menu. Upon selection of this option, the user can change correlation parameters or data. The data editing sequence is illustrated in Figure 5-20. This is a menu-driven sequence that enables operators to zero-in on particular data or parameters and effect changes therein. Again, Figure 5-20 illustrates content and format. Upon selection of option two in the master menu, the operator is prompted to enter the ship name from which data is to be edited. The database scans its list of ship names until the appropriate one is located and then displays all current data classification codes contained under that ship name. The operator is then asked to select a particular classification code that contains the survey date and/or parameters to be edited. Once the proper code is identified, the edit menu appears and offers four edit options: compartment correlation parameter, panel correlation parameter, data and survey date.

Figure 5-19
Sample Data Input Sequence

Corrosion Database Master Menu

Select One:

1. Input New Data
2. Edit Existing Data
3. Analyze Data
4. Exit Database

:1

Enter ship name:

:John Doe

Enter Ship Type, select one:

B-Breakbulk	M-Chemical Tanker
C-Container	P-Products Tanker
D-Drybulk	R-Ro/Ro
G-LNG	S-Semisubmersible
H-Heavylift	U-ULCC
I-ITB	V-VLCC
L-Lash	O-Other

:C

Enter compartment type and number, Select one followed by number:

B-Ballast Only
L-Liquid Cargo
D-DryCargo
X-Liquid Cargo/Dirty Ballast
Y-Liquid Cargo/Clean Ballast
Z-Dry Cargo/Ballast

:B2

Enter Structure Type, Select One
(screen displays list of structures)

Figure 5-19 (cont)

:SSP

Enter panel number (1-9):

:2

Compartment Correlation Parameters

Enter primary navigational route (city, city):

:Rotterdam, New York

Enter compartment content, select one:

1. Ballast
2. Bulk
3. Container
4. Petroleum/vil
5. Chemical
6. Combination of above

:1

Enter estimated time in Ballast (%)

:50

Enter average ballast level (FT)

:20

Note: Each of the six content options will trigger different clarifiers following the same format as the compartment correlation parameter sheet.

Is compartment coated (y/n)

:Y

Enter type of coating, Select one:

1. Paint
2. Inorganic Zinc
3. Coal Tar Epoxy
4. Pure Epoxy
5. Other

:2

Enter extent of coating, select one:

Figure 5-19 (cont)

1. Complete

2. Partial

:2

Enter percent of compartment coated;

:75

Enter average time between coatings (years)

:3

Are anodes used (Y/N)

:Y

Enter type of anode, select one:

1. Zinc

2. Aluminum

3. Other

:1

Enter compartment humidity, select one:

1. 0-50%

2. 50-60%

3. 60-70%

4. 70-80%

5. 80-90%

6. 90-100%

:2

Is tank washing used (Y/N)

:N

Note: If tank inerting is used, prompts for medium would follow.

Panel Correlation Parameters

Is panel coated (y/n)

:Y

Is panel anode protected (y/n)

:N

Is panel in a residual-liquid zone (y/n)

Figure 5-19 (cont)

:N

Is panel in a village zone (y/n)

:N

Is panel in a splash zone (y/n)

:Y

Enter type of corrosion, select one:

1. General
2. Pitting
3. Grooving
4. Return to master menu

:1

Enter area of panel experiencing wastage (%)

:90

Enter thickness measurement error (mils)

:10

Enter thickness data (return after each entry, double return signifies end of data entry)

:120

:115

:122

.

.

.

.

:118

:

:

:

Enter type of corrosion, select one:

1. General
2. Pitting
3. Grooving
4. Return to master menu

Figure 5-19 (cont)

:2
Enter intensity of panel pitting (%)
:15
Enter depth measurement error (mils)
:10
Enter Depth Data
:80
:60
:70
. .
Enter diameter measurement error (mils)
:10
Enter diameter data
:50
:55
:60
Enter type of corrosion, select one:
1. General
2. Pitting
3. Grooving
4. Return to master menu
:4
Corrosion Database Master Menu
Select One:
1. Input New Data
2. Edit Existing Data
3. Analyze Data
4. Exit Database
:4

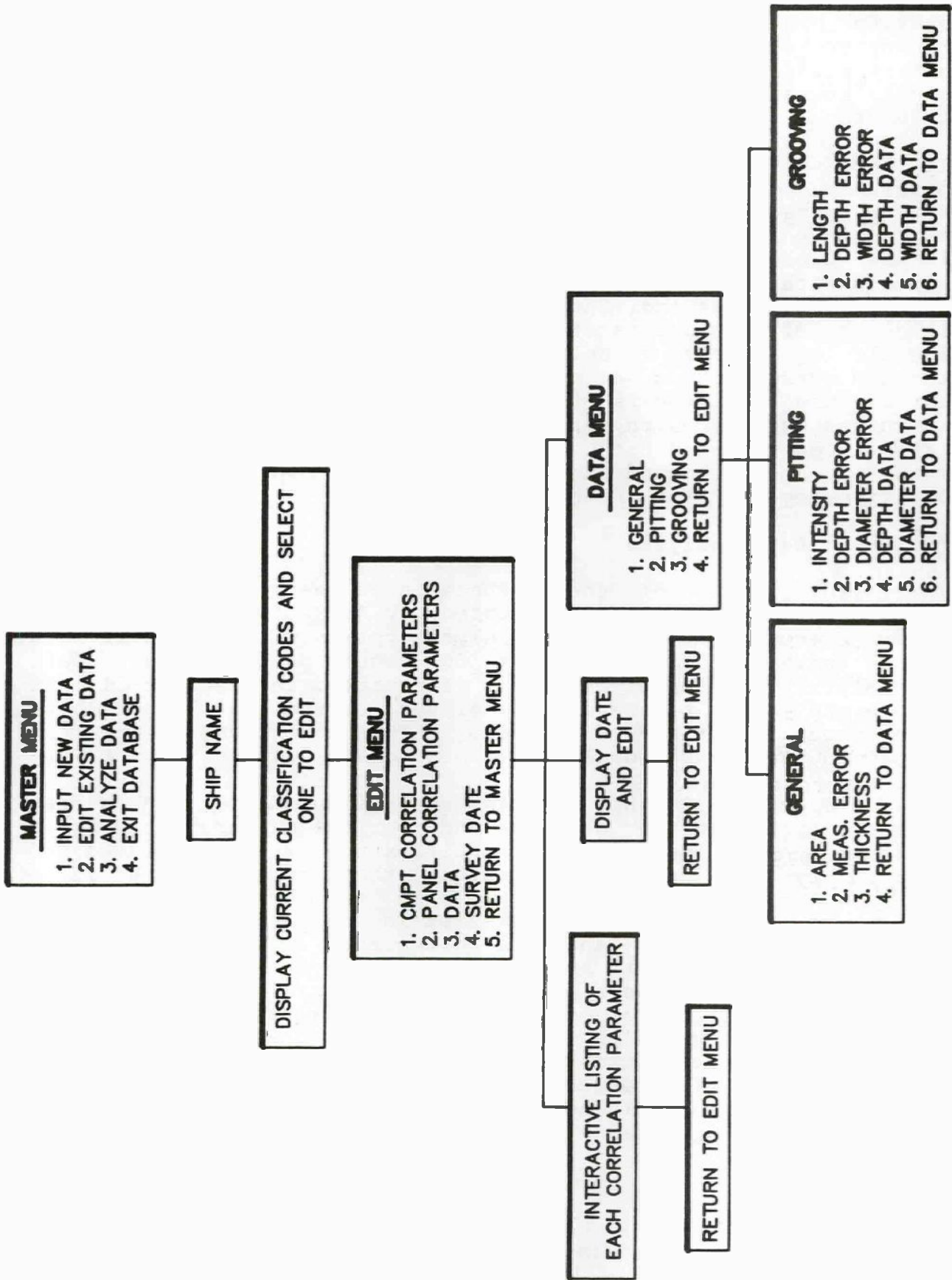

FIGURE 5--20 DATA EDITING SEQUENCE

If correlation parameters are selected, the existing parameter responses are displayed on the screen in line format and the operator is asked whether changes should be made. If yes, parameter responses are displayed one at a time allowing the operator to edit. A return without changes through parameters simply keeps the existing responses as defaults. Once each parameter is examined, the user is returned to the edit menu.

If the survey date option is selected, the current date is displayed and the user can change month or year. The user is then returned to the edit menu.

If the data option is selected in the edit menu, a data menu appears with options to edit the three corrosion data types. Each data type has individual data parameters that can be edited. Selection of a data parameter (i.e., thickness, depth) results in the display of the actual data which can be individually edited through cursor or mouse control. After data parameters are edited, the operator is transferred back to the data menu from which another corrosion type can be selected. The data menu can transfer an operator back to the edit menu and then to the master menu. A cancel command executed anywhere in the database should position the operator in the previous menu.

5.3.4 Data Analysis

The third function of the database is to analyze data following the statistical guidelines presented by ASTM (4-1) (See Section 4-4. Execution of the data analysis option will result in mean values with associated errors for each of the eight data parameters. A sample output is illustrated in Figure 5-21. Of the eight data parameters analyzed, three will not have associated, quantifiable errors. This is because no error is placed on their individual measurement or observance.

Note in Figure 5-21 that results are presented for each survey date currently in the database and for the differences between subsequent chronological dates. Differences are calculated and divided by the number of months, then multiplied by 12 to determine annual corrosion rates. In the hypothetical sample shown, only two dates currently exist in the database. Therefore each individual date and the difference is shown. The classification code(s) being analyzed are also presented along with a listing of compartment and panel correlation parameters. Multiple classification codes may be analyzed together in a single output provided that all associated correlation parameters match. Data classification code correlation will be assured through the use of an expert systems interface to the database. The expert system will not permit the combined analysis of data that does not correlate.

AVERAGE CORROSION VALUES (mils)

CORROSION TYPE	DATA PARAMETER	SURVEY DATE 1 (MM,YY) 05,85	SURVEY DATE 2 (MM,YY) 09,87	1-2 MONTHS 28	ANNUAL CORROSION RATE
General	Thickness	200 +/- 3	150 +/- 3	50 +/- 6	21.4 +/- 2.5
	Area	50%	80%	30%	12.9%
Pitting	Depth	12 +/- 2	28 +/- 2	16 +/- 4	6.9 +/- 1.7
	Diameter	10 +/- 2	25 +/- 2	15 +/- 4	6.4 +/- 1.7
	Intensity	10%	15%	5%	2.1%
Grooving	Depth	14 +/- 2	30 +/- 2	16 +/- 4	6.8 +/- 1.7
	Width	16 +/- 2	30 +/- 2	14 +/- 4	6 +/- 1.7
	Length	39 inches	45 inches	6 inches	2.6 inches

Compartment Correlation Parameters

1. Navigational Route: Rotterdam, NY
2. Compartment Content: Ballast
3. Time in Ballast: 50%
4. Coating: Coal Tar Epoxy
5. Anode: Zinc
6. Humidity: 60%

Panel Correlation Parameters

1. Residual Zone: NO
2. Ullage Zone: NO
3. Splash Zone: NO
4. Wet Zone: YES
5. Coated: YES
6. Anodes: YES

Data Classification Codes

1. C02B2SSP1
2. C02B3SSP1
3. C04B2SSP1

Figure 5-21. Sample Data Analysis Output

Figure 5-22 illustrates the sequence required for data analysis. Upon selection of the analysis option in the master menu, the analysis menu appears. Analysis of data requires the input of desired data classification codes. The analysis menu offers two ways of imputing classification codes: directly or interactively.

The direct input option requires that the operator have knowledge of the codes and enter them as they are stored in the database (i.e., C02B2SSP2). It is likely that the operator may not know ship, compartment and panel numbers thus prohibiting direct code entry. The preferable method of code input is interactively. The user is prompted individually for ship, compartment and structure type. The database will respond with a list of classification codes (including ship compartment and panel numbers) that correlate suitably for analysis. Therefore the operator is freed from the constraint of knowing ship, compartment and panel numbers. The operator has the option of selecting and analyzing individual codes from the correlated listing instead of analyzing the entire list (even though correlation is assured). After the analysis is completed and results obtained, the user is returned to the analysis menu to continue or exit.

5.4 Program Implementation

The scope of a corrosion survey required to obtain corrosion data and infer corrosion rates depends to a large extent on the application. For example, corrosion in containerships occurs primarily in ballast tanks and in the cargo hold which will most likely be inaccessible unless the ship is pierside or in drydock. On the other hand, corrosion occurs in the majority of internal structure in tankers and extensive at-sea surveys are required to minimize interference with operating schedules. Tanker surveys are conducted over a two to three week timeframe with three people obtaining data.

Regardless of the scope of the corrosion project anticipated, the survey methodology presented in this report could be easily modified to meet the user's needs. An individual problem area may be studied and a margin assigned. However, the scope of a corrosion survey program planned to obtain corrosion rates and assess corrosion margins in ships in general is an extensive undertaking. In the latter case, a consortium should be considered where data would be contributed, according to the methodology described herein, to form the required database. The survey should start by examining key areas such as bottom structure and expand the database as more interest and funding materialize.

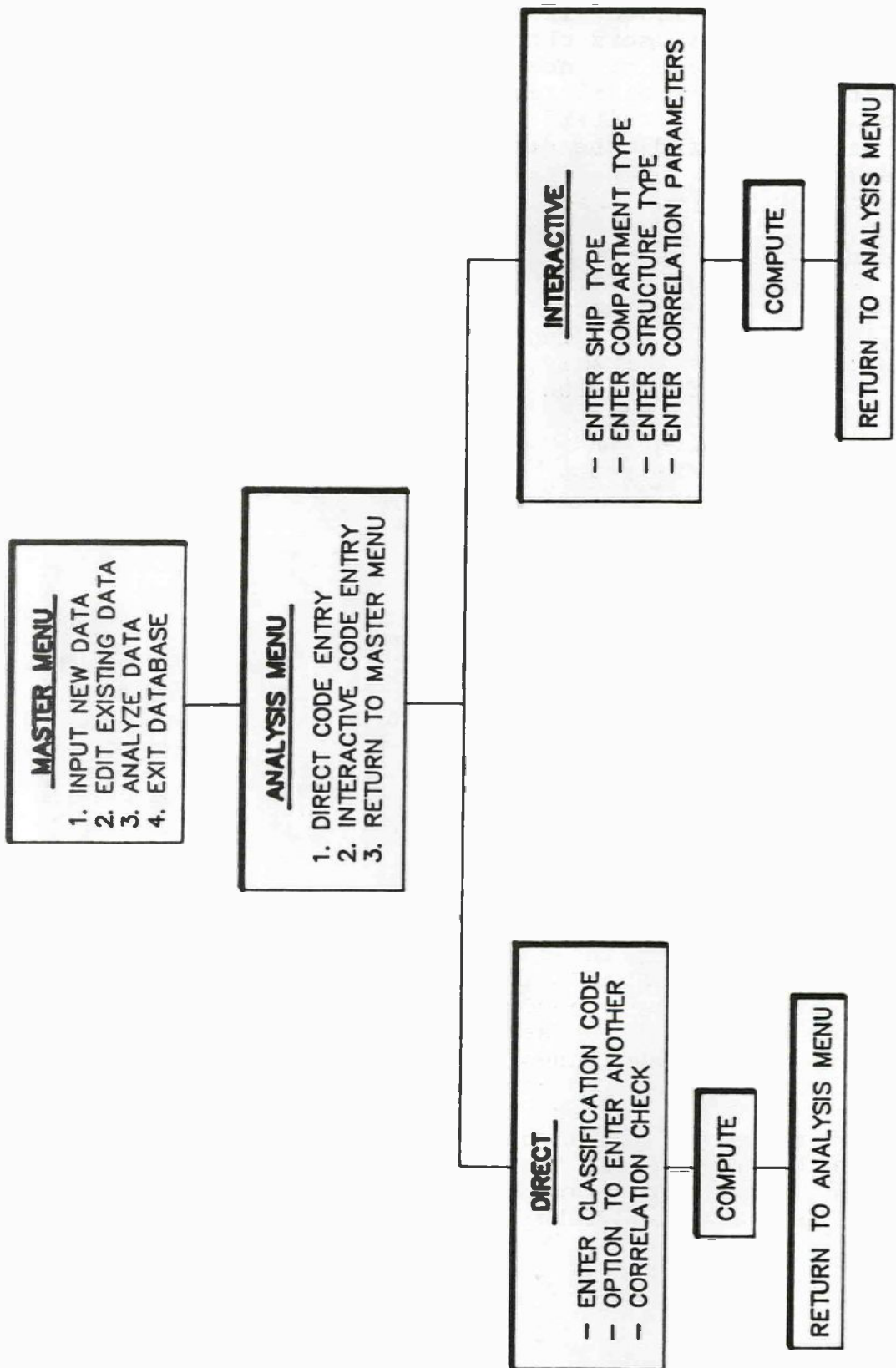

FIGURE 5-22 DATA ANALYSIS SEQUENCE

The extent and duration of any program should be determined based on the accuracy calculations presented in Section 4.4. Each set of data is then included in the database with an associated quantified error. Data users can then determine for themselves whether to use the data or not, if it suites their individual needs or requirements. Similarly, if existing corrosion data meets the accuracy criteria and appropriate correlation parameters are documented, the data could be evaluated for entry into the database.

6.0 CONCLUSIONS AND RECOMMENDATIONS

The following conclusions and recommendations are presented here for review prior to implementing a corrosion rate survey.

1. The corrosion rate survey should be based on visual inspection, ultrasonic measurements and statistical data characterization and analysis.
2. Coordination and planning are essential to cover extensive surveys efficiently;
3. Because many variables influence corrosion rates, it is difficult to establish a large database for any given set of conditions. Therefore, care must be exercised to standardize the data acquisition and locations to minimize errors.
4. The corrosion rate survey methodology is applicable to differing requirements ranging from investigating specialized locations to developing extensive databases.
5. An expert system should be used to interface between the user and the corrosion database.
6. Research should be conducted to develop methods for analyzing the strength of partially corroded or pitted plates and structural members to aid in the development of rational corrosion margins.

7.0 REFERENCES

- 2-1 Exxon Corporation, "Large oil tanker structural survey experience," 1982.
- 2-2 Weber, P.F., "Structural Surveys of Oil Tankers," IMF, RINA, 1984.
- 2-3 Moore, T.R., "Corrosion and Association Problems: Eating up the maintenance and Repair Budget - A VLCC operator's experience," Chevron Shipping Co., ShipCare 81.
- 2-4 Munger, C.G., "Deep Pitting Corrosion in Sour Crude Oil Tankers," Sixth International Congress on Metallic Corrosion, Sydney, Australia, 1975.
- 2-5 U.S. Coast Guard, "Marine Board Casualty Report: M/V Chester A. Poling; sinking in the Atlantic Ocean on 10 January 1977 with Loss of Life," 1979.
- 2-6 Stambaugh, K., Wood, W. "Ship Fracture Mechanisms Investigations," Draft final report, Giannotti & Associates, Inc., December 1986.
- 2-7 Nippon Kaiji Kyokai, "Guide to Protection Against Corrosion of Ship's Hull and Equipment", October 1986.
- 2-8 Private Communications with Container Ship Operator
- 3-1 Little, R.S., Discussion of Committee 10 Report, Proceedings of the International Ship Structures Congress, OS10, 1967
- 3-2 Evans, J.H., "Ship Structural Design Concepts," Cornell Maritime Press, 1973
- 3-3 "Pilot Study on the Effect of Pitting upon the Strength of Plates", Tanker Structure Cooperative Forum, Project 300, 1984
- 3-4 Haroun, M., Erbar, R., Heidersbach, R., "The Use of Computers in Corrosion Control and Monitoring," Corrosion/86, NACE, 1986.
- 3-5 ICAS Unified Requirement S.7.
- 3-6 "Standard Definitions of Terms Relating to Corrosion and Corrosion Testing," American Society of Testing Materials, G15-85a, 1985
- 4-1 "Standard Practice for applying statistics to analysis of Corrosion Data," American Society of Testing Materials, G16-71, 1971

- 4-2 "Gauging accuracy and Gauging guidelines," Tanker Structure Co-operative Forum, Project 101, 1984
- 5-1 "Guidance Manual for the Condition Assessment of Tanker Structure," Tanker structure Co-operative Forum.
- 5-2 "International Safety Guide for Oil Tankers and Terminals", (ISGOTT, 2nd edition)
- 5-3 Pessal, N., Schreurs, J., "Expert Systems Development By Corrosion Specialists," 1986