

**STRUCTURAL COMPOSITE ARCHITECTURE MADE OF WASTE**  
Material Aware and Circular Design inspired by Nature's Strategies  
Stefanie Tsegai / 1513613 / Delft University of Technology



# 1. INTRODUCTION

In Western society waste is produced in large quantities, often without acknowledging the qualities it might still have. In 2010 the Netherlands produced almost 60 kton of waste (Compendium voor de Leefomgeving, 2010). In processing of this waste 88 per cent is designated as 'useful application', 9 per cent is burned, 2 per cent is land filled and 1 per cent is dumped (Ibid.). See graph 1-3. 'Useful application' includes preparation for re-use, recycling and use as fuel, indicating more waste is burned than merely 9 per cent. Indeed in 2010 an extra 1268 kton was incinerated (Compendium voor de Leefomgeving, a 2015)

Yet at the other end of our consumer society, the start, a constant shortage of primary material resources is apparent. In the Netherlands the total demand for building materials is approximately 150 million tons per year, dependent on large-scale infrastructural projects (Compendium voor de Leefomgeving, b 2015). Up to 20 per cent consists of reused secondary building materials and the majority of the remaining part consists of surface minerals, which are mainly derived in the Netherlands, although an increasing part is imported (Ibid.). Whereas the government attests that the Dutch stock of surface minerals is geologically 'very large', mainly spatial, societal and economical aspects determine its finiteness (Ibid.).

Annually 100 to 150 ha land area is used for the extraction of surface minerals (gravel and sand for concrete and masonry), mainly in provinces rich in sand: Gelderland, Overijssel, Noord-Brabant en Limburg (Rijksdienst voor het Cultureel Erfgoed, 2009). In Limburg also silver sand, lime and marl is extracted (Ibid.). In the southeast of Limburg deep mining for coal constituted the industry, which especially provided great economic prosperity for the region. The coalmines were closed between 1965 and 1974 and despite initiatives of the national government to provide new job opportunities, closing of the mines resulted in a decline of local economy (Bontje, 2009, p. 28). A development reciprocally accompanied by demographic changes, i.e. migration of the working population, younger generation and higher educated, which is dubbed *krimp* (shrink) in Dutch.

Eight municipalities in the southeast of Limburg, formerly known as the Eastern Mining Area, have formed a collective body *Parkstad Limburg* in order to transform the region. They have decided to accept the demographic changes and use it as a change to improve environmental living and work quality

(Structuurvisie Parkstad Limburg, 2009, p. 3). Moreover, the region has recently been designated as *Internationale Bau Ausstellung* (IBA) to invigorate local economy, space and society (IBA Open Oproep, 2013, p. 2). Until a final exhibition in 2020 IBA Parkstad will function as a laboratory and empowerment for innovative ideas and projects (Ibid.).

Therefore the question: how to propose an incentive for new industrial activity? Assuming novel technologies can answer to the interruption in continuity of work, it seems logic these innovations should be closely related to the historic industries of the region. Bearing in mind the heritage of these industries is not only present in physical form, such as infrastructure and buildings, but also in immaterial modes, such as knowledge and identity.

Combining the before mentioned issues of excessive waste, scarcity and the discontinuing of traditional mining in Parkstad, an answer is offered by forward-thinking theories, which eliminate the concept of waste, like industrial ecology, the Blue Economy, Cradle2Cradle and Urban Mining. For example, in his book the Blue Economy, Pauli (2010, p. 6) explains learning from models in natural ecosystems could be the solution to both the environmental challenges of pollution and the economic challenges of scarcity, since 'in nature, the waste of one process is always a nutrient, a material, or a source of energy for another.' He exemplifies that many industrial processes are inefficient, using resources we do not have and generating (often toxic) residues; natural ecosystems on the other hand are self-sufficient, often achieving overabundance and diversity, while only using locally available resources (Ibid., p. 8-9). Therefore Pauli emphasizes that in designing industrial processes we ought to learn from natural ecosystems.

This paper aims to comprehend the complete process of producing a structural composite made of uniform and consistent waste streams, abundantly available in or close to the Parkstad region. The factory of this composite ought to function as a cyclifier. *Cyclifiers* are defined as metabolic processors that decrease system-level inputs and outputs by operating in ecological niches, creating symbiotic connections, and increasing resource efficiency (Jongert, Nelson & Korevaar, 2015, p. 1).

The starting point for development of this novel building material constitutes of using bacterial alginate (ALE) as a binder. ALE is retrieved from the Nereda wastewater treatment process, researched by PhD student Jure Zlopasa from the faculty of Civil

Engineering at Delft University of Technology. Consequently several locations for the factory are selected, based on the availability of waste resources and site requirements due to the production processes. Finally the defined processes are illustrated in a Material Flow Analysis and translated into a program of requirements for the factory. The program of requirements includes spatial requirements due to the composite's production process and technical guidelines due its mechanical properties. Ultimately is strived for an authentic architectural application of the composite, illustrating the possibility of up-cycling low valued waste streams.

Hence the main research question of this paper is: How to design a factory, which functions as a

cyclifier and where a structural composite can be produced and applied, which is made of bacterial alginate (ALE) as a binder and (biomass) waste materials as aggregate and fibre? In order to answer the main question the following sub questions are formulated: (1) What are the properties of ALE and reference composites with ALE as binder? (2) How can the non-waste components be substituted by local rest or waste streams using Material Flow Analyses? (3) Which model making and fabrication methods are suitable to explore the architectural possibilities of the composite? In the following section the research framework and strategy are described, then the results are presented, to end with the conclusion and discussion.

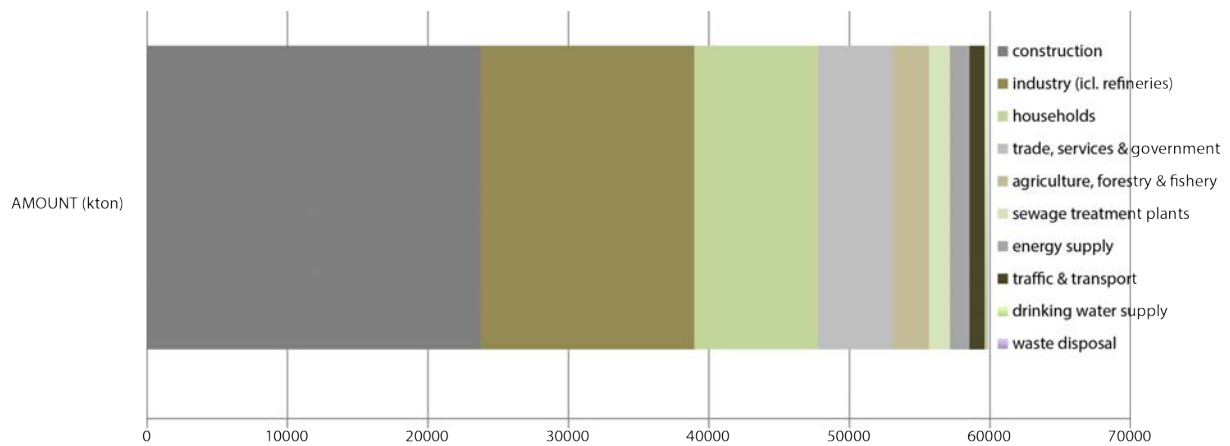

Graph 1: Waste generation per sector in the Netherlands in 2010 (Compendium voor de leefomgeving, 2010).

Graph 2: Waste management in the Netherlands in 2010 (Compendium voor de leefomgeving, 2010).

Graph 3: Waste management of sewage treatment plants in the Netherlands in 2010 (Compendium voor de leefomgeving, 2010).

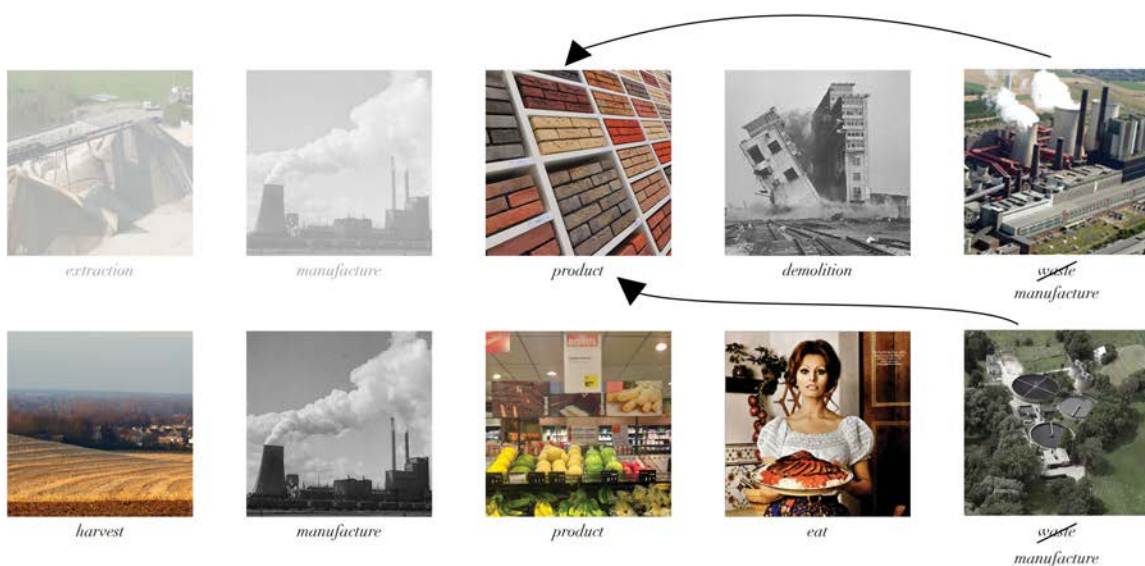

Image 1: The linear life cycle of materials and products and the proposed intervention (Own image based on Addis, 2006, p. 13)

By closing material and energy loops a linear (open) process is transformed into a cyclical (closed) process, the principle of round put (2012 architecten, 2009, p. 4). Consequently the environment is no longer depleted from its resources nor used as sink for wastes such as heat (Ibid).

## 2. RESEARCH FRAMEWORK & STRATEGY

The term composite is derived from the French or Latin word *compositus*, meaning ‘made up of various parts or elements’ (Oxford English Dictionary; on Historical Principles, 1993). Essential in the definition is the notion that the product is greater than unity and that its constituents remain recognizable (Ibid.) Modern structural composites are mixtures of two or more components: stiff long fibres and a matrix, which affixes the fibres (Chollakup, Nardin, Smitthipong, 2015, p. 1). By layering the fibres and matrix in different directions it is possible to customize the directional strength and stiffness to the occurring loads (Ibid., p. 2).

The process of producing a structural composite from uniform and consistent waste streams takes place on different scale levels: a regional scale for the collection of waste resources; the scale of a compound or building, which might consist of only one space, for the fabrication of the material; and since the material is a composite, fabrication also requires a much smaller scale at the level of its components, which ranges from visible with the bear eye to microscopic.

To ensure a research scope within the architectural realm, a strategy is set out in steps, addressing each scale, but always considering the possible architectural effects of the investigated topic. First literature is studied on the alginate from the Nereda process and example composite materials using alginate as a binder. Then the properties and role of its components are defined in order to replace virgin material with local waste materials possessing similar characteristics. Additionally a Material Flow Analysis (MFA) is made of the production process of the example composite, which functions as a basis for the MFA of the designed waste composite. Subsequently suitable locations for an ALE-waste composite factory are selected based on vicinity of the waste streams and a set of logistic and environmental criteria. Finally architectural model making and production techniques are selected, in order to explore the functional, technical and especially the aesthetic potential of the novel composite material. This selection is based on a few material samples, technical literature and an analogy with existing composite materials.

### Principles & Tools

For inventorying local waste materials and defining the production processes, principles and tools are employed from industrial ecology. Industrial ecology considers non-human natural ecosystems as models for industrial activity, with a focus on manufacturing processes and product design (2012 architecten and

Goossens, 2009, p. 3). It signifies a holistic approach, since it takes into account the total functioning of a system rather than particular parts (Ibid. p. 10). This ‘system perspective’ and ‘system analyses’ aim to prevent limited and incomplete studies, which might lead to poor designs with negative effects (Ibid.). Principles such as recycling of materials, cascading of energy, symbiosis and diversity are fundamental; these are listed in table 1. Tools can be divided into two types (table 3): with a focus on the product, the products life-cycle and product chain; or with a focus on analysis of the metabolism and flows of a system (Ibid., p. 16). The research described in this paper concentrates on using Material Flow Analyses to close material and energy cycles.

### Criteria

Before selecting the example composite, a survey was done of different bio-based composite products, some completely and others partly made of waste. In order to assess the products for further research the following criteria were employed: true waste, low-tech production, scalable and non-chemical. In order to define the position of the material within an edifice, supplementary criteria were: biodegradable, durable, weather proof, fireproof, load bearing, self-supporting and insulating.

From the survey a limited list was made of promising waste resources available in the Netherlands. Once more these were assessed after interviewing researchers from Wageningen University and Delft University of Technology. In the interviews extra aspects were put forward, such as susceptibility of the materials to microorganisms and humidity. More importantly, in the interviews it became evident that availability of information is an essential criterion to enable further research, on the one hand due to the status of scientific research into bio-based resins, on the other hand due to confidentiality commitments of the researchers.

Therefore not only fulfilling the aforementioned requirements, but especially availability of information influenced the choice to continue the research based on the studies of Jure Zlopasa and Natalie Carr, PhD students at the Civil Engineering faculty of Delft University of Technology. Zlopasa works in the field of internal and external curing systems of cement based materials, with a focus on bio-based curing compounds, such as ALE, and microstructure performance. Carr is developing renewable sustainable cement, BioCement, based on ashes derived from incinerating biomass residues.

Finally, an important aspect to take into account when fabricating a composite material is preventing the creation of a 'monstrous hybrid', i.e. a product or material comprised of biological and technical components, which are difficult to separate and recycle in either the ecosphere or technosphere (McDonough & Braungart, 2002, p. 59). Hence it is necessary to have a clear definition of components belonging to either one

of the spheres. 'To eliminate the concept of waste means to design things -products, packaging, and systems- from the very beginning on the understanding that waste does not exist. It means that the valuable nutrients contained in the materials shape and determine the design: form follows evolution, not just function' (Braungart and McDonough, 2002, p. 104).

| Principle                                  | Example                                                                                                                                                                                                                                                                                                                                                                                                                                                                                                                                                                                                                                                                                                                                                                                                                                                                                                                                                                 |
|--------------------------------------------|-------------------------------------------------------------------------------------------------------------------------------------------------------------------------------------------------------------------------------------------------------------------------------------------------------------------------------------------------------------------------------------------------------------------------------------------------------------------------------------------------------------------------------------------------------------------------------------------------------------------------------------------------------------------------------------------------------------------------------------------------------------------------------------------------------------------------------------------------------------------------------------------------------------------------------------------------------------------------|
| Analogy between technosphere and biosphere | <p>Round put: close material and energy cycles.</p> <p>Dematerialisation (or eco-efficiency*): disconnect the use of virgin resources and impact on the environment from economic growth.</p> <p>Symbiosis: mutual relationship between different species (or companies).</p> <p>Industrial metabolism: material and energy uses and flows in an industrial area.</p> <p>Locality: adaptation of the system to local circumstances (use of local or regional resources) and recognition of local limiting factors.</p> <p>Integration in the wider context: controlling and adapting scale of industrial activity to carrying capacity of surrounding ecosystem.</p> <p>Diversity: variety in species fulfilling a role and within each species, which generates flexibility and resilience of the ecosystem.</p> <p>Gradual change: comparing the wish of companies to multiply themselves, production methods and products to reproductive capacity of organisms.</p> |
| Use of systems perspectives and analysis   | <p>Complexity theory: intertwinements of sub-systems, frequently to the extent it infers 'path dependency' or even 'technology lock-in'.</p> <p>Multi- and interdisciplinary approach: enables synergetic collaboration, but also involves dissimilar and difficult to assimilate stances.</p> <p>Levels and layers in the system: activities occur within a hierarchy of layers (see image 2).</p>                                                                                                                                                                                                                                                                                                                                                                                                                                                                                                                                                                     |

Table 1: Core principles in industrial ecology and corresponding examples (2012 architecten and Goossens, 2009, p. 4).

\*Or better, aim for 'eco-effectiveness' by starting from redundancy instead of reduction in accordance with the cradle-to-cradle concept (Ibid., p. 6).

| Focus                                          | Tool                                                                     |
|------------------------------------------------|--------------------------------------------------------------------------|
| Product, products life cycle and product chain | <p>Life Cycle Analysis (LCA)</p> <p>Product chain analysis</p>           |
| Analysis of metabolism and flows of a system   | <p>Material Flow Analysis (MFA)</p> <p>Substance Flow Analysis (SFA)</p> |

Table 2: Tools and their focus in industrial ecology (based on 2012 architecten and Goossens, 2009, pp. 16-17).

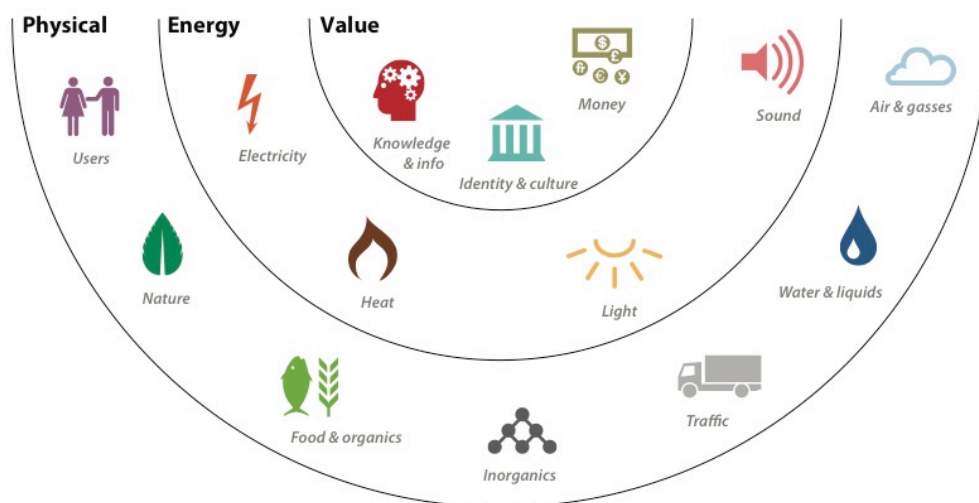

Image 2: The categories of layers with their flows (Jongert, Nelson and Korevaar, 2015, p. 3).

### 3. RESULTS

The search, described in the previous section, for a biomass waste stream suitable as resource for a structural composites ended surprisingly at one of the lowest valued biomasses: sewage. A novel treatment process of sewer water, developed by professor van Loosdrecht and Picken from Delft University of Technology, not only simplifies purification, but also makes it possible to perceive a sewage treatment plant as infinite mine for valuable materials. In the following sections the results of each of the sub-research questions is presented.

#### **PROPERTIES OF ALE & REFERENCE COMPOSITES WITH ALE AS BINDER**

In this section, first the wastewater treatment process is described and its spatial and financial advantages, then the polymer ALE is explained, its properties and a few applications. This paragraph is concluded, by comparing the ALE example materials with historic cement based composites, in order to define the substituting waste components and their roles for the objectified structural composite.

#### **Sewage: an infinite mine**

Sewage in the Netherlands is treated according to the activated sludge process. Activated sludge is defined by Van Loosdrecht and Brdjanovic (2014, p. 1452) as 'a mix of inactive solids from sewage and a microbial population, which grows on the biodegradable substrates in the sewage'. They explain that 'the morphogenesis of the microbial communities in activated sludge is a complex process based on the interaction of microbiological, chemical and physical processes' and that just recently it has become possible to 'engineer these microbial structures' so that bacteria can form a stable granular sludge instead of flocculent sludge (Ibid.).

Van Loosdrecht and Brdjanovic (2014, p. 1453) assert that treatment of sewage by the activated sludge technology enables closing of cycles and reuse of resources. Examples they mention are recovery of water by membrane technology, generation of energy for example by biogas produced from sludge, reclamation of phosphate and valuable materials such as cellulose fibres and production of bio-plastics and biopolymers (Ibid.). Images 3 to 5 show examples of recycled materials produced by wastewater treatment. Van Loosdrecht and Brdjanovic (Ibid.) claim preliminary outcomes illustrate it is possible to produce valuable

products in quantities and at costs equivalent to present-day market demands and prices.

#### **Spatial and financial advantages**

The advantage of granular sludge compared to flocculent sludge, according to van Loosdrecht and Brdjanovic (2014, p. 1452), is that it allows for compact gravity-based separation of the sludge from the treated wastewater (image 6). This can be incorporated into the treatment reactor and significantly lowers land area requirements and costs (image 7). Large area requirements, together with high investment costs in advance, are mentioned as primary limiting conditions of traditional activated sludge treatments (Ibid.). Giving sewage treatment in the Netherlands is relatively low-cost (50 to 70 EUR per person per year) and requires limited energy (<7W per person) (Ibid.).

Additional advantages of the granular sludge technology by Nereda (Royal HaskoningDHV a, 2014) are minimized energy consumption, cost-effectiveness and the option to adapt the system to diverse situations. Moreover, the technology can be applied in new treatment plants, but also in the expansion of existing systems (Ibid.). Several water boards in the Netherlands have adopted the Nereda technology, including the water board of Limburg, which manages sewer treatment plants in the Parkstad region.

#### **Bacterial alginate-like exopolysaccharides (ALE)**

The mixture of microbial species in the aerobic granules synthesizes different sorts of exopolysaccharides, of which some contribute to preserving the matrix structure of the aerobic granular sludge (Lin, de Kreuk, Adin, van Loosdrecht, 2010, p. 3356). Exopolysaccharides are key elements in shaping and providing structural support for biofilms (Sutherland, 2001 in Lin, et al. 2010, p. 3355). In the aerobic granular sludge, which is identified as hydrogel, they function as gelling agent (Ibid., p. 3356). The quantity of exopolysaccharides, which is obtained from the sludge granules, depends highly on the extraction method (Ibid.). Bacteria create biofilms by secreting polymers from sugar residues (the exopolysaccharides) into their surroundings (Zlopasa, 2015). The biofilm protects the bacteria when accumulated in for example a dental plaque. In the wastewater this activity results in aerobic granules (Ibid.).

The wastewater-derived material, which forms the starting point in developing the structural composite in this research, is alginate-like exopolysaccharides (ALE). In nature alginates are

present in brown algae (Zlopasa, Norder, Koender and Picken, 2015, p. 1204) and omnipresent alginate secreting bacteria *Pseudomonas* and *Acetobacter* (Lin, 2010, p. 3356). When extracted from brown algae, the material is called commercial alginate. Generally, [commercial] alginates are employed for drug delivery and as gelling agents, food additives and wound dressings (Zlopasa et al., 2015, p. 1204). Extraction of ALE from sewage sludge consists of three procedures: firstly,  $\text{Na}_2\text{CO}_3$  is isolated at  $80^\circ\text{C}$ ; secondly, acidity is lowered to pH 2; finally, precipitate is collected and dissolved in NaOH (Zlopasa, 2015).

In the granular sludge ALE is one of the dominant exopolysaccharides and its yield currently reaches 20% of the organic matter in sludge (Lin, 2015). One gram of sewage sludge consists of 0.8 gram organic and 0.2 gram inorganic matter (Ibid.). The colour of the extracted ALE is similar to the dark brown of the aerobic granules (Lin et al., 2010, p 3357). Furthermore, the chemical structure of the polymer makes it one of the 'functional gel-forming exopolysaccharides, contributing significantly to the hydrophobic, compact, strong and elastic structure of aerobic granular sludge' (Ibid., p. 3363).



Image 3 to 5: Examples of recycled materials produced by wastewater treatment. From left to right: alginate biopolymers, polyhydroxyalkanonate bioplastic and struvite (van Loosdrecht and Brdjanovic, 2014, p. 1453).



Image 6: Nereda Aerobic Granules (left) next to Conventional Activated Sludge (CAS) (Royal HaskoningDHV b, 2014).



Image 7: Picture showing 75% decrease in required space by Nereda wastewater treatment system compared to CAS (own image based on xxx).



### **ALE as soil stabilizer**

A study performed by Galán-Marín, Rivera-Gómez and Petric (2010, p. 1462) aimed to stabilize clay soil with fibres and alginate as natural polymer. The objectives as formulated by the researchers was to 'capture and test the essential, natural qualities of traditional materials through research into enhanced combinations of essential components such as mixtures of soil with natural fibres (wool) for strength and with plant-derived polymer binders (alginates extracted from seaweed)' (Ibid., p 1463). The Galán-Marín et al. (Ibid.) claim that these subjects are 'under-explored for their potential as building materials that respond environmentally, contain no synthetic toxins, and may be employed through conventional as well as advanced technology and design.' Hereafter Galán-Marín et al. (2010, p. 1463) assert that for low rise and non-load bearing structures unfired clay materials offer a healthy and sustainable alternative for materials usually used in masonry, like fired clay and concrete blocks.

The central disadvantage of raw earth, according to Galán-Marín et al. (2010, p 1462), is its susceptibility to water, which can be amended by stabilizing the soil. Stabilizing of earth-based materials is defined as the addition of diverse products, which can be natural, such as straw, or manmade, such as cement or lime, in order to improve the mechanical properties and resistance to water (Ibid.). Later expounded as compression strength and durability. 'Unstabilized rammed earth' is consequently described as compacted clay soil of varying composition, without organic components and with clay as solitary binder (Ibid., p 1463). Galán-Marín et al. (Ibid.) explain that the term 'stabilized rammed earth' was assigned to modern constructions with additional binders such as cement and calcium or hydraulic lime, which were built in western countries after industrialization.

The results of the study by Galán-Marín et al. (2010, p. 1467), in stabilizing soil with alginate and wool fibres, showed substantial improvement of mechanical characteristics. Firstly, adding fibres averted visible shrinkage cracks due to drying. Secondly, after reaching the ultimate load the samples showed deformation and development of fine cracks, to eventually partly disintegrate after failure. This performance contrasted to the samples consisting of only soil, which instantly failed after reaching the ultimate load (Ibid.). An explanation given by the authors for this difference is that internal forces were redistributed from the soil matrix to the fibre reinforcement. Thirdly, adding alginate and fibres doubled compression strength (from 2.23 to 4.44 MPa). Best results were obtained with merely a 0.25%

wool content. The authors parallel these numbers to Spanish standards for stabilization with Portland cement at a 10% content, moreover the results exceed stabilization with a high dosage of lime (3.6 MPa). Finally, when only alginate was added, compression strength increased with 69% (from 2.23 to 3.77 MPa), and adding only wool signified an increase of 37% (2.23 to 3.05 MPa) (Ibid.). Thus, combining alginate and wool fibres as stabilizer illustrated the best results, rather than adding only one of these components to earth materials.

Based on the study by Galán- Marín et al. Zlopasa, Bijl, Redeker, Marinus and Lanting (2015) made brick samples composed of loam stabilized with ALE from the Nereda process and abaca fibres. In order to see if adding ALE, with or without fibres, increases strength and hydrophobicity of loam bricks, three monitor samples were made (image 12). Each of these ought to be submitted to a mechanical test and water exposure, but after removing the samples from the moulds, two samples types were of insufficient quality to be submitted to tests; loam and ALE; loam, commercial alginate and abaca fibres (Ibid., p. 26). The results of the other samples (only loam; loam, ALE and abaca fibres) illustrated that bending strength of the stabilized brick increased with 10 per cent (from 3.47 MPa to 3.80 MPa) and compression strength increased with 27 per cent (from 3.85 MPa to 4.91 MPa). Moreover it did not absorb water in contrast to the samples of only loam (Ibid.). Although less extreme, these test samples illustrate a similar change in mechanical properties as the loam stabilized by Galaán et al.

Zlopasa et. al (2015, p. 24) also explain how to fabricate the bricks, a process consisting of four simple actions. First, acidity of ALE is lowered to pH 7 by adding sodium hydroxide and stirring the mixture (image 9). Second, sand (35%), silt (45%) and clay (20%) are combined with water to make loam, which is mixed in a Hobart dough mixer (image 10). Third, to differentiate the loam samples a small ratio was added of the ALE solution or alginate and/or abaca fibres. Subsequently each of the mixtures was put into steel moulds (image 11), which was placed on a vibrating plate to ensure equal division. Finally, the moulds containing the mixtures were dried in an oven at 35°C for two days. This last action is however optional, since increasing temperature accelerates the drying process, but is not necessary in case a longer waiting time is possible. The fabrication process is illustrated in a MFA on page 13, which forms the basis for development of the MFA for the waste composite described in the following section.



Image 8: Components for brick samples, from left to right: commercial alginate, Abaca fibres, silt, modelling clay, ALE (Zlopasa, 2015).



Left, Image 9: ALE in laboratory (Own picture, 2015).

Middle, image 10: Hobart kitchen mixer (Own picture, 2015).

Right, image 11: Steel mould for bricks 160 x 40 x 40 mm (Own picture, 2015).



Image 12: Loam brick samples removed from mould. From left to right: loam; ALE, Abaca fibre; loam, ALE; loam, commercial alginate, Abaca fibre (Zlopasa, 2015).



Image 13: Loam brick sample with ALE and Abaca fibres after three point bending test (Zlopasa, 2015).

### **ALE and clay on a nano scale**

The strong affinity between ALE and clay can be explained on a nano scale: alginate polymers can form highly ordered bionanocomposites with clay (Zlopasa, Norder, Koender, Picken., 2015, p. 1204). Polymers combined with nanosized clay particles are called polymer clay nanocomposites (PCN) and have improved properties in comparison to the original polymer (Ibid.). Adding clay results in a significant alteration of mechanical properties, reduction of permeability and enhancement of flame retardance. The samples of highly ordered alginate-clay bionanocomposites, shown in image 14c, also display a high light transmittance resulting from the well-aligned lamellar microstructure and notable mechanical flexibility (Ibid., p. 1206).

The preparation processes of PCN's with high percentages of clay in the polymer matrix, such as layer-by-layer deposition and water-based processes similar to paper making, are based on the physical adsorption of polymers onto the surface of the clay particles (Zlopasa et al., 2015, p. 1206). The high alignment of particles can be explained by an affine deformation model, which originally was developed by Kuhn and Grün to describe changed orientation of the order in an ideal rubber due to elongation (Ibid.). This model showed that high alignment of the PCN resulted from vertical gel shrinkage. In case PCN's are up-scaled to fulfil an architectural application, further research is needed, such as shrinkage during production.

### **ALE as curing compound for cement**

Alginate has been tested as external curing compound for cement-based materials (Zlopasa, Koenders, Picken, 2014, p 1). Curing is defined as a procedure avoiding moisture loss [after casting] from the surface of cement based materials; moisture loss leads to dehydration of the cement (Ibid.). Keeping the cement hydrated is necessary, since water enables the reaction of minerals (tri-calcium silicate and di-calcium silicate) that provide maturity in strength of the material (Ibid.). Hence, hydration products of the cement clinker bond aggregates, which function as inert filler adding volume and durability. Hydration is also needed to avoid drying shrinkage, eventually minimizing surface cracks, creating a stronger bond between aggregates and resulting in fewer voids and lower connectivity of capillary pores (Ibid.). This denser microstructure limits aggressive fluids of penetrating the material, causing e.g. corrosion of steel reinforcement. Therefore well-cured, cement-based materials will endure longer and have longer service lives (Ibid.).

Usually curing is done by prolonging the addition of water to the surface or preventing water evaporation from the surface of cement-based materials (Zlopasa, et al., 2014, p. 2). The first procedure is costly

due to the need of workers and in certain regions due to scarcity of water. The second procedure consists of surface covering with a plastic sheet or a thin film created by spraying a curing compound. Curing compounds can be water based, which do not perform as good as organic-solvent based, which on their turn might have a negative effect on the environment (Ibid.).

The test with sodium alginate, a water-soluble bio-based polymer, showed positive effects on the microstructure and hydration progress, indicating a more durable cement-based material (Zlopasa, et al., 2014, p. 7). The sodium alginate reacted with the calcium ions ( $\text{Ca}^{2+}$ ) produced by the reaction of minerals in cement hydration and subsequently formed non-water soluble calcium alginate (Ibid., p. 2). After 28 days [of curing] the mortar samples were tested and the ones covered with alginate had a denser microstructure and less cracks than the samples, which were just air-dried (Ibid., p 6). Image 16 and 17 show pictures of the samples.

### **Other possibilities of ALE**

Despite the initial stage in scientific research, experiments performed by inter alia Picken, van Loosdrecht and Zlopasa (2015) indicate that ALE offers a range of additional applications. Examples of samples made by the aforementioned scientists show that ALE can have many forms: in its pure state it consists of black leather-like elastic plastic (image 18); when only combined with clay the resulting material ranges from stiff to slightly flexible and has a translucency comparable to Bakelite (image 19-20); ALE can also be transformed into a fibre (image 21). To these fibres cellulose can be added for extra strength and then even 'endless' fibres could be made by for example a simple wet spinning process. These varieties of ALE can also be used as component in a structural composite.

### **Sub-conclusion**

Applying the Nereda wastewater treatment system and subsequently extracting energy and materials, such as ALE, offers several advantages and opportunities. Advantages of introducing the system in an existing or newly built treatment plant include adaptability of the system, reduction in energy consumption and processing costs and a 75 per cent reduction in required land area. The significant compaction of an existing sewage treatment site offers the opportunity to repurpose the redundant spaces for other activities, such as extraction of resources from sludge, processing them and finally using them in fabrication and testing of products. In case of newly built treatment sites, the addition of activities could be facilitated in an integrated architectural design, allowing the 'closing of cycles' as stated by the inventors of the system.

The wastewater-derived material ALE, a secretion product of the purifying bacteria, has certain properties which contribute to the hydrophobicity, compaction, strength and elastic structure of the granules and which seem useful in man-made products as well. ALE can act as a soil stabilizer in raw-earth building products (especially when combined with natural fibres), meaning it improves strength, failure behaviour and durability, i.e. susceptibility to water. ALE can also act as a curing compound for cement-based materials, analogue to its function as bio-film in nature, preventing dehydration of the cement during curing which increases strength and durability.

The role ALE fulfils in these two examples can be compared to the role of admixtures in (historic) mortars. Mortars consist of one or more inorganic

binders, aggregates, water and sometime admixtures (Lubelli, n.d., p. 2). These are added to improve workability or durability. Historical examples are casein, animal blood and linseed oil, but also natural fibres like straw and animal hair, which increase cohesion and decrease shrinkage cracks (Ibid., p. 13).

Combining the notion ALE can have a similar function as admixtures in historical mortars with the objective of creating a modern structural composite of only waste, allows defining criteria to which the other components of such a composite should answer. These criteria are listed in table 3 and function as input for answering the following sub-research question: how to replace the non-waste components of a structural composite, with ALE as binder, by waste materials, which are locally available in the Parkstad region?

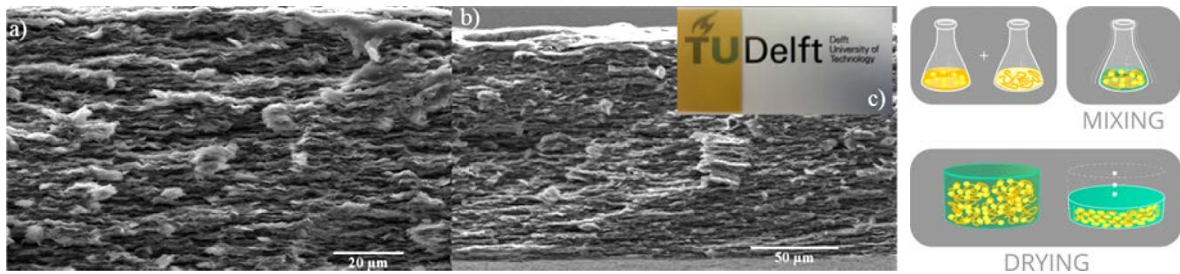

Left, image 14: Environmental Scanning Electron Microscopy (ESEM) micrographs (a, b) of a cross section of an Na-Alg with 50 wt % MMT. The inserted photo (c) of Na-Alg with 80 wt % MMT illustrates the high light transluency of the material sample (Zlopasa et al., 2015, p. 1206). Right, image 15: Preparation of Highly Ordered alginate and clay (Na<sup>+</sup>MMT) by 'a simple film casting method' (Zlopasa et al., 2015, p. 1205).

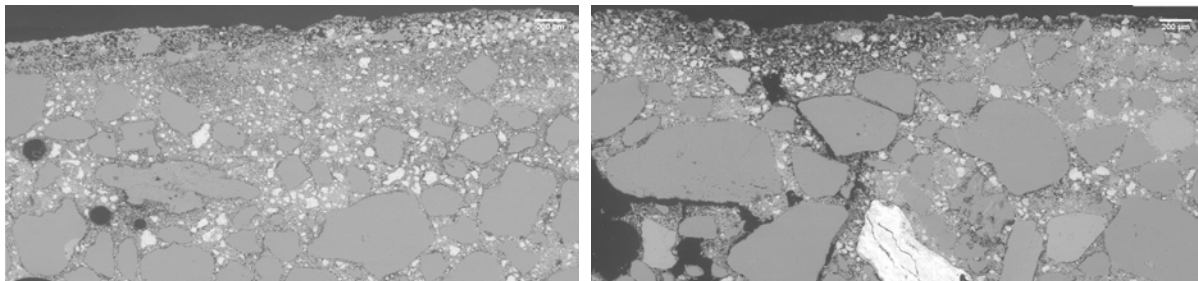

Left, image 16: Micrograph (ESEM-BSE) of area close to surface of alginate-cured mortar sample (Zlopasa, et al., 2014, p. 5).

Right, image 17: Micrograph (ESEM-BSE) of area close to surface of air-cured mortar sample (Zlopasa, et al., 2014, p. 6).

Samples were made with commercial Portland cement with a w/c ratio of 0.5 and aggregate particles according to the Fuller distribution (Zlopasa, et al., 2014, p. 3). These were cast into cylindrical moulds with a 100 mm diameter and compacted on a vibrating table. After compaction, a water solution with 3wt% sodium alginate was poured onto the surface of three samples. The remaining three samples were cured leaving the surface uncovered to air.



Left, image 18: Pure ALE looks and acts like a black, leather-like, elastic plastic (Own picture).

Middle, image 19-20: ALE and clay composites range from stiff to slightly flexible and have a transluency comparable to Bakelite (Own image).

Right, image 21: ALE in fibre form (Own image). It is possible to add cellulose for extra strength and create long fibres by a wet spinning process.

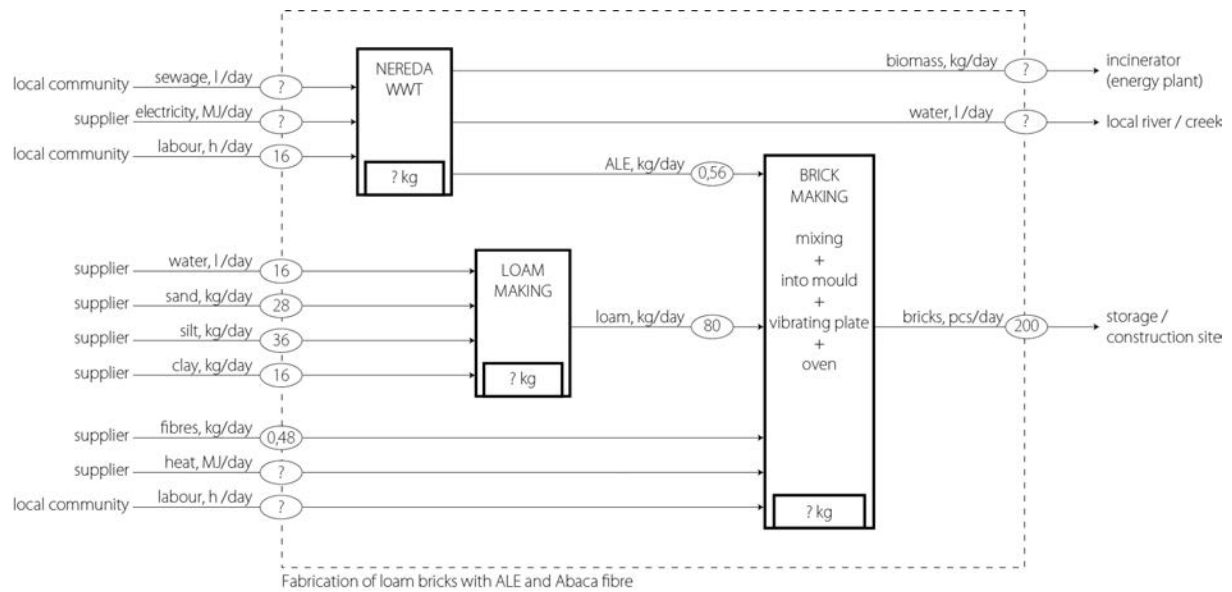

Image 22: Material Flow Analysis of loam bricks with ALE and Abaca fibre (Own image based on Zlopasa, 2015).

| Component        | Material    | Ratio                     | Properties                                                         | Function                                                                                              |
|------------------|-------------|---------------------------|--------------------------------------------------------------------|-------------------------------------------------------------------------------------------------------|
| Inorganic binder | Clay        | 400 g                     | Rock particle with size smaller than 0.4 $\mu\text{m}$             | Binds aggregates                                                                                      |
| Aggregate        | Silt        | 900 g                     | Rock particles with size of 0.4 $\mu\text{m}$ - 0.62 $\mu\text{m}$ | Bears pressure loads<br>Acts as filler (creating volume)                                              |
|                  | Sand        | 700 g                     | Rock particles with size of 0.62 $\mu\text{m}$ - 2 mm              | Bears pressure loads<br>Acts as filler (creating volume)                                              |
| Admixture        | ALE         | 14 g<br>(400 ml solution) | Smell and colour depend on (waste) water source                    | Has synergetic binding capacity with clay<br>Improves workability<br>Changes hydrophobicity           |
|                  | Abaca fibre | 12 g                      | Length 20 mm<br>Diameter xx mm                                     | Bears tension loads<br>Enables formation of cracks under loading<br>Enables deformation after failure |
| Hydrator         | Water       | 400 ml                    | -                                                                  | Enables mixing                                                                                        |

Table 3: Criteria of components for structural composite.

## **SUBSTITUTION OF NON-WASTE COMPONENTS WITH LOCAL WASTE STREAMS**

In the previous section it became clear that producing ALE-fibre-loam composite bricks is a simple process, which requires little energy and only a few modest tools. This section has a two-fold focus. First, replacing the non-waste components with waste resources locally available in Parkstad Limburg. A criteria is purity and consistency of the waste stream to ensure a constant quality of the final building product. Second, selecting suitable locations for an ALE-waste-composite factory based on the chosen waste resources and a set of logistic and environmental criteria. A final location for the factory is chosen in the concluding part of this paper, since the following paragraph will centre on processing techniques, which are needed for the chosen waste streams, in order to set up a program of requirements for the factory.

### **Criteria for selecting factory locations**

The first and foremost criterion is the vicinity of a wastewater treatment plant (WWTP) with the Nereda process. In this way, between the factory and WWTP, transport of materials can be minimized and a direct feedback-loop in information can be created. As mentioned in the previous section, it is possible to retrieve different kinds of materials from the sludge, which can have very diverse applications (conversion for energy to high-tech products). Moreover research is in its initial stage. Hence, creating a direct physical and informational link between factory and WWTP allows for immediate testing of retrieved materials and quick adjustment of for example extraction or processing techniques. Essentially the factory could then be observed as an extension of the WWTP, endowing it an infinite mine.

The Nereda technology has been invented by the aforementioned scientists of TU Delft and is now being further developed and implemented by a consortium of partners: TUDelft, Royal HaskoningDHV, AgentschapNL, STOWA and seven Dutch water boards, i.a. Water Board Limburg (NNOP, n.d.). Royal Haskoning (2015c) states currently more than twenty Nereda WWTP's are operational or being constructed and claims the number of Nereda plants will increase exponentially, not only in the Netherlands, but also Portugal, South Africa, Australia and South America. Existing WWTP's using the Nereda system in the Netherlands are listed in appendix A.

One of the Nereda partners, Water Board Limburg (WBL), manages the WWTP's in Parkstad Limburg. Currently after treatment the cleaned water is discharged into surface water, such as a local creek,

and the sludge is firstly dehydrated in sieve belt presses and centrifuges on location (Waterschapsbedrijf Limburg, 2013, p. 7). Then half of the sludge is dried into granules in an installation in Susteren, subsequently grinded by Biomill BV in Maastricht to finally be used as fuel by ENCI in cement ovens in Maastricht and Lixhe (Ibid. p. 24). The fly ash left after incineration is used as filler in cement (Ibid.). The other half of the dehydrated sludge is incinerated by 'Slibverwerking Noord-Brabant' located in Moerdijk (Ibid.). This 'conventional' processing of sewage water (influent) and sludge (effluent) is illustrated in a [MFA on page x](#).

WBL claims to be a business oriented water board, striving for sustainable innovation ([VIDEO](#)), hence in recent years WBL has developed the Verdygo system, which uses the Nereda technology, and implemented several means to reduce the use of fossil fuels and virgin resources, such as generating electricity and heat with self-made biogas (WBL, 2013, p. 25 & 36). The Verdygo system is explained as a modular and sustainable WWTP, which can be transported, is flexible and adjustable to changing circumstances, such as demographic changes.

The region Parkstad Limburg counts five WWTP's, of which Sijpeveld functions as a pilot for the Verdygo system (Verdygo, 2015). The substituted middle section of this plant uses the Nereda technology. Moreover WBL has planned to implement the Verdygo system in four other WWTP's in Limburg within the next four years (Ibid.). An answer of WBL is expected on which WWTP's exactly. In the IBA region the WWTP located in Hoensbroek is the largest. In 2013 this site was connected to a central operating system together with the installations in Susteren, Gennep, Meijel, Venray and Venlo (Ibid.,p11). The WWTP's located on the map shown on page 17 and listed in appendix B, which includes their capacity.

A second important criterion for the factory location is well accessibility, not only for transportation of goods, but also passage of tourists or locals. Easy transport of goods is vital since not all components for the structural composite can be obtained from the WWTP. Furthermore, to ensure resilience of the objectified composite business and its partners within the production process, interdependence between them should be moderated; analogue to the ability of a species in nature within a symbiotic relationship to survive without the other (2012 architecten and Goossens, 2009, p. 7). Well accessibility for tourists or locals is important to show and promote sustainable production in (possibly) future industries. Both infrastructure for trains, motorized vehicles and touristic hiking are indicated on the map on page 17.

A third criteria is that the location, considering the planned activities, complies to zoning regulations, such as functional and spatial zones formulated in the policy of Parkstad Limburg and environmental zones to control air (also scent) or noise pollution. In its spatial policy Parkstad Limburg strives for a stronger contrast between urban and green areas, an improved orientation, better quality of surroundings and better investment conditions for companies (Structuurvisie Parkstad Limburg, 2009, p. 45). Hence is stated that new developments ought to be located within the existing urban structure, the area nearby the highways N281 and A74 is designated for businesses and the eastern area of the region for recreation and tourism (Ibid., p. 53). Moreover, some zoning regulations of central and provincial governments apply to certain areas within the region, such as the European Ecological Main Structure and Habitat- and Bird-areas (Ibid, p. 45).

A fourth criterion in choosing a location is the possibility of expanding the factory in case business increases and/or new fabrication techniques wish to be added to the program. Considering large upfront investment costs are pared with greater financial risks, the design of the design initial factory will be tailored to present processes, keeping in mind potential expansion. Therefore the site should be significantly larger than the initial spatial program, but still offer attractive surroundings (considering the sightseeing aspect). A preliminary selection of locations (indicated on map page 17) consists of existing or planned Nereda WWTP's sites, business parks and industrial sites, which will soon be discontinued. The images on page 18 show three locations, which are of main interest..

### **Local waste streams as source for components**

According to the criteria defined in the previous section an inventory is set up of local waste streams, which can substitute the non-waste components of the described example composite. Not only these criteria considering material properties influence the search, but also the fact if a waste stream is pure and consistent. Plus, cases of excessive waste production, which do not immediately comply with the criteria, are also taken into account, since these might function as filler. Information for the inventory is obtained from company websites and by emailing and telephoning with employees of IBA Parkstad, Parkstad Limburg and several local companies. Moreover, the inventory is still being supplemented with information, due to expected responses and newly attained contacts.

The first needed component is an inorganic binder, i.e. a replacement for clay. Inorganic binders within mortars can be classified into non-hydraulic, which dry in air, and hydraulic, which set and harden

under water due to chemical reaction with water (Lubelli, n.d., p. 6). Examples of hydraulic binders are hydraulic lime and cement, which can be combined. It is also possible to acquire hydraulic mortars by adding pozzolanic materials (Ibid.). Natural pozzolans are certain types of earth such as Trass from Germany; artificial pozzolans are brick dust, silica fume and fly ash (Ibid., p. 7).

Consequently three types of waste streams generated in or close to Parkstad are of interest: brick dust, glass dust and biomass fly ash. Brick and glass dust can for example be retrieved from bulk waste produced at demolition sites. Parkstad has planned to demolish 11,151 houses between 2010 and 2020 (Stadsregio Parkstad Limburg, 2011, p. 15) in order to compete vacancy and subsequent decline of housing prices and decay (de Graaf, 2015). Mostly post-war buildings, erected between 1945 and 1980, will be demolished, which are of low quality or unfortunately situated, f.e. in sub-urban areas to intensify the aforementioned distinction between built and green zones (Rademaker, 2015). Hence the province of Limburg has implemented a so-called 'Sustainable Demolition Protocol', which means owners of buildings can obtain a higher subsidy in case building components and materials are inventoried before demolition, so these can be repurposed or recycled in high valued applications (Provincie Limburg, n.d.). Demolition waste is categorized into material resources, such as debris (mixed and concrete), gypsum, metals, plastics and glass; and products, such as bricks, roof tiles, timber beams and window frames (Ibid.). Therefore glass and bricks can be obtained as separate streams from the companies executing demolition.

In accordance with regular fly ash, fly ash residues after incineration of biomass can be used as filler in cement, moreover if combusted in correct ratio's this fly ash can even be used as replacement of Ordinary Portland Cement. Natalie Carr (2015), PhD student from Civil Engineering at Delft University of Technology, researches how to adjust the ratio of raw materials and modify the sintering process in order to generate energy and obtain ashes, which contain functional clinker minerals. She explains that the desired chemical composition for clinker can be obtained by a correct ratio of fly ash from biomass rich in Lime (CaO) and biomass rich in Quarts (SiO<sub>2</sub>). Lime, or calcium, can for example be found in grasses, weeds and newspaper waste. Quarts, or Silica, can be found in woody biomass (mainly bark) or wheat husks. Production of these clinker ashes, named by Carr *BioCement*, result in negligible CO<sub>2</sub> emissions compared to the production of Portland cement. She has four arguments: biomass belongs to the short carbon cycle; firing occurs due to self-combustion; no more use of

limestone; and firing temperature and duration are decreased. Biomass is not only incinerated in large-scale furnaces, such as biomass- and waste- energy plants, but also during or after other industrial processes. Examples are incineration of the above-mentioned sludge from municipal WWTP's during cement production or sludge after paper fabrication. Furnaces in or close to Parkstad are listed in appendix D and located on the map of the Netherlands (page 17).

The second type of component needed for the composite are aggregates: some to replace silt and sand, others to act as filler to create volume. Volume is needed in certain architectural applications, such as non-load bearing walls. Concrete debris, which is a distinct category in the previously discussed 'Sustainable Demolition Protocol', could be used as filling aggregate in a variant of the composite. A replacement for sand and silt should consist of mineral materials with particle sizes between 0.4 µm and 2 mm. An option is to use ground brick or ground glass, again from demolished constructions. A probably less energy requiring option is to use the residual biomass fly ash, which does not have the chemical composition for clinker, just as currently is done to fill cement.

The fourth component is a fibre, which could have different lengths depending on the subsequent fabrication technique. In case short fibres are needed, for example to form non-woven mats, it is possible to use fibres similar to the Abaca from the example composite. A somewhat shorter fibre is wastewater-derived 'toilet paper' cellulose (length of 2 mm), which is not yet validated and can easily be extracted (Lin,

2015). In the previous section is mentioned that longer fibres can be created by wet spinning ALE or a mix of ALE and cellulose, which has extra strength. Furthermore it is possible to collect wood by-products from a local timber factory or from roadside mowings done by the municipalities and subsequently obtain fibres by retting. To ensure a constant quality of the fibres, collection from the wood factory is preferred.

The last element needed for fabrication of the composite is water, although officially not designated a component. Before is mentioned that effluent from WWTP's is currently discharged into surface water. A part of the effluent could be redirected to the composite factory as input for making solutions and mixtures. Another input for fabrication is energy, which consists electricity for lighting and driving the machines and optionally of heat to accelerate the drying of the material. In case the energy plant, where biomass is incinerated, and the factory are closely located, heat and electricity generated at the plant can be directly used in the factory.

The discussed waste streams, supplementary inputs and processes, but also the needed hours of labour to perform fabrication, are illustrated in MFA's on page 19. These show the two options in type of composite, which are construed from the locally available waste streams. The first: unfired structural composite consisting of ALE, unfired filler/aggregate and fibre. Second, strain hardening cementitious composite consisting of ALE, BioCement, residual biomass fly ash and a fibre.

| Component        | Material    | Waste                  | Flow rate | Company                 | Location                         |
|------------------|-------------|------------------------|-----------|-------------------------|----------------------------------|
| Inorganic binder | Clay        | BioCement - Calcium    |           | See table x.            | See map x.                       |
|                  |             | BioCement* - Silica    |           | See table x.            | See map x.                       |
| Aggregate        | Silt        | Brick dust             |           | Re-use Materials **     | Deken Nicolayestraat 24, Heerlen |
|                  |             | Glass dust             |           | Re-use Materials        | Deken Nicolayestraat 24, Heerlen |
|                  | Sand        | Biomass Fly ash        |           | See table x.            | See map x.                       |
|                  |             | Ground Brick           |           | Re-use Materials        | Deken Nicolayestraat 24, Heerlen |
| Admixture        | ALE         | Ground glass           |           | Re-use Materials        | Deken Nicolayestraat 24, Heerlen |
|                  |             | Ground concrete        |           | Re-use Materials        | Deken Nicolayestraat 24, Heerlen |
| Hydrator         | Water       | Biomass Fly ash        |           | See table x.            | See map x.                       |
|                  |             | Ground Brick           |           | Re-use Materials        | Deken Nicolayestraat 24, Heerlen |
| Admixture        | Abaca fibre | ALE sewage             |           | Water Board Limburg     | See WWTP's on map page x         |
|                  |             | ALE food factory       |           | Gulpener beer brewery   | Rijksweg 16, Gulpen              |
| Admixture        | Abaca fibre | Toilet paper cellulose |           | Water Board Limburg     | See WWTP's on map page x         |
|                  |             | ALE (fibres)           |           | Water Board Limburg     | See WWTP's on map page x         |
| Admixture        | Abaca fibre | Wood dust              |           | Houtwarenfabriek Daemen | Mingersborgerweg 7, Voerendaal   |
|                  |             | Roadside mowings       |           | Afvalzorg Brunssum      | Waubacherweg 11, Brunssum        |
| Hydrator         | Water       | Effluent of sewage     |           | Water Board Limburg     | See WWTP's on map page x         |

Table 4: Waste streams in Parkstad Limburg (based on company websites and telephone interviews, 2015).



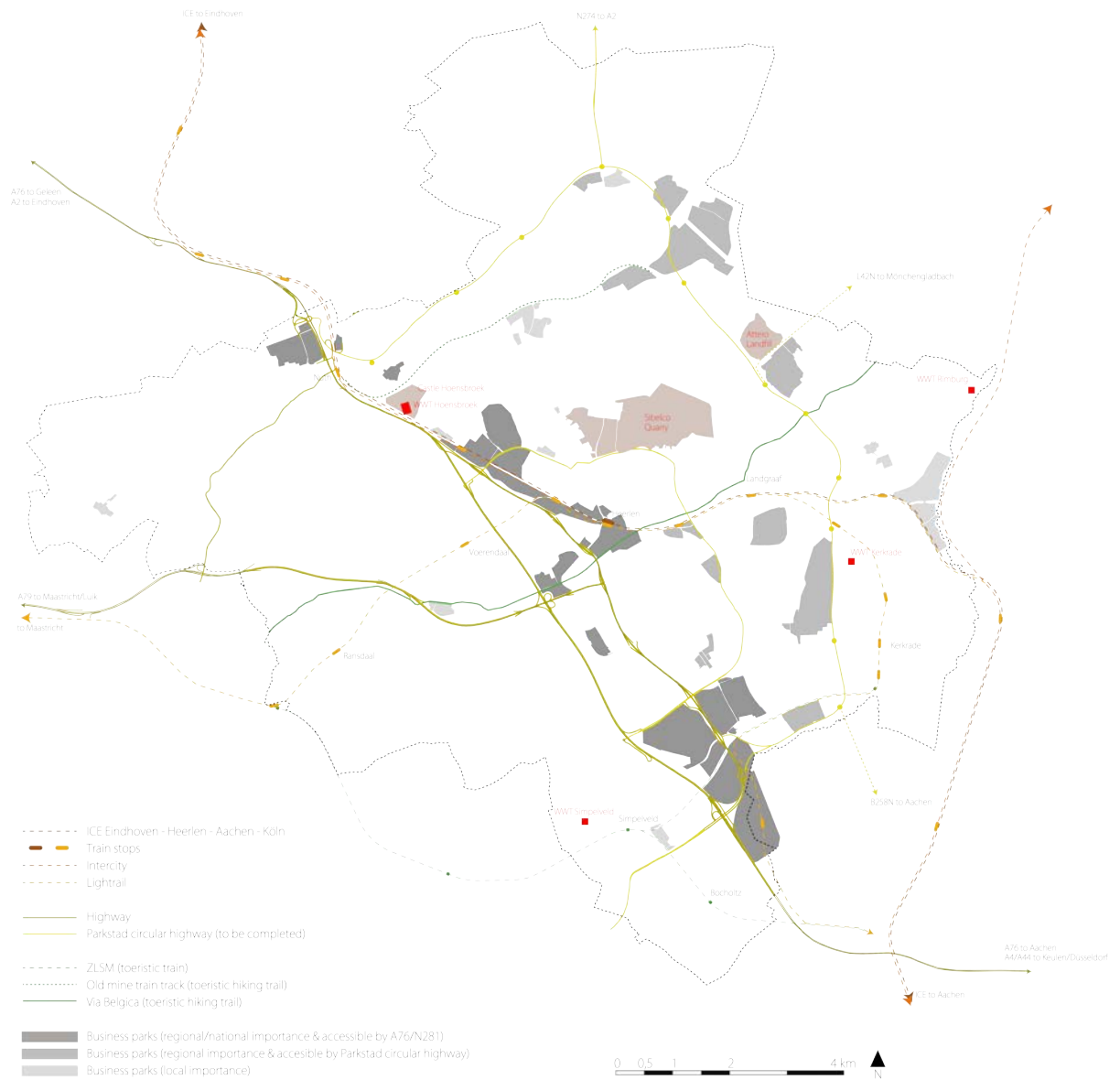

Image 23: Map with waste streams and selected locations in Parkstad Limburg (based on company websites and telephone interviews, 2015).



Image 24: Map with waste and biomass energy plants within close to Parkstad or related due to company logistics (based on company websites and telephone interviews, 2015).



Image 25: WWTP Hoensbroek (Google Earth, 2015)



Image 26: WWTP Simpelveld (Google Earth, 2015)



Image 27: Sibelco quarry (Google Earth, 2015)

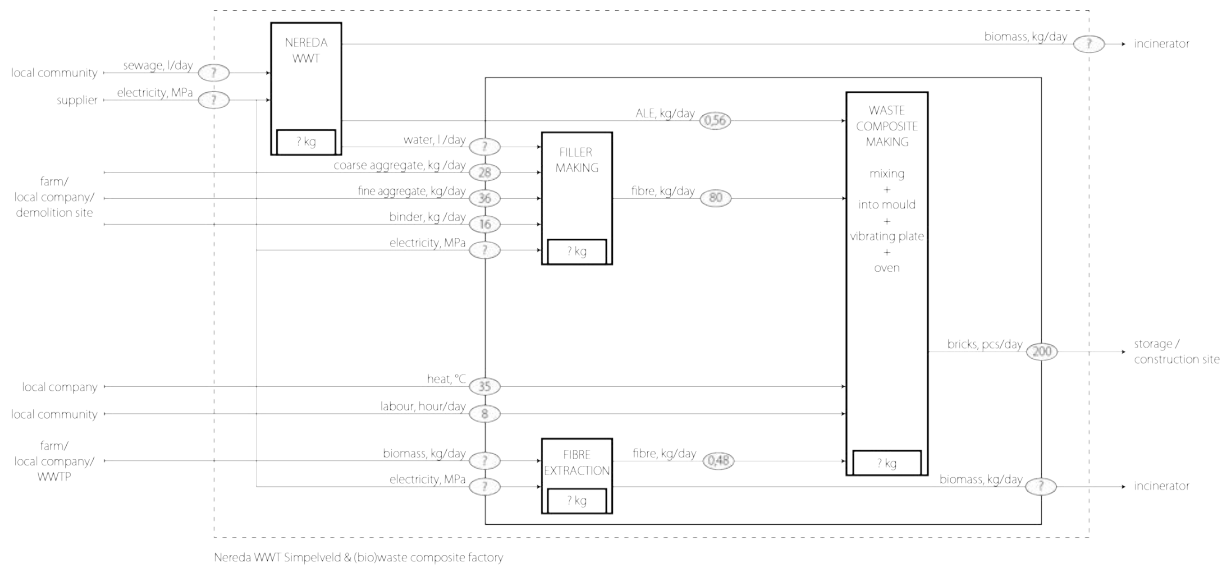

Image 28: MFA Nereda WWTP and ALE - Unfired filler - Fibre composite factory (Own image).  
 This MFA illustrate the production process of option one: unfired structural composite.

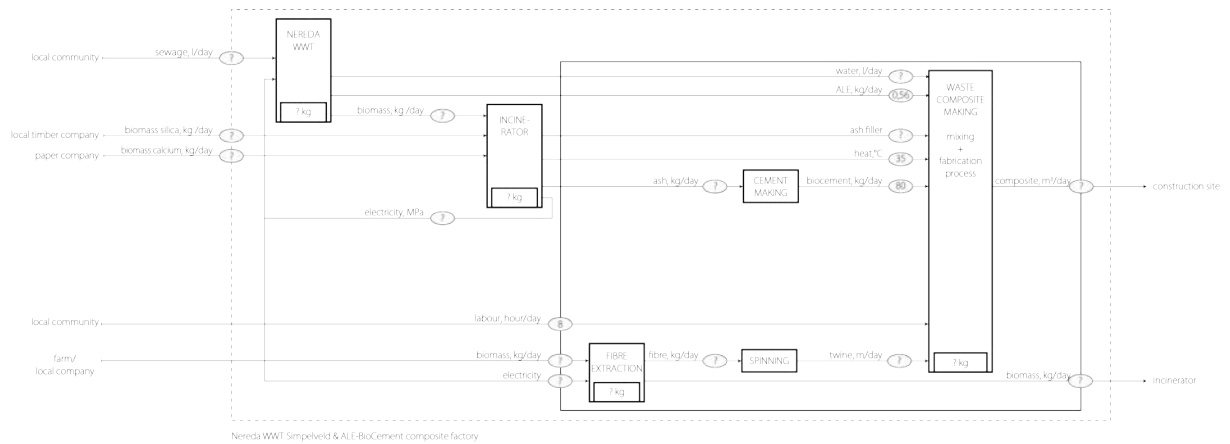

Image 29: MFA Nereda WWTP and ALE - BioCement - Fibre composite factory (Own image).  
 This MFA illustrate the production process of option two: strain hardening cementitious composite.

## MODEL MAKING & FABRICATION METHODS

In the previous sections, a focus was on the rational composition of the material; in this section, the focus will shift to the architectural implications of such a composite material. First, a survey will be done of model making and fabrication methods, which are suitable to explore the architectural possibilities of the composite material, i.e. structure and details. Then, conform the machines, tools and actions of these methods a program of requirements will be defined for the composite factory. Essentially, the 'black box' of the composite factory in the MFA on page x will be specified.

The selection of model making and fabrication methods is based on a few material samples and technical literature. Moreover selection is founded on the analogy with the two existing composite types and accompanying processing techniques: unfired structural composites and strain hardening cementitious composites. Below the selected methods are discussed in sequence of use in a design and construction process.

### Model Making Methods

An essential quality of composite materials is the ability to customize the properties of the substance by adjusting the ratio and relation of its components. These can be adjusted according to occurring loads or for the purpose of climate regulation.

Currently the first stage in an architectural design process often consists of sketching by hand or computer. Oxman (2010, p. 32) asserts conventional CAD and BIM programs are limiting for designers who aim to explore and design materials with graduated properties, since these programs consider materials like traditional design practice does, i.e. assembling of homogenous components, and therefore are only able to assign a material to closed solids or surface polygons. She also determined that in architectural design fabrication, no existing rapid prototyping technique offers the possibility of producing a surface or volume with a continuous gradual change in material properties, such as density, strength, stiffness and elasticity (Ibid., p. 35). In case of differentiation within a volume, this is realized by printing multiple components with slightly different properties, assembled after fabrication and having perceivable outlines between materials (Ibid.).

Hence Oxman (2010) developed a software tool and 3-D printing fabrication technology, which allow distribution of material properties as continuous gradients. She (Ibid., p. 33) named her digital tool

*Material-based Design Computation*, which she defines as 'computationally enabled form-finding, informed by material properties and environmental constraints'. In order to represent digital anisotropy she developed computational material units, *material pixels* or *maxels*, which can include local physical information such as a unit for pressure, thermal heat, light or comfort (Ibid., pp. 33-34). In the software program color-codes indicate the divers properties of these digital material units, which can be calibrated to physical printing units (Ibid., p. 36). The printing technology proposed by Oxman is dubbed *Variable Property Rapid Prototyping*, which consists of 3-D material deposition and offers gradation control of multiple materials within one print (Ibid., p. 35). Moreover Oxman (Ibid.) states this technology saves weight and material quantity while reducing energy inputs.

Similar to some pre-digital architects and engineers, Oxman derives design principles by observing principles of form in nature and its morphogenesis. She (2010, p. 34) focuses on advancing the designer's competence [with contemporary digital tools] to strategically control density and directionality of material substance in the *generation of form*. She explains that the pre-digital architects and engineers have been practicing *form finding*, i.e. 'the exploitation of material properties and behaviour as source of form-generation'. One of the example architects, Frei Otto (1996, p. 45), has named the practice of identifying formation processes in animate and inanimate nature in order to emulate such processes artificially, *the reverse path*.

Otto devised several types of model making and experimenting equipment to enable form finding in architectural design. He defines models as 'simple physical experiments that reveal the infinite diversity of possible forms and constructions without a great deal of effort' (Otto, 1996, p. 57). Certain equipment can be of use for designing and experimenting with the objectified ALE-waste composite material. Both high-tech computational and 'low-tech' physical model-making methods relevant for the composite factory are listed in table 5, together with their requirements. The list is perpetually supplemented with methods of other engineers and designers.

### Fabrication Methods

Fabrication methods of bio-based composites and natural fibre reinforced cementitious composites range from archaic to state-of-the-art, in case historical mortars and raw earth with natural fibre reinforcement and natural polymers are taken into account. Therefore the list of possible fabrication methods for the composite proposed in this research (table 6) includes rammed earth, *opus caementicium* and casting using

centering or timber moulds. A great historical example of a concrete building, although not reinforced with fibres, but with changing material properties throughout its structure, is the Pantheon in Rome.

Modern fibre-reinforced cement-based materials (FRC) can be pre-cast or cast-in-place (Sierra-Beltran, 2011, p. 2), with continuous ordered fibres or discontinuous randomly distributed fibres. Modern bio-based composites or fibre-reinforced plastics (FRP) can be fabricated through a variety of techniques, such as

hand lay-up, compression moulding, vacuum or pressure bagging and filament winding. The methods, which are relatively 'low-tech' and require relatively little energy, are selected and briefly discussed in table 6. Furthermore ways of constructing *ferro cemento* are included, because of the comparable properties of this material to FRC. This list is also perpetually supplemented with novel or rediscovered construction techniques.

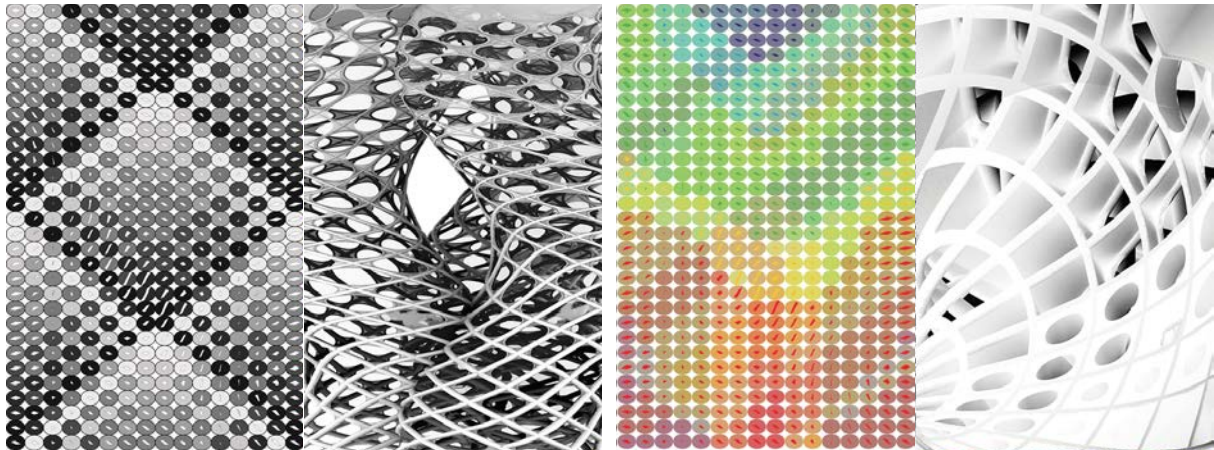

Image: 30 & 31: Tessellated tiles containing information about size and properties (thick/thin or opaque/transparent) and the resulting tower, which follows self-loading and wind-loading (Oxamn, 2010, p. 181)



Image: 32-33: Model-making methods devised by Frei Otto. From left to right: Chain net; Plaster bandages; Sand piles (Otto, 1996, p 63-64).

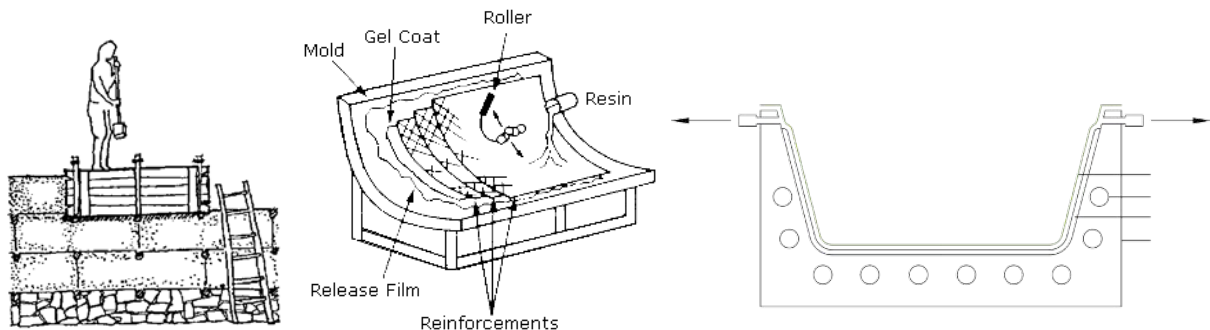

Image 34-36: Fabrication techniques. From left to right: rammed earth, hand lay-up, vacuum bagging (Gkaidatzis, 2014, p. 68-69).

| Model Making Method                               | Description                                                                                                           | Needed Tools                                                                               | Space requirements                                                      |
|---------------------------------------------------|-----------------------------------------------------------------------------------------------------------------------|--------------------------------------------------------------------------------------------|-------------------------------------------------------------------------|
| Material-based Design <sup>1</sup><br>Computation | Computationally enabled form-finding based on material properties and environmental constraints.                      | Computer<br>Desk                                                                           | 8 m <sup>2</sup><br>Ventilation 25 m <sup>3</sup> /h/p<br>Light 400 lux |
| Variable Property Rapid Prototyping <sup>1</sup>  | 3-D printing by material deposition.                                                                                  | 3-D printer<br>Storage for material                                                        | 5 m <sup>2</sup>                                                        |
| Chains & Chain nets <sup>2</sup>                  | Suspended line (hyperboloid cosine) idealized form for arch, vault of lattice shell (open).                           | Chains<br>Framework for suspension                                                         | 3 m <sup>2</sup>                                                        |
| Plaster bandages <sup>2</sup>                     | Reversal of tension-loaded suspension forms; form for pressure-loaded arch, vault and shell (closed).                 | Medical plaster bandages<br>Bowl with water<br>Framework for suspension<br>Table           | 3 m <sup>2</sup>                                                        |
| Papier maché with starch <sup>3</sup>             | Moisten newspapers or immerse in water-starch solution and shape or apply to formwork.                                | Bowl with water<br>Inflatable/metal frame<br>Mixer<br>Table                                | 3 m <sup>2</sup>                                                        |
| Sand piles <sup>2</sup>                           | Funnel forms and residue cones to examine 'natural' angle of repose for earth buildings and settlement constructions. | Upper and lower plate<br>Vibrating/tilting table<br>Storage for sand                       | 5 m <sup>2</sup>                                                        |
| Flexible mould <sup>4</sup>                       | Panels that can be curved in x- and y- direction (convex and concave) for plastic, concrete or glass production.      | Frame with series of pins, which support a flexible mat of spring steel.<br>Stepper motor. | 6 m <sup>2</sup>                                                        |
| Casting                                           |                                                                                                                       | Mould<br>Mixer                                                                             | 10 m <sup>2</sup>                                                       |

Table 5: Model Making Methods (Based on: <sup>1</sup>Oxman, 2010; <sup>2</sup>Otto, 1996; <sup>3</sup>Picken, 2015; <sup>4</sup>Pronk, Erinkveld, Schipper, Eigenraam, 2015, pp. 12-13)

| Fabrication Method                               | Description                                                                                                                       | Needed Tools                                                          | Space requirements                        |
|--------------------------------------------------|-----------------------------------------------------------------------------------------------------------------------------------|-----------------------------------------------------------------------|-------------------------------------------|
| Variable Property Rapid Prototyping <sup>1</sup> | 3-D printing by material deposition.                                                                                              | 3-D printer<br>Storage for material                                   | 20 m <sup>2</sup>                         |
| Pre-cast                                         | Cast mixture into steel mould, cure under specific conditions.                                                                    |                                                                       | 40 m <sup>2</sup>                         |
| Casting                                          | Cast mixture into mould, cure under controlled conditions.                                                                        | Timber / Air inflated /<br>Modular / Flexible moulds                  | 40 m <sup>2</sup>                         |
| Hand lay-up <sup>2</sup>                         | Apply by hand gel-coat as base on mould, when cured apply reinforcement and resin with brush or roller.                           | Metal sheets / Timber or rigid foam moulds                            | 30 m <sup>2</sup>                         |
| Vacuum / pressure bagging <sup>2</sup>           | Apply pressure to fibre reinforcement with resin by air extraction or insertion in airtight bag.                                  | GFRP / metal mould                                                    | 30 m <sup>2</sup>                         |
| Compression moulding <sup>2</sup>                | Composite mixture is shaped and cured in two-part mould under pressure and heat.                                                  | Steel / Iron / Aluminum / GFRP mould                                  | 30 m <sup>2</sup>                         |
| Filament winding <sup>2</sup>                    | Continuous rovings / twines / tapes (pre-impregnated or impregnated during process) are wound over a (rotating) spindle or frame. | Winding machine<br>Steel / Aluminum / Plaster spindle<br>Timber frame | 40 m <sup>2</sup>                         |
| Spray-up <sup>2</sup>                            | Short fibre-resin mixture is sprayed on mould with hand-held spray gun and then air inclusions are removed with roller.           | GFRP / Timber mould<br>Hand-help spray gun<br>Roller                  | 40 m <sup>2</sup><br>Constant ventilation |
| Layer-by-layer film casting <sup>3</sup>         | ALE - inorganic binder solution is mixed and cast into large Petri dish, dry under specific conditions.                           | 5 liter Erlenmeyer<br>Magnetic stirrer<br>Upscaled Petri dish         | 20 m <sup>2</sup>                         |

Table 6: Fabrication methods (Based on: <sup>1</sup>Oxman, 2010; <sup>2</sup>Gkaidatzis, 2014; <sup>3</sup>Zlopasa, 2015).

### 3. CONCLUSION & DISCUSSION

The wastewater-derived material ALE, obtained through the Nereda purification process, formed the starting point in development of the waste composite in this paper. It is a secretion product of the purifying bacteria and has certain properties, which seem useful in man-made products as well. In the sewage sludge these properties contribute to the hydrophobicity, compaction, strength and elastic structure of the granules.

Applying the Nereda wastewater treatment system and subsequently extracting energy and materials, such as ALE, offers several advantages and opportunities, such as adaptability of the system, reduction in energy consumption and processing costs and a 75 per cent reduction in required land area.

First, by discussing reference studies a description was given of its origin, fabrication and subsequent mechanical and perceptible characteristics. ALE can act as a soil stabilizer in raw-earth building products (especially when combined with natural fibres), meaning it improves strength, failure behaviour and durability, i.e. susceptibility to water. ALE can also act as a curing compound for cement-based materials, analogue to its function as bio-film in nature, preventing dehydration of the cement during curing, which increases strength and durability. The role ALE fulfils in these two examples can be compared to the role of admixtures in (historic) mortars, which are added to the mix of inorganic binder, aggregate and water in order to improve workability and/or durability.

An essential quality of composite materials is the ability to customize the properties of the substance by adjusting the ratio and relation of its components. A distinctive characteristic of the ALE-waste composite is that the odour and colour of ALE depend on its (waste) water origin. However in case aggregate is added, this will mainly define the appearance and texture of the composite, since it constitutes the largest ratio.

Second, based on the ratio and role of the composite's components an inventory was done of locally available waste resources. The inventory and initial fabrication process formed the foundation for a Material Flow Analysis of an industrial intervention by means of a composite factory. Simultaneously, based on logistic and spatial requirements, a few locations for this factory have been selected.

Criteria for selection are vicinity of a wastewater treatment plant with the Nereda technology, well accessibility, answering to zoning regulations and the possibility of expanding the factory.

In IBA Parkstad are six existing wastewater treatment plants of which the plant in Simepveld functions as pilot for the Nereda process. Simepveld is a small site and generates the smallest amount of dry sludge per year compared to the other plants. Whereas Hoensbroek generates the largest amount of sludge, which will even increase due to annexing the capacity of nearby Terworm. Hoensbroek is surrounded by the estate of caste Hoensbroek, the A76 highway and on one side houses. It is close to a highway exit, well accessible by foot or bike and has open area much larger than the initial program of the factory. Therefore complying with the defined criteria.

The significant compaction of required sewage treatment, due to implementing the Nereda technology, offers the opportunity to repurpose the redundant spaces for composite production or related functions. However, incompleteness of information on types and sizes of local waste streams and planned Nereda WWTP's, due to expected responses from local companies and institutions, prohibits the possibility of making a well grounded decision in selecting the final location.

It is possible to construe two options in type of composite from the locally available waste streams: unfired structural composite (ALE, unfired filler/aggregate and fibre) and strain hardening cementitious composite (ALE, BioCement, residual biomass fly ash and a fibre). Together with a few material samples and technical literature, these types form the basis for the selection of model making and fabrication methods, which are suitable to explore the architectural possibilities of the composite material. Conform the necessary machines, tools and actions a program of requirements is defined for the composite factory. Finally a MFA is set up taking into account the exemplary objective for the factory.

The paper revealed several important aspects to take into account. First, although uniform and consistent waste streams are selected, these might alter or cease flowing. Second, the primary stage of research is accompanied by rapid advances, not only into the aforesaid extraction of materials from wastewater and the extracted materials, but also digital computation and fabrication of composite materials. Therefore the initial requirement of the factory is to allow room for explorations, such as a testing hall or field, and room for change in testing, model making and fabrication methods. Finally, the program of requirements needs to be further specified.

| Process / Space                                | Space requirements                                 | Input (Flow rate)                                                                                     | Output (Flow rate) |
|------------------------------------------------|----------------------------------------------------|-------------------------------------------------------------------------------------------------------|--------------------|
| Material production hall                       | 120 m <sup>2</sup><br>High ventilation             | Fibre<br>Water<br>ALE<br>Ash filler<br>Ash / BioCement<br>Aggregates<br>Labour<br>Heat<br>Electricity | Composite<br>Data  |
| Storage for composite materials                | 400 m <sup>2</sup>                                 | Composite                                                                                             | Composite          |
| Fabrication hall (Fab Lab)                     | 300 m <sup>2</sup><br>High ventilation             | Composite<br>Knowledge<br>Electricity                                                                 | Prototypes<br>Data |
| Model Making hall                              | 60 m <sup>2</sup><br>Insulated                     | Composite<br>Knowledge<br>Electricity                                                                 | Models<br>Data     |
| Storage for models                             | 40 m <sup>2</sup>                                  | Models                                                                                                | –                  |
| Laboratory (testing of materials)              | 60 m <sup>2</sup><br>Clean air<br>Insulated        | Wastewater derived materials<br>Composite                                                             | Data               |
| Computer Room                                  | 24 m <sup>2</sup><br>High ventilation<br>Insulated | Data<br>Electricity                                                                                   | Knowledge          |
| Reception & Office                             | 20 m <sup>2</sup><br>Insulated                     | Electricity<br>Heat                                                                                   | Waste              |
| Services (incl. toilet)                        | 40 m <sup>2</sup><br>Insulated<br>High ventilation | Electricity                                                                                           | Waste              |
| Expo (Space for models + Field for prototypes) | 120 m <sup>2</sup>                                 | Models<br>Prototypes                                                                                  | –                  |

Table 6: Program of requirements for composite factory.  
The thick lines indicate the grouping of spaces according to climate requirements.

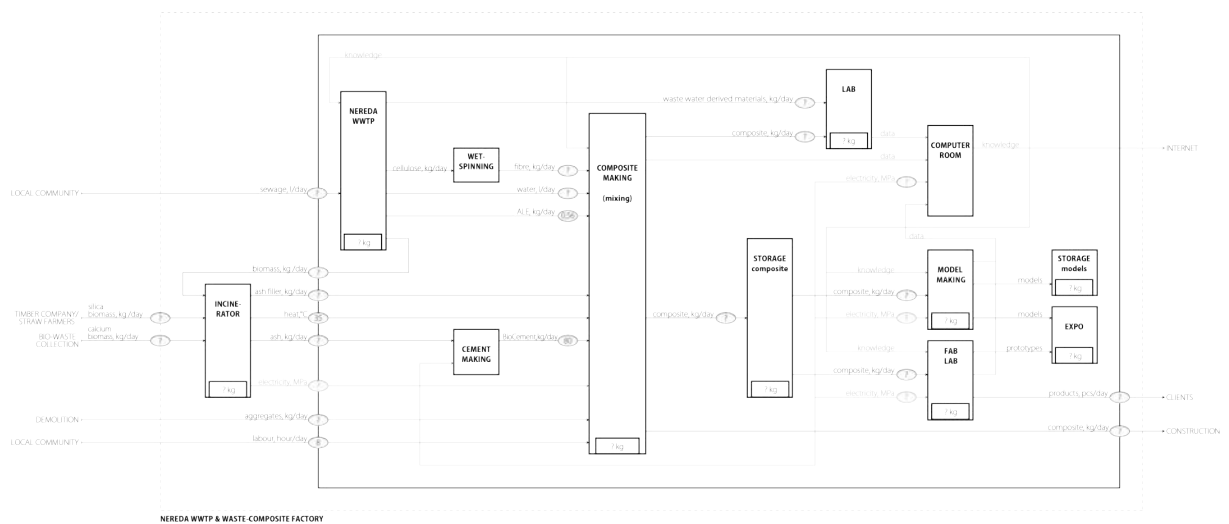

Image 34: Nereda WWTP and waste composite factory (Own image).



## LITERATURE

2012Architecten & Goossens, F. (2009). *Recyclicity: industrial ecology applied in the urban environment*. Place: Publisher.

Bontje, M. (2009). Parkstad Limburg; Krimpregio op zoek naar identiteit en toekomst. *Geografie* (18), 28-31. Retrieved on 24 May, 2015 from <http://dare.uva.nl/document/2/71522>

Braungart, M. & McDonough, W. (2002). *Cradle to cradle: Remaking the way we make things*. London: Vintage Books.

Brdjanovic, D. & Van Loosdrecht, M.C.M. (2014). Anticipating the next century of wastewater treatment: advances in activated sludge sewage treatment can improve energy use and resource recovery. *Science magazine*, 344(6191), pp. 1452-1453. Retrieved on 8 May, 2015 from [www.sciencemag.org](http://www.sciencemag.org).

Carr, N. (2015). PhD student *BioCement*. Interviews May and June 2015.

Chollakup, R., Nardin, M. & Smitthipong, W. (2015). *Bio-Based Composites for High-Performance Materials: From Strategy to Industrial Application*. Boca Raton: CRC Press, Taylor & Francis Group.

Compendium voor de Leefomgeving (2010). *Vrijkomen en verwerking van afval per doelgroep, 1990-2010*. Retrieved on 24 May, 2015 from <http://www.compendiumvoordeleefomgeving.nl/indicatoren/nl0206-Vrijkomen-en-verwerking-van-afval-per-doelgroep.html?i=1-4>

Compendium voor de Leefomgeving, a (2015). *Afvalverbrandingsinstallaties, aantal en capaciteit, 1970-2013*. Retrieved on 24 May, 2015 from <http://www.compendiumvoordeleefomgeving.nl/indicatoren/nl0394-Aantal-en-capaciteit-van-afvalverbrandingsinstallaties.html?i=1-3>

Compendium voor de Leefomgeving, b (2015). *Winning en verbruik van oppervlakedelfstoffen, 1980-2012*. Retrieved on 24 May, 2015 from <http://www.compendiumvoordeleefomgeving.nl/indicatoren/nl0067-Winning-en-verbruik-van-oppervlakedelfstoffen.html?i=15-18>

Galán-Marín, C., Rivera-Gómez, C. & Petric, J. (2010). Clay-based composite stabilized with natural polymer and fibre. *Construction and Building Materials*, 24(2010). pp. 1462-1468. doi:10.1016/j.conbuildmat.2010.01.008

Gkaidatzis, R. (2014). *Bio-based FRP structure; a pedestrian bridge in Schiphol Logistic Park*. TU Delft.

de Graaf, P. (2015) *In strijd tegen de krimp vecht Limburg ook tegen leegstand*. De Volkskrant, 6 May, 2015.

IBA Open Oproep (2013)

Jongert, J., Nelson, N. & Korevaar, G. (2015). *Cyclifiers: an investigation into actors that enable intra-urban metabolism*. Place: Publisher.

Lin, Y., de Kreuk, M., Adin, A., van Loosdrecht, M.C.M. (2010). Characterization of alginate-like exopolysaccharides isolated from aerobic granular sludge in pilot-plant. *Water Research*, 44(11), pp. 3355-3364. doi:10.1016/j.watres.2010.03.019

Lubelli, B. (n.d.). *Mortar; use and development during the centuries*. Reader Construction History AR0014, version 2014, TU Delft.

NNOP (n.d.). Partners. Retrieved on 8 June, 2015 from <http://www.neredannop.nl/partners/>

Otto, F. (1996). *Finding Form: Towards an Architecture of the Minimal*.

Pauli, G. (2010). *The Blue Economy; 10 years, 100 innovations, 100 million jobs*. Taos: Paradigm Publications.

Picken, S. (2015) Professor Biotechnology Delft University of Technology. Interview

Pronk, A., Erinkveld, D., Schipper, R., Eigenraam, P. (2015). Een flexibele mal voor glas, beton en kunststof. *Stedenbouw en architectuur*, 2(April), pp. 12-13.

Provincie Limburg (n.d.). *Het Limburgs duurzaam sloopprotocol*. Retrieved on 20 May, 2015 from

Rademaker, J. (2015). Employee Parkstad Limburg, Housing department. Telephone interview. 20 May 2015.

Rijksdienst voor het Cultureel Erfgoed (2009). *Delfstoffenwinning*. Retrieved on 24 May, 2015 from <http://erfgoedbalans.cultureelerfgoed.nl/ruimtelijke-ontwikkelingen/het-cultuurlandschap/delfstoffenwinning>

Royal Haskoning DHV a, Nationaal Nereda Onderzoeks Programma (Commissioner), Jotja Bessems AV Producties (Producer) (2014). Nereda in Dutch practice: Vroomshoop and Dinxperlo [Video], from <https://www.youtube.com/watch?v=Yfz0lvVddFE>.

Royal HaskoningDHV b (2014). Australia pioneers Dutch wastewater treatment solution. Retrieved on 28 May, 2015 from <http://www.royalhaskoningdhv.com/en-gb/nereda/news-and-events/20141119n-australia-pioneers-dutch-wastewater-treatment-solution/3918>

Royal HaskoningDHV c (2015). *Nereda, the sustainable and innovative wastewater treatment technology*. Retrieved on 1 June, 2015 from <http://www.royalhaskoningdhv.com/en-gb/nereda>

Sierra-Beltran, M. G. (2011). *Ductile cement-based composites with wood fibres; Material design and experimental approach*. Delft University of Technology.

Stadsregio Parkstad Limburg (2011). *Geactualiseerde envelop; Herstructureringsvisie Parkstad Limburg 2010-2010*. Heerlen.

Structuurvisie Parkstad Limburg (2009)

Verdygo (2015). *Showcase*. Retrieved on 6 May, 2015 from <http://www.verdygo.com/showcase>

Waterschapsbedrijf Limburg (2013). *Technologisch jaarverslag 2013*. Roermond. Retrieved on 1 June, 2015 from <http://www.wbl.nl/jaarverslagen/2013/technologisch/Pages/Downloads.aspx>.

Zlopasa, J. (2015). PhD student ALE. Interviews May and June 2015.

Zlopasa, J. Norder, B., Koender, E.A.B. & Picken, S.J. (2015). Origin of Highly Ordered Sodium Alginate/Montmorillonite Bionanocomposites. *Macromolecules*, 48 (4), pp. 1204-1209. Retrieved on 8 May, 2015 from <http://pubs.acs.org/doi/abs/10.1021/ma502147m>.

Zlopasa, J., Koenders, E.A.B. & Picken, S.J. (2014). Using bio-based polymers for curing cement-based materials. Proceedings of the 1st Ageing of Materials & Structures Conference, Delft, The Netherlands, 26-28 May 2014. Retrieved from <http://repository.tudelft.nl/view/ir/uuid:dd760c59-7f6f-40b1-9ed7-c96567921a94/>

Zlopasa, J., Bijl, A., Redeker, J., Marinus, A. & Lanting, M. (2015). *Building your future; Making bricks with alginate in South Africa*. Not published.

## APPENDIX A – NEREDA WASTEWATER TREATMENT PLANTS

| Location    | Client                                                             | Waste Water Type                            | Average capacity           | Peak flow                  | Output                                                             |
|-------------|--------------------------------------------------------------------|---------------------------------------------|----------------------------|----------------------------|--------------------------------------------------------------------|
| Dinxperlo   | Water Board Rijn en IJssel                                         | Municipal                                   | 3,100 m <sup>3</sup> /day  | 570 m <sup>3</sup> /hour   | Post treatment via water park, also for public recreation          |
| Ede         | Vika                                                               | Cheese specialty industry                   | 50-250 m <sup>3</sup> /day | –                          | –                                                                  |
| Epe         | Water Board Veluwe                                                 | Municipal & Industrial                      | 8,000 m <sup>3</sup> /day  | 1,500 m <sup>3</sup> /hour | Sludge thickened via gravity belt thickener & transported off-site |
| Oosterwolde | Smilde Foods                                                       | Production convenient food, sauces & salads | 500 m <sup>3</sup> /day    | –                          | Effluent discharged in municipal sewer.                            |
| Garmerwolde | Construction consortium GMB/Imtech for Water Board Noorderzijlvest | Municipal                                   | 30,000 m <sup>3</sup> /day | 4,200 m <sup>3</sup> /hour | –                                                                  |
| IJsselstein | Westfort Meatproducts                                              | Industrial (pig slaughterhouse)             | 1,400 m <sup>3</sup> /day  | –                          | –                                                                  |
| Rotterdam   | Cargill                                                            | Edible oil industry                         | 700 m <sup>3</sup> /day    | –                          | Effluent discharged in surface water.                              |
| Simpelveld  | Waterschapsbedrijf Limburg                                         | Municipal                                   | 3,668 m <sup>3</sup> /day  | 945 m <sup>3</sup> /hour   | –                                                                  |
| Vroomshoop  | Water Board Vechtstromen                                           | Municipal                                   | 1,500 m <sup>3</sup> /day  | 400 m <sup>3</sup> /hour   | –                                                                  |
| Utrecht     | Water Board Hoogheemraadschap De Stichtse Rijnlanden               | Municipal (trial)                           | 1,500 m <sup>3</sup> /day  | 600 m <sup>3</sup> /hour   | –                                                                  |

Table x: Nereda Wastewater Treatment Plants in the Netherlands. (Royal Haskoning DHV, 2015)  
Retrieved on 1 June 2015 from <http://www.royalhaskoningdhv.com/en-gb/nereda/locations>



Wastewater Treatment Plant Dinxperlo with post-treatment waterpark  
(<http://www.royalhaskoningdhv.com/en-gb/nereda/locations/the-netherlands-dinxperlo/1416>)  
([http://waterforum.net/Images/stories/voorpagina/2012/2012mei/Luchtfoto\\_Nereda\\_installatie\\_rwzi\\_Epe\\_foto1-400px.jpg](http://waterforum.net/Images/stories/voorpagina/2012/2012mei/Luchtfoto_Nereda_installatie_rwzi_Epe_foto1-400px.jpg))



Wastewater Treatment Plant Epe



Wastewater Treatment Plant Garmerwolde  
(<http://www.royalhaskoningdhv.com/en-gb/nereda/locations/the-netherlands-garmerwolde/1406>)



Wastewater Treatment Plant Simpelveld

## APPENDIX B – WASTE WATER TREATMENT PLANTS PARKSTAD LIMBURG

| Location               | System | Capacity                                                   | Input                                                                                         | Flow rate               | Output                                                                    |
|------------------------|--------|------------------------------------------------------------|-----------------------------------------------------------------------------------------------|-------------------------|---------------------------------------------------------------------------|
| Hoensbroek (1974/1990) |        | xx m <sup>3</sup> /day<br>289.136 TZV* i.e. <sub>150</sub> | xxx m <sup>3</sup> of sewage<br>8.137.878 kWh electricity<br>2,174 m <sup>3</sup> natural gas | xx m <sup>3</sup> /hour | 22.567.000 m <sup>3</sup> /year cleared water<br>4,542 tons of dry sludge |
| Heerlen (1968/1981)    |        | 79.152 TZV i.e. <sub>150</sub>                             | 646,592 kWh electricity                                                                       |                         | 1.947.000 m <sup>3</sup> /year cleared water<br>477 tons of dry sludge    |
| Kerkrade (1973/2004)   |        | 90.395 TZV i.e. <sub>150</sub>                             | 1.883.420 kWh electricity                                                                     |                         | 5.262.000 m <sup>3</sup> /year cleared water<br>994 tons of dry sludge    |
| Rimburg (1973)         |        | 90.395 TZV i.e. <sub>150</sub>                             | 1.319.771 kWh electricity<br>3,114 m <sup>3</sup> natural gas                                 |                         | 3.222.000 m <sup>3</sup> /year cleared water<br>854 tons of dry sludge    |
| Simpelveld (1966/1981) |        | 20.491 TZV i.e. <sub>150</sub>                             | 428.343 kWh electricity<br>2,643 m <sup>3</sup> natural gas                                   |                         | 1.260.000 m <sup>3</sup> /year cleared water<br>429 tons of dry sludge    |

Table x: Wastewater Treatment Plants in Parkstad Limburg (Waterschapsbedrijf Limburg, 2013)

(Technologisch jaarverslag 2013. Retrieved on 1 June, 2015 from <http://www.wbl.nl/jaarverslagen/2013/technologisch/Pages/Eigenschappen-en-prestaties.aspx#>)

\* TZV i.e. (Totaal Zuurstof Verbruik per inwoner equivalent) is the amount of pollution in the sewage water caused by one person per 24 hours. A thumb rule 150 g of oxygen is needed to clear 1 i.e. of pollution.

Influent – sewage

Effluent – cleared water

### INPUT MFA WWTP Waterschapsbedrijf Limburg

Effluent:

- Cleaned water → surface water (f.e. Maas or creek)
- Sludge → dehydrated in sieve belt presses and centrifuges (at WWTP)
  - 50% dried into granules by installation Susteren → grinded by Biomill BV in Maastricht → fuel cement ovens of ENCI in Maastricht/ Lixhe → fly ash used as filler in cement
  - 50% incinerated by 'Slibverwerking Noord-Brabant' located in Moerdijk

Influent:

- Sewage water
- Energy (heat and electricity)
  - Self-made biogas – originates during sludge fermentation process (6,900,000 m<sup>3</sup>)
    - Self-generated energy by combined heat and power installation (10.7 million kWh)
    - Directly drive gas motors of aeration system
  - Purchased electricity (50.6 million kWh)
  - Purchased natural gas (4.1 million m<sup>3</sup>) → (reduction of 0.6 million mainly due to closing of dryer in Hoensbroek)
  - Purchased heating oil (1.100 kg)

Energy use:

- Electricity
  - WWTP's 42.2 million kWh
  - Sewage pumping station 6.2 million kWh
  - Dryer 2.2 million kWh
- Natural gas
  - Dryers
- Heating oil
  - heating of buildings at WWTP Kaffenberg

Innovations:

- Thermal pressure hydrolysis (sludge fermentation installation) → 30% increase in generated biogas
  - at WWTP Venlo, where it provides 50% of electricity requirements
- Verdygo (or Modular Sustainable WWTP) – developed bij Waterschapsbedrijf Limburg based on proved technologies
  - in 2013 implemented at part of WWTP Simpelveld
- Neighbourhood of Tomorrow: 0-water concept developed together with Zuyd Hogeschool
  - at industrial area Avantis in Heerlen (construction of four sustainable houses with closed water cycle)
- Pilot CarCON-process of Royal Haskoning DHV
  - Largest ratio of energy is used for aeration, hence CarCon-process implemented as pilot at WWTP Susteren, decreases air input by 9%.
- Pilot project to retrieve nutrients
  - at WWTP Venlo phosphate is retrieved
- Virtual computer models to ease analysis and improvements of existing WWTP's
  - in 2013 Venlo
  - in 2014 Roermond and other (still to be defined) WWTP
- WAUTER (WaterAutomatisERing)
  - Standardization and central operating system in order to manage WWTP from one central location

## APPENDIX C – WASTE STREAMS PARKSTAD LIMBURG

| Component        | Material    | Waste                  | Flow rate | Company                 | Location                         |
|------------------|-------------|------------------------|-----------|-------------------------|----------------------------------|
| Inorganic binder | Clay        | BioCement - Calcium    |           | See table x.            | See map x.                       |
|                  |             | BioCement* - Silica    |           | See table x.            | See map x.                       |
|                  |             | Brick dust             |           | Re-use Materials **     | Deken Nicolayestraat 24, Heerlen |
|                  |             | Glass dust             |           | Re-use Materials        | Deken Nicolayestraat 24, Heerlen |
| Aggregate        | Silt        | Biomass Fly ash        |           | See table x.            | See map x.                       |
|                  |             | Ground Brick           |           | Re-use Materials        | Deken Nicolayestraat 24, Heerlen |
|                  |             | Ground glass           |           | Re-use Materials        | Deken Nicolayestraat 24, Heerlen |
|                  | Sand        | Biomass Fly ash        |           | See table x.            | See map x.                       |
|                  |             | Ground Brick           |           | Re-use Materials        | Deken Nicolayestraat 24, Heerlen |
|                  |             | Ground glass           |           | Re-use Materials        | Deken Nicolayestraat 24, Heerlen |
| Admixture        | ALE         | ALE sewage             |           | Water Board Limburg     | See WWTP's on map page x         |
|                  |             | ALE food factory       |           | Gulpener beer brewery   | Rijksweg 16, Gulpen              |
|                  | Abaca fibre | Toilet paper cellulose |           | Water Board Limburg     | See WWTP's on map page x         |
|                  |             | ALE (fibres)           |           | Water Board Limburg     | See WWTP's on map page x         |
|                  |             | Wood dust              |           | Houtwarenfabriek Daemen | Mingersborgerweg 7, Voerendaal   |
|                  |             | Roadside mowings       |           | Afvalzorg Brunssum      | Waubacherweg 11, Brunssum        |
| Hydrator         | Water       | Effluent of sewage     |           | Water Board Limburg     | See WWTP's on map page x         |

Table

\*BioCement is obtained by incinerating biomass rich in calcium and biomass rich in silica in the right ratio.

\*\* Re-use Material is a company in Parkstad Limburg, which is a partner of province Limburg in developing the 'Sustainable Demolition Protocol'.

## APPENDIX D - BIOMASS/WASTE ENERGY PLANTS

| Function                                                                                                                                                                            | Company                                                                   | Location                                                                         | Input                                                                                                                                                                          | Activities                                                                                                                                           | Output**                                                                                                                           |
|-------------------------------------------------------------------------------------------------------------------------------------------------------------------------------------|---------------------------------------------------------------------------|----------------------------------------------------------------------------------|--------------------------------------------------------------------------------------------------------------------------------------------------------------------------------|------------------------------------------------------------------------------------------------------------------------------------------------------|------------------------------------------------------------------------------------------------------------------------------------|
| Transfer station & landfill<br>Transfer station                                                                                                                                     | Attero<br>Attero                                                          | Landgraaf<br>Kerkrade                                                            | ?<br>Waste East Mining<br>Region                                                                                                                                               | 'Sustainable' dumping,<br>waste water treatment<br>Compaction, train to Wijster<br>& Moerdijk AVI's                                                  | 'Dump gas' (used for<br>energy generation)<br>?                                                                                    |
| Waste Energy Plant<br>Power plant                                                                                                                                                   | MVA (ITAD)<br>RWE<br>Generation                                           | Weisweiler,<br>DE<br>Weisweiler,<br>DE                                           | ?<br>Lignite/Sewage<br>sludge/Ash                                                                                                                                              | Grate firing<br>Incineration                                                                                                                         | Electricity (& grate ash<br>& polluted fly ash)<br>Electricity                                                                     |
| Transfer station<br>Compost factory<br>Biomass Energy Plant<br>Biomass Energy Plant<br>Biomass Energy Plant<br>Biomass Energy Plant                                                 | Attero<br>Attero<br>Imtech<br>BES<br>Imtech<br>Essent                     | Maastricht<br>Maastricht<br>Maastricht*<br>Sittard<br>Venlo<br>Cuijk             | Household & company<br>waste<br>Kitchen/Garden waste &<br>Mowings<br>A- & B- wood: recycle<br>company Bowie<br>?<br>Dried grass/sieving<br>overflow, woodchips &<br>paper pulp | Compaction, train to Wijster<br>& Moerdijk AVI's<br>Filtered to bio-fuel for<br>biomass energy plants<br>?<br>?<br>Co-fermentation<br>Wervelbedketel | Compacted biomass<br>Bio-fuel<br>Electricity & Heat<br>Electricity<br>–<br>Electricity & Extraction<br>for products                |
| Waste Energy Plant<br>Waste Energy Plant<br>Biomass Energy Plant<br>Biomass Energy Plant<br>Waste Energy Plant<br>Bioconversion Plant<br>Biomass Energy Plant<br>Waste Energy Plant | Attero<br>Attero<br>BMC<br>Twence<br>Twence<br>Twence<br>Cogas<br>Attero? | Moerdijk<br>Wijster<br>Moerdijk,<br>Hengelo<br>Hengelo<br>Hengelo<br>Goor<br>Wlp | Compacted waste<br>Compacted waste<br>Poultry Manure<br>Wood & agriculture<br>residues<br>Kitchen/Garden waste<br>Polluted biomass<br>(mowings)<br>Wood clippings<br>?         | Incineration<br>Wervelbedketel<br>Incineration<br>Incineration<br>Fermentation<br>–<br>–<br>?                                                        | Electricity & Ash<br>Electricity & Minerals<br>Electricity<br>Electricity<br>Biogas & Compost<br>Heat & Electricity<br>–<br>–<br>? |

\*Construction finished end 2015. Exact location: Bossherveld Business park.

\*\* Only what is mentioned on website, often missing residues.