

Potential of short-wave infrared spectroscopy for quantitative depth profiling of stratum corneum lipids and water in dermatology

Ezerskaia, Anna; Uzunbajakava, Natallia Eduarda; Puppels, Gerwin J.; De Sterke, Johanna; Caspers, Peter J.; Urbach, H. Paul; Varghese, Babu

DOI

[10.1364/BOE.9.002436](https://doi.org/10.1364/BOE.9.002436)

Publication date

2018

Published in

Biomedical Optics Express

Citation (APA)

Ezerskaia, A., Uzunbajakava, N. E., Puppels, G. J., De Sterke, J., Caspers, P. J., Urbach, H. P., & Varghese, B. (2018). Potential of short-wave infrared spectroscopy for quantitative depth profiling of stratum corneum lipids and water in dermatology. *Biomedical Optics Express*, 9(5), 2436-2450. Article #324743. <https://doi.org/10.1364/BOE.9.002436>

Important note

To cite this publication, please use the final published version (if applicable). Please check the document version above.

Copyright

Other than for strictly personal use, it is not permitted to download, forward or distribute the text or part of it, without the consent of the author(s) and/or copyright holder(s), unless the work is under an open content license such as Creative Commons.

Takedown policy

Please contact us and provide details if you believe this document breaches copyrights. We will remove access to the work immediately and investigate your claim.



Potential of short-wave infrared spectroscopy for quantitative depth profiling of stratum corneum lipids and water in dermatology

ANNA EZERSKAIA,^{1,2} NATALLIA EDUARDA UZUNBAJAKAVA,¹ GERWIN J. PUPPELS,³ JOHANNA DE STERKE,³ PETER J. CASPERS,³ H. PAUL URBACH,² AND BABU VARGHESE^{1*}

¹Department of Personal Care and Wellness, Philips Research, 5656AE, Eindhoven, The Netherlands

²Optics Research Group, ImPhys Department, Delft University of Technology, 2628CH, Delft, The Netherlands

³RiverD International B.V., Rotterdam Science Tower, 3029AK, Rotterdam, The Netherlands

*babu.varghese@philips.com

Abstract: We demonstrate the feasibility of short wave infrared (SWIR) spectroscopy combined with tape stripping for depth profiling of lipids and water in the stratum corneum of human skin. The proposed spectroscopic technique relies on differential detection at three wavelengths of 1720, 1750, and 1770 nm, with varying ratio of the lipid-to-water absorption coefficient and an ‘isosbestic point’. Comparison of the data acquired using SWIR spectroscopy with that obtained by a gold standard for non-invasive quantitative molecular-specific skin measurements, namely confocal Raman spectroscopy (CRS), revealed specificity of the proposed modality for water and lipid quantification. At the same time, we provide evidence showing aberrant sensitivity of Corneometer hydration read-outs to the presence of skin surface lipids, and a lack of sensitivity of the Sebumeter when attempting to measure the lipids of the cornified lipid envelope and intracellular lipid layers. We conclude that a spectroscopic SWIR-based spectroscopic method combined with tape stripping has the potential for depth profiling of the stratum corneum water and lipids, due to superior measurement sensitivity and specificity compared to the Corneometer and Sebumeter.

© 2018 Optical Society of America under the terms of the [OSA Open Access Publishing Agreement](#)

OCIS codes: (170.1870) Dermatology; (170.5660) Raman spectroscopy; (170.6935) Tissue characterization; (300.6340) Spectroscopy, infrared.

References and links

1. D. J. Tobin, “Introduction to skin aging,” *J. Tissue Viability* **26**(1), 37–46 (2017).
2. P. C. Arck, A. Slominski, T. C. Theoharides, E. M. Peters, and R. Paus, “Neuroimmunology of stress: skin takes center stage,” *J. Invest. Dermatol.* **126**(8), 1697–1704 (2006).
3. K. R. Feingold and P. M. Elias, “Role of lipids in the formation and maintenance of the cutaneous permeability barrier,” *Biochim. Biophys. Acta* **1841**(3), 280–294 (2014).
4. D. J. Tobin, “Biochemistry of human skin—our brain on the outside,” *Chem. Soc. Rev.* **35**(1), 52–67 (2006).
5. M. Akiyama, “Corneocyte lipid envelope (CLE), the key structure for skin barrier function and ichthyosis pathogenesis,” *J. Dermatol. Sci.* **88**(1), 3–9 (2017).
6. K. C. Madison, “Barrier function of the skin: “la raison d’être” of the epidermis,” *J. Invest. Dermatol.* **121**(2), 231–241 (2003).
7. D. J. Tobin, “Introduction to skin aging,” *J. Tissue Viability* **26**(1), 37–46 (2017).
8. N. K. Brogden, L. Mehalick, C. L. Fischer, P. W. Wertz, and K. A. Brogden, “The emerging role of peptides and lipids as antimicrobial epidermal barriers and modulators of local inflammation,” *Skin Pharmacol. Physiol.* **25**(4), 167–181 (2012).
9. A. Watabe, T. Sugawara, K. Kikuchi, K. Yamasaki, S. Sakai, and S. Aiba, “Sweat constitutes several natural moisturizing factors, lactate, urea, sodium, and potassium,” *J. Dermatol. Sci.* **72**(2), 177–182 (2013).
10. J. van Smeden, M. Janssens, G. S. Gooris, and J. A. Bouwstra, “The important role of stratum corneum lipids for the cutaneous barrier function,” *Biochim. Biophys. Acta* **1841**(3), 295–313 (2014).
11. R. J. Richters, D. Falcone, N. E. Uzunbajakava, B. Varghese, P. J. Caspers, G. J. Puppels, P. E. van Erp, and P. C. van de Kerkhof, “Sensitive skin: assessment of the skin barrier using confocal Raman microspectroscopy,” *Skin Pharmacol. Physiol.* **30**(1), 1–12 (2017).

12. R. Richters, D. Falcone, N. Uzunbajakava, W. Verkruysse, P. van Erp, and P. van de Kerkhof, "What is sensitive skin? A systematic literature review of objective measurements," *Skin Pharmacol. Physiol.* **28**(2), 75–83 (2015).
13. R. J. Richters, N. E. Uzunbajakava, D. Falcone, J. C. Hendriks, E. J. Jaspers, P. C. van de Kerkhof, and P. E. van Erp, "Clinical, biophysical and immunohistochemical analysis of skin reactions to acute skin barrier disruption - a comparative trial between participants with sensitive skin and those with nonsensitive skin," *Br. J. Dermatol.* **174**(5), 1126–1133 (2016).
14. M. Akiyama, "Corneocyte lipid envelope (CLE), the key structure for skin barrier function and ichthyosis pathogenesis," *J. Dermatol. Sci.* **88**(1), 3–9 (2017).
15. M. Sullivan, N.B. Silverberg, "Current and emerging concepts in atopic dermatitis pathogenesis," *Clin. Dermatol.* **35**(4), 349–353 (2017).
16. S. Li, M. Villarreal, S. Stewart, J. Choi, G. Ganguli-Indra, D. C. Babineau, C. Philpot, G. David, T. Yoshida, M. Boguniewicz, J. M. Hanifin, L. A. Beck, D. Y. Leung, E. L. Simpson, and A. K. Indra, "Altered composition of epidermal lipids correlates with *Staphylococcus aureus* colonization status in atopic dermatitis," *Br. J. Dermatol.* **177**(4), e125–e127 (2017).
17. S. A. Koppes, K. A. Engebretsen, T. Agner, I. Angelova-Fischer, T. Berents, J. Brandner, R. Brans, M. L. Clausen, E. Hummler, I. Jakasa, R. Jurakić-Tončić, S. M. John, D. Khnykin, S. Molin, J. O. Holm, S. Suomela, H. J. Thierse, S. Kezic, S. F. Martin, and J. P. Thyssen, "Current knowledge on biomarkers for contact sensitization and allergic contact dermatitis," *Contact Dermat.* **77**(1), 1–16 (2017).
18. M. Leroy, T. Lefèvre, R. Pouliot, M. Auger, and G. Laroche, "Using infrared and Raman microspectroscopies to compare ex vivo involved psoriatic skin with normal human skin," *J. Biomed. Opt.* **20**(6), 067004 (2015).
19. H. Takahashi, H. Tsuji, M. Minami-Hori, Y. Miyauchi, and H. Iizuka, "Defective barrier function accompanied by structural changes of psoriatic stratum corneum," *J. Dermatol.* **41**(2), 144–148 (2014).
20. M. R. Prausnitz and R. Langer, "Transdermal drug delivery," *Nat. Biotechnol.* **26**(11), 1261–1268 (2008).
21. R. Daniels, "Basic therapeutics: What are the features of modern personal care products to protect and regenerate the skin barrier?" *Hautarzt* **68**(11), 912–915 (2017).
22. A. R. Parrish, "The impact of aging on epithelial barriers," *Tissue Barriers* **5**(4), e1343172 (2017).
23. A. Pons-Guiraud, "Dry skin in dermatology: a complex physiopathology," *J. Eur. Acad. Dermatol. Venereol.* **21**(s2), 1–4 (2007).
24. N. Samson, B. Fink, and P. J. Matts, "Visible skin condition and perception of human facial appearance," *Int. J. Cosmet. Sci.* **32**(3), 167–184 (2010).
25. T. Igarashi, K. Nishino, Sh.K. Nayar, *The Appearance of Human Skin: A Survey* (now Publishers Inc. 2007).
26. A. O. Barel, M. Paye, and H. I. Maibach, *Handbook of Cosmetic Science and Technology* (Informa Healthcare 2009).
27. M. A. Gupta and A. K. Gupta, "Dissatisfaction with skin appearance among patients with eating disorders and non-clinical controls," *Br. J. Dermatol.* **145**(1), 110–113 (2001).
28. A. E. Rizzo and H. I. Maibach, "Personalizing dermatology: the future of genomic expression profiling to individualize dermatologic therapy," *J. Dermatolog. Treat.* **23**(3), 161–167 (2012).
29. R. Marks, J.-L. Leveque, and R. Voegeli, *The Essential Stratum Corneum* (CRC Press 2001).
30. M. A. Lampe, A. L. Burlingame, J. Whitney, M. L. Williams, B. E. Brown, E. Roitman, and P. M. Elias, "Human stratum corneum lipids: characterization and regional variations," *J. Lipid Res.* **24**(2), 120–130 (1983).
31. H. J. Weigmann, J. Ulrich, S. Schanzer, U. Jacobi, H. Schaefer, W. Sterry, and J. Lademann, "Comparison of transepidermal water loss and spectroscopic absorbance to quantify changes of the stratum corneum after tape stripping," *Skin Pharmacol. Physiol.* **18**(4), 180–185 (2005).
32. G. E. Nilsson, "Measurement of water exchange through skin," *Med. Biol. Eng. Comput.* **15**(3), 209–218 (1977).
33. H. Tagami, M. Ohi, K. Iwatsuki, Y. Kanamaru, M. Yamada, and B. Ichijo, "Evaluation of the skin surface hydration in vivo by electrical measurement," *J. Invest. Dermatol.* **75**(6), 500–507 (1980).
34. R. Pethig and D. B. Kell, "The passive electrical properties of biological systems: their significance in physiology, biophysics and biotechnology," *Phys. Med. Biol.* **32**(8), 933–970 (1987).
35. O. G. Martinsen, S. Grimnes, and J. Karlsen, "Electrical methods for skin moisture assessment," *Skin Pharmacol.* **8**(5), 237–245 (1995).
36. B. Cravello and A. Ferri, "Relationships between skin properties and environmental parameters," *Skin Res. Technol.* **14**(2), 180–186 (2008).
37. Z. Movasaghi, S. Rehman, and I. U. Rehman, "Raman Spectroscopy of Biological Tissues," *Appl. Spectrosc. Rev.* **42**(5), 493–541 (2007).
38. H. W. Siesler, Y. Ozaki, S. Kawata, and H. M. Heise, *Near-Infrared Spectroscopy* (Wiley-VCH 2002).
39. D. Cialla-May, X. S. Zheng, K. Weber, and J. Popp, "Recent progress in surface-enhanced Raman spectroscopy for biological and biomedical applications: from cells to clinics," *Chem. Soc. Rev.* **46**(13), 3945–3961 (2017).
40. H. U. Gremlich and B. Yan, *Infrared and Raman Spectroscopy of Biological Materials* (Marcel Dekker 2001).
41. D. W. Shipp, F. Sinjab, and I. Notingher, "Raman spectroscopy: techniques and applications in the life sciences," *AOP* **9**(2), 315–428 (2017).
42. K. Guze, H. C. Pawluk, M. Short, H. Zeng, J. Lorch, C. Norris, and S. Sonis, "Pilot study: Raman spectroscopy in differentiating premalignant and malignant oral lesions from normal mucosa and benign lesions in humans," *Head Neck* **37**(4), 511–517 (2015).
43. A. Ezerskaia, A. Ras, P. Bloemen, S. F. Pereira, H. P. Urbach, and B. Varghese, "High sensitivity optical measurement of skin gloss," *Biomed. Opt. Express* **8**(9), 3981–3992 (2017).

44. A. Ezerskaia, S. F. Pereira, H. P. Urbach, R. Verhagen, and B. Varghese, "Quantitative and simultaneous non-invasive measurement of skin hydration and sebum levels," *Biomed. Opt. Express* **7**(6), 2311–2320 (2016).
45. P. J. Caspers, G. W. Lucassen, E. A. Carter, H. A. Bruining, and G. J. Puppels, "In vivo confocal Raman microspectroscopy of the skin: noninvasive determination of molecular concentration profiles," *J. Invest. Dermatol.* **116**(3), 434–442 (2001).
46. J. Lademann, G. W. Lucassen, P. J. Caspers, and G. Puppels, "Infrared and Raman spectroscopy of human skin in vivo," in *Handbook of Optical Biomedical Diagnostics, Second Edition, Vol 2: Methods*, V.V. Tuchin, ed. (2016).
47. P. J. Caspers, G. W. Lucassen, E. A. Carter, H. A. Bruining, and G. J. Puppels, "In vivo confocal Raman microspectroscopy of the skin: noninvasive determination of molecular concentration profiles," *J. Invest. Dermatol.* **116**(3), 434–442 (2001).
48. P. Caspers, *In vivo Skin Characterization by Confocal Raman Microspectroscopy* (Optima Grafische Communicatie 2003).
49. Y. Gao, X. Wang, S. Chen, S. Li, X. Liu, "Acute skin barrier disruption with repeated tape stripping: an in vivo model for damage skin barrier," *Skin Res Technol.* **19**, 162–168 (2013).
50. R. R. Warner, M. C. Myers, and D. A. Taylor, "Electron probe analysis of human skin: determination of the water concentration profile," *J. Invest. Dermatol.* **90**(2), 218–224 (1988).
51. M. Egawa, T. Hirao, and M. Takahashi, "In vivo estimation of stratum corneum thickness from water concentration profiles obtained with Raman spectroscopy," *Acta Derm. Venereol.* **87**(1), 4–8 (2007).
52. Y. N. Kalia, I. Alberti, N. Sekkat, C. Curdy, A. Naik, and R. H. Guy, "Normalization of stratum corneum barrier function and transepidermal water loss in vivo," *Pharm. Res.* **17**(9), 1148–1150 (2000).
53. C. Choe, J. Lademann, and M. E. Darvin, "Depth profiles of hydrogen bound water molecule types and their relation to lipid and protein interaction in the human stratum corneum in vivo," *Analyst (Lond.)* **141**(22), 6329–6337 (2016).
54. M. Boncheva, J. de Sterke, P. J. Caspers, and G. J. Puppels, "Depth profiling of Stratum corneum hydration in vivo: a comparison between conductance and confocal Raman spectroscopic measurements," *Exp. Dermatol.* **18**(10), 870–876 (2009).
55. K. R. Feingold and P. M. Elias, "Role of lipids in the formation and maintenance of the cutaneous permeability barrier," *Biochim. Biophys. Acta* **1841**(3), 280–294 (2014).
56. M. Akiyama, "Corneocyte lipid envelope (CLE), the key structure for skin barrier function and ichthyosis pathogenesis," *J. Dermatol. Sci.* **88**(1), 3–9 (2017).
57. J. Pinnagoda, R. A. Tupker, T. Agner, and J. Serup, "Guidelines for transepidermal water loss (TEWL) measurement. A report from the Standardization Group of the European Society of Contact Dermatitis," *Contact Dermat.* **22**(3), 164–178 (1990).
58. C. W. Blichmann and J. Serup, "Assessment of skin moisture. Measurement of electrical conductance, capacitance and transepidermal water loss," *Acta Derm. Venereol.* **68**(4), 284–290 (1988).
59. M. Egawa and H. Tagami, "Comparison of the depth profiles of water and water-binding substances in the stratum corneum determined in vivo by Raman spectroscopy between the cheek and volar forearm skin: effects of age, seasonal changes and artificial forced hydration," *Br. J. Dermatol.* **158**(2), 251–260 (2008).
60. M. Poncet, A. Weerheim, J. Kempenaar, A. M. Mommaas, and D. H. Nugteren, "Lipid composition of cultured human keratinocytes in relation to their differentiation," *J. Lipid Res.* **29**(7), 949–961 (1988).
61. G. W. Lu, S. Valiveti, J. Spence, C. Zhuang, L. Robosky, K. Wade, A. Love, L. Y. Hu, D. Pole, and M. Mollan, "Comparison of artificial sebum with human and hamster sebum samples," *Int. J. Pharm.* **367**(1-2), 37–43 (2009).
62. V. R. Wheatley, "The sebaceous glands," in *The Physiology and Pathophysiology of the Skin, vol 9*, A. Jarrett, ed. (Academic press 1986).
63. I. Brody, "A light and electron microscopy study of normal human stratum corneum with particular reference to the intercellular space," *Ups. J. Med. Sci.* **94**(1), 29–45 (1989).
64. D. N. Menton and A. Z. Eisen, "Structure and organization of mammalian stratum corneum," *J. Ultrastruct. Res.* **35**(3), 247–264 (1971).
65. H. Nakazawa, N. Ohta, and I. Hatta, "A possible regulation mechanism of water content in human stratum corneum via intercellular lipid matrix," *Chem. Phys. Lipids* **165**(2), 238–243 (2012).
66. J. van Smeden, M. Janssens, G. S. Gooris, and J. A. Bouwstra, "The important role of stratum corneum lipids for the cutaneous barrier function," *Biochim. Biophys. Acta* **1841**(3), 295–313 (2014).

1. Introduction

1.1 Stratum corneum structure and composition

From an anatomic and physiological perspective, human skin represents a complete biologic universe. Not only does it house the skin appendages, such as sweat glands and pilosebaceous units, but also blood vessels, muscle tissue, nerves, components of immunocompetence and endocrine function [1]. Furthermore research over the past ten years has demonstrated the skin's remarkable stress sensing capacity [2].

While the function of human skin goes far beyond a guardian of water-holding capacity and mechanical integrity, evidently its most traditional mission remains to be forming a barrier to the hostile external environment [3], protecting against physical, chemical and microbial insults, as well as against water- and electrolyte loss [3,4]. The barrier function of the skin is primarily fulfilled by the stratum corneum (SC), the outermost layer formed by corneocytes (keratinocytes that have migrated from the basal layer to the very top of the skin and acquired a phenotype of terminally differentiated, denucleated cells).

The barrier structure of the stratum corneum in human skin has four major components, from the inside of cornified cells to the outside: (i) keratin, filaggrin, involucrin and loricrin and their degradation products filling the cytoplasm of cornified cells, (ii) the cornified cell envelope (CCE), (iii) the corneocyte lipid envelope (CLE) and (iv) the intercellular lipid layers [5]. Of these structures, the CLE and the intercellular lipid layers consist of essential epidermal lipid components. Ceramides are one of the three major lipid classes (among free fatty acids and cholesterol/chol-esters), each representing approximately about one third of the total SC lipids and this specific composition is required to form the highly ordered lipid lamellae, which are crucial for the barrier function.

The extracellular space of cornified cell layers is occupied by multiple lipid layers called “intercellular lipid layers” that consist mainly of ceramides (50%), cholesterol (25%) and free fatty acids (10%-20%) with very little phospholipid [3,4,6–8] arranged in parallel layers (lamellae) between the corneocytes and is essential for permeability barrier. Next to the lipid matrix originating from lamella bodies of corneocytes, sebum secreted by sebaceous gland also contributes to the overall lipid profile at the surface of the stratum corneum.

The corneocytes are filled with water, keratins and a mixture of highly hygroscopic substances known as natural moisturizing factor (NMF) [5,9]. The water-binding property of NMF contributes to the hydration of the stratum corneum, which is essential for hydrolytic enzymatic processes, required for normal desquamation to take place [5].

The stratum corneum thus is a complex structure, which integrity and barrier function depends on cohesion of corneocytes, the presence and organization of lipids between them and their water-holding capacity.

1.2 Importance of skin barrier, lipids and water for cosmetic- and medical dermatology and skin pharmacology

Characterization of the skin barrier is of central importance in several fields including dermatology, skin pharmacology and personal care. Skin barrier function is affected in patients with extensive list of dermatological diseases including lamellar ichthyosis, psoriasis, Netherton syndrome, Chanarin–Dorfman and atopic dermatitis (AD) [10] and has been suggested to play a role in sensitive skin [11–13].

For example, barrier defect abnormalities (contributing to increased transepidermal water loss in addition to increased allergen exposure), such as a shared filaggrin mutation were noted in ichthyosis vulgaris [14] and atopic dermatitis, where reduced structural proteins and lipids (e.g., ceramides), have been discovered as well [15]. Altered composition of epidermal lipids was also found to be correlated with *Staphylococcus aureus* colonization status in atopic dermatitis [16]. It was also proposed that information on biomarkers including lipids could be essential in distinguishing allergic contact dermatitis from other types of dermatitis, for example irritant and atopic dermatitis [17]. In psoriatic skin, a chronic inflammatory disease associated with a variety of co-morbid conditions, including cardiovascular disease, heterogeneity in lipid/protein composition at the micrometer scale [18] and changes in transepidermal water loss (TEWL), free fatty acids and sebum [19] have been reported. In skin pharmacology, new transdermal drug delivery methods have to overcome the skin barrier while maintaining its integrity [20] or deliver optimized formulations [21].

In personal care, skin care and shaving routines, such as shaving, exfoliation, microdermabrasion, and hair removal, need to carefully balance their effectiveness and

mildness towards SC barrier in order to prevent excessive discomfort and skin irritation. Looking from a perspective of cosmetic dermatology, alterations in skin water holding capacity, water and lipids concentrations are thought to be implicated in aging skin [22] and in dry skin [23]. To continue, in cosmetic industry, skin appearance is traditionally and at least partly judged based on skin oiliness or/and glossy appearance, where the latter one is caused by a presence of emulsified film composed of lipids of sebum, cornfield envelope, cosmetics and environment pollution with sweat [24,25]. While extensive skin oiliness or/and gloss are often attributed to decreased appearance, their suboptimal levels are associated with itchy and dry-feeling skin, which looks lusterless, erythematous, and scaly [26,27].

1.3 Need in quantification of skin barrier, lipids and water

All this requires *in vivo*, non-invasive, quantitative tools assessing skin barrier function and in particular its water and lipid composition. Furthermore a continuously increasing demand towards personalized-aesthetics treatments [28], further emphasizes a need for non-invasive, quantitative skin measurements of the stratum corneum water and lipids.

1.4 State of the art methods for quantification of skin lipids and water

In the past years, quantification of the amount and composition of the extracted stratum corneum have been performed using a range of different methods such as weighing, optical spectroscopy, electron microscopy, X-ray diffraction [29]. For example, electron microscopy and X-ray diffraction studies have been carried out to investigate the degree of organization of intercellular lipids and its composition [30]. An optical method based on measurement of the pseudo absorption determined by scattering, reflection and diffraction of the corneocytes in the visible range was described by Weigmann et al. [31].

Several easy-to-use and high throughput *in vivo* non-invasive methods for skin barrier assessment are well accepted in the dermatologist's office and in the mainstream of the cosmetic industry. They include transepidermal water loss, capacitance- and conductance measurements for assessment of skin water content and its water-holding capacity and Sebumeter and gloss meter for assessment of skin lipids and gloss [32,33].

The simplicity of these traditional, easy-to-use techniques comes, however, at a cost of their specificity. The data interpretation is not straightforward, as read-outs might be affected by external and internal factors not taken into account by these techniques. In particular, in the case of the electrical techniques, substances or treatments that interact with the keratin-water network of the stratum corneum can change the electrical properties of the skin without actually altering the water content [34]. Moreover, despite the apparent ease of use, measurements have to be performed under strictly controlled conditions in order to obtain reliable results, minimizing the influence of biasing factors, such as ambient temperature and humidity as well as skin appendages [35,36].

Also knowing that the stratum corneum is a non-uniform, inhomogeneous membrane, the question “whether the lipid and water composition is distributed uniform across the stratum corneum thickness?” is not well addressed by existing methods. In particular, quantitative information on how the lipid and water composition changes with the depth in the stratum corneum is very limited.

In contrast, optical method based on light absorption and/or scattering by specific molecules, such as Raman microspectroscopy [37,38] is well known for their chemical specificity and high spatial resolution and, thus, are inherently superior to traditional indirect electrical methods. Until now, confocal Raman microspectroscopy remains to be the gold standard for non-invasive quantitative, spatially-resolved measurements of concentration profiles of molecular components through the skin, including water and lipids. Confocal Raman microspectroscopy has been successfully used for several dermatological applications. With further developments for reducing the cost, CRS has the potential to enter the

mainstream of clinical and dermatological practice with even wider range of applications [39–42].

1.5 Short wave infrared spectroscopy for the quantification of lipids and water in the stratum corneum

Near-infrared microspectroscopy is an alternative lower cost approach to confocal Raman microspectroscopy for quantification of the molecular composition of the skin. While this technique offers far less molecular specificity compared to Raman scattering, near-infrared microspectroscopy can provide quantitative and molecular-specific information on water and lipids in the skin—two components that play an important role in skin condition (e.g., oily skin versus dry skin) as well as skin barrier and its disorders.

Recently we reported two highly sensitive optical methods for quantitative assessment of the skin gloss in the low value regime of relevance for daily applications [43]. Subsequently, we reported preliminary results demonstrating the feasibility of a novel non-invasive optical method for simultaneously measuring the hydration and sebum retaining ability of the skin [44]. The methods rely on the detection of signals at three carefully selected wavelengths in the spectral region around 1720 nm, with ratio of sebum-to-water absorption coefficient greater than 1; lower than 1 and an ‘isosbestic point’, where lipids and water absorb equally.

To gain spectroscopic information from the deeper layers of stratum corneum, we used tape-stripping, a well-established method for the investigation of skin permeability and barrier function, evaluation of dermatological disorders and assessment of penetration profile and efficacy of various cosmetic and dermatological formulations.

As a follow-up, in this study, we show the feasibility of short wave infrared spectroscopy as a novel method for analyzing the stratum corneum components, lipids and water, as a function of depth where the stratum corneum layers were removed using a double-sided adhesive tape. We also compared the results with the gold standard of skin measurements, confocal Raman spectroscopy, and with traditionally accepted, mainstream biophysical devices such as Corneometer, TEWL and Sebumeter.

2. Materials and methods

The study was approved by an internal ethics committee, the Internal Committee for Biomedical Experiments (ICBE) and the volunteer provided written informed consent. Data was acquired in vivo on the forehead (T-zone) of a female volunteer (26 years old) with no history of atopic dermatitis, asthma, allergy, contact dermatitis, or any other skin disorders. The forehead region was chosen because it represents a skin area with a high density of sebaceous glands with medium level of hydration.

D-Squame Sampling Disc (CuDerm Corporation, Dallas, USA) with the diameter 30.16 mm was applied for tape stripping. The exerted pressure on the tape was controlled by the D-Squame pressure instrument at 225 gr/cm² for 10 seconds. Tapes were removed by fast movement with D-Squame angular tweezers to ensure minimal variations in the conditions of tape stripping and in the amount of skin removed.

The developed infrared spectroscopic setup relies on skin illumination using three laser sources and utilizes differential detection at 1720 ± 4 nm, 1750 ± 5 nm and 1770 ± 20 nm wavelength (Fig. 1). These specific wavelengths were previously selected as representative bands corresponding to the lipid vibrational bands that lay “in between” the prominent water absorption bands [44]. Following the logic, the wavelengths 1750 nm and 1770 nm were used for estimating the water content and 1720 nm and 1750 nm were used for estimating the lipid content. The amount of water and lipids is then calculated based on the ratio of backscattered light to the incident intensity using an algorithm based on Beer–Lambert’s law. The setup and algorithms are described in more detail elsewhere [44].

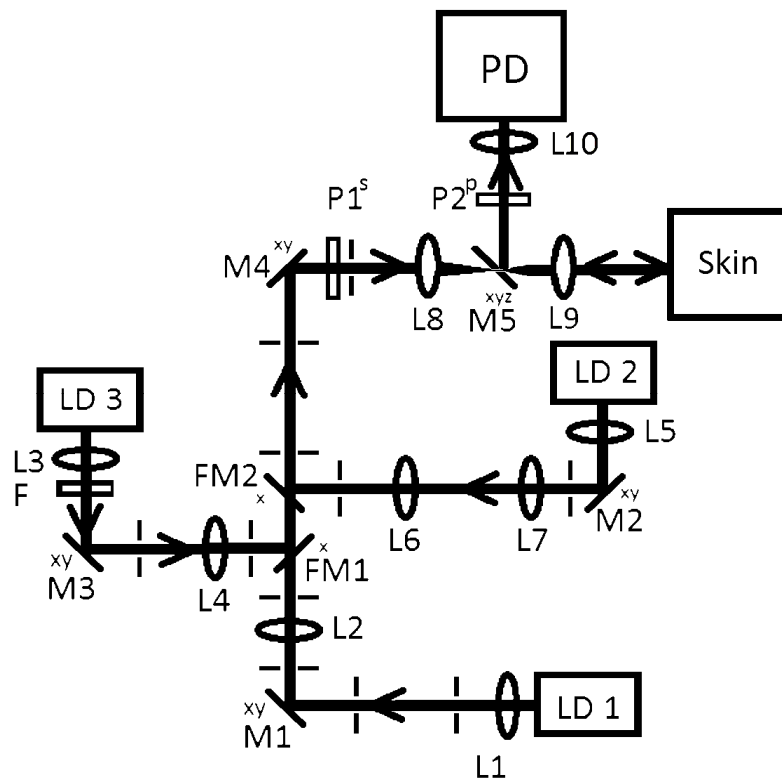

Fig. 1. Schematic of the short wave infrared experimental set-up [44]: LD1 – Laser Diode (1720 ± 4 nm, Roithner Laser), LD2 – Laser Diode (1750 ± 5 nm, Roithner Laser), LD3 – Laser Diode (1770 ± 20 nm, Roithner Laser), F – Narrowband filter (1770 ± 5 nm, Spectrogon), M1, M2, M3, M4 – mirrors, M5 – Mirror with a central aperture, FM1, FM2 – Flipping mirrors, L1, L3, L5 – Aspheric lenses, L2 ($f = 300$ mm), L4 ($f = 300$ mm), L6 ($f = 75$ mm), L7 ($f = 150$ mm), L8 ($f = 35$ mm), L9 ($f = 35$ mm) – Plano convex lens, L10 ($f = 25.4$ mm, LA1951-C) P1^s, P2^p – polarizers, PD – photodiode (DET30B/M).

The relative amount of water and lipids content in the stratum corneum with respect to the baseline were measured after each tape stripping with the shortwave infrared spectroscopic experimental set-up, Corneometer CM825 (Courage & Khazaka, Köln, Germany), AquaFlux Transepidermal water loss (TEWL) instrument (Biox Systems Ltd, Herts, England) and Sebometer SM815 (Courage & Khazaka, Köln, Germany). These reference biophysical devices were used according to instructions given in the corresponding user manuals. Data were acquired five times in a row with all devices (SWIR, CRS, Corneometer, TEWL, Sebometer) within a small area of investigation (6 cm^2).

To obtain benchmark (or gold standard) values for the water and lipids concentrations as a function of depth, confocal Raman microspectroscopy measurements were performed on the same volunteer before tape stripping as a reference (using an inverted confocal Raman microspectrometer gen2-SCA equipped with 785 nm and 671 nm laser sources, model RiverIcon 4.0 instrument control, RiverD International B.V., Rotterdam, The Netherlands). The system was previously described in detail elsewhere [45,46]. Raman spectra were obtained over a depth range of $30 \mu\text{m}$, starting from the skin surface and at an axial resolution of $2 \mu\text{m}$. For each depth, measurements were performed at 10 different lateral locations ($50 \mu\text{m}$ apart) to average out the intrinsic spatial variation of molecular composition at a microscopic scale. SkinTools 2.0 software (RiverD International B.V., Rotterdam, The Netherlands) was used for spectral analysis. Lipid and water content was calculated based on

lipid to protein (keratin) and water to protein (keratin) ratio's, respectively (lipid: 2790-2910 cm^{-1} ; protein: 2910-2966 cm^{-1} ; water: 3350-3550 cm^{-1}) [47].

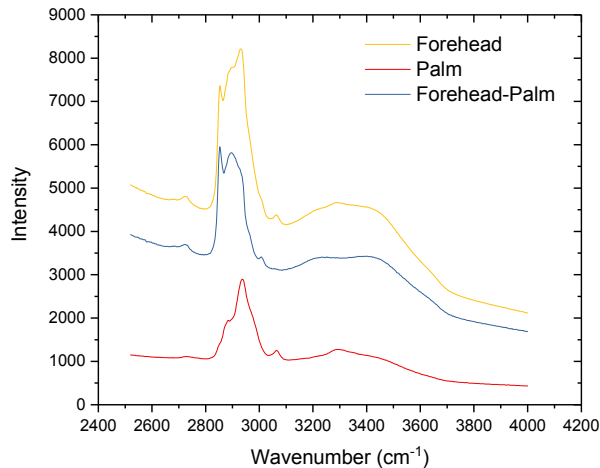

Fig. 2. Raman spectra of forehead, palm and differential spectrum of both.

Protein is used as an internal reference and the signal due to water and lipids is normalized by the protein signal to compensate for the depth dependent losses in Raman signal. The overlap in the high wavenumber region between spectral bands for proteins (2910–2966 cm^{-1}) and lipids (2790–2910 cm^{-1}) can lead to an inexactitude as described by Choe et al. [49]. To minimize this, a spectrum of the stratum corneum of the palm of hand was obtained (Fig. 2). Palmar stratum corneum spectra show very little signal contributions of lipids. The intensity ratio of the lipid-band (2790–2910 cm^{-1}) and the protein-band (2910–2966 cm^{-1}) was used as baseline value. This baseline value was subtracted from the intensity ratios obtained from the forehead spectra.

3. Results

Raman spectra measured at three different axial positions in the skin (0, 4 and 16 μm with respect to the surface of the SC) together with spectral regions with preferential signal of water (3350-3550 cm^{-1}), protein (2910-2966 cm^{-1}) and sebum/lipid (2790-2910 cm^{-1}) are shown in Fig. 3. It can be seen from the Fig. 3 that there is a very low water signal at the top surface of the stratum corneum and just below the skin (0 to 4 μm depth with corresponding physiological concentration of approximately 25%). The spectra at 0 and 4 μm can also be measured within the thin layer of sebum or at the sebum-skin interface. A notably strong water signature is appearing at a depth corresponding to the boundary between the SC and the viable epidermis (approximately 10-15 μm below the skin surface, where the water concentration in healthy skin reaches about 65%). These experimental findings are fully in line with what is known from the literature [48].

As for the lipids, their clearly visible spectral signature both at the skin surface and at a depth of 4 μm is notable, while at a deeper location (16 μm) the spectral band 2790 - 2966 cm^{-1} becomes dominated by proteins, i.e., lipid content is decreasing. Relatively high contribution of lipids to the spectra acquired from the superficial layers originates from a mixture of intercellular lipids of corneocytes and components secreted by the sebaceous glands. Note that in the regions of high density of sebaceous glands such as T-zone (where the measurements have been performed), the contribution of epidermal components is very

low (3-6%). At the same time, at body locations with sparse presence of the sebaceous glands, epidermal lipids are expected to leverage a larger contribution to the overall lipid signal.

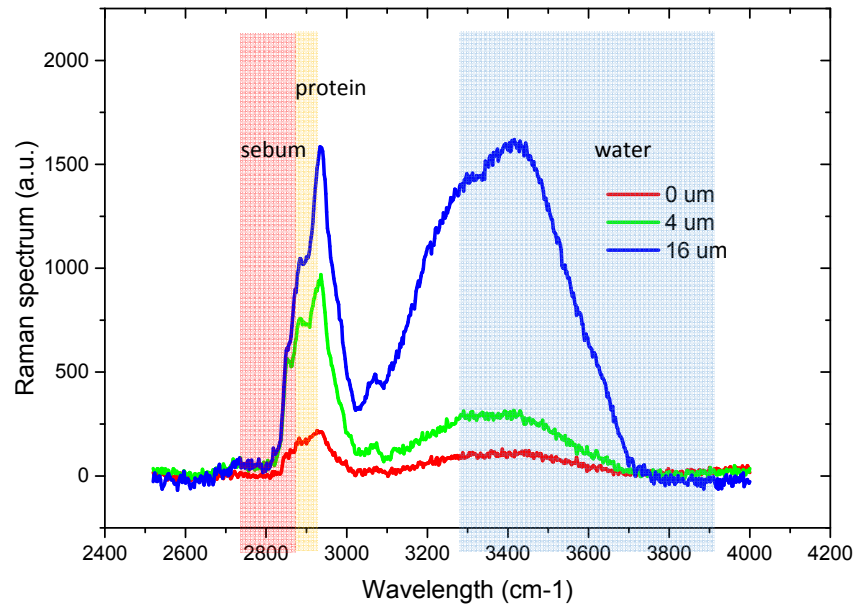

Fig. 3. Raman spectra of the stratum corneum acquired at three axial positions, 0, 4 and 16 μm . Spectral regions with preferential contribution of water (3350-3550 cm^{-1}), protein (2910-2966 cm^{-1}) and sebum/lipid (2790-2910 cm^{-1}) are marked.

The results of water and lipid content measurement as a function of tape strip number using the proposed SWIR method, together with the corresponding data acquired using Corneometer, TEWL are shown in Fig. 4-5. The water content is normalized with respect to the maximum value corresponding to 70% water content in viable epidermis and lipid content is normalized with respect to the maximum value corresponding to the lipid content measured at the skin surface before tape stripping. Corresponding depth resolved water and lipid measurements using confocal Raman micro spectrometer is shown for comparison. Except for Raman spectroscopy, all other methods require tape stripping to obtain depth resolved information because these measurement systems do not have inherent depth resolution required for depth profiling.

As was expected, one can observe an increase in the level of the SC hydration with an increase in the number of the removed tape strips, as corneocytes with higher amount of water become 'exposed' to the probes used in SWIR, Corneometer and TEWL measurements. As for the overall shape of the water concentration profile, it shows a very steep initial rise corresponding to the first 6-8 tapes, where the barrier function got impaired as shown by corresponding TEWL readings, which shows abrupt increase in water flux [49]. Our findings are fully in line with previously reported water concentration profile across the SC of human subjects obtained using electron-probe analysis [50] and confocal Raman microscopy [51].

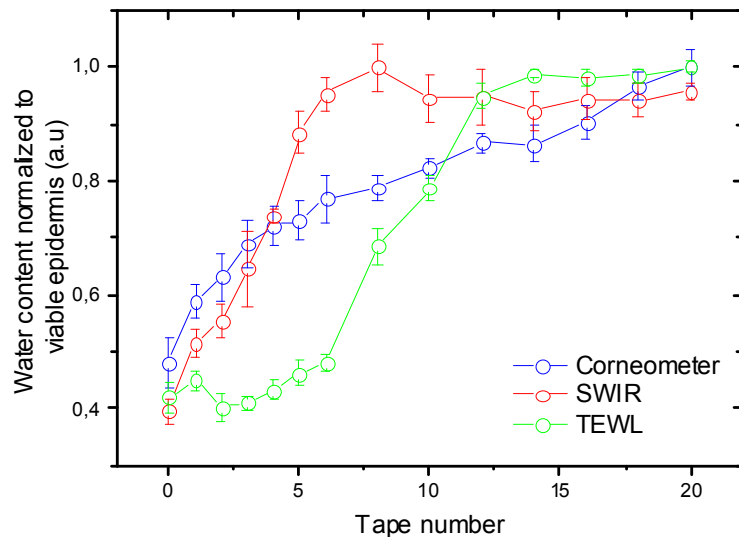

Fig. 4. Relative Stratum corneum water content normalized with respect to the maximum value (70% water) as a function of tape-strip number measured with SWIR, Corneometer and TEWL.

In contrast to the profiles measured using SWIR, capacitance increase with depth is almost linear in the low hydration regime of the nearly intact skin (corresponding to up to five tapes removed), while changes to exponential growth when the barrier function is impaired (in a depth region corresponding to $\sim 30\%$ increase of TEWL values [52]). Similar results for the capacitance measurements were previously demonstrated by Boncheva et. al, where the authors hypothesized that these linear and exponential regions reflect different proton mobilities in bound and liquid/free water (where the water molecules are tightly bound to SC keratins at lower water content up to 40 mass% and are present in unbound state at high water content [53]). This suggests that once the skin barrier has been impaired by tape stripping, it is not clear whether the increase in capacitance and SWIR measurements are related to a higher water content of the deeper layers or to an increased water flux induced by tape stripping, as shown by the increased TEWL readings. Therefore, the electrical and SWIR measurements when used in combination with tape stripping for depth profiling need to be applied in combination with the measurement of TEWL [54].

The results of lipid content measurement as a function of tape strip number using the proposed SWIR method, together with the corresponding data acquired using Sebumeter are shown in Fig. 5. Each data set shows a relative lipid content, where the data were normalized with respect to the maximum value measured at the very surface of the skin, prior to tape stripping, where lipids of the SC envelope, of corneocytes and of sebum contribute to the overall signal). The corresponding depth-resolved profile acquired using confocal Raman micro-spectrometer in non-disturbed intact skin is shown for comparison as a gold standard/ground truth in Fig. 6.

One notices a very similar trend in the depth-resolved data obtained using the SWIR and the Raman spectroscopy methods: both show an almost linear decrease in the lipid signal over the first 10 micrometers, followed by a nearly steady-state plateau. This is specific for the T-zone where physiologically a thin layer of sebum content is expected.

This lipid signal across the SC measured using SWIR after a thin layer of sebum was removed is in line with what is known about their deposition by epidermal keratinocytes. The

latter are delivering lipids to construct the cornified envelope by exocytosis of lamella bodies organelles at the boundary between the SC and the viable epidermis [55,56].

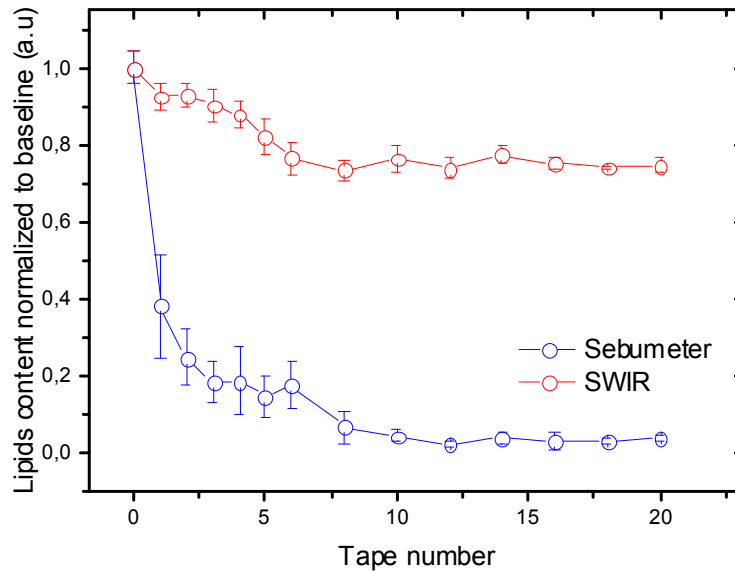

Fig. 5. Relative Stratum corneum lipid content normalized with respect to the baseline (no-strip) as a function of tape-strip number measured with SWIR and Sebumeter.

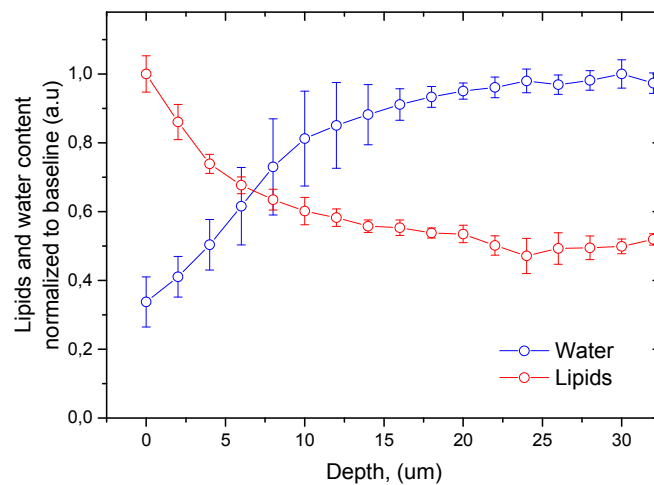

Fig. 6. Depth resolved relative stratum corneum water and lipid content normalized with respect to the baseline measured with confocal Raman micro spectrometer for comparison.

Figure 7 shows the dependence of capacitance based skin hydration measurements using the Corneometer to measure the presence of lipids. The baseline skin hydration value was measured on the T-zone having casual sebum levels (250-300 units measured with Sebumeter) and hydration measurements were repeated while the amount of sebum on the

skin surface was gradually removed. We observe that skin hydration values increases (Fig. 7, black line) by a factor of two as the sebum levels drops from 250 to 300 to 50-60 Sebum units measured with the Sebumeter. Figure 6 (red line) shows the decrease in the baseline skin hydration measured with the Corneometer as we gradually apply a thin layer of artificial sebum on the skin surface, in a range relevant for physiological values. We observe that skin hydration drops by a factor of three as the amount of sebum was increased from 0 to 1.2 $\mu\text{l}/\text{cm}^2$ on the skin surface, indicating the influence of sebum on hydration measurements.

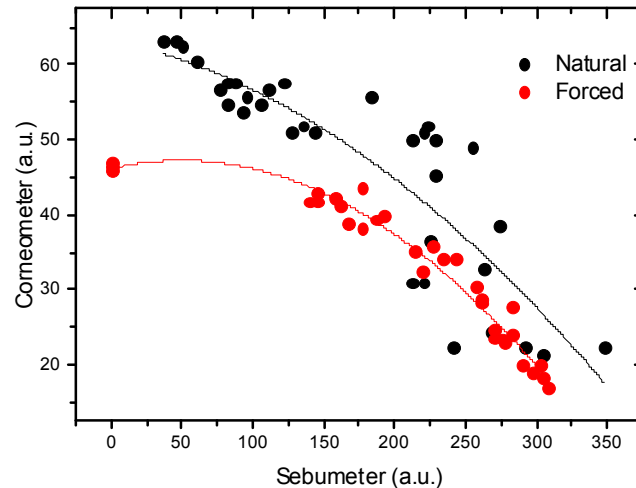

Fig. 7. Dependence of capacitance based skin hydration measurements using Corneometer on the presence of skin surface lipids (sebum).

4. Discussion

We quantify the depth profile of SC lipids and hydration using short wave infrared spectroscopy combined with tape stripping and compare the results with conventional biophysical devices such as Corneometer, Sebumeter, AquaFlux TEWL and Confocal Raman spectrometry, which provides the gold standard. The method of tape stripping in combination with short wave infrared spectral analysis presented in this study demonstrate a simple and noninvasive method for the analysis of intercellular lipids and the degree of hydrogen bonding (or hydration) as a function of depth in the SC. The results show that the SC is a non-uniform membrane, characterized by gradients of the water and lipid content.

Regarding non-invasive methods reported for monitoring water content in the skin in vivo, instruments based on transepidermal water loss properties [57], dielectric properties such as conductance and capacitance [58] and spectroscopic techniques, such as near-infrared spectroscopy [38], and Confocal Raman microscopy [40,59] have been used. Even though conductance and capacitance based hydration measurements are cheap and portable, these measurements give only relative water content, not absolute values as in the case of Confocal Raman. The relationship between electrical properties and water content is highly complex and nonlinear. The device readings using electrical measurements are affected by the presence of sebum, sweat, hairs, surface microtopography and other environmental factors such as humidity and temperature. The measurement of hydration level of the stratum corneum obtained with the capacitance method can be affected by the presence of a thin layer of lipids (sebum) and also moisturized creams, having lower value of dielectric constant. This is expected because when a thin layer of oil or artificial sebum having very low dielectric constant ($\epsilon_r \sim 3$) is present in the probing depth of the Corneometer, which is typically in the

range of few tens of microns, the hydration of skin based on the relatively high dielectric constant of water ($\epsilon_r \sim 80$) can be influenced. Furthermore, the sensitivity of the capacitance-based method in the low hydration regime is limited. In addition, water present in the skin can be tightly bind, bind and not bind and therefore the variation in water binding strength can lead to poor correlation between total water content and electrical conductance [58]. The electrical methods based on capacitance and conductance give an integrated value of the SC hydration, rather than the actual water distribution of the superficial epidermal layers. In addition, it is not clear whether the increased water content measured with electrical measurements during tape stripping is due to high water content of the deeper SC layers or because of the water flux induced by tape stripping [54]. However, electrical devices and methods can be used to distinguish between dry SC, normal SC and highly hydrated SC.

The transepidermal water loss (TEWL) is used as an indirect measure to characterize the thickness of the SC layer. This method is inaccurate, especially for tape strips removed from the superficial layers of the stratum corneum. In addition, emulsions or creams applied on the skin surface can influence the TEWL. TEWL measurements suggest a high influx of water after about stripping half of the stratum corneum.

Unlike depth resolved Confocal Raman measurements, the amount of lipids and water content measured with SWIR and other biophysical devices do not directly reflect the individual layer contents because of the probing depth of these devices. The results rather correspond to a weighted average over the outermost few layers because these measurement systems do not have inherent depth resolution like Confocal Raman. Except for Raman measurements that was done in intact skin, all other measurements were done in combination with tape stripping to get depth information and this will impair the barrier function and in particular can influence the water content compared to intact water measurements performed with Confocal Raman. In addition, as the skin hydration changes with SC depth, the refractive index of the skin, its absorption and consequently the penetration depth of the beam also change. The amount of lipid and water content per layer could be quantitatively determined by measuring the attenuation characteristics of each tape as a function of depth. Compared to Raman measurements, all other devices have to be used in combination with tape stripping to get depth information. Nevertheless, the trends observed in the measurements and the general nature of the behavior obtained remain unchanged.

Several non-invasive in vivo methods such as solvent extraction, cigarette paper pads, photometric assessment, bentonite clay, and lipid-sensitive tapes have been developed to quantify skin surface lipid parameters: sebum casual level, sebum excretion rate, sebum replacement time, instant sebum delivery, follicular excretion rate, and sustainable rate of sebum excretion. Sebumetry, based on photometric measurement technique is an established photometric method in the diagnostic practice and in clinical trials, as they are time-saving and highly reproducible. The lipids near the surface represent a mixture of true intercellular lipids and sebaceous lipids. The amount and composition of the skin surface lipids is a mixture of epidermal and sebaceous components. Epidermal lipids originate from the maturing corneocytes and are liberated at the skin surface during the normal desquamation process where the terminal keratinocytes exfoliate. The amount and composition of the intracellular lipids change during the maturation process of the keratinocyte [60]. Sebaceous lipids containing large quantities of relatively low -melting-point fatty acids delivered to the skin surface is attenuated quite quickly as one proceeds (through the sequential tape-stripping) into the membrane [61]. The relative ratio of these two components depends on the density of sebaceous glands and therefore on the body locations. In the regions of high density of sebaceous glands such as in the T-zone, the contribution of epidermal components is very low (3-6%) whereas in sebaceous glands sparse body regions epidermal lipids have a more significant influence on the lipid mixture [62]. Sebum present on the surface may be high as 100 to 500 $\mu\text{g}/\text{cm}^2$, compared with the low quantities of epidermal lipids, which can vary in the range of 5-10 to 25-40 $\mu\text{g}/\text{cm}^2$ [62]. Sebumeter is sensitive only to the non-bound

skin surface sebaceous lipids and epidermal lipids present in the first one or two layers. The decreases in SC lipid content observed in spectroscopic measurements may be also reflected due to the increase in the fractional volume occupied by the corneocytes with increasing depth. This observation is consistent with previously reported microscopic histology, which showed dense corneocytes surrounded by relatively large amounts of lipid near the skin surface and larger corneocytes with smaller intercellular spaces deeper in the membrane [63,64].

Until now, no non-invasive devices and methods except confocal Raman spectroscopy have been reported for the quantitative and simultaneous measurement of stratum corneum lipids and water content. Development of a non- or minimally invasive method for measuring stratum corneum hydration and lipids simultaneously will enable to assess the balance between these factors related to skin health and to select the appropriate dermatological treatment and provide personalized skin treatment solutions. This will also enable to classify the skin types into Normal skin (N), Dry skin (D), Oily Skin (O), Oily-Hydrated skin (OH) and oily-dry skin (OD) and select appropriate water or oil based skin care products and to monitor the progress during treatment. Confocal Raman microscopy has developed as a powerful tool for analyzing the depth dependent physio-chemical properties of the SC, providing valuable information on the water and intercellular content [65]. Even though Confocal Raman is a highly reliable method for direct and spatially resolved depth profiling of water and lipid content, the commercially available devices are expensive. More recently, this technique was further applied for analyzing the intercellular lipid conformation and the lipid lateral packing order which are directly linked to an impaired skin barrier function and skin diseases, such as atopic eczema, psoriasis [66].

Compared to Sebumeter measurements that is sensitive to surface lipids only, short wave infrared spectroscopic method is sensitive to both bound and non-bound lipids and therefore makes it possible to measure the changes for lipids present in stratum corneum during tape stripping. One of the potential advantages of the proposed optical method is that it is insensitive to the presence and variation of other skin chromophores such as blood and melanin and can be applied independent of skin type. Moreover, the probe does not need to be in contact with the skin so that the repeated measurements can be performed on the same location without changing the skin conditions.

5. Conclusions

In this manuscript, we quantify changes in skin hydration and lipids using short wave infrared spectroscopic set-up combined with tape stripping and compare the results with conventional biophysical devices such as Corneometer, Sebumeter and AquaFlux TEWL. The preliminary results demonstrate the feasibility of the novel optical method for simultaneously measuring the hydration and sebum retaining ability of the skin as a function of tape strip number during tape stripping. Compared to Confocal Raman measurements, all other measurement devices including SWIR need to be used in combination with tape stripping, as these measurement devices do not have inherent depth resolution. Furthermore, changes in the stratum corneum barrier function and the corresponding increase in the flux of water occurring during tape stripping suggest that these measurement devices need to be used in combination with TEWL for quantitative estimation of water content. Confocal Raman and shortwave infrared spectroscopic measurements show that the SC barrier in terms of the intercellular lipid and the degree of hydration is not uniform across the entire thickness: the outer few layers appear to be less hydrated and contains increased amount of intercellular lipids than the deeper layers of the membrane. We conclude that the short wave infrared spectroscopic technique combined with tape stripping can be used for analyzing the stratum corneum components and thereby provide more quantitative and more reliable skin barrier function information than conventionally employed electrical methods.

Funding

PhD research project between Philips Electronics Nederland B.V. and Technische Universiteit Delft.

Acknowledgments

We would like to thank Dr. S. F. Pereira from the Delft University of Technology, for her contribution and support throughout our research.

Disclosures

The authors declare that there are no conflicts of interest related to this article.