

Survey of Israel Three-Dimensional Cadastre and the ISO 19152 - The Land Administration Domain Model

Report 2 (updated version)

20 September 2014, Prof. dr. ir. Peter van Oosterom, TU Delft

Summary

This report contains the results of the second phase of the 3D Cadastre and LADM investigations in context of possible future renewal of the Cadastral database at the Survey of Israel. This report sequels the report of phase 1 and complements the presentation given on 17 July 2014 ‘Towards an Israeli - 3D LADM country profile 3D Cadastres’ at the Survey of Israel, Tel Aviv. The first phase of the investigations covered two studies: 1. the state of the art of three-dimensional cadastre and 2. current cadastral procedures, land model and database. In the report of phase 1 the motivation for 3D Cadastre became very clear: Israel is a relatively small country, with a rapidly growing population, the pressure on the available land/space is increasing, and today’s technology is enabling 3D functionality as proven in some other countries; e.g. China (or other application areas). Also institutional aspects are an important part of the second phase and therefore, besides staff members of the Survey of Israel, also staff members of the other main actors in the Israeli land administration domain have participated in the 17 July 2014 meeting. For completeness the presentation is included as annexes to this report. The second phase document in this report continues with the recommendations from the first phase of the investigations and addresses a series of 3D Cadastre/LADM topics: standards, procedures, case studies, SDI, LADM country profile, data transfer, DBMS schema, query and visualization.

Contents

1. Introduction
 2. Israeli 3D LADM country profile
 - 2.1. LADM background
 - 2.2. Developing a 3D LADM country profile for Israel
 3. Technical model / implementation
 - 3.1. 3D Cadastre workflow
 - 3.2. Deriving technical model from conceptual model
 4. 5D Cadastre research
 5. Conclusion
- References
- Annex A. Slides ‘Towards an Israeli - 3D LADM country profile 3D Cadastres’
- Annex B. Various LADM Questions and Answers
- Annex C. 3D LADM example: Malaysian LA

Chapter 1.

Introduction

An overview of the international state of the art of three-dimensional cadastre, and specific 3D issues to consider in Israel (legal context, sub-parcel concept) is given in the report of phase 1 (Oosterom, 2014). Further, the report of phase 1 analysed the current cadastral procedures, land model and database in Israel, made an initial comparison between the Israeli model and the ISO 19152 (LADM, the Land Administration Domain Model) as first step towards an LADM country profile for Israel.

In the second phase of the investigations, the next step is taken towards an Israeli 3D LADM country profile. The development of this LADM country profile is a joint activity involving the Israeli key players, that is, besides the Survey of Israel, also the Land Registry (especially when also considering to register apartments, condominiums in 3D), Israel Land Authority (93% of the land in Israel is in the public domain, and ILA is responsible for managing this land), and the licensed surveyors (creating the new 2D and 3D parcel representations). Different organizations are involved and cooperation is needed, not only for creating the new Israeli LADM country profile, but also to agree on new functionality (such as 3D Cadastre) and most important for data exchange, data synchronization and joint data delivery supporting the daily activities. This setting asks for an information infrastructure approach, which is also assumed in ISO 19152. Various organizations are, or will be in the near future, involved in maintaining and disseminating the land administration information. In addition with emphasis on the 3D component, there may be even more need for an information infrastructure approach (or spatial data infrastructure, when the spatial aspect is emphasized). For example the underground and above ground legal spaces in a 3D cadastre are often related to real world (physical) objects, such as tunnels, underground parking or shops, above road constructions (buildings), etc. The scoping of the Israeli 3D LADM country profile, the SDI context, and initial conceptual model will be described in Chapter 2 of this report.

More technical aspect of the 3D Cadastre, such as various implementation decisions (3D data acquisition, modeling, quality checking, storing, disseminating and visualization) based on the conversion from the conceptual model to the technical model (actual database schema and exchange format) is described in Chapter 3 of this report. This will be illustrated with actual example implementations and selected (software) tools from other countries. It should be noted that every situation is different and also at technical level Israel has to make its own choices. An obvious important factor is the current (software) infrastructure. Chapter 4 looks ahead towards possible further developments beyond 3D cadastre, including deep integration of 3D space and time in a higher dimensional representation. Also the issue of level of detail or accuracy of the representation is addressed. These topics are related to the recently started research “5D Cadastral GIS project (5DMpLIS)” by an Israel-Greek consortium. This report ends with Chapter 5, which recaptures main conclusions and recommendations.

Chapter 2.

Israeli 3D LADM country profile

This chapter describes the first developments of the conceptual model of the Israeli 3D LADM country profile. First a short summary is first given of the key concepts in the international standard ISO 19152 (section 2.1). The next section addresses the Israeli country profile (section 2.2).

2.1. LADM background

The Land Administration Domain Model (ISO-TC211 2012, van Oosterom, Lemmen and Uitermark 2013) provides an international standardization of the key concepts of land administration. LADM covers both the survey, cadastral map and land registry (legal) information. Figure 1 shows the four core classes reflecting the LADM scope: LA_Party (natural and non-natural persons), LA_RRR (rights, restrictions, and responsibilities), LA_BAUnit, and LA_SpatialUnit (parcels). LA_BAUnit stands for basic administrative unit and groups parcels (LA_SpatialUnits) with same rights (LA_RRRs) attached, e.g. when forming together one property. Note that LA_SpatialUnits can be 2D or 3D representations and these are well integrated in LADM standard. The explicit linking between parcels and related rights is to be implemented in Israeli setting via the SDI (with SOI, LR, and ILA participating), rather than copying and maintaining redundant information. This integrated service is also what society will expect (and will care less which parts of government are involved).

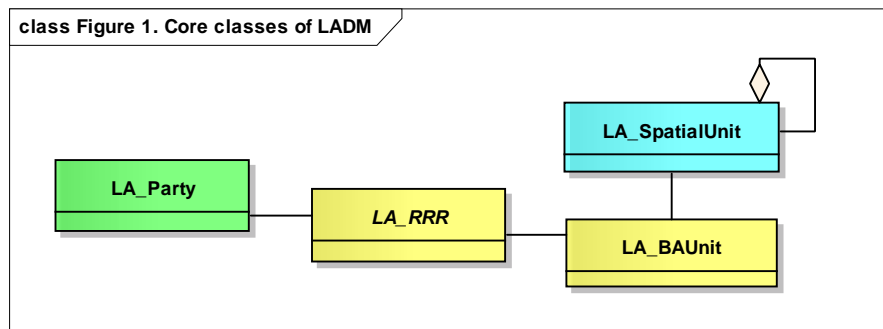

Figure 1. The four core classes from LADM.

LADM supports full versioning/ history for all features (by inheriting from LADM's VersionedObject; see Figure 2). This means that all objects get a life span via the two attributes: beginLifespanVersion and endLifespanVersion. Different versions of the same object instance keep the same identifier, but with different time stamps. This allows recording the changes over time and allows retrieval of past states in a simple and efficient manner. Objects should only change based on events which are described in source documents. LADM supports the explicit linking of the data in the database (cadastral map, land registry) with the source documents. Two main types of source

documents are available LA_AdministrativeSource (for supporting the RRRs) and LA_SpatialSource (for supporting the spatial descriptions); see Figure 3.

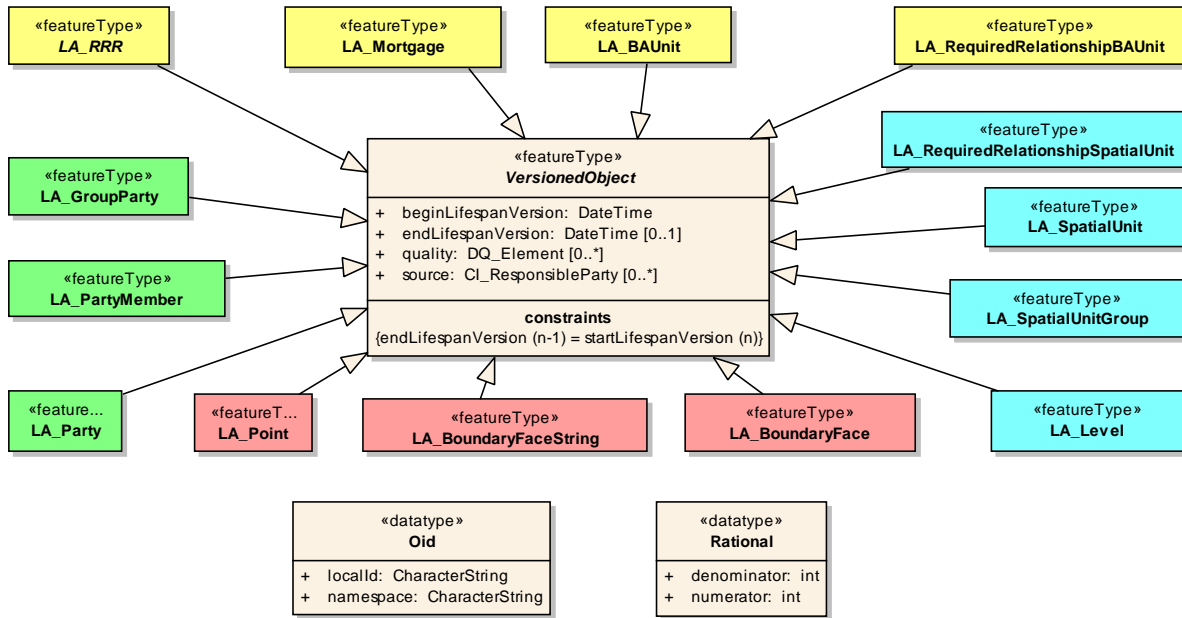

Figure 2. All LADM classes inheriting from VersionedObject.

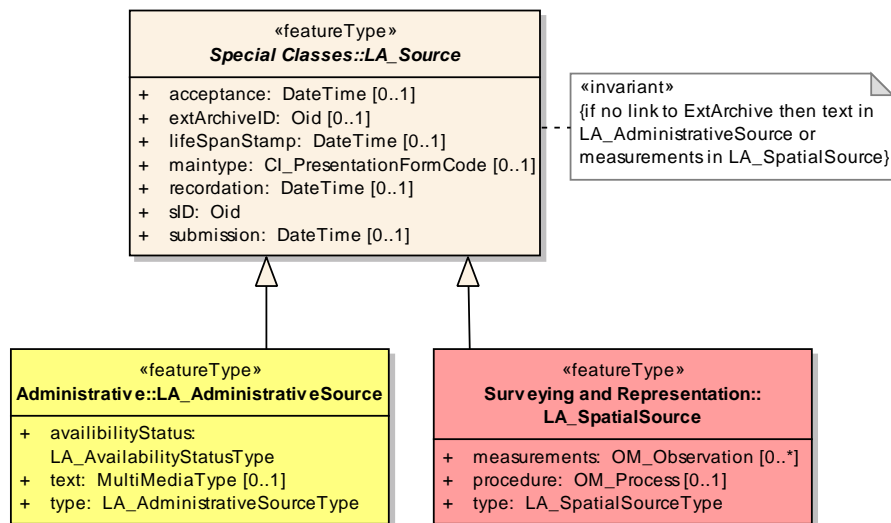

Figure 3. Administrative and Spatial source documents in LADM.

LADM supports a range of spatial representation: from simple textual descriptions to storage in a topological structure (and polyline or circular arc boundaries with left and right references to parcels). LADM reuses other ISO TC211 standards; e.g. for the basic

geometry representations (GM_Point, GM_Curve), but also for maintaining relevant quality and other meta-data (DQ_Element). Note that all ISO TC211 classes start with a two letter prefix: for LADM this is 'LA', for basic geometry this is 'GM'. With respect to integrated 2D and 3D parcels (or spatial units) according to LADM, it can be observed that this is not too different from the original 3D sub-parcel concepts as developed in Israel (but LADM could allow a 3D parcel to cross multiple surface parcels). LADM is very generic; it is rather a language for the concepts is land administration, often offering ranges of options for the main concepts. It is not a prescriptive standard in the sense of specifying just a single option. When developing a country profile, one can select the most appropriate options and build a model on top of these classes by adding country specific aspects (attributes, relationships, constraints).

2.2. Developing a 3D LADM country profile for Israel

During the various meetings and other communication means (mainly emails) the main scoping questions were addressed, giving clear indications for further developing the Israeli 3D LADM country profile. The four scoping questions raised by the FIG Working group 3D Cadastres (van Oosterom, Stoter, Ploeger, Thompson and Karki 2011) have now been answered and indicate where, when, and how to apply 3D Cadastre in Israel:

1. What are the types of 3D cadastral objects? Are these related to (future) constructions (buildings, pipelines, tunnels, etc.) or can these be any part of the 3D space, both airspace or subsurface?
Answer: Both a. related to (future) constructions (buildings, pipelines, tunnels, etc.), and b. any part of 3D space (airspace, subsurface). This in order to make the registration system future proof. Initially not all options may be used and supported in the system, but the model should enable representing all these situations.
2. Use 3D Parcels also for simple apartments/ condominium buildings with possible related (subsurface) facilities such as storage or parking or use more traditional 2D floor plans for the different levels?
Answer: Not in short term (use 2D floor plans), but may be in longer term. As this is a very common case, happening very often this is also an important aspect. Instead of using exact height information, also estimated heights can be used as for example in Spain's 3D Cadastre solution (Olivares García et al, 2011).
3. Are 3D Parcels for infrastructure objects, such as long tunnels, pipelines, and cables, divided by surface parcels or are these represented by one object?
Answer: Only divided by blocks ('Gush'). So, join subparcels in block, which is a slight modification to the original Israeli 3D subparcel approach, but joining subparcels immediately after creation will result in a more manageable registration.
4. For representation of 3D parcel: does a legal space have its own geometry or is it specified by referencing to existing topographic objects?
Answer: Own geometry. This similar with today's practise to 2D parcels, also having their own geometry and makes the solution more robust and not depending on changes in the real world.

It may be wise to design a more generic solution, from legal, organizational and technical points of view, of which initially only the most urgent cases will be represented in 3D. However, it is to be expected that in less urgent cases the needs or expectations of society in the future may also change and it is good to anticipate or even stimulate these future uses of 3D registration (e.g. registration of air-space or the registration of apartments in 3D). Another scope/ modelling question is related to the Earth surface (terrain elevation).

5. Should we define a surface that specifies whether a parcel is above or under ground level (see Figure 4)? How should ground level be defined?

Answer: It is often very relevant to know whether a parcel above, below or in mixed position w.r.t. Earth surface. So, for 3D parcels it may be tempting to use relative height w.r.t. Earth surface. However, as the Earth surface may change over time (due to natural or man-related causes) this is not a stable reference, and it is therefore advised to have at least absolute height in coordinates of 3D parcels and maintain and use Earth surface (height) description as separate registration. During data dissemination and visualization 2D parcels can then be projected on Earth surface and combined with 3D parcels (via SDI approach).

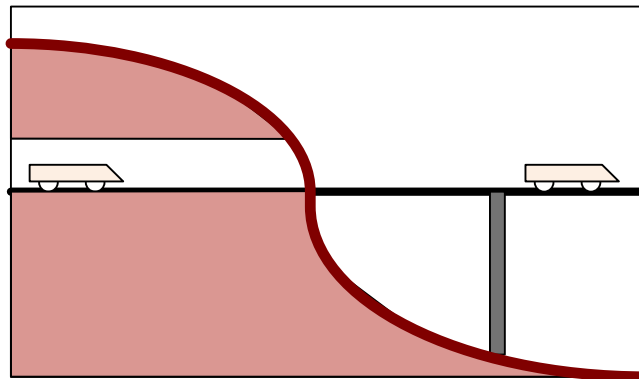

*Figure 4: The railway parcel is above and under the ground
(source illustration: Yaron Felus/Shimon Barazani).*

Investigating exemplary cases, such as the apartments/ condominium buildings case in question 2, and the tunnel/pipeline discussion in question 3, is important. Analysing these cases then better support scoping and taking future proof design decisions. Another exemplary case is the use of 3D space below the surface/ property of another party. The Israeli cadastral database nowadays is still two-dimensional. It was discussed that in the 3D Cadastre, the 2D parcels should be interpreted as 3D parcels as vertical columns based on the 2D geometry. These 3D parcels can then have 3D exclusions or 3D additions to represent using the space below someone else's property (beneficiary party gets the additional 3D space, the other party gets exclusion of this space from his property). This raises the following LADM modelling question:

6. The parcel 2D records (base properties) will be linked with these exclusions/ additions (see Figure 5). The question is how to define a parcel which is open on the side of top and/or bottom and bounded on the other sides?

Answer: In LADM an elegant way to model the cases such as example in Figure 5 is as follows: use the LA_Level approach with a 2D parcel level and a 3D parcel level:

- have 3 parcels (A, B, C) in 2D parcel level, implying 3D columns;

- have 1 parcel (A-1+B-1) in 3D parcel level; and
- use LA_BAUnit to combine C with A-1+B-1.

Then the parcels A and B, both 3D columns, have exclusion (A-1+B-1) via the LA_Level approach. Parcel C has documented extension via LA_BAUnit grouping.

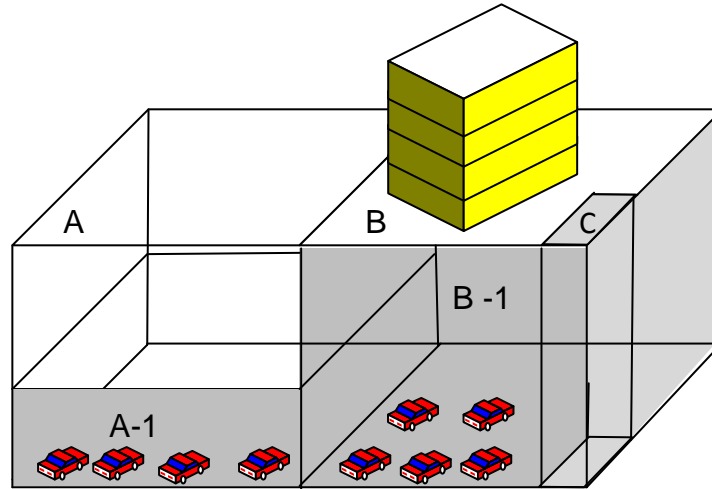

Figure 5: The parking lot parcel is composed out of the shaft parcel (C) which is infinite parcel A-1 which is the exclusion from parcel A and B-1 which is the exclusion from B (source illustration: Yaron Felus/Shimon Barazani).

After the discussed scope and various design considerations (based on analysing the cases), the conceptual model for the Israeli 3D LADM country profile can be made. This country profile should both consider the current registration (in 2D) and the wishes for the future registration. Therefore the first step is analysing the key concepts in LADM and their counterparts in the actual registrations and link related concepts. In Table 1 the mapping of LADM and BNKL key concepts is repeated from the report of phase 1. It should be noted that for a nationwide 3D country profile this mapping should also include the mappings to the key concepts of other relevant registrations; that is, the registrations of Land Registry, Israel Land Authority, and perhaps even more organizations (e.g. geometries with legal implications resulting from spatial planning).

Table 1. An initial mapping between the key concepts of BNKL and LADM from report phase 1 (van Oosterom 2014).

BNKL	LADM	remark
Gush	LA_SpatialUnitGroup	
Parcel	LA_SpatialUnit	
Parcel_arc	LA_BoundaryFaceString	
	LA_BoundaryFace	No 3D currently in BNKL
Parcel_node	LA_Point	
Talar	LA_SpatialSource	
	LA_BAUnit	Not explicit in BNKL
	LA_RRR	In scope of Land Registry
	LA_AdministrativeSource	In scope of Land Registry
	LA_Party	In scope of Land Registry

As stated in report 1, it is very good to make the relationships explicit (linking to concepts in the shared language of LADM) as these are crucial in the Information Infrastructure in a country, in which multiple organizations maintain and provide related (source) information. Figure 6 shows a UML diagram of the current registration in the initial Israeli country profile as specialization of LADM. The prefix 'IL_' is used to indicate the fact that this is the Israel country profile. The following inheritance relationships are shown IL_Parcel (from LA_SpatialUnit), IL_ParcelArc (from LA_BoundaryFaceString), IL_ParcelNode (from LA_Point), IL_Gush (from LA_SpatialUnitGroup), and IL_Talar (from LA_SpatialSource). The first step towards 3D parcels is the introduction of the 3D IL_BoundaryFace (from LA_BoundaryFace), but this needs to be further developed. The same is true for the administrative side of the Israeli LADM country profile. Several model considerations (including defining code lists) are given in the presentation; see Annex A, slides 26-28.

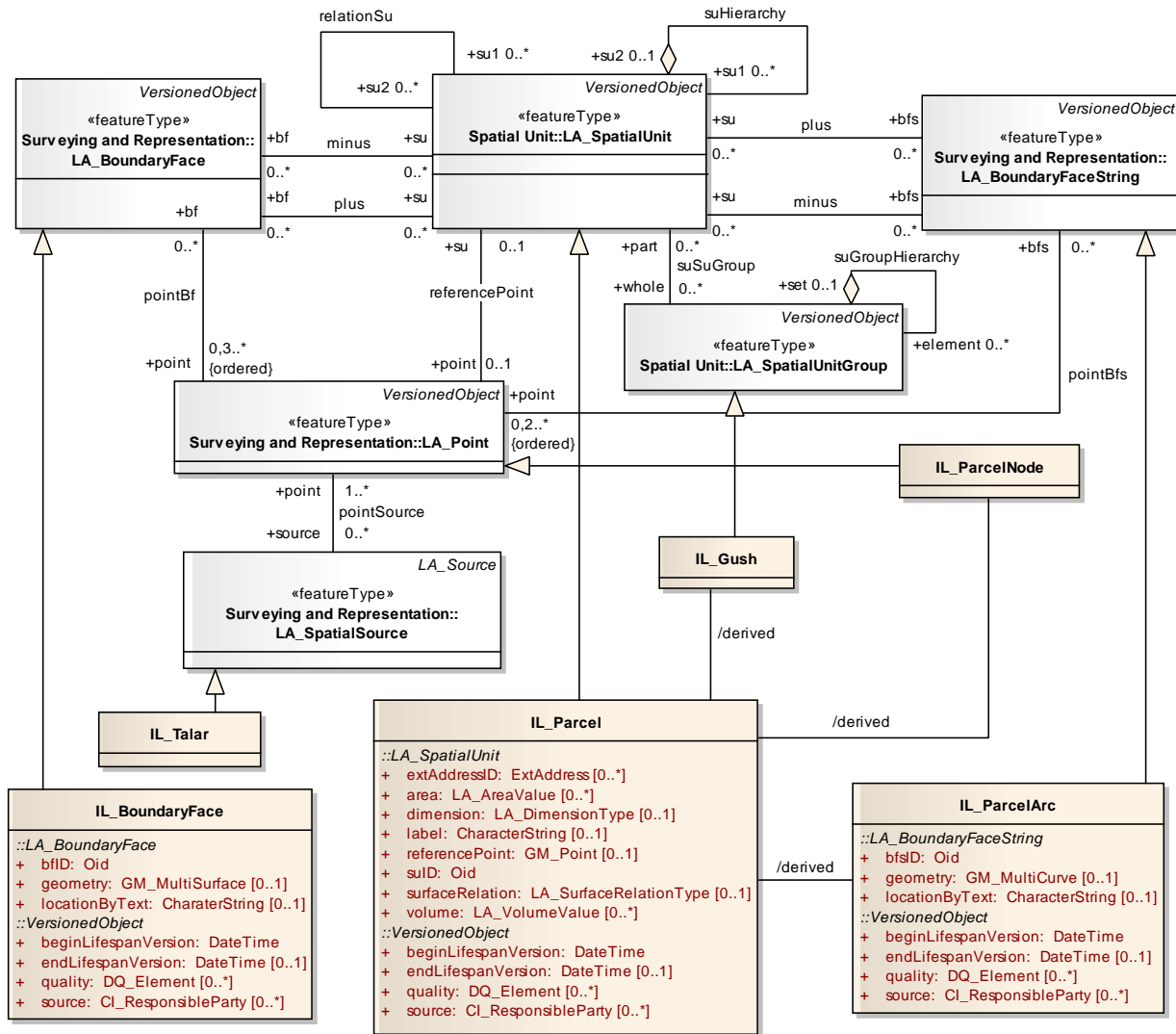

Figure 6. Current situation of spatial side of land administration in Israel, UML model of the initial Israeli country profile as specialization of LADM.

Chapter 3. Technical model / implementation

In this chapter the complete 3D Cadastre workflow is presented (Section 3.1), together with the conversion from the conceptual model (Israeli LADM country profile) into the technical model (Section 3.2), which can be used for implementation in the context of a database schema (e.g. SQL DDL) and/or exchange format (e.g. XML schema). In this more implementation oriented chapter also the tooling issues will be addressed and illustrated with examples from other countries.

3.1. 3D Cadastre workflow

Realizing a cadastral registration with 3D support has impact on the complete workflow: from data acquisition until data dissemination in 3D and all steps in between. Figure 7 shows the seven steps of this workflow, which are identified and will be discussed in more detail below.

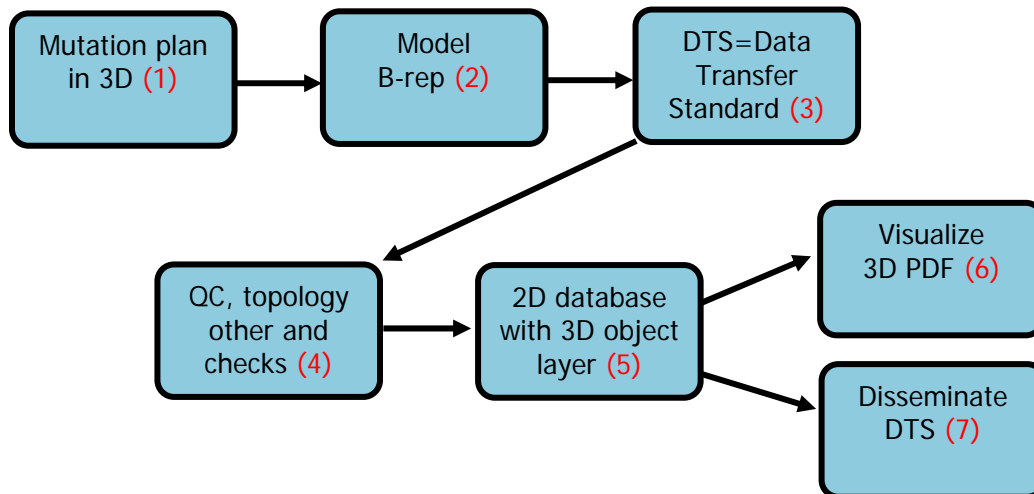

Figure 7. The 3D cadastre workflow.

Steps 1 (survey or mutation plan in 3D) and 2 (B-rep of model) take care of providing the spatial data sources of the new 3D parcels. In cadastral context we are used to survey as basis to create the 3D geometries of parcels. However, direct survey in 3D, might be challenging, e.g. how to survey a subsurface object or an airspace object? Experience from Queensland, Australia shows that a lot of the submitted ‘survey plans’ (mutation plans) do seem to have a CAD origin. For existing physical objects with legal spaces attached, there are some methods to obtain the 3D geometries:

- Upgrade existing 2D floor plans to 3D volumes: manual initially, in the future more automation
- If no plans available, then do a survey. Laser scan based measurement may be more effective than Tachymeter

Today, new buildings are often directly designed in 3D. With some limited additional effort (and clear guidelines) it should be possible to create the relevant 3D cadastral objects. This illustrates that 3D Cadastral registration is not an isolated activity, but actually part of a complete spatial development workflow chain. For 3D models there are different options available than the obvious B-rep approach. For example: CSG (constructive solid geometry) or voxel representations. However, the B-rep approach is preferred, because this is also the approach used in the 2D cadastral modelling, but more importantly the B-rep models support well both survey and design originated 3D data.

```
<?xml version="1.0" encoding="utf-8"?>
<CityModel xmlns="http://www.opengis.net/citygml/1.0"
  xmlns:xsi="http://www.w3.org/2001/XMLSchema-instance"
  xmlns:xlink="http://www.w3.org/1999/xlink"
  xmlns:generic="http://www.opengis.net/citygml/generics/1.0"
  xmlns:gml="http://www.opengis.net/gml"
  xsi:schemaLocation="http://www.citygml.org/citygml/1/0/0
http://schemas.opengis.net/citygml/1.0/cityGMLBase.xsd
http://www.opengis.net/citygml/generics/1.0
http://schemas.opengis.net/citygml/generics/1.0/generics.xsd">
  <gml:name>TU Delft example 3D Parcel for Cadastre</gml:name>
  <gml:boundedBy>
    <gml:Envelope srsDimension="3" srsName="urn:ogc:def:crs:EPSG:7.6:7415">
      <gml:lowerCorner srsDimension="3">84936.169 444962.883 0.0 </gml:lowerCorner>
      <gml:upperCorner srsDimension="3">86082.217 446807.742 90.0 </gml:upperCorner>
    </gml:Envelope>
  </gml:boundedBy>
  <cityObjectMember>
    <generic:GenericCityObject gml:id="Parcel_1">
      <creationDate>2011-04-01</creationDate>
      <generic:class>LA_LegalSpaceBuildingUnit</generic:class>
      <generic:lod4Geometry>
        <gml:Solid>
          <gml:exterior>
            <gml:CompositeSurface>
              <gml:surfaceMember>
                <gml:Polygon>
                  <gml:exterior>
                    <gml:LinearRing>
                      <gml:pos>85514.91 445173.489 0.0</gml:pos>
                      <gml:pos>85511.709 445170.399 0.0</gml:pos>
                      <gml:pos>85510.892 445172.368 0.0</gml:pos>
                      <gml:pos>85514.066 445175.521 0.0</gml:pos>
                      <gml:pos>85514.91 445173.489 0.0</gml:pos>
                    </gml:LinearRing>
                  </gml:exterior>
                </gml:Polygon>
              </gml:surfaceMember>
            </gml:CompositeSurface>
          </gml:exterior>
        </gml:Solid>
      </generic:lod4Geometry>
    </generic:GenericCityObject>
  </cityObjectMember>
</CityModel>
```

Figure 8. CityGML with LADM extension: DTS from Russian 3D Cadastre prototype.

With respect to step 3, the data transfer standard (DTS), there are again a range of options. Figure 8 shows a fragment of the encoding of a 3D parcel as a Solid in CityGML with LADM extension: DTS from Russian prototype (Vandysheva et al 2012). However, some other options for data transfer standard are available: LandXML (for which within OGC now the initiative has started to develop a more modern variant, called InfraGML) or more building oriented standards such as BIM/ IFC. The next step (4) covers the automated quality check in 3D in order to assess if the data is complete, and if there are no geometry and topology errors. Queensland, Australia has implemented and highly automated the checking of the survey plans, which are submitted via ePlan, and with data encoded in LandXML. Based on over 20 years of experience, they developed formal validation rules to support digital lodgement of 3D cadastral plans (Karki, Thompson and McDougall, 2013). This was possible because of the solid legal basis of the Queensland

Land Title Act (Queensland Government, 1994) with specification of various methods for defining 3D cadastral objects (Building Format Plans and Volumetric Format Plans) and additional directions specifying details for the submission of survey/mutation plans: Registrar of Titles Directions for Preparation of Plans, Section 10 (DNRM, 2013). Note that the 3D geometry aspect of the quality check is not trivial as there are various types of valid, but non 2-manifold 3D Parcels (Ying et al 2011, Thompson and van Oosterom 2012); see Figure 9.

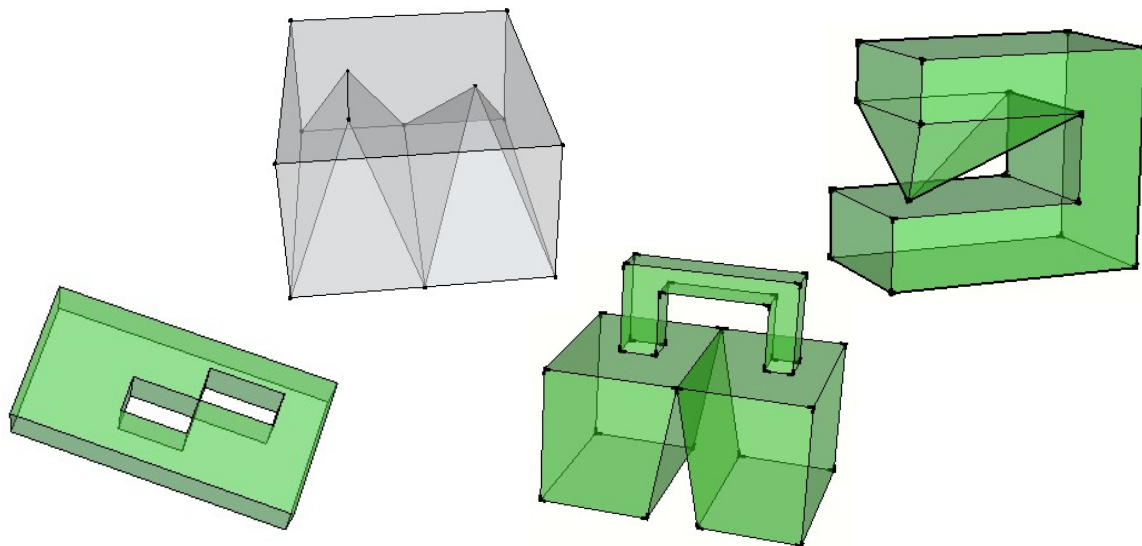

*Figure 9. Some examples of valid, but non 2-manifold 3D Parcels according to the 'Single object correctness main rule': interior connected
Illustrations by Shen Ying (Wuhan University, visiting TU Delft).*

After checking and accepting the newly submitted 3D Parcels they have to be stored in the database (Step 5). For this the conceptual model (Israeli 3D LADM country profile, see Chapter 2) and transformation of this model into a technical database model (SQL DDL, see Section 3.2) are the foundation. This technical model in SOI context is realized using an Oracle database and Esri ArcGIS. Currently both Oracle and Esri do not yet support 3D topology structure. For data visualization (step 6) and data dissemination (step 7) it is again important to use well accepted standards and products. In the Netherlands experiments have been conducted based on 3D pdf (Stoter, Ploeger and van Oosterom 2013); see Figure 10. For web based dissemination X3D (ISO/IEC 2007, ISO/IEC 2008) is a good option as illustrated in the 3D Cadastre prototype in Russia (Vandysheva et al 2012); see Figure 11. The first time that the 3D web browser is used, the installation of an X3D-plugin (BS Contact from Bitmanagement) in the web browser is needed. An alternative which is supported natively in various browsers today is WebGL (Web Graphics Library). WebGL is a JavaScript API for rendering interactive 3D graphics within any compatible web browser without the use of plug-ins (as supported in Chrome, Firefox, Safari, Opera, Internet Explorer and many mobile browsers). WebGL is integrated completely into all the web standards of the browser allowing GPU accelerated usage of physics and image processing and effects as part of the web page canvas; source: <http://en.wikipedia.org/wiki/WebGL>.

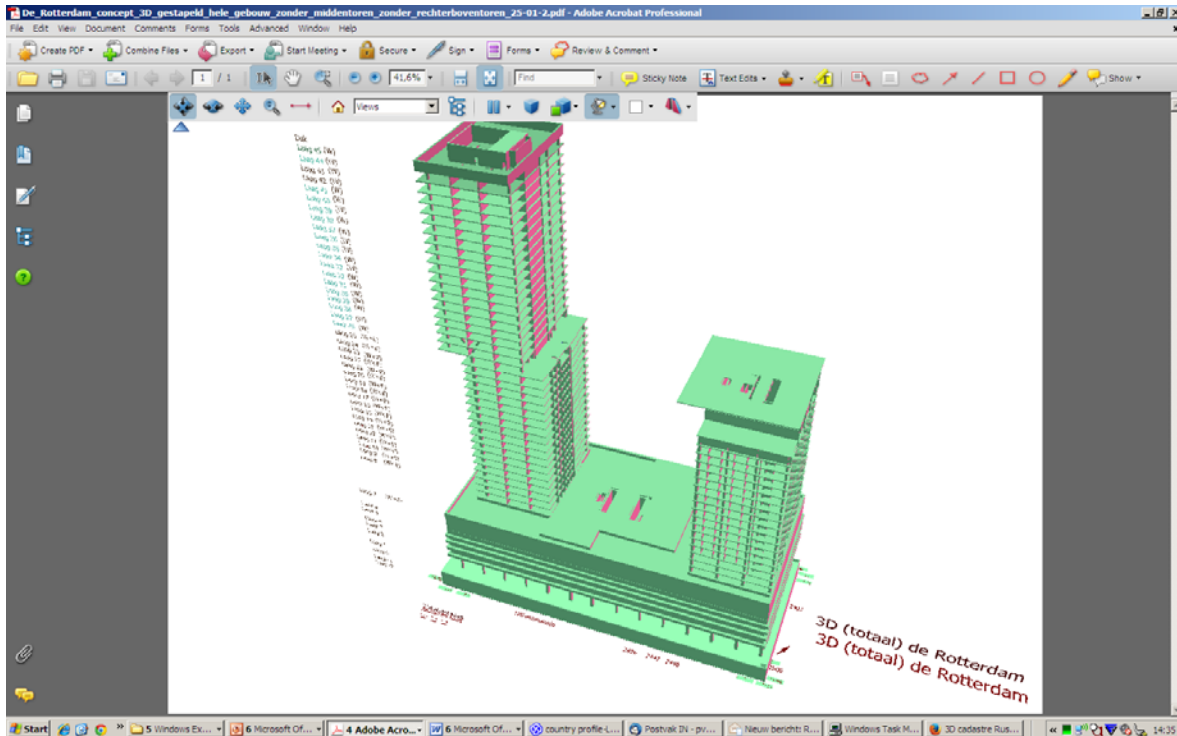

Figure 10: A 3D Cadastral model in a 3D pdf (source: Kees van Prooijen, Bentley).

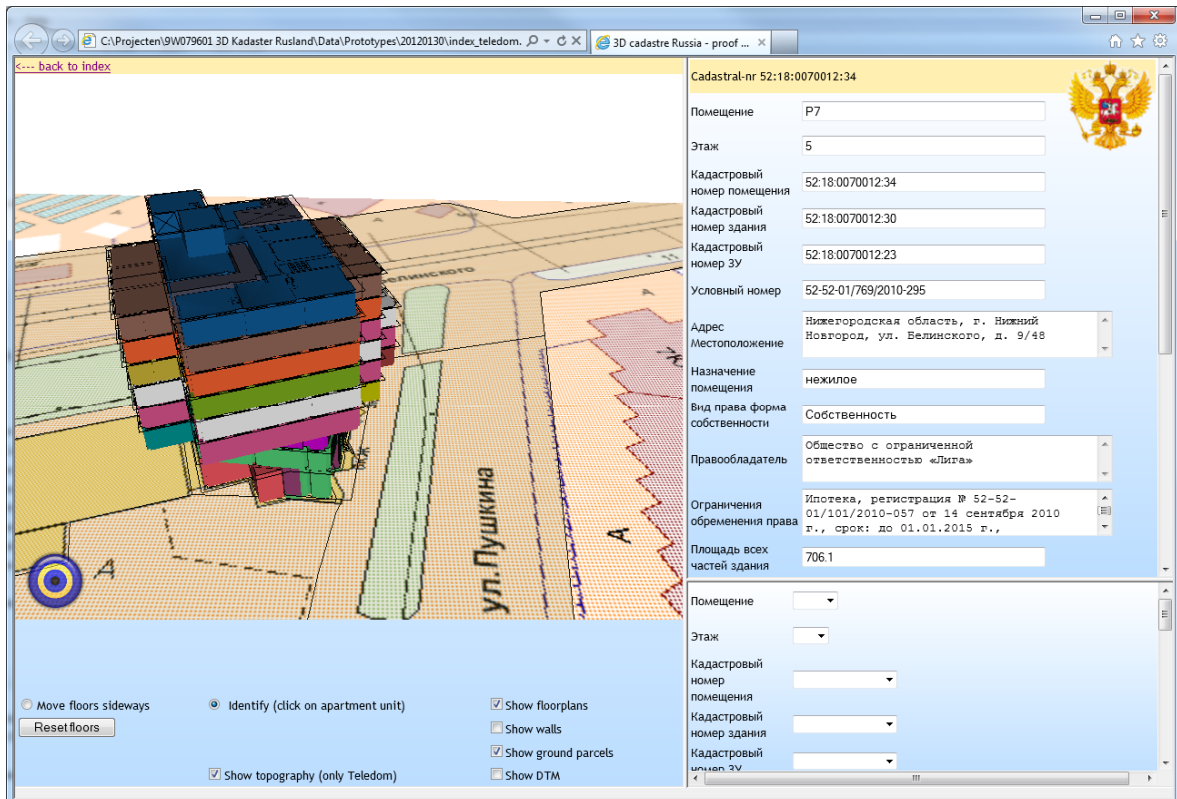

Figure 11: X3D based web based solution, Russian prototype: 3D viewer (left), selection (lower right) and result display (upper right); source (Vandysheva et al 2012).

3.2. Deriving technical model from conceptual model

Many design decisions have to be taken to develop the database schema during the conversion from conceptual (UML class diagrams of Israeli 3D LADM country profile) to technical model (SQL DDL database schema in Oracle and suitable for Esri use). In this phase the nature of the design decisions will be more technical and closer to actual implementation. A class in the UML model, normally corresponds to table with same name in the database schema. Additionally, there are also views (and it is proposed that their names end with 'View'), tables for code lists (and it is proposed that their names end with 'Type'), and additional tables for representing relationships in case of a many-to-many relation between two classes (and it is proposed that their names end with 'Relationship').

According to LADM, the data type for the object identifier, Oid, has two parts: the namespace and a local ID; see Figure 2 (bottom left). An example of a possible namespace is parcel.mapi.gov.il (or point.mapi.gov.il) and by adding this to the local ID, it becomes globally unique (as nobody else is allowed to assign ID's in this name space). However, within the system of SOI (internally), it is not needed to add the namespace (as this is the same for all objects in the same table). Therefore, internally the local ID is enough for the various identifier values. The important aspect is that the ID's have to be unique for all objects. Note that for a single object there may be multiple versions, which have the same ID, but can be differentiated via their beginDateTime attribute. Another point of attention is defining the proper Primary Keys (PK), Foreign Keys (FK) and indices (usually a B-tree) in order to implement relationships between objects in an effective manner.

In the Israeli LADM country profile, it is possible to have attributes with multiple values; e.g. multiple types of area/volume attributes (surveyed, official and calculated). There are at least 3 different ways to implement this (and after careful analysis, the optimal solution has to be selected for every specific case of attributes of which the multiplicity may be unequal to 1):

- additional table for this multiple attribute (and 1-to-n relationship with base table),
- use varray to represent all values, or
- have a fixed number of area/volume attribute (e.g. 3 or 4 and indicate in name of attribute which area/volume type is intended).

In the LADM (and therefore in the Israeli country profile and implementation) there are many types of constraints which need to be supported: e.g. primary key must be unique, endDateTime > beginDateTime, end date of previous version must be equal to start of next version, sum of shares must equal to 1, boundary of parcel must be closed, boundaries may not intersect (topology constraints), and so on.

To realize derived attributes, Structured Query Language (SQL) 'create view' should be used. Functions can be used in the 'create view' statement deriving attribute values from another table or attribute. The advantage of using a view is that these derived attributes are not stored, but for the users it is easy as the views look the same manner as normal

tables. Besides saving storage space, the advantage is that this cannot cause inconsistencies, which is the danger when these derived attributes would be explicitly stored.

In order to enable efficient searching based on selecting on an attribute value (also other than keys), an index is created in the database. This can be done for both spatial (R-tree index) and non-spatial (B-tree index) data. Primary Key ID's attributes in the various tables for administrative data are used to physically organize the data in so called index organized tables. In this manner one additional B-tree index is saved, which is making the system more compact and efficient. The (derived) geometry in each spatial class is used to index the spatial object based on geometry type using the R-tree index.

For all spatial types in the model, decide what data type to use in database: string, blob, Esri geometry, Oracle geometry, standard SQL/SFS, etc. Another important design decision, both for 2D and 3D, is the use of topology (or not) in order to avoid redundant storage of shared boundaries. Also, different parts boundaries of the same parcel may have different attributes, which can not be stored at parcel level, but which belong really at the boundary level; e.g. accuracy. If no topology structure is used then constraints should be defined in order to avoid problems such as overlapping parcels (should not be allowed). The use of topology (or not) is a separate decision for 2D and 3D, assuming they are organized in their own levels. It is possible to use a 2D topology structure and use plain 3D geometries without topology (or vice versa).

Chapter 4.

5D Cadastre research

Until now this report discussed the 3D Cadastre developments by extending the parcels (LA_SpatialUnits) and using the VersionedObject for the temporal dimension with DQ_Quality (accuracy, scale) as separate attribute for quality related aspect. The fundamental question arises should these 3D space, time and scale 'attributes' be treated separately, or is it worthwhile to deeply integrate these in a single higher dimensional representation as suggested in (van Oosterom and Stoter, 2010). These topics are related to the recently started research "5D Cadastral GIS project (5DMpLIS)" by an Israel-Greek consortium. This chapter recaptures some of the 4D, 5D principles based on earlier publications, starting with 4D Cadastre (van Oosterom, et al. 2006, Döner et al, 2010, Döner et al 2011).

The relationship between people and land (or space in case of 3D) is very dynamic. From a legal perspective it is clear that interests in land have a component in time. Real world 3D dynamic cases in Australia show requirements for a true 4D cadastre as this reflects the actual real world situations (van Oosterom et al, 2006). Of course, it is possible that these cases are represented with separate spatial and temporal attributes. However, deep integrated treatment of space and time in one internal 4D data type representation does have some benefits for the future realization of a 4D cadastre. Some of these benefits are:

1. optimal efficient 4D searching (specifying both space and time in same query) can only be realized if a 4D data type (and index/clustering) is used, otherwise the DBMS (query plan) has to select first on space and then on time (or the reverse order);
2. with true 4D data types parent-child relationships between parcels (the lineage) are neighbour queries in a topological structure (neighbours for which at least the time attribute did change), which is more efficient than a spatio-temporal overlay needed as in the non-integrated approach; see Figure 12 left: Parcel P3 has parent parcel P1 and children parcels P4 and P5,
3. 4D analysis; e.g. 'Overlap': do two moving cattle rights have spatio-temporal overlap/touch (Figure 12 right)? If stored and represented in the database by a 4D data type, this is just a simple query. If stored as separated attributes, this is not a trivial query to answer,
4. but most important if we do want the full (4D) partition (of 3D space+time, no overlaps, no gaps) as our foundation for a 4D Cadastre, then having true 4D geometry and topology (space and time integrated) is the most solid foundation.

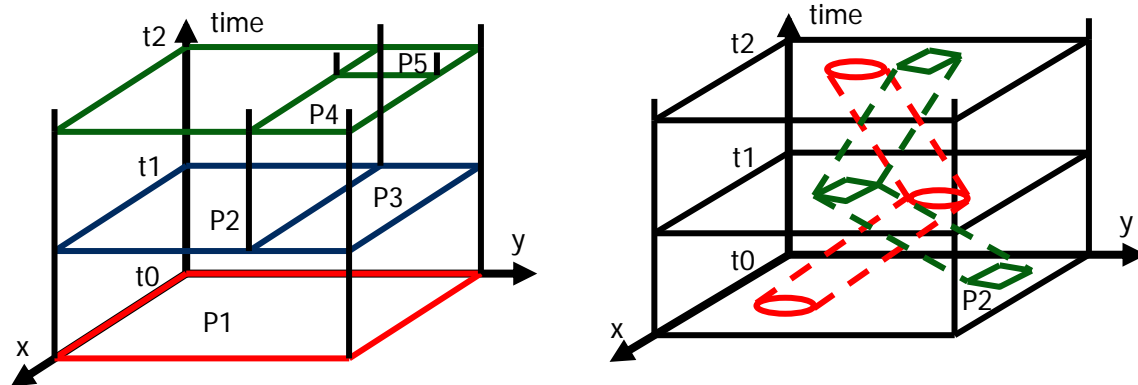

Figure 12. Integration of 2D space and time into 3D Cadastral representation.
 Left: repeated splitting of parcels, Right: two moving rights.

The conceptual foundation of a 4D cadastre is the partition concept: no overlaps or gaps in the registered rights. In this case it is not only space which is considered, but also the time dimension. So, every right (RRR) is attached to a primitive in 4D space. The boundaries mark the discontinuity in the relationships (rights) between people and land (or space). Represented within a 4D volume primitive, the rights are homogenous. A boundary can be a spatial boundary, in the traditional sense of the separation between two parcels, existing at same moment in time; but a boundary can also be a temporal boundary: e.g. A transfers his right on a parcel to B on certain moment in time. In theory there could be mixed spatial-temporal boundaries in case of dynamic objects, for example a moving river or coast line as boundary, or impacts of natural disaster. The 4D partition fits very well to our (legal) cadastral thinking on the organization of rights (RRRs). Note that parcels with static geometry generate vertical walls in temporal dimension (see Figure 12 left), but rights that move will generate non-vertical walls as boundaries in the temporal dimension (Figure 12 right).

So far the first four dimensions. What about the fifth dimension? In earlier publications (van Oosterom and Stoter 2010, van Oosterom and Meijers 2013) an additional dimension was used for the scale aspect. However, example data sets used in these investigations are typically topographic base maps, land use/ cover maps, soil and geology maps; see Figure 13. For cadastral maps the question is whether it does make sense to have cadastral parcels at different scales. In case it would be allowed to aggregate cadastral objects (parcel), what would be the meaning of such an aggregated object in cadastral sense, as multiple owners are involved. Grouping of parcel to another discrete level such as cadastral sections ('Gush' in Israel), municipalities, provinces/ regions can be useful. However, these aggregated (smaller scale maps) would not show cadastral parcel, but rather higher level units (which may be convenient in navigation when zooming in and out). Instead of scale, another use of the fifth dimension could be the encoding of quality/accuracy. More investigations needed here in context of 5DMpLIS project.

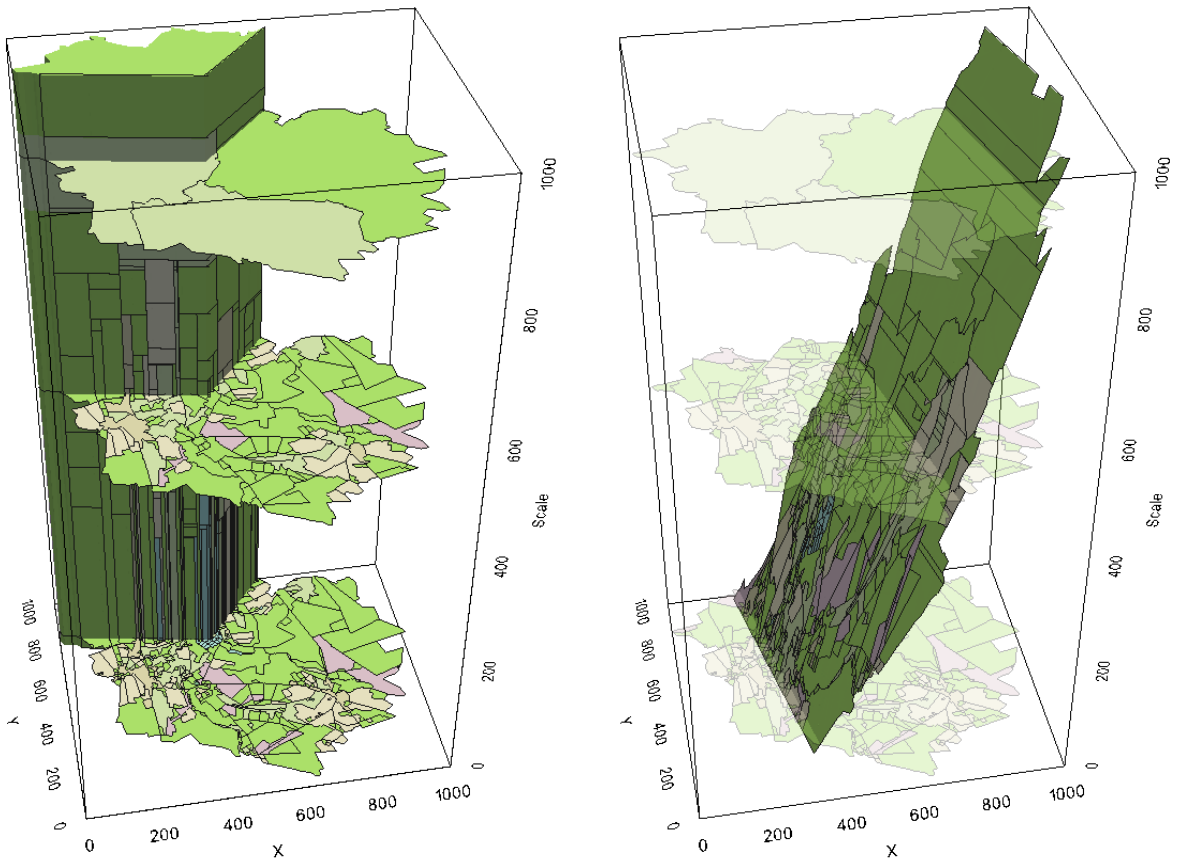

Figure 13. Using an additional dimension to represent scale: the space scale cube, illustration shows German ATKIS data (van Oosterom et al, 2014); Left: horizontal slices (uniform scale maps), Right: diagonal slice (mixed scale map).

Chapter 5.

Conclusion

This second report has presented the first steps towards the Israeli 3D LADM country profile in Chapter 2. In addition various technical aspects of the implementation were presented in Chapter 3. The benefits of deep integration of space and time (and scale) were presented in Chapter 4, providing the foundation for future R&D towards 5D Cadastre. The development of the Israel LADM country profile, the conceptual model, needs to be a national activity (with initiating organization: SOI). The LADM provides standardized class names for spatial and non-spatial data and is therefore a good basis for national harmonization of land administration related information, maintained by various organizations. The unique identifiers form the important links between spatial and non-spatial data. The identifiers should not only be unique within a single organization, but should be globally unique and can be used in the context of the national SDI to realize references to objects in each others registrations. Besides specifying the classes, their attributes and relationships in the Israeli 3D country profile, also attention has to be paid to agreeing on the new code lists (including code list values) for spatial and non-spatial data, based as much as possible on accepted practices. The LA_SpatialUnits are the “glue” joining the spatial description of land to the RRR aspects. LA_SpatialUnits are universal in their land administration application (ownership, easement, utilities, building,...). The LA_SpatialUnits can be documented according to a range of representations: from textual description to 3D topology structure (and the country profile needs to specify which exact representations are to be used). In any case, LA_SpatialUnits should always be based on proof from LA_SpatialSource documents with LA_Points. After developing the country profile, still many technical design and implementation decisions have to be made during the conversion of country profile to technical model: identifiers (PK, FK), time stamps, versioning, indexing, clustering, multiplicity of attributes and relationships, constraints, derived attributes and the earlier mentioned 2D/3D geometry/topology structure.

Future work includes, besides developing the initial new conceptual model (country profile), also assessment of the proposed model before taking further implementation decisions. For this purpose a prototype system should be developed in order to discover the possibilities and limitations of the conceptual model. Experience from the prototype development will be used to further improve the conceptual model, before actual implementation. The steps in developing this prototype include:

1. deriving the technical model (Oracle, Esri frontend) from the conceptual model: from UML diagram, to database tables SQL DDL scripts for data storage (and/or XML schema for exchange format according to LandXML/ InfraGML, CityGML, BIM/ IFC),
2. convert some (and/or create) sample SOI/LR/ILA data into the newly proposed model: this covers both spatial and non-spatial data, and should also include selection for the exemplary 3D cases, which are to be supported by the future 3D Cadastre, and
3. develop frontends (possibly based on Esri) to view and edit for professional desktop access, and also develop an appropriate web-interface for SOI/LR/ILA data access.

In general it is a good practice to learn from other countries before implementing specific new functionality into the system. In case of 3D cadastre, countries which share the British roots in the system may be more relevant than other examples. Recently a study was conducted in Malaysia to convert their system into a 3D LADM based implementation. Special attention was given to modelling condominium rights in 3D (strata titles); see Annex C.

In addition to the various technology aspects, it is important to consider the legal and organizational aspects. In the organizational setting of Israel with licensed surveyors (responsible for the creation the new 2D and 3D representations of parcels), it is crucial to develop regulations/formats for digital 3D mutation plans. This will then enable more automated validation to check correctness (e.g. non-overlapping issues). As mentioned in conclusion of report 1, 3D cadastral registration is part of whole 3D spatial development life cycle in 3D consisting of many steps of which the order may differs per country (van Oosterom 2013): from the development and registration of zoning plans in 3D, to the dissemination, visualization and use the spatial units (parcels) in 3D. This aligns well with the goals of the recently started Rainbow project in Israel with goals to realize a unified property database (distributed via SDI), and on top of this a Location Based Business Intelligence (LBBI) system to exploit this data. As the LADM covers data from various government parties, it can very well support the digital collaboration within the Israeli government. Various organizations are sources of different types of RRRs with either: own geometry or references cadastral parcels.

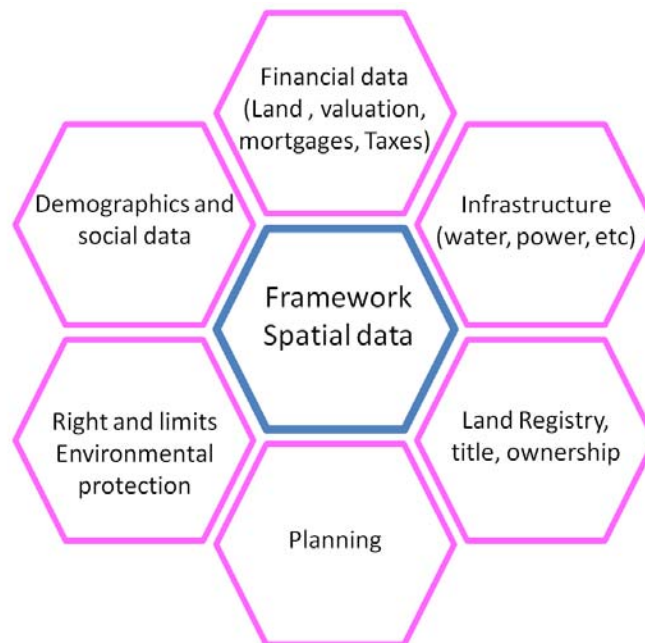

Figure 14: Various data sources in the Rainbow project in the spatial data framework (source illustration: Yaron Felus/Shimon Barazani).

References

Fatih Döner, Rod Thompson, Jantien Stoter, Christiaan Lemmen, Hendrik Ploeger, Peter van Oosterom and Sisi Zlatanova (2010). 4D cadastres: First analysis of Legal, organizational, and technical impact - With a case study on utility networks. In: Land Use Policy, Volume 27, 2010, pp. 1068-1081

Fatih Döner, Rod Thompson, Jantien Stoter, Christiaan Lemmen, Hendrik Ploeger, Peter van Oosterom and Sisi Zlatanova (2011). Solutions for 4D cadastre - with a case study on utility networks. In: International Journal of Geographical Information Science, Volume 25, 7, 2011, pp. 1173-1189.

DNRM (2013). Department of Natural Resources and Mines, State of Queensland. Registrar of Titles Directions for Preparation of Plans. Website visited 28 February 2014, http://www.dnrm.qld.gov.au/__data/assets/pdf_file/0011/97319/directions-for-the-preparation-of-plans.pdf

ISO/IEC (2007), ISO/IEC 19776-1.2, X3D encodings - Part 1: XML encoding (Edition 2), <http://www.web3d.org/x3d/specifications/ISO-IEC-19776-1.2-X3DEncodings-XML/>, 2007-12-06.

ISO/IEC (2008), ISO/IEC 19775-1.2:2008, X3D Architecture and base components Edition 2, <http://www.web3d.org/x3d/specifications/ISO-IEC-19775-1.2-X3D-AbstractSpecification/>, 2008-07-10.

ISO-TC211 (2012). Geographic information – land administration domain model (LADM). ISO/IS 19152.

Sudarshan Karki, Rod Thompson and Kevin McDougall (2013). Development of validation rules to support digital lodgement of 3D cadastral plans. In: Computers, Environment and Urban Systems, Volume 37, 2013, 12 p.

José Miguel Olivares García, Luis Ignacio Virgós Soriano and Amalia Velasco Martín-Varés (2011). 3D Modeling and Representation of the Spanish Cadastral Cartography. In proceedings 2nd International Workshop on 3D Cadastres, 16-18 November 2011, Delft, The Netherlands.

Peter van Oosterom, Hendrik Ploeger, Jantien Stoter, Rod Thompson and Christiaan Lemmen (2006). Aspects of a 4D Cadastre: A First Exploration, In proceedings XXIII International FIG congress, Munich, October 2006, 23 p.

Peter van Oosterom and Jantien Stoter (2010). 5D Data Modelling: Full Integration of 2D/3D Space, Time and Scale Dimensions. In: S.I. Fabrikant, T. Reichenbacher, M. van Kreveld and M. Schlieder (Eds.); Proceedings of the Sixth International Conference GIScience 2010, Springer, pp. 311-324.

Peter van Oosterom and Martijn Meijers (2014). Vario-scale data structures supporting smooth zoom and progressive transfer of 2D and 3D data. *International Journal of Geographical Information Science*, Volume 28, Issue 3, 2014.

Peter van Oosterom, Martijn Meijers, Jantien Stoter, and Radan Suba (2014). Data structures for continuous generalisation: tGAP and SSC. Chapter 4 in book 'Abstracting geographic information in a data rich world: methodologies and applications of map generalisation', *Lecture Notes in Geoinformation and Cartography* (Dirk Burghardt, Cécile Duchêne, and William Mackaness Editors), 2014, pp. 83-118.

Peter van Oosterom (2013). Research and development in 3D cadastres. In: *3D Cadastres II*, special issue of *Computers, Environment and Urban Systems*, Volume 40, July 2013, pp. 1-6.

Peter van Oosterom (2014). Survey of Israel Three-Dimensional Cadastre and the ISO 19152 - The Land Administration Domain Model, Report 1 (updated version), 25 March 2014.

Queensland Government (1994). Land title act. Reprint 10A, Website visited 28 February 2014, www.legislation.qld.gov.au/LEGISLTN/CURRENT/L/LandTitleA94.pdf.

Jantien Stoter, Hendrik Ploeger and Peter van Oosterom (2013). 3D cadastre in the Netherlands: Developments and international applicability. In: *3D Cadastres II*, special issue of *Computers, Environment and Urban Systems*, Volume 40, July 2013, pp. 56-67

Rod Thompson and Peter van Oosterom (2012). Validity of Mixed 2D and 3D Cadastral Parcels in the Land Administration Domain Model. In: P. van Oosterom, R. Guo, L. Li, S. Ying, S. Angsüsser (Eds.); *Proceedings 3rd International Workshop 3D Cadastres: Developments and Practices*, October 2012, Shenzhen, pp. 325-342.

Natalia Vandyshva, Sergey Sapelnikov, Peter van Oosterom, Marian de Vries, Boudewijn Spiering, Rik Wouters, Andreas Hoogeveen and Veliko Penkov (2012). The 3D Cadastre Prototype and Pilot in the Russian Federation. *FIG Working Week 2012*, May 2012, Rome, 16 p.

Shen Ying, Renzhong Guo, Lin Li, Peter van Oosterom, Hugo Ledoux and Jantien Stoter (2011). Design and Development of a 3D Cadastral System Prototype based on the LADM and 3D Topology. In: P. van Oosterom, E. Fendel, J. Stoter, A. Streilein (Eds.); *Proceedings 2nd International Workshop on 3D Cadastres*, November 2011, Delft, pp. 167-188

Nur Amalina Zulkifli, Alias Abdul Rahman, Hasan Jamil, Teng Chee Hua, Tan Liat Choon, Looi Kam Seng, Chan Keat Lim and Peter van Oosterom (2014a). Towards Malaysian LADM Country Profile for 2D and 3D Cadastral Registration System. In *proceedings FIG Congress 2014*, Kuala Lumpur, Malaysia, 16-21 June 2014, 19 pages.

Nur Amalina Zulkifli, Alias Abdul Rahman, Hasan Jamil, Teng Chee Hua, Tan Liat Choon, Looi Kam Seng, Chan Keat Lim and Peter van Oosterom (2014b). Development of a Prototype for the Assessment of the Malaysian LADM Country Profile. In proceedings FIG Congress 2014, Kuala Lumpur, Malaysia, 16-21 June 2014, 18 pages.

Annex A.

Slides 'Towards an Israeli - 3D LADM country profile 3D Cadastres'

Presentation at the Survey of Israel, Tel Aviv, 17 July 2014.

Towards an Israeli 3D LADM country profile

20-9-2014

Peter van Oosterom

Meeting on LADM at the Survey of Israel
Tel Aviv, 17 July 2014

Contents

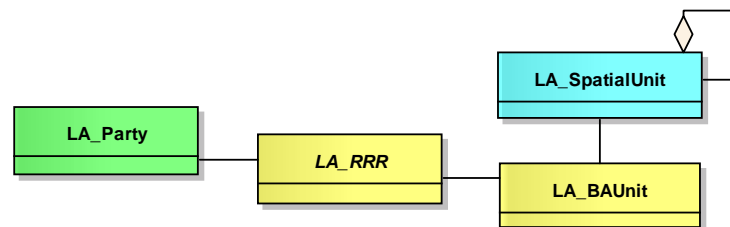

1. *Motivation (refresh)*
2. LADM Overview (refresh)
3. Israeli 3D LADM country profile
4. Technical model / implementation
5. Conclusion

→ Discussion, questions, answers

Land Administration Domain Model

ISO 19152 (LADM)

- Model includes:
 - Spatial part (geometry, topology)
 - Extensible frame for legal/administrative part
- Object-orientation → expressions in UML
- Model Driven Architecture (MDA)
- FIG proposed LADM to ISO/TC211, January 2008

Motivation LADM

Reasons to apply LADM

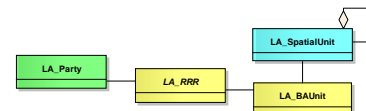

- LADM collective experience of experts from many countries (FIG)
- LADM is based on consensus and adopted by ISO (and CEN)
- LADM allows *meaningful data exchange*: 1. *within country*, SDI-setting (other types of data), 2. between countries/states (same type)
- LADM covers complete land administration spectrum: survey, cadastral maps, rights, restrictions, responsibilities, mortgages, persons, etc.
- LADM focuses on information, not on process/organization aspect
- LADM is modular (packages) and extensible → country profiles
- LADM allows *integrated 2D and 3D representation* of spatial units
- LADM supports both formal and informal RRRs
- LADM links essential land information data to source documents, both spatial (survey) and legal (title, deed)

LADM compliance will seldom be main reason for new system in country
→ every system needs upgrades: consider becoming LADM compliant!

Motivation LADM

Expressed at 5th FIG LADM workshop

- Some quotes from Kalantari (et al, 2013):
 1. International compliance
 2. Cross jurisdictional data exchange
 3. Upgrading or new versions for existing systems
 4. Existing institutions ('do fit in well')
 5. Semantic Compliance (definition of key concepts)
 6. Structural Compliance (agreed model patterns)
 7. Feedback and improvements (during standard development, and after)
 8. Capacity building (LADM included in various curriculums).
- Thompson (2013) added: LADM provides excellent growth path from text, sketch and point parcels to full topology and 3D (and same range of options available in administrative side of model)
- LADM workshop slides (and papers) available at <http://isoladm.org>



Contents

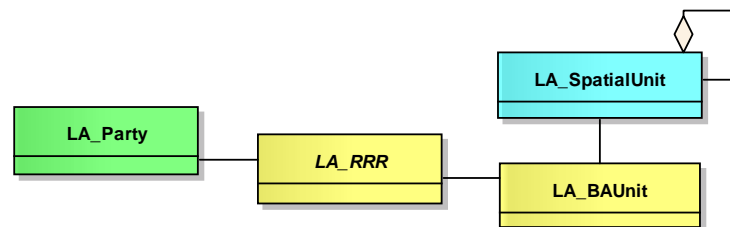

1. Motivation (refresh)
2. *LADM Overview (refresh)*
3. Israeli 3D LADM country profile
4. Technical model / implementation
5. Conclusion

→ Discussion, questions, answers

Requirements, support for:

1. Continuum of land rights
2. Continuum of parties
3. Continuum of spatial units
4. Basic Administrative Units (or Basic Property Unit)
5. A range of data Acquisition methods
6. A range of authentic source documents
7. Transparency
8. History
9. Different organisations
10. Keep data to the source (within SDI)
11. Existing standards
12. Reference system
13. Identifiers
14. Marine Cadastres, 3D Cadastres
15. Quality

ISO 19152 **core** in action Land Administration Domain Model

- *LA_Party* Peter has *LA_RRR* ownership on *LA_BAUnit* Peter's estate consisting of 2 *LA_SpatialUnit* parcels (with same *LA_RRR*)
- *LA_BAUnit* stands for Basic Administrative Unit

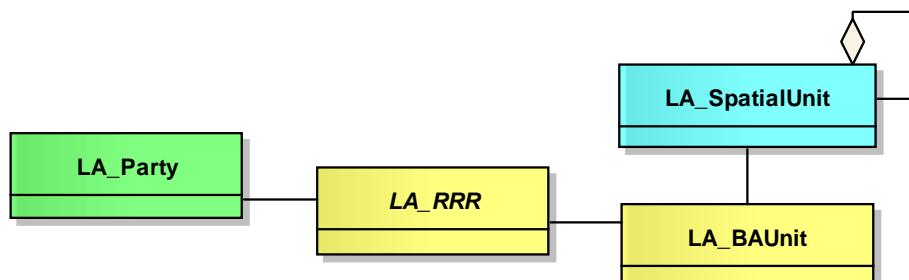

Full version management → inherit from VersionedObject

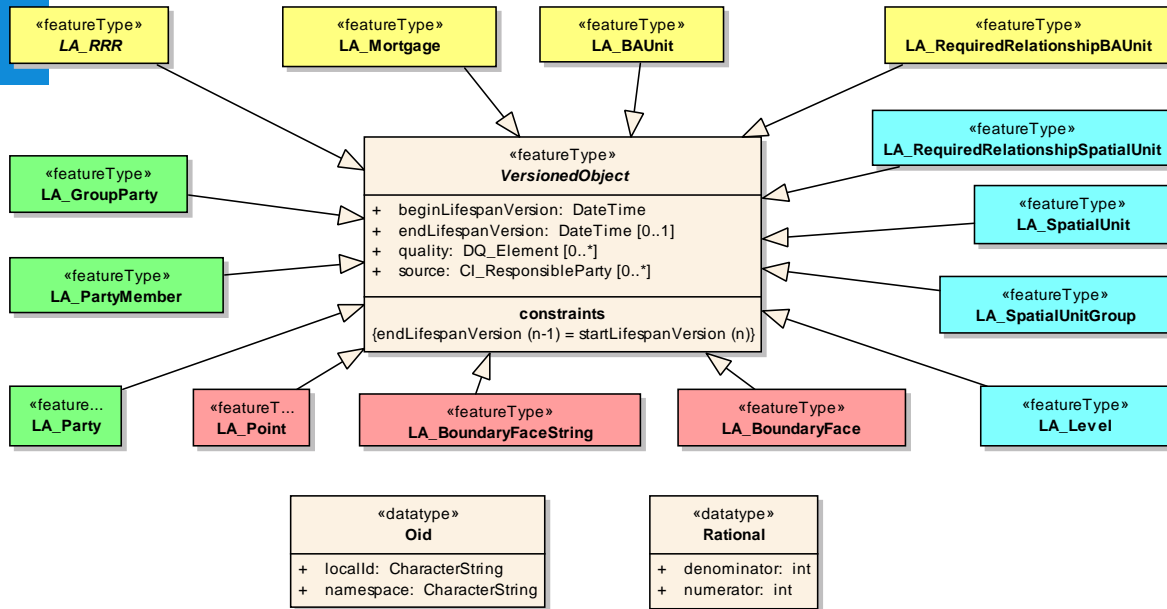

Administrative and Spatial Sources

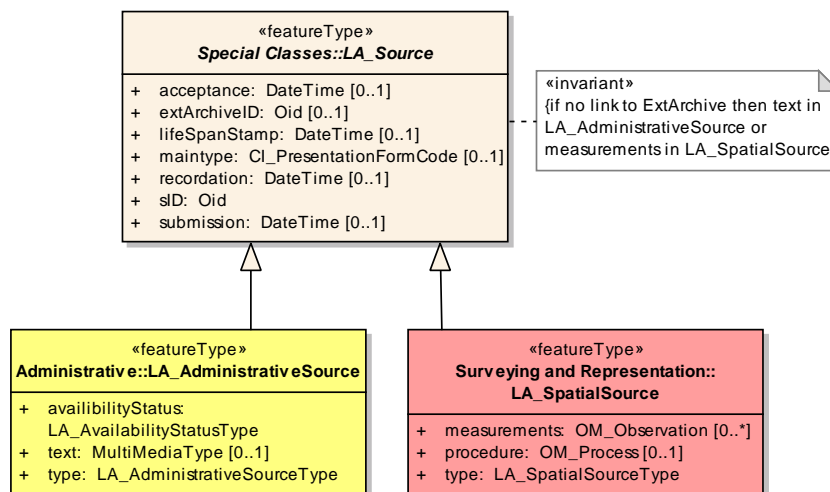

LADM Diagram

- Parties → green
- RRRs → yellow
- Spatial Units → blue
- Surveying → pink
- Mapping → violet

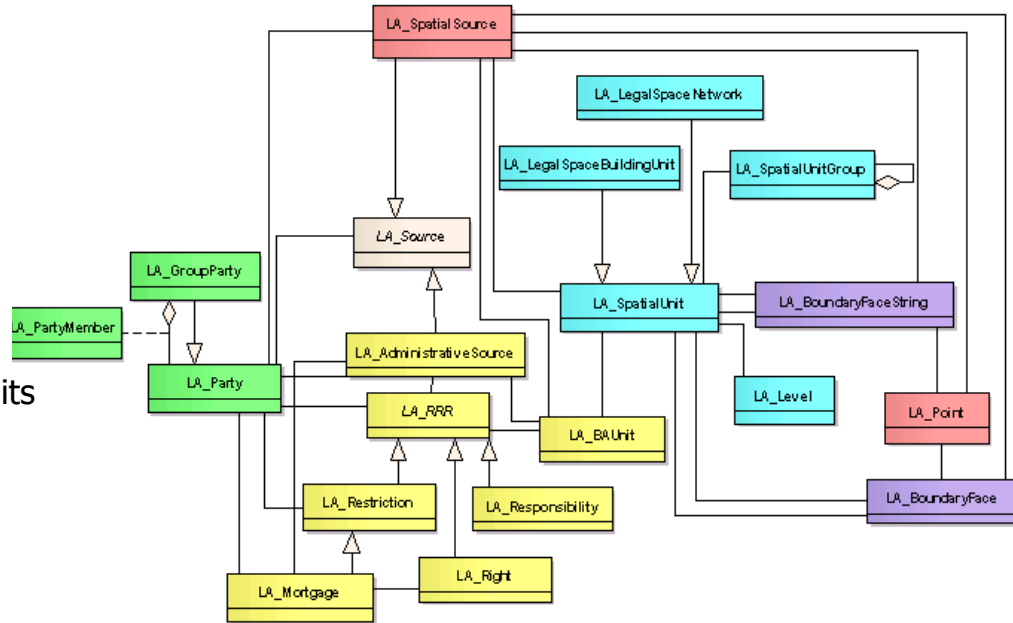

RRR supports all land rights

2D and 3D Integration

- between 2D and 3D spatial unit transition via *liminal* spatial units

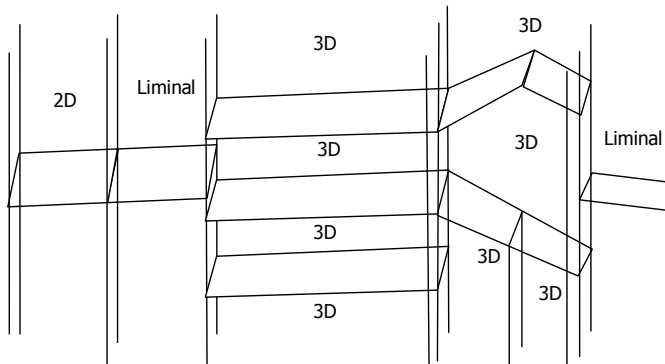

- Liminal spatial units are 2D parcels, but are stored as 3D parcels

- Liminal spatial units are delimited by a combination of LA_BoundaryFace and LA_BoundaryFaceString objects

Simple 2D spatial unit	Liminal 2D spatial unit	3D spatial units	3D spatial units	Liminal 2D spatial unit
			Liminal 2D spatial unit A	

LADM and external classes

- Determine scope LA
- Apply SDI thinking
- Link to external registrations:
 - Address
 - Party (person)
 - Valuation
 - Taxation
 - LandCover
 - LandUse
 - PhysicalNetwork (utility)
 - ...

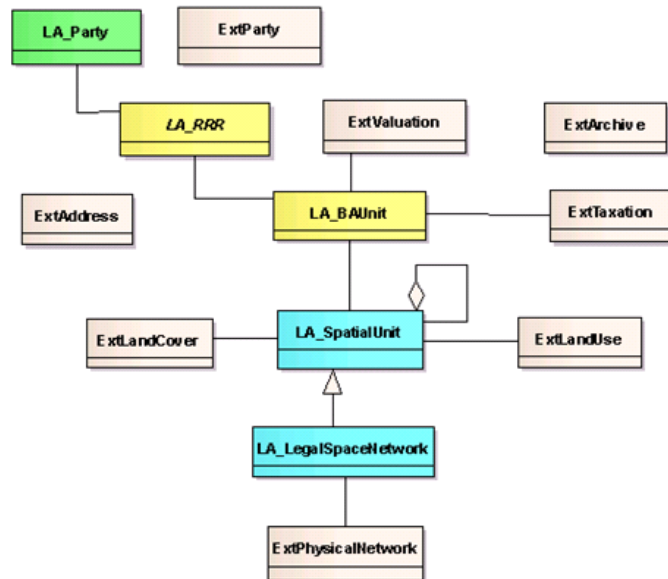

Spatial Information Infrastructure

- Standards needed as users are at unknown distance
→ ISO LADM (and CEN)
- Network of related information sources, blueprints for
→ Address, Building, Party, Taxation, Valuation, Network, LandUse,..
- Remote users might need/refer to historic version
→ All object classes need to be versioned objects

- Maintain consistency: subscription on update warnings
- Legal counterparts of physical objects
- Information assurance (contracts)

- In LADM, external classes as *<<blueprint>>* and expected to be defined in more detail elsewhere (other standard)

SDI for other reference data

- Terrain elevation (earth surface) not part of land administration
- Via SDI this data may be obtained in order to be able if a 3D parcel is above, below the surface (or both)

- In 3D Cadastre:
absolute coords
(additional option
relative coords)
- 3D Parcel does
not change when
Earth surface
changes!

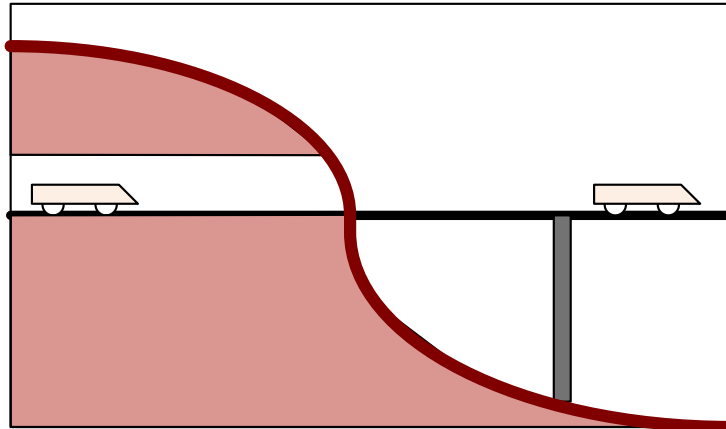

Contents

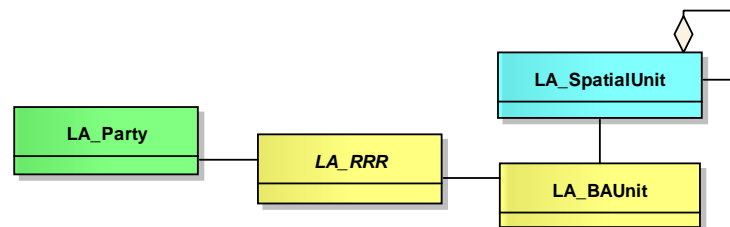

1. Motivation (refresh)
2. LADM Overview (refresh)
3. *Israeli 3D LADM country profile*
4. Technical model / implementation
5. Conclusion

→ Discussion, questions, answers

Introduction Israel 3D LADM

- Design, develop and test a complete LADM country profile for 2D and 3D cadastral registration system in Israel
- Partly based on the existing Israel LA system and new developments inspired by the LADM standard
- Attempt to cover all Israel LA related information in the model
→ data maintained by different organizations
- Several novel aspects for the Israel LA may be introduced: 3D, integrated history, link to sources, link spatial-legal, BAUnit concept, topology, quality ISO 19115, unique id's all data, ...

Towards an Israel SDI approach

- Establish national SDI enabling meaningful exchange of information between different organizations within Israel):
 1. Survey of Israel (SOI) + Licensed Surveyors (LSs, creating new 2D/3D representations)
 2. Land Registry (LR, register apartments, condominiums in 3D),
 3. Israel Land Authority (ILA, 93% of Israel in public domain),
 4. Others: Interior Min (plans), Construction, Tax/bank, Municipalities,...



Illustration:
Yaron Felus/Shimon Barazani

Scope of Israel 3D Cadastre, checklist of FIG 3D Cadastre WG

- What are the types of 3D cadastral objects?
→ *Both a. related to (future) constructions (buildings, pipelines, tunnels, etc.), and b. any part of 3D space (airspace, subsurface)*
- 3D Parcels also for simple apartments/ condominium buildings?
→ *Not in short term (use 2D floor plans), May be in longer term*
- 3D Parcels for infrastructure objects, such as long tunnels, pipelines, cables: divided by surface parcels or single object?
→ *Only divided by blocks (so join subparcels in block)*
- For representation of 3D parcel, has legal space own geometry or specified by referencing to existing topographic objects
→ *Own geometry*

Israel 3D subparcel concept

- 3D subparcel is temporarily created by subtraction from 3D column implied by 2D base parcel
- In single transaction for a infrastructure object many temporary 3D subparcels are created (involving multiple owners)
- Within transaction these join in single 3D parcel with own ID within block (same RRR/Party)
- Future changes of base parcels independent of 3D parcel

Illustration:
Shoshani et al. 2005

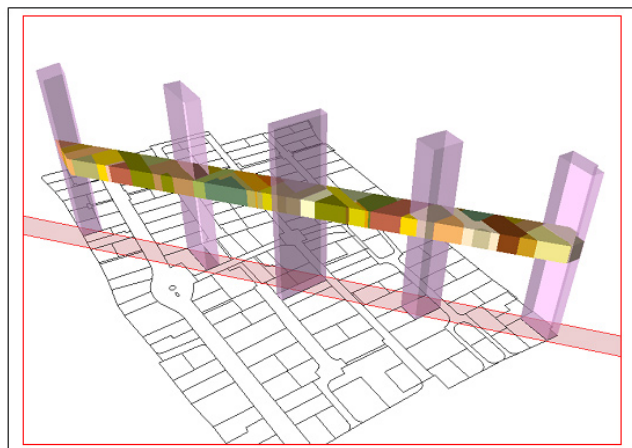

IL_LADM Country Profile

- Israel country profile based on inheriting LADM classes
- 'IL_' is the prefix for the Israel country profile, covering both the spatial and administrative parts
- Classes in IL_LADM model are derived directly or indirectly from LADM classes (and may be extended with new attributes or even new classes when needed)

Initial mapping between the key concepts of BNKL and LADM

BNKL	LADM	remark
Gush	LA_SpatialUnitGroup	
Parcel	LA_SpatialUnit	
Parcel_arc	LA_BoundaryFaceString	
	LA_BoundaryFace	No 3D currently in BNKL
Parcel_node	LA_Point	
Talar	LA_SpatialSource	
	LA_BAUnit	Not explicit in BNKL
	LA_RRR	In scope of Land Registry
	LA_AdministrativeSource	In scope of Land Registry
	LA_Party	In scope of Land Registry

IL_LADM Country Profile (administrative part)

- Administrative part of Israel LADM country profile with data from various organizations (SOI, LR, ILA,..)
- To be developed...

IL_LADM Country Profile (spatial part, very first draft...)

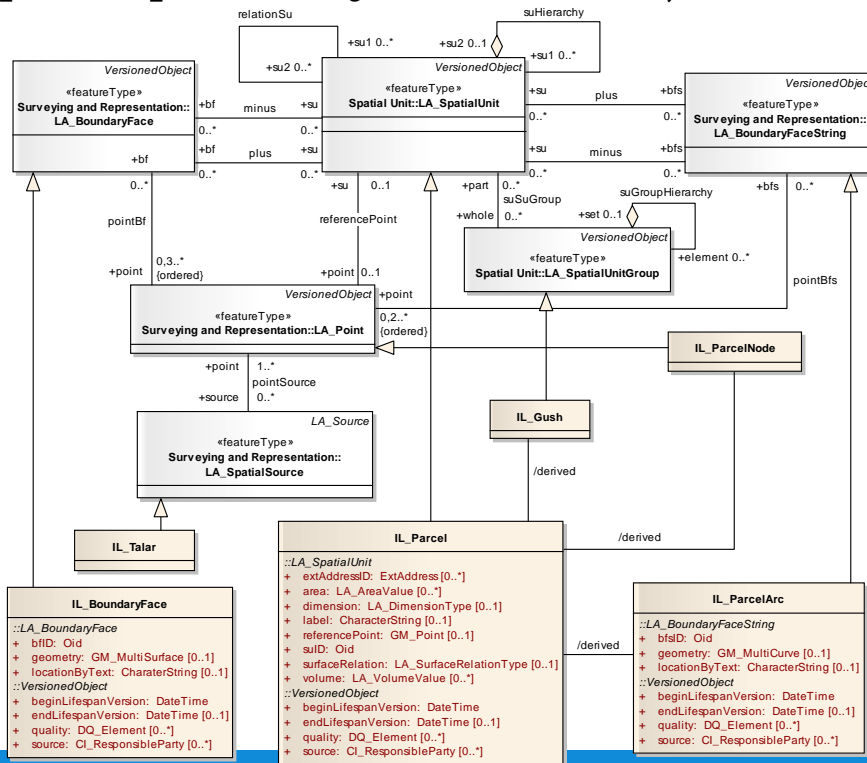

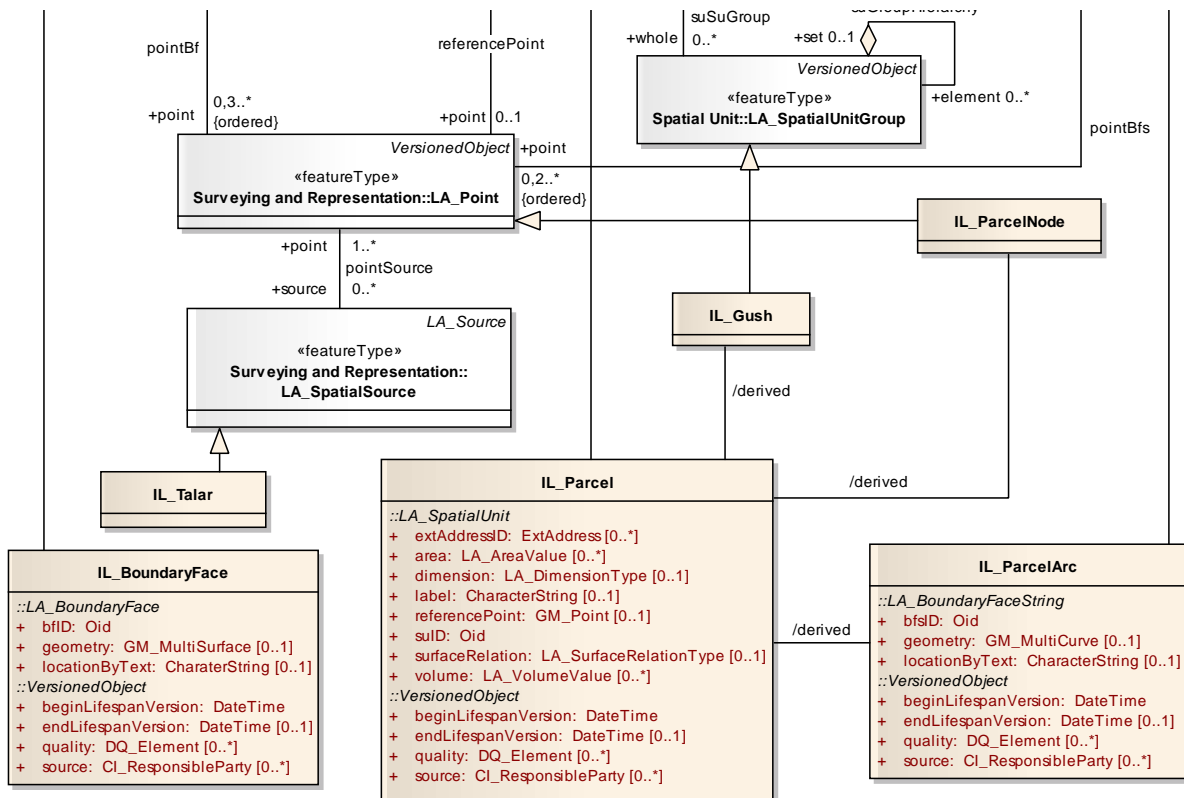

LADM Country Profile (more model considerations)

- All information in the system should originate from source documents
- In case of spatial source documents; i.e. subdivision/mutation plans (TALAR) there are links with spatial unit and point tables
- In case of administrative source documents (i.e titles) there are associations with RRRs (incl. mortgage) and BAUnit
- Unique identifier for all objects in model (not only parcels)
→ crucial for SDI (links with LR, ILA)

LADM Country Profile (even more model considerations)

- There may be cases (in the future) where one BAUnit (with same RRRs attached) has multiple Spatial Units
- To make the model comprehensive and future proof, a range of spatial units is supported: 2D and 3D
- Various types of spatial units may be organized in levels, e.g.:
 1. Base layer with parcels
 2. Apartment right
 3. Utilities, tunnels, pipelines, etc.
 4. Other 3D subparcels (joined)

LADM Country Profile (code lists)

- Standard code lists for allowed attribute values
- Codes should cover the spatial part and non-spatial part
- In most cases, values are proposed for the LADM code lists
- In future there may be a global (ISO/ FIG/ OGC) organization, maintaining code list and their values

LADM's current code lists for Administrative Package (annex J.2)

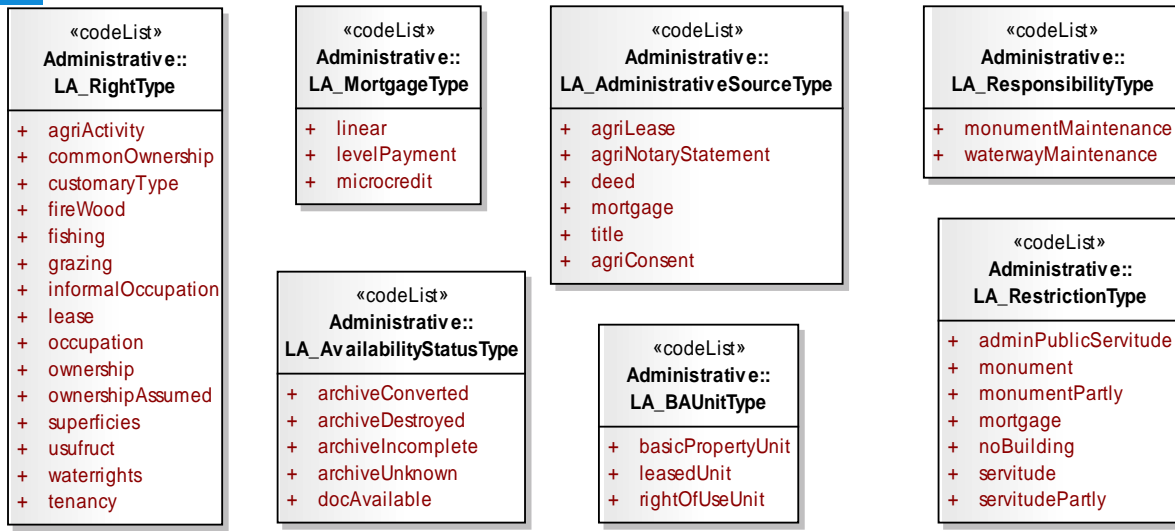

Contents

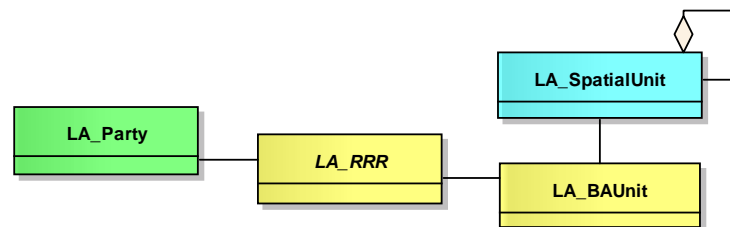

1. Motivation (refresh)
2. LADM Overview (refresh)
3. Israeli 3D LADM country profile
4. *Technical model / implementation*
5. Conclusion

→ Discussion, questions, answers

Conceptual to technical model

- Conversion takes technical design decisions for:
 - ID, PK, FK and versioning
 - Relationships between objects
 - Constraints
 - Derived attributes/ relationships
 - Multiplicity of attributes
 - Indexing and clustering
 - 2D/3D geometry/topology structure
- Resulting database schema will consist of:
 - Normal table
 - Relationship table
 - View on table (with derived attributes added)
 - Code list table
- Also possible to derive exchange format (XML schema)

Primary/Foreign Key (PK, FK) and versioning

- The important aspect is that the ID's have to be unique
- For a single object there may be multiple versions, which have the same ID with different timestamps
- Each table has a Primary Key (PK), a combination of one or more attributes
- Foreign Key (FK) is used to refer to the PK attributes within another table
- In one table, we can have multiple FK attributes to refer to different tables

Constraints

- There are many types of constraints: e.g.
 - primary key must be unique,
 - endDateTime > beginDateTime,
 - boundary of parcel must be closed,
 - boundaries may not intersect (topology constraints),
 - sum of ownership right shares must be 1,
 - and so on
- It would also be possible to use GIS or database built-in functionality; for example, Esri's or Oracle's versioning

Multiplicity of attributes

- In LADM country profile, it is possible to have attribute with multiple values; e.g. multiple types of area/volume attributes (surveyed, official and calculated)
- There are at least 3 different ways to implement this:
 1. additional table for this multiple attribute,
 2. use varray to represent all values or
 3. have a fixed number of area/volume attribute (e.g. 3 or 4 and indicate in name of attribute which area/volume type is intended)

2D/3D geometry/topology structure

- For all spatial types in model decide what data type to use in database: string, blob, Esri geometry, Oracle geometry, standard SQL/SFS, etc.
- With or without topology structure: both options possible (but given the importance of boundary, as basis of cadastre, and avoiding storing same point several times → topology preference)
 - The end points of an edge (node), play an important role in the topology of the model and therefore it is good to be able to differentiate them from intermediate points
 - The topology implementation can be based on own structure
 - The alternative would be to use the SDO_TOPO package from Oracle (available version 11 and higher)
- Note: no 3D topology standard available in Esri or Oracle

Resulting technical database model: SQL DDL and DML

```
CREATE TABLE MY_POINT (  
  pid varchar2(10) primary key,  
  sid varchar2(25) REFERENCES my_spatialsource(sid),  
  survey_point mdsys.sdo_geometry,  
  transformation varchar2(250),  
  map_point mdsys.sdo_geometry,  
  type varchar2(5) REFERENCES la_pointtype(cid),  
  begin_date_time timestamp,  
  end_date_time timestamp);
```

SQL DDL

```
-----  
INSERT INTO MY_POINT VALUES (  
  'N1',  
  '04-42351',  
  MDSYS.SDO_GEOMETRY (2001,24571,MDSYS.SDO_POINT_TYPE (23664.166398,12426.942536,NULL),NULL,NULL),  
  'NULL',  
  MDSYS.SDO_GEOMETRY (2001,24571,MDSYS.SDO_POINT_TYPE (23764.739732,12526.967747,NULL),NULL,NULL),  
  'PN01',  
  '01-JAN-14 08:10:04.20',  
  '');
```

SQL DML

Technical model: basis for implementation

Consider the whole 3D Cadastre processing chain:

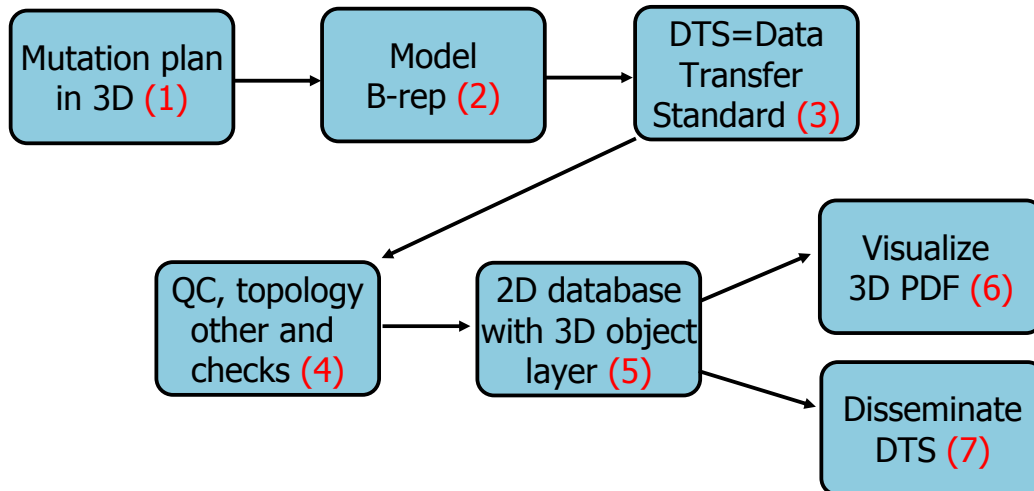

3D Data sources: survey (or design?)

→ create 3D geometry (1+2)

- Direct survey in 3D, might be challenging, e.g. how to survey a subsurface object or an airspace object?
Experience from Queensland, Australia shows that a lot of the submitted 'survey plans' do seem to have a CAD origin...
- For existing physical objects with legal spaces attached:
 1. Upgrade existing 2D floor plans to 3D volumes:
manual initially, in the future more automation
 2. If no plans available, then do a survey. Laser scan based measurement may be more effective than Tachymeter
- New buildings designed (CAD) direct in 3D, with limited additional effort (and clear guidelines) result in 3D cadastral objects → *complete development workflow chain*

3D Solid CityGML with LADM extension: DTS from Russian prototype (3)

```
<?xml version="1.0" encoding="utf-8"?>
<CityModel xmlns="http://www.opengis.net/citygml/1.0"
  xmlns:xsi="http://www.w3.org/2001/XMLSchema-instance"
  xmlns:xlink="http://www.w3.org/1999/xlink"
  xmlns:generic="http://www.opengis.net/citygml/generics/1.0"
  xmlns:gml="http://www.opengis.net/gml"
  xsi:schemaLocation="http://www.citygml.org/citygml/1/0/0
http://schemas.opengis.net/citygml/1.0/cityGMLBase.xsd
http://www.opengis.net/citygml/generics/1.0
http://schemas.opengis.net/citygml/generics/1.0/generics.xsd">
  <gml:name>TU Delft example 3D Parcel for Cadastre</gml:name>
  <gml:boundedBy>
    <gml:Envelope srsDimension="3" srsName="urn:ogc:def:crs:EPSG:7.6:7415">
      <gml:lowerCorner srsDimension="3">84936.169 444962.883 0.0 </gml:lowerCorner>
      <gml:upperCorner srsDimension="3">86082.217 446807.742 90.0 </gml:upperCorner>
    </gml:Envelope>
  </gml:boundedBy>
  <cityObjectMember>
    <generic:GenericCityObject gml:id="Parcel_1">
      <creationDate>2011-04-01</creationDate>
      <generic:class>LA_LegalSpaceBuildingUnit</generic:class>
      <generic:lod4Geometry>
        <gml:Solid>
          <gml:exterior>
            <gml:CompositeSurface>
              <gml:surfaceMember>
                <gml:Polygon>
                  <gml:exterior>
                    <gml:LinearRing>
                      <gml:pos>85514.91 445173.489 0.0</gml:pos>
                      <gml:pos>85511.709 445170.399 0.0</gml:pos>
                      <gml:pos>85510.892 445172.368 0.0</gml:pos>
                      <gml:pos>85514.066 445175.521 0.0</gml:pos>
                      <gml:pos>85514.91 445173.489 0.0</gml:pos>
                    </gml:LinearRing>
                  </gml:exterior>
                </gml:Polygon>
              </gml:surfaceMember>
            </gml:CompositeSurface>
          </gml:exterior>
        </gml:Solid>
      </generic:lod4Geometry>
    </generic:GenericCityObject>
  </cityObjectMember>
</CityModel>
```

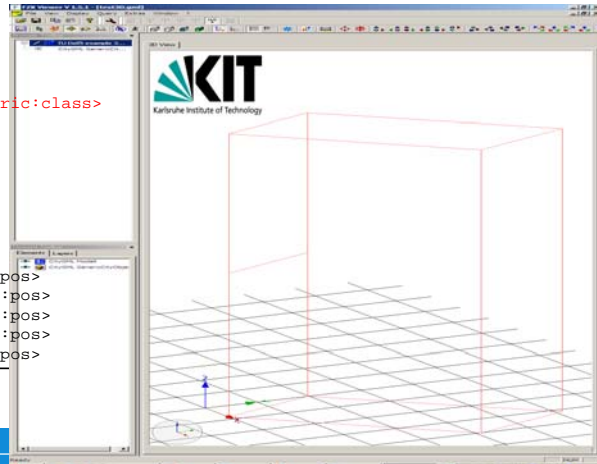

Automated quality check: data complete, topology ok, etc. (4)

- Automated checking, nice example (20 years experience):
Sudarshan Karki, Rod Thompson and Kevin McDougall
Development of validation rules to support digital lodgement of 3D cadastral plans. In: CEUS, Vol. 37, 2013, 12 p.
(note submission via ePlan, data encoded in LandXML)
- *Queensland Land Title Act, 1994* specifies 2 methods for defining 3D cadastral objects:
 1. Building Format Plans ('2D' floor plans for the different levels) and
 2. Volumetric Format Plans (true 3D geometric description)
- In addition to the Land Title Act there are directions specifying details for the submission of survey/mutation plans:
Registrar of Titles Directions for Preparation of Plans, Section 10

Non trivial 3D quality check (4): Valid, but non 2-manifold 3D Parcels

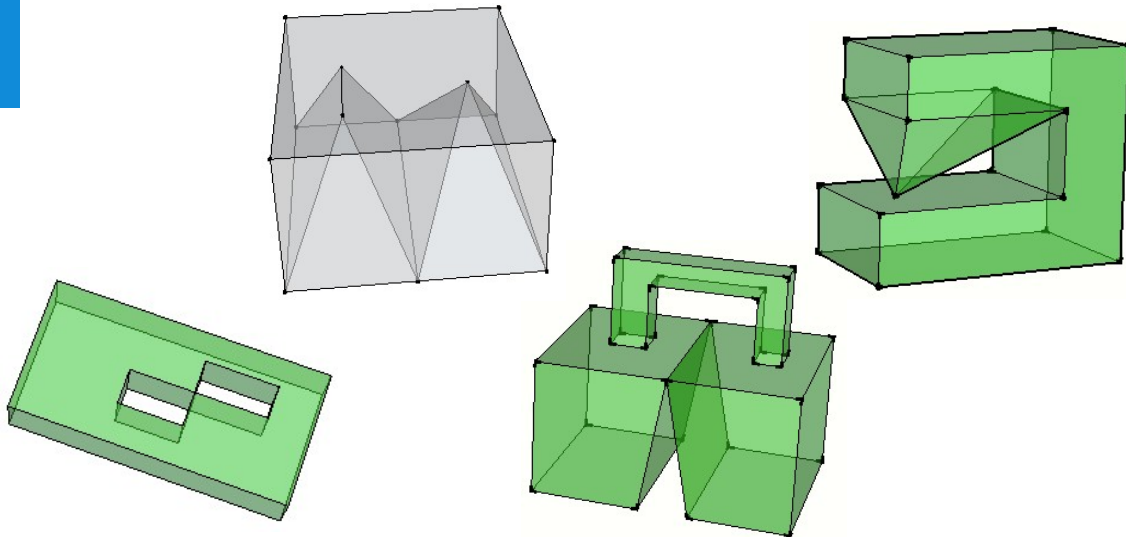

Single object correctness rule: *interior connected*
Illustrations by Shen Ying (Wuhan University, visiting TU Delft)

Existing 2D database extended with 3D LA_Level (5)

- LA_Level organization based on content or structure:
 - example 1, content-based: one layer with 'primary' (strongest) rights, another layer with rights that can be added/subtracted (e.g. restrictions)
 - example 2, structure-based: one layer with topologically structured parcels (one part of the country), another layer with (unstructured) line based parcels (other part of country)
- can also be used in 3D context:
one layer 'normal' parcels, another layer with subtracted 3D parcels
- Note: again quality checks at database level, just to be sure (4)

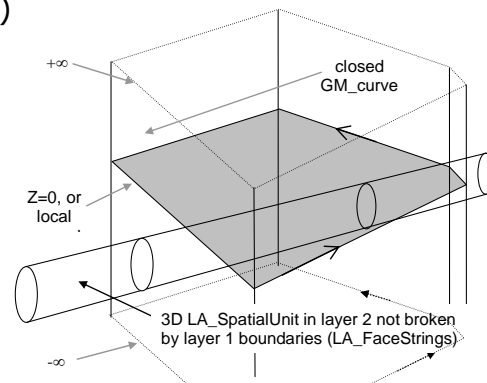

3D case: parking below 2 other parcels (5)

- There are different ways to in LADM to model 3D parcels
- With LA_Level approach the illustrated case could be modeled
 - 3 parcels (A, B, C) in 2D parcel level, implying 3D columns
 - 1 parcel (A-1+B-1) in 3D parcel level
 - LA_BAUnit to combine C with A-1+B-1
- A and B 3D column have *exclusion* (from LA_Level approach)
- C has *extension* (via LA_BAUnit)
- Illustration:
Yaron Felus/
Shimon Barazani

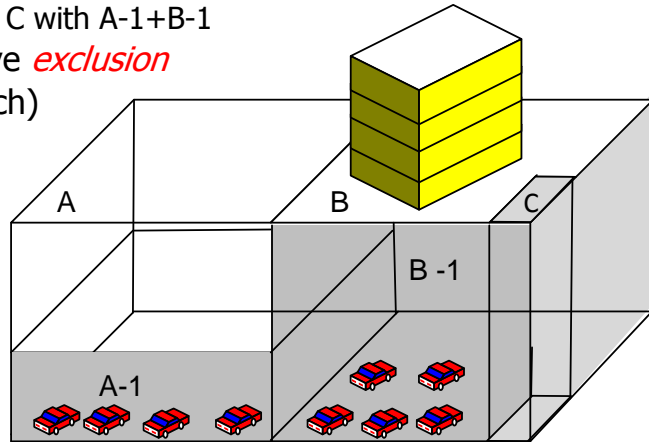

3D PDF, NL example/demo (6)

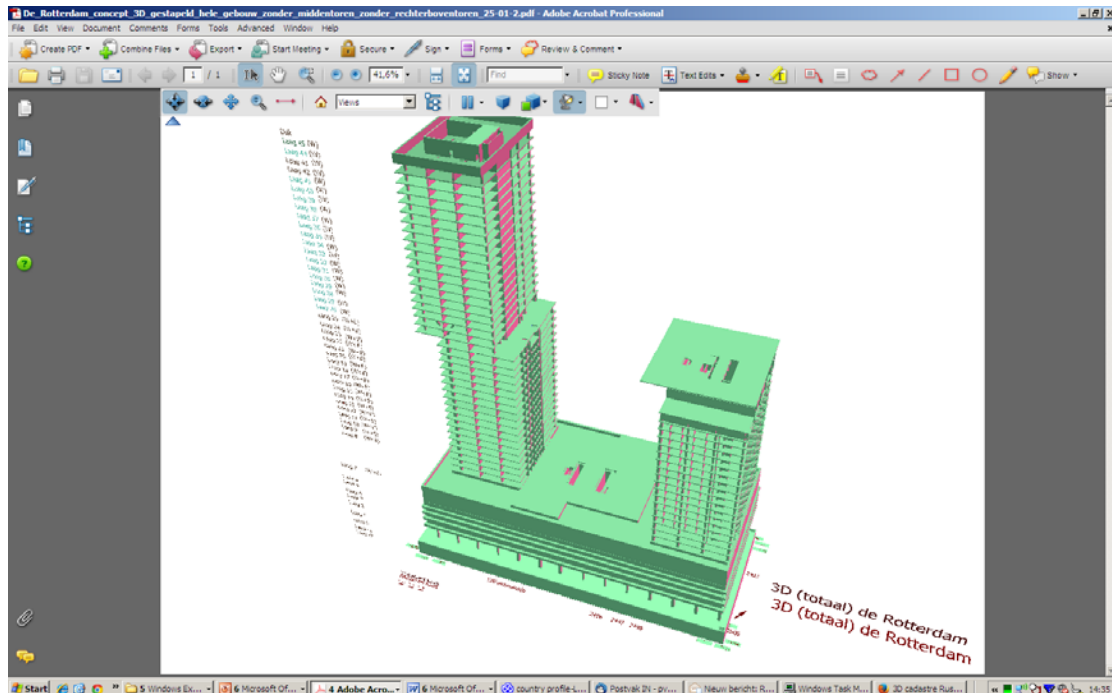

Dissemination (7)
Web-demo, X3D

3D cadastre Russia - proof ...

C:\Projecten\9W079601 3D Kadaster Rusland\Data\Prototypes\20120130\index_telemom... 3D cadastre Russia - proof ...

← back to index

Cadastral-nr 52:18:0070012:34

Помещение P7

Этаж 5

Кадастровый номер помещения 52:18:0070012:34

Кадастровый номер здания 52:18:0070012:30

Кадастровый номер ЗУ 52:18:0070012:23

Условный номер 52-52-01/769/2010-295

Адрес Нижегородская область, г. Нижний Новгород, ул. Великого, д. 9/48

Местоположение

Назначение помещения нежилое

Вид права форма собственности Собственность

Правообладатель Общество с ограниченной ответственностью «Липа»

Ограничения обременения права Ипотека, регистрация № 52-52-01/101/2010-057 от 14 сентября 2010 г., срок: до 01.01.2015 г.,

Площадь всех частей здания 706.1

Помещение

Этаж

Кадастровый номер помещения

Кадастровый номер здания

Кадастровый номер ЗУ

Move floors sideways
 Identify (click on apartment unit)
 Show floorplans

 Show walls
 Show ground parcels
 Show topography (only Teledom)
 Show DTM

TU Delft

Israel 3D LADM 45

Contents

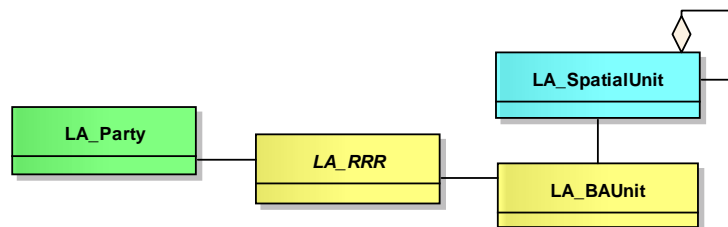

1. Motivation (refresh)
2. LADM Overview (refresh)
3. Israeli 3D LADM country profile
4. Technical model / implementation
5. *Conclusion*

Conclusion Israeli LADM country profile

- The development of draft Israel LADM country profile needs to be a national activity (with one initiating organization: SOI)
- LADM provides standardized class names for spatial and non-spatial data
- The unique identifiers form the important links between spatial and non-spatial data
- New code lists (including code list values) for spatial and non-spatial data also need to be proposed, based on accepted practices as much as possible

Conclusion 3D Cadastre (in Israel)

- Spatial Units are the “glue” joining the spatial description of land to the RRR aspects
- Spatial Units are universal in their land administration application (ownership, easement, utilities, building,..)
- Range of representations: text → 3D topology
- Spatial Units based on Source Documents and LA_Points
- Many technical design and implementation decisions have to be made during the conversion of country profile to technical model

Future work

- Conversion of conceptual model to technical model: from UML diagram, to database tables SQL DDL scripts for data storage or XML (LandXML → InfraGML, CityGML, BIM) for exchange format
- Develop regulations/formats for digital 3D mutation plans
- Realization of prototype with sample data and most functionality:
 - Test database + XML exchange formats for LADM with Israeli data
 - Other countries with British history (strata): Australia, Malaysia,...
- Consider complete development life cycle of rural+urban areas all related to cadastral registration (Parties, RRRs, Spatial Units) and more and more these will involve 3D descriptions.
- Creating appropriate web-interface for SOI/LR/ILA data access

Intention more than 3D Cadastre ...full life cycle in 3D

Involved steps (order differs per country):

1. Develop and register zoning plans in 3D
2. Register (public law) restrictions in 3D
3. Design new spatial units/objects in 3D
4. Acquire appropriate land/space in 3D
5. Request and provide (after check) permits in 3D
6. Obtain and register financing (mortgage) for future objects in 3D
7. Survey and measure spatial units/objects (after construction) in 3D
8. Submit associated rights (RR)/parties and their spatial units in 3D
9. Validate and check submitted data (and register if accepted) in 3D
10. Store and analyze the spatial units in 3D
11. Disseminate, visualize and use the spatial units in 3D

Rainbow project: Unified property database (*distributed*), Location Based Business Intelligence (LBBI) system

- LADM covers data from various government parties and can support digital collaboration
- Various organizations are source of different RRRs with either:
 - own geometry
 - ref's cadastral parcels

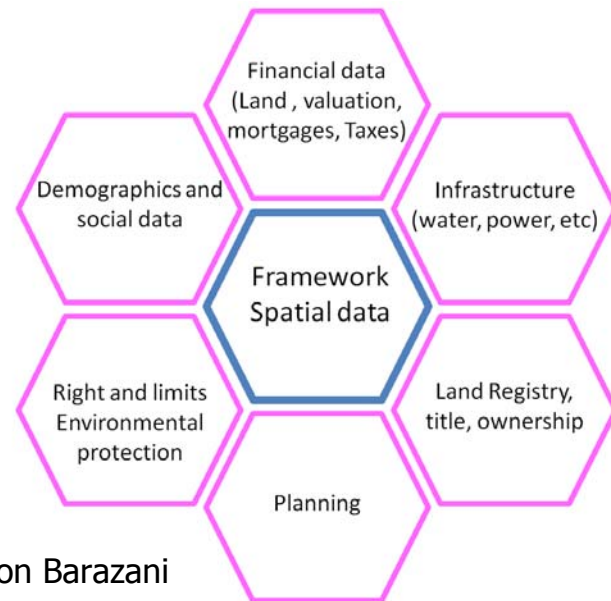
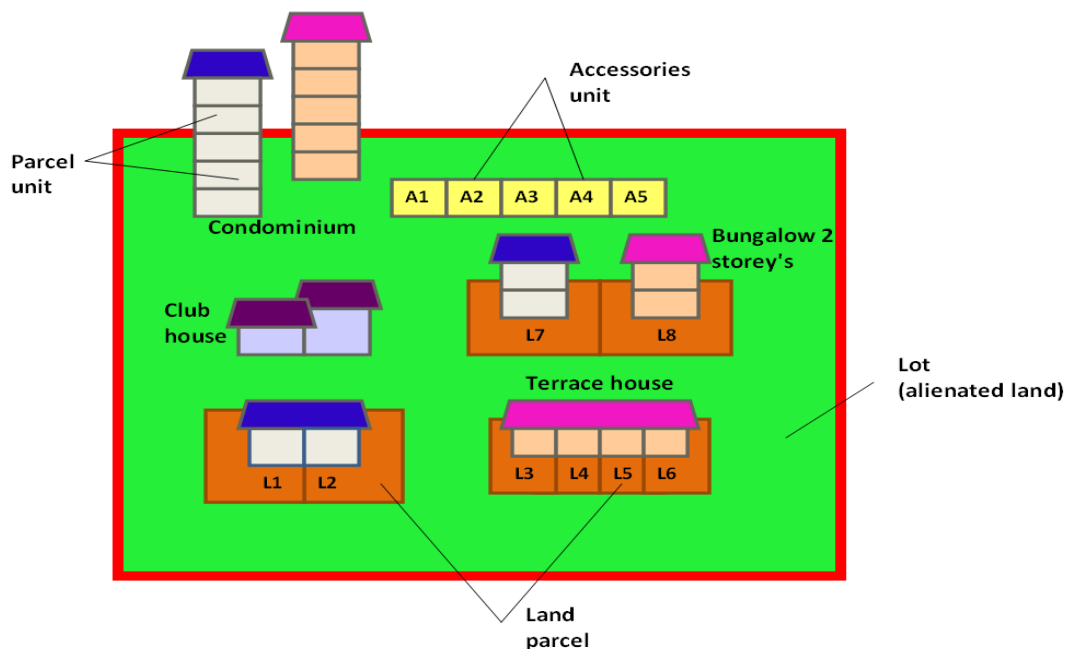

Illustration: Yaron Felus/Shimon Barazani

3D LADM example: Malaysian LA



Various cadastral objects related to *strata titles* in context of one lot

MY_LADM Country Profile (spatial part)

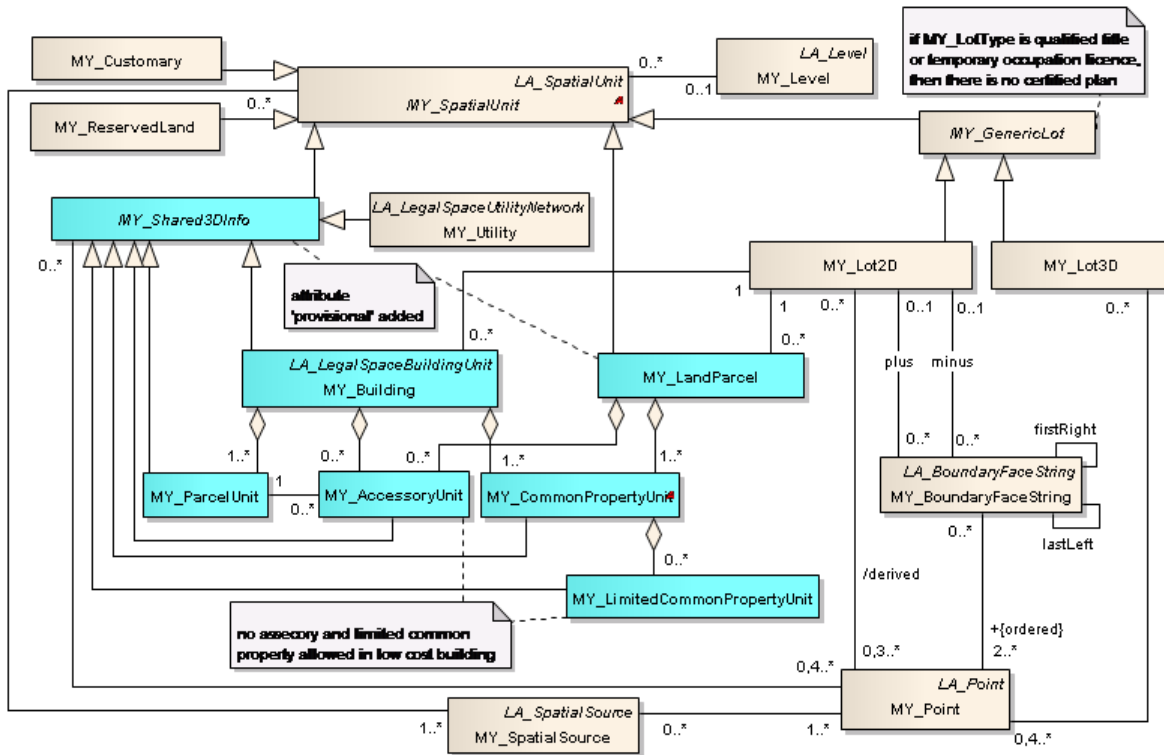

Contents

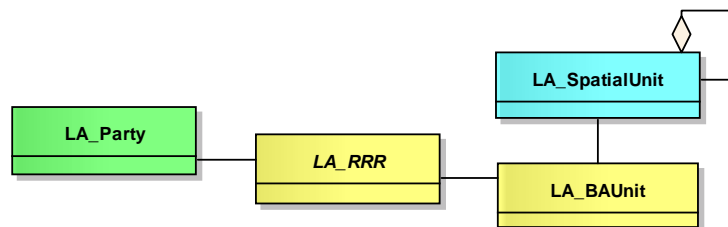

1. Motivation (refresh)
2. LADM Overview (refresh)
3. Israeli 3D LADM country profile
4. Technical model / implementation
5. Conclusion

→ Discussion, questions, answers

LADM Questions Nimrod Blumkine (ILA)

1. Besides open source, what about commercial implementation?
→ *countries (Cyprus, Singapore, Bahrain,..) had tenders with required both LADM support and main vendors ArcGIS, Oracle*
2. How are spatial plan (תב"ע, תמ"א וכו') data represented?
→ *as spatial plan has legal impact, it is within scope of LADM and should be recorded as type of RRR with SpatialUnit*
3. What part of the standard is implemented in ArcGIS?
→ *more question for Esri (Brent Jones)*
4. What granulation of LA_Source is recommended?
(many steps in land sale: tender, getting proposals, survey etc.)
→ *document that caused new Party, RRR, BAUnit, SpatialUnit*
5. How about naming conventions of entities / tables etc.?
→ *IL_ in country profile (own language possible, give mappings)*

R&D: Deep integrating 3D space and time: 4D Cadastre

Partition: *no gaps or overlaps in the parcelation on which the rights (e.g. ownership) are based*

2D: a planar partition of the surface

3D: a partition of space with no overlaps or gaps

4D: no overlaps or gaps in the rights, not only in space but also in parallel the time dimension

What about 5D?

→ scale (TU Delft topographic research)

→ accuracy, uncertainty



Integrated 4D data type advantages

- optimal efficient 4D searching
- Parent-child becomes topology neighbor query in time
- Foundation of full (4D) partition: no overlaps or gaps in space and/or time
- 4D analysis: do two moving rights have spatio-temporal overlap/touch

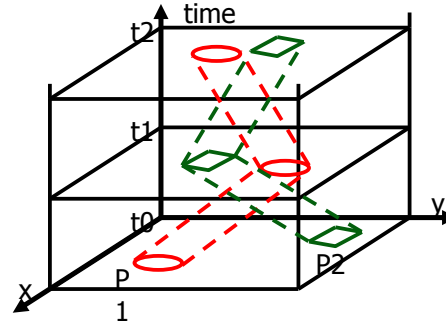
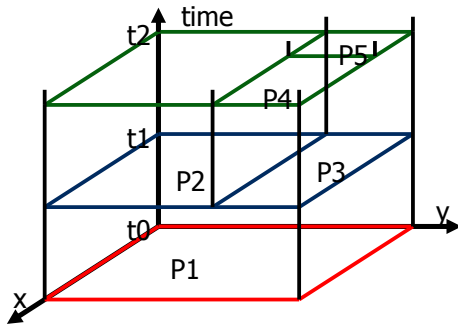

Vario-scale: additional dimension (2D→3D) for topographic data

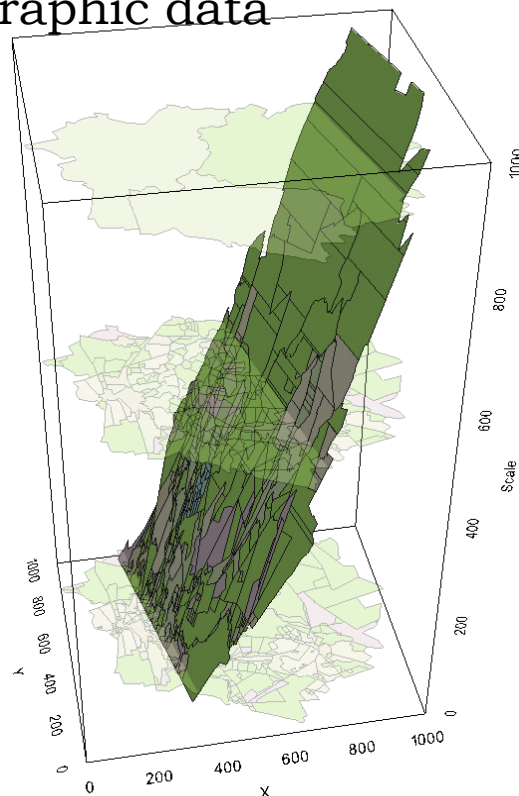
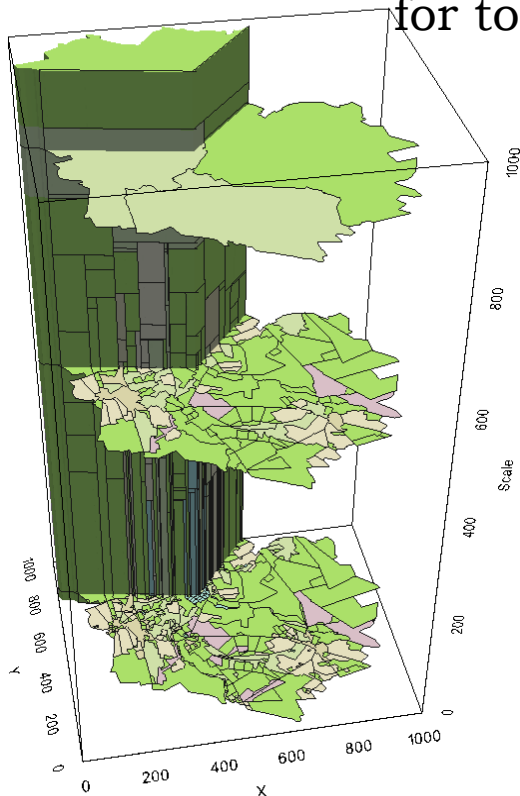

Topology model (base parcels)

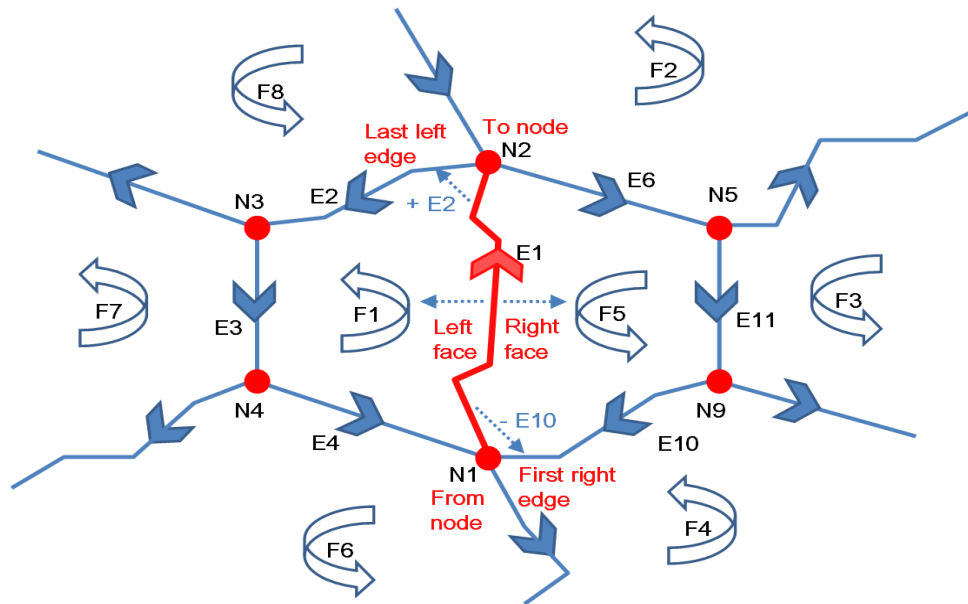

LADM Country Profile (topology model)

- 2D topology: based on 3 primitives node (point), edge (boundaryFaceString), face (spatialUnit)
- Topological boundaries do not intersect and do meet other boundaries at begin and end nodes
- Boundaries have own attributes: date, quality, type,..
- Adjacent features (i.e. two parcels) will have a common boundary between them and share same edge
- Topology references (in BoundaryFaceString) are:
 1. edge-node = fromNode and toNode
 2. edge-edge = firstRightEdge and lastLeftEdge
 3. edge-face = rightFace and leftFace.

Relationship between objects

1. Class A – Class B with 1-n relationship:
→ include reference in Table B (FK) to record in Table A (PK)
(note exactly one)
2. Class A – Class B with n-m relationship:
→ new relationship Table C with references to Tables A+B
(note every record in Table C contains single pair)
3. Association Class C between Class A and B
→ as in case two, but now with attributes in Table C (for Class C)

Derived attributes/relationships

- To realize derived attributes, Structured Query Language (SQL) *'create view'* can be used
- Function used in the *'create view'* statement derives the attributes from another table or attribute
- There are standard functions in Oracle to derive the attribute (i.e. SDO_GEOM.LENGTH function)
- If there is no standard function in Oracle to derive the attribute, then we have to create our own function by programming



Indexing and Clustering

- An index is created for efficient searching based on selecting of (admin or spatial) attribute value
- B-tree index can be created on the attribute of administrative classes (if selections are often based on this attribute)
- R-tree index is created on the geometry attributes in the spatial tables
- For administrative tables, the primary key is used for physically clustering
- For spatial table, the (derived) geometry is used for spatially clustering the records in the table

Annex B. Various LADM Questions and Answers

During the investigations, various question related to LADM were raised by Nimrod Blumkine (from the Israel Land Management Authority). This annex shows these questions and corresponding answers.

1. If I understand correctly, the standard represents all data that relate to the party data in ExtParty classes according the data source.

→ Party is indeed modeled as external as it is assumed that (in future) most countries will have some kind of registration of persons (natural and non-natural) and that this should not be repeated in LA, but accessed via the Information Infrastructure. In reality this is today often not yet operational (and alternative, temporary solutions have to be used).

2. If I'll model the DB to mimic the class diagram I'll have complicated DB with low performance, so basically I intend build an LA_Party table which holds all the common relevant data for legal entity that can be linked to the RRR entity (with some joined data for special attributes of special parties) and because the conformance to the standard is tested at the class level, the physical level is open for interpretations?

→ Transforming the conceptual model to an efficient implementation is a significant activity (in a few steps). The most realistic approach is: 1. first develop country profile (select from LADM what is relevant and extend where needed with Israel specifics), 2. convert country profile to implementation (e.g. SQL DDL database schema or XML schema exchange format), probably by mix of automated transformation of model and manual fine-tuning (there are quite a number of area's where automated model transformation into implementation is weak; e.g. all kinds of geometry and topology aspects, supporting constraints, deciding on storage structure, indices, etc.), 3. test implementation model in prototype with real world data against real applications (and if needed fine-tune, before going into operational production).

3. From my understanding of the standard and according to annex N (history and dynamic aspects) – I'll have to use parcelation events in LA_source that document the restructuring of the rights. And at the same time update the versionedObject of the new and old parcels. If the users want to know the relation between the state before the restructuring and after the restructuring we perform a join on the same LA_source event that created the restructuring and get the triplet {before_data, Event, after_data}

→ On the LADM and transactions/ events modelling (and recorded by LA_Source objects): your interpretation is right. If you have end date/time X of an object, then you can:

0. find more old objects ended in same transaction by selecting on end date/time X

1. find corresponding LA_Source by selecting on date/time X

2. find new object(s) by selecting on start date/time X

4. I know there there is an open source implementation but is there a commercial implementation of the standard with one of the big vendors (i.e. SAP, IBM, etc.)?

→ countries (Cyprus, Singapore, Bahrain,..) had tenders with required both LADM support and main vendors ArcGIS, Oracle.

5. How are land management programs/ spatial plan (תוכנית, ע"מ) data is represented in the standard?

→ as spatial plan has legal impact, it is within scope of LADM and should be recorded as type of RRR with SpatialUnit.

6. Since we are using ESRI ArcGIS, what part of the standard is implemented in it and what is outside it's scope?

→ more question for Esri (Brent Jones), but some information can be found in the Esri white paper on land administration: <http://www.esri.com/~media/files/pdfs/library/whitepapers/pdfs/arcgis-and-land-administration.pdf> which states: 'Built on the Land Administration Domain Model (LADM, ISO 19152:2012), this provides land administration agencies with access to the latest technology to meet the standard. This allows vendors and Esri partners to build configurable applications that run on the ArcGIS platform with limited custom software development.'

7. What granulation of LA_Source is recommended since LA business processes are very long and some legal sources are only indirectly related to RRR or spatial changes? For example selling land involves several steps that proper existence of all, is a prerequisite for change of rights (setting up a tender, getting proposals, ordering a survey etc.) are all documented within the LA_source.

→ the document that caused new Party, RRR, BAUnit, or SpatialUnit indicates the actual granularity.

8. How the standard relates to naming conventions of entities / tables etc.

→ 'IL_' is used as prefix in the Israeli country profile (own language possible, give mappings)

9. Am I correct in my understanding that it's what you called TALAR in the attached slide and it's mapped to the LA_spatialSource?

If so, how do you differentiate in the RRR entity between rights that are specific (I have ownership right in a specific BA_unit or parcel) from non-specific rights (for example because of a change in the usage plan I now have the right to potentially build 300 sqm on my land)?

→ Yes as far as I did understand the SOI uses the term TALAR as source document for parcels (and parcel groups/Gush).

Rights (or more general RRRs) are always related to a BA_Unit, which should normally refer to location. The location could be a specific parcel (e.g. ownership) or could be more general as the right to build (upto certain size) in certain area. In the second case the area could be specified with its own geometry (e.g. specify part of the city/ country) or as a collection of parcels (as maintaining the last option may be difficult I would prefer the first option: own geometry).

TALAR is the spatial source for parcels, but there may be other spatial sources for spatial units related to other types of RRRs (e.g. a zoning plan could be considered a spatial source).

PS. There are several LADM based implementations which do include business processes. At FIG congress (June 2014) the STDM implementation (based on LADM) was released as open source by UN-HABITAT; see <http://wiki.tudelft.nl/bin/view/Research/ISO19152/ImplementationMaterial>

Annex C. 3D LADM example: Malaysian LA

Figure C1 depicts some of the cadastral object types in Malaysia in context of a single lot. Note the term lot is used in Malaysia where in other countries the term parcel would be used (but in Malaysia the term 'land parcel' has other meaning). Figure C2 shows the spatial part of the Malaysian LADM country profile. Note that the Malaysian specific classes all start with the prefix 'MY_'. More information on the Malaysian LADM country profile can be found in recent literature (Zulkifli et al 2014a, Zulkifli et al 2014b).

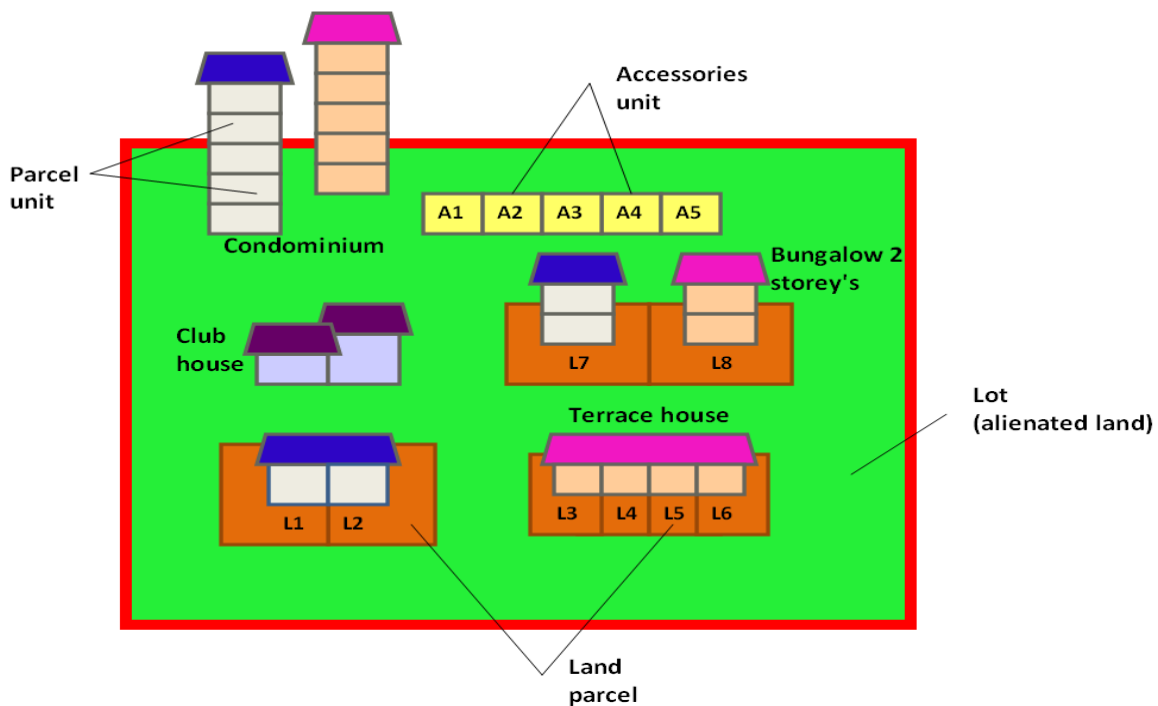

Figure C1. Various cadastral objects related to strata titles in context of one lot; illustration from (Zulkifli et al 2014a).

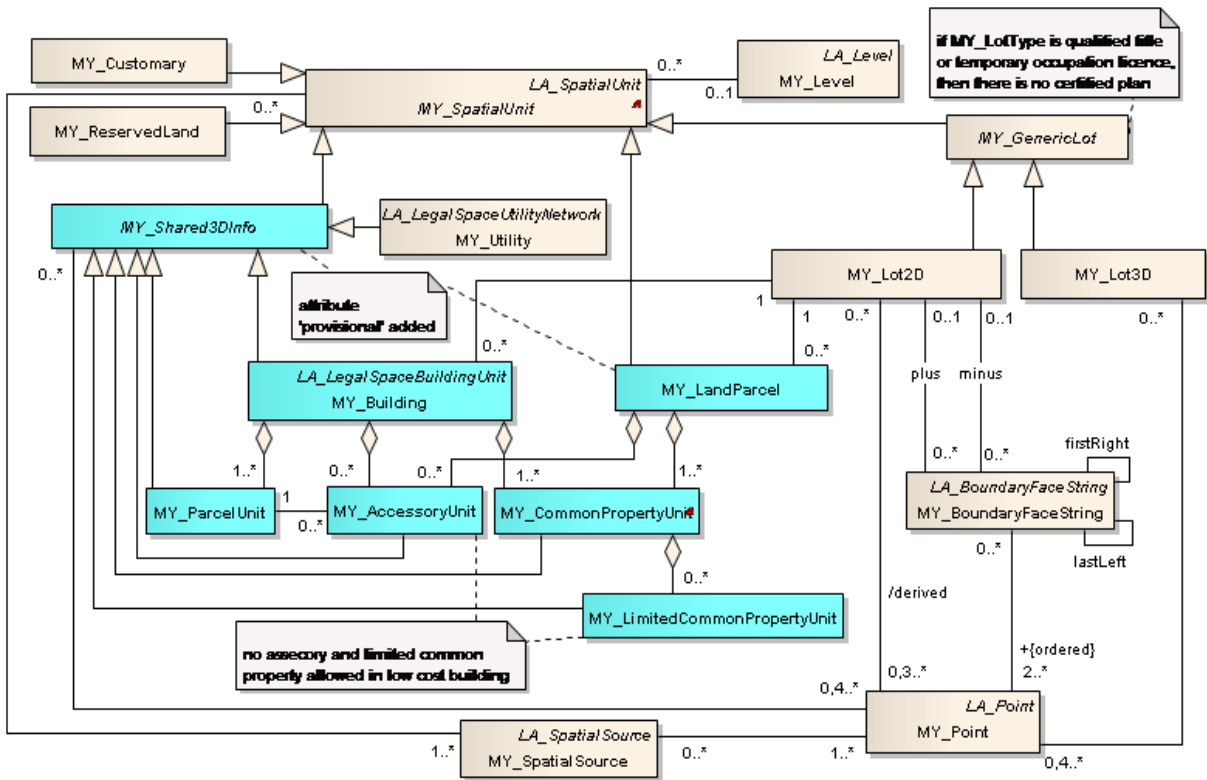

Figure C2. Overview of the spatial part of the Malaysian LADM country profile (blue is used for strata related classes); illustration from (Zulkifli et al 2014a).