

+ + + + + + + + + + + + + + +

+ + + + + + + + + + + + + + +

+ + + + + + + + + + + + + + +

THE CORPOREAL

+ + + + + + + + + + + + + + +

THE COLLECTIVE

+ + + + + + + + + + + + + + +

+ + + + + + + + + + + + + + +

+ + + + + + + + + + + + + + +

THE CLINICAL

+ + + + + + + + + + + + + + +

+ + + + + + + + + + + + + + +

| + EXPLORE LAB GRADUATION

+ + + + + + + + + + + + + + +

THE PROBLEM OF (CORPOREAL) HEALTH

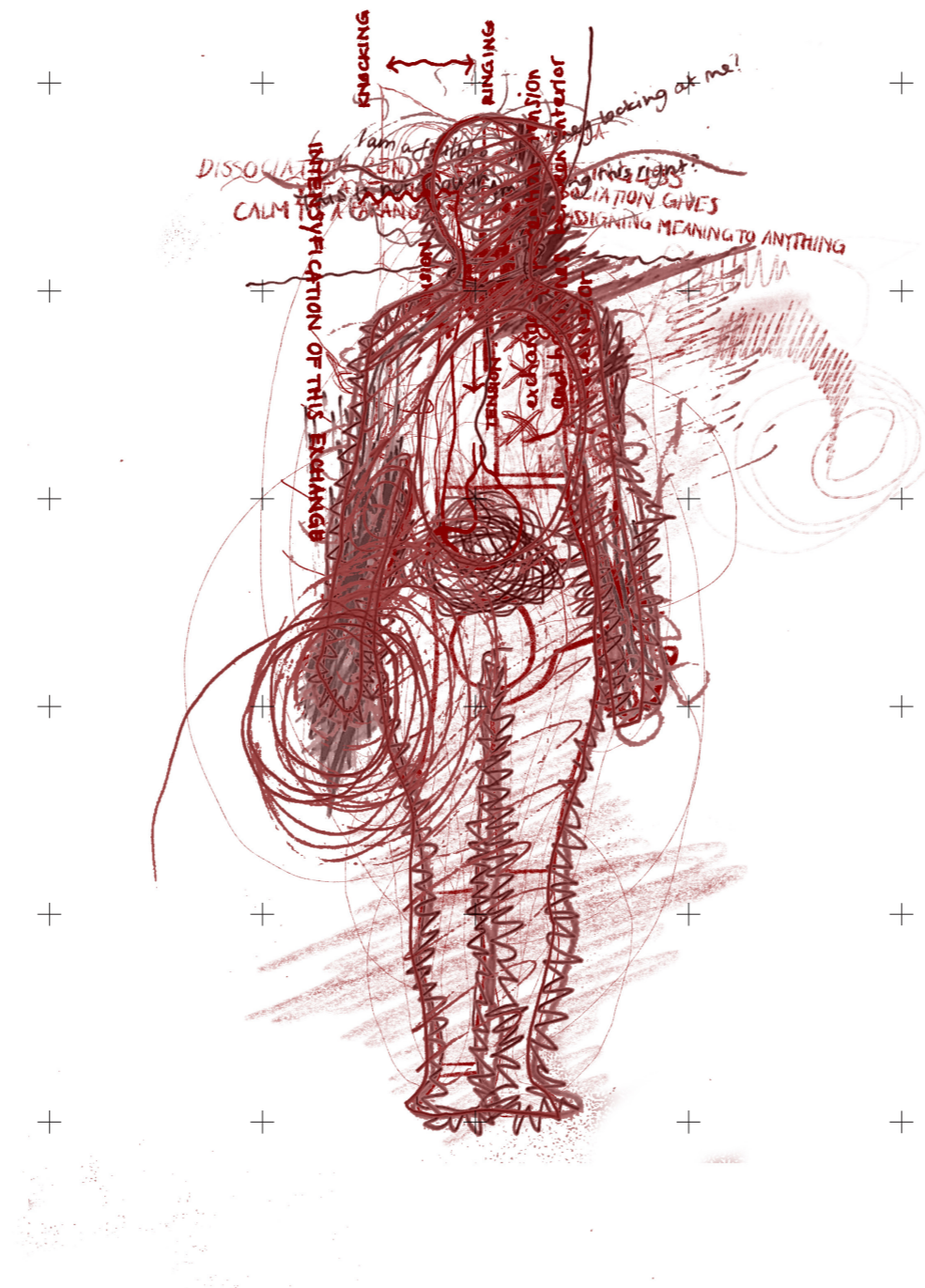

THE PROBLEM OF (CLINICAL) HEALTH

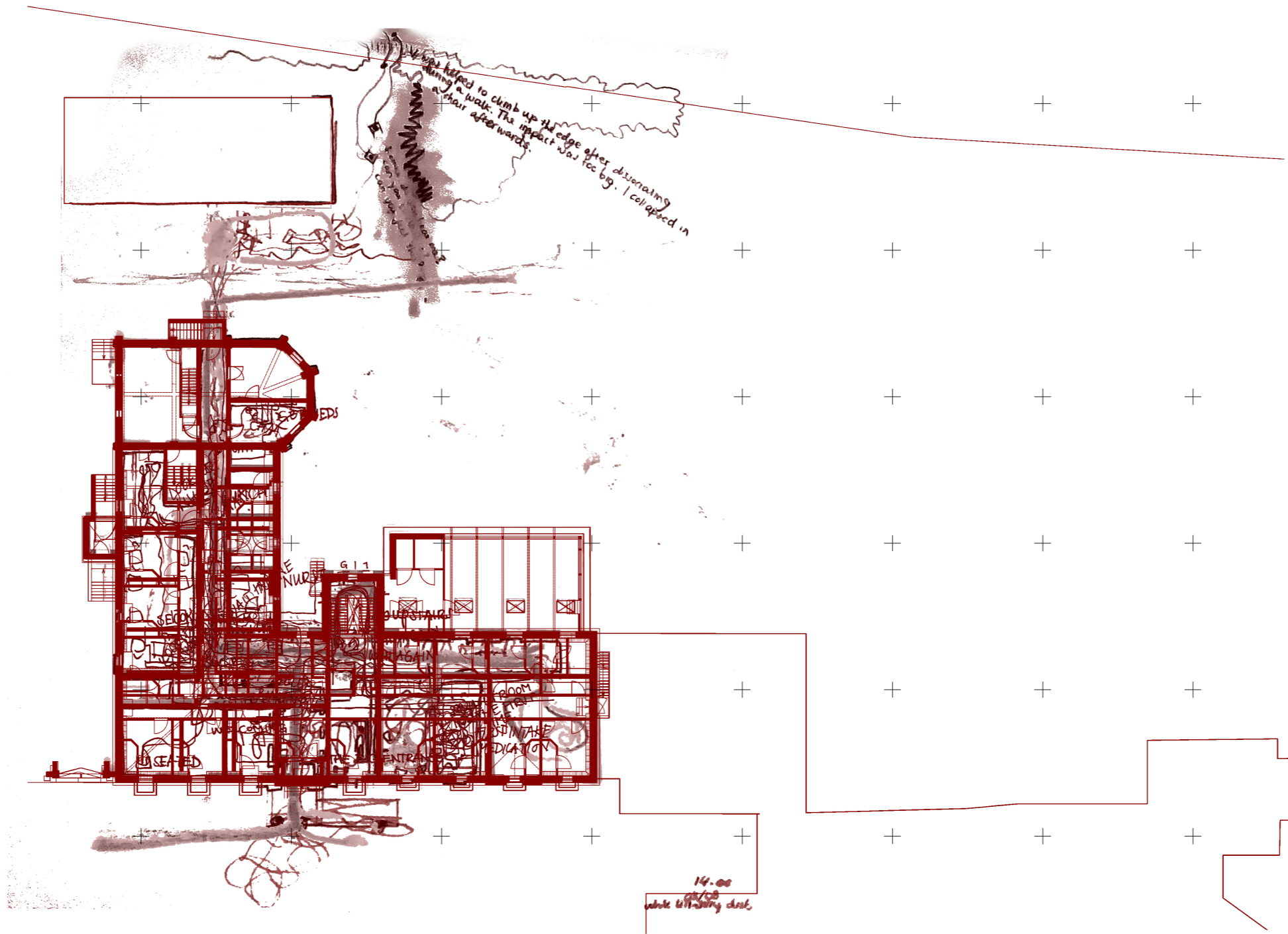

THE PROBLEM OF (COLLECTIVE) HEALTH

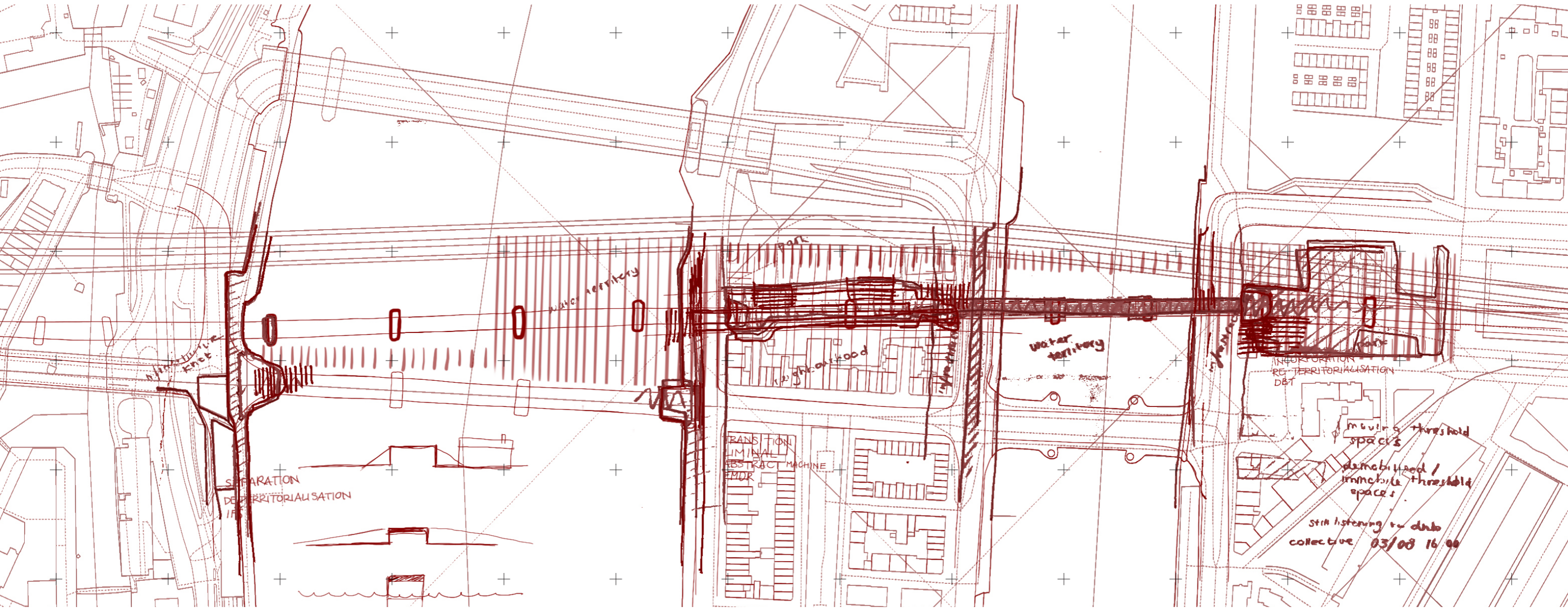

+
PROBLEMATISATION

+
CORPOREAL

+
CLINICAL

+
COLLECTIVE

+
DETERRI-
TORIALISATION

+
RETERRI-
TORIALISATION

+
REMKE SEYBEN

+
ANTONIN ARTAUD

+
VINCENT VAN GOGH

+
READER'S GUIDE

+
LEGEND

+
THE PROBLEM OF
HEALTH

+
THE PROBLEM OF CORPOREAL
HEALTH

+
THE PROBLEM OF CLINICAL
HEALTH

+
THE PROBLEM OF COLLECTIVE
HEALTH

+
THE THREE
SYNTHESES OF THE UNCONSCIOUS

+
PROBLEMATISTION

+
ANTI-METHOD

+
SCHIZ

+
SCHIZOID

+
SCHIZOPHRENIA

+
SCHIZOANALYSIS

+
SCHIZO-
CARTOGRAPHY

+
MACHINIC
PHYLUM

+
DEFENSE

+
DISORDER

+
DECAY

+
DETERRI-
TORIALISATION

+
DIAGNOSIS

+
UNIVERSES OF
VALUE

+
FEELINGS

+
FLASHBACKS

+
FRAGMENTS

+
BWO

+
FATIGUE

+
EXISTENTIAL
TERRITORIES

+
CUT

+
CURE

+
CITY

+
CAESURA

+
CONJUNCTION

+
MATERIAL,
ENERGETIC,
SEMIOTIC FLOWS

+
POISON

+
PRESCRIPTION

+
PLANE

+
PHARMAKON

+
ACU-PUNCTURE

+
CORPOREAL
HEALTH

+
CLINICAL
HEALTH

+
COLLECTIVE
HEALTH

+
CRITICAL

+
CONCLUSION

PROBLEMATISATION

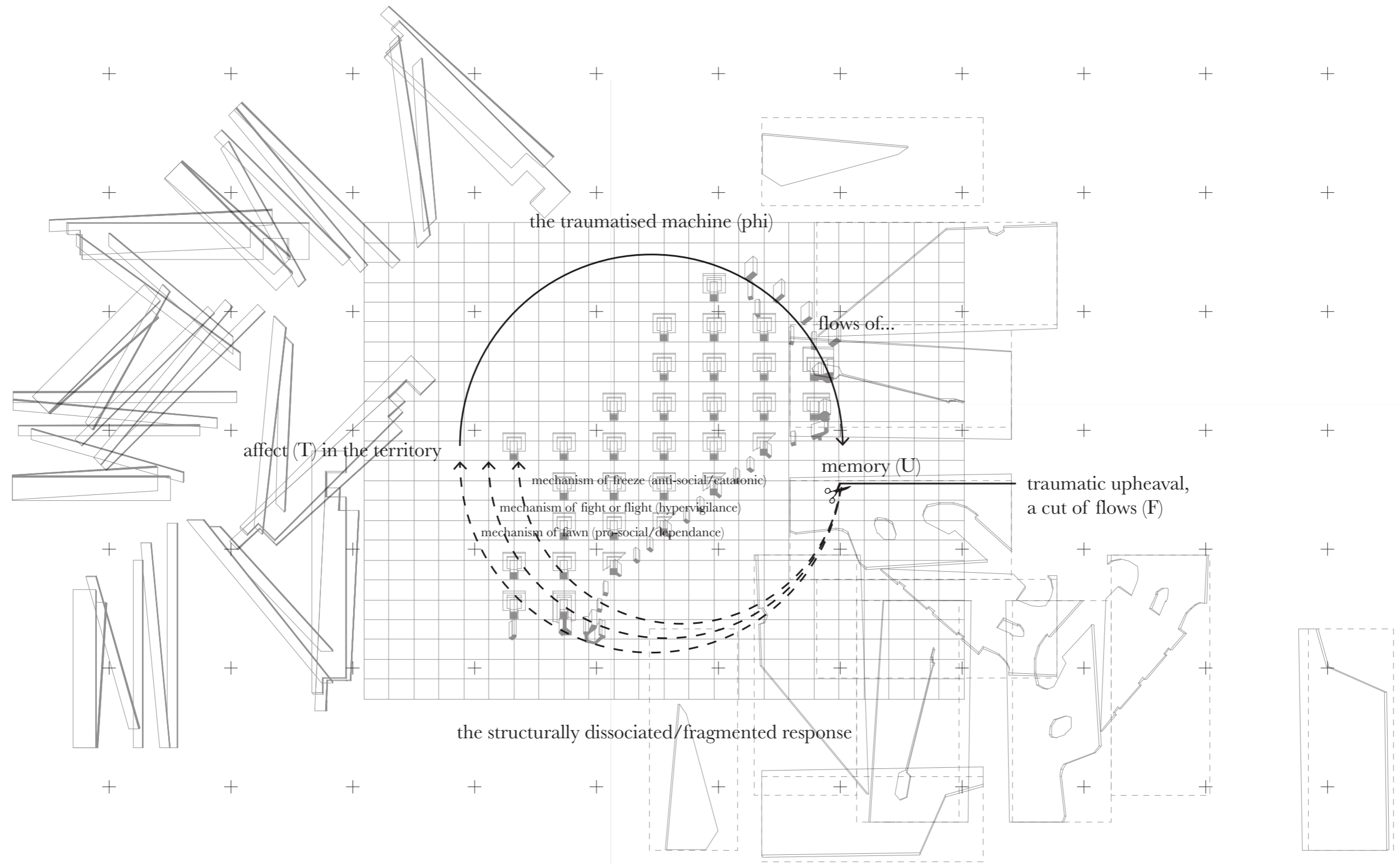

the traumatised machine (ϕ)

affect (T) in the territory

mechanism of freeze (anti-social/catatonic)

mechanism of fight or flight (hypervigilance)

mechanism of fawn (pro-social/dependance)

flows of...

memory (U)

traumatic upheaval,
a cut of flows (F)

the structurally dissociated/fragmented response

SCHIZOANALYSIS

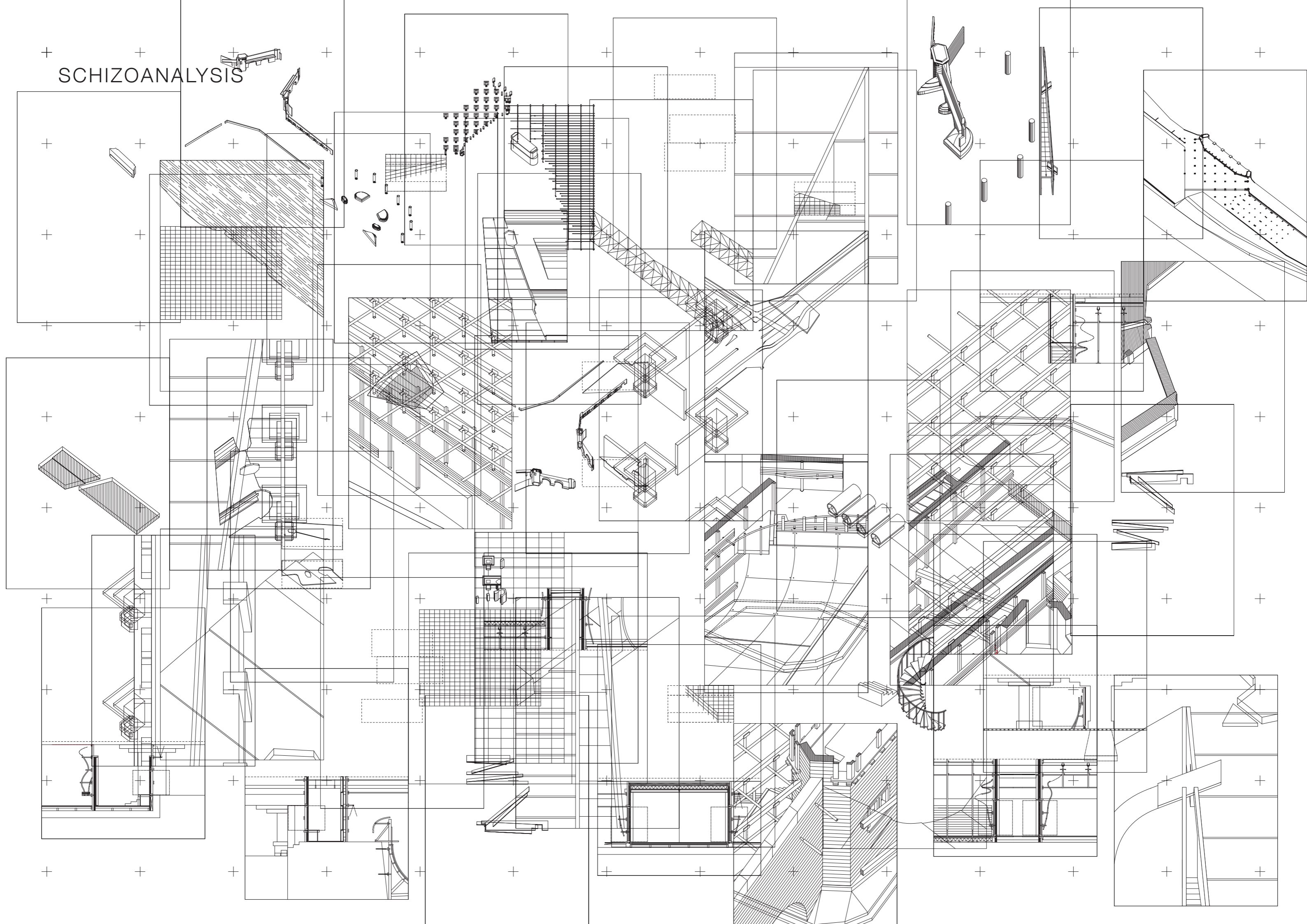

+ + +
SCHIZOCARTOGRAPHY

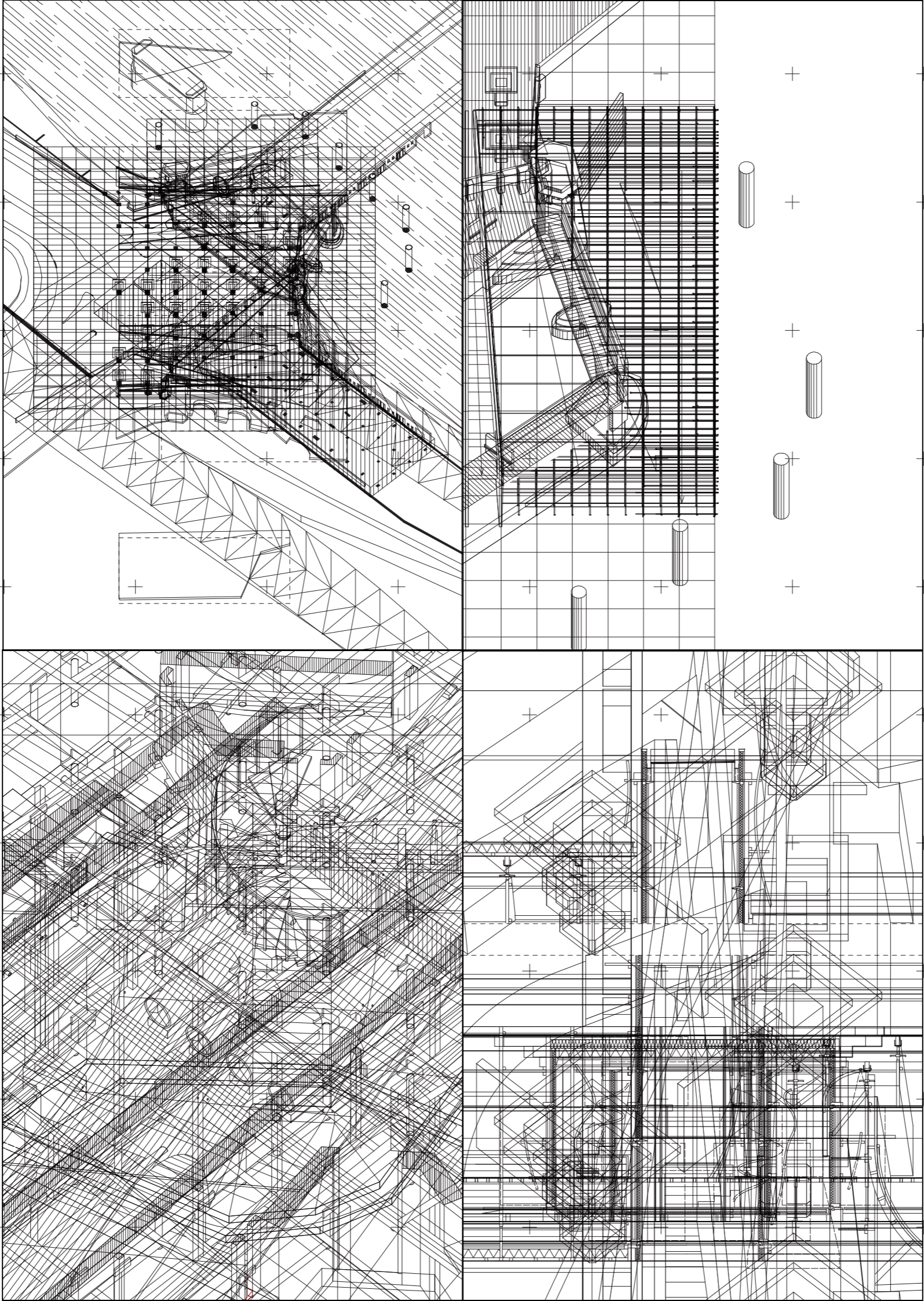

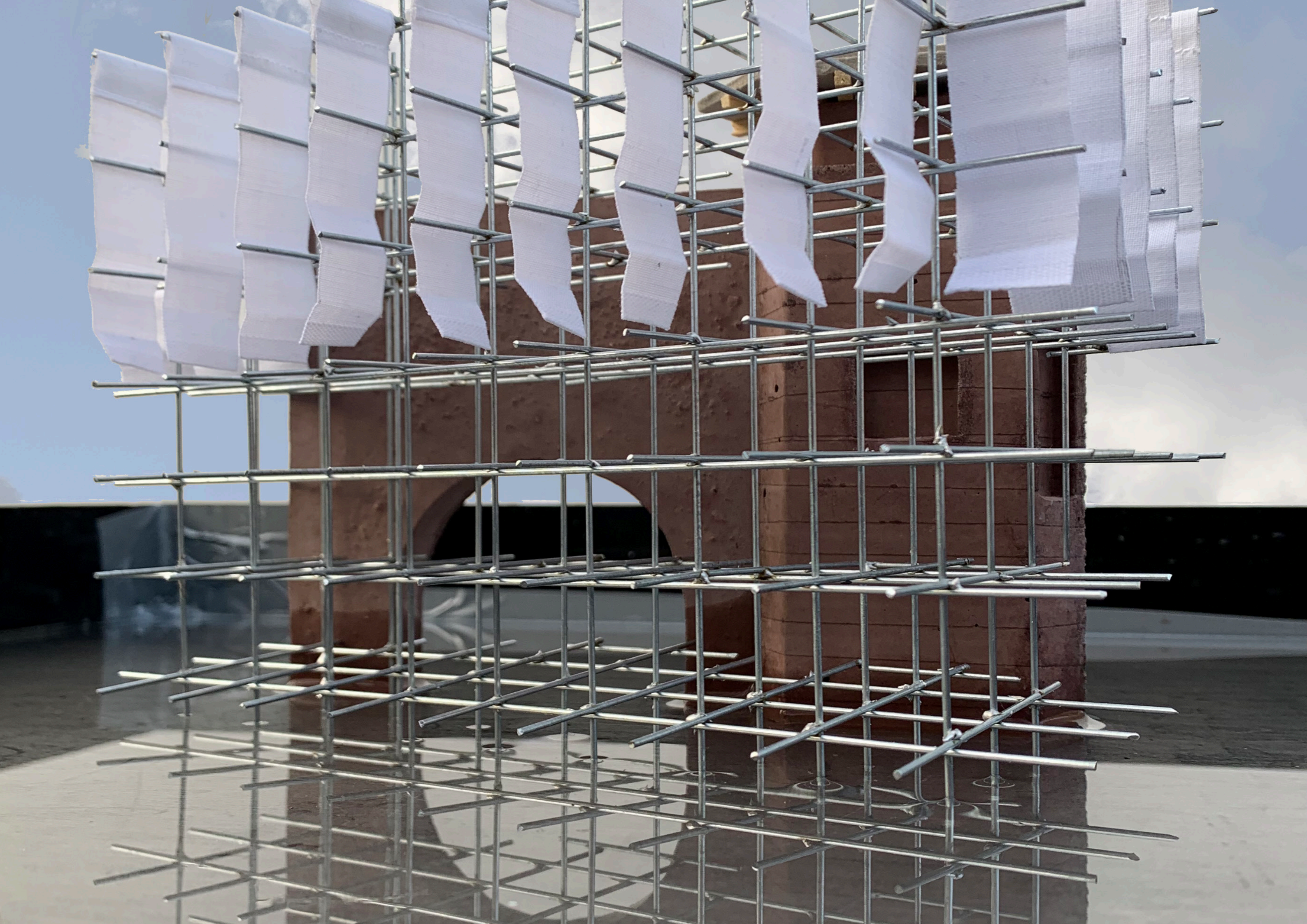

DEFENSE

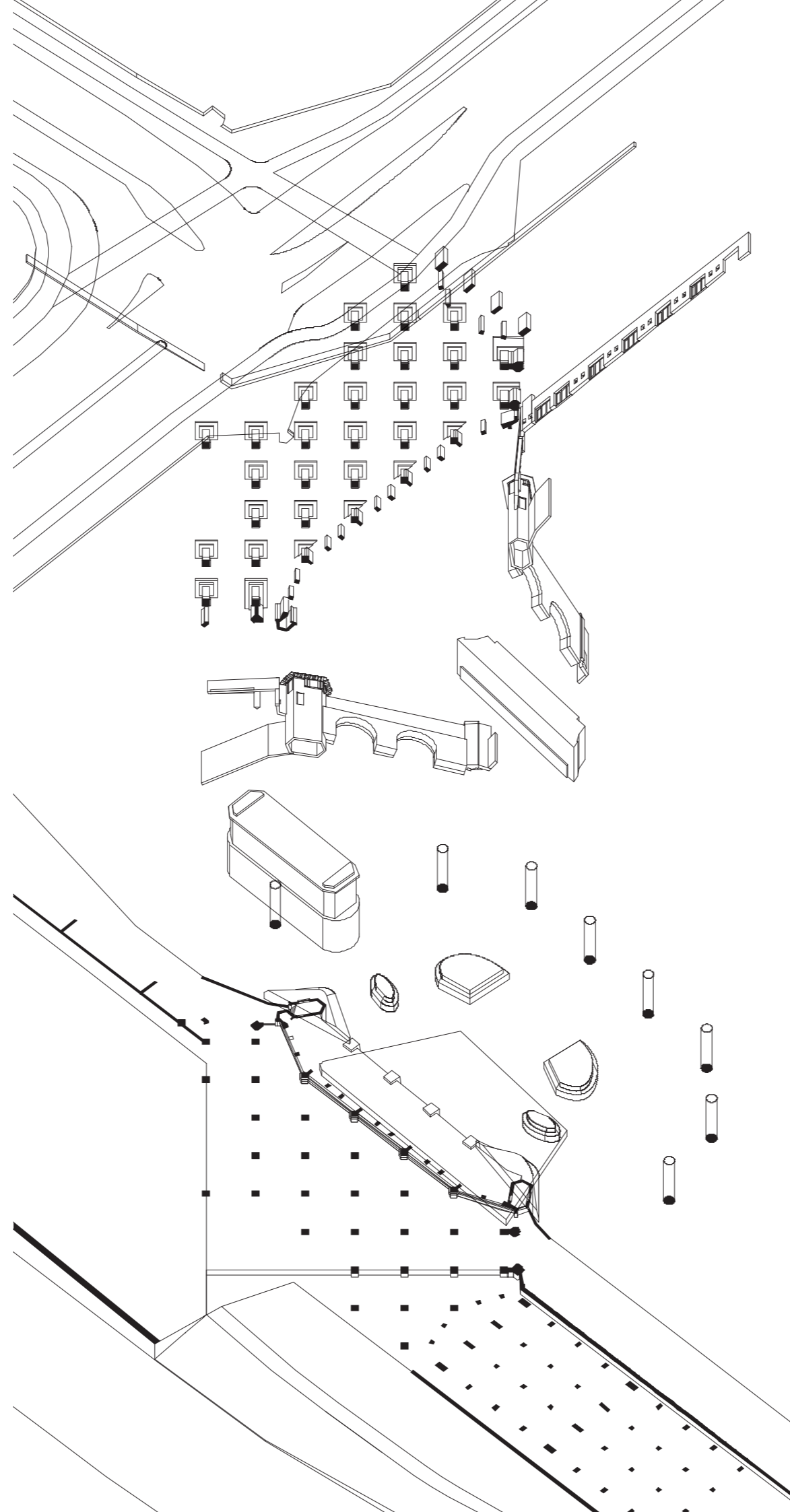

+ + + +
DISORDER

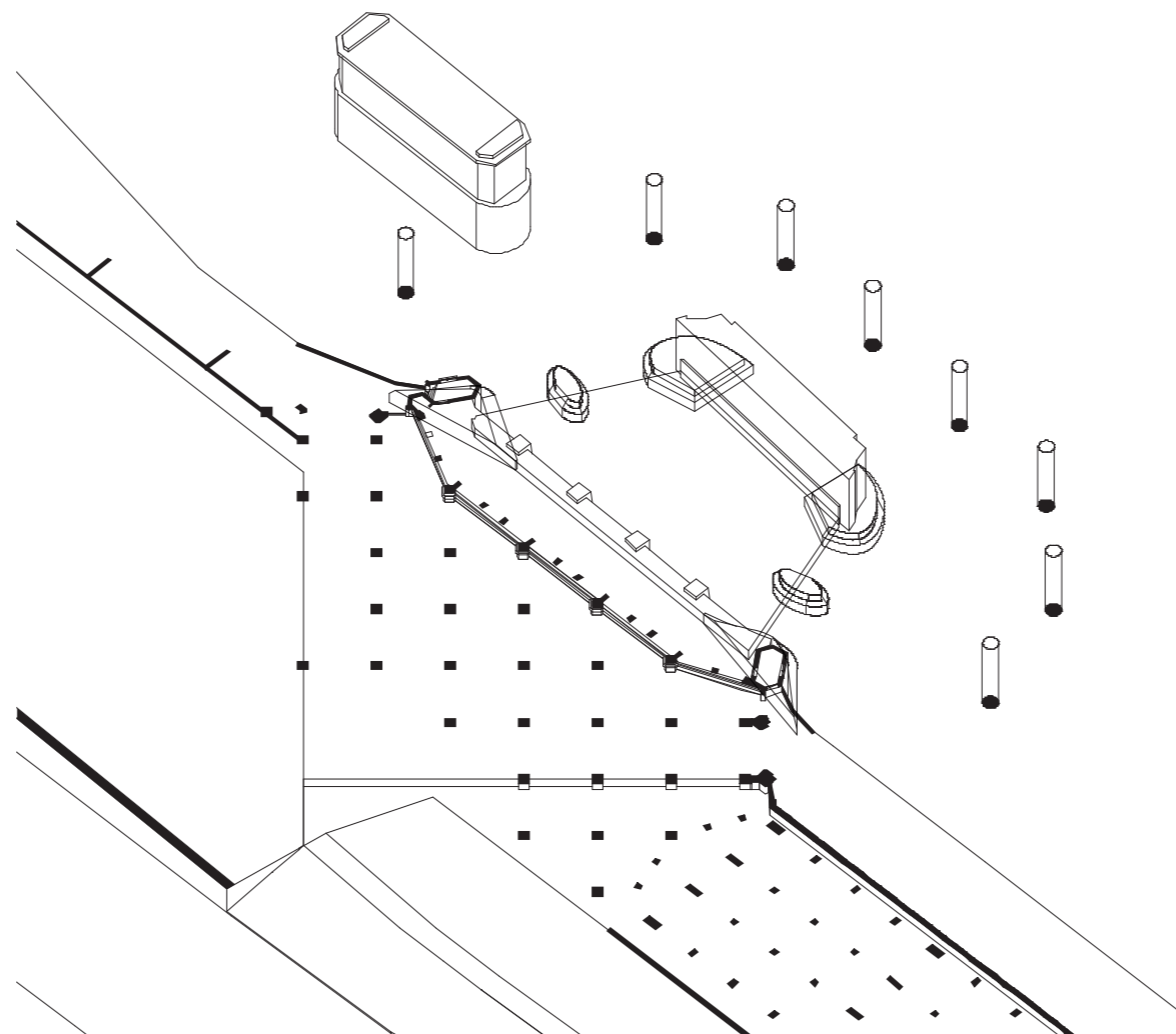
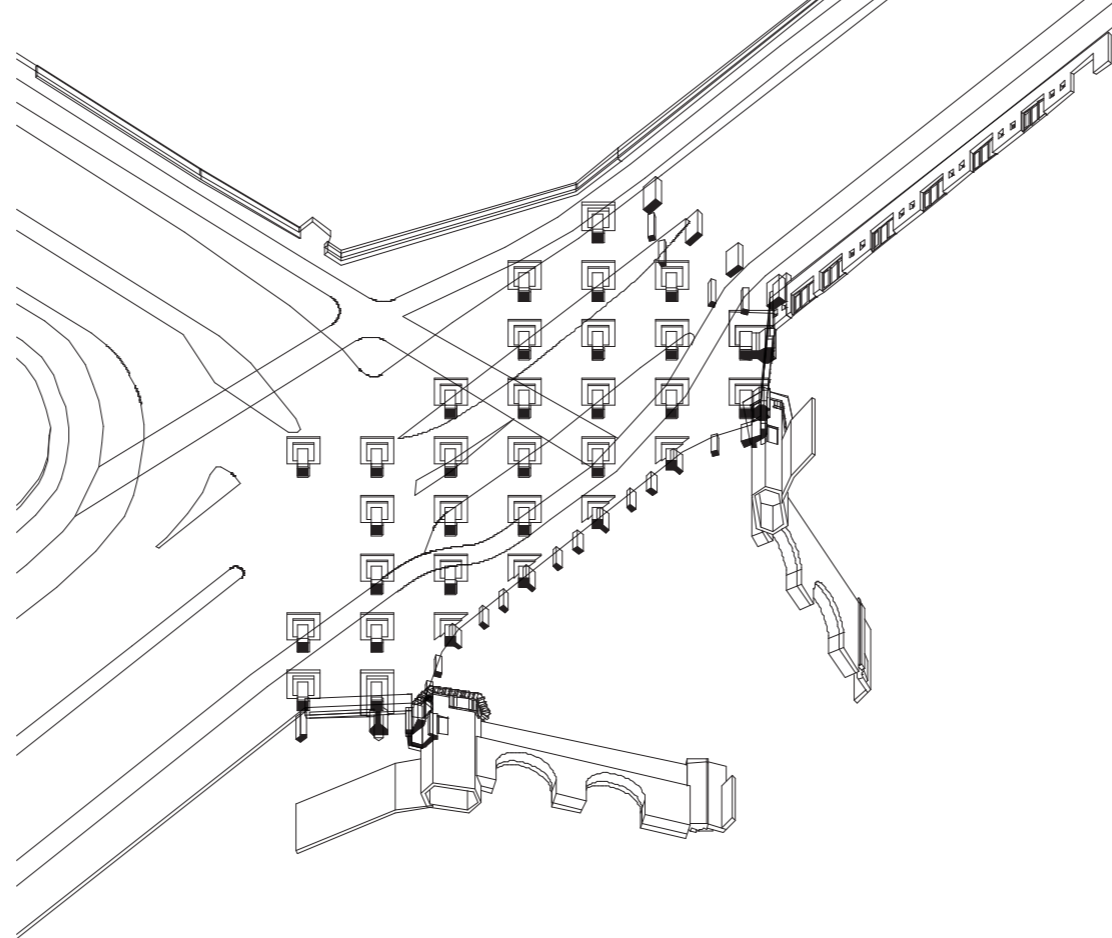

+ + + +
DECAY

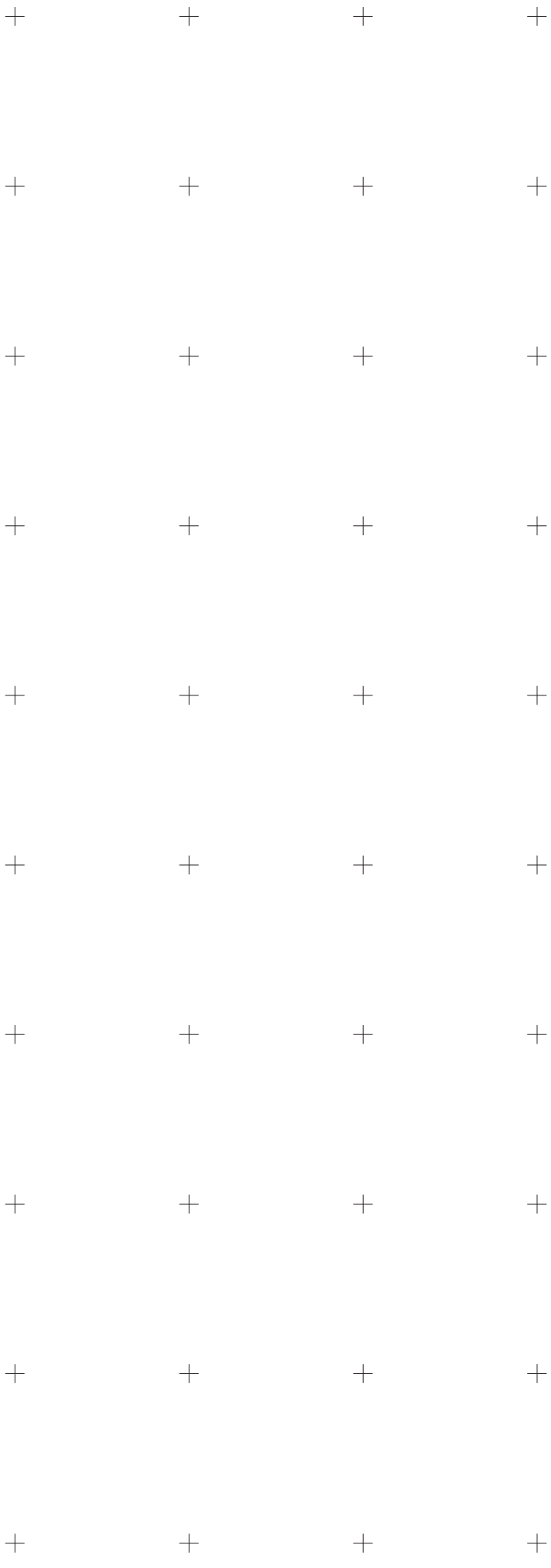
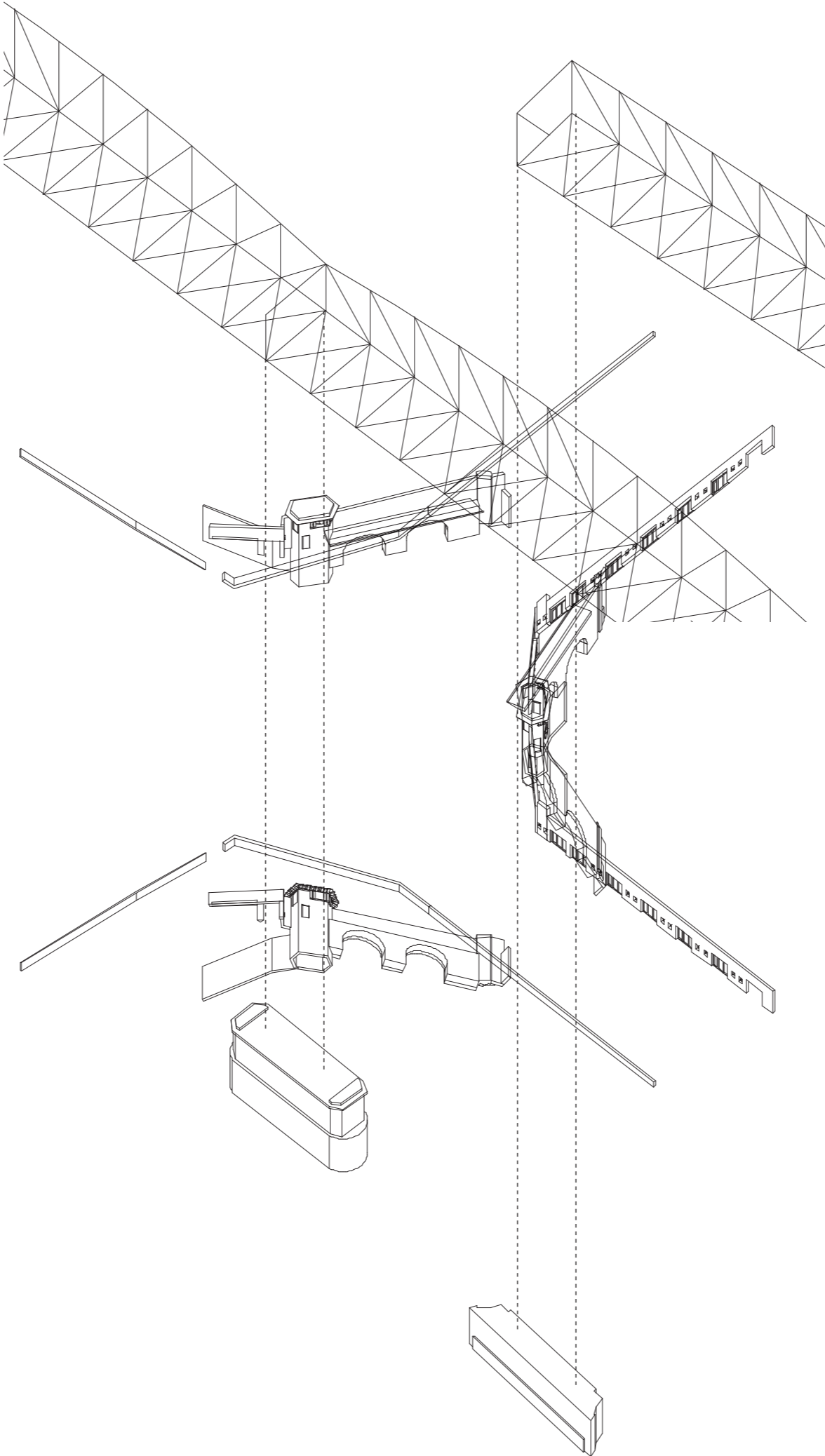

DECAY



DETERRITORIALISATION

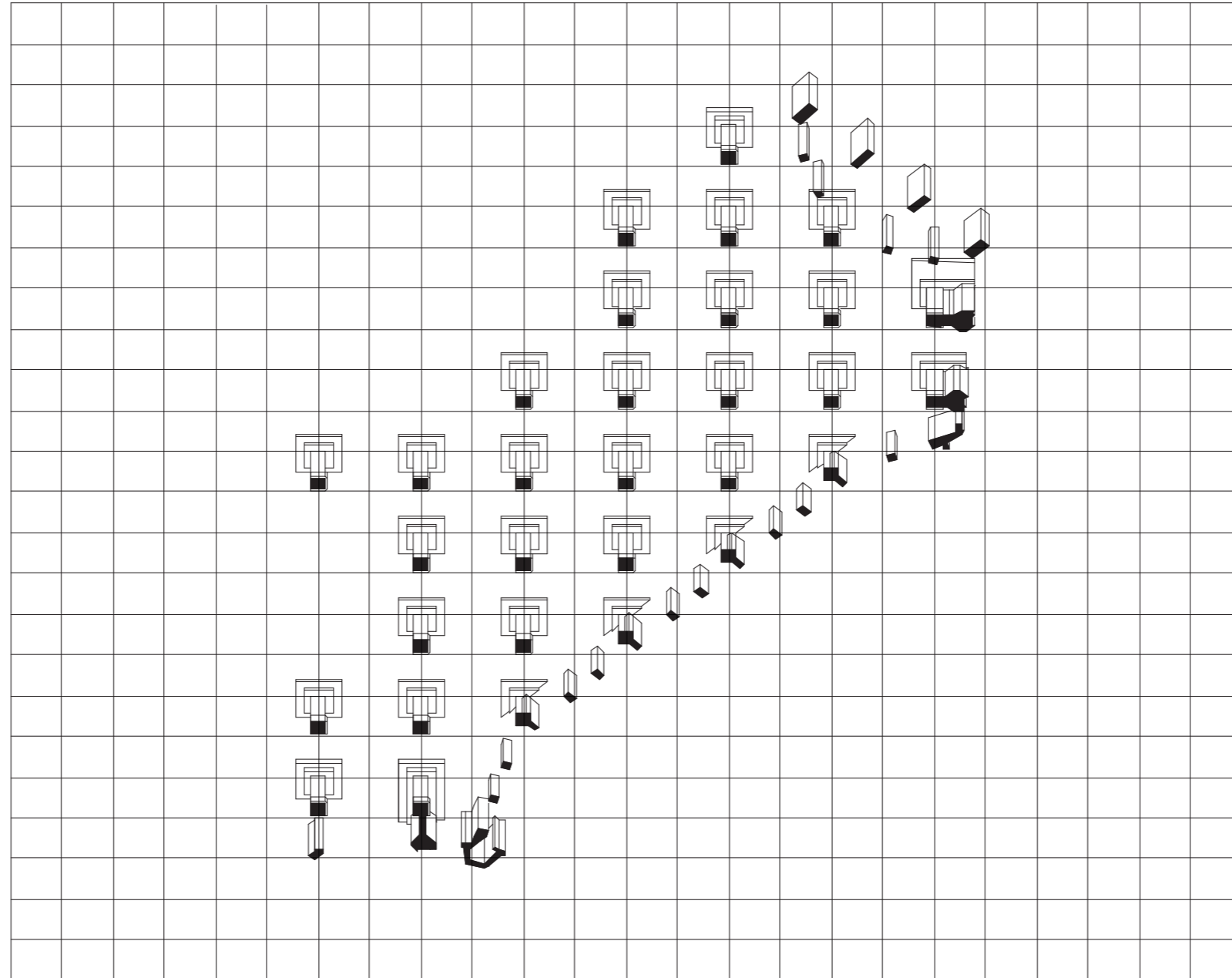

DIAGNOSIS

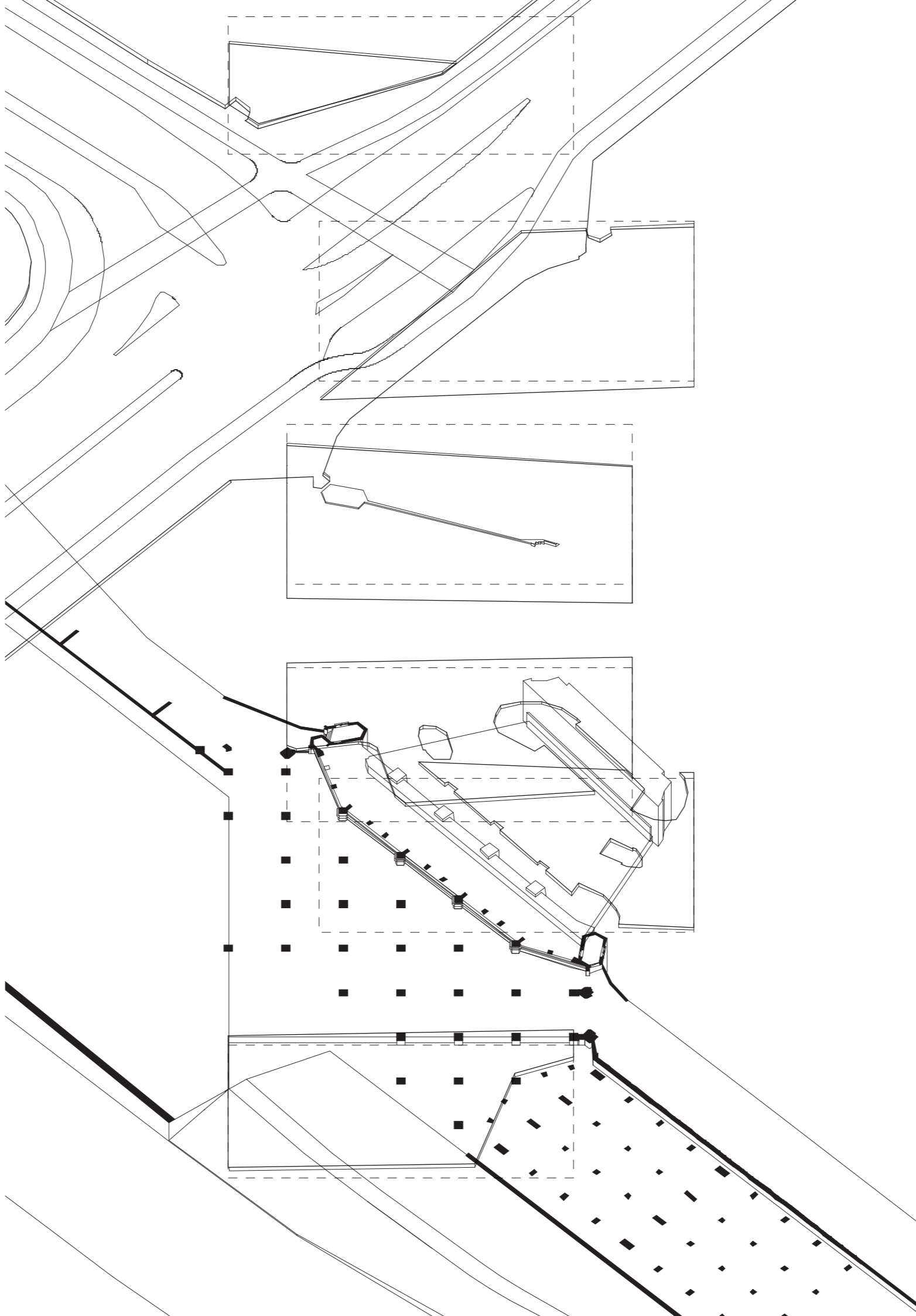



FEELINGS

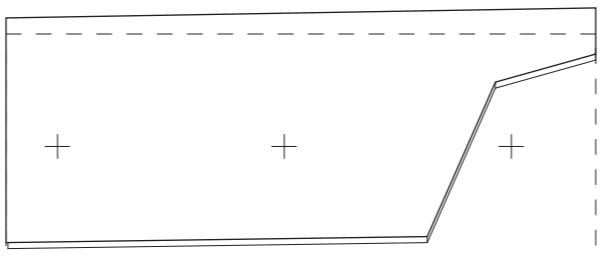
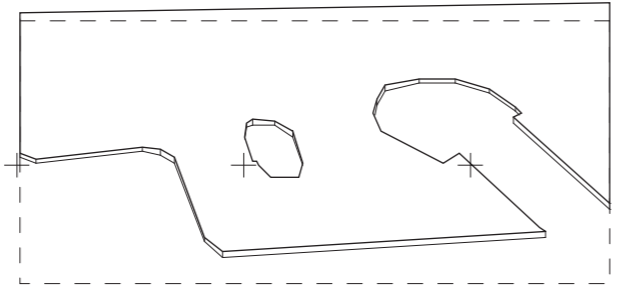
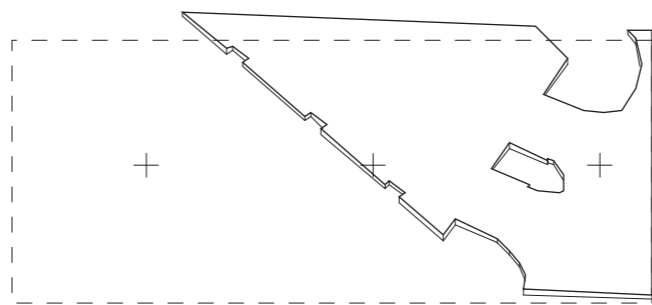
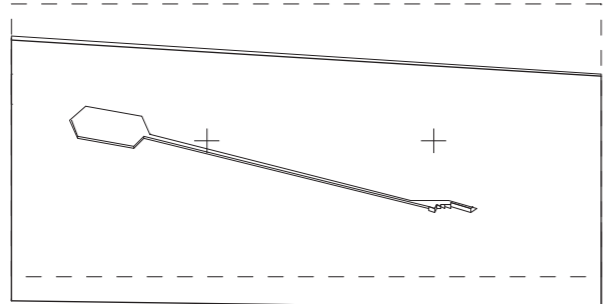
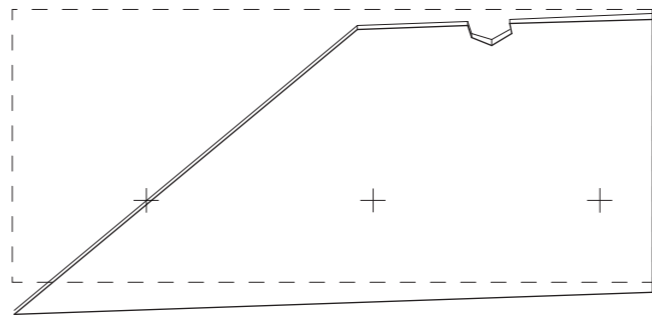
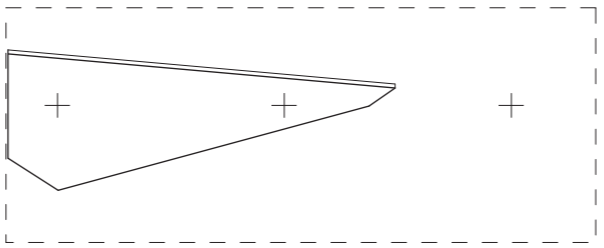

+ + + -
FLASHBACKS

+ + + -
+ + + -
+ + + -
+ + + -
+ + + -
+ + + -
+ + + -
+ + + -
+ + + -
+ + + -

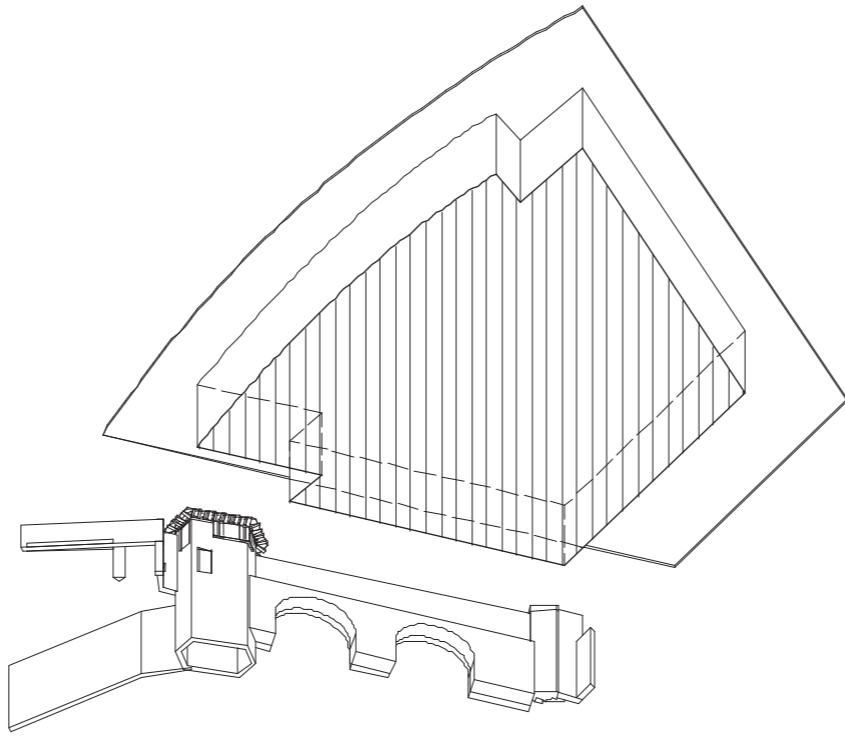

+ + + +
+ + + +
+ + + +
+ + + +
+ + + +
+ + + +
+ + + +
+ + + +
+ + + +
+ + + +

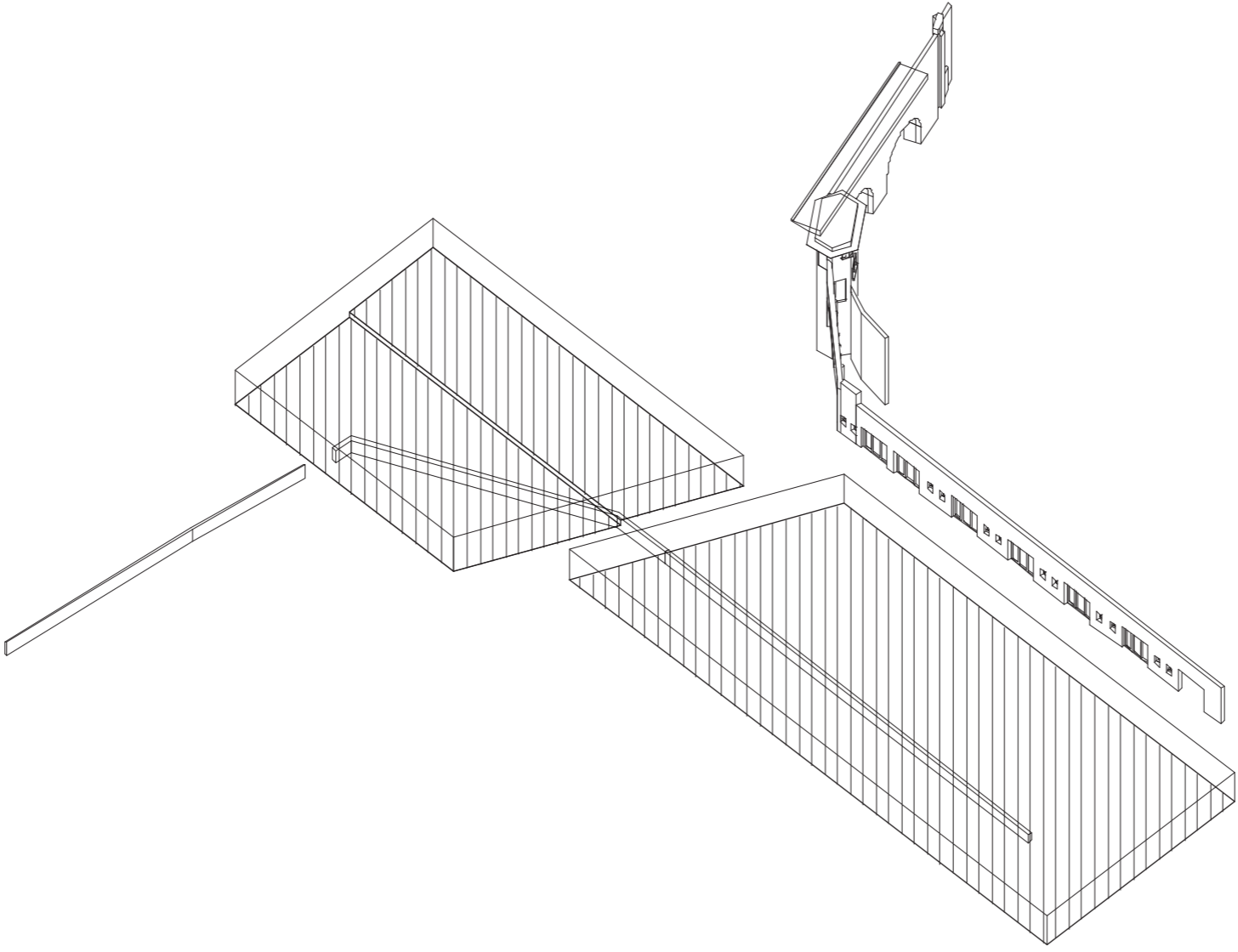

FRAGMENTS

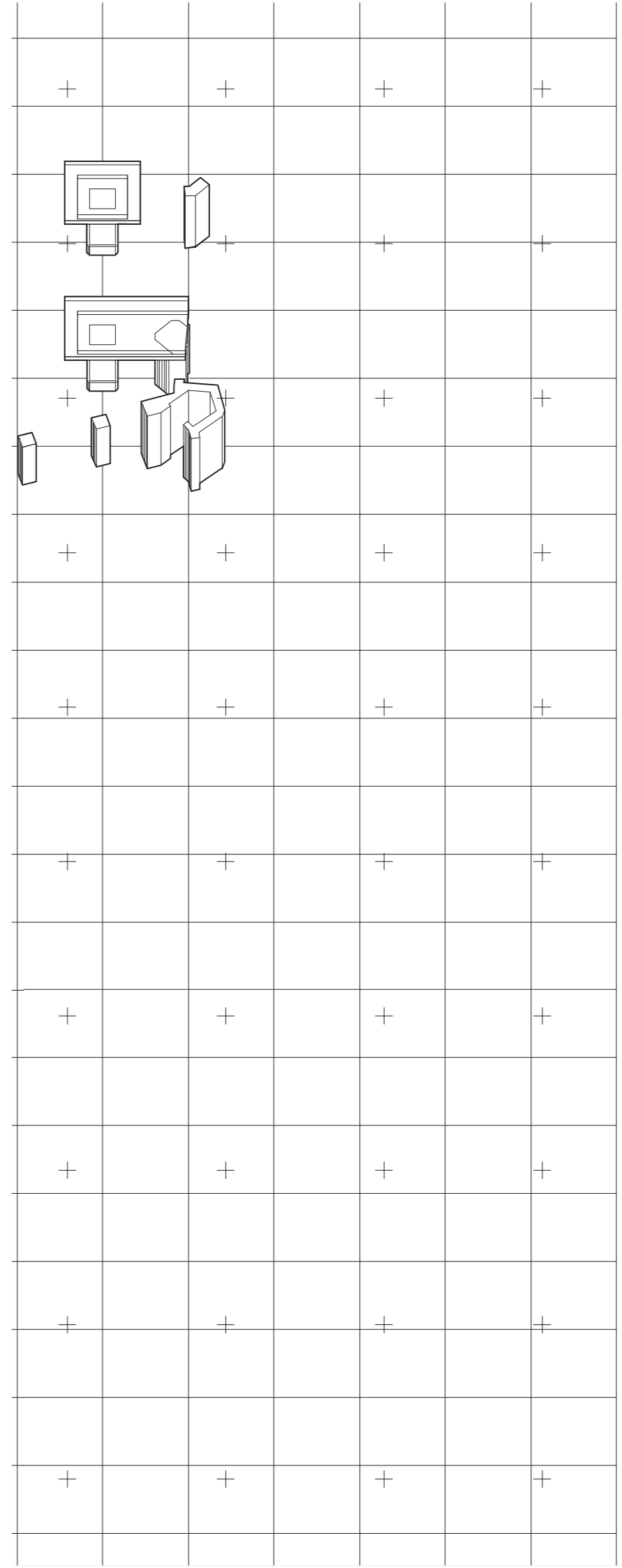
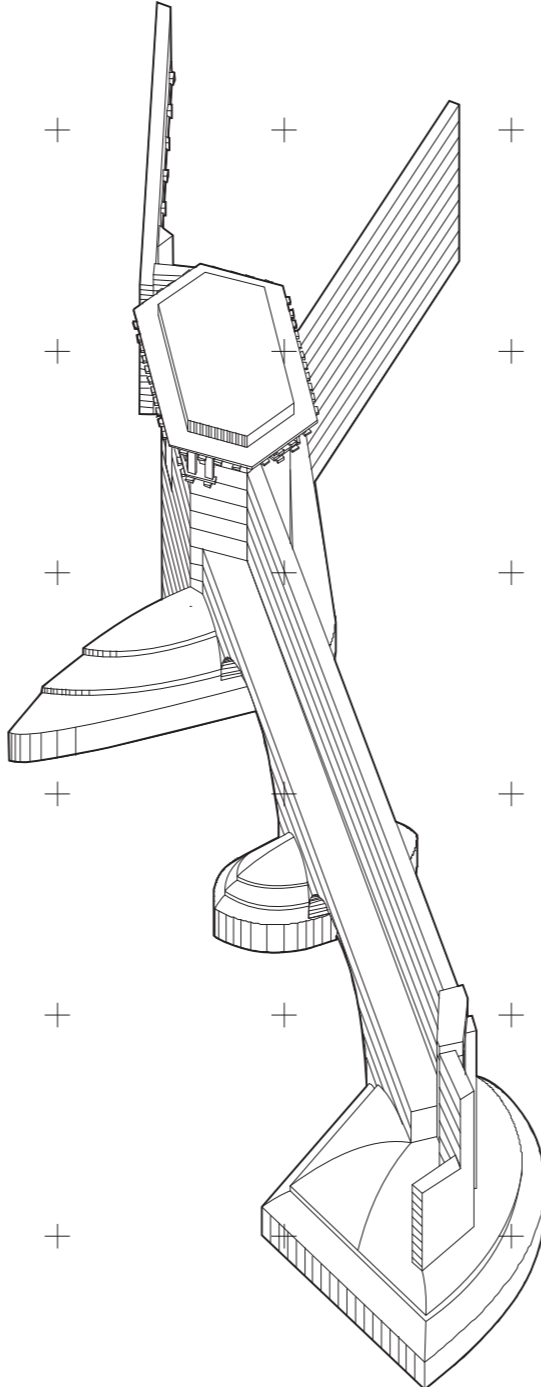
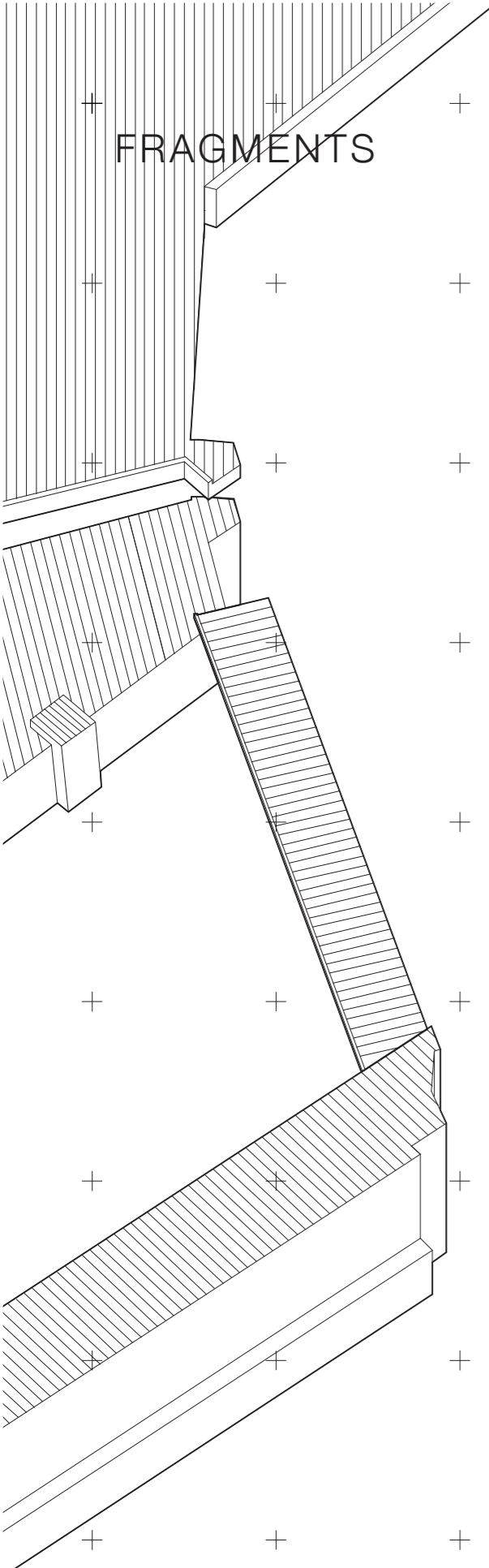

BODY WITHOUT ORGANS



+ + + + +
BODY WITHOUT ORGANS
+ + + + +
+ + + + +
+ + + + +
+ + + + +
+ + + + +
+ + + + +
+ + + + +
+ + + + +
+ + + + +
+ + + + +
+ + + + +
+ + + + +

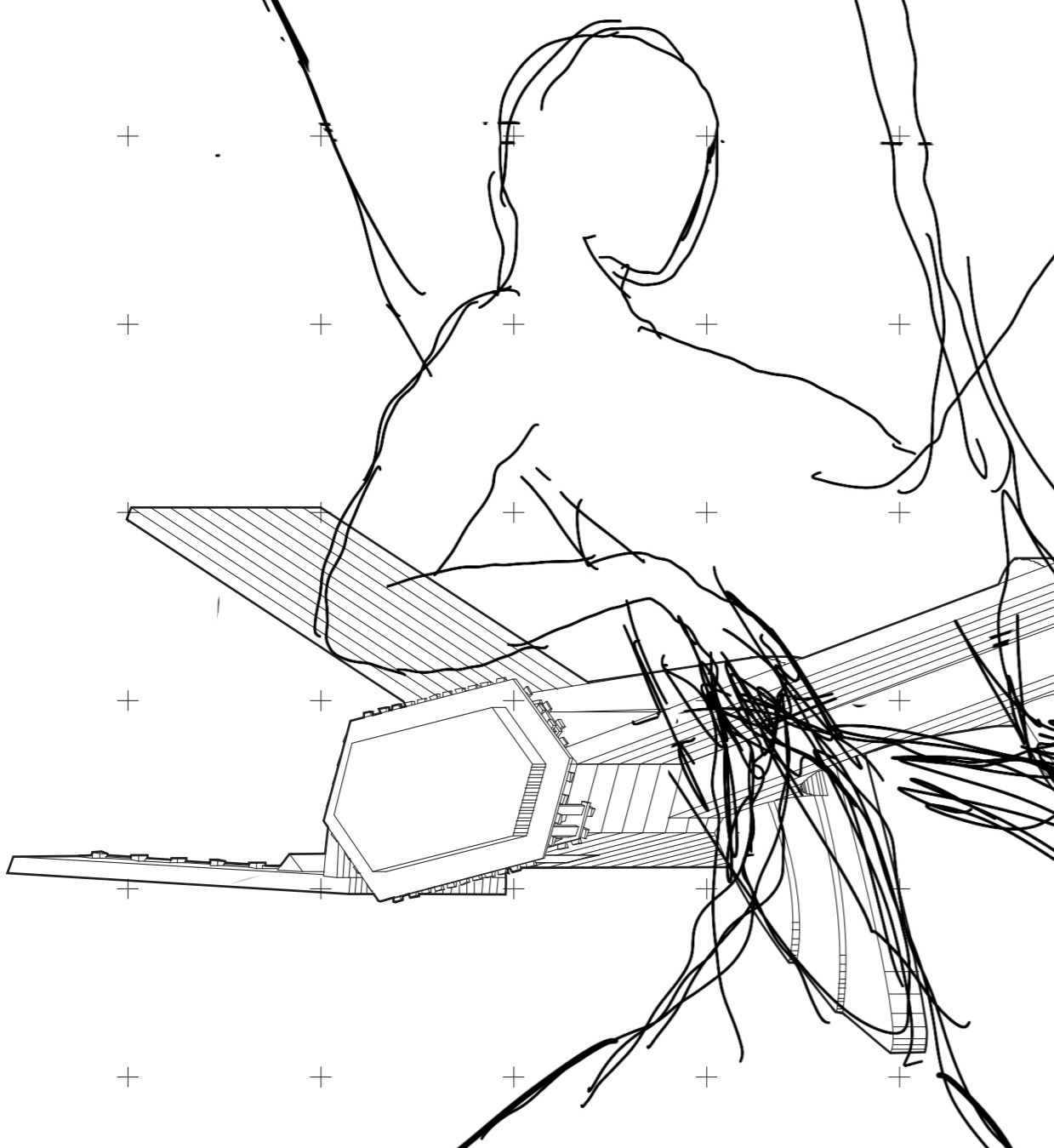

BODY WITHOUT ORGANS

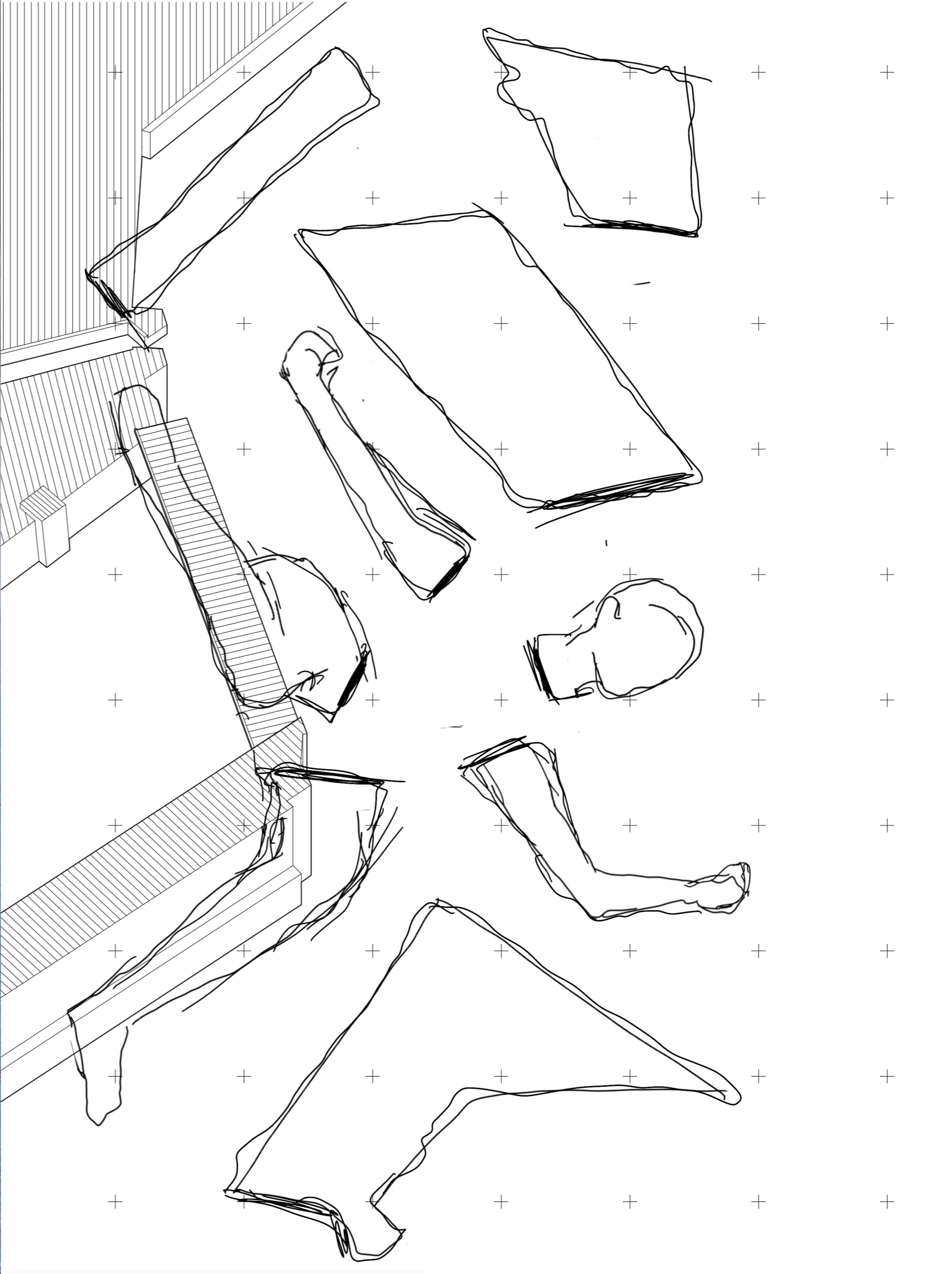

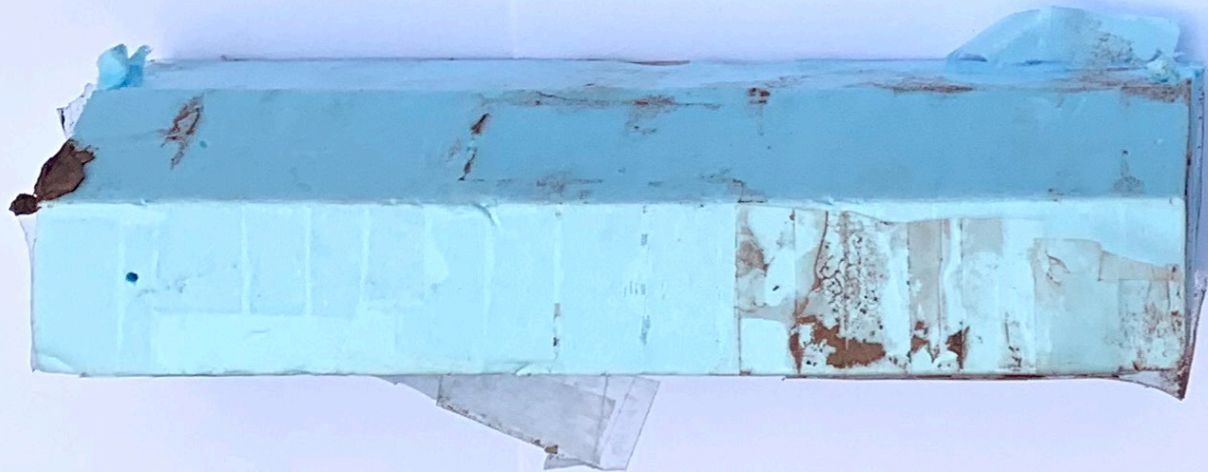

FATIGUE

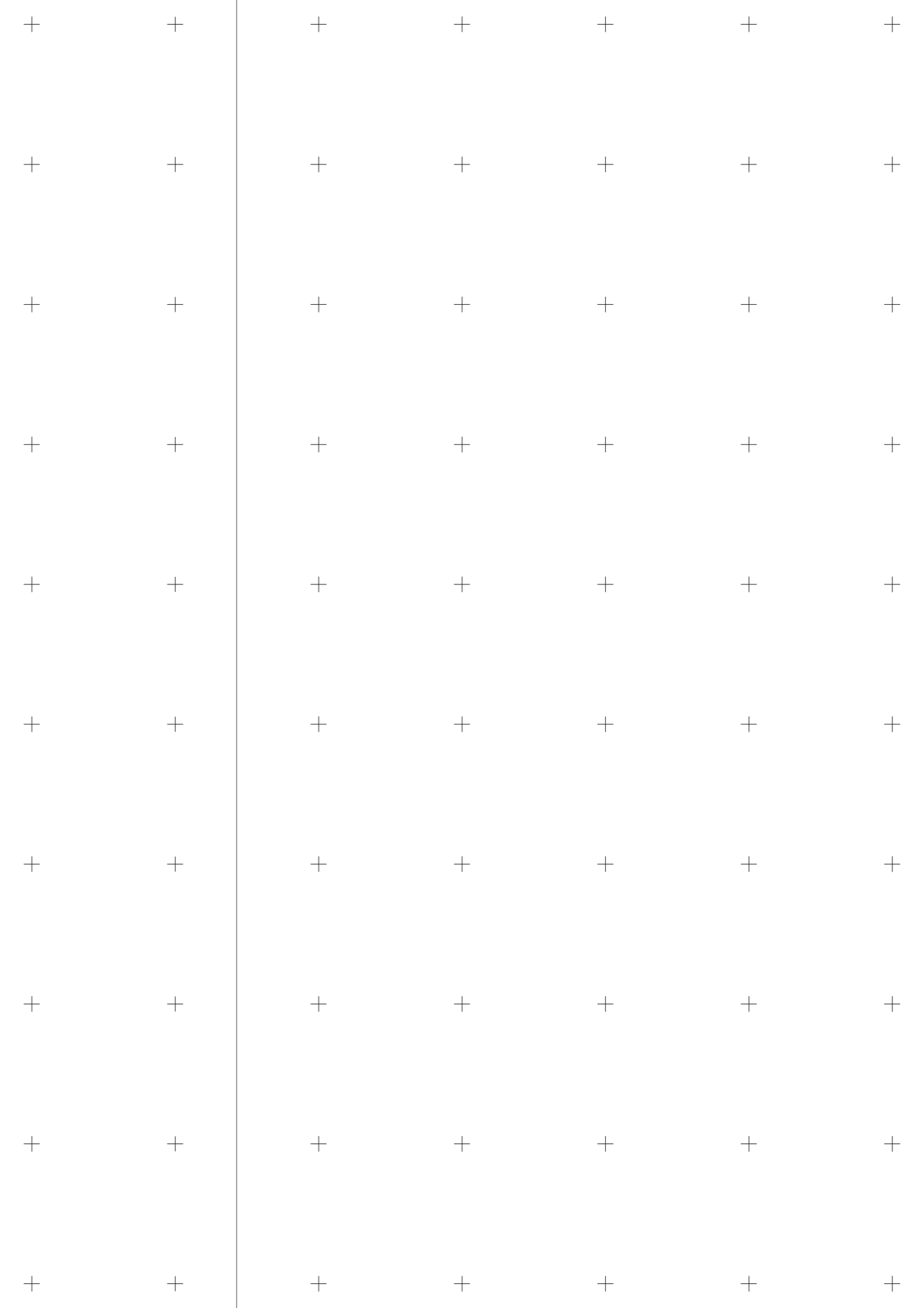
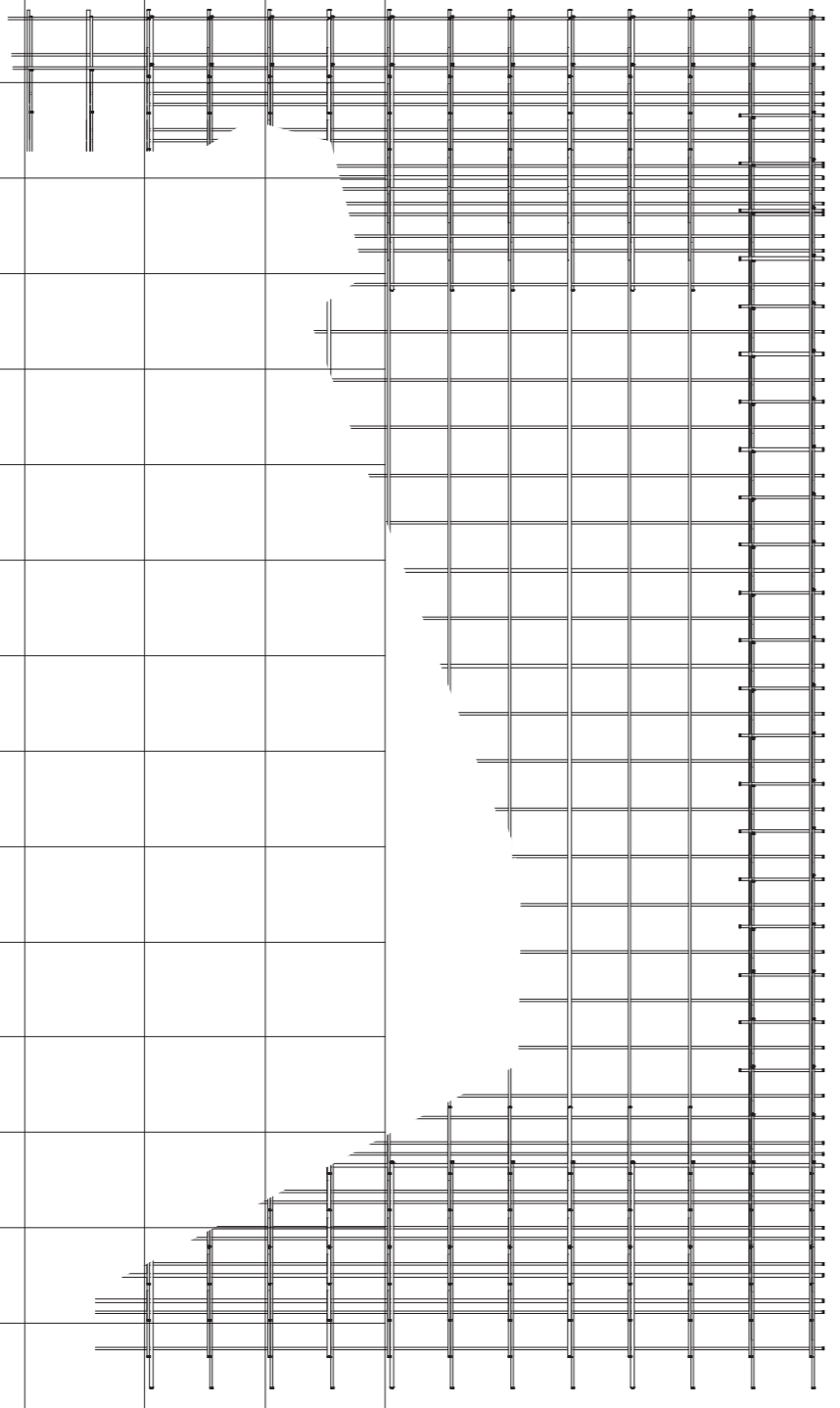
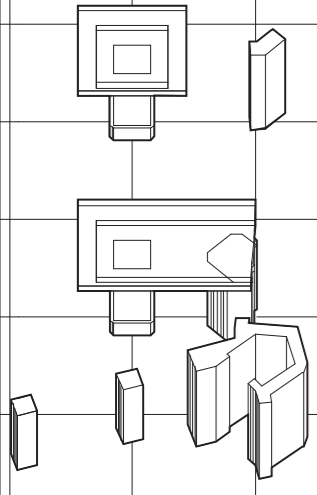

FATIGUE

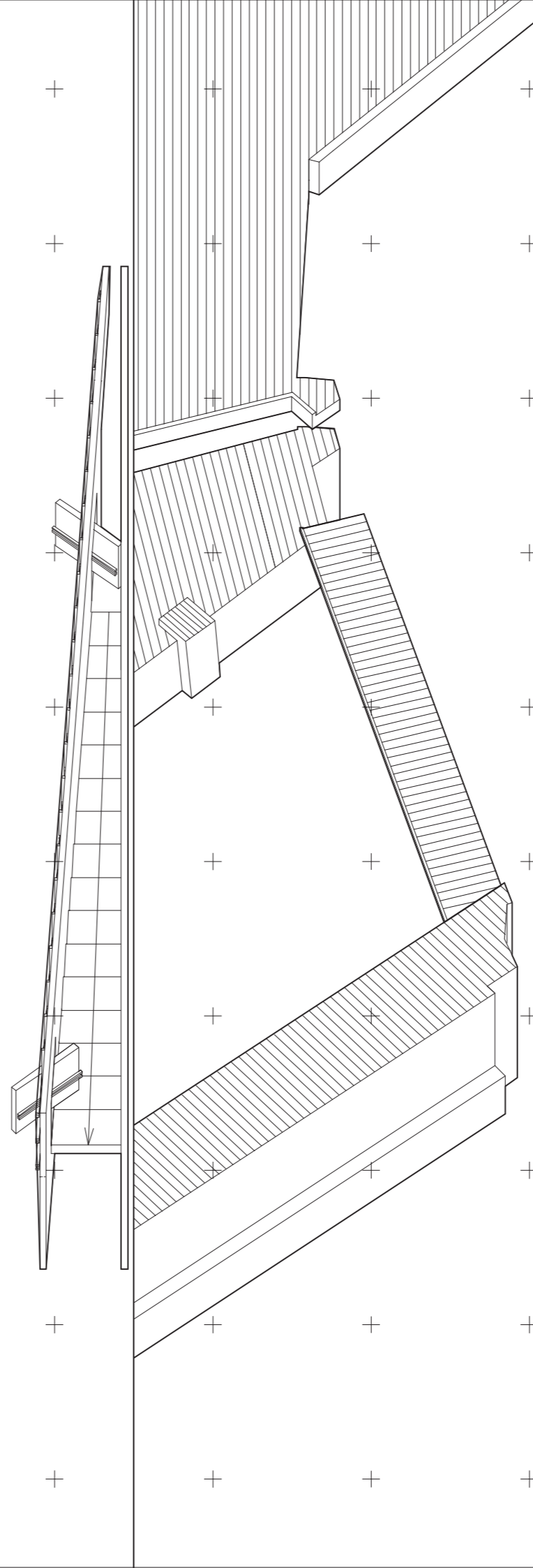

FATIGUE

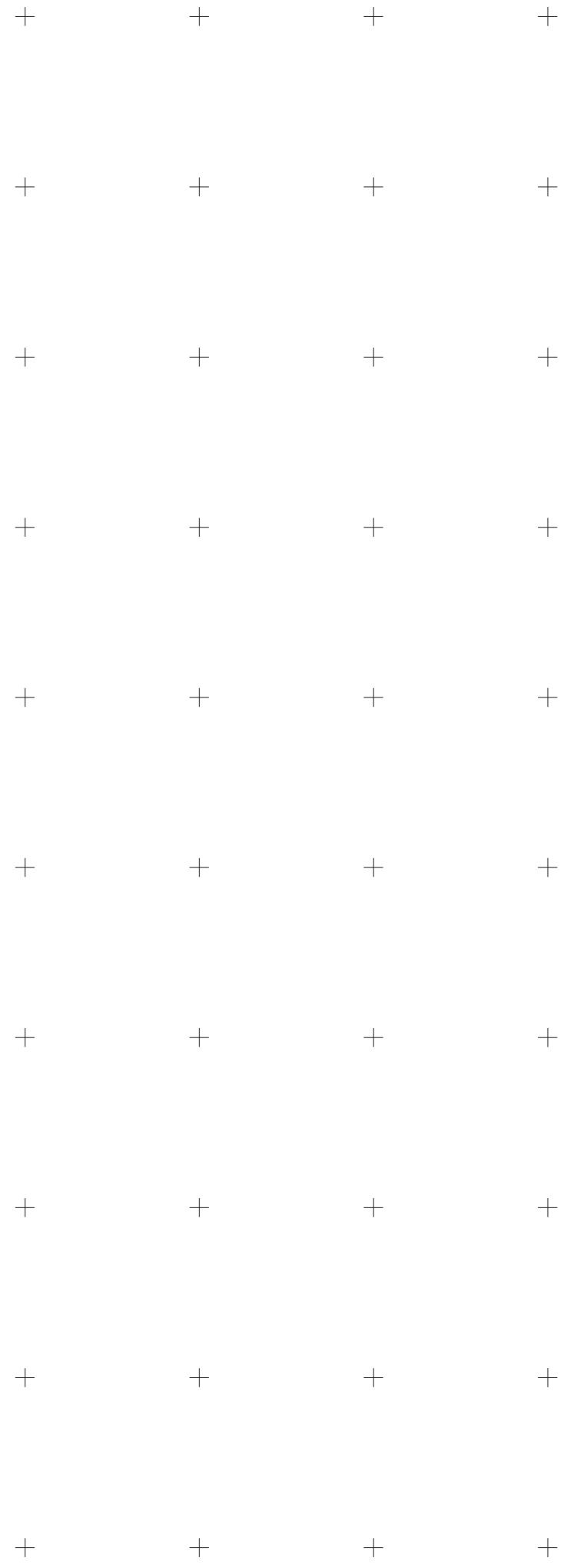
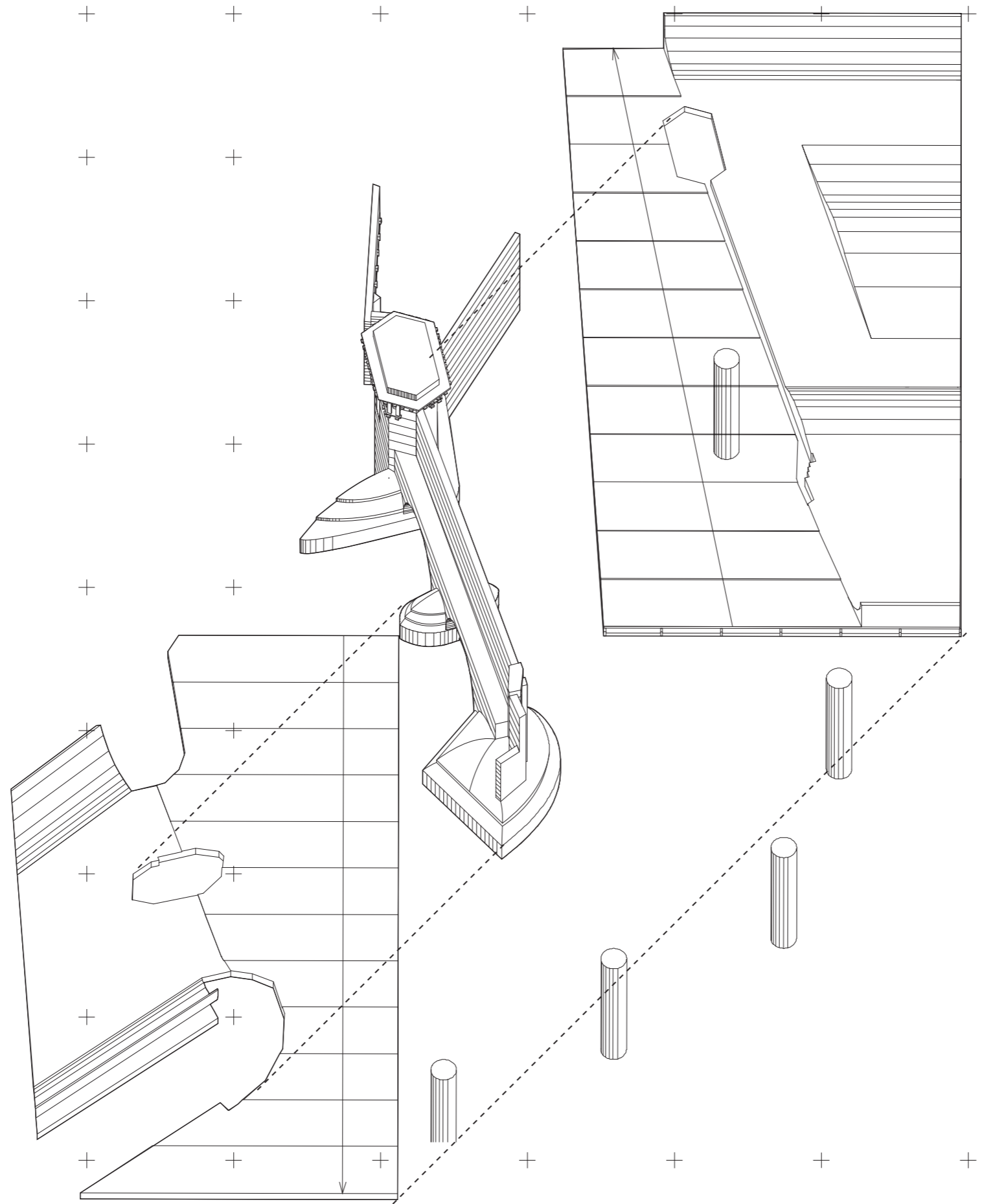



CUT

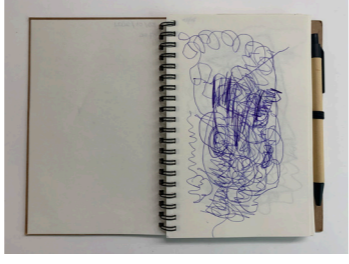
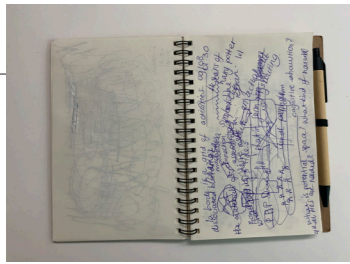
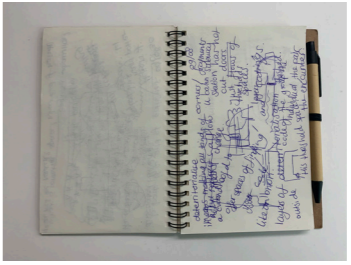
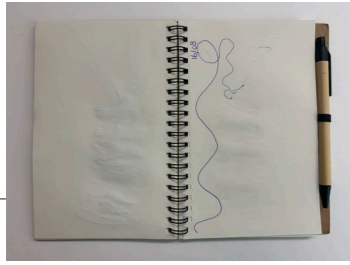

CUT

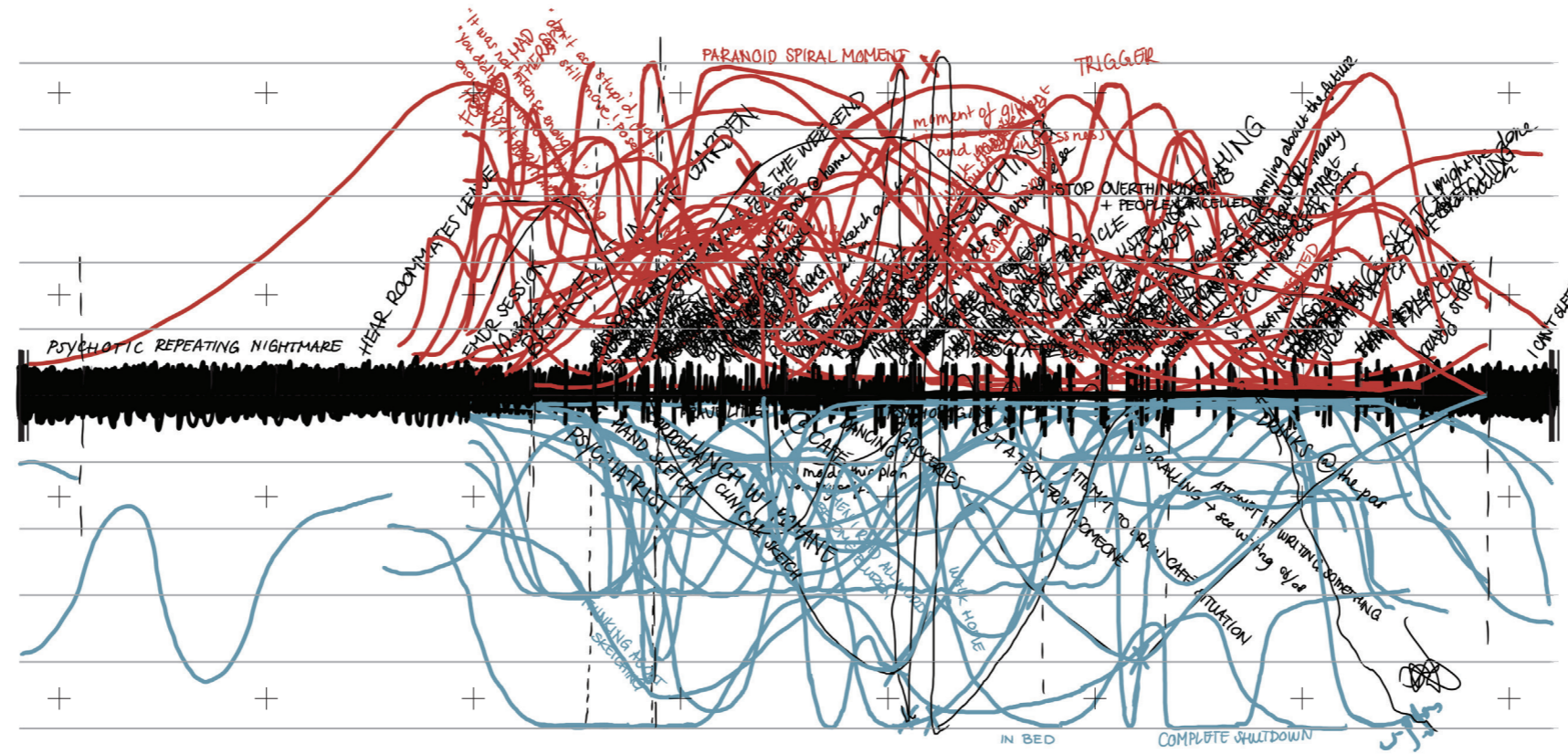

CUT

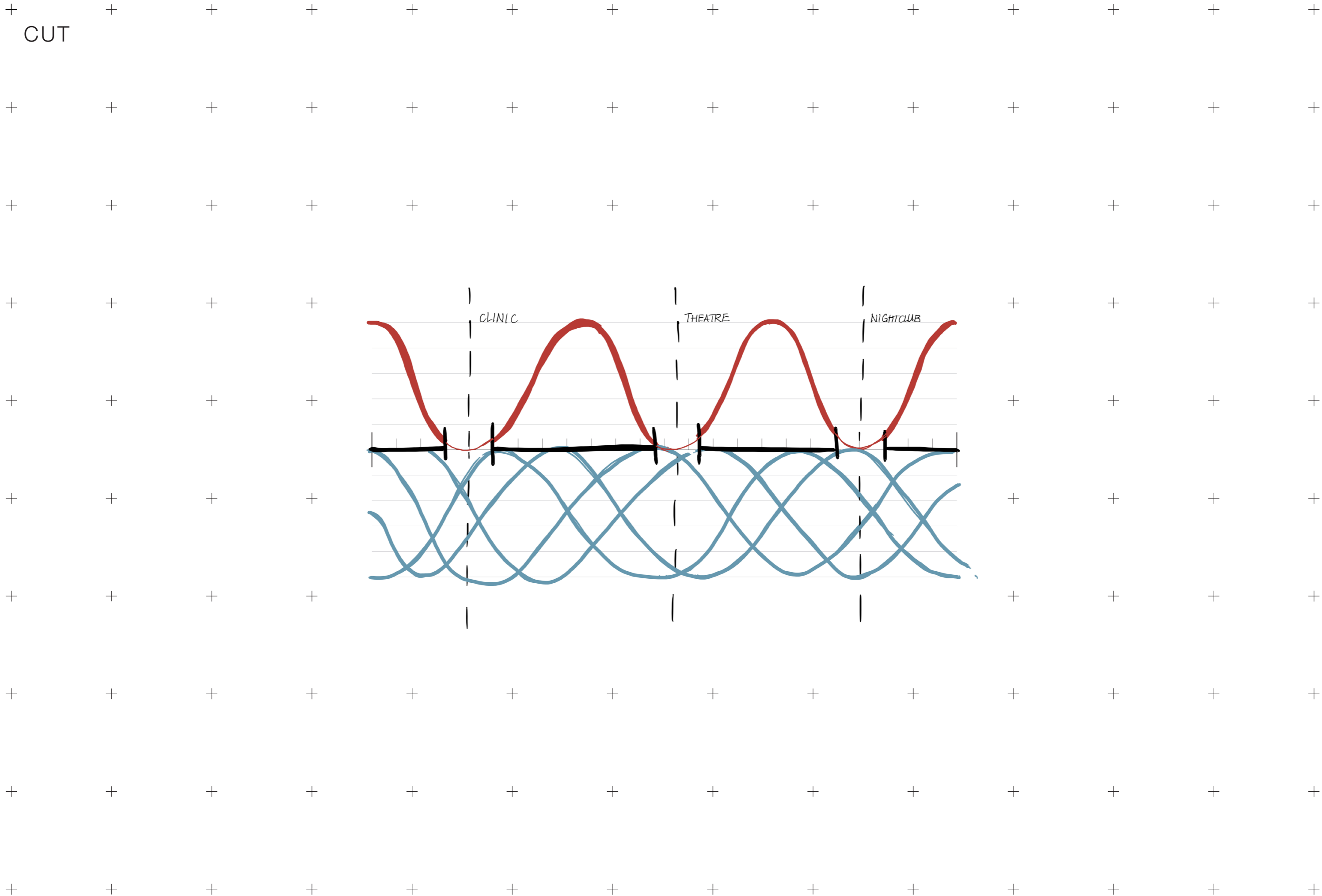



CURE

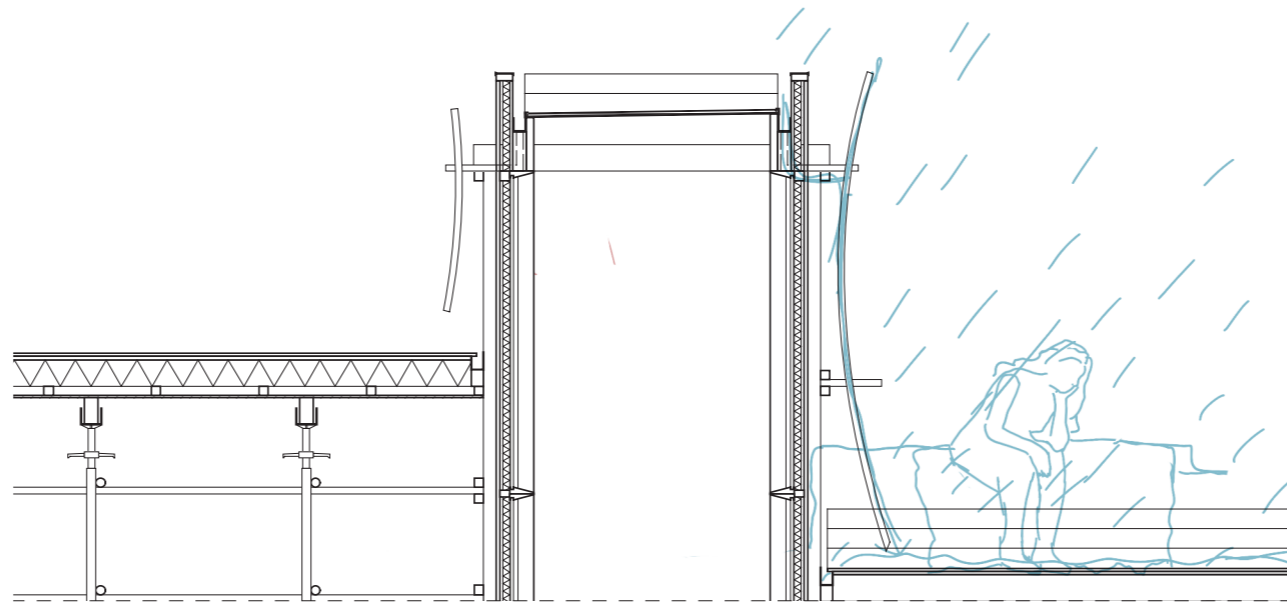

+ rain pipe

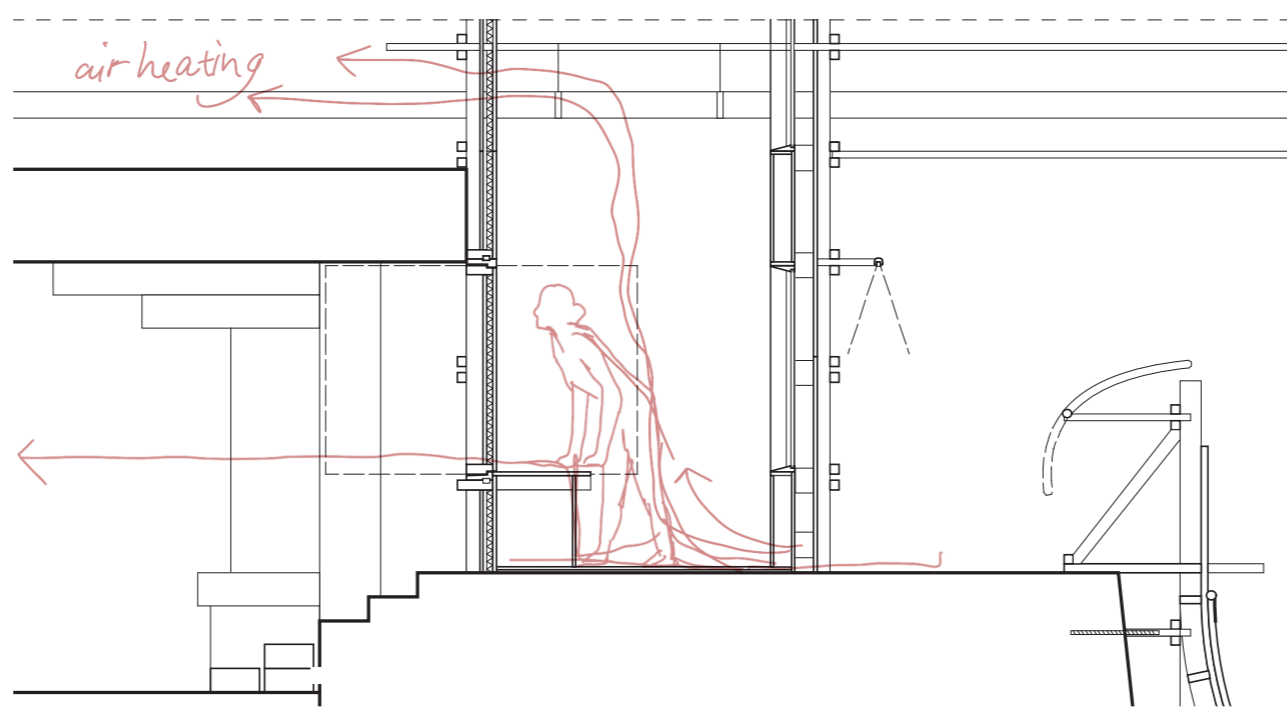

air heating

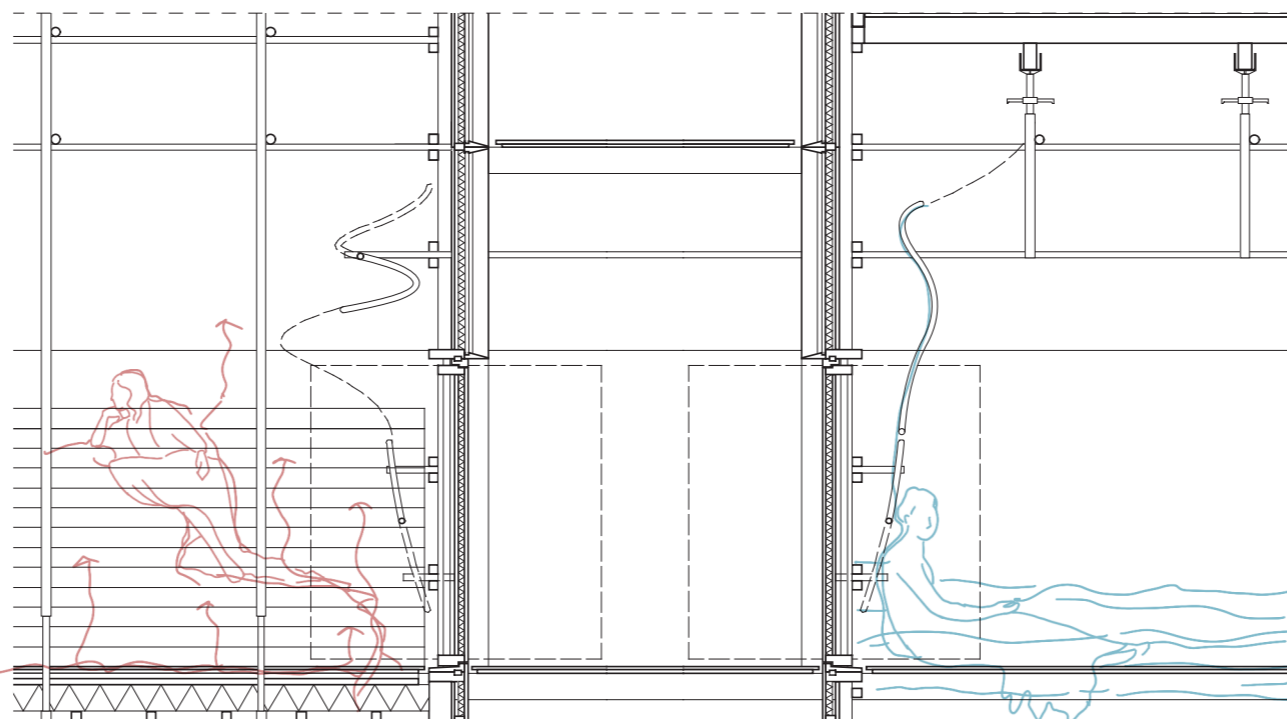

+ floor heating

+ interior water

CITY

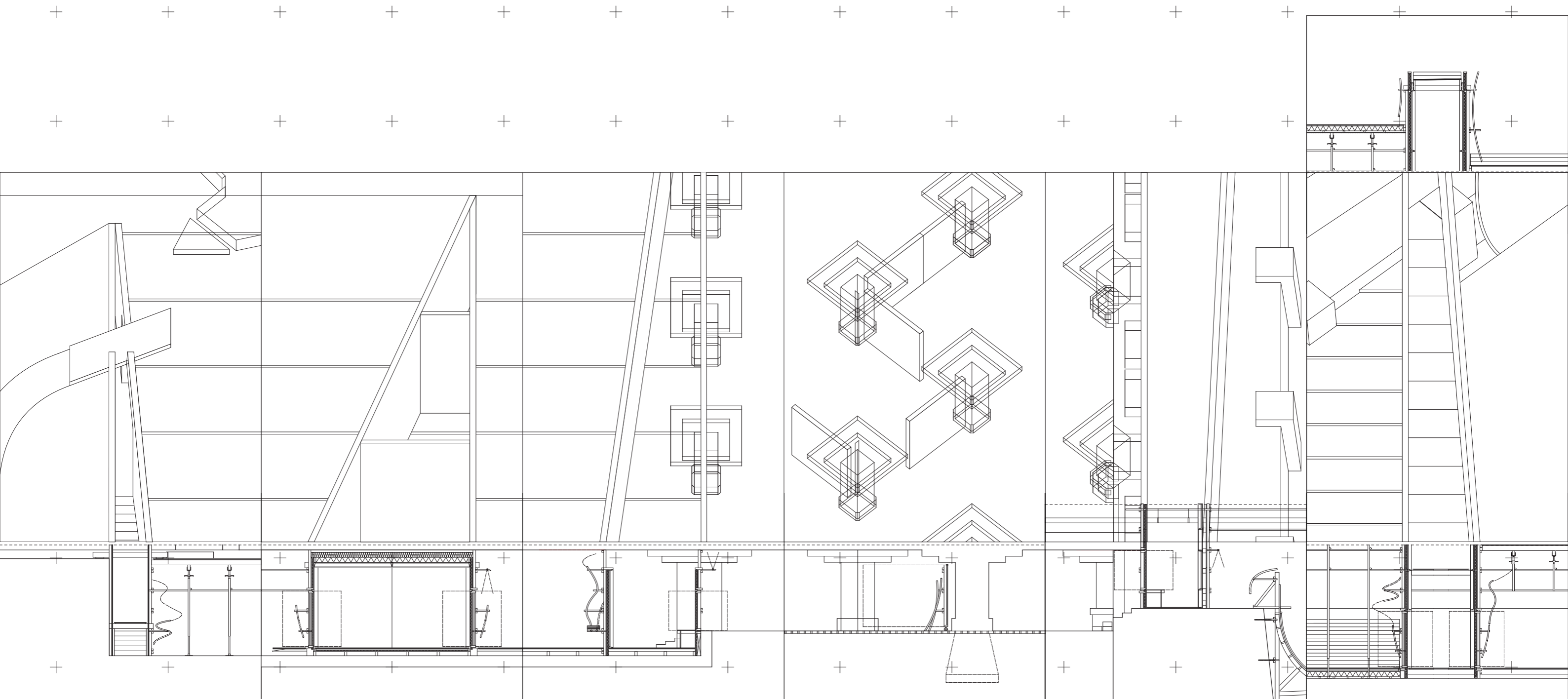

CAESURA

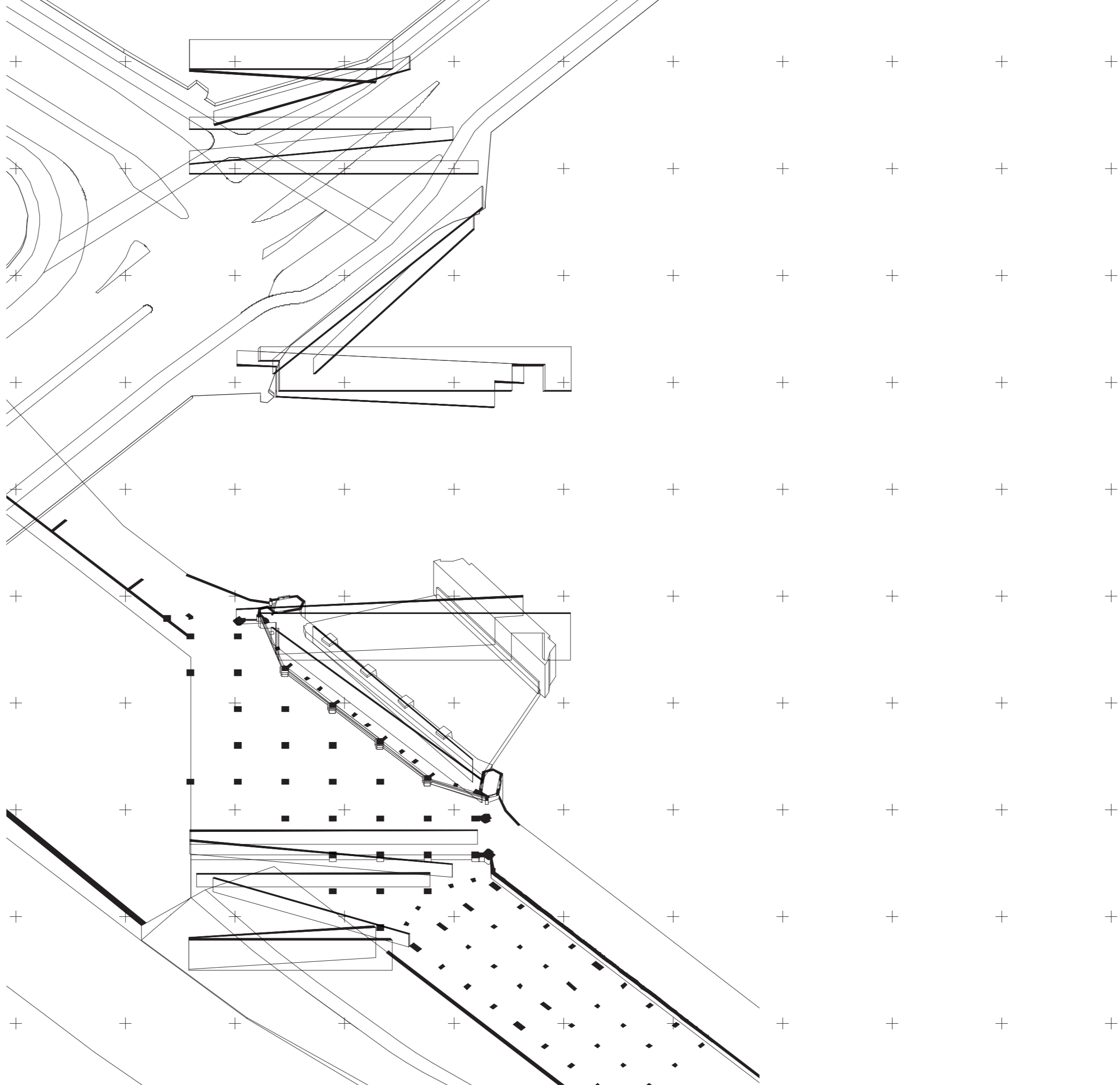



+ +
POISON

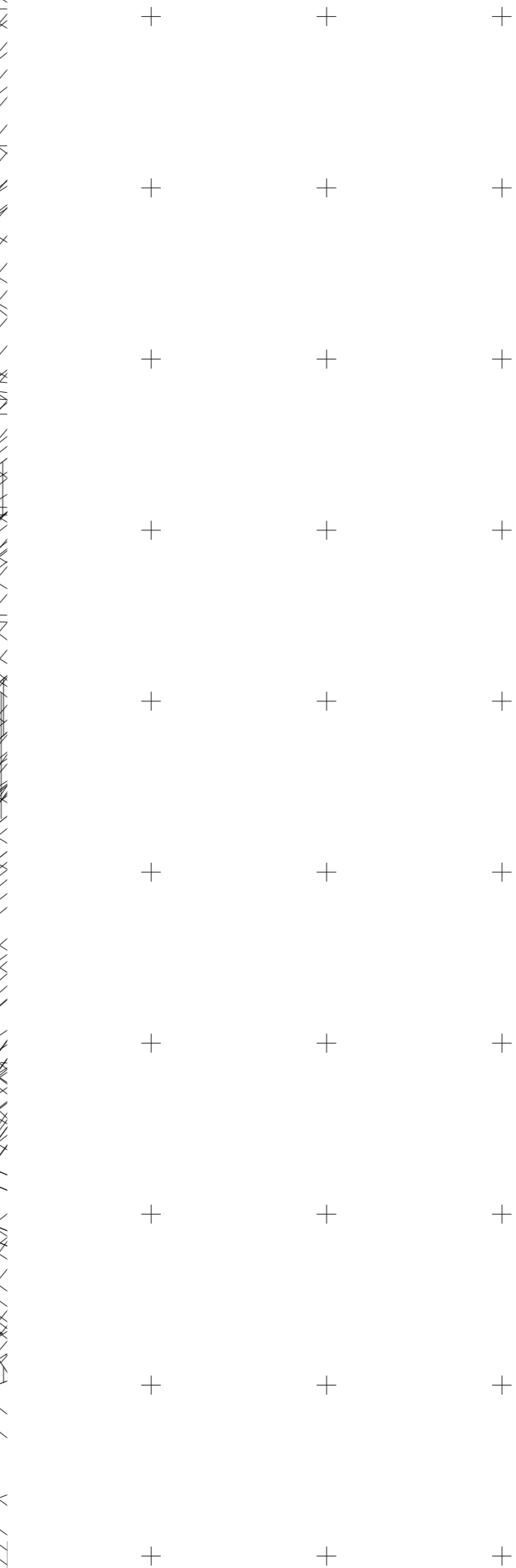
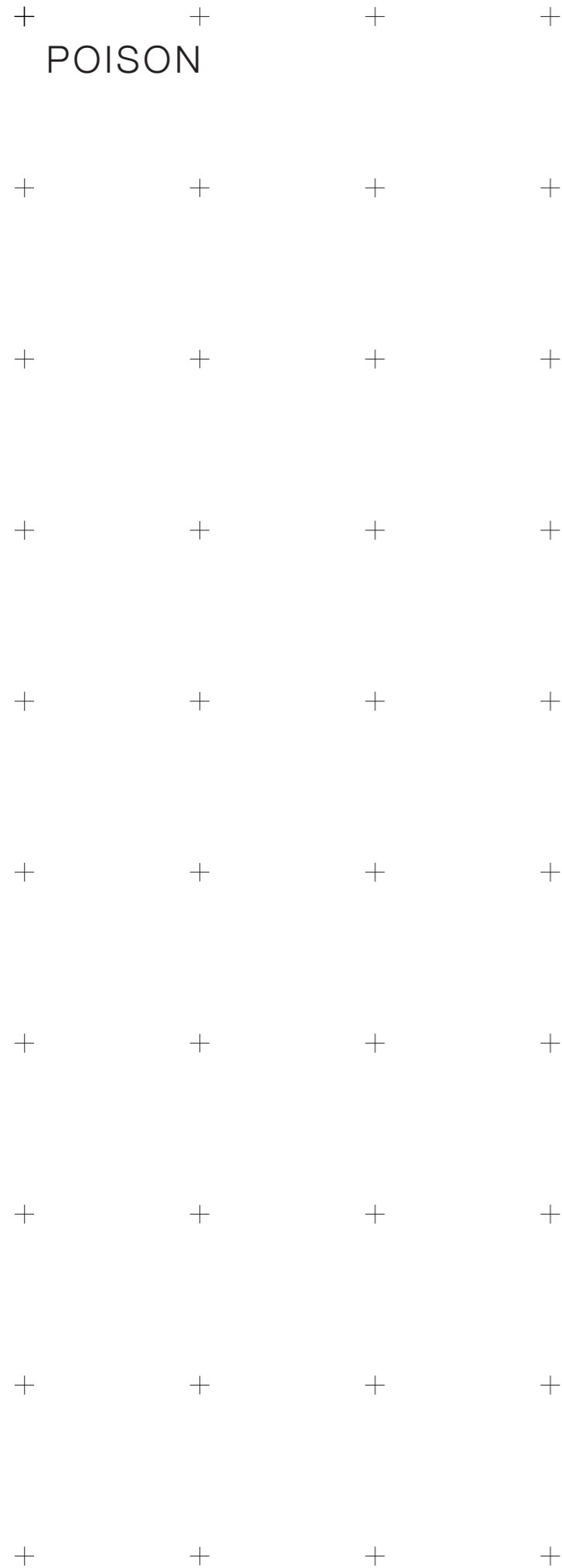
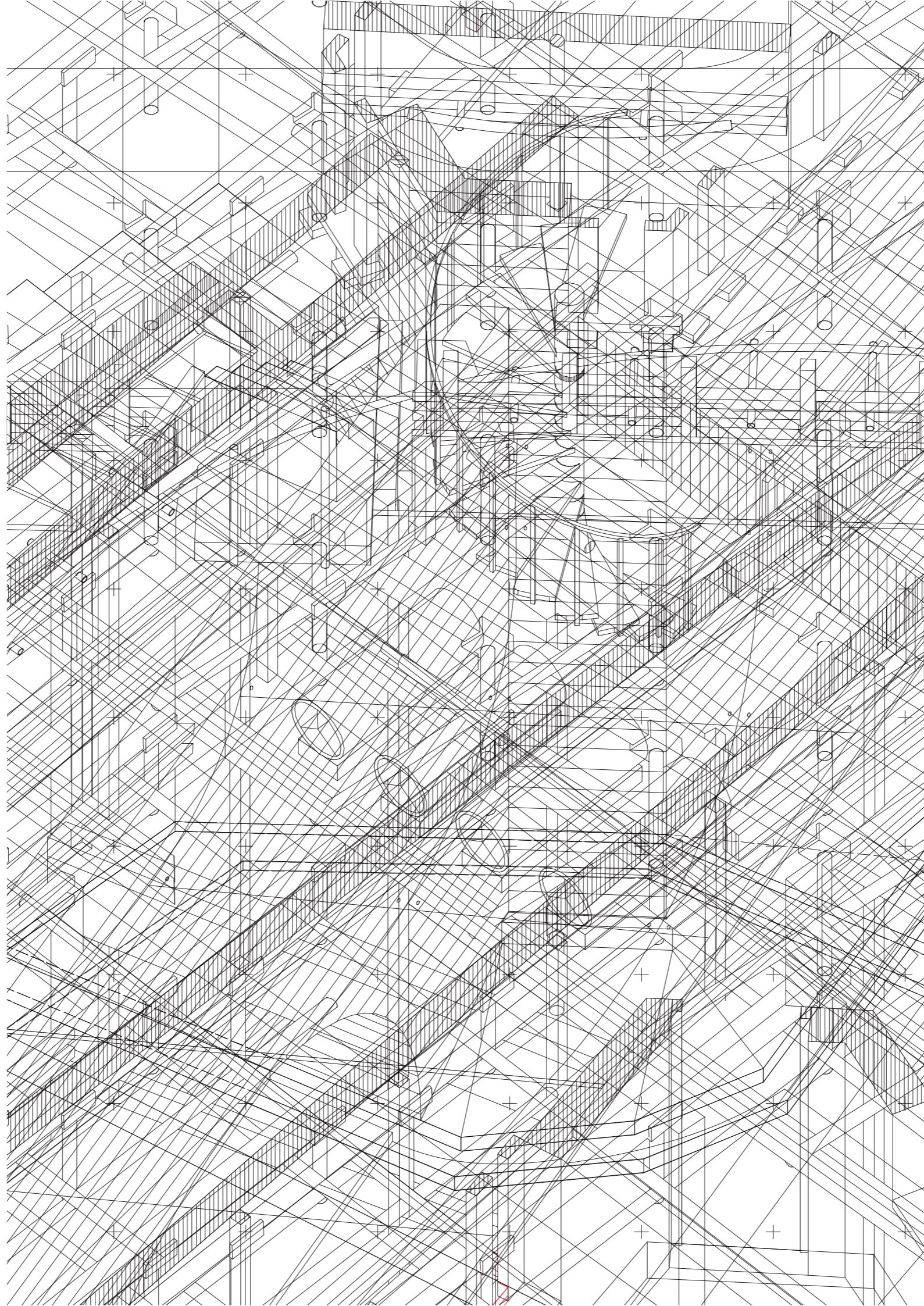

PRESCRIPTION

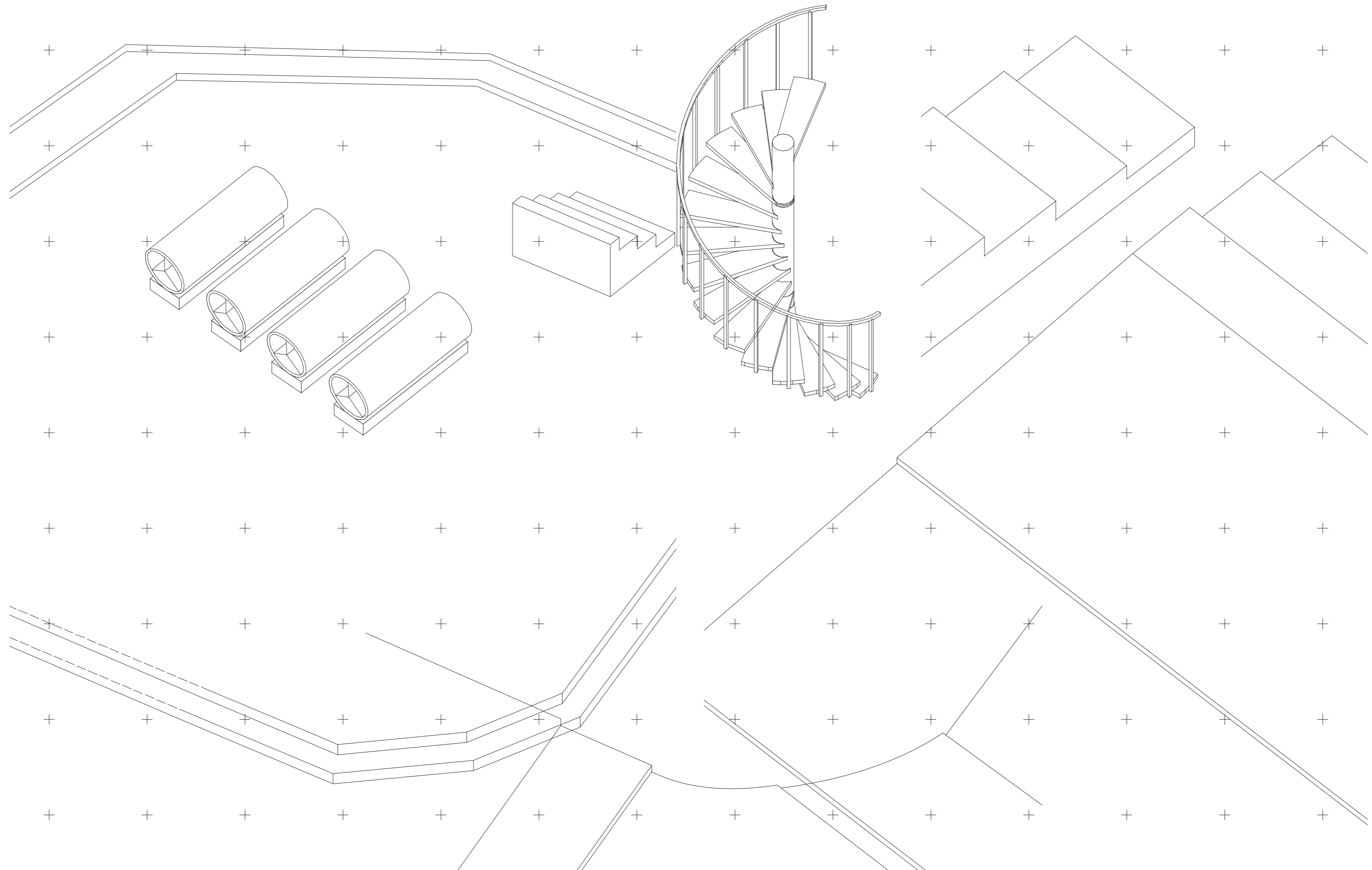

+ + +
PLANE

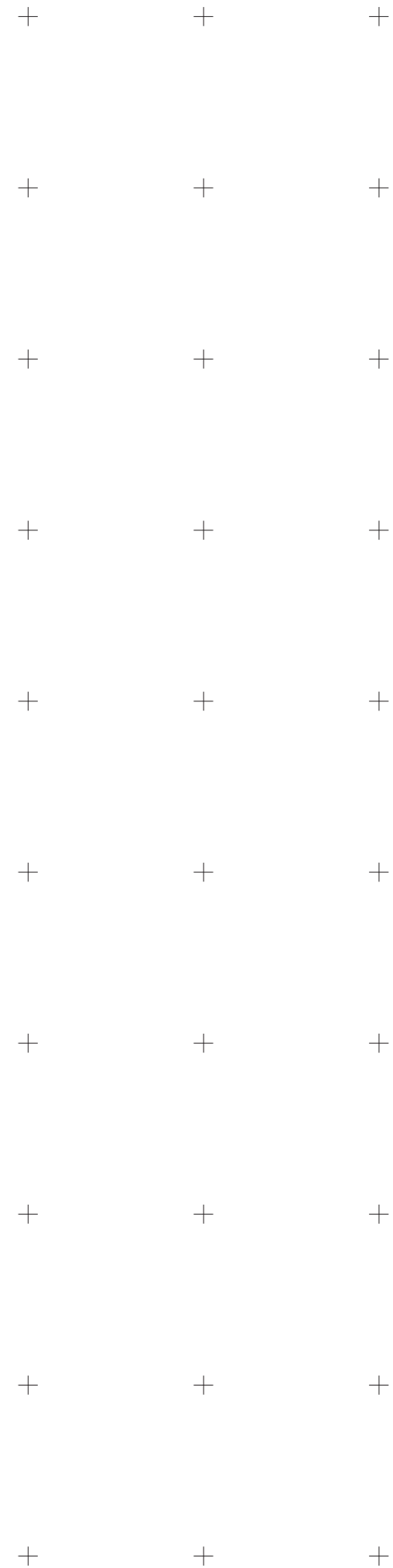
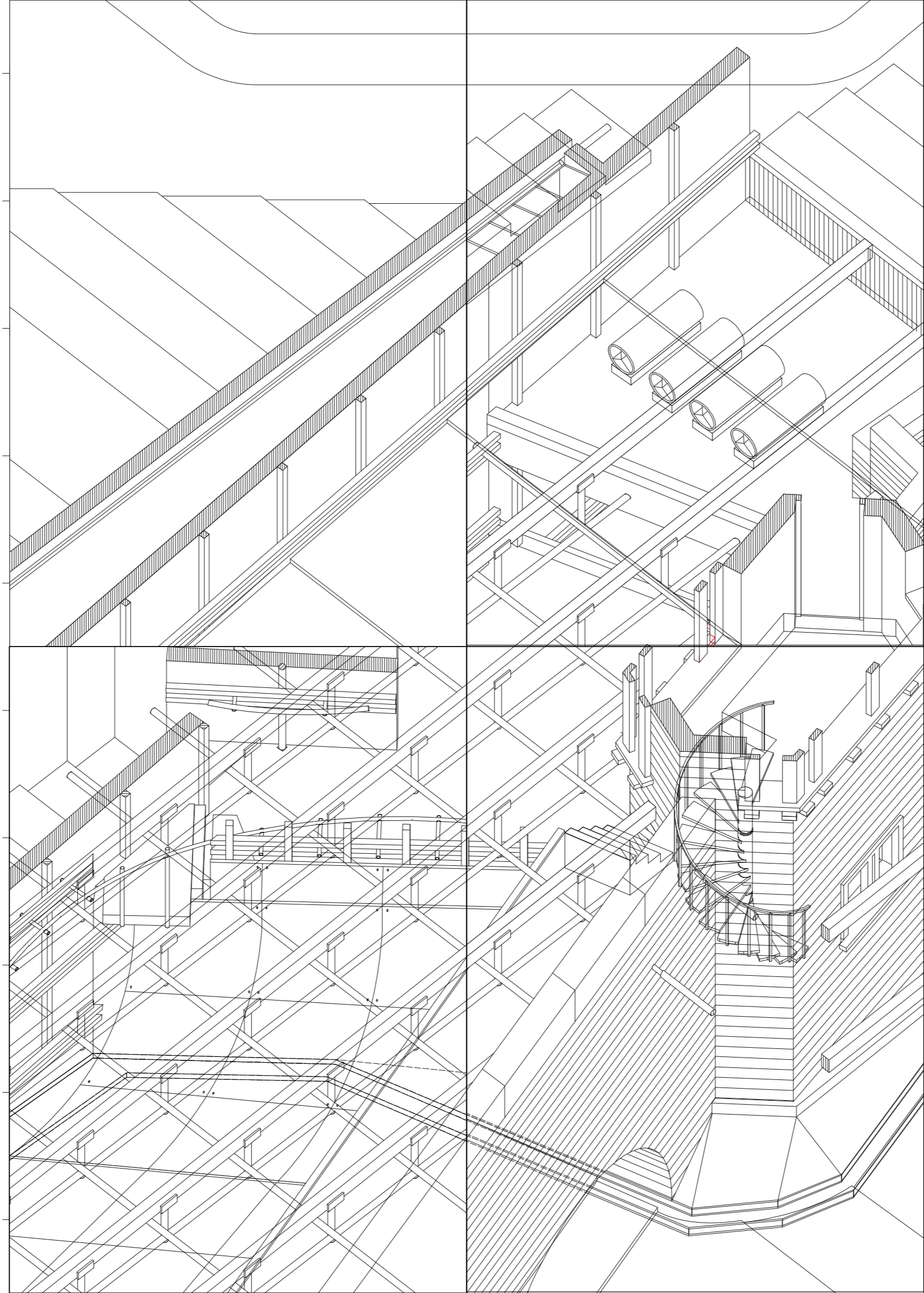

PHARMAKON

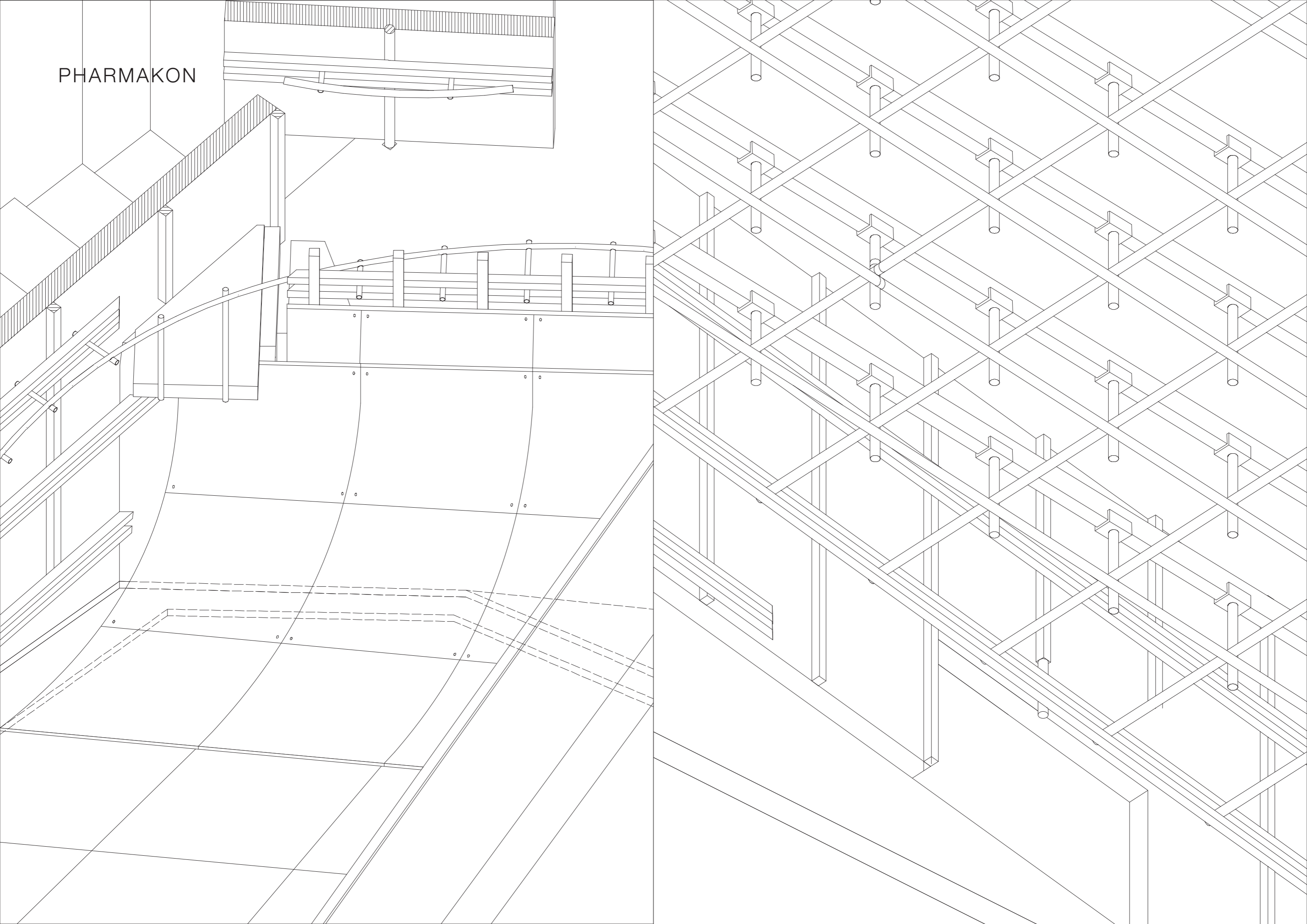

PHARMAKON

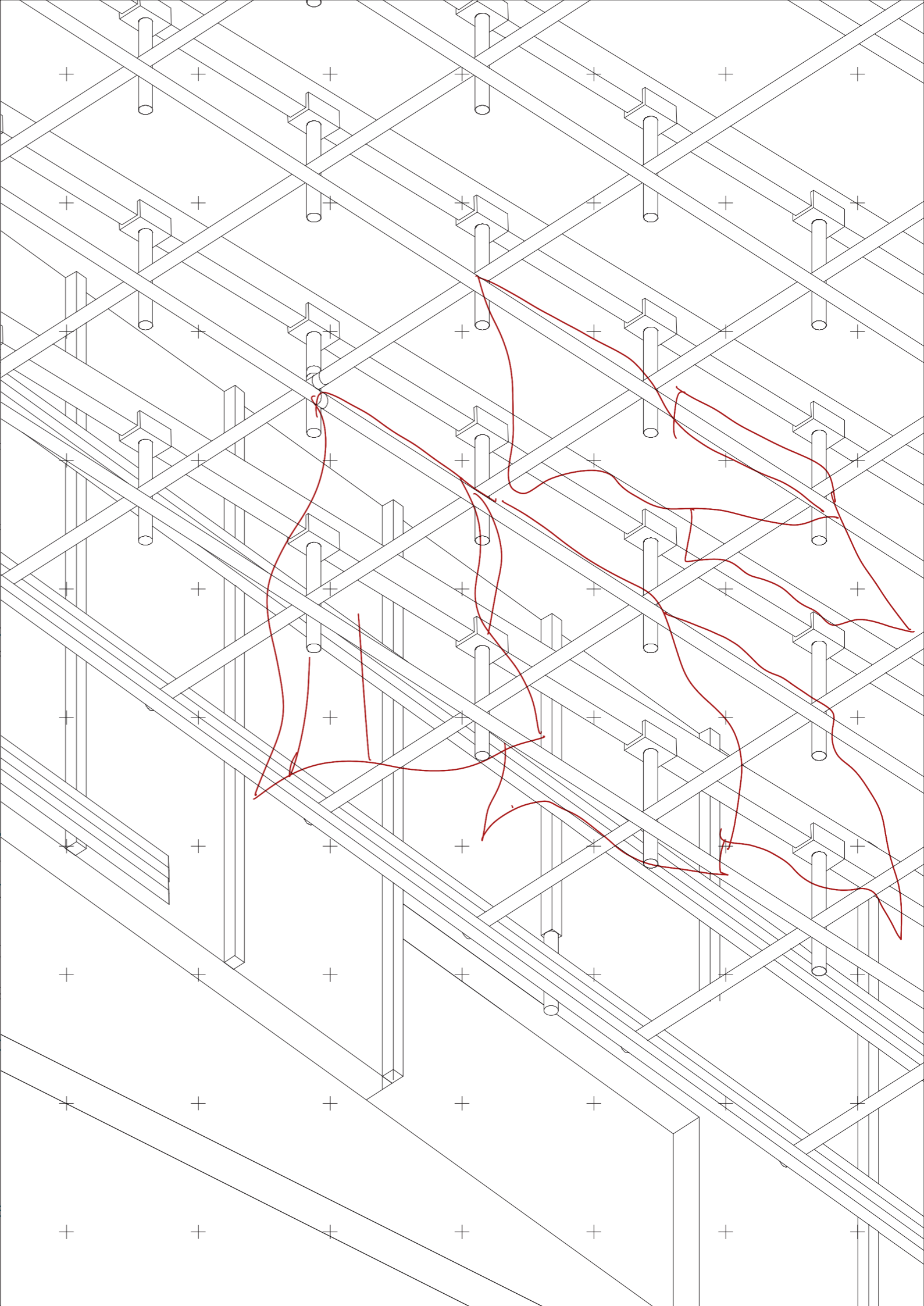
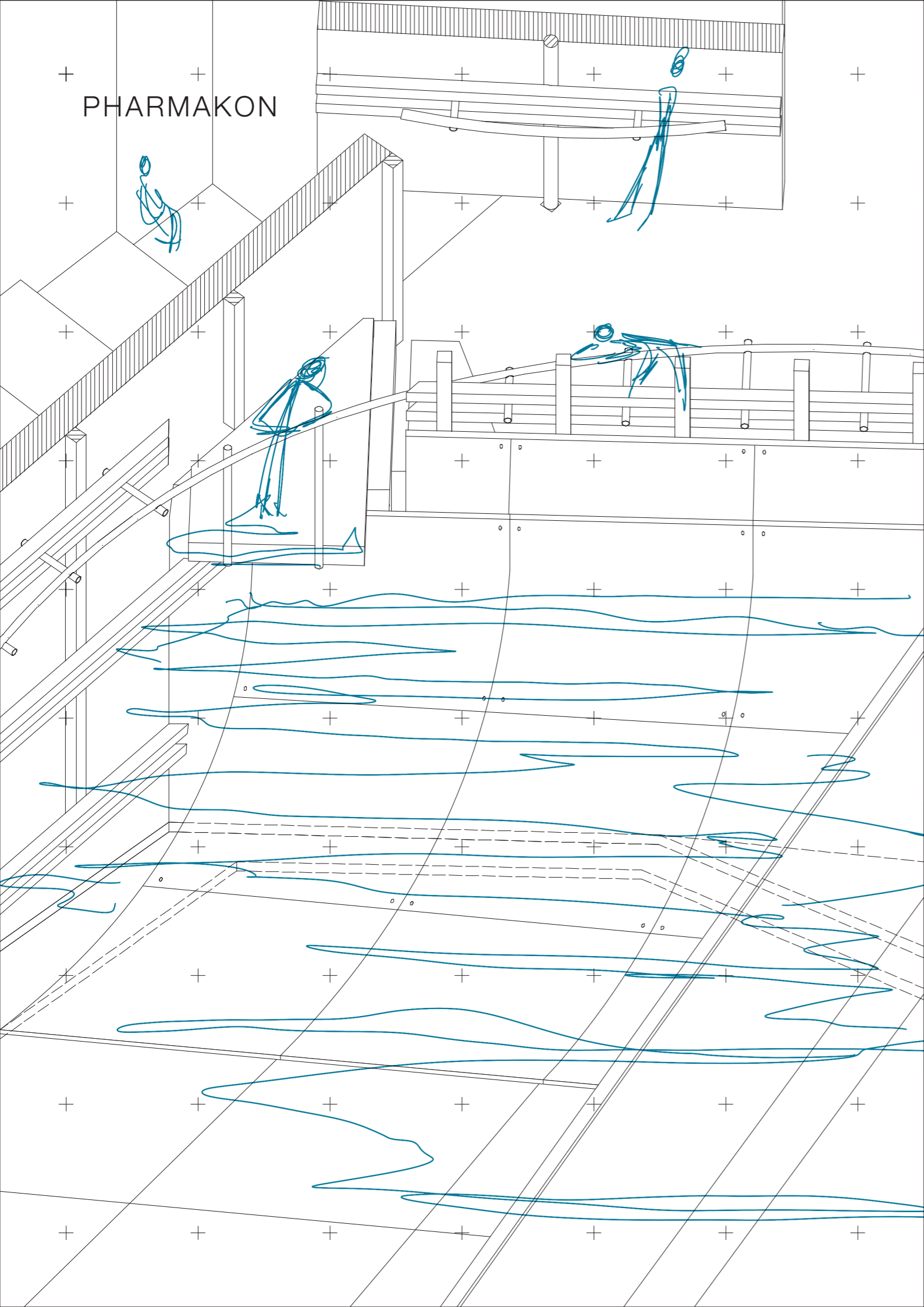

ACU-PUNCTURE





+ + + + + + + + + + + + + + +

+ + + + + + + + + + + + + + +

+ + + + + + + + + + + + + + +

THE CORPOREAL

+ + + + + + + + + + + + + + +

THE COLLECTIVE

+ + + + + + + + + + + + + + +

+ + + + + + + + + + + + + + +

+ + + + + + + + + + + + + + +

THE CLINICAL

+ + + + + + + + + + + + + + +

+ + + + + + + + + + + + + + +

+ EXPLORE LAB GRADUATION

+ + + + + + + + + + + + + + +