

**Ultrasonic welding of epoxy- to polyetheretherketone- based composites
Investigation on the material of the energy director and the thickness of the coupling layer**

Tsiangou, Eirini; Teixeira de Freitas, Sofia; Villegas, Irene Fernandez; Benedictus, Rinze

DOI

[10.1177/0021998320910207](https://doi.org/10.1177/0021998320910207)

Publication date

2020

Document Version

Final published version

Published in

Journal of Composite Materials

Citation (APA)

Tsiangou, E., Teixeira de Freitas, S., Villegas, I. F., & Benedictus, R. (2020). Ultrasonic welding of epoxy- to polyetheretherketone- based composites: Investigation on the material of the energy director and the thickness of the coupling layer. *Journal of Composite Materials*, 54(22), 3081-3098.
<https://doi.org/10.1177/0021998320910207>

Important note

To cite this publication, please use the final published version (if applicable).
Please check the document version above.

Copyright

Other than for strictly personal use, it is not permitted to download, forward or distribute the text or part of it, without the consent of the author(s) and/or copyright holder(s), unless the work is under an open content license such as Creative Commons.

Takedown policy

Please contact us and provide details if you believe this document breaches copyrights.
We will remove access to the work immediately and investigate your claim.

Ultrasonic welding of epoxy- to polyetheretherketone- based composites: Investigation on the material of the energy director and the thickness of the coupling layer

Eirini Tsiangou , Sofia Teixeira de Freitas ,
Irene Fernandez Villegas and Rinze Benedictus

Journal of Composite Materials

0(0) 1–18

© The Author(s) 2020



Article reuse guidelines:

sagepub.com/journals-permissions

DOI: 10.1177/0021998320910207

journals.sagepub.com/home/jcm

Abstract

Ultrasonic welding is a highly promising technique for joining thermoplastic to thermoset composites. A neat thermoplastic coupling layer is co-cured on the surface to be welded to make the thermoset composite ‘weldable’. A reliable bond is attained when miscible thermoplastic and thermoset materials are chosen. For welding carbon fibre/polyetheretherketone (PEEK) to thermoset composite samples, a PEEK film is not preferable due to its immiscibility with epoxy resins. On the other hand, polyetherimide is an excellent candidate, since it is known to be miscible to most epoxy systems at high temperatures and PEEK polymers. This study focusses on two main subjects; firstly, the nature of the material of the energy director, i.e. a flat thermoplastic film used to promote heat generation at the interface. In this case, the energy director can be either polyetherimide, as in the coupling layer or PEEK material, as in the matrix of the thermoplastic composite adherend. It was found that both materials can produce welds with similar mechanical performance. This study focusses secondly on the thickness of the coupling layer. Due to the high melting temperature of the PEEK matrix, a 60- μm -thick coupling layer was seemingly too thin to act as a thermal barrier for the epoxy resin for heating times long enough to produce fully welded joints. Such an issue was found to be overcome by increasing the thickness of the coupling layer to 250 μm , which resulted in high-strength welds.

Keywords

Composites, thermoplastic, thermoset, ultrasonic welding

Introduction

The appealing properties of thermoplastic composites (TPC), such as their easy and fast processing capabilities and infinite shelf life of the raw materials, have led to an increasing interest in their usage in the aerospace industry. One example is the thousands of carbon fibre/polyetheretherketone (CF/PEEK) clips that already exist in the A350 and Boeing 787 aircraft. The clips are currently joined to the CF/epoxy fuselage skin via mechanical fasteners.¹ However, mechanical fasteners are not the best choice for composites, since drilling holes results in breakage of the reinforcing fibres, and furthermore it is time consuming. Welding on the other hand can produce high-strength joints without damaging the parts and in a rather fast way.²

Welding of thermoset composites (TSC) is possible by placing a thermoplastic film (namely coupling layer) on the uncured TSC laminate and curing them together. A reliable way of bonding the two materials is with the use of a compatible thermoplastic (TP) film that allows for interdiffusion of one material into the other and vice versa.³ Out of the thermoplastic

Aerospace Structures and Materials Department, Faculty of Aerospace Engineering, Delft University of Technology, The Netherlands

Corresponding author:

Eirini Tsiangou, Aerospace Structures and Materials Department, Faculty of Aerospace Engineering, Delft University of Technology, Kluyverweg 1, Delft 2629HS, The Netherlands.

Email: E.Tsiangou@tudelft.nl

materials that are known to be miscible with epoxy,⁴ polyetherimide (PEI) is the one with the best mechanical performance and is also compatible with PEEK. Compatibility between these two materials allows for them to be fusion bonded.⁵

Ultrasonic welding is the fastest joining technology to assemble TSC and TPC. Its remarkably fast heating times have been found to help prevent the thermoset matrix from thermally degrading during the welding process.⁶ Ultrasonic welding is based on high-frequency and low-amplitude vibrations and relies on frictional and viscoelastic heating. In order to promote heat generation at the welding interface and avoid excessive bulk heating, a flat thermoplastic film is placed at the interface, called energy director (ED).⁷ Due to the lower stiffness of the ED, hence its higher cyclic strains when compared to the reinforced composite adherends, the ED is going to concentrate heat generation at the interface. Frictional heating is generated at the beginning of the process and is the dominant heating mechanism until the T_g of the ED material is reached. After that point viscoelastic heating becomes the dominant mechanism.⁸ Figure 1 shows the typical 5 stages in the vibration phase (or heat generation phase) of the welding process of TPC, as identified by Villegas⁷ in which CF/PEI composites were welded. The stages are the following:

- Stage 1: heating of the ED without physical changes being observed at the interface. The power starts increasing during this stage.
- Stage 2: local melting of the ED due to frictional heating. The power starts decreasing with the displacement remaining constant at around 0 mm.

- Stage 3: the entire ED is molten (or softened when an amorphous material is used). The sonotrode starts moving downwards as the ED is being squeezed out. The power and the displacement both increase at this stage.
- Stage 4: the ED is flowing and the matrix of the uppermost layers of the adherends starts melting. The power remains constant whereas the displacement keeps increasing until the end of the vibration phase.
- Stage 5: further melting and occasionally squeeze out of the matrix of the adherends. The power starts decreasing.

In a latter study,⁹ Villegas correlated these stages to the mechanical performance of samples welded within each stage. She concluded that the optimum weld quality can be achieved within stage 4. It was shown therefore that the power and displacement curves can be a useful tool to determine the desired weld quality. This can ensure a high reproducibility rate.

Despite the increasing knowledge of ultrasonic welding, the process has still not been widely utilised in welding of TSC. The limited studies found in open literature include a study by Lionetto et al.,¹⁰ in which CF/epoxy samples were welded to each other through a polyvinyl-butyl coupling layer and using either induction or ultrasonic welding. Comparison between the two techniques showed that the ultrasonically welded samples yielded higher lap shear strengths (LSS). Previous work from Tsiangou et al.¹¹ focused on ultrasonic welding of dissimilar composites without a loose ED, solely with the coupling layer. PEI was used as the material of both coupling layer and matrix of the TPC

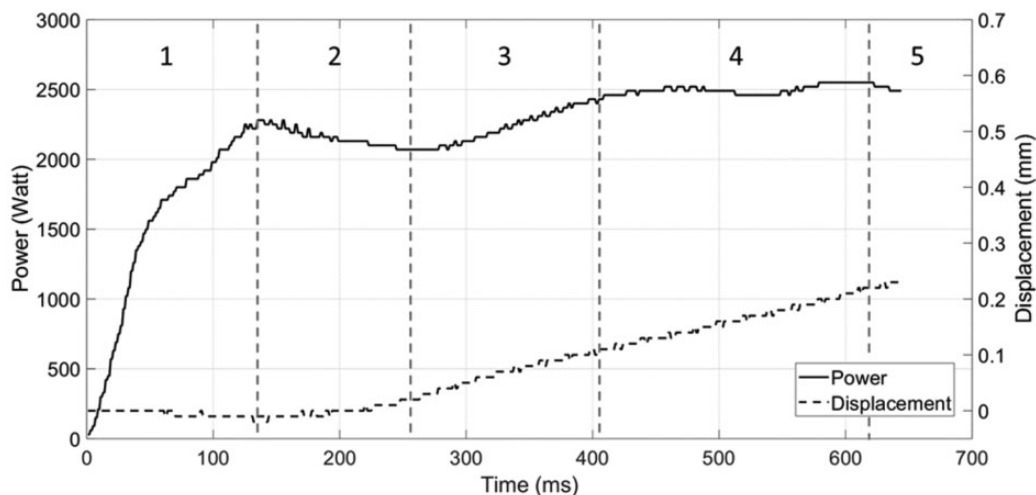

Figure 1. Typical power and displacement curves obtained during the vibration phase when welding CF/PEEK and CF/PEEK composites.

CF/PEEK: carbon fibre/polyetheretherketone.

adherend. It was concluded that the use of an ED is necessary in order to avoid excessive bulk heating and to achieve high strengths. The CF/epoxy and CF/PEI welded samples had a LSS of 37.7 ± 1.6 MPa (average \pm LSS standard deviation), which was similar to the LSS of CF/epoxy and CF/PEI co-cured joints which had a 34.7 ± 1.4 MPa LSS. In the research by Villegas and van Moorleghe,¹ a preliminary study on the ultrasonic welding of CF/epoxy/PEI (i.e. CF/epoxy with a PEI coupling layer) and CF/PEEK with the use of a PEI ED was performed. Unwelded areas were observed in the samples and the LSS of the samples was lower than the reference co-cured samples. No further investigation on the failure mechanisms of the joints was performed.

Considering the current application of CF/PEEK and CF/epoxy composites in the aerospace industry, the focus of this paper is on further understanding ultrasonic welding of CF/epoxy and CF/PEEK composites. Based on previous works,^{1,6,11} PEI was chosen as the coupling layer. Firstly, it was interesting to evaluate whether the most suitable material for the ED will be PEI (same as the coupling layer) or PEEK (same as the matrix of the TPC adherend). Additionally, it was important to determine the effect of the thickness of the coupling layer on the weld quality. A study on induction welding of CF/epoxy/PEI samples showed that the thickness of the coupling layer plays an important role in the mechanical performance of the welds.¹² Our hypothesis was that a thin coupling layer might not be able to act as a thermal barrier for the epoxy resin during welding, especially taking into account the high melting temperature of the PEEK resin. Hence, two different coupling layer thicknesses were examined namely $60 \mu\text{m}$ and $250 \mu\text{m}$. Cross sectional analysis was used to identify the effect of the welding process on the adherends. The mechanical performance of the welds was assessed through single lap shear tests and fractographic analysis.

Experimental procedure

Materials and manufacturing

As the TSC material, T800S/3911 unidirectional CF/epoxy prepreg from TORAY (Japan) was used. The prepreg plies were manually stacked in a $[0,90]_{2s}$ configuration. A PEI film was attached on one of the sides of the CF/epoxy laminates, serving as the coupling layer. Two PEI coupling layers with two different thicknesses were used, a $60\text{-}\mu\text{m}$ -thick PEI film provided by SABIC (The Netherlands), and a $250\text{-}\mu\text{m}$ -thick PEI film provided by LITE (Germany). The $60\text{-}\mu\text{m}$ -thick PEI film was chosen due to its usage in prior studies considering ultrasonic welding of thermoset- and

thermoplastic-based composites,^{1,11} and the $250\text{-}\mu\text{m}$ -thick PEI film was chosen due to its availability as an ED in the same studies. Analysis to determine the chemistry of the two different PEI films was not performed. However, comparison between the data sheets of the two PEI films showed similar thermal and physical properties, which are the main points of interest for this study. Moreover, the epoxy-PEI interphase was identical in both cases.

The CF/epoxy laminates with the attached coupling layer were cured in an autoclave at 180°C and 7 bars for 120 min. An aluminium caul plate was used on the side of the vacuum bag, in order to ensure a flat surface. The thickness of the CF/epoxy/PEI laminate (i.e. the CF/epoxy laminate with the co-cured PEI film on its surface) was ~ 2 mm.

In our previous study, we found that during curing, an interdiffusion process occurs between the monomers of the T800S/3911 epoxy and the PEI polymer. Due to the limited miscibility between the two materials after the gelation point of the epoxy resin, phase separation occurs, which results in the formation of a gradient interphase.¹¹ Figure 2 shows the morphology of this interphase, which consists of epoxy spheres dispersed in a PEI-rich matrix, with diameters decreasing towards the PEI coupling layer. The interphase has a varying thickness, with a maximum of $25 \mu\text{m}$. The existence of the interphase is a strong evidence that a reliable bond is created between the epoxy and PEI resins.⁴

The material of the TPC adherend was CF/PEEK powder-coated semi-preg with a 5-harness satin weave fabric, manufactured by TenCate Advanced Composites (The Netherlands). The CF/PEEK laminates with a $[0/90]_{3s}$ stacking sequence were consolidated

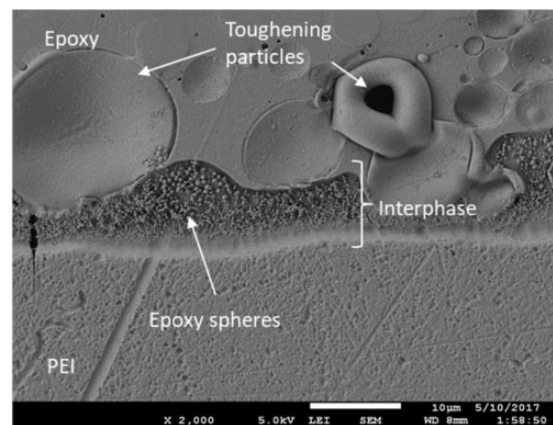

Figure 2. Morphology of the interphase formed between the epoxy and PEI materials. PEI: polyetherimide.

in a hot-platen press at 385 °C at 20 bar for 30 min. The thickness of the consolidated laminates was ~ 1.9 mm.

Both adherends were cut from the laminates with dimensions $25.4 \times 106 \text{ mm}^2$ using a water-cooled circular diamond saw. The CF/epoxy/PEI adherends were cut with their longitudinal direction parallel to the 0° fibres. The CF/PEEK adherends were cut with their longitudinal direction parallel to the main apparent orientation of the fibres.

The EDs used in this study were a 250- μm -thick PEI film provided by LITE, Germany, and a 250- μm -thick PEEK film provided by Victrex, UK.

Welding process

Individual samples were welded with a Rinco Dynamic 3000 ultrasonic welder in a single-lap configuration, with the overlap being 12.7 mm long and 25.4 mm wide. The custom-made welding jig shown in Figure 3 was used. A cylindrical sonotrode with a 40 mm diameter was utilised. To ensure minimum heating times and hence, minimum risk of thermal degradation at an acceptable level of dissipated power, the parameters chosen were 1500 N welding force and 86.2 μm peak-to-peak vibration amplitude. These parameters are close to the highest within the limits of the machine and hence result in very short heating times, as shown in the study by Villegas and Rubio.⁶ Solidification force and time were kept constant at 1500 N and 4 s, respectively. The duration of the vibration phase was indirectly controlled through the downward displacement of the sonotrode. The power and displacement of the sonotrode values during the vibration phase, as well as

the total duration of the vibration phase were recorded by the welding machine and could be obtained at the end of the welding process.

Figure 4 shows the schematics of the different types of joints in this study. The first row of the figure corresponds to joints welded through a 60- μm -thick coupling layer, hereafter referred to as hybrid-60 configurations, in which (a) is with a PEI ED (hybrid PEI-60) and (b) is with a PEEK ED (hybrid PEEK-60). The second row corresponds to joints welded through a 250- μm -thick coupling layer, hereafter referred to as hybrid-250 configurations, in which (c) is with a PEI ED (hybrid PEI-250) and (d) is with a PEEK ED (hybrid PEEK-250). The third row corresponds to reference joints with CF/PEEK adherends, in which (f) is with a PEI ED (reference PEI) and (g) is with a PEEK ED (reference PEEK).

Testing

Single-lap shear. Single-lap shear tests were performed in order to assess the mechanical performance of the joints, following the ASTM D 1002 standard. A Zwick 250 kN universal testing machine operating at 1.3 mm/min cross-head speed and under displacement control was used for these tests. The apparent LSS of the joints was calculated as the maximum load divided by the overlap area. Five specimens were tested per welding case to determine the average LSS and corresponding standard deviation.

Material characterisation. Heating during ultrasonic welding relies on frictional and viscoelastic heating. Frictional heating is not expected to change significantly when using different ED materials. On the other hand, viscoelastic heating depends on the material of the ED among other parameters. Specifically, the rate of viscoelastic heat generation can be described by the following equation¹³

$$\dot{Q}_v = \frac{\omega \cdot \varepsilon_0^2 \cdot E''}{2} \quad (1)$$

where \dot{Q}_v is the rate of viscoelastic heat generation, ω is the frequency of the vibrations, ε_0 is the cyclic strain and E'' is the loss modulus of each material. Assuming that the frequency and cyclic strains are the same for both ED materials, the loss modulus seems to play the biggest role in viscoelastic heat generation rate, and it is important that it is determined for both materials. The viscoelastic properties were measured with a dynamic mechanical analysis (DMA) apparatus. Tensile DMA tests were carried out in a Pyris Diamond DMA (Perkins Elmer) between room temperature and 300 °C for the PEI resin and 400 °C for the PEEK

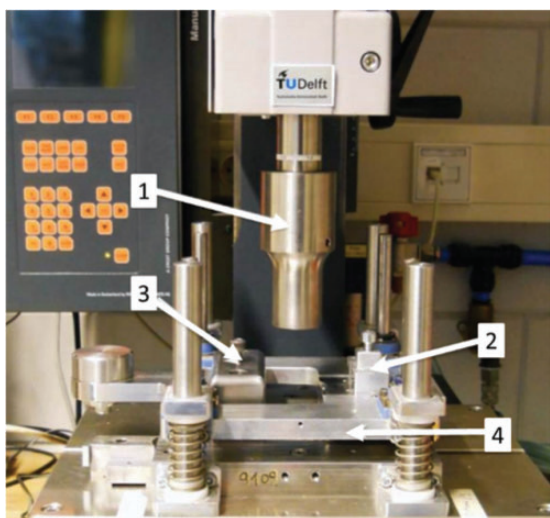

Figure 3. Custom made welding setup. Arrows point at the sonotrode (1), the clamp for the top sample (2), the clamp for the bottom sample (3) and the sliding platform (4).

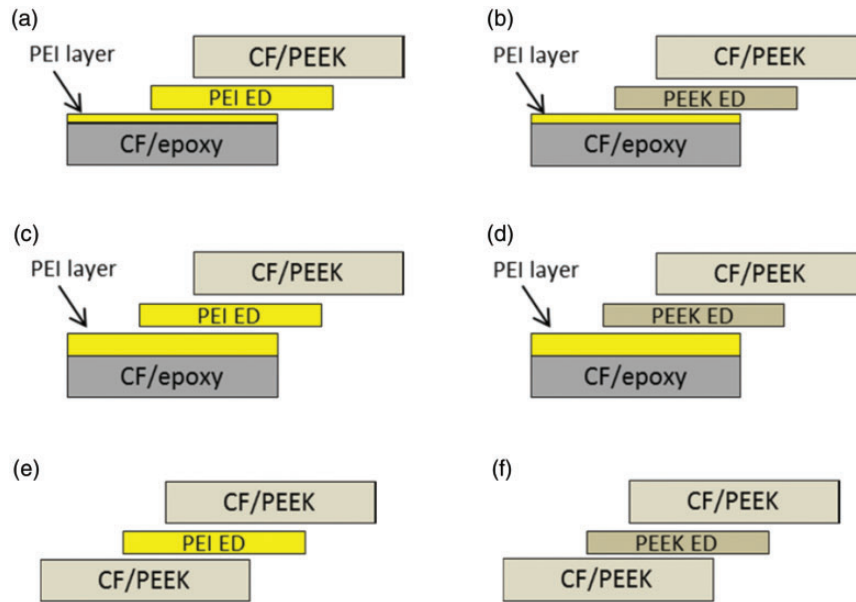

Figure 4. Schematic representation of all the welded configurations. ED is an abbreviation for energy director. Dimensions are not to scale. (a) Hybrid PEI-60, (b) hybrid PEEK-60, (c) hybrid PEI-250, (d) hybrid PEEK-250 (e) reference PEI and (f) reference PEEK. ED: energy director.

resin, at 1 Hz frequency. Those temperatures were chosen since they were the threshold above which the PEI and PEEK samples failed and thus the DMA apparatus stopped recording.

Another parameter that can have an influence in the welding process is the viscosity of the two resins. The viscosity determines how easily a resin flows, thus the material with the lowest viscosity will probably result in faster displacement increase, i.e. shortest duration of stages 3–5. A Thermo Scientific™ HAAKE™ MARS™ rheometer was used to measure the viscosity of the PEI and PEEK resins. The viscosity was measured at 1 Hz frequency and for a temperature range between 220 °C and 400 °C for the PEI resin and 290 °C and 420 °C for the PEEK resin.

Process characterisation

Schematics of the two types of temperature measurements that were performed can be seen in Figure 5. In the first type of measurement, the temperature at the welding interface was measured in order to determine whether the temperature evolution depended on the material of the ED. For that, the thermocouple was placed between the ED and the CF/epoxy/PEI adherend (see Figure 5(a)), at the centre of the overlap, just before the welding process. For this specific temperature measurement, the samples were welded at a displacement equal to the total thickness of the ED and the coupling layer, in order to monitor the temperature evolution during all five stages of the vibration phase.

The second type of measurement targeted the temperature evolution in the top ply of the CF/epoxy adherend. The main objective was to evaluate whether the thick coupling layer (250 µm) was able to better shield the CF/epoxy adherend from the high temperature in the welding interface, as opposed to the thin coupling layer (60 µm). The thermocouple was placed in between the coupling layer and CF/epoxy laminate prior to the co-curing process (see Figure 5(b)). After the co-curing process the samples seemed to remain flat, without waviness being introduced by the existence of the thermocouple. After curing, samples were cut from the laminate in such way that the tip of the thermocouple was in the middle of the overlap. For this second temperature measurement, the samples were welded until the target displacement that resulted in the highest LSS was reached, as it will be discussed in the following sections.

K-type thermocouples with a 100 µm diameter were used. The temperature during welding was measured with a sampling rate of 1000 Hz. An in-house built device was used to monitor the temperature. The temperature was measured in at least five samples per configuration.

Microscopic analysis

Naked-eye observation and scanning electron microscopy (JEOL JSM-7500F Field Emission Scanning Electron Microscope, SEM) were used for fractographic analysis of tested joints. An optical microscope (Zeiss Axiovert 40) together with the scanning electron

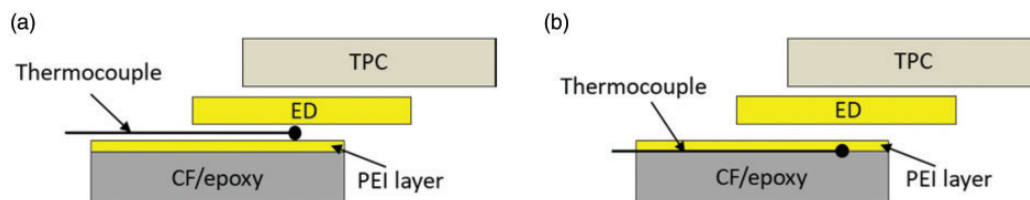

Figure 5. Schematic representation of the temperature measurements. (a) Thermocouple at the welding interface between the ED and the CF/epoxy/PEI adherend and (b) thermocouple between the PEI coupling layer and the CF/epoxy adherend. CF: carbon fibre; ED: energy director; PEI: polyetherimide.

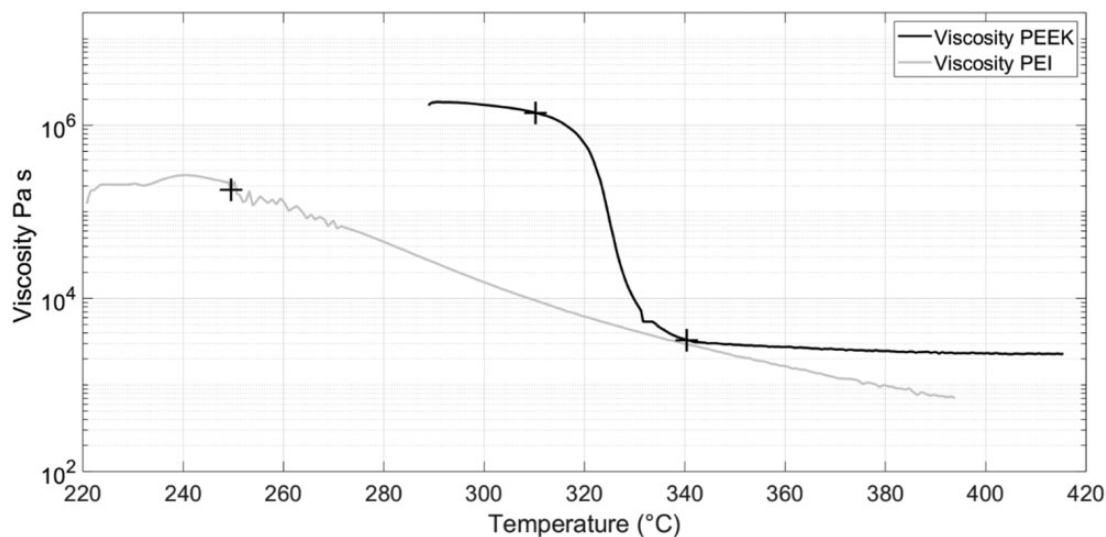

Figure 6. Viscosity of the PEEK and PEI resins versus temperature. The '+' signs indicate the changes in the viscosities. PEEK: polyetheretherketone; PEI: polyetherimide.

microscope was used for cross-sectional analysis of as-welded specimens. Samples for cross-sectional microscopy were embedded in EpoFix resin and subsequently grinded and polished. To observe the epoxy-PEI interphase, polished samples were etched with 1 ml of N-Methyl-2-pyrrolidone and then immediately rinsed with ethanol and distilled water to provide contrast between the epoxy and PEI resins.

Results and discussion

Material characterisation

Figure 6 presents the viscosity of the PEI and PEEK resins as a function of temperature. Above around 250°C, the viscosity of the PEI resin drops linearly. The viscosity of the PEEK resin decreases rapidly once the temperature reaches around 310°C and it becomes almost constant above 340°C. At all considered temperatures, the viscosity of the PEI resin is lower than that of the PEEK resin. Note that the rheometer can only successfully measure the melt viscosity,

thus results for the PEEK resin could only be obtained after around 290°C.

The loss moduli of the PEI and PEEK resins can be seen in Figure 7. Four main stages can be identified:

- (i) 25°C–140°C: The PEI resin generates heat faster than the PEEK one. Both resins generate heat at a constant rate.
- (ii) 140°C–170°C: The PEEK resin generates heat faster than the PEI resin. At 150°C (i.e. close to the T_g of the PEEK resin) the loss modulus of the PEEK resin reaches a maximum and then starts decreasing again.
- (iii) 170°C–230°C: The PEI resin generates heat faster than the PEEK resin, with the highest rate being at the T_g of the PEI resin. After that, the loss modulus of the PEI resin drops again.
- (iv) 230°C–350°C: The two resins generate heat at a significantly lower rate than at lower temperatures. The PEEK resin generates heat somewhat faster than the PEI resin until it reaches its melting point (343°C).

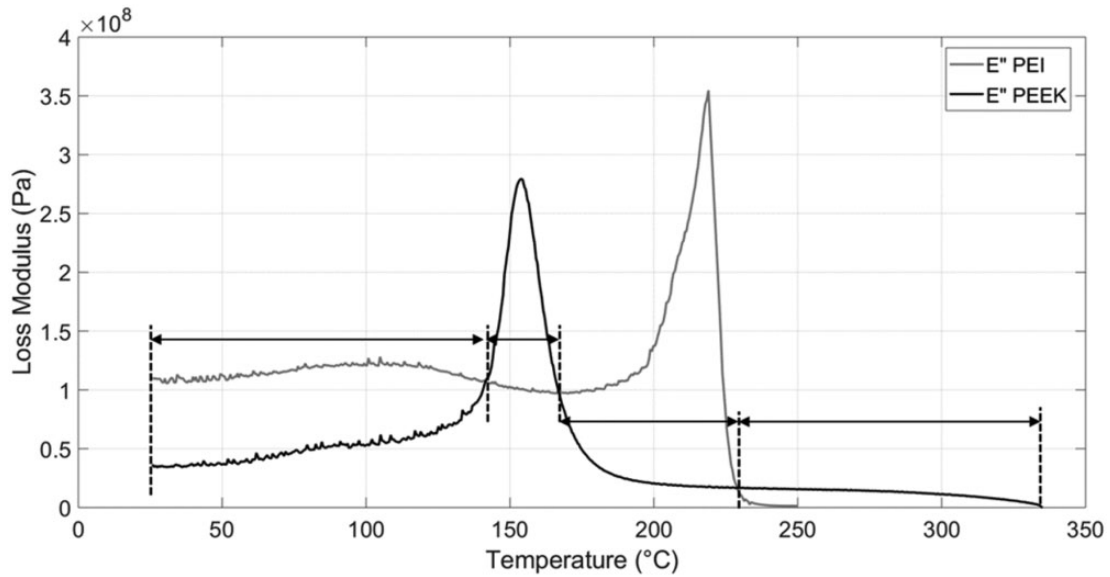

Figure 7. Loss modulus versus temperature of PEI and PEEK resins. The arrows indicate the intervals in which the PEI and PEEK loss moduli exhibited a certain behaviour with respect to each other. PEEK: polyetheretherketone; PEI: polyetherimide.

Since the rate at which viscoelastic heat is generated is highly dependent on the loss modulus of the resins (see equation (1)), it can be expected that the differences in the loss moduli mentioned above can potentially influence the temperatures reached at the weld interface when welding with either PEEK ED or PEI ED.

Power and displacement curves

Figure 8 shows complete power and displacement curves of the hybrid-60, hybrid-250 and reference configurations. The term ‘complete curves’ means that the samples were welded at a displacement value within the fifth stage of the vibration phase. The behaviour of the curves was similar to what was discussed in the introduction, following the typical five stages. The main difference in the displacement curves was that the displacement increased at a higher rate when a PEI ED was used rather than when a PEEK ED was used. Displacement of the sonotrode occurs as the ED flows; hence, the PEI ED flowed faster than the PEEK ED, resulting in faster increase in the displacement. This can be attributed to the lower melt viscosity of the PEI resin when compared to the PEEK resin, as seen in Figure 6. No significant/consistent differences could be found between the power curves of different configurations. In most samples a change in the slope could be found at around 50 ms. This change in the slope could be possibly related to the change between the initial transient phase (duration 50 ms) in which the amplitude is increased from 0 to 43.1 μm (which is the peak amplitude in this study) and the stable phase in

which the amplitude is kept constant. This is further explained in the study by Villegas.⁷

Process characterisation

Figure 9 shows temperature profiles taken at the welding interface (see Figure 5(a)) for different samples of each welding configuration. Figure 9(a) shows all the samples of the hybrid 60 configurations and Figure 9(b) shows all the samples of the hybrid 250 configuration (black lines indicate the usage of the PEEK ED and grey lines indicate the usage of the PEI ED). Note that out of the five samples tested in all configurations, only the ones in which the thermocouples remained intact after the welding process are presented, i.e. three samples of the hybrid PEEK-60, hybrid PEI-60 and hybrid PEI-250 configurations and four samples of the hybrid PEEK-250 configuration. The temperature in all configurations increased to an average maximum temperature of $750^\circ\text{C} \pm 38^\circ\text{C}$, $670^\circ\text{C} \pm 38^\circ\text{C}$, $702^\circ\text{C} \pm 20^\circ\text{C}$ and $722^\circ\text{C} \pm 35^\circ\text{C}$ (average temperature \pm standard deviation) in the hybrid PEEK-60, hybrid PEI-60, hybrid PEEK-250 and hybrid PEI-250 configuration, respectively. The time frame within which the temperature increased to a maximum varied per sample. However, for most samples this increase happened within the first 200 ms of the vibration phase. After that, the temperature started fluctuating differently for each sample, possibly because of movement of the thermocouple along the weld interface and/or heating being generated at random locations in each sample. The vertical arrows indicate the

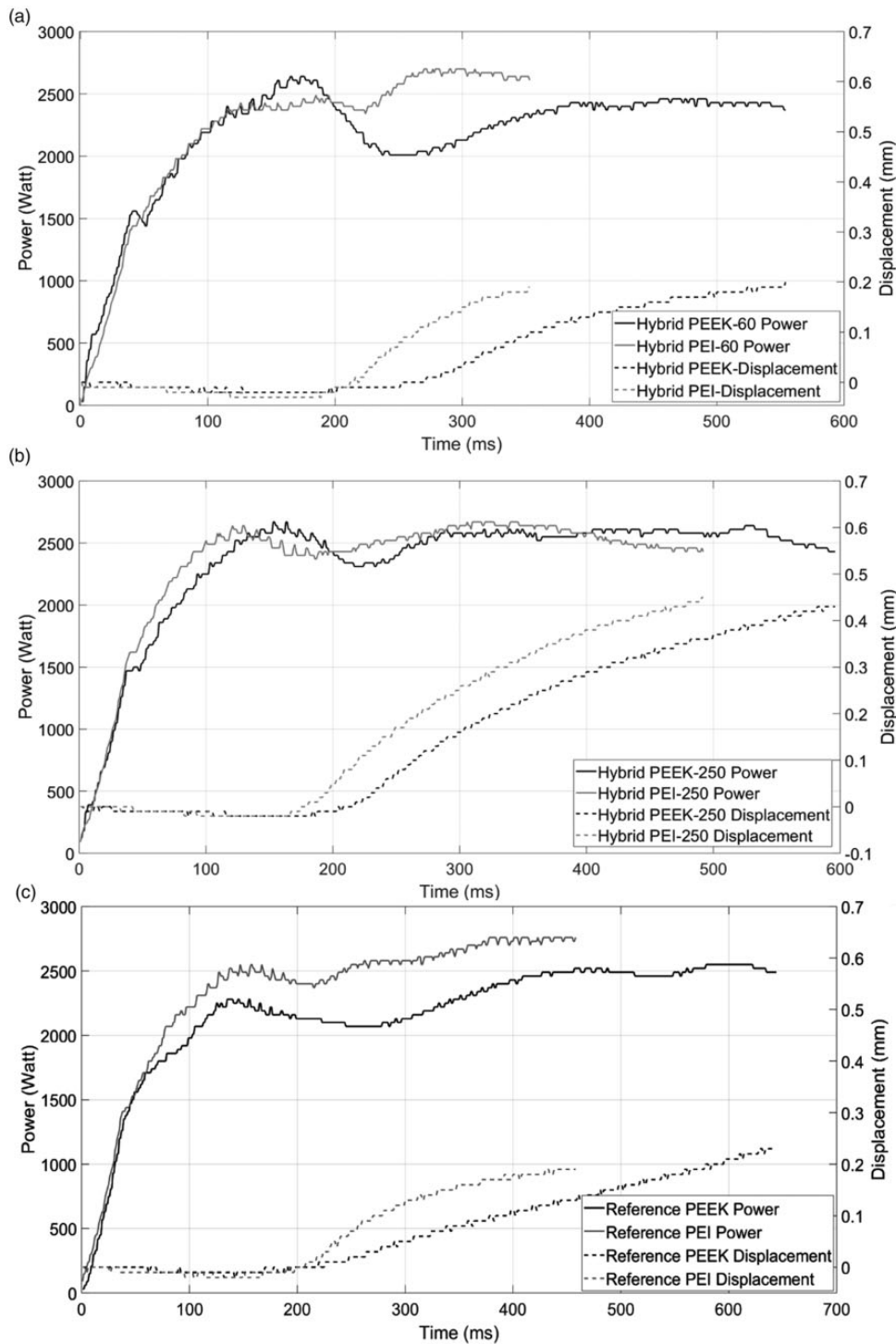

Figure 8. Power (solid line) and displacement (dotted line) curves of the (a) hybrid-60, (b) hybrid-250 and (c) reference configurations.

completion of the vibration phase and initiation of the consolidation phase (i.e. the phase at which only a consolidation force was applied without the vibrations). Note that the maximum measured temperatures were higher than the degradation temperatures of the PEI and PEEK resins. However, no fumes were observed

and also no degradation signs were found in the PEEK and PEI resins in the micrographs (as will be shown in the next sections). One explanation could be that the exceptionally short heating times allowed for such high temperatures without causing degradation of the resins. There is also the possibility that the peak temperature is

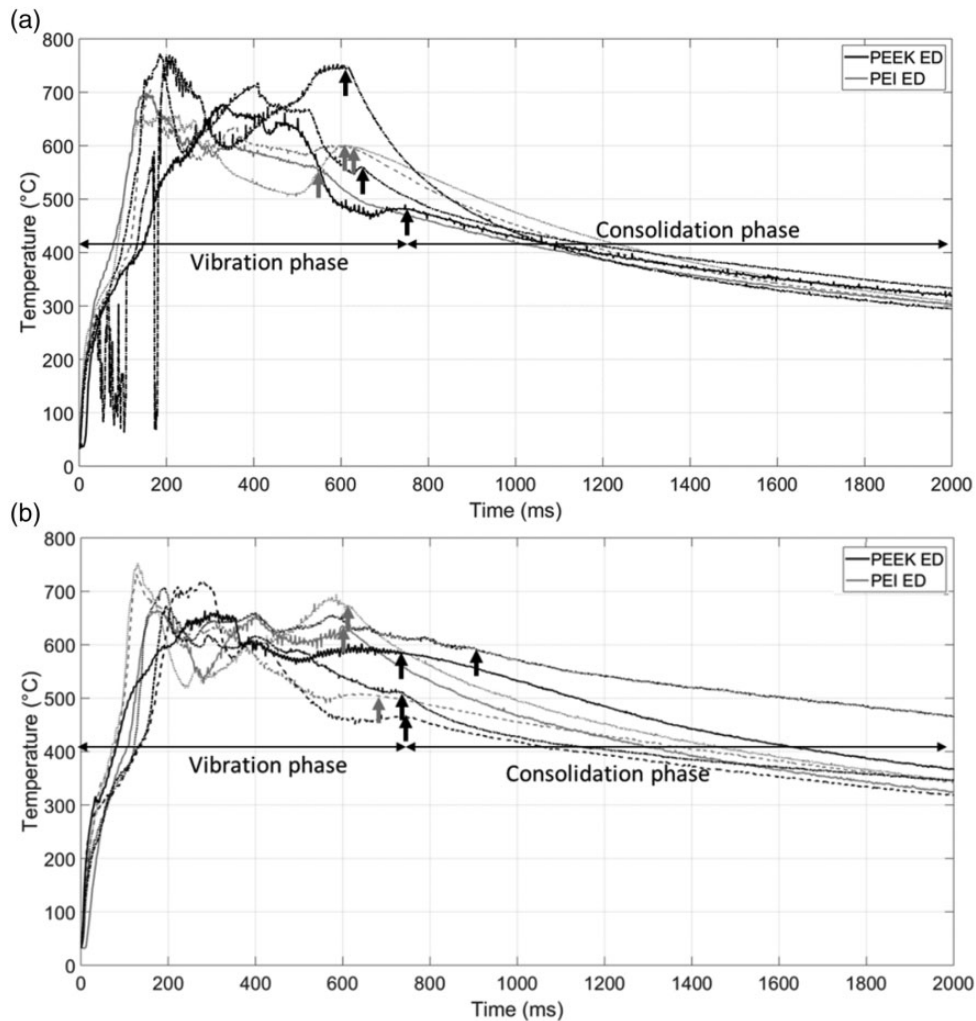

Figure 9. Temperature profile at the welding interface of the (a) hybrid 60 and (b) hybrid 250 configurations (see schematic in Figure 5(a)). Different line styles indicate different samples (welded with same parameters) within each configuration. The vertical arrows indicate when the vibration phase was stopped.

not truly representative of the actual peak temperature at the interface but rather the response of the thermocouple, acting as an energy director. However, such potential interference should remain limited at the start of the vibration phase, since the thermocouple is expected to be embedded in the ED or coupling layer right after the resin surrounding it becomes soft. Regardless, since experimentally validating whether the measured peak temperature corresponded to the actual peak temperature was not possible, it was decided to only use the temperature measurements for comparison purposes and not to make conclusions regarding the highest temperatures reached. Considering the scatter in the measurements within the same configuration, it cannot be concluded whether the material of the ED or the thickness of the coupling layer played a significant role in how heat was generated during welding.

In addition to the temperature at the weld interface, the temperature between the coupling layer and the CF/epoxy adherend was measured as well. The main focus was to compare the maximum temperature reached underneath the coupling layer in each configuration, since the higher the temperature is, the higher the risk of thermal degradation of the epoxy resin. Representative measurements of each configuration are presented in Figure 10. The temperature kept increasing during the vibration phase, since (i) more heat was being generated and transferred from the interface to the coupling layer and (ii) the coupling layer most likely flowed during welding; hence, it started losing its ability to act as a thermal barrier for the CF/epoxy adherend. Once the target displacement was reached, i.e. when the vibration phase was stopped (indicated by the vertical arrows), the temperature

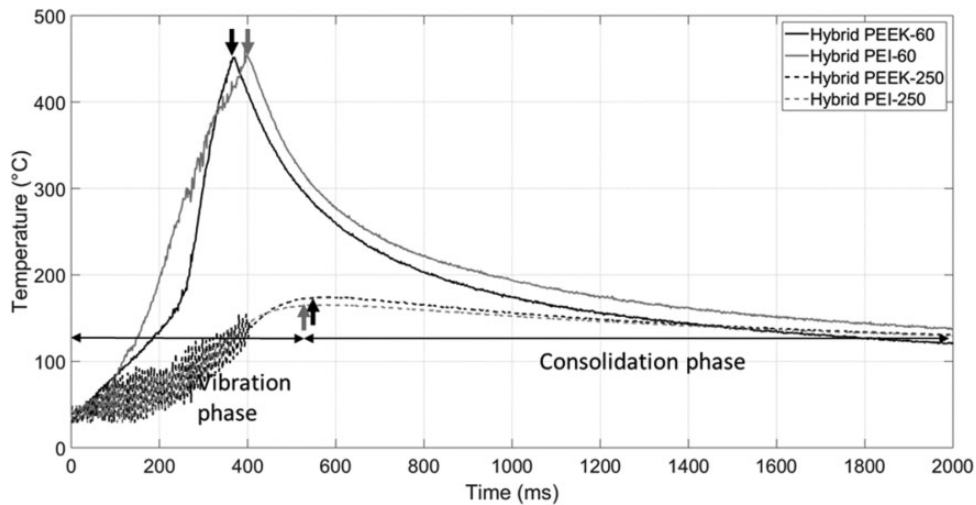

Figure 10. Temperature evolution between the coupling layer and the CF/epoxy adherend (see schematic in Figure 5(b)). The vertical arrows indicate when the vibration phase was stopped. CF: carbon fibre.

started dropping, since no further heat was generated. The two hybrid-250 configurations presented similar temperature curves, with some noise at the beginning of the welding process. The hybrid PEEK-60 samples presented a change in the slope at around 155 °C, which might be because the PEEK ED generated viscoelastic heat with a much higher rate around that temperature (Figure 7). The maximum temperature reached was $461^{\circ}\text{C} \pm 114^{\circ}\text{C}$, $446^{\circ}\text{C} \pm 156^{\circ}\text{C}$, $176^{\circ}\text{C} \pm 14^{\circ}\text{C}$ and $160^{\circ}\text{C} \pm 18^{\circ}\text{C}$ in the hybrid PEEK-60, hybrid PEI-60, hybrid PEEK-250 and hybrid PEI-250 configuration, respectively. The particularly higher temperatures measured in the hybrid-60 configurations as compared to the hybrid-250 configurations could pose a greater risk of thermal degradation, especially since the duration of the vibration phase, thus the heating time, is similar in both cases. The exact temperature at which the epoxy resin is expected to degrade during ultrasonic welding is difficult to quantify, because the heating time is significantly shorter (<1 s) than the capabilities of any thermal analysis apparatus. Moreover, as explained in the study by Abouhamzeh and Sinke,¹⁴ the material properties can start deteriorating even before the weight of the material decreases, which is how the degradation temperature is defined in thermogravimetric analysis.

Cross-section analysis

Cross-section analysis was performed in order to evaluate the effect of the ED material and of the coupling layer thickness on the adherends and weld line. Figure 11 depicts the cross-section of a hybrid PEEK-60 sample (PEEK ED and 60- μm -thick coupling layer).

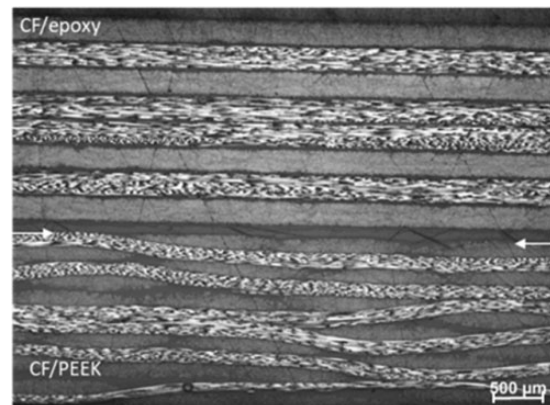

Figure 11. Cross-sectional micrograph of a hybrid PEEK-60 sample. White arrows indicate the weld line. Similar micrographs were obtained with all hybrid configurations. PEEK: polyetheretherketone.

The cross-section is representative of all other hybrid configurations. The final thickness of the weld line was similar in all hybrid cases and amounted to $\sim 100\ \mu\text{m}$. Optical microscopy did not reveal any visible signs of thermal degradation of the resins, i.e. porosity caused by resin sublimation. A closer look on the cross-sections of the hybrid PEEK-60 and hybrid PEEK-250 samples is found in Figure 12. It can be seen in both Figures 12(a) and (b) that the PEI resin is depicted as the dark grey area and the PEEK resin as the lighter grey area. The weld line of the hybrid PEEK-60 samples appears to consist mostly of PEEK resin, i.e. the light grey area. The PEI coupling layer seems to have flowed almost entirely in some locations. The

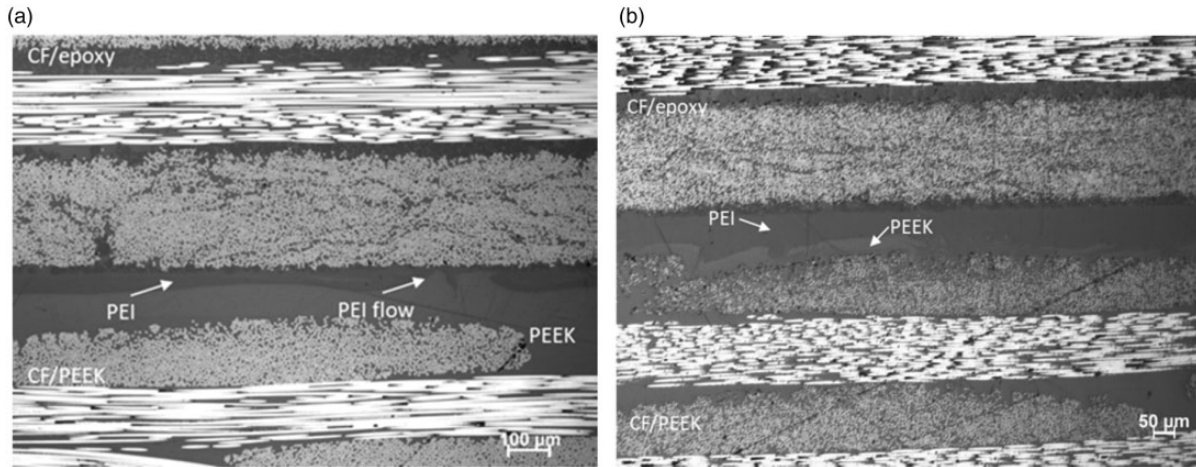

Figure 12. Higher magnification micrographs of (a) a hybrid PEEK-60 sample and (b) a hybrid PEEK-250 sample. The PEI coupling layer seems to flow entirely in some locations in the hybrid PEI-60 sample. PEEK: polyetheretherketone; PEI: polyetherimide.

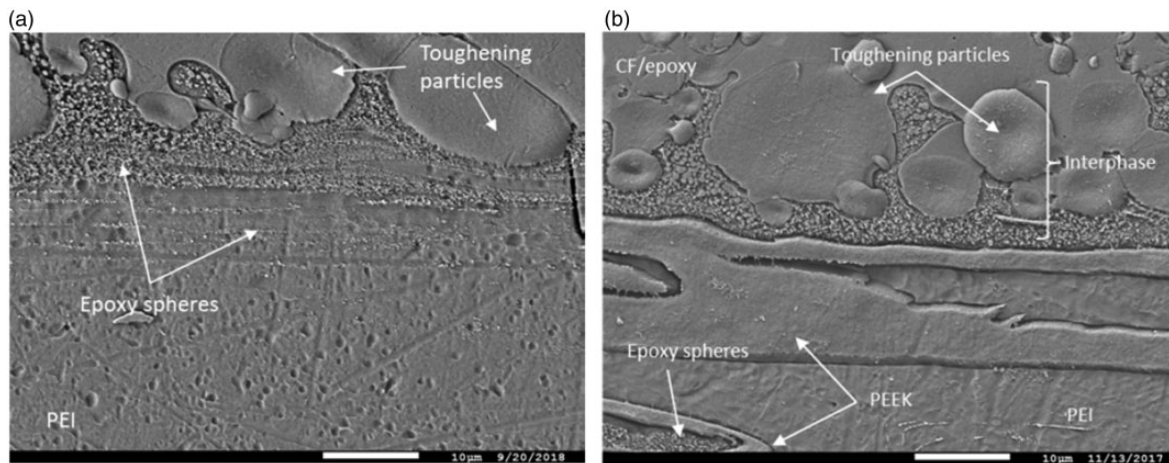

Figure 13. SEM micrographs of the cross-sections of (a) a hybrid PEI 60 sample and (b) a hybrid PEEK-60 sample. The interphase was affected by the welding process for both configurations. PEEK: polyetheretherketone; PEI: polyetherimide; SEM: scanning electron microscopy.

reason for that is most likely the fact that PEI softens at a temperature much lower than the melting temperature of PEEK, hence the majority of the 60- μm -thick coupling layer probably flowed before the PEEK matrix in the adherend started melting. On the other hand, the weld line of the hybrid PEEK-250 sample consists of mostly PEI resin (implied by the ratio between the dark and light grey areas), since the coupling layer is much thicker. Using optical micrographs to determine whether the coupling layer flowed in the hybrid PEI-60 and hybrid PEI-250 samples was not possible, since both coupling layer and ED are made out of the same material; hence, they could not provide any contrast in the images.

SEM analysis of the weld lines of the hybrid samples was performed in order to determine whether the welding process had an effect on the PEI-epoxy-interphase. Figures 13 and 14 present SEM micrographs of the cross-section of representative hybrid-60 and hybrid-250 samples, respectively. It is clearly seen that the interphase morphology in the hybrid-60 samples is altered during the welding process, as some of the epoxy spheres seem to flow along with the softened PEI coupling layer. The fact that the epoxy spheres flow in the hybrid PEI-60 samples is another indication that the coupling layer probably flowed almost entirely during the welding process. However, the interphase remained intact in the hybrid-250 samples.

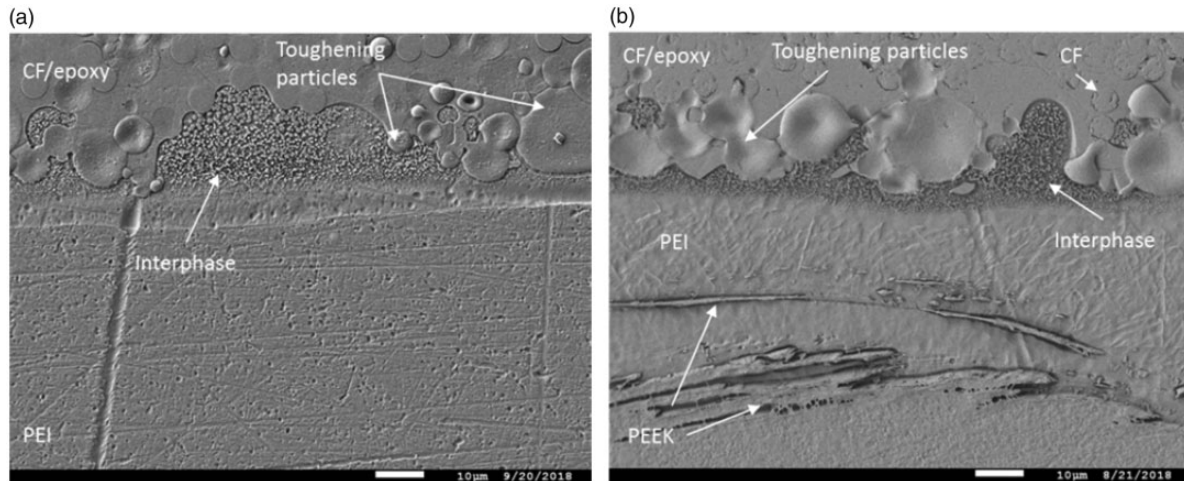

Figure 14. SEM micrographs of the cross-sections of (a) a hybrid PEI 250 sample and (b,c) a hybrid PEEK-250 sample. For both configurations, the interphase seems intact after the welding process.

PEEK: polyetheretherketone; PEI: polyetherimide; SEM: scanning electron microscopy.

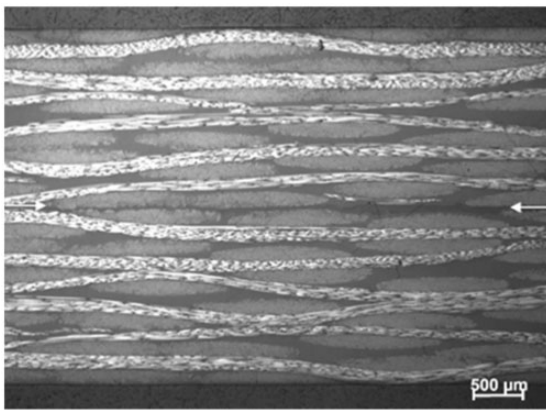

Figure 15. Cross-sectional micrograph a reference PEI sample. The weld line thickness is similar to that of the resin-rich areas in the composites. White arrows indicate the weld line. A similar micrograph was obtained with the reference PEEK samples. PEEK: polyetheretherketone; PEI: polyetherimide.

The 250- μm -thick coupling layer is probably thick enough in order to prevent flow of the PEI resin to occur close to the interphase.

Another observation made from the SEM micrographs is that there is a clear boundary between the PEI and PEEK resins. This means that the two resins did not blend very well at the weld line. This is probably because of the significantly short welding times provided by the ultrasonic welding process, which prevented the two materials from diffusing into one another.

Figure 15 illustrates a representative cross-section of a reference PEI sample. A similar micrograph was obtained with the reference PEEK samples. Both reference configurations produced samples with almost no

Table 1. LSS values with corresponding scatter.

Welding configuration	LSS (MPa) with coefficient of variation (%)
Hybrid PEI-250	$37.5 \pm 3\%$
Hybrid PEEK-250	$40.8 \pm 5\%$
Hybrid PEI-60	$32.4 \pm 4\%$
Hybrid PEEK-60	$34.9 \pm 4\%$
Reference PEI	$42.6 \pm 1\%$
Reference PEEK	$44.8 \pm 9\%$

LSS: lap shear strength; PEEK: polyetheretherketone; PEI: polyetherimide.

distinguishable weld line, as expected from TPC samples welded under optimum conditions.⁷

Mechanical performance

Table 1 illustrates the results of the single-lap shear tests. The hybrid-250 configurations yielded higher average LSS as compared to the hybrid-60 configurations. However, the hybrid configurations yielded lower average LSS than their respective reference configurations. The results of the analysis of variance (ANOVA) presented in Table 2 show that whether the ED is PEEK or PEI does not have a significant effect on the apparent LSS of the hybrid-60 and reference welds. For the hybrid-250 samples, the F and F_{crit} values imply that the scatter within each configuration is too high to clearly determine whether they come from

Table 2. ANOVA results.

Comparison	F	F_{crit}	Same population ($F < F_{crit}$)?
Hybrid PEEK-60 and hybrid PEI-60	3.76	5.59	Yes
Hybrid PEEK-250 and hybrid PEI-250	5.960315	5.317655	–
Reference PEEK and reference PEI	0.99408	5.317655	Yes

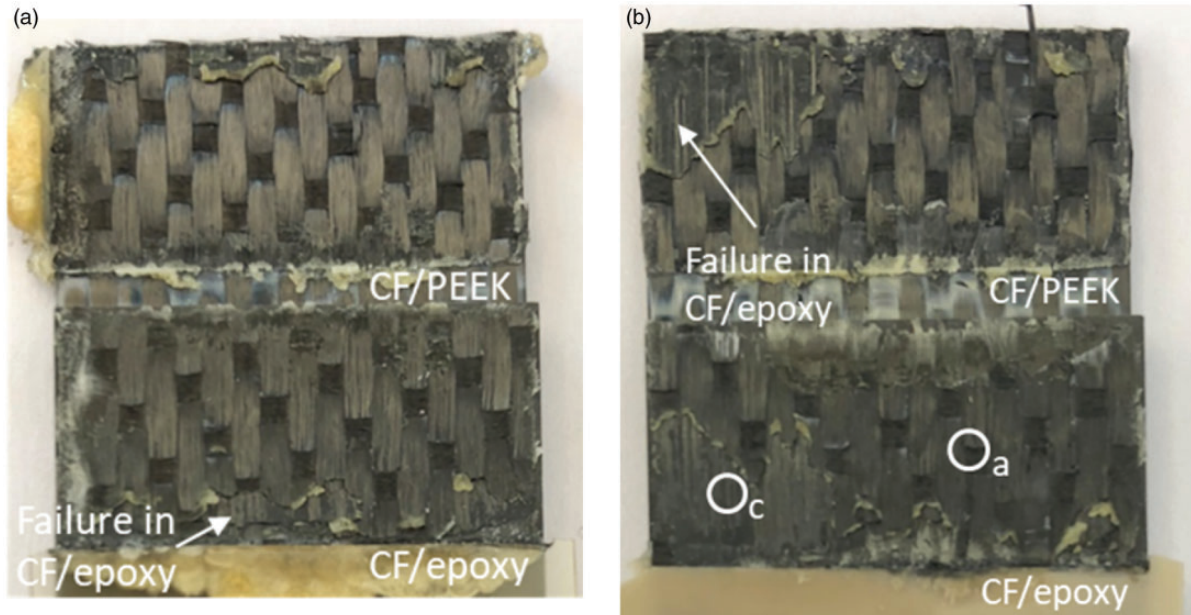

Figure 16. Fracture surfaces of (a) a hybrid PEI-250 sample and (b) a hybrid PEEK-250 sample. PEEK: polyetheretherketone; PEI: polyetherimide.

the same population. The hybrid PEI-250 samples yielded an average LSS of 37.5 MPa with 3% coefficient of variation. The hybrid PEEK-250 samples yielded a somewhat higher average LSS of 40.8 MPa with 5% coefficient of variation. As seen in Figure 16, both configurations failed predominantly in the CF/PEEK adherend and the failure was characterised by broken fibre bundles, which were covered by a thin layer of fractured PEEK resin (see Figure 17). Some of the hybrid-250 samples also featured upon testing partial failure in the CF/epoxy adherend, characterised by exposed fibres and brittle matrix failure, as also seen in Figure 17. However, for the hybrid PEI-250 samples this type of failure can be neglected as it was very limited to areas close to an edge of the overlap, whereas for the hybrid PEEK-250 samples this failure type covered a larger area. Failure in the CF/epoxy in the hybrid PEEK-250 samples might indicate local thermal damage on the epoxy resin due to the high temperature of the molten PEEK ED.

As already mentioned, welding through a 60- μ m-thick coupling layer resulted in a lower LSS than

welding through a 250- μ m-thick coupling layer. Figure 18(a) and (b) depict the fracture surfaces of representative hybrid PEI-60 and hybrid PEEK-60 samples, respectively. For both configurations, failure occurred mostly in the CF/epoxy adherend which, as seen in Figure 19(a), was characterised by exposed fibres and brittle matrix failure. This type of failure can be attributed to either the fact that the interphase was affected during welding, hence the bond between the epoxy and PEI resin might have been weakened, and/or the possibility that the epoxy resin was thermally damaged due to the high temperatures that were measured between the coupling layer and the CF/epoxy adherend in the hybrid-60 configurations (see Figure 10). Partial failure in the CF/PEEK adherend, towards the edges, can be seen as well, characterised by broken fibre bundles, covered by a thin layer of fractured PEEK matrix (see Figure 19(b) and (c)).

Another feature of both hybrid-60 configurations was the unwelded areas that covered \sim 20% of the whole overlap. Evidence of the unwelded areas can be

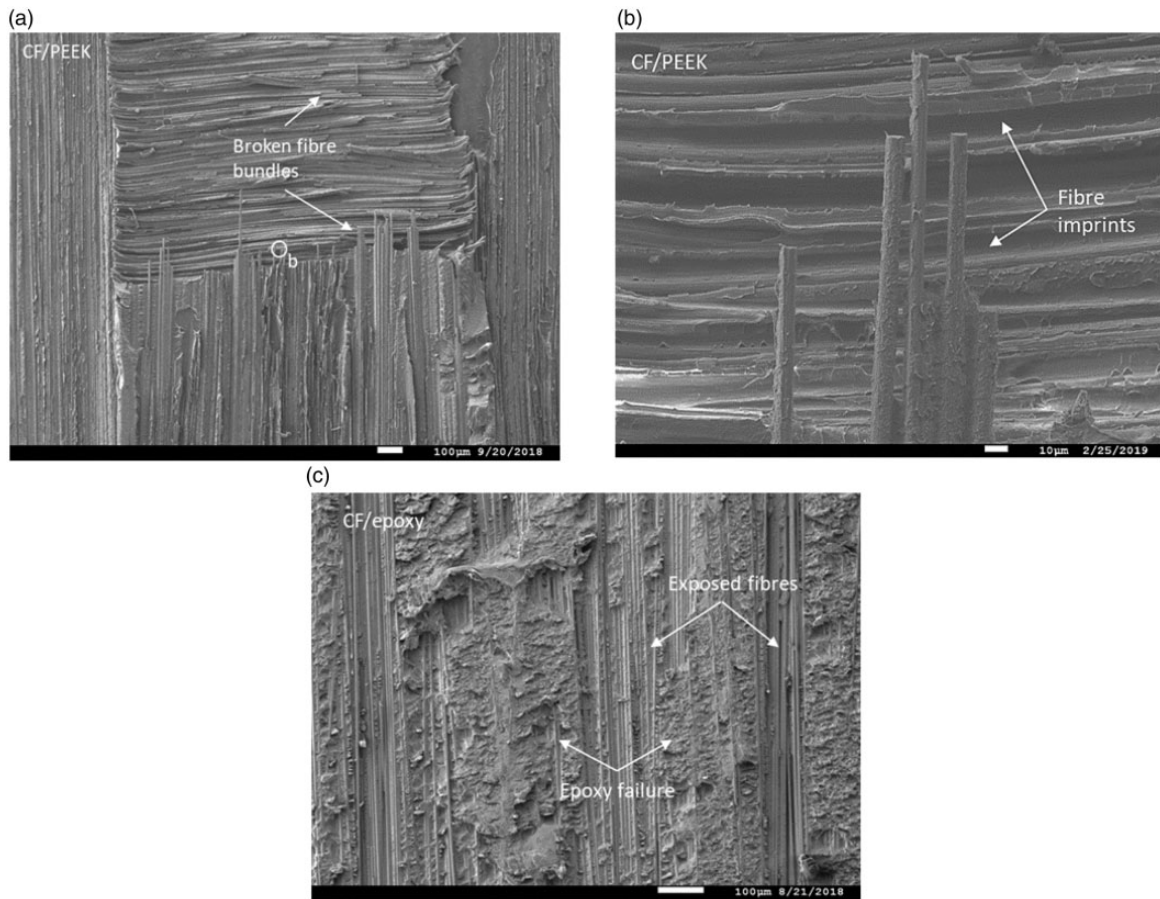

Figure 17. (a) SEM detail of the circled area 'a' in Figure 16(b), showing broken fibre bundles of the CF/PEEK adherend attached on the CF/epoxy adherend, (b) SEM detail of the circled area 'b' in (a) showing fibres covered in PEEK resin and fibre imprints and (c) SEM detail of the circled area 'c' in Figure 16(b) showing failure in the CF/epoxy characterised by epoxy resin failure and exposed fibres. Note that the above-mentioned SEM micrographs also apply to the hybrid PEI-250 configuration. CF/PEEK: carbon fibre/polyetheretherketone; SEM: scanning electron microscopy.

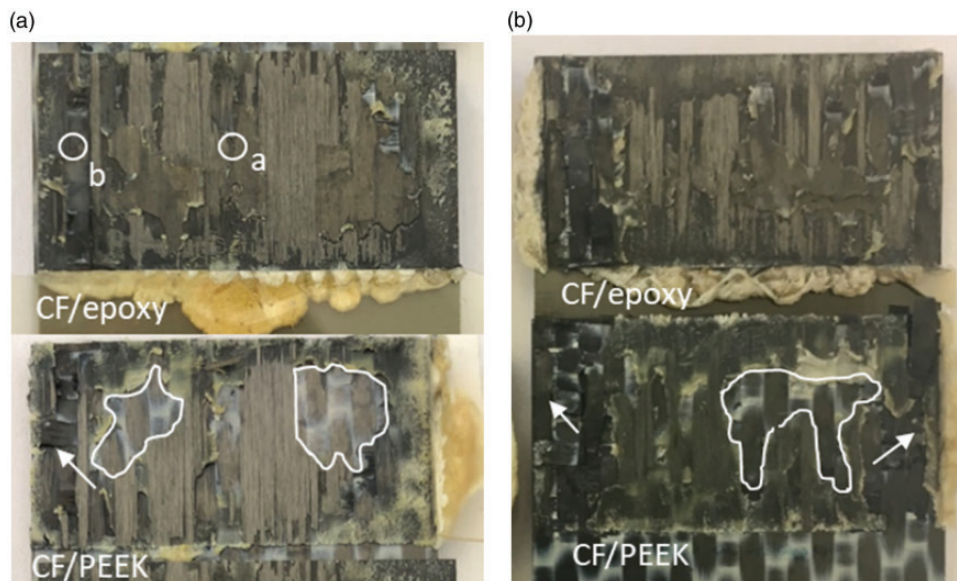

Figure 18. Fracture surfaces of (a) a hybrid PEI-60 sample and (b) a hybrid PEEK-60 sample. The unwelded areas are highlighted by the white lines. The locations where failure in the CF/PEEK adherend occurred is indicated by the white arrows. CF/PEEK: carbon fibre/polyetheretherketone; PEI: polyetherimide.

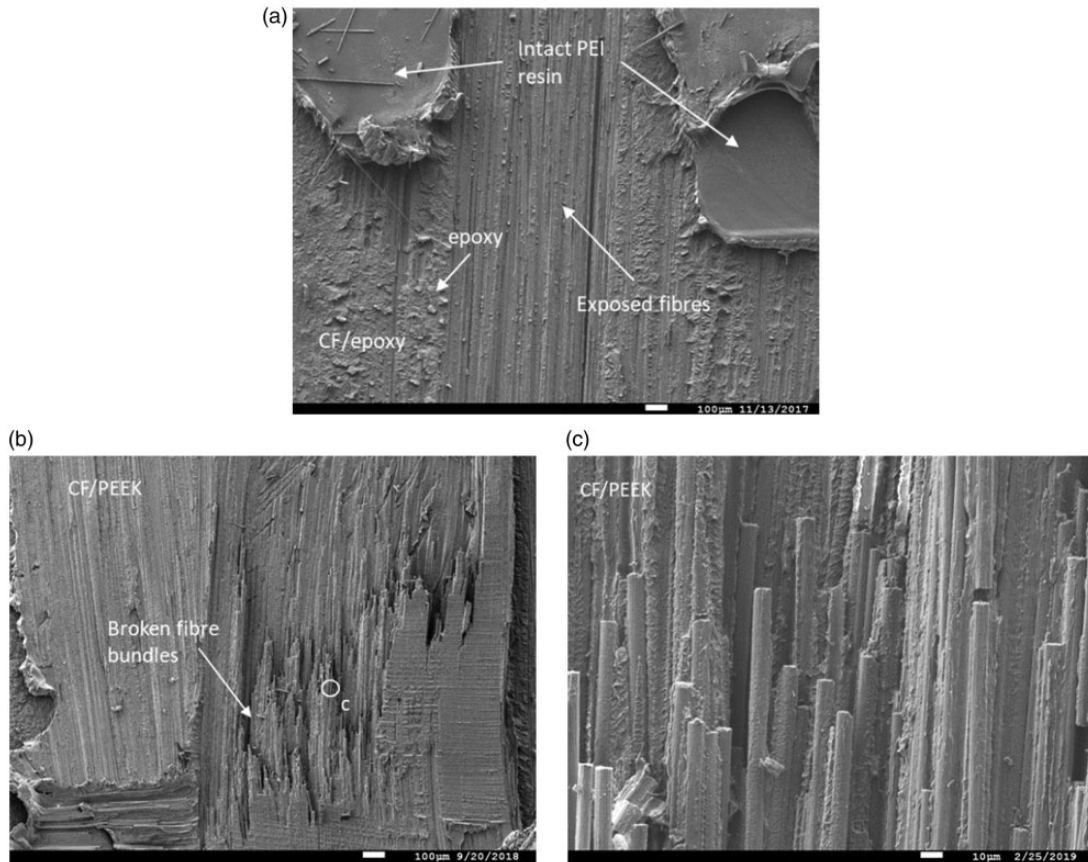

Figure 19. (a) SEM detail of the corresponding circled area in Figure 18(a), showing failure in the CF/epoxy characterised by epoxy resin failure, exposed fibres and intact PEI resin, (b) SEM detail of the corresponding circled area in Figure 18(a) showing broken fibre bundles of the CF/PEEK adherend attached on the CF/epoxy adherend and (c) SEM detail of the corresponding circled area in (b) showing broken fibres covered in PEEK resin. Note that the SEM micrographs of the fracture surfaces were similar for both configurations; hence, the micrographs apply to both hybrid-60 configurations.

CF/PEEK: carbon fibre/polyetheretherketone; SEM: scanning electron microscopy.

seen in Figure 19(a), indicated by the intact PEI resin. The unwelded areas were an indication that a higher displacement (hence longer heating time) was needed in order to fully melt the surface of the CF/PEEK adherend. However, welding at a higher displacement (0.17 mm instead of 0.13 mm for the hybrid PEEK-60 samples and 0.19 mm instead of 0.17 mm for the hybrid PEI-60 samples) resulted in welds that failed entirely in the CF/epoxy adherend, with fracture surfaces that featured mostly exposed fibres as seen in Figure 20, and a noticeable decrease of LSS to around 20 MPa, when compared to samples welded at the lower displacement values. Such failure is an indication of thermal degradation of the epoxy resin. Therefore, achieving fully welded areas without a significant drop in the LSS was not possible when the 60- μ m-thick coupling layer was used. This finding seems to support the hypothesis that the 60 μ m coupling layer cannot shield the CF/epoxy adherend from the high temperature in the weld line long enough to prevent thermal degradation

in the epoxy resin, when welded to a CF/PEEK adherend. In previous work,¹¹ in which a CF/PEI adherend was welded instead of the CF/PEEK adherend as in this study, the 60- μ m-thick coupling layer was found to be sufficient for the production of high-strength welds, most likely because of the much lower temperature that is needed to soften the PEI matrix.

Table 1 also presents the LSS values of the reference samples. The reference PEEK samples yielded the highest average strength of all listed configurations. Both reference configurations presented fully welded areas as seen in Figure 21. Figure 22 shows that the main difference in the failure locus of the two configurations was that failure in the reference PEI samples occurred within the first ply of the adherends, whereas the reference PEEK samples also featured failure within the second ply.

The hybrid PEI-250 samples and the hybrid PEEK-250 samples exhibited only 12% and 9% lower LSS as compared to the corresponding reference samples,

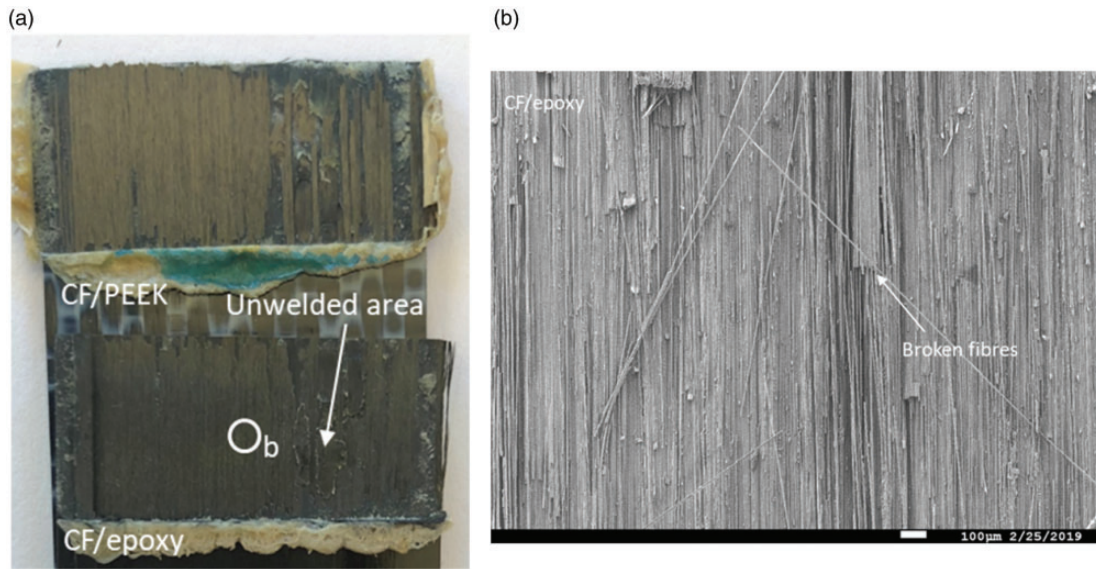

Figure 20. (a) Fracture surfaces of a hybrid PEEK-60 sample welded at 0.17 mm displacement and (b) SEM detail of the corresponding circled area in (a), showing failure in the CF/epoxy adherend characterised by exposed and broken fibres. CF: carbon fibre; PEEK: polyetheretherketone; SEM: scanning electron microscopy.

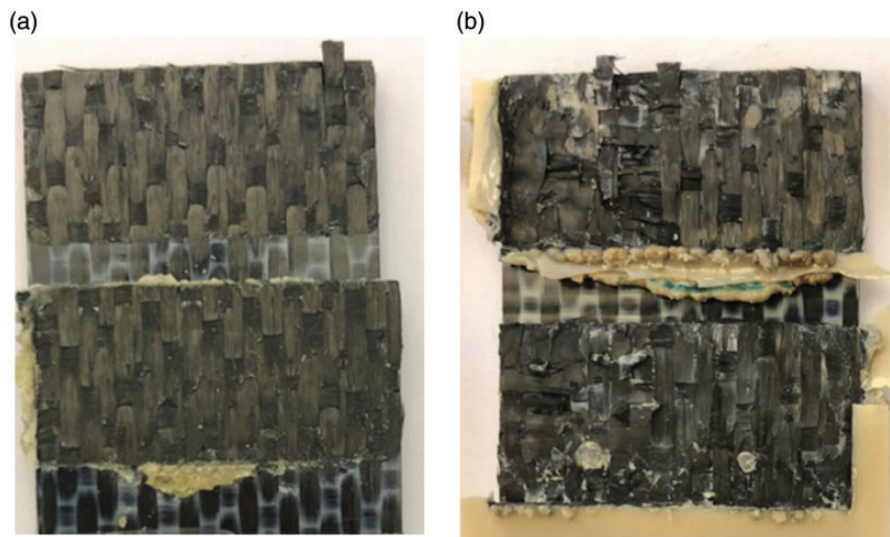

Figure 21. Fracture surfaces of a (a) reference PEI sample and (b) reference PEEK sample. Both samples featured fully welded overlaps. PEEK: polyetheretherketone; PEI: polyetherimide.

respectively. However, comparison between the LSS of the hybrid-250 and the corresponding reference samples is not straightforward because of the different adherends in each configuration.

In this study and in our previous one¹¹ several practices have been suggested in order to successfully weld epoxy- and thermoplastic-based composites by means of ultrasonic welding. Tsiangou et al. had shown that

welding CF/epoxy and CF/PEI composites through a 250- μm -thick PEI ED on top of a 60- μm -thick PEI coupling layer resulted in welds with a similar mechanical performance as reference co-cured samples of the same adherends.¹¹ In the current study, for welding of CF/epoxy and CF/PEEK adherends a 60- μm -thick coupling layer was not sufficient to produce welds with an acceptable LSS, possibly due to the higher

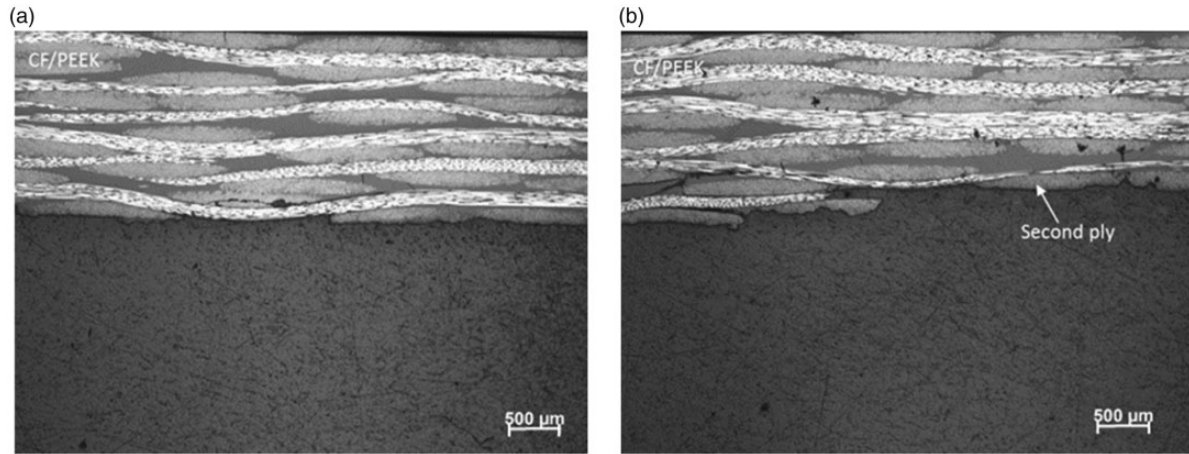

Figure 22. Cross-sections of one adherend after mechanical testing of (a) the reference PEI configuration, showing failure within the first ply and (b) the reference PEEK configuration, showing failure within the first and second plies.

PEEK: polyetheretherketone; PEI: polyetherimide.

melting temperature of the PEEK matrix as compared to the PEI matrix of our previous study. Increasing the coupling layer thickness to 250 μm and using either a PEEK or a PEI ED allowed for welds with a comparable LSS to reference CF/PEEK welds. Remaining open gaps in the knowledge of ultrasonic welding of such dissimilar composites include the determination of the robustness of this ultrasonic welding process with respect to the duration of the vibration phase and its sensitivity to the process parameters (i.e. welding force and amplitude of vibrations).

Conclusions

This paper presents an experimental study on the effect of (i) the ED material and (ii) the thickness of the coupling layer on the ultrasonic welding process of CF/epoxy and CF/PEEK welds. Four welding cases were considered, welding with (a) a 60- μm -thick PEI coupling layer and a PEI ED (hybrid PEI-60 configuration), (b) a 60- μm -thick PEI coupling layer and a PEEK ED (hybrid PEEK-60 configuration), (c) a 250- μm -thick PEI coupling layer and a PEI ED (hybrid PEI-250 configuration) and (d) a 250- μm -thick PEI coupling layer and a PEEK ED (hybrid PEEK-250 configuration). These welding configurations were then compared to two reference cases, namely CF/PEEK welds with either a PEI ED (reference PEI configuration) or a PEEK ED (reference PEEK configuration). The main conclusions are the following:

- The nature of the material of the ED did not have a significant effect on the apparent LSS of the hybrid and reference configurations.
- In the hybrid-60 configurations, the morphology of the PEI-epoxy interphase was altered after welding,

most likely because the coupling layer flowed almost entirely before the matrix of the CF/PEEK adherend melted. The interphase remained intact in the hybrid-250 configurations, since the coupling layer was much thicker.

- The hybrid-60 samples exhibited unwelded areas that covered $\sim 20\%$ of the overlap. Attempting to achieve fully welded areas in the hybrid-60 samples resulted in apparent thermal damage in the CF/epoxy adherend. Hence, it is believed that the thin coupling layer could not act as a sufficient thermal barrier for the CF/epoxy adherend.
- The hybrid-250 samples featured fully welded overlaps and failed predominantly in the CF/PEEK adherend, demonstrating none or limited thermal damage in the CF/epoxy adherend. The LSS were comparable to the reference configurations, demonstrating the promising potential of ultrasonic welding of dissimilar composites.

Acknowledgements

This research is part of the European project EFFICOMP that focuses on efficient manufacturing of composite parts.

Declaration of Conflicting Interests

The author(s) declared no potential conflicts of interest with respect to the research, authorship, and/or publication of this article.

Funding

The author(s) disclosed receipt of the following financial support for the research, authorship, and/or publication of this article: This work is supported by European Union Horizon 2020 research and innovation program under grant agreement no. 690802.

ORCID iDs

Eirini Tsiangou  <https://orcid.org/0000-0002-8382-531X>
Sofia Teixeira de Freitas  <https://orcid.org/0000-0002-0847-6287>

References

1. Villegas IF and van Moorlegghem R. Ultrasonic welding of carbon/epoxy and carbon/PEEK composites through a PEI thermoplastic coupling layer. *Compos Part A Appl Sci Manuf* 2018; 109: 75–83.
2. Ageorges C, Ye L and Hou M. Advances in fusion bonding techniques for joining thermoplastics materials composites: a review. *Compos Part A Appl Sci Manuf* 2001; 32: 839–857.
3. Lestriez B, Chapel J-P and Gérard J-F. Gradient interphase between reactive epoxy and glassy thermoplastic from dissolution process, reaction kinetics, and phase separation thermodynamics. *Macromolecules* 2001; 34: 1204–1213.
4. Deng S, Djukic L, Paton R, et al. Thermoplastic-epoxy interactions and their potential applications in joining composite structures - A review. *Compos Part A Appl Sci Manuf* 2015; 68: 121–132.
5. Grewell DA, Benatar A and Park JB. *Plastics and composites welding handbook*. Munich: Hanser Gardner Publications, 2003.
6. Villegas IF and Rubio PV. On avoiding thermal degradation during welding of high-performance thermoplastic composites to thermoset composites. *Compos Part A Appl Sci Manuf* 2015; 77: 172–180.
7. Villegas IF. In situ monitoring of ultrasonic welding of thermoplastic composites through power and displacement data. *J Thermoplast Compos Mater* 2015; 28: 66–85.
8. Zhang Z, Wang X, Luo Y, et al. Study on heating process of ultrasonic welding for thermoplastics. *J Thermoplast Compos Mater* 2010; 23: 647–664.
9. Villegas IF. Strength development versus process data in ultrasonic welding of thermoplastic composites with flat energy directors and its application to the definition of optimum processing parameters. *Compos Part A Appl Sci Manuf* 2014; 65: 27–37.
10. Lionetto F, Morillas MN, Pappadà S, et al. A Hybrid welding of carbon-fiber reinforced epoxy based composites. *Compos Part A Appl Sci Manuf* 2018; 104: 32–40.
11. Tsiangou E, Teixeira de Freitas S, Villegas IF, et al. Investigation on energy director-less ultrasonic welding of polyetherimide (PEI)- to epoxy-based composites. *Compos Part B Eng* 2019; 173.
12. Schieler O and Beier U. Induction welding of hybrid thermoplastic-thermoset composite parts. *Int J Appl Sci Technol* 2016; 9: 27–36.
13. Benatar A and Gutowski TG. Ultrasonic welding of PEEK graphite APC-2 composites. *Polym Eng Sci* 1989; 29: 1705–1721.
14. Abouhamzeh M and Sinke J. Effects of fusion bonding on the thermoset composite. *Compos Part A Appl Sci Manuf* 2019; 118: 142–149.