



Lintel in a dry-stacking system for masonry

MSc Thesis in Building Technology

By: J.J. Wassing

Lintel in a dry-stacking system for masonry

J.J. Wassing

J.J.Wassing@student.tudelft.nl

Strn. 4162706

04-07-2018

Mentors:

Ir. K.B. Mulder

Ir. G.J. Arends

External examiner

Drs. D.J. Dubbeling

Delft University of Technology

Faculty of Architecture and the Build Environment

Master Building Technology

Julianalaan 134

2628BL, Delft, Netherlands

Abstract

For over ten years the number of skilled masons has been dropping. A large drop was due to the collapse of the housing bubble in 2008. The trend has continued, as the aging workforce is leaving the field. Educators have not been able to enthuse enough people to fill the ranks left by the retirees. The result is delays in construction, as contractors struggle to find enough workers. Also, the hourly wage of masons has increased, compared to similarly skilled jobs.

To mitigate the problem, several dry stacking systems for masonry have come on the market in recent years. Dry stacking eliminates the skill necessary to make masonry, by more closely controlling the interfaces between components. By doing this dry stacked masonry tend to lose some of the abilities of its traditional cousin. One of these is the ability to span a facade opening, without hanging the masonry from the inner cavity-leaf.

The objective of this research is to investigate the possibilities to span a façade opening using dry stacked masonry. The investigations focus on a single system, namely H-block by the company Drystack bv. The result is seven typologies elaborated in varying depth. The typologies range from integrating existing lintels into H-block, to the investigation of the structural potential of masonry itself.

One typology was chosen to elaborate on further. This typology uses vertical prestress to create various internal arches in the masonry to span the facade opening. The report describes the presumed workings of this lintel and concludes with a full-scale prototype.

Keywords

Masonry, Brick, Lintel, Dry stack, Mortarless, vertical prestress

Preface

This report is my graduation thesis for the Master track Building Technology, at the Faculty of Architecture and the Built Environment of Delft University of Technology. It signifies the final result of a nine month investigation into the world of dry stacked masonry.

Firstly, I'd like to thank my first mentor, Koen Mulder, for his unwavering enthusiasm. And for properly introducing me to the art of masonry. Also, a big thanks to Jan Arends, my second mentor, for his knowledge and the interesting talks on structural aspects of this thesis.

My thanks to people of DryStack bv. (Dennis Deen, Sjon de Koning en Cas van Zanden) for developing an interesting product and letting me join meetings and being open with information. It has been fascinating to see part of the process of getting a product certified and on the market. I will be following the developments of the system in the coming years. Additionally, I'd like to thank them for providing the materials for the brick models.

Lastly, I would like some attention to the quote printed below. It has been in the back of my mind in the making of this thesis. It talks about the need to honor the material you're working with.

For the last 60 years or so, masonry seems to have rarely been honored. The choice for masonry has often, not been on basis of its merits, but a default. In this position, we have taken most of its responsibilities away from the masonry. The attributes that made masonry a part of the culture have all but gone.

The attention to detail, the playfulness and the choice of expression which were commonplace, have been replaced by a quick hatch and the occasional off-colored brick.

New techniques have the potential to return some honor to masonry. Whether this will happen remains to be seen. I hope this thesis can contribute to the restoration of a little bit of honor to contemporary masonry.

Jeroen Wassing, Delft, June '18

*“If you think of Brick, you say to Brick, ‘What do you want, Brick?’ And Brick says to you, ‘I like an Arch.’ And if you say to Brick, ‘Look, arches are expensive, and I can use a concrete lintel over you. What do you think of that, Brick?’ Brick says, ‘I like an Arch.’
And it's important, you see, that you honor the material that you use. [...] You can only do it if you honor the brick and glorify the brick instead of shortchanging it.”*

— Louis Kahn

Transcribed from the 2003 documentary 'My Architect: A Son's Journey by Nathaniel Kahn'. Master class at Penn, 1971.

Table of contents

Abstract	4
Preface	5
Background: A short introduction to masonry	8
Research framework	10
0.0 An introduction to H-block	12
0.1 Use case	13
0.2 Sustainability	14
0.3 Parts overview	16
0.4 Opportunities of the system	18
0.5 Future development	20
1.0 Typology 1: Adapting existing lintels	24
1.1 Background	25
1.2 Adapting lintel to H-block	27
1.3 New component, Half H-profile	29
1.4 Findings	30
2.0 Typology 2: Outside reinforcement	32
2.1 Component parts	33
2.2 Design workflow	34
2.3 Findings	35
3.0 Typology 3: Lintel in a component library	36
3.1 Profile stiffener	37
3.2 Wide head-joint	38
3.3 Findings	39
4.0 Typology 4: Horizontal prestress	40
4.1 Theory	41
4.2 Prototypes	42
4.3 Details	44
4.4 Findings	46
5.0 Typology 5: H-profiles in bending	48
5.1 Simplification	49
5.2 Testing: bending	51
5.3 Findings	54

6.0 Typology 6: Structural masonry	56
6.1 Structural wire-frame model	57
6.2 Testing: Behavior at break	62
6.3 Detailing	64
6.4 Findings	66
7.0 Typology 7: Vertical prestress	68
7.1 Theory: Load distribution in masonry	69
7.2 Theory: Corbeling	72
7.3 Precedent: Gevelklem	75
7.4.0 Structural behavior	76
7.4.1 Observations	83
7.4.2 Limiting factors	88
7.4.3 Variations	91
7.5.0 Detailing	94
7.5.1 Tension rod assembly	95
7.5.2 Hanging bricks	100
7.6 Safety	102
7.7.0 Construction process	103
7.7.1 Prefab construction	104
7.7.2 In-situ construction	105
7.8.0 Full-scale prototype	106
7.8.1 Continuous profile	108
7.8.2 Archetype	110
7.8.3 Loss of tension	111
7.9 Findings	112
Conclusions	114
Reflection	118
Addendum	121
References	122
Image references	124

Background:

A short introduction to masonry

For thousands of years people have made buildings by stacking blocks of material together, usually connecting them with mortar. This is called masonry. It is a way to make a solid structure from small, easy to move components. It negated the need for massive blocks of stone, while providing more security than wood. Masonry requires only two components, a block and a joint. This simplicity of masonry has made it possible for it to endure the test of time, almost unchanged.

The block gives the system its strength. It is usually a stone or stone-like material and has a wide variance in the size and precision of the block. From found rock, carved stone, brick, to now glass bricks. All imprecision in the blocks is taken up in the joint. So in general, the more imprecise the block, the larger the joint. The second purpose of the joint is to glue the blocks together. So all the blocks work, more or less, as a single unit.

Masonry is almost always laid in a bond. The bond is stacking pattern of the bricks. The overlap of the brick, in these patterns, gives the masonry its stability. In the times of solid masonry, the bonds were necessary to keep the two wythes of the wall together. Nowadays, with the single wythe thickness of the masonry, stretcher bond is used almost exclusively. This is when the brick overlap half a brick.

The last century:

The use of bricks in Dutch architecture has radically changed the last hundred years. In the beginning of the last century facades were still made with solid masonry walls. In 1901 legislation was drawn up for dwellings, to improve the quality of living. This accelerated the adoption of cavities in the masonry walls. In the following years, the improvements in the design of these cavity walls would increasingly separate the inner and outer cavity leaf.

In the 1960s and 70s advances were made in sand-lime stone construction. This would result in sand-lime stone starting to completely replace brick as a structural material in the Netherlands. Also in the 1970s, facades were starting to be supported by steel supports attached to concrete floors, rather than by the concrete floors themselves.

In the years following, the insulation inside the cavity would start to increase, and with it the size of the cavity. Another thing that increased, was the amount of expansion joints in the facade, to relieve cracking. (Vekemans, 2016)

In the present day, masonry is almost exclusively used as a cladding. The stability of the wall is ensured by the inner cavity leaf, made from some other material. However, brick is still the most common cladding for dwellings. It is ingrained in

figure 01, Jargon words

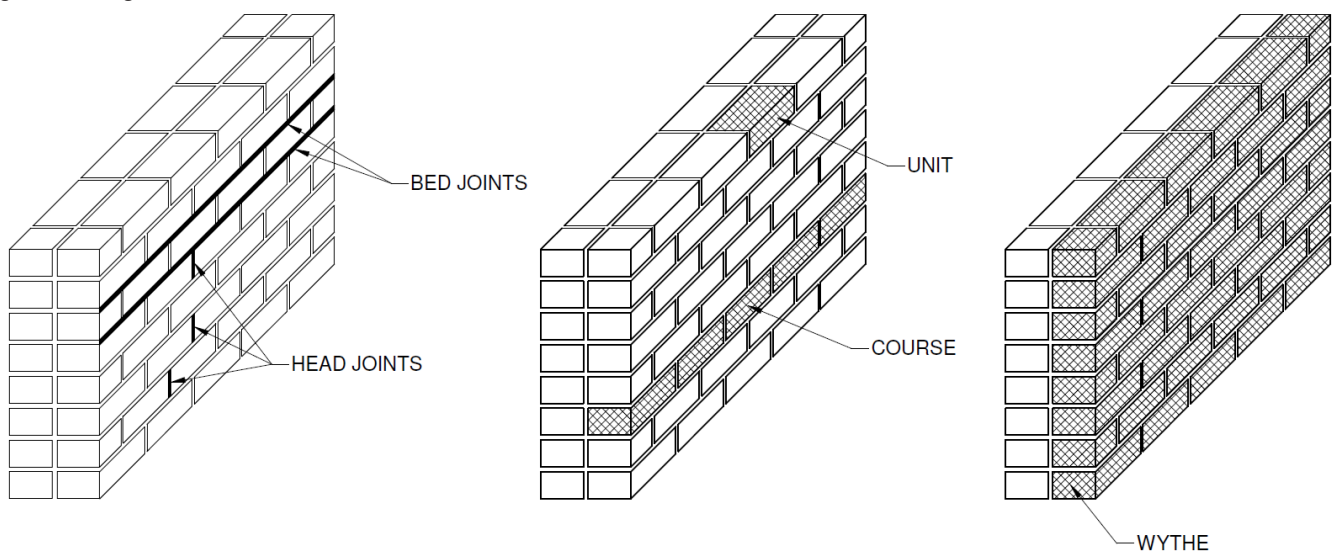

Dutch culture. It is a sign of quality. Houses have looked more or less the same for hundreds of years. People still expect their house to 'be made of' brick.

Masonry of the future, today

Masonry has a long history and shows no signs of going away anytime soon. How will masonry confront the challenges of the future.

Robots

Robotic masons which place bricks with incredible accuracy, straight from the computer model. This is actually not in the future at all. ETH Zurich is leading the charge of robots in architecture. Their masonry robots are already creating impressive masonry structures, using dry-stacked and glued brickwork.

Although the results of the ETH robots is the most impressive, robots are already taking over. In a visit to Ploegsteert, in Belgium, we saw a machine making the prefab structural masonry walls. It wouldn't be that much of a stretch to say these machines will be in other places as well.

Robots work best in a clean, controlled and known environment, using uniform bricks and properly mixed mortar or glue. Prefab is the easiest choice. However, SAM100 from Construction Robotics proves on-site work can be done as well. It is a semi-automated system, which means the robot lays the brick, and the workers finish the joints. Judging from the pictures and videos posted by CR, the results vary in neatness, but that will probably be further developed.



figure 02, ETH Zurich robot at work



figure 03, Automated wall production at Ploegsteert factory.



figure 04: Construction worker working next to SAM100 robot.

Research framework

Problem statement

Masonry is the most popular cladding for dwellings in the Netherlands. But it takes a lot of skill to construct a brick wall, and skilled masons are increasingly hard to find. For over ten years the number of skilled masons has been dropping. A large drop was due to the collapse of the housing bubble in 2008. The trend has continued, as the aging workforce is leaving the field. Educators have not been able to enthruse enough people to fill the ranks left by the retirees. The result is delays in construction, as contractors struggle to find enough workers. Also, the hourly wage of masons has increased, compared to similarly skilled jobs.

To combat this growing problem, several dry-stacking systems for masonry have come on the market in recent years. Dry stacking eliminates the skill necessary to make masonry, by more closely controlling the interfaces between components. This makes dry stacked masonry easier and often quicker to construct. The dry stacking also makes it possible to deconstruct and reuse components, and makes it easier to separate and recycle the materials.

Because of the simplification of the masonry, dry stacked masonry tend to lose some of the abilities of its traditional cousin. The modern dry-stacked systems haven't been around long enough to fully integrate the knowledge and capabilities that are available in traditional brick.

Façade openings are vital to the design of any building. They are made possible by the structure above it, the lintel. Dry-stacked systems often don't have lintels that use the strengths of the system. Rather, they use off the shelf products, that were made for traditional masonry.

Objective

The objective of this research is to investigate the possibilities to span a façade opening in a dry stacked masonry. The solutions need to be native to the system. Native in this sense means it is designed for or built into a certain system. The investigations focus on a single system, namely H-block by the company Drystack bv. The thesis will define multiple typologies, and develop them to varying degrees. The end result can be used to increase the speed of the first stages of future lintel development, by providing information on several possible routes of development.

Research question

How can a lintel be made, which is native to a dry-stacked system?

Sub-questions

- What are the defining characteristics of the dry-stacked system?
- How can existing products be integrated into the dry-stacked system?
- How can the dry-stacked system be used for a structural masonry lintel?

Design assignment

Investigating the structural potential of H-block will result in several designs for lintels, all with their own requirements and specifications. These typologies will then need to be bundled in such a way that they can be found and understood, and potentially spark new ideas for making lintels.

Method description

The research will be performed as a case study, in which the focus will be on a single dry-stacked system. The system in question is H-block.

The research starts with a literature review, to get a better understanding of traditional masonry. First in general and later specifically for lintels. Special attention will be given to the mechanics that result in the properties of the lintels, and how H-block changes these properties. The literature review will go hand in hand with testing with scale models. Some practical experience will be gathered, by helping with the building of two walls using H-block at the green village (4 to 8 December 2017).

Typology investigation

The thesis will define several typologies in varying depth. It will be discussed how the typologies could and should work, informed by theory, physical models and prototypes.

The idealized structural view of the typology will need to be translated to something that can be built. To do this, the specific problems that need to be solved in the detailing, will be defined. Where possible a potential solution will also be provided.

During the whole process, physical models and prototypes will help to find specific quirks of a typology and the best practices to alleviate that problems.

Relevance

The aim of this graduation project is to expose the structural potentials of the H-block system. With a greater understanding of these potentials, it will be stepping stone for the further development. The overview of possibilities for lintel constructions in the H-block system, can be useful for choosing a development path. Additionally, it may spark new ideas, which could be added, in later research. The research can hopefully also be used for development in other systems.

The research will also bring us one step closer to a self-bearing facade skin, that will reduce the load on the main structure, thus reducing the embodied energy of the structure. This is compounded by the re-use friendly attributes of drystacking, making it possible to deconstruct the outer facade and use it somewhere else.

Some of the design criteria of the lintel are the freedom to use different kinds of bricks and bonds. This will lead to more design freedom for architects and with that hopefully to more beautiful masonry (clad) buildings.

0.0 An introduction to H-block

This chapter will go into detail on this specific drystacking system, which forms the context of this research. It goes into how the system works, what the opportunities of the system are, and what developments are expected in the future.

H-block was created to react on two trends in the construction industry. The first, is the lack of skilled masons. The second is the push for prefabricated. The push for prefabrication is fueled by shorter on-site construction and better quality-control. Masonry is limited in its construction speed by the drying of mortar. Masonry can commonly grow one meter in height per day At which point the mortar need to dry, before it can support more masonry. The relatively long construction time of masonry has left contractors unable to optimize the building speed, leading them to choose different cladding materials.

To solve these problems, H-block replaces the mortar in the masonry with plastic components. The components click together to form a solid construction. H-block is designed in such a way, that no specific skill is required to make it. After a

short instruction, almost anyone can make a wall. The build speed is also increased, because it isn't bottlenecked by the drying of the mortar.

So, H-block is a dry stacking system for masonry walls. There are other systems on the market that do the same thing. ClickBrick and FixBrick are already available in the Netherlands and focus on facing bricks, just like H-block. Internationally, there are countless other systems for mortarless masonry and block-work. Most of these systems use specially produced bricks and reduce the joints to a minimum.

The way H-block is different, is that the bricks are only post-processed. Meaning they can come from almost any supplier. The joints are kept the same size as in traditional Dutch masonry.

H-block is a dry stacking system for masonry, that is being developed in the Netherlands. H-block isn't actually called H-block, this was a temporary name which was used when the thesis started, the name later changed to Drystack. However, H-block stuck for the thesis, partly because it is a better name, partly because it is less confusing in the text.

figure 05, H-block inventor and companion discussing their product



0.1 Use case

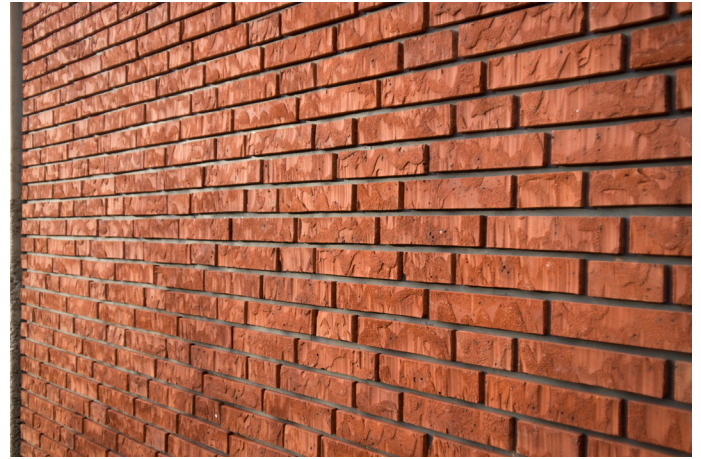

figure 06: Result at the Green village.

H-block was primarily designed for use as veneer masonry, as this is the most common form of masonry constructed today. H-block distinguishes three use cases: prefabricated high-rise, prefabricated low-rise, and on-site stacking.

At this moment, prefabrication is the main focus for H-block. The high-rise and low-rise strategies are very similar. In the assembly hall, the masonry will be constructed on a substructure. This substructure will be used to crane the masonry into place. It will stay in place during the lifetime of the facade. In high-rise, the substructure will be supported by the floors, while in the low-rise the substructures will be stacked on top of each other. The low-rise facade will ultimately be supported on the foundation.

Insulation would be integrated into the substructure and even the integration with the main structure is being investigated.

Dream house

H-block has formulated a long-term vision, which they call their dream house. This would be a standardized, modular house, which is prefabricated in a factory and assembled on site. The part most relevant to this thesis, is the proposed facade lifetime of 50 years, which is quite short when thinking of masonry facades. The idea is the facade can be refurbished quite easily and cheaply. For a small sum, the facade could be changed to fit the customers preference, like you would change a kitchen or a bathroom. Switching facades would take only a single day. Whether this is feasible, or even allowed under Dutch building code remains to be seen. However, it is an interesting approach to facade maintenance.

0.2 Sustainability

H-block has the potential to be quite sustainable, by following the principles of the circular economy. Where streams of goods do not only flow from the production chain towards the consumer, but also in reverse. To make this happen, it must be easy and worthwhile to establish these return flows (Brito & Dekker, 2002). People need to be convinced to do the sustainable option with some kind of personal gain (usually financial). Doing good for the world, is often not enough. The best way to If done well, H-block has the potential to have no substantial waste streams.

The largest problem of traditional brick, when viewing it from this angle, is the fact that the bricks are bonded together with cement-based mortar. The bricks can be used in the production of new bricks. However, the bricks and mortar are hard to separate from each other. Therefore, most masonry ends up as rubble under roads.

The following strategies are ordered according to energy consumption, with the first using the least amount of energy, and therefore being the most advantageous. The idea being, you move to the next step, only if the current step is not feasible.

Re-use

When the masonry is no longer useful in its current configuration, it is at end-of-use. The dry stacking nature of H-block, makes it possible to disassemble the masonry into its component parts, and re-stack them in a different configuration or on a different location. This makes it feasible to make temporary structures with masonry, which in traditional masonry should be frowned upon.

To make re-use work, the masonry will need to take apart carefully, with minimal damage to the components. This costs time and money. If the costs are too high, re-use is not feasible, and the components will just be recycled, or discarded. To make the most of the re-use potential, disassembly should be easy and quick. An adjustment to the system could be, to not have all head-joints click in the H-profiles. This would make the masonry come apart more easily, although this may not be desirable in all circumstances.

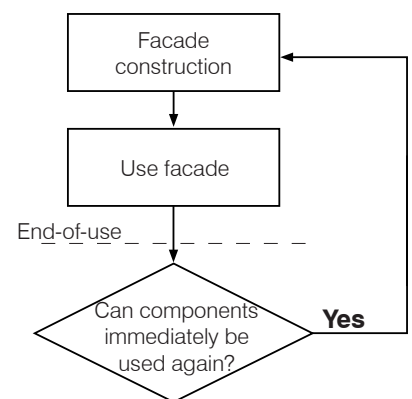

Re-processing

An often forgotten part of the circular economy. When a component can be re-used, but it needs a bit of work, to bring it up to par, it can be re-processed. For instance: if a façade of the 'dream house' comes back to the factory after twenty years. The profiles will still have another thirty years life span, but they cannot be sold as new anymore. If the profiles were made of galvanized steel, they could be re-galvanized, to make them as good as new. The shape value of the steel is preserved, i.e. the steel doesn't need to be molten and re-shaped.

Re-processing covers numerous actions, for example: repairing, re-furbishing and re-manufacturing. H-block will probably be focused on re-furbishing the H-profiles and head-joints, as the bricks have a much longer lifespan.

Re-cycle

Re-cycling is similar to re-use but on a material level. All shape value is lost. The most important thing for recycling is to have clean material streams. This can be very easily assured with H-block. As the components can be easily separated into clearly differentiated streams, because of the dry stacking nature of the system.

To improve the likelihood that the materials will actually be recycled. The value of the material at end-of-life needs to be high. The plastic used in the current version of H-block is quite a bad choice for this. The plastic can officially be recycled, but with the specific blend of additives, it is only valuable to H-block itself. Even then, 80% virgin material would need to be added in the recycling process.

Aluminium is a much better choice, if the material were to be optimized for the likelihood of recycling. Recycling aluminium takes about 10% of the cost of making virgin material. This makes it very valuable to the aluminium industry, especially if it is clear of other metals. If there is a substantial amount of aluminium in the façade, it is sure to be sold as scrap aluminium, unless the value of the components is higher for re-use.

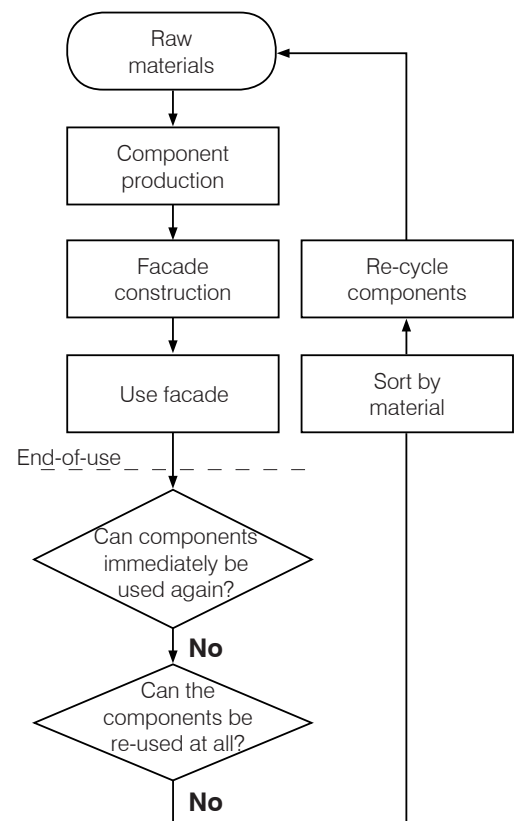
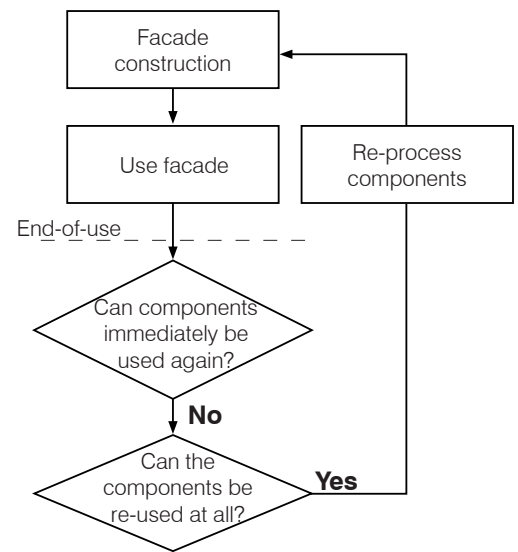

0.3 Parts overview

The H-block system consists of four main components: the brick, the bed-joint profile, the head-joint, and the cavity tie.

Brick

What is masonry without brick? As stated before the bricks for H-block are post-processed to get them in the shape that is needed. This means the bricks can come from almost any supplier. Two lengthwise channels are cut, to seat the bed-joint profile. In traditional masonry, the mortar is used to even out inaccuracies of the brick. In H-block this is impossible, therefore the channels are used to make the bricks a precise size where it matters, while preserving most of the looks of the brick. The length of the brick could also be controlled in a similar manner.

Bed-joint profile

The profile that forms the bed-joint of the masonry is shaped like the letter H. It will therefore sometimes also be called H-profile. In the current version of the system the length of the profile is 420mm, and in the production version the profiles will lock together. On the inside of the profiles there are small hooks, for the head-joint to snap into. The web of the profile has large holes, to make sure no water gets trapped in the masonry.

Head-joint

The head-joint fills the space between the bricks on every course. The head-joints snap into the bed-joints to ensure the minimum of gaps between the two components, for a better look. The head-joint could be designed to transfer loads, although it isn't now.



figure 07, H-block during construction at The Green Village

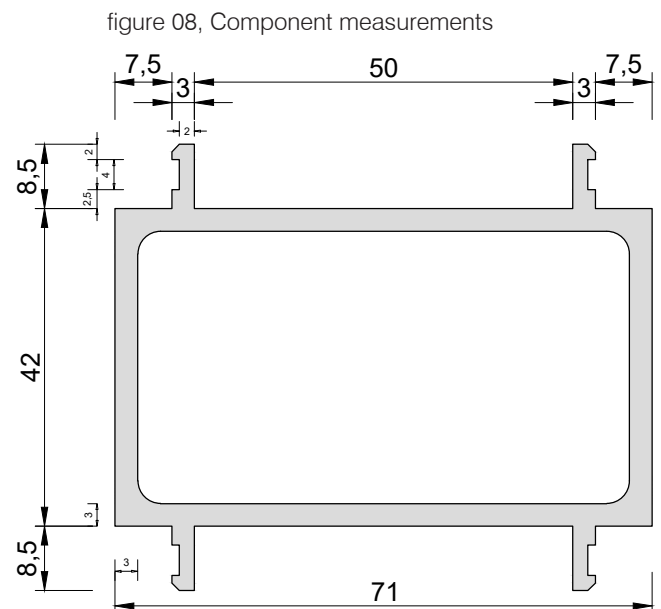
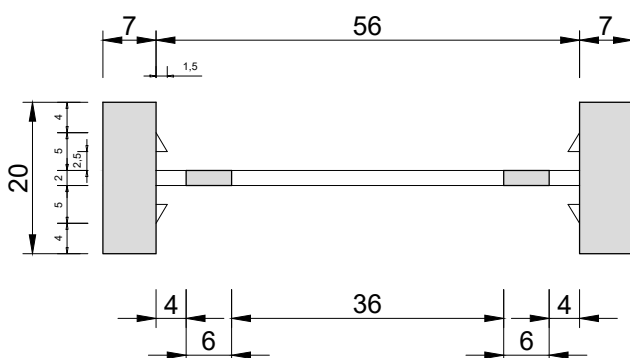

figure 08, Component measurements

Cavity ties

The cavity ties connect the masonry to the inner cavity leaf, thereby insuring out-of-plane stability of the masonry. The cavity ties needed to be redesigned, because of the lack of mortar. The final design isn't certain yet, but it can be expected to work the same as in traditional masonry.

Material

The plastic parts of H-block are made from a polyamide, with the commercial name: Durethan. The generic code is PA6, sometimes called nylon 6. In this case it will be glass filled, to either 25 or 30%, this is not clear yet.

PA6 is a widely used molding plastic, on the low end of the polyamide strength scale. All PA plastics absorb water, according to the CES database. Increased water content, makes the plastic more malleable and decreases the tensile strength. Of the PA plastics, PA6 has the highest water absorption.

Unmodified PA6 is flammable, but chemicals can be added to the resin to reduce the flammability to meet safety standards. This does impact the possibilities of the plastic to be recycled. The PA6 used for H-block is made flame-retardant.

Thermal properties

PA6 is a thermoplastic, meaning it can be melted with the application of heat. When the temperature approaches the melting temperature, the material starts to lose its mechanical properties. Around 200 °C the stiffness of the material is reduced significantly.

In case of a fire, the loss of stiffness can be a real problem and should be addressed. Fire testing is planned to be done for H-block, by an independent testing authority. The effect of heat and thermal radiation on the facade should be tested as much as the flammability.

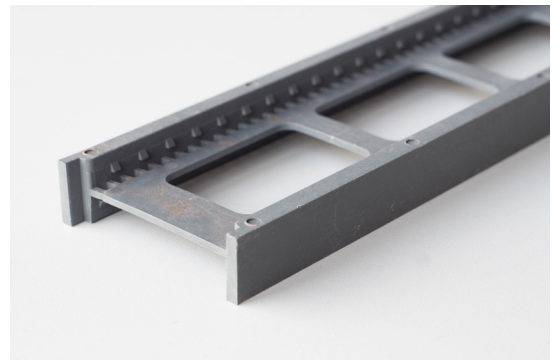
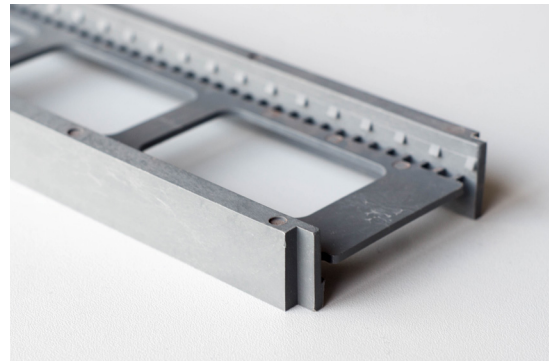
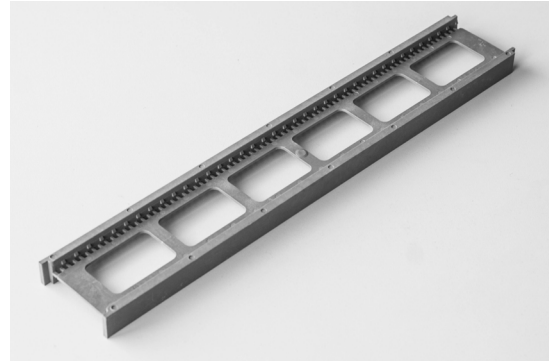

figure 09, H-block components in PA6

0.4 Opportunities of the system

Design freedom

H-block is a bit different where it comes to modern masonry systems, it has some design freedom. In the design of the lintel, this design freedom needs to be considered and where possible preserved. The freedom stems from the fact that the bricks and head joints can be placed anywhere along the length of the bed joint.

There is a large variety of bricks to choose from, as they can come from any manufacturer. It is even possible to include different materials in the walls, or modules with specific functions. Blocks and modules of different sizes can be included into the wall. And lastly the bricks can be ordered in any solid pattern. The size and visual appearance of the joints could be designed to an extent.

A good analog for the potential design freedom of H-block is the façade of the national library of Slovenia, designed by Jože Plečnik. Building this façade in H-block could be possible, if the design freedoms are not infringed upon in the development process.

Whether these design freedoms will be used in practice, remains to be seen. A bland wall in stretcher bond will always be cheaper to design and produce than an intricately designed wall. But at least the argument of skill of the masons can no longer be used to deny well designed facades.

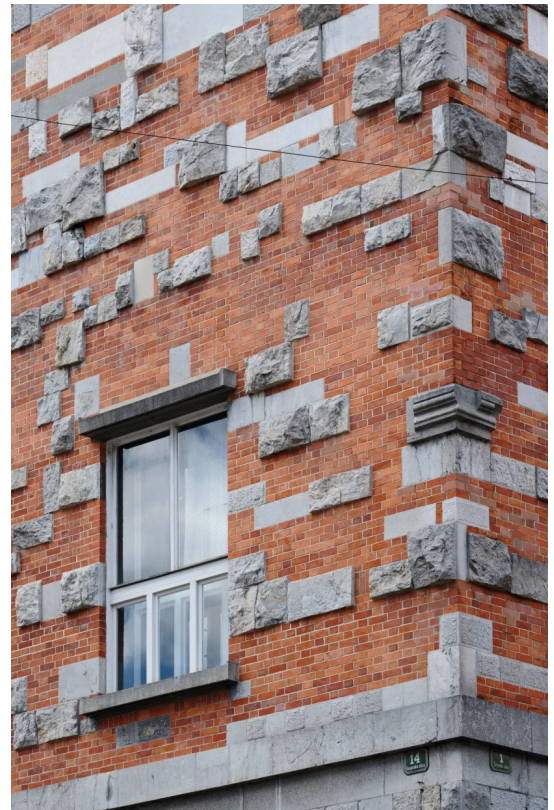

figure 10, National and university library of Slovenia, by architect Jože Plečnik

figure 11, Green Village prototype



Structural masonry

The recent Brick-BENG publication from the KNB (Royal Dutch Construction-ceramics association), shows there is a new interest in structural masonry. The interest isn't so much for masonry for the main structure of the building, rather it is about outer cavity-leaves that are mostly self sufficient in their structural needs.

The publication explores a case study of an intermediate height apartment block, that will fulfill the BENG norms, that will be enacted 2021 in the Netherlands. BENG stands for almost energy neutral building. The case study goes into the differences between building with veneer masonry, or double-wythe structural masonry.

The results show that structural masonry is marginally more expensive, but comes with some benefit in the form of reduced complexity

of construction, especially with thick layers of insulation (KNB, 2017a). The masonry is simpler to construct because it rests on the foundation, and it is only connected to the rest of the building at the floors, for stability. The main problem for this way of building is the increased amount of masonry that needs to be done to complete the building. With the current lack of masons this increases the risk of delays.

H-block may want to get into structural masonry. If they do, the masonry would need to be able to resist wind loads over the height of a floor. It might be possible to do this with the clicking head-joints. It could also be some other solution. In the current version of the product however, the test in the Green Village has shown that the walls aren't stable enough.

figure 12: Brick-BENG structural masonry detail, connection to floor

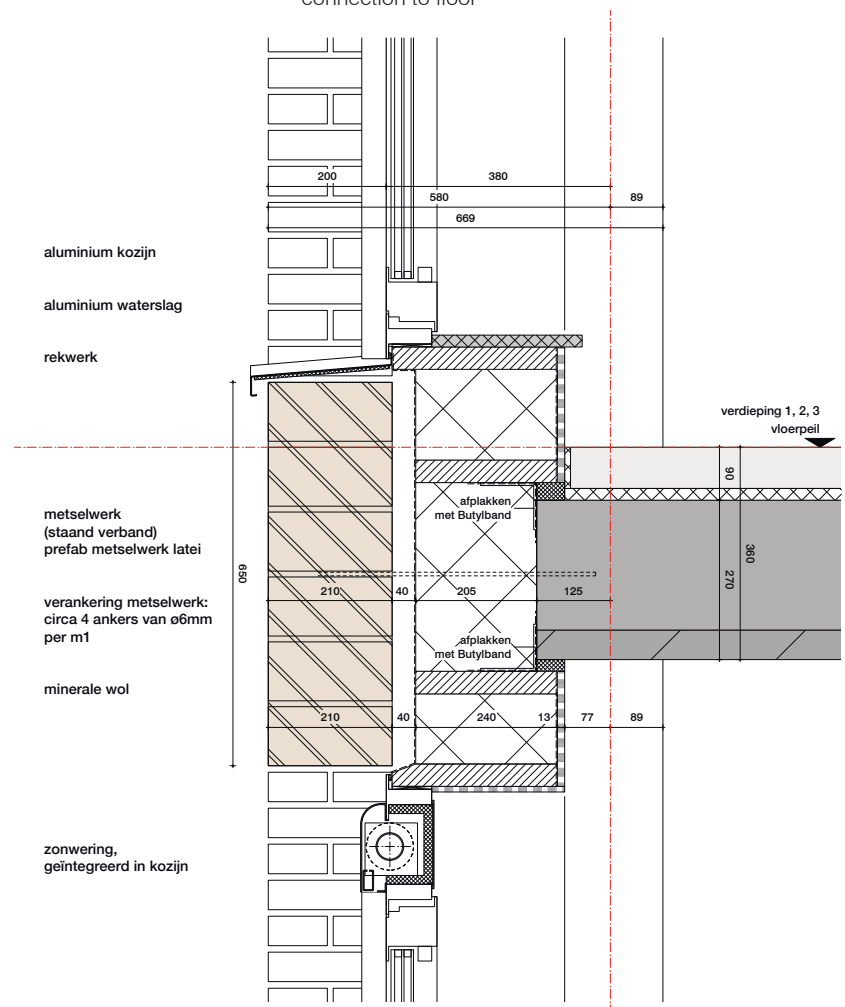

0.5 Future development

The parts overview describes the components of H-block as they were when the research started. However, development continues. Lessons learned in practice will be integrated in newer versions of the product. If necessary, the company isn't afraid to make radical design changes to the product. In some of areas, changes are already clear. They can be considered in the development of a lintel.

Longer H-profiles

The profiles are currently about 2 bricks long. This is quite short, and leads to lots of lines between components. Changes have already been made, to make the profiles attach to each other to minimize the lines.

In future the length of the profiles will probably increase to reduce the labor in placing the profiles. Initially, there are plans to increase the length to about a meter, with the current design. In the long term, it is quite feasible the profiles will be made to length. By changing the production process for the H-profiles to one that is continuous, the profiles can be cut to any length. The design of the lintels will not have to be limited by the length of the profiles that are currently available.



figure 14, Visible lines between plastic components

figure 13, Bend steel sheet concept

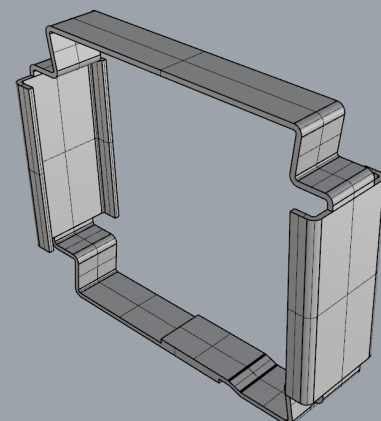
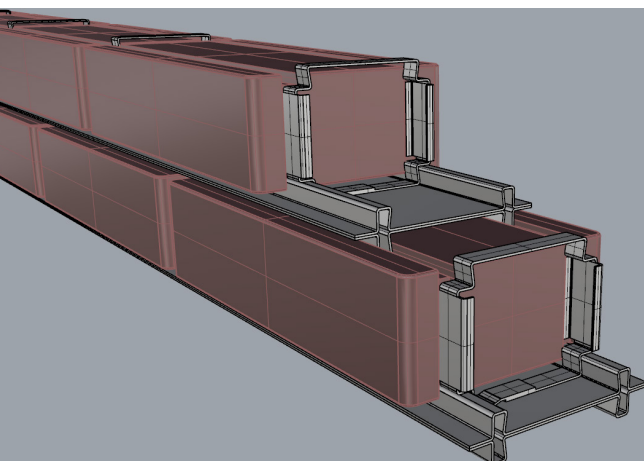

Changes of material

At this point the material of the material of the head-joints and bed-joints is likely to change. The PA6 is not quite suited to the scale of production H-block is planning. The material that will replace the current plastic is unknown, but a broad spectrum of materials is considered, some better suited for lintels than others.

A different plastic can replace the Nylon 6 that is currently used. Preferably, this would be non-flammable by itself, like polycarbonate. In the search for a new plastic, it should be reconsidered whether the glass fibers are necessary. The production process for plastics will probably remain the same, though extrusion is also possible.

Changing the material to a metal will probably be beneficial for making a lintel with masonry. The increased strength and stiffness will aid the structural applications. In the main body of the masonry, however, these properties are not so important.

Aluminium and steel are common building materials and are well suited for large scale production. For the scale of the components, the production will probably be with extrusion and some kind of sheet manipulation, for aluminium and steel respectively. In both materials it is possible to make strong mechanical connections between head and bed joints.

On the other end of the material scale, are the more stone-like materials. Ceramics or cement-based joints in a masonry wall sound quite logical. In the main body of the masonry these types of material can be beneficial, especially because of their thermal expansion coefficient like those of the bricks. These materials are less conducive to lintels, because of their generally limited tensile strength. In these materials the possibilities to make connections are also more limited than in aluminium and steel. It might require the masonry that is part of a lintel structure to have specialized joints.

figure 15, Aluminium extrusion concept, by Drystack

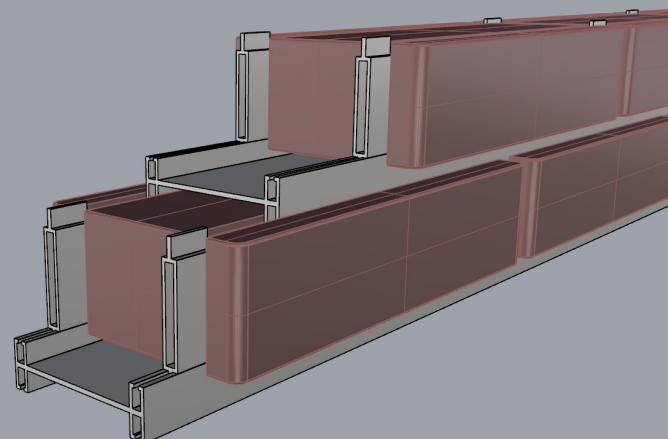
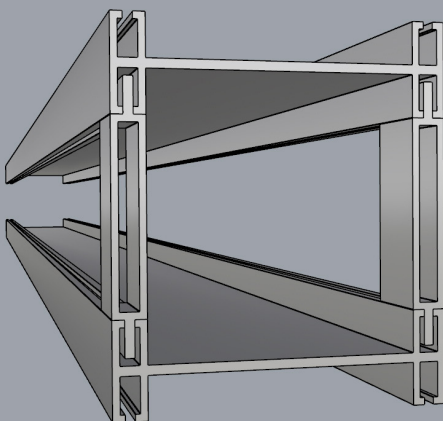

Typological investigations

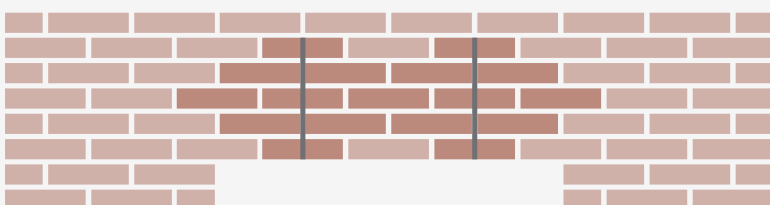
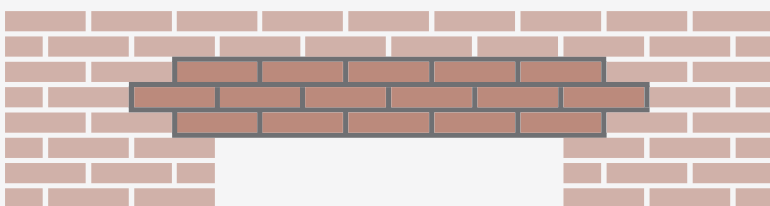
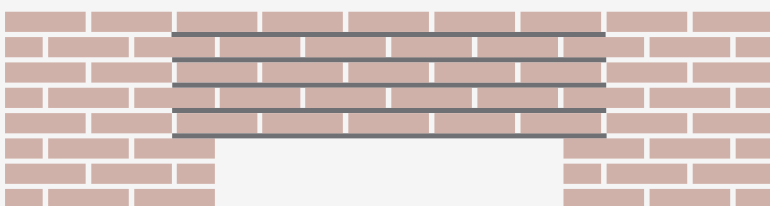
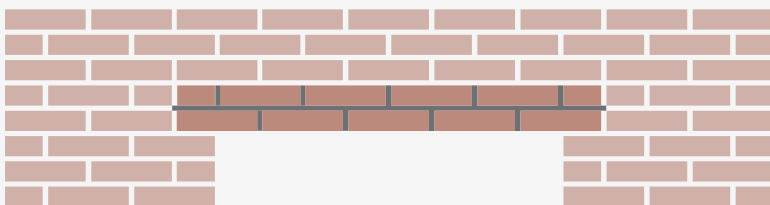
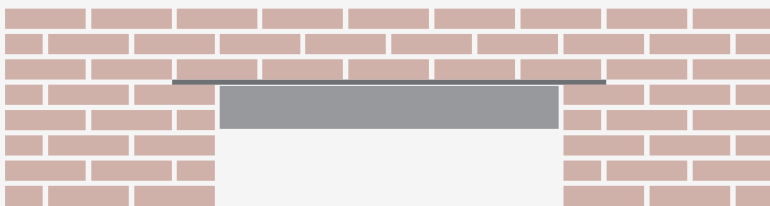
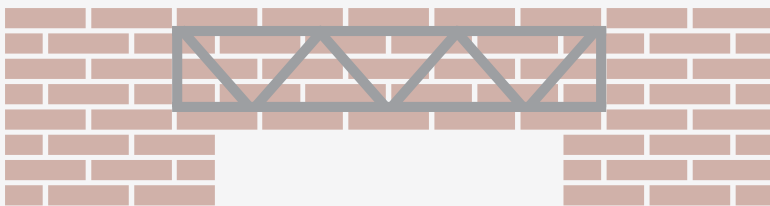
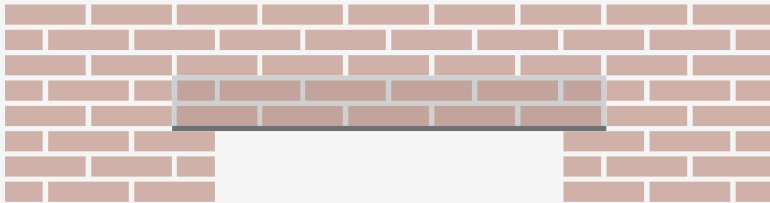
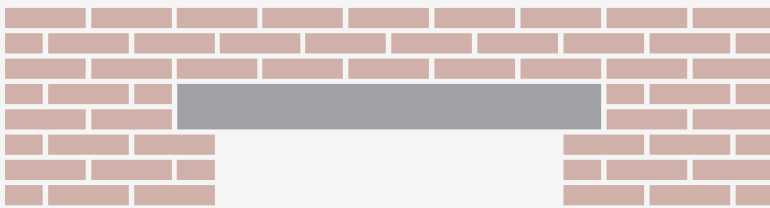

1.0 Typology 1: Adapting existing lintels

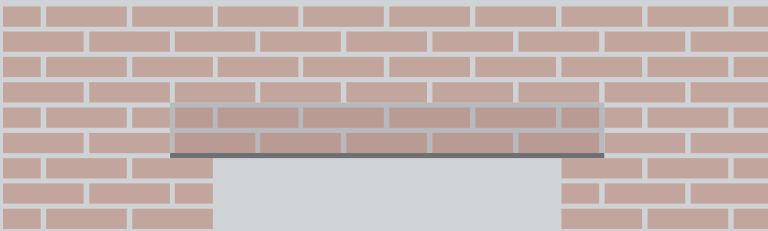
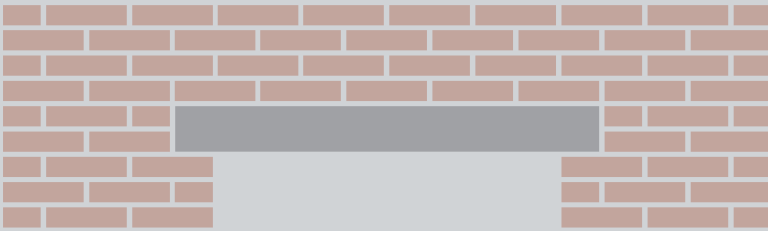

Introduction

The first typology that will be investigated, is more of a strategy. Over the years, a lot of lintels have been developed and adopted in the construction industry. It would be foolish and wasteful not to consider these for use in the H-block system. The cost of adapting these existing lintels is a lot lower than developing a new lintel completely from scratch. This chapter will focus on achieving a façade opening with minimal development time and cost, by using these existing products.

To do this, the kinds of lintel will first be investigated, along with some of the products that are available. When suitable products have been identified, it will be investigated how to adapt them to H-block. Followed by, how to adapt H-block for use with the lintels.

1.1 Background

A lintel is not much more than a beam-like object that supports the material in a wall above an opening. Lintels are much older than arches, which were only developed in roman times. It can easily be imagined, that big tree branches were used in huts to make it possible to open part of the walls. These branches made way to more processes timber and large stone blocks, which have more recently been replaced by concrete and steel.

In general, two different types of lintel are distinguished structurally. Lintels that work together with the masonry and lintels that don't. These are called composite and non-composite lintels respectively. A third category could be considered, were the masonry itself is made to function as a lintel, by the addition of reinforcement, but as it is not a separate lintel it will omitted, in this chapter.

Non-composite lintel

Essentially just a normal beam, the non-composite lintel provides all the necessary strength and stiffness, to effectively support the masonry, by its self. The lintel doesn't rely on the masonry for its stiffness and can therefore be structurally de-coupled, which is can be done with gliding foil. This combats the formation of cracks, which can occur due to differences in thermal expansion(Hofkes, Rentier, Reymers, & Salden, 2011).

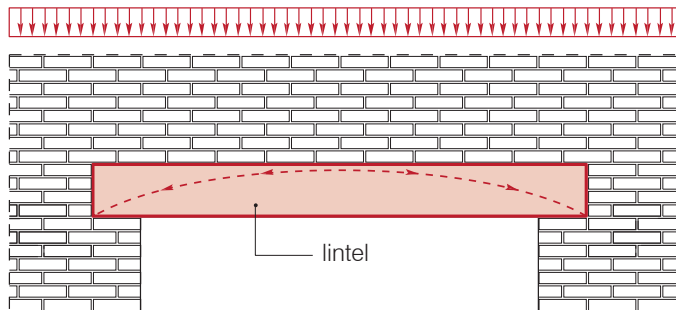

figure 16, Self bearing lintel and arching effect

Composite lintel

Composite lintels work together with the masonry to resist bending under the weight of the masonry. The compression and tension forces are divided between the masonry and (prestressed) steel. A compression arch forms in the masonry. This exerts horizontal forces outwards at the base of the arch, which are counteracted by the steel in the lintel. The connection between the masonry and lintel is crucial to the performance of the structure, as is the connections within the masonry. The bricks are pushed outward by the forming of the arch, if they can slide the structure loses its stiffness. This is also the reason that composite lintel in traditional masonry need to be supported temporarily while the mortar fully dries.(KNB, 2017)

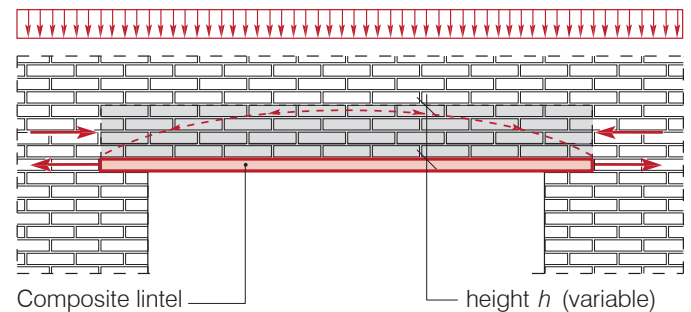

figure 17, Composite lintel,

At this moment, composite lintels in H-block are not feasible. The bricks can slide on the H-profiles, with only friction to resist it. Making composite lintels reliable in H-block, would require significant testing and development, to resist the horizontal forces in the masonry. As this chapter tries to minimize development time, it will continue with only non-composite lintels.

Concrete lintels

Usually formed in a rectangular section, the concrete lintels are always reinforced with steel and are sometimes prestressed. The concrete lintels can be poured on site, but they are more likely to be prefabricated. Often, we are not able to see the concrete lintels in building, as they get clad with brick. Two construction methods are used for these brick lookalikes. The first is to glue brick slips on a finished concrete lintel. The second is to cast the concrete directly in the hollowed-out bricks.



figure 18, Concrete lintel

Steel lintels

In the Netherlands steel lintels are usually made as an angle profile. The lintel is usually largely hidden from view, except for the bottom. Where they can be seen at the top of the facade opening. Sliding supports are also used with steel lintels, to prevent cracks. Other profiles have been used as well, like I-beams and U-beams. But as architects want to keep lintels out of sight, these beams do not make up a significant part of the market.



figure 19, Steel lintel in use

Prefab masonry lintels

It is possible to find some lintels that are made from genuine brickwork. They usually take the form of a soldier course, but don't necessarily have to. These lintels mostly prestressed or glued. The advantage of these kinds of lintels in traditional masonry is that they have the same thermal expansion coefficient as the rest of the masonry. For H-block, the look of the joints need to be coordinated. If H-block will end up being pointed, this is not a large problem. In that case the pointing on the lintel can be the same as for the rest of the masonry. If the H-profile ends up in sight, it will be a bit harder.



figure 20, Steel lintel

figure 21, Verbaan systems' glued masonry lintel,



1.2 Adapting lintel to H-block

By adjusting the design of some of these lintels a little bit, they can fit H-block quite well. However, there is a large difference between the lintels with full rectangular sections, and the thinner steel profiles.

The lintels with a rectangular section can be adapted by removing a bit of material from the top and bottom of the lintel, to make room for the H-profile. A cut similar to those made in the brick. On the bottom, the cut can be limited to the supports. Concrete or masonry lintels are the best for this kind of adaption. The machines used for cutting the bricks, could perhaps be used to make the cuts in the lintel.

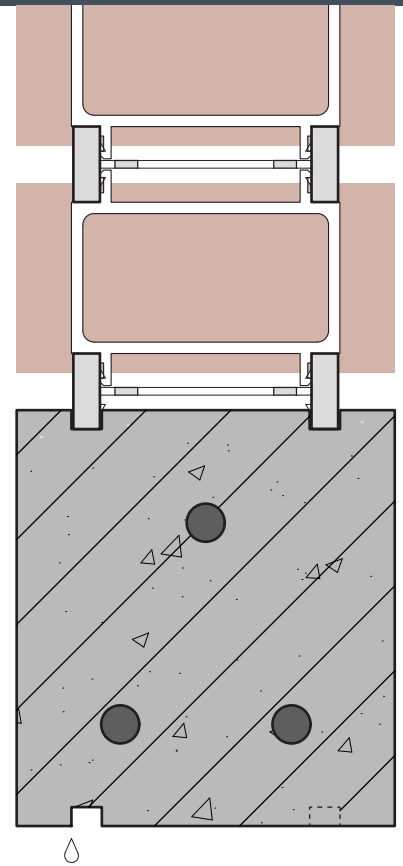
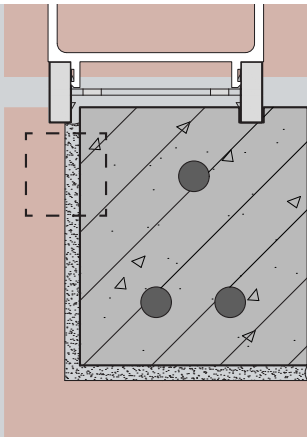
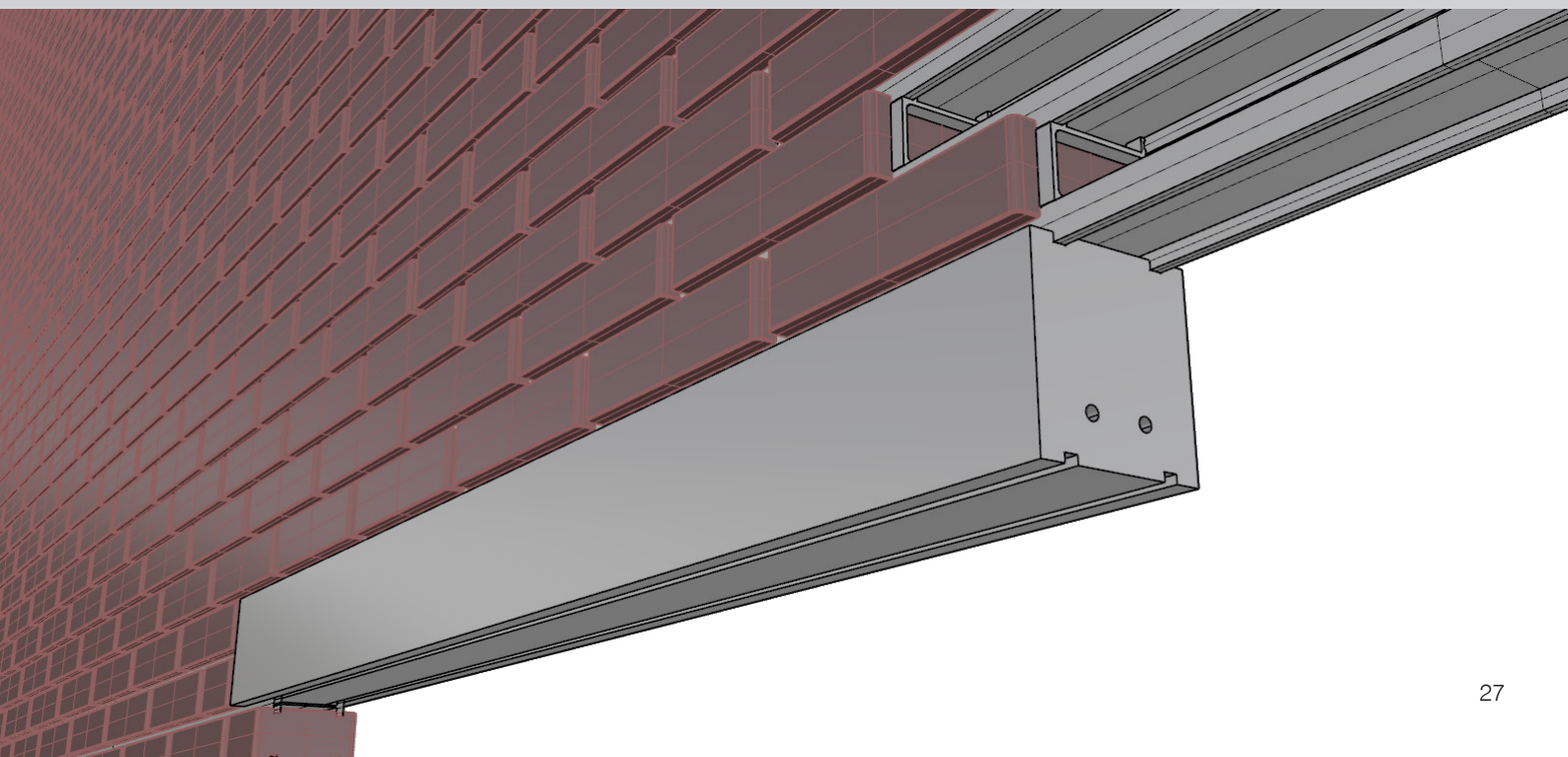
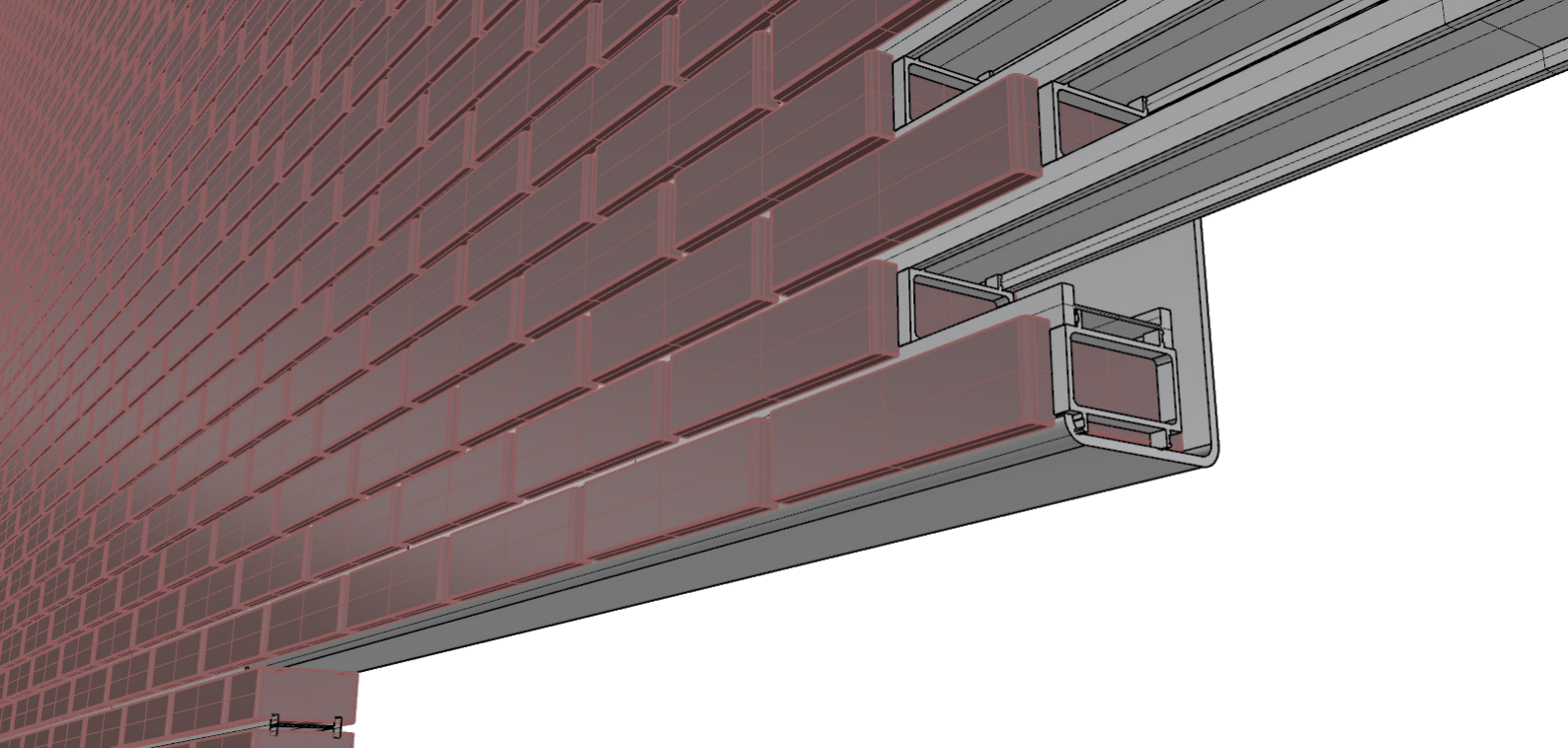

figure 22, Concrete lintel



For concrete lintels clad in brick, the H-profile could end up resting on the brick or the joint between the brick and the concrete. This could put extra stress on this joint. Whether this causes problems would need to be tested.





The steel lintels are too thin to just cut parts out of. Therefore, it is more suitable to integrate the H-profile into the lintel. If the lintels were made of aluminium, the two raised parts of the profile could be extruded along with the rest of the lintel. In steel it would probably end up needing to be welded, before galvanizing. Welding is costly and would probably not be cost effective.

The steel angle can be adapted by forming the horizontal end into one of the raised parts of the H-profile. The L-shape of the lintel would then turn into a J-shape. This can be done in two ways, by bending the end upwards, or by cutting two J-shapes out of one box profile. Because this first raised part will keep the bricks securely in place, the second can be a loose component.

The J-shape of the lintel will require it to have weep holes in the bottom of the lintel, because the water cannot flow out the front. The weep holes can have a double function. They can also be the mounting points for special head joints that hold a row of bricks underneath the steel angle.

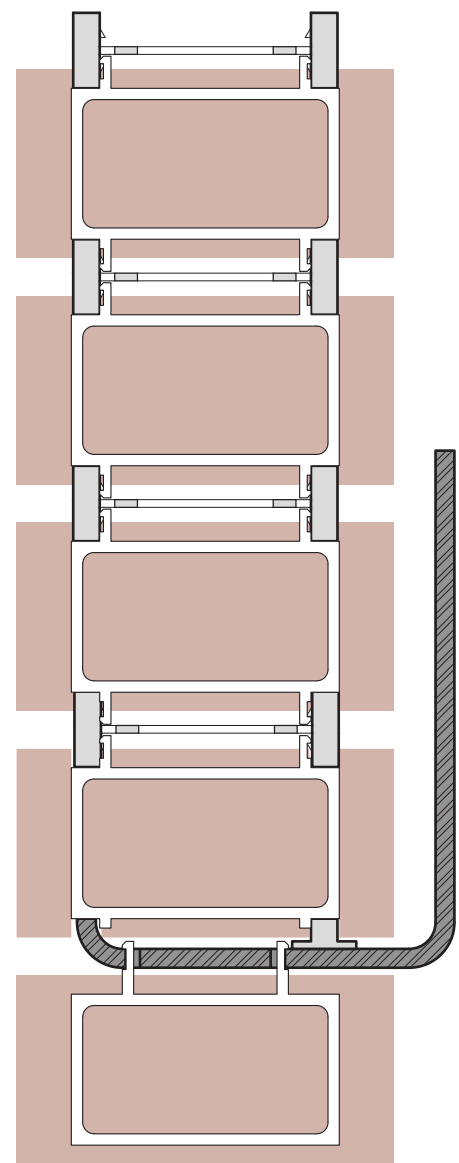
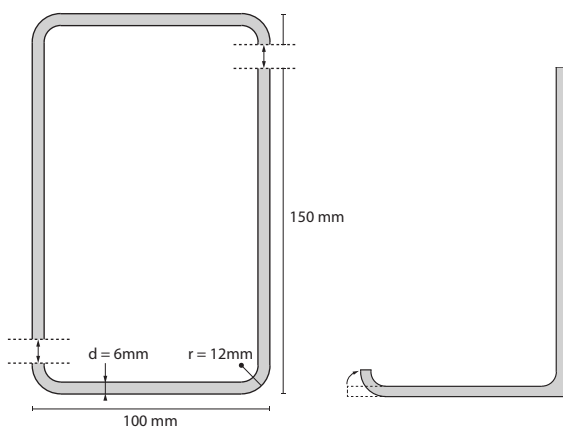

figure 23, J-lintel with hanging bricks

figure 24, Left, two ways of making J-lintel

1.3 New component, Half H-profile

1.2: New component, Half H-profile

Compatibility between the lintels and H-block can also be reached by adapting H-block a little. Or rather, by adding a new component to H-block. The component is similar to the H-profile, but one site is flat. It would basically be half a H-profile.

Depending on the specific type of lintel the height of this component might need to be different, to keep the joint-size consistent across the wall. The size might also differ for the support of the lintel and on top of the lintel.

If the lintel would be standardized for H-block, by using a single brand, it is possible to make a separate mold for this component. If the size needs to be different depending on the situation, this is also possible. During the construction in the Green Village, we used a plainer to reduce the size of the H-profiles in the top row. This could also be done for use with the lintels.

The H-profile may be altered in such a way, in these specific places that the head-joints won't be able to click into place, as they are supposed to. In that case the head-joints need to be adjusted a bit. Alternatively, a mold can be made for head-joints that only click on either the top or the bottom.

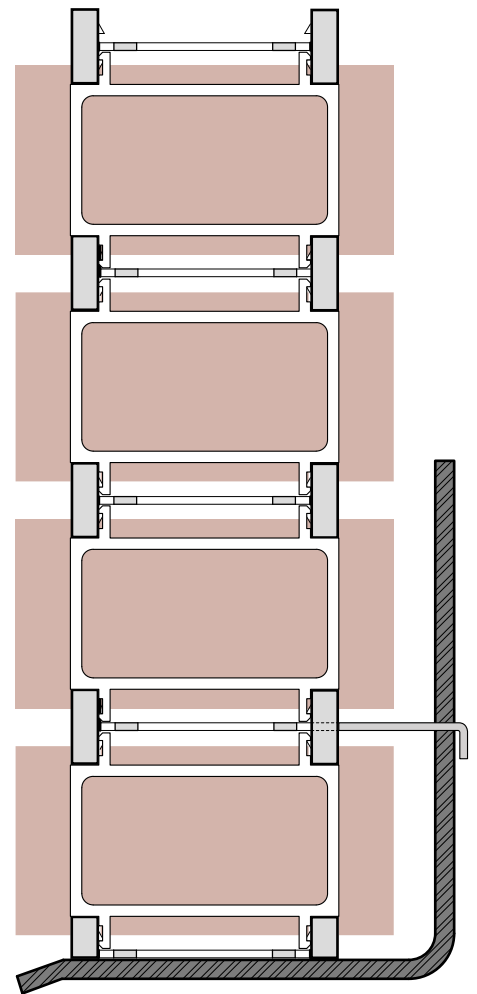

figure 25, Half profile on L-lintel

figure 26, Half H-profile on concrete



1.4 Findings

The previous pages have shown two reasonable ways to integrate existing lintels with H-block. Especially the halved H-profile can be used immediately, by cutting the normal profiles down to the required size. Lintel have only a small part of the total bed-joints in a facade. Cutting down some profiles for this shouldn't be too much work, at first.

By cutting the H-block channels into a lintel, the full H-profile can be used. This can be done for lintels with rectangular sections.

When using existing lintels, it is of great importance that the lintels do not require a composite action with the masonry. At this point, composite lintels do not work with H-block, because the masonry is not fixed horizontally.

This is the easiest and most cost-effective way of having a lintel in H-block. The lintels themselves are certified by other companies and don't need any development from H-block.

Typology Summary

	Type 1
Forces in masonry	
Tension in bed-joint	No
Tension in head-joint	No
Extra stress on brick	No
Horizontal forces in masonry	No
Detailing	
Subject to initial settling	No
Precise sized brick necessary	No
Long bed joint needed	No
Stronger head-joint connections needed	No
Special head-joint needed	No
Construction process	
Temporary support during construction	No
Lintel prefab possible	Yes
Lintel on-site fabrication possible	No
Design	
Lintel is in plain sight	Yes
Lintel is obscured	Yes
Lintel is out of sight	No
Allows various stacking patterns	n/a

2.0 Typology 2: Outside reinforcement

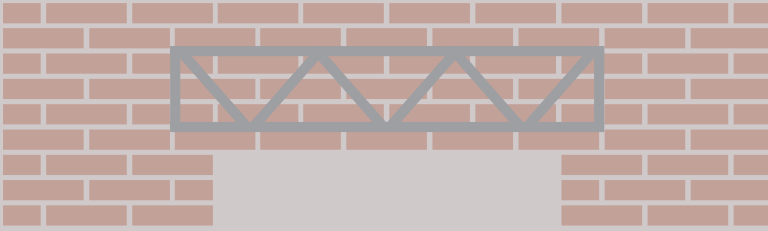

Introduction

In recent years, digital manufacturing has taken a leap forwards. This typology follows this trend by proposing a CAD/CAM workflow for the design of the lintel. The workflow will provide freedom for architects to produce unique lintels for their designs.

The chapter only consists of two parts. First, the general construction will be discussed. After that, a workflow is proposed for the design and construction of the lintel.

2.1 Component parts

In general, the lintel consists of two steel plates, in front and behind the masonry. These are the main load-bearing components of the lintel. The plates can be cut to the desired shape with CNC equipment. They are connected to each other with steel rods that go through the masonry. The plates screw onto these rods with countersunk bolts.

The masonry is supported on the steel rods. The out-of-plane stability of the lintel is provided by the connection between the plates and the rods and through the masonry.

It is important that the front and rear plate have similar stiffness. If this is not the case the lintel might bend forward or back. The plate may not have to be identical, similar might be good enough.

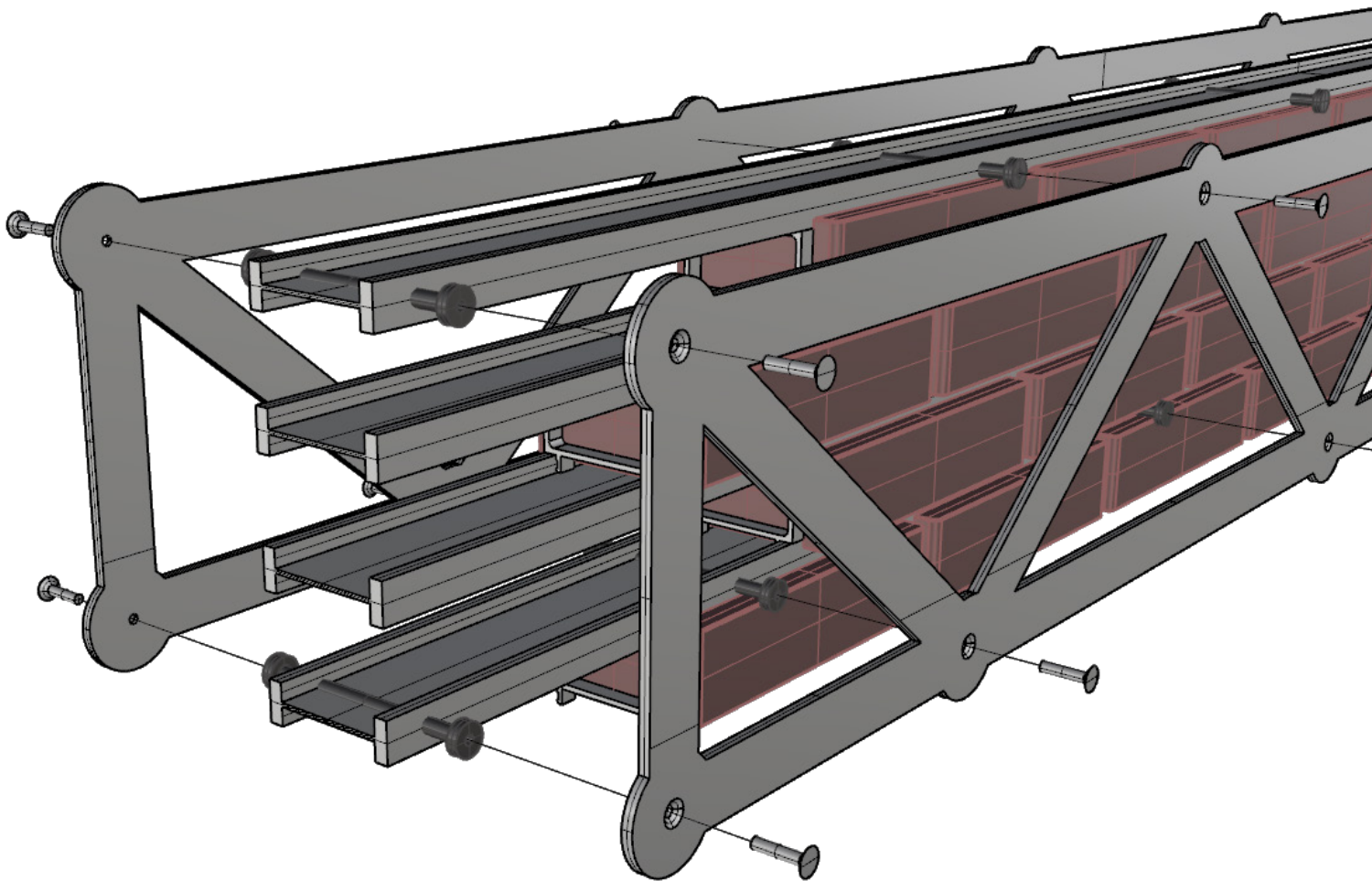

figure 27, General construction principle

2.2 Design workflow

The construction of this lintel can be quite simple, yet a large variety of designs can be made with relatively little effort. The key is a combination of digital design and manufacturing techniques.

A design is made, by cutting holes in these plates. The design is inherently 2d, but this still leaves a lot of freedom. The holes can be cut in all kinds of ways, although the leftover steel will need to be able to work structurally. Some design guidelines will need to be set up. The steel will probably need an uninterrupted top and bottom cord and some steel to connect them. When the design is finished it can be sent to be checked.

The holes in the plates will impact the strength and stiffness of the lintel. It might also cause undesirable stress concentrations. In this stage the strength and stiffness will be checked, to see if the design will work. The thickness of the plate can also be defined in this stage. If the design needs to be changed, the structural engineer may propose some improvements. The structural performance of the lintel can be checked using finite element modeling (FEM). The 2d nature of the lintel plates make it relatively easy to model design variations. Over time the structural check could be (partly) automated, to the point where only a vector file needs to be imported.

When the lintel design clears the structural checks, it can be manufactured. With the CAD/CAM workflow, the 2d vector files of the lintel which were previously used for the structural analysis can now be used to control the CNC machine that cuts the plates. Cutting can be done with laser, plasma or water-jet cutting, depending on the thickness of the plate and the availability and cost of the machines. The plates can be finished with a layer of powder coat, or any of various other ways to protect steel. The lintel is assembled separately, and then placed in the wall during construction.

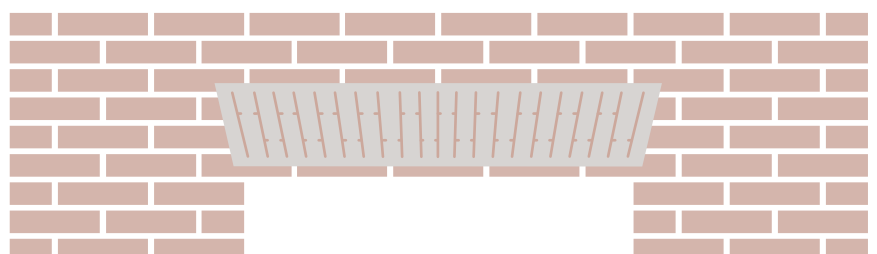
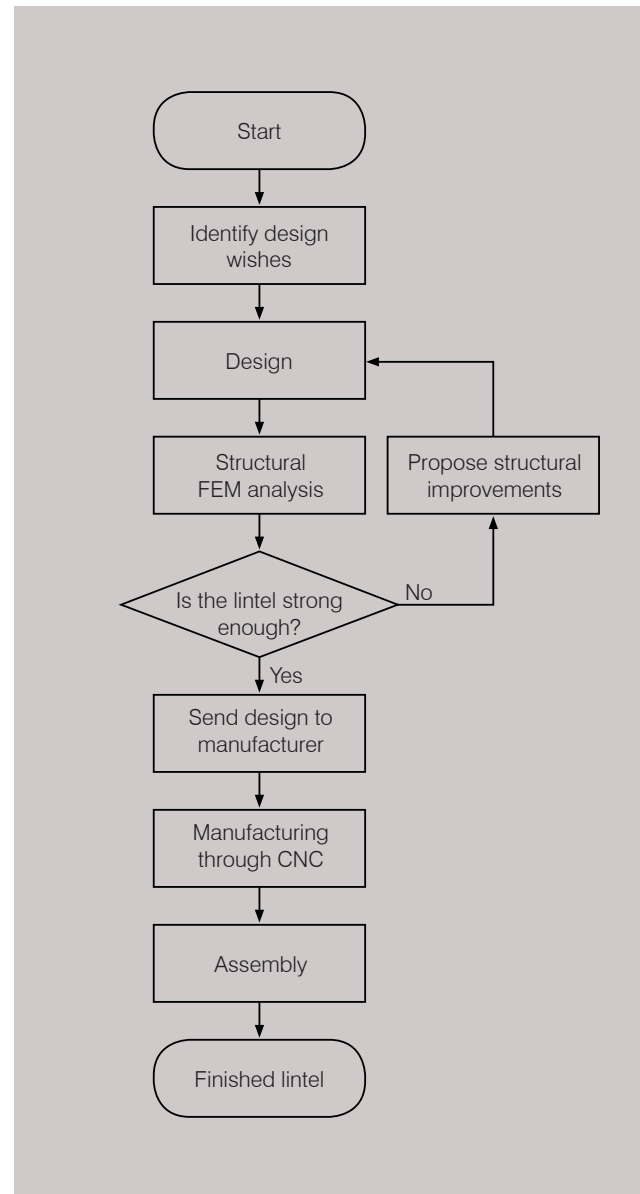

figure 28, A new kind of jack-arch

2.3 Findings

This typology is still in the conceptual phase. As a concept it works, but the real problems have not come up yet.

The lintel works by having two plates that resist bending. The rods that connect these plates will be a interesting detail to solve. If a circular steel rod, that fits between the bricks, is strong enough, the detail will be quite straightforward. If it isn't, the detail becomes a lot harder.

The workflow is still quite basic and doesn't account for guidance that might be needed for designers. It would be aided by a short feedback cycle between design and structural analysis. So, alternatives can quickly easily be compared, and the impact of decisions made clear. In this sense the development may need to take place as software development, rather than in architecture.

The possibilities of this lintel are quite interesting. A lot of design freedom is possible with this typology. However, the lintels will also all look the same in a way.

In a way this typology seems more suited for use in a single large project or when something needs to be a bit different, rather than a large scale use in the general architectural profession.

Typology Summary

Forces in masonry

Tension in bed-joint	No
Tension in head-joint	No
Extra stress on brick	No
Horizontal forces in masonry	No

Detailing

Subject to initial settling	No
Precise sized brick necessary	No
Long bed joint needed	Maybe
Stronger head-joint connections needed	No
Special head-joint needed	No

Construction process

Temporary support during construction	No
Lintel prefab possible	Yes
Lintel on-site fabrication possible	No

Design

Lintel is in plain sight	Yes
Lintel is obscured	No
Lintel is out of sight	No
Allows various stacking patterns	Yes

3.0 Typology 3: Lintel in a component library

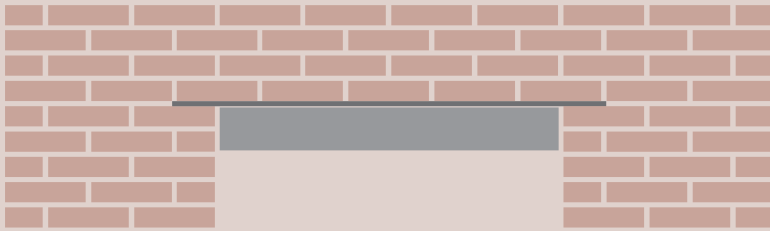

Introduction

One of the design freedoms of H-block is that it is possible to have specialized components in the masonry. The 4TU.bouw lighthouse pitch for H-block hinted at an entire library of specialized parts. What if a lintel was one of these components? A component with a specialized function, specifically made for H-block.

With H-block itself as inspiration, the lintel clicks into the H-profile to increase its loading capacity. The H-profile is used as an interface for the lintel, as it could for many other components.

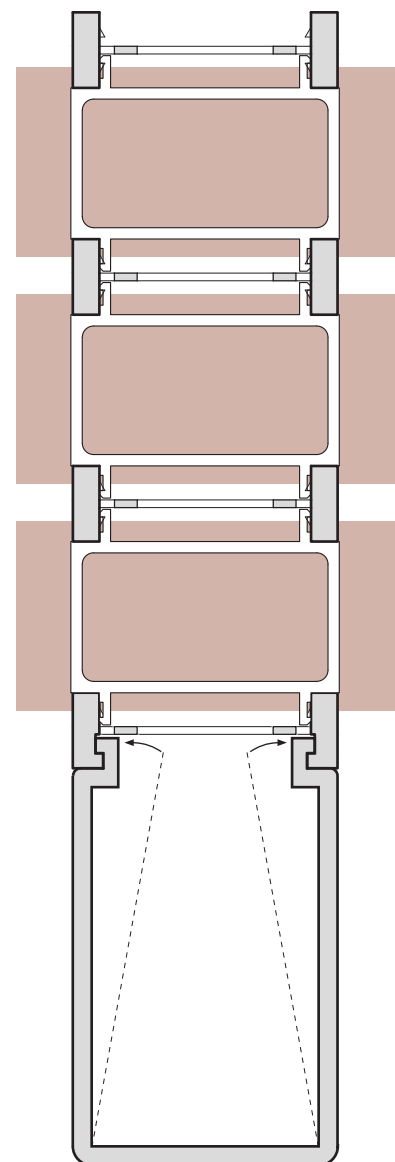
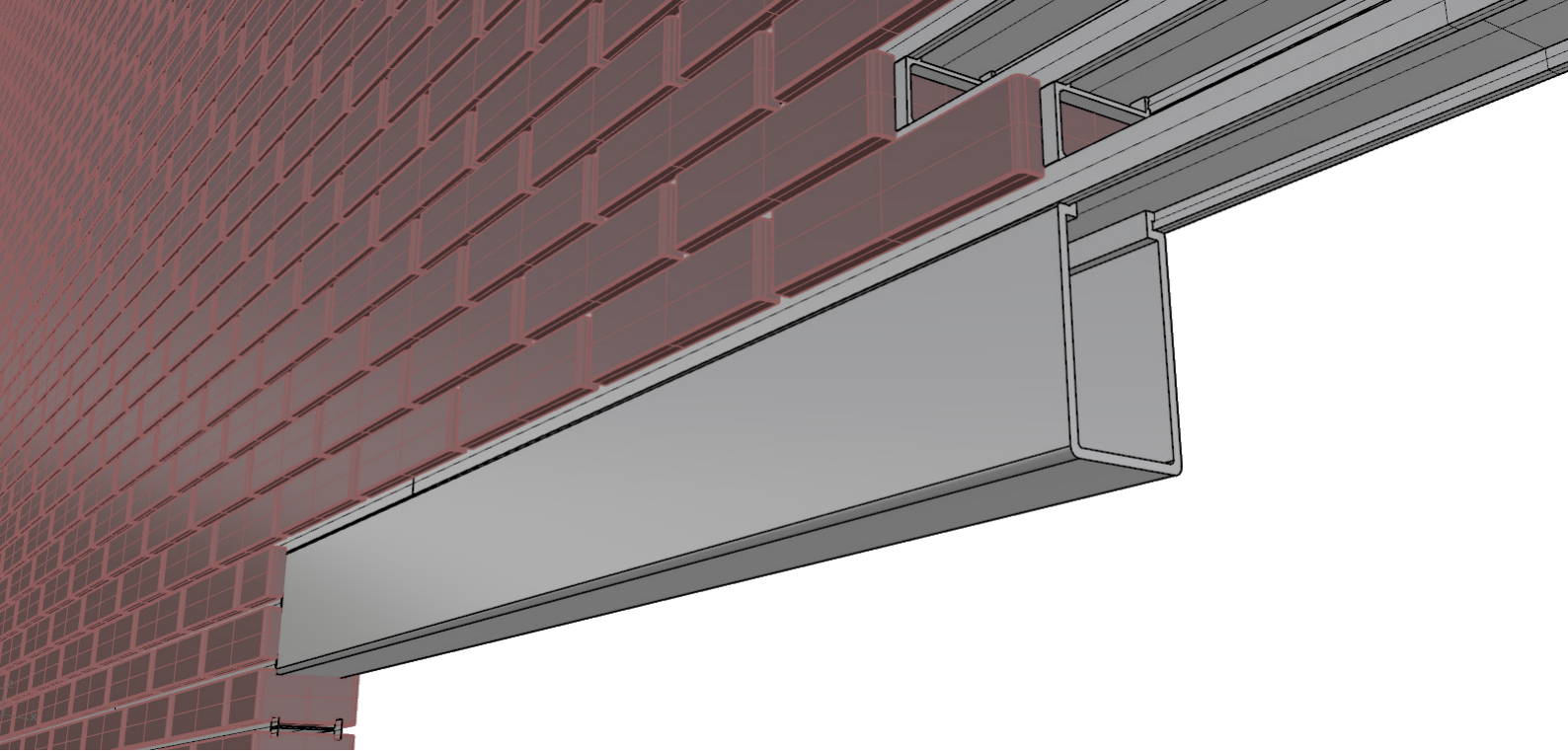

figure 29: Section profile stiffener



3.1 Profile stiffener

The profile stiffener is a component that locally adds an additional section to the H-profile to resist bending moments. The component will hang from the H-profile inside the façade opening, this might make it possible to use as a temporary support during construction. It also makes it that the lintel doesn't overhang the façade opening in the wall. The overhang of the lintel can disrupt the 'verticality' of the design of the façade. This is also why some lintel manufacturers disguise the supports of the lintel.

The crucial part of this lintel is the connection between the profile and the stiffener. The two components can be allowed to slide, but they must not come apart. Under loading the profile will want to bend more than the stiffener. This will put a compression force on the middle of the stiffener and tension forces at the ends. The ends will therefore try to come loose from the H-profile. The hooks on the profile will need to prevent this. The hooks on the H-profile may need to be redesigned to accomplish this.

Another important part is the shear stress near the supports in the profile. All the shear stresses will have to go through the H-profile, which may cause it to break. As the section of the stiffener can be adjusted to what is needed, the shear forces in the profile could be the prevalent factor for determining the maximum span.

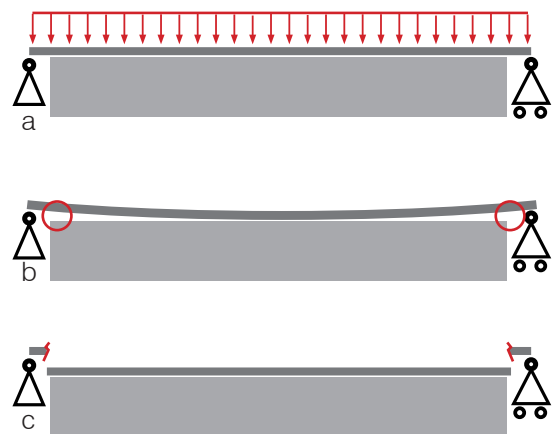
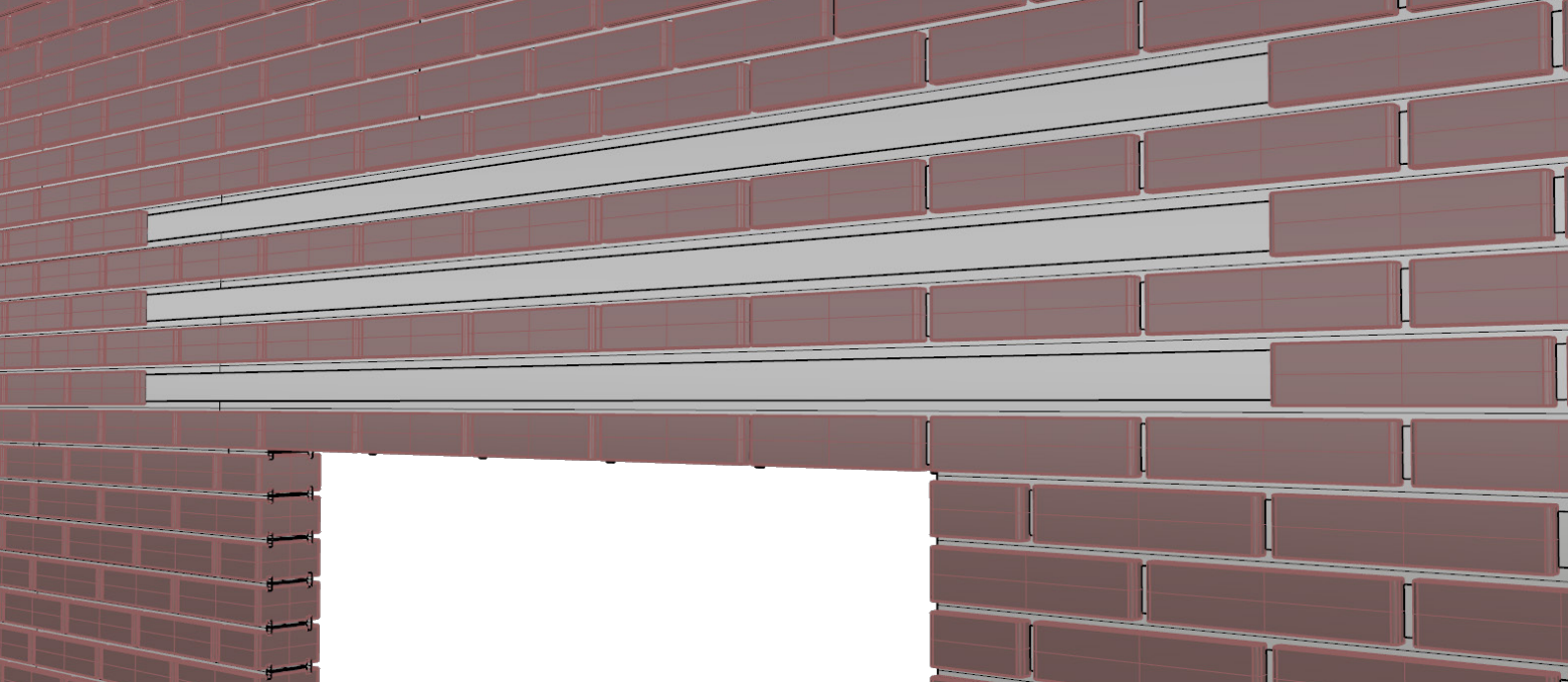

figure 30: a, Section near the support is different than the main body. b, Stresses on the connection between profile and stiffener are greatest near the ends. c, Shear stresses might break profile near supports



3.2 Wide head-joint

A variation on the profile stiffener can be made to be embedded into the masonry at large. The component that can be as simple as a very wide head-joint. If the normal head-joints are to be produced through extrusion, this will be an extremely simple component to make.

The section of the head-joint have a certain stiffness, this can be used to span the façade opening. The head-joints might be doubled up, if necessary.

Because the component will be embedded in the masonry, the shear forces are less of a concern. The lowest layer of bricks would need to hang from the H-profile.

3.3 Findings

This typology is inspired by H-block itself. The lintel attaches to the bed joints, though the little hooks on the profile.

The added value of this typology is that it attaches to a 'normal' bed joint. However, the detailing of the profiles would probably need to be changed. The hooks on the profiles would need to be stronger. If the changes to the profiles are not beneficial for the H-block in general, the lintel may need specialized H-profiles. If this is the case the usefulness of the typology can be called into question.

If it were to be developed further, the lintel will need to be designed so it can't accidentally fall down.

The usefulness of the principle on which this typology works is clear, but whether this should be used as a lintel remains to be seen. A more fruitful continuation of this typology might not be as a lintel, but as some other product, for instance sun shades.

Typology Summary

Forces in masonry

Tension in bed-joint	No
Tension in head-joint	No
Extra stress on brick	No
Horizontal forces in masonry	No

Detailing

Subject to initial settling	No
Precise sized brick necessary	No
Long bed joint needed	No
Stronger head-joint connections needed	Yes
Special head-joint needed	No

Construction process

Temporary support during construction	No
Lintel prefab possible	Yes
Lintel on-site fabrication possible	Yes

Design

Lintel is in plain sight	Yes
Lintel is obscured	No
Lintel is out of sight	No
Allows various stacking patterns	n/a

4.0 Typology 4: Horizontal prestress

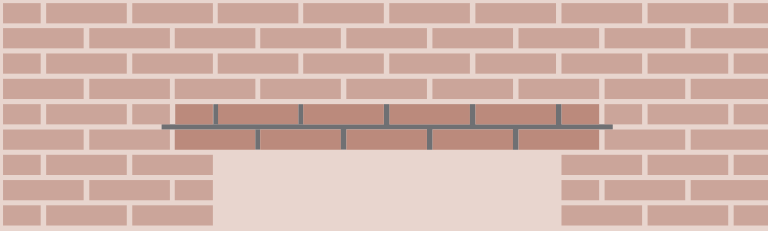

Introduction

Like concrete, masonry works best in compression. It can be prestressed to compensate for the lack of tensile strength. Prestressed masonry lintels usually take the form of a soldier or row-lock course. For this typology it will be done a bit differently. This chapter looks into the possibilities for a prestressed bed-joint. The tension rod can be conveniently placed in the bed-joint of the masonry.

The chapters starts with a bit of theory on prestress. This is followed by some observations from the prototypes. Finally these observations are translated into some design rules for the lintel.

4.1 Theory

Prestress works by applying axial compressive stress to counteract the tensile stress, that is caused due to bending. The stresses are summed to find the resulting stress.

In figure 31 is shown how the resulting stress changes when the bending stress is increased. The middle row is the optimum where precisely enough prestress is applied for the given bending stress.

In the bottom row the tensile stress, due to bending is larger than the compressive prestress. From the resulting stress we see, that part of the section of the lintel will have no stress. This part rises from the bottom of the lintel when the bending stress increases. If the entire stress on the entire bottom brick is zero. The brick might fall, because there is not pressure to keep it in place. In detailing this should be accounted for.

What is not shown in figure 31, is the stress that can occur because of the eccentric placement of the prestress. This takes a similar for to that of the bending stress, and thus can make the lintel bend and or buckle.

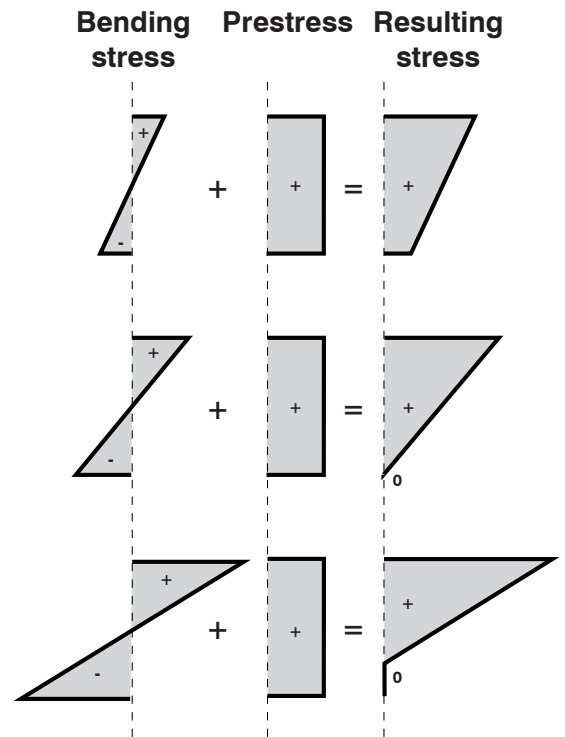

figure 31: Adding bending stress and prestress to find the resulting stress. With loose components the resulting stress cannot be negative.

Precedent: Carlsberg Bjælker, prestressed beams

This Danish manufacturer makes prestressed brick beams and lintels, for use in facades. The production process looks similar to that of Stalton lintels, except that these are made from standard bricks with groves cut out, to provide a large variety of bricks. The groves are filled with a proprietary cement mortar. At least 65% of the brick's volume is preserved, to make sure the linear expansion coefficient remains similar that of the brick.

Interestingly, multiple prestressed courses of brick can be bonded together to form stronger sections. This is done in both height and width. According to the website, the longest span bridged by Carlsberg Bjælker's product is over 12 meters long. Lintels with two layers of brick and a single brick wide, are used up to a maximum span of 5 meters.



figure 32: Production line at carlsberg



figure 33: Large Carlsberg beam

4.2 Prototypes

During the process two prototypes were made for this typology. One was with wooden blocks, the other with bricks. In general, the prototypes felt very promising. Once the prestress is applied, the structure becomes quite stiff, even though it was tensioned by hand. It feels like it can be developed into something that can hold up masonry. It is not so surprising that this is the case. Prestress has long been used for beams. The main issue is dealing with the fact that the lintel will be made with multiple unbonded components, all with a tolerance. The prototypes gave some insights on this front.



Prototype construction

The prototypes were made by using two courses of bricks, with a threaded rod in the middle. On the ends of the rod were two steel brackets to spread the load over the two courses of brick. Between the bricks were different joints for the two models. In the wooden model, the joints were made with the normal H-block head-joints. The wooden blocks are quite precise, and the joints are flat, so this worked out quite well. The joints on the brick model were a bit different. These were made with gray cardboard, to take up some of the unevenness of the sides of the bricks. The cardboard also connected the top and bottom course to each other and the tension rod.

figure 34: Brick prototype

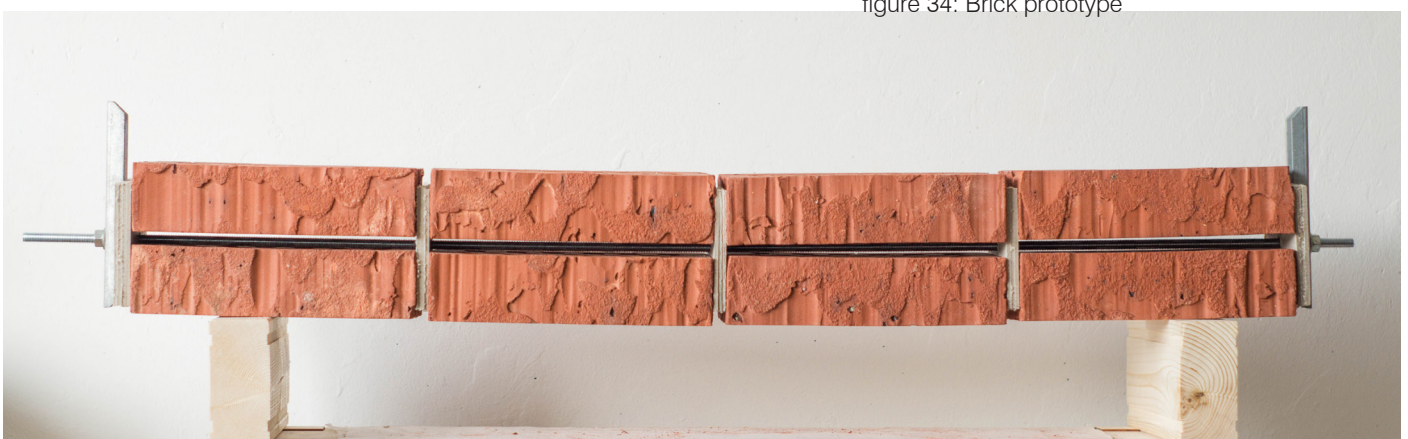



figure 35: Wooden prototype

Although the section of the beam is symmetrical, the prototypes still bent under prestress. In the wooden model, where the courses are not attached to each other, the courses bended separately. In the brick model, the entire model bended together. After playing around with the models in several configurations, three main factors can be distinguished, and they are quite straightforward.

- The comparative length of the two courses.
- The squareness of the sides of the bricks.
- The position where the prestress presses on the brick.

If the two courses are not the same length, the prestress will not be equally divided between the two courses, thereby introducing an eccentricity for the longer course, making it bend outward.

When the interface between the brick and the head-joint is not square and even, the pressure on the bricks will try to press the surfaces against each other, thereby misaligning the bricks.

The brackets distributing the load over the two courses were not distributing the load evenly over the surface of the brick. Imprints in the wood suggest the force was bigger near the tension rod. This eccentricity also makes the course bend outwards.

The place where the bracket presses on the brick can be controlled by adding a bit of material to a specific place. When this is done on the outside of both courses, they will bend inward a bit, ultimately pressing against each other and evening out the deformation.

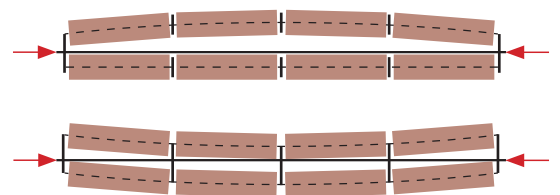

figure 36: Deformation due to tensioning, in wood model (top), and brick model (Bottom).

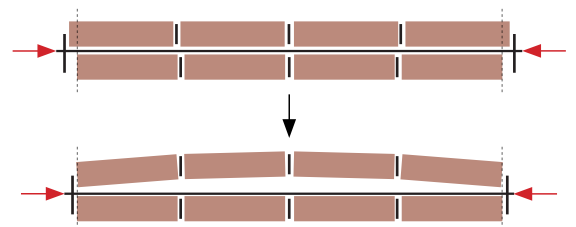

figure 37: When the lengths are not equal

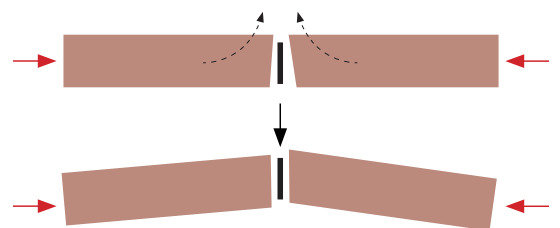

figure 38: When the interface isn't square

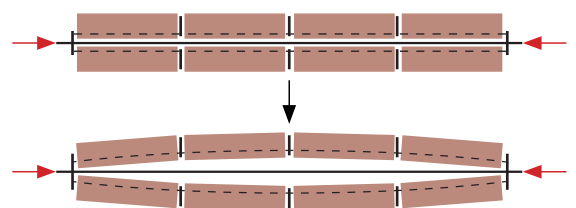

figure 39: When prestress is applied eccentricly

4.3 Details

The prototypes have shown that the detailing will be instrumental in making sure the lintel will be straight. From the three main factors that guide the deformation of the lintel, we can define three rules for the construction of the lintel.

- The length of the brick needs to be controlled.
- The interfaces between bricks need to be flat and square.
- The place where the prestress impinges on the brick needs to be controlled.

Additionally, for safety some other rules may be preferable.

- The two courses need to be connected to each other or the tension rod, to prevent buckling.
- Bricks need a backup mechanical connection, to prevent falling bricks when tension is higher than compression under bending.

The first two rules can be fulfilled in the same action. When the length is made precise by grinding parts off the brick, it can immediately be made flat. In these two rules it is presumed that the head-joints themselves will have precise measurements.

To fulfill the third rule, the components that spread the prestress over the two courses cannot be flat. It needs a raised line of area to control the contact point with the brick. This controls the eccentricity of the prestress on the brick. Controlling this can help keeping the lintel straight, but I may also make it possible to make a slight upward bow in the lintel. The weight of the masonry on top will force the lintel down and the result is a straight lintel.

Rule four is an extra precaution. Buckling can most probably be prevented with the first three rules. By applying rule four, the risk of buckling is further reduced, because the tension rod would need to bend for buckling to occur.

Rule five is in case the tension forces in the beam are higher than the prestress. Bricks could fall from the bottom of the lintel. This could happen, if the prestress is partially lost, or the lintel is overloaded. An extra mechanical connection would prevent the bricks from falling on people. It might be good if the bricks could move a few centimeters, to signal that the lintel has a problem.

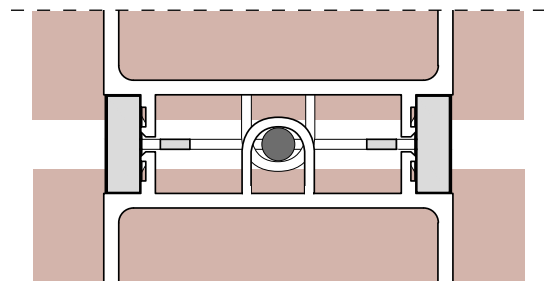

figure 40: Head joints hook around the tension bar to prevent buckling

Brick bonds

Brick bonds are not inherently a problem for this lintel. The order of the bricks in the top and bottom course don't necessarily have to be the same. If the head-joints are very soft, a different number of them in the top and bottom course might be a problem, but that can be solved. The biggest question for whether the bonds are a problem is:

How indistinguishable from the surrounding masonry does the lintel need to be?

The easy way to make the lintel is to have straight ends. That makes it possible for the component that distributes the prestress to be straight. Visually, the effect of this that the head-joints at the ends of the lintel will line up vertically. It is a small detail, but it can break the rhythm of the masonry.

When it is necessary to hide the lintel completely, the detailing will become harder. The prestress could be distributed with a z-shaped bracket. Whether this is the best solution, would need to be researched.

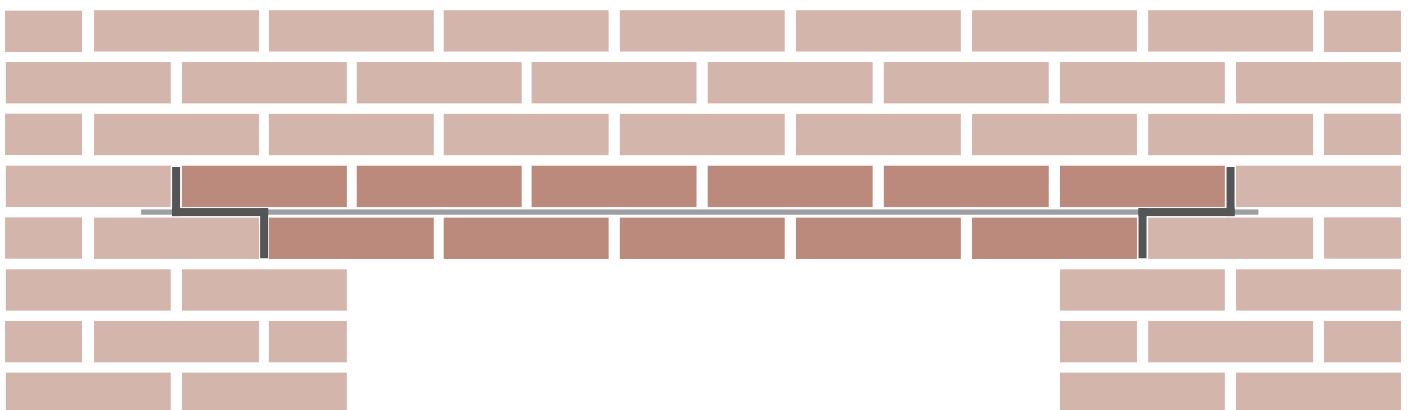
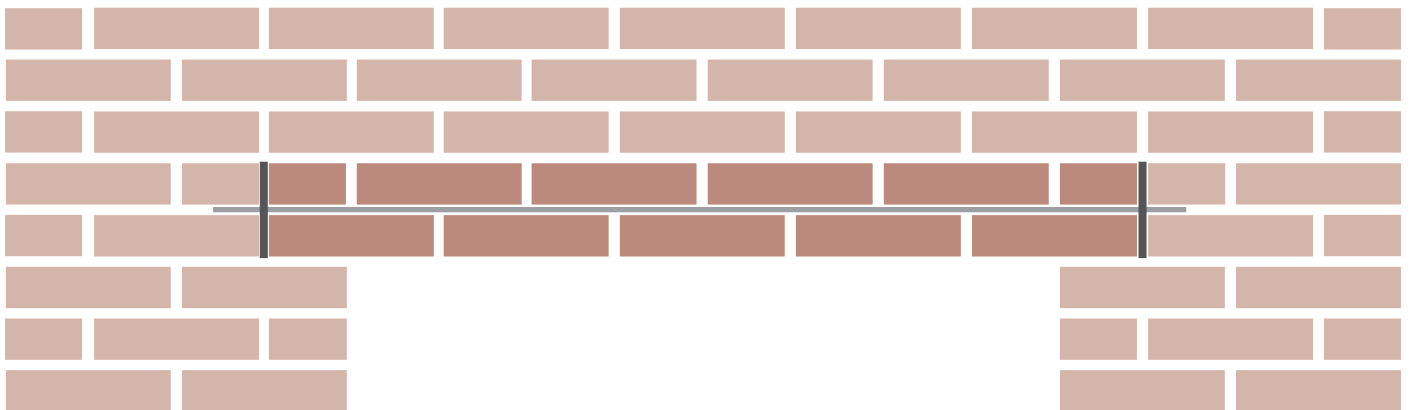
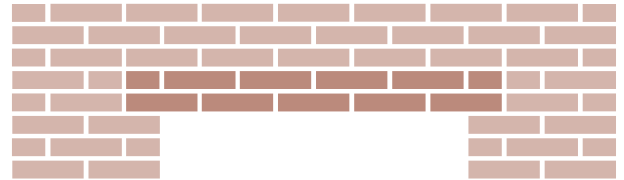

4.4 Findings

This chapter describes how a lintel can be made by letting a tension rod put pressure on two courses of dry stacked masonry.

The largest challenge for this type of lintel, is the deformations caused by the prestress. Preferably, these deformations happen in a controlled and consistent manner. However, this is not the case. The many loose components of the lintel, and the loose tolerance of the brick make the deformation somewhat random. To combat this, three rules were defined:

- The length of the brick needs to be controlled.
- The interfaces between bricks need to be flat and square.
- The place where the prestress is applied to the brick needs to be controlled.

With all the loose components, the lintel should be additionally secured for falling brick. Bricks can fall when the prestress is smaller than the tension forces in the linter, or when the lintel buckles. With a mechanical connection between the head-joints and the bricks, and with the head-joints hooked around the tension bar, the lintel should be safe.

Typology Summary

Forces in masonry

Tension in bed-joint	No
Tension in head-joint	No
Extra stress on brick	Yes
Horizontal forces in masonry	Yes

Detailing

Subject to initial settling	No
Precise sized brick necessary	Yes
Long bed joint needed	No
Stronger head-joint connections needed	No
Special head-joint needed	Yes

Construction process

Temporary support during construction	No
Lintel prefab possible	Yes
Lintel on-site fabrication possible	No

Design

Lintel is in plain sight	No
Lintel is obscured	No
Lintel is out of sight	Yes
Allows various stacking patterns	Yes

5.0 Typology 5: H-profiles in bending

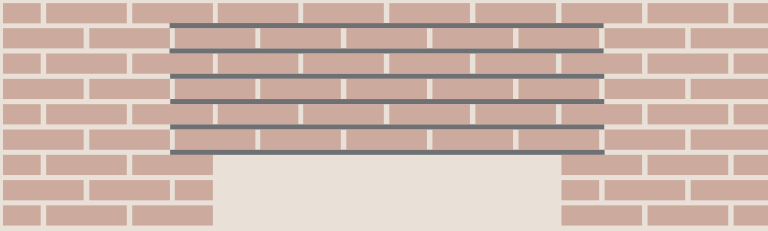

Introduction

This chapter will be the first to investigate the structural opportunities provided by H-block itself. The design of H-block, with its special joints, might make it possible to have the lintel be made of normal H-block components. The components may need to be further developed or redesigned to fit the specific needs, but they all come from the basic H-block toolkit.

The investigation in this chapter will focus on the H-profile as a structural component for the lintel. The profile is a kind of small beam and can hold a certain amount of weight, without visibly bending, as was found in a small experiment early on. The limiting factor at that point was the length of the profiles that were available. Therefore, this chapter will presume the profiles will be available in any length and a span can be made with a single profile.

In this chapter the potential for the head-joints to transfer tension load will be omitted. This is to keep things manageable and to have a clear distinction with the next chapter.

5.1 Simplification

In this typology the profiles are seen as small beams. The bricks are both loads on these beams and are spacers between the beams that can transfer compression forces. If the bricks are simplified to only be loads on a beam, the result is a stack of beams, all with similar loads. It would look something like 49.

When a beam is simply supported and subjected to loads, it will bend. When a second, equal beam is laid on top of the first one, the bottom beam will not bend further. This is because the beams will only touch at the ends, which are above the supports. The beams will only touch in the ends, because the top of the beam has a slightly stronger curvature than the bottom. When another beam is added the, the bottom two beams don't bend further. With other words, the deformation of the bottom beam is independent from the number of beams stacked on top. Therefore, if the deformation of one beam is known, the deformation of any number of stacked beams is known.

The deformation of one H-profile under the load of one course of brick can be calculated with formula:

$$d = 5/384 * ql^4/EI$$

The stiffness of the section of the beam can be approximated as only the two main rectangles. The stiffness of the material was found in a datasheet from the manufacturer. The maximum allowable deformation in masonry is two thousandth of the span. By equating these two the maximum allowable span can be determined. For the plastic profiles this turns out to be

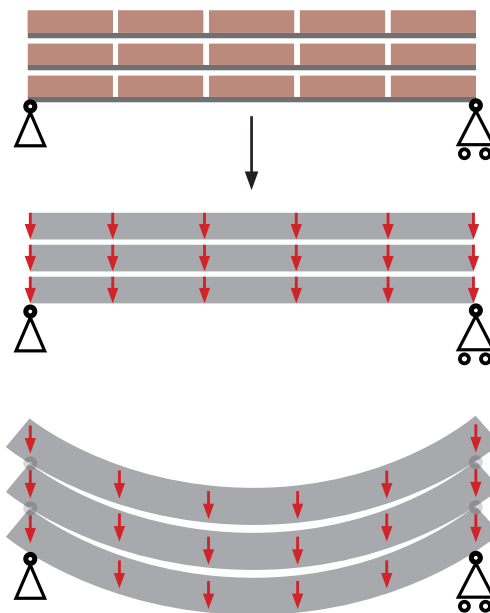

figure 41: Simplification from masonry to a stack of beams. And the result when these beams bend.

Formulas

$$d = 5/384 * ql^4/EI$$

$$d_{\max} = 0,002 * l$$

Inputs

Weight bricks = 1800 - 2200 kg/m³

$$\Rightarrow q = 0,1 \text{ N/mm}$$

$$I = 1/12 * bh^3$$

$$I = 2 * (1/12 * 7 * 20^3)$$

$$\Rightarrow I = 9,3 * 10^3 \text{ mm}^4$$

$$\Rightarrow E_{\text{PA6}} = 9,3 * 10^3 \text{ MPa}$$

$$E_{\text{Al}} = 69 * 10^3 \text{ MPa}$$

$$E_{\text{Fe}} = 210 * 10^3 \text{ MPa}$$

Calculation

$$\Rightarrow 5/384 * ql^4/EI = 0,002 * l$$

$$l = \sqrt[3]{\frac{384 * EI * 0,002}{5 * q}}$$

$$l = \sqrt[3]{\frac{384 * 9,3 * 10^3 * 9,3 * 10^3 * 0,002}{5 * 0,1}}$$

$$\Rightarrow l = 510 \text{ mm in PA6/Nylon6}$$

$$\Rightarrow l = 995 \text{ mm in Aluminium}$$

$$\Rightarrow l = 1442 \text{ mm in Steel}$$

510mm. This number is a rough estimation. Several aspects that could impact the maximum span.

In the length of span that has been calculated, the masonry loads the profile in specific points, rather than a distributed load. The calculation could be done again for a more precise result. For the plastic profile creep would probably also need to be included in the calculation

The maximum span is based on a standard maximum allowable deformation for masonry, but that is to reduce the chance of cracking. In H-block, there is no chance of cracking, as everything is already loose. The maximum deformation could perhaps be increased to 4/1000 of the span, where the masonry would still look straight to the eye. The maximum span would consequently be twice as big.

The material of the profiles could also be changed, while keeping the profile the same. Changing to aluminium, would increase the maximum span to about one meter. Steel would be 1,4 meters. The question is, would you want to keep the section if the material changes? Probably not.

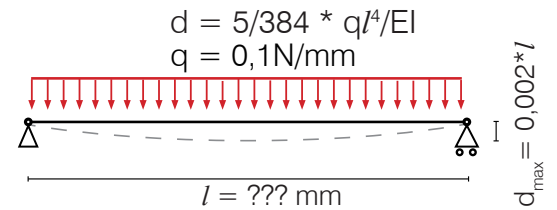

figure 42: Simply supported beam under a distributed load

5.2 Testing: bending

When a beam bends under a distributed load, it forms a continuous curve. When two equal beams are laid on top of each other they will only touch at the ends. This is because the top of the beam will have a slightly stronger curvature than the bottom of the beam.

When the H-profile with brick on top bend, the profile will form a curve, but the bricks will form a segmented curve. The bricks do not bend, they just lay on top of the profile. The middle of the curve segments will be high spots compared with the continuous curve. If the profile above touches these high spots, it will load this spot, rather than above the support.

In figure 43 is shown where the connection points are for a specific curve. The image shows something that has also been observed in physical tests. Namely, the layers only touch on the outer most bricks. In the middle is a gap between the layers. The point where the layers touch is not above the supports. It shifts a bit to the middle. Therefore it should be assumed that the lower layer will deform a bit more with the adding of a new layer. The image also shows that the relative shift of the contact point is larger, when the amount of bricks is smaller.

To see if the masonry works like figure 43, some tests were done, both with strips of PMMA and with aluminium. Each material has their use.

PMMA, better known as Perspex, bends relatively easily. The large deformations make it easier to see how the model works. This makes it useful for qualitative tests.

For quantitative tests, PMMA is less useful. The bricks don't easily slide over the PMMA. This is a problem, especially for large deformations, because this makes the masonry want to settle. It is possible to press on the masonry, bending it a bit further. When pressure is released, the masonry won't come back up. Because of this, the measurements are not consistent and can vary depending on how the materials were handled.

In a test with PMMA, where the layers of masonry were laid out, and carefully placed on top of each other. The PMMA models show a very similar shape to those in the scheme of figure 43. When inspected closely, figure 46 shows the two diagonal bricks are not parallel. The curvature of the top layer is weaker. When a third layer is added, the curvature of that layer is again a bit

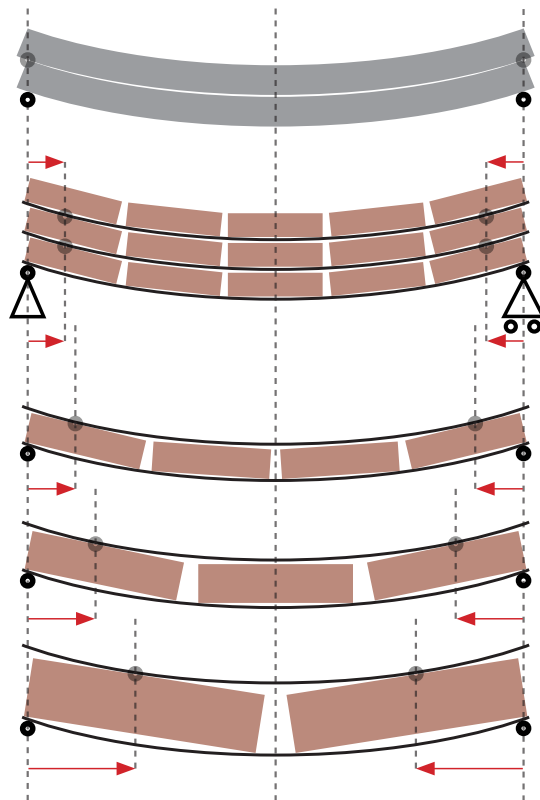

figure 43: Connection points between multiple layers when curvature per layer stays the same, and relative impact when scaled.



figure 44: The layers don't touch in the middle, with PMMA strips 3 bricks wide.

weaker than the second layer. This could mean that the influence of adding a layer would diminish as more layers are added. As the curvature decreases as more layers get added.

For quantitative analysis the aluminium is better. The deformations are a lot smaller and more consistent. This makes it harder to see if components are touching. The smaller deformations also makes the tests more susceptible the influence of varying size and shape of the brick.

Aluminium deflection tests

In the test, the layers of masonry were again laid out beforehand and carefully placed on top of each other, measuring with each layer. The precision of the measurement is the same as in the test with the plastic profiles. So, the measurements are rounded to a quarter millimeter. The deflection of only the aluminium is taken as the zero mark, to be able to compare the deformation of the first layer to that of the additional layers.

The measurements of the deformation with the aluminium strips show that the total deformation, for this typology, is dependent on the amount of layers that is used. With the limited amount of layers and the precision of the measurement, a pattern cannot be distinguished.



figure 45: Setup for measurements in aluminium. Again the layers don't touch in the middle.

Deflection Aluminium 50x5 and Brick
Values in mm 27-03-2018

Span	3 bricks (630mm)		2 bricks (390mm)	
	Defl.	Δd	Defl.	Δd
1P0B	0	-	0	-
1P1B	4	4	1	1
2P2B	4,5	0,5	1	0
3P3B	5	0,5	1,25	0,25

xProfiles xBricks



figure 46: Half of a span with two layers.



figure 47: Reduction of bending over multiple layers

More qualitative tests show that the pattern, where the deformation of subsequent layers decreases, continues. In figure 47 is shown how this looks, with wooden blocks and PMMA strips.

Why this happens is not yet clear, it could have something to do with the cantilever that is produced when the supports move towards the middle.

5.3 Findings

This typology looks at the H-profiles as a series of small beams that might be able to span a gap. It is important to keep in mind that in between these small beams are rows of brick.

Initially, it was presumed that the masonry could be simplified as a stack of beams. Where the height of the stack has no influence on the deformation. This presumption has been found to be false. Bending tests have shown that the deformation does increase with additional layers.

A further investigation into the progression of this deformation when adding layers, could be interesting.

The construction of this typology is extremely simple, therefore it would be interesting to develop. The maximum span seems to be rather limited, that makes the potential of this typology as a whole quite limited.

If this typology can be developed to span a doorway, it may be useful. It will probably require a different material than plastic. For larger spans, another kind of lintel will need to be used.

Typology Summary

Forces in masonry

Tension in bed-joint	Yes
Tension in head-joint	No
Extra stress on brick	No
Horizontal forces in masonry	No

Detailing

Subject to initial settling	No
Precise sized brick necessary	No
Long bed-joint needed	Yes
Stronger head-joint connections needed	No
Special head-joint needed	No

Construction process

Temporary support during construction	Maybe
Lintel prefab possible	No
Lintel on-site fabrication possible	Yes

Design

Lintel is in plain sight	No
Lintel is obscured	No
Lintel is out of sight	Yes
Allows various stacking patterns	Yes

6.0 Typology 6: Structural masonry

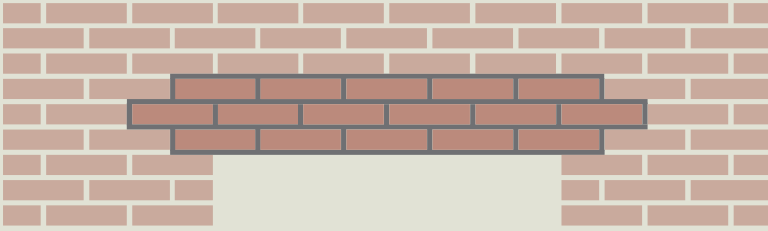

Introduction

The logical advance from typology 5 is to include the head-joints and the bricks in the structure. All the components of H-block are working together to span the facade opening.

The chapter starts with the definition of a structural model, to get a grip on the general distribution of forces in the masonry. Then the bending and breaking behavior is looked at, with a full-scale model. Lastly, the changes in detailing are discussed, that would enhance the performance of H-block as a lintel.

6.1 Structural wire-frame model

To get an understanding of how the forces are distributed in the masonry, the masonry has to be schematized. H-block can be modeled as a truss, with the bricks as the diagonals in compression. The plastic components are the horizontal and vertical members.

Why a truss?

In modeling as a wire-frame there are two options for this structure: a truss or a vierendeel beam. The reason the truss was chosen is because the vierendeel effect doesn't get the chance to work. The vierendeel beam needs to deform to become stiff, and the brick is so stiff that it prevents this deformation. If the infill would be a much softer material, like some kind of foam, the stiffness of the connections might come into play.

Use of the model

The use of the model is to get a grip on the distribution of forces in the masonry. Therefore the bricks are simplified as lines. The forces can flow in multiple directions through the brick, thus there can be multiple lines. Because the amount lines (in compression) varies per brick, the stiffness of the models varies per brick. This will result in an inaccuracy in the results. To have a more accurate simulation, the model can later be adjusted so simulate the bricks as a mesh. However, for this step the wire-frame gives a first impression of the distribution of forces.

Modeling horizontal and vertical members

In real life the components of H-block click together, however the connections are not rated for a specific load. Moreover, the bricks and head joints can slide along the bed joints, so horizontal forces are not transferred in a specific point. In the model several assumptions are made in relation to the aforementioned facts. By using these assumptions, the model can give the requirements for the detailing of the connections.

The bed joints (horizontal) are presumed to be a single continuous member. The connections between the profiles are therefore disregarded, or assumed to be made in such a way, the forces are completely transferred.

The head joints (vertical) are presumed to be pinned to the bed joints. This means they do not resist rotation, but they do resist translation. The horizontal forces are presumed to be transferred only at the connection of the head joints.

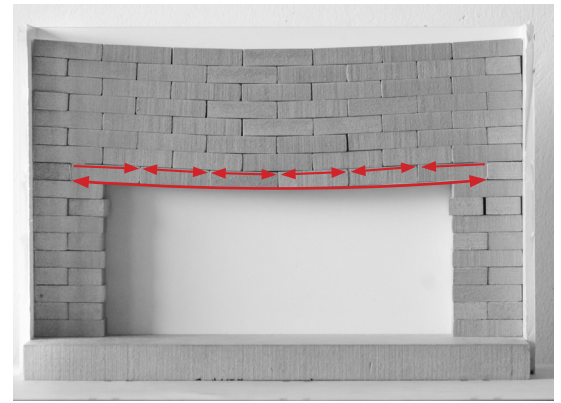

figure 49

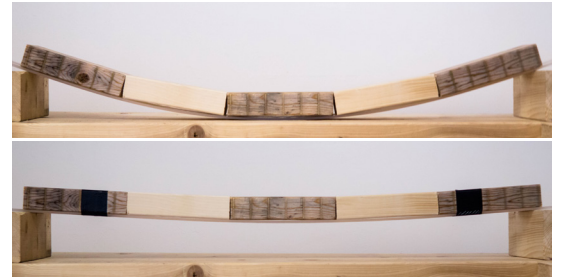
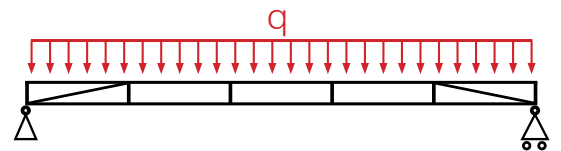

figure 48: Blocks free to move, and with the ends taped to perspex



Modeling the diagonals

In order to model the bricks as diagonals, the brick has to be schematized from a solid to a line, or several lines. Lines will be drawn between the place where the bricks are loaded, and the place where they are supported. In that way the lines will approximately follow the greatest stress in the brick.

Dry-stacked masonry has the tendency to transfer forces through specific points, rather than larger surfaces. As was previously mentioned in the literature studies. In the literature, the masonry was supported along the entire bottom edge. For the lintel, the masonry is only supported at the ends of the slab. Therefore, the points will be slightly different.

As any other beam, the lintel will deform under its own weight. However, the stiffness of the bricks will not allow them to deform. Therefore, the lintel will deform a bit like what is shown in figure 50. You can see the bricks are resting on the two bottom corners. With H-block the bricks will be resting on the plastic profiles. These will bend more than the bricks, resulting in the same effect.

In stretcher bond the bottom corners of the brick align with the middle of the brick underneath, which in turn will be supported on the two bottom corners. Therefore the lines for the model will be drawn between the middle of the top edge of the brick and the two bottom corners.

In other bonds the lines may differ. It all depends on the place where the bottom corners of the brick touch the brick underneath.

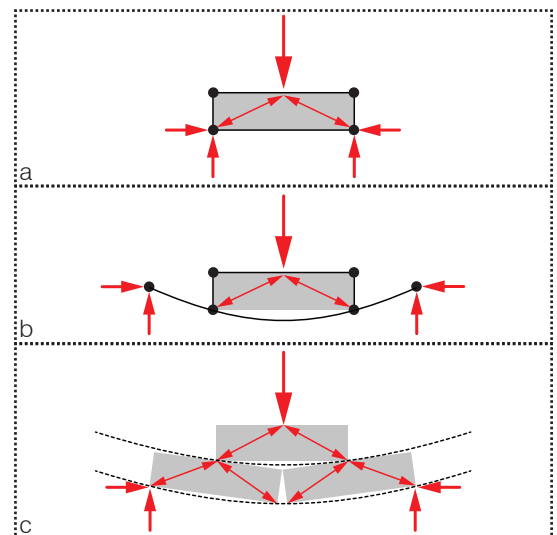
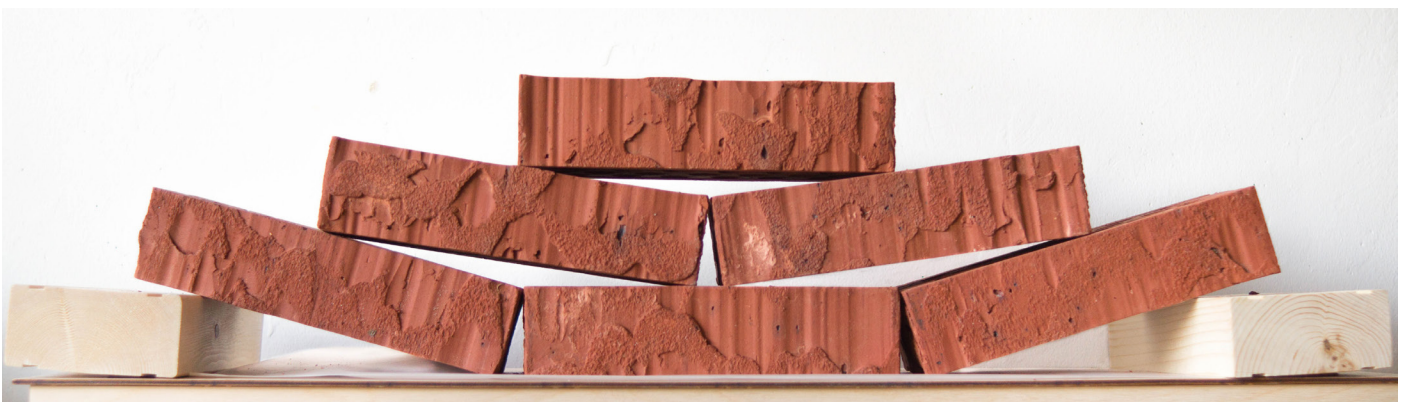

figure 50, a: Brick on two supports, b: Brick on a bent beam, c: two layers of brick on bent beams

figure 51, Bricks stacked as if on a curved support



Another diagonal needs to be added. The line goes from one corner-point to the complete opposite one. Like the diagonal in normal compression trusses. In bending the top and bottom horizontal members of the truss will try to move relative to each other, this diagonal keeps this from happening.

The two sets of diagonals are put together to form the scheme like figure 53. This shows the potential stress lines, but in the brick only the compression lines. In the software the members in tension can be automatically eliminated, which was done to reach the results on the next page.

Materials

For this preliminary model the materials were approximated with pre-loaded materials in the software. The plastic was modeled as wood, with $E = 10,5 \text{ GPa}$. Quite near the E of the considered plastic blend.

The bricks were modeled as concrete, with $E = 34 \text{ GPa}$, which is a bit less than the range of E for brick.

Cross-sections

All structural members were modeled with the same cross-section. In further developments of the model this will be changed.

Load

In the current model the truss can be loaded in two ways. The first is a point load in the middle of the truss. The second places a load on the top of every brick, simulating the self-weight bricks.

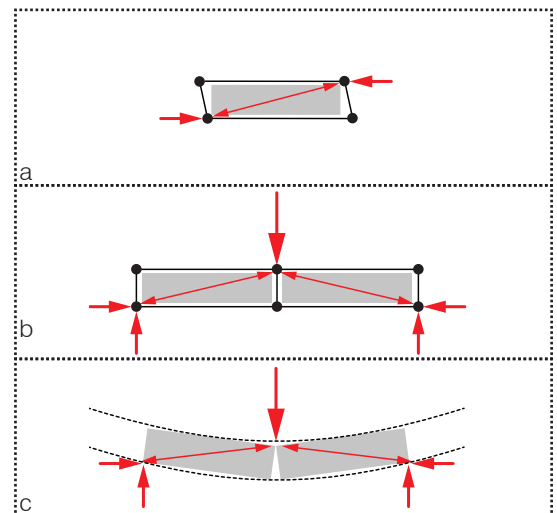

figure 52, a: Brick resists skewing of the rectangle, b: brick as 'normal' diagonal, c: bricks in bending

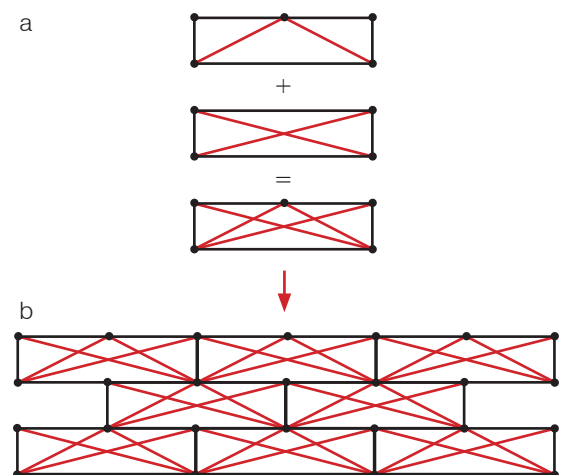

figure 53, a: Scheme of potential members in a single brick (in stretcher bond), b Scheme of multiple bricks

Potential inaccuracies

Head joints:

The head joints are modeled as plastic. However, in real life, the plastic would only transfer tension forces. In compression the plastic would bend out, and let the compression forces be transferred through the brick. In the model both materials were tried, which resulted in minimal changes in the axial forces. In the end it was decided to model the head joints as plastic, because the tension forces are of more interest.

Brick diagonals:

The diagonals that start in the top middle of the brick (see figure 50) are not cut loose for horizontal forces, as they are in real life. Therefore these diagonals may take more forces in the model than in real life.

Observations

Looking at the images of figure 54, the model seems to make an arch over the span. Which is what is expected in masonry. From 'd' onwards the tension forces are almost completely focused in the bottom profile. It seems quite similar to stresses in an composite lintel. The composite lintel could be another approach to modeling this typology. Although, figure 56 looks more like reinforced masonry, when viewing the triangle that is formed at the bottom.

What figure 56 also shows is that the model is inaccurate, in that the diagonals of the bricks cause large tension forces in the middle of supported masonry. These forces are actually, largely internally in the brick. The bricks should be represented as triangles, rather than only diagonals.

Discussion

To get a more accurate view of the result the masonry should actually be modeled with a different technique. Using software that is able to model the masonry as separate components that interface with each other, in specific ways. The problem with this, is that the information about these interfaces has not yet been measured.

The model as it is shown here is mostly useless. It is here to signify a part of the process, but it was abandoned as relatively early on.

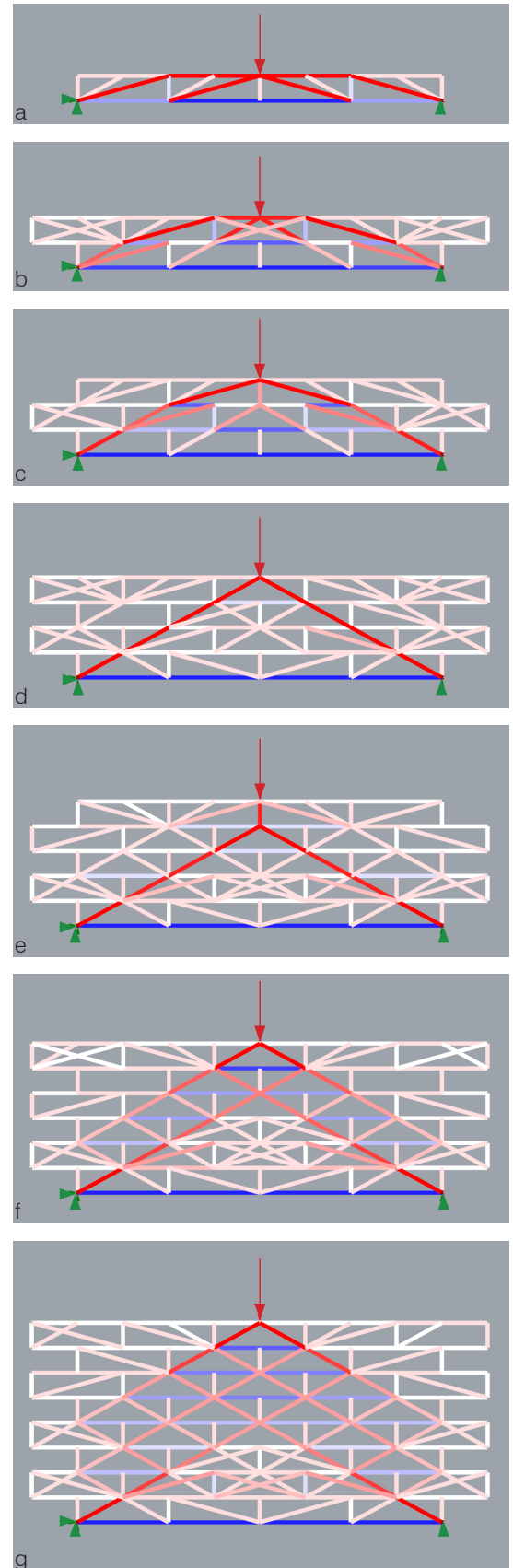

figure 54, Variation on a four brick span, axial forces, single load

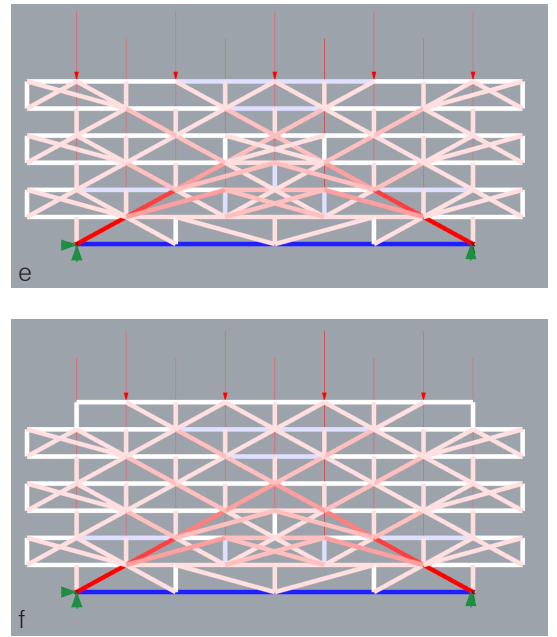
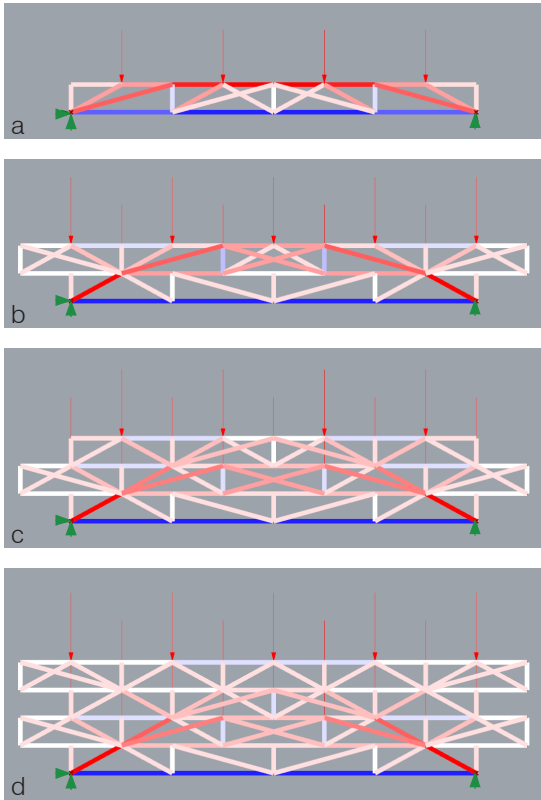
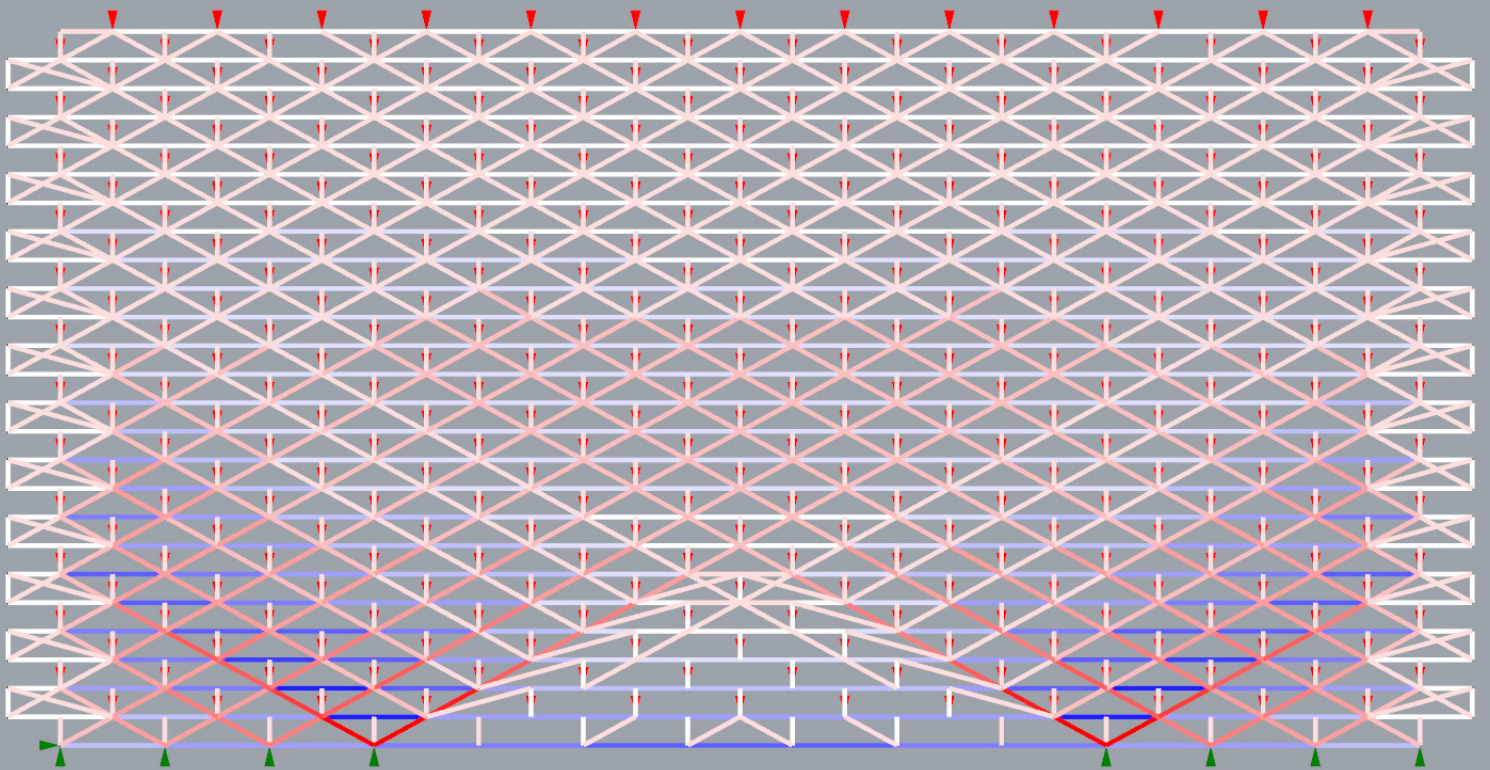

figure 55, Variation on a 4 brick span, axial forces, loaded with self-weight of every brick

figure 56, Force distribution for a large wall.



6.2 Testing: Behavior at break

Some small tests were done to see how H-block fails under loads, when in bending. The goal was to observe the behavior at breaking point. Whether the break announces itself or happens suddenly.

The pictures of figure 30 represent the four stages of the test. The models were built while on supports (a). The supports in the middle would then be removed, to see the performance under self-weight (b). To see the behavior of the masonry at break some extra load would temporarily be added, first to see the progression of bending (c), then finally till the breaking point (d).

The first thing to notice is that the masonry almost doesn't bend elastically. That's why it is possible to temporarily press on the masonry and still see a difference in bending. So, what happens?

The masonry is made up of many different components. When the masonry bends, these components move relative to each other. In the lower courses of the masonry, gaps appear between the different parts of the bed-joints. Under load the friction between the components is overcome to find a new equilibrium position. When the load is removed, the components remain in this position. This is also true for the head-joints, which can unhook under the load.

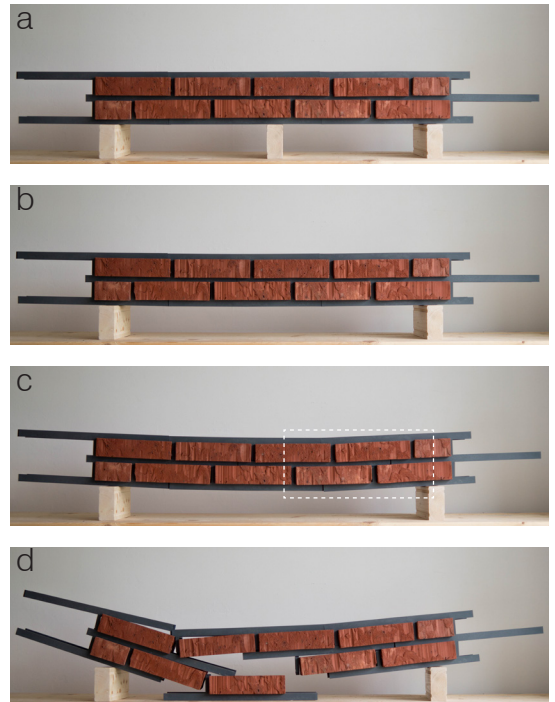

figure 57, H-block spanning ~900mm, 2 courses.

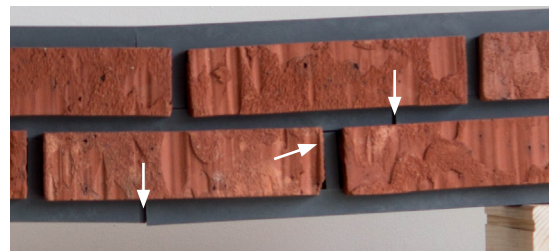

figure 58, Detail of figure 57c, showing parts have moved under deformation.





The behavior under bending can be separated in three distinct parts. The first is when the bed-joints start to move outwards. This will always happen as the bottom of the masonry elongates under bending. It shows the masonry, in its current form, is unable to effectively resist tension forces. The masonry would fair much better if the bed-joints were attached to each other.

Then at some point, head joints start to come loose. They were designed to give a visual improvement to the system, not to make take a lot of forces. The fact that some of the head joints come loose before the entire structure collapses, can be taken as a warning sign. This is, however, not clearly visible from far away, and won't necessarily be noticed.

Finally, when a critical number of the head-joints unhook from the bed-joints. A chain reaction will follow, in which the masonry suddenly loses all its stiffness and falls to the ground.

In this limited piece of masonry, the final collapse comes without warning. If the masonry is part of a larger wall, the result might be different. Also, if the bed-joints are longer, or running the entire length of the masonry, the failure might occur in stages. For instance, where some of the courses come loose from the rest of the masonry and hang down, without falling. This would make it much safer in use.

figure 59, Stages 3 and 4, span ~1100mm, 4 courses.



6.3 Detailing

The structural performance is based on the entire masonry system working together. It is presumed the details can be changed in such a way that this will be the case. In its current state H-block does yet not work like this, nor was it designed to do. For the structural scheme to work, some aspects would need to be ensured with the details.

The detailing need to ensure:

1. Horizontal fixation of the brick and bed-joint, with the head joints.
2. Vertical tension strength for connections of the head-joints.
3. Tension forces in bed-joint, with continuous or interlocking profiles.

Solving these aspects with detailing, will make it possible for the masonry to work together to resist bending, but only once it starts to build up stiffness. Before the stiffness starts build, the masonry will shift and settle. Minimizing this initial settling of the masonry, will be the largest challenge. This challenge is mainly centered around the first statement. The second and third are relatively easy to solve.

Horizontal fixation of bricks and bed-joints

For the structure to work, the bricks cannot be allowed to slide over the profiles, nor the profiles over the bricks. It was envisioned that this would be controlled by the head-joints, as a specific point to counteract the horizontal forces.

Friction also helps to keep the bricks in place, but this is dependent on the weight pressing down on the brick. The weight is variable and sometimes quite limited above a façade opening, therefore it is difficult to work with. So, the actual question is:

How can we horizontally fixate the head-joint on the bed-joint, so the bricks cannot slide, with minimal slack, while also being able fixate the head-joints vertically and keep design freedom?

This is quite a complicated question, especially the last part. The way the head-joints attach to the bed-joint directly impacts the design freedom of the entire system. In the current version, head-joints can be placed anywhere along the bed-joint, which makes it possible to use bricks of any width. It also leaves the possibility to stack the wall in any masonry bond. It leaves a lot of freedom, but also a lot of freedom to control for.

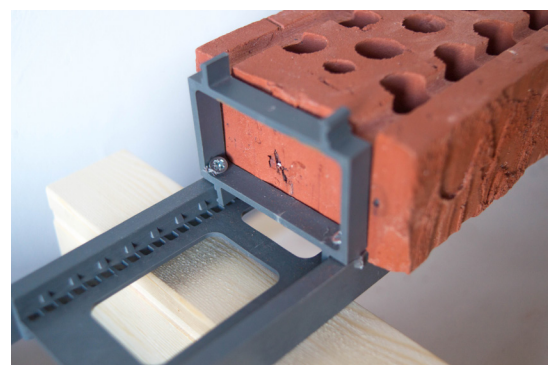

figure 60, Prototype to see the effect of fixed head-joints. Fixating joints with screws is cumbersome, slow and imprecise.

Head-joints can be fastened at specific intervals

The H-profile can be prepared for head-joint to be securely placed in specific intervals. But what would the size of the interval need to be? Basically, there are two options, either the intervals are as small as possible, or the intervals are designed for specific freedoms.

If the intervals are as small as possible, the pros and cons will be similar to the situation when the head-joints can be placed anywhere, but with the additional imprecision of the size of the interval. The detail could feature serrated edge for the head joint to fall into.

The interval can be designed to allow a bit of design freedom. If the head-joints can be placed every quarter bat distance (55mm for Waal-size brick), most masonry bonds will remain possible, as will be the use of stretcher, header and quarter bat (if this is cut at 45mm). Whether this is enough design freedom can be argued over, but it is still more than most other dry stacking systems.

A relatively simple way to fix the head-joint would be to mill a piece out of the H-profile. A shoulder on the head-joint can then fall into this. To control the slack in the stacking system. The width of the bricks would need to be controlled, which can be done in the same way as the height is controlled.

figure 61, Possible solution to fix the head-joint horizontally, while keeping it visually unchanged.

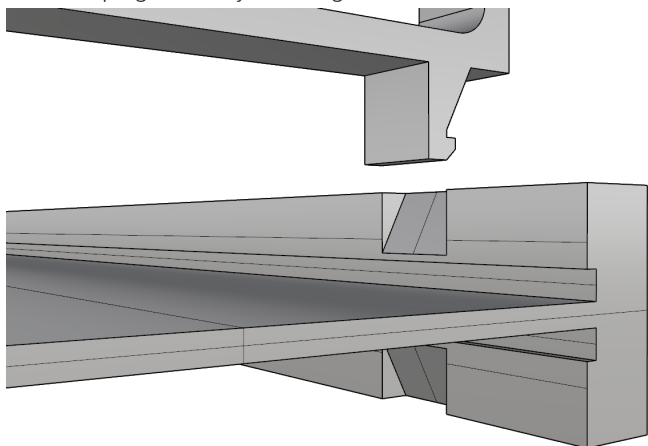

Head-joints can be locked in place anywhere along the profile

If an effective way can be found to achieve anywhere along the profile, it would be preferred. However, the tests up till now have been overly complex, time consuming and imprecise.

How do you ensure that the head-joint will be placed snugly against the brick? The interface between the head-joint and the brick will still need to be controlled. The brick will probably need to be processed on the ends, not for length but for contact area.

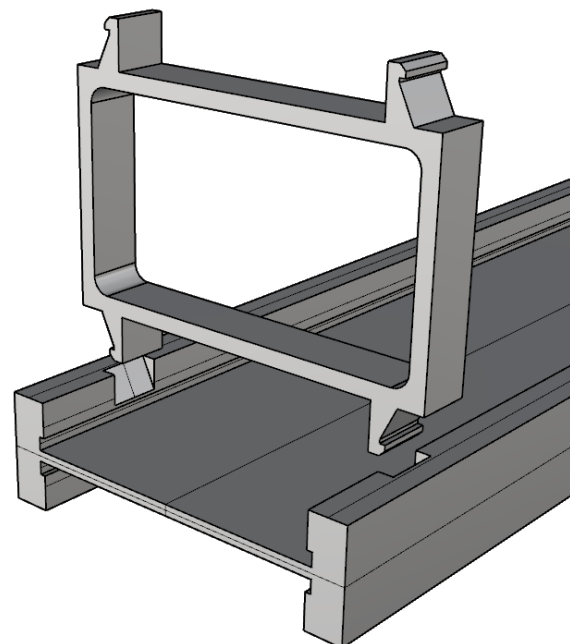

6.4 Findings

H-block in its current form can span some distance. Its capacity is quite small however. The system is limited by the short profiles and the relatively weak connection between head-joint and bed-joint. Additionally, the bricks slide relative to each other, which limits the stiffness of the masonry.

The break of the masonry slowly progresses, till it suddenly snaps. This can lead to safety problems.

For this typology to work, the profiles need to be longer, the connections with the head-joint needs to be stronger, and the bricks need to be fixated horizontally.

H-block can be optimized to increase its performance as a lintel. The changes to benefit the lintel, go in against the needs for the general system, namely cheaper components and quicker construction. The choice will be whether to change H-block or continue with two compatible versions.

Typology Summary

Type 6

Forces in masonry

Tension in bed-joint	Yes
Tension in head-joint	Yes
Extra stress on brick	Yes
Horizontal forces in masonry	Yes

Detailing

Subject to initial settling	Yes
Precise sized brick necessary	Yes
Long bed-joint needed	Yes
Stronger head-joint connections needed	Yes
Special head-joint needed	No

Construction process

Temporary support during construction	No
Lintel prefab possible	Yes
Lintel on-site fabrication possible	No

Design

Lintel is in plain sight	No
Lintel is obscured	No
Lintel is out of sight	Yes
Allows various stacking patterns	Yes

7.0 Typology 7: Vertical prestress

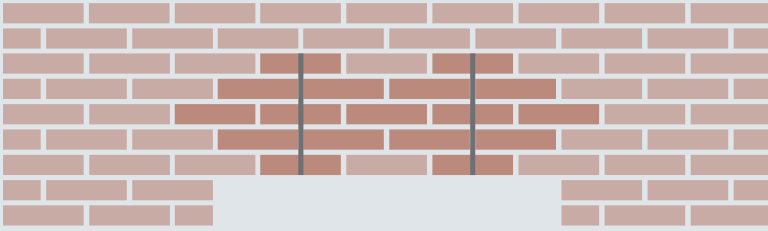

Introduction

This chapter investigates the possibility of vertical prestress. The masonry is prestressed every few bricks, making it possible to span a significant distance.

The chapters starts with some theory on the stress distribution in masonry and corbeling. It continues by introducing the Dutch gevelklem, which works under a similar principle. How the structure works will then be explained, together with some observations in models and potential limitations. The construction will be discussed. Finally, a full-sized prototype is made as a proof of concept.

7.1 Theory: Load distribution in masonry

Masonry is an interesting material, where the bricks themselves are extremely stiff, while surrounded by a more flexible material. This makes the transmission of forces through masonry less straight forward than in a homogeneous material. A point-load on a piece of masonry, which is continuously supported, is spread out over a certain area. How much does it spread?

In design literature, the distribution of a point-load is usually condensed into a single number. Depending who you ask the distribution is either assumed as at 45° (Hendry, Sinha, & Davies, 2003; Yeomans, 2016) or 30° from the vertical (Pfeifer, Ramcke, Achtziger, & Konrad, 2002; Rai, 2005). The 30 degrees spread is an adjustment from the 45 degree, after conducting tests, according to Rai (2005).

None of these sources give any qualifications to the number they give. The frontal ratio of the brick and the bond in which the bricks are laid, are not specified. Instinctively, these are things that would influence the angle in which forces are distributed.

Photoelastic experiments

Photoelastic imaging is a way to show stresses in a material. Some materials bend light when they are subjected to a force. By polarizing the light going in and out of the material, the bent light is shown.

Bigoni and Noselli (2010a) used the photoelasticity properties of several plastics to experimentally show the stress distribution in models of dry-stacked masonry. The models were supported along the entire bottom edge and were made in stretcher bond. The results show a distribution that is, to a certain extent, random. The forces flow through the masonry in distinct paths, while not loading other areas at all. The authors also note that the stress distribution can be different for situations which you expect to be the same, i.e. two pieces of masonry stacked and loaded in the same way.

The article also notes that the stresses flow almost vertically through the masonry, with very little spread over the width. This is quite different from what the simplified design literature sketches.

An especially interesting part of the article is the way the forces are transmitted through the masonry. This happens through specific points, almost exclusively

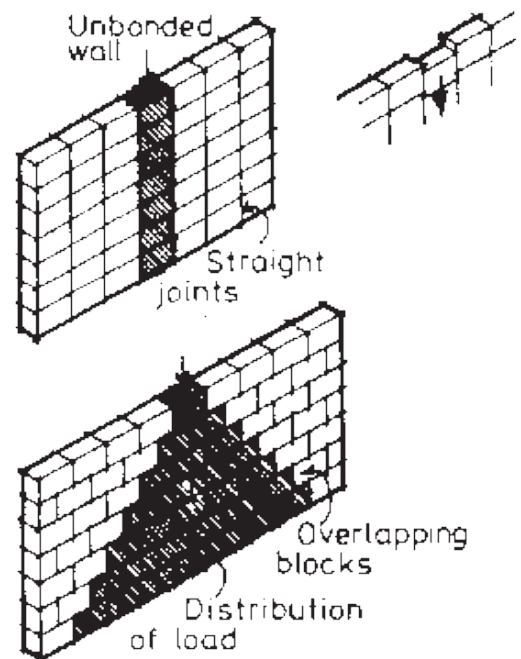

figure 62, Load distribution in bonded and unbonded wall

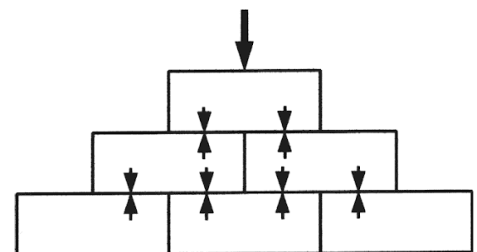

figure 63, Load distribution with perfect bricks

at the edges of the brick, which was corroborated by Baig, Ramesh, and Hariprasad (2015). Because the tests were done in stretcher bond this means the forces flow between the edges of the brick and the middle of other bricks, because the edges always line up with the middle of the brick above and below.

In the second part of the study, Bigoni and Noselli (2010b) define rules for how the forces can flow in dry stacked masonry. They do this for both stretcher bond and Brazilian open bond. A brick has several possible places where it can be loaded, and several places where it can be supported, dependent on the masonry bond. The brick is always supported as a beam on two points, chosen from the available ones. The forces acting on the brick, depend on the bricks above. Given a (partial) support situation the forces acting on the brick will determine how the forces are transmitted.

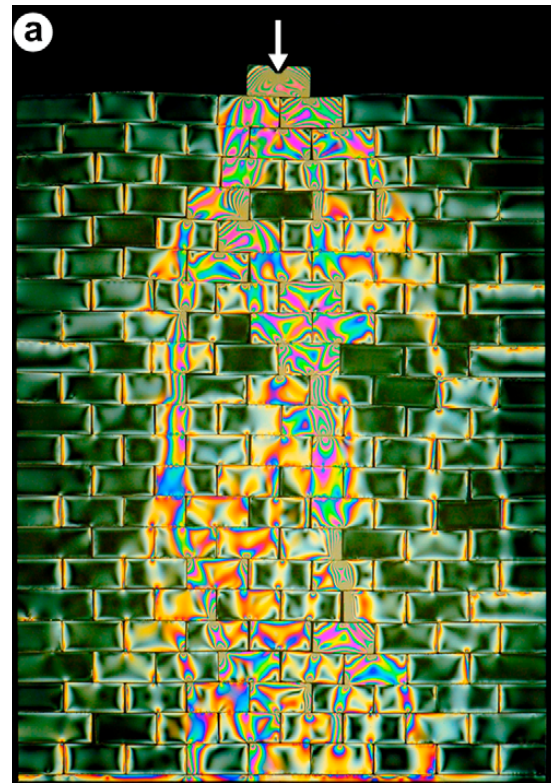

figure 64, Stress distribution in masonry made visible by photoelastic imagery

Why do the forces act in a semi-random way?

What the article doesn't do very well, is to explain the physical reason why this behavior is observed. It is all down to imperfections of the brick. Two bricks are never exactly the same size, even if they have been machined to be the same. The stiffness of the brick ensures these imperfections matter. In others words, the brick doesn't conform to these imperfections.

In figure 65, we see all possible progressions of forces in stretcher bond. The contact points can be on the two corners of the top brick (1), in which case the load is divided over the two bricks underneath. One of the contact points can also be in the middle of the brick (2 and 3), or rather on the corner of the bricks on the bottom. When one of the contact points is in the middle, support R2 acts as a pivot. Depending on the incoming forces the second support will be either R1 or R3. The difference between 2 and 3 is, that in 2 the bottom-left brick is bigger than the bottom-right and in b3 the bottom-right brick is bigger. This means the support R2 is placed either on the left or right brick respectively. R2 is never on both bricks at the same time.

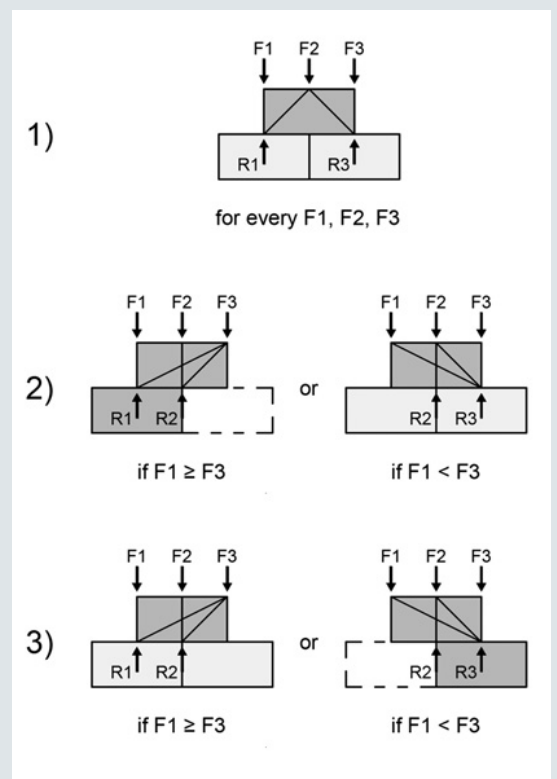

figure 65, Bigoni's and Noselli's rules for random percolation in masonry

Relating back to H-block. It is a dry-stacking system and some of the topics in these articles should be considered in developing H-block, namely the presence of these localized stress streams. However, the rules that were set up in the articles might not completely apply in this new situation, in the same way it doesn't completely apply in traditional masonry. The bricks in H-block are relatively precisely sized, because of the post-processing. In combination with the joints, made of a relatively flexible material, the points where forces are transmitted may be in different places, and they may be spread along an area. This would be quite interesting to find out but falls outside of the scope of this thesis.

As it stands, point loads won't have a large part to play for the lintel, because the lintel only needs to carry the masonry itself and not the beams for the floor and roof, as it used to be. If point loads do come into play, the 30 degrees spread will be used, as it seems a more reasonable simplification than 45 degrees.

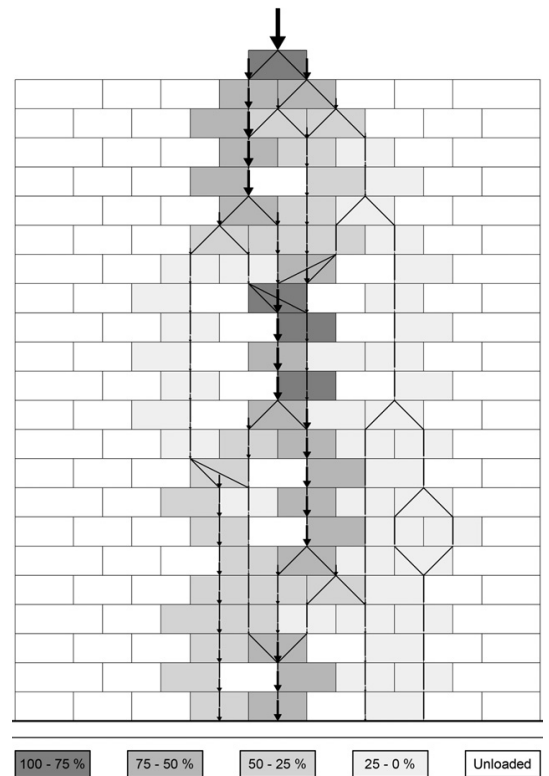

figure 66, Model representation of a stress transmission in masonry.

7.2 Theory: Corbeling

A corbel is a structural piece of stone sticking out of wall. Sometimes it is also used to describe a console on concrete columns. In masonry these corbels can be stacked to achieve large overhangs. It has long been used to make chimneys on the side of buildings, and to make primitive arches and domes. These corbel arches can form inside the wall as well. Above wall openings they form, even when a lintel is in place. When the lintel is taken out, only a part of the bricks will be in danger of falling down. The remainder has formed a corbel arch, therefore masonry is sometimes called self-corbeling.

A lot of the literature takes this self-corbeling or arching effect into account when calculating the load of the masonry on a lintel. It is then assumed only the part of the masonry under the arch needs to be carried by the lintel. Usually, this is defined as a triangle with its base on the lintel, and diagonals at a 45 degree angle. However, this 45 degree angle is never explained. The rest of this section will be focused on how corbeling works and how it can be used with H-block.

Corbel cantilever

First the corbel as a cantilever. Everyone who has played with blocks as a kid, knows that you can make a cantilever by stacking a block partly over the edge of the block beneath. This works as long as the center of gravity of the block, is above the block underneath. When you continue stacking in the same way, there will be a point where the combined center of gravity is outside the lower block, and the cantilever will fall. Because the blocks can distribute the loads as described before, the cantilever can be counterbalanced, to adjust the center of gravity.

Usually, the bottom block is the critical one, but it is not necessarily the case. As a general rule it can be stated that: *A stack of blocks is stable if and only if there is an admissible configuration of forces acting on them under which each block is in equilibrium* (Paterson & Zwick, 2006).

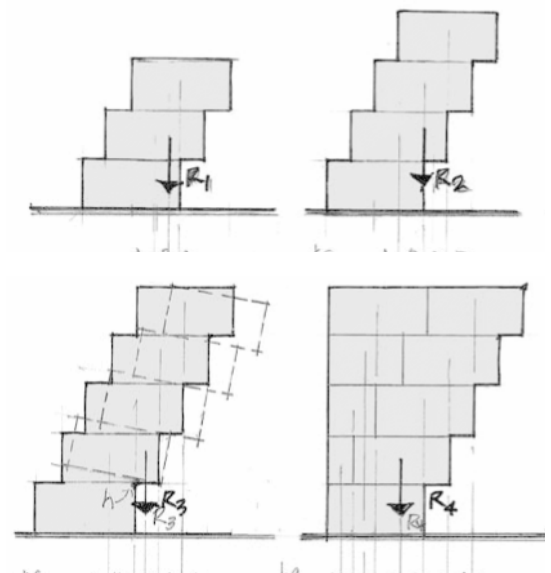

figure 67, Center of gravity of a stack

To find the maximum cantilever, with a specific amount of blocks, is actually a mathematical problem. To assure a perfect situation some rules are used.

- The blocks are rectangular
- All blocks are of equal size and density
- The blocks are rigid
- The center of mass of the block is at the centroid
- Blocks are laid horizontal on the long edge
- The gravity field is uniform

When using these rules there are two routes that can be followed. One is to make a stack of a single block wide, as seen in figure 68. It is called the leaning tower of Lire. The relative distance of the overhang follow the following formula: $d = 1/(2 \times n)$. Where n is the number of the block from top to bottom.

However, this is not so relevant for the problem at hand. The second strategy allows multiple blocks on the same row.

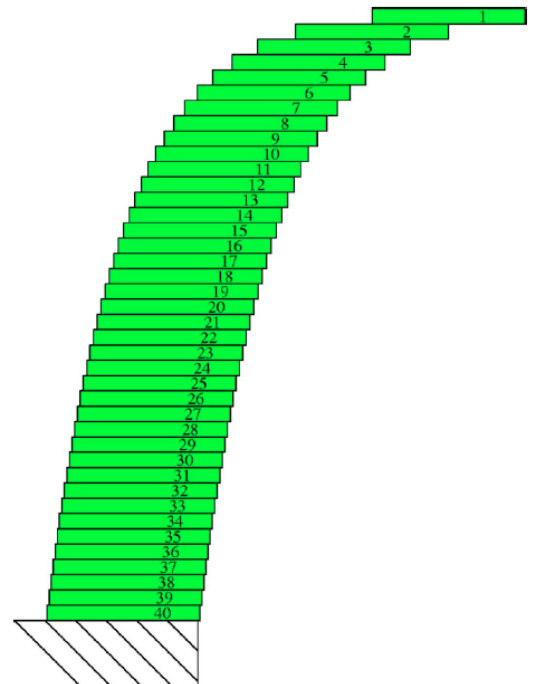

figure 68, Leaning tower of Lire

Multiwide stacks

The 'multiwide' stacks use counterweight to reach a point of neutral rotational stability. Hall (2005) formalized it in figure 69. It shows the minimum force required to keep the balance for every position of i . That force is expressed in W , which is the weight of a single block. The total number of steps is called n .

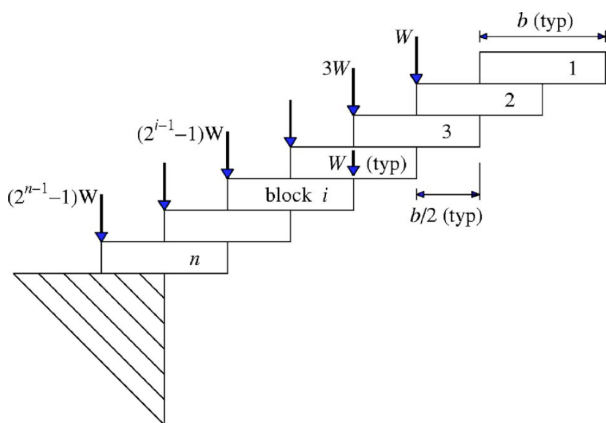

figure 69, Unified rule for counterweight in multiwide stacks.

Two examples of stacks of $n=5$, made with 31 blocks, are shown in figure 70. One is symmetrical and one that is not. Note that in both cases the stacks of blocks are quite high, with 10 blocks higher than what is drawn. This is necessary to make all the blocks in the stack stable.

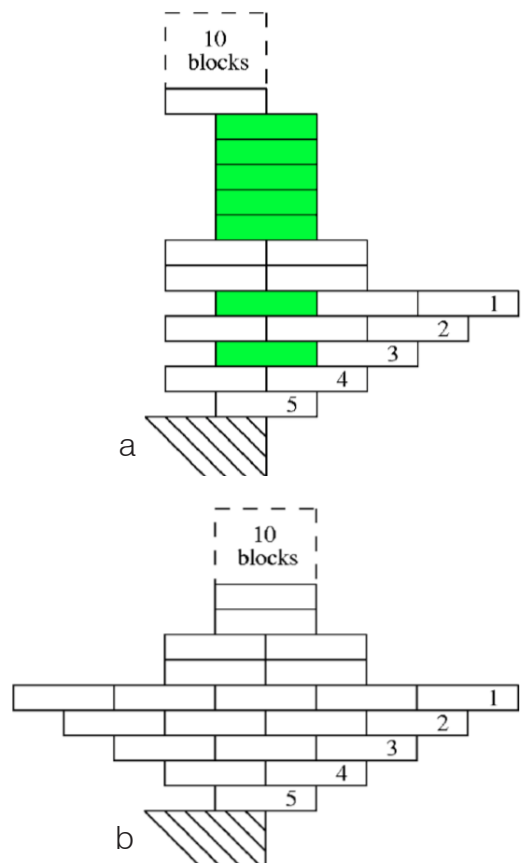

figure 70, Two stacking patterns for multiwide stacks

Corbel arch and arching effect

By placing two corbels facing each other, you can make a corbel arch, sometimes called a false arch. It is called this, because when the corbels are balanced, the corbel arch does not exert horizontal forces.

Other times the corbel arch works the same as a true arch. This is when the corbels, from which the arch is made aren't stable. The unstable corbels want to fall over, but instead lean against each other. When this happens the arch does exert horizontal forces.

So, what is the angle of a corbel arch? It depends. The angle is somewhere between zero and ninety degrees from horizontal. The angle is determined by the proportions of the block that is used and how they are stacked.

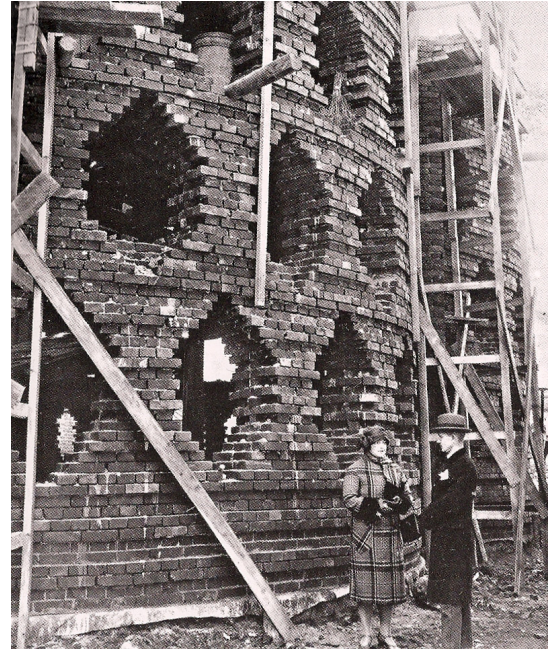

figure 71: Melnikov house under construction.

Precedent: Melnikov house, by Konstantin Melnikov

The arching effect can be used to make facade openings. Konstantin Melnikov used it with his own house, eliminating the need for lintels. It is a lot cheaper than a normal arch, as it doesn't need any specially cut bricks.

The windows, ofcourse, have a very distinctive shape, because of how they are made. This is not what the general public is looking for. They want rectangular windows.



figure 72: Finished window at Melnikov house

7.3 Precedent: Gevelklem

In the Netherlands, a product has come on the market that eases masonry maintenance, by creating temporary masonry lintels in normal masonry. Gevelklemmen, literally translated: façade clamps, clamp the masonry horizontally, over a certain height, in regular intervals. This keeps the masonry from falling.

The gevelklem features a telescoping arm, with on one side a small shelf, and on the other a pin. The installation requires the bed-joint on the bottom of the masonry to be partially removed, to make room for the shelf. Then a hole is drilled in one of the joints, several courses higher. The pin of the gevelklem is inserted in the hole. The shelf hooks under the masonry. Now, the clamp needs to be fastened tightly, with the internal thread.

The installation notes for the gevelklem specify that the masonry needs to be clamped over a height of 7 courses. It also specifies the maximum interval between clamps to be 700mm. Which sound like numbers, chosen to be easily remembered together. The resulting maximum is 5 meters.



figure 73: Gevelklemmen in use

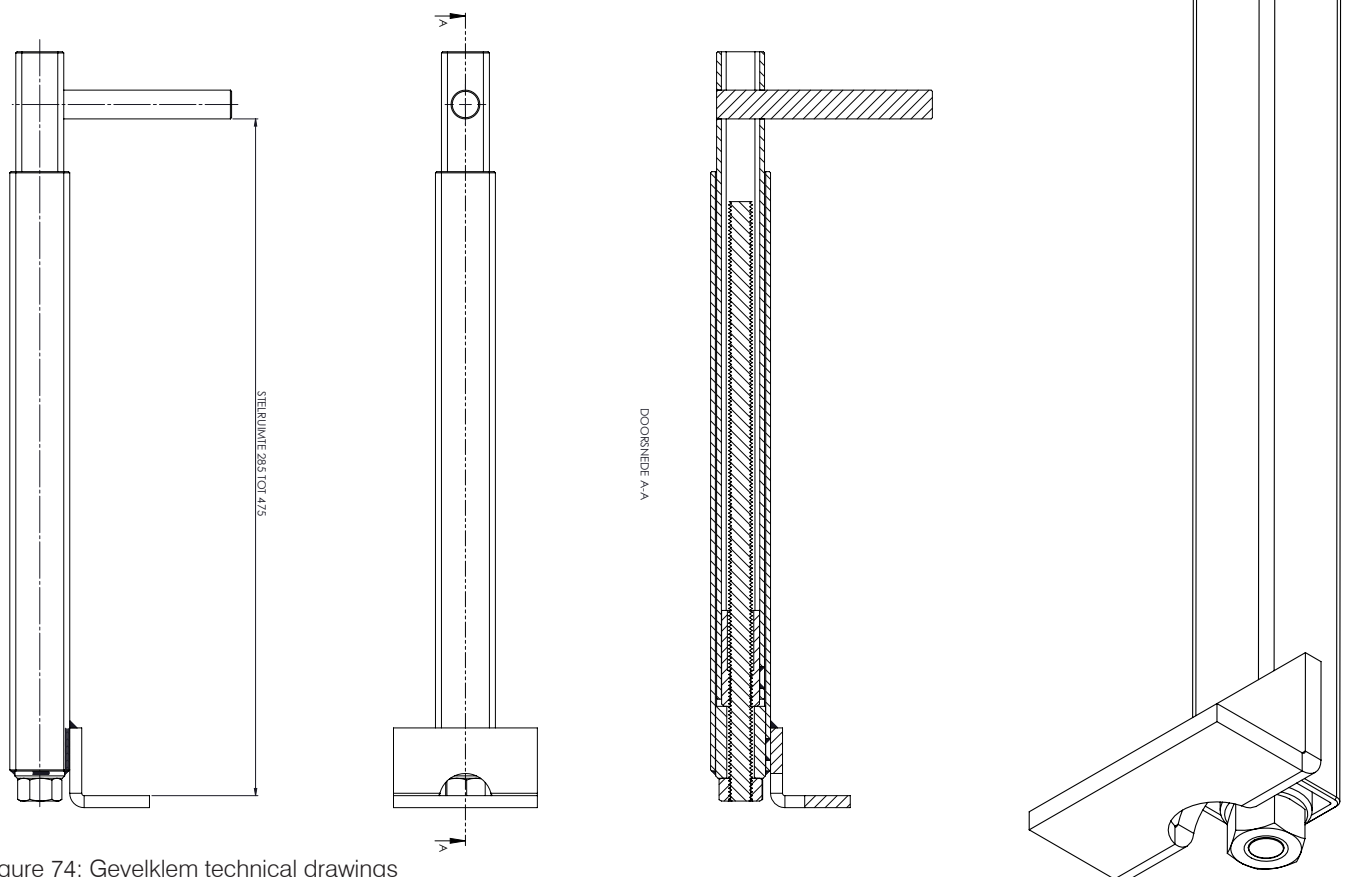

figure 74: Gevelklem technical drawings

7.4.0 Structural behavior

To start understanding how the structure works, this chapter will follow the rules set in for the gevelklemmen, to see how they convert to dry stacked masonry and how they can be adjusted to different situations.

First is to see what happens when you clamp down on a piece of masonry. Then, by using the rules of defined for the gevelklemmen, the interaction between the clamped parts will be investigated. And finally, the chapter goes into how H-block can be integrated in the lintel.

The structural behavior will be investigated for use in dry stacked masonry. In traditional masonry the mortar might make the masonry behave differently.

Clamping action on brick

Under prestress, a part of the masonry forms a more or less stable structure. The shape of this structure is determined by the masonry bond, the size is determined by the number of courses that is clamped together. In stretcher bond the shape of this stable structure, resembles a rhombus quite strongly. In any bond, the shape will always taper towards a single brick, because of the compression forces that hold the bricks together. Examples of other bonds can be found on page 92.

The vertical prestress from the clamps can be simplified as two equal and opposite point loads, pressing the masonry together. From theory we know that point loads on masonry spread. We also know that the precise way in which these loads spread is partially random. Moreover, a significant part of the load may percolate almost vertically through the masonry. So, in general it can probably be said that the bricks in line with the tension rod, have the most prestress and the pressure diminishes further away from the rod.

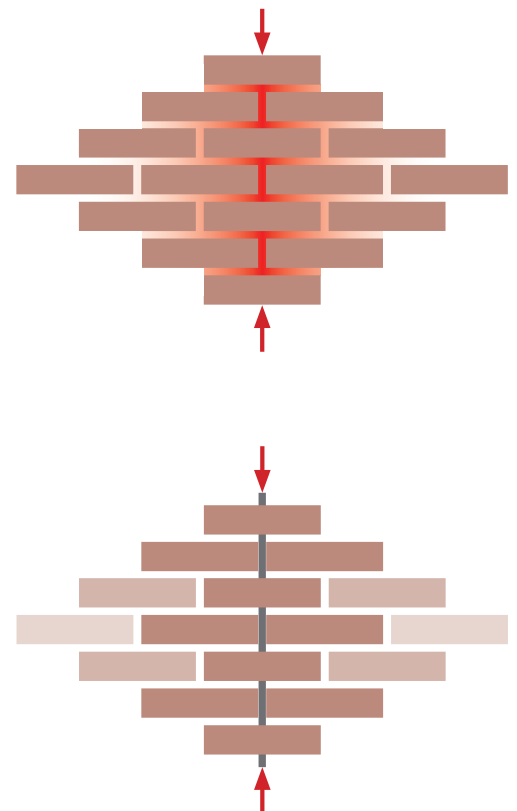
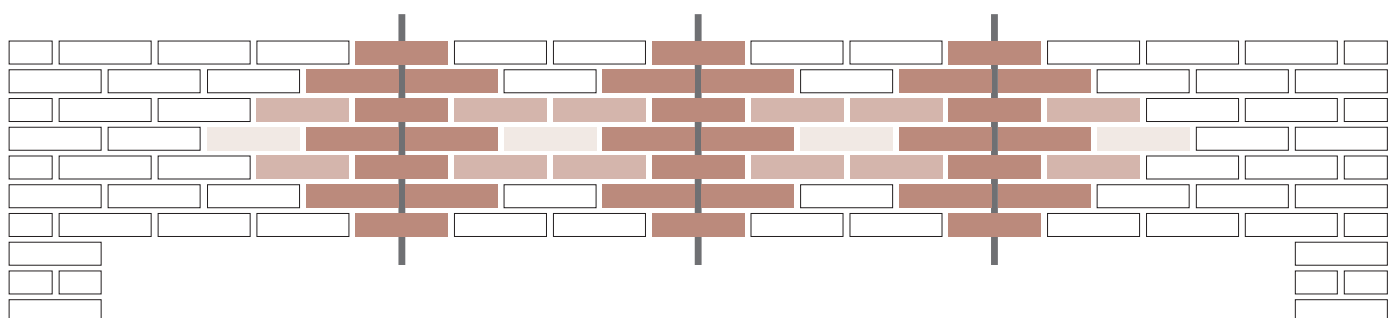

figure 75,



Prestress increases friction

The prestress not only holds the bricks together vertically, it also increases the friction between the bricks. Friction depends on a friction coefficient between two surfaces, and a normal force pressing on these surfaces. When the prestress is applied the normal force increases, thus the maximum frictional force increases. If the friction is high enough, multiple layers of brick will effectively be locked together. In handling the models, it is clear the friction between the blocks lessens further away from the clamp.

Prestress counteracts rotation

The stable part of the masonry acts a lot like a corbel. Where the prestress is the 'counterweight' that keeps the corbel stable. The surrounding masonry tries to unsettle the corbel. If the prestress is large enough, in the right place, the corbel will remain stable. In figure 77 is shown how a force applied the masonry acts as a lever to try to rotate bricks. The prestress is the force that prevents this from happening.

Looking at figure 78, we see 7 courses of prestressed blocks, with a force applied to one side, the other side is fixed in place. The deformation shows four levers in the masonry, all in a 2:1 favor of the force. The rest of the masonry has no visible deformation. The masonry deforms reliably in this pattern.

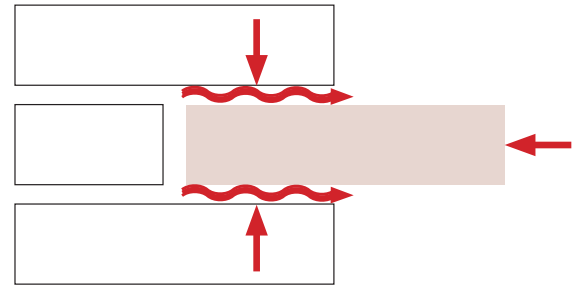

figure 76, Pressing on one side of the rhombus

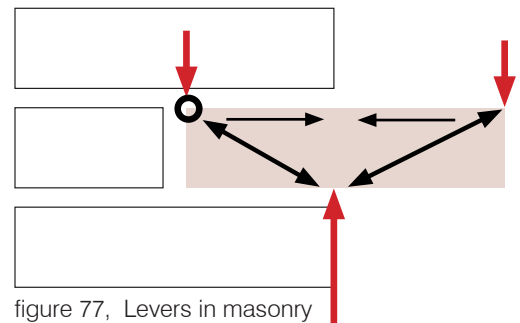
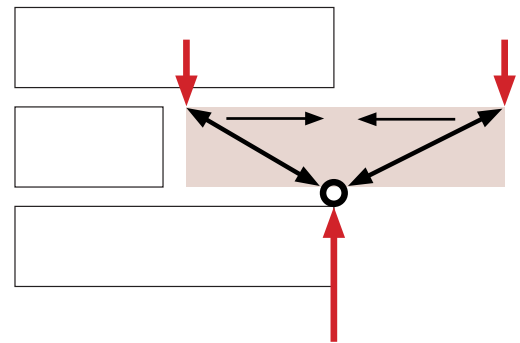

figure 77, Levers in masonry

figure 78, Pressing on one side of the rhombus



Interaction between clamped areas

The instructions of the gevelklem clearly states the maximum distance between the clamps is 700mm for a clamped height of 7 layers. In stretcher bond, this means the area of effect of a clamp, almost always overlap. In wild bond, for which the same rules apply, the clamped areas do not necessarily overlap. In traditional masonry, the cement mortar is apparently strong enough that this is not a problem. When only bricks are used, the overlap is critical.

The overlap of the areas of prestress makes sure there is a diagonal line of bricks from the bottom of one clamp, to the top of another. This diagonal row of bricks makes it possible to transfer compression loads from one clamp to another. If the areas of effect of the clamps did not overlap the masonry would just slide apart (figure 79). When the areas of prestress do overlap, the areas press against each other (figure 80). The result is similar to figure 78, but now with two prestressed areas of masonry. Both sides deform in the same way, but in the opposite direction. The middle brick has come loose from either side of the masonry is held in the middle by friction.

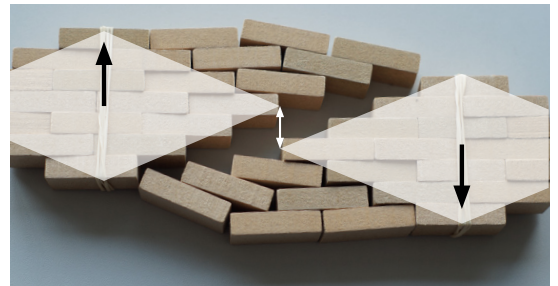
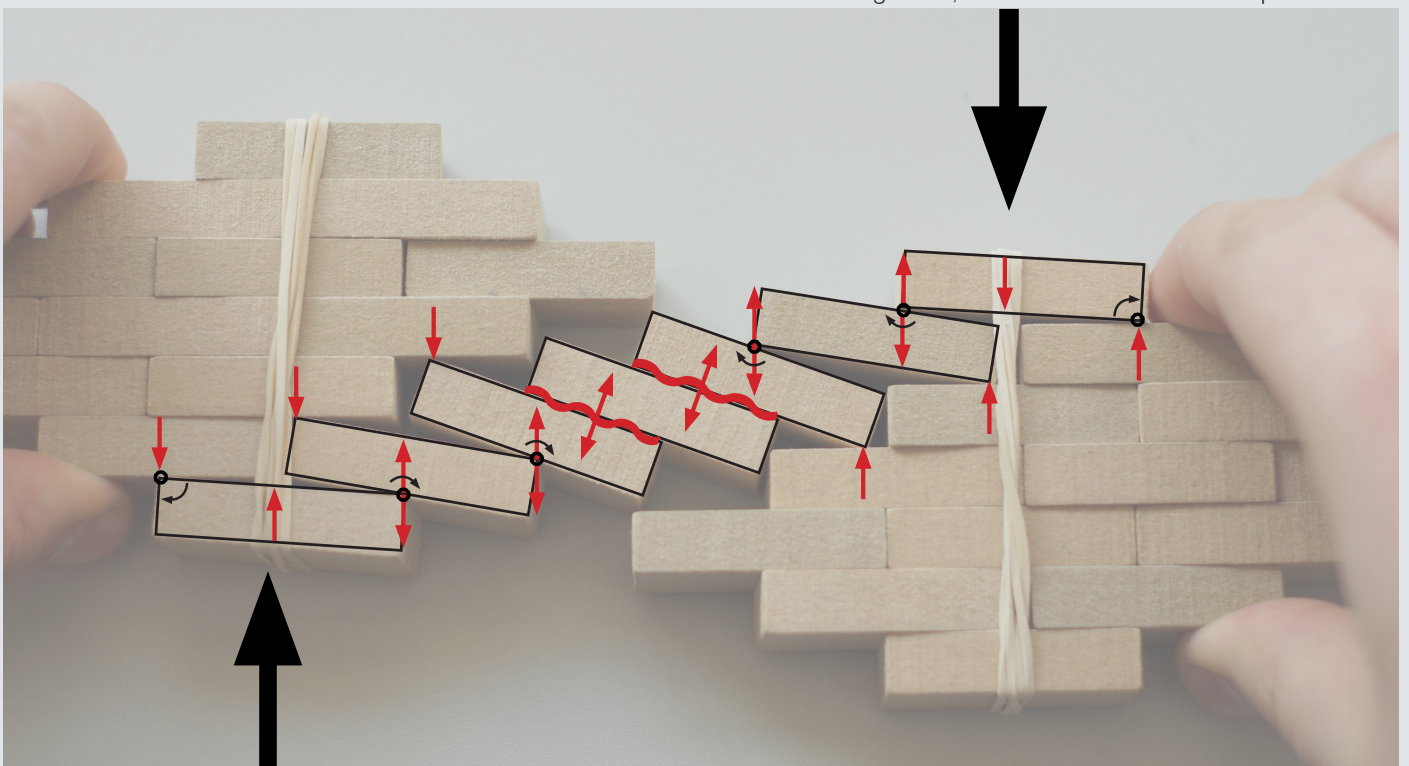

figure 79, Prestressed areas don't overlap, masonry just slides apart.

figure 80, Prestressed areas do overlap.



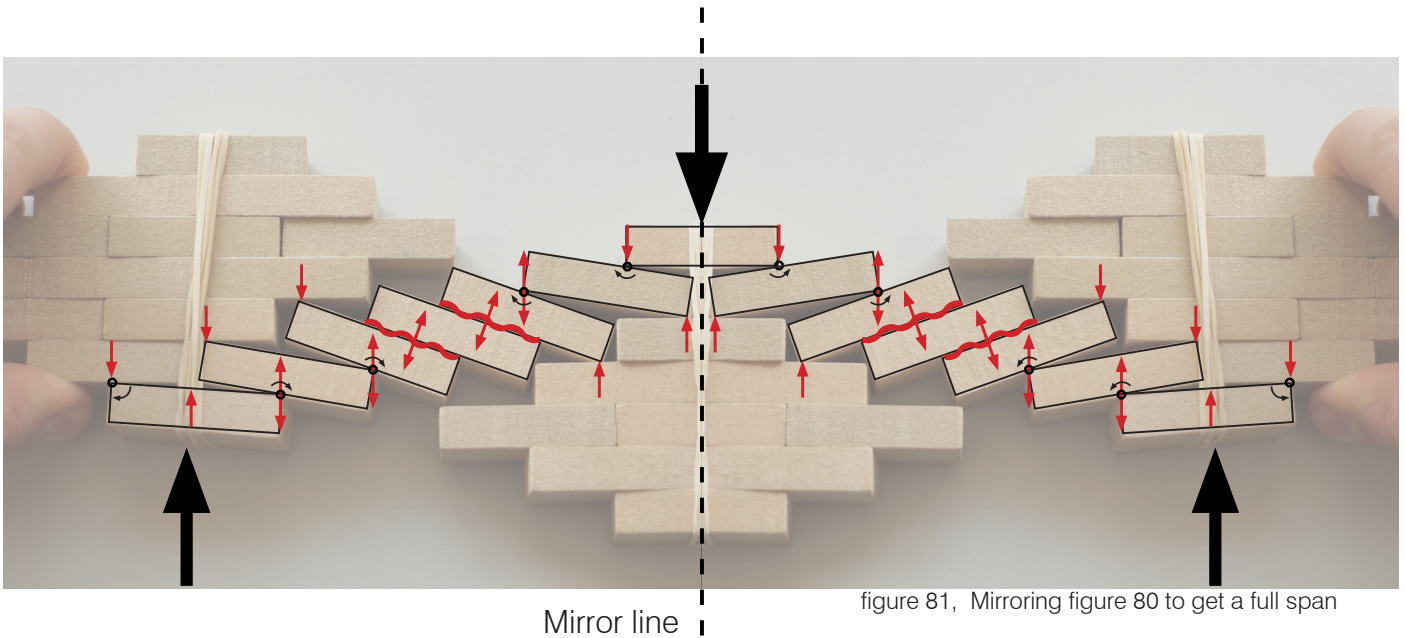

figure 81, Mirroring figure 80 to get a full span

Corbel arch in the center

When figure 80 is mirrored, it reveals itself to be half of a corbel arch. The arch is supported on the outer two prestress points, while the center stress point forms the top of the top of the arch. The corbel arch is not in balance, therefore the diagonals are leaning against each other, so horizontal forces are expected in the supports.

With the extreme deformation of figure 81 it is easy to see that a large part of the bricks in the middle are just hanging from the arch. This is something that will be seen on every model with an odd number of prestress points.

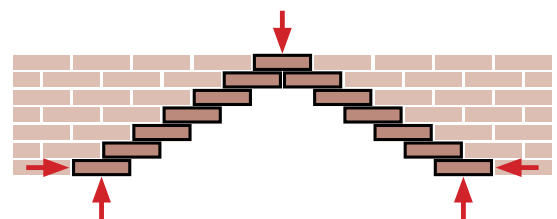
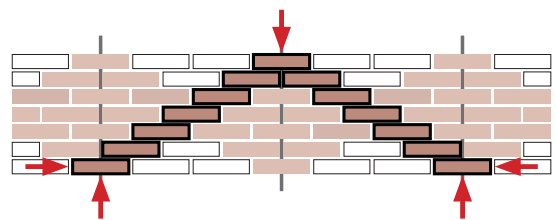

figure 82, Corbel arch in the lintel and normal masonry

The corbel arch itself is not the special part of this typology. The same corbel arch can be made with masonry that is not prestressed. The special part is the support this corbel arch is placed on, the tension rod. The tension rod can take the vertical component of the forces that acts on it, and translate these back to the top of the masonry. The horizontal component continues horizontally along the bottom course, till it comes to a horizontal support (figure 83).

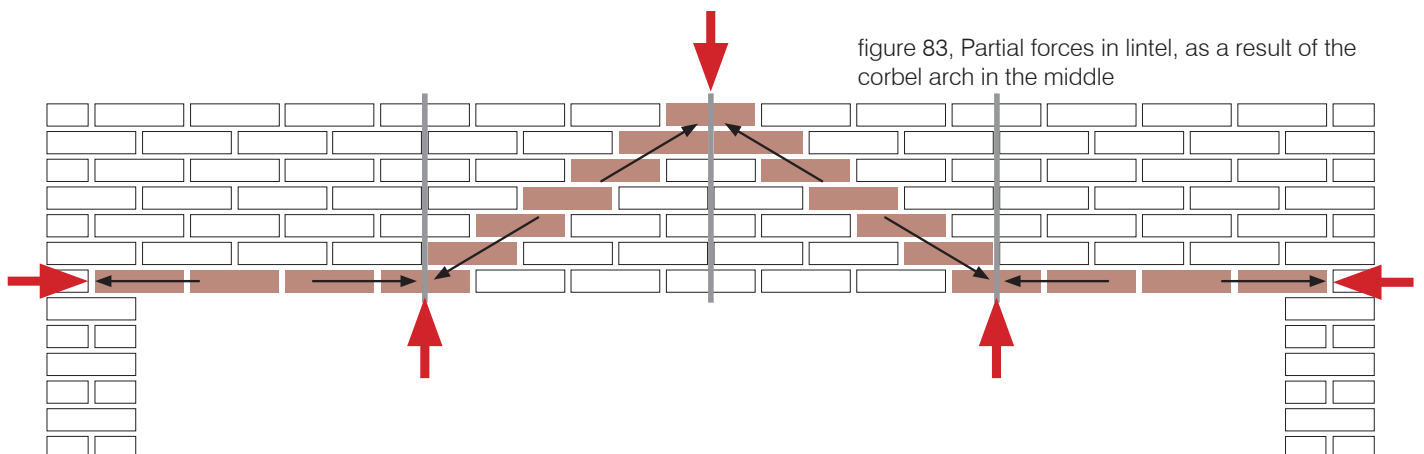

figure 83, Partial forces in lintel, as a result of the corbel arch in the middle

Tension rod transfers the load to top of masonry

At this point, we've seen that in the middle of the span the masonry forms a corbel arch, that is supported on the tension rods at the base of the arch. This tension rod can then translate the horizontal force back to the top of this rod.

In figure 84 we see what happens when we isolate this translated vertical force. The force is loading the top of the masonry, as stated before, but it only has one support, in this case on the right. On the left is the middle of the span. The masonry is not in balance and therefore will try to fall over, but it falls against the mirror line. The masonry falls against its mirror image, and the two hold each other upright. The two sides of the masonry leaning against each other causes horizontal compression forces in the top course(s) and at the support.

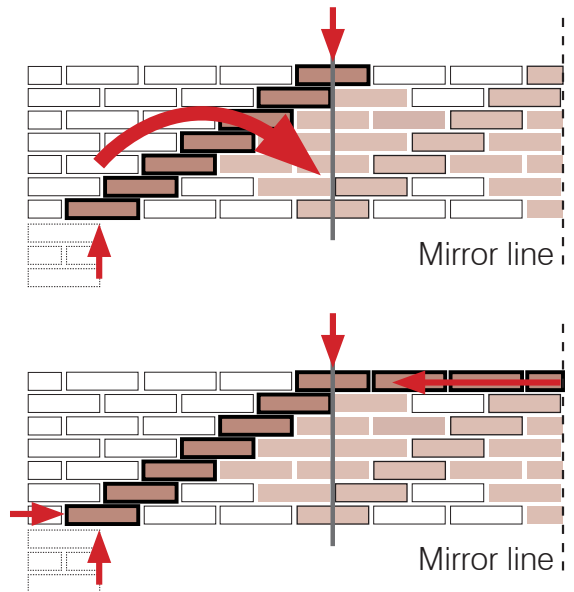

figure 84, Masonry tries to fall over, and rests against its mirror image

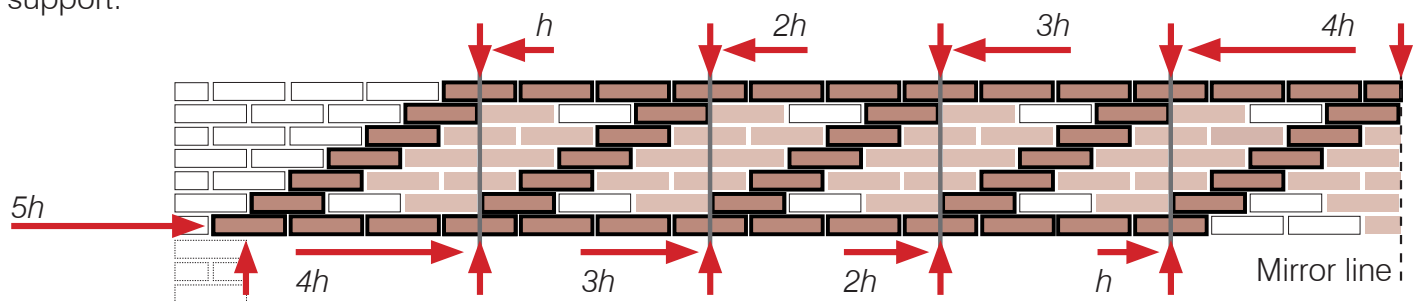
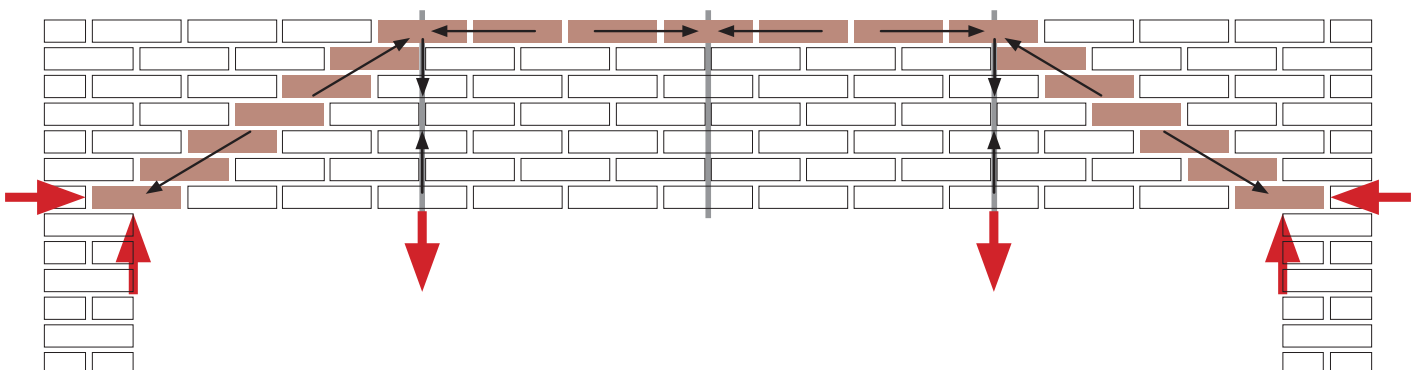

figure 85, Horizontal forces, as a result of the point, increase.

The 'new' diagonal works exactly the same way as the corbel arch in the middle, except that it is further away from the middle. This means that the trick can be repeated multiple times. In figure 85, we see that the each additional diagonal causes horizontal forces, which accumulate over the length of the span. The increase is without counting the weight of the materials in the lintel.

figure 86, Partial forces in lintel, as a result from forces on the tension rod



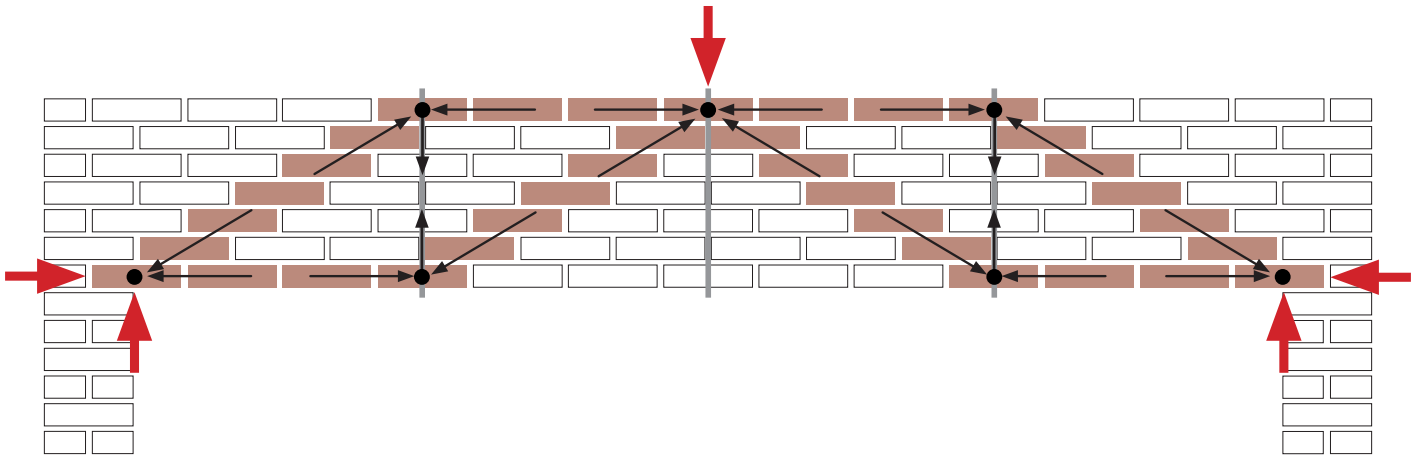

figure 87, Main stresses in the archetypal configuration of this typology with 7 courses.

Total lintel

The lintel has up till now been discussed in parts. When the parts are put together, the result is figure 87. The image shows what could be called the archetype of this kind of structure. It is the simplest and clearest, all other configurations are a variation on this one. The reason why this is the simplest version of this lintel, is because figure 87 shows the largest span that can be created with three tension rods. This means the diagonals run neatly between the top and bottom of the lintel. More about that later.

The lintel works very similar to a three-hinged truss. The middle tension bar therefore doesn't seem to help a lot. It supports the masonry in the middle of the span, but it also has another function. The middle tension rod prestresses part of diagonals in the middle. As discussed before, the prestress increases friction and counteracts rotation. It is these two things that make the brick diagonal work. The diagonals in a brick truss are therefore not loaded with axial forces. Because of the orientation of the brick, each brick is loaded in bending.

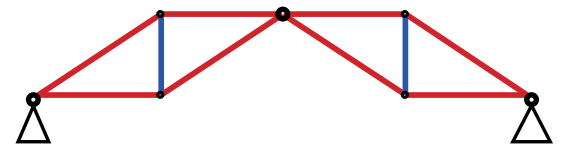

figure 88, Three-hinged truss

Variations on archetype

The last section establishes an archetype (for 7 masonry courses) for this typology. The archetype shows the configuration where the stresses are the simplest. In this configuration the lintel has its maximum span for three tension rods, 2750mm. But what if the span needs to be some other length, or the amount of tension rods is changed for some reason, how would the stresses be organized?

The distance between the load or support, and the tension rods can only become smaller than in the archetype.

From the point load the stresses go diagonally down, through the corbel, till it hits the tension rod. At this point, the diagonal can be dismantled into the horizontal and vertical components. The horizontal part continues, and the vertical part is translated to the top of the tension rod, if the next diagonal is of full length. In figure 89 we see three different configurations. The height of the horizontal stresses is determined by the distance between the load and the tension rod. When the distance is smaller the stresses can get spread over multiple diagonals.

For the supports the stresses work the same way, only the other way round.

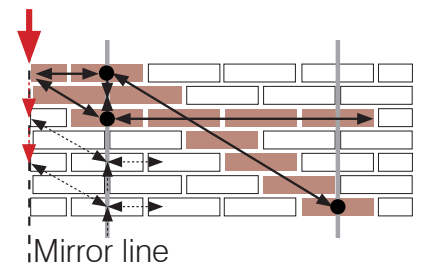
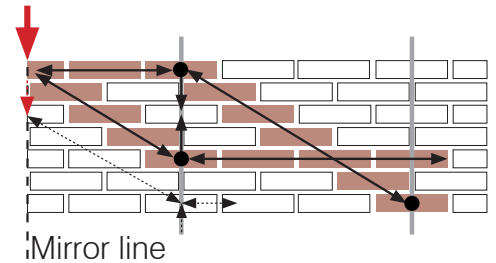
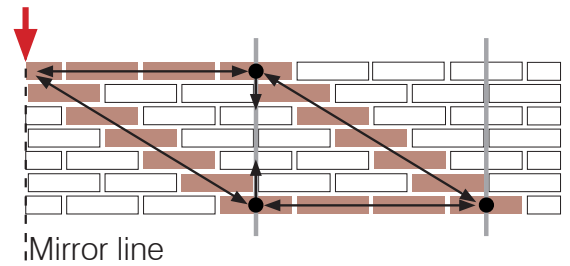

figure 89, Flow of stresses changes when the distance between the load and tension rod decreases.

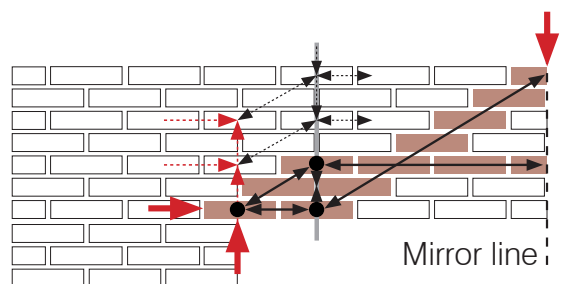
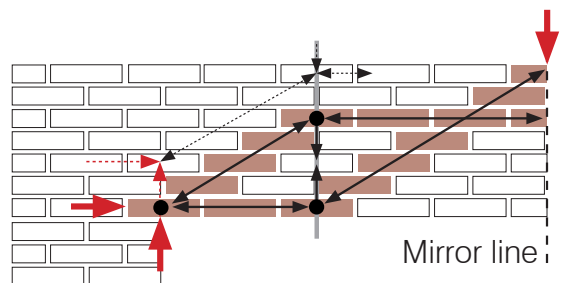
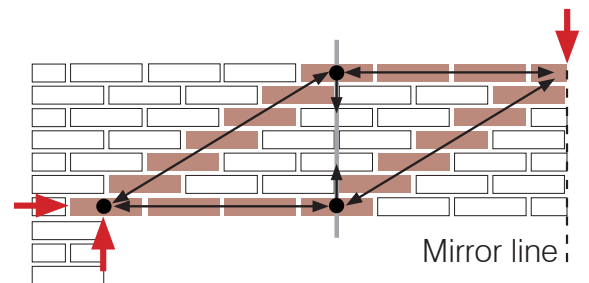
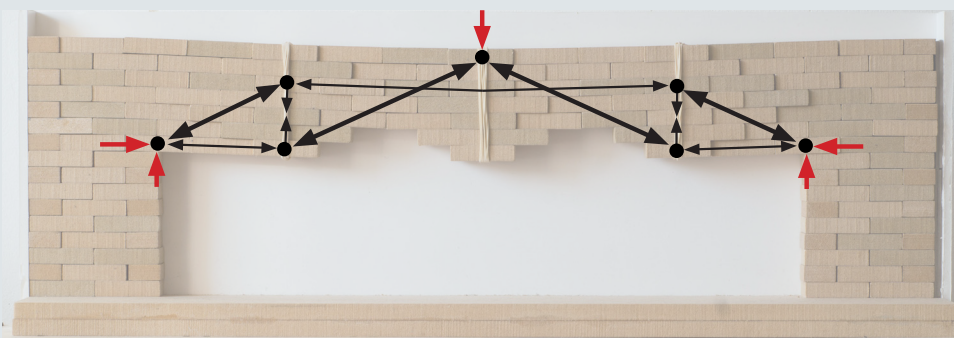
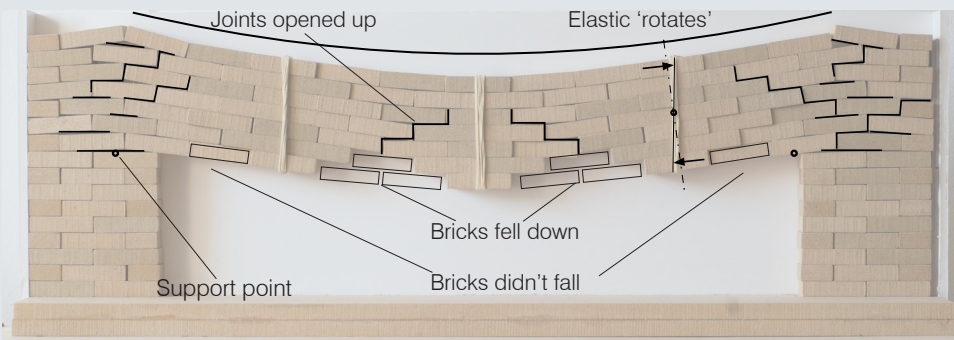
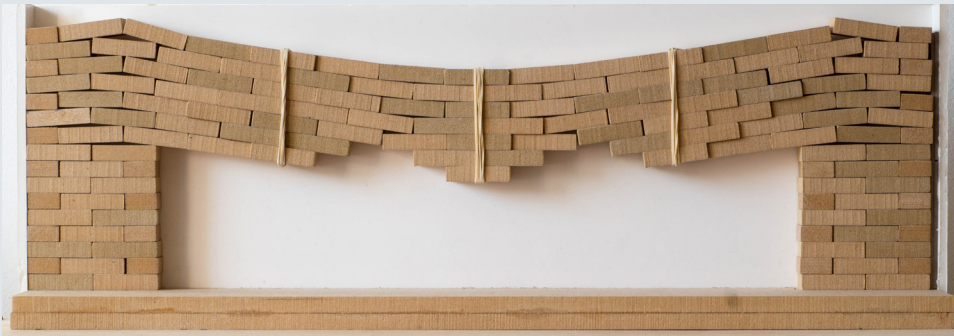
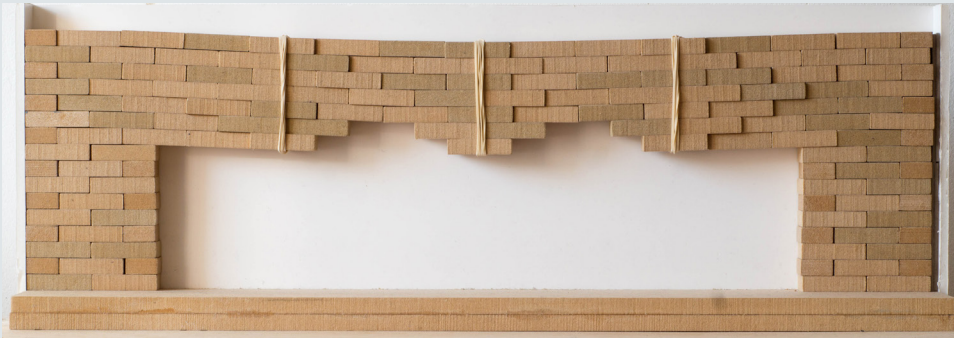

figure 90, Flow of stresses changes when the distance between the support and the tension rod decreases.

7.4.1 Observations

Model: 7 courses, 3 prestress, 10 brick span



Model: 7 courses, 4 prestress, 10 brick span

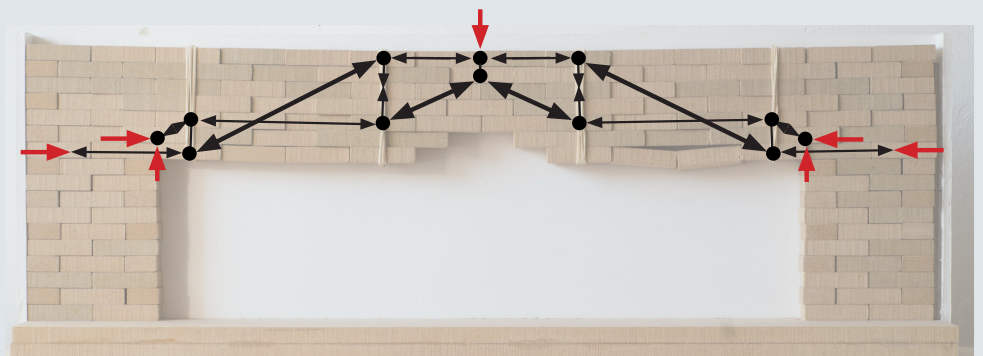
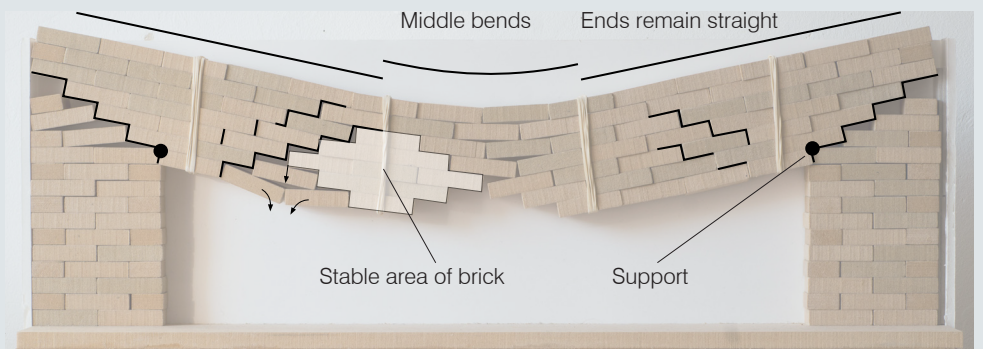
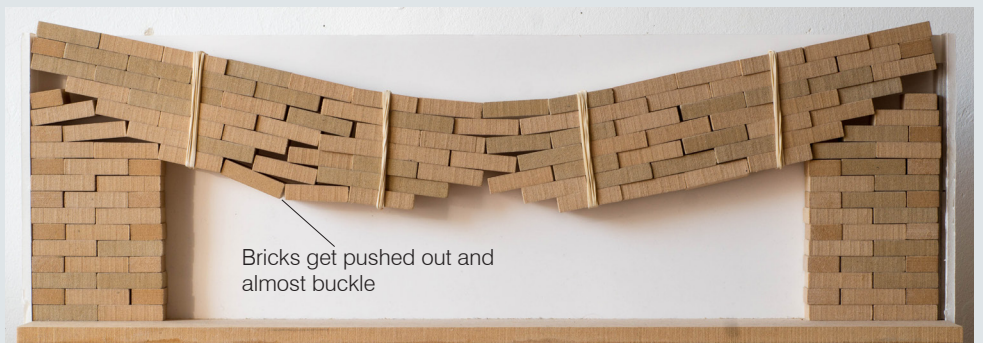
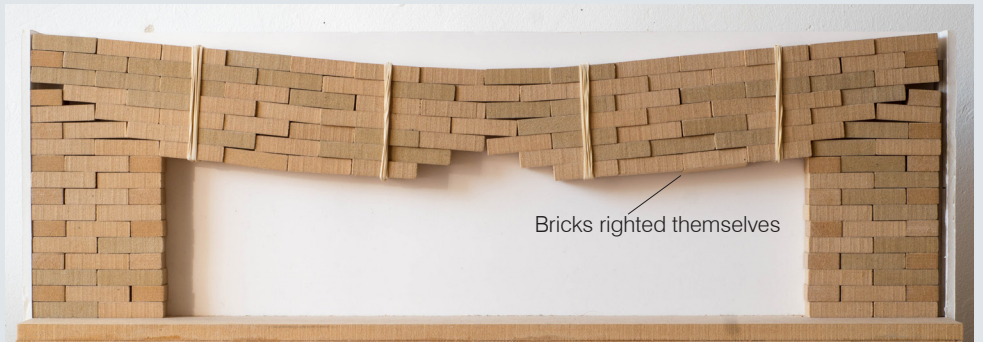
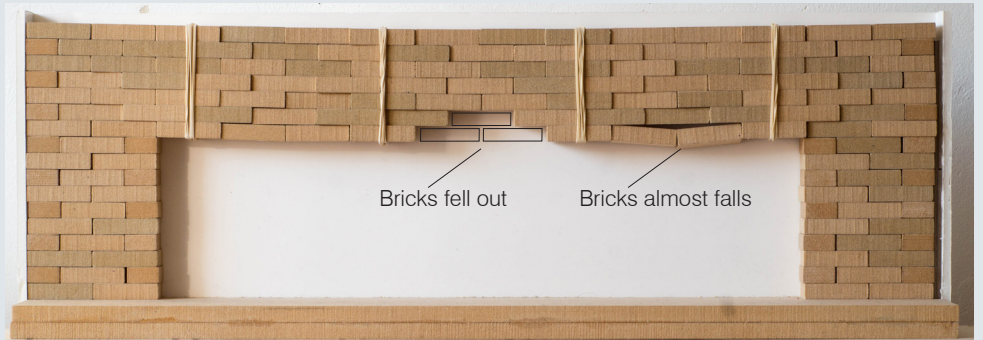

Model: 7 courses, 4 prestress, 12 brick span

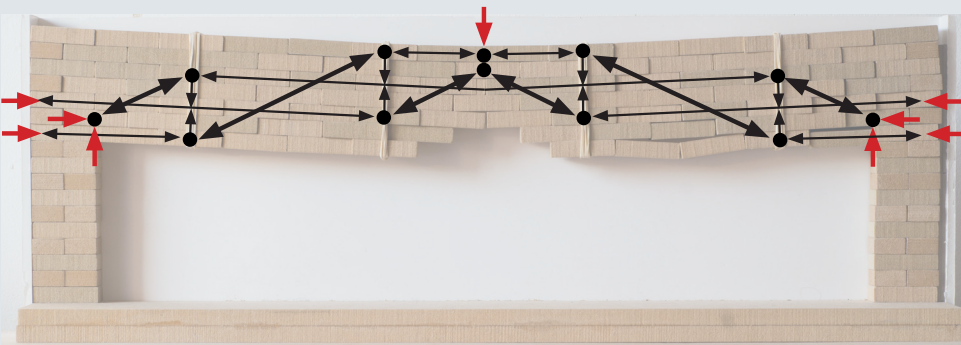
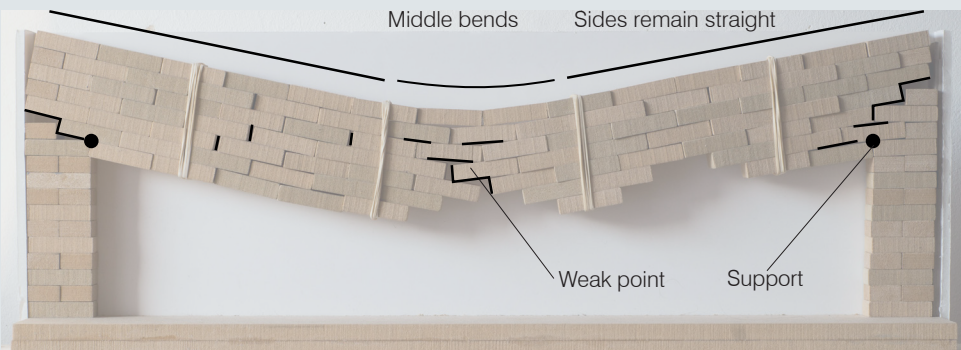
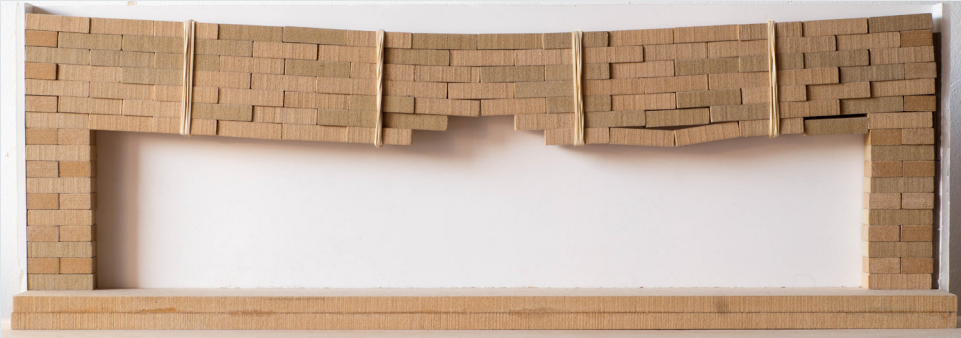

Model: 7 courses, 5 prestress, 12 brick span

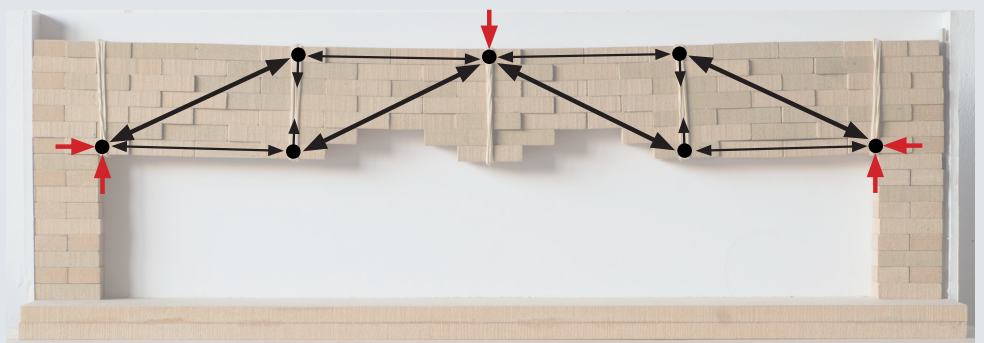
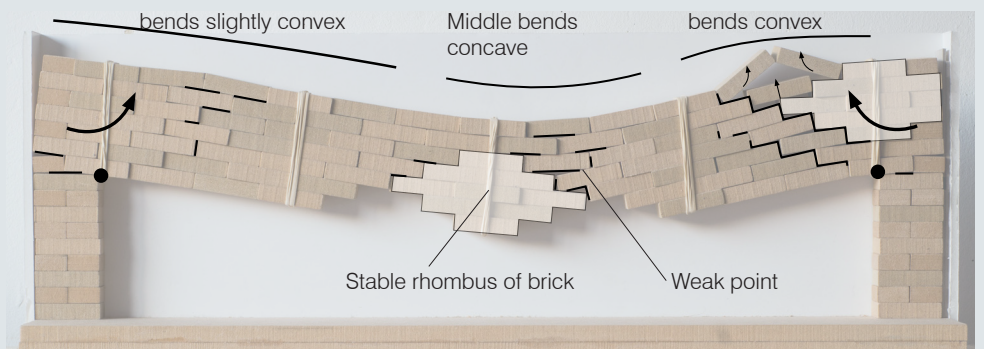
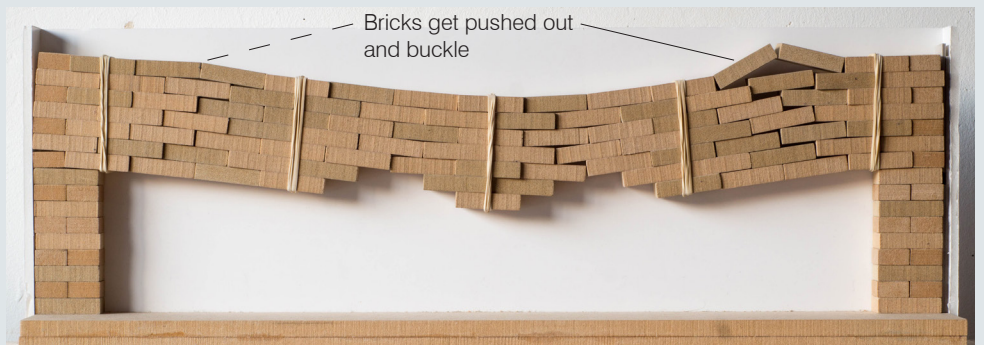
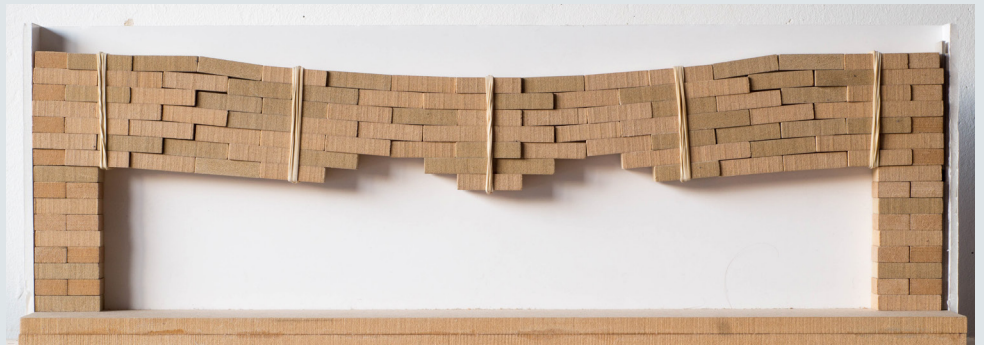
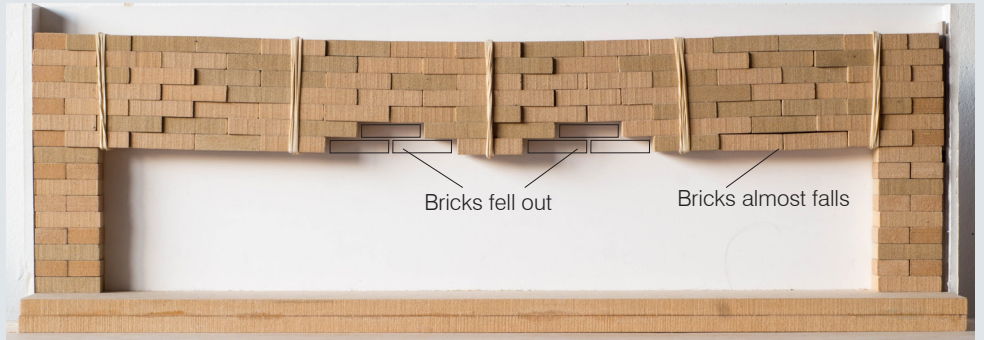

Some bricks fall down

From the pictures in the last couple of pages, it is obvious that the bottom of the lintel is missing some bricks. These have fallen down. The places where the bricks have fallen are not prestressed. Sometimes the bricks are held in place by the horizontal stresses. The detailing of the lintel needs to have some provision to keep these bricks in their place.

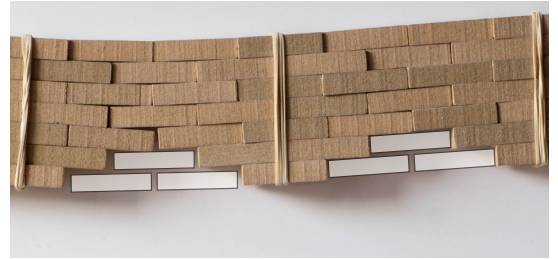

figure 91, Missing bricks

Bricks pushed out under extreme deformation

It has been observed that some bricks seem to get pushed out of the lintel, under extreme deformation. The diagonal sometimes bends separately from the rest of the masonry in a prestressed area. This can be seen in figure 78 on page 77.

The stable part of the masonry then start to press against the bricks next to it, causing them to bend outwards. The reason why this is mentioned separately, is because the bricks did not show any sign of falling, if it wasn't for push. The bricks were in areas of compression and held in place by the horizontal forces.

This is only observed under extreme deformation, and thus shouldn't be a problem. The lintel should never be allowed to bend this far.

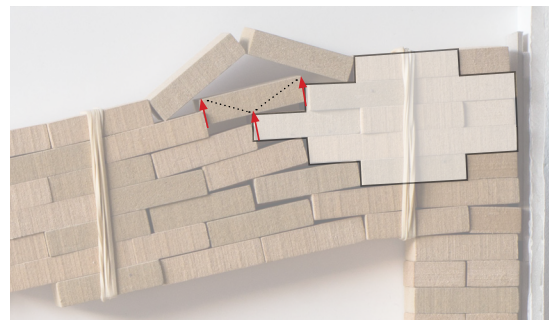
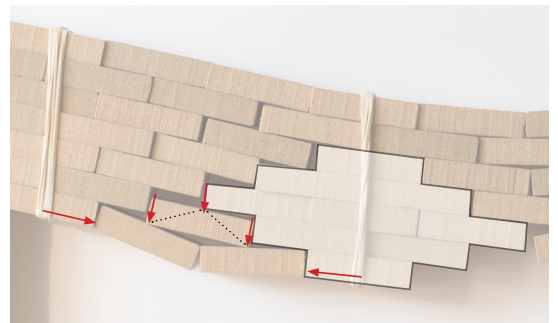

figure 92, Bricks can be pushed out in both the top and the bottom of the lintel

Cantilever

When a tension rod is placed at the ends of the span, the masonry around it will act as a cantilever, potentially reducing the deformation.



figure 93, Masonry corbel forms a sometimes forms a cantilever at the end of the lintel

7.4.2 Limiting factors

Stiffness limited by static friction

In the model, it was noted that the elastic bands seem to rotate, or rather the bricks have moved, making the elastic band slightly diagonal. The bricks on the top moved towards the outside, and the bricks on the bottom moved towards the center to the span.

In a simplified view of the masonry (figure 95), we see horizontal and diagonal forces. The horizontal forces are transferred directly from one brick to another. The diagonal forces have a horizontal component that are transferred through the friction between the bricks. When a large enough load is applied to the masonry, the static friction between the bricks is overcome and the bricks start to slide. In the scale model, sliding bricks seems to be the limiting factor to prevent deformation, when the supports are fixed.

While the friction between the bricks is the limiting factor in the scale model, this needn't be in the real lintel. The prestress provided by the elastic bands is relatively small, therefore the friction force is quite small. In the real lintel, the bricks might break long before they start to slide.

Another reason the bricks cannot be allowed to slide, is that the bricks will start to impinge on the tension rod. This is effective at stopping the sliding bricks, but also puts unintended concentrated stresses on the bricks, increasing the chance they will break.

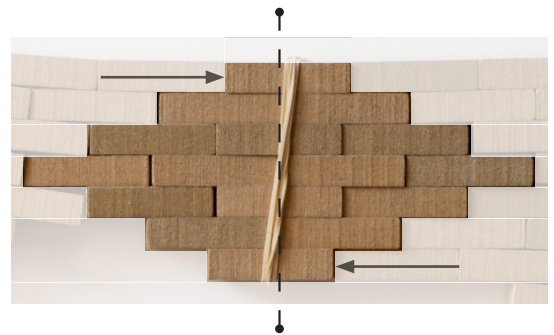
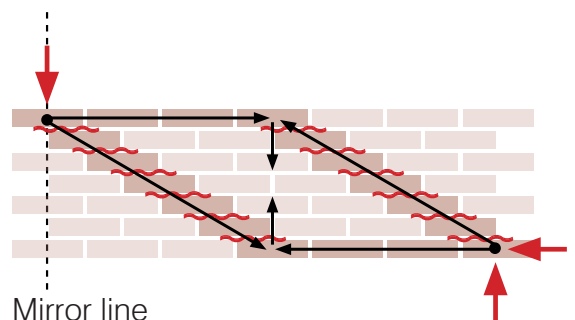

figure 94,



Mirror line
figure 95,

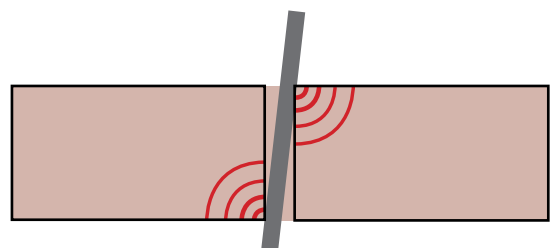

figure 96, Tension rod putting unintended loads on the bricks.

Further testing

If the static friction, controlled by the prestress, is the main force that prevents deformation, investigations should be made to see what happens when the bricks start to slide. Kinetic friction is usually smaller than the maximum static friction, so the bricks could keep sliding under a constant load. Another possibility is that the masonry finds a new equilibrium, as the diagonal forces move towards vertical. This increases the vertical component of the force compared to the horizontal.

Stiffness limited by supports

To get a sense of the structural behavior of the masonry when the bricks cannot slide, the bricks that would normally be in line with the tension bar were glued together. This has a similar effect to the prestress, preventing the rotation and increasing friction in the surrounding bricks. Plus the glued bricks themselves are completely prevented from sliding.

The glued bricks simulate the situation where the bricks are prestressed to such a degree that the static friction is not the limiting factor in the stiffness of the lintel. The center tension rod was left as an elastic band to have a dedicated failure point. Also, in the middle of the span, the bricks don't slide.

While handling the model, it is immediately noticeable that the structure works much more elastically, than with the elastic bands. The bricks cannot slide, therefore the stiffness of the masonry is not limited by the maximum static friction. The horizontal forces are transferred much more efficiently towards the supports. In this model the supports are the limiting factor in the deformation, rather than the friction between the bricks.

Horizontal forces in the supports are a problem for H-block. The supports can therefore be a real limiting factor, if the horizontal forces aren't dealt with.

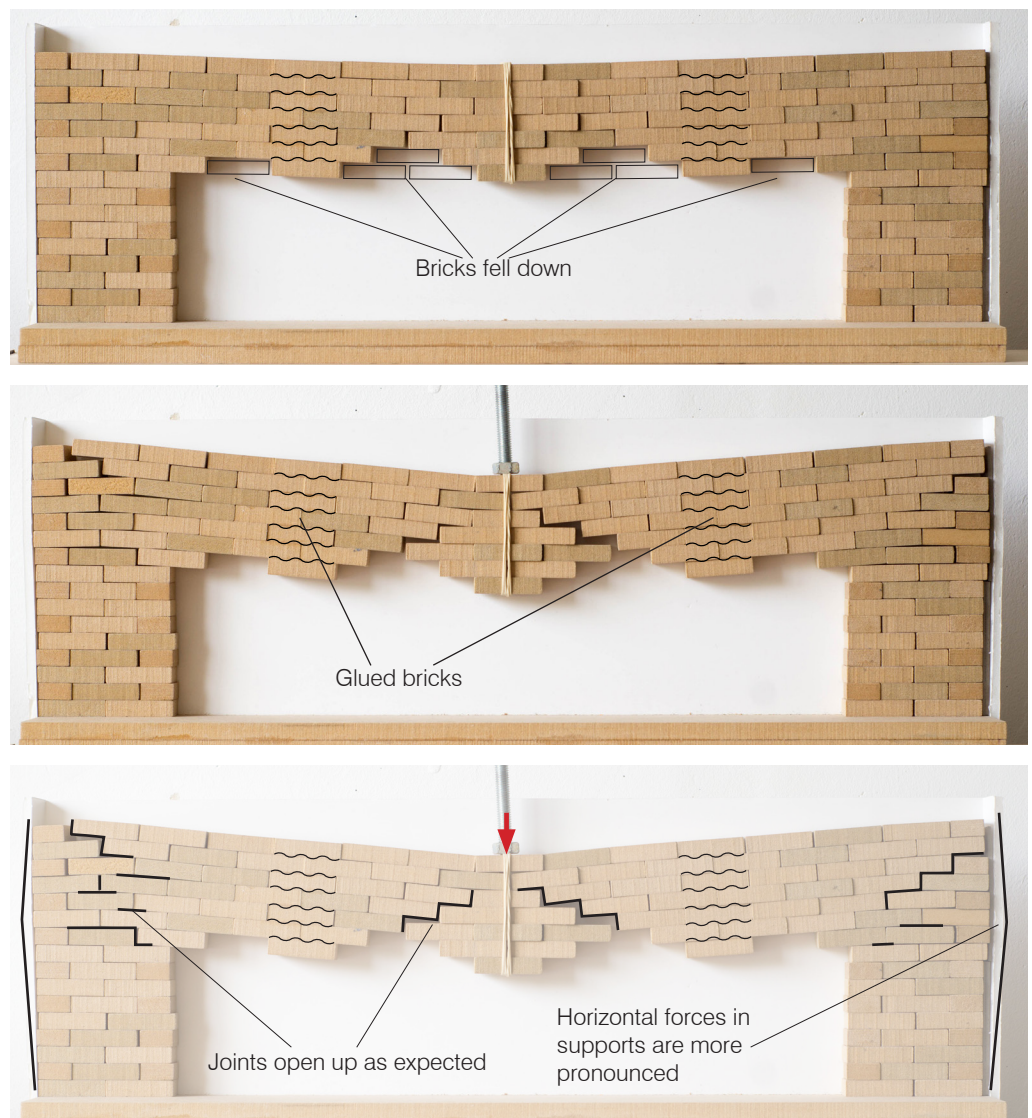

Horizontal forces in the supports

H-block isn't able to resist these horizontal forces. The system has no substantial mechanical connection in that direction. The only thing preventing the bricks from sliding over the H-profile is friction. The lintel is applying horizontal forces in the supports, because of the way it works. This is a problem. If the supports start sliding the lintel will deform and ultimately break. The best thing would be if the lintel itself would resist the horizontal forces, so the supports don't have to.

The lintel works like a three-hinged truss, and thus applies horizontal forces in the supports. If the supports were connected together with a tension element, these forces would not be a problem. Even better is to connect every diagonal together, so the forces don't have to flow all the way to the supports.

Continuous H-profile as tension member

If the H-profile used in the lintel was a continuous piece, it could take up the horizontal forces in the lintel. To do this the profile would need to be securely connected to the bricks. The material of the profiles would need to be able to take tension forces, and preferably wouldn't exhibit creep.

Typology 6 has a similar problem. there, it has been discussed to lock the head-joints into the bed-joints. This could be a solution for this typology as well. However, doing this has an impact on the design freedom of the lintel. Also, simpler solutions are available.

The prestress in the lintel causes high friction between the bricks and the profiles. The prestress makes sure that the bricks don't slide relative to each other, at least until a certain design load. This automatically means that the profiles won't slide. The ends of the lintel would need to be prestressed, to make sure the friction is large enough at the supports.

By making all profiles in the lintel continuous, the tension forces would be spread somewhat. It also makes it easier to pick up the lintel with a crane. And makes it possible to make use of cantilevers.

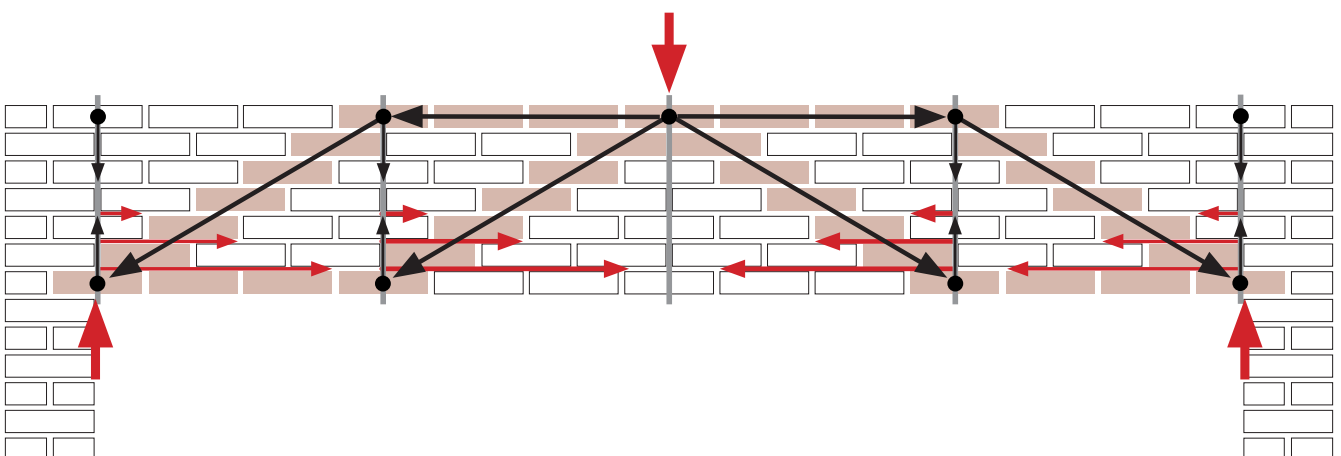

figure 97, H-profiles take up the horizontal forces.

7.4.3 Variations

Masonry height

The height of the masonry that is prestressed determines, together with the masonry bond, how far the tension rods can be placed apart. The higher the masonry, the greater the distance between the tension rod. We also know, however, that the prestress in the masonry decreases further away from the tension rod. With less prestress the diagonals will be less strong. So, there is probably an optimum height to get the strongest lintel, with the least tension rods.

As the number of prestressed courses increases, the number of bricks that will fall out also increases. With nine courses the number of bricks, between two tension rods, that will fall is already six.

Masonry bond

The bond in which the masonry is constructed has a great influence on the angle of the diagonal. In stretcher bond the diagonal is relatively shallow, because the bricks overlap half a brick. Most bonds only have an overlap of a quarter brick, making the angle more steep. The quarter brick overlap also in some cases causes the lever action in the diagonals to be a 3:1 advantage for deformation, which may limit the effectiveness of the lintel.

The upcoming pages show some of the possibilities of different bonds. In general, it can probably be said that stretcher bond is the most efficient bond for the lintel, as it is in many other applications, but other bonds should also be work.

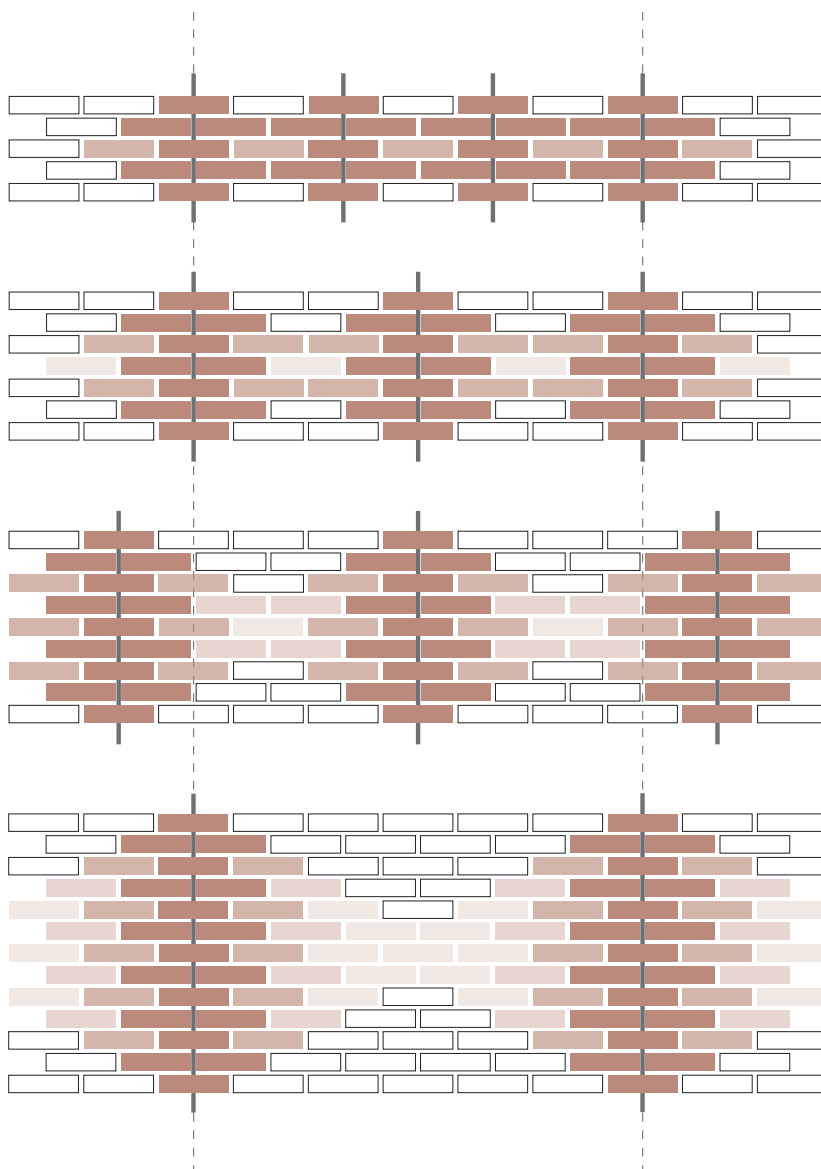

Clamping in various bonds

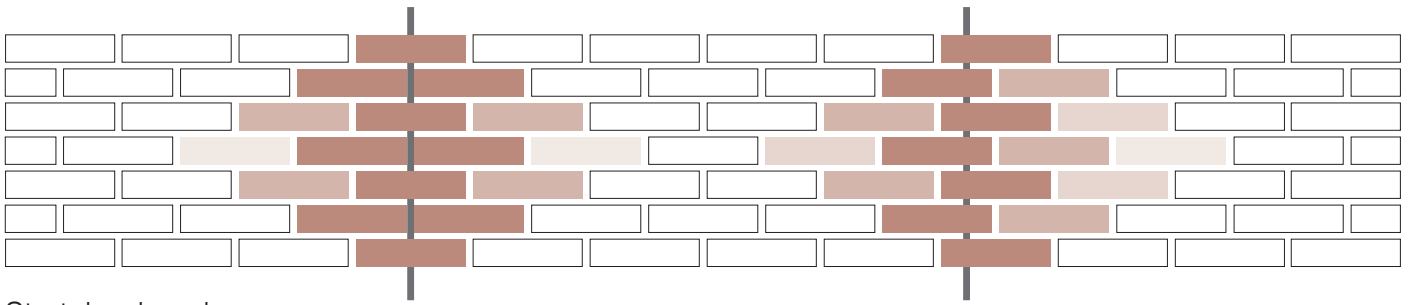

Stretcher bond

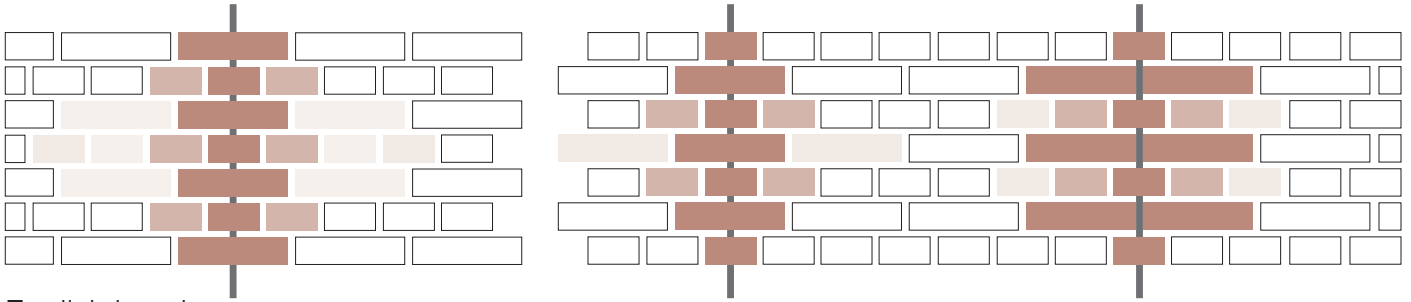

English bond

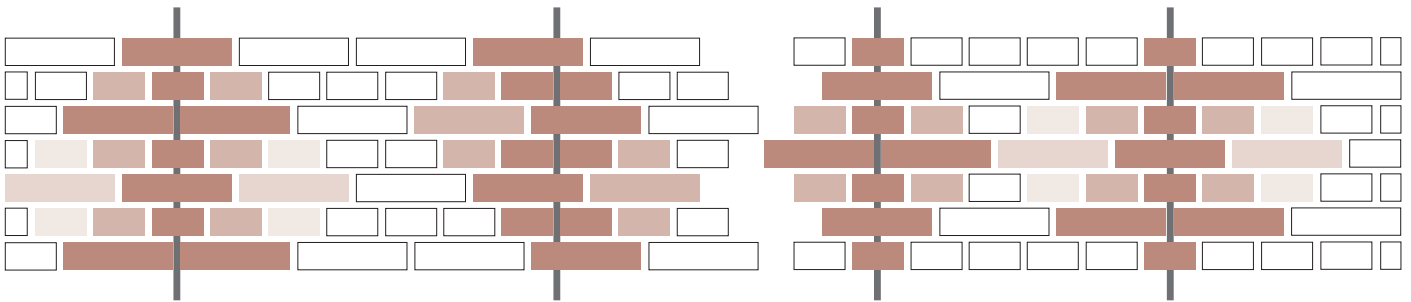

English cross bond / Dutch bond

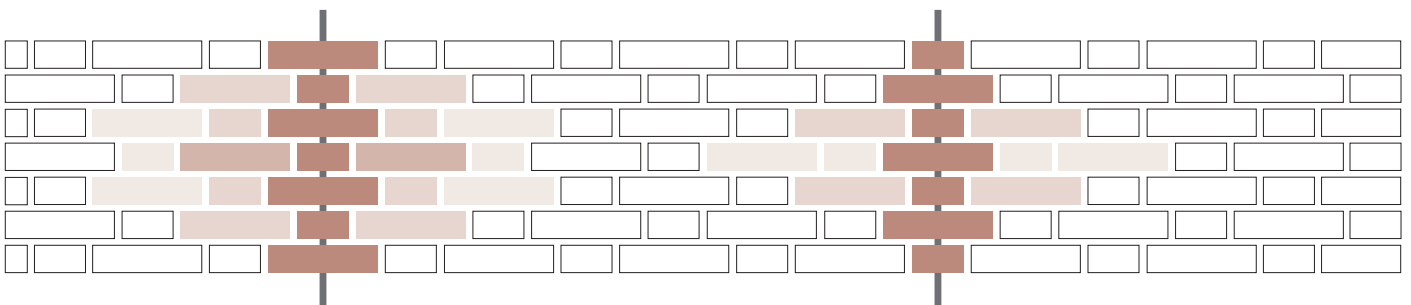

Flemish bond

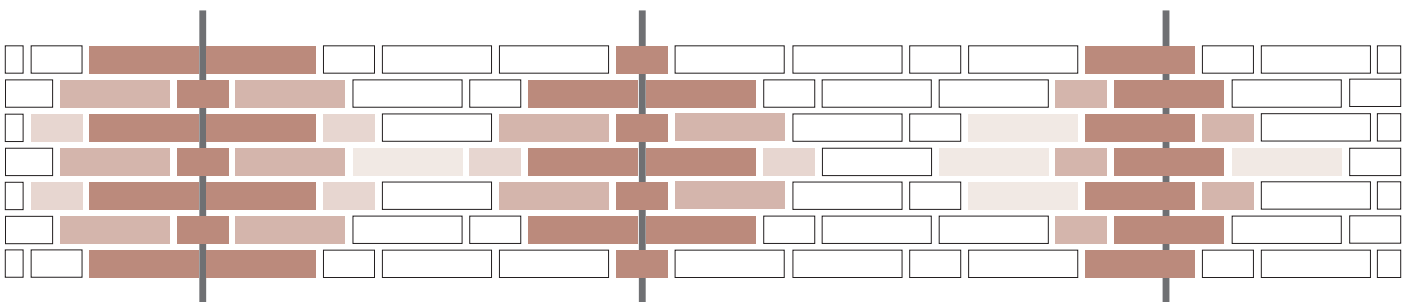

Monk bond

Diagonal connections in various bonds

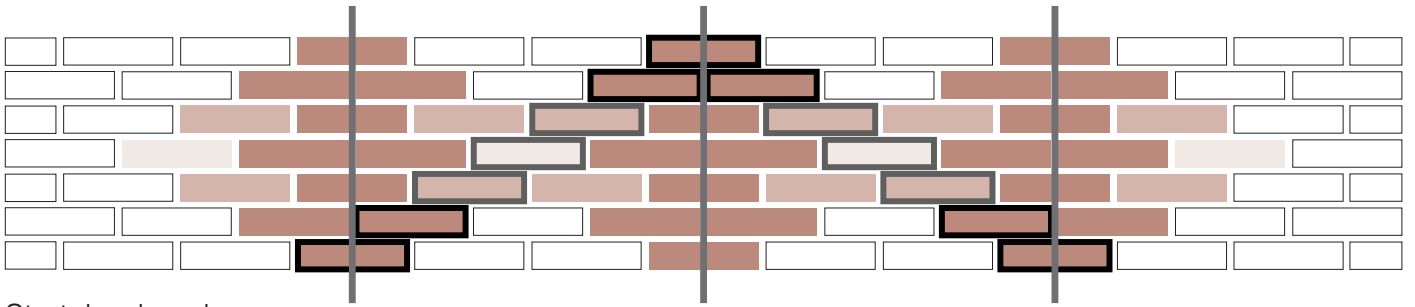

Stretcher bond

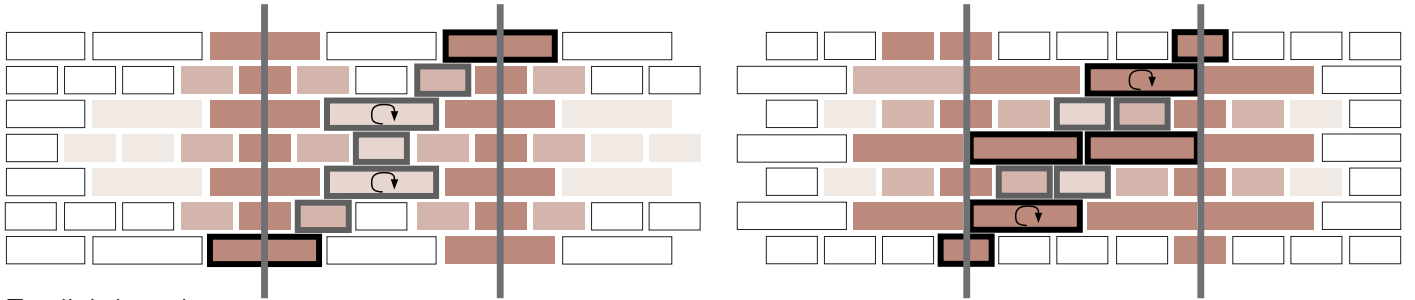

English bond

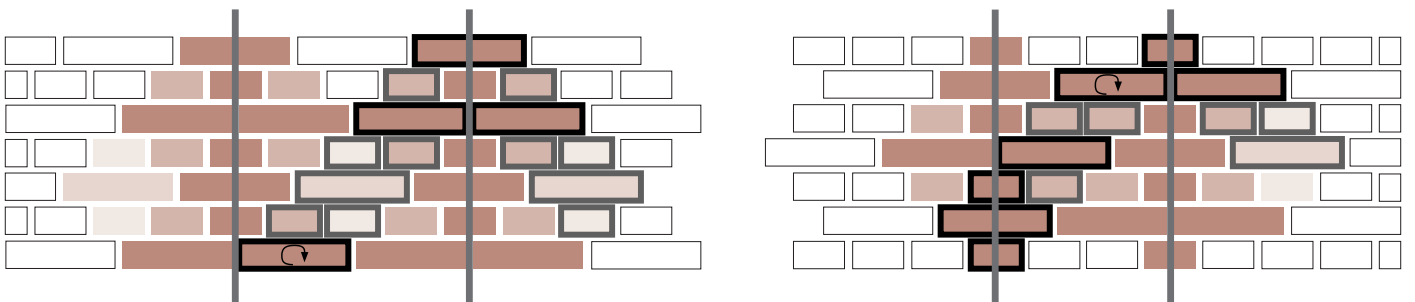

English cross bond / Dutch bond

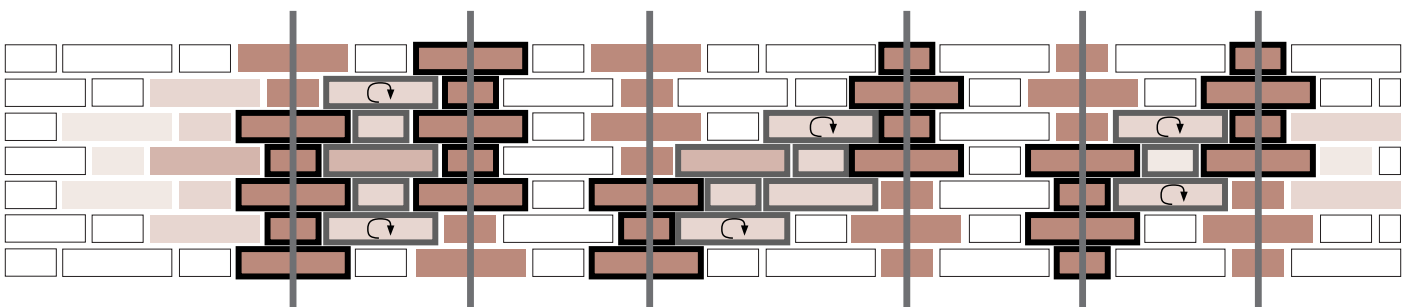

Flemish bond

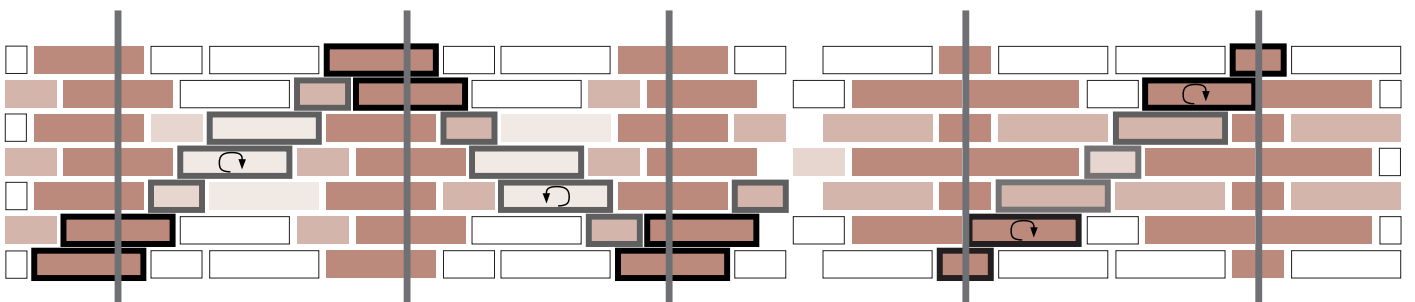

Monk bond

7.5.0 Detailing

In the following pages the general construction of the lintel will be discussed. They will feature potential solutions to several design challenges and weigh the some of the alternatives.

The goal for the design of the lintel, is have the visual quality that is expected of products in modern architecture. This means the facade openings need to be rectangular and the lintels straight.

It also means that the lintel is, to a certain extend, expected to be hidden. For the majority of the lintel this will automatically be the case, as the lintel blends with the surrounding masonry. At the

bottom course of the lintel, however lies a choice. Are the tension rods allowed to be seen, or not?

Personally, I like it when objects show how they have been constructed. Especially, if effort and care have gone into the design of these details. Therefore I'd say the bottom of the tension rod is allowed to be seem. It may look something like the lintels of Casa 1219.

The architectural profession doesn't necessarily agree, however. Functional objects need to be hidden. For this part of the industry, a version of the lintel with a brick cladding will also be discussed.

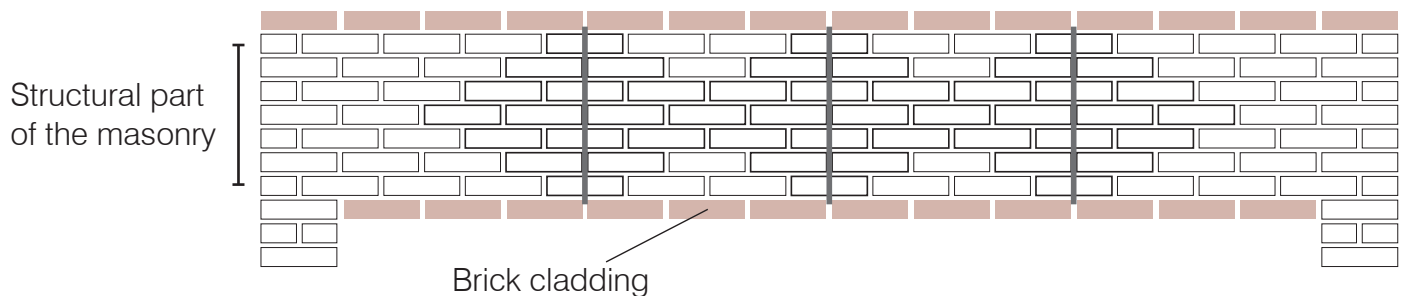

figure 98, Division, structural and non-structural part of the lintel.

Precedent: Harquitectes, Casa 1219

This single-family home, built near Barcelona, has quite interesting lintels. When looked at closely, the masonry above the opening seem to have small metal disks on the bottom. These are almost a kind of embellishment of the masonry, and perfectly compliment the minimalist detailing of the rest of the masonry. These disks are the ends of threaded rods embedded in the masonry.

In the English Detail magazine (Vol. 2017-6) the lintel is described with the drawing as: Bricks, with reinforced mortar joint, shear-resistant connections with stainless-steel threaded rods. Structurally this probably means the lintel works differently than the gevelklemmen, as the joints are also reinforced. The design does show the vertical prestressed masonry could look in practice.

figure 99: Lintel construction of Casa 1219



7.5.1 Tension rod assembly

Tensioning at top or bottom?

The prestress will be applied to the tension rod by tightening a nut with an impact wrench or some other tool where the torch can be controlled. This nut only has to be on one side of the rod. So, should the rods be tensioned on the bottom or the top of the lintel?

Tensioning on the bottom has one advantage. The tension could be checked and adjusted for maintenance, with removing minimal bricks. During construction it would be easier to tension from the top, as you wouldn't need to work above your head or while awkwardly bent down. Tensioning at top also allows the lintel to be built from the bottom to the top, further easing the construction process.

For ease of construction the tension nut will be at the top of the lintel.

How is the tension rod kept from spinning while tightening?

There is legion of ways to solve this problem. One of the easier ways is to have a internal or external hex on the bottom end-cap, to hold while tensioning.

If the bottom end cap cannot be reached during tensioning, it could preemptively be locked in line with the H-profile, by use of a small plate with a hexagonal hole, as shown in figure 100. This requires the end-cap for the tension rod to have corresponding shape. The order of the components can be changed if the prestress is applied to the profile. In that case the endcap wouldn't need to reach all the way through the brick.

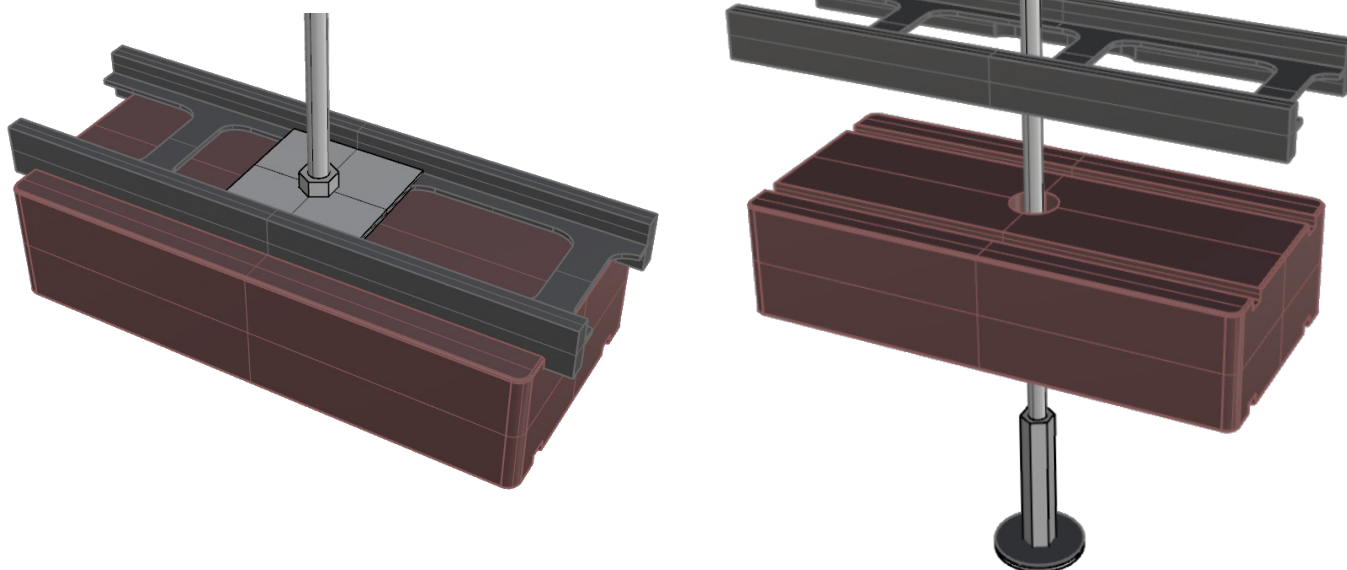

figure 100, The plate makes sure the tension rod cannot rotate during tensioning.

What component should the prestress be applied to?

There are two logical candidates to apply the prestress to. Either the prestress is loading the brick directly, or the brick is loaded through the H-profile. Both options can work, but they both have specific pros and cons.

Brick:

Placing the prestress directly on the brick will require a pressure plate to spread the load a bit. It probably also needs a little pressure pad, to even out the brick's surface. Except for a ring and a nut, that is all the components. No H-block components need to be altered for this method.

The nut that controls the prestress only needs to be at one side of the tension rod. The other side can be an end-cap. This end cap can be designed to be an ornament on the bottom of the lintel, like in Casa 1219. The caps give a hint, as to why the masonry doesn't fall. This also means the bottom course of the structural lintel is the bottom of the entire lintel. Which is especially useful if the maximum height of the lintel is limited.

If the lintel needs to be completely out of sight, the bottom profile probably needs to be connected to the tension rods somehow.

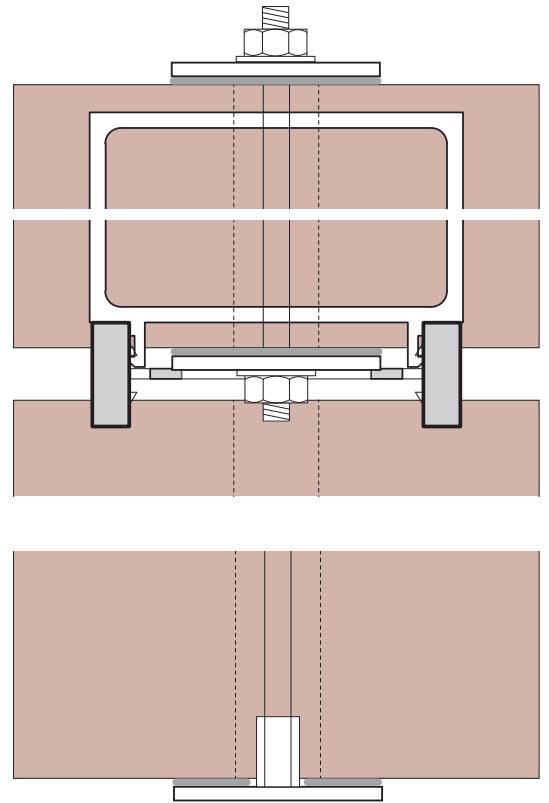
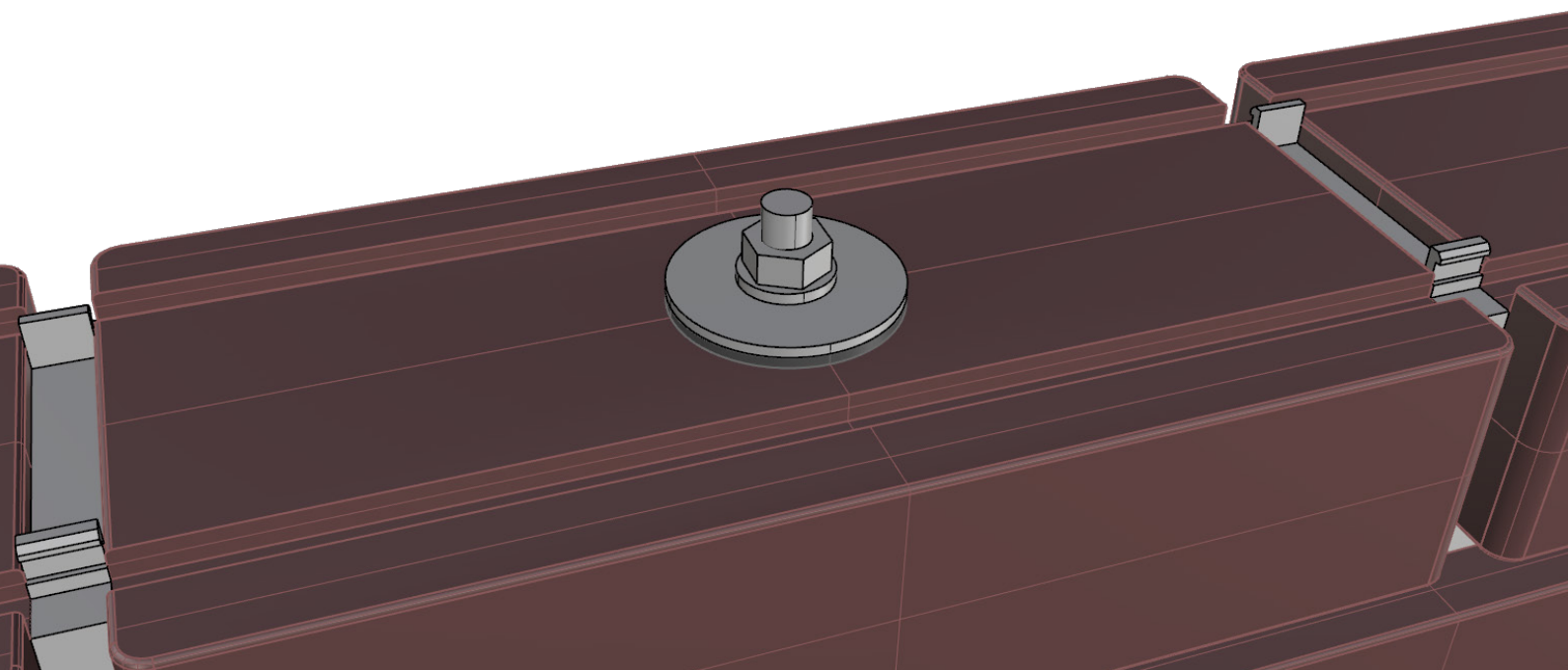

figure 101, Possible details for loading the brick directly. Tension nut exposed, between bricks, and end cap.



H-profile:

Applying the prestress to the H-profile sounds quite logical. In this way the only thing that loads the brick is the profile, either due to gravity or to concentrated loads. The profile also acts to spread the prestress a little over the brick. How much this spread is, will greatly depend how the force is applied to the profile. If the application is too concentrated, the profile might just bend away from the brick.

The biggest challenge is to get the prestress from the middle of the brick to the two main ribs of the profile. This can be done with a bracket, that falls into a void in the profile that has been milled out for this purpose. The question is how thick the bracket has to be, and if it still fits between the brick and the profile. A problem with this particular solution is, that no head-joints can be clicked in the profile where the bracket is, because part of the profile has been milled away.

When the load is applied to the profile, that means that the top and bottom of the structural lintel, will always be a profile. Because we don't want the profile to be in sight, the lowest course of brick will always be a cladding to hide this profile. The profile will, however, be a relatively secure mounting point.

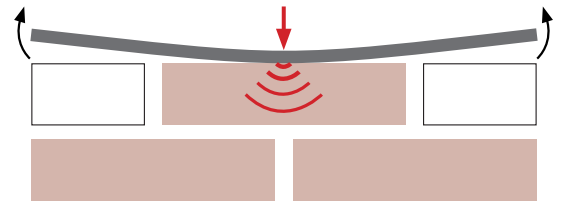

figure 102, Concentrated load causes profile to bend.

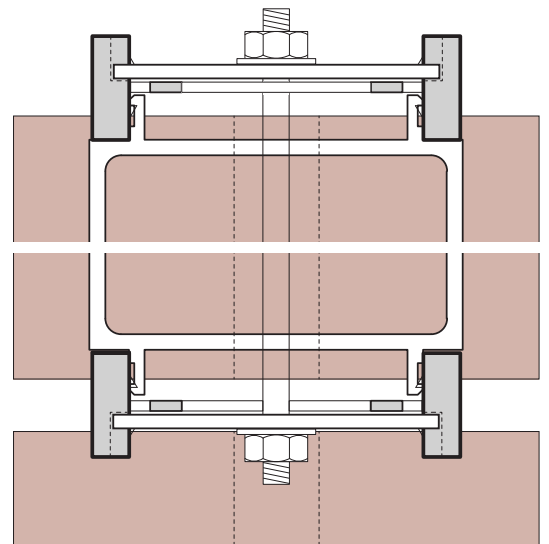
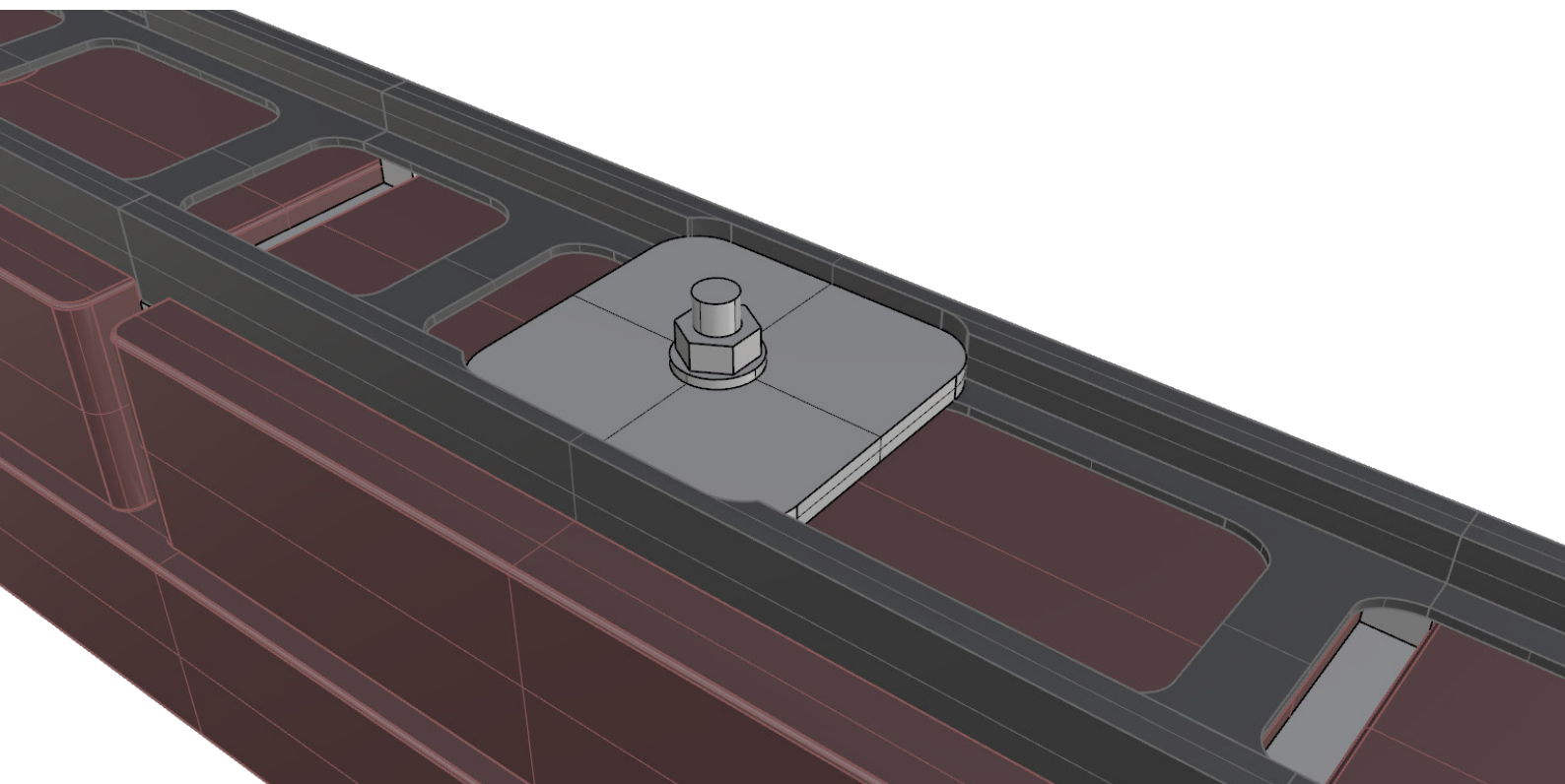

figure 103, Possible detail to apply prestress to profile.



Where along the brick should the prestress be applied?

In figure 104, three ways are shown to prestress 7 courses of masonry. The prestress can be placed in the middle of a brick, on the edge, or somewhere in between.

The prestress in the middle of the brick is structurally optimal, the prestress will on average spread symmetrically over the masonry. In stretcher bond, the prestress can only be applied in the middle of the brick on both the top and the bottom, if the number of courses is odd. When the number of courses is even, one of point loads will press on the edge of a brick.

Putting the prestress on the edge of the brick is not preferable. The brick will have the tendency rotate away from the rest of the masonry. Additionally, the force will not spread over multiple bricks, effectively making the prestressed area smaller. If the prestress is adequately spread before impinging on the masonry, these effects could be mitigated.

The prestress can also be place in between the aforementioned options. For seven courses the potential area of effect is the same, as when the prestress is in the middle of the brick. The stress concentration, however, is no longer symmetrical. One side of the prestressed area will probably be stronger than the other. If the number of courses is even, the prestressed area is also asymmetrical [see figure 105].

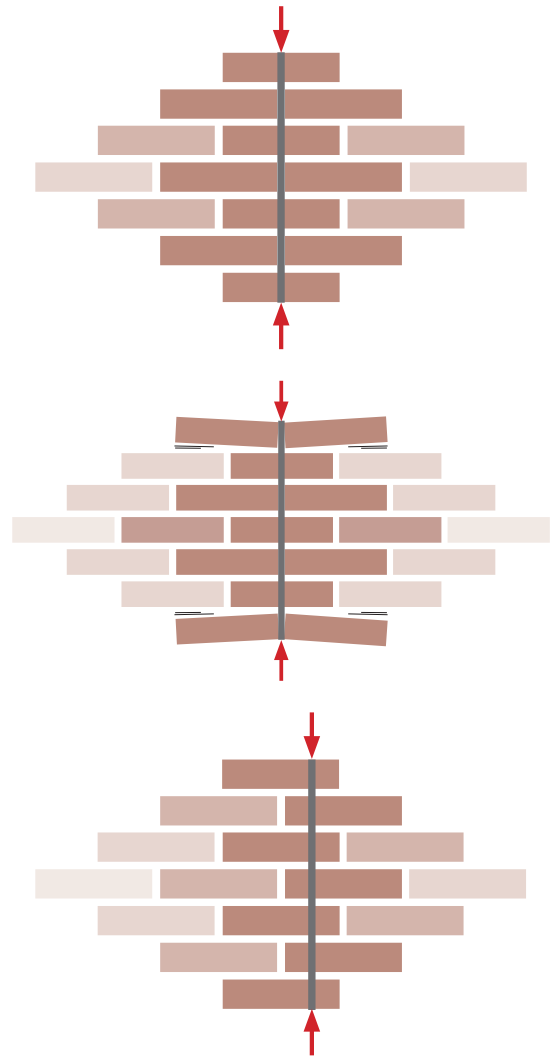

figure 104, Three ways of placing prestress on masonry in stretcher bond, 7 courses high.

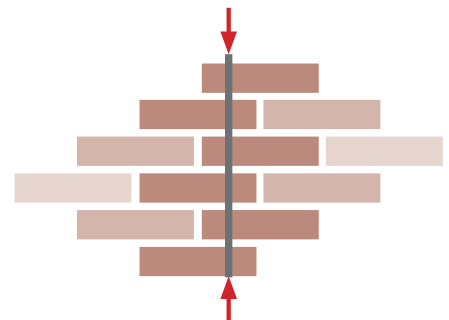

figure 105, Prestress at a quarter bat, 6 courses high.

In stretcher bond the middle of the brick and the head-joint alternate every course. This means that if the prestress is applied to the middle of the brick, the course that needs to hide tension nut has a joint at this place. The nut is larger than the joint, if the tension rod is M8 or bigger. So, some material needs to be removed.

In the middle of the brick, a drill can be used to make room for the tension rod and nut. On the edge of the brick cannot be drilled. Therefore it must be ground away with a brick saw. Therefore, figure 106a shows a square relief cut.

The benefit of placing the tension rod at a quarter of the brick, is that all the bricks can be cut in the same place. The hole for the finishing brick is the same place as in the structural part of the masonry. This makes detailing easier, as the situation is the same on every course.

Alternatively, two tension rods can be used to get both the benefit of on average symmetrical stresses, and the easier detailing associated with placing a tension rod at a quarter bat. Whether this weighs up against the additional work and materials, remains to be seen.

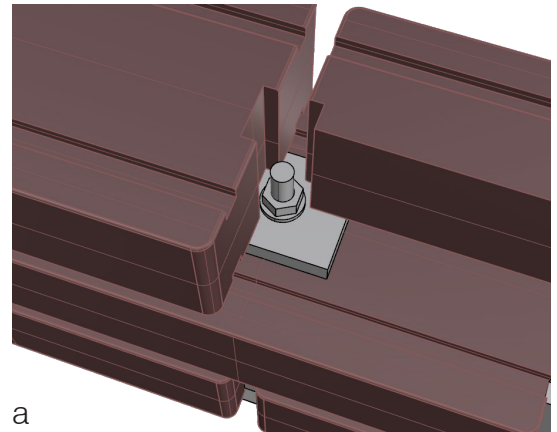

a

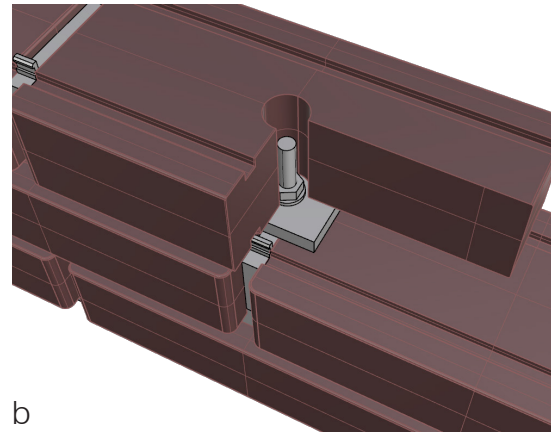

b

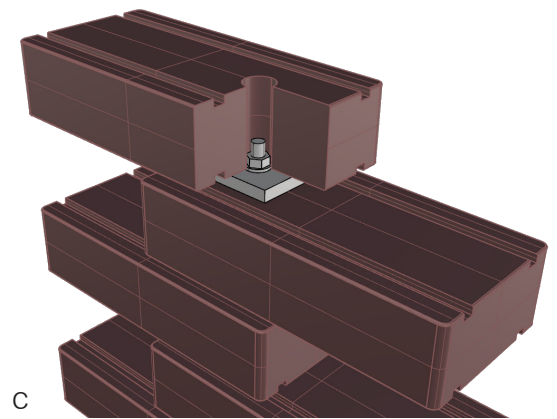

c

figure 106, Relief cuts for the top of the tension rod.

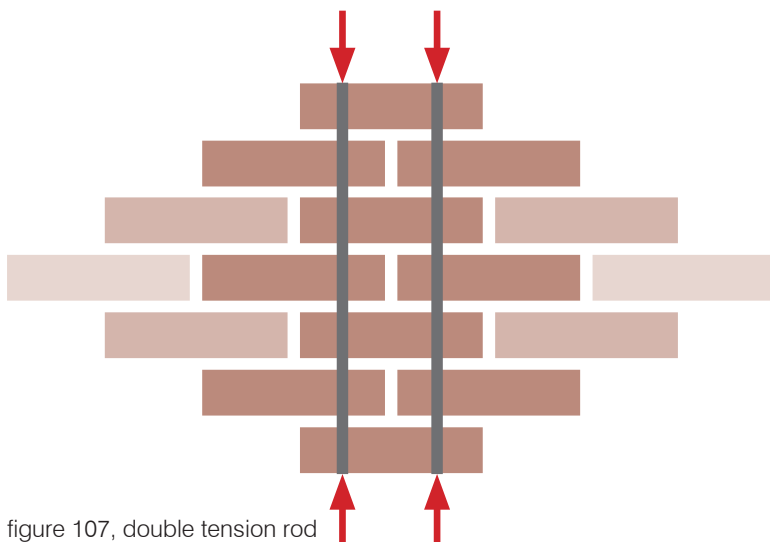

figure 107, double tension rod



figure 108, Prototype for a quarter bat overlap, using the holes in extruded brick.

7.5.2 Hanging bricks

We want our facade openings to be rectangular and our lintels to be nice and straight. The models, however, show only masonry with pieces fallen out. These bricks clearly need to be held in place in some other way than the rest of the masonry. Additionally, we might want an extra course of masonry on the bottom of the lintel, to hide the tension rods entirely.

In both cases, the bricks can be hung under a H-profile. The head-joints can transfer the weight of the brick to the H-profile. For this to work, the head-joint needs to be able to hold the brick. This can be accomplished by adding a component that slides into the head-joint (see figure 109). That component has surfaces that extend into a slot in the side of the brick. The surfaces, that extend into the brick, are now rectangular, but might need to be shaped like the saw, that will cut the slot in the side of the brick. The slot won't be cut over the full width of the brick, because it mustn't be visible from the front.

The head-joints transfer the weight of the bricks to the H-profile. The profile needs to be stiff enough to under these loads, so as to not bend noticeably. For typology 5, the maximum span a plastic profile loaded by a single layer of brick was found to be about half a meter, when simply supported. In this new situation the maximum span will longer or maximum load greater, because the supports are now fixed. The span may yet be longer, if the profile is also in tension, as proposed on page 90.

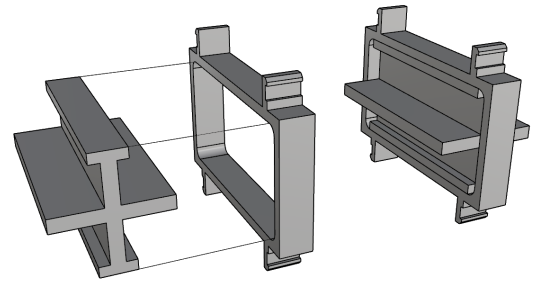

figure 109, A second component slides into the head-joint, to make a 3d shaped head-joint that can hold a brick.

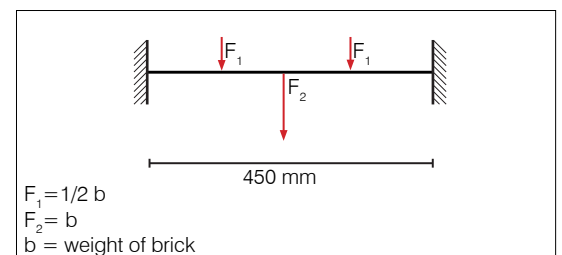
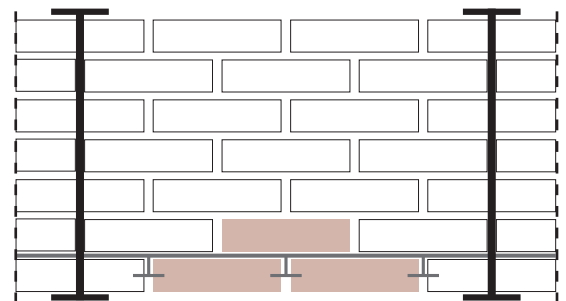
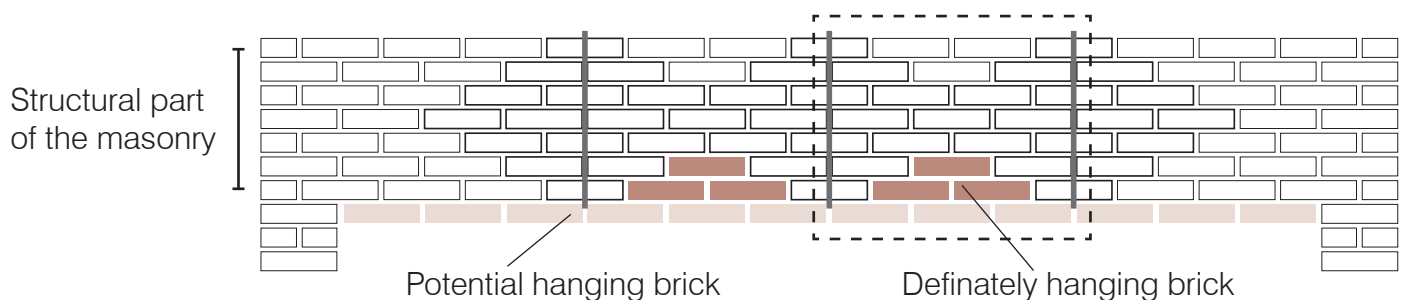
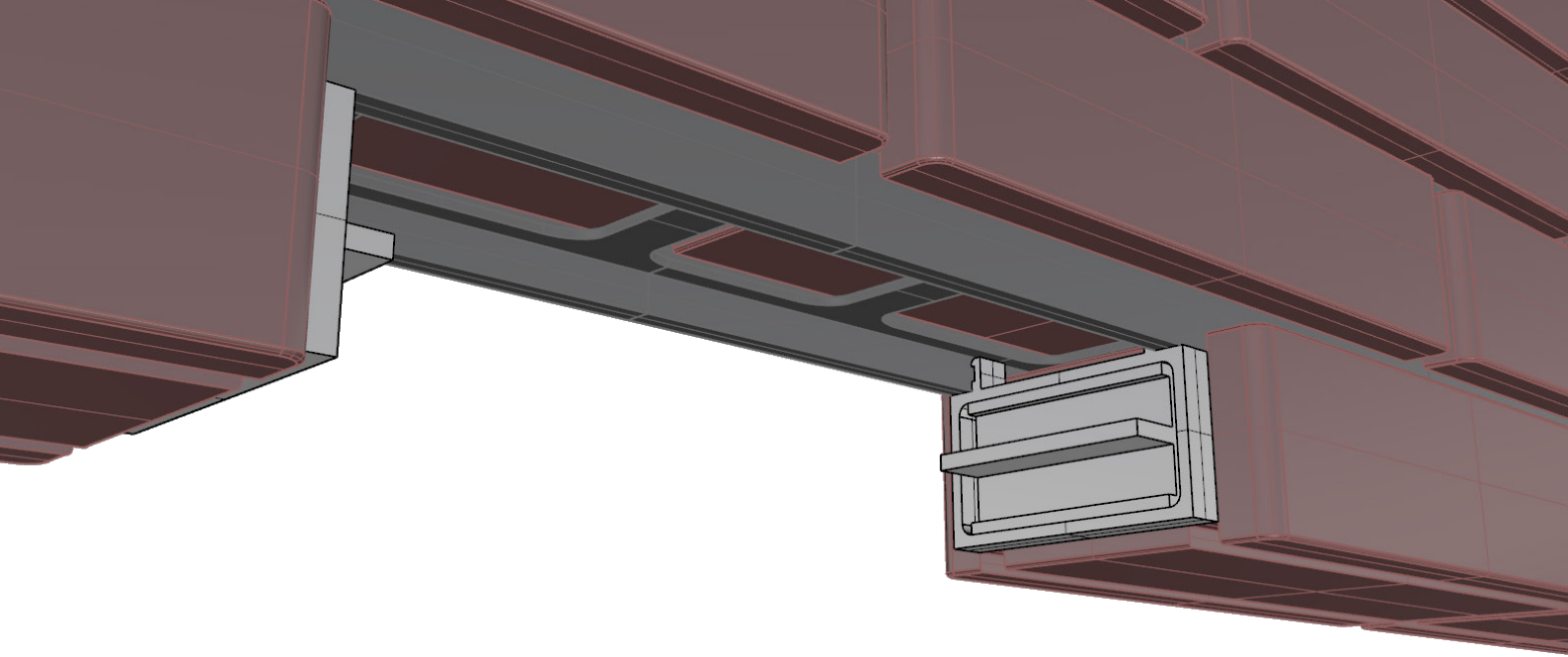

figure 110, 7 course lintel, prestress on brick.





The profile can support several bricks under the lintel, but it will also have a limit. When the profile bends too much. In this situation a secondary support can be made, by hanging a rod from the arch above, like in figure 112. The construction of this secondary support can be similar to that of the tension rods, but it doesn't necessarily have to be prestressed.

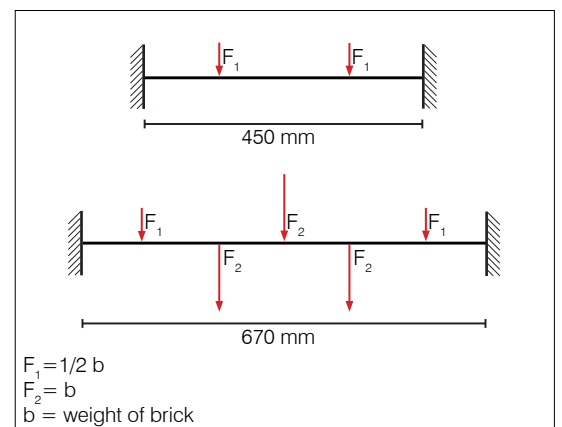
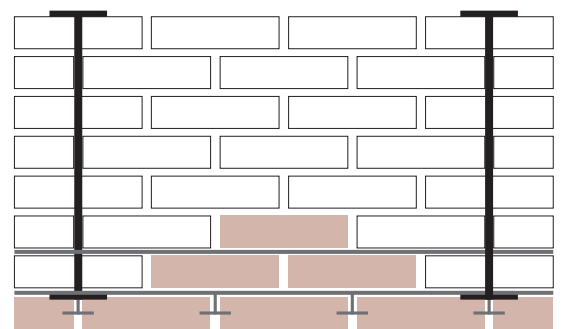
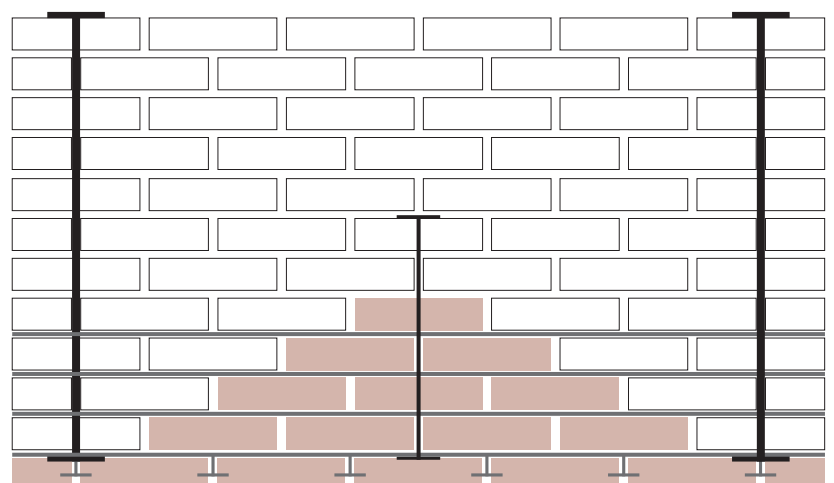

figure 111, 7 course lintel, prestress on profile, with additional course of brick.

figure 112, 11 course lintel, prestress on profile, with additional course of brick.



7.6 Safety

At some point, a lintel will fail. It can be a lack of maintenance, a production fault or something else. When this happens, the lintel should remain relatively safe. Preferably, none of the bricks will fall and it should be clear that action need to be taken, to replace or repair the lintel.

In **section 7.8.3** is shown how the lintel behaves when some of the tension rods lose prestress. The lintel deforms but doesn't collapse. None of the bricks fell. The help of the H-profiles in the masonry shouldn't be underestimated in this test, therefore the result probably doesn't translate directly into another masonry system. The test suggests the lintel in H-block can be safe. A continuous bottom profile is advised.

What the test didn't show, was the security of the bricks that might hang on the bottom of the lintel. In the current design of the head-joints, they probably would have fallen, because of the large deformations. To prevent this the detail would need to be revised. The next section on fire safety will also call for a change in material for the bottom course. Making this a special part of the masonry, for safety reasons.

Fire safety

The case of a fire, the regulations covering the façade focus on the progression of that fire between fire compartments. In that sense the main danger comes from the material in the joints of the masonry. As standard parts of a façade system, these are expected to be safe, if not the system shouldn't be on the market. The materials added to the masonry to form the lintel are non-combustible, and therefore shouldn't pose a danger for fire progression.

The structural integrity of the lintel in during a fire can be debated. As the lintel is not part of the main structure, the building code does not prescribe definitive rules. In most cases, a few bricks falling close to the façade of a burning building is acceptable. Above a fire exit this is probably not acceptable. The collapse of the entire lintel probably shouldn't be acceptable, because of the amount of material, but also considering the fire progression.

How susceptible the lintel is to fire is unknown at this point. The length of time the lintel must be safe should definitely be discussed if the lintel is developed further. What can be discussed now are some of the ways the lintel can be made safer.

The largest problem would be the failure of the tension rods. The main body of the tension rod is relatively well protected against fire. It is completely surrounded by masonry. The ends of the rods can be open to fire. From a fire safety perspective, it might be good to clad the bottom of the lintel with the extra course of brick. That course of brick would protect the bottom ends of the rods from direct contact with fire.

The problem with the bottom course for the lintel as it was described before is the connections are all made with plastic. The plastic will melt, and the protecting course of brick will fall. The bed joint and head joints of the bottom course might therefore need to be made from steel or another fire-resistant material.

Another potential failure can occur through the loss of tension, due to the melting of the plastic components. If this is a problem, it is not clear how to solve it. Changing the material of all the joints in the lintel is not a very satisfying answer. Pointing the joints might help.

7.7.0 Construction process

The construction process must be reasonably quick and simple, with a minimum of awkward operations. Therefore, it was chosen for a method, where the lintel is constructed from the bottom to the top, like the rest of the masonry.

The awkward operations associated with constructing the lintel would happen when it is necessary to install components under the lintel. Often resulting in working above your head or while bending over. Constructing the lintel from bottom to top, like normal masonry, will be the most comfortable procedure. It also makes sure there are no problems with placing 'the final brick', because there is always access from the top and one of the sides.

Constructing the lintel in this way presents some difficulties. Mainly, the tension rod might not be available to manipulate at the bottom of the lintel. The rod is completely surrounded by the masonry. Therefore, the detailing must ensure the rod cannot rotate during tensioning. **Section 7.5.1** already shows a solution for this.

The prestress can be applied by use of special tooling, which regulates the stress, by the amount of torque it puts out. It can also be done by hand. By use of a load indicating washer, the prestress can be checked. These washers deform at a certain pressure, with a small feeler, that deformation is checked.

In on-site construction, the lintel will need to be supported temporarily. This can be done in a similar way as in traditional masonry. A small tool can be developed similar to the Brick Bracket, from Bekaert. For H-block the bracket doesn't need a lot of adjustment capability, as the height of the courses is set at 60mm. Ideally, the beam can be telescoping to be able to use it with a variety of spans. The traditional wooden beam also works



figure 113, Tensioning with pneumatic tensioning bridge

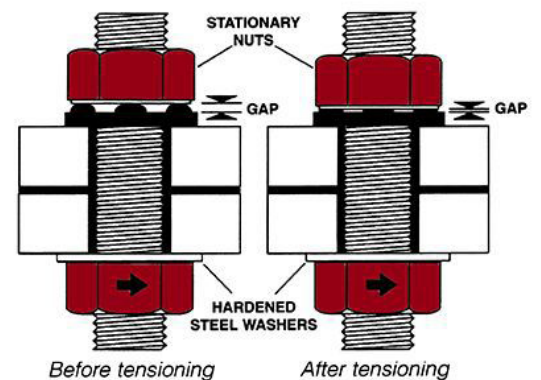

figure 114, Load indicating washers



figure 115, Tensioning by hand

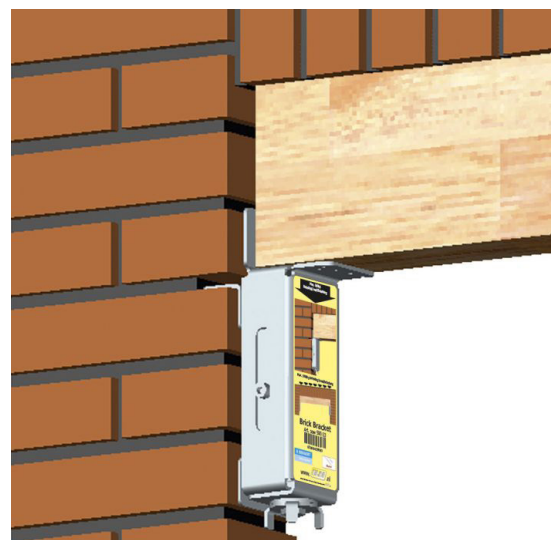
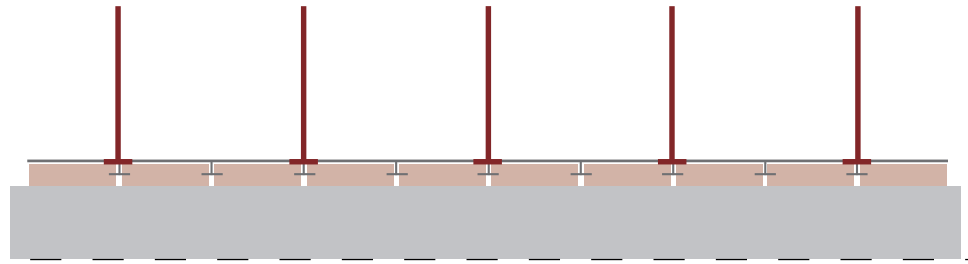

figure 116, Bekaert Brick Bracket

7.7.1 Prefab construction

1. Construct bottom course of the lintel, including hanging bricks and tension rod.



2. Install masonry as normally, till the top of the structural lintel. Bricks with holes go around the tension rods.

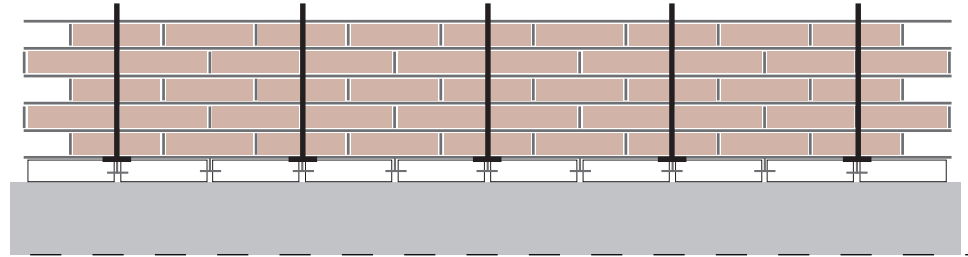

3. Tension rods are tightened to a specific torque.

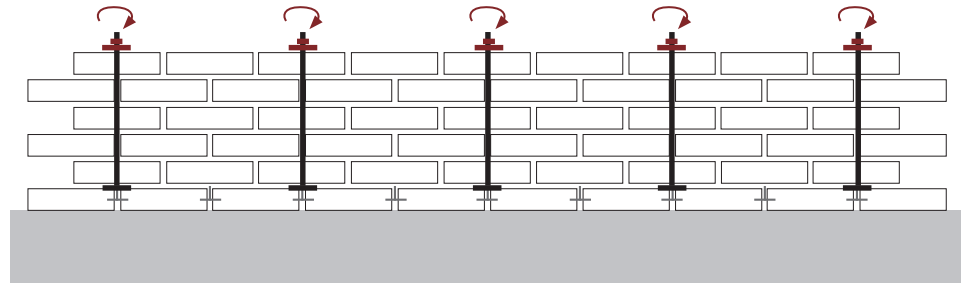

Prefab complete, go to site

4. Construct masonry normally, till the top of the facade opening



5. Place lintel

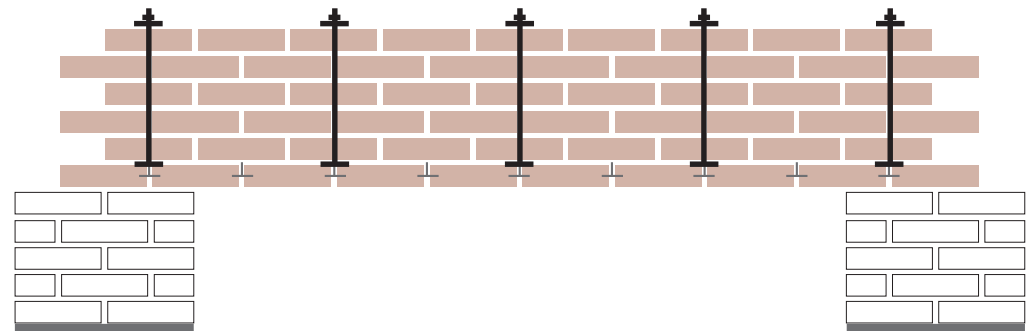

6. Add remaining masonry

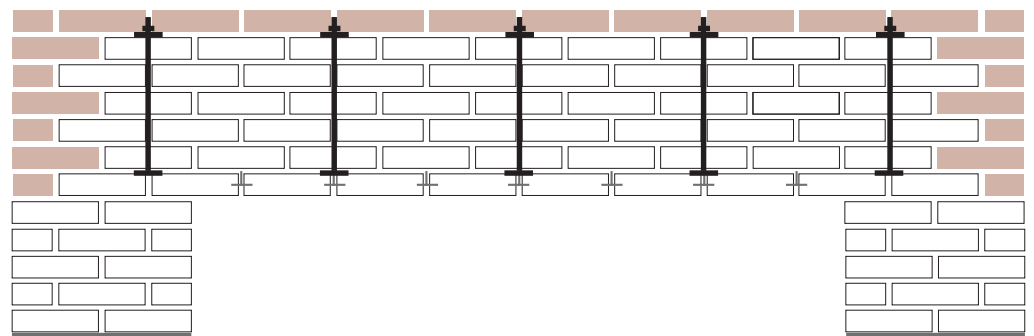

7.7.2 In-situ construction

1. Construct masonry normally, till the top of the facade opening



2. Install temporary lintel and set to correct height



3. Construct bottom course of the lintel, including hanging bricks and tension rod.

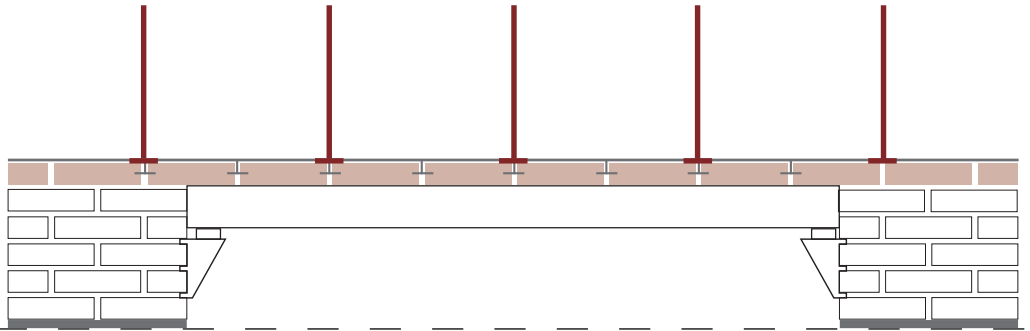

4. Install masonry as normally, till the top of the structural lintel. Bricks with holes go around the tension rods.

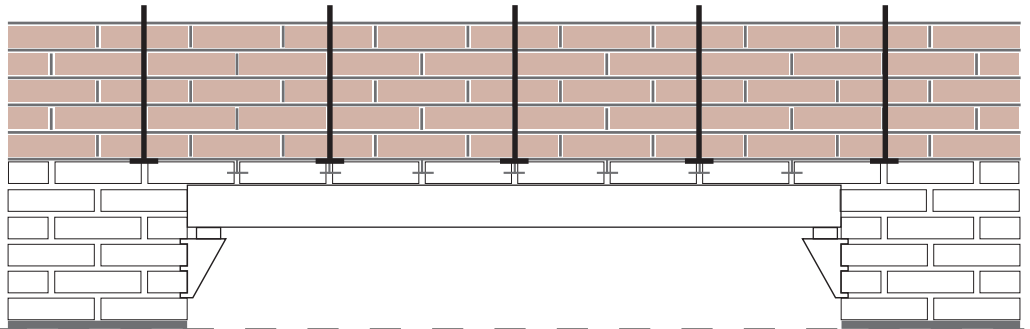

5. Tension rods are tightened to a specific torque.

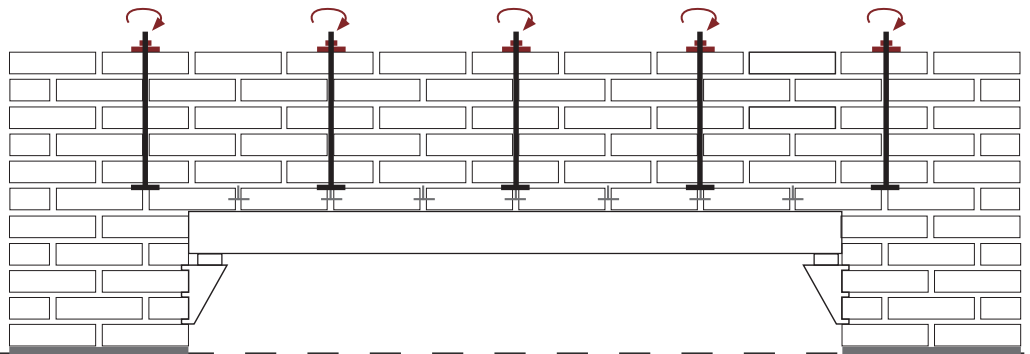

6. Temporary support can now be removed.

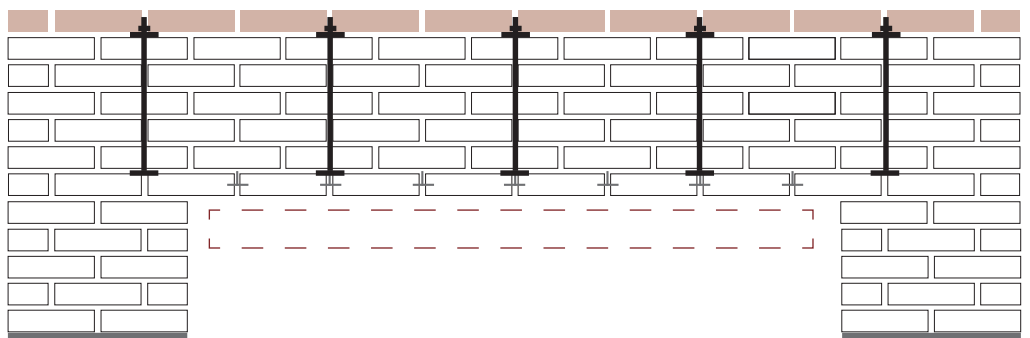

7.8.0 Full-scale prototype

Near the end of the project, a full-scale prototype was built. It serves as a proof-of-concept. Up to this point, the understanding of the lintel was mostly gathered with scale models and wooden blocks. The prototype is made in brick, which is more stiff and heavier than the models. The relationship between the weight and stiffness is closer to how the lintel would be made in practice, therefore it should provide a reasonable first impression of the finished product.

The main aim of the prototype is to see: how the materials react to the forces inside the lintel, whether materials tend to break, and the effect of horizontal tension inside the lintel. Additionally, it was observed how the lintel reacts when tension is released in the tension rods. The prototype is not meant as a precise measure of strength and stiffness. However, as a general figure, the deformation under self-weight was measured.

Construction

The construction of the prototype is generally the same as how it is described previously in the chapter. Some parts were slightly different.

On the bottom, the prestress was always applied on the profile. On the top this alternated and can be seen in the pictures. The pressure plate was made of 8mm plywood, instead of steel. The tension rods had nuts on both the top and bottom. The lintel was constructed on temporary supports. These supported the H-profiles on which the bricks were stacked. The lintel in was simply supported, as shown in figure 114. The supports therefore weren't able to resist horizontal forces.

figure 117, Profile adapted for tension rod



figure 118, Wooden pressure plate



The impact of these changes is quite limited. Some other parts of the construction process may have noticeably influenced the results.

Firstly, the bricks. The channels in the brick were cut by hand, on the two-bladed prototype saw. The problem with this is, that the channels on the two sides of the brick, were cut with two different reference surfaces. The channels in the top were cut with the top of the brick as a reference, and the bottom channels had the bottom surface as a reference. Therefore, the interfaces between the brick and plastic components aren't as consistent as they would be in the real thing. This can cause some extra deformation.

The ground on which the lintel was constructed wasn't completely flat. When closely looking at the pictures the lintels seem to initially be constructed with a slight arch. The deformation could be larger because of this, as the lintel would need to go past neutral to start working. On the other hand, it might help with the compression zone in the top of the lintel.

Lastly it should be noted that the amount of prestress per rod is unknown in these prototypes. The rods were tightened by feel, which is especially imprecise between setups.



figure 119, cutting the channels

figure 120, Lintel support



7.8.1 Continuous profile

One of the goals for this prototype is to see the effectiveness of the continuous profiles. The bottom of the pages show two setups. Left with short profiles, right with a continuous bottom profile. The right setup was slightly moved, to get a clearer view.

Comparing the two setups. The setup with the continuous profile had noticeably less deformation under its own weight, from about 10mm to 3mm. With a span of around 1,5 meter, the 3mm deformation is just about acceptable. With a bit more development, the deformation can probably be reduced a bit more.

The subjective experience of the setups underlines the measurements. The setup 2, with the continuous profile, feel more secure while handling it. In setup 1 seems like the bricks want to slide more, although the pictures don't really confirm this.

As a whole, tension in the bed joints, by using continuous profiles, is a good solution for the thrust in the supports. In further development it should be tested whether replacing all bed joints is even more effective.

Setup 1: 5 courses, 5 tension rods, only standard profiles

figure 121



figure 122, Connection continuous profile

Continuous profile construction

Some of the setups of the prototype make use of a continuous bottom profile. This profile was made by attaching multiple smaller profiles together. The connection was made with screws and steel connecting plates. By drilling the pilot holes for the screws a bit too far apart, the profiles are tightly pressed together.



Setup 2: 5 courses, 5 tension rods, continuous bottom profile

figure 123



7.8.2 Archetype

Most of the investigations into this typology has been done with a lintel of 7 courses high. The same as with the *gevelklemmen*. It is only logical to see how this performs in real life. To do this, the continuous profile was used with 5 tension rods to secure it. The lintel has a span of about 2,4 meters.

Under its own weight, the deformation was about 14 mm, about three times as much as is acceptable. The lintel after deformation, looks quite flat. The pictures show the lintel was substantially arched upward on the temporary supports. This may have contributed to the large deformation. To be sure, the deformation would need to be measured properly, in a test where this is the main objective. Maybe in a situation where the stiffness can also be separately measured.

As a proof of concept, the prototype can be considered a success. The lintel is strong enough to sit on. None of the bricks has broken yet, not under prestress, nor as a result of bending.

The deformation in all cases is a bit high. It should be investigated further, whether the deformation is caused by a lack of stiffness, or as part of a initial settling of the lintel. The second might be solved with more precise bricks and construction procedure.

Setup 3: 7 courses, 5 tension rods, continuous bottom profile

figure 124



7.8.3 Loss of tension

As part of the changing setups, the behavior when tension is lost was observed. Below is a series of pictures, showing the result of removing some of the tension rods. White arrows show the location where the tension rods are loosened and removed. The dotted line shows a tension rod which is still in place, but without tension.

What can be seen in the pictures, is that the loss of tension in the middle of the span has relatively little effect on the deformation of the lintel. These tension rods were also easily removed from

the lintel. The loss of tension near the edges of the lintel causes large deformations. The bricks immediately start to slide, and jam up against the tension rod. The metal rod then prevents the lintel from completely falling apart. Helped by the continuous profile, none of the bricks fell.

With noticeable deformation, but no falling components, the first test suggests the lintel can be safe, when one of more tension rods fail.

Setup 4: 5 courses, 6 tension rods, continuous bottom profile

figure 125

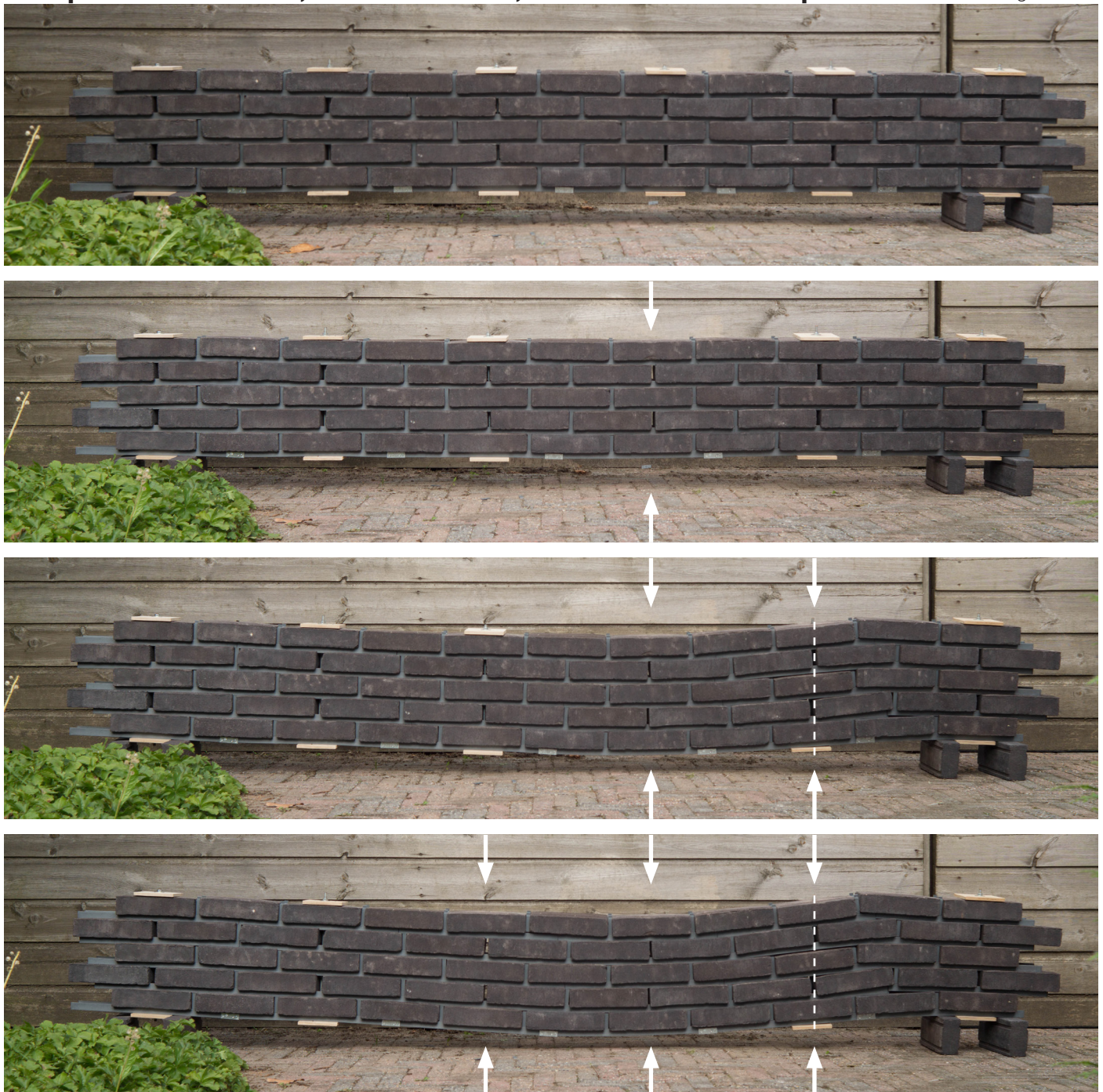

7.9 Findings

Applying vertical prestress makes it possible to make a lintel out of masonry. The prestress increases the friction between the bricks and bed-joints. It also prevents the bricks from rotating.

An advantage of vertical prestress is that the surfaces that are pressed together are already precise. The system requires these interfaces to be precise. Therefore, this typology requires less post-processing than typology 5.

The lintel has a truss-like stress distribution within the masonry. The diagonals work as corbels, in which the bricks are prevented from rotating by the counterforce that is provided by the prestress. The bricks in the diagonals are all in bending.

The lintel produces horizontal forces in the supports. This can be prevented by including continuous bed-joints, that can work in tension. It is advisable to at least do this on the bottom course. For fire-safety reasons the continuous bottom bed-joint may need to be made in steel.

The lintel should be possible in most masonry bonds. Stretcher bond is the most efficient. In other bonds the distance between tension rods will be smaller.

The lintel will always have a few bricks that will want to fall. These are held in place with the H-profiles and other details specific to H-block.

The lintel needs a relatively large height. The absolute minimum number of courses where this typology would work is 3 courses. This would probably be clad with an additional course on the bottom, making it 4. However, it is more likely the structural part of the lintel would need to be 5 or 7 courses high.

figure 126, The prototype can hold a significant load



Further development:

A lot of options are left open in the detailing of the lintel. This is done deliberately. The decisions will need to be made in relation to cost and construction time. Both will need further investigation.

The structural behavior of the lintel is focused on the bricks. In further development the influence of the H-profiles will need to be investigated. Perhaps, also with different lengths.

The stiffness of the lintel will need to be tested. This should be done in relation to the amount of prestress. With these measurements it may be possible to start development of a structural computer model.

The prototype shows the initial settling of the lintel may be a factor to consider in further development.

The behavior of the lintel during a fire will need to be tested. If the bed-joints start melting due to the heat, it might be a significant problem.

Typology Summary

Type 7

Forces in masonry

Tension in bed-joint	Yes
Tension in head-joint	No
Extra stress on brick	Yes
Horizontal forces in masonry	Yes

Detailing

Subject to initial settling	Yes
Precise sized brick necessary	Yes
Long bed-joint needed	Yes
Stronger head-joint connections needed	No
Special head-joint needed	Yes

Construction process

Temporary support during construction	Yes
Lintel prefab possible	Yes
Lintel on-site fabrication possible	Yes

Design

Lintel is in plain sight	No
Lintel is obscured	No
Lintel is out of sight	Yes
Allows various stacking patterns	Yes

Conclusions

The main objective of this thesis was to investigate the possibilities to span a facade opening in a dry stacked masonry. This was performed as a case study for a single system, but in this section the results will be extrapolated to try to define conclusions that are relevant for other systems.

The thesis has resulted in seven typologies of lintel structures for H-block. Each is distinct, but they can be categorized in several groups.

1. Lintel, existing products
2. Lintel, using system attributes
3. Structural masonry, using systems strength
4. Structural masonry, with added components

Lintels

1. Existing products

Integrating existing products into the system is probably the easiest and cheapest way of having a lintel. Steel lintels are probably necessary for every system.

The products of course need to fit with the layer height of the masonry. Another thing to keep in mind is that the lintel should transfer the precision of the system to the bricks that are stacked on top. So, don't just place the first layer of bricks on top of the lintel. The interface between the lintel and bricks needs to be precise. The solutions of typology 1 show this.

2. Lintel using system attributes

The masonry system can also inspire new types of lintel. Every system allows for different things. Typology 2 and 3 show that H-block makes it quite easy to add reinforcement on the side of the masonry, or click it on the H-profile. This is due to the way the profile is designed.

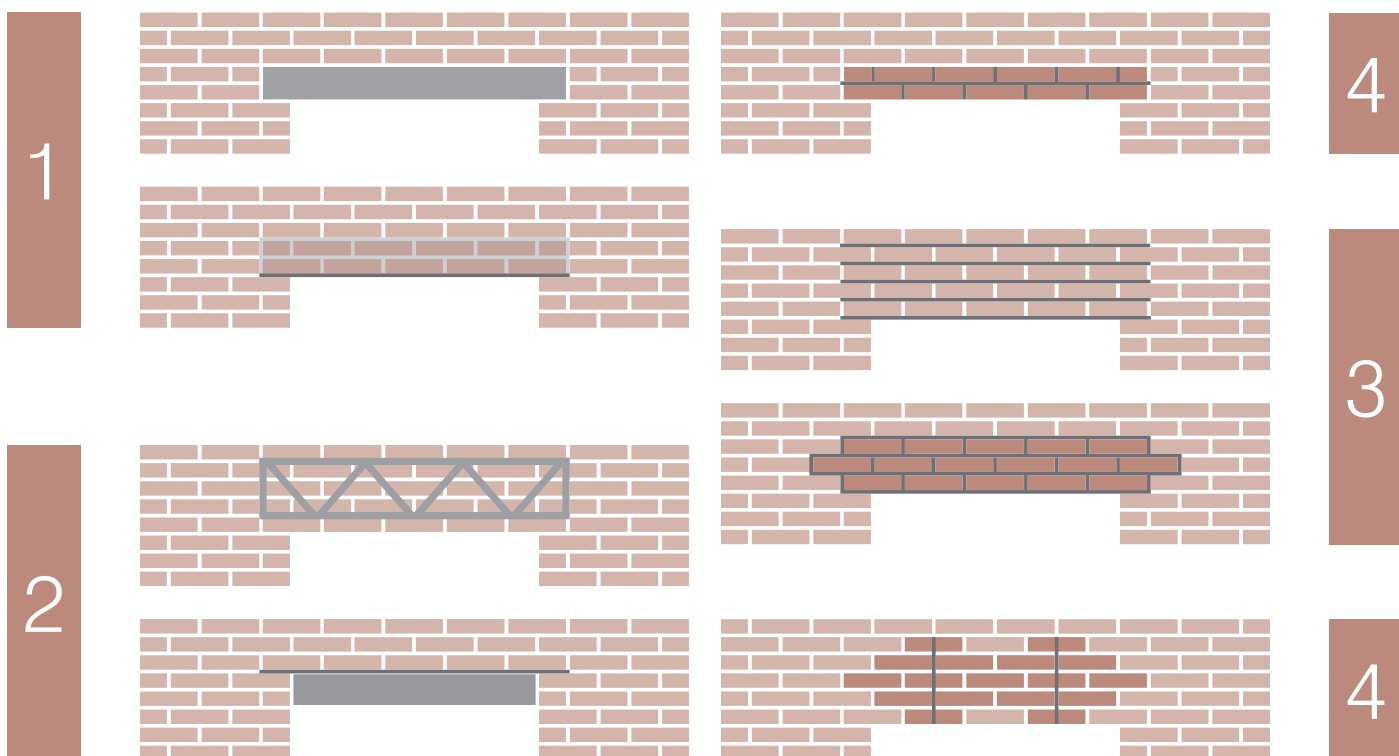

Structural masonry

In structural masonry, brick is the main structural material. It is very capable in compression and a bit less so in tension. The main challenge for making a lintel out of brick, is the size of bricks. The relatively small size of the brick means that many of them have to work together. Multiple bricks together almost automatically form arches within the masonry. But, the bricks cannot be allowed to slide relative to each other. Whenever the bricks slide, the lintel bends.

Traditional masonry has a wealth of solution to all kinds of structural uses. The key is to translate the traditional mortar joint, to the joint in a particular system.

Translating mortar joints

The main difference between traditional and dry stacked masonry, is that the interface between components changes from a chemical bond to a mechanical bond. The bricks in traditional masonry are glued together, thereby securing the bricks in three dimensions. The strength in tension may be limited, but certainly isn't completely useless. The mortar also takes up all the slack in the system, so there is no play between components.

The connections in dry stacked masonry often don't secure the bricks in three dimensions. H-block for instance, secures the bricks in the out-of-plane direction of the wall, but the bricks can slide along the length of the wall. In the height direction the head-joints provide some strength, but with the forces in play this is quite limited. So, the bricks are secured in only two dimensions.

For creating structural masonry lintels, the bricks must be sufficiently fixed in all three directions. Horizontally along multiple courses, so the bricks can transfer loads to each other and create stiffness. Vertically, so the bricks cannot fall and break the lintel. And in the Out-of-plane direction to ensure stability, although the third direction can be solved with cavity ties.

Initial settling

The settling of the lintel, when the temporary supports are removed, is a major consideration in dry stacked masonry, in a way it isn't for traditional masonry. The settling is caused by components moving to fill the empty space between components. The mortar in traditional masonry completely fills the space between bricks, effectively negating the size differences and imperfections between bricks. Thereby reducing the slack in the system to zero. With dry stacked masonry this is impossible. Even if the bricks are made to be precise, the number of separate components make that tolerances add up quickly.

To reduce the initial settling of the lintel, the slack in the system needs to be minimized. This means that tolerances that might be an asset in the main body of the wall, for instance in the case of thermal expansion, can be unacceptable in the lintel. The tolerances need to be optimized for the job the masonry is doing.

3. Using the strength of the system

In some cases, part of a system or the way a system is put together can have the potential to span an opening. By altering the system slightly, these potentials can be realized.

When investigating this option in typology 5 and 6, it became quite clear that the components were not designed to be used structurally.

Designs are always a balance between several aspects, and the structural aspect wasn't an important one up till now.

If the detailing of the system needs to change, it will lead to an interesting discussion, because changes in favor of the lintel, will not necessarily benefit the non-lintel part of the masonry.

In typology 6 this is very clear. To improve the type the components of the system need to be strengthened. For the non-lintel parts of the masonry, it would be better if the connections between the components would be even weaker. This would mean less material and quicker assembly.

In the end, it will always be the question whether it is worth it, to change the design of the system to be able to make a lintel.

In any masonry system with isn't optimized to be used structurally, some form of this discussion probably needs to be held, if the (potential) strength of the system is to be used. A possible outcome of this discussion might be to have two versions of the system.

4. Structural masonry with added components

By adding components, the system can be augmented for a better structural performance, without changing the components of the system. In this report, this takes the form of adding prestress.

An interesting side effect that was observed in typology 4 and 7, is that the emphasis is placed more on the brick, rather than on the system. These typologies are therefore much easier to translate to other dry stack systems. The structural characteristics seem to mostly be related to the brick, while the system makes it possible to solve specific problems. The system, of course, also provides specific problems to solve.

The need for precision of the interfaces doesn't change. In these cases, it was even more noticeable, because the prestress takes advantage of any imperfection.

Further research

Any piece of research will always spark new research. Topics specific to a typology, usually smaller in scope, can be found in those chapters.

Arches in dry stacked masonry

A continuation of this thesis. Although arches have largely gone out of fashion, partly because of the labor involved in making them. The research should be focused on cutting down on that labor, while also minimizing the amount of special parts. The difficulty will depend on the system which is used.

Structural dry stacked masonry

In a way, this thesis can be seen as a precursor to this topic, exploring some structural behavior of dry stacked masonry. It would be interesting to see a Brick-BENG like approach to dry stacked masonry. Masonry supported on the foundation, multiple levels high, with minimal connections

to the inside. The main problem here would probably be the stiffness of the masonry in its height, to resist wind loads.

Combinations of traditional and dry stacked masonry

The two kinds of masonry are usually seen as two separate things, but maybe they can be combined. Dry stacked masonry may be able to fill a role to help with expansion joints in traditional masonry. Combining sections of one and the other might be useful. For instance, sections above a window can be dry stacked, so it doesn't have to be cut loose from the rest of the masonry.

Typology Summary

	Type 1	Type 2	Type 3	Type 4	Type 5	Type 6	Type 7
Forces in masonry							
Tension in bed-joint	No	No	No	No	Yes	Yes	Yes
Tension in head-joint	No	No	No	No	No	Yes	No
Extra stress on brick	No	No	No	Yes	No	Yes	Yes
Horizontal forces in masonry	No	No	No	Yes	No	Yes	Yes
Detailing							
Subject to initial settling	No	No	No	No	No	Yes	Yes
Precise sized brick necessary	No	No	No	Yes	No	Yes	Yes
Long bed-joint needed	No	Maybe	No	No	Yes	Yes	Yes
Stronger head-joint connections needed	No	No	Yes	No	No	Yes	No
Special head-joint needed	No	No	No	Yes	No	No	Yes
Construction process							
Temporary support during construction	No	No	No	No	Maybe	No	Yes
Lintel prefab possible	Yes	Yes	Yes	Yes	No	Yes	Yes
Lintel on-site fabrication possible	No	No	Yes	No	Yes	No	Yes
Design							
Lintel is in plain sight	Yes	Yes	Yes	No	No	No	No
Lintel is obscured	Yes	No	No	No	No	No	No
Lintel is out of sight	No	No	No	Yes	Yes	Yes	Yes
Allows various stacking patterns	n/a	Yes	n/a	Yes	Yes	Yes	Yes

Reflection

Process:

In what way has the research changed with respect to the initial plan?

In general, the plan was to do more and in a more structured way. At the beginning of the research, I thought the subject of the research was quite narrow. In reality it isn't, and the result reflects that. The research is exploratory, and to a large extent open-ended. Now, at the end of the research, I feel like I know enough to start a carefully planned research into vertical prestress.

The approach that is preached to the students at the start of the thesis, is one of meticulous preparation and planning. In general, this is a good thing, it forces you to think about the result of the thesis, and how to get there. It also serves as a tool to see if the research is possible in the time allotted to it. However, it suggests a rigid process. This is fine, when the result and process of the research is known in detail. When you, for instance, have a hypothesis that needs to be tested.

If the research is more open-ended, the planning it is much harder to make a good planning, because you need to make decisions during the process. This is something that I had some problems with, to the point where the planning that was initially made, was for the most part useless.

Looking back at the timing of some of the decisions. The choice to focus on one typology came during the P3 presentation. This might have been too late. After P3 there is only 2 months to work on the chosen typology, which in hindsight could have been a bit longer. Then again, it is always nice to have a bit more time.

Doing research vs developing a product

This thesis comes relatively close to the building practice. The results can quite literally be toughed. However, if the research would actually be conducted in practice, the result would probably be a lot different. Different in how decisions are made, and how the process progresses in general.

After conceiving several typologies for the lintel, one was chosen to continue with. The basis for this decision was mostly on what was the most interesting to work on. Maybe even the most unusual type. The sales potential of the lintel was not a consideration at all. If the research was done of a company money would need be a consideration, and probably would have led to a different typology being chosen to focus on.

The process in general would be different as well. In practice, it is much more expected to discard things that aren't feasible. The typologies can be presented in an informal manner, discussed and a decision is made to continue or not. The typologies that you don't continue with, don't necessarily need to show up in the rest of the process.

In academia you always write for people who have not been involved in the process and may use your research to further their own. Therefore, you need to present the whole process in a formal manner. It takes time to do this. Time that could have been used to go deeper into a single type.

Product:

The product of this research is an overview of possibilities for spanning structures in dry stacked masonry. The overview is in no way complete, nor could it be. Hopefully, the report is able to spark other ways of solving the same problem. The list of typologies can in that case be expanded. The emphasis of the explorations is on the understanding of the structure and the relationship with the details. Often, the impact of small things, characteristic for dry-stacked masonry, is discussed.

The usefulness of the thesis is therefore mostly in the beginning of a development project. To speed up development, to spark ideas, for seeing what could be possible, but also to get acclimatized to the specifics of working with dry stacked masonry. These are the things that I learned from doing this research, and hopefully this has been transferred into this document. The thesis does not provide hard numerical data on the impact of certain decisions. The usefulness for later stages of development therefor might be limited.

At the beginning of the project, I thought I would use more digital tools to work on the structural design of the lintels. In the end, this kind of structural design software was used very sparingly, while mostly relying on physical models to understand the structure. The thesis, therefore, doesn't really produce numeric data on the typologies at all. By doing this, the results of the research have remained mostly in my comfort zone, discussing the structures qualitatively rather than quantitatively. I may have needed someone to push me a bit, to go out of my comfort zone. On the other hand, I probably overestimated the usefulness of these digital tools and the work I would be able to do in the allotted time.

Is vertical prestress going to be the new standard?

No, it isn't.

As stated before, the decision to focus on typology 7 was made because it was the most interesting for research. It had the most unknowns. For vertical prestress to become the new standard lintel, or at least get significant use, it would have to have some sort of compelling advantage. If the rest of the masonry in the façade isn't prestressed, the vertical prestress doesn't make a lot of sense.

The vertically prestressed lintel uses less steel than normal steel lintel, but it also requires a lot more work. If materials were expensive and labor cheap, that would be fine, but it isn't. Add to this the fact that nobody really looks at lintels, except for some architects. It would be difficult to convince a client to use this type of lintel.

But what if the whole façade is prestressed? For instance, if we want some of the advantages of Brick-BENG in a single wythe wall. Less connections to the inner cavity leaf. Or if a pre-fabricated dry stacked masonry façade needs to be hoisted into place without the need for a sub-construction. If that is the case than it could become quite interesting to use vertically prestressed masonry lintels.

Addendum

Quite early in the thesis, I made some wood blocks to fit with the H-block system. The idea for this was not only to have a larger number of 'bricks' to play with, but also bricks that were more manageable in their weight. The wood blocks can also fall on the floor without breaking. In short, it is an excellent prototyping tool.

It also looks quite good, at least to me. And it goes into the design freedom of H-block where it comes to material. I can imagine this being developed into an interior wall, and I thought I would just write a little bit about my experience with wood as a brick.

The wooden blocks are made with 2x4 finished lumber. These were cut to length and then the H-block grooves were routed into the top and bottom. I did this with the help of Marcel Bilow, at the Buckylab workshop, which made the construction quite easy.

The width of the lumber is perfect for dutch bricks. The height isn't large enough. The bed-joints are too large, but it also makes the channels too shallow.

Working with wood in the kind of tolerance of the H-block system, you will run into problems that are closer related to cabinetry than the construction industry. In the rush to have some blocks to work with, these problems were not taken into account.

The wood shrinks when it dries, but not homogeneously, which produces deformations. A bow or a twist in the wood isn't any problem because the blocks are relatively short. The cup that forms in the wood poses a problem. The cup changes the placement of the channels in the wood in such a way that they don't fit perfectly anymore.

So, when making wooden bricks, start with a little bit wider stock than 2x4, if budget allows it. Also, account for the inevitable shrinking of the wood, by making the channels a bit wider than strictly necessary.



References

- Adell Argiles, J. M., García Santos, A., Lauret Aguirregabiria, B., Lopez, C., Martin, H., Peña, J., . . . Vega, S. (2008). 6m Span Lintels Tests on a New Wall Pi-brackets Type. Paper presented at the 14th International Brick and Block Masonry Conference. Incorporating the 8th Australasian Masonry Conference, Sydney, Australia. <http://oa.upm.es/4243/>
- Allen, E., & Zaleski, W. (2012). *Form and Forces : Designing Efficient, Expressive Structures*. New York, UNITED STATES: John Wiley & Sons, Incorporated.
- Baig, I., Ramesh, K., & Hariprasad, M. (2015). Analysis of stress distribution in dry masonry walls using three fringe photoelasticity. Paper presented at the International Conference on Experimental Mechanics 2014.
- Beall, C. (1993, 01-03-1993). *Lintel Design and Detailing*. Masonry Construction.
- Beall, C. (2004). *Masonry Design and Detailing : For Architects and Contractors (Vol. 5th ed)*. New York: McGraw-Hill Professional.
- Beatini, V., Royer-Carfagni, G., & Tasora, A. (2017). A regularized non-smooth contact dynamics approach for architectural masonry structures. *Computers & Structures*, 187(Supplement C), 88-100. doi:<https://doi.org/10.1016/j.compstruc.2017.02.002>
- Bengtsson, L. P., & Whitaker, J. H. (1986). *Farm structures in tropical climates : a textbook for structural engineering and design*: Rome : FAO.
- Bigoni, D., & Noselli, G. (2010a). Localized stress percolation through dry masonry walls. Part I – Experiments. *European Journal of Mechanics - A/Solids*, 29(3), 291-298. doi:<https://doi.org/10.1016/j.euromechsol.2009.10.009>
- Bigoni, D., & Noselli, G. (2010b). Localized stress percolation through dry masonry walls. Part II – Modelling. *European Journal of Mechanics - A/Solids*, 29(3), 299-307. doi:<https://doi.org/10.1016/j.euromechsol.2009.10.013>
- Brito, M. P. d., & Dekker, R. (2002). Reverse logistics - a framework. *Econometric Institute Research Papers*. Retrieved from <http://hdl.handle.net/1765/543>
- Curtin, W. G., Shaw, G., Beck, J. K., & Bray, W. A. (1995). *Structural Masonry Designers' Manual (Second Edition (revised) ed.)*: Wiley.
- Hall, J. F. (2005). Fun with stacking blocks. *American Journal of Physics*, 73(12), 1107-1116. doi:10.1119/1.2074007
- Hendry, A. W., Sinha, B. P., & Davies, S. R. (2003). *Design of Masonry Structures*: CRC Press.
- Hofkes, K., Rentier, C., Reymers, J., & Salden, M. W. R. (2011). *Hogere bouwkunde Jellema. 4, Bouwtechniek : omhulling B, Gevels (3e dr. ed.)*. Amersfoort :: ThiemeMeulenhoff.
- Hohm, T., Egli, M., Gaehwiler, S., Bleuler, S., Feller, J., Frick, D., . . . Zitzler, E. (2008). An Evolutionary Algorithm for the Block Stacking Problem. In N. Monmarché, E.-G. Talbi, P. Collet, M. Schoenauer, & E. Lutton (Eds.), *Artificial Evolution: 8th International Conference, Evolution Artificielle, EA 2007, Tours, France, October 29-31, 2007, Revised Selected Papers (pp. 112-123)*. Berlin, Heidelberg: Springer Berlin Heidelberg.
- Jonaitis, B., Zavalis, R., & Oganian, J. (2017). Experimental Investigation of the Behaviour of Brick Lintels. *Procedia Engineering*, 172(Supplement C), 465-472. doi:<https://doi.org/10.1016/j.proeng.2017.02.054>
- KNB. (2017a). BENG met zelfdragende buitenspouwbladen in steensmetselwerk. In. Velp: vereniging Koninglijke Nederlandse Bouwkeramiek.
- KNB. (2017b). Draagconstructies boven gevelopeningen. In. Velp: vereniging Koninglijke Nederlandse Bouwkeramiek.
- Mulder, K., & Tekstbureau Veronique, H. (2016). *Het zinderend oppervlak : metselwerkverband als patroonkunst en compositiegereedschap. [Delft] :: Uitgave in eigen beheer*.
- Paterson, M., & Zwick, U. (2006). Overhang. Paper presented at the Proceedings of the seventeenth annual ACM-SIAM symposium on Discrete algorithm, Miami, Florida.
- Pfeifer, G. (2001). *Masonry Construction Manual*: Princeton Architectural Press.
- Pfeifer, G., Ramcke, R., Achtziger, J., & Konrad, Z. (2002). *Masonry Construction Manual (Vol. 6)*:

Birkhäuser with Edition Detail.

Rai, D. C. (2005). Structural use of unreinforced masonry. IITK-GSDMA EQ, 12, 19.

Vekemans, H. (2016). Legislation and brickwork facades in a historical perspective. In J. P. Wingender (Ed.), *Brick: an exacting material*. Amsterdam: Architectura & Natura Press.

Wingender, J. P. (2016). *Brick : an exacting material*. Amsterdam :: Architectura & Natura Press.

Yeomans, D. (2016). *How Structures Work: Design and Behaviour from Bridges to Buildings*: Wiley.

Image references

All images by author, unless otherwise stated.

- figure 01: From: <http://alohonyai.blogspot.nl/2015/03/masonry-terminology.html>
- figure 02: Gramazio Kohler Research, ETH Zürich, From: <https://www.architectum.com/re-thinking-masonry-digital-technologies/>
- figure 04: Construction Robotics, From: <https://www.flickr.com/photos/constructionrobotics/29628331626/in/album-72157673739967886/>
- figure 10: From: scavengedluxury.tumblr.com/post/145123988800
- figure 12: KNB. (2017a). BENG met zelfdragende buitenspouwbladen in steensmetselwerk. In: Velp: vereniging Koninglijke Nederlandse Bouwkeramiek.
- figure 16: Adapted from: Rentier, C., Reymers, J., & Salden, M. (2011). Hogere bouwkunde jellema: Omhulling (3e dr. ed., Vol. 4, b, bouwtechniek : gevels /) (K. Hofkes, Ed.). Amersfoort: ThiemeMeulenhoff.
- figure 17: Adapted from: Rentier, C., Reymers, J., & Salden, M. (2011). Hogere bouwkunde jellema: Omhulling (3e dr. ed., Vol. 4, b, bouwtechniek : gevels /) (K. Hofkes, Ed.). Amersfoort: ThiemeMeulenhoff.
- figure 18: From: <https://www.permagard.co.uk/advice/lintel-repair-guide>
- figure 19: From: <http://www.pbtmuurkracht.nl/stalen-lateien-0>
- figure 20: From: <http://jiglintels.com/lintels/standard-lintels/single-leaf-lintels/>
- figure 21: From: http://www.verbaansystems.nl/Verbaan_Systems/Home/Artikelen/2016/12/20_Eerste_3D_gevel_gerealiseerd_voor_de_BAM_in_Groningen.html
- figure 32: From: <http://www.randerstegl.com/en/om-randers-tegl/carlsberg-bjaelker-a/s>
- figure 33: Randers Tegl-Gruppen, From: <http://www.dagensbyggeri.dk/artikel/87914-randers-tegl-investerer-30-millioner-i-ny-bjaelkeproduktion>
- figure 62: Bengtsson, L. P. & Whitaker, J. H. (1986). Farm structures in tropical climates : a textbook for structural engineering and design. Rome: FAO.
- figure 63: Yeomans, D. (2016). How Structures Work: Design and Behaviour from Bridges to Buildings, Wiley.
- figure 64: Bigoni, D., & Noselli, G. (2010b). Localized stress percolation through dry masonry walls. Part II – Experiments. European Journal of Mechanics - A/Solids, 29(3), 291-298. doi:<https://doi.org/10.1016/j.euromechsol.2009.10.009>
- figure 65: Bigoni, D., & Noselli, G. (2010b). Localized stress percolation through dry masonry walls. Part II – Experiments. European Journal of Mechanics - A/Solids, 29(3), 291-298. doi:<https://doi.org/10.1016/j.euromechsol.2009.10.009>
- figure 66: Bigoni, D., & Noselli, G. (2010b). Localized stress percolation through dry masonry walls. Part II – Experiments. European Journal of Mechanics - A/Solids, 29(3), 291-298. doi:<https://doi.org/10.1016/j.euromechsol.2009.10.009>
- figure 67: Allen, E., & Zalewski, W. (2012). Form and Forces : Designing Efficient, Expressive Structures. New York, UNITED STATES: John Wiley & Sons, Incorporated.
- figure 68: J. F. Hall. Fun with stacking blocks. Am J Phys, 73(12):1107–1116, 2005.
- figure 69: J. F. Hall. Fun with stacking blocks. Am J Phys, 73(12):1107–1116, 2005.
- figure 70: J. F. Hall. Fun with stacking blocks. Am J Phys, 73(12):1107–1116, 2005.
- figure 71: From: <https://www.archdaily.com/151567/ad-classics-melnikov-house-konstantin-melnikov>
- figure 72: Denis Esakov, From: <https://www.archdaily.com/151567/ad-classics-melnikov-house-konstantin-melnikov>
- figure 73: From: <http://www.jskhandelsonderneming.nl/gevelklauw-gevelklem-geveldrager/>
- figure 74: Gebr. Bodegraven. Gevelklem, From: <https://www.gb.nl/gevelklem-370x80-ev>
- figure 99: Adria Goulà, From: <https://www.archdaily.com/887073/house-1219-harquitectes/5a5d7>

- 559f197cc2bba000012-house-1219-harquitectes-photo
- figure 113: Quick Tie Products Inc. (2017). Quick tie System (QTS) Post-tensioned Concrete masonry Wall Applications
- figure 114: From: <http://www.fastorq.com/uncategorized/load-indicating-washers/>
- figure 115: Tidwell masonry. 5278 Bloch Street UTC San Diego, From: <http://www.tidwellmasonry.com/San-Diego-Masonry-Contractors-Current-Projects.8.html>, Retrieved: 25-06-2018
- figure 116: From: <https://www.abcadamas.nl/diversen/brick-brackets.html>