

Parametric Modelling Method based on Knowledge Based Engineering

The LNG Bunkering Vessel Case

N.D Charisi

Parametric Modelling Method based on Knowledge based Engineering – N.D Charisi

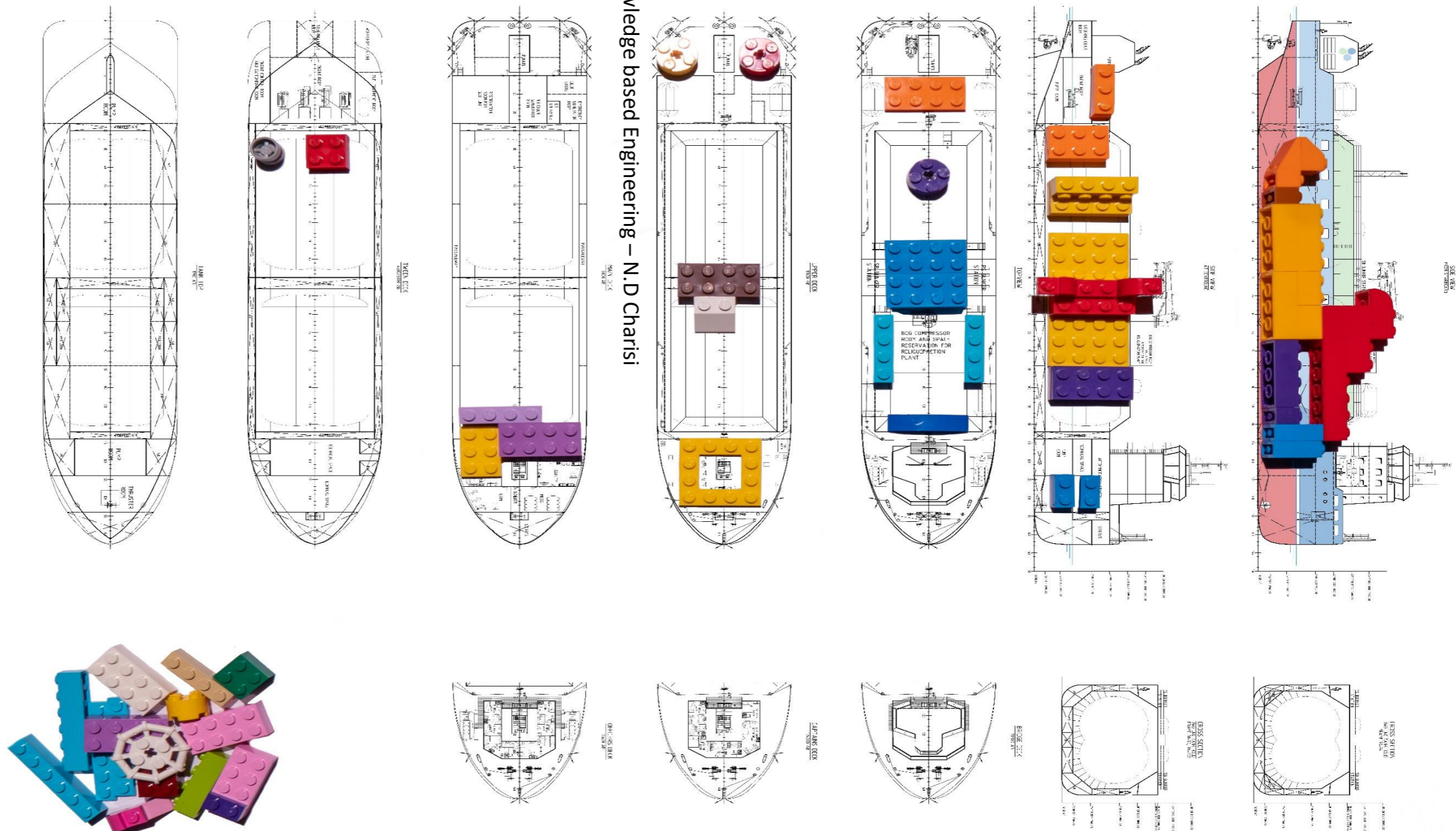

The research work developed a parametric modelling method based on Knowledge Based Engineering. This framework is applied at C-Job Naval Architects B.V.

Written as a MSc thesis to obtain the degree of Master of Science at the Delft University of Technology.

December 2019

Parametric Modelling Method based on Knowledge Based Engineering

The LNG Bunkering Vessel Case

by

N.D Charisi

to obtain the degree of
Master of Science in Marine Technology
in the specialization of
Ship Design
at the
Delft University of Technology

Student number: 4699920
Project duration: February 25, 2019 – December 18, 2019
Thesis committee: Dr. A.A. Kana, TU Delft, mentor
Prof. Ir. J.J. Hopman, TU Delft, mentor, committee chair
Dr. W.W.A. Beelaerts van Blokland, TU Delft
Ir. N. Papapanagiotou, C-Job Naval Architects, supervisor

An electronic version of this thesis is available at <http://repository.tudelft.nl/>.
Report number: SDPO.19.039.m.

But knowledge is not a result merely of filtering or algorithms. It results from a far more complex process that is social, goal-driven, contextual, and culturally-bound. We get to knowledge especially “actionable” knowledge by having desires and curiosity, through plotting and play, by being wrong more often than right, by talking with others and forming social bonds, by applying methods and then backing away from them, by calculation and serendipity, by rationality and intuition, by institutional processes and social roles. Most important in this regard, where the decisions are tough and knowledge is hard to come by, knowledge is not determined by information, for it is the knowing process that first decides which information is relevant, and how it is to be used.

by David Weinberger

Preface

The present thesis has been written to fulfill the graduation requirements of the Master of Science Marine Technology in the field of Marine Technology at the faculty of Mechanical, Marine and Materials Engineering at the Delft University of Technology. I was engaged in researching and writing this research work from February to December 2019.

Acknowledgements

This thesis would not have been shaped without the valuable input and guidance of my mentors. I feel privileged to have had Austin Kana as my daily supervisor, as he managed through his guidance to keep me structured and creative at the same time. Also, I would like to thank Hans Hopman for his feedback and inspiring information, which he shared during our meetings. Besides, I would like to thank my supervisor from C-Job, Nikos Papapanagiotou, for his feedback and the practical aspects of ship design shared with me. I would also like to thank Thijs Muller for encouraging me to use my research freedom to lead my project. Finally, I would like to thank Johan Verbruggen for sharing his ideas about my project.

I would also like to thank my amazing colleagues at C-Job Naval Architects B.V, who made this period an unforgettable journey.

Last but not least, I would like to thank my family and friends for supporting me throughout my studies and reminding me of the crucial goals to aim in life. Besides, I would like to thank my uncle Michael for sharing his insightful ideas about my project and showed me the aerospace design perspective. I would also like to thank my beloved friend and director, Asteris Tziolas, for the editing of my thesis cover. Finally, I would like to thank my boyfriend, Stamatis, for being such a critical teammate during academic work and such a wonderful partner in life. This two-year journey would not be the same without him.

N.D Charisi
Delft, December 2019

Abstract

Nowadays, parametric models can be seen as the core of the design practice as they facilitate the exploration of the preliminary design space, and thus, multiple design solutions can be assessed. The research gap in the parametric modelling methodologies was identified in the development of parametric models based on knowledge building blocks instead of geometric entities. This improvement was expected to lead in improved results as different design variations could be built based on the same fundamental units, such as lego structures.

The research was conducted in cooperation with C-Job Naval Architects B.V. C-Job is a design and engineering company which invests in innovation and improvement of its established practices.

The objective of the present study is directly tied to the identified literature gap. However, the study was limited to the design of the LNG Bunkering Vessel (LNGBV). Thus, the objective of the present study was formed as follows: “Develop a method that is able to create the parametric models of the LNGBV in which C-Job is interested, in order to facilitate the exploration of the preliminary design space”.

Knowledge Based Engineering (KBE) was identified as the suitable tool to deploy for the development of the parametric modelling method. KBE has already proved advantageous in other engineering sectors such as aerospace, automotive, and architecture. The “fundamental bricks” of every KBE application are the High Level Primitives (HLPs). The HLPs are primitives capturing product knowledge. Thus, the proposed method is based on KBE principles.

The proposed parametric modelling method consists of the following steps:

- Identification of the design requirements
- Main drivers analysis
- Determine the HLPs
- Qualitative description of the HLPs
- Mathematical representation of the HLPs
- Define the HLPs for each “total ship” architecture
- Tuning the HLPs to fit the design problem
- Extract and evaluate the geometrical model

The proposed method was applied to the LNGBV. The outcome of the case study was to extract different design variations of the vessel within a completion time of a few minutes (approximately five to ten minutes). The design that C-Job performed, and three more design cases are given and explained. The conclusions based on the case study results are that the generated models are functional and can be encompassed on the C-Job’s design process. Another significant advantage is that since many design variations can be examined the Naval Architect can get a “design feeling” about the impact of the different design decisions.

The present research concluded that the proposed method will improve the established parametric modelling technique based on geometric entities. The core of this statement is that the geometrical representation of the problem is translated into a mathematical representation. This fact enhances the flexibility of the set up of the design problem. As a consequence, different design variations can be assessed within a short time frame. This achievement is essential for the exploration of the preliminary

design phase.

From a design perspective, the primary recommendation for further research is the development of a parametric modelling method for different ship types. Two steps of implementation are recommended. The first one is to address different vessel types with geometrical similarities. The second step is to implement the proposed idea for vessels with significant geometrical differences. Regarding the practical implementation of the proposed framework, it is recommended to build a link with analysis tools. Finally, the development of an optimization framework addressing the decision-making problem is suggested.

Contents

List of Figures	ix
List of Tables	xi
1 Introduction	1
1.1 Problem background	1
1.2 Research Objective	2
1.3 Problem Statement	3
1.4 Layout of the thesis.	3
2 Literature Review	5
2.1 Ship design process	5
2.1.1 Ship design methodologies	5
2.1.2 C-Job's design process	6
2.2 Preliminary design phase	7
2.2.1 Scientific perspective	7
2.2.2 C-Job's perspective	9
2.3 Parametric Modelling in Ship Design	10
2.3.1 Overview	10
2.3.2 Parametric modelling techniques and tools	11
2.3.3 State-of-the-art literature review	11
3 KBE Application in Ship Design	13
3.1 Problem summary	13
3.2 Technical background of KBE	13
3.3 Proposed Method.	16
4 Case Study: the LNG Bunkering Vessel (LNGBV)	19
4.1 Overview of the LNG Bunkering vessel	19
4.1.1 Design aspects of the LNGBV	19
4.1.2 Reference study	20
4.1.3 Rules and regulations	22
4.2 Application of the proposed method to the LNGBV	22
4.2.1 Step 1: Design requirements analysis.	22
4.2.2 Step 2: Main drivers analysis	23
4.2.3 Step 3: Determine the HLPs.	24
4.2.4 Step 4: Qualitative description of the HLPs	25
4.2.5 Step 5: Mathematical description of the HLPs	49
4.2.6 Step 6: Define the HLPs for each total ship architecture	50
4.2.7 Step 7: Tuning the HLPs	51
4.2.8 Step 8: Extract and evaluate the geometrical models	56
5 Evaluation of the Results	63
5.1 Design Variations	63
5.1.1 Design Case 1	63
5.1.2 Design Case 2	65
5.1.3 Design Case 3	67
5.2 Discussion based on the results of the proposed method	68
6 Discussion and Recommendations for Further Research	71
6.1 Thesis Conclusions.	71
6.2 Recommendations for future research	73

Appendices	77
A Interviews of Naval Architects at C-Job	79
A.1 Interview with Kevin Houwaart (03.04.2019)	79
A.2 Interview with Nikos Papapanagiotou (10.04.2019)	80
A.3 Interview with Thijs Muller (3.03.2019)	81
A.4 Interview with Alexander van den Ing (25.04.2019).	82
A.5 Interview with Basjan Faber (16.04.2019).	84
B OOS of the LNGBV	85
C Electric Load Balance Sheet	87
D Equations for the mathematical representation of the HLPs	89
D.1 Engine Room	89
D.2 Technical Spaces	91
D.3 Cargo Space	92
D.4 Superstructure	94
D.5 Bow thruster room	94
D.6 Forepeak	95
D.7 Aftpeak	95
D.8 Afthull	95
D.9 Midhull	95
D.10 Forehull	96
E Tuning of the engine room's machinery components	97
E.1 Diesel Engines	97
E.2 Dual-Fuel (DF) Engines	98
E.3 Gearboxes	100
E.4 Generator Sets	101
E.5 Electric Motors	102
F LNGBV: C-Job's design	103
Bibliography	107

List of Figures

2.1	Design spiral by Harvey Evans (1959)	6
2.2	C-Job's design circle	7
2.3	C-Job's Design Funnel	8
2.4	Design freedom versus committed cost [47]	9
2.5	Design flow in NAPA [48]	10
2.6	TSHD model constructed in NAPA and optimized by the ACD	10
3.1	Schematic representation of the DEE [63]	15
3.2	Different aircraft configurations generated by KBE system with the high level primitive approach [70]	15
3.3	Flowchart of the proposed method	18
4.1	Coral Methane bunkers the cruise vessel Aidanova [21]	20
4.2	SFI main groups for the LNGBV	24
4.3	Diagram of the mechanical propulsion system	27
4.4	Diagram of the electrical propulsion system	27
4.5	Diagram of the hybrid propulsion system	28
4.6	Propulsion systems for LNG carriers [30]	29
4.7	LNG handling system by Wärtsilä [16]	29
4.8	DF/D Engine Direct Mechanical Drive (Layout1)	30
4.9	Electrical Drive (Layout2)	30
4.10	Electrical Drive (Layout3)	30
4.11	Hybrid Drive (Layout4)	31
4.12	Hybrid Drive (Layout5)	32
4.13	LNG carriers cargo tanks [22]	32
4.14	Cargo tank location requirements	33
4.15	Membrane tanks	34
4.17	Cylindrical tanks	35
4.18	Bilobe tanks	35
4.19	Cargo space Layout 1	36
4.20	Cargo space Layout 2	36
4.21	Cargo space Layout 3	37
4.22	Cargo space Layout 4	37
4.23	Cargo space Layout 5	38
4.24	Cargo space Layout 6	38
4.25	Cargo space Layout 7	38
4.27	Different types of BOG handling system [19]	43
4.28	Reliquefaction plant Wärtsilä MarkIII	43
4.29	S-T-S bunkering operation [20]	44
4.31	Hull design variations	47
4.32	Ship curves forehull	48
4.33	Ship curves midhull	48
4.34	Ship curves afthull	49
4.37	MCR regression fitting by using RefWeb's data	54
4.38	MCR regression (revised data set) fitting by using RefWeb's data	54
4.39	LSW prediction by using RefWeb's data	55
4.40	NAPA model of the LNGBV (Reference Case)	59
4.41	Sub-components of the LNGBV model (reference case)	59

5.1	NAPA model of the LNGBV (Design Case 1)	64
5.2	Sub-components of the LNGBV model (Design Case 1)	65
5.3	NAPA model of the LNGBV (Design Case 2)	65
5.4	Sub-components of the LNGBV model (Design Case 2)	66
5.5	NAPA model of the LNGBV (Design Case 3)	68
5.6	Sub-components of the LNGBV model (Design Case 3)	68
B.1	OOS of the LNGBV	86
E.1	Dimensions of the Diesel Engines versus their power output	97
E.2	Regression results Diesel Engines	98
E.3	Dimensions of the DF Engines versus their power output	99
E.4	Regression results DF Engines	100
E.5	Dimensions of the GB versus their power output	101
E.6	Regression results Gearboxes	101
E.7	Dimensions of the Generator sets versus their power output	102
E.8	102
F.1	LNGBV: C-Job's design	104

List of Tables

4.1	Reference study	21
4.2	LGBV functions - LGBV systems	24
4.3	Secondary barrier	33
4.4	Coefficients of semi-empirical formulas for the estimation of C_B [54]	55
4.5	Vessels Characteristics (Reference Case)	58
5.1	Vessel's Characteristics (Design Case 1)	64
5.2	Vessel's Characteristics (Design Case 2)	66
5.3	Vessel's Characteristics (Design Case 3)	67

Introduction

The subject of the present MSc thesis is the development of a parametric modeling method to fit the C-Job's design process. In the present chapter, the reader is introduced to the research problem. Therefore, the problem background and statement are presented. In addition, the research questions are outlined and a detailed description of the research process is given. Finally, the layout of the report is presented.

1.1. Problem background

Nowadays, due to technological advancements, ship design is rapidly evolving, and the designed vessels are characterized by increased complexity. Also, due to the enhanced competitiveness of the shipping industry and the stringent regulatory framework, advanced design solutions need to be developed in short lead-time. Therefore, several design factors should be taken into account and assessed to come to an improved design solution.

Furthermore, new software packages, including packages for the visualization of the vessel and analysis tools, are being released to better adapt to the design needs. At the same time, design companies put effort into exploiting their stored knowledge, which contains data, empirical rules, and human experience in their design process. At a company's level, developing the connection between the stored design knowledge and the state-of-the-art software packages will lead to the improvement of the design process.

Parametric Modelling

Parametric models have been widely researched in product design. Their primary advantage is that they facilitate the exploration of the concept design space and give answers related to essential design decisions. As a consequence, competitive design solutions will be developed in short lead-time. Parametric modelling is an established technique in the design process in the aerospace, automotive, maritime, and architecture sector. According to Papanikolaou [42], the parametric design procedure is associated with the design of a certain object, component or system which will be "automatically" elaborated for each particular set of values of the design variables defined by the designer or the optimization algorithm, based on the use of specifically developed software tools. Parametric models allow the automation of the design process.

Regarding the available literature in parametric modeling, there are several studies conducted with different research goals. The latest research work is the Horizon 2020 European Research project-HOLISHIP- Holistic Optimization of Ship Design and Operation for Life Cycle [56], a joint project of 40 European maritime stakeholders. The project aims to give answers and provide solutions for ship design in the twenty-first century in the form of a new synthesis concept applied in the design process. A detailed study of the use of parametric modeling in ship design is given in Section 2.3.

The available literature focuses on the development of parametric models to be used as an input for optimization. These models are based on geometry. This research separates itself from the other ship-

design literature by proposing a parametric modelling method based on knowledge entities and not in geometric ones. Knowledge Based Engineering (KBE) was decided to be the suitable tool for the development of the parametric modelling method. In short, KBE is defined as the approach of the compilation of knowledge required in a product development process and aims to the identification, record, and re-use of engineering knowledge by combining Artificial Intelligence (AI) techniques, IT tools and Object-Oriented methodologies [70]. Further technical details related to KBE are presented in Section 3.2.

C-Job Background

The present thesis has been conducted in cooperation with C-Job Naval Architects, which is an innovative ship design and engineering company based in the Netherlands, Ukraine, and the United States and operates globally. Regarding the C-Job's design process, NAPA geometric models are constructed according to the design case during the initial and concept design stage. This method has been proved time-consuming and inflexible.

In order to respond to the design challenges, the company has developed in-house frameworks to assist its design processes. Regarding the initial design, the company developed the Refweb, which is a database containing 172,000 vessels. This tool aims to provide the Naval Architect guidelines and trends for the initial design. Furthermore, C-Job has developed the Accelerated Concept Design (ACD), intending to achieve a more broad exploration of the design solutions during the concept design phase. The tool performs the optimization of the design problem by using the Constrained Efficient Global Optimization (CEGO) algorithm. CEGO is a surrogate assisted optimization algorithm that uses Design and Analysis of Computer Experiments to explore and model the design space [33],[34]. In each iteration, a design solution is evaluated, and the process continues until the evaluation budget is exhausted. As a final stage, the Pareto "optimal" solutions are selected. At the moment, the ACD has been tested solely for dredgers. Currently, a NAPA parametric model for dredgers is being used as the input intended to be optimized. Therefore, the next step following the company's needs is to make a connection between these tools in order to be exploited more efficiently.

To summarize, the research challenge of developing a parametric modeling method based on knowledge entities forms the core of the present study. In addition, C-Job's focus can be seen as a part of the aforementioned research field. More specifically, Refweb and other company's knowledge sources will be integrated into the developed parametric modelling framework in order to efficiently exploit the company's stored knowledge. Regarding the ACD, the generated parametric models will be used as an input to be optimized. It should be noted that developing a parametric modelling method forms a vast research topic. Thus, the proposed method was formed for the generic case of a vessel's design; nevertheless the case study was limited to the design of the LNG Bunkering Vessel (LNGBV).

1.2. Research Objective

The research presented in this dissertation aims at the development of a parametric modeling method, which will be used to construct the parametric models in which C-Job is interested. The method should result in efficient, robust, and accurate models that will be used to facilitate the exploration of the preliminary design space. The primary research objective is directly tied to the aforementioned aim. Thus, the primary research objective is the following:

Develop a method that is able to create the parametric models of the LNGBV in which C-Job is interested, in order to facilitate the exploration of the preliminary design space.

The secondary research questions can be categorized regarding the different perspectives that the problem can be analyzed.

Parametric Modelling

- What is the state of the art in parametric design methodologies?

- Which are the main design drivers for the LNGBV and how will these be identified into geometry for the parametric models?
- Is KBE application a suitable way to address the research problem? Which is the most suitable way to develop the knowledge base for the KBE models?

C-Job's Focus

- Will the method result in functional parametric models? Will the method be proven improved in comparison to the established practice?

1.3. Problem Statement

Resuming the aspects discussed in Section 1.1, the development of a parametric modeling methodology to efficiently address the preliminary design phase forms the core of the present MSc thesis. The parametric modeling method will be based on the implementation of KBE.

The following points have been identified as the “key” challenges of the research work:

- the identification of the main drivers for the preliminary design of the LNGBV. The results will lead to the parametrization decisions which in turn, will impact on the parametric models
- the development of a suitable KBE application to address the concept design of the LNGBV.

1.4. Layout of the thesis

Chapter 2: Literature Review

This chapter includes an introduction to the ship design methodologies and the preliminary design phase. In addition, C-Job's design process is stated. Finally, the state-of-the-art of the research in parametric modeling and KBE is presented.

Chapter 3: KBE application in Ship Design

In this chapter, the technical details of KBE are discussed. Furthermore, the steps of the proposed method are analyzed.

Chapter 4: Case study: the LNG Bunkering Vessel (LNGBV)

The proposed method is applied to the LNGBV. Initially, an overview of the LNGBV is given and the design problem is presented. Then, each step of the proposed method is applied and analyzed.

Chapter 5: Evaluation of the Results

A few design variations resulted from the case study are presented and analyzed. In addition, a discussion based on the results of the case study is presented.

Chapter 6: Discussion and Recommendations for Further Research

Finally, key research findings are discussed. Furthermore, suggestions for future research are listed.

2

Literature Review

Design is a one-time process that can add value when we do something differently.

David Andrews

In the present chapter, the reader is introduced to the main elements of the MSc thesis. Firstly, the evolution of the ship design methodologies is reviewed. Similarly, C-Job's design process is presented. Besides, the preliminary design phase is examined. The state-of-the-art parametric modeling approaches is described.

2.1. Ship design process

2.1.1. Ship design methodologies

The ship design process is divided into four different phases, according to Papanikolaou [54]. The phases are described as follows:

1. Concept design; This stage of the process corresponds to a feasibility study of translating the ship owner's requirements into technical characteristics.
2. Preliminary design; This stage corresponds to a more elaborate study of the design steps partly addressed in the concept stage. Main dimensioning is the result of this phase.
3. Contract design; This stage involves all the calculations, naval architectural drawings and the technical specifications of the ship's building in order to proceed with the contract between the shipowner and the yard.
4. Detailed design; The last stage consists of a detailed design of all the structural elements of the vessel, the setup of the technical specifications for the vessel's construction and the fitting of the equipment.

It should be noted that other researchers have proposed distinctions with slight differences. More specifically, the concept and preliminary stage are joined in one design stage called preliminary [35]. For the present thesis, this categorization is followed. In the following lines, the most influential ship design methodologies for the preliminary design phase are presented.

The ship design process is traditionally connected with the design spiral by J. Harvey Evans (1959) (Figure 2.1). The design spiral can be seen as a methodology to calculate and balance the ship design parameters of a vessel by using a sequential and iterative process. However, ship design methodologies have been dramatically evolved in the years past, leading later researchers to challenge previous practices. According to Nowacki [50], the design spiral is incomplete, inflexible, misleading, and thus, an obsolete example of the design process. Similarly, Andrews [24] states that "it would be naive to believe that such a range of complex ship types [...] follow the same design process such that one size fits all"

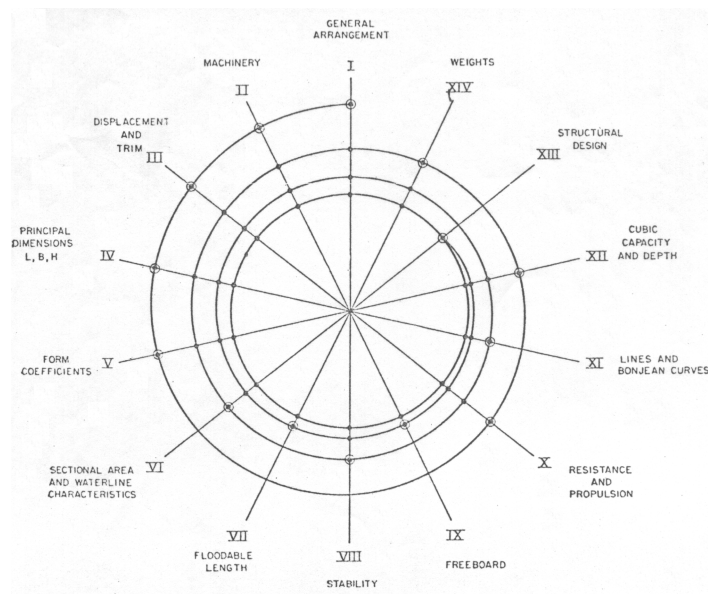

Figure 2.1: Design spiral by Harvey Evans (1959)

A state-of-the-art detailed description of the ship design literature is presented in [59],[68]. It is worth mentioning that writing a deep analysis regarding the ship design methodologies is beyond the scope of the present thesis. However, the most influential approaches will be presented.

Andrews [23] discusses Requirement Elucidation. This approach bases on the fact that constraints related to the design, the design process, and the design environment can have a dominating impact on the design. In addition, Andrews and Pawling [25] introduced an architecturally driven design approach called the UCL Design Building Block (DBB) approach. Regarding the DBB, the design problem is approached in terms of functional requirements. This leads to the definitions of a hierarchy of elements divided into functional groups. These groups consist of building blocks representing components and systems of the vessel. The Design Building Block (DBB) approach originates from the design of naval vessels. Furthermore, Erikstad and Levander presented the System Based Ship Design process, which claims that the starting point for the design process is a set of well-defined requirements. Consequently, the vessel is divided into ship-systems, and by using information from previous similar designs, the main dimensioning is performed. Nowacki [49] followed a systems analysis approach. More specifically, the researcher states that ship design as a form of engineering design is a decision-making process that leads from given requirements to a product definition with all the relevant information for the performance assessment and product of the ship.

Stein Ove Erikstad [37] researched the “design for modularity” concept, according to which the vessel is divided into well-defined sub-components which can later be recombined as stated in given rules and procedures. The significant benefit of the method is that the design becomes flexible in the way that the different parts are recombined and form the final product. This approach can be seen as a lego approach, where the different design solutions result from the rearrangement of the different building blocks. A similar approach has been adopted in system-based design, Design Building Block (DBB) design and the packing approach [69].

2.1.2. C-Job’s design process

The design circle forms the core of C-Job’s design methodology (Figure 2.2). Thus, the design process is a concurrent design process that addresses the following disciplines: motions, floating position, intact

stability, damage stability, strength, weight & cost, space reservation, and resistance. The associated calculations can be performed at a different level of detail. Thus, ship design can be seen as a multi-level and multi-disciplinary design process.

Further details regarding the levels are given below:

- Level 1; Results are based on reference/comparison vessel analysis. Data are taken from C-Job's reference database.
- Level 2; Results are based on multi-regression analysis.
- Level 3; Results are based on simplified simulation analysis such as CFD potential flow analysis.
- Level 4; Results are based on accurate simulated analysis such as CFD viscous flow analysis.

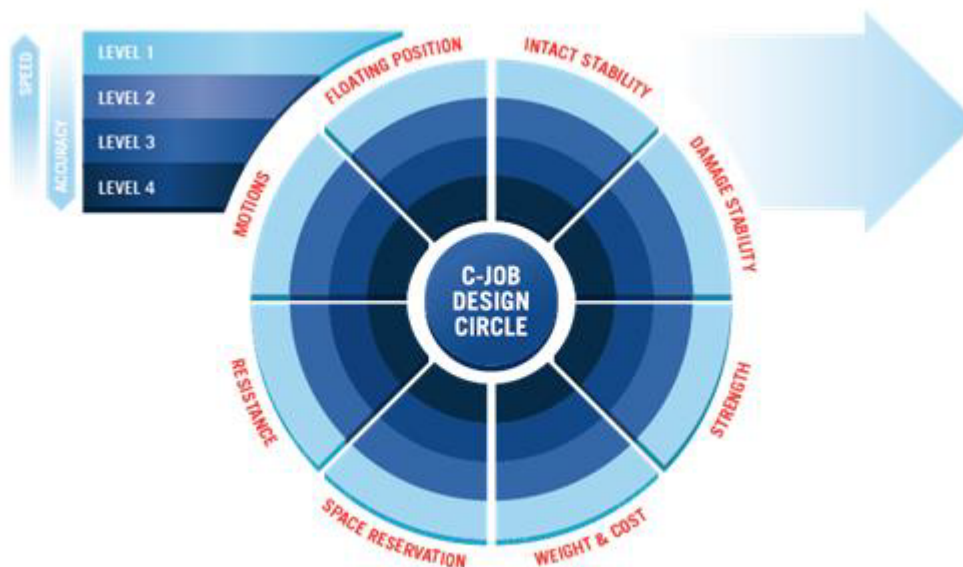

Figure2.2: C-Job's design circle

According to C-Job, the design funnel schematically presents the design phases (Figure 2.3). The design funnel represents the gradual limitation of the design freedom from the preliminary phase to detail design.

2.2. Preliminary design phase

2.2.1. Scientific perspective

There are several definitions regarding the preliminary design phase in the available literature. Their core element consists of the translation of the operational requirements of the vessel into technical characteristics. Indicatively, the systems engineering approach is presented in [44], according to which the principal objective of the preliminary design exploration is to convert the operationally oriented view of the system derived in the requirements analysis into an engineering-oriented view required in the preliminary definition and the subsequent phases of development.

The preliminary design phase plays a crucial role in the overall design process. Andrews [24] deals with the research question why this phase of the ship design has a different motivation of subsequent phases. The researcher concludes that there are five aspects explaining the unique features of this phase. These aspects are the following:

- The process is characterized as a wicked problem; the phase is characterized by several blank sheets of paper and producing as many design concepts as possible to gain insight on performance, cost, time, and risk.

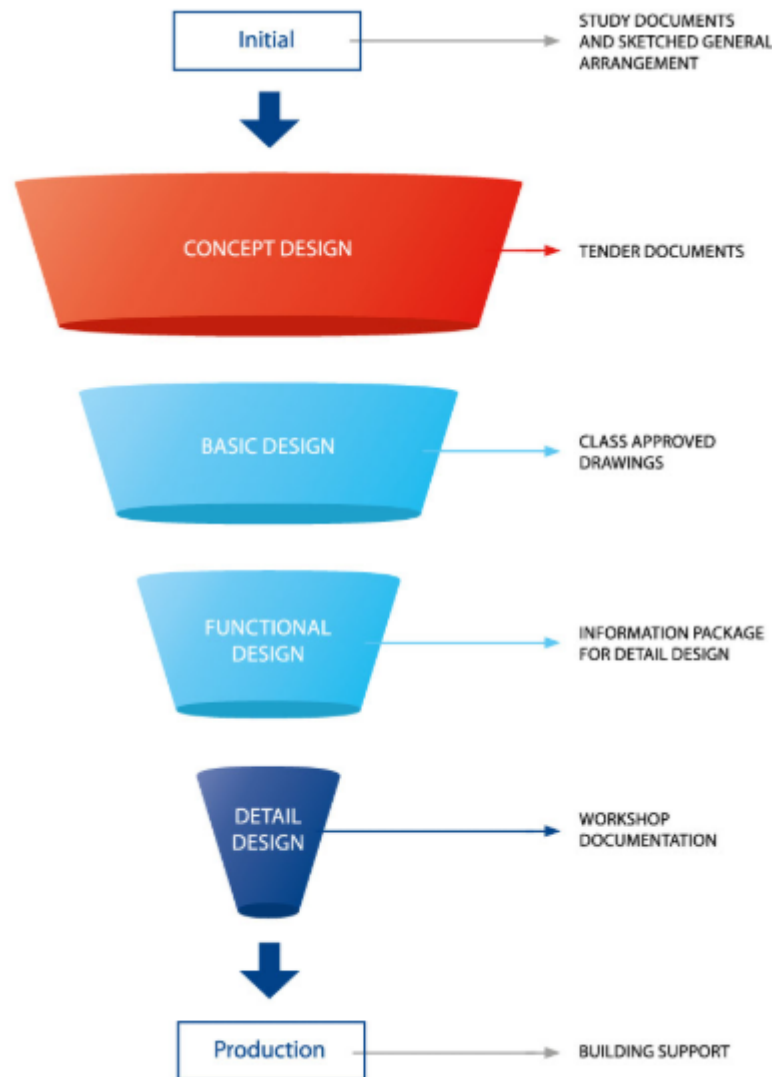

Figure2.3: C-Job's Design Funnel

- During the preliminary design phase, the naval architect should make critical decisions which will determine the final design solution.
- It is essential to perform a comprehensive and challenging design exploration before proceeding with solution-focused trade-off studies.
- The designer has to explore and define many issues of importance for the ship operator; in other words, it is important to explore the “style” of the design concept.
- The final element, which should be considered, is the requirement elucidation (see Section 2.1).

It is estimated that 60% to 80% of the total lifecycle cost is determined at this stage, even though only a small fraction of the total expenses are expended at this stage [59]. In Figure 2.4, the committed cost of the design is compared with the design freedom and problem knowledge during the different phases. During the preliminary design phase, it can be seen that the committed cost rapidly increases while the design freedom decreases, respectively. Thus, the aim of the naval architect is to delay determined costs, have design freedom later in the design process, and gain problem knowledge sooner [41].

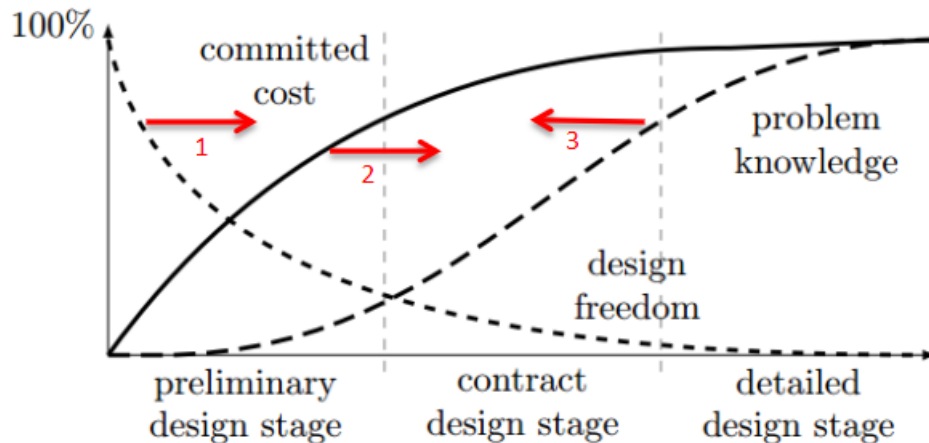

Figure 2.4: Design freedom versus committed cost [47]

The preliminary design phase was investigated in order to understand its specific features in-depth. The present study focuses on developing a parametric modelling method addressing the preliminary design phase. Thus, the parametric models should provide the appropriate answers for the design solution to effectively proceed with the following design phases.

2.2.2. C-Job's perspective

Naval architects at C-Job have identified the challenges associated with the early stages of ship design. Thus, research was conducted to create tools to improve ship design in the early phases. Regarding the concept design phase, Refweb was developed. Refweb is a database containing information for 172,000 vessels; therefore, data-based guidelines and trends can be provided to the Naval Architect. Furthermore, ACD was built to improve the preliminary design phase.

Further technical details about the architecture and functionality of the ACD are given as the ACD is directly tied with the proposed parametric modelling method.

Technical details about the ACD framework

The ACD framework has been built using NAPA software. Thus, every parametric NAPA model is compatible with the ACD framework. Figure 2.5 shows the design flow in NAPA. Thus, after the definition of the hull, the hydrostatic calculations can be performed. As a next step, the user defines the rooms and the compartments by using reference planes. The advantage of the aforementioned method is that the constructed model is flexible. By categorizing the created rooms and assigning functions to them, the associated compartments are formed. The definition of the arrangements leads most of the calculation subsystems, such as the Loading Conditions and the Damage Stability.

The design flow in the ACD framework, which is currently tested and focused on the Trailing Suction Hopper Dredger (TSHD), is as follows:

- As a first step, the design requirements are defined. More specifically, the design parameters are the following: the hopper payload and volume, the overall length, the breadth, the draft and the number of crew. In addition, limits regarding the water depth, the trim and the heel are set.
- As a second step, the hull and room definition is performed. Then, the parametric model is tested for its stability. If the model is not balanced, changes are made in order to proceed with the calculations.
- Regarding the calculations part, the lightship weight is calculated. In addition, the longitudinal center of buoyancy and the center of gravity are calculated. The naval architect defines the

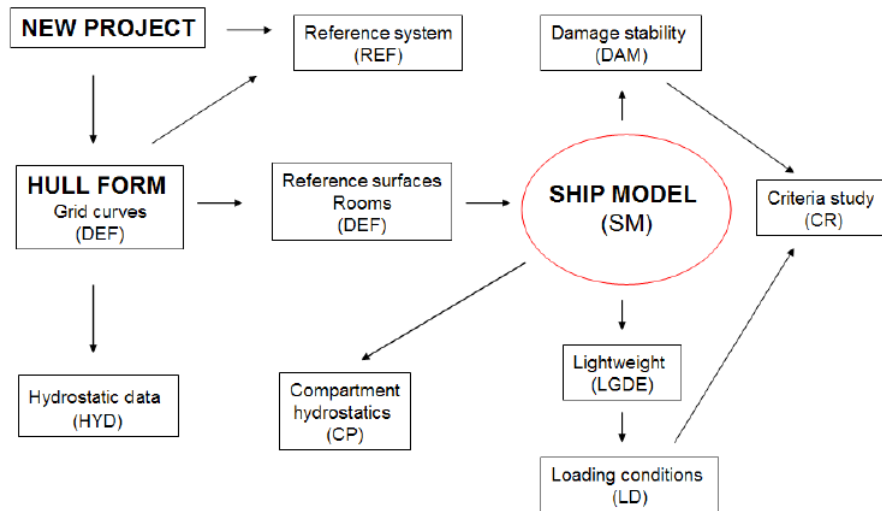

Figure2.5: Design flow in NAPA [48]

loading conditions according to the specific design case, and the relevant calculations are performed. Furthermore, the resistance is estimated via the Holtrop & Mennen method. Following the calculations, the design requirements and constraints are being checked.

- The final subroutine is associated with the optimization. Thus, the optimization problem is formulated and, the optimization solver begins to create and evaluate the different solutions. Further information about the optimization algorithm can be found in [33], [34].

It is worth mentioning that the aforementioned steps form separate calculating loops of the design procedure.

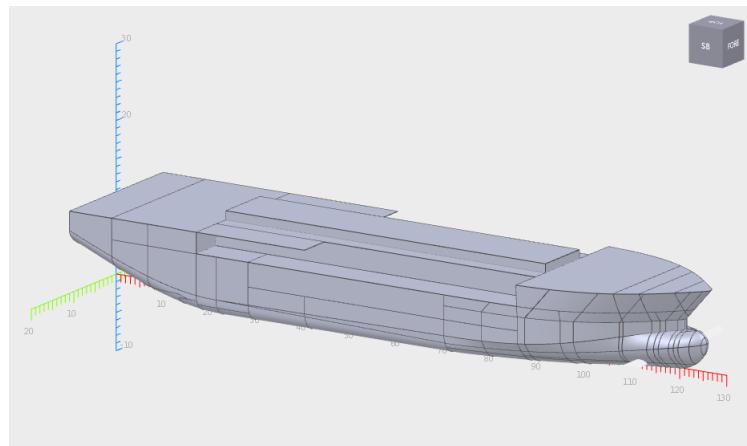

Figure2.6: TSHD model constructed in NAPA and optimized by the ACD

2.3. Parametric Modelling in Ship Design

2.3.1. Overview

This section aims to give a brief overview of the developments in parametric modelling and its modern applications. Engineers use parametric modelling to establish a consistent parametric description of the vessel in the early stages of design, starting from the basic principle that a vessel should be able to perform a given mission efficiently [57]. The parametric models should be flexible and generic in order to apply to many design alternatives [42]. In addition, the parametric model aims to capture the geometry of the vessel with exactly the number of variables that are needed to achieve the desirable global and local design variations, while avoiding unnecessary complexities.

Parametric modelling has been widely researched and applied in product design in many different fields such as aerospace, automotive, architecture, and civil engineering. The significant advantage that the parametric models offer is that they lead to flexible designs that can be evaluated according to needs. Another significant advantage is that by using parametric models as a starting point of the design procedure the leading time, and as a consequence, the cost are decreasing.

2.3.2. Parametric modelling techniques and tools

Initially, D. W. Taylor researched the mathematical functions to represent hull shapes at the beginning of the 20th century. Furthermore, he started to use parameters to generate systematic variations of existing hull forms [51]. A similar approach was developed around 1960s. More specifically, shapes were captured using high order polynomials or conformal mapping techniques [27]. The introduction of B-splines and Non-Uniform Rational B-splines (NURBS) into Naval Architecture simplified the ship design process. This development led parametric modelling becoming more a design task rather than a mathematics challenge.

The dominant curve representations related to ship design are the Bézier curves, the B-splines, and the NURBS. A detailed description of the aforementioned geometric techniques can also be found in [65]. According to Nowacki [49], the advantage of the aforementioned techniques is that the curves can be manipulated by vertex control. Besides, they offer any desired order of piecewise continuity and can be elevated to high polynomial degrees, and as a result, a wide variety of shapes can be created. According to Bole [27], the ease, in which NURBS can be manipulated, maintained them as the dominant method for hull surface design since the 1980s. It is worth mentioning that interest in improving parametric modelling techniques remains. In the study of Guan et al.[40], the research aims on developing a method for parametric design of the hull based on energy optimization.

However, there are only a few commercially available software tools exploiting the capabilities of parametric modelling. The different approaches vary from commercially available ship parametric modelling tools such as FRIENDSHIP-Modeler via integration of parametric capabilities to a well-established ship design system such as NAPA to the parametric definition of shape deformation functions (GMS/Facet) [45]. Regarding the scope of the present thesis, NAPA software will be used for the construction of the parametric models, as this condition forms a limitation regarding the ACD.

The Technical University of Berlin developed the FRIENDSHIP-Modeller since 1995. However it is still being improved to adapt to the current technological challenges. The tool is being successfully used for many industrial applications. The most recent one is the European R&D project HOLISHIP, for which CAESES[®] by Friendship Framework acts as the integration platform for software tools for the design, analysis, and optimization of maritime assets.

The HOLISHIP integration concept was developed in the context of H2020 European Research project HOLISHIP- Holistic optimization of Ship Design and Operation for Life Cycle (2016-2020). The key findings of the project are presented and discussed in [53]. The integration platform aims to incorporate a large number of techno-economical tools in the ship design and optimization procedure. The HOLISHIP design platform is based on CAESES[®]. Thus, different tools associated with hydrodynamic performance, ship stability, and energy systems simulation were integrated into the design platform in a “bottom-up approach”. It is worth mentioning that the project will continue until August 2020 therefore, further developments are expected. The latest results are described in [56].

2.3.3. State-of-the-art literature review

In the maritime sector, parametric modelling dates back to 1970. Early studies in parametric modelling in the ship design literature can be found in [57]. It is worth mentioning that a significant part of the research in parametric modelling is dedicated to the parametrization of the hull. The parametric model of the hull is being used for hydrodynamic optimization. Biliotti et al.[26] conducted research about the automatic optimization of the fore hull forms of a fast frigate. The software used included the Mode-Frontier optimization environment to interface the Friendship Framework (parametric hull definition),

the CFD codes developed by CETENA and a MOGA genetic algorithm. Brizzolara et al.[28] researched the global hull shape optimization problem for a high speed round bilge monohull vessel by using parametric modelling in combination with CFD methods. Furthermore, Full Parametric Approach (FPA) and Free Form Deformation (FFD) were applied to the aforementioned problem and compared. The results showed that FPA led to realistic design solutions whereas FFD produced unrealistic designs. Furthermore, Timur at MIT [65] developed PHull, which is a parametric modelling tool developed in Java programming for rapid hull geometry generation. Finally, a method for parameterization of the three dimensional surface of merchant hulls by using FRIENDSHIP framework was presented in [62].

The undermentioned studies are based on the holistic design approach. Nevertheless, different parametric models were developed for different vessels; the parametric modelling methodology was not investigated in-depth. In the study of Papanikolaou et al.[55], the parametric model of the hull form and internal compartmentation of a double-hull AFRAMAX tanker was constructed. The parametric model was used for optimizing the design according to the following objectives: maximization of the cargo capacity, minimization of the accidental oil-outflow and minimization of the steel weight. The model was constructed in NAPA[®] in cooperation with modeFRONTIER[®] and POSEIDON[®]. Also, Papatreou and Papanikolaou [52] developed a software tool for fast and robust optimization of Small Waterplane Area Twin Hull (SWATH) vessels. The parametric model created for this study aimed to be flexible and predict automatically and accurately a large number of SWATH properties regarding geometry, resistance, and capacity. For the development of the parametric model, Friendship Framework software system was used. Priftis et al.[58] investigated the parameterization and optimization of containerships by using CAESSES-Friendship framework. The methodology applied to a 6,500 TEU containership. In the aforementioned study, indicators such as the Energy Efficiency Design Index (EEDI), the Required Freight Rate (RFR), the zero ballast container box capacity, and the ratio of the above and below deck number of containers, were also parameterized. In the context of SHOPERA project, a series of parametric models have been developed for various types of vessels such as RoPax ships, cruise ships, tankers, bulk carriers, container ships, and general cargo carriers by using CAESSES software by Friendship Framework and NAPA software [42]. Furthermore, Kanellopoulou et al. [42] researched the parametric ship design and optimization of tankers and bulk carriers aiming to identify designs with adequate powering to ensure safe operation in adverse weather conditions while taking into account improving the economy, efficiency and safety of the ship and the environment. Finally, Martzi et al. [46] researched the optimization of a RoPAX vessel using concurrent hydrodynamic and machinery simulation software to improve the design and the operational behavior of the vessel. The optimization performed via the HOLISHIP integration platform. Further details about the HOLISHIP integration platform are given in Section 2.3.2.

Parametric models have also been developed based on the DBB approach. More specifically, in the context of Low Carbon Shipping and Shipping in Changing Climates, the WSH was developed. The model combines a parametric model with the operational profile and a range of performance-enhancing or emissions-reducing technologies [29].

Therefore, engineers are effectively using parametric modelling in a wide variety of applications in the ship design field. Depending on the way of setting up the parametric models, they can reflect different design methodologies and adapt to various design problems.

To sum up, a part of the aforementioned studies focused on the parametrization of the hull to perform hydrodynamic optimization. Another group of researchers developed parametric models of specific vessel types to be used for optimization. There is the last group of studies connected with the development of parametric models based on the DBB approach. By taking into account the information above, the gap in the literature is identified the development of a parametric modelling method based on knowledge blocks. As a suitable approach, it was selected to effectively apply the KBE principles, which have been already applied in the aerospace, automotive and architecture sector, to the ship design. The technical details of KBE are given in the following chapter (Section 3.2).

3

KBE Application in Ship Design

A human is capable to relate different worlds and find an “out-of-the-box” solution. However a computer is never bored and can perform the same routine “endlessly”.

Michael Van Tooren

In the present chapter, the research problem is summarized, and the technical background of KBE is presented. In addition, a detailed description of the proposed method is given.

3.1. Problem summary

The research problem was identified in developing a parametric modelling method for the preliminary ship design based on knowledge blocks instead of geometric entities. As a result, the way of the parametrization should be revised, and a suitable tool was researched. KBE, first developed and applied in the aerospace sector, was selected as a suitable approach to address the research problem. Thus, the research aims to develop a method based on KBE principles. The reasoning for choosing KBE is that it is an already proved advantageous methodology in other sectors (aerospace, automotive, and architecture); however, there is little research transferring the methodology in ship design. The additional challenge associated with ship design is the customization of the vessel according to the requirements.

Furthermore, C-Job aims in continuous improvement of its established methods in the generation of parametric models in the preliminary design phase. Thus, a parametric modelling method based on KBE applies to the company’s design problem. Furthermore, it offers the potential to integrate its in-house developed tools, like the Refweb, and the ACD (Section 2.2.2) to the development of the preliminary designs for the requested vessels. Another significant advantage for the company is that the creation of a “parametric modelling core”, based on the company’s gathered knowledge and design process, will give the potential for further integration of analysis tools. Finally, the “parametric modelling core” will enhance flexibility as the creation of the parametric models will not depend on specific design programs and analysis tools. These can be chosen according to needs in each design case.

3.2. Technical background of KBE

KBE which was developed as part of Knowledge Based Systems (KBSs) in the field of Artificial Intelligence (AI), dates back to 1970s. In the beginning, KBSs had many applications in software applications for solving complex problems by reasoning about facts. Regarding engineering applications, KBSs faced two major limitations, namely the inability for geometry manipulation and data processing [60]. The technological advancements in the field of CAD and CAE systems addressed these limitations, and the concept of KBE began to be widely applied in product design. The definition of KBE was given in Section 1.1.

In order to develop a KBE application, the identification, acquisition, and codification of the relevant knowledge should be performed. The KBE product model represents the core of every KBE application, and it consists of a structured and dynamic network of classes where both product and process knowledge, both geometry-related and non-geometry related are modeled using a broad typology of rules [60]. The KBE product model consists of High Level Primitives (HLPs), which are parametric building blocks incorporating and reusing relevant knowledge. The HLPs can be seen as functional blocks which allow the designer to define a product as a result of a structured set of HLPs. These functional blocks are a set of rules using parameters to initiate objects that represent the product under consideration or to apply an engineering process to the initiated object [64]. Thus, the HLPs can be combined to represent the design solution and analyze its specific properties. The framework of developing the HLPs should provide flexibility to the designer through re-generation by following the designer thoughts of improvement, and the generation of new HLPs to represent new knowledge about the design process. The use of HLPs leads the design process to integrate knowledge primitives instead of geometric model primitives.

Nowadays, the common practice is to use parametric CAD models as the basis to create a vessel's design; therefore, geometric model primitives (points, curves, and surfaces) are combined to construct the parametric models. This approach has the limitation that the parametric relations are not connected with the design requirements and decisions. Thus, different parametric models should be developed for different vessel configurations.

Knowledge is the core element of every KBE model. Knowledge can be defined as relations between facts and becomes central when it comes to reasoning processes [59]. Design supporting knowledge includes the methods and data (presented in forms of handbooks), software for recording analysis (CAD and CFD software) and humans experts[70]. In the context of conceptual ship design, Erikstad's research identifies and classifies the critical categories of knowledge for the conceptual design of vessels [36]. The challenges of the method can be identified in the identification of the knowledge in an organization, its capture, and formalization in reusable rules and the way of embedded them in the KBE system.

KBE can be seen as a powerful tool to address high volatile markets due to the decrease of the leading time and cost for product development. Nowadays, KBE tools are being used by many companies operating in the automotive and aerospace sector. In the aerospace industry, Airbus, Fokker Elmo, Fokker Aerostructures are some examples, to mention but a few. As a result, powerful KBE software tools have been developed. An extended review of the existing KBE application is presented in the research work of Verhagen et al.[71].

It is worth mentioning that KBE has been extensively researched for the preliminary aircraft design. More specifically, the Design and Engineering Engine (DEE), an integrated design support tool, was developed in order to incorporate KBE in the aircraft's conceptual design [70]. The structure of DEE is schematically presented in Figure 3.1. Briefly, the initiator provides a set of feasible starting parameters as an input for the optimization algorithm. The optimized parameters resulted from the optimization are being used as an input for the Multi Model Generator (MMG). The MMG generates the product model and extracts the different files to be used in analysis tools. These tools are testing properties of the suggested design in terms of aerodynamics, structures, and manufacturing. The data collected from the analysis tools lead to a revised form of the objective and constraints of the optimization process. Finally, the convergence of the design solution and the compliance with the design requirements is being done. Further information can be found in [63]. In addition, R.L.A de Jonge [31] shows that in the current MDO framework the MMG can be implemented in different ways to fit better the purpose of the design needs.

Regarding aircraft design, a recent example of KBE application is the ParaPy tool. The unique feature of this tool is that it is built on Python programming language. Thus, the benefit is that a large amount of libraries is available to be incorporated. Also, due to the active Python users community, its capabilities are continuously being expanded.

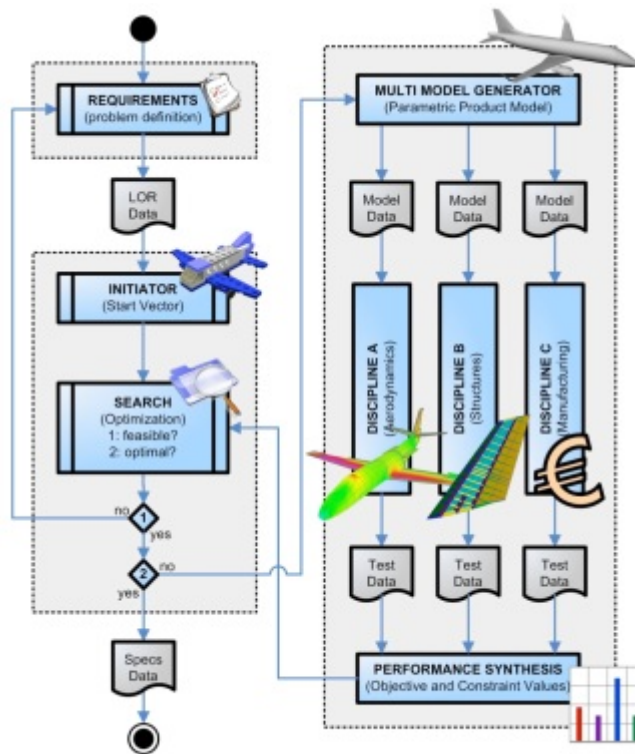

Figure3.1: Schematic representation of the DEE [63]

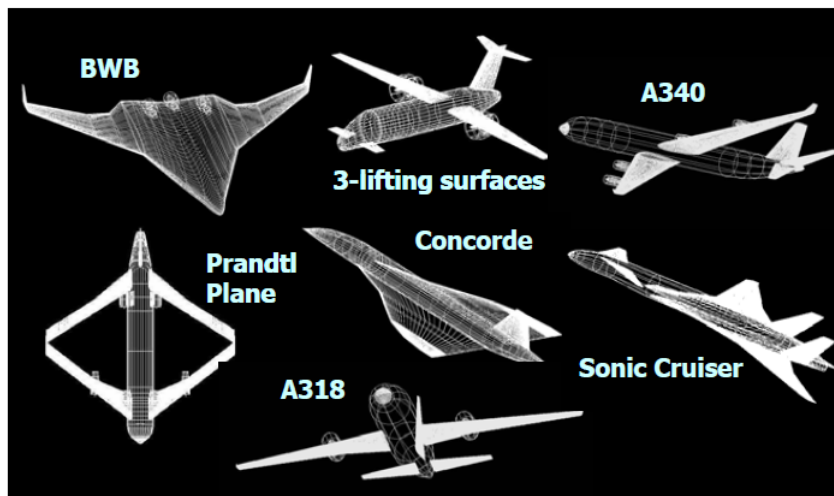

Figure3.2: Different aircraft configurations generated by KBE system with the high level primitive approach [70]

Although ship design is a suitable field for the application of KBE due to its complexity, the applications of KBE in the maritime field are limited due to the high level of customization. The study of Wu and Shaw [73] suggested a basic (preliminary) ship design knowledge-model for information storage and retrieval using KBE and developed a semantic inquiry function that allows users to use the retrieved information immediately. The acquired knowledge was collected from experienced engineers or information from journals and theses. KBE methodology has been also used for ship hull structural member design [74].

The concept of exploiting gained knowledge in ship design forms a part of current scientific research.

The data-driven design developed by Henrique M. Gaspar [38], make use of data regarding both the product (ship) and the process (design) to extract information and knowledge. In addition, Arendt and van Uden developed a decision-making module for enhancing automation in ship design by combining KBSs with AI. The selected method for the creation of the database was the Analytic Hierarchy Process (AHP), which was applied in the selection of the temperature sensors in a fuel transport system.

The KBE model is constructed via Object Oriented Programming (OOP), which gives the possibility to achieve many different configurations according to the design requirements. As it can be seen in Figure 3.2, many different aircraft configurations can be constructed by the KBE approach. The main reasoning for adopting KBE is to automate time-consuming and non creative tasks in order to dispose intellectual sources to creative work. Design optimization can benefit from KBE as there is the potential to create complex models with many different configurations and perform design optimization according to different problems.

3.3. Proposed Method

The flowchart of the proposed method is depicted in Figure 3.3. The method was applied to the design of the LNGBV, and further details are given in Chapter 4. Regarding the vessel's preliminary parametric design, the method consists of the following steps:

1. Identification of the design requirements

The first step of the research procedure is to determine the design requirements, which are dependent on the vessel type and the specific design problem. In general, the design requirements focus on the deadweight, the speed, and the building cost of the vessel. The design requirement correspond to the input variables, which lead to the tuning of the model to fit different design problems.

2. Main drivers analysis

The main drivers analysis is conducted to identify the way that the vessel should be parameterized. By taking into account the idea of KBE, the "building blocks" of the vessel should be determined and translated into HLPs. The main drivers' analysis mainly depends on the vessel type.

3. Determine the HLPs

The third step consists of the determination of the HLPs of the examined vessel. The principles of KBE will be used for the definition and modelling of the HLPs. The developed HLPs form the toolkit, from which different parts can be combined to form the different vessel's alternatives.

4. Qualitative description of the HLPs

The fourth step is associated with the way that the HLPs are modeled. The qualitative description will be the guideline for the mathematical representation. In the context of developing the geometric model of the vessel, space reservation should be ensured.

5. Mathematical representation of the HLPs

The mathematical description of the HLPs is defined based on their qualitative description. Hence, their interrelations are also defined, and thus, the vessel's architecture can be created.

6. Define the HLPs for each "total ship" architecture

The selected HLPs from the vessel's toolkit are combined to form the "total ship" architecture according to the design decisions of the Naval Architect. The total of the different design decision combinations lead to the different solutions in the design space.

7. Tuning the HLPs to fit the design problem

The selected HLPs are being tuned to fit a specific design problem. The design requirements are being used as the guidelines to form a feasible and suitable design solution for the design problem.

8. Extract and evaluate the geometric model

The output of the described framework is the geometric model of the vessel for the Naval Architect to visualize his ideas and use the model as an input for analysis. For the aim of the present study, NAPA software was selected in order to adapt to the company's design needs. However, the method can be expanded to other software packages as well, according to needs. Besides, a first weight and stability analysis based on semi-empirical methods was included to give an idea about the feasibility of the design solution.

The proposed method was formed in a generic form in order to apply to different vessel types and fulfill different design problems. However, in order to bound the research work, a proof of concept was built based on the LNGBV. In addition, the case study was tailor-made for C-Job. In the context of C-Job design tools, all the relevant knowledge was gathered to be used for the building of the HLPs and the tailoring of the case study according to the company's design process. It is worth mentioning that the calculations associated with the HLPs lie on the 1st and 2nd level of detail of the C-Job's design circle (Figure 2.2). The sources of the company's intellectual capital, which were deployed, are the following:

- Interviews from Naval Architects to dive into the company's design process and design way of thinking.
- Datasets of machinery components from manufacturers.
- RefWeb data for initial predictions.
- Empirical method for manoeuvrability assessment.
- Other empirical design rules.

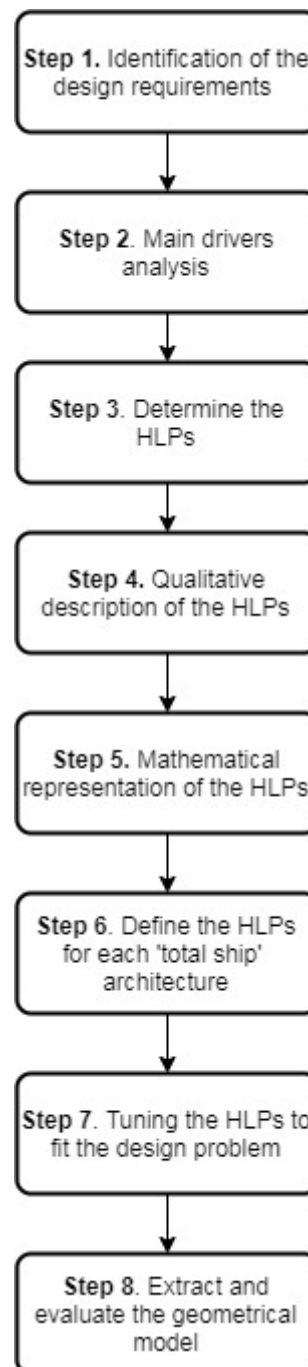
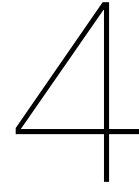

Figure3.3: Flowchart of the proposed method



Case Study: the LNG Bunkering Vessel (LNGBV)

In the present study, the proposed method is applied to the case of the LNGBV. Firstly, an overview of the LNGBV is presented. Afterwards, each step of the proposed method is elaborated for the design of this specific vessel type. Furthermore, a specific C-Job's design case is analyzed, and the results are discussed.

4.1. Overview of the LNG Bunkering vessel

The demand of building LNGBVs is expected to be increased due to the wider adoption of LNG as a marine fuel and the lack of land-based infrastructure. The primary reasoning is that the use of LNG lowers the polluting emissions, and thus, the compliance with the stringent IMO's regulatory framework can be achieved. Nowadays, the LNG propulsion system is a well-proven technology that has around fifty-years of knowledge gathered on its successful implementation throughout the marine industry. The first LNG fuelled oceangoing vessel MV Methane Pioneer was built on 1959. Other benefits of using LNG are its proven competitive cost and the growing bunkering infrastructure. In contrast with other types of alternative fuels, the LNG seems to be the first step to be taken for the transition to a more environmentally friendly maritime industry.

The LNG bunkering infrastructure forms a key point on the establishment of LNG as a marine fuel. However, the Ship-To-Ship (S-T-S) bunkering around the world brings new opportunities as unlike a fixed LNG terminal; it is not dependent on location. In other words, the LNGBV provides refueling services in a flexible way. At the moment, there is a small number of LNGBVs operating worldwide. These vessels are either custom-built, small LNG carriers converted to bunkering vessels, or bunker barges (pushed or self-propelled). Further information is given in Section 4.1.2.

From a design point of view, the LNGBV has similarities with the LNG carrier. However, there are also significant differences, such as their operational profile. In other words, the LNG carrier is an ocean-going vessel transporting cargo worldwide. On the other hand, the LNGBV aims to bunker other vessels; thus, it has less capacity and sails for short distances. Furthermore, the LNGBV's design is challenging due to the fact that there are only a few built vessels and as a consequence, design decisions based on design trends will not be reliable.

By taking into consideration the reasons mentioned above in combination with the fact that C-Job sees potential on this specific vessel type, the LNGBV was considered as an interesting case study to apply the parametric modelling method developed for the present MSc thesis.

4.1.1. Design aspects of the LNGBV

In general, the design, construction, and equipment of the LNGBV are similar to the design of a LNG carrier vessel. Thus, significant components of these vessels are the following: the LNG cargo contain-

ment system, the propulsion system, the Boil-off Gas (BOG) handling system, the inert gas system, the bunkering equipment, the S-T-S equipment, and the superstructure. A unique characteristic of the propulsion unit of the LNG carriers is that the BOG from the cargo can be used in different ways. The most common way is that the BOG is being used as a fuel source for propulsion.

However, a unique feature of the LNGBV is its manoeuvrability capabilities. This fact can be explained from its major function, the bunkering procedure, and the fact that it operates most of the time within ports. Therefore, manoeuvrability is connected with safety as the two vessels involved in the S-T-S bunkering process are subjected to six degrees of freedom and the environmental conditions (wind, tide, and current). Another specific feature of the LNGBV is the large amount of BOG, which should be handled. More specifically, the BOG rate for an LNG carrier varies from 0.1% to 0.15%, whereas for the LNGBV the same percentage varies from 0.2% to 0.6% of their cargo capacity [43]. The increased BOG rate results from the increased surface area of the LNG tanks and the loading and unloading process.

Regarding the general design trends for the LNGBV, the Naval Architects at C-Job state that the length should be minimized to improve manoeuvrability and limit the cost. As a consequence, the beam will be comparatively increased in order to comply with the cargo capacity requirement. Also, the draught should be minimized to improve compatibility with the LNG terminals and ports.

The current trends in the design of the LNGBVs are presented in the reference study (Section 4.1.2).

4.1.2. Reference study

A reference study of the existing LNGBVs was conducted, and the gathered data are presented in Table 4.1.

The data for seven LNGBVs, which have already been built from 2013 to 2018, and two published concept designs were gathered. The first LNGBV was a converted coastal ferry named Seagas. From the data of the existing vessels, it can be seen that the cargo capacity is steadily increasing over the years. Furthermore, the design speed is relatively low and varies from 12.5 to 15 knots; thus, the LNGBVs are considered as slow-speed vessels. In addition, their cargo handling system consists of IMO type C independent LNG tanks. Nevertheless, their propulsion system varies, most of them use BOG as an additional fuel source for propulsion. Finally, the existing designs are either purpose-built bunker vessels, converted LNG carriers (Seagas, Coral Methane), or barge designs such as Clean Jacksonville. It is worth mentioning that non-self propelled barges were not studied in the context of the present thesis.



Figure4.1: Coral Methane bunkers the cruise vessel Aidanova [21]

Table 4.1: Reference study

Vessel	Delivery date	Capacity (m^3)	Speed (knots)	Length (m)	Beam (m)	Draught (m)	Type of tanks	Propulsion	BOG as fuel	Reliquefaction	Reference
Seagas	2013 (retrofit)	170	12.5	49	11.25	3.1	1870-HCB-15-DNV/PED	Diesel Engine Alfa MAN B&W 6L23/30A, 735KW, 828RPM	No	No	[11]
Engie Zeebrugge	2017	5,100	13.1	107.6	18.4	4.8	Two type C cargo tanks (cylindrical)	2x Wärtsilä 9L20DF - 4 stroke 9 cylinder combustion engines 3.330 kW / 4.524 hp at 1.200 rpm	Yes	No	[43],[8]
Cardissa	2017	6,500	-	119.94	19.4	5.8	-	DF Engine, Electric Motor	Yes	Yes	[43]
Coralius	2017	5,800	13.5	99.6	18	5.7	Two Bilobe tanks	DF Engine Wärtsilä W6L34DF B, 3000 kW	Yes	Yes	[12], [43]
Oizmendi	2018 (retrofit)	600	9.3	80	15	4.6	-	Electric Motor	-	-	[4],[43]
Coral Methane	2018 (retrofit)	7,500	13.5	117.8	18.6	6.8	Two IMO type C	Main Engine 2x Roll Royce Bergen KVGB-12G4 diesel generators for 2 electro-motors each 2.380 kW	Yes	Yes	[9], [6],[43]
Kairos	2018 (Ballast free concept))	7,500	-	117	20	4.8	2 IMO type C	Electric Motor 2x 2.380 kW	Yes	No	[7], [43]
Wartsila WSD50 7.5K LNG Carrier	Concept	7,500	13.5	115.1	18.6	5.5	2 IMO type C	4-stroke Wärtsilä DF Main Engine 1 x 3,000 kW 6L34DF 4-stroke Wärtsilä Generating Sets 2 x 1,065 kW 6L20DF	Yes	Optional	[14]
Sener	Concept (AiP by DNV GL)	8,000	15	114.8	20.4	5.7	2 IMO type C	-	-	-	[10]

4.1.3. Rules and regulations

The design of the LNGBV is governed by the International Code of the Construction and Equipment of Ships Carrying Liquefied Gases in Bulk (IGC) Code. Other regulatory frameworks to be taken into account, are the following: International Code of Safety for Ship Using Gases or Other Low-flashpoint Fuels (IGF), Guidelines for systems and installations for supply of LNG as fuel to ships (ISO/TS 18683:2015), International Convention for the Prevention of Pollution from Ship (MARPOL), and the S-T-S transfer guidelines.

Further information about the applicable rules will be given in the relevant sections.

4.2. Application of the proposed method to the LNGBV

In the present section, the proposed method presented in Section 3 is applied step-by-step to the LNGBV.

4.2.1. Step 1: Design requirements analysis

The first aspect which should be examined in a product design problem is its design requirements. In order to research a realistic design problem, the requirements of a C-Job's design project are taken into account. However, solely the significant points are given due to confidential reasons.

The design requirements are listed as follows:

1. The vessel shall comply with all the applicable regulations, codes and standards.
2. The vessel should be specifically designed to interface with small scale and large LNG terminals but also to perform S-T-S bunkering with any type of LNG fueled vessel.
3. The vessels should have high manoeuvrability characteristics and a service speed of 12 knots with a 15% sea margin allowance.
4. The propulsion arrangement will be DF diesel engine with two azimuth or azipod thrusters and one bow thruster.
5. The vessels should also be equipped with a MGO cargo tank with capacity varying between 500 and 750 m^3 .
6. The cargo capacity of the LNGBV will be 7,500 m^3 accommodated in two (2) type C cargo tanks. Bi-lobe or cylindrical Type C tanks may be considered.
7. BOG and / or forced evaporated LNG shall be the supply of gas to the engines. The generator engines shall be compliant to IMO Tier III emission standards when operating in gas mode. An emergency generator fueled by MGO will be available.
8. An LNG reliquefaction plant or sub-cooling system with suitable capacity to be considered with the aim to handle the whole quantity of extra BOG when necessary.
9. An adequate Nitrogen generation plant or liquid Nitrogen storage should be arranged to accommodate all Nitrogen related operations.
10. In the case where a reliquefaction system is not fitted, a GCU or DF thermal oil or steam boiler shall be considered.
11. The LNGBV accommodation structure shall be positioned forward or aft, to be decided by the designer. It shall comply to MLC requirements and accommodate a minimum of 14 persons as normal crew in single cabins.
12. The design of the vessel is to satisfy all stability and sea-keeping criteria and regulations without sea water ballast requirement. A sea water ballast system (transfer system and ballast water tanks) is to be included in the design of the vessel for the purpose of ensuring that cargo operations may be completed without changes on the vessels draught. Trimming requirements to be satisfied by dedicated technical fresh water tanks and transfer system. No ballast water treatment system to be considered.

The design requirements mentioned above lead the Naval Architect to define the technical characteristics of the LNGBV. For the present research work, in order to avoid an inflexible, over-detailed, and over-constrained model, these requirements will be simplified and modified to a generic form.

As a second step, the process of identifying and evaluating the design requirements was further investigated by interviewing Naval Architects at C-Job (Appendix A). The major extracted conclusion from the interviews was that the design drivers are different for each design case. However, similarities can be found within design cases of the same vessel type. Even though the ship designer should address the client's specific requirements in each design case with creativity and fresh design ideas to perform a successful early-stage design.

According to the LNGBV design case, the main design requirements which will be taken into account in the development of the HLPs are the following:

1. The LNG cargo capacity and the LNG cargo handling system layout
2. The required service speed and the propulsion layout.
3. Manoeuvrability characteristics
4. Compliance with the applicable regulations, codes and standards related to the preliminary design stage.
5. The technical systems for the BOG treatment and the inert gas system.
6. The crew accommodation.
7. Ballast water storage.

4.2.2. Step 2: Main drivers analysis

The main drivers analysis aims to identify the vessel's aspects, which will be parameterized. In the present study, the vessel is not examined as an entity. Its fundamental blocks are defined, and the vessel results from their combination. Therefore, the expected outcome of the main drivers analysis is the determination of the vessel's fundamental blocks, which in turn will be translated into HLPs (Step 3).

As a starting point, the LNGBV's functions should be identified and translated into the required systems. The main functions of the vessel are the following:

1. Float
2. Move
3. Manoeuvre
4. Navigate
5. Transport LNG as cargo
6. Conduct bunkering operations
7. Accommodate crew
8. Ensure safety

The next step is to identify the required vessel's systems, which are connected with the functions mentioned above. More specifically, the hull of the vessel ensures that the vessel is floatable. The propulsion system and the thrusters (if azimuth thrusters are selected) are responsible for the sailing of the vessel. The main factors for the vessel's manoeuvrability are the selected propulsion system, the thrusters (azimuth and bow), and the rudder. The LNG cargo handling system should also be included in order to ensure the transportation of the LNG cargo. The bunkering equipment and the ballast water system ensure bunkering operations. Safety is a significant aspect to be taken into account for the design of this vessel's type; therefore, BOG handling system and inert gas system are also included. Finally, the

superstructure and the bridge are included in the design to accommodate the crew and to enable navigation. Further details in these systems are given in Section 4.2.4. Table 4.2 shows the correspondence between the vessel’s functions and the associated vessel’s systems.

	Hull	Propulsion system	Cargo handling system	Bunkering equipment	BOG handling system	Inert gas system	Ballast water system	Thrusters	Rudder	Superstructure	Bridge
Float	✓										
Move		✓						✓			
Manoeuvre		✓						✓	✓		
Navigate											✓
Transportation of LNG cargo			✓								
Bunkering operations				✓			✓				
Accommodate crew										✓	
Ensure safety					✓	✓					

Table4.2: LNGBV functions - LNGBV systems

Therefore, the LNGBV consists of the different systems mentioned above. The identification of the required system forms the basis for the determination of the HLPs (Section 4.2.3). A further categorization of these systems is presented in Figure 4.2.

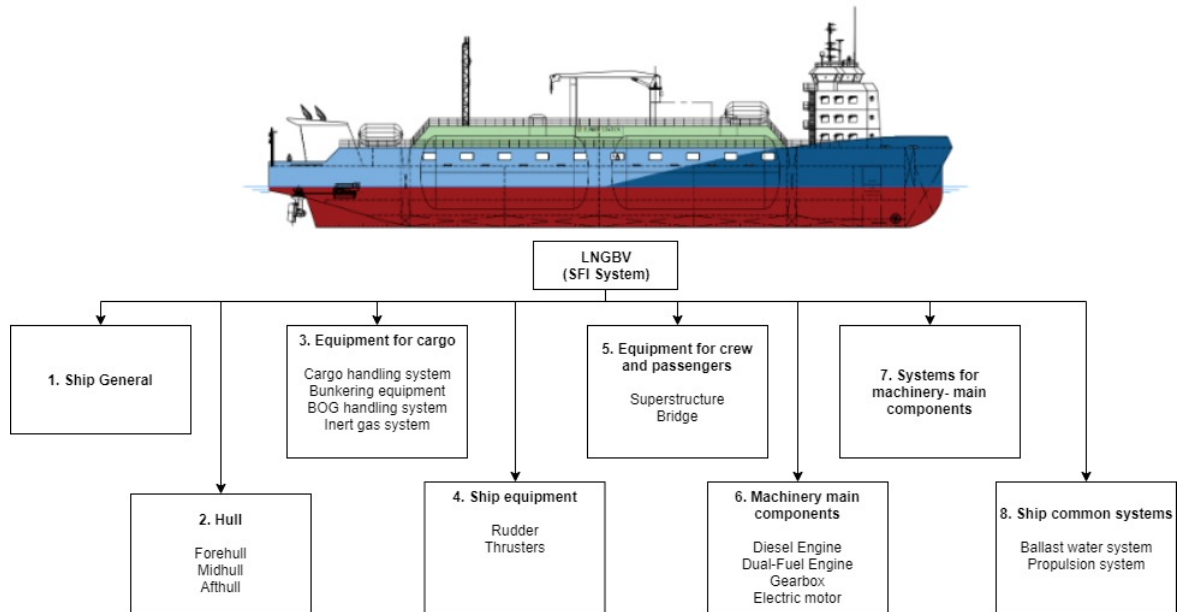

Figure4.2: SFI main groups for the LNGBV

4.2.3. Step 3: Determine the HLPs

Following the main drivers analysis, the HLPs are defined. The required systems resulted from the main drivers analysis are the following: the hull, the propulsion system, the cargo handling system, the bunkering equipment, the BOG handling system, the inert gas system, the ballast water system, the thrusters, the rudder, the superstructure, and the bridge. These systems should be filtered and translated into HLPs by taking into account the properties of the expected outcome, the NAPA geometric model. Therefore, the hull was translated into three different HLPs, namely the afthull, midhull, and forehull. This decision was made in order to enhance the flexibility of generating different hull shapes. Although, for the present thesis, one design variation was developed. The HLP Engine Room

corresponds to the propulsion system of the vessel. Similarly, the HLP Cargo Space is equivalent to the cargo handling system. The inert gas system and the BOG handling system are combined to form the hlp of the Technical Space. The ballast water system results from the vessel's design. Thus, it is not an influential design entity that should be taken into account. The HLP Superstructure contains the superstructure and the bridge. The bunkering equipment, the stern thrusters, and the rudder are not taken into account since these entities do not add information to the geometric model at this design stage. The HLP Bow Thruster Room was developed to accommodate the bow thruster system. Finally, the HLPs Aftpeak and Forepeak were defined for geometrical purposes.

To summarize, the HLPs which will be used for the synthesis of the LNGBV are the following:

- Engine room
- Cargo space
- Superstructure
- Technical space
- Bow thruster space
- Aftpeak space
- Forepeak space
- Afthull part
- Midhull part
- Forehull part

The HLPs were modelled based on OOP principles. The developed Object-Oriented Structure (OOS) can be found in Appendix B. Python programming language was chosen for the development of the HLPs. The reasoning is that Python is a user friendly coding language, which is open source and being supported by an active and growing community of users.

4.2.4. Step 4: Qualitative description of the HLPs

In the present section, the HLPs are qualitatively described. This qualitative description forms the basis for the mathematical description (Step 5).

Engine room

Overview

According to Wärtsilä Encyclopedia of Marine Technology, the engine room is defined as the compartment onboard a ship that includes the main propulsion machinery as well as the control room, the auxiliary machinery, and other equipment. The engine room layout, design, and arrangement is governed by SOLAS- International Convention for the Safety of Life at Sea Ch.II-1 Part C, and IGF code.

According to Klein Woud and Stapersma [72], the following spaces will form the typical layout of the engine room of a small cargo vessel:

- a main machinery space including the propulsion engine, gearbox transmission, diesel generators and auxiliaries
- a steering gear room, which is located above the rudder
- a workshop, in which maintenance is carried out
- a control and/or main switchboard room

Main design drivers for the engine room

Regarding the required level of detail for the preliminary design phase, the following aspects can be seen as the design drivers for the engine room layout:

- type of propulsion
- selected machinery components
- type of propulsor(s)
- required propulsive power
- required electrical power
- requirements for manoeuvrability

Type of propulsion

An extensive analysis of the power plant concepts can be found in [72]. In short, the power plant concepts can be divided into mechanical and electrical concepts.

According to Klein Woud and Stapersma [72], the main drivers for the selection of the power plant are the following:

- Cost parameters (fuel consumption and procurement, installation and operational costs)
- Required space and weight of the installed machinery (power density, engine room layout)
- Required speed under different operating conditions
- Reliability, availability, and maintainability of the machinery and the associated level of redundancy required
- Skills of the crew and the level of automation, control, and monitoring
- Vibrations and associated noise induced in the ship
- Signatures caused by the machinery (an important factor for warships)

The aforementioned aspects are given in order to show the broader picture of the design of the engine room. However, addressing these goes beyond the scope of the present research.

Mechanical concepts are based on the mechanical transmission of energy from the prime mover to the propulsor and the other direct-driven consumers of mechanical energy. There are two types of mechanical drive; namely the direct type and the geared drive. Suitable prime movers for the direct drive is low-speed engines. Conversely, medium- and high-speed engines, gas turbines and steam turbines fit in the geared drive concept.

Briefly, the power plant consists of separate propulsion and electric power systems. The main engine(s) power the propulsion system. The electric plant is powered by auxiliary engines and generators respectively. The mechanical propulsion system is the most widely used in commercial vessels due to its high efficiency. Geertsma et al.[39] list the challenges of using mechanical propulsion and the following should be highlighted for the present study:

- Poor manoeuvrability due to the limited engine's operating envelope. Improvement can be achieved by the use of CPP but remains limited to prevent engine overloading.
- Poor fuel efficiency and high emissions when sailing at speeds below 70% of top speed.
- Poor availability due to the fact that the failure of any of the components in the drive train leads to propulsion loss.

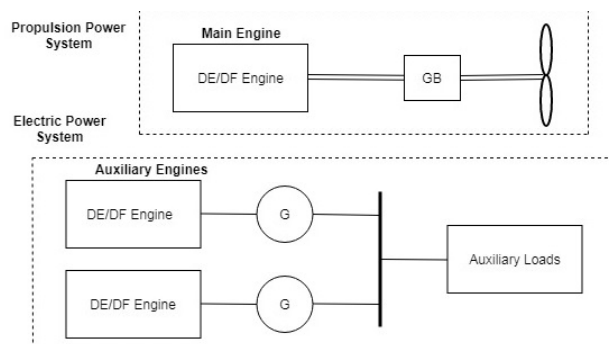

Figure4.3: Diagram of the mechanical propulsion system

Regarding the electrical concepts, a prime mover drives a generator and in turn, the generator power an electric motor through switchboard and converters.

A practical advantage of the electrical concepts is the flexibility of the arrangement of the equipment due to the fact that the prime mover is not mechanically connected to the propulsor. Even though electric propulsion has additional losses of 5% - 15% in the electrical components (generators, power converters, transformers, and electric motors), it is more efficient at low speeds. [39].

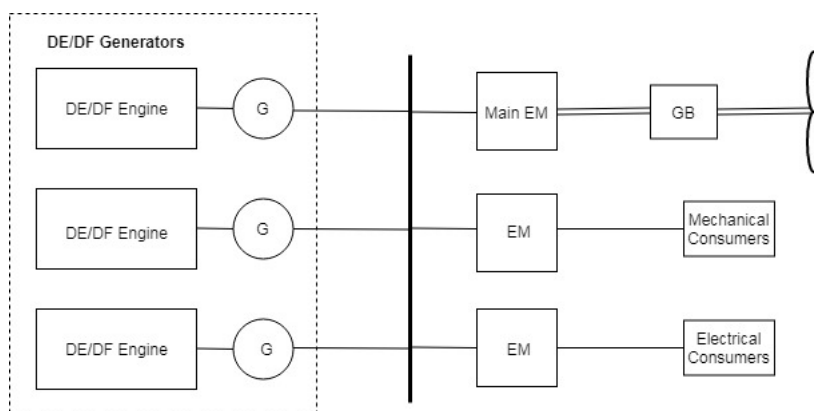

Figure4.4: Diagram of the electrical propulsion system

The hybrid concept consists of a combination of mechanical and electric drives. Regarding the configuration (Figure 4.5), a direct drive provides the propulsion for high speeds, and an electric motor provides propulsion for low speed. Thus, higher efficiency can be achieved in different operating profiles. Hybrid propulsion can have the advantages of both the mechanical and electrical propulsion. However, the careful design of the propulsion system is required.

Propulsors

Regarding the propulsors, the design decision to be made is the propulsors' type. The choice should be determined according to the vessel's operational profile. Other related aspects such as manoeuvrability characteristics, shallow water operation, noise emissions etc. should also be, taken into account. In general, the most commonly used type of propeller is the Fixed Pitch Propeller (FPP). Its primary advantage is that a large diameter slow turning propeller will give the best overall efficiency for a specific design speed. On the other hand, the Controllable Pitch Propeller (CPP) improves the manoeuvrability characteristics of the vessel and has advantages in case of dynamic positioning (bunkering operation). Finally, the azimuth thruster is suitable for applications where high manoeuvrability and dynamic po-

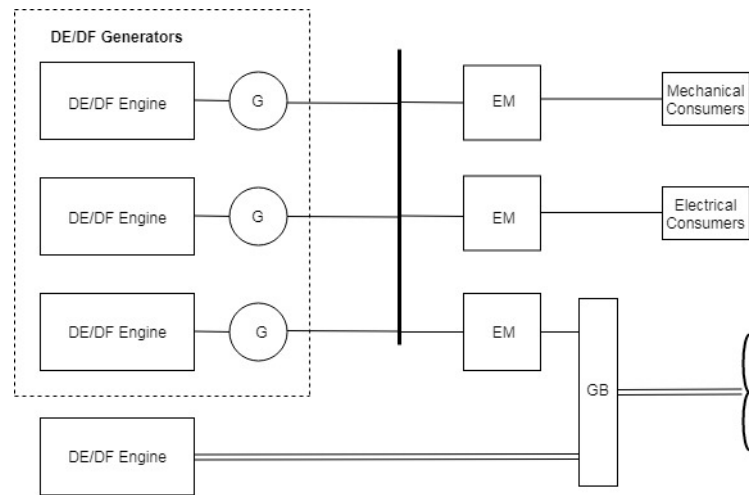

Figure4.5: Diagram of the hybrid propulsion system

sitioning are required.

The different types of propulsors which can be considered for the design of the LNGBV are the following:

- Fixed pitch propeller
- Controllable pitch propeller
- Azimuth thrusters

It is worth mentioning that the propulsor(s) will not be added in the NAPA models as an entity since its/their presence does not affect the initial stability and strength calculations, which are integrated into the ACD. In general, the decisions regarding the propulsor(s) affect the engine room layout and the vessel's manoeuvrability characteristics and the shape of the aft-hull.

LNGBV's engine room

By taking into account the aspects as mentioned above, the engine room layout of the LNGBV will be determined. Besides, it is worth mentioning that the unique features related to the LNGBV's engine room are the disposal of the BOG from the cargo holds and the need for high reliability related to safety issues. In Figure 4.6, the different ways to handle the BOG, either consume it as a fuel or re-liquefy it, are matched with different propulsion systems. In addition, Wärtsilä's LNG handling system is depicted in Figure 4.7 as a characteristic example.

Since the 1960's, the dominant propulsion plant for the LNG carrier was the steam turbine due to its capability to make use of the BOG [66]. However, regarding the present thesis, steam turbines will not be taken into account due to the fact that the steam turbine plant is a large installation. Thus it does not fit the design of the LNGBV. However, DF engines and DF generators will be considered.

By taking into account the aforementioned information, the following engine room layouts will be included in the HLPs "toolkit":

- Layout 1: Diesel / Dual-Fuel (DF) Engine Direct Mechanical Drive

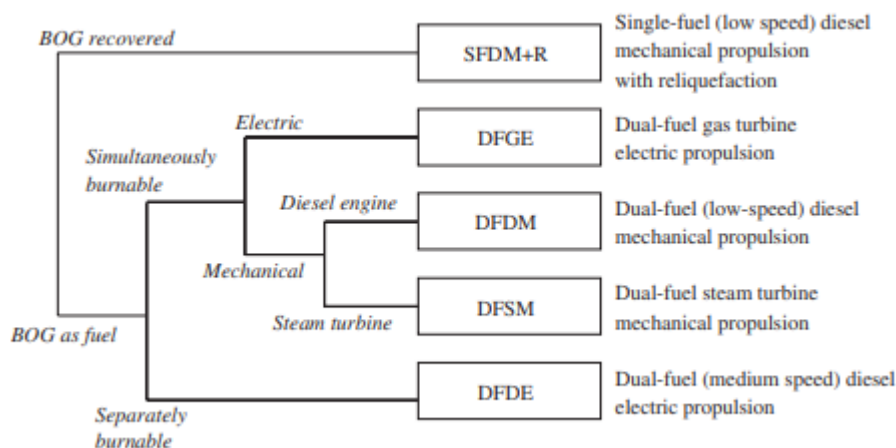

Figure4.6: Propulsion systems for LNG carriers [30]

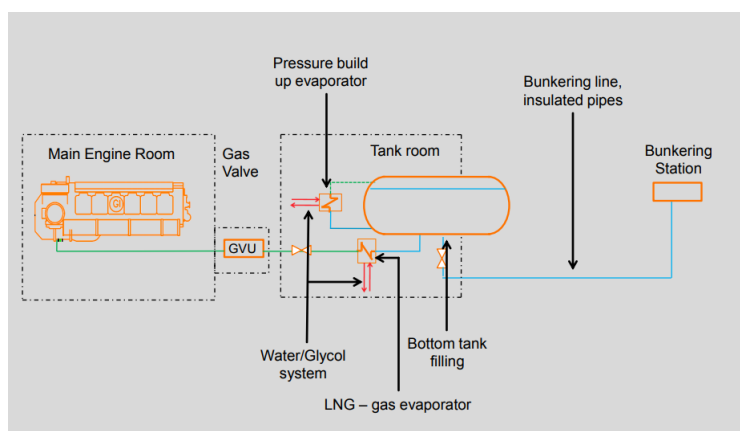

Figure4.7: LNG handling system by Wärtsilä [16]

The depicted layout (Figure 4.8) consists of the following main components: the Diesel / DF Engine(s) providing the propulsion power, the Genset(s) providing electrical power for the consumers, the workshop area, the fuel equipment room and the control room/ main switchboard area. The workshop area and the control room are being used for maintenance and monitoring machinery, respectively. The fuel equipment room is being used to store equipment in order to provide the DF engines with the BOG. The major variable for the estimation of the engine's room volume is the volume of the Diesel / DF Engine(s) and the Genset(s). In order to build a flexible engine room architecture adapting to different design problems and follow the designer's needs and thoughts, the following variables are defined to describe the layout:

1. Type of engines
 2. Type of drive
 3. Nr of engines
 4. Nr of gensets
 5. Nr of gearboxes
- Layout 2: Electrical Drive (1 unit)

The main components of the electrical drive are the GenSet(s), the Electric Motor (EM), the workshop area, and the control and main switchboard room, and the fuel equipment room. For

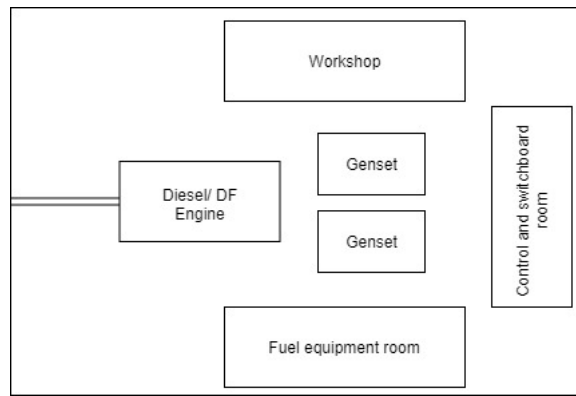

Figure4.8: DF/D Engine Direct Mechanical Drive (Layout1)

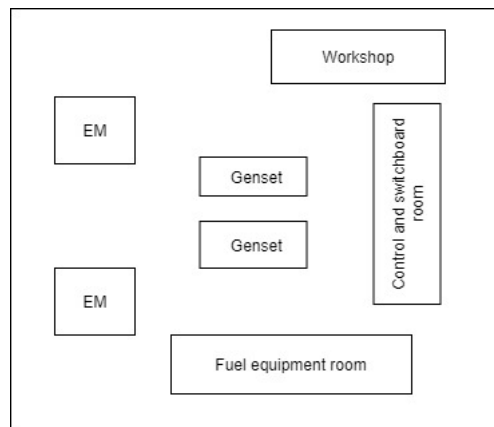

Figure4.9: Electrical Drive (Layout2)

determining the volume of the engine room, the main component to be taken into account is the volume of the GenSets. Regarding this layout, it is worth highlighting that the GenSet(s) are placed in the engine room, located in the aftship. The following variables are used to describe the layout:

1. Nr of GenSets
 2. Nr of Electric Motor (EM)
- Layout 3: Electrical Drive (2 units)

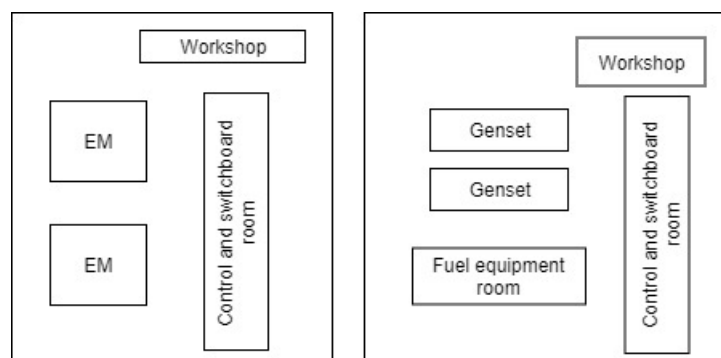

Figure4.10: Electrical Drive (Layout3)

The presented layout is similar to Layout 2. The main difference is associated with the geometrical model. Thus, the GenSets are placed in the forepart of the vessel. This feature enhances the flexibility of the design. However, efficiency is decreasing due to losses on the electrical transmission parts. The variables describing the layout are similar to those related to Layout 2.

- Layout 4: Diesel / Dual-Fuel (DF) Engine Hybrid Drive (1 unit)

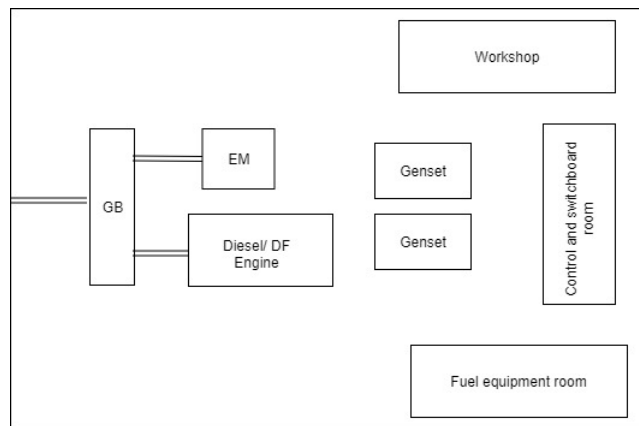

Figure4.11: Hybrid Drive (Layout4)

The shown engine room (Figure 4.11) is associated with the hybrid drive. Its main components are the Diesel/ DF Engine(s) and GenSets, the GB, the em, the workshop area, the control and main switchboard room and the fuel equipment room. The elements which should be considered for the estimation of the engine room volume are the diesel/ DF engine, the GenSets, and the GB. The following variables are used to describe the layout:

1. Type of Engines
 2. Nr of Engines
 3. Nr of GenSets
 4. Nr of Electric Motor (EM)
 5. Nr of GB
- Layout 5: Diesel/ Dual-Fuel (DF) Engine Hybrid Drive (2 units)

Layout 5 is similar to Layout 4. However, its unique feature is connected with the placement of the GenSets in a separate compartment located in the foreship. The variables describing the layout are similar to those related to Layout 4.

Cargo space

The cargo space of the LNGBV consists of the LNG tanks. According to the IGC code, a cargo containment system is the total arrangement for containing cargo including a primary barrier (the cargo tank), a secondary barrier (if fitted), associated thermal insulation, any intervening spaces, and adjacent structure, if necessary, for the support of these elements. In addition, the cargo tanks are categorized into two main types: integral tanks and independent tanks. Independent tanks are self-supporting and do not form part of the ship's hull structure. Thus they have no contribution to the hull strength.

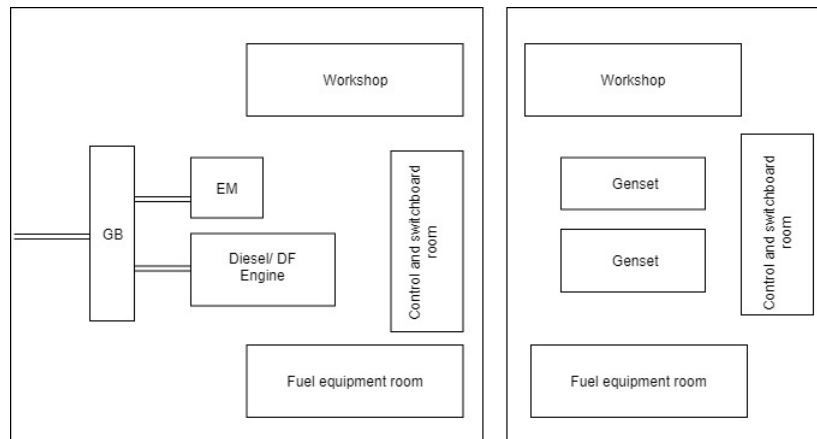

Figure4.12: Hybrid Drive (Layout5)

Scientific information about the independent tanks can be found in [17]. On the other hand, integral tanks are not self-supported cargo tanks surrounded by a double hull ship structure. The main advantage of the membrane tank is its relatively higher utilization of the hull volume for carrying cargo. The different tank types are schematically presented in Figure 4.13.

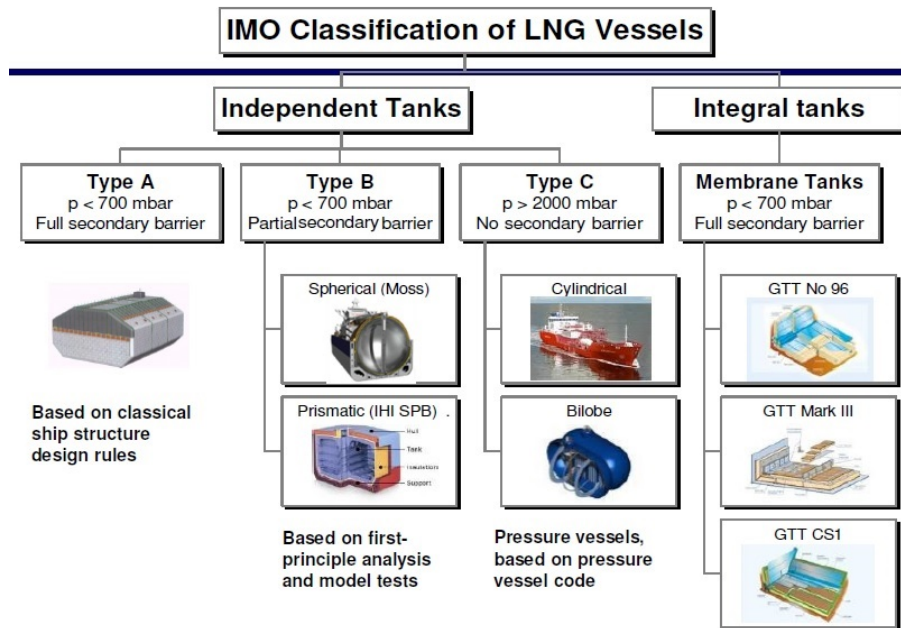

Figure4.13: LNG carriers cargo tanks [22]

Main drivers for the design of the LNG tanks

According to American Bureau of Shipping (ABS), the following key points should be considered in order to select tank type:

- Design pressure
 - Vessel's operational profile
 - BOG handling equipment requirements
- Volume space efficiency (ship's main dimensions)

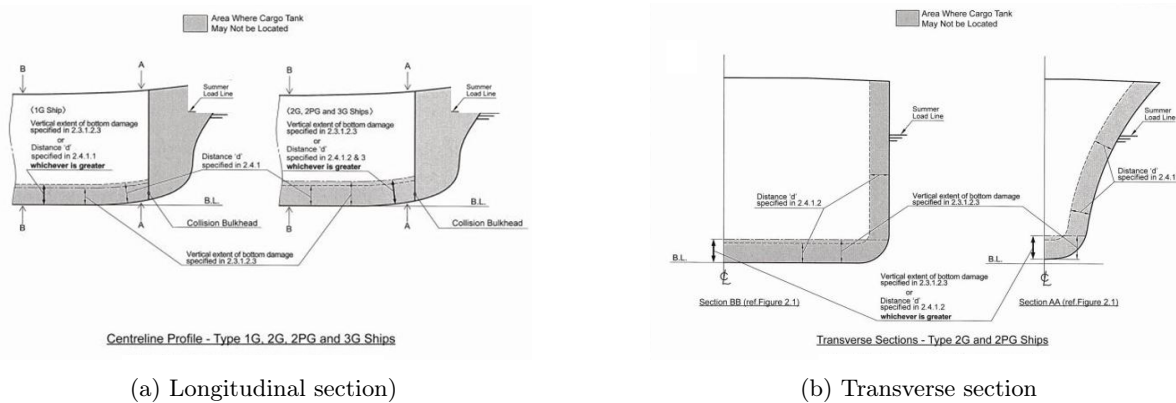

Figure 4.14: Cargo tank location requirements

- Secondary barrier - inerting requirements
 - Additional equipment
 - Operators skills
- Filling limits restrictions (sloshing)
- Loading limits restrictions (design pressure)
- Design and building specialized workforce (availability of shipyards / builders)
- Cost

Regulatory framework

The applicable regulatory framework regarding the cargo space of the LNGBV is the IGC. The LNGBV is considered a 2G ship type according to the IGC code. The IGC rules that apply in the cargo space architecture are the following:

- Cargo tanks shall be located at the following distances inboard: $B/15$ or 2m (whichever is less) from moulded line of bottom shell at centerline not less than the vertical extent of damage specified and nowhere less than $d=0.8m$.
- Secondary barriers in relation to the tank types shall be provided in accordance with the Table 4.3.

Table 4.3: Secondary barrier

Cargo temperature at atmospheric pressure	-10°C and above	Below -10°C down to -55°C	Below -55°C
Basic tank type	No secondary barrier required	Hull may act as secondary barrier	Separate secondary barrier where required
Integral		Tank type not normally allowed ¹	
Membrane		Complete secondary barrier	
Semi-membrane		Complete secondary barrier ²	
Independent:			
-type A		Complete secondary barrier	
-type B		Partial secondary barrier	
-type C		No secondary barrier required	
Note 1: A complete secondary barrier shall normally be required if cargoes with a temperature at atmospheric pressure below -10°C are permitted in accordance with 4.25.1 Note 2: In case of semi-membrane tanks that comply in all respects with the requirements applicable to type B independent tanks, except for the manner of support, the Administration may, after special consideration, accept a partial secondary barrier.			

- Cargo tanks shall not be located forward of the collision bulkhead.
- The default value for the filling limit (FL) of cargo tanks is 98% at the reference temperature.

Main design drivers for the cargo space

The main components of the cargo space of the LNGBV are the LNG tanks. Thus, the major designer's decisions are the following:

1. Type of LNG tanks



(a) Architecture of the membrane tanks [17]

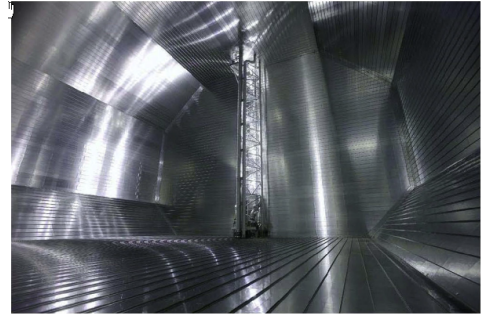

(b) Inner part membrane tanks [17]

Figure4.15: Membrane tanks

2. Nr of LNG tanks

Regarding the type of LNG tanks, at the present stage of the MSc thesis, membrane, “Type A” and “Type C” LNG tanks will be researched. Thus, “Type B” will be excluded. The reasoning is that to research and understand the research problem in-depth, it should be bounded by limiting the available options. In addition, from the reference study (Section 4.1.2) it was concluded that the majority of the LNGBVs have “Type C” LNG tanks, which are the most suitable containment system for the current cargo capacity of these vessels.

The membrane tanks are non-self-supported cargo tanks surrounded by a complete double hull ship structure. The membrane containment tanks consist of a thin layer of metal (primary barrier), insulation, secondary membrane barrier, and further insulation in a sandwich construction [17]. The architecture of the membrane tanks is depicted in Figure 4.15.

In addition, “Type A” tanks are non-pressurized independent tanks which employ a prismatic design and full secondary barrier. Their architecture is shown in a cross-section drawing in Figure 4.16. Their significant advantage is their high volumetric efficiency. Thus, “Type A” tanks are well suited to the design of the LNGBV.

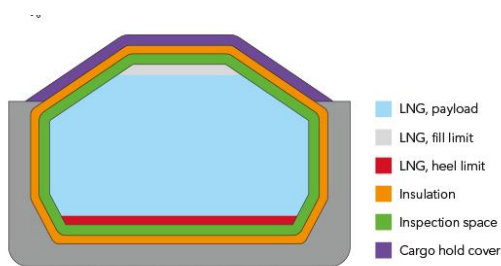

(a) Architecture of the “Type A” tanks [67]

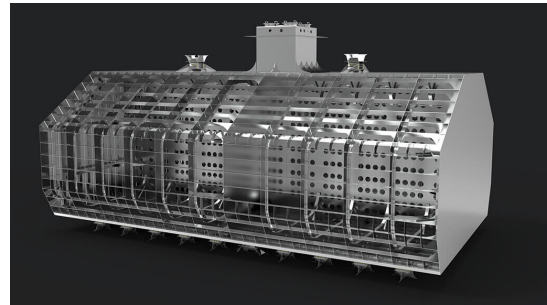

(b) “Type A” tanks [13]

Figure4.16: “Type A” tanks

Although the structural characteristics of the membrane and “Type A” tanks are different, their design with respect to geometry is quite similar. Thus, for the level of detail that is needed for the concept design, their design will be considered similar. For the membrane and “Type A” tanks, one configuration was modeled based on 1 membrane/“Type A” tank (1 cargo hold).

Regarding the “Type C” tanks, two different types will be considered, namely the cylindrical and the bilobe LNG tanks. The main parts of the cylindrical tank are shown in Figure 4.17. Three different layouts were modelled by using as the basic building block the cylindrical tanks. These layouts are the

following: 1 cylindrical tank (1 cargo hold), 2 cylindrical tanks (2 cargo holds), and 4 cylindrical tanks (2 cargo holds). Besides the layout of the bilobe tank is presented in Figure 4.18. Regarding the bilobe tank, the following configurations were taken into consideration: 1 bilobe tank (1 cargo hold), 2 bilobe tanks (2 cargo holds), and 3 bilobe tanks (3 cargo holds).

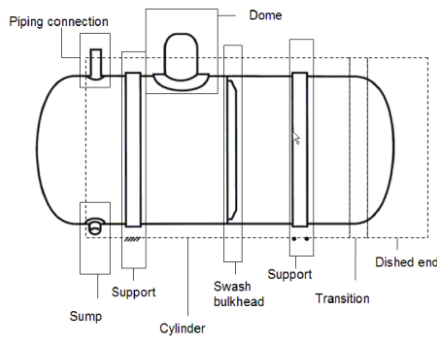

(a) Division of a type C LNG tank [18]



(b) LNG cylindrical tank [3]

Figure4.17: Cylindrical tanks

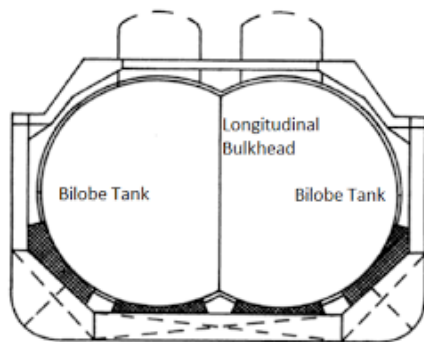

(a) Architecture of the bilobe tanks [1]



(b) Bilobe tanks (largest tanks in 2013) built at Chinas Sinopacific yard [2]

Figure4.18: Bilobe tanks

By taking into consideration the aforementioned information, the following space layouts will be included in the HLPs “toolkit”:

- Layout 1: 1 Membrane/“Type A” Tank (1 Cargo Hold)

The variables which are adopted in order to define the layout are the following:

1. Length of the LNG tank
2. Width of the LNG tank
3. Height of the LNG tank
4. Filling ratio
5. Thickness of the insulation

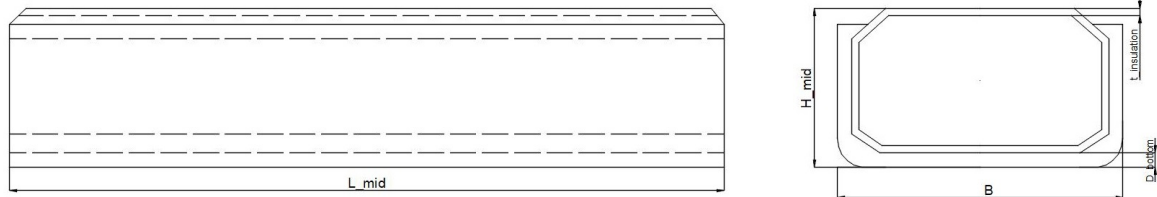

Figure4.19: Cargo space Layout 1

- Layout 2: 1 Cylindrical Tank (1 Cargo Hold)

The variables used to describe the layout are the following:

1. Length of the LNG tank
2. Diameter of the LNG tank
3. Ratio Length/Diameter
4. Filling ratio
5. Thickness of the insulation
6. Distance from the LNG tank to the other surfaces of the cargo space

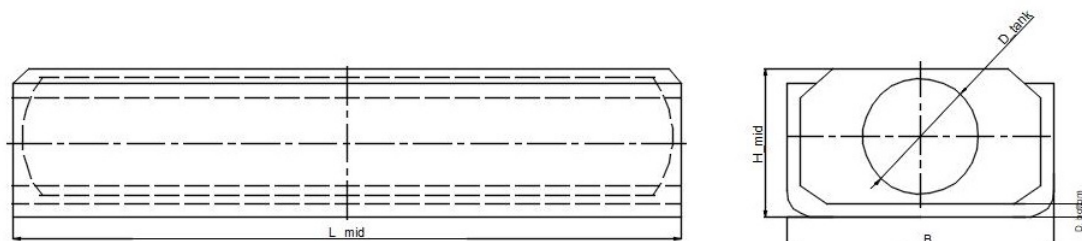

Figure4.20: Cargo space Layout 2

- Layout 3: 2 Cylindrical Tanks (2 Cargo Holds)

The variables used to describe the layout are the following:

1. Length of the LNG tank
2. Diameter of the LNG tank
3. Ratio Length/Diameter
4. Filling ratio
5. Thickness of the insulation
6. Distance from the LNG tank to the other surfaces of the cargo space
7. Thickness of the cofferdam

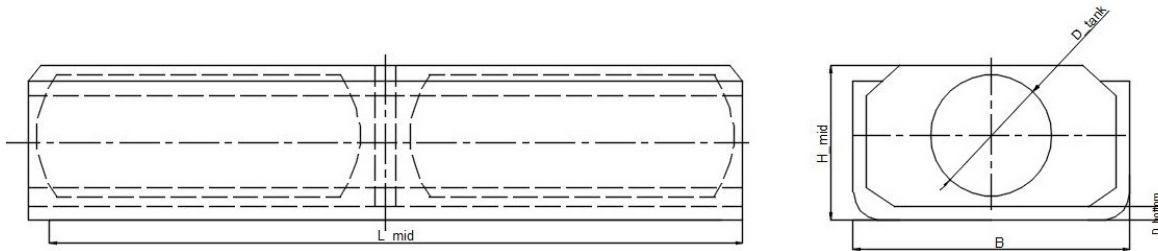

Figure4.21: Cargo space Layout 3

- Layout 4: 4 Cylindrical Tanks (2 Cargo Holds)

The variables used to describe the layout are the following:

1. Length of the LNG tank
2. Diameter of the LNG tank
3. Ratio Length/Diameter
4. Filling ratio
5. Thickness of the insulation
6. Distance from the LNG tank to the other surfaces of the cargo space
7. Distance from the surface of the one tank to the surface of the other in the cargo hold
8. Thickness of the cofferdam

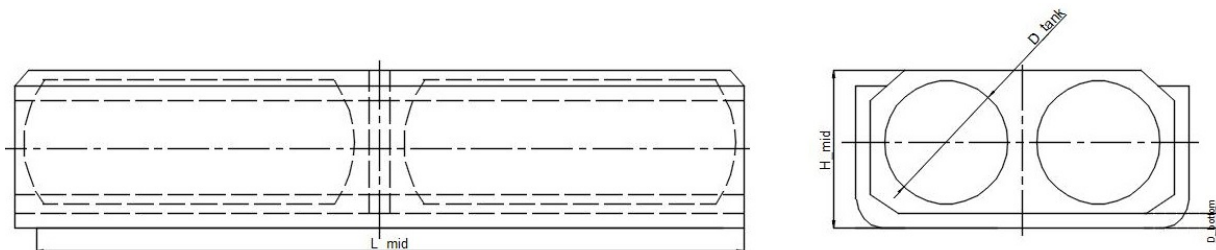

Figure4.22: Cargo space Layout 4

- Layout 5: 1 Bilobe Tank (1 Cargo Hold)

The variables used to describe the layout are the following:

1. Length of the LNG tank
2. Diameter of the LNG tank
3. Ratio Length/Diameter
4. Reduction coefficient (reduced cross-section area by taking as reference the cross-section area of two circles)
5. Filling ratio
6. Thickness of the insulation
7. Distance from the LNG tank to the other surfaces of the cargo space

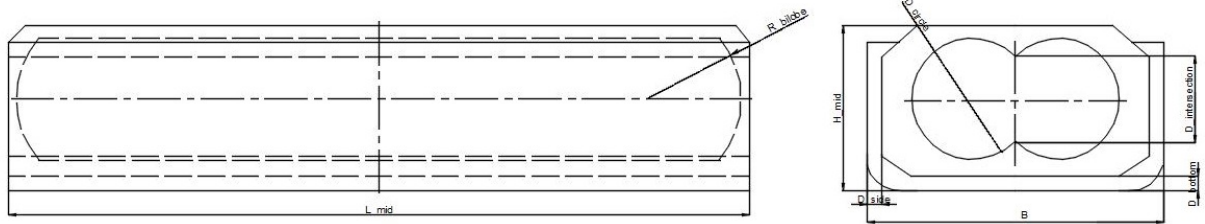

Figure4.23: Cargo space Layout 5

- Layout 6: 2 Bilobe Tanks (2 Cargo Holds)

The variables used to describe the layout are the following:

1. Length of the LNG tank
2. Diameter of the LNG tank
3. Ratio Length/Diameter
4. Reduction coefficient (reduced cross-section area by taking as reference the cross-section area of two circles)
5. Filling ratio
6. Thickness of the insulation
7. Distance from the LNG tank to the other surfaces of the cargo space
8. Thickness of the cofferdam

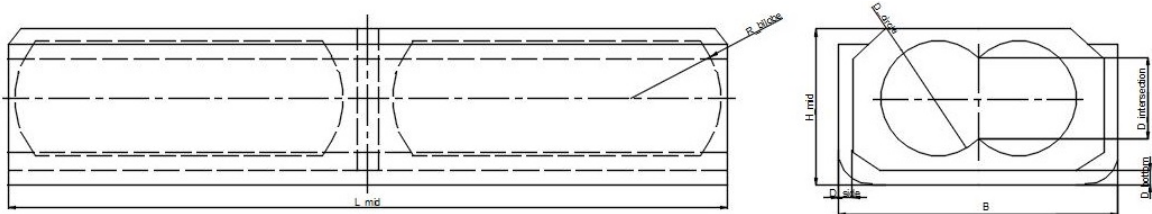

Figure4.24: Cargo space Layout 6

- Layout 7: 3 Bilobe Tanks (3 Cargo Holds)

The variables to describe the layout are similar to those used for the definition of Layout 6.

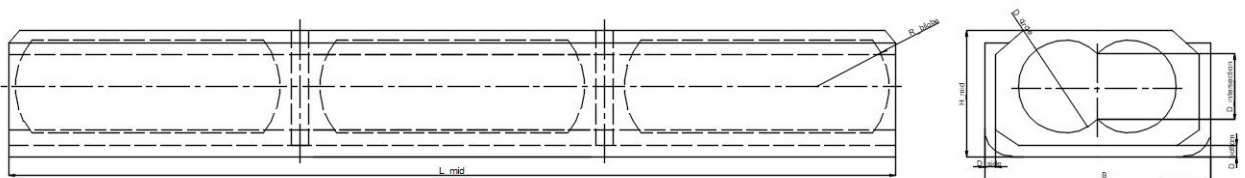

Figure4.25: Cargo space Layout 7

Superstructure

Overview

According to Wärtsilä Encyclopedia of Marine Technology, the superstructure is defined as a decked structure on the freeboard deck extending from side to side or with the side plating not inboard of the

shell plating more than 3% of the breadth (B). A superstructure may be a poop, a raised quarterdeck, a bridge, a forecastle or a full superstructure.

The spaces which should be located in the superstructure are the hotel-related rooms, the mission-related rooms and the bridge.

The hotel-related rooms which should be located in the superstructure are the following:

- Cabins
- Galley
- Mesh
- Sanitary facilities
- Storage

The mission-related rooms which should be located in the superstructure are the following:

- Cargo control room

The bridge is the area from which the navigation and ship control is exercised, including the wheelhouse and bridge wings (Wärtsilä Encyclopedia of Marine Technology).

A typical crew configuration for a LNGBV is considered as follows:

- 1 Master; Overall in charge of the vessel.
- 1 Cargo Officer; In charge of the cargo plant.
- 1 Chief Engineer; In charge of the engine department.
- 1 Second Engineer; Assistant of the Chief Engineer.
- 1 Engineering Officer; Assists with running the engineering plant and auxiliary equipment.
- 4 Deck Ratings; Assist in maintaining deck, lifesaving and cargo equipment and running cargo operations.
- 3 Engine Ratings; Assist in maintaining engineering equipment and running engineering operations.
- 1 Chief Cook; In charge of the galley, stores, and preparation of food for the crew.
- 1 Assistant; Assists the Chief Cook.

It is worth mentioning that the crew size is directly tied to the functions of the vessel. Thus, changing dimensions will not impact the crew size regarding the needed level of detail. The crew configuration, as mentioned above, will be taken into account in order to dimension the superstructure in a default way. However, in order to enhance the flexibility of the design regarding sizing, the number of the crew is treated as a variable.

Main design drivers for the superstructure

The decision variables for the the design of the superstructure are the following:

1. Nr of high-ranked crew
2. Nr of low-ranked crew
3. Type of cabins
4. Position

Regulatory framework

The design of the required spaces of the superstructure is governed by the rules specified in Maritime Labour Convention (MLC) [2006]. More specifically, the applicable rules are the following:

- The competent authority shall pay particular attention to ensuring implementation of the requirements of this Convention relating to:
 - the size of rooms and other accommodation spaces;
 - heating and ventilation;
 - noise and vibration and other ambient factors;
 - sanitary facilities;
 - lighting; and
 - hospital accommodation.
- With respect to general requirements for accommodation:
 - there shall be adequate headroom in all seafarer accommodation; the minimum permitted headroom in all seafarer accommodation where full and free movement is necessary shall be not less than 203 centimetres; the competent authority may permit some limited reduction in headroom in any space, or part of any space, in such accommodation where it is satisfied that such reduction:
 - ◊ is reasonable; and
 - ◊ will not result in discomfort to the seafarers;
 - in ships other than passenger ships, as defined in Regulation 2(e) and (f) of the International Convention for the Safety of Life at Sea, 1974, as amended (the SOLAS), sleeping rooms shall be situated above the load line amidships or aft, except that in exceptional cases, where the size, type or intended service of the ship renders any other location impracticable, sleeping rooms may be located in the fore part of the ship, but in no case forward of the collision bulkhead;
- When sleeping accommodation on board ships is required, the following requirements for sleeping rooms apply:
 - in ships other than passenger ships, an individual sleeping room shall be provided for each seafarer; in the case of ships of less than 3,000 gross tonnage or special purpose ships, exemptions from this requirement may be granted by the competent authority after consultation with the shipowners and seafarers organizations concerned
 - separate sleeping rooms shall be provided for men and for women;
 - sleeping rooms shall be of adequate size and properly equipped so as to ensure reasonable comfort and to facilitate tidiness;
 - a separate berth for each seafarer shall in all circumstances be provided;
 - the minimum inside dimensions of a berth shall be at least 198 centimetres by 80 centimetres;
 - in single berth seafarers sleeping rooms the floor area shall not be less than:
 - ◊ 4.5 square metres in ships of less than 3,000 gross tonnage;
 - ◊ 5.5 square metres in ships of 3,000 gross tonnage or over but less than 10,000 gross tonnage;
 - ◊ 7 square metres in ships of 10,000 gross tonnage or over;
 - in ships of less than 3,000 gross tonnage other than passenger ships and special purpose ships, sleeping rooms may be occupied by a maximum of two seafarers; the floor area of such sleeping rooms shall not be less than 7 square metres;
 - on ships other than passenger ships and special purpose ships, sleeping rooms for seafarers who perform the duties of ships officers, where no private sitting room or day room is provided, the floor area per person shall not be less than:

- ◊ 7.5 square metres in ships of less than 3,000 gross tonnage;
- ◊ 8.5 square metres in ships of 3,000 gross tonnage or over but less than 10,000 gross tonnage;
- ◊ 10 square metres in ships of 10,000 gross tonnage or over;
- the master, the chief engineer and the chief navigating officer shall have, in addition to their sleeping rooms, an adjoining sitting room, day room or equivalent additional space; ships of less than 3,000 gross tonnage may be exempted by the competent authority from this requirement after consultation with the shipowners and seafarers organizations concerned;
- for each occupant, the furniture shall include a clothes locker of ample space (minimum 475 litres) and a drawer or equivalent space of not less than 56 litres; if the drawer is incorporated in the clothes locker then the combined minimum volume of the clothes locker shall be 500 litres; it shall be fitted with a shelf and be able to be locked by the occupant so as to ensure privacy;
- each sleeping room shall be provided with a table or desk, which may be of the fixed, drop-leaf or slide-out type, and with comfortable seating accommodation as necessary.
- With respect to requirements for hospital accommodation, ships carrying 15 or more seafarers and engaged in a voyage of more than three days duration shall provide separate hospital accommodation to be used exclusively for medical purposes; the competent authority may relax this requirement for ships engaged in coastal trade; in approving on-board hospital accommodation, the competent authority shall ensure that the accommodation will, in all weathers, be easy of access, provide comfortable housing for the occupants and be conducive to their receiving prompt and proper attention.
- Appropriately situated and furnished laundry facilities shall be available.

Regarding the bridge visibility, the following SOLAS, Ch-II-Reg.22 requirements are applicable:

- The view of the sea surface from the conning position shall not be obscured by more than two ship lengths, or 500 m, whichever is the less, forward of the bow to 10° on either side under all conditions of draught, trim and deck cargo;
- No blind sector, caused by cargo, cargo gear or other obstructions outside of the wheelhouse forward of the beam which obstructs the view of the sea surface as seen from the conning position, shall exceed 10°. The total arc of blind sectors shall not exceed 20°. The clear sectors between blind sectors shall be at least 5°. However, in the view described in .1, each individual blind sector shall not exceed 5°;
- The horizontal field of vision from the conning position shall extend over an arc of not less than 225°, that is from right ahead to not less than 22.5° abaft the beam on either side of the ship;
- From each bridge wing the horizontal field of vision shall extend over an arc at least 225°, that is from at least 45° on the opposite bow through right ahead and then from right ahead to right astern through 180° on the same side of the ship;
- From the main steering position, the horizontal field of vision shall extend over an arc from right ahead to at least 60° on each side of the ship;
- The upper edge of the navigation bridge front windows shall allow a forward view of the horizon, for a person with a height of eye of 1,800 mm above the bridge deck at the conning position, when the ship is pitching in heavy seas. The Administration, if satisfied that a 1,800 mm height of eye is unreasonable and impractical, may allow reduction of the height of eye but not to less than 1,600 mm;

LNGBV's superstructure layout

A detailed design of the general arrangement of the superstructure is beyond the scope of the present research work. Therefore, the sizing of the superstructure aims to ensure the required floor area for

the placement of the arrangements. In order to enhance flexibility, each layer of the superstructure was modelled individually. Thus, the combination of these layers forms the superstructure (Figure 4.26).

The variables to describe the layout of the superstructure are the following:

1. Length of each Layer
2. Width of each Layer
3. Height of each Layer
4. Nr of Layers
5. Positioning of each Layer in comparison with a reference Layer

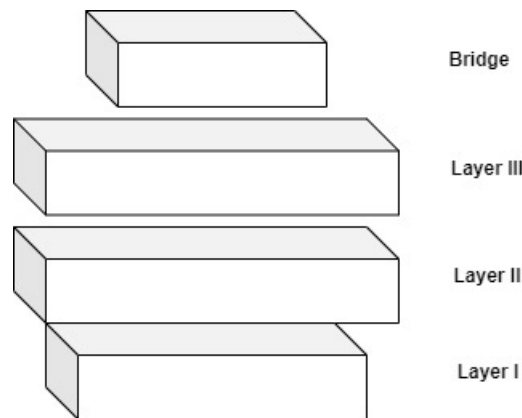

Figure4.26: Schematic representation of the HLP "Superstructure"

Technical Space

Overview

Technical spaces are defined as the spaces containing additional systems in order to ensure the vessel's mission. Thus, the technical spaces consist of the following sub-components:

- BOG handling system
- Bunkering equipment
- Inert gas system

Main design drivers for the technical space

The decision variables for the the design of the technical space are the following:

1. Included technical systems
2. Position

BOG handling system

The BOG handling system is required on board of LNG carriers in order to balance the BOG generated from the tanks. The different types of BOG handling system are depicted in Figure 4.27. The available solutions are either make use of the BOG as additional source of fuel, or re-liquefy it.

The reliquefaction plant allows the liquefaction of the BOG and return the LNG back to the cargo tanks. Further information about the different available reliquefaction plants can be found in [61]. The reliquefaction process is based on reversed nitrogen Brayton circle refrigeration technology, combined



Figure 4.27: Different types of BOG handling system [19]

with a process for separating nitrogen from the BOG. It is worth mentioning that the reliquefaction plant can handle either the full amount of the BOG or only the excessive BOG (partly liquefaction). Also, from an economic perspective, the installation of the reliquefaction plant onboard of the vessel using DF engines allows taking advantage of price differentials between LNG and heavy fuel oil.

The design of the reliquefaction plant is customized according to the needs of each vessel. Therefore, further analysis is beyond the scope of the present thesis. However, the dimensioning of the reliquefaction plant can be approximated by using data from the manufacturers. A relevant database is not available at the moment. Therefore, the reliquefaction plant was modelled as a python object with default characteristics (which can be changed according to the Naval Architect's needs).

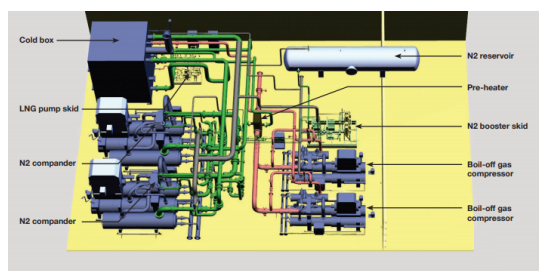

(a) Architecture of the reliquefaction plant [15]



(b) Installation of the system onboard of the vessel "Nusantara Regas Satu" [15]

Figure 4.28: Reliquefaction plant Wärtsilä MarkIII

As an alternative to the reliquefaction plant, a LNG fuel gas system can be used to provide the gas fueled engines with the BOG. However, the LNG fuel gas system is not a voluminous installation and its design was not taken into account at this design stage. In addition, the space reservation for the LNG fuel gas system is considered in the fuel equipment room (part of the engine room).

Furthermore, the Gas Combustion Unit (GCU) is a burner which combusts the BOG in a controlled manner without the risk of releasing unburned natural gas to the atmosphere [5]. However GCU ensures the handling of the BOG in a safe and environmentally friendly way, useful energy can not be recovered from the gcu; thus, it should not be used as a primary mean of BOG handling. The GCU was modelled as a python object with default characteristics (which can be changed according to the Naval Architect's needs), due to the fact that there is not an available manufacturers database.

Bunkering equipment

According to American Bureau of Shipping (ABS), the required equipment in order to perform a bunkering operation is the following:

- Fendering, Vessel Separation and Cryogenic Spill Protection
- Bunker Hose and Fittings

- Hose Handling
- Bunker Loading Arms
- Monitoring and Control
- Fire Protection
- Inerting and Purging Requirements for Hoses and Pipes
- Ignition Sources, Safety Zones and Vent Mast Locations
- Lighting, Platforms and Other Outfit
- Personal Protective Equipment

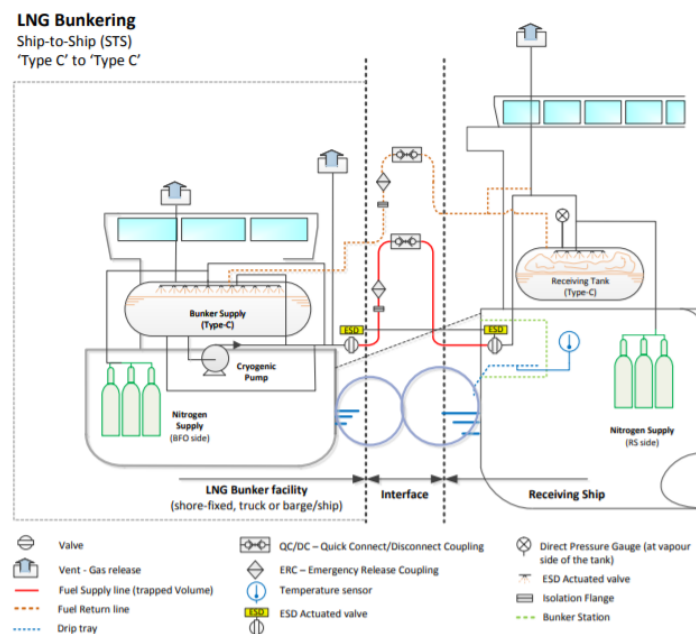

Figure4.29: S-T-S bunkering operation [20]

However, the equipment mentioned above will not be modelled in an object. The reasoning is that there is enough space reservation on the mid hull.

Inert gas system

According to Wärtsilä Encyclopedia of Marine Technology, the inert gas system is a device in which fuel is burnt to create exhaust gases which contain less than 5% oxygen. The inert gas system consists of a combined burner and scrubber, both seawater-cooled. In short, MDO or HFO is burnt to produce flue gas with oxygen content of 2-4%. As a next step, the gas enters the scrubber in order to be cooled and cleaned by sprayed seawater before being led to the deck area. The produced inert gas is being used for the inerting of the cargo tanks, cargo pipes, and void spaces when required prior to and after a refit or inspection period. The inert gas system ensures safety onboard due to preventing the unexpected explosions due to the presence of flammable gases. The inert gas system was modelled as a python object with default characteristics (which can be changed according to the Naval Architect's needs) since there is not an available manufacturers' database.

LNGBV's technical space layout

The LNGBV's technical space can be seen as the space consisting of the required technical systems of the vessel. The variables used to describe the layout are the following:

1. Length of each technical system
2. Width of each technical system
3. Height of each technical system
4. Length of the technical space
5. Width of the technical space
6. Height of the technical space

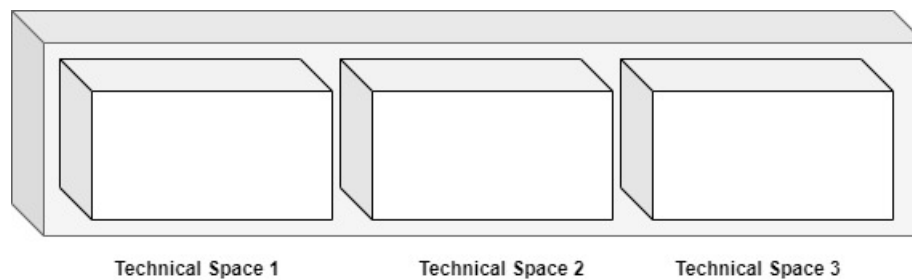

Figure4.30: Schematic representation of the HLP “Technical Space”

Ballast water system

Ballast water is required in order to ensure safe operating conditions (reduced stress on the hull, improved transverse stability, and compensation for weight change). However, a serious ecological problem arose because the surviving transferred species contained in the ballast water, established a reproductive population in the host environment, out-competing the native species. In order to address the aforementioned problem, IMO adopted the International Convention for the Control and Management of Ships’ Ballast Water and Sediments (BWM Convention). The convention requires that all ships have to implement a ballast water management system.

For the scope of the present research, the ballast water is developed and fitted in the developed hull. More specifically, ballast tanks are fitted in the forepeak and between the cargo space and the midhull. The requirements for the design of the ballast water system are stated in Design Requirement 9 [Section 4.2.1].

Bow thruster space

Overview

The bow thruster space is the space of the vessel where the bow thruster is located. Main design drivers for the bow thruster s

The main design driver for the design of the bow thruster space is the required bow thruster for the manoeuvring of the vessel.

LNGBV’s bow thruster space layout

The variables used to describe the layout are the following:

1. Length bow thruster space
2. Width bow thruster space
3. Height bow thruster space
4. Dimensions of the required thruster

Aftpeak space

Overview

According to Wärtsilä Encyclopedia of Marine Technology, the aftpeak is defined as the compartment located aft of the aftermost watertight bulkhead enclosing the stern tube and rudder trunk. This compartment can also be used to locate the ballast water tanks.

LNGBV's aftpeak space layout

The aftpeak results from the developed aft hull part. Thus, the variables to describe the aftpeak are the following:

1. Length
2. Developed aft hull shape

Forepeak space

Overview

According to Wärtsilä Encyclopedia of Marine Technology, forepeak is defined as the watertight compartment situated forward of the collision bulkhead. It is used to locate ballast water tanks. In addition, its dimensioning is governed by the regulatory framework.

Regulatory framework

According to SOLAS ChII, Reg 12.1, a collision bulkhead shall be fitted which shall be watertight up to the bulkhead deck. This bulkhead shall be located at a distance from the forward perpendicular of not less than $0.05L$ or 10 m, whichever is the less, and, except as may be permitted by the Administration, not more than $0.08L$ or $0.05L + 3$ m, whichever is the greater.

LNGBV's forepeak space layout

The forepeak results from the developed fore hull part. Thus, the variables to describe the forepeak are the following:

1. Length
2. Developed fore hull shape

Forehull, Midhull and Aft hull part

Overview

The hull of the vessel is translated into three different HLPs, namely the forehull, midhull, and aft hull. The reasoning is to enhance flexibility in the design variations of hull; thus, different hull shapes can be created by combining various forms of forehull and aft hull. For the commercial vessels, the midhull shape is relatively simple, and the deadrise and flare angle are not significant factors. Some design variations applicable for the design of the LNGBV are depicted in Figure 4.31.

Main design drivers for the hull parts

The main factors to be defined for the hull design are the following:

1. Shape of the different hull parts
2. Inner hull arrangements

For the present research work, one design variation for each hull part was developed. The reasoning is that developing different hull shapes is a complicated and time-consuming process that would not add scientific value to the present research. Modelling different hull shapes is tied to the hydrodynamic perspective of the ship design problem. Therefore, selecting and developing a suitable hull shape for the design of the LNGBV is sufficient for the scope of the present research.

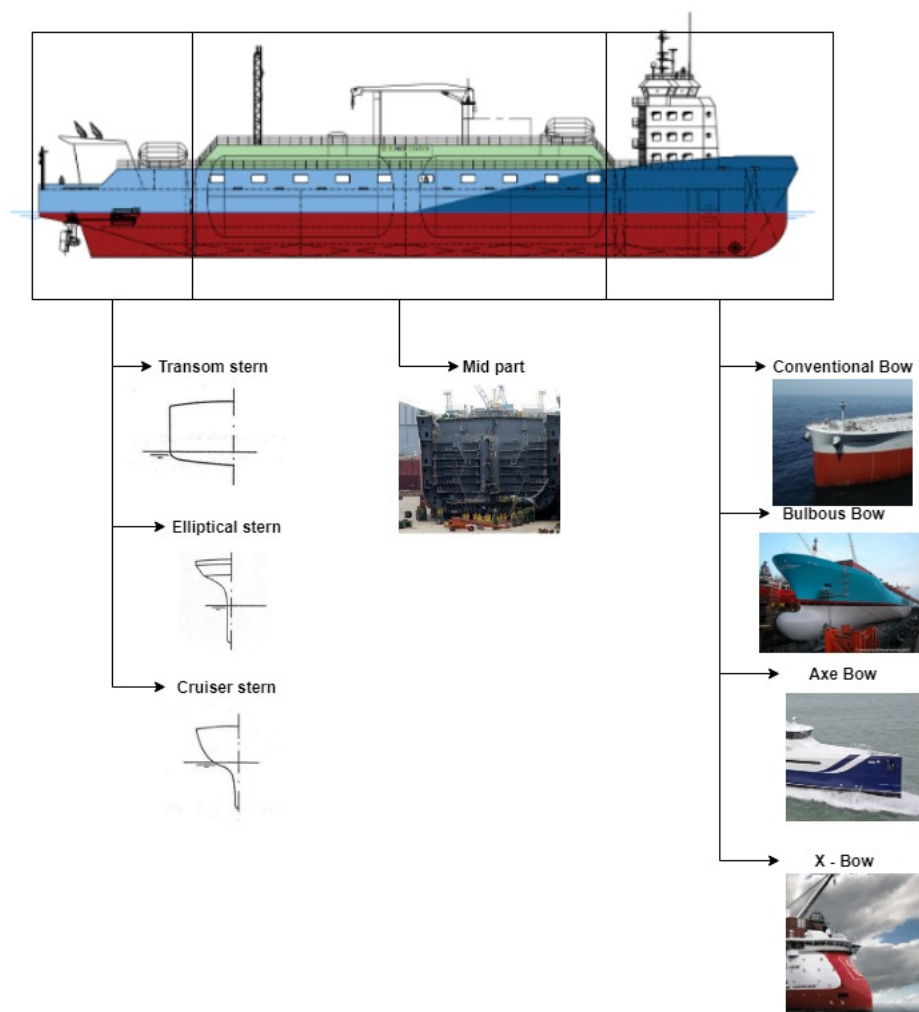

Figure4.31: Hull design variations

The HLPs, located inside each hull part, form the main driver for its dimensioning. More specifically, as it can also be seen in the Flowchart E.8, the inner arrangements are first created according to the design problem and as a result, the HLPs of the hull parts are wrapped around these HLPs.

Regulatory framework

Regarding the preliminary design of the hull, the regulation for the Minimum Required Freeboard rule included in the International Convention on Load Lines 1996 was taken into account. However, it should be noted that the corrections were not implemented. Since the formulation of the regulation is extensive, it will not be given in the present report.

LNGBV's forehull part layout

The variables to describe the forehull layout are the following:

1. Length of the forehull
2. Beam
3. Height
4. Parametric description of the curves: DECKF, WLF2, WLF1, CLF, FBF, FSF, FRF1-1, FRF1-2, and FRF1-3.

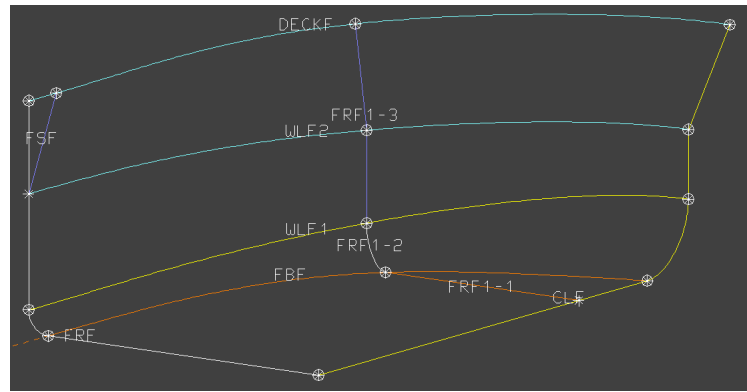

Figure4.32: Ship curves forehull

LNGBV's midhull part layout

The variables to describe the midhull layout are the following:

1. Length of the midhull
2. Beam
3. Height
4. Parametric description of the curves: DECKM, FSM, FBM, CLM, FRA, and FRF.

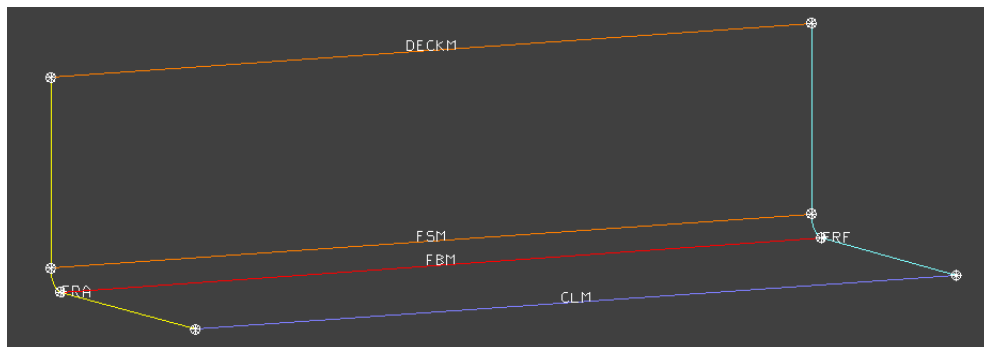

Figure4.33: Ship curves midhull

LNGBV's aft hull part layout

The variables to describe the forehull layout are the following:

1. Length of the aft hull
2. Beam
3. Height
4. Parametric description of the curves: DECKA, FSA, TRANSOM, CLA, FBA, FRA1-1, FRA1-2, FRA2-1, FRA2-2, and SA1.

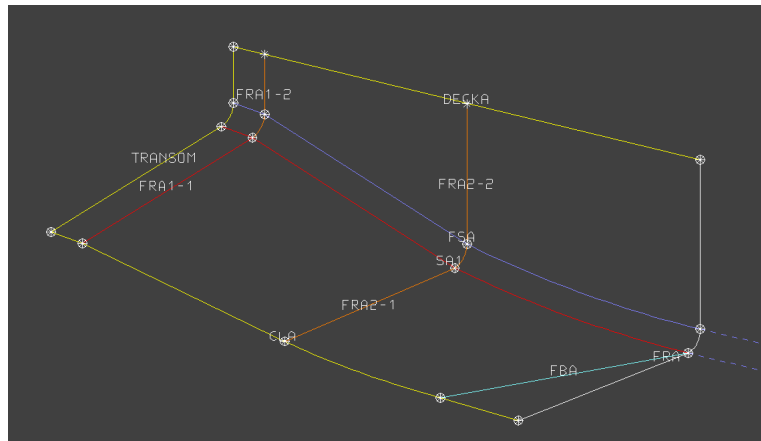

Figure4.34: Ship curves aft hull

4.2.5. Step 5: Mathematical description of the HLPs

The mathematical representation of the HLPs was built in Python by developing an OOS. The developed OOS is given in Appendix B. Every HLP forms a class containing the relevant attributes and methods which are required to build the design solution. For the present research study, the expected outcome is the concept visualization of the vessel by creating the NAPA geometric models and perform an initial estimation to ensure initial stability and buoyancy. Thus, four different methods were developed for each HLP associated with their definition, tuning, geometrical representation, and weight estimation.

In general, for each HLP the following equations apply:

$$Length_i = f1_i(IndependentVariables_i) \quad (4.1)$$

$$Width_i = f2_i(IndependentVariables_i) \quad (4.2)$$

$$Height_i = f3_i(IndependentVariables_i) \quad (4.3)$$

$$Weight_i = f4_i(IndependentVariables_i) \quad (4.4)$$

$$GeometricModel_i = f5_i(IndependentVariables_i) \quad (4.5)$$

Therefore, the main dimensions of the vessel are defined as follows:

$$L_{PP} = \sum LengthInnerBlocks \quad (4.6)$$

$$Beam = \max(WidthInnerBlocks) \quad (4.7)$$

$$Height = Height_{CargoSpace} \quad (4.8)$$

$$Depth = Draft + MinRequiredFreeboard \quad (4.9)$$

Engine room

For the mathematical representation of the engine room, a virtual box containing all the required machinery components (diesel engines, DF engines, gearboxes, generator sets, electric motors) is created, according to the engine room layouts presented in 4.2.4. Besides, a safety distance is added around the components to ensure accessibility as well as safety. The equations are presented in detail in Appendix D.1. Regarding weight estimation, the weight of the main machinery components is estimated by using the available manufacturers' database increased by a coefficient to account for the auxiliary equipment.

Technical Spaces

Similarly, a virtual box containing the required technical spaces was created. Safety distance is also taken into account for the different components to ensure safety and accessibility. There are three possible locations for this LNGBV entity, namely on the aft part or fore part of the hull, or the mid-part of the deck. The equations are presented in detail in Appendix D.2. The weight is defined as the summation of the weight of the major components increased by a factor to account for the additional equipment.

Cargo space

For the cargo space, the developed virtual box contains the selected LNG tanks configuration. Safety distance is also added due to the associated regulations. The cargo space is positioned on the midhull, and the equations for its mathematical representation are presented in Appendix D.3. The weight of the cargo space is approximated by estimating the weight of the LNG tanks increased by a factor to account for the auxiliary equipment.

Bow thruster room

Regarding the bow thruster room, the developed virtual box contains the required bow thruster for the manoeuvring of the vessel. Accessibility of the bow thruster room is also taken into account. This entity is positioned on the vessel's forehull. The equations for its mathematical representation are presented in Appendix D.5. For its weight estimation, the weight is approximated as the weight of the bow thruster, as it is the main component of the entity, increased by a weight factor.

Superstructure

Conversely, the superstructure is treated as a block entity which is placed on the developed hull. The superstructure was modeled as the combination of different layers (block entities). The maximum feasible dimensions are defined, and thus, the individual layers are defined according to these. For the positioning of the superstructure, the mooring deck space is also taken into account. The equations for its mathematical representation are presented in Appendix D.4. The estimated weight of the superstructure was approximated based on the semi-empirical method proposed in [54].

Forepeak

The vessel's forepeak depends on the generated hull by means of sizing and shape. The regulation regarding the collision bulkhead determines the length of the forepeak. In addition, its shape follows the shape of the hull. The equations for its mathematical representation are presented in Appendix D.6. The forepeak is used for the allocation of the ballast water tanks.

Aftpeak

Similarly, the aftpeak of the vessel depends on the generated hull. More specifically, its shape follows the hull shape. In the design case where a rudder is included, a steering gear room should also be fitted in the afthull. The equations for its mathematical representation are given in Appendix D.7.

Afthull, Midhull and Forehull

The different hull parts are modelled as box-shaped entities to avoid unnecessary complexities. The implemented equations are presented in Appendix D.8-D.10. The dimensioning of the hull parts depends on the configuration of the inner blocks. In other words, the hull parts are wrapped around the HLPs located inside the vessel's hull. Finally, the hull shape is corrected by generating the equivalent NAPA's script.

The weight estimation for the forepeak, aftpeak, afthull, midhull and forehull was combined. More specifically, the predicted lightship weight was used after subtracting the already estimated weights. The weight distribution was assumed trapezoidal.

4.2.6. Step 6: Define the HLPs for each total ship architecture

This step coincides with "Block 1" of the developed python framework. Figure 4.35 shows the flow chart of the process. In summary, there are three sub-processes, namely the definition of the inputs (design requirements and design decisions), the access of the required databases, and the definition of the HLPs. Metaphorically, step 6 can be visualized as picking the appropriate "lego bricks" from the vessel's "tool kit". The end product of the combination of the selected HLPs will be vessel's architecture.

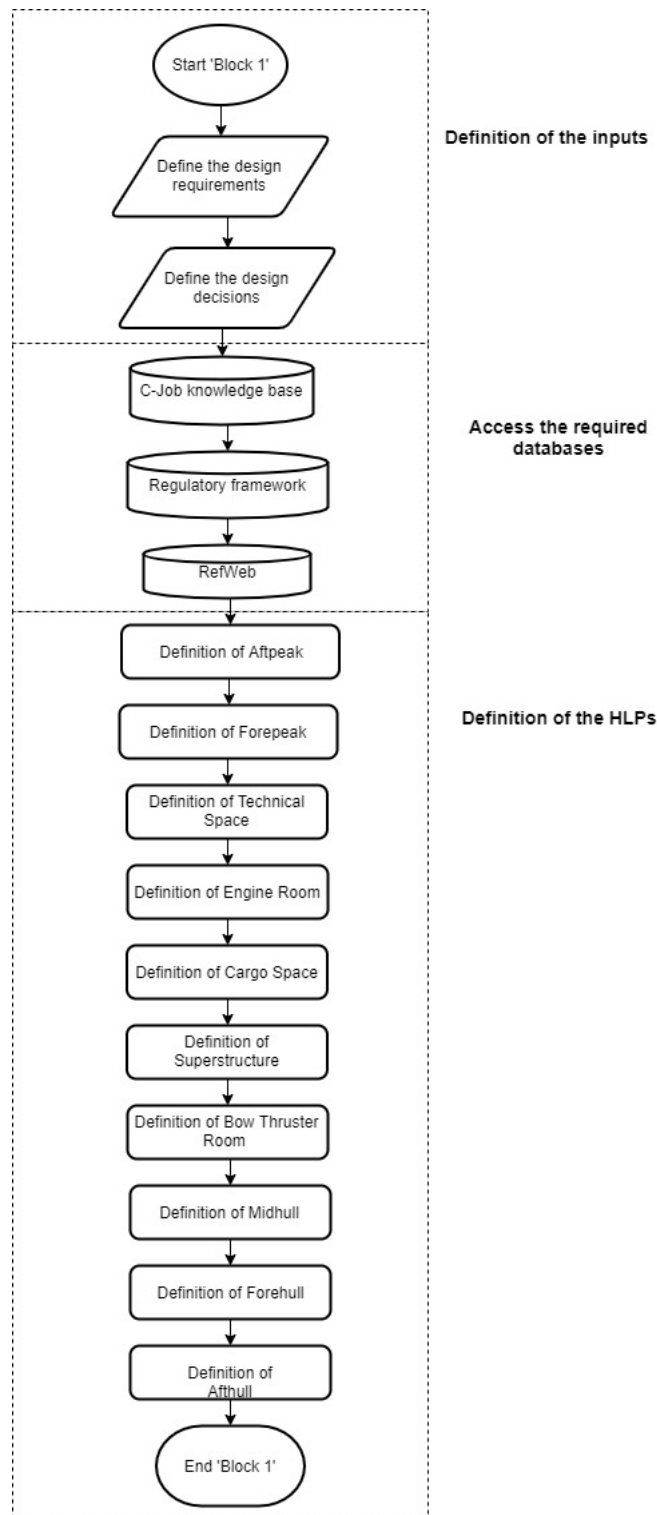

Figure 4.35: Flow chart of "Block 1" of the modelling process

4.2.7. Step 7: Tuning the HLPs

It should be noted that up to this step, all the dimensions of the HLPs are set to zero. Step 7 is associated with the method of tuning the HLPs to form a solution suitable for a specific design problem. Figure 4.36 shows the flow chart of the tuning process. The process consists of two sub-processes, namely the tuning of the parameters of each HLP, and the balancing of the parameters of the individual HLPs to create a feasible design solution.

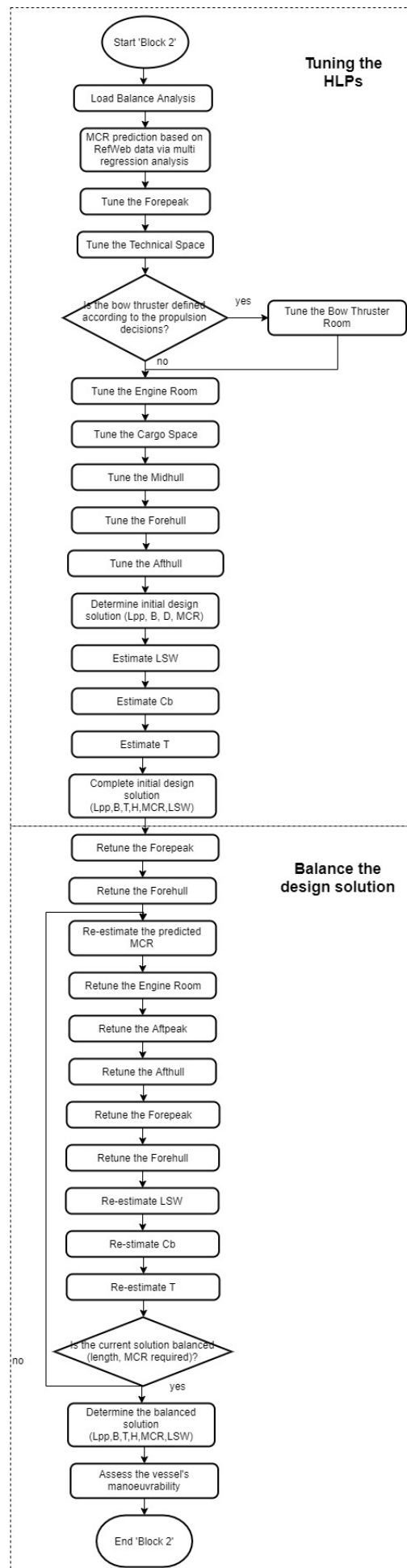

Figure4.36: Flow chart of "Block 2" of the modelling process

In the following lines, further required information about the sub-processes is given.

Load Balance Analysis

The estimation of the power for the electric consumers was performed. For the prediction of the electrical power demand, it is necessary to investigate various operation profiles. For the LNGBV, the characteristic operational profiles are the following: sailing, manoeuvring, bunkering-loading, bunkering-unloading, at anchor. According to Klein Woud and Stapersma [72], there are three ways to approximate the electric power demand, namely the empirical formulas, the electrical load analysis, and the simulation. From these methods, the electrical load analysis was chosen as the most suitable. The empirical formulas are not reliable because there are very few built LNGBVs, and the simulation goes beyond the scope of the preliminary design. The load balance analysis is translated into a Python function to be included in the developed framework.

The load balance should be parametrically developed to fit designs with different systems included. The primary electric consumers are considered in the load balance study. These are the following:

- Inert gas generation system (compressors, air dryer, control system)
- Nitrogen generation system (compressors, air dryer, control system)
- Bunkering systems
- Voyage fuel supply system
- Bow thruster
- General ship systems (deck equipment, engine room equipment, ventilation, heating, workshop, domestic facilities, cargo room equipment)

The variables which will be used for each of the systems above are their power demand at full load, and their load factor [varying from 0 to 1] for the examined operational conditions. Indicatively, the formation of the load balance sheet of the LNGBV is given in Appendix C. Furthermore, the load factors were proposed. However, an in-depth power demand analysis goes beyond the scope of the present research work.

MCR prediction based on RefWeb data via multi-regression analysis

The required MCR will be predicted via multiple regression from the stored data of the vessels on RefWeb. It is worth mentioning that other methods for resistance and power prediction, such as Holtrop and Mennen method, were considered. However, it was concluded that the most suitable way is to use the RefWeb because fast predictions can be made according to the main dimensions of the vessel, excluding complex hydrodynamic factors. Thus, although the prediction of the required power is simplified, the results are sufficient for the required level of detail. Also, the efficient exploitation of the company's knowledge sources is in line with the KBE methodology.

A first estimation of the MCR was performed via multiple regression analysis. As independent values, the length, breadth, draft and F_n were used. The aforementioned variables were chosen in order to combine the size of the vessel as well as the speed requirement. The correlation factor was calculated 0.73. The fitting of the predicted values to the actual data is presented in Figure 4.37.

As it can be clearly seen in Figure 4.37, the majority of the data points follow the trend. However, there are some vessels for which the predicted value for the MCR and the actual data value have a significant error. These vessels are the Coral Methane, the Bella, the Js Ineos Ingenuity, theHavfru and the Pioneer Knutsen. This error, probably, occurred from wrong data values (comparison of similar vessels). For the scope of the present thesis, the data set was revised by excluding the aforementioned 5 vessels. Thus, the total amount of vessels used were 29 and the correlation factor was increased to

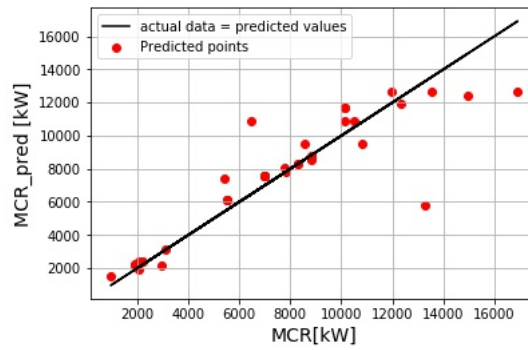

Figure4.37: MCR regression fitting by using RefWeb's data

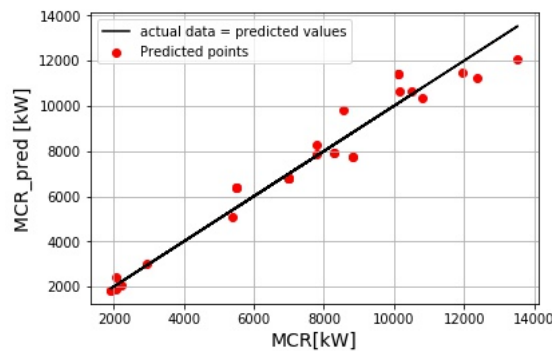

Figure4.38: MCR regression (revised data set) fitting by using RefWeb's data

0.95. The revised regression analysis can be seen in Figure 4.38.

Finally, the required propulsive power is calculated as follows:

$$power_{propulsion} = power_{total} - power_{electric} \quad (4.10)$$

Tuning the Engine Room

In order to tune the engine room, its sub-components should also be sized. Additional factors such as the accessibility of the space and the space reservation for the fuel equipment room, workshop, and control/ switchboard room (as presented in Section 4.2.4) should be taken into account. Therefore, a “toolkit” of machinery components should also be modelled. By combining, the suitable machinery parts, the different layouts for the engine room will be synthesized.

The building blocks which form the architecture of the engine room are the mechanical components such as the diesel engines, DF engines, gearboxes, and generators. Thus, the sizing of these components is the first step for the sizing of the engine room. The proposed methodologies for sizing the machinery components are the following:

1. Make use of a database containing information from the suppliers of the required equipment.
2. Follow the dimension prediction models based on first principles proposed by Stapersma and de Vos [32].

From the methods mentioned above, it was selected to use C-Job's database containing information from machinery equipment suppliers to approximate the machinery equipment sizing. However, the method proposed by Stapersma and de Vos is suggested as further development.

Lightship Weight Estimation

The essential component for the calculations mentioned above is the lightship weight (LSW) of the vessel. The LSW can not be accurately calculated at this design stage. Thus, the available RefWeb data will be used to get an initial estimation of the LSW. This approach is in line with the concept of kbe to deploy all the available company's knowledge sources in the design. Thus, a multi-regression analysis was conducted with the main dimensions of the vessel (L, B and D) and the block coefficient C_b . Indicatively, the regression results (Figure 4.39) were predicted with a correlation coefficient of 0.84. As can be seen, there is a short-range of LNG carriers available as data points. Thus, the predictions are not adequate for designs varying from the ones in the database. As a further improvement, the extension of the database is suggested.

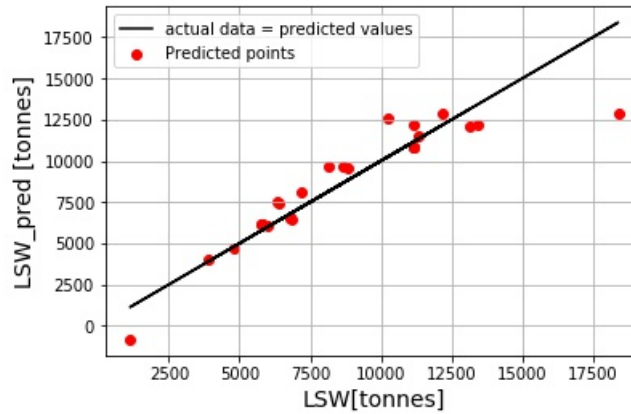

Figure4.39: LSW prediction by using RefWeb's data

Estimation of C_b

For the estimation of the C_b the semi-empirical method discussed in Papanikolaou [54] was implemented. Thus,

$$C_B = K_4 - K_5 \cdot V / \sqrt{L} \quad (4.11)$$

where V [knots] and L [ft].

Table4.4: Coefficients of semi-empirical formulas for the estimation of C_B [54]

Formula	K_4	K_5	Comments
Alexander and Watson	1.06	0.500	$0.65 \leq V / \sqrt{L} \leq 0.8$ (cargo ships)
	1.03	0.500	$V / \sqrt{L} > 0.89$ (fast cargo ships)
	1.12	0.500	$V / \sqrt{L} < 0.65$ (slow cargo ships)
Silverleaf and Dawson	1.214	0.394	bulky ships, $C_B \geq 0.75$, length L[m]
Chirila	1.225	0.378	bulky ships, $C_B \geq 0.75$, length L[m]
Troost	1.156	0.625	Service speed $V_s \cong 0.94 V_T$

Estimation of the vessel's draft

The vessel's draft is estimated by the following equation:

$$T = \frac{\rho_{seawater} * L * B * T * C_b * coeff_{corr}}{LSW + DWT} \quad (4.12)$$

The $coeff_{corr}$ is the moulded hull correction coefficient accounting for the average thickness of the ship's outer shell plating (for tankers the value 1.0035 is suggested [54]).

Assess the vessel's manoeuvrability

For the scope of the manoeuvrability assessment, three different levels are defined namely "low", "medium" and "high". The basis of the manoeuvrability characterization is an empirical method based

on the ratio L/B and the coefficient C_b . Due to confidentiality reasons, the method is not published in the present report.

The assessment process is as follows:

- An initial manoeuvrability level is defined based on the hull characteristics (ratio L/B and the coefficient C_b).
- The defined level can be upgraded by one level with the use of stern or bow thrusters.

4.2.8. Step 8: Extract and evaluate the geometrical models

The flowchart of the developed framework is shown in Figure 4.42. The subprocesses of the step can be divided into the development of the geometric model and its assessment. For the assessment of the design solution, the regulation regarding the minimum freeboard area, the initial stability, the manoeuvrability requirement, the ballast capacity, and LCG and LCB are checked.

Ballast water capacity

Due to the requirement for free ballast operation (Section 4.2.1), the ballast water capacity should be checked in order to compensate for the changes in the cargo volume during the cargo loading and unloading during the vessel's operation.

Initial stability

Regarding the preliminary design phase, it is sufficient to check the intact stability of the vessel. In order to evaluate the stability, the semi-empirical methods proposed by Papanikolaou [54] were adopted.

$$GM = KM - KG \quad (4.13)$$

where

GM:metacentric height

KM:vertical position of the metacenter

KG:vertical position of the center of buoyancy

$$KM = KB + BM \quad (4.14)$$

According to Schneekluth:

$$KB = T(0.9 - 0.3C_M - 0.1C_B) \quad (4.15)$$

In addition, for the estimation of the metacentric radius:

$$BM = \frac{I_t}{\nabla} = C_1 * \frac{B^2}{12 * T * C_B} \quad (4.16)$$

where

$$C_1 = C_{wp}^{1.8} \quad (4.17)$$

$$KG = C * D_S \quad (4.18)$$

where the modified side depth D_S is defined as:

$$D_S = D + \frac{\nabla_{SS}}{L_{pp} * B} \quad (4.19)$$

In order to evaluate the trim of the designed vessel, the LCG needs to be estimated and compared with the LCB. For the estimation of the LCG, the weight and the LCG of the different HLPs was approximated and as a result, the LCG of the vessel is estimated. The advantage of this approach is that the according to the positioning and selection of the different building units, the effect on the stability and the trim of the vessel can be assessed. However, the integrated information was not adequate

to estimate the weight of the hull parts, the forepeak and aftpeak, and the superstructure. For the superstructure, the semiempirical method proposed in [54] was selected. The weight estimation for the hull parts, the forepeak, and aftpeak was done by taking into account the LSW estimation.

Nowadays, specialized software programs perform the stability calculations and provide results with higher precision. However, regarding the current study, direct feedback from NAPA was not built due to the following drawbacks:

1. Setting up the NAPA stability problem requires to add more precision to the current model as all the weight components, and their centroid should be defined manually for each design variation by setting a NAPA matrix.
2. The stability problem should be defined manually for each design solution.

However, a direct connection and feedback link with NAPA is suggested as a further improvement. This improvement is mainly suggested since, for the design of innovative and complex vessels, the semi-empirical methods will not apply.

Extract the NAPA model

At the final design step, the NAPA geometric model of the developed design solution is presented. As it is already mentioned, the design solution results from the design requirements presented in Section 4.2.1. The design characteristics of the vessel are given in Table 4.5. In addition, the visualization of the model and the geometrical model of the HLPs can be seen in Figures 4.40 and 4.41 respectively.

The vessel was designed to carry 7,500 m^3 of LNG cargo with a design speed of 12 knots, and high manoeuvrability characteristics for enhanced safety during bunkering and port operations. For the propulsion system, a hybrid drive consisting of two DF engines, two electric motors, and four generator sets, was selected. For the storage of the cargo, two bilobe tanks were considered. The superstructure was positioned fore to improve visibility. The technical space, which includes the inert gas system and the GCU, is positioned on the forepart of the vessel. There is also the option to include a reliquefaction plant placed on the deck.

LNGBV 7500 LNG - Reference Design		
	Proposed method	C-Job's design
GENERAL		
Length overall	109.54m	99.90m
Length b.p.p	106.86m	95.75m
Beam moulded	22.00m	21.00m
Height	16.00m	-
Depth	6.5m	9.00m
Draft	5.13m	6.00m
Lightshipweight (approx)	6350t	4000t
Block Coefficient	0.80	0.82
Deadweight	3750t	3750t
Total installed power	3300kW	4500kW
Inert Gas System	YES	YES
GCU	YES	YES
Reliquefaction Plant	OPTION	OPTION
TANK CAPACITIES		
Ballast water	3900 m^3	-
PERFORMANCE		
Speed (at the design draft and 100% MCR)	12 knots	12 knots
PROPULSION SYSTEM		
Hybrid drive	4 diesel generator sets, 2 electric motors driving the 2 azimuth thrusters	4 diesel generator sets, 2 electric motors driving the 2 azimuth thrusters
ACCOMMODATION		
Crew (Single Cabins)	14 people	14 people

Table4.5: Vessels Characteristics (Reference Case)

Regarding the evaluation of the design, the vessel's GM was estimated as 5.6 m. The manoeuvrability characteristics of the vessel was ranked as "high" due to the manoeuvrable hull, stern thrusters and bow thruster. In addition, the predicted LCB and the LCG were at 5% Lpp and at 3% Lpp respectively. In Table 4.5, the design solution proposed by C-Job, which is given in Appendix F, is also given. Although the designs are based on similar design decisions, they are not identical, and thus, they should not be directly compared. According to C-Job's design, the technical space containing the inert gas

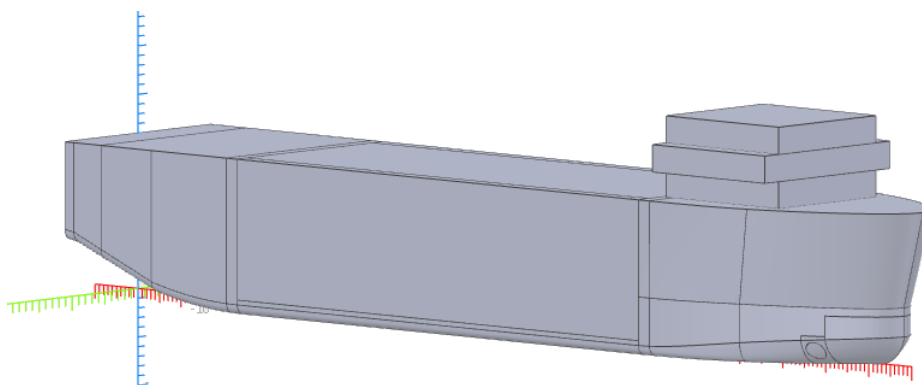

Figure4.40: NAPA model of the LNGBV (Reference Case)

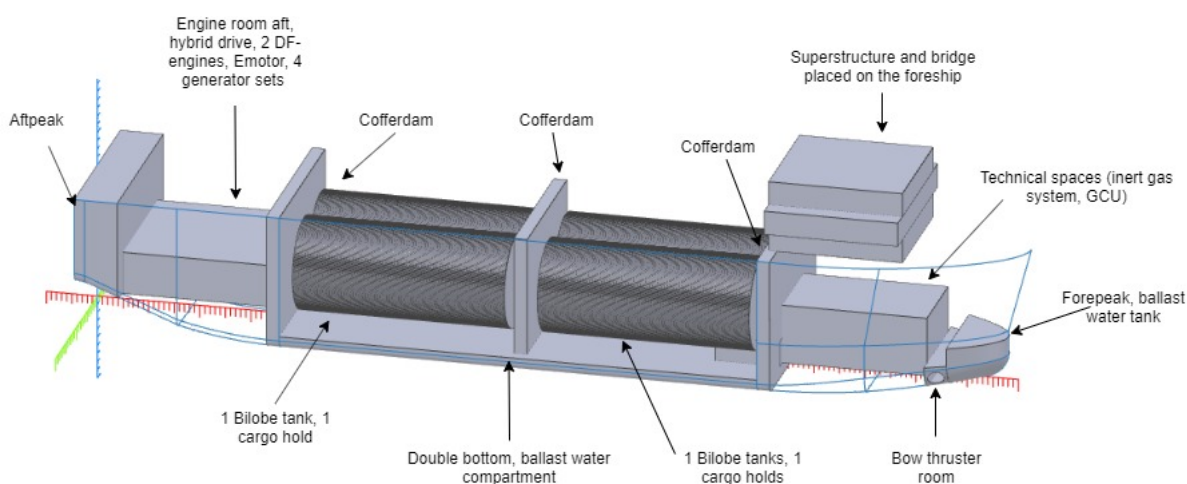

Figure4.41: Sub-components of the LNGBV model (reference case)

system and the GCU was placed on the aftpart of the hull on a higher level than the one used for the engine room. In addition, in the fore part space reservation is ensured for the pump room. The estimations of the equivalent parts such as the aftpeak, the engine room, the cargo space, and the forepeak have similar values in both designs. Therefore, the generated solution from the developed framework can approximate adequately the one given by the Naval Architects at C-Job.

However, the primary advantage of the proposed method lies on the exploration of different design variations. Thus, in the following chapter, some indicative design cases will be examined and the results will be discussed.

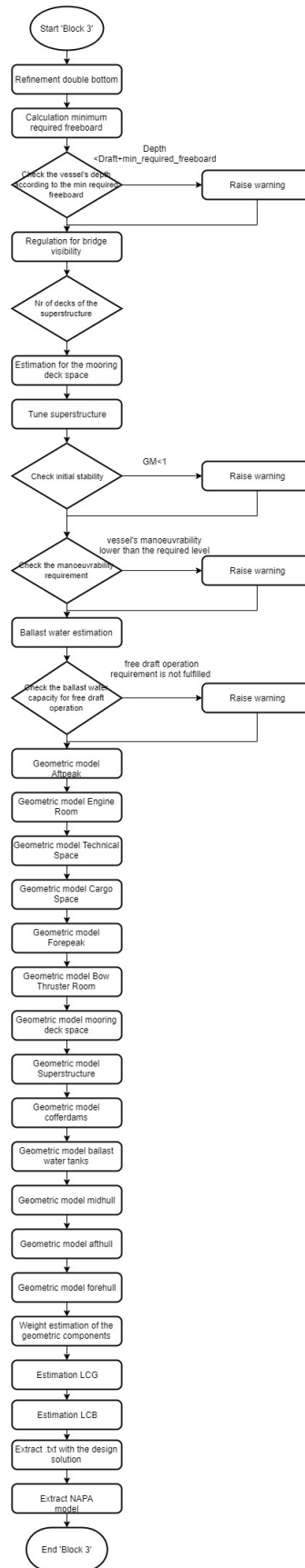

Figure4.42: Flow chart of "Block 3" of the modelling process

5

Evaluation of the Results

In this chapter, indicatively some design variations are presented. The starting point to generate these was the design requirements presented in 4.2.1. Finally, the results are assessed and discussed.

5.1. Design Variations

The design variations result from different design options. The different options for the propulsion system, the cargo handling system, and the technical systems have the most critical impact to the design solution. In addition, the positioning of the superstructure and the technical space also impacts the design. It is interesting to visualize the influence of the different parts to the end product, the vessel.

Indicatively, the following design cases are presented.

5.1.1. Design Case 1

Firstly, the use of a membrane tank (one cargo hold) for the cargo handling system was examined. Direct mechanical drive consisting of two DF engines and two FPP was selected. Two generator sets provided the required power for the electric consumers. Furthermore, a steering gear room was included in the aftpeak of the vessel. The superstructure is positioned on the aft part of the ship. Also, a bow thruster was included to enhance manoeuvrability and compensate for the limited manoeuvrability of the mechanical drive propulsion system. The technical space was placed on deck.

The proposed vessel's characteristics are presented in the Table 5.1. For the evaluation of the design, the vessel's GM was estimated as 5.5 m. The manoeuvrability characteristics of the vessel was ranked as "high". In addition, the predicted LCB and the LCG were at 6% Lpp and at 0% Lpp respectively.

In Figure 5.2, the sub-components of the technical space are also shown. This further subdivision leads to improved flexibility because these components can be placed individually inside the hull or on the deck for more efficient use of the available space. However, for the rest of the design cases, the technical space will be shown as one entity.

Table5.1: Vessel's Characteristics (Design Case 1)

LNGBV 7500 LNG - Design Case 1	
	Proposed method
GENERAL	
Length overall	102.87m
Length b.p.p	100.36m
Beam moulded	24.00m
Height	11.00m
Depth (min)	5.8m
Draft	4.6m
Lightshipweight (approx)	4740t
Block Coefficient	0.73
Deadweight	3750t
Total installed power	2700kW
Inert Gas System	YES
GCU	YES
Reliquefaction Plant	YES
TANK CAPACITIES	
Ballast water	4480 m^3
PERFORMANCE	
Speed (at the design draft and 100% MCR)	12 knots
PROPULSION SYSTEM	
Mechanical drive	2 diesel generator sets, 2 DF engines, 2 FPP
ACCOMMODATION	
Crew (Single Cabins)	14 people

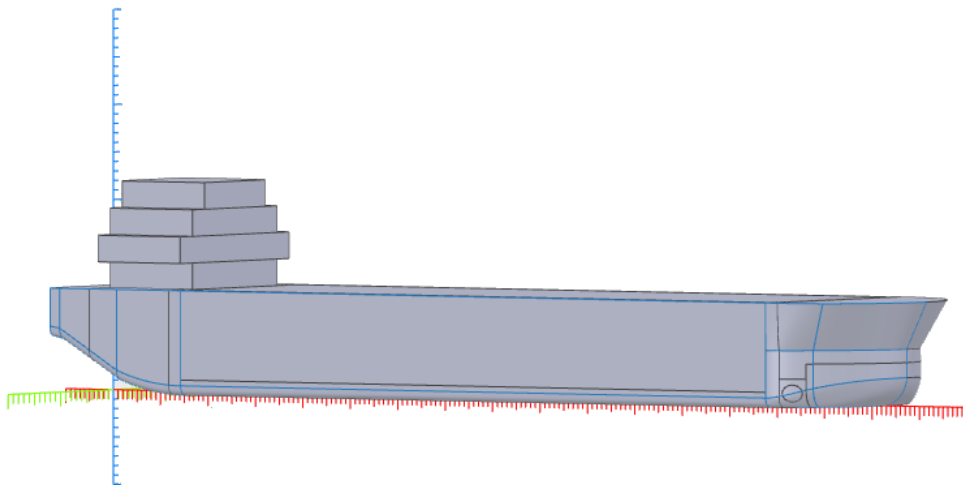

Figure5.1: NAPA model of the LNGBV (Design Case 1)

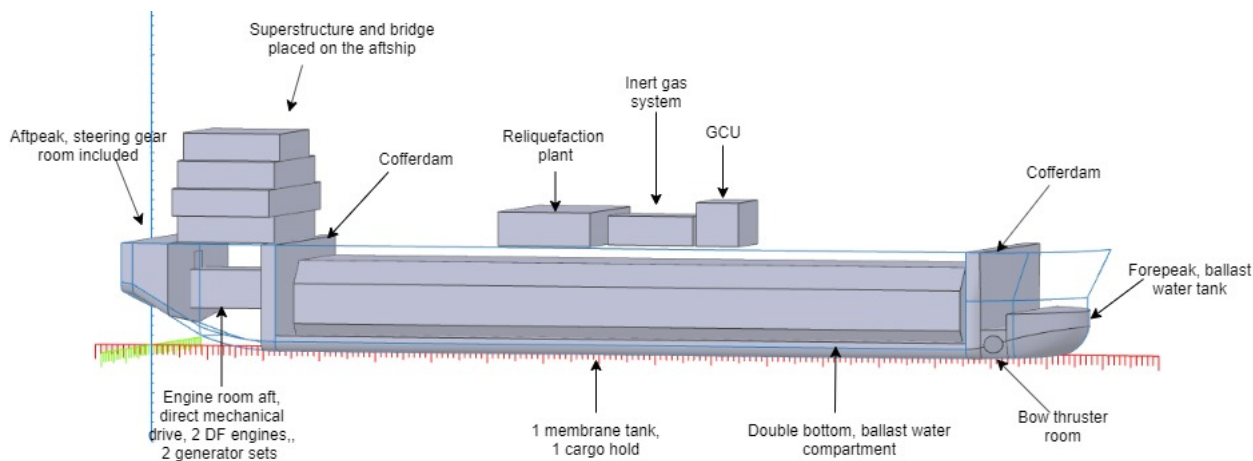

Figure 5.2: Sub-components of the LNGBV model (Design Case 1)

5.1.2. Design Case 2

For this design case, it was decided to examine the use of two cylindrical tanks for the LNG storage. The ratio L/D was set to 3. For the propulsion layout, it was selected to use mechanical drive consisting of 2 two diesel engines driving two fixed pitch propellers. Besides, a bow thruster was included in order to improve the manoeuvrability of the vessel. The superstructure was placed in the aft since more deck space was available at the aft hull.

The proposed vessel's characteristics are presented in the Table 5.2. Regarding the evaluation of the design, the vessel's GM was estimated at 3.3 m. The manoeuvrability characteristics of the vessel were ranked as "high". In addition, the predicted LCB and the LCG were at 5% L_{pp} and at 2% L_{pp} respectively. Indicatively, the design solution is similar to the Liquefied Gas Carrier 7500 by Damen.

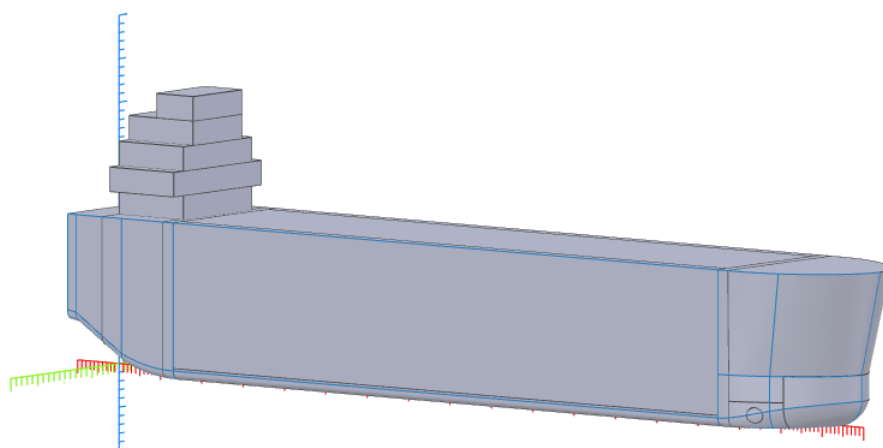

Figure 5.3: NAPA model of the LNGBV (Design Case 2)

Table5.2: Vessel's Characteristics (Design Case 2)

LNGBV 7500 LNG - Design Case 2	
Proposed method	
GENERAL	
Length overall	110.40m
Length b.p.p	107.71m
Beam moulded	19.00m
Height	18.00m
Depth (min)	7.5m
Draft	6.07m
Lightshipweight (approx)	6680t
Block Coefficient	0.80
Deadweight	3750t
Total installed power	3570kW
Inert Gas System	YES
GCU	YES
Reliquefaction Plant	YES
TANK CAPACITIES	
Ballast water	5300 m^3
PERFORMANCE	
Speed (at the design draft and 100% MCR)	12 knots
PROPULSION SYSTEM	
Mechanical drive	2 diesel generator sets, 2 diesel engines, 2 FPP
ACCOMMODATION	
Crew (Single Cabins)	14 people

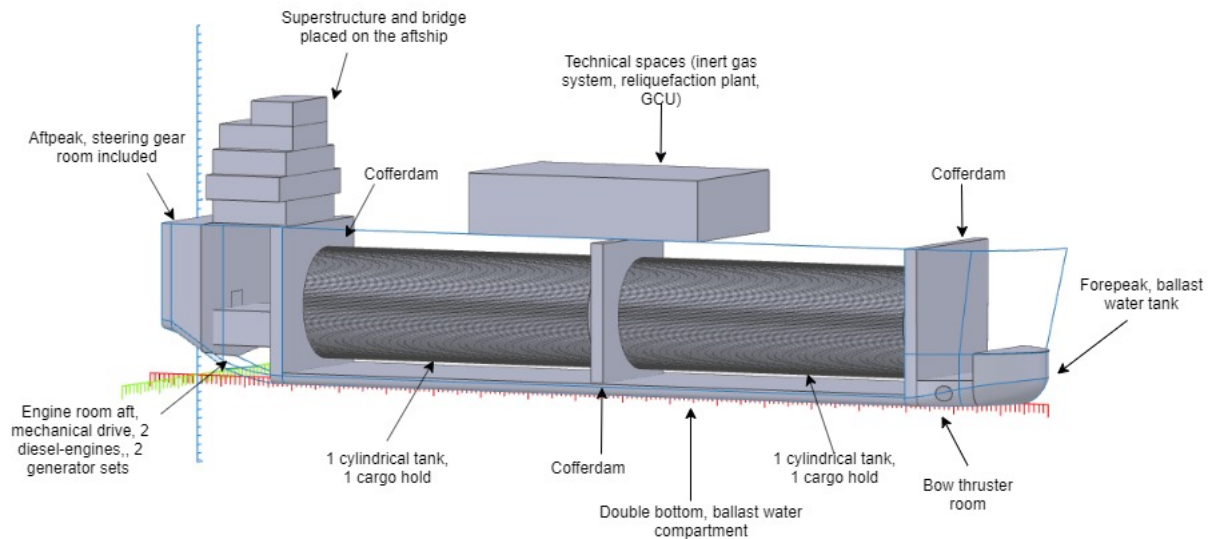

Figure5.4: Sub-components of the LNGBV model (Design Case 2)

5.1.3. Design Case 3

Regarding this design case, the use of four cylindrical tanks was examined. This decision would lead to reduced length and an increased beam. Diesel-electric propulsion was selected (the generator sets were positioned on the engine room on the forepart), and the technical spaces were placed on the aft (inert gas system and GCU). The superstructure was placed in the fore to enhance visibility.

The proposed vessel's characteristics are presented in the Table 5.3. Regarding the evaluation of the design, the vessel's GM was estimated at 6 m. The manoeuvrability characteristics of the vessel was ranked as "high". In addition, the predicted LCB and the LCG were at 5% Lpp and at 1% Lpp respectively.

Table5.3: Vessel's Characteristics (Design Case 3)

LNGBV 7500 LNG - Design Case 3	
	Proposed method
GENERAL	
Length overall	115.82m
Length b.p.p	113.00m
Beam moulded	27.00m
Height	15.00m
Depth (min)	5.5m
Draft	4.1m
Lightshipweight (approx)	6820t
Block Coefficient	0.81
Deadweight	3750t
Total installed power	3600kW
Inert Gas System	YES
GCU	YES
Reliquefaction Plant	OPTION
TANK CAPACITIES	
Ballast water	5330m ³
PERFOMANCE	
Speed (at the design draft and 100% MCR)	12 knots
PROPULSION SYSTEM	
Diesel electric drive	4 diesel generator sets, 2 electric motors, 2 thrusters
ACCOMMODATION	
Crew (Single Cabins)	14 people

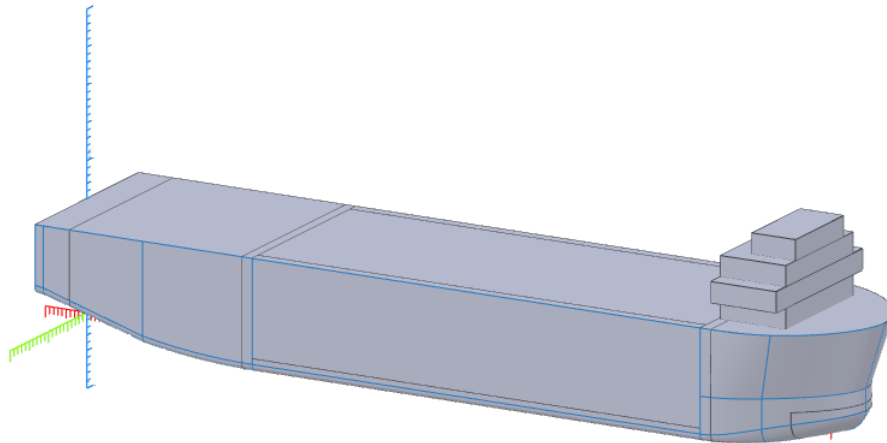

Figure 5.5: NAPA model of the LNGBV (Design Case 3)

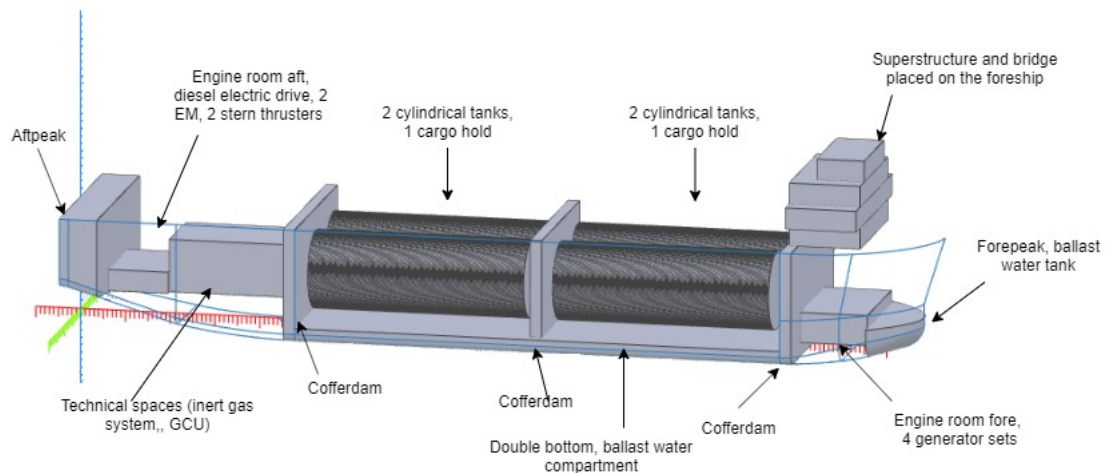

Figure 5.6: Sub-components of the LNGBV model (Design Case 3)

5.2. Discussion based on the results of the proposed method

The proposed framework was proved advantageous in comparison with the traditionally established practice. Its significant benefit is the time efficiency of the solution development (5-10 min). Besides, different design alternatives can be checked within a few minutes, and as a consequence, the Naval Architect is able to understand which design decisions are more suitable for each design problem. Another essential feature is that each HLP is being automatically built by using the relevant company's knowledge. This fact leads to the efficient exploitation of the company's knowledge sources to automate the design process.

The developed NAPA models are functional and can be used for further stability and strength calculations by using NAPA or incorporated in the ACD for optimization. Furthermore, the additional systems and compartments can also be added to the model.

By taking into account the design cases, it can be seen that the leading factor for the determination of the length and the beam of the vessel is the cargo room layout. Other important parameters are the selection of the propulsion layout and the positioning of the technical spaces on the forehull,

afthull, or on the deck. It is interesting to realize in the presented design cases how much different design solutions were given, although the design requirements were the same. In this observation lies the “design value” of the proposed method.

The proposed framework was developed in line with the idea of building the vessel by combining its sub-components. In this way, empirical and semi-empirical methods to predict the vessel’s characteristics were excluded from the design process. However, a direct feedback link with NAPA was not developed, and the GM, LCB, and LCG were estimated via semi-empirical methods. It is observed that the GM is overestimated. Thus, a direct feedback link with NAPA would provide more accurate predictions.

To sum up, the significant advantages of using the method mentioned above for the development of the parametric models are the following:

- The method is time-efficient (approx 5-10 min) and leads to parametric models containing adequate information for this design phase.
- The method proves to be flexible through the quick creation of new design variations.
- The Naval Architect can get a “design feeling” about the different design variations associated with the different design decisions faced on the preliminary design of the LNGBV.
- The accuracy of the generated models is enhanced in comparison with the traditional methods because the design starts from the smaller units; thus, the predictions are more accurate.

On the other hand, the limitations¹ of the developed framework are the following:

- The hydrodynamic performance of the hull was not taken into account. From a research point of view, the parameterization of the hull has been extensively studied in the available literature. Thus, it was excluded from the present research. However, in order to practically implement the developed framework at a company’s level, the hydrodynamic performance of the hull should be considered.
- Data should be collected for the components related to the technical spaces.
- A direct link with NAPA would be useful in order to automatically connect the already developed tools of the company with the developed framework (Level 2 of C-Job’s design circle).

¹The limitations refer to the developed framework and not to the method itself.

6

Discussion and Recommendations for Further Research

Things should be made as simple as possible, but not any simpler.

Albert Einstein

The present research work proposes a parametric modeling method based on the principles of KBE. As a case study, the study focused on the LNGBV. The general idea of the technique was the development of the parametric models based on the combination of the different HLPs. The HLPs can be seen as lego bricks, which can change shape, size, and re-order according to the design case and the Naval Architect's decisions. This chapter contains the research conclusions and recommendations for further research.

6.1. Thesis Conclusions

The thesis conclusions are presented by providing answers to the research questions.

- What is the state of the art in parametric design methodologies?

Parametric models have been widely researched in order to address the vessel's preliminary design phase. Their main advantage is that they facilitate the exploration of the preliminary design phase. Furthermore, due to the fact that parametric models are flexible designs that can be transformed according to the design needs to form the final design solution, the lead time and the cost are decreased.

A significant part of the parametric modelling methodologies focuses on the parametrization of the hull. The developed models are used for the hydrodynamic optimization of the hull, usually combined with CFD and optimization techniques. Another group of studies is dedicated to the development of parametric models of a specific vessel type, which will be used as the optimization core. A large number of vessel types such as tankers, cruise ships, bulk carriers, containerhips, and general cargo vessels were studied. In most of the research cases, the selected software was CAESES by the Friendship Framework. The most recent research which is still going on is HOLISHIP. This project is the joint effort of 40 European maritime RTD stakeholders, funded by the Horizon 2020 EU framework. In their latest finding, parametric modelling of an Offshore Service Vessel, a Double Ended Ferry, and a Multi-Purpose Ocean Vessel were developed.

The conclusions extracted from the literature study about the state-of-the-art in parametric modelling formed the basis of the parametric modelling method proposed by the present research work. The research gap was identified in the development of parametric models based on knowledge blocks instead of geometric entities such as points and curves. In order to develop such a

method, KBE methodology was selected as a suitable tool to take into account.

- Which are the main design drivers for the LNGBV and how will these be identified into geometry for the parametric models?

It was decided to examine the vessel as an architecture built from its fundamental blocks. By following this principle, design flexibility improves, and more innovative concepts can be explored. As a result, the main drivers are related to these fundamental blocks instead of the vessel's characteristics. Thus, the analysis began from the definition of the vessel's functions. These functions were translated into the required systems. In turn, the required systems will form the required HLPs which will form the "design toolkit" of the case study.

Specifically for the LNGBV case, the main drivers (or the HLPs) of the design are the engine room, the cargo space, the superstructure, the technical space, the bow thruster space, the aft-peak, the forepeak, the athull, the midhull and the forehull. Qualitatively, the following statement applies:

$$\begin{aligned} \text{LNGBV} = & \text{EngineRoom} + \text{CargoSpace} + \text{Superstructure} + \text{TechnicalSpace} + \text{BowThrusterRoom} \\ & + \text{Aftpeak} + \text{Forepeak} + \text{Aft hull} + \text{Midhull} + \text{Forehull} \quad (6.1) \end{aligned}$$

Each HLP was modelled by using four different functions. These functions are associated with its definition, tuning, geometrical representation, and weight estimation. The functions were modified in order accordingly to contain all the relevant information for each different HLP. In order to model the HLPs, an OOS was built in Python.

- Is KBE application a suitable way to address the research problem? Which is the most suitable way to develop the knowledge base for the the KBE model?

KBE was proved a suitable way to address the research problem of the development of a parametric modelling method based on knowledge blocks. Its significant advantage lies in the fact that the design problem is translated into a mathematical representation. This fact leads to a flexible problem structure which can be transformed according to the design needs.

Furthermore, the developed HLP toolkit can be used to build different design variations effectively, and thus it leads to an efficient exploration of the preliminary design phase. This tool can be a valuable tool for the Naval Architect to visualize the different design variations based on the design decisions. There is also the potential to build an optimization algorithm in order to identify the "optimal" solutions based on the different design configurations.

- Will the method result in functional parametric models? Will the method be proven improved in comparison to the established practice?

The developed framework results in functional NAPA models. The generated models can be integrated in C-Job's strength and stability calculations. Furthermore, the models can be used as the core of the company's optimization framework, the ACD.

The company will benefit significantly from the integration of the proposed framework in its design process. The advantages applied to the company are the following:

- The lead-time and cost are decreased for the development of the parametric model variations for the exploration of the preliminary design phase due to the replacement the time-consuming and inflexible established technique with the proposed framework.

- The company’s stored knowledge will be efficiently exploited in the design process.
- The developed “parametric modelling platform” will be independent of specific design and analysis tools.

The key finding of the research is tied to the research objective “Develop a method that is able to create the parametric models of the LNGBV in which C-Job is interested, in order to facilitate the exploration of the preliminary design space”.

The proposed parametric modelling method consists of eight steps. The starting point of the method is the definition of the design requirements (step 1). In this way, the design problem is defined. The main drivers (step 2) of the vessel’s design are identified and translated into the equivalent HLPs (step 3). Then, the HLPs are qualitatively described (step 4) by answering the question “Which is the required information to be integrated in the each HLP?”. As a consequence, the mathematical representation (step 5) of the HLPs is developed by answering the question “How will the determined information be translated into a mathematical representation by following the principles of OOP?”. At the next step of the method, the required HLPs to create a ship variation are defined (step 6). The design solution should fit the design problem; thus, the tuning of the individual HLPs (step 7) will result in the required main dimensioning of the vessel. At the final stage, the results (step 8) are extracted, which are the NAPA geometric model and an estimation of the feasibility of the design in the examined case study.

The method was formed in a generic form in order to apply to the design of different vessel types. However, the proof of concept was built based on the design of the LNGBV.

The proposed study differentiates itself from the available literature by proposing a parametric modelling method based on knowledge blocks. The proposed framework lead to answers to the following crucial questions:

- Which are the design decisions which should be examined for a specific design case?
- Which are the different design variations which should be considered for the design of a specific vessel?
- Moreover, as a final step, which is the design variation, which should be further optimized through sizing optimization? In the context of the C-Job design process, which design solution should be further optimized in the ACD?

6.2. Recommendations for future research

The results of the application of the proposed method to the LNGBV are promising. Thus, the presented case study can be seen as a self-contained proof of concept, which proves that there is potential in the application of the KBE ideas in the parametric modelling. However, further research is proposed in order to harness its full potential. The ideas for further improvement are listed as follows:

Design Perspective

- It is scientifically interesting to validation of the proposed parametric modelling method for the design of different vessel types with geometrical similarities. For example, in the group of commercial vessels, the qualitative statement 6.1 applies. This is suggested to be the first step for the expansion of the proposed method to different vessel types.
- Inspired by the implementation of KBE in the preliminary aircraft’s design (Figure 3.2), develop a parametric modelling method to address the design of vessels with radically different geometrical features. This improvement will lead to the exploration of more innovative concepts.
- Performance functions should be researched and integrated into the proposed framework. These performance will be associated with the vessel’s characteristics. In this way, the assessment of the design variations can be performed.

Analysis tools

- The development of a feedback link between suitable analysis tools and the proposed framework. In the specific case of C-Job, a feedback link with NAPA is suggested. However, other state-of-the-art software packages for analysis should also be considered.

Optimization Framework

- The development of an optimization framework for decision-making optimization. Regarding the C-Job case, the sizing optimization is addressed by the ACD. A decision-making framework will be complementary to the ACD.

Personal Reflection

Εν οίδα, ότι ουδέν οίδα.

Σωκράτης

The nine-month of working on my MSc thesis was an exciting journey of research work and self-development.

To begin with, I enjoyed researching this specific topic as I gained insight in various interesting fields. Firstly, I spend the first two months of my research to explore the magnificent field of the ship design methodologies. It was really interesting to realize how the design methodologies changed and evolved in parallel with the technological advancements. The third month of my research I invested my time in researching design in different engineering fields. At that time I started to research about KBE, and the way that this methodology had been applied to the aerospace sector. Personally speaking, I got inspired by the different design variations achieved with the combination of just a few HLPs (Figure 3.2).

In the fourth month of my research work, I started to build the proposed method alongside with the case study. One significant difficulty that I had to handle was working on different levels. More specifically, I had to think in three different levels, the scale of the components of each HLP, the HLP itself as a component and the vessel itself as an entity. I managed to handle this by mapping the different levels. Thus, I decided to start from the smaller units to the larger entities and try to make simple mathematical relationships to describe the “physics” of each one. In this way, I realized that each entity could be seen as a lego brick described by its dimensions, shape, and weight. This idea led me to the visualization of the problem; thus, it was easier to approach it.

There were two major difficult points that I had to solve during the development of the proposed framework. The first one was the creation of the hull geometry due to the shape complexity. The lesson that I learnt from that challenge was that everytime you should start from a simplified version of the problem in order to understand it in-depth and then increase its complexity. The second challenge was to define the interrelations of the HLPs, and determine the flowchart of the modelling process.

There were two major difficult points that I had to solve during the development of the proposed framework. The first one was the creation of the hull geometry due to the shape complexity. The lesson that I learned from that challenge was that every time you should start from a simplified version of the problem in order to understand it in-depth and then increase its complexity. The second challenge was to define the interrelations of the HLPs and determine the flowchart of the modelling process. From this challenge, I realized that the complexity of the problem increases exponentially as you transform the problem from a simplified version to a more realistic one.

Personally speaking, I believe that the developed tool has the potential with further improvement to form a powerful design tool which will lead the Naval Architect to examine different design variations. Unlike an optimization algorithm which provides the values of the design characteristics of data points representing vessels, the developed tools provides different designs which you can experience by making transformations and understand the results as physical entities and not like data points. In this statement, I find the beauty of the proposed method.

Personally speaking, I believe that the developed tool has the potential with further improvement to form a powerful design tool that will lead the Naval Architect to examine different design variations. Unlike an optimization algorithm that provides the values of the design characteristics of data points representing vessels, the developed tool provides different designs that the Naval Architect can experience by making transformations and understand the results as “physical entities” and not like “data

points". In this statement, I find the beauty of the proposed method.

I experienced working on my MSc thesis like playing around with puzzle pieces, which I managed to fit together and build something which I am proud of.

Appendices

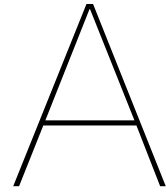

Interviews of Naval Architects at C-Job

A.1. Interview with Kevin Houwaart (03.04.2019)

Kevin will give an insight about the concept design of a TSHD. Kevin is a Naval Architect at C-Job.

The questions are the following:

1. Which were the clients requirements?

The client wanted a dredging vessel but they had no expertise on designing a new to be build dredger. The requirements can not be published due to confidentiality.

2. Which do you think are the drivers for the clients requirements today?

The specific client was not influenced from the competition of the shipping market thus, the requirements would be the same. Also the client relied on the experience of C-Job's naval architects for the design.

3. Which elements you would identify as the main drivers of the design?

The main design drivers for the dredger are the hopper capacity, the operational profile of the vessel (dredging speed in combination with the environmental conditions in the area of operation), and the established regulation for the vessels in the US namely the Jones Act.

4. Did you deal with contradicting requirements?

The initially given requirements were very few so, the real challenge was to keep length under 90m (if under 85m according to SOLAS big lifeboat was not needed) and try to fit max hopper volume, and the required installed power.

5. Which were the technical challenges that you faced in the design?

The design was challenging due to the lack of requirements which may lead to diverse alternative design solutions.

6. Can you describe the procedure of the concept design?

The requirements were translated into technical characteristics (rough and basic estimations). The naval architect performed a sketch with the basic characteristics according to experience (high Cb a lot of hopper volume, in dredgers bulb is free length for extra displacement, v shape hopper because there are less moving parts, more easy to build less costs w shape is more efficient for volume/ cargo capacity but it is a more complicated system and it is more interesting for light weight sand approximate engine and pump room). The second step was to perform a few design iterations according to the design spiral including more extensive studies to conclude the best design alternative.

7. Looking back, would you change any aspect in the design?
Reconsideration of some client's requirement. In addition, a more extensive study for the propulsion system would have been used.
8. Which design decisions were made according to your experience?
The design was well balanced so no ballast water system was needed (thus, not ballast water treatment as well).
9. Discuss some design alternatives (maybe specific system) that you had to evaluate?
Some examples are the following: example was the propulsion system, the superstructure's position fore or aft. The superstructure was placed forward as the vessel would perform maintenance dredging near river-mouth/ harbour areas 24 hours for 7 days per week and the advantage is that own light will not negatively influence the eyesight.
10. Did the ACD assisted the concept design? If not, do you think that its contribution would lead to better design alternatives?
Yes it would be really helpful because only a few design alternatives were evaluated due to limited time.
11. According to your personal experience as a Naval Architect, do you think that your professional experience gained from previous concepts plays a role in improving your designs? How? Explain.
Experience plays a great role. The initial sketch was purely based on personal experience. In addition, you can foresee bad solutions. Thus, the initial sketch is developed in less lead time due to gained experience. The avoidance of the ballast water system was an important aspect that was learnt from previous designs. In addition, other decisions are based on experience (location of suction pipes, locate overflow).

A.2. Interview with Nikos Papapanagiotou (10.04.2019)

Nikos will give an insight about the concept design of an LNGBV. Nikos is Lead Naval Architect.

The questions are the following:

1. Which were the clients requirements?

The requirements were the following: LNG capacity (range 7,500-8,000), high manoeuvrability, design speed of 12 knots and diesel electric propulsion.

2. Which do you think are the drivers for the clients requirements today regarding the LNGBV?

The drivers related to the clients requirements were the following: determination of the operational profile (bunkering operation and/or feeder), visibility, the mooring arrangement, the port requirements, the choice of the type of tanks, and the cargo handling system.

3. How does the fact that there are very few reference vessels influence the design procedure?

Although, it leads to more design freedom, every step of the design process requires sufficient proof.

4. Did you deal with contradicting requirements?

The shipping company aimed to have a vessel with maximized flexibility and minimized costs.

5. Which were the technical challenges that you have faced in the design?

The technical challenges were related to the LNG containment, handling and operation system. Designing the vessel balanced in order to use less ballast as possible. Another important aspect is its ability to bunker all types of vessels. In addition, the team decided to develop a modular design because the owners want to build the vessels in 3 different continents.

6. Can you describe the procedure of the concept design?

The team considered four different parts; the propulsion, the LNG cargo handling, the specialized technical spaces and the hull.

Regarding the propulsion, the following decisions had to be made:

- (a) one propeller or two propellers
- (b) conventional propeller or azimuth thrusters
- (c) conventional direct, hybrid or diesel electric propulsion
- (d) bow thruster(s) and/or retractable thruster fore

Regarding the LNG containment system, the following decisions had to be made:

- (a) Bi-lobe tanks, membrane tanks or cylindrical tanks

Regarding the specialized technical systems, the decisions related to the BOG system and the cargo handling system had to be made.

Regarding the LNG containment system, the following decisions had to be made:

- (a) Placement of accommodation
- (b) Shape of the hull (type of stern and bow)
- (c) Consider ballast free operation hull

7. Do you think that the contribution of the ACD would lead to better design alternatives?

Yes definitely, more design solutions would have been evaluated.

8. According to your personal experience as a Naval Architect, do you think that your professional experience gained from previous concepts plays a role in improving your designs? How? Explain.

It is important that you cut down decisions, avoid chaotic cases. The experience gained from the design of different vessel types gives solutions and technologies used in a horizontal way.

A.3. Interview with Thijs Muller (3.03.2019)

Thijs will give an insight about the concept design of a heavy lift vessel. Thijs is R&D manager and Lead Naval Architect.

The questions are the following:

1. Which were the clients requirements?

The client operates a fleet of heavy lift cargo vessels. The client wanted a new vessel which will combine design aspects of two other company's vessels. The most important feature was the stern ramp which facilitates the placement of the heavy cargo onboard.

2. Which do you think are the drivers for the clients requirements today?

The requirements would not have been changed. If the naval architect would have performed the same design today, he would choose a more elaborate study for design alternatives.

3. Which elements you would identify as the main drivers of the design?

Maximization of the performance in terms of moving heavy/ bulky load (volume was the leading factor instead of weight) and achieving as much hold capacity as possible. In addition, the regulations played an important role (SOLAS). Finally, the water ballast system played a crucial role to ensure stability.

4. Did you deal with contradicting requirements?

An example was that to maximize cargo capacity and improve stability, beam should be increased, but a slender and narrow design alternative would have been more fuel efficient.

5. Which were the challenges that you faced in the design?

One challenge was to fit the engines (2 medium engines) because the space aft was limited, as well as to fit the ballast water system.

6. Can you describe the procedure of the concept design?

First, an elaborate study of reference vessels (client and competitors) was performed. The key drivers were identified (resistance, cargo capacity and stability). The main dimensions were decided. Then, a 3D model was built, damaged and intact stability, and resistance were more extensively examined. Then the arrangements were decided.

7. Looking back, would you change any aspect in the design?

The naval architect would have created a parametric model to find the optimal balance between cargo, breadth and resistance. The varied parameters would be the length and beam.

8. Which were the lessons learned of this specific design?

The stern ramp was an important feature. In addition if you decrease C_b and maximize beam then you can achieve a design with good stability and decreased added resistance.

9. Which design decisions were made according to your experience?

An example is the minimization of the draft. There will always be draft restrictions because the vessels had to operate in specific ports etc.

10. Did the ACD assisted the concept design? If not, do you think that its contribution would lead to better design alternatives?

Yes, it would have helped as only few design alternatives were evaluated due to limited time.

11. According to your personal experience as a Naval Architect, do you think that your professional experience gained from previous concepts plays a role in improving your designs? How? Explain.

You can always gain from the experience, but an inexperienced designer has more open mind to explore.

A.4. Interview with Alexander van den Ing (25.04.2019)

Alexander will give an insight about the concept design of different vessel types. Alexander is Lead Naval Architect of C-Job Naval Architects.

The questions¹ are the following:

1. According to your experience, which are the vessel's design characteristics that are associated with the client's requirements in most of the cases?

The client requirements are associated with the following: payload, small main dimensions, OPEX, CAPEX, low fuel consumption, speed is not so important (for specific vessels), slow streaming is preferred nowadays. Operability is also important for offshore activities (motions). Contrarily, for inshore activities it is not important. Comfort also matters, as few crew members as possible and low maintenance.

¹The questions are associated with the Naval Architect's experience and not to a specific design

2. Consequently, can you identify the main design drivers for the design of this type of vessels?

For the LNGBV, the LNG volume and size matter. There is a trade-off to be made between sailing more and return often to port to fill the tanks and to have a higher capacity so sailing less to port. For the LNGBV, manoeuvrability and mooring are important to be taken into account. The main dimensions (draft limitations) are also important as well. The fuel consumption for the LNGBV is not so important as there is also, the boil off gas system. For the heavy lift cargo vessels, the Naval Architect has to check the modules related to cranes, roll-on and roll-off and float-in/float-out, the maximum single load should be also checked, and weight in combination with size should be addressed (manoeuvring between the cranes).

3. Do you think that the design requirements are changing through the years? If this is the case, can you identify the current trend?

There is a current trend to focus on the offshore market. Bureau Veritas has adopted wind loads from the MODU code to evaluate wind heeling moments on crane ships, when performing a lift. This is an example where stringent offshore rules are adopted for other purposes as well. Evacuation analysis shall be carried out for passenger ships constructed on or after the 1st of January 2020 carrying more than 36 passengers and the same applies automatically for Special Purpose Ships carrying more than 240 PoB. The trend to use LNG as fuel, results in applying the rules for Gas Fuelled Ships more often. Some clients request to have their vessel LNG-ready, without installing tanks and piping. There are International Rules for the Gas Fueled Ships. In addition clients request more often for improved comfort onboard, reduced environmental footprint, modular units, easy retrofit and replacement.

4. Which are the technical challenges of dealing with the concept design of LNGBVs and heavy lift cargo vessels?

Finding the optimum balance between the client requirements, OPEX, CAPEX and regulations.

5. Can you describe the concept design procedure? Which are the important design decisions which have to be made?

Study of the reference vessels and find out what really matters for the owner and create a quick GA sketch and hull shape. The light ship weight can be estimated and a preliminary subdivision can be applied, to perform the most critical calculations with respect to power/resistance, freeboard, draft and stability, while meeting all relevant criteria.

6. Do you think that the contribution of ACD would lead to better design alternatives regarding the concept design of different vessels?

Yes, for sure. However, there are computational limitations (think about CFD or probabilistic damaged stability). Still, human intelligence in creative tasks is essential.

7. Discuss some design alternatives (maybe specific systems) that you have to evaluate?

8. According to your personal experience as a Naval Architect, do you think that your professional experience gained from previous concepts plays a role in improving your designs? How? Explain.

The transfer of knowledge from project to provide solutions at other projects is a key characteristic that you gain by experience.

9. According to your personal experience, can you outline aspects of the concept design process which need to be improved?

Combine experience from different fields. Information, engineering tricks and knowledge should be accessible to everyone.

A.5. Interview with Basjan Faber (16.04.2019)

Basjan will give an insight about the concept design of passenger vessels. Basjan is managing director and owner of C-Job Naval Architects.

The questions² are the following:

1. According to your experience, which are the vessel's design characteristics that are associated with the client's requirements in most of the cases?

The design drivers were associated with the passenger logistics. A big portion of economic benefit for the company was the money spent onboard. Thus, the optimization objective was to optimize the amount of money spent onboard by performing suitable arrangements.

2. Consequently, can you identify the main design drivers for the design of this type of vessels?

The design drivers were safety (leading the arrangements) and comfort (ergonomics).

3. Do you think that the design requirements are changing through the years? If this is the case, can you identify the current trend?

Life is changing quickly thus, modular design needs to be taken into account. Therefore, economic retrofit of the arrangements is an important aspect.

4. Which are the technical challenges of dealing with the concept design of passenger vessels?

The technical challenges were associated with the logistics, safety, and comfort of the passengers.

5. Can you describe the concept design procedure of the passenger vessels? Which are the important design decisions which have to be made?

Guided from the owners' requirements and by checking the reference database, the first sketch is being made.

6. Regarding passenger vessels, do you think that the contribution of ACD would lead to better design alternatives?

Yes, definitely!

7. Discuss some design alternatives (maybe specific systems) that you have to evaluate?

Different technical solutions were examined such as different propellers, number of engines, type of propulsion, fuels and the implementation of batteries.

8. According to your personal experience as a Naval Architect, do you think that your professional experience gained from previous concepts plays a role in improving your designs? How? Explain.

Design knowledge is gained via previous designs. Sometimes if you are experienced, you think in an over-constrained way and your creativity is blocked. In the passenger vessels, 60% is engineering work and 40% is artwork.

²The questions are associated with the Naval Architect's experience and not to a specific design

B

OOS of the LNGBV

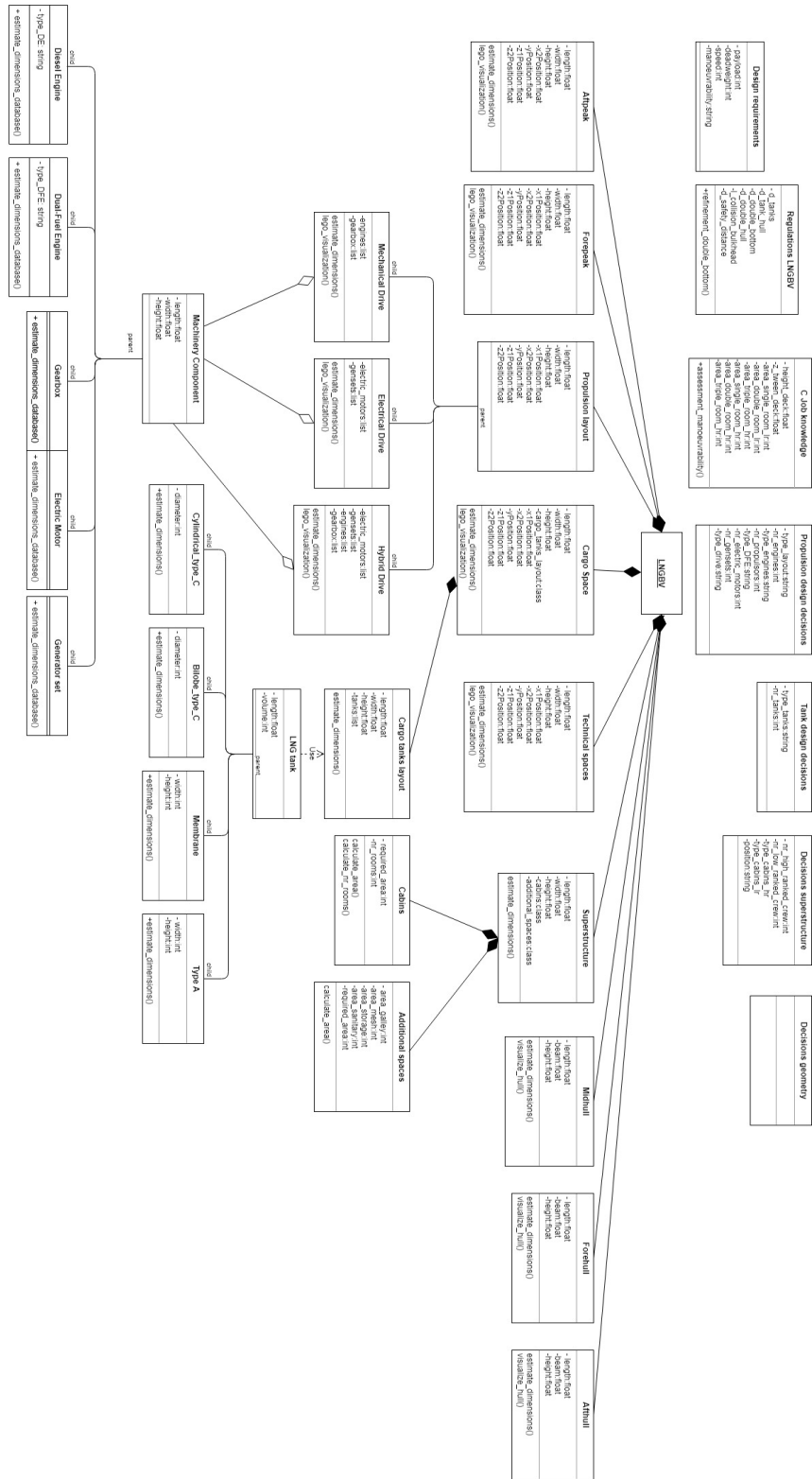
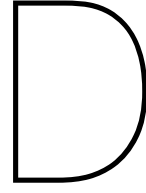

Figure B.1: OOS of the LNGBV

C

Electric Load Balance Sheet



Equations for the mathematical representation of the HLPs

D.1. Engine Room

Layout 1

The equations for the sizing of the virtual box containing the required machinery components are the following:

$$Length_{VB} = Length_{MainEngine} + Length_{Genset} + 3 * d_{safety} \quad (D.1)$$

where the type of the mechanical propulsion is direct drive

$$Length_{VB} = Length_{MainEngine} + Length_{Genset} + 3 * d_{safety} \quad (D.2)$$

where the type of the mechanical propulsion is geared drive

$$Width_{VB} = \max[Nr_{ME} * Width_{ME} + (Nr_{ME} + 1) * d_{safety}, Nr_{GS} * Width_{GS} + (Nr_{GS} + 1) * d_{safety}] \quad (D.3)$$

$$Height_{VB} = \max[Height_{MainEngine}, Height_{Genset}] + z_{Overhauling} \quad (D.4)$$

Thus, the equations for the sizing of the engine room are the following:

$$Length_{ER} = Length_{VB} * (1 + coeff_{length}) \quad (D.5)$$

$$Width_{ER} = Width_{VB} * (1 + coeff_{width}) \quad (D.6)$$

$$Height_{ER} = Height_{VB} \quad (D.7)$$

The equations for the weight estimation are the following:

$$Weight_{ER} = Weight_{MainMachinery} * (1 + coeff_{weight}) \quad (D.8)$$

The equations for the geometrical representation are the following:

$$X1_{ER} = Length_{AP} \quad (D.9)$$

$$X2_{ER} = X1_{ER} + Length_{ER} \quad (D.10)$$

$$Y1_{ER} = 0 \quad (D.11)$$

$$Y1_{ER} = Width_{ER}/2 \quad (D.12)$$

$$X2_{ER} = X1_{ER} + Length_{ER} \quad (D.13)$$

$$Z1_{ER} = Z_{TweenDeck} \quad (D.14)$$

$$Z2_{ER} = Z_{TweenDeck} + Height_{ER} \quad (D.15)$$

$$LCG_{ER} = (X1_{ER} + X2_{ER})/2 \quad (D.16)$$

Layout 2

The equations for the sizing of the engine room, the weight estimation and the geometrical representation are similar to those presented for Layout 1. However, the equations for the sizing of the virtual box containing the machinery components are the following:

$$Length_{ER} = Length_{EM} + Length_{GS} + 3 * d_{safety} \quad (D.17)$$

$$Width_{ER} = Nr_{GS} * Width_{GS} + (Nr_{GS} + 1) * d_{safety} \quad (D.18)$$

$$Height_{ER} = Height_{GS} + z_{Overhauling} \quad (D.19)$$

Layout 3

Regarding this type of layout, two engine rooms are created in order to fit the necessary equipment. The one is placed on the aft of the vessel and the other one on the fore part according to Figure 4.10. Therefore, The equations for the sizing of the virtual box containing the required machinery components are the following:

$$Length_{VB}^{aft} = Length_{EM} + 2 * d_{safety} \quad (D.20)$$

$$Width_{VB}^{aft} = Nr_{EM} * Width_{EM} + (Nr_{EM} + 1) * d_{safety} \quad (D.21)$$

$$Height_{VB}^{aft} = Height_{HumanSpace} \quad (D.22)$$

$$Length_{VB}^{fore} = Length_{GS} + 3 * d_{safety} \quad (D.23)$$

$$Width_{VB}^{fore} = Nr_{GS} * Width_{GS} + (Nr_{GS} + 1) * d_{safety} \quad (D.24)$$

$$Height_{VB}^{fore} = Height_{GS} + z_{Overhauling} \quad (D.25)$$

Thus, the equations for the sizing of the engine rooms are the following:

$$Length_{ER}^{aft} = Length_{VB}^{aft} * (1 + coeff_{length}^{aft}) \quad (D.26)$$

$$Width_{ER}^{aft} = Width_{VB}^{aft} * (1 + coeff_{width}^{aft}) \quad (D.27)$$

$$Height_{ER}^{aft} = Height_{VB}^{aft} \quad (D.28)$$

$$Length_{ER}^{fore} = Length_{VB}^{fore} * (1 + coeff_{length}^{fore}) \quad (D.29)$$

$$Width_{ER}^{fore} = Width_{VB}^{fore} * (1 + coeff_{width}^{fore}) \quad (D.30)$$

$$Height_{ER}^{fore} = Height_{VB}^{fore} \quad (D.31)$$

The equations for the weight estimation are the following:

$$Weight_{ER}^{aft} = Weight_{MM}^{aft} * (1 + coeff_{weight}^{aft}) \quad (D.32)$$

$$Weight_{ER}^{fore} = Weight_{MM}^{fore} * (1 + coeff_{weight}^{fore}) \quad (D.33)$$

The equations for the geometrical representation are the following:

$$X1_{ER} = Length_{AP} \quad (D.34)$$

$$X2_{ER} = X1_{ER} + Length_{ER}^{fore} \quad (D.35)$$

$$X3_{ER} = Length_{AftSpaces} + Length_{MidSpaces} \quad (D.36)$$

$$X4_{ER} = X3_{ER} + Length_{ER}^{fore} \quad (D.37)$$

$$Y1_{ER} = 0 \quad (D.38)$$

$$Y2_{ER} = Y1_{ER} + Width_{ER}^{aft}/2 \quad (D.39)$$

$$Y3_{ER} = 0 \quad (D.40)$$

$$Y4_{ER} = Y3_{ER} + Width_{ER}^{fore}/2 \quad (D.41)$$

$$Z1_{ER} = Z_{TweenDeck} \quad (D.42)$$

$$Z2_{ER} = Z_{TweenDeck} + Height_{ER}^{aft} \quad (D.43)$$

$$Z3_{ER} = Z_{DB} \quad (D.44)$$

$$Z4_{ER} = Z3_{ER} + Height_{ER}^{fore} \quad (D.45)$$

$$LCG_{ER}^{aft} = (X1_{ER} + X2_{ER})/2 \quad (D.46)$$

$$LCG_{ER}^{fore} = (X3_{ER} + X4_{ER})/2 \quad (D.47)$$

Layout 4

The equations for the sizing of the engine room, the weight estimation and the geometrical representation are similar to those presented for Layout 1. However, the equations for the sizing of the virtual box containing the machinery components are the following:

$$Length_{ME} + Length_{GB} + Length_{GS} + 4 * d_{safety} \quad (D.48)$$

$$Width_{ER} = \max(Nr_{GS} * Width_{GS} + (Nr_{GS} + 1) * d_{safety}, Nr_{ME} * Width_{ME} + Nr_{EM} * Width_{EM} + (Nr_{ME} + Nr_{EM} + 1) * d_{safety}) \quad (D.49)$$

$$Height_{ER} = \max(Height_{GS}, Height_{ME}) + z_{Overhauling} \quad (D.50)$$

Layout 5

The equations for the sizing of the engine room, the weight estimation and the geometrical representation are similar to those presented for Layout 3. However, the equations for the sizing of the virtual boxes containing the machinery components are the following:

$$Length_{ER}^{aft} = Length_{ME} + Length_{GB} + 3 * d_{safety} \quad (D.51)$$

$$Width_{ER}^{aft} = Nr_{EM} * Width_{EM} + Nr_{ME} * Width_{ME} + (Nr_{EM} + Nr_{ME} + 1) * d_{safety} \quad (D.52)$$

$$Height_{ER}^{aft} = Height_{HumanSpace} \quad (D.53)$$

$$Length_{ER}^{fore} = Length_{GS} + 3 * d_{safety} \quad (D.54)$$

$$Width_{ER}^{fore} = Nr_{GS} * Width_{GS} + (Nr_{GS} + 1) * d_{safety} \quad (D.55)$$

$$Height_{ER}^{fore} = Height_{GS} + z_{Overhauling} \quad (D.56)$$

D.2. Technical Spaces

The equations for the sizing of the virtual box containing the required technical components for the LNGBV are the following:

$$Length_{VB} = \sum_{1}^n Length_{TS_i} + (n + 1) * d_{safety} \quad (D.57)$$

where n is the number of the defined technical spaces

$$Width_{VB} = \max(Width_{TS_i}) + 2 * d_{safety} \quad (D.58)$$

where $i=1,\dots,n$

$$Height_{VB} = \max(Height_{TS_i}) + d_{safety} \quad (D.59)$$

where $i=1,\dots,n$ Thus, the equations for the sizing of the technical spaces are the following:

$$Length_{TS} = Length_{VB} * (1 + coeff_{length}) \quad (D.60)$$

$$Width_{TS} = Width_{VB} * (1 + coeff_{width}) \quad (D.61)$$

$$Height_{TS} = Height_{VB} \quad (D.62)$$

The equations for the weight estimation are the following:

$$Weight_{TS} = \sum_1^n Weight_{TS_i} * (1 + coeff_{weight}) \quad (D.63)$$

where n is the number of the defined technical spaces

The equations for the geometrical representation are the following:

If the technical spaces are positioned on the aft part of the hull:

$$X1_{TS} = Length_{AP} + Length_{AP}^{AftPart} \quad (D.64)$$

$$Z1_{TS} = Z_{Tweendeck} \quad (D.65)$$

If the technical spaces are positioned on the fore part of the hull:

$$X1_{TS} = Length_{AftHull} + Length_{ForeHull} + Length_{Cofferdam} \quad (D.66)$$

$$Z1_{TS} = Z_{DB} \quad (D.67)$$

If the technical spaces are positioned on the main deck:

$$X1_{TS} = Length_{AftHull} + Length_{MidHull} * coeff_{positioning} \quad (D.68)$$

$$Z1_{TS} = Z_{MainDeck} \quad (D.69)$$

The rest of the equations apply in every positioning case:

$$X2_{TS} = X1_{TS} + Length_{TS} \quad (D.70)$$

$$Y1_{TS} = 0 \quad (D.71)$$

$$Y2_{TS} = Width_{TS}/2 \quad (D.72)$$

$$Z2_{TS} = Z1_{TS} + Height_{TS} \quad (D.73)$$

$$LCG_{TS} = (X1_{TS} + X2_{TS})/2 \quad (D.74)$$

D.3. Cargo Space

For the sizing of the LNG tanks the following equations apply:

$$Length_{tanks} = Volume_{LNG}/(a_{filling} * \pi * d^2/4) \quad (D.75)$$

$$Diameter_{tanks} = Length_{tanks}/Ratio \quad (D.76)$$

If the type of LNG tanks is bi-lobe:

$$Length_{tanks} = Volume_{LNG}/(a_{filling} * coeff_{red} * \pi * d^2/4) \quad (D.77)$$

where $1 < coeff_{red} < 2$

$$Length_{tanks}/Diameter_{tanks} = ratio \quad (D.78)$$

If the type of LNG tanks is membrane or type A:

$$Length_{tank} * Width_{tank} * Height_{tank} * coeff_{red} * a_{filling} = Volume_{LNG} \quad (D.79)$$

where $coeff_{red} < 1$

For the sizing of the virtual box containing the LNG tanks:

If the type of LNG tanks is cylindrical and the $Nr_{tanks} = 1$:

$$Length_{VB} = Length_{tanks} \quad (D.80)$$

$$Width_{VB} = Diameter_{tanks} \quad (D.81)$$

$$Height_{VB} = Diameter_{tanks} \quad (D.82)$$

If the type of LNG tanks is cylindrical and the $Nr_{tanks} = 2$:

$$Length_{VB} = 2 * Length_{tanks} + 2 * d_{safety} + Length_{Cofferdam} \quad (D.83)$$

$$Width_{VB} = Diameter_{tanks} \quad (D.84)$$

$$Height_{VB} = Diameter_{tanks} \quad (D.85)$$

If the type of LNG tanks is cylindrical and the $Nr_{tanks} = 4$:

$$Length_{VB} = 2 * Length_{tanks} + 2 * d_{safety} + Length_{Cofferdam} \quad (D.86)$$

$$Width_{VB} = Diameter_{tanks} + d_{safety} \quad (D.87)$$

$$Height_{VB} = Diameter_{tanks} \quad (D.88)$$

If the type of LNG tanks is bi-lobe:

$$Length_{VB} = \sum_1^{Nr_{tanks}} Length_{tanks} + Nr_{tanks} * d_{safety} + (Nr_{tanks} - 1) * Length_{Cofferdam} \quad (D.89)$$

$$Width_{VB} = coeff'_{red} * Diameter_{tanks} \quad (D.90)$$

$$Height_{VB} = Diameter_{tanks} \quad (D.91)$$

If the type of LNG tanks is membrane or type A:

$$Length_{VB} = Length_{tank} \quad (D.92)$$

$$Width_{VB} = Width_{tank} \quad (D.93)$$

$$Height_{VB} = Height_{tank} \quad (D.94)$$

For the sizing of the cargo space:

$$Length_{CS} = Length_{VB} + 2 * d_{safety} \quad (D.95)$$

$$Width_{CS} = Width_{VB} + 2 * d_{safety} \quad (D.96)$$

$$Height_{CS} = Height_{VB} + 2 * d_{safety} \quad (D.97)$$

The equations for the weight estimation are the following:

$$Weight_{CS} = a * volume_{tanks} * (1 + coeff_{weight}) \quad (D.98)$$

where a: specific weight of tanks [ton/m^3]

The equations for the geometrical representation are the following:

$$X1_{CS} = Length_{AftHull} \quad (D.99)$$

$$X2_{CS} = X1_{CS} + Length_{AftHull} \quad (D.100)$$

$$Y1_{CS} = 0 \quad (D.101)$$

$$Y2_{CS} = Width_{CS}/2 \quad (D.102)$$

$$Z1_{CS} = Z_{DB} \quad (D.103)$$

$$Z2_{CS} = Z1_{CS} + Height_{CS} \quad (D.104)$$

$$LCG_{CS} = (X1_{CS} + X2_{CS})/2 \quad (D.105)$$

D.4. Superstructure

In order to calculate the required floor area of the superstructure:

$$Area_{req} = Area_{cabins} + Area_{AdditionalSpaces} \quad (D.106)$$

The equations for the sizing of the superstructure are the following:

$$\sum_i Length_{Deck_i} * Width_{Deck_i} * (Nr_{decks} - 1) = Area_{req} \quad (D.107)$$

where $i=1\dots(Nr_{decks} - 1)$ as the wheelhouse is not taken into account

$$Width_{SS}^{max} = B_{midhull} * coeff_{width} \quad (D.108)$$

If the superstructure is placed on the aft part of the hull:

$$Length_{SS}^{max} = Length_{AftHull} - Area_{MooringSpace} \quad (D.109)$$

If the superstructure is placed on the fore part of the hull:

$$Length_{SS}^{max} = Length_{ForeHull} - Area_{MooringSpace} \quad (D.110)$$

The equations for the weight estimation of the superstructure can be found in [54].

The equations for the geometrical representation depend on the design of the different layers.

D.5. Bow thruster room

Regarding the sizing of the bow thruster room, the following equations apply:

$$Length_{BTR} = Length_{BowThruster} * (1 + coeff_{length}) \quad (D.111)$$

$$Height_{BTR} = (Radius_{BowThruster} * X_{BowThruster}^{center}) * (1 + coeff_{height}) \quad (D.112)$$

if $Height_{BTR} < Height_{access}$: $Height_{BTR} = Height_{access}$ (D.113)

Regarding the weight estimation of the bow thruster room, the following equation applies:

$$Weight_{BTR} = Weight_{BowThruster} * (1 + coeff_{weight}) \quad (D.114)$$

The equations for the geometrical representation are the following:

$$X2_{BTR} = X1_{Forepeak} \quad (D.115)$$

$$X1_{BTR} = X2_{BTR} - Length_{BTR} \quad (D.116)$$

$$Z1_{BTR} = Z_{DB} \quad (D.117)$$

$$Z2_{BTR} = Z1_{BTR} + Height_{BTR} \quad (D.118)$$

$$LCG_{BTR} = (X1_{BTR} + X2_{BTR})/2 \quad (D.119)$$

D.6. Forepeak

Regarding the sizing of the forepeak, the following equation applies:

$$Length_{FP} = d_{CollisionBulkhead} = F(Loa_{LNGBV}) \quad (D.120)$$

D.7. Aftpeak

As a generic empirical rule, the sizing of the aftpeak can be defined as:

$$Length_{AP} = coeff_{AP} * Loa_{LNGBV} \quad (D.121)$$

where $coeff_{AP}$ is defined by C-Job knowledge base.

However, if the type of propulsion is mechanical drive:

$$Length_{AP} \geq Length_{SteeringGearRoom} \quad (D.122)$$

D.8. Afthull

For the sizing of the afthull the following equations were implemented:

$$Length_{AH} = \sum_1^n Length_{InnerBlock_i} \quad (D.123)$$

where n is the number of blocks located in the afthull.

$$Beam_{AH} = Beam_{MH} \quad (D.124)$$

$$Depth_{AH} = Depth_{MH} \quad (D.125)$$

The equations for the weight estimation are the following:

$$coeff_{wt}^{AH} = Length_{AH}/Loa_{LNGBV} \quad (D.126)$$

$$Weight_{AH} = coeff_{wt}^{AH} * LSW_{pred}^{Hull} \quad (D.127)$$

Due to the complexity of the hull shape, the equations for the geometrical representation will not be presented in detail. However, the LCG is estimated as follows:

$$X1_{AH} = 0 \quad (D.128)$$

$$X2_{AH} = Length_{AH} \quad (D.129)$$

$$LCG_{AH} = (X1_{AH} + X2_{AH})/2 \quad (D.130)$$

D.9. Midhull

For the sizing of the midhull the following equations were implemented:

$$Length_{MH} = Length_{CS} \quad (D.131)$$

$$Beam_{MH} = Width_{CS} + 2 * d_{DH} \quad (D.132)$$

$$Depth_{MH} = Height_{CS} + d_{DB} \quad (D.133)$$

The equations for the weight estimation are the following:

$$coeff_{wt}^{MH} = Length_{MH}/Loa_{LNGBV} \quad (D.134)$$

$$Weight_{MH} = coeff_{wt}^{MH} * LSW_{pred}^{Hull} \quad (D.135)$$

Due to the complexity of the hull shape, the equations for the geometrical representation will not be presented in detail. However, the LCG is estimated as follows:

$$X1_{MH} = Length_{AH} \quad (D.136)$$

$$X2_{MH} = Length_{AH} + Length_{MH} \quad (D.137)$$

$$LCG_{MH} = (X1_{MH} + X2_{MH})/2 \quad (D.138)$$

D.10. Forehull

For the sizing of the forehull the following equations were implemented:

$$Length_{FH} = \sum_1^n Length_{InnerBlock_i} \quad (D.139)$$

where n is the number of blocks located in the forehull.

$$Beam_{FH} = Beam_{MH} \quad (D.140)$$

$$Depth_{FH} = Depth_{MH} \quad (D.141)$$

The equations for the weight estimation are the following:

$$coeff_{wt}^{FH} = Length_{FH} / Loa_{LNGBV} \quad (D.142)$$

$$Weight_{FH} = coeff_{wt}^{FH} * LSW_{pred}^{Hull} \quad (D.143)$$

Due to the complexity of the hull shape, the equations for the geometrical representation will not be presented in detail. However, the LCG is estimated as follows:

$$X1_{AH} = Length_{AH} + Length_{MH} \quad (D.144)$$

$$X2_{AH} = Length_{AH} + Length_{MH} + Length_{FH} \quad (D.145)$$

$$LCG_{AH} = (X1_{FH} + X2_{FH}) / 2 \quad (D.146)$$

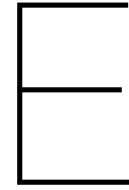

Tuning of the engine room's machinery components

E.1. Diesel Engines

Regarding the sizing of the diesel engines, a total of 336 engines was used for the estimation of the dimensions of the required diesel engine(s). Firstly, the trends of the dimensions (length, width, height) versus the maximum output power were investigated. The data-sets and the associated trend lines are depicted in Figure E.1.

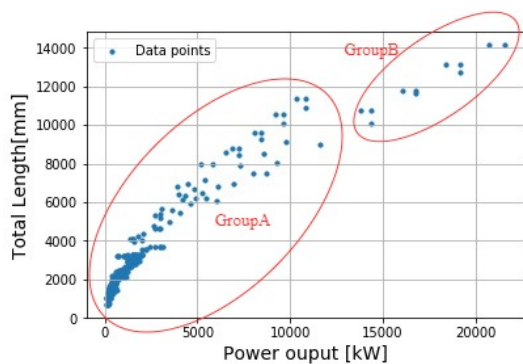

(a) Length=f(MCR)

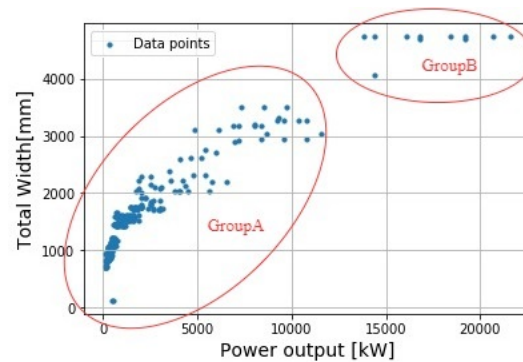

(b) Width=f(MCR)

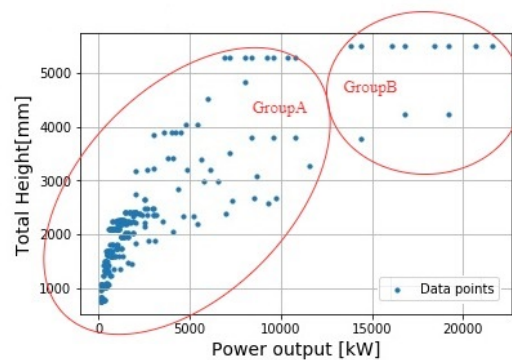

(c) Height=f(MCR)

FigureE.1: Dimensions of the Diesel Engines versus their power output

The results show that the predicted length is sufficient for the requested level of precision. On the other

hand, for the estimation of the width, there are no data points in the range of $11600 - 14000kW$. In order to improve the results of the predicted dimensions, the dataset was split into two subsets, namely from $0 - 11600kW$ and from $13800 - 21600kW$. The values included in the range of $11600kW$ to $13800kW$ will be overestimated as the requested MCR was $13800kW$. In this way, it is ensured that the required equipment will fit in the engine room. The two different groups follow different dimensioning trends. Regarding group A, the length is approximated by polynomial regression (2nd order), an exponential function estimates the height and the width. The results are shown in Figure E.2a, E.2b, E.2c. Similarly, for group B, the length is predicted by using linear regression (Figure E.2d). For the width and the height, there is no design trend; thus, the maximum values will be used to ensure adequate space reservation. However, this is a default option which can be changed in the developed framework.

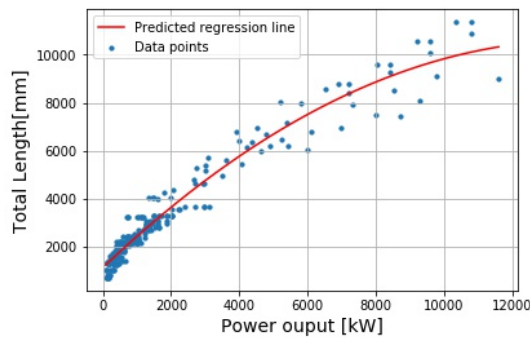

(a) Length=f(MCR) group A

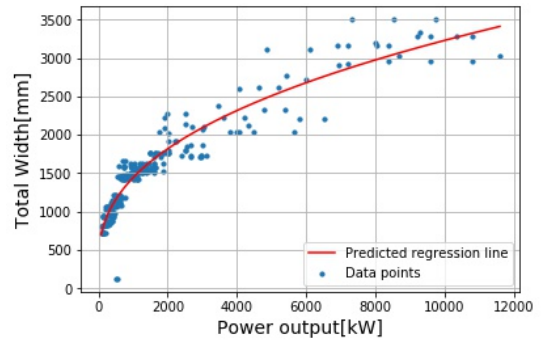

(b) Width=f(MCR) group A

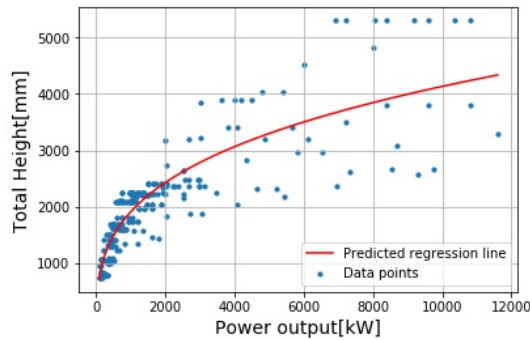

(c) Height=f(MCR) group A

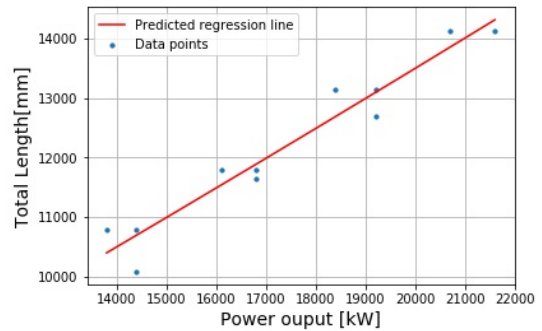

(d) Length=f(MCR) group B

FigureE.2: Regression results Diesel Engines

E.2. Dual-Fuel (DF) Engines

Regarding the sizing of the DF engines, a total of 51 engines was used for the prediction of the dimensions. The trends of the dimensions (length, width, height) versus the maximum output power were investigated. The results are shown in Figure E.3.

Regarding the available data, the DF engines can be divided into two subgroups, group A and B, to improve the predicted results. As it can be seen in Figure E.3a, DF engines in Group B have lower length values compared with DF engines in Group A. For the engine's width, there is lack of data regarding DF engines in Group B. Finally, DF engines in Group B have higher height values compared with DF engines in Group A. Trends can be only determined for the length (Group A and B) and the width (Group A). Figure E.4 shows the results.

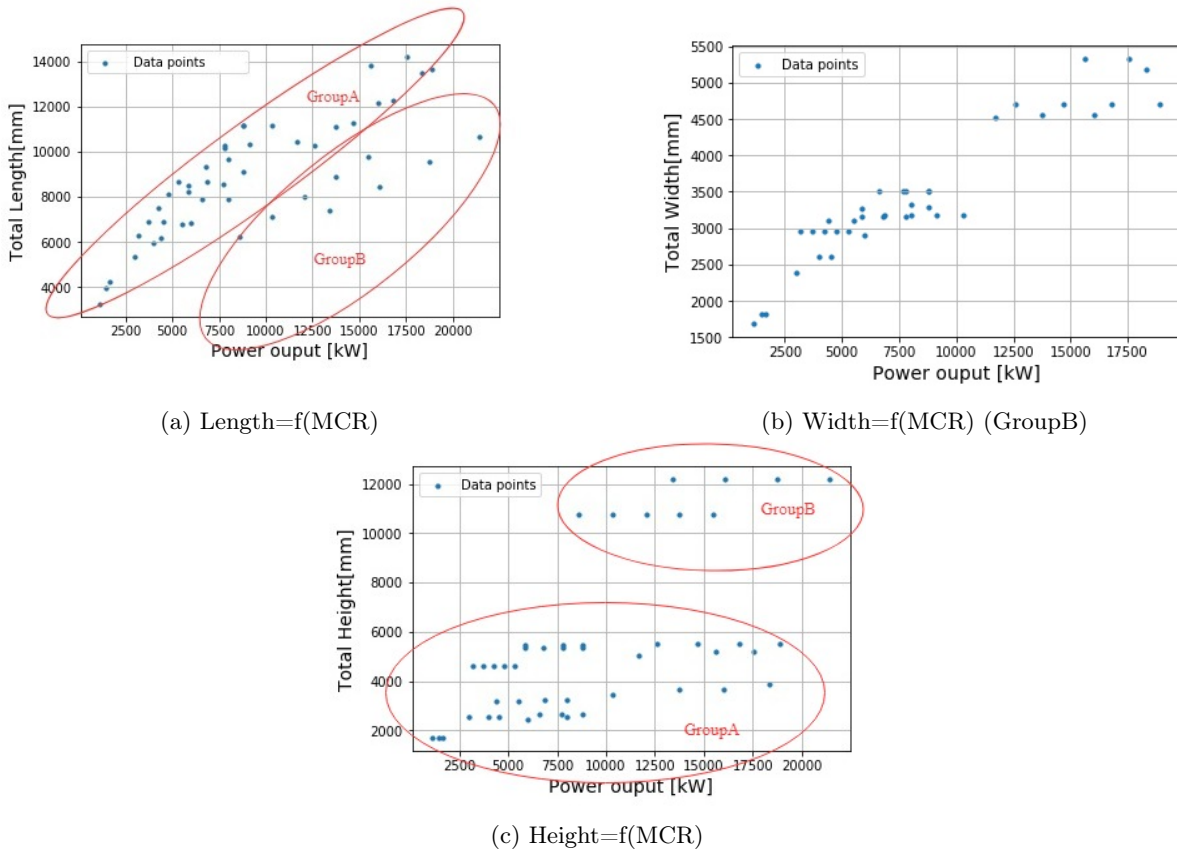

FigureE.3: Dimensions of the DF Engines versus their power output

It should be noted that suitable approximations should be adopted for the predictions associated with the missing data. Thus, it was decided that the data of DF engines in Group A will be used to predict the width of those in Group B. Besides, the maximum values of height will be used for both Group A and Group B to ensure adequate space reservation (this decision was set as default but it can be changed according to needs and experience).

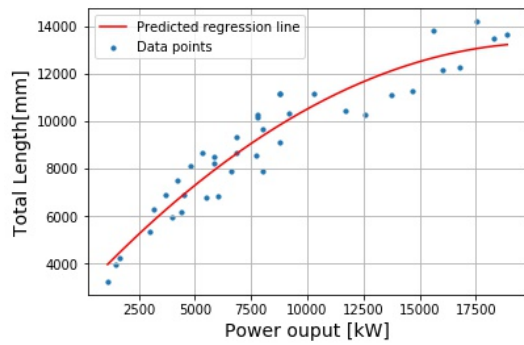

(a) Length=f(MCR) group A

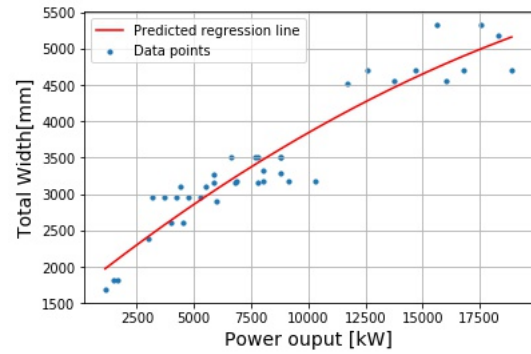

(b) Width=f(MCR) group A

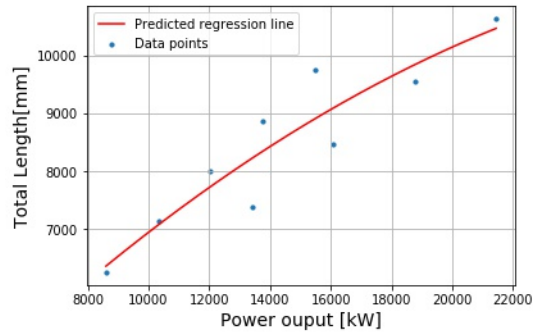

(c) Length=f(MCR) group B

FigureE.4: Regression results DF Engines

E.3. Gearboxes

For the dimensioning of the gearboxes, a trend for the estimation of the width and the height can not be identified. Thus, an exponential fit is solely defined for the length of the gearbox according to the output power (Figure E.6). For the width and the height, the maximum value is being used as a default input in order to ensure space reservation.

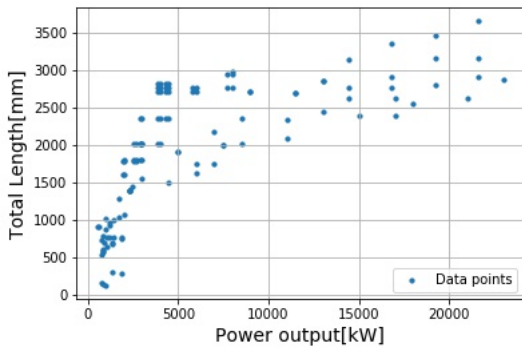

(a) Length=f(MCR)

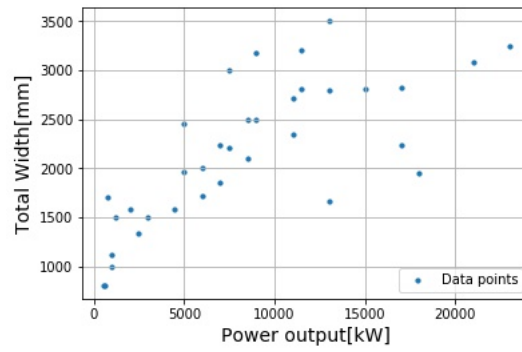

(b) Width=f(MCR)

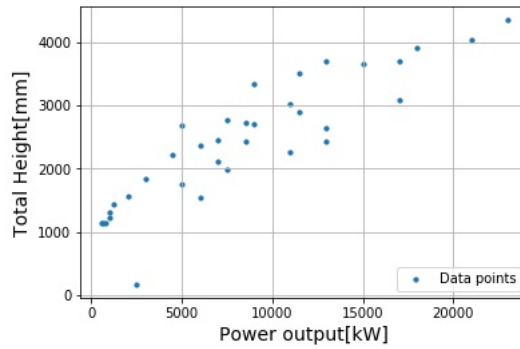

(c) Height=f(MCR)

FigureE.5: Dimensions of the GB versus their power output

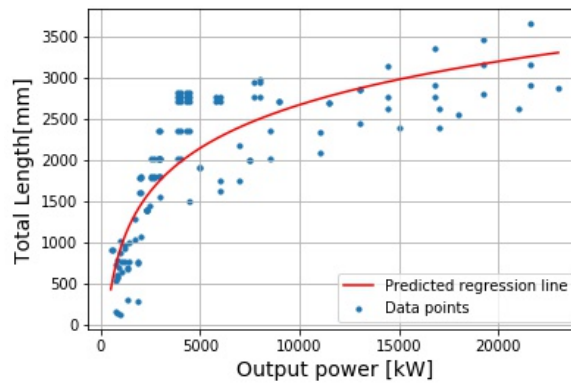

FigureE.6: Regression results Gearboxes

E.4. Generator Sets

For the generator sets, a data set of 339 generator sets was examined. The trends between the principal dimensions of the machinery component and the power output are shown in Figures E.7a-E.7c.

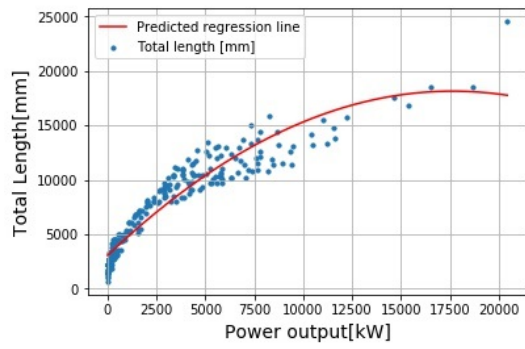

(a) Length=f(MCR)

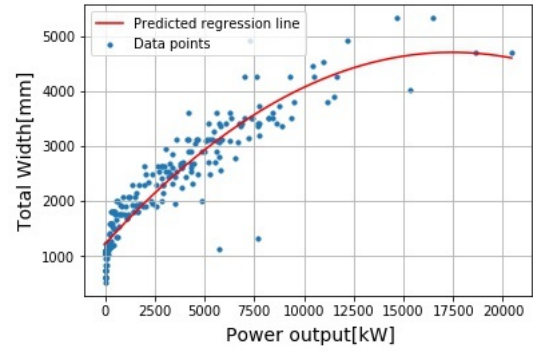

(b) Width=f(MCR)

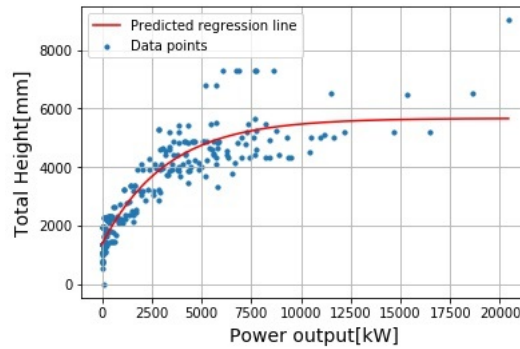

(c) Height=f(MCR)

FigureE.7: Dimensions of the Generator sets versus their power output

E.5. Electric Motors

Regarding the electric motors, a dimensioning trend was identified between the length and the power output. However, the result is not accurate, but it is sufficient for the level of detail that is required. Besides, the dimensions of the electric motor do not play a crucial role in the design of the engine room as these are relatively small machinery components.

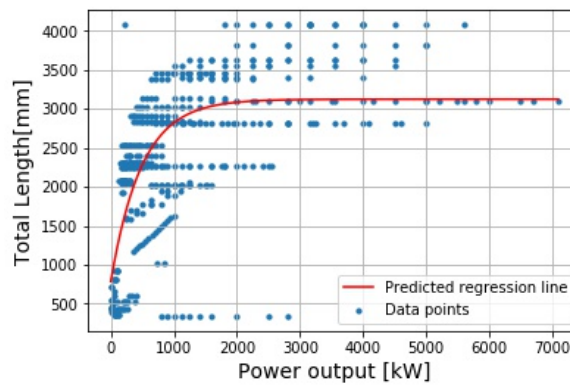

FigureE.8

F

LNGBV: C-Job's design

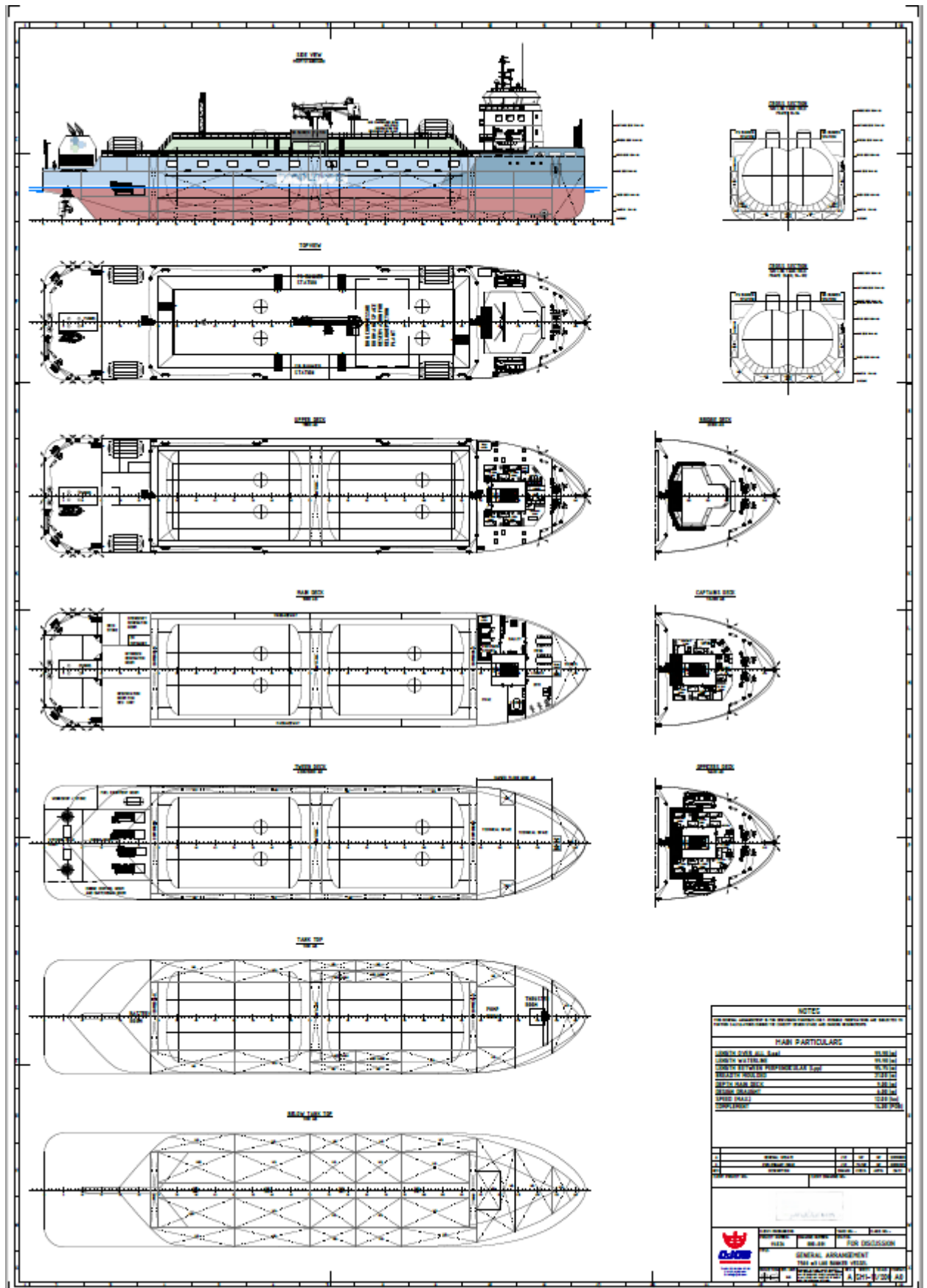

Figure F.1: LNGBV: C-Job's design

Acronyms

- ABS American Bureau of Shipping. 32, 43
- ACD Accelerated Concept Design. ix, 2, 9–11, 13, 28, 68, 72–74, 80, 81, 83, 84
- AHP Analytic Hierarchy Process. 16
- AI Artificial Intelligence. 13, 16
- BOG Boil-off Gas. ix, 20, 22–25, 28, 29, 32, 42, 43
- BWM Convention International Convention for the Control and Management of Ships' Ballast Water and Sediments. 45
- CAD Computer-Aided Design. 13, 14
- CAE Computer Aided Engineering. 13
- CEGO Constrained Efficient Global Optimization. 2
- CFD Computational Fluid Dynamics. 14, 71
- CPP Controllable Pitch Propeller. 26, 27
- DBB Design Building Block. 6, 12
- DEE Design and Engineering Engine. ix, 14, 15
- DF Dual-Fuel. viii–x, 22, 28–31, 43, 49, 54, 58, 63, 98–100
- EEDI Energy Efficiency Design Index. 12
- EM Electric Motor. 29–31
- FFD Free Form Deformation. 12
- Fn Froude Number. 53
- FPA Full Parametric Approach. 12
- FPP Fixed Pitch Propeller. 27, 63
- GB Gearbox. x, 31, 101
- GCU Gas Combustion Unit. 22, 43, 58, 59, 67
- HFO Heavy Fuel Oil. 44
- HLP High Level Primitive. 24, 25, 49, 51, 68, 72, 73, 75
- HLPs High Level Primitives. v, vii, 14, 16, 17, 23–25, 28, 35, 46, 47, 49–51, 56, 58, 71–73, 75
- IGC International Code of the Construction and Equipment of Ships Carrying Liquefied Gases in Bulk. 22, 31, 33
- IGF International Code of Safety for Ship Using Gases or Other Low-flashpoint Fuels. 22, 25

- IMO International Maritime Organization. 19, 20, 22, 45
- ISO/TS 18683:2015 Guidelines for systems and installations for supply of LNG as fuel to ships. 22
- KBE Knowledge Based Engineering. v, 2, 3, 12–16, 53, 71–73, 75
- KBSs Knowledge Based Systems. 13, 16
- LCB Longitudinal Center of Buoyancy. 56, 58, 63, 65, 67, 69
- LCG Longitudinal Center of Gravity. 56, 58, 63, 65, 67, 69, 95, 96
- LNG Liquefied Natural Gas. ix, 19, 20, 22, 23, 28, 29, 31–38, 42, 43, 50, 55, 58, 65, 83, 92, 93
- LNGBV LNG Bunkering Vessel. v, vii, ix, 2, 3, 16, 17, 19, 20, 22–26, 28, 30–34, 36, 38–42, 44–50, 52–54, 56, 58, 60, 69, 71–73, 80, 83, 91
- LNGBVs LNG Bunkering Vessels. 19, 20, 34, 53
- LSW lightship weight. 55, 57
- MARPOL International Convention for the Prevention of Pollution from Ship. 22
- MCR Maximum Continuous Rating. ix, 53, 54, 98
- MDO Multi Disciplinary Optimization. 14, 44
- MGO Marine Gas Oil. 22
- MLC Maritime Labour Convention. 22, 40
- MMG Multi Model Generator. 14
- NURBS Non-Uniform Rational B-splines. 11
- OOP Object Oriented Programming. 16, 25, 73
- OOS Object-Oriented Structure. x, 25, 49, 72, 86
- RFR Required Freight Rate. 12
- S-T-S Ship-To-Ship. ix, 19, 20, 22, 44
- TSHD Trailing Suction Hopper Dredger. ix, 9, 10
- WSH Whole Ship Model. 12

Bibliography

- [1] Understanding the design of liquefied gas carriers. <https://www.marineinsight.com/naval-architecture/understanding-design-liquefied-gas-carriers/>, . Accessed: 22-11-2019.
- [2] Worlds largest bilobe lng tanks near completion. <https://www.swzmaritime.nl/news/2013/12/05/worlds-largest-bilobe-lng-tanks-near-completion/?gdpr=accept>, . Accessed: 22-11-2019.
- [3] Imo c class equipment certified by furuise europe. <http://www.furuise.eu.com/en/maritime/>. Accessed: 22-11-2019.
- [4] Oizmendi. https://www.fleetmon.com/vessels/oizmendi_9494981_2031970/.
- [5] Boil-off gas handling onboard lng fuelled ships. <https://www.wartsila.com/twentyfour7/in-detail/boil-off-gas-handling-onboard-lng-fuelled-ships>. Accessed: 23-11-2019.
- [6] Coral methane - lng tanker. <https://www.marinetraffic.com/el/ais/details/ships/shipid:223928/imo:9404584/mmsi:244092000/vessel:CORAL%20METHANE>, .
- [7] Kairos - bunkering tanker. <https://www.marinetraffic.com/el/ais/details/ships/shipid:5625363/mmsi:209275000/imo:9819882/vessel:KAIROS>, .
- [8] Engie zeebrugge - imo 9750024. <https://www.scheepvaartwest.be/CMS/index.php/gas-tankers/7473-engie-zeebrugge-imo-9750024>, .
- [9] Coral methane - imo 9404584. <https://www.scheepvaartwest.be/CMS/index.php/gas-tankers/1321-coral-methane-imo-9404584>, .
- [10] Lng bunkering vessel. <http://www.revistanoticias.sener/en/news/lng-bunkering-vessel/5/>.
- [11] Lngf seagas. <http://www.siriussshipping.eu/ship/lngf-seagas/>, .
- [12] M/t coralius. <http://www.siriussshipping.eu/ship/mt-coralius/>, .
- [13] Lng containment systems: Finding the way for type a. <https://www.dnvgl.com/expert-story/maritime-impact/LNG-containment-systems-finding-the-way-for-Type-A.html>. Accessed: 22-11-2019.
- [14] Wsd50 7.5k, 7,500m3 lng carrier. <https://www.wartsila.com/marine/build/ship-design/merchant-gas-carriers/lng-carrier-wsd50-7-5k>.
- [15] W
- [16] Lng as ship fuel: Effects on ship design, operations and supporting infrastructure. New Technologies for the Marine Highway TRB Marine Highways Committee (AW010(1)), 2013.
- [17] Chapter 1 lng fundamentals. In Saeid Mokhatab, John Y. Mak, Jaleel V. Valappil, and David A. Wood, editors, Handbook of Liquefied Natural Gas, pages 1 – 106. Gulf Professional Publishing, Boston, 2014. ISBN 978-0-12-404585-9. doi: <https://doi.org/10.1016/B978-0-12-404585-9.00001-5>. URL <http://www.sciencedirect.com/science/article/pii/B9780124045859000015>.
- [18] 2016. URL <https://rules.dnvgl.com/docs/pdf/DNVGL/CG/2016-02/DNVGL-CG-0135.pdf>.
- [19] Boil-off gas handling onboard lng fuelled ships. <https://www.wartsila.com/twentyfour7/in-detail/boil-off-gas-handling-onboard-lng-fuelled-ships>, April 2016.
- [20] Guidance on lng bunkering to port authorities and administrations. <https://www.parismou.org/sites/default/files/EMSA%20Guidance%20on%20LNG%20Bunkering.pdf>, 2018.

- [21] Coral methane successfully executes lng bunkering operation on aidanova. <https://www.anthonyveder.com/coral-methane-bunkering-aidanova/>, 2019.
- [22] <http://www.liquefiedgascarrier.com/LNG-vessel-construction.html>, 2019.
- [23] D. Andrews. Marine requirements elucidation and the nature of preliminary ship design. *The International Journal of Maritime Engineering*, 153:A23–A39, 01 2011. doi: 10.3940/rina.ijme.2011.a1.202.
- [24] D Andrews. The sophistication of early stage design for complex vessels. *INTERNATIONAL JOURNAL OF MARITIME ENGINEERING*, 160:1–53, 2018.
- [25] D.J. Andrews. A creative approach to ship architecture. *The International Journal of Maritime Engineering*, 145, 01 2003. doi: 10.3940/rina.ijme.2003.a3.9031.
- [26] I Biliotti, Stefano Brizzolara, Michele Viviani, Giuliano Vernengo, Danilo Ruscelli, M Galliussi, and A Manfredini. Automatic parametric hull form optimization of fast naval vessels. 09 2011.
- [27] Marcus Bole. A strategy for closely integrating parametric generation and interactive manipulation in hull surface design. 03 2019.
- [28] Stefano Brizzolara, Giuliano Vernengo, Carlo Pasquinucci, and S Harries. Significance of parametric hull form definition on hydrodynamic performance optimization. *MARINE 2015 - Computational Methods in Marine Engineering VI*, pages 254–265, 01 2015.
- [29] John Calleya, Rachel Pawling, Christopher Ryan, and Henrique Gaspar. Using data driven documents (d3) to explore a whole ship model. pages 1–6, 06 2016. doi: 10.1109/SYSOSE.2016.7542947.
- [30] Daejun Chang, Taejin Rhee, Kiil Nam, Kwangpil Chang, Donghun Lee, and Samheon Jeong. A study on availability and safety of new propulsion systems for lng carriers. *Reliability Engineering System Safety*, 93(12):1877 – 1885, 2008. ISSN 0951-8320. doi: <https://doi.org/10.1016/j.res.2008.03.013>. URL <http://www.sciencedirect.com/science/article/pii/S0951832008001105>. 17th European Safety and Reliability Conference.
- [31] R.L.A de Jonge. Development of a knowledge-based engineering application to support conceptual fuselage sizing and cabin configuration, 2017.
- [32] Peter de Vos and Douwe Stapersma. Dimension prediction models of ship system components based on first principles. 05 2015.
- [33] Muller T. Furustam J. Back T. de Winter, R. Optimizing ships using the holistic accelerated concept design methodology. unpublished.
- [34] Roy de Winter, Bas van Stein, Matthys Dijkman, and Thomas Bäck. Designing ships using constrained multi-objective efficient global optimization. In Giuseppe Nicosia, Panos Pardalos, Giovanni Giuffrida, Renato Umeton, and Vincenzo Sciacca, editors, *Machine Learning, Optimization, and Data Science*, pages 191–203, Cham, 2019. Springer International Publishing. ISBN 978-3-030-13709-0.
- [35] E. Duchateau. Interactive Evolutionary Concept Exploration in Preliminary Ship Design. PhD thesis, Delft University of Technology, 2016.
- [36] Stein Erikstad. Efficient exploitation of existing corporate knowledge in conceptual ship design. *Ship Technology Research*, 54:184–193, 10 2007. doi: 10.1179/str.2007.54.4.005.
- [37] Stein Erikstad. Design for Modularity: Volume 1: Optimisation of Ship Design and Operation for Life Cycle, pages 329–356. 01 2019. ISBN 978-3-030-02809-1. doi: 10.1007/978-3-030-02810-7_10.
- [38] Henrique Gaspar. Data-driven ship design. 05 2018.
- [39] R.D. Geertsma, R.R. Negenborn, K. Visser, and J.J. Hopman. Design and control of hybrid power and propulsion systems for smart ships: A review of developments. *Applied Energy*, 194: 30 – 54, 2017. ISSN 0306-2619. doi: <https://doi.org/10.1016/j.apenergy.2017.02.060>. URL <http://www.sciencedirect.com/science/article/pii/S0306261917301940>.

- [40] Guan Guan, Qu Yang, Xiaole Yang, and Yunlong Wang. A new method for parametric design of hull surface based on energy optimization. *Journal of Marine Science and Technology*, 05 2018. doi: 10.1007/s00773-018-0562-2.
- [41] Austin Kana. Course introduction. *Introduction to MT 44035: Design of Complex Specials*, 4Q 2017/2018.
- [42] Aphrodite Kanellopoulou, Ageliki Kytariolou, Apostolos Papanikolaou, Vladimir Shigunov, and George Zaraphonitis. Parametric ship design and optimisation of cargo vessels for efficiency and safe operation in adverse weather conditions. *Journal of Marine Science and Technology*, 01 2019. doi: 10.1007/s00773-018-00620-1.
- [43] Kyunghwa Kim, Kido Park, Gillae Roh, and Kangwoo Chun. Case study on boil-off gas (bog) minimization for lng bunkering vessel using energy storage system (ess). *Journal of Marine Science and Engineering*, 7:130, 05 2019. doi: 10.3390/jmse7050130.
- [44] Sweet William N. Seymour Samuel J. Biemer Steven M. Kossiakoff, Alexander. John Wiley Sons, 2011. ISBN 978-0-470-40548-2. URL <https://app.knovel.com/hotlink/toc/id:kpSEPPE006/systems-engineering-principles/systems-engineering-principles>.
- [45] Jean Jacques Maisonneuve, S Harries, Jochen Marzi, H C Raven, Umberto Viviani, and H Piippo. *Towards optimal design of ship hull shapes*. 04 2019.
- [46] Jochen Marzi, Apostolos Papanikolaou, Philippe Corrigan, George Zaraphonitis, and Stefan Harries. *Holistic ship design for future waterborne transport*. 11 2018. doi: 10.5281/zenodo.1436316.
- [47] Dimitri Mavris and Daniel DeLaurentis. *Methodology for examining the simultaneous impact of requirements, vehicle characteristics, and technologies on military aircraft design*. 01 2000.
- [48] NAPA. *NAPA for Design Manuals 2017.3*. NAPA.
- [49] Horst Nowacki. Five decades of computer-aided ship design. *Computer-Aided Design*, 42:956–969, 11 2010. doi: 10.1016/j.cad.2009.07.006.
- [50] Horst Nowacki. A farewell to the design spiral. Invited Note Presented at the Mini-Symposium on Ship Design, Ship Hydrodynamics Maritime Safety, Athens, September 30, 2016.
- [51] M.I.G; Oleksiewicz B. Nowacki, H; Bloor. *Computational Geometry for Ships*. 1995.
- [52] C Papandreou and Apostolos Papanikolaou. Parametric design and multi-objective optimization of swath. 05 2015.
- [53] A. Papanikolaou. *A Hollistic Approach to Ship Design*. Springer, 2019.
- [54] Apostolos Papanikolaou. *Ship Design - Methodologies of Preliminary Design*. 09 2014. ISBN 978-94-017-8750-5. doi: 10.1007/978-94-017-8751-2.
- [55] Apostolos Papanikolaou, George Zaraphonitis, Evangelos Boulougouris, Uwe Langbecker, Sven Matho, and Pierre Sames. Multi-objective optimization of oil tanker design. *Journal of Marine Science and Technology*, 15:359–373, 12 2010. doi: 10.1007/s00773-010-0097-7.
- [56] Apostolos Papanikolaou, Maarten Flikkema, Stefan Harries, Jochen Marzi, Romain Néna, Sverre Torben, and Antti Yrjänäinen. *A holistic approach to ship design: Tools and applications*. 11 2019.
- [57] M. G. PARSONS. *Parametric Design*. 2003.
- [58] Alexandros Priftis, Evangelos Boulougouris, Osman Turan, and Apostolos Papanikolaou. Parametric design and multi-objective optimisation of containerships. 10 2016.
- [59] Carl Fredrik Rehn. *Ship Design under Uncertainty*. PhD thesis, 06 2018.

- [60] Gianfranco La Rocca. Knowledge based engineering: Between ai and cad. review of a language based technology to support engineering design. *Advanced Engineering Informatics*, 26(2):159 – 179, 2012. ISSN 1474-0346. doi: <https://doi.org/10.1016/j.aei.2012.02.002>. URL <http://www.sciencedirect.com/science/article/pii/S1474034612000092>. Knowledge based engineering to support complex product design.
- [61] J Romero Gómez, Manuel Romero-Gomez, Ramón García, and A De Miguel Catoira. On board lng reliquefaction technology: A comparative study. *Polish Maritime Research*, 21, 01 2013. doi: 10.2478/pomr-2014-0011.
- [62] F.M Sanches. Parametric modelling of hull form for ship optimization, 2016.
- [63] E.J. Schut and Michael Van tooren. Engineering primitives to reuse design process knowledge. 49th AIAA/ASME/ASCE/AHS/ASC Structures, Structural Dynamics and Materials Conference, 4th AIAA Multid. Design Optimization Specialis Conference, Schaumburg, Illinois, 7-10 April (2008), 04 2008. doi: 10.2514/6.2008-1804.
- [64] E.Joost Schut and Michael Van tooren. A knowledge based engineering approach to automation of conceptual design option selection. 01 2007. doi: 10.2514/6.2007-968.
- [65] M. Timur. A parametric modelling tool for high speed displacement monohulls, 2015.
- [66] Huan Tu. Options and Evaluations on Propulsion Systems of LNG Carriers. 02 2019. doi: 10.5772/intechopen.82154.
- [67] Johan Petter Tuttüren. Lng containment systems: Finding the way for type a, 2019. URL <https://www.dnvgl.com/expert-story/maritime-impact/LNG-containment-systems-finding-the-way-for-Type-A.html>,urldate={2019-07-24}.
- [68] Ties van Bruinessen, Hans Hopman, and Frido Smulders. Towards a different view on ship design: The development of ships observed through a social-technological perspective. volume 1, 06 2013. doi: 10.1115/OMAE2013-11585.
- [69] Bart van Oers. A Packing Approach for the Early Stage Design of Service Vessels. PhD thesis, 12 2011.
- [70] Michael Van tooren, Gianfranco La Rocca, L Krakkers, and Adriaan Beukers. Design and technology in aerospace. parametric modelling of complex structure systems including active components. 04 2019.
- [71] Wim J.C. Verhagen, Pablo Bermell-Garcia, Reinier E.C. van Dijk, and Richard Curran. A critical review of knowledge-based engineering: An identification of research challenges. *Advanced Engineering Informatics*, 26(1):5 – 15, 2012. ISSN 1474-0346. doi: <https://doi.org/10.1016/j.aei.2011.06.004>. URL <http://www.sciencedirect.com/science/article/pii/S147403461100036X>. Network and Supply Chain System Integration for Mass Customization and Sustainable Behavior.
- [72] H.K. Woud and D. Stapersma. Design of Propulsion and Electric Power Generation Systems. IMarEST publications. IMarEST, Institute of Marine Engineering, Science and Technology, 2002. ISBN 9781902536477. URL <https://books.google.nl/books?id=BzRdAAAACAAJ>.
- [73] Ying-Han Wu and Heiu Shaw. Document based knowledge base engineering method for ship basic design. *Ocean Engineering - OCEAN ENG*, 38:1508–1521, 09 2011. doi: 10.1016/j.oceaneng.2011.07.014.
- [74] H.Z. Yang, J.F. Chen, N. Ma, and D.Y. Wang. Implementation of knowledge-based engineering methodology in ship structural design. *Computer-Aided Design*, 44(3):196 – 202, 2012. ISSN 0010-4485. doi: <https://doi.org/10.1016/j.cad.2011.06.012>. URL <http://www.sciencedirect.com/science/article/pii/S0010448511001540>. Applications in Ship and Floating Structure Design and Analysis.