

# Studio Cité Noord

Amsterdam

---

Elana Bos

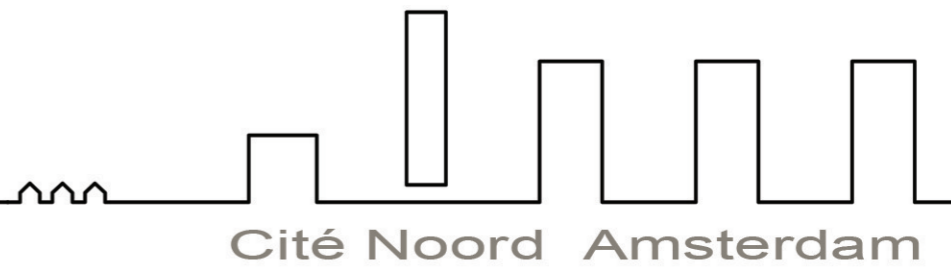

## Context

Situation & Developments

## Project Cité Noord

What is Cité Noord?

## Design

How Cité Noord should be

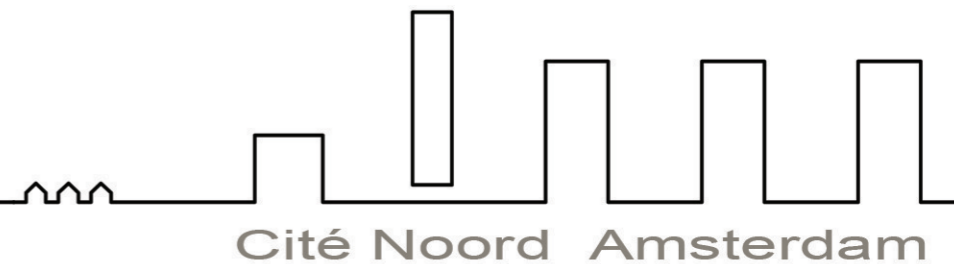



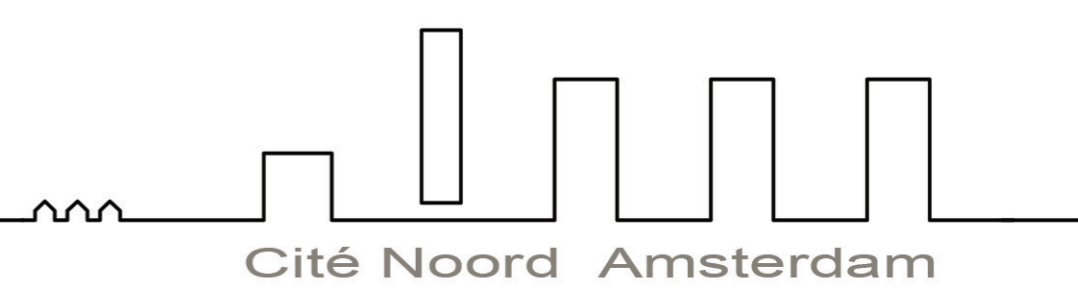
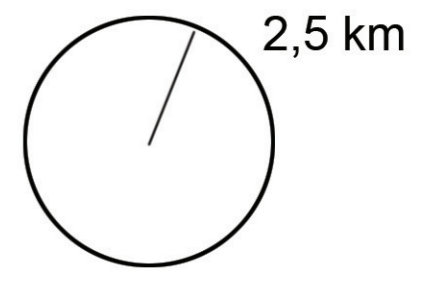

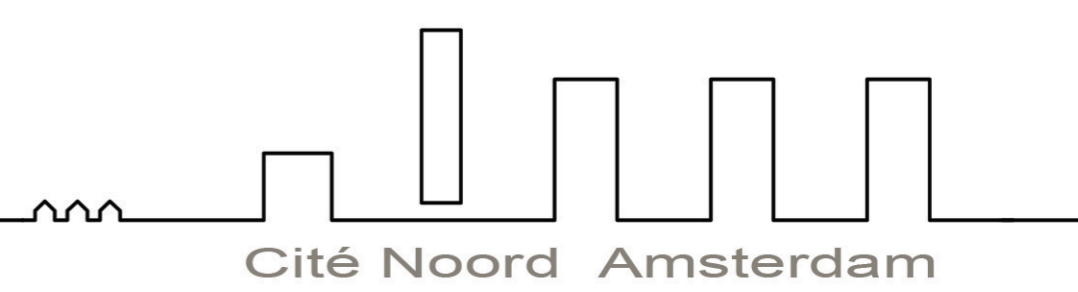
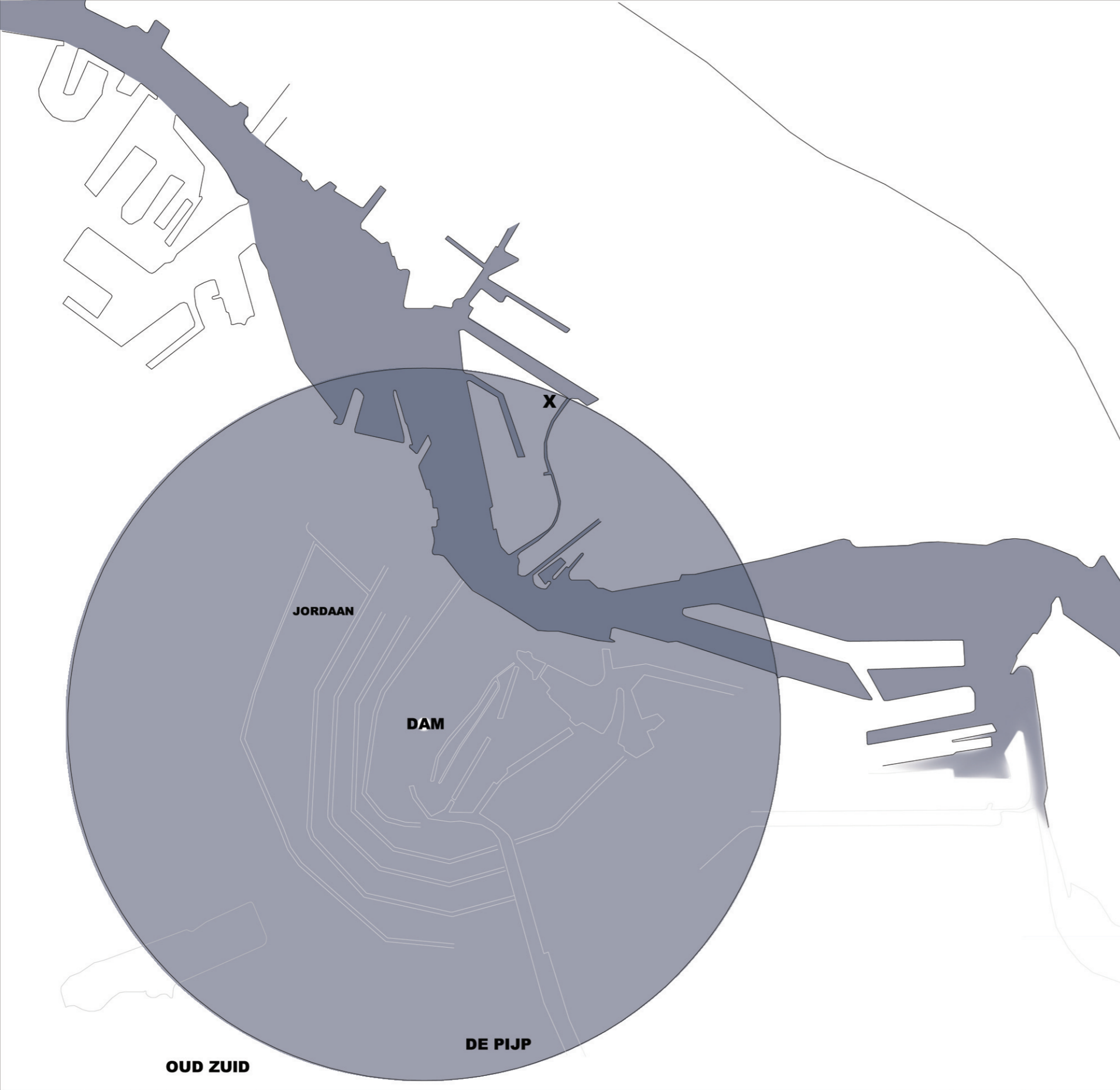



**OUD ZUID**

**JORDAAN**

**DAM**

**DE PIJP**

**X**

Cité Noord Amsterdam

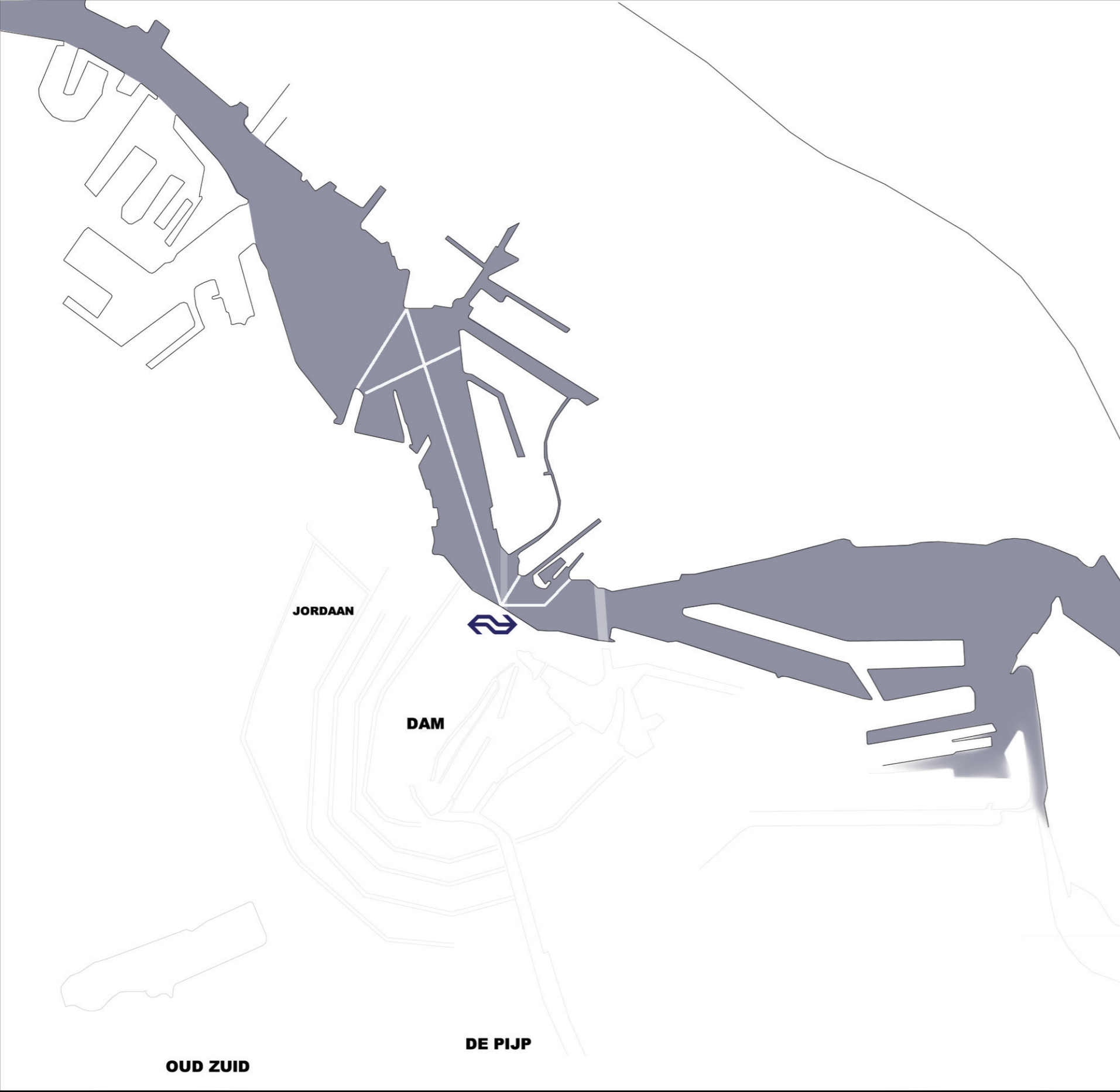

**2002**  
a general Masterplan for the Northern IJbanks

**Accessibility  
&  
Connections**  
between water & housing areas

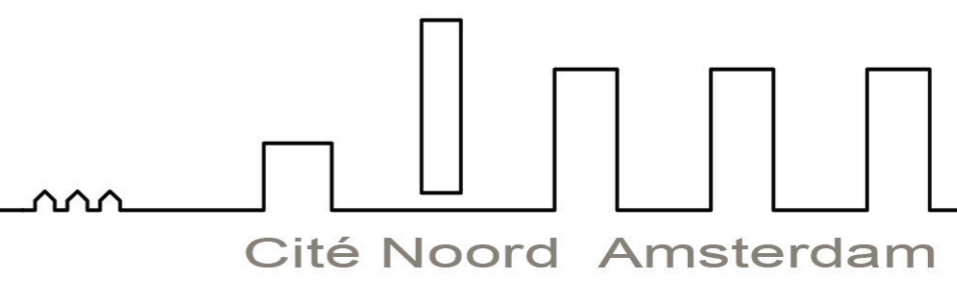



**NDSM wharf** creative industry

MTV  
ID-TV  
Discovery channel

**Shell area**

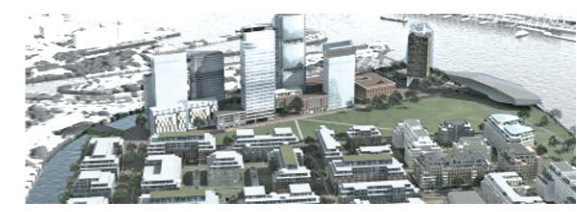

**Buiksloterham**

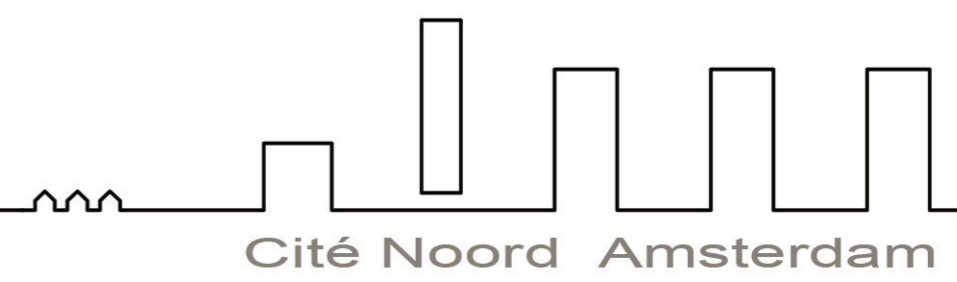



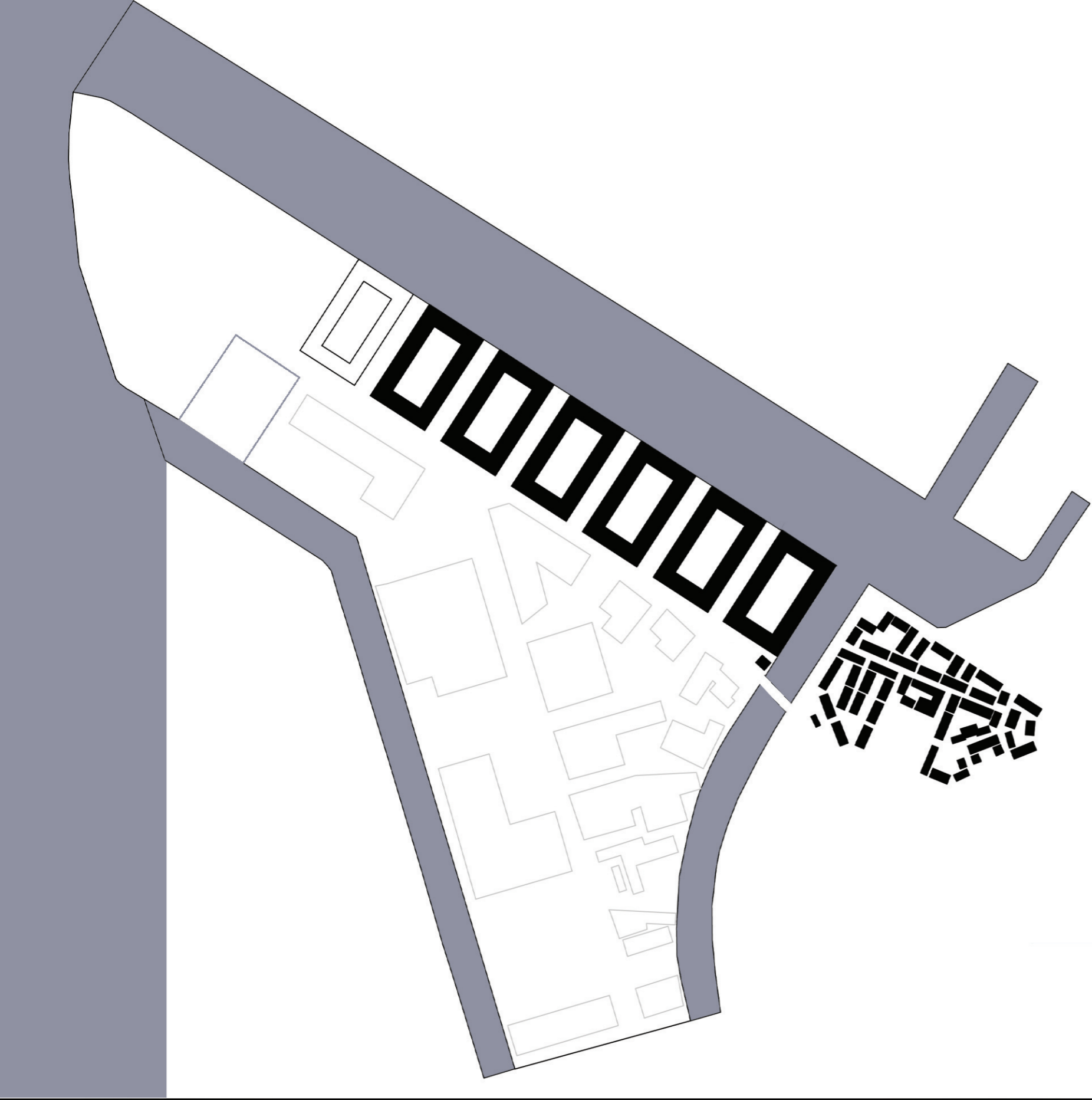

**BSH Buiksloterham**  
**Business area for shipbuilding**



'60 & '70 → **Asia**

**General industrial area**



'90  
 Poor quality water discovered

↓  
**slow transformation**  
 to a **habitable region**

**BSH** → **Lively mixed urban area**

**BUT** **development by Private initiatives ...**  
**X**

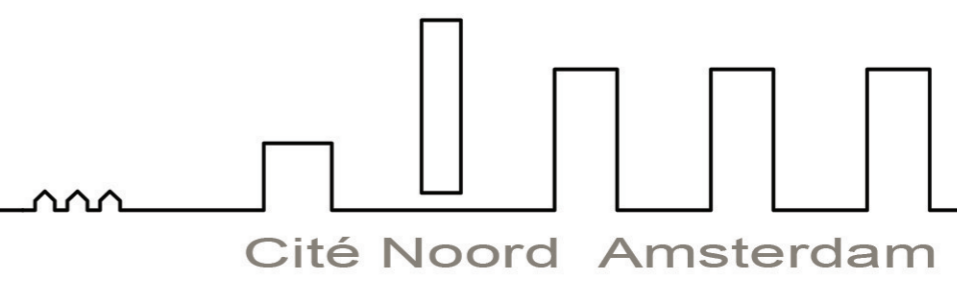

**COLLECTIVE DOMAIN**  
— *Manuel de Sola-Morales*

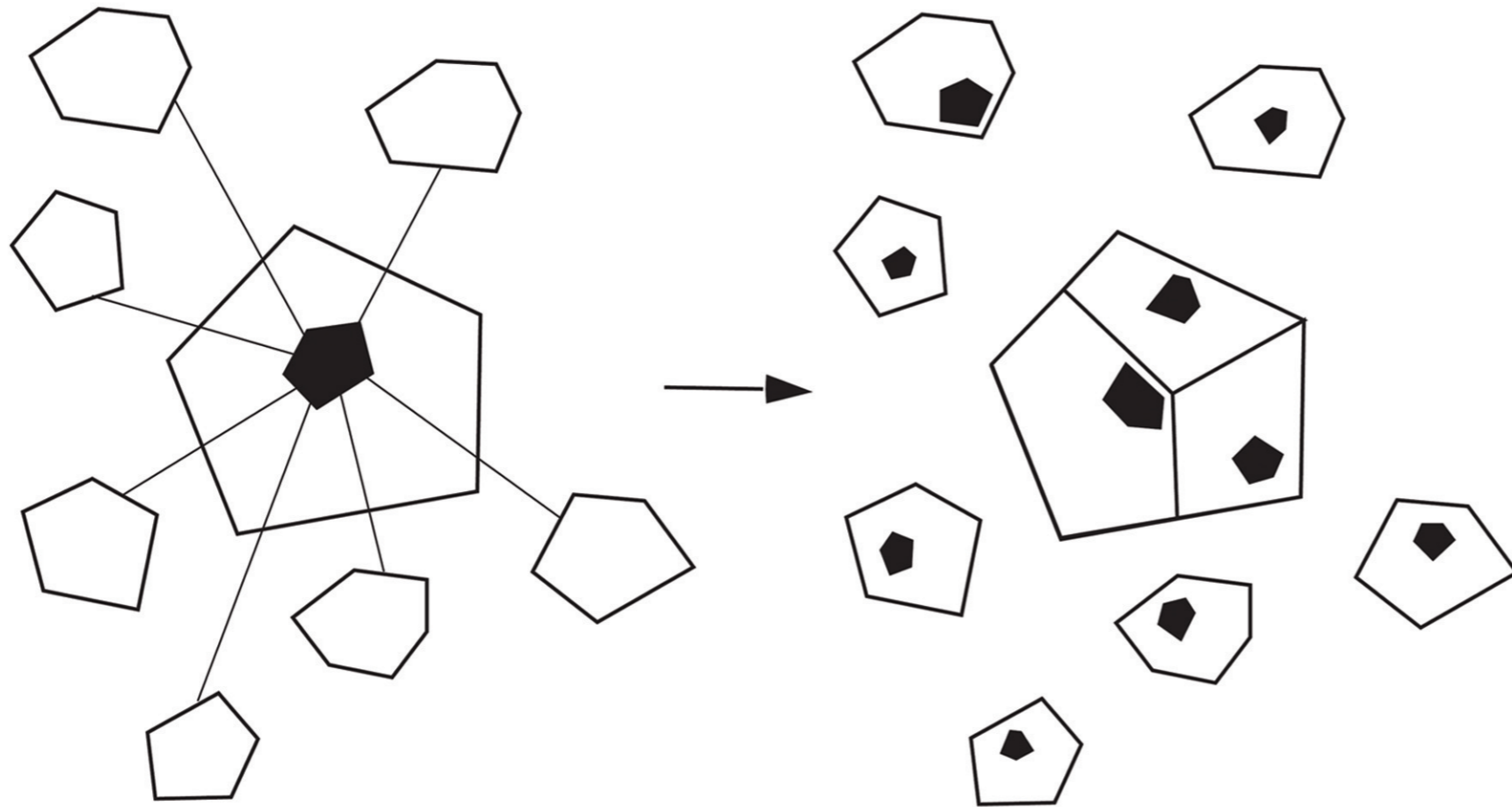

The transition of the public domain and collective spaces

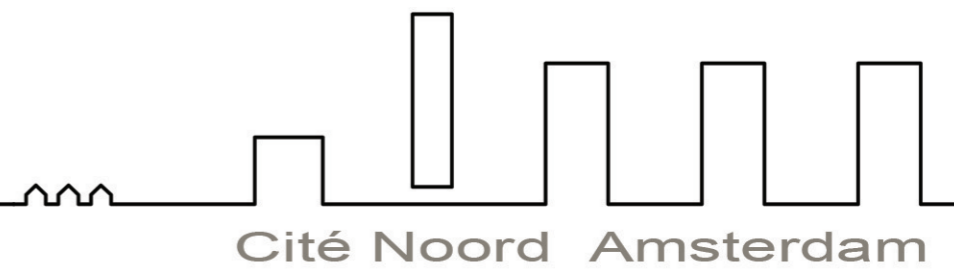

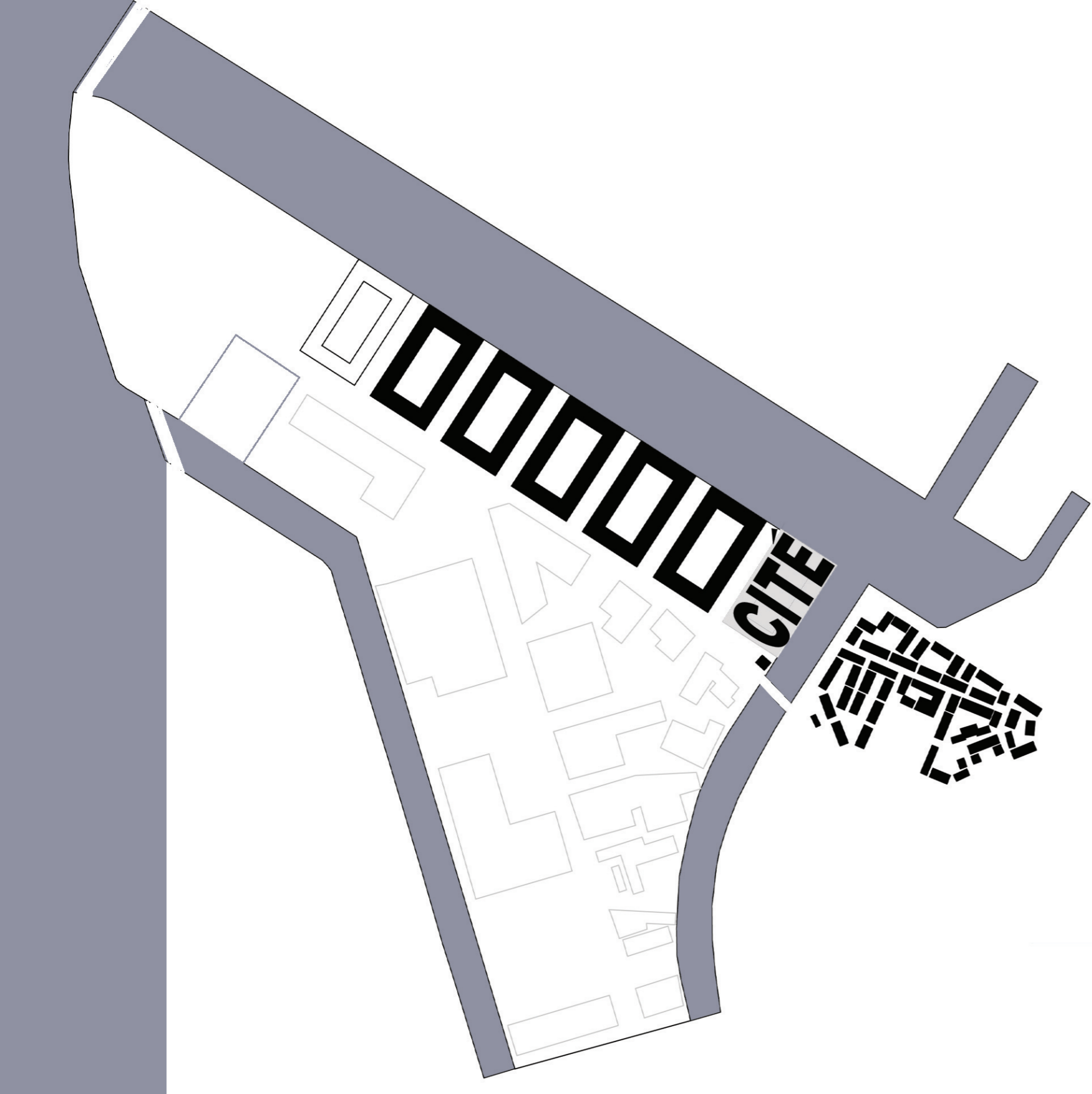

**BSH Buiksloterham**



**Lively mixed urban area**

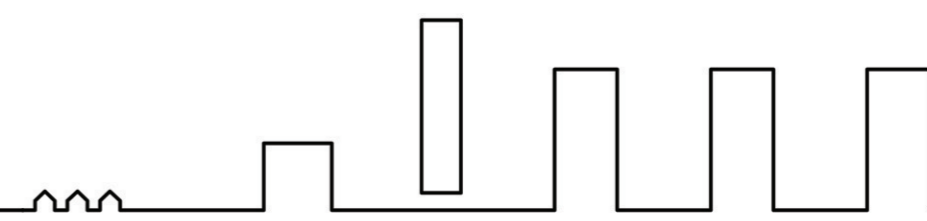

Cité Noord Amsterdam

**Cité**

=



**a new type of concentration  
that exhibits a combination of  
living, working & leisure**

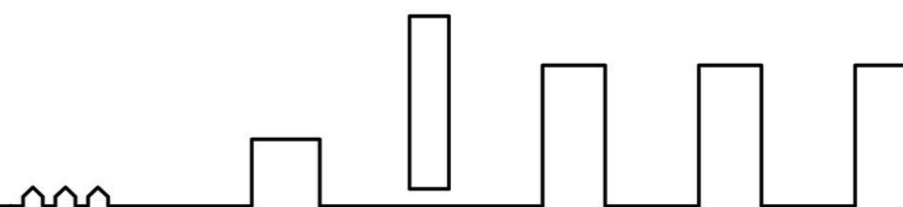

Cité Noord Amsterdam



## Housing

122 Senior apartments  
10 Short Stay apartments  
Care takers office  
Office for cleaning arrangements

## Art-Music & Dance Studios

## Office-space

10 Office units  
2 Open Office Spaces

## Shops

## Public swimming pool

Changing rooms with sauna  
Restrooms  
Pool  
Hot pool & Outdoor pool  
Physio pool  
first aid-room/ strage/ counter

## Physiotherapy

2 Treatment-rooms  
Waiting room

## Fitness

Dressing rooms & sanitary  
Fitness-room  
Yoga-room

## Restaurant

Seating area  
Restrooms  
Kitchen

## Parking

174 cars  
120 bicycles  
65 boats

LIVING  
WORK  
LEISURE  
SPORT  
FOOD & DRINK

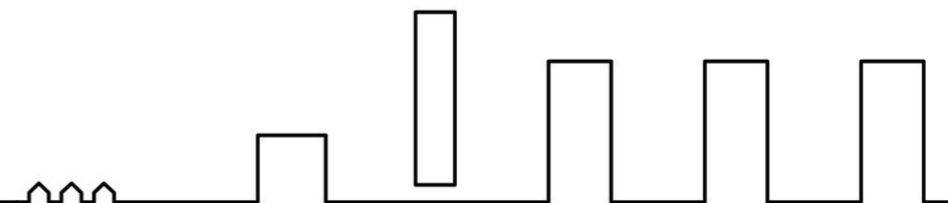

Cité Noord Amsterdam



## Programme

Housing **12 800 m<sup>2</sup>**

Art-Music & Dance Studios **360 m<sup>2</sup>**

Office-space **2 230 m<sup>2</sup>**

Shops **260 m<sup>2</sup>**

Public swimming pool **780 m<sup>2</sup>**

Physiotherapy **136 m<sup>2</sup>**

Fitness **380 m<sup>2</sup>**

Restaurant **660 m<sup>2</sup>**

Parking **5 650 m<sup>2</sup>**

Total net **23 256 m<sup>2</sup>**

Total gross **36 046 m<sup>2</sup>**

**6050 m<sup>2</sup>**

**FSI = 5.96**

**6050 m<sup>2</sup>**

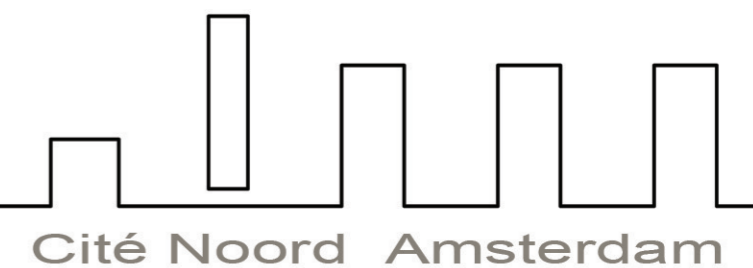

**PUBLIC**

**HOUSE**

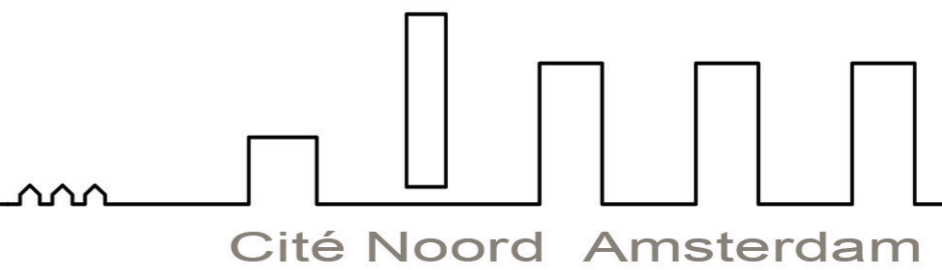

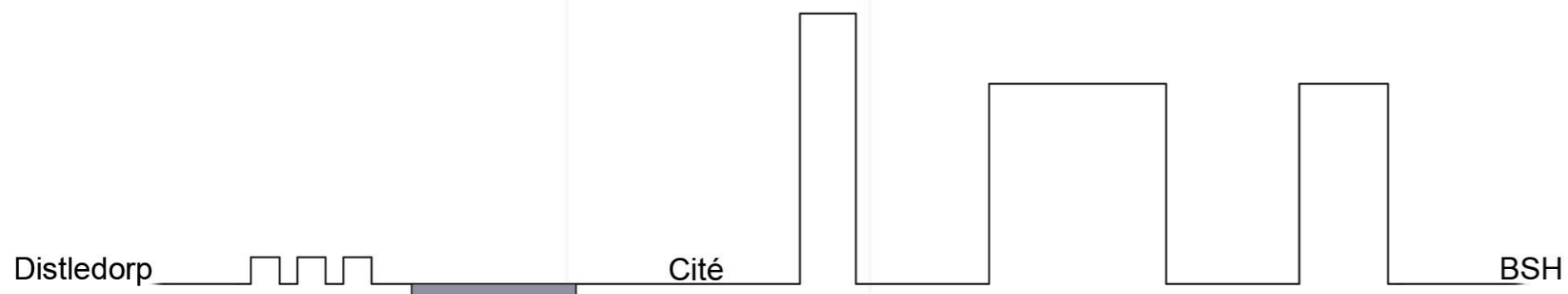

**Facilitated House block**

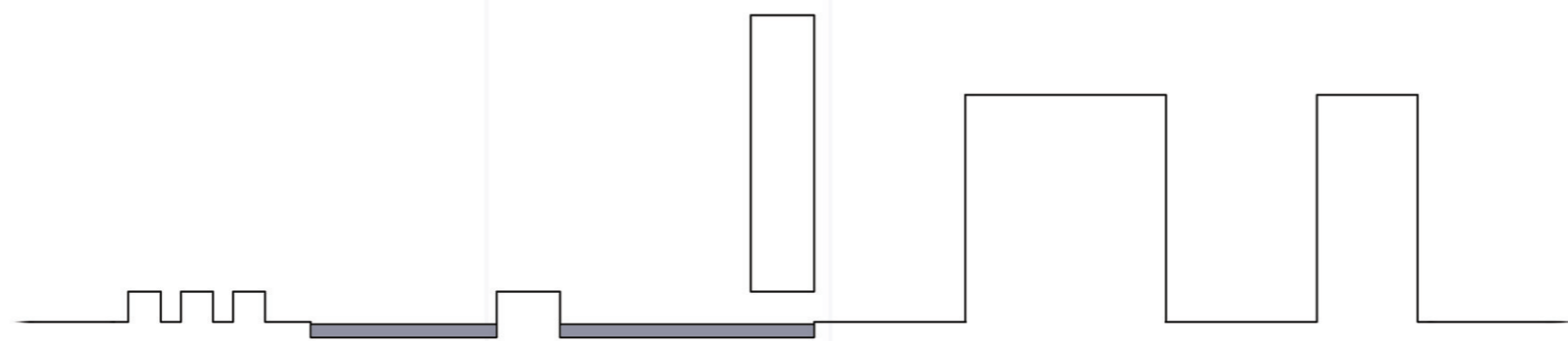

**House Block & Facilities**

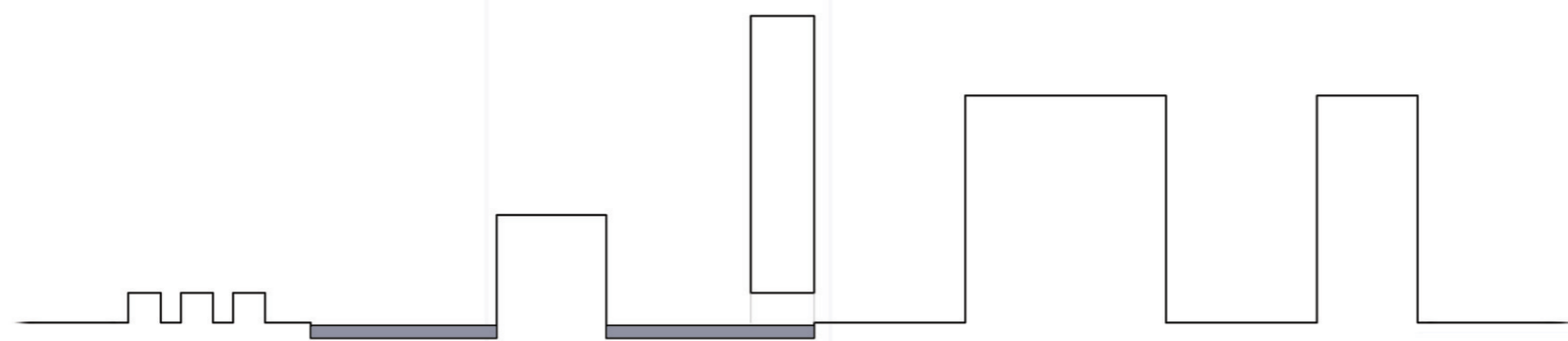

**House Block & Public House**

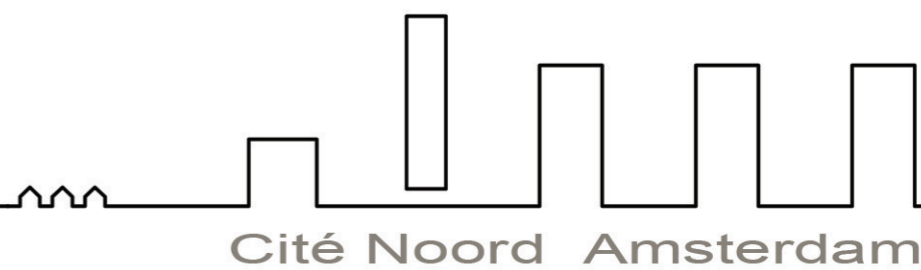





Cité Noord Amsterdam

WATER

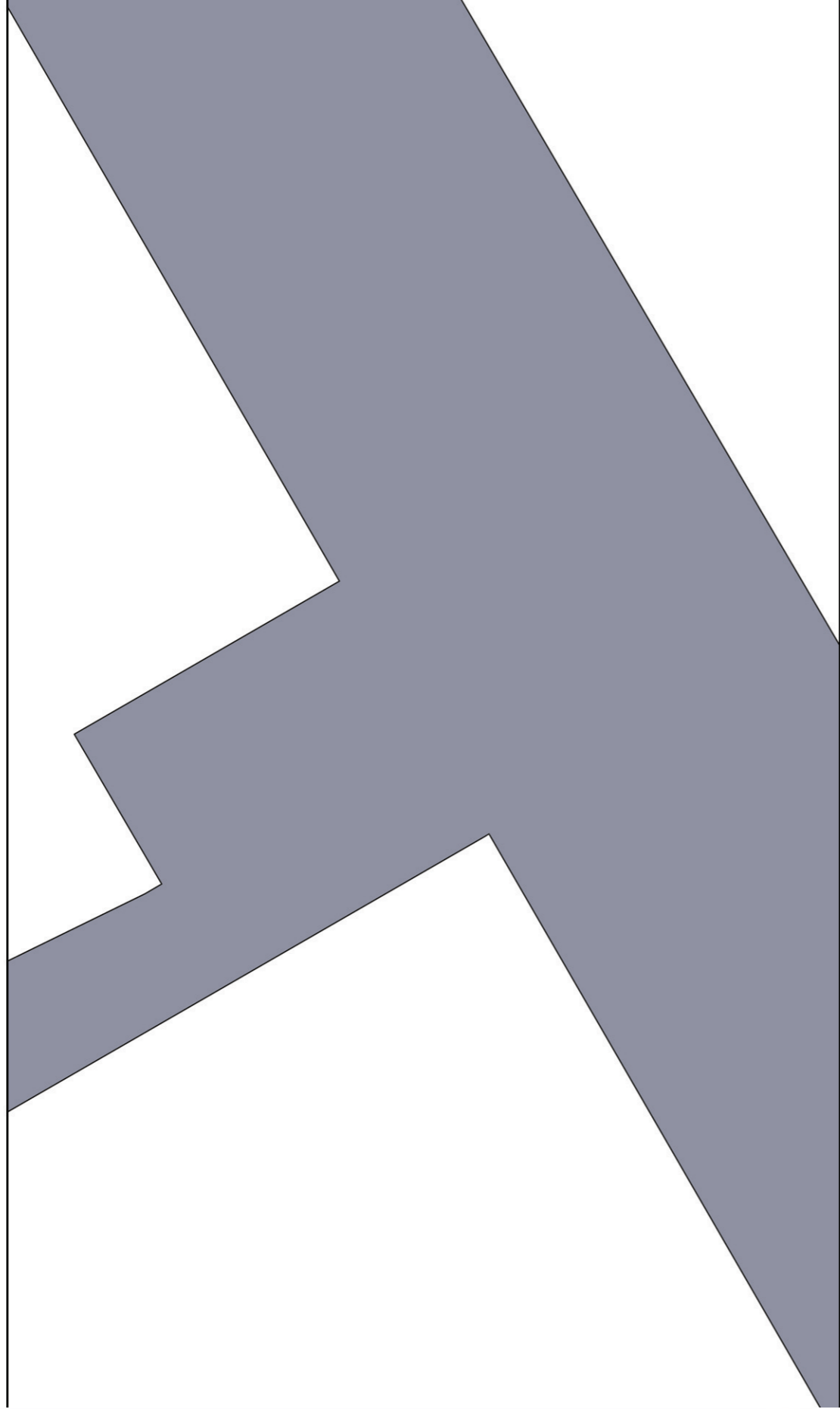

Cité Noord Amsterdam

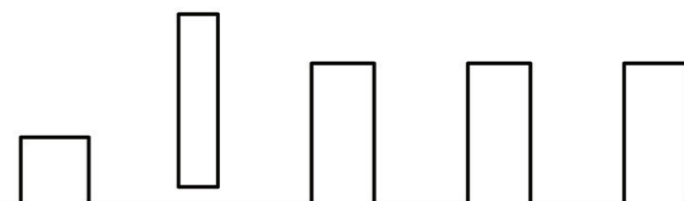

WATER  
MARINA  
PIER

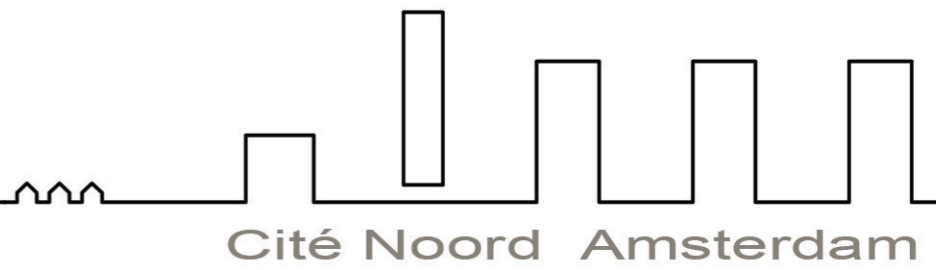
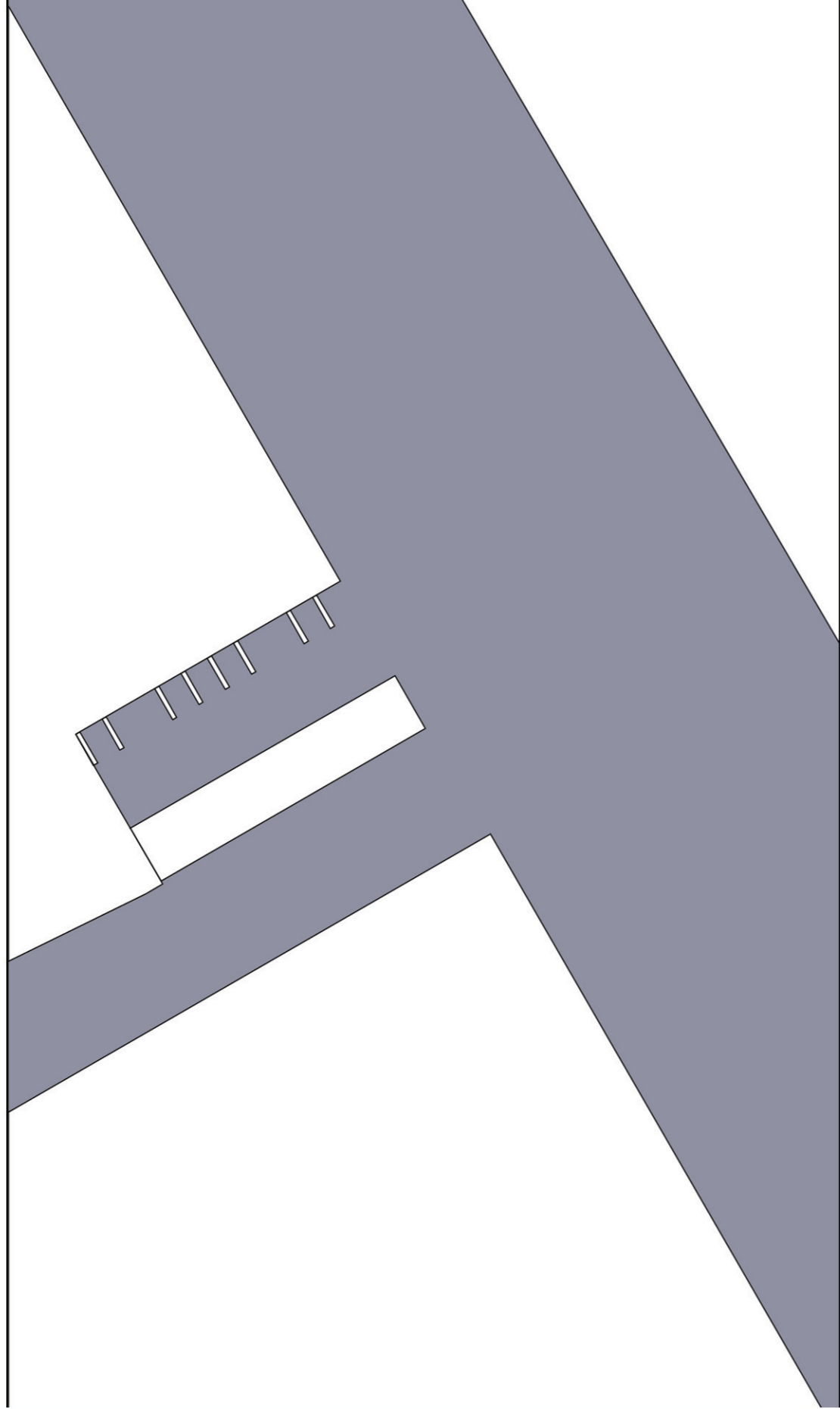

Cité Noord Amsterdam

WATER  
MARINA  
PIER  
HOUSING  
PUBLIC  
BUILDING

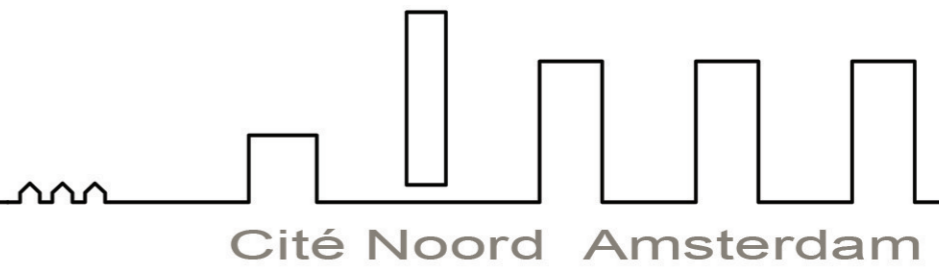
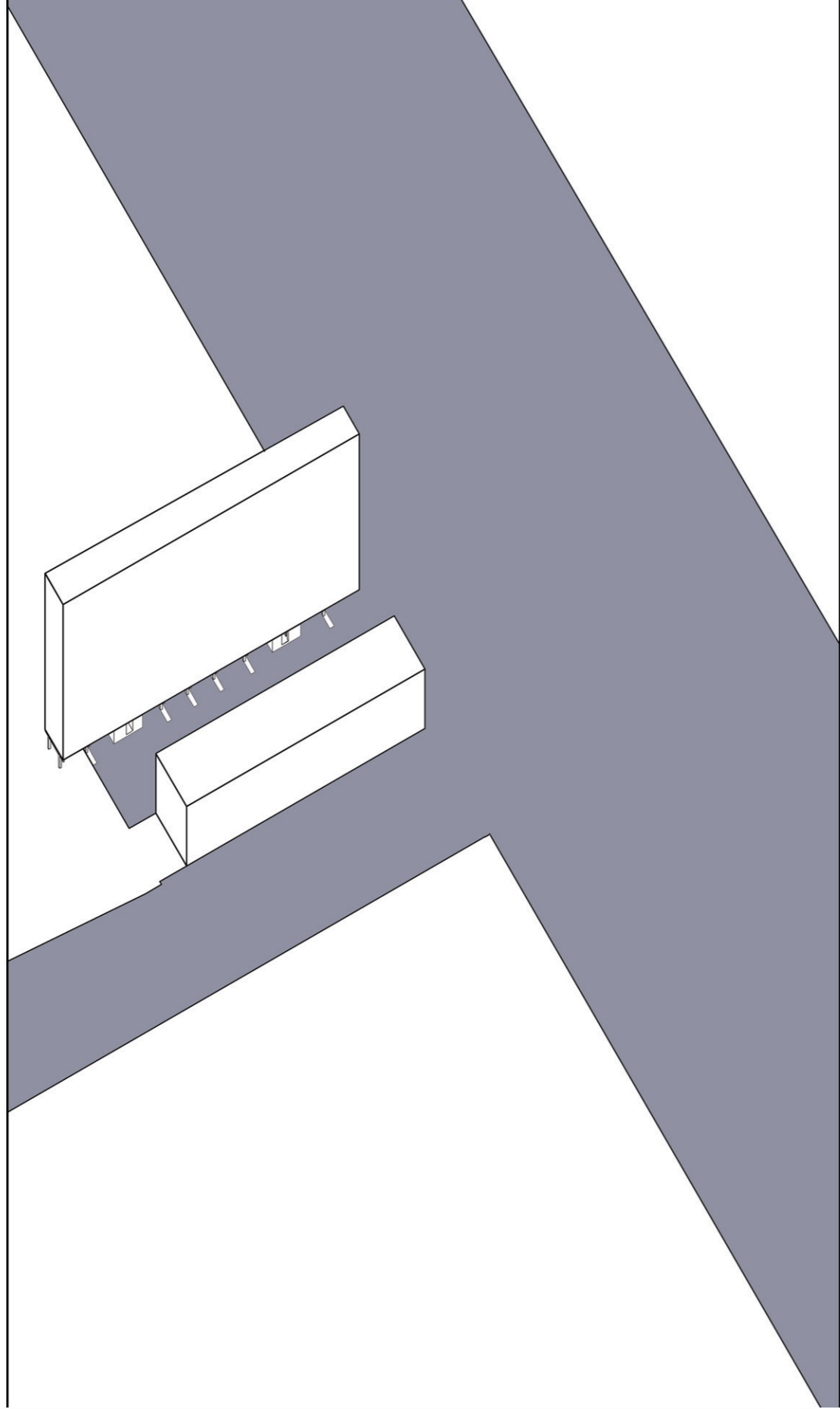

Cité Noord Amsterdam

WATER  
MARINA  
PIER  
HOUSING  
PUBLIC  
BUILDING  
**BRIDGE**

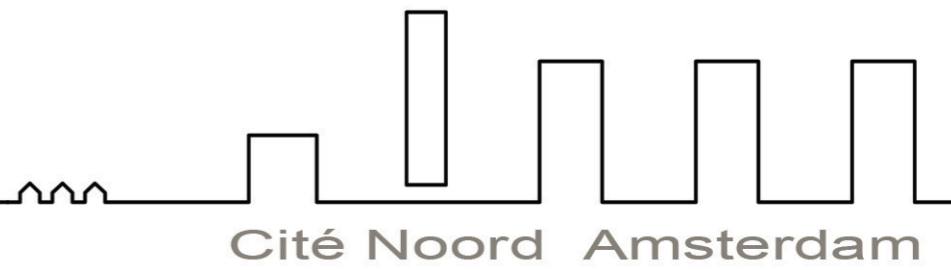
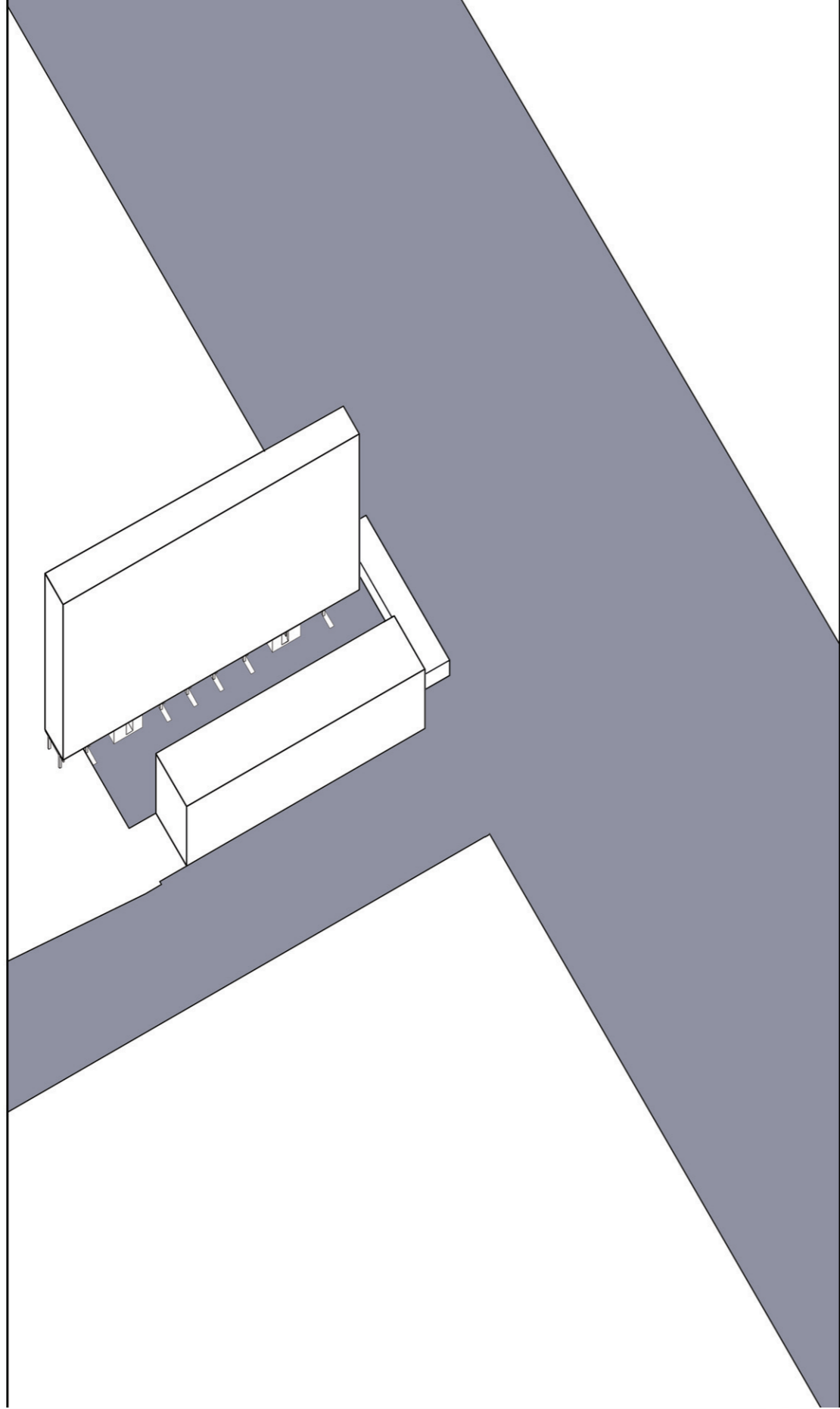

Cité Noord Amsterdam



Johan van Hasselt kanaal

Johan van Hasselt kanaal

**BSH**

**Disteldorp**

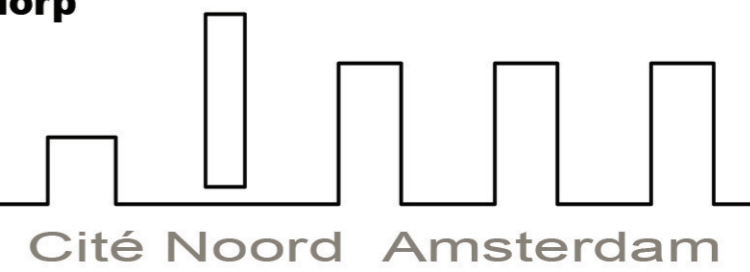

Cit  Noord Amsterdam

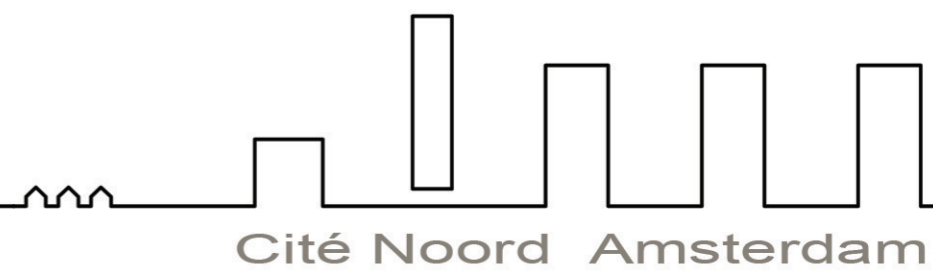
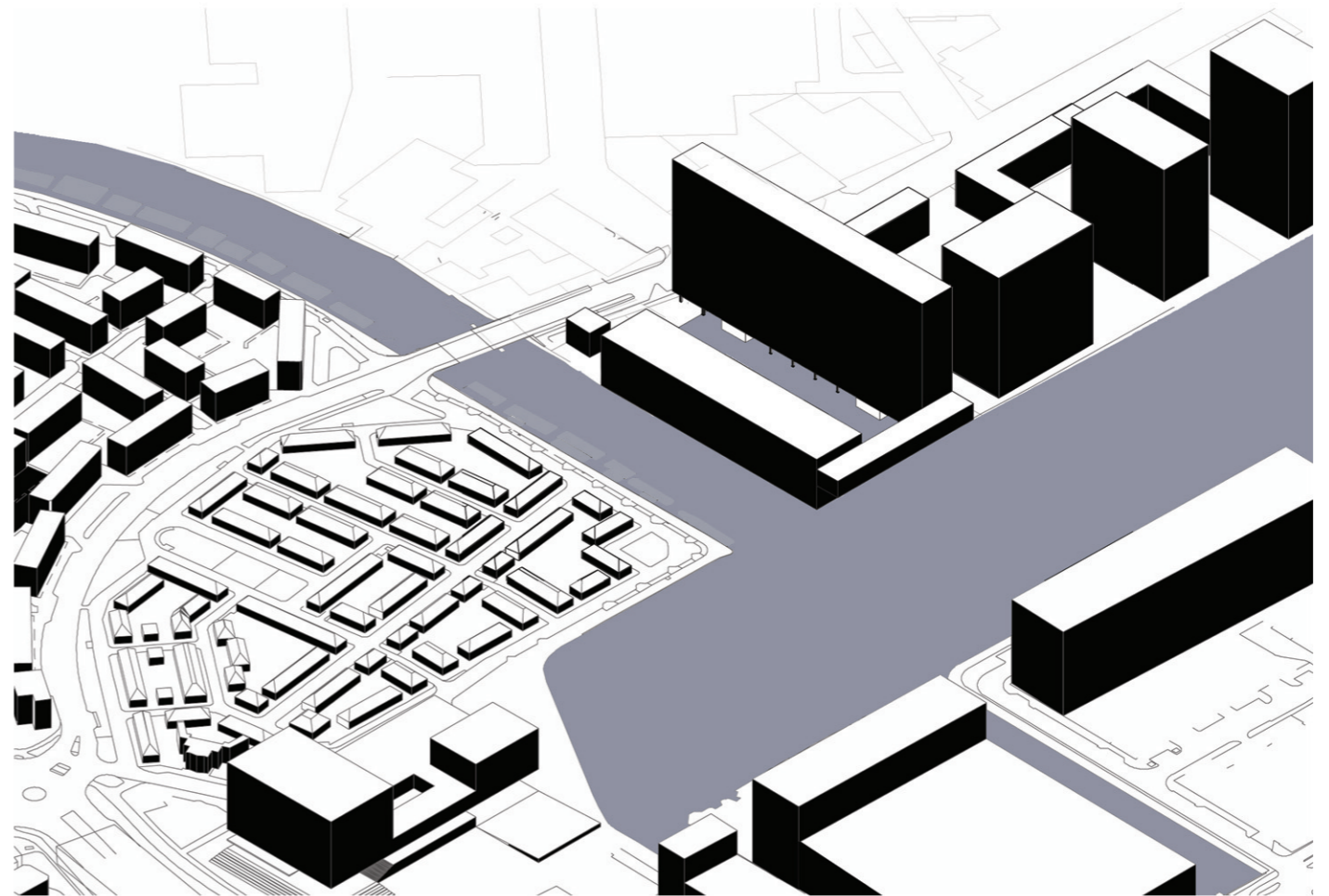

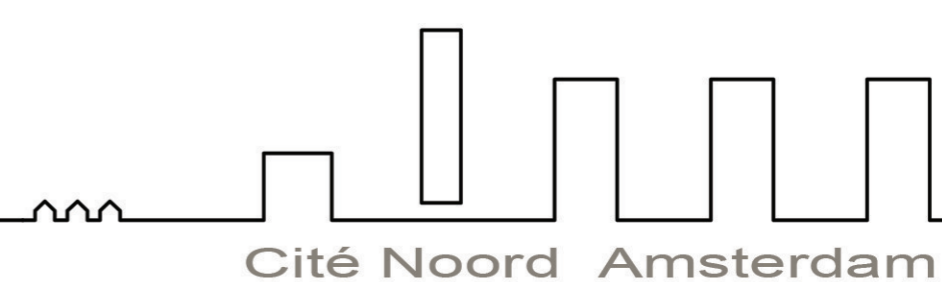

Cité Noord Amsterdam



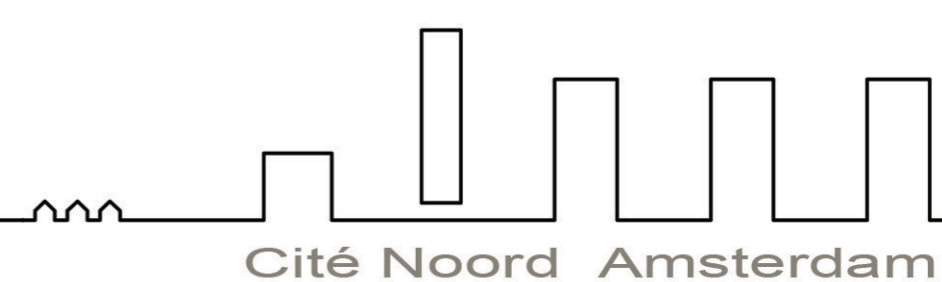

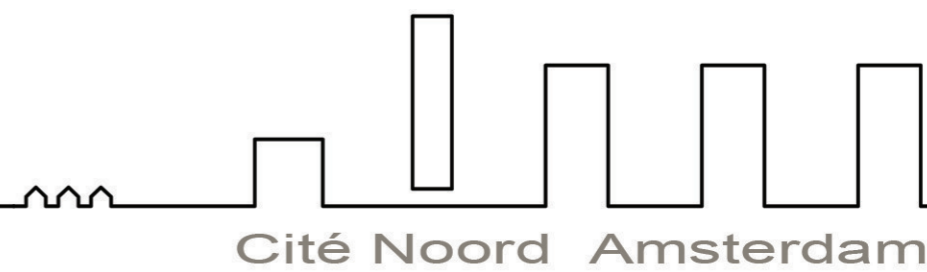

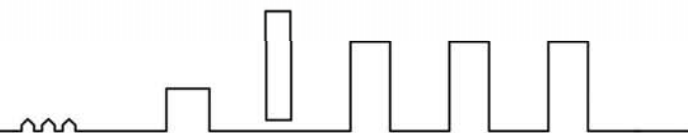

Cité Noord Amsterdam

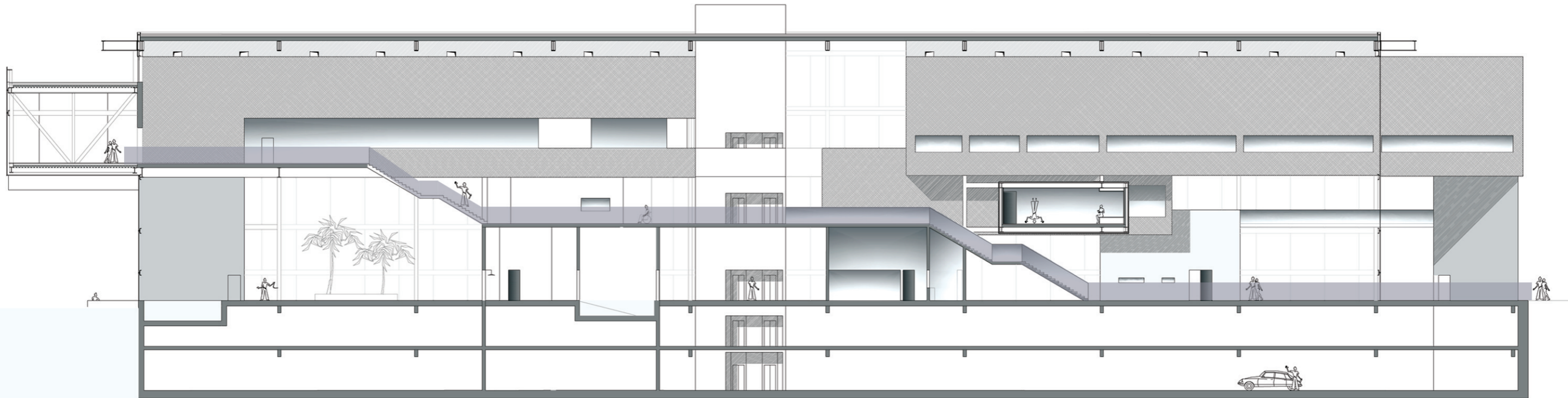

**Route**  
viewing the various activities

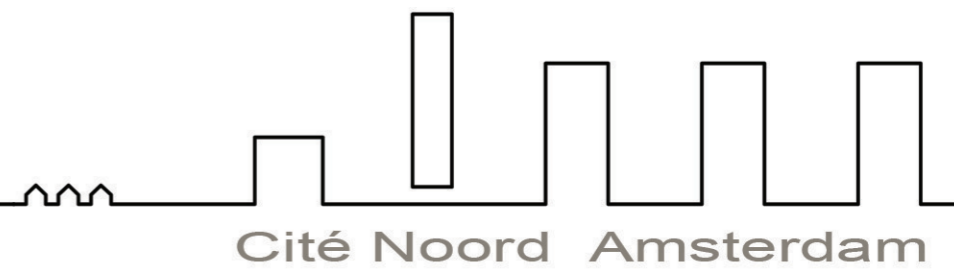

# Cooks Island

**Creative Offices**  
**Swimming pool**

**Yoga**  
**Fitness**  
**Shops**

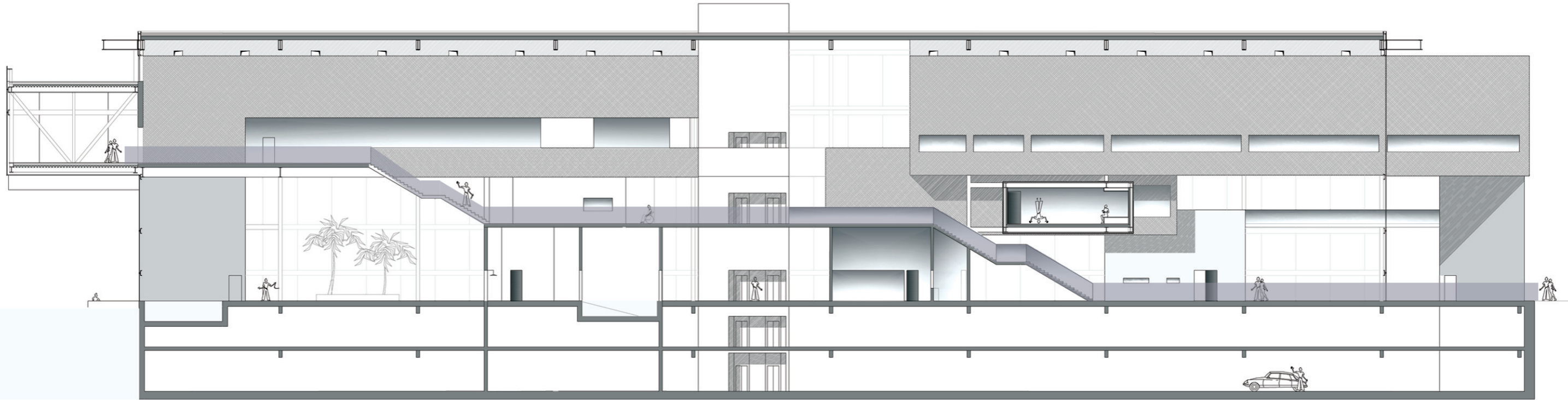

**Route**  
viewing the various activities

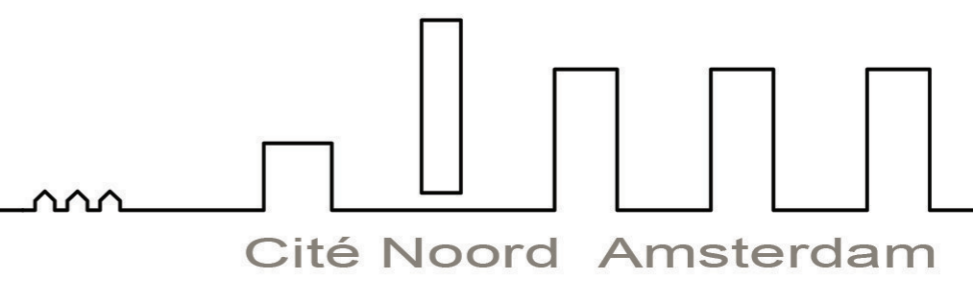

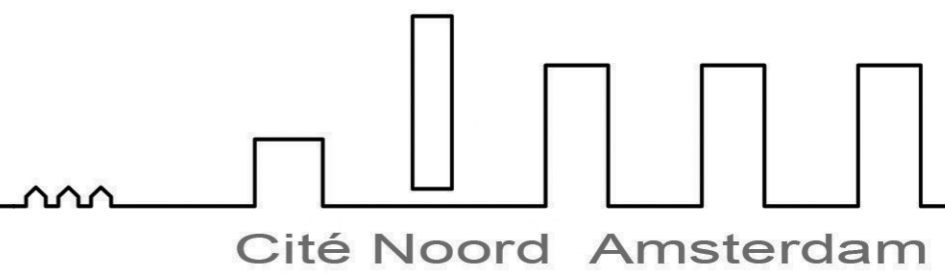

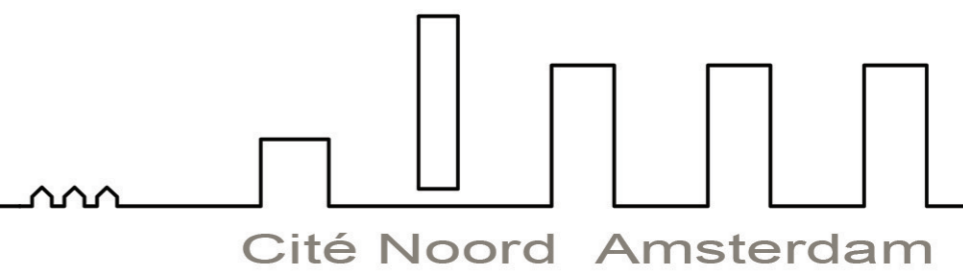

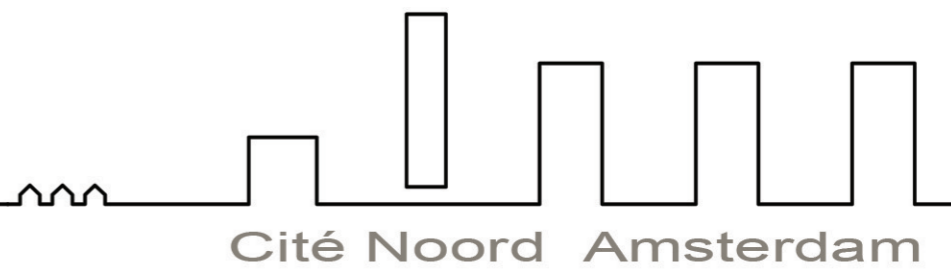



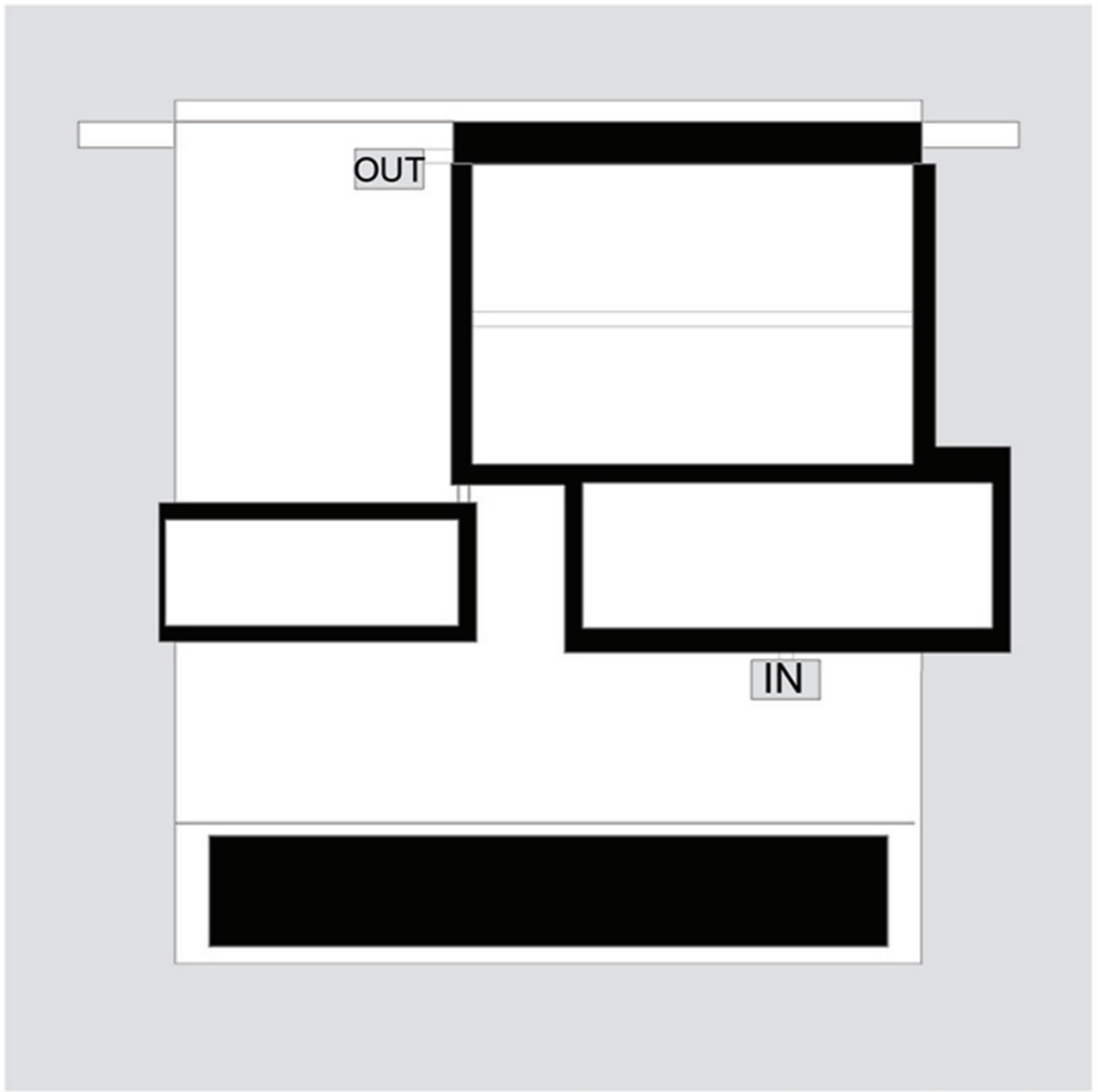

The space between the walls and ceiling allow instalation circulation

Natural ventilation may be controlled in an unsophisticated way sliding windows

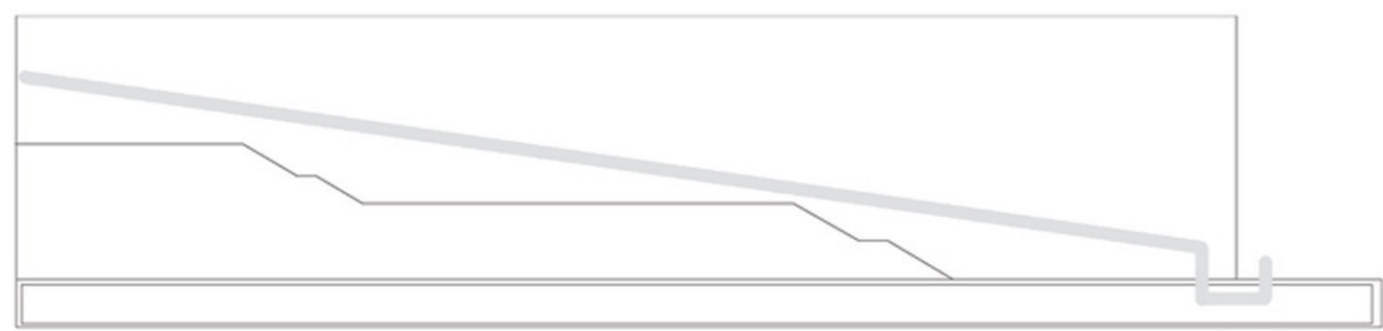

Stack effect



**FRESH AIR**

Cit  Noord Amsterdam

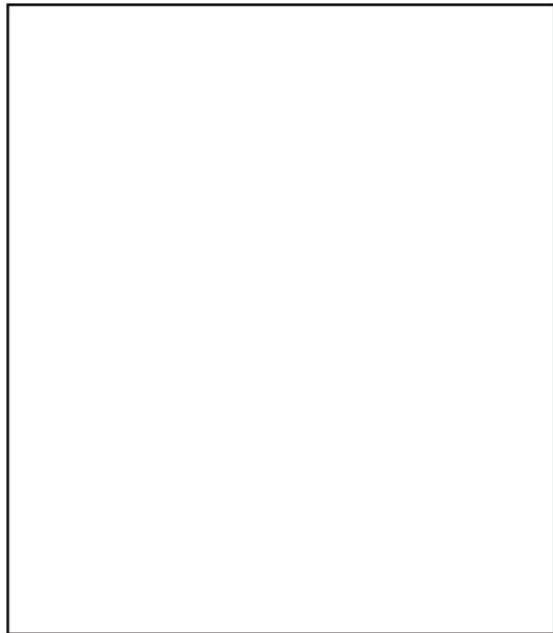

## **WATER cooling & heating**

Combined Ground and Radiant Floor Cooling  
with supplement heat pump

&

Combined Ground and radiant Floor heating  
with supplement heat pump

**HEAT/COLD STORAGE**

**constant temperature**

**± 10°- 12°**

**WATER**

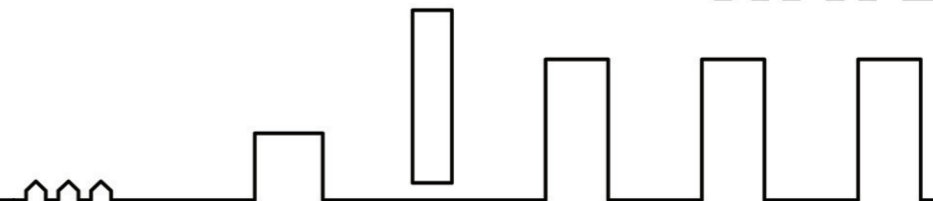

Cité Noord Amsterdam

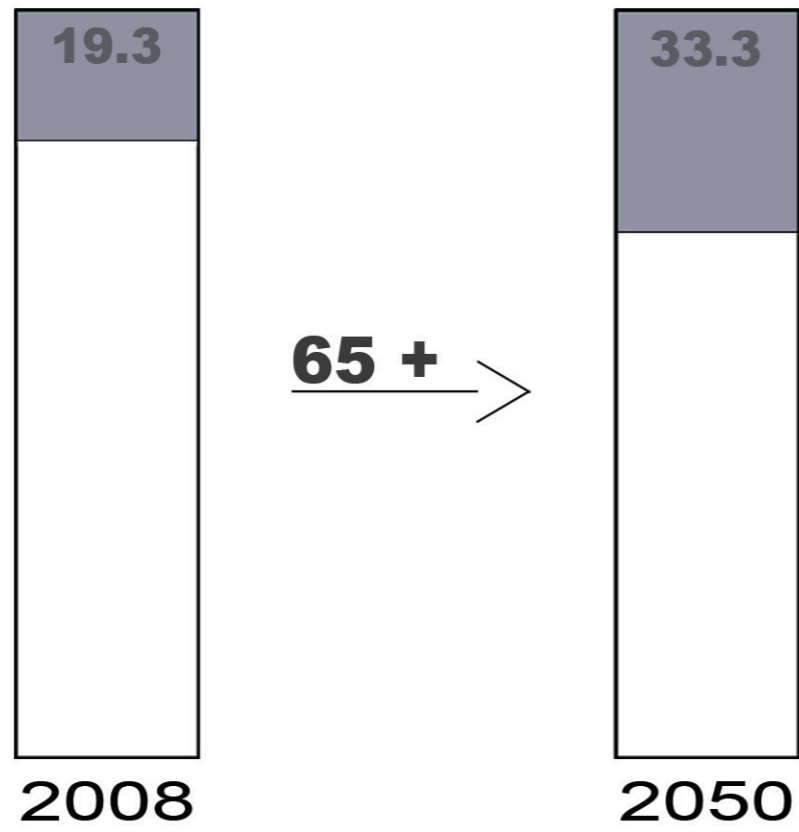

In comparison to previous generations the younger group of **senior citizens** remains **active** for much longer

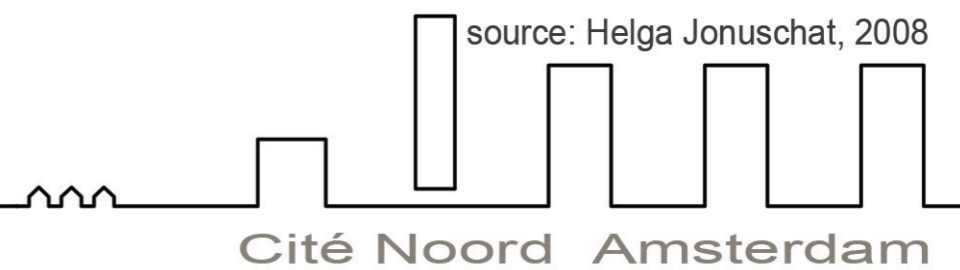



**END 60's - BEGIN 70's**

**Housing shortage**

**1981**

**Legalisation Squatting**

**MID 80's**

**Warehouses new targets**

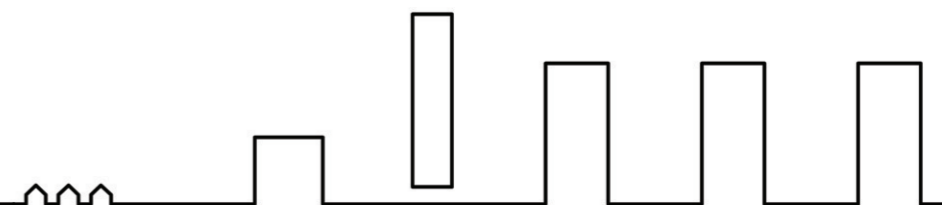

Cité Noord Amsterdam

# Parking Entrance

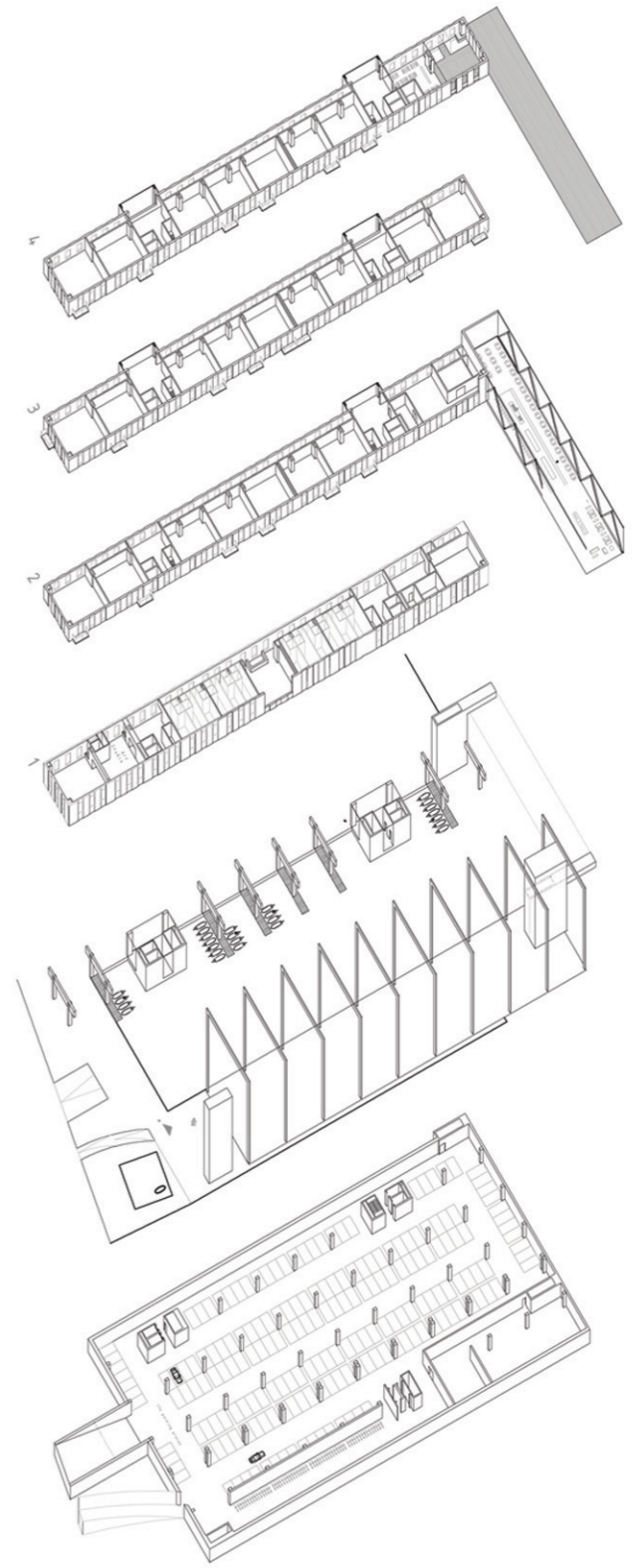
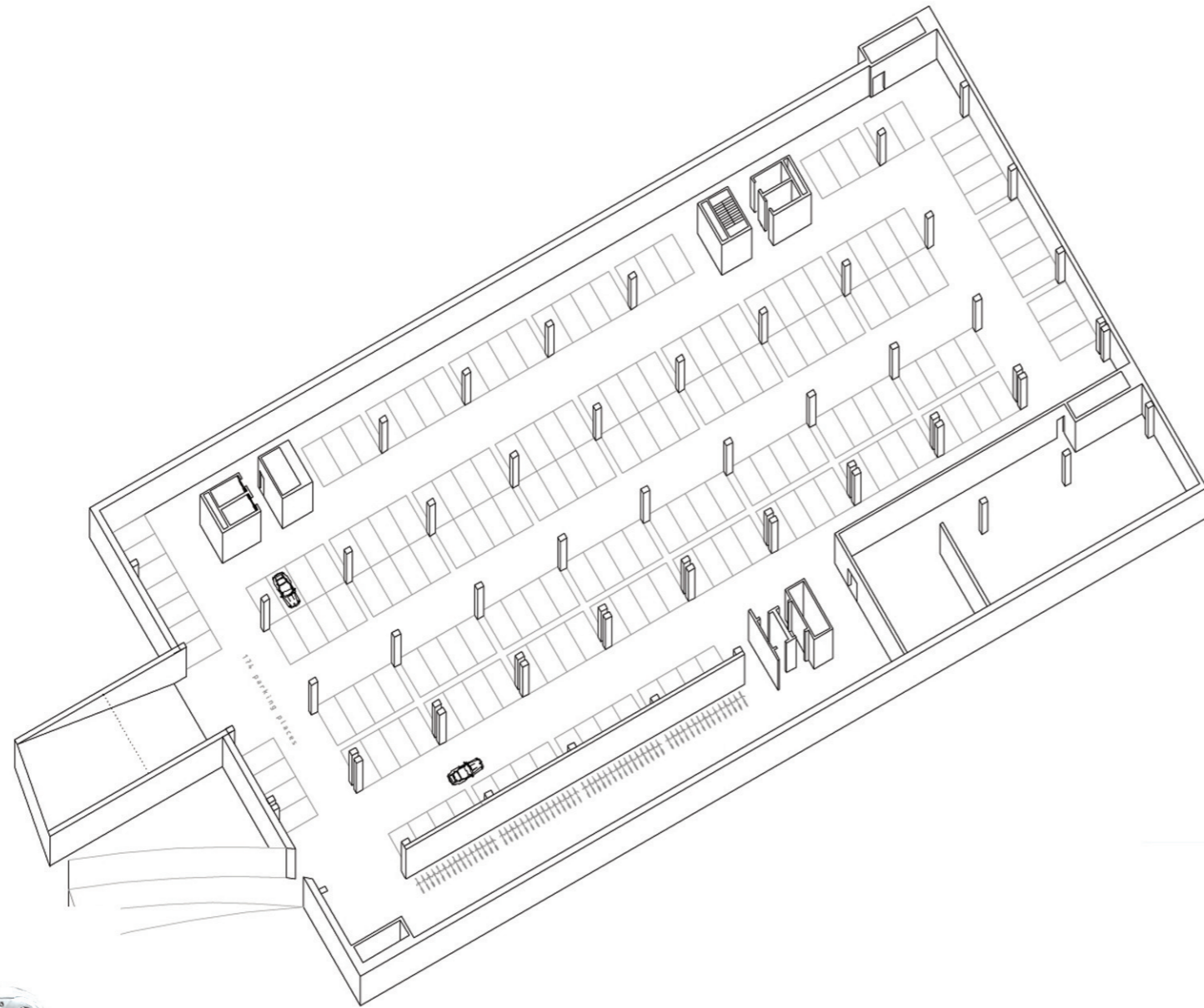

**-2**

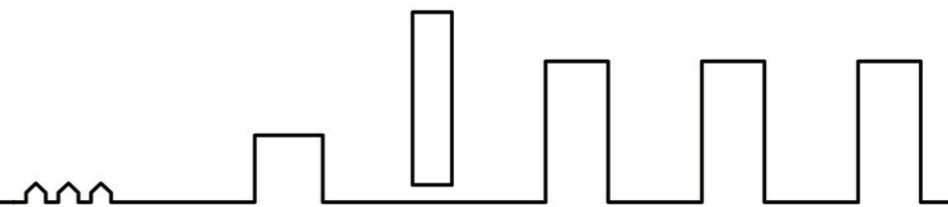

Cité Noord Amsterdam

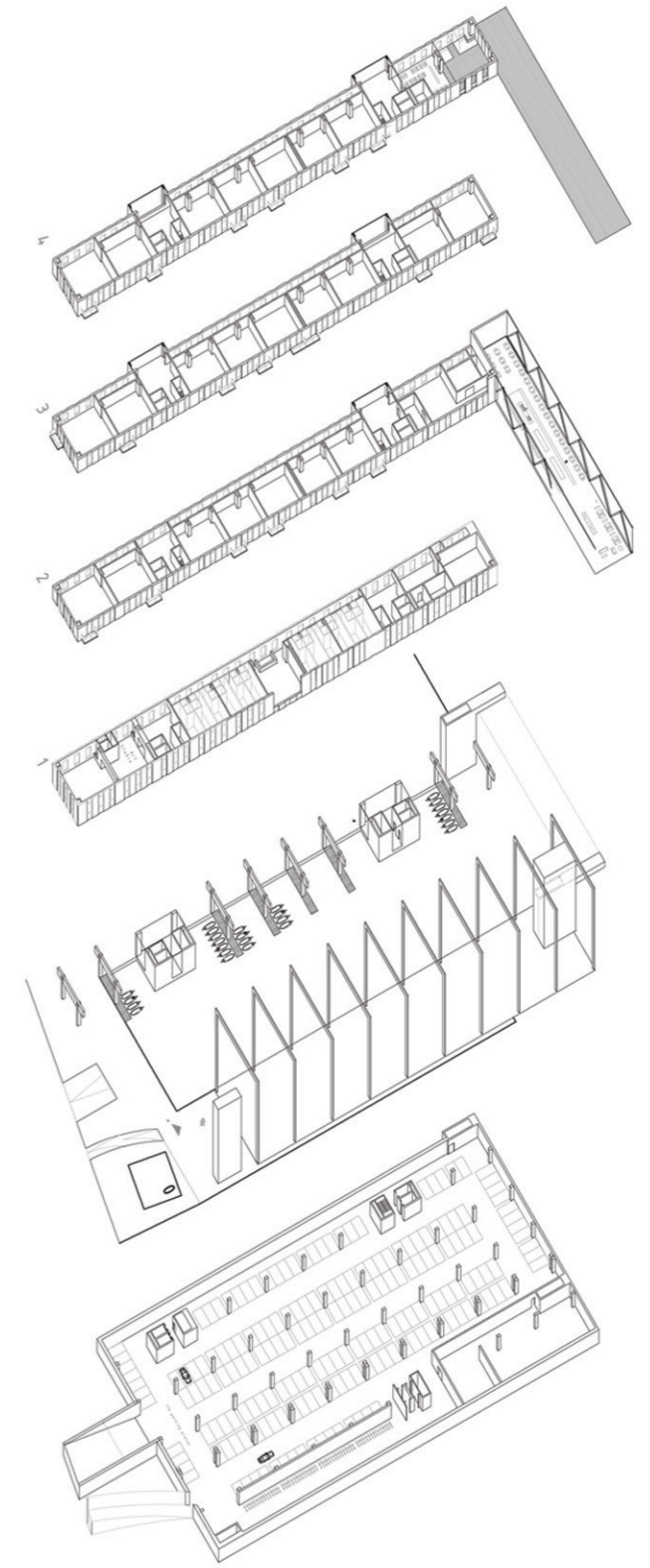
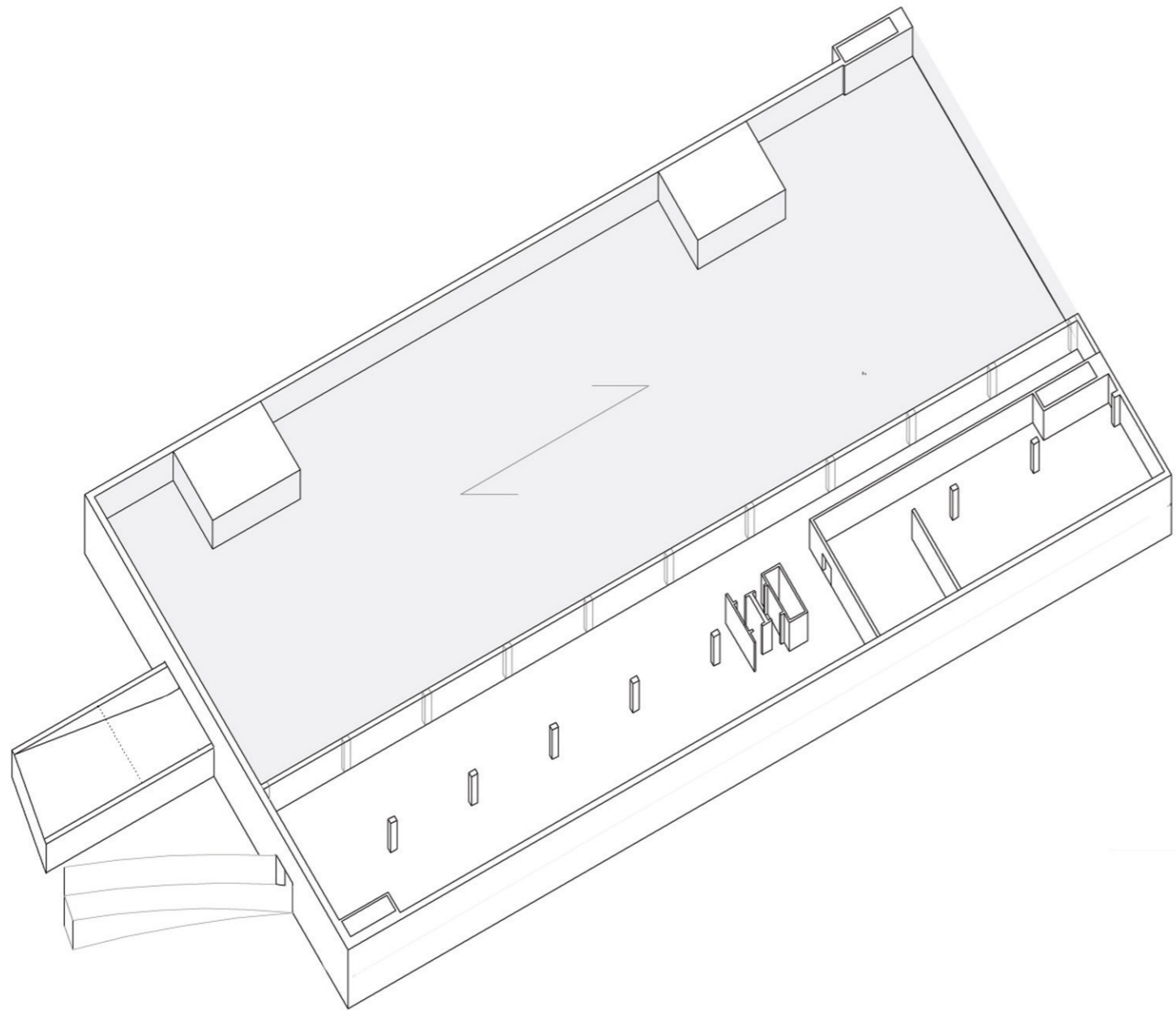

**-1**  
**-2**

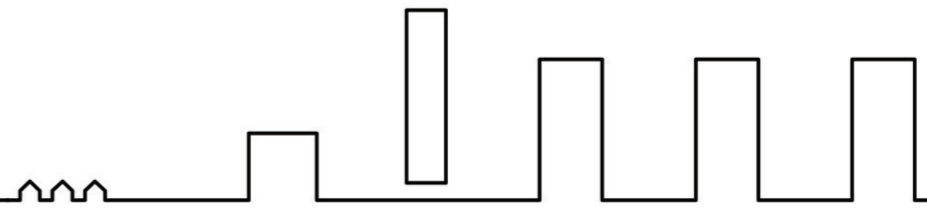

Cité Noord Amsterdam

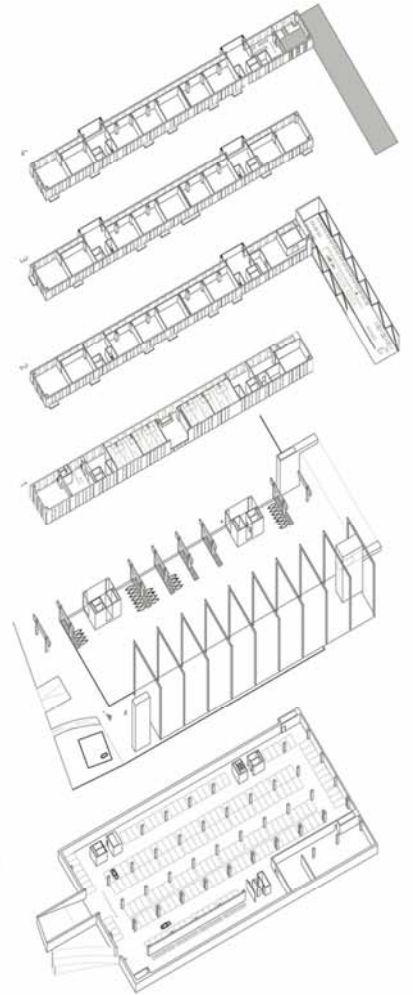
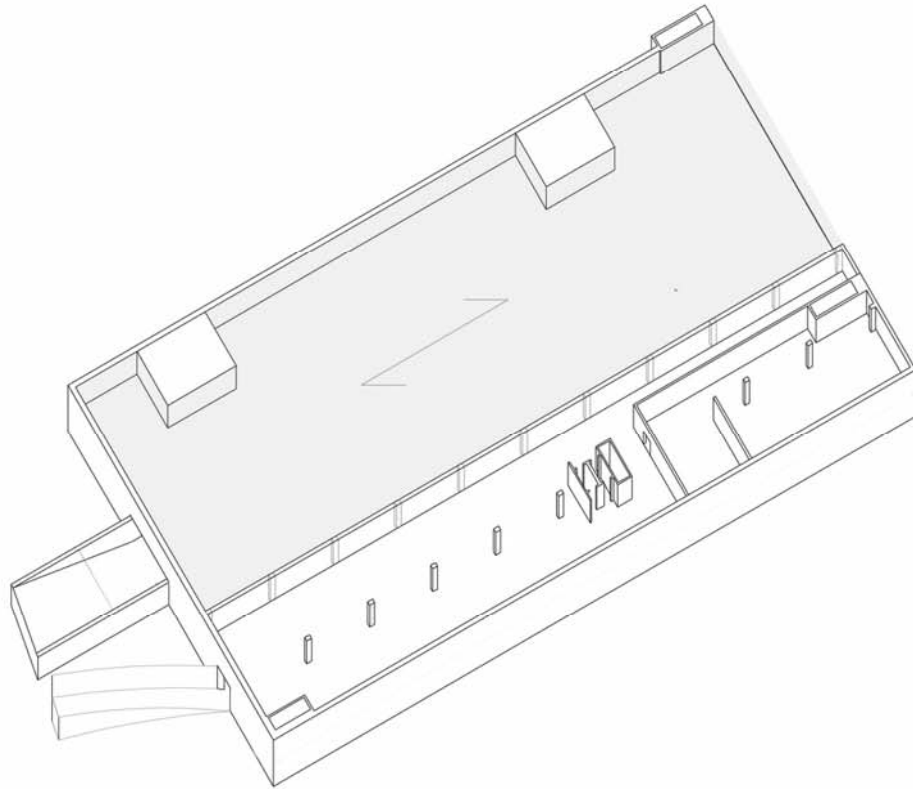

**-1**  
**-2**



Cité Noord Amsterdam

# Marina Entrance

± 65 boat

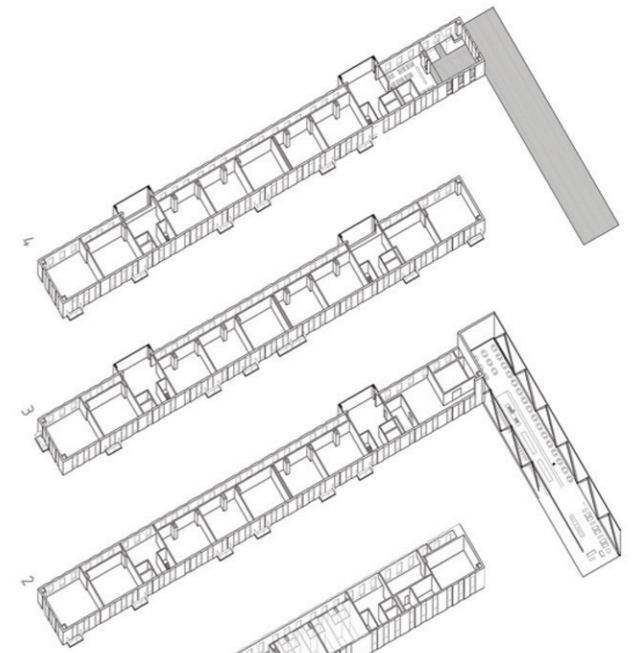
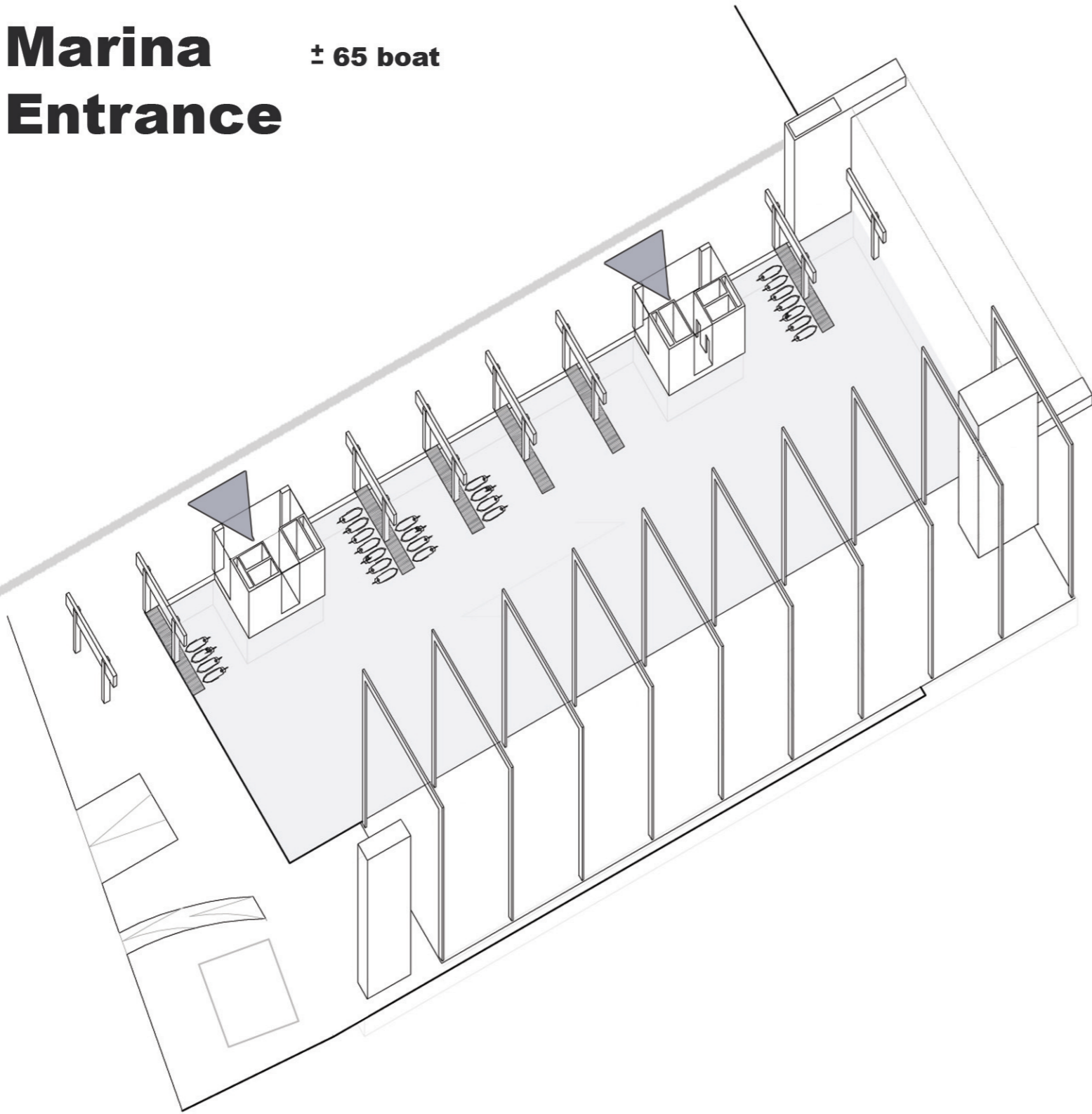

0

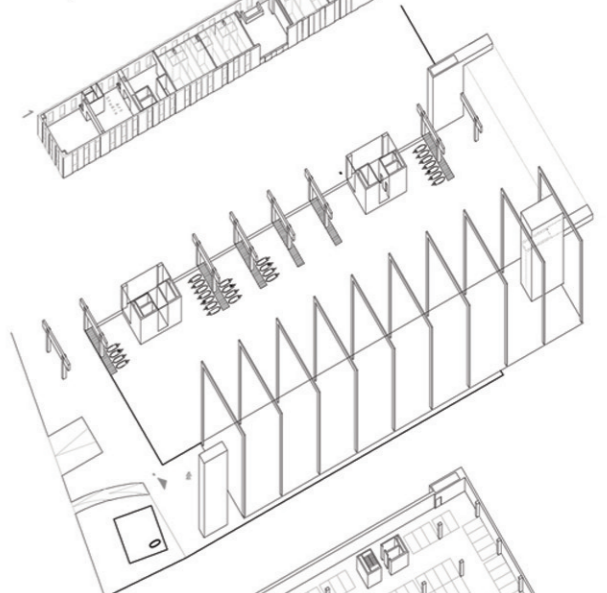

-2

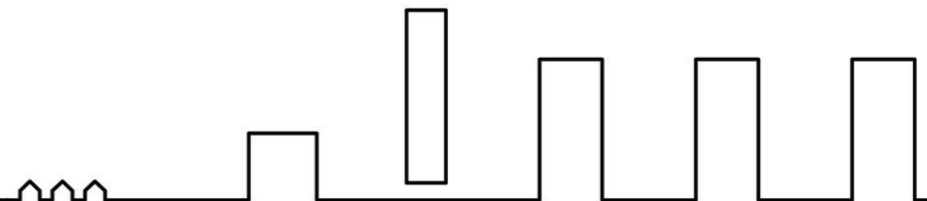
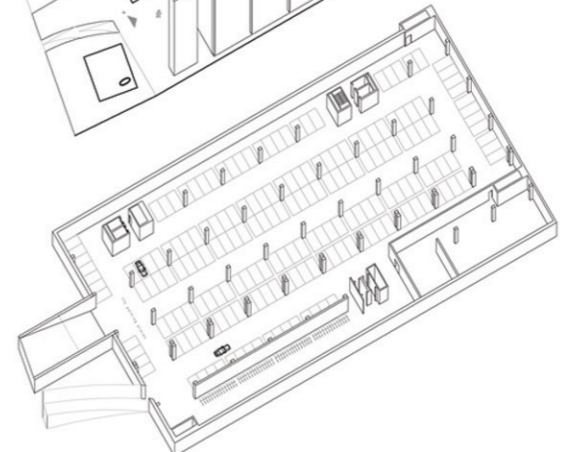

Cité Noord Amsterdam



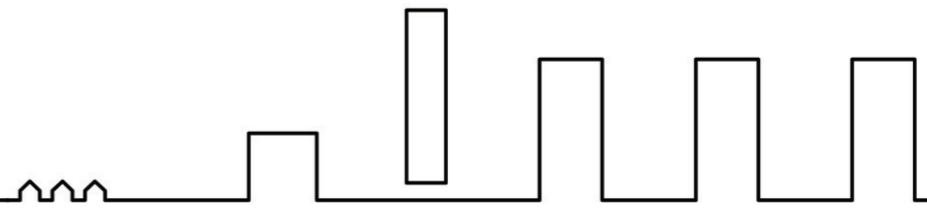
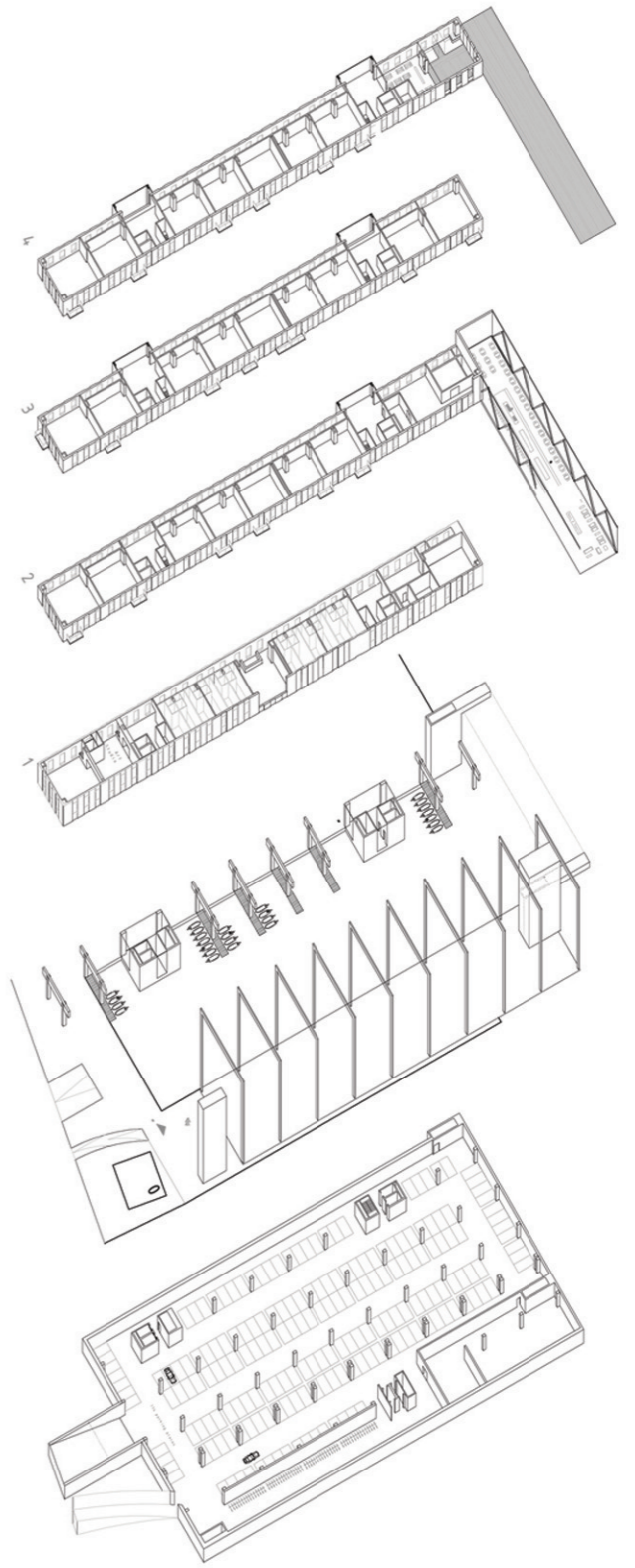
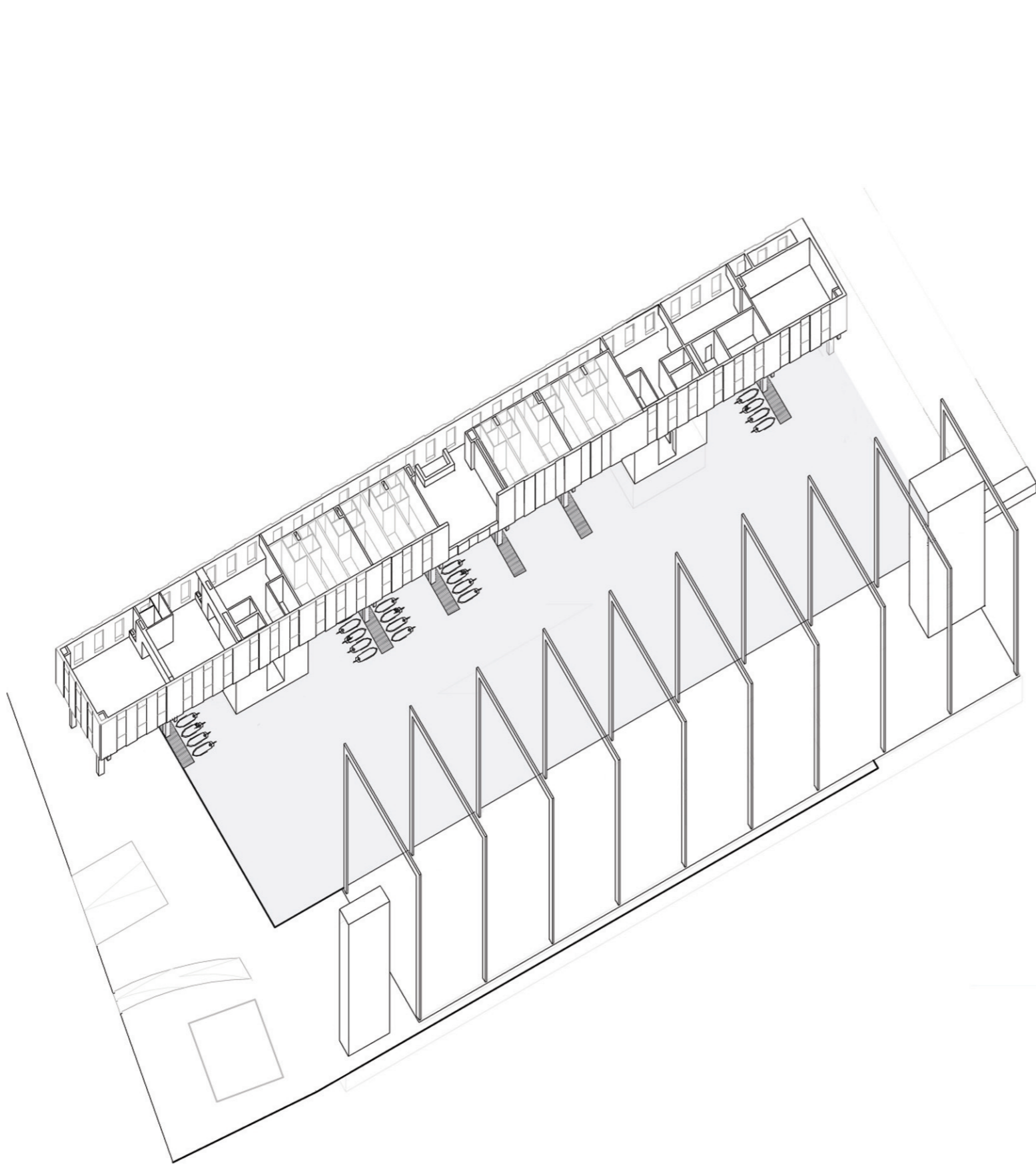

Cité Noord Amsterdam

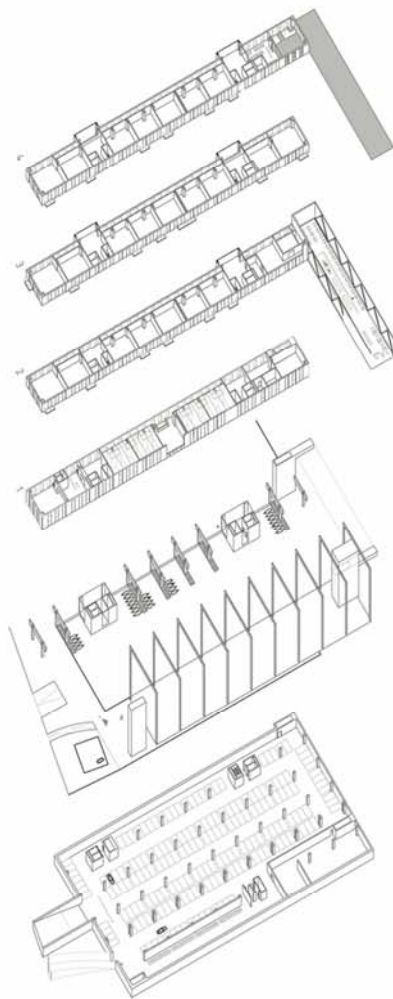
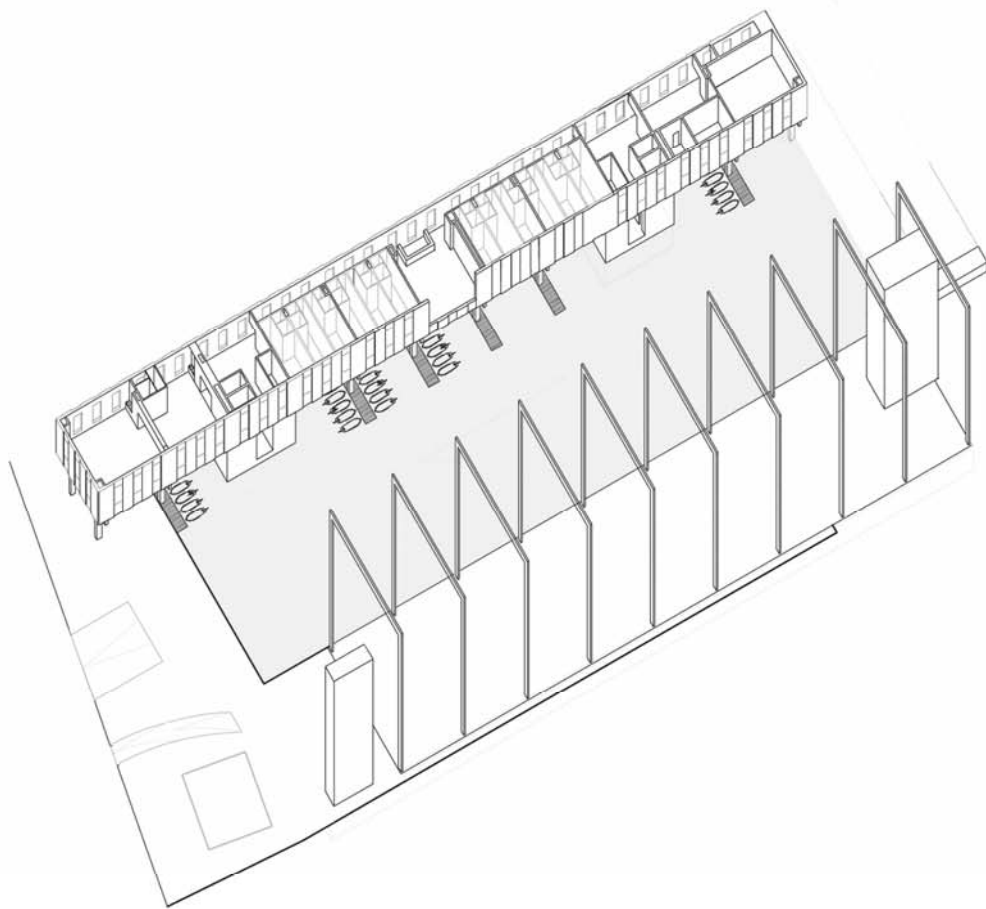

Cité Noord Amsterdam

# Apartments Cooks Island

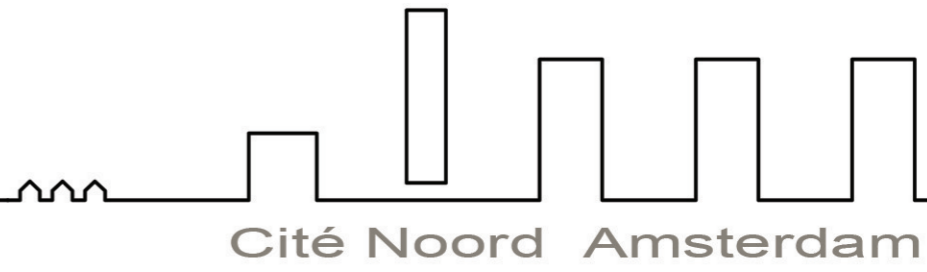
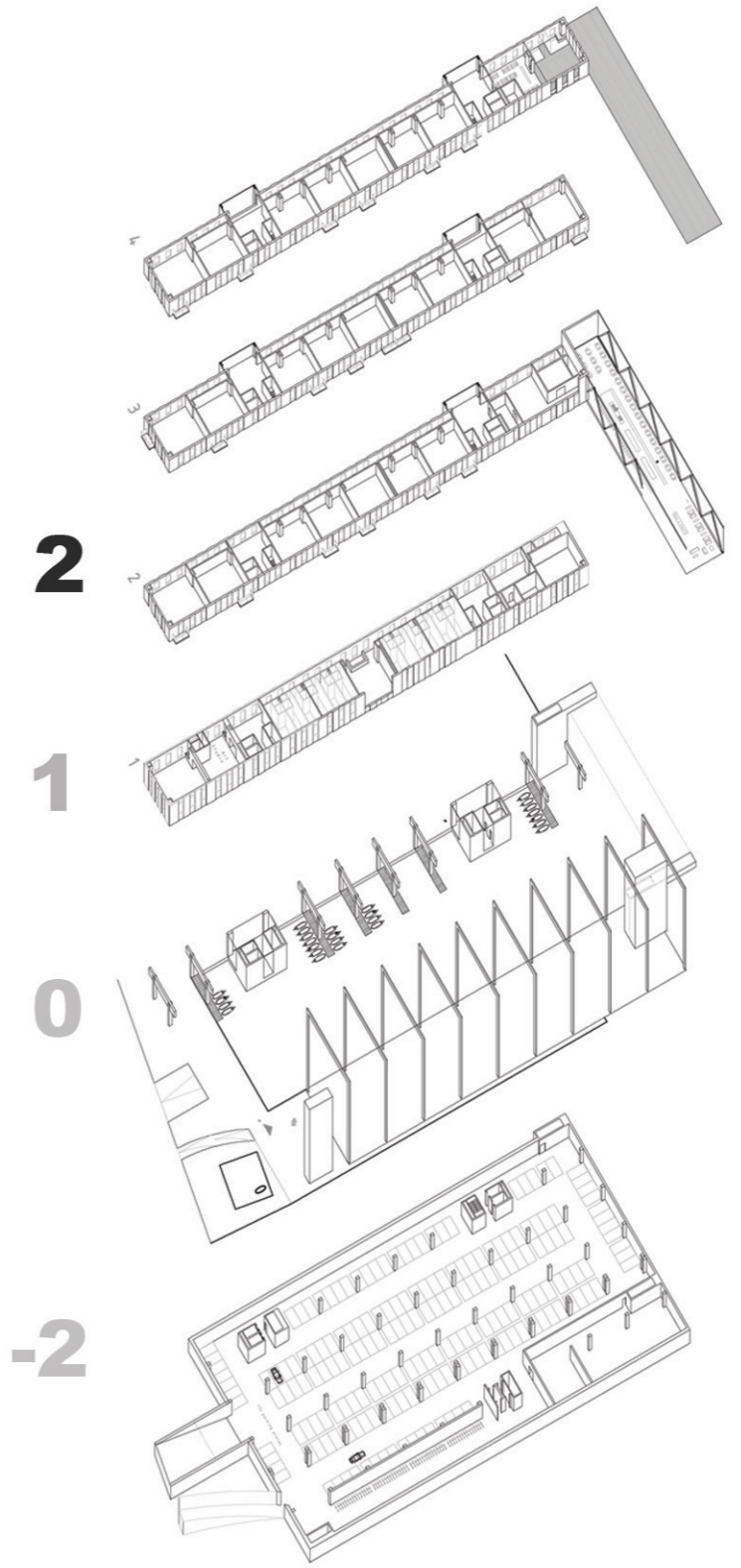
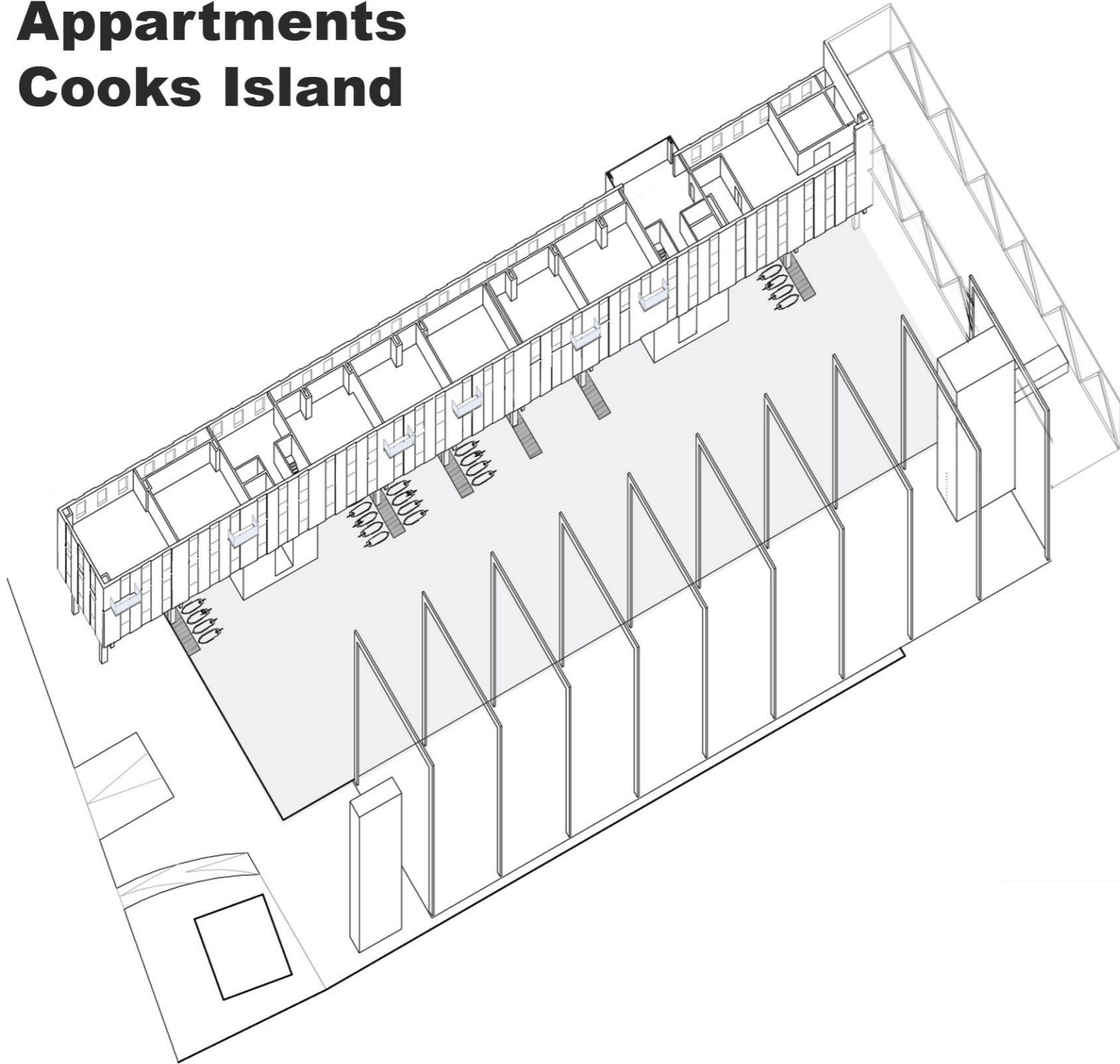

# Apartments Cooks Island

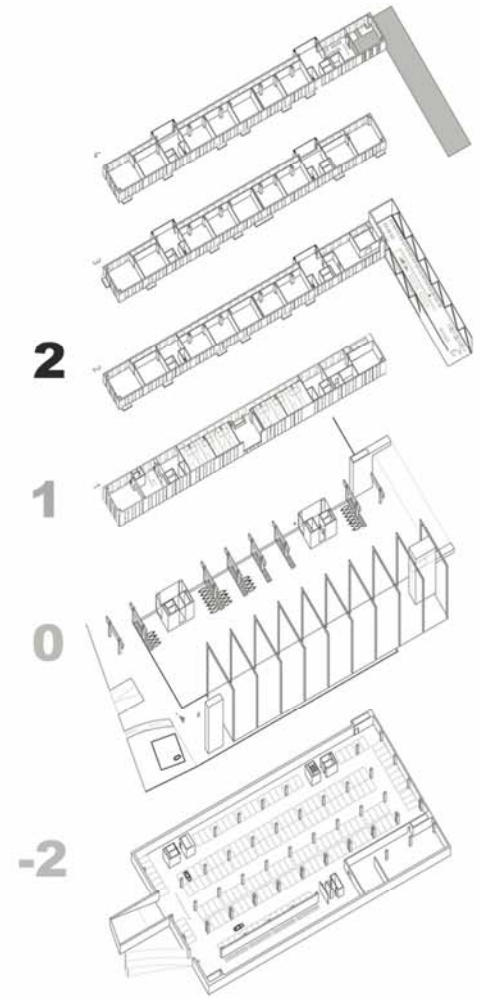
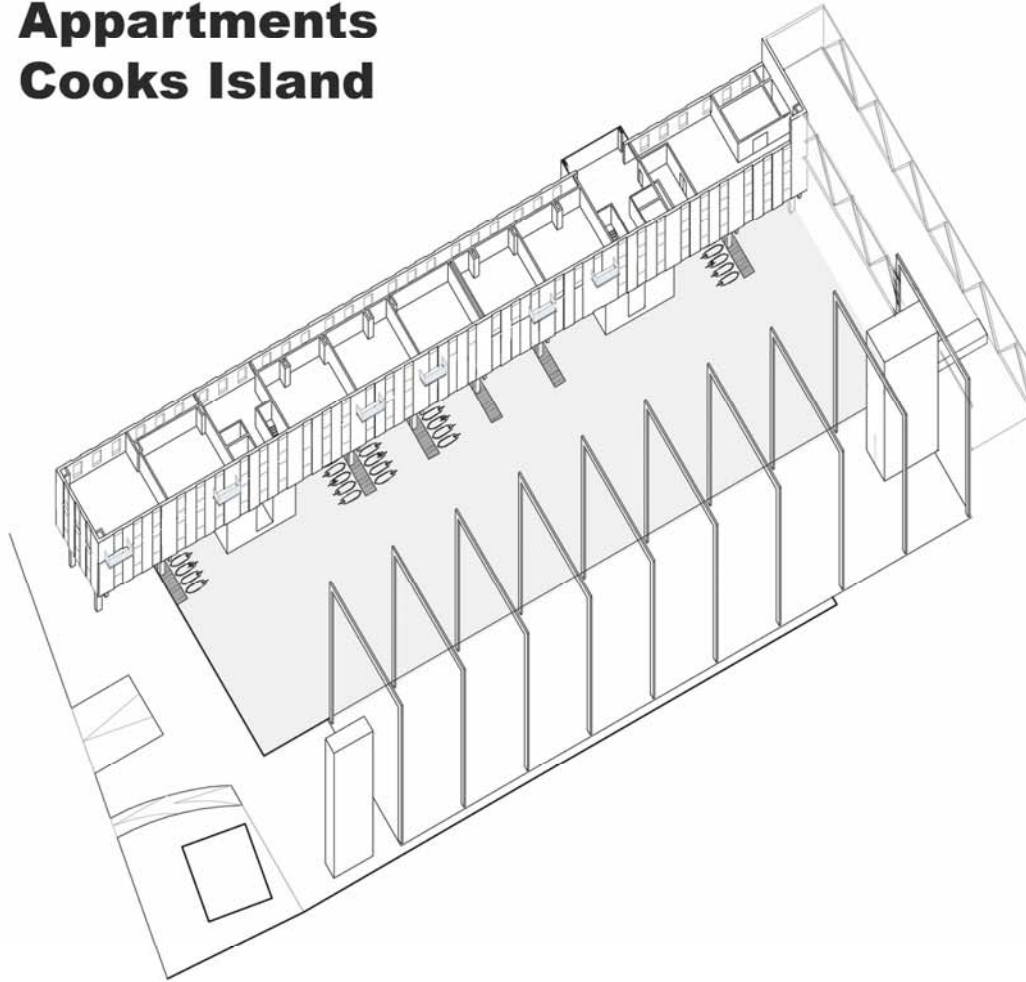

Cité Noord Amsterdam

# Apartments TeaRoom Terrace

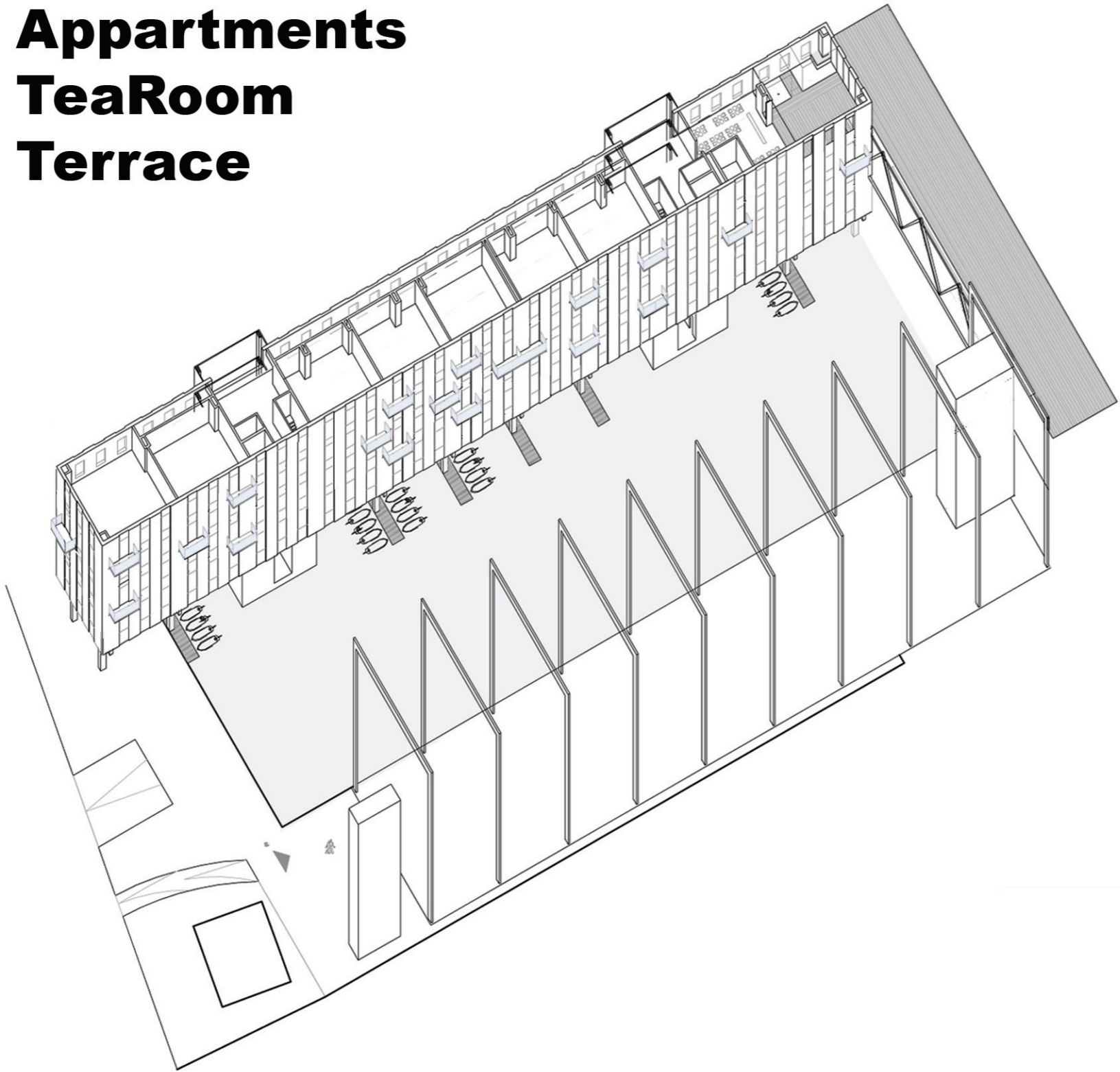

4

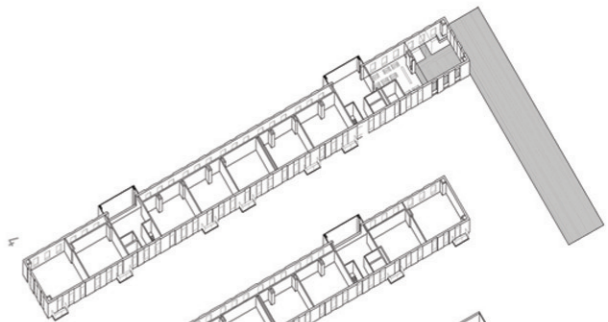

3

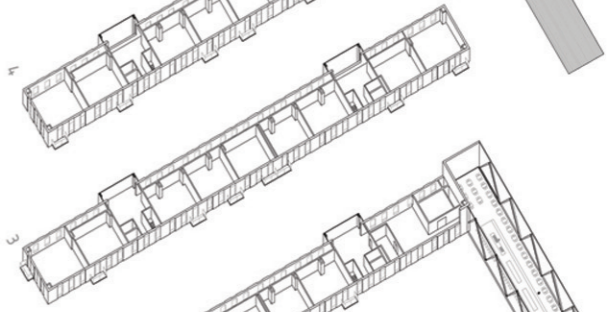

2

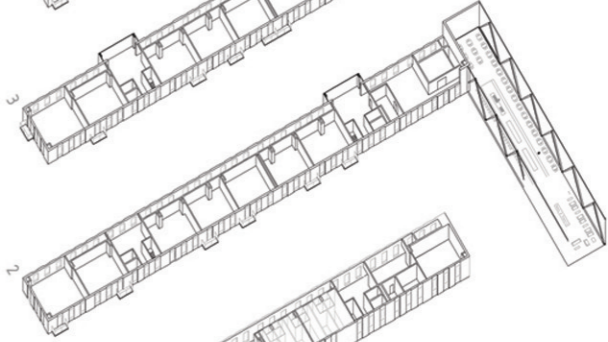

1

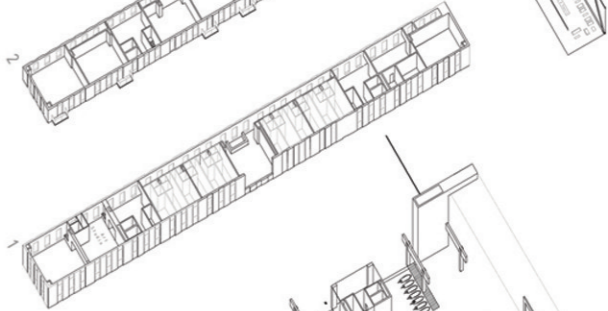

0

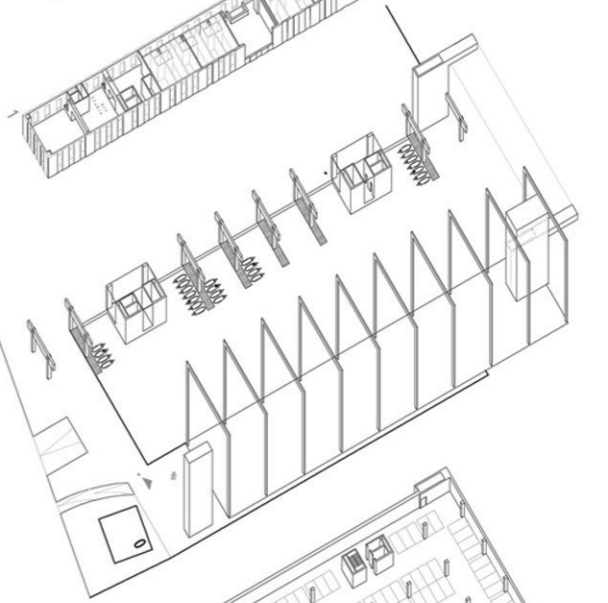

-2

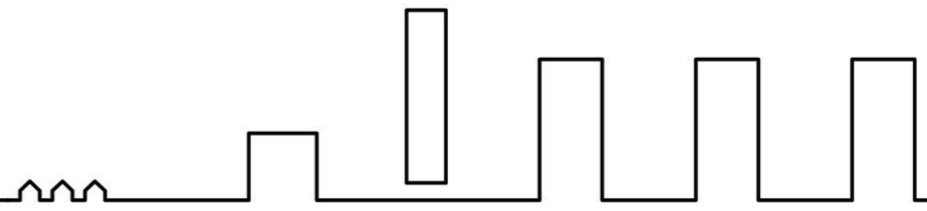
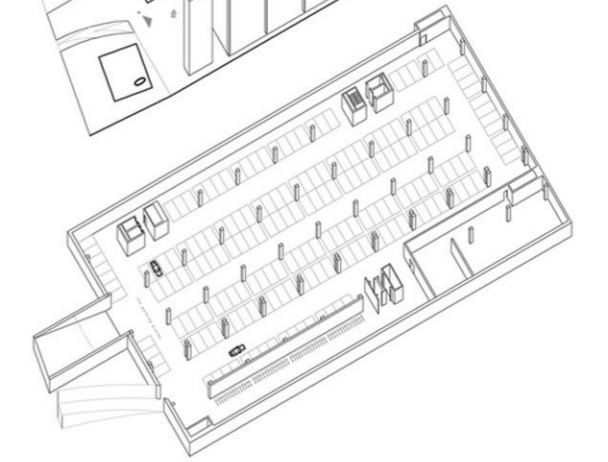

Cité Noord Amsterdam

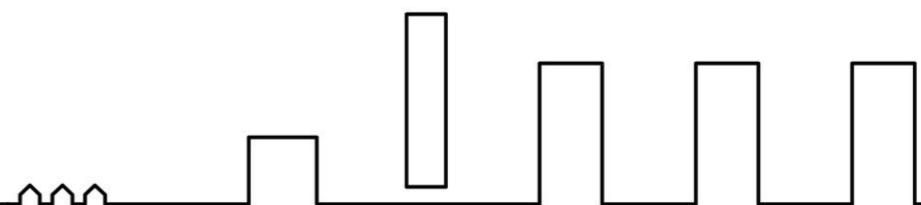
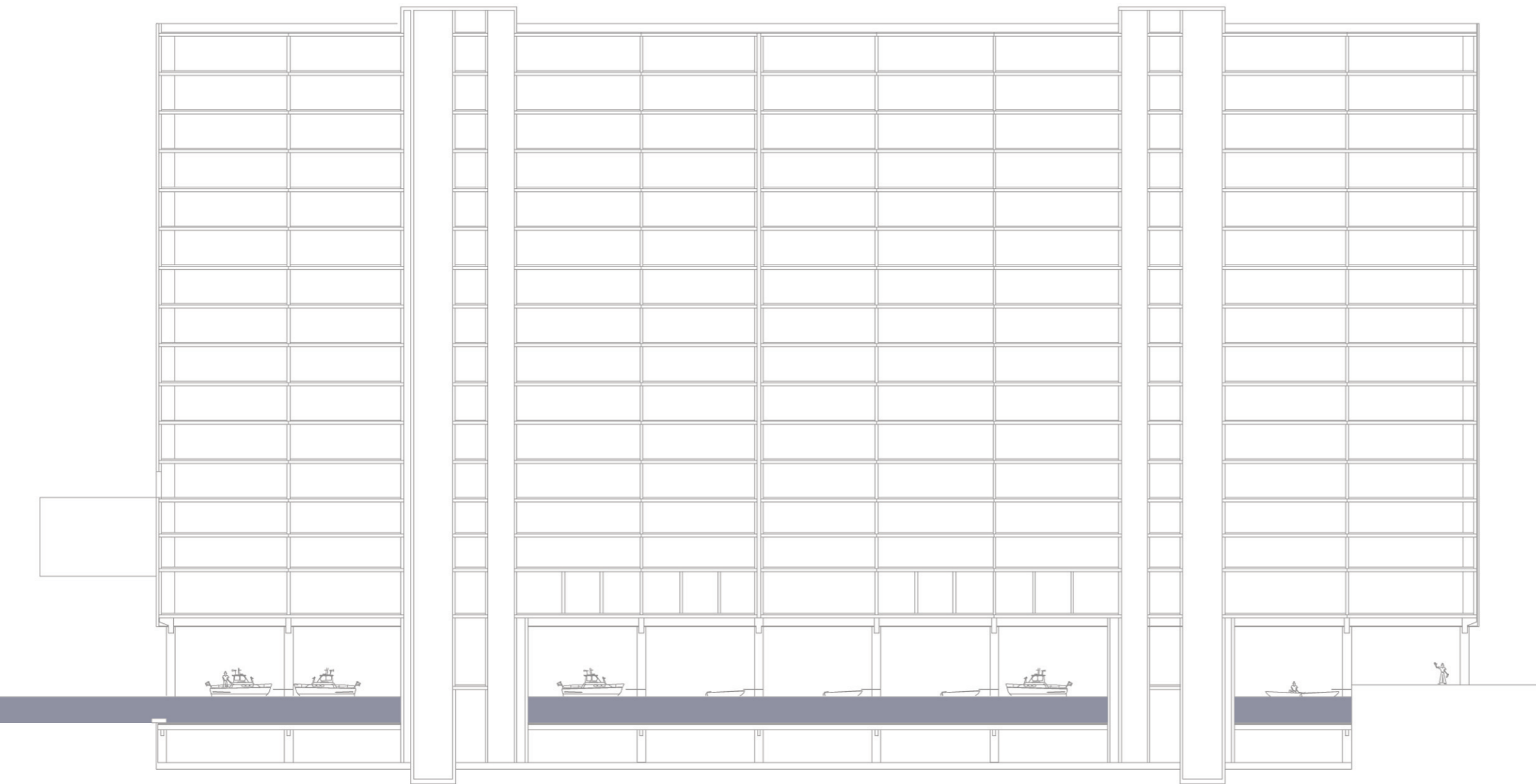

Cité Noord Amsterdam

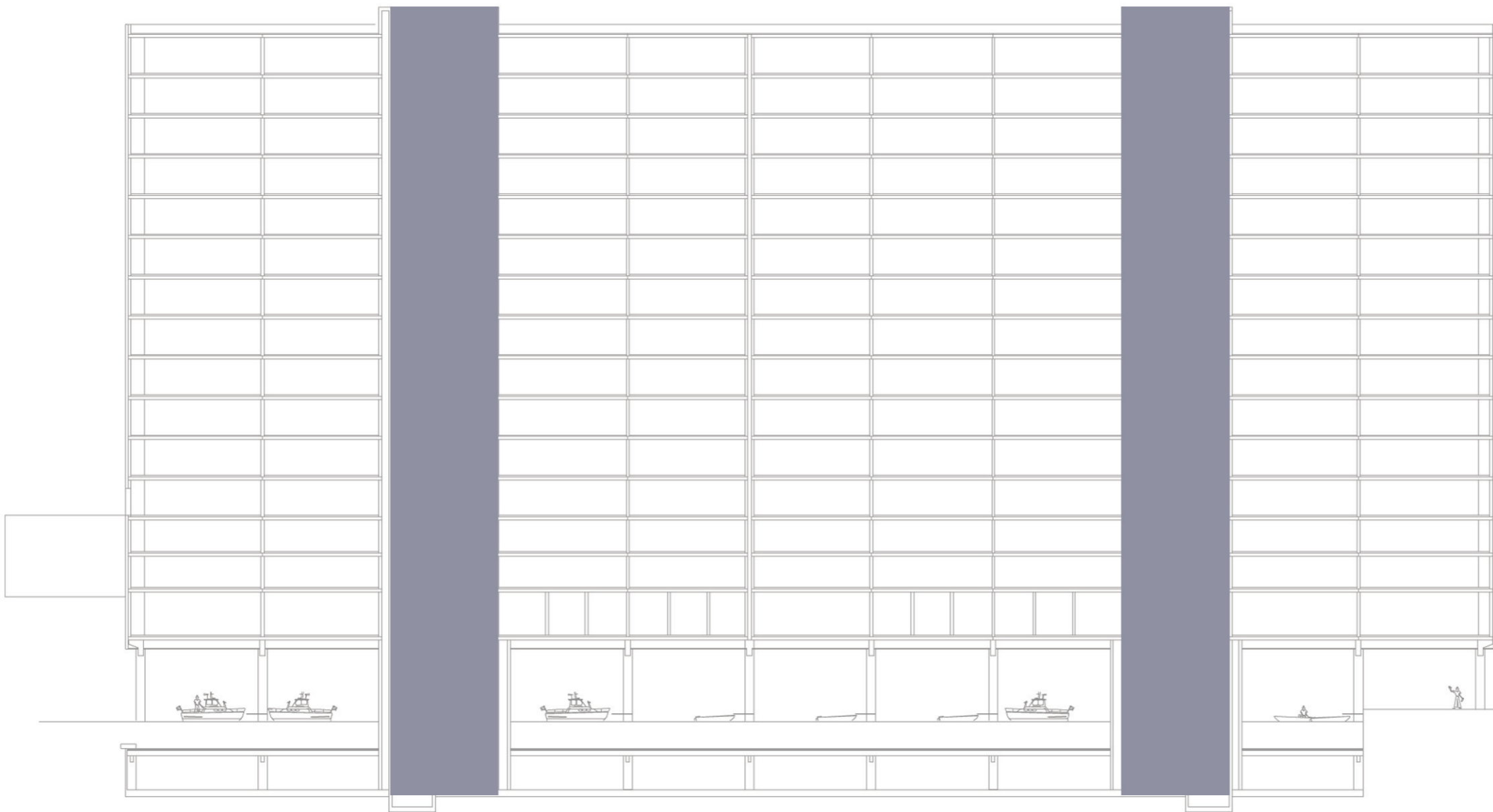

# Stability

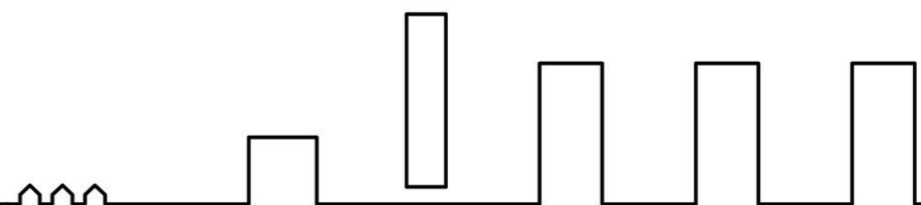

Cité Noord Amsterdam

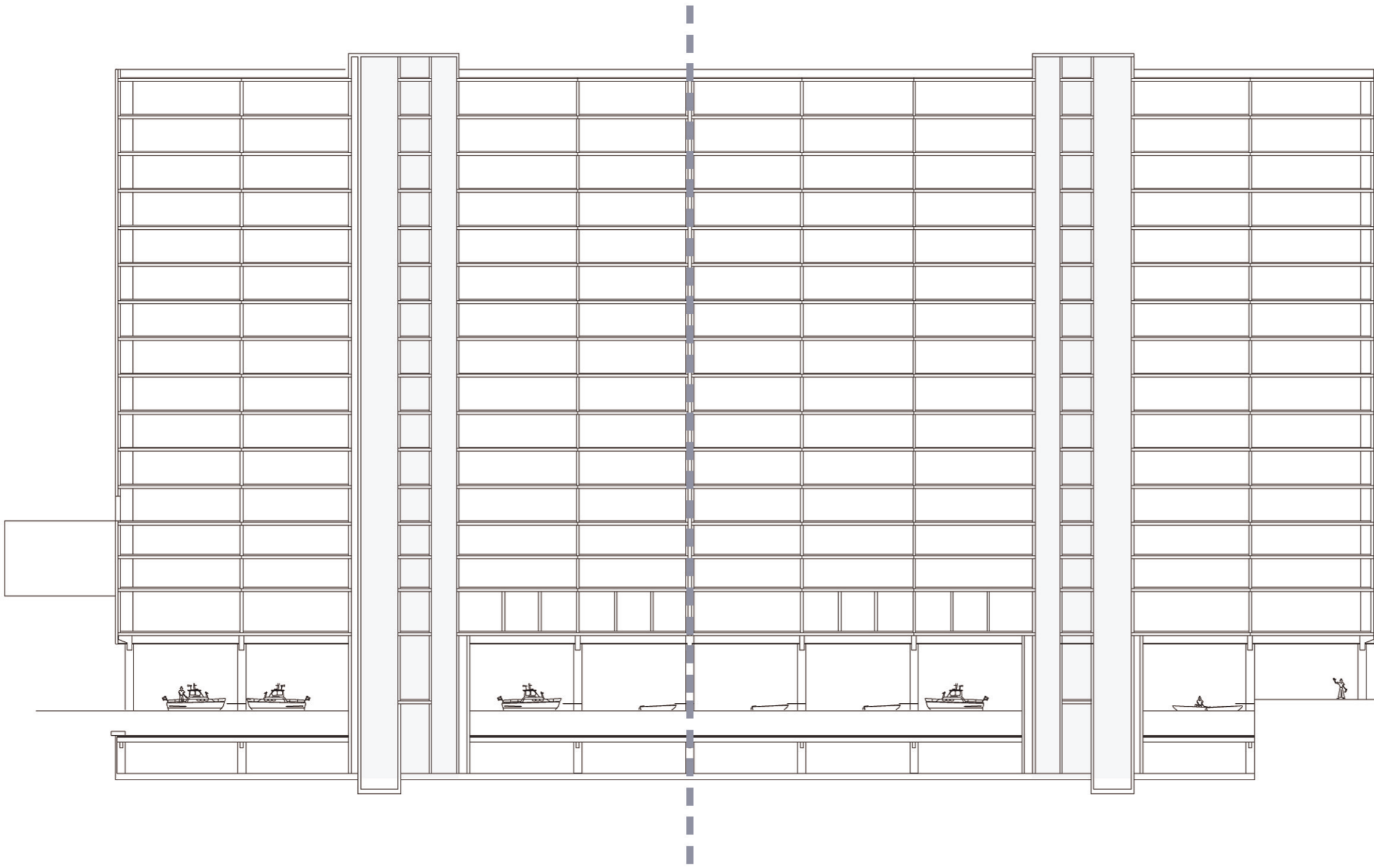

# Dilatation

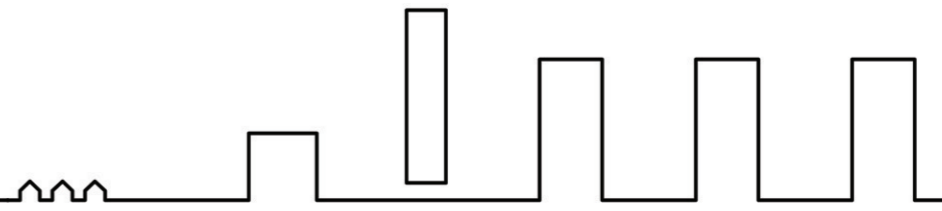

Cité Noord Amsterdam



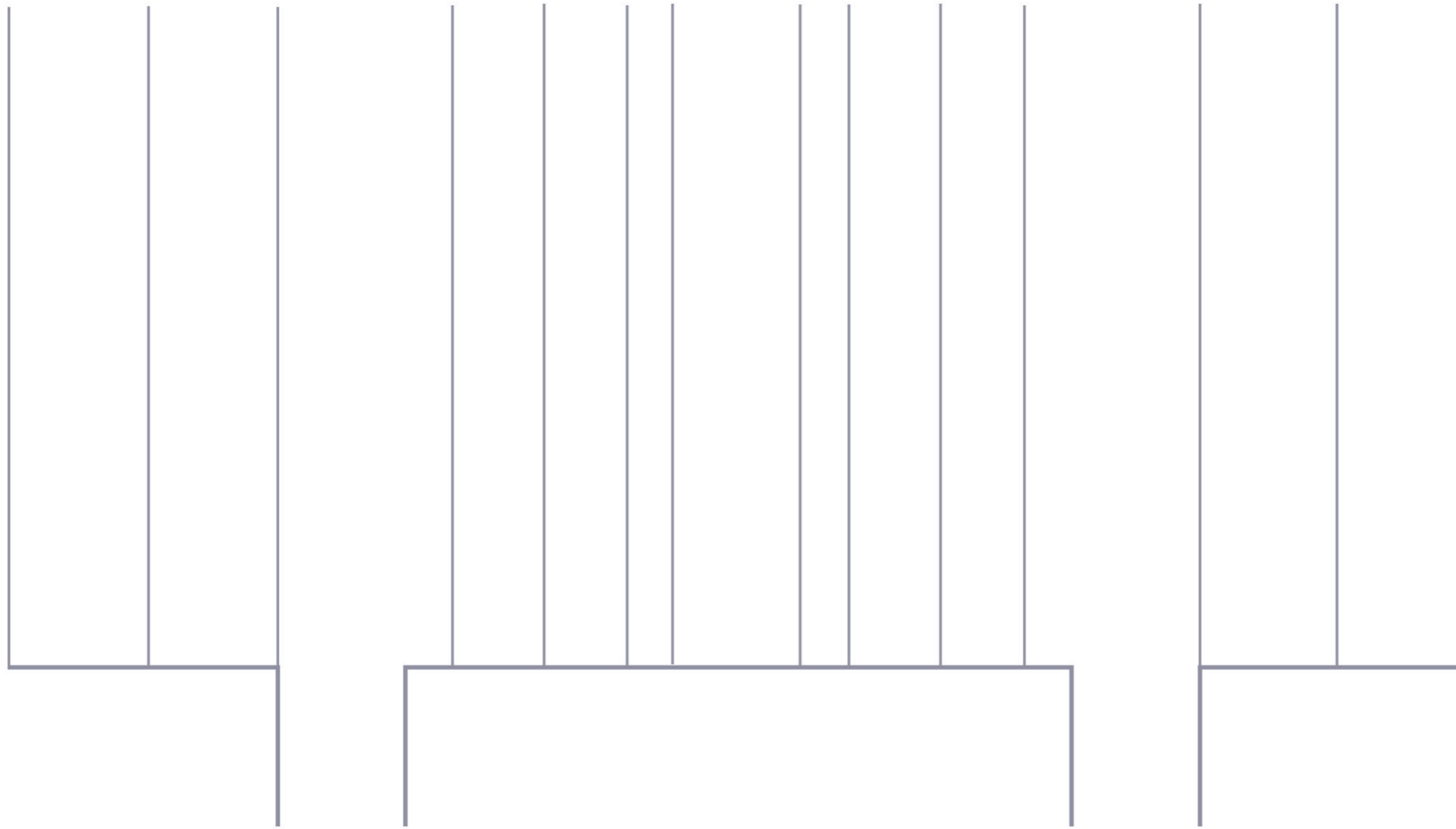

## Shafts

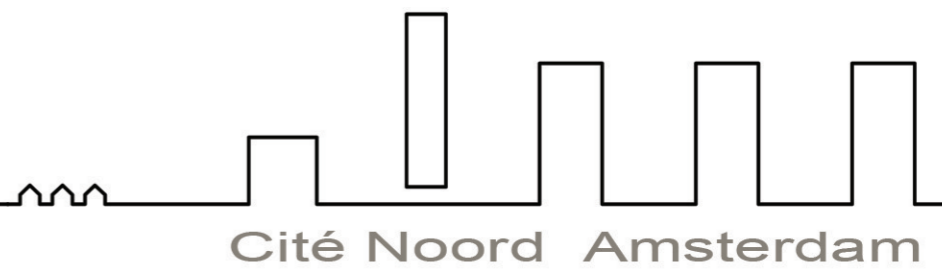

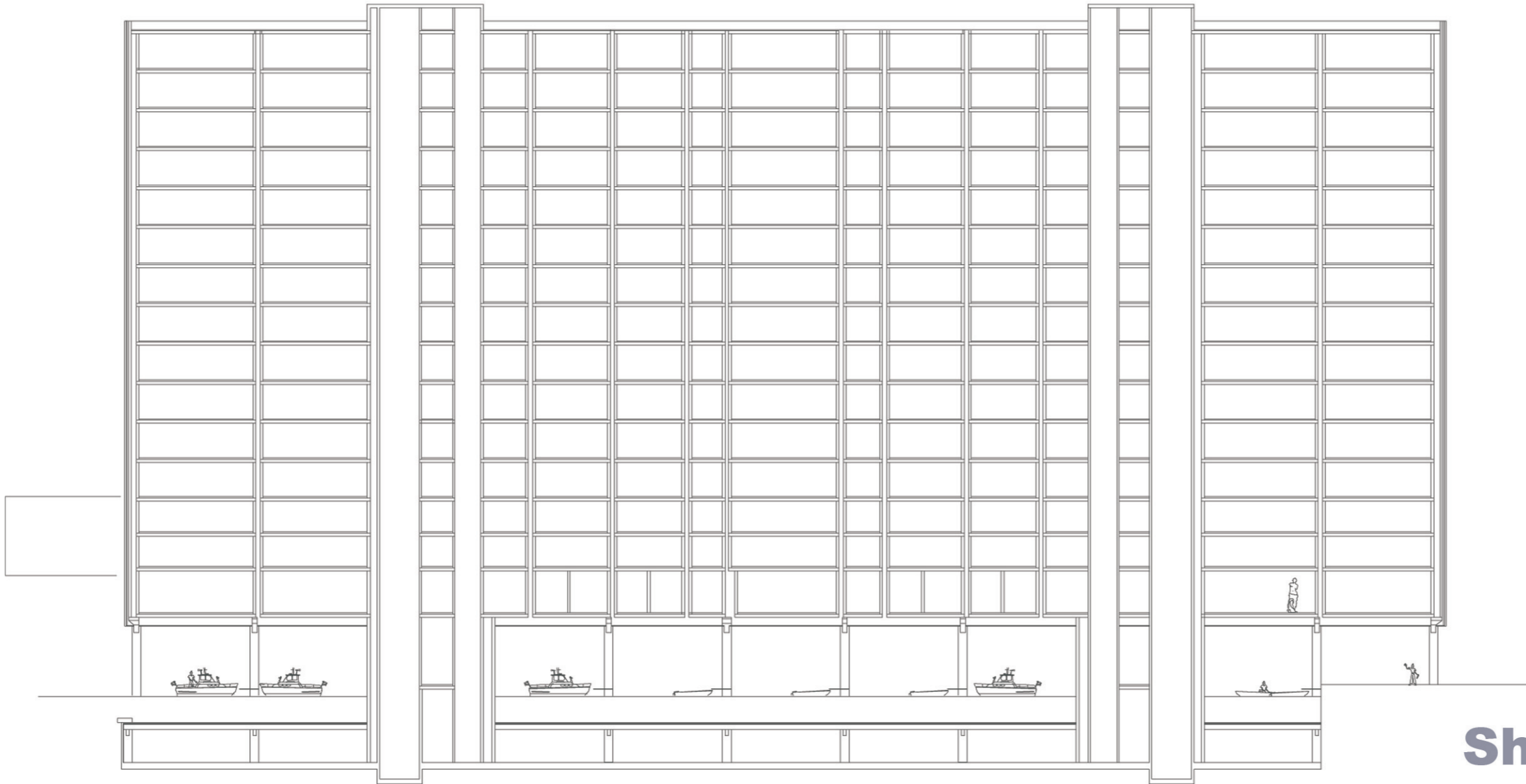

**Shafts**

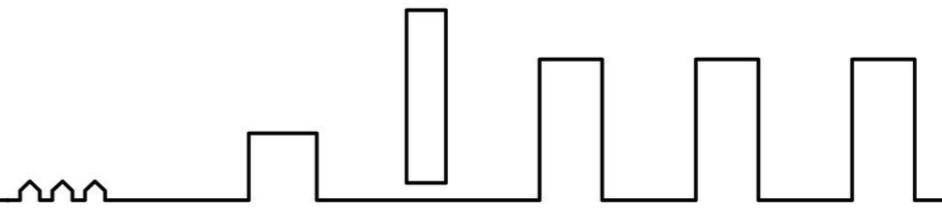

Cité Noord Amsterdam

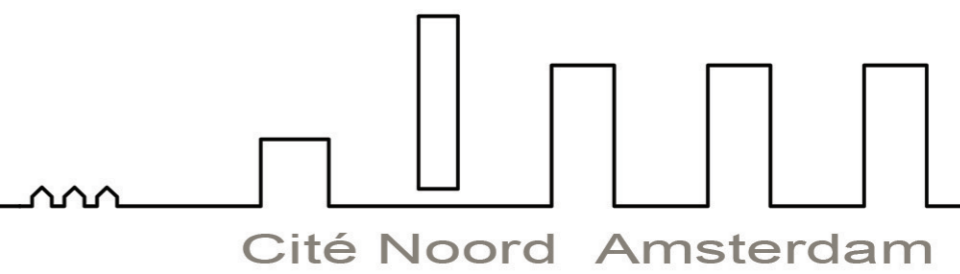

Cité Noord Amsterdam

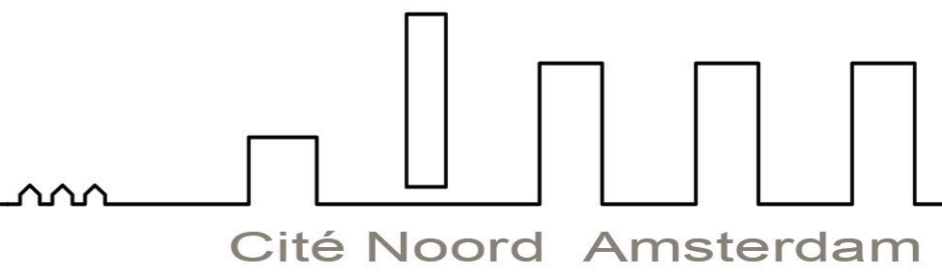



# COOKS ISLAND

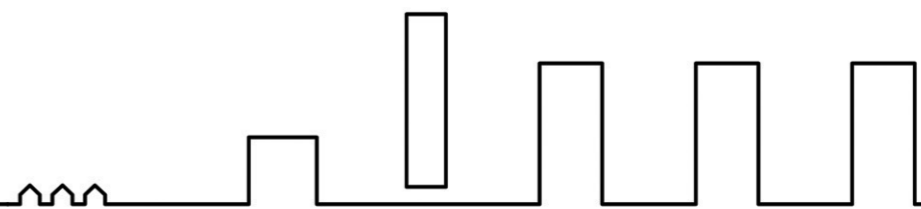

Cité Noord Amsterdam

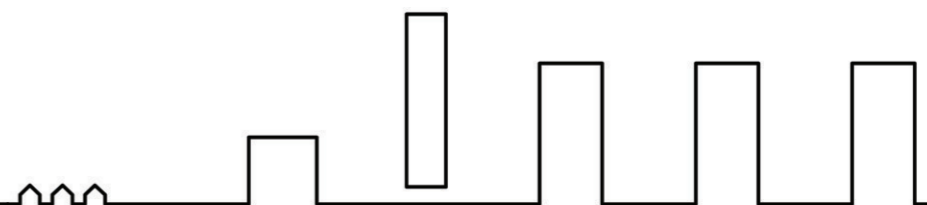

Cité Noord Amsterdam