

# Lely Manure Check

Optimizing feed for Dairy cattle with the help of Manure Monitoring



Integrated Product Design  
Master Thesis by Rémon van Nieuwenhuizen

April 2022



Delft University of Technology

# Awcknowledgement

I would like to thank my supervisory team, consisting of Bas Flipsen and Wilfred van der Vegte. They have always provided me with useful insights during meetings. Their critical thinking and questions made this project stronger and of more value.

At Lely industries I would like to thank Dogan Ozmen for always making time for me and helping me navigating the company. I have always felt appreciated and welcomed into the Lely family. Thank you for allowing me to work on this project and supporting me well.

I am grateful to my roommates and friends for listening to my considerations of every single step in the process and mocking of how much work graduating is.

My girlfriend Isabel has been the best in supporting me through good and bad times, and my parents have been a source of comfort. Thank you all!

I am hoping this thesis will give you an idea of all the work I have done and convince you of the effect it might have.

Rémon van Nieuwenhuizen

# Contents

<b>1. SUMMARY</b>	<b>4</b>	<b>5. DEVELOP</b>	<b>35</b>	<b>10. REFLECTION</b>	<b>65</b>
<b>2. INTRODUCTION</b>	<b>5</b>	5.1 How to's	36	10.1 Approach	65
2.1 Problem statement	6	Seperation pen	40	10.2 Design choices	65
2.2 Assignment	6	Funnel dump pit	41	10.3 Prototyping	65
2.3 Scope	6	Vector feedback	42	10.4 Conclusion	65
2.4 Approach	7	5.2 Direction choice	43	<b>11. REFERENCES</b>	<b>66</b>
<b>3. ANALYSE</b>	<b>8</b>	5.3 Function analyses	45	<b>12. APPENDIX</b>	<b>68</b>
3.1 Precision livestock farming	9	<b>6. PROTOTYPING</b>	<b>48</b>	3. Interview questions	72
3.2 Dairy cows	10	6.1 Design	49	4. Basic regression: Predict manure composition	73
3.3 Feed optimization	12	6.2 Setup	50	5. Arduino code for test setup	78
3.4 Manure monitoring	15	6.3 Results	51	6. Cost calculation	79
3.5 Farm data	16	6.4 Iteration	52	7. Feedback dashboard ideation	86
3.6 Discovery Collector	17	6.5 Results	53		
3.7 Interviews	19	6.6 Design improvements	55		
3.8 Barn environment	21	<b>7. FINAL DESIGN</b>	<b>57</b>		
<b>4. DEFINE</b>	<b>22</b>	7.1 Integration	57		
4.1 Sensors	23	7.2 Manufacturing	59		
4.2 Sensor selection	26	7.3 Manure monitoring	60		
4.3 NIRS sensor	28	<b>8. CONCLUSION</b>	<b>61</b>		
4.4 Calibration	30	<b>9. RECOMMENDATIONS</b>	<b>63</b>		
4.5 Data analyses	31	9.1 Roadmap	64		
4.6 Data processing	33				
4.7 Requirements	34				

# 1. Summary

To improve efficiency, dairy farmers monitor the inputs and outputs of their cows based on data collected by sensors. Currently the main sources for this data are the given food and information about the milk (composition and volume). This data helps the farmer make better decisions regarding animal welfare and feeding practices. However, one of the outputs of the cow is currently not monitored, namely the manure.

A system that monitors herd manure data in a barn using sensor technology was proposed. It should give the farmer interpreted feedback enabling him to have more control over farm efficiency both financially and ecologically.

It was found that currently farmers use a feed advisor to optimize their feeding ration. They use 2 parameters to measure a cows performance Feed Efficiency (FE) and Income Over Feed Cost (IOFT). FE tells how efficient a cow is in converting feed into milk while IOFT tells how much is spend on feed per unit of milk.

Optimizing feed for dairy cows is a complex system with many factors to consider. The manure parameters that will help the most towards improving this were identified with the help of a feed advisor:

- Proteins
- Dry matter
- Organic matter
- Fibres
- PH value
- Starches
- Sugars

Many sensors were considered but eventually the choice was made for a NIRS sensor. This sensor was able to measure almost all the considered parameters and was already being used in manure, a harsh environment.

A NIRS sensor can be used to determine the composition of a sample. Using a light source and a NIRS sensor, it is determined what the light reflection of a sample is for certain frequencies. The amount of light that is absorbed per frequency can be linked to what the distribution of components is in that sample.

The NIRS though is not yet calibrated for the desired parameters. Research was done on how to calibrate this sensor and what the costs would be. To calibrate the sensor, samples need to be put through the NIRS sensor as well as send to the laboratory. By comparing the laboratory data to the NIRS absorption graphs it is possible to generate a calibration line.

After validating the value of the NIRS sensor several concepts for integration were created. The concepts were tested on criteria found during the analyses phase of this project. Ultimately it was chosen to integrate the NIRS sensor in the dumping pit of the Lely Collector, a robotic manure vacuum cleaner.

Two prototypes were made to test different solutions for making sure the manure went past the sensor. Eventually it was decided to create a combination of a funnel and a siphon to ensure that the design worked with all thicknesses of manure. Something that can vary between different farms.

The learned lessons from the prototype resulted in a final design. This final design is mounted inside the dumping pit using brackets. The collector drives on top of it and dumps the first through the sensor which output ends in the dumping pit.

The data from the parameters that is measured is then send to a Lely cloud-based system where a machine learning algorithm converts the data into feedback for the farmer. The farmer will then receive the feedback via the Lely Horizon application and can send it to his Lely Vector feeding dispenser to be automatically processed.

The conclusion of the project is that manure monitoring could be valuable for the farmer since it can reduce emission as well as improve business performance. Therefore, Lely should execute more research into calibrating the NIRS sensor and generating feedback form the manure monitoring data.

## 2. Introduction

The Netherlands has committed itself in a European context to protect nature areas against an excess of nitrogen deposition. Earlier this year, a law was passed to ensure that nitrogen levels in 74% of the vulnerable nature areas no longer exceed the standard by 2035. Agriculture is one of the major nitrogen emitters, responsible for more than 45% of the total nitrogen deposition in the Netherlands (Figure 1).

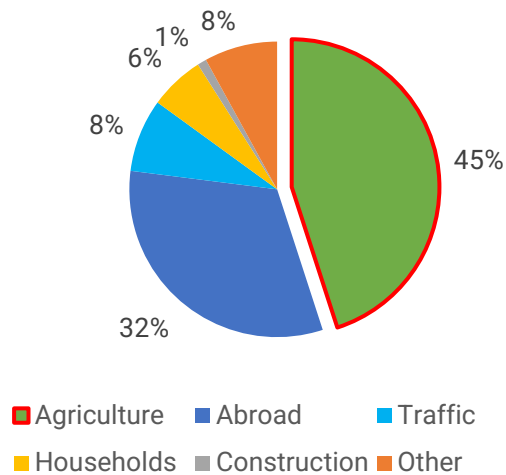

Figure 1 - Nitrogen deposition by origin, 2019. (CBS & RIVM, 2019)

To reach the set goal, policy changes have made farming stricter and as a result less viable. The government is even going as far as buying out farmers who emit too much. To stay afloat farmers, have to take many (expensive) measures to combat emissions and become more efficient. In livestock

farming these measures come in the form of precision livestock farming (PLF). Due to the increased need, the PLF market is growing and becoming more and more important for farmers worldwide. PLF solutions make agriculture viable again while also helping to comply with current and future regulations.

The client for this project, Lely Industries N.V., is a company that focuses on solutions for smart farming which they describe as: affordable, practical, safe, profitable, efficient, and sustainable. Over the last few years, they have released multiple products that help farmers become more future proof.

To improve efficiency, dairy farmers monitor the inputs and outputs of their cows based on data collected by sensors. Currently the main sources for this data are the given food and information about the milk (composition and volume). This data helps the farmer make better decisions regarding animal welfare and feeding practices. However, one of the outputs of the cow is currently not monitored, namely the manure.

The manure of the cow can contain additional nutritional information. Dairy cattle have a nutrient excretion rate of around 50 – 90% which is influenced by overfeeding. By monitoring the manure of a herd, the farmer can reduce nutrient excretion by receiving better and new feedback regarding feed efficiency.

To fill this knowledge gap, currently, around every 6 weeks a feed advisor visits the farm. This consultant checks the animals and periodically analyses the manure by sending a sample to a lab. Afterwards he

gives advice on how to proceed with a tailor-made feeding schedule.

Since Lely is already analysing milk and feeding data this offers an innovative opportunity to monitor manure. Manure has good indicators of how well cows are utilizing the feed and transforming it into milk. The manure contains all the excreted/unused nutrients and can tell the farmer how to alter his feeding practices to be more efficient.

Lely could develop a separate product or add a sensor to one of their current barn products. By having full access to the combined data set of the sensors, Lely can offer more tailored feedback to the farmer. Which in term can help the farmer be more viable and sustainable.

## 2.1 Problem statement

Farming is becoming more and more strict due to policy changes driven by environmental means. This forces farmers to innovate to keep up with current and future regulations while also staying viable. Therefore, dairy farmers are already using a lot of data from their animals to make better decisions regarding well-being and feed efficiency.

Data is available on what the cow eats (input), what the cow transforms to milk (output) but there is a gap in data on manure (output), which can be highly beneficial to the farmer. Currently the farmer makes use of a feed advisor to bridge this knowledge gap which leads to a tailor-made feeding schedule. However, this consultant only comes by every 6 weeks and only occasionally sends a manure sample to the lab for checking.

The farmer could benefit with more up-to-date data on the manure from his herd. He already receives feedback from the milk data through an application. Adding more information to this system could lead to better feedback. Allowing the farmer to be more efficient with feeding and looking after the welfare of his animals.

It is known that manure contains vital information regarding feed efficiency and animal welfare. But currently it is unknown on what scale this extra data can benefit the farmer. There are no comparable products that generate this data. Also, no research has been done on what can be done with manure samples from cattle herds.

## 2.2 Assignment

Design a product that monitors herd manure data in a barn using sensor technology and gives interpreted feedback to the farmer. To that end, investigate how, by automatically interpreting it and allowing interaction with it, manure data can enable the farmer to have more control over farm efficiency both financially and ecologically.

## 2.3 Scope

At the beginning of this project a lot of benefits of manure monitoring were identified. This was done by talking to experts from the University of Wageningen and by generating mind maps with the help of employees of Lely (Figure 2). Because this project is limited to around 20 weeks it was decided, together

with the Lely farm management experts, that there will be focused on one benefit: cow welfare. Since this would have the most direct impact for the farmer, the suspected main stakeholder of this project.

Cow welfare can be divided into multiple sub benefits: detecting illnesses, detecting food problems, and improving feed efficiency. Lely has indicated that for them feed efficiency is the most interesting. Improving feed efficiency can lead to higher profits for their customers which makes investing in a manure monitoring product accountable. Improving feed efficiency with the help of manure monitoring will therefore be the main focus of this project with a side focus on improving and monitoring cow wellbeing.

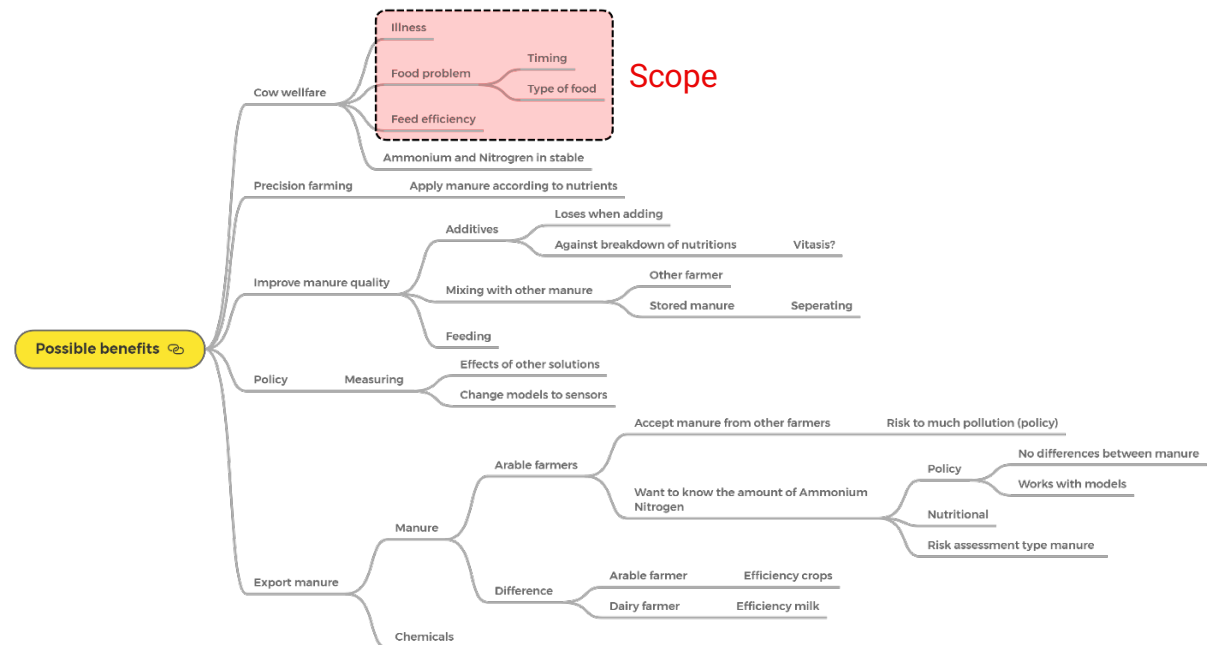

Figure 2 - Partial mind map of manure monitoring identifying possible benefits

## 2.4 Approach

Since the topic of this covers a lot of research areas, it was chosen to start with a thorough analysis phase. This was necessary because not a lot is currently known about manure monitoring. No competitor products exist, and research papers only identify it as an interesting research direction (Evangelista, Basiricò, & Bernabucci, 2021).

First a basic understanding of the required research topics was created using literature study. Doing this first allowed better communication with the experts from Lely and identify knowledge gaps that they could help fill.

Afterwards the current situation for feed optimization was analysed. Farmers use feed experts to help with cow welfare and increasing business performance. Lely employs multiple feed experts that were consulted about how they go about their job as well as what they think could be interesting manure parameters to monitor.

During interviews with farmers, they were asked to help identify shortcomings within this current situation of having feed experts, as well as how they

look towards a manure monitoring system that can replace them.

There was also looked at what products Lely has now inside the barn and what data they generate. This data could be used in combination with the designed product and the combination could lead to improved feedback for the farmer. The environment these products operate in, was also researched. Since the barn is a harsh environment, this led to new requirements for operation.

In the next phase multiple topics were defined and described further concluding from the research phase. Deciding to fixate some topics in an early stage of this project allowed to not make the scope too broad. It was important to select a sensor in an early stage because all sensors come with their own list of requirements. These would have resulted into many concept directions, making the project too broad for the allowed time frame.

During the development phase first multiple sub solutions were identified and explored that were later combined into concepts. The context that the product will operate in combined with the sensor requirements and the analysis phase led to a list of

requirements that was used to test and select one of these concepts. The chosen concept was further defined, and some design choices were made to allow for a prototype to be created.

Prototyping was the next step in the development of this project. A prototype was constructed out of sheet metal with the goal of collecting data from a farm as well as getting experience with the NIRS sensor and barn environment. The result of putting this prototype inside a dump pit was that another iteration of the prototype was created. The results of this iteration led to some iteration on sub solutions which ultimately led to the final design.

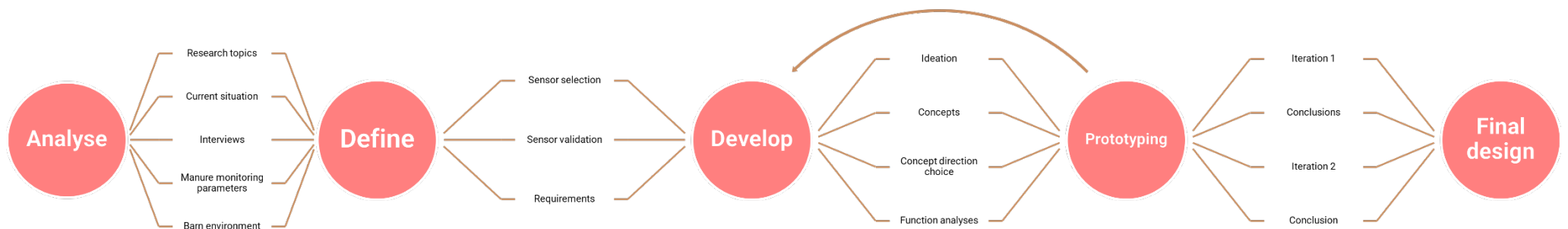

### 3. Analyse

The analysis phase of this project was very important. The topic of cow welfare and feed efficiency is broad and complex. To be able to later select a sensor, generate requirement and create a final product, a certain basic level of understanding is required.

The first topic to be described is Precision Livestock Farming (PLF). Precision livestock farming is a growing market that is becoming more and more important for farmers worldwide. This project will result in a product that will support farmers in PLF. Therefore, it is necessary to understand what the definition is of PLF, what drives this growing market and what benefits does PLF have for farmers. This will later help with creating a viable product that is appealing to the customer.

Secondly the topic dairy cows will be covered. Dairy cows can be seen as complex systems with inputs and outputs. When trying to optimize these 'systems' it is important to understand the underlying processes and have a basic knowledge of terminology. This makes it easier to discuss and communicate with farmers and other experts. It also helps with understanding what is necessary to have a good functioning cow. A cow that produces a lot of milk and is healthy.

The next research topic that will be discussed is feed optimization. After knowing what processes are being optimized, it is interesting to know how that is currently being done. This chapter will describe how the farmer calculates his ration, how he adjusts these

accordingly, what indicators he uses for performance and how he identifies problems with feeding. This will help with describing factors that can be improved upon, finding parameters to monitor and create an understanding of how performance on a farm is defined.

Next, with the help of feed experts, the most valuable parameters that can be used to monitor manure will be identified. It is important to differentiate the value of certain parameters since that can be used later to value the sensors.

After the research topics, an overview will be given of current Lely products and the data they collect. In PLF, data plays a big role in the day-to-day operation of a farm. By combining data streams, a more complete picture can be given about the current state of a farm business. It is therefore important to look at what data Lely already collects and how this new product will integrate with the Lely product ecosystem.

Two farmers were also interviewed to understand how they look at farm optimization and the growing importance of technology for their business. For this project it is valuable to know what they expect of new technologies, how they would like to interact with these devices and what they think about manure monitoring. They can also indicate what can be improved upon in the current situation.

Lastly, the barn environment that the product will operate in is described. The barn is a harsh environment since it is filled with manure and living animals. Describing the barn environment resulted in the addition of multiple requirements.



### 3.1 Precision livestock farming

Precision livestock farming (PLF) is a concept that is becoming more and more popular within the farming world. The global market revenue for PLF products was estimated at €2,6 Billion in the year 2020 and projected to reach the size of €4,1 Billion by the year 2026 (Global Industry Analysts Inc., 2021). Since this projects outcome will likely be a PLF product it is important to understand this market better. Some research questions were constructed to achieve this:

- *What is the definition of PLF?*
- *What benefits does PLF have for the farmer?*
- *What drives the PLFs rapidly growing market?*

#### Definition

In the PLF concept, the animal is used as a sensor. Algorithms translate measured animal responses into key indicators which will help with optimal performance, improved animal welfare, and farm sustainability. PLF applications assist farmers in taking their daily management decisions and generate early warnings when something is going wrong or can be improved in the production process (Vranken & Berckmans, 2017).

#### Context

PLF is the result of an increasing world-wide demand for quality animal products combined with the demand for responsible farming. The world now produces more than three times the quantity of meat as it did fifty years ago (Ritchie & Roser, 2019). Due to this increased demand, large farms are becoming the new norm. In the past most farmers knew each of their animals by name. Each animal was

approached as an individual which resulted in tailored care for all animals. But over the past decades, farms have grown. Making highly automated processes for feeding and other tasks necessary to stay viable. Precision livestock farming helps the farmer with tailored animal care even with large amounts of animals.

Another factor for the increased use of PLF is that world-wide people are becoming more and more aware of the risks we face due to global warming. Increasing effort is put into reducing the influence of society on this problem.

At the U.N. Climate Summit the 2nd of November 2021, a surplus of 100 countries signed the global methane pledge. Participants joining this pledge agree to take actions contributing towards reducing the global methane emissions by at least 30% by 2030. This could eliminate over 0.2°C warming by 2050 (Secretariat, Climate & Clean Air Coalition, 2022). In the Netherlands two-thirds of methane emissions comes from livestock farming (Wageningen university & research, 2022).

Agriculture is also one of the major nitrogen emitters, responsible for more than 45% of the total nitrogen deposition in the Netherlands (CBS & RIVM, 2019). Too much nitrogen in the air is harmful for our health and nitrogen eventually also ends back up on the ground. This deposition of nitrogen makes the soil become richer in nutrients, especially a problem in nature reserves. Rare plants that do well in nutrient-poor soil will disappear as a result. This also means that animals that live from those rare plants will disappear. As a result, biodiversity is decreasing.

Earlier this year, a law was passed to ensure that nitrogen levels in 74% of the vulnerable nature areas in the Netherlands no longer exceed the standard by 2035.

Emissions from livestock farming are a serious problem. Despite significant improvements in recent decades, much remains to be done to reach set goals. The Dutch government even plans to shrink and buy out the livestock industry to achieve set environment goals (Aanpak Stikstof, 2022).

Precision livestock farming can help with reducing greenhouse gasses while retaining the current industry size. This is also why the Dutch government is offering subsidy for farmers to reduce their greenhouse gas emission. From 2020 to 2030, €172 million is reserved in subsidy for source-oriented sustainability measures (Rijksoverheid, 2022). In European context subsidies also exist for developing smart farming solutions.

Precision livestock farming will help the farmer make better more substantiated business choices. With the help of data, the farmer will have better indicators to improve business performance, animal welfare and farm sustainability.

There are 2 main factors driving the increased use of PLF solutions. Firstly, farms are getting bigger due to an increased demand for animal products. To provide the same quality of care farmers are obligated to use PLF solutions. Secondly because of the increased global awareness for environmental problems, farming is becoming stricter. Pushing farmers to PLF solutions to comply with regulations. The government helps stimulate this by providing subsidies.

### 3.2 Dairy cows

Dairy cows are a specific type of cattle that have been bred to produce large volumes of milk while keeping methane emission levels low. High performing cows can make a big difference for any farm both economically and ecologically. Since this project is about improving cow welfare in terms of overall health and feed efficiency it is important to have a basic understanding of what it means to keep dairy cows. This will help communicate with experts and farmers as well as help identify what is necessary to have a good performing cow. To achieve this several research questions were constructed:

- *What are a cow's feed necessities?*
- *How does the farmer feed cow in practice?*
- *How does a cow transform feed into milk?*
- *What processes are being optimized in a cow?*

The dairy cow can be seen as a system with inputs and outputs (Figure 4). They consume feed and water and transform it into energy, growth, milk, faeces, and urine (VanSaun & White, 2020).

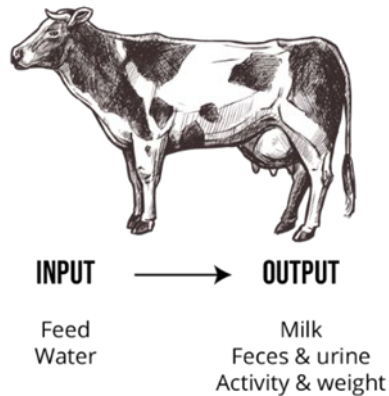

Figure 4 - Dairy cattle as a system (This image has been designed using images from Freepik.com)

### Feed

An average cow's diet consists of multiple feed materials (Figure 3). This is necessary to provide the cow with all the necessary nutrients for optimal functioning.



Figure 3 - Average daily diet of a Dutch cows (Dutch dairy association, 2022)

These feed materials are made up of dry matter and water. The dry matter in the feed contains carbohydrates (fibres, starches, sugars), proteins, fats, minerals, and vitamins (Table 1). Nutrients that the cow uses for sustenance and producing milk.

Dry matter						
Energy			Protein	Vitamins	Minerals	Fat
Carbohydrates						
Fibre	Starch	Sugar				

Table 1 - Major components of dry matter in feed materials (Kay, 2022)

### Feeding methods

There are two different feed methods for cows that are used in most farms (Hulsen, Aerden, & Rodenburg, 2014). The first one is Total Mixed Ration (TMR). With this method the feed is mixed according to a certain ratio depending on nutrient levels (Figure 5). The purpose of feeding a TMR diet is that each cow can consume the required level of nutrients in each bite.



Figure 5 - Total Mixed Ration feed (University of Guelph, 2022)

The other method is Partial Mixed Ration (PMR). A method that is used when milk robots are present. With PMR the concentrates are provided through the milk robot or feed box and the rest is mixed and provided at the feeding fence. The concentrates help lure the cow to the milk robot for automated milking.

### Fermentation & digestion

A cow has two different processes to obtain nutrients out of the feed material, fermentation, and digestion (Hulsen, Aerden, & Rodenburg, 2014). Fermentation happens in the ruminant stomach and digestion happens in the hindgut (small intestine & large intestine) (Figure 6).

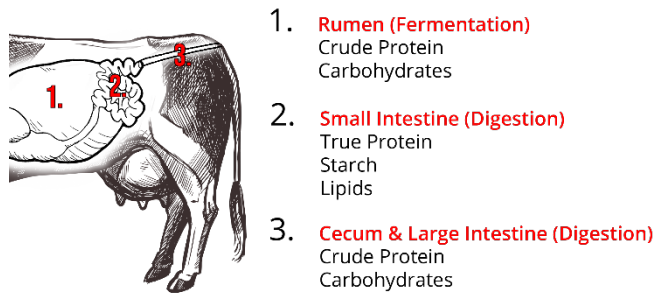

Figure 6 - Overview of cow fermentation & digestion

### Rumen (Fermentation)

The ruminant stomach consists of 4 compartments: the rumen, the reticulum, the omasum, and the abomasum (Hulsen, Aerden, & Rodenburg, 2014). The rumen is the largest compartment and is sometimes described as the 'fermentation vat'.

In the ruminant stomach the feed is fermented by bacteria and enzymes. Some feed material is too big to be processed, this is brought back to the mouth where rumination happens.

For the rumen to work correctly, cows must eat enough chewable and total fibre to maintain rumination. These fibres contribute to the floating mat in the rumen (Figure 7).

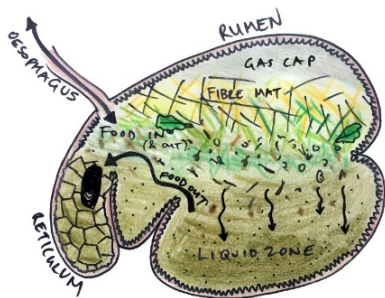

Figure 7 - Rumen floating mat

This floating mat remains in the rumen for some time so that the rumens flora has enough time to ferment it. Fermentation by microbes break down the fibre and feed particle size. If the cow doesn't eat enough fibre only a small floating mat will form. As a result, feed can pass out of the rumen too quickly and in larger particles than it should. As a result, the feed material will not be utilized by the cow optimally.

### Nutrient absorption

When the cow is processing feed efficiently, more feed ferments in the rumen and less passes to be digested in the hindgut (Hulsen, Aerden, & Rodenburg, 2014). The rumen and hindgut produce the same basic products: organic acids, microbial cells, and gas. These products are absorbed and used as energy source or building blocks by the cow.

Though, contrary to the rumen, the hindgut will not utilize microbial protein, excreting it through manure. Organic acids in the hindgut will also only be partially absorbed in comparison to the rumen (Figure 8).

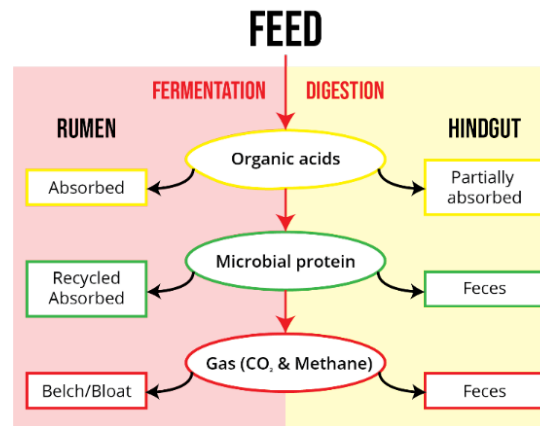

Figure 8 – Difference in processing of nutrients between fermentation in the rumen and digestion in the hindgut.

Within this complex system the farmer wants to find the most profitable equilibrium. The ratio between what is fermented in the rumen and what is digested in the hindgut is an important factor for that.

An average cow's diet consists of multiple feed materials. This is necessary to provide the cow with all the necessary nutrients for optimal functioning (Table 1).

Two feeding methods are dominant amongst farmers: total (TMR) and partial (PMR) mixed ration. Both methods mix the feed materials pre-emptively to provide the cows with the right mix of nutrients. With PMR some of the feed, the concentrates, is given at the milking robot or feeding box.

There are 2 main processes responsible in cows for extracting nutrients out of feed. Fermentation which happens in the rumen and digestion which happens in the hindgut. These processes follow each other up and have to be balanced properly for the cow to preform optimally. This is because both processes absorb nutrients in a different way (Figure 8).

The optimization of cows lies in the ratio between what is fermented in the rumen and what is fermented in the hindgut. Most of the feed should be fermented in the rumen because the rumen will absorb nutrients better than the hindgut. For this to happen it is important for the cow to receive enough fibre to contribute to its fibre mat (Figure 7). The fibre mat blocks the feed from exiting the rumen to quickly, without being fermented.

### 3.3 Feed optimization

Dairy cattle can excrete up to 50 – 90% of the nutrients they are fed (Manitoba, 2015). This depends on many factors including species, stage of growth, weather and the feed ration provided. A nutrient excess of what the cattle requires, leads to an increase in the amount that is excreted unused in the manure. Since this project will result in a product that will help the farmer improve his feed efficiency it is important to understand the topic of feed optimization better. To achieve this multiple research questions have been composed.

- *How do farmers currently calculate what feed to give to his cows?*
- *What indicators do farmers use to compare the performance of his cows?*
- *What will be the difference between a badly optimised farm versus a well optimised farm?*
- *How do farmers currently go about feed optimization?*
- *What can be improved upon the current situation?*

#### Ration calculations

Feeding cows starts with calculating a ration. This ration calculation considers the available feed and the cows nutrient requirements (Hulsen, Aerden, & Rodenburg, 2014).

These nutrient requirements can be found in documents such as the Table Book for Livestock Nutrient Requirements published by the Dutch Central Bureau for Livestock Feeding (Appendix 2).

They are dependent on the production targets for milk and the targeted weight gain etc.

A ration consists of multiple feed materials. In most scenarios the calculation will start with the forage in inventory since this is readily available. The amount and nutritional value are measured so that it can be compared to the nutrient requirements. These requirements are then complemented with feed that needs to be purchased. This is chosen based on nutritional value and price. The fermentation rate should also be taken into consideration to ensure efficient fermentation and digestion.

#### Feed efficiency

One of the indicators used by farmers to track a cow's performance is Feed Efficiency (FE) (Hulsen, Aerden, & Rodenburg, 2014). This efficiency describes how well nutrients are converted into milk.

$$FE = \frac{\text{Milk produced (kg)}}{\text{Dry matter consumed (kg)}}$$

Basically, this number tells how much milk a certain cow produces per kg of fed dry matter. Since the feed efficiency can vary greatly between cattle and companies, certain guidelines exist (Table 2).

Type	Days in lactation	Feed efficiency
All cattle	150 - 225	1.3 - 1.6
Heifers	< 90	1.4 - 1.5
Heifers	> 200	1.1 - 1.3
Older cattle	< 90	1.5 - 1.7
Older cattle	> 200	1.2 - 1.3
Fresh cattle	< 21	1.15 - 1.3
Problematic	150 - 200	< 1.15

Table 2 - Global feed efficiency guidelines (Schooten & Dirksen, 2013)

With these guidelines in mind, it is reasonable to think that at most farms an improvement of 0.1 in terms of feed efficiency is achievable. In Table 3 an example calculation with data from 4 real farms can be seen that illustrates this can lead to almost €30.000 in extra profit for the average high production farmers.

Production	High (milk robot)		Low (traditional)	
Average size herd	130	110	91	45
Average DM-intake kg/cattle/day	21.5	21.9	16.8	15.8
Average milk production kg/cattle/day	31.1	28.7	18	17.3
Feed efficiency	1.45	1.31	1.07	1.09
Average milk price / kg (Feb 2021)	€ 0.34	€ 0.34	€ 0.34	€ 0.34
Extra income 0.1 FE improvement	€ 32,222	€ 27,697	€ 17,625	€ 8,210
Average extra income	€ 29,960		€ 12,918	

Table 3 - Example calculations of extra income per year with a 0.1 FE improvement for 4 companies (Ulderink, 2017)

#### Income over feed cost

Another indicator widely in use by farmers to optimize the mixed ration on costs and feed efficiency is 'income over feed cost' (IOFC) (Hulsen, Aerden, & Rodenburg, 2014). This indicator is defined by taking the total milk profit of a cattle and subtracting the total feeding costs.

$$IOFC = \text{Milk Price} \left( \frac{\text{€}}{\text{kg}} \right) \times \text{Daily Milk Production (kg)} - \text{Daily Feeding Cost (€)}$$

In many situations increasing feed input in a high producing dairy cow is an economically sound practice. However, in some circumstances the cost of having a more energy dense or better digestible diet can be more expensive than the return from

increased milk, leading to a higher feed efficiency but to a lower IOFC. In this case the extra profit from the milk is not worth the extra cost for the feed. This can happen for example when the farmer feeds his herd expensive concentrates to increase milk production while he also owns cheaper self-grown hay.

### Feed advisor

Currently farmers make use of a feed advisor to increase feed efficiency and IOFT. The feed advisor comes by around every 6 weeks. He uses smell, sight, and touch to get an indication of how efficient a cow's digestion is.

The smell of the manure can indicate possible problems with protein digestibility. Fibre rumination problems can be identified by touching and inspecting the manure. Feed advisors use a manure scoring system to classify manure and indicate what is desirable (Figure 9). This is not an exact science and mostly based on the experience of the feed advisor.

The advisor also uses a manure sieve to separate the undigested fibres from the manure into 3 categories,

small, medium, and large (Figure 10). From the 3 categories the finest fraction should be the biggest in volume. This means that digestion is correct and leads to the best feed efficiency.

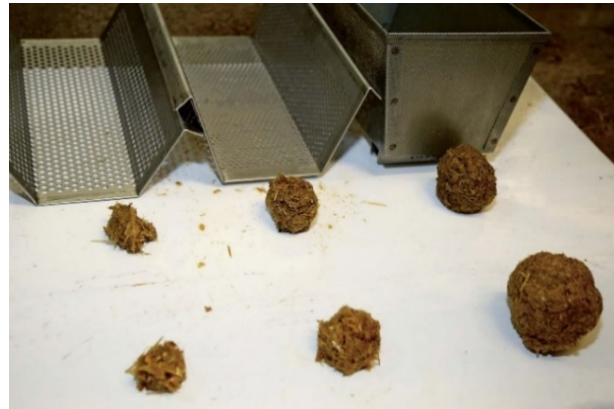

Figure 10 - Manure sieve with fraction volumes

By combining this information, the feed advisor decides what needs to be changed to the feeding plan. An overview of how feed advisors work can be found on the next page.

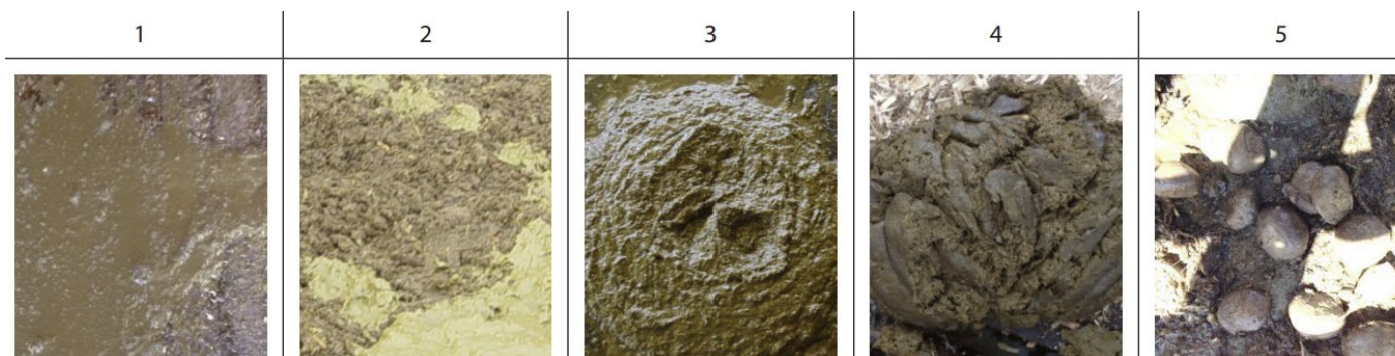

Figure 9 - Manure scoring system that is used by feed advisors

Farmers currently calculate their feed ration according to the Table Book for Livestock Nutrient Requirements published by the Dutch Central Bureau for Livestock Feeding. This will give them a good starting point that can be optimized later to meet his cows' individual needs.

To track these optimizations, farmers use 2 main indicators, Feed Efficiency (FE) and Income Over Feeding Cost (IOFC). FE tells how much milk a certain cow produces per kg of fed dry matter. IOFC tells how much profit is made over a kg of milk by calculating its price and subtracting the made feeding costs.

The difference between a badly optimized and well optimized farm can be big. With an average farm of 130 cows, it could differ more than €30,000 per year in extra profit. This number is even quite conservative since this calculation is based on a FE improvement of 0.1 while the global FE guidelines offer a range of 0.3.

Farmers currently use feed advisors to help with feed optimization. These consultants first help the farmers with calculating their rations, where they bring in their own experience from years of practice. Afterwards they come by every 6 weeks and use various methods to conclude what can be improved in the ration and if the cows are performing as expected.

The current feed advisors only come by every 6 weeks. Since the expenses of feed are so high, a small improvement can mean big changes on a yearly basis. More adjustments could mean a big increase in profit for the farmer. Also, the feed advisor uses unscientific assessments to conclude what could be improved in the ration, mostly based on intuition and experience.

# Feed advisor overview



1. Make inventory of available food from own field
2. determine required nutritional values for herd according to tables
3. make calculation feed plan also taking into account the costs and goals of the farmer



Self grown feed is send to the lab to Determine nutritional values

Nutrition Tables as a result of research by the university Wageningen are used

every year →



**Ration Calculation**

every 6 weeks →

**Advisor visit**



**Manure**



**Sight**



**Touch**



**Smell**



**Cow**



**Behaviour**



**Milk output & composition**

←  
**Adjustments**

### 3.4 Manure monitoring

Manure has good indicators of how well cows are utilizing the feed and transforming it into milk. The manure contains all the excreted/unused nutrients and can tell the farmer how to alter his feeding practices to be more efficient. A cow's manure reacts the fastest to feed changes which makes it the most preferable indicator to monitor and steer feed efficiency on (Table 4).

Problem indicator	Problems visible after
Manure	2 days
Milk	2 weeks
Cow behaviour	1 month

Table 4 - Feed problems indicators (Hulsen, Aerden, & Rodenburg, 2014)

The parameters in manure can be divided into two categories. Physical parameters and composition parameters. Physical parameters can be seen as descriptions of manure. For example, its density, weight, colour etc. These parameters are currently used by feed advisors and can indicate possible feed problems/improvements. They do not however tell anything about the internal processes that occur in a cow directly. This is where composition parameters come in. Composition parameters will tell much more about a cow's internal processes and takes away the guesswork and experience that feed advisors are necessary for.

By talking to feeding experts, it was found that these composition parameters in manure are the most helpful to improve feed efficiency. The following parameters were identified as the most promising:

#### PH value

PH value (acidity) in manure will tell something about a cow's internal ratio between fermentation and digestion. When a cow is fed too much concentrate it can develop rumen acidosis or intestinal acidification. This will lead to lower cow welfare and a lower feed efficiency. The PH value of manure can help indicate these rumination problems and help solve them in an earlier stage.

#### Amount of dry matter (DM) (%)

Dry matter is the residue that stays behind when manure is dehydrated. The dry matter content forms the basis for all other key figures. These are reported as % per kilogram of dry matter. DM gives an easy way to compare manure composition independent of moisture content.

#### Amount of organic matter (% of DM)

The organic matter content consists of everything in the dry matter that the cow can use as nutrients. Matters such as ground/sand etc., that the cow cannot use, are not part of organic matter and are called ash. By knowing the organic matter / ash percentage of the manure, feed pollution by ground/sand can be identified, a big health risk for cows.

#### Amount of crude protein (% of DM)

Proteins are long strings of amino acids. These amino acids are an important source for energy for cows. In manure, protein is often reported as crude protein (CP) and is estimated from the amount of nitrogen in the manure with the following formula:

$$CP = Nitrogen * 6.25$$

The amount of unused crude protein that is still present in the manure can indicate feed inefficiency by comparing it to input CP from food.

#### Amount of starch (% of DM)

Starch is an important source of glucose for the cow. Glucose is the most essential source for the formation of lactose in milk. For the milk yield of cows, a good starch digestibility is important.

The amount of starch that is present in the manure can be a good indicator for starch digestibility and can help steer feeding decisions.

#### Amount of crude fibre (% of DM)

Fibres are important for a cow's rumination. Without enough fibres in its ration, feed will pass through the rumen too quickly and in too large particles. This will lead to unused nutrients being excreted.

#### Neutral detergent fibre (NDF)

Neutral detergent fibre (NDF) indicates the amount of cell walls in manure. These cannot be fermented / digested by dairy cattle. However, a cow does need a certain level of NDF for correct rumination.

#### Acid detergent fibre (ADF)

Acid detergent fibre (ADF) shows the amount of cellulose and part of the lignin of a plant. Cellulose can partly be used as an energy source for animals, while lignin cannot be used by the animal.

#### Amount of sugar (% of DM)

Sugars are an important energy source for the cow. When not fully absorbed and found in the cow manure, something is wrong with rumination.

## 3.5 Farm data

Data is used increasingly at livestock farms to make well calculated decisions. Farmers make use of sensors and laboratories to get this information. Lely is supplying multiple of these products which are described in an overview on this page.

This data is gathered in the Lely Horizon dashboard that farmers use to steer their farm. They use this data to improve their feeding practices, keep an eye on their cow's health and make decisions regarding breeding.

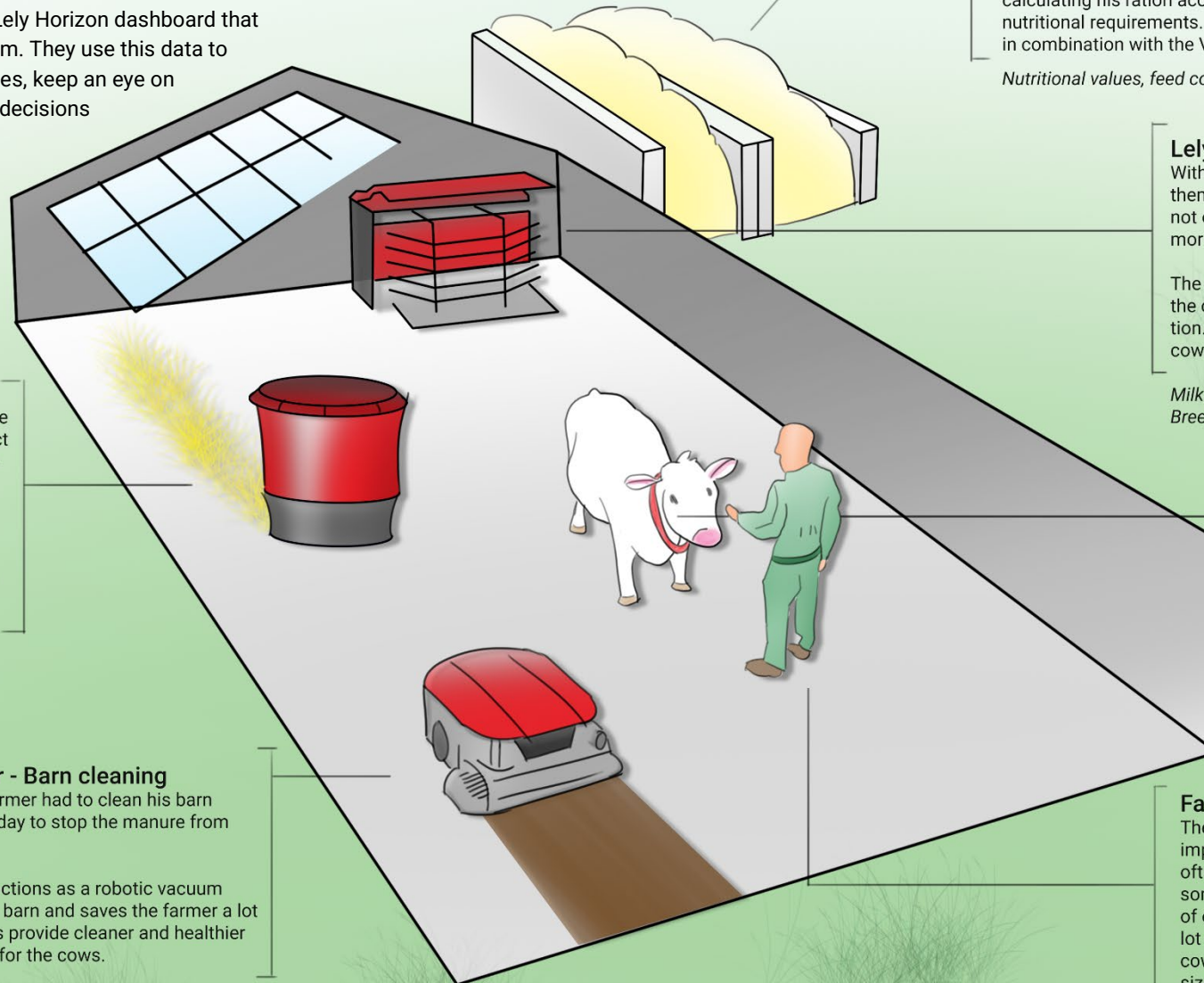

### Lely Vector - Food dispenser

In combination with a feed grabber the Vector automatically mixes the correct ration of multiple feed materials. This ration is then distributed at the cows feeding fence.

The Vector saves the farmer a lot of time as well as give him the ability to control his feeding schedule more precisely.

*Dietary information*

### Lely Collector - Barn cleaning

In the past the farmer had to clean his barn multiple times a day to stop the manure from building up.

The Collector functions as a robotic vacuum cleaner for in the barn and saves the farmer a lot of time as well as provide cleaner and healthier living conditions for the cows.

### Grass silage + other feed

The hay and feeding materials that come from the farmers own fields are monitored closely. Once in a while a sample is send to a laboratory to determine it's nutritional values.

From bought feeding materials the nutral values are mostly known. This will help the farmer with calculating his ration according to defined nutritional requirements. The data can also be used in combination with the Vector.

*Nutritional values, feed costs*

### Lely Astronaut - Milk robot

With the astronaut, cows can determine themselves when they want to be milked. This not only saves the farmer a lot of time but is also more comfortable for the cow.

The astronaut also collects a lot of data from the cows milk suchs as volume and composition. This data can give information about a cows health and breeding status.

*Milk composition/volume, Feed efficiency, Health, Breeding status*

### Lely Smarttag - Collar

This smarttag collar that is worn by each cow can do identification, heat detection, detect eating minutes, rumination activity and localization.

The data that is collected by the smarttag can help the farmer identify possible health issues in an early stage.

*Rumination, identification, localization*

### Farmer

The farmer himself is still also an important source of information. He can often see from the cow's behavior that something is wrong. With his many years of experience, he is an expert and pays a lot of attention to deviant behavior per cow. This becomes more difficult as the size of the herds increases.

*Health, behavior*



### 3.6 Discovery Collector

Lely already has a product that works with manure called the Discovery Collector. This robot drives through the barn and collects all the manure that remains on the ground.

The Collector sucks up the manure (Figure 12) while navigating through the barn and drops it in the dumping pit (Figure 14). The dumping pit is connected to a big tank that is situated under the barn. In this tank the manure is temporarily stored and from time to time this tank is emptied.

Having the Discovery Collector saves the farmer time. Normally the farmer has to drive his tractor through the barn multiple times a day to clean up all the manure, even during the night (Figure 11). The robot prevents the build-up of manure and improves cow health and well-being.

The Collector is battery powered so has it to charge from time to time. It also uses water to clean the barn floor better, so it also has to fill up its water tank (Figure 13).



Figure 12 - Collector vacuuming manure.



Figure 11 - The Collector drives in between the cows.

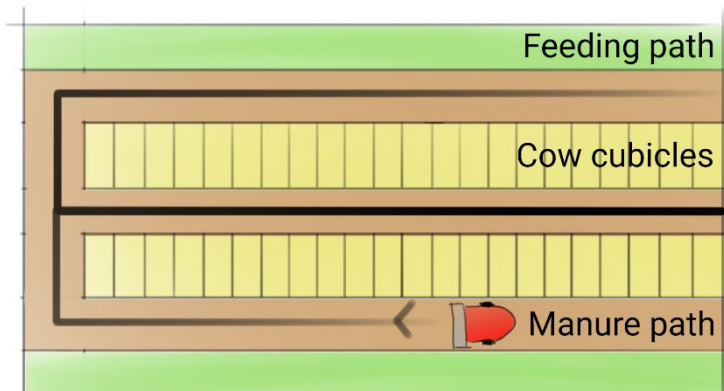

Figure 14 - Collector navigating through barn



Figure 13 - Collector section view

## Dump pit

The dumping pit is the hole where the collector dumps its collected manure after each route (Figure 15).

The dump pit has several components that are mounted to it (Figure 16): the water station (1), the charging station (2), and the dump hooks (3). The water station refills the water tank inside the Collector that it uses to clean the barn floor. The charging station will charge the Collector using wireless charging technology. Lastly, the dump hooks will stop the Collector from driving past the dump pit and help it position.

Then there are 2 types of dump pits, the general dump pit, and the Sphere farm dump pit. The general dump pit consists of a hole that directly leads to the manure pit (left column of pictures). While a Sphere farm dump pit has a siphon mounted in it to restrict gasses from exiting the manure pit (Figure 16).

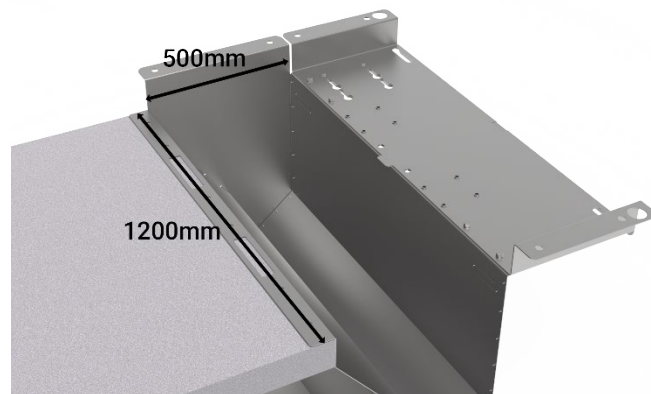
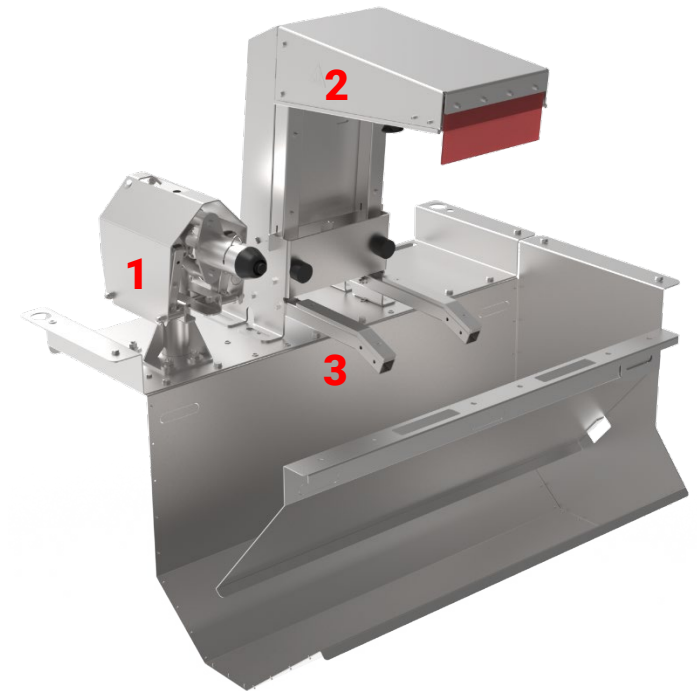

Figure 15 - Dump pit with dimensions



### 3.7 Interviews

To understand better how farmers look at farm optimization and the growing importance of technology for their business, two farmers were interviewed. For this project it is valuable to know what they expect of new technologies, how they would like to interact with these devices and what they think about manure monitoring. They can also indicate what can be improved upon in the current situation as well as express their interest and opinion on manure monitoring.

After talking to experts from Lely it was found that there are two types of farmers. On the one hand farmers that are more managers and want the most profit possible. On the other hand, more old school farmers that want the most milk possible. The farmers that were chosen for interviewing represent these types. The interview questions can be found in appendix 3.

#### Mathé van den Bosch

Mathé is a dairy farmer in Oudenbosch. He owns a big farm with over 300 cows that he manages closely. Mathé his business is a test location for new Lely products. Many products that are on the market today have been tested in his barn. He loves technology and automatization.

*"I would like to automate everything. I cannot continuously monitor 330 cows; I have to rely on the automation. Craftsmanship is delegation. I've always been an automation farmer. Together with my parents, we started automatic milking in 2000 and the first feeding robot was developed here by Lely on our farm."*

When speaking to Mathé it almost felt like speaking to a manager. Smart and sharp guy who really likes his data and graphs.

*"My business runs on data. When I get up in the morning, I first check on my phone what the cows have eaten, the attention list, the costs. My automatic feeding system saves labour, but the main advantage is the amount of data it provides."*

Asking about feed efficiency and how important is to him gave the following answer.

*"Feed is actually our biggest expense. If you count the value of your own land and what it costs to make your own feed... It often seems like only a few cents per day per cow that you can save. But because it concerns such large quantities. At the end of the year, it can be a large sum of money, whether you have fed efficiently or less efficiently. End of the song you are of course just an entrepreneur to earn an income."*

It was also asked if manure monitoring could be the future. This concluded in the following answer.

*"It is a complex system of various factors that ultimately determine what you feed. So yes, if you want to complete the circle and you really want to make a balanced nutrition budget. Or be able to point out where something is lost and where there is still something to use. Maybe you really should go to that manure after all. Yes."*



## Marcel Molenaar

Marcel is a dairy farmer in Aarlanderveen. He owns an average sized farm with around 120 cows that he manages. Marcel is a more traditional farmer who likes automation because he's getting a bit older and the heavy work on the farm takes its toll on him.

*"I got involved in Lely products because I wanted to have the evenings off. Before I was hiring someone to milk the robots in the evening but that didn't always work out. Installing the Lely milk robot saved me from this inconvenience."*

He's very involved with Lely and has been a test farm for Lely for years. As he states it: "I'm down for trying anything, the crazier the better". But he later nuances this by saying that he would like to have some extra profit from it or that it saves him some time.

Marcel has a Lely Vector system that he uses to feed his cows singular raw materials. He feeds protein, starch etc. separately. When asked about how he does feed optimization he says that this is a difficult story.

*"I have a feed advisor for optimizing feed ration. But it's difficult to find someone that fits your philosophy as a farmer. Many can do their job well, from the books but cows don't work that way. There is also a bit of craftsmanship involved."*

When asked about this philosophy it becomes clear that farmers differ a lot about how they think about keeping cows.

*"You have different livestock farmers. One prioritizes for the cow to be as healthy as possible, the other on*

*low budget. I steer more on healthy cows that eat a lot. If they give a lot of milk, then I'm a happy man. IOFT is more me less important. I want a high feed efficiency in combination with healthy cows. Price isn't as important for me."*

*"We work together with independent feed advisors. Most feed advisor are affiliated to feed vendors, but I don't really trust those. They try to sell you too much concentrates, which are expensive. Also, I don't want to be stuck to a certain vendor. That is a reason that I change a lot with feed advisors. If they don't perform, I chose a different one."*

After introducing a manure monitoring system that has the potential to provide 30.000€ in extra income. He makes a quick calculation and concludes that such a system could cost between 80.000€ – 90.000€ for him.

Marcel is later asked what he thinks about a system that could send changes to his Lely Vector feeding system he states that this would be his preferable solution.

*"That would be the best. But first I want to trust the system completely. In the beginning I would like to give permission to all dietary changes."*

The kind of feedback Marcel would expect from such a system would be ration advice and comparisons between the years on how well his cows perform.

Marcel concludes the interview as follows:

*"At first, I was sceptical about monitoring manure. But as this conversation progressed, I started to believe in it more. I'd be interested in it if it performed well."*



### 3.8 Barn environment

The pictures on the right were taken during a farm visit and indicate how harsh the environment can be inside a barn. It is important to describe the conditions the end product will operate in because they will lead to new requirements. The following conclusions were made after talking to a Lely service technician with experience on why products fail most inside a barn.

Firstly, everything in a barn is covered in manure. Products that operate inside a barn should be manure proof. When left to dry, slowly a layer of manure will build up on top of surfaces. This can hinder operation and is also problematic for sensitive equipment.

Manure is also quite reactive in terms of corrosion. All materials of barn products should be manure proof. Materials that were widely present inside the barn were stainless steel, plastics and rubber because they don't react to manure.

Manure contains urine/water which makes it electrically conductive. All electrical components inside a barn should be water proof. This will prevent short circuits which can lead to defect products and even fire hazards. Because of the flammable methane inside barns there can be an increase risk of explosions.

Lastly, cows are curious animals. They will lick, bite and chew on anything that is exposed. They also have a strong kick. Products and materials that live inside a barn should be cow proof.

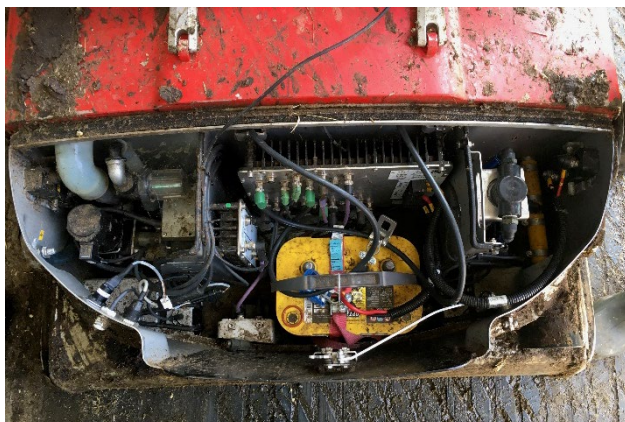

## 4. Define

The defining phase of this project will fixate some of the topics to be able to proceed with the development stage. Still not everything is known about manure monitoring since it's a recent topic of interest. A multitude of research papers could be generated from this project that in the future could help substantiate manure monitoring better. But deciding to fixate some topics in an early stage of this project allows to not make the scope too broad to fit within the given timeframe while still providing a valuable starting point to explore manure monitoring as a product.

First, the considered sensors are identified and described to later make a substantiated choice which sensor will be integrated. This choice was made on several factors: cost, value for manure monitoring and usability in a farm environment. These factors came forth from the analyses phase.

Afterwards the chosen sensor, the NIRS sensor, is described. A company that could provide a NIRS sensor and had experience with measuring in manure was searched and contacted. The sensor that was used for this project from Dynalynx is further described.

To prepare for measuring the selected parameters in manure the NIRS sensor needs to be calibrated. The process of calibrating and the required steps are described as well as the accommodating costs and facilities necessary.

Lastly the discovered requirements will be defined that were found during this project. These requirements will later be used to select a certain concept direction to proceed with. The requirements can be linked back to their origin by looking at the chapter names.

## 4.1 Sensors

In this chapter the sensors that could possibly be used in this project are described. To determine the potential of a sensor, certain research questions were determined:

- What is the average price of this sensor?

The sensor shouldn't be too expensive relative to the possible returns and benefits of the product. This question was answered by looking at the website of the different suppliers of Lely and looking at the average prices. The price range shown should be taken as an indicator since sensor specific requirements were not yet considered.

- Is the sensor usable with manure and in a barn environment?

As described before, a barn is a harsh environment to design for. Not all sensors are suitable to use in this environment. For each sensor the current use cases were identified to get an idea of how durable and sensitive each sensor is. It should also give an indication if the sensor will work with manure instead of its usual material.

- What is the value of this sensors measured parameter for manure monitoring?

For this question there will be looked at physical versus compositional parameters. Where compositional parameters are mostly more valuable for the farmer. There is also looked at what the parameter can mean for the farmer and how it can help improve cow wellbeing.

**NIRS sensor** €1000 - €1500

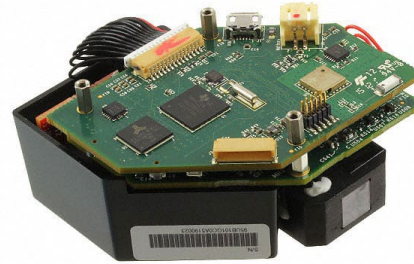

*Figure 17 - NIRS sensor - <https://nl.farnell.com/texas-instruments/dlpnirnanoevm/eval-board-dlp2010nir-dlp-spectrometer/dp/3125557>*

A NIRS sensor can be used to determine the composition of a sample. Using a light source and a NIRS sensor, it is determined what the light reflection of a sample is for certain frequencies (Evangelista, Basiricò, & Bernabucci, 2021). The amount of light that is absorbed per frequency can be linked to what the distribution of components is in that sample.

Currently this sensor is already used to determine the nitrogen, phosphate, and potassium contents in manure. Literature research shows that proteins, dry matter, organic matter, fibres, sugars, and starches should also be able to be determined in manure (Evangelista, Basiricò, & Bernabucci, 2021). But to use this sensor with these parameters a new calibration line needs to be created.

The parameters described above would give the farmer useful insights in how the cow utilizes its feed which can help with determining its ration.

**Ph sensor** €50 - €200



*Figure 18 - Ph sensor - <https://nl.farnell.com/omega/phe-7351-1/inser-submersible-probe-ph-equipment/dp/3899458>*

A PH Sensor can be used to test the acidity of an aqueous solution (ThermoFisher Scientific, 2020). The acidity of the solution will be indicated by a PH value which can vary between 0 – 14, where 0 is acidic, 7 is neutral and 14 is basic. These sensors are widely used in environmental monitoring, chemical industry, pharmaceutical industry, universities, and research institutions.

Since manure is an aqueous solution, it should be possible to measure its acidity. In terms of cow welfare this can be an indicator for rumen acidosis (Queensland Government, 2013), a common health problem with cows.

One of the disadvantages of pH sensors is that they must be periodically calibrated with a known calibration fluid (Sensorex, 2019). This is a complex and time-consuming process where contaminants could lead to a big difference in accuracy (ThermoFisher Scientific, 2020). This makes Ph sensor not suitable for harsh environments. When not calibrated in a timely manner the performance of the sensor will offset over time leading to inaccurate and drifting results.

### Soil moisture sensor €5 - €20

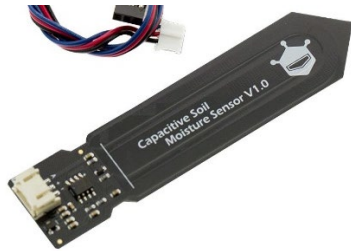

Figure 19 - Moisture sensor - <https://nl.farnell.com/dfrobot/sen0193/analog-capacitive-soil-moisture/dp/2946124>

Soil moisture sensors can be used to measure the water that is held in the spaces between soil particles (Arnold, 1999). This sensor is mostly used with plants for irrigation scheduling, and crop yield forecasting.

With a moisture sensor it might be possible to measure the amount of moisture in the cow's manure since manure has a similar texture as soil.

Though it is currently unknown if a moisture sensor is valuable for the farmer. Possibly the amount of moisture in manure could have a relationship with the amount of dry matter in the manure but more research is needed.

### Soil conductivity sensor (salinity) €50 - €150



Figure 20 - Conductivity sensor - <https://www.antratek.nl/nse01-nb-iot-soil-sensor>

Soil conductivity sensors are used to measure the amount of salts in soil. This is an important indicator of soil health since it can be correlated to concentrations of nitrates, potassium, sodium, chloride, sulphate, and ammonia (United States Department of Agriculture, 2013).

Possibly correlations can also be found for manure components in the same way as for soil. But for this more research is needed.

### Turbidity sensor €10 - €15



Figure 21 - Turbidity sensor - <https://nl.farnell.com/amphenol-advanced-sensors/tst-10/turbidity-sensor-5vdc-phototransistor/dp/2381323>

Turbidity sensors make use of a light and a light sensor. It sends a light through a medium and measures the amount of light that is scattered by the suspended solids (Campbell Scientific, 2022). These sensors are used in wastewater and effluent

Define

measurements, control instrumentation for settling ponds, sediment transport research, and laboratory measurements.

It is unknown if turbidity sensors are usable with manure since manure is much thicker than for instance wastewater. Further research is necessary if turbidity sensors are applicable with manure and what value it could have for the farmer. It might be possible to measure the amount of dry matter in manure.

### Camera €25 - €150

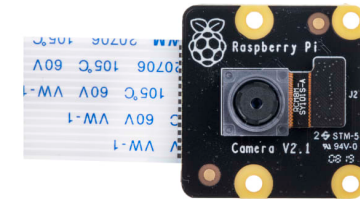

Figure 22 - Camera - <https://nl.farnell.com/raspberry-pi/rpi-noir-camera-board/raspberry-pi-noir-camera-board/dp/2510729>

Cameras have a wide range of applications. They can be used to track motion, recognize objects, count objects, determine colour etc. Their versatility makes them widely used across many industries.

With the help of a camera, it might be possible to mimic a feed advisor and identify the size of individual fibres in manure. Counting these fibres can help with identifying rumination problems. Another option is to track manure colour which could also help identify feeding problems. Further research should be done what value cameras can have in manure monitoring though.



### Temperature sensor €5 - €20



Figure 23 - Thermistor - <https://nl.farnell.com/labfacility/xf-321-far/sensor-k-ptfe-1m-250deg-c/dp/4100748>

Thermistors will make it possible to measure and monitor the temperature of manure. They are basically variable resistors that will change resistance while temperature changes. Thermistors are widely used in many different industries and can be altered to be used in harsh environments (El Sensor, 2022).

It is unknown if monitoring the temperature of manure could help with improving cow wellbeing. More research would be needed to investigate this.

### Weight sensor €20 - €50



Figure 24 - Weight sensor - <https://nl.farnell.com/sensor-solutions-te-connectivity/fx29k0-100a-0050-l/load-cell-sensor-50lb-5-5v/dp/3290107>

With a load cell it is possible to measure weight. Most load cells work with a strain gauge. A small wire that has a changing resistance the more it deforms. Weight sensor come in many different size and

specifications and are widely used in many industries (Trent, 2022). They do not have any components that are influenced by manure or a barn environment.

With a load cell it can be measured how much manure is produced by the cows each day. This could be an indicator for health problems. But also, the density of manure can be determined by measuring a known volume of manure.

### Triad spectroscopy sensor €50 - €100

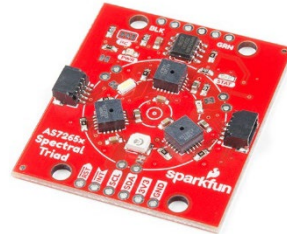

Figure 25 - Triad spectroscopy sensor - <https://www.antratek.nl/triad-spectroscopy-sensor-as7265x-qwiic>

In a triad spectroscopy sensor 3 spectral sensors are combined alongside a visible, UV, and IR LED to illuminate and test various surfaces for light spectroscopy.

A triad spectroscopy sensor is similar to a NIRS sensor though the used light frequencies have less sample penetration (Eurofins Laboratories, 2022). Therefore it is probably not possible to look at components in manure, but more research could be conducted to be certain.

### Total dissolved solids sensor €100 - €200



Figure 26 - Total dissolved solids sensor - <https://www.antratek.nl/industrial-ec-tds-sensor-modbus-rtu-rs485-0-2v>

A Total Dissolved Solids (TDS) sensor can measure the Inorganic and organic substances present in water (World Health Organization, 1996). Since manure is much thicker than water it is unknown if this sensor is suitable for manure measurement. Also, it is unknown what value TDS measurements have in manure. More research could be conducted.

### Gas sensor €5 - €60



With gas sensors it is possible to measure the amount of methane, hydrogen, ammonia, and carbon dioxide in the air (Fierce Electronics, 2019). They are mostly used in security systems connected to an audible alarm. It is unknown if these sensors will have value for the farmer. More research could be done to explore this.

## 4.2 Sensor selection

To select a sensor multiple criteria have been chosen to make a substantiated choice. These criteria will be discussed and explained further in this chapter. A summary of all the sensors and the criteria can be found on the next page.

### Return of investment

During the analyses phase it was found that farmers are entrepreneurs. They need to optimize their business to keep it viable. It was also found that optimizing feed efficiency could lead to big profit increases over a years' time.

Therefore, the sensor should be compared to the expected extra income for the farmer which was estimated to be €30.000 per year for an average farm of 130 cows.

When looked at the sensors on the next page, even the most expensive sensor will have a return of investment of less than a month. Though it should be kept in mind that the cost of the sensor is not what the final product will cost. Still the ROI time is so low that the cost of all the sensors is subordinate to other criteria.

### Sensor type

In the defining phase of the parameters, it was found that 2 types of parameters exist for manure monitoring. Physical and compositional parameters. Physical parameters mimic the work of a feed advisor while compositional parameters tell more about the inner processes in a cow. It was decided that for manure monitoring, compositional parameters/ sensors are mostly more valuable.

### Use case / value

For manure monitoring there are many parameters that can be tracked. In the chapter manure monitoring the parameters that are the most valuable for the farmer were identified. These parameters will be used for sensor selection since they will help most towards improving feed efficiency and IOFT.

### Applicable

Not all sensors are applicable with manure or in a barn environment. In the chapter environment is described what harsh conditions a barn has. For each sensor it was looked at in what current situations they are being used and estimated if they would be suitable for use with manure and in a barn environment.

### Conclusion

It was chosen to continue with a NIRS sensor. The NIRS sensor is expensive, but still acceptable compared to the estimated extra income. This sensor is a compositional sensor and will possibly measure all the parameters that were selected with help of a feed advisor. Furthermore, it is already proven inside a manure and barn environment. The NIRS sensor needs to be calibrated for selected parameters, but literature provides positive results for this.

Other sensors that looked promising were a pH sensor and a camera. The pH sensor is a composition sensor and measures acidity, one of the selected parameters. Though this sensor is very sensitive and needs to be recalibrated periodically. Which is not very suitable for in a barn environment. It also only measures 1 of the selected parameters compared to the 6 parameters the NIRS sensor can measure at once.

A camera as sensor also looked promising. It can possibly be calibrated to measure fibres and colour of manure. Though there is no proof that this is possible as compared to the NIRS sensor. Also, it only does 1 of the selected most valuable parameters compared to the 6 parameters of the NIRS sensor.

Sensor	Return of investment	Sensor type	Use case in manure	Value for farmer improving FE and IOFT	Applicable in manure and barn	Comments
Near Infrared Spectroscopy	18,3 days €1000 - €1500	Composition	Proteins, Dry matter, Organic matter, Fibres, Sugars, and Starches	✓	Needs calibration	Calibration proven possible in literature
Total Dissolved Solids	2,4 days €100 - €200	Physical	Inorganic and organic substances present	Currently unknown value for improving FE and IOFT	Unknown if applicable in manure	
pH sensor	2,4 days €50 - €200	Composition	Acidity	✓	Very sensitive	Needs to be recalibrated periodically
Conductivity	1,8 days €50 - €150	Physical	Conductivity	Currently unknown value for improving FE and IOFT	✓	
Camera	1,8 days €25 - €150	Physical	Fibres, Colour	✓	Needs calibration	
Triad Spectroscopy	1,2 days €50 - €100	Composition	Components	✓	Needs calibration	Probably not possible to calibrate for components
Carbon dioxide air	0,7 days €30 - €60	Physical	Carbon dioxide	Currently unknown value for improving FE and IOFT	✓	
Weight	0,6 days €20 - €50	Physical	Weight, Density	✓	✓	
Turbidity	0,18 days €10 - €15	Physical	Dry matter	✓	Unknown if applicable in manure	
Methane air	0,6 days €5 - €50	Physical	Methane	Currently unknown value for improving FE and IOFT	✓	
Hydrogen air	0,6 days €5 - €50	Physical	Hydrogen	Currently unknown value for improving FE and IOFT	✓	
Ammonia air	0,6 days €5 - €50	Physical	Ammonia	Currently unknown value for improving FE and IOFT	✓	
Moisture	0,2 days €5 - €20	Physical	Thickness	✓	✓	
Temperature	0,2 days €5 - €20	Physical	Temperature	Currently unknown value for improving FE and IOFT	✓	

### 4.3 NIRS sensor

NIRS stands for Near InfraRed Spectroscopy, a technology that uses the near-infrared region of the electromagnetic spectrum to investigate the physio-chemical properties of samples in a non-destructive way (Evangelista, Basiricò, & Bernabucci, 2021). This is the region where overtone and combination oscillation reside of the fundamental molecular oscillation.

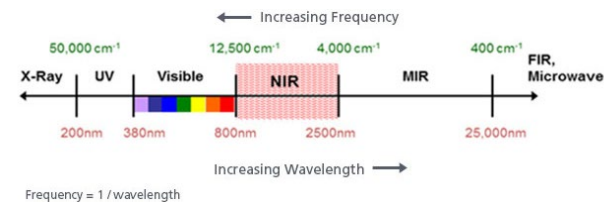

Figure 27 - Electromagnetic spectrum

This technology works by sending near infrared electromagnetic radiation onto a sample which in turn will stimulate molecular oscillations. Due to these oscillation and n<sup>th</sup> overtones certain frequencies of this spectrum will be absorbed and the rest will be reflected.

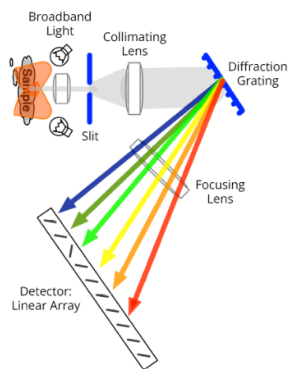

Figure 28 - Schematic overview of NIR Spectroscopy

This will result in an absorbance graph where the peaks can be identified and linked to molecules due to the know absorbance wavelength of molecular oscillations and n<sup>th</sup> overtones.

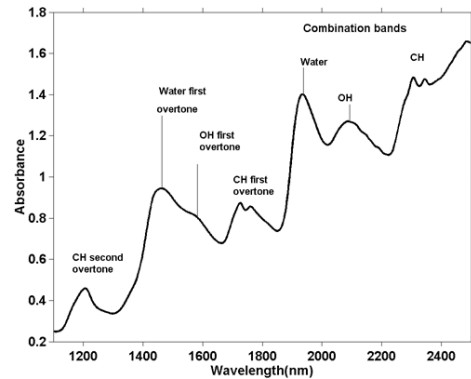

Figure 29 - Example of absorbance graph

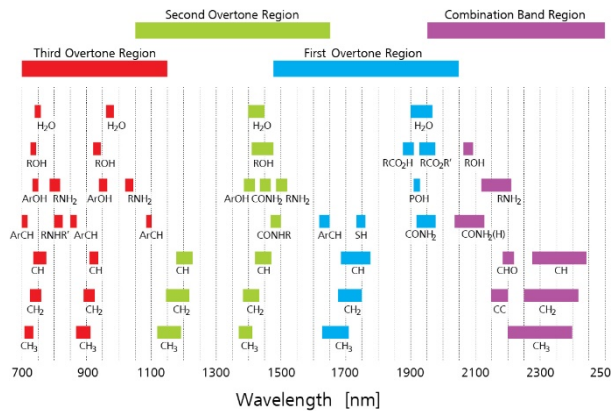

Figure 30 - Regions of vibrational overtones and combination bands

To link these absorbance graphs to useable data, calibration lines need to be created. This is done by taking NIRS measurements of a sample and combining that with laboratory results. This is also one of the cons of NIRS technology, thousands of

Define

samples are needed to make it accurate (Boerenbusiness, 2015). Though this calibration will only have to be done once per sensor type.

In literature it was found that the following parameters can possibly be measured with the help of NIRS technology (Evangelista, Basiricò, & Bernabucci, 2021):

Possibly	Not possible
Crude proteins (R <sup>2</sup> = 0.89)	PH value
Dry matter (R <sup>2</sup> = 0.69)	
Organic matter	
Crude fibres	
ADF (R <sup>2</sup> = 0.34)	
NDF (R <sup>2</sup> = 0.62)	
Sugars	
Starches (R <sup>2</sup> = 0.83)	

Some regression values for the validation of the calibration set were not found to be statistically significant. The authors assumed that the results were probably due to the low number of samples used (58 for calibration and 7 for validation).

## Dynalynx sensor

After it was clear that the NIRS sensor would be the most valuable sensor for manure monitoring there was searched for a company that could help with knowledge about this sensor.

Some criteria were set to select the best party to partner with. They had to have a readily available sensor that could be used for this project since this project has a limited timeframe. Also, it was required that they had experience with NIRS measurements in manure, since it is a harsh environment to measure in. Lastly, they had to have experience with generating calibration lines for manure measurements. Using existing contacts for calibration would enable a speedier calibration.

Multiple companies were contacted (Allied Scientific Pro, Consumer Physics, Neospectra, Dynalynx) but only one complied with all the set criteria especially having worked with manure. It was chosen to proceed with the company Dynalynx since they had experience with NIRS sensors, doing measurements in manure and calibration of these sensors for manure measurements (Dynalynx, 2022). The company was also from the Netherlands which enabled easier and quicker collaboration.

For this project they provided a test setup that could be used for prototyping and proving the possibility of calibration. This test setup consists of 2 components. The measurement head and an electrical compartment (Figure 31). The price of the assembly used for testing varies between 3000€ and 4000€ depending on the configuration.



Figure 31 - Dynalynx NIRS sensor

The Dynalynx assembly is already optimized to work in cow manure. This means that the measurement head and electrical compartment are already manure proof when used properly.

The measurement head (Figure 32) houses the lights that are used to create the reflection. Reflections are sent back to the sensor through a glass fibre cable to limit the heads footprint. Inside the head there is also a moving mirror. The mirror allows to send 100% of the light back as a reflection. This functions as a zero measurement and is used to counteract light degradation over time.

The measurement head is connected to the electrical compartment (Figure 33) via a 1m long pipe. Dimensions of the electrical compartment are 300 x 400 x 212,5 mm. Inside the electrical compartment the power delivery is housed as well as the NIRS sensor and a Raspberry Pi. The Raspberry Pi is used

to gather and process the data from the NIRS sensor and send it to the database of Dynalynx.

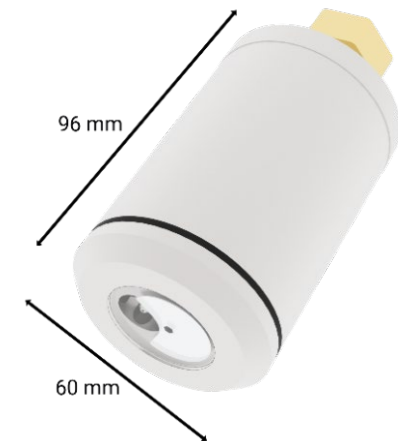

Figure 32 - Sensor head dimensions

This database can then be accessed through the web application that Dynalynx created. In this interface the measurements can also be converted into several parameters that Dynalynx owns calibrations for.

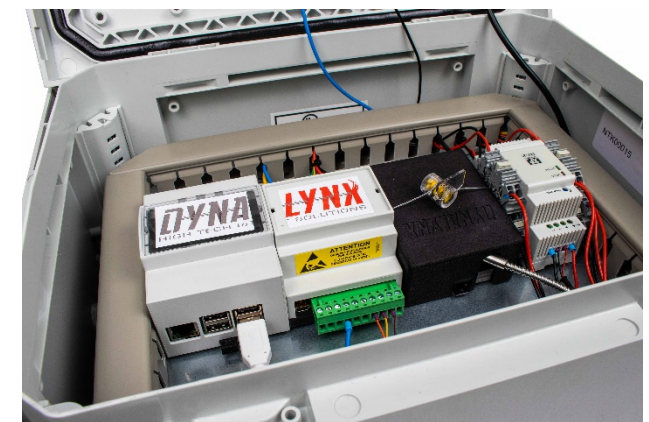

Figure 33 - Electrical compartment

Internally the NIRS sensor assembly from Dynalynx uses the Texas Instrument DLPNIRNANOEV (Figure 34). This is the sensor that does the NIRS measurement.

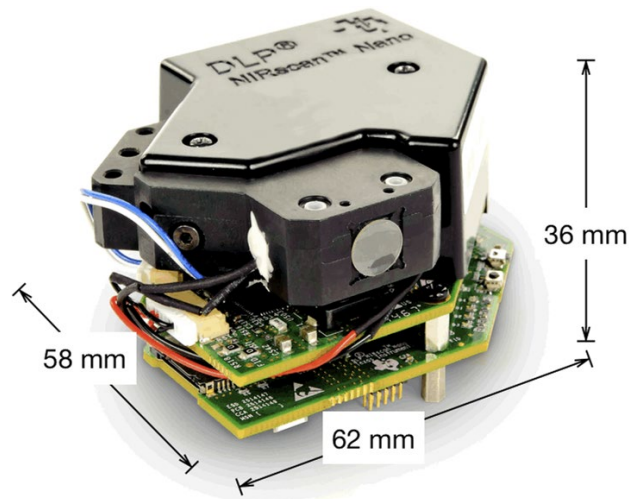

Figure 34 - Texas Instrument DLPNIRNANOEV

What Dynalynx has created is an assembly that integrates this sensor and its required components to function remotely. Also, they created the measurement head, which allows the sensor to be used in a manure environment.

The cost of the Texas Instrument DLPNIRNANOEV is around 1000€ (Farnell, 2020). The footprint is much smaller than currently the test setup. In the future creating a more integrated solution for this sensor could mean a big reduction in size as well as make the sensor assembly more cost efficient. Dynalynx could provide this service if necessary but internal development should also be considered.

## 4.4 Calibration

Dynalynx does not currently own all required calibration lines. To be able to use their NIRS sensor for manure monitoring these calibrations have to be created. The model Dynalynx uses to create calibration lines is based on a neural network, machine learning.

While the model of Dynalynx uses a neural network, there are more options for calibrating this sensor using machine learning. In general, there are 2 approaches of machine learning that exist supervised and unsupervised learning (Yan, Liu, Zhibin, & Xinkai, 2018). The problem that exists with calibrating this sensor is a supervised learning regression problem. Where regression means predicting values with as input some values.

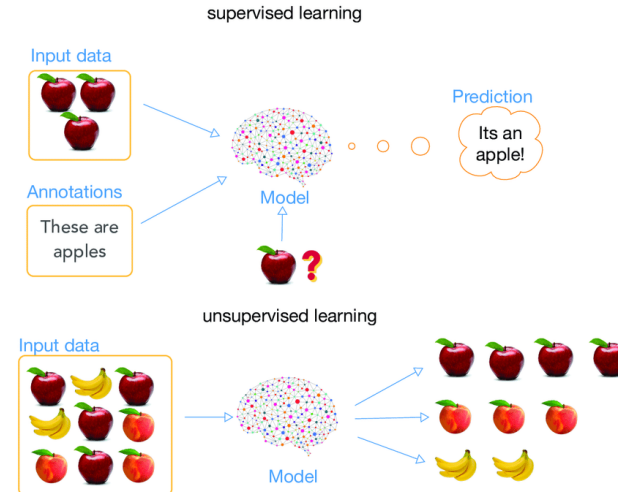

Figure 35 - Difference between supervised and unsupervised learning (Yan, Liu, Zhibin, & Xinkai, 2018).

In supervised learning the computer receives sample inputs, in which the desired output is also presented. The goal is to learn a general rule that translates the given input into this desired output. The system learns to see connections between the input and the output. If the machine learning process is completed properly, the system makes fewer and fewer errors and can ultimately produce the correct output based on new input.

There are multiple machine learning algorithms that can help solve supervised regression problems such as: Multiple Linear Regression, Polynomial Regression, Robust Regression, Decision Tree, Random Forest, Gaussian process regression and Support Vector Regression.

To have more control and speed up the calibration process, a proof-of-concept piece of code was created based on a neural network (Appendix 4). Next to recommending this algorithm by their experience, this also allowed Dynalynx to support development.

For machine learning the API Keras was used which under the hood uses Tensorflow, a machine learning library created by Google. Keras is used by CERN, NASA, NIH, and many more scientific organizations around the world.

To train this neural network training data is needed. NIRS sensor data must be linked to real laboratory data, so the neural network knows the expected output. An overview of how this calibration process will look like can be found on the next page.

A partner of Dynalynx, Normec Robalab, was asked to provide the laboratory results to proceed with calibration. Robalab also owns a Dynalynx NIRS sensor which can be used to also provide accurate NIRS sensor data.

To get an indication if a parameter can be measured with a NIRS sensor it was recommended by Dynalynx to test 200 samples. This will not provide great accuracy but will be enough to check if calibration is possible. The costs per parameter for feasibility testing can be found in Table 5. To get better accuracy for the final product, Dynalynx recommends taking 1000 samples. The cost per parameter for final calibration can be found in Table 6. All these costs will be an investment for Lely and only have to be executed once.

	Price	Unit	#	Total
Preparation	€ 20,00	piece	200	€ 4.000,00
Dry matter	€ 8,00	piece	200	€ 1.600,00
Organic matter	€ 8,00	piece	200	€ 1.600,00
Protein	€ 18,50	piece	200	€ 3.700,00
Starch	€ 33,00	piece	200	€ 6.600,00
NDF	€ 18,50	piece	200	€ 3.700,00
ADF	€ 18,50	piece	200	€ 3.700,00
Sugar	€ 37,50	piece	200	€ 7.500,00
NIRS	€ 30,00	hour	16	€ 4.000,00
				€ 36.400,00

Table 5 - Pricing for calibration feasibility test. (Normec Robalab)

	Price	Unit	#	Total
Preparation	€ 20,00	piece	1000	€ 20.000,00
Dry matter	€ 8,00	piece	1000	€ 8.000,00
Organic matter	€ 8,00	piece	1000	€ 8.000,00
Protein	€ 18,50	piece	1000	€ 18.500,00
Starch	€ 33,00	piece	1000	€ 33.000,00
NDF	€ 18,50	piece	1000	€ 18.500,00
ADF	€ 18,50	piece	1000	€ 18.500,00
Sugar	€ 37,50	piece	1000	€ 37.500,00
NIRS	€ 30,00	hour	80	€ 15.000,00
				€ 177.000,00

Table 6 - Pricing for final calibration. (Normec Robalab)

Another aspect to consider for calibration is that the more water the manure contains, the less accurate the results are for NIRS measurements (Evangelista, Basiricò, & Bernabucci, 2021). Since Lely has their Lely Sphere product, which separates manure and urine, it was chosen to first calibrate for this type of manure first. This separated manure will contain much less water (urine) and thus result in easier calibration. Since the costs of calibration are high, this limits the risk of unusable results. In a later stadium calibration can also be tried for a mix of urine and manure, to increase the group of potential customers.

Due to time constrains it was not possible to execute the calibration and to train the neural network. This is a recommended first step to be able to start with manure monitoring with a NIRS sensor.

## 4.5 Data analyses

For this project the data that comes out of the NIRS sensor should be converted into feedback for the farmer. This can also be done with machine learning by tracking what effect ration changes have on cow performance.

First the system will track the input data and output data of a farm steered by a feed advisor. The system will learn what effect certain ration changes will have on the cow's performance. Once the system has enough data, the system will start generating its own predictions on what the best ration changes will be. This feedback will then be executed and learned from by feeding the actual performance changes back into the system (Figure 36).

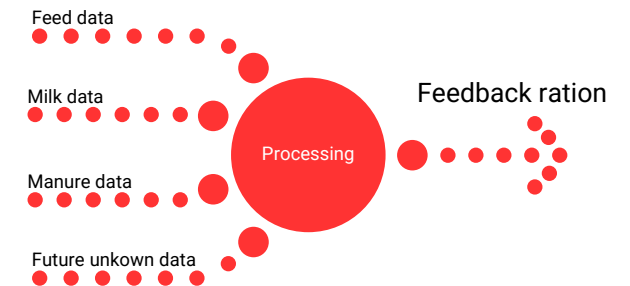

Figure 36 - Feedback loop machine learning.

As the system collects more and more information on how cows react on ration changes, the feedback should become smarter and better over time. This data will be collected from farms after release as well.

More research is necessary in order to arrive at the optimal machine learning system for this as well as what other data could be beneficial for this system.

## Feasibility calibration overview

To calibrate the NIRS sensor, 200 manure samples (on advice of the manufacturer) need to be taken. These samples will be sent to the laboratory where the values of the parameters will be determined using wet chemistry. At the same time the samples will be put through the NIRS sensor to get the absorbance graphs.

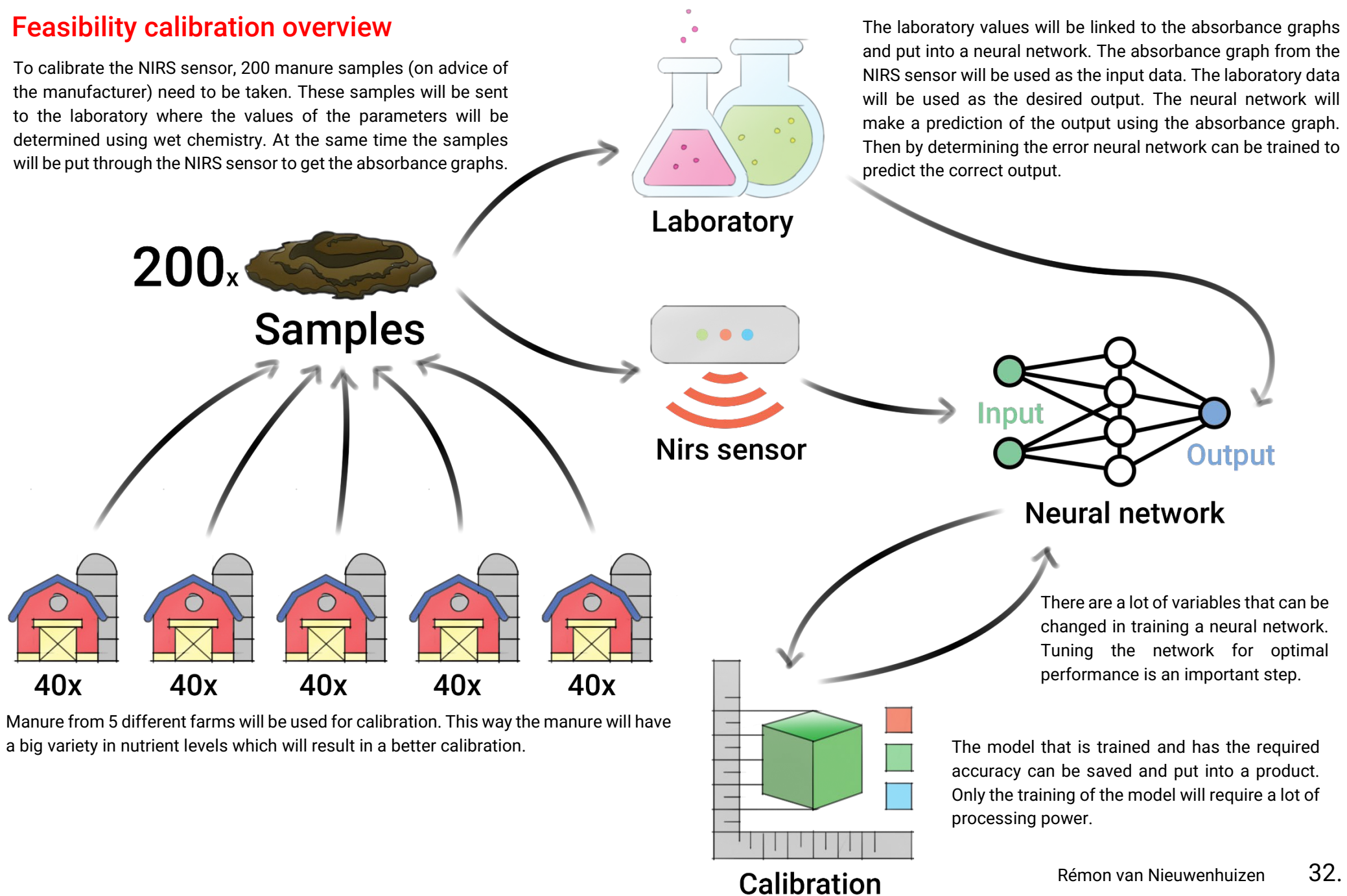

The laboratory values will be linked to the absorbance graphs and put into a neural network. The absorbance graph from the NIRS sensor will be used as the input data. The laboratory data will be used as the desired output. The neural network will make a prediction of the output using the absorbance graph. Then by determining the error neural network can be trained to predict the correct output.

There are a lot of variables that can be changed in training a neural network. Tuning the network for optimal performance is an important step.

The model that is trained and has the required accuracy can be saved and put into a product. Only the training of the model will require a lot of processing power.

## Calibration



## 4.6 Data processing

The data that is retrieved from the manure also need to be transferred and processed to generate feedback for the farmer. Dynalynx currently already offers a solution to store and process NIRS data in the cloud (Figure 38). This system was taken as an example for Lely on what their cloud system could look like.

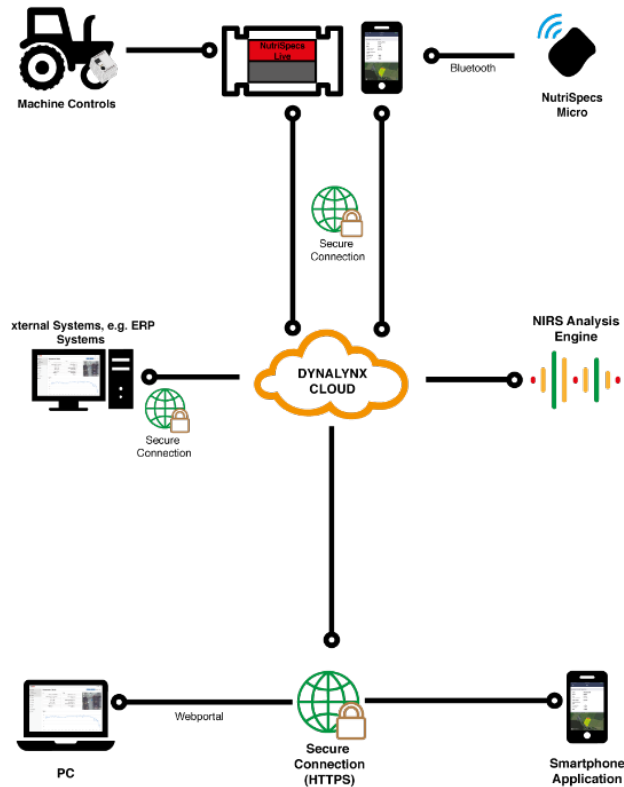

Figure 38 - Dynalynx cloud overview (Dynalynx, 2022)

For Lely there exist 2 options, running the calibration and processing locally or in the cloud. The calibration lines don't take a lot of processing power while the data analyses and feedback generation does.

Since these calculations only have to be done periodically it's more efficient to use shared processing power. Besides, Lely wants to use its client's data to improve their feedback model. Therefore a cloud-based solution is more cost efficient and better for Lely.

### Lely cloud

The NIRS sensor will be connected via Wi-Fi or ethernet to the farm's router. This will give the sensor

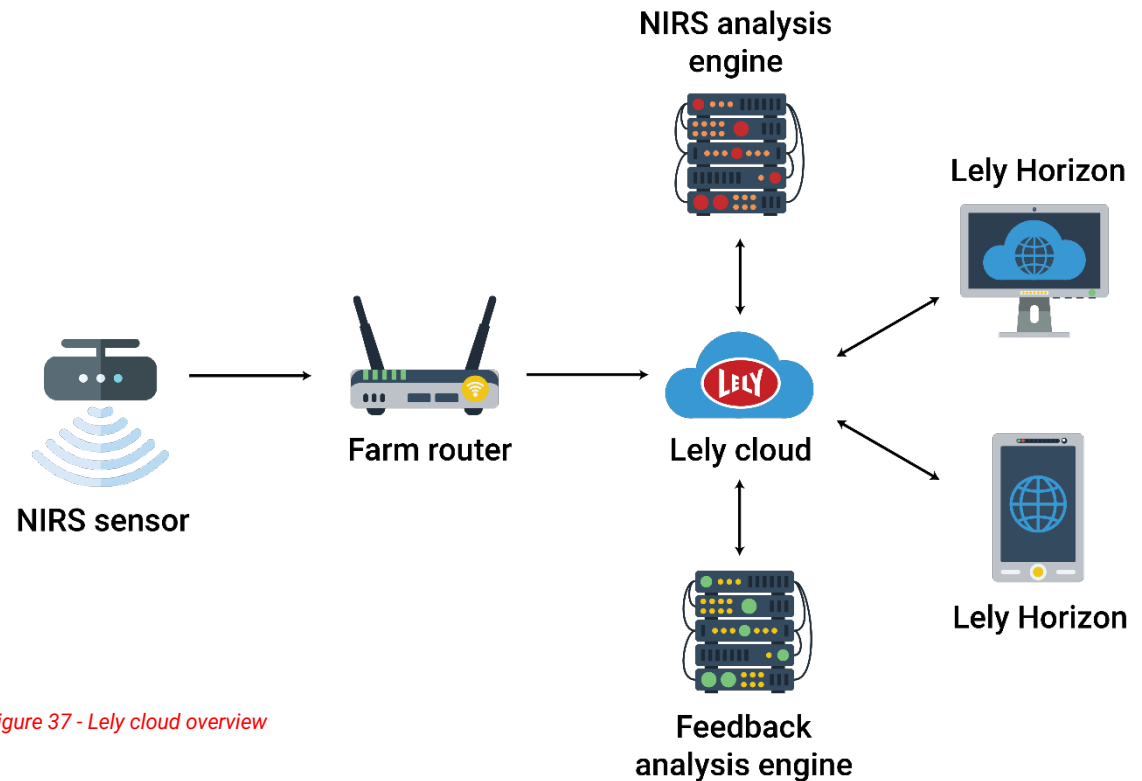

Figure 37 - Lely cloud overview

Define

access to the internet which it will use to send the NIRS absorbance graphs to the Lely cloud database.

Connected to the Lely cloud is a NIRS analysis engine. This engine contains the calibration lines that Lely has created. It uses these calibration lines to convert the retrieved absorbance graphs into valuable results. These results are sent back to the Lely cloud database where they will be stored.

Next the feedback analysis engine takes over. This system converts the parameter data into ration feedback that is send back to the farmer using the Lely Horizon application.

## 4.7 Requirements

During the analyses phase many requirements were collected. In the following overview these requirements are noted per chapter so they can be linked back to their origin.

### Precision livestock farming

1. Feedback from product must be valuable to the farmer by:
  - a. improving business performance
  - b. improving animal welfare
  - c. improving farm sustainability
2. Feedback from product must help farmers with giving tailored care to larger amounts of animals.
3. Product should be applicable for receiving subsidization.

### Dairy cows

4. Feedback from product must give an overview of the distribution of a cow's required nutrients inside its current feed.
 

a. Fibre	b. Protein
c. Starch	d. Vitamins
e. Sugar	f. Minerals
g. Fat	
5. Feedback from product must help the farmer with calculating a ration for his herd.
6. Product should be suitable for Total Mixed Ration and Partial Mixed Ration farms.
7. Feedback from product must help the farmer with optimizing his herds ratio between fermentation and digestion.
8. Product must have an understanding what effect feed changes have on internal processes.

### Feed efficiency

9. Product feedback must show a comparison between the Table Book for Livestock Nutrient Requirements and the current ration.
10. Product feedback must help with optimizing Feed Efficiency.
11. Product feedback must help with optimizing Income Over Feed Costs.
12. Product feedback must show Feed Efficiency over time.
13. Product feedback must show Income Over Feed Costs over time.

### Interviews

14. Feedback from product must make the feed advisor obsolete.
15. Product should require as little interaction as possible for the farmer.
16. Farmer should be able to manually agree to every feed change.
17. Product should be able to communicate with the Lely Vector feed grabber / dispenser.

### Farm data

18. Feedback from product should integrate with other Lely products that provide data.
19. Feedback from product must improve upon the data already available.
20. Feedback from product must integrate with the Lely Horizon Dashboard.

### Barn environment

21. Product must be able to endure a barn environment.
  - a. Not hindered by manure build up.
  - b. Electrically waterproof.
  - c. Corrosion proof.
22. Product be cow-proof.
  - d. Withstand or limit cow impacts.

- e. Non destructible by cows.
  - i. Chewing
  - ii. Licking
23. Product should be easy to perform maintenance on.

### Manure monitoring

24. Sample rate of product should be at least once every 2 days.
25. Product should monitor compositional parameters.
 

a. Proteins	b. Dry matter
c. Organic matter	d. Fibres
e. Sugars	f. Starches

### Dump pit

1. Product should be flexible to fit different kind of dumping pits.
2. Product mustn't interfere with the charging station
3. Product mustn't interfere with the water station

### NIRS sensor

4. Should have a reflective calibration surface to counteract light degradation.
5. NIRS lights should be replaceable.
6. Lens should be covered with manure, no air bubbles.
7. Lens of NIRS sensor should be cleanable.
8. NIRS sensor should be cooled properly to prevent overheating.

### Dynalynx sensor

9. Sensor lens should extent 5mm.

### Data processing

10. Sensor should send its data over the internet to a database from Lely.

## 5. Develop

In this chapter the direction for the integration of the sensor will be chosen. There will be started with a brainstorm for multiple sub solutions that need to be solved. This brainstorm was executed in the form of several how to's.

By combining these sub solutions, several concepts have been created that each have their own advantages and disadvantages. 3 concepts for integration were created as well as 1 concept on feedback to the farmer.

These concepts were then tested on several criteria with the help of a harris profile. The criteria have been carefully selected with help of the research that was done earlier in this project as well as criteria that came forth of speaking with the client. The criteria can also be linked back to the requirements that can be found earlier in this report.

## 5.1 How to's

In order to create product concepts, several how to's were constructed. These how to's help with generating solutions for sub problems. The solutions that were found are later combined into concepts by making different combinations. The origin of the concepts can be found in the how to's and are marked with an asterisk.

From the cow

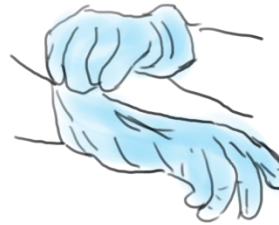

With collector

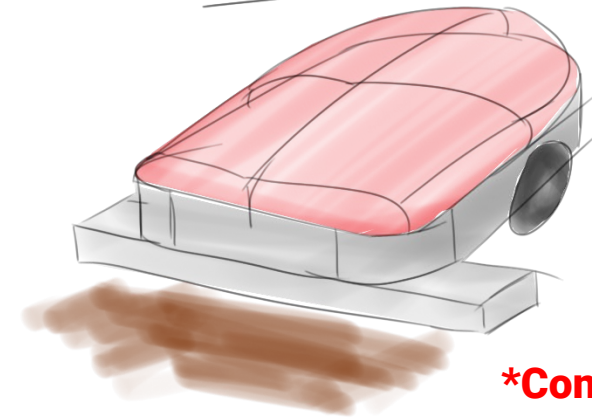

**\*Concept 1**

At the dump

**\*Concept 3**

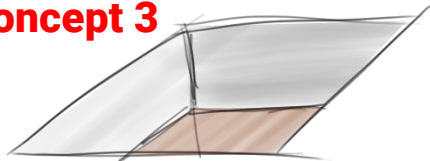

Ideation

### Where to collect manure on a farm?

Manure can be collected on many locations inside a barn. Some provide manure from a whole herd while others provide manure from individual animals. Identifying places where manure can be collected is important because it helps with placement of the manure monitoring device.

At the cow



At the feedbox



From the floor



At the milKrobot

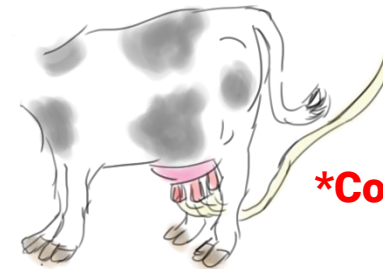

**\*Concept 2**

collection bag attached to cow



**\*Concept 3**

Separate cows

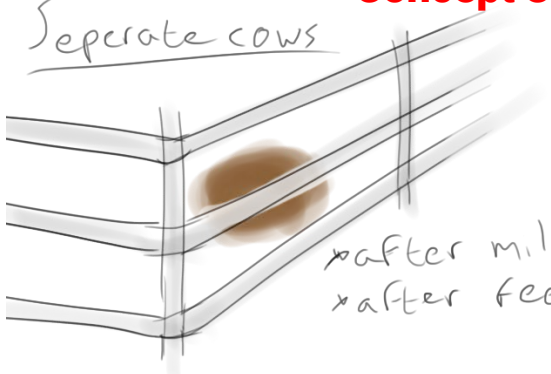

after milking  
after feeding

With an implant



Manually

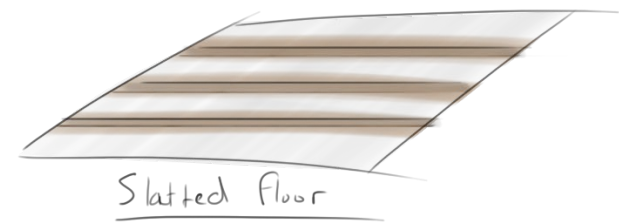

Slatted floor

Drone

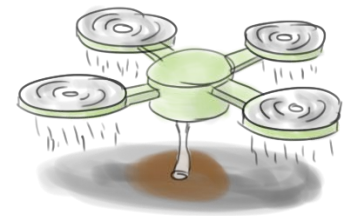

funnel

+ ?



+ ?

**\*Concept 2**

dump put

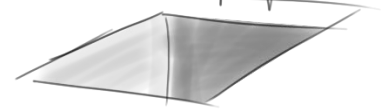

+ ?

With collector

**\*Concept 1**

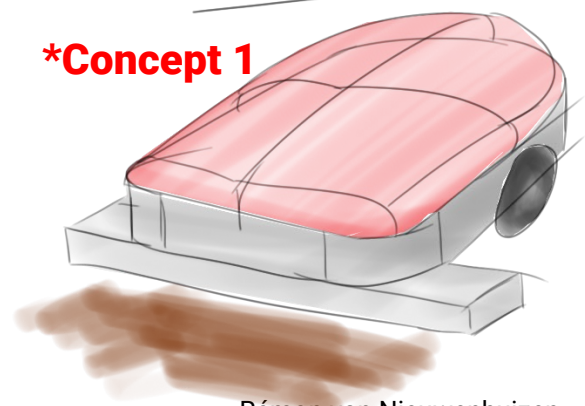

Ideation

### How to collect manure?

Collecting the samples automatically is an important requirement of a manure monitoring product and influences where the product will be integrated and what form the product will take.

potty trained cows



pavlov

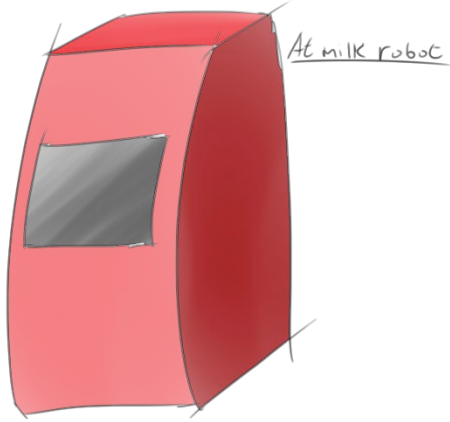
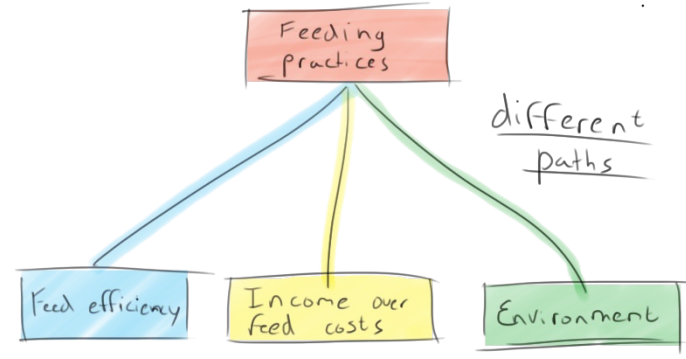
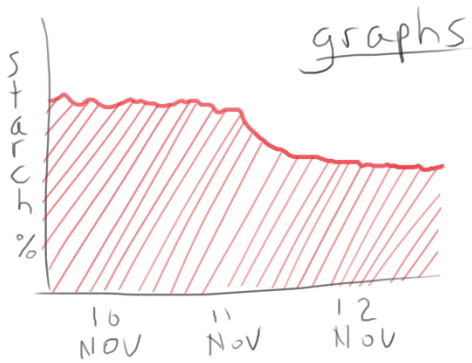

Ideation

### How provide feedback to the farmer?

Interaction with the results of manure monitoring can take many forms. How the farmer will interact with the data will change what form the feedback of the product will take.

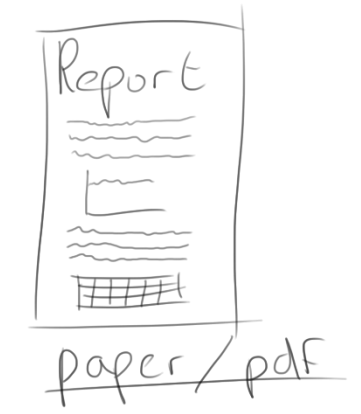

ration suggestions

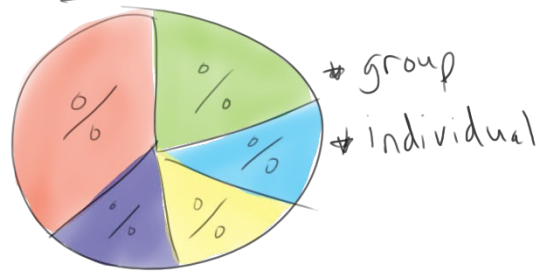

### \*Feedback concept

No feedback  
Automatic changes feedbox



# Discovery Collector Concept 1

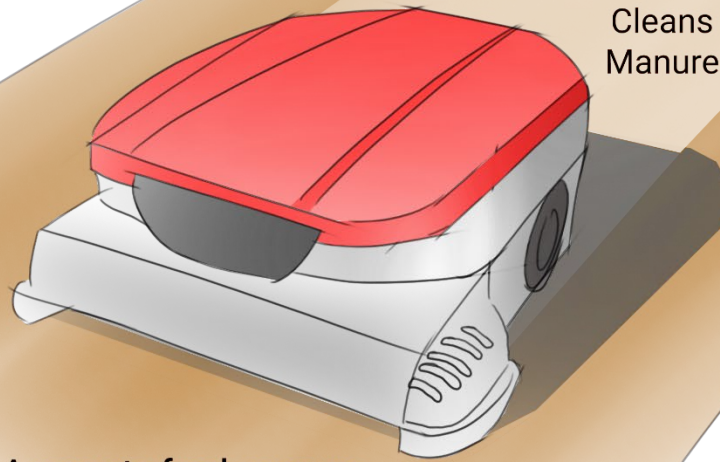

Cleans Manure

Has Access to fresh manure

The Lely Collector is one of the obvious choices for housing the NIRS sensor. It has access to fresh manure that represents a full group of cows.

The NIRS sensor would be mounted inside the manure storage tank. As the manure will fill up this tank it will flow past the NIRS sensor which will continuously measure. When filled up the measurements will be converted into an average value.

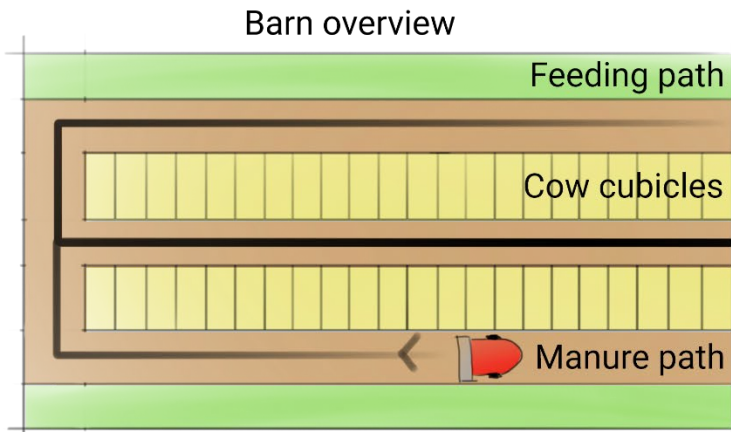

Barn overview

Feeding path

Cow cubicles

Manure path

Lely Discovery Collector - Barn cleaning robot

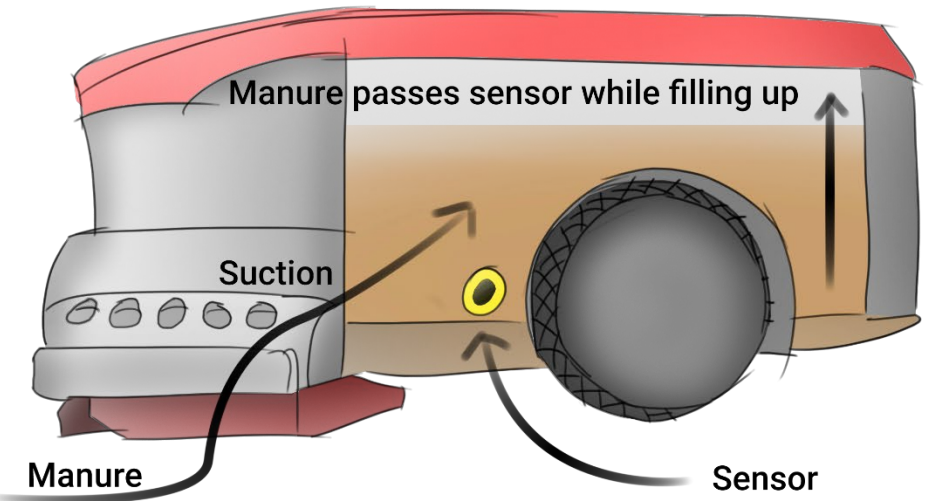

Manure passes sensor while filling up

Suction

Manure

Sensor

Representable sample collection from group of cows

# Seperation pen Concept 2

Lely Astronaut a5  
Milking Robot

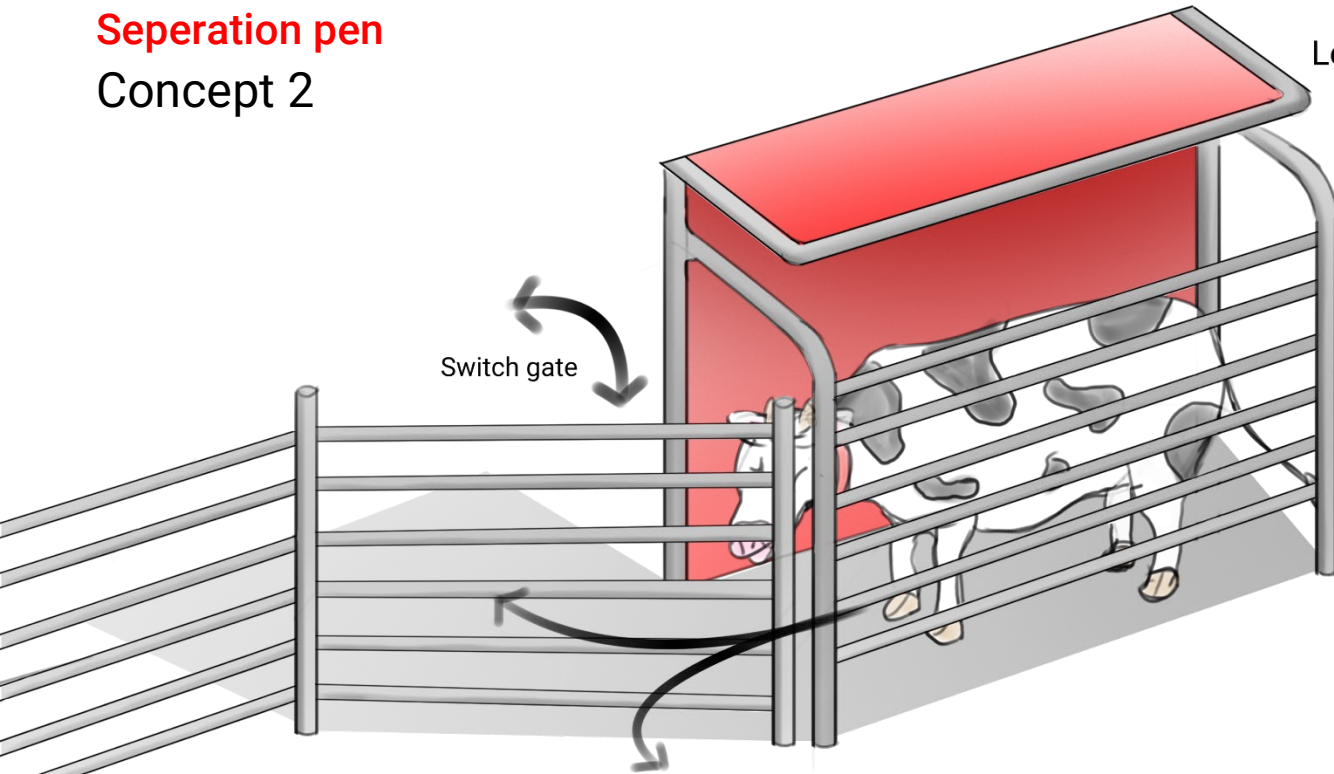

Cows get seperated at the milking robot

Monitoring nutrient levels on herd level is interesting but doesn't allow for optimizing on a per cow basis. This implementation will separate cows one by one in a separation pen after milking the cow will stay in the separation pen until it has defecated.

This happens around 10-20 times a day which allows to not keep the cow separated for too long. Afterwards the manure should be collected and tested which can lead to individual diets for all cows.

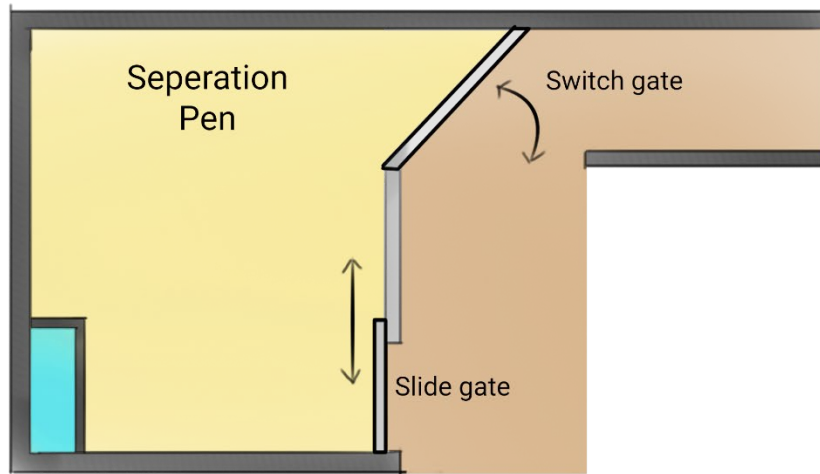

One cow at the time in the seperation pen

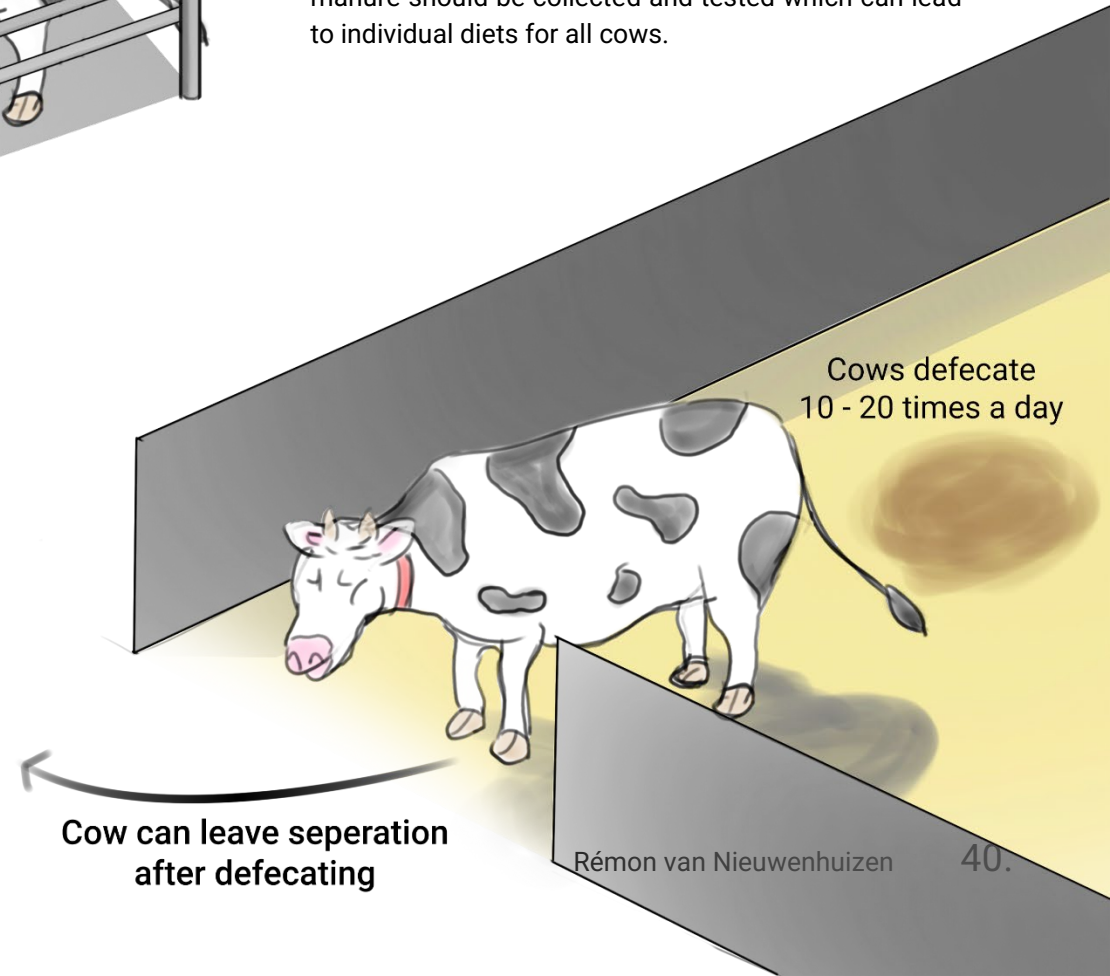

Cow can leave seperation after defecating



# Funnel dump pit Concept 3

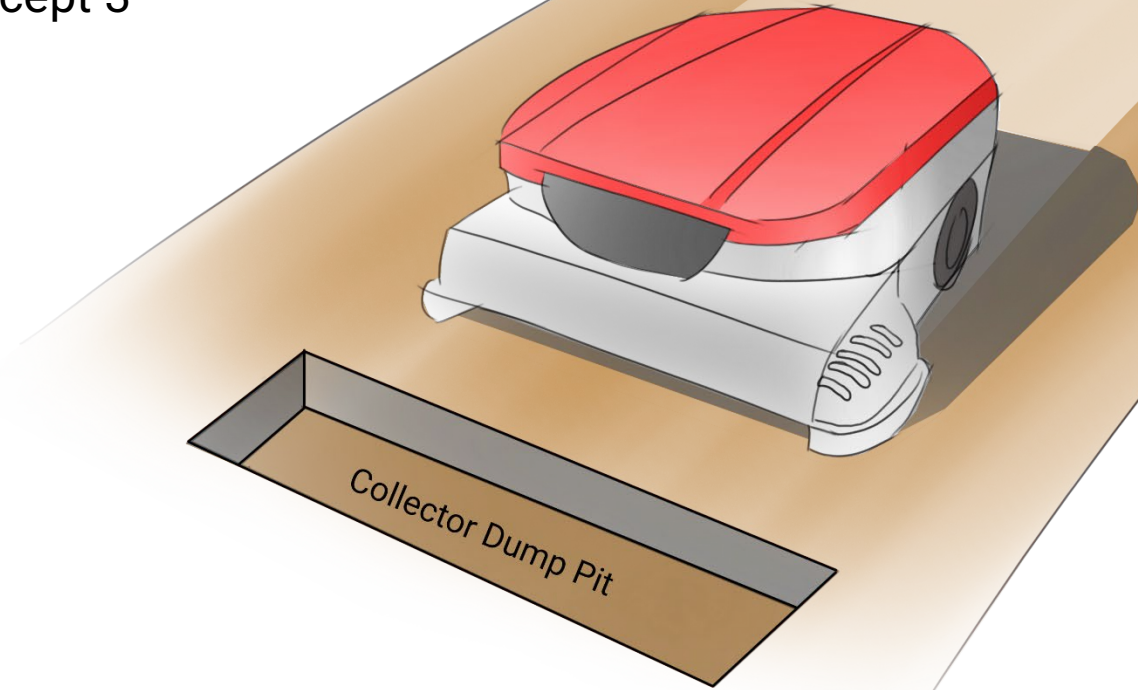

All the manure that is cleaned from the barn will eventually end up in the dumping pit. The collector will drive to the dumping pit and drop all its manure.

By placing a funnel inside the dumping pit that collects all this manure it is possible to send it past the NIRS sensor. This way all the manure from a herd is monitored.

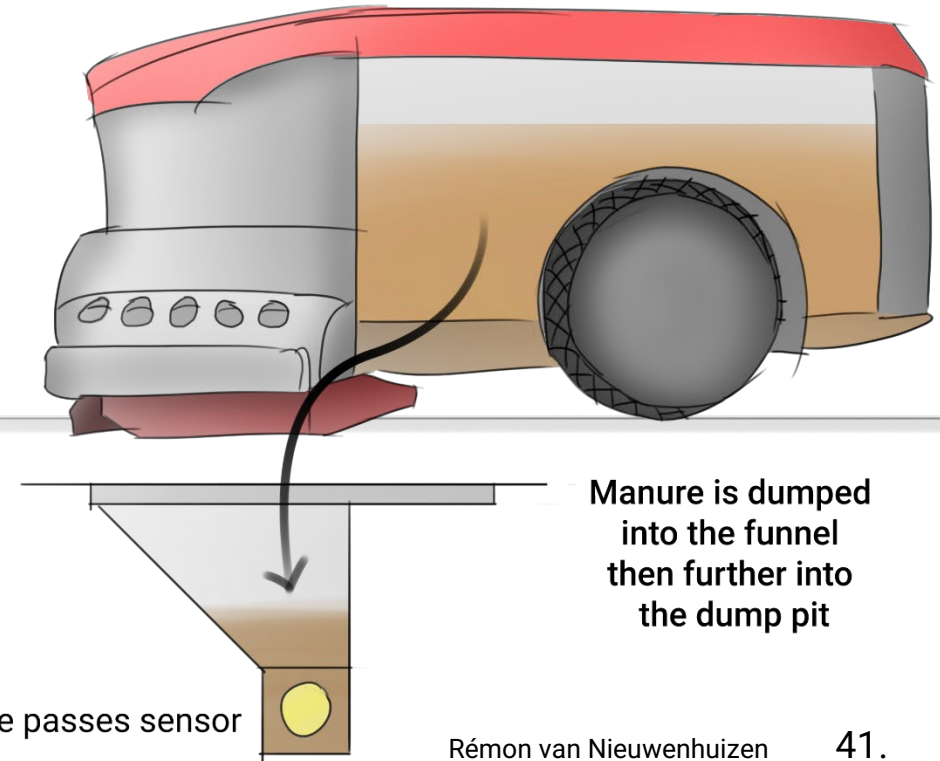
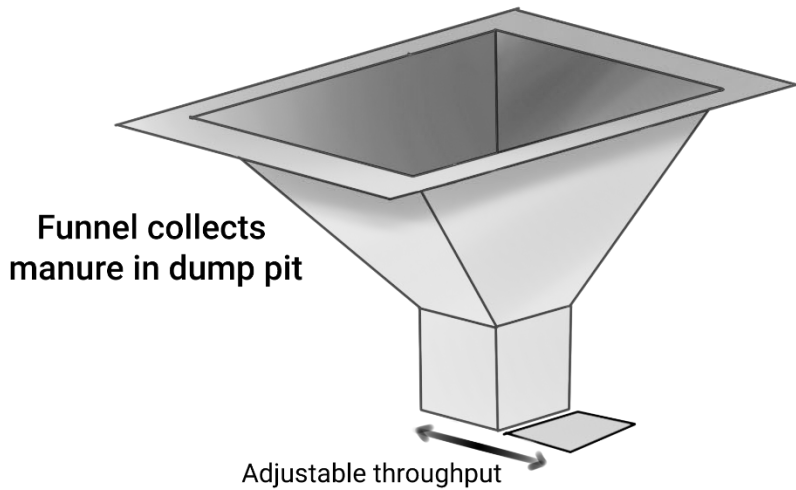

# Vector feedback

## Feedback concept

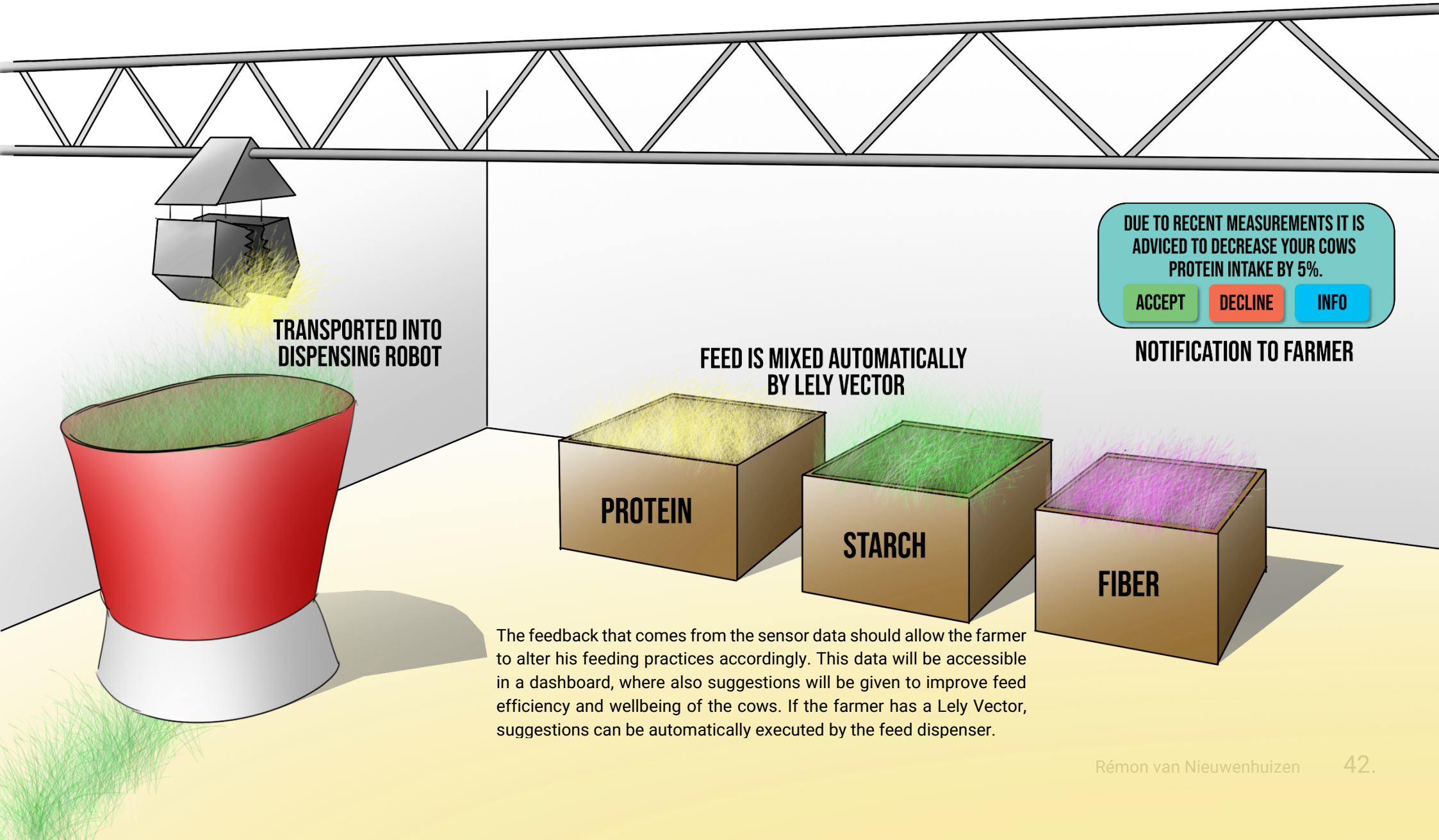

The feedback that comes from the sensor data should allow the farmer to alter his feeding practices accordingly. This data will be accessible in a dashboard, where also suggestions will be given to improve feed efficiency and wellbeing of the cows. If the farmer has a Lely Vector, suggestions can be automatically executed by the feed dispenser.

## 5.2 Direction choice

It was chosen to select a concept direction with the help of a harris profile. This method will help with making a substantiated choice based on the earlier defined requirements. The criteria used in this harris profile can be linked back to the requirements and therefor analyses and defining phase of this project.

### Costs

Farmers are entrepreneurs and have to make managing decisions to keep their business viable. With the sensor selection costs was of less importance since parameter value was much more important. But for concept selection it is still an important criterion, having a less costly product can mean more farmers are willing to invest in a product. An overview of the extra costs that come with the different integrations can be found in Table 7.

Collector	Seperation pen	Dump pit
Limited extra costs of integration.	Changes need to be made to the barn layout.	Extra material is necessary to construct the funnel.

Table 7 - Integration costs overview

To implement the sensor into the separation pen, changes must be made to a barns structure. Most barns have a separation pen already but that is already in use most of the time. An extra separation pen will have to be created which will be an expensive renovation.

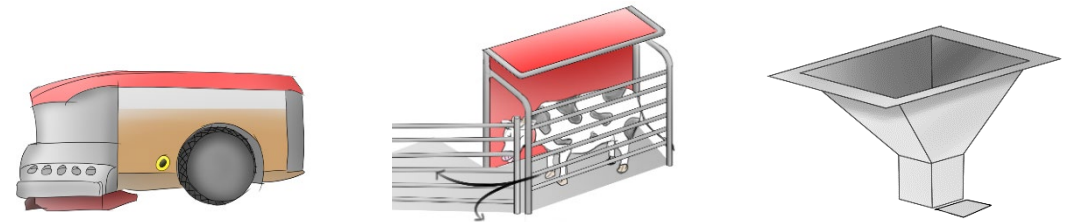

	Collector				Seperation Pen				Dump Pit			
	--	-	+	++	--	-	+	++	--	-	+	++
Costs				+	-						+	
Maintenance	-							+			+	
Sell as addon		-					+					+
Sample rate				+	-							+
Install time				+	-						+	
	3				-3				7			

With the dump pit concept there will be less expenses. The sensor will be built into a funnel of stainless steel which will be hanging inside the dumping pit. The stainless-steel funnel differentiates it from integrating it into the collector directly. Which will be the most cost-effective option since it needs no extra materials.

### Maintenance

Ease of preforming maintenance is important because this product will operate in harsh condition which make it likely someday maintenance is needed. Also, there are light bulbs present inside the sensor that might need to be replaced. As well as the lens of the sensor that may need to be cleaned if ultimately manure builds up on it. An overview of the ease of maintenance with the different integrations can be found in Table 8.



Collector	Seperation pen	Dump pit
 <p>Without a redesign of the Collector, it is very hard to reach inside the manure tank for maintenance.</p>	 <p>The monitoring device will live in the separation pen which will make maintenance easier.</p>	 <p>With the monitoring device inside the dumping pit, maintenance will be dirty but still easy to reach.</p>

Table 8 - Ease of maintenance overview

Maintenance will be hardest inside the collector. When the sensor is placed inside the manure tank it is not easily reached. The collector cannot be opened and is very heavy to lift or move. Also, the collector

has a tight operating schedule and can often not be turned off for more than a couple of hours before the barn is full of manure.

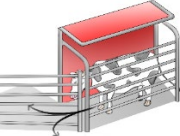
Inside the dumping pit will be a bit easier though there is still a lot of manure build up there. Also, the collector needs to use the dumping pit after every round trough the barn.

With the separation pen concept, maintenance will be the easiest. It will be in a separate place where there won't be cows present.

**Sell as addon**

Since the sensor on its own is already quite expensive it is preferable to sell the solution as an addon. Another benefit of selling it as an addon is that it can be sold to farmers already owning Lely product. An overview of complications for creating an addon with the different integrations can be found in Table 9.



Collector	Seperation pen	Dump pit
		
<p>Current Collectors in the field are not equipped to fit a NIRS sensor in its body. Making a compatible upgrade package will be challenging.</p>	<p>Barns currently only have 1 separation pen. Fitting another separation pen will be challenging.</p>	<p>The dump pit concept allows even current Collectors to be easily adapted for a NIRS sensor.</p>

Table 9 - Ease of creating addon overview

Selling as an addon can be most easily done in the dumping pit concept because it's basically a separate device. When the farmer already owns a collector, this product can be added afterwards.

Adding a NIRS sensor would need a redesign of the Collector but afterwards the NIRS sensor could be an addon that is fitted in the assembly line. Current Collector though will not be able to use the integration.

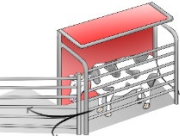
The separation pen would make it an expensive addon as the farmer would already need to have a milking robot and an extra separation pen.

**Sample rate**

Sample rate is quite important since changes in feed ration can be seen in the manure after 48 hours. Since farmers have such big expenses every day on feed, small changes could have a big impact at the end of each year.

With the separation pen concept samples will only be taken around once every couple of weeks since cows need to be separated for up to a couple of hours. With a large farm it could take a while before all cows are tested.

With herd level monitoring the sample rate will be multiple times a day. The farmer stated that feeding is also done on herd level which would make herd monitoring preferable for him.

**Install time**

Lely has employed installers that install new Lely products at farms. This installing costs them a lot of manpower and short installation times are

preferable. Install time is important to the client since it adds a to the products costs.

The collector concept is the quickest since there is no added install time outside of assembly. Installing the sensor in the dump pit is a little slower since the funnel needs to be place. But not as slow as integrating the concept into the separation pen which needs multiple adjustments to the barns arrangement as well as install a switching gate.

**Conclusion**

It was chosen to proceed with the dump pit concept since it scores the best on most criteria. The collector concept scores better on costs and install time. But the dump pit concept is not far off and scores overall better. It has the extra cost of a stainless-steel funnel and will need to be installed on site which will require extra installation time. Though it has the added benefit that it can be sold to current collector owners and maintenance is easier. The collector concept would also need a redesign of the machine to make integration feasible.

The separation pen concept only scores better on maintenance since it will not be located near a lot of manure and will stay a lot cleaner that way. But the separation concept will be expensive since it needs a lot of modifications to existing barn layouts which also increases the install time. Furthermore, the sample rate will be to low which will hurt optimizing performance. The benefit of individual cow manure monitoring is less important since farmers feed their cows on a herd level and cannot alter an individual cow's ration.

### 5.3 Function analyses

To proceed with the development phase of this project it was important to define the functionalities and features of the manure monitoring product. Defining these functionalities helped with identifying sub solutions and problems that still needed to be explored before proceeding to the prototyping phase. These functionalities found their origin in the requirements which came forth from the analyses phase.

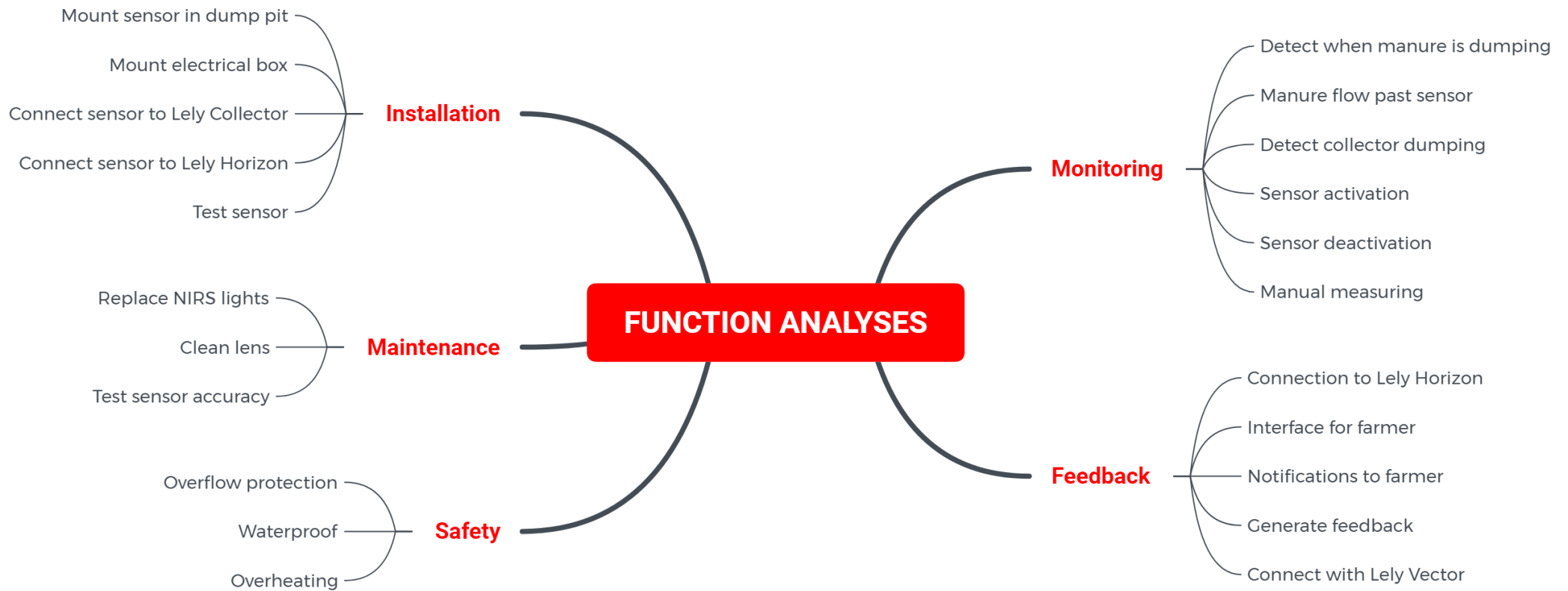

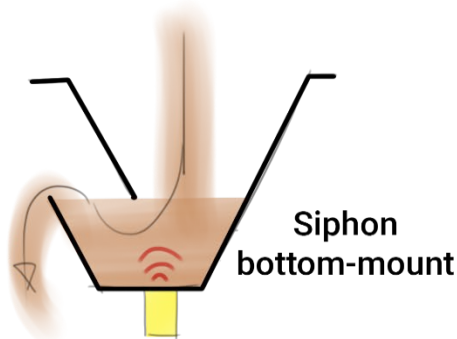
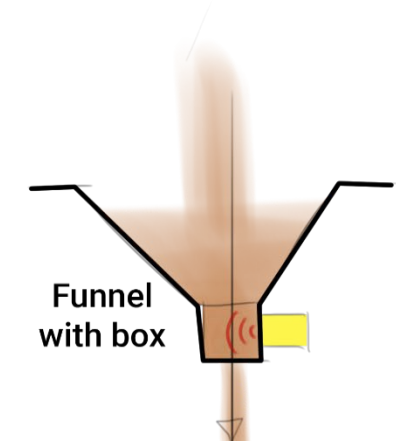
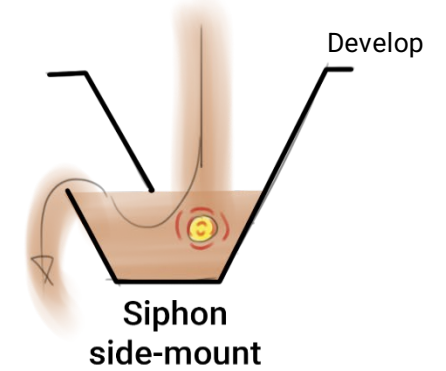
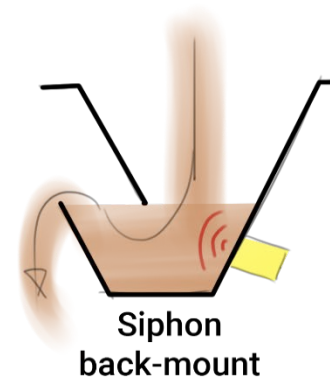
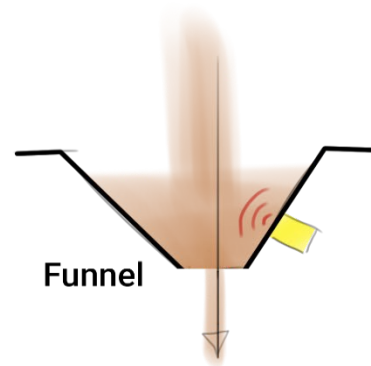
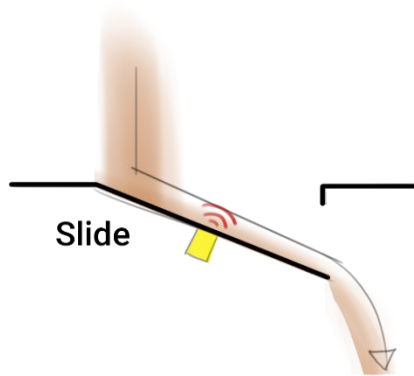

### Ideation

## How to intergrate the sensor inside the dump pit?

There are multiple solutions to implement this sensor into the dump pit. It is important that the fresh manure from the collector flows past the sensor lens.

### Slide

By dumping the manure on a slide, the manure passes the sensor as it flows into the dumping pit. This solution isn't very adjustable since the flow speed cannot be easily changed other than by changing the slide angle. Thicker or more liquid manure might cause problems.

This design cannot guarantee that there is always manure in contact sensor which is necessary for the NIRS sensor to get accurate results.

### Siphon

With the siphon design the sensor is mounted under the surface of the manure. This makes sure that there

is always enough manure in front of the sensor to get accurate readings.

A possible problem with the siphon design is that the dumping can happen without causing enough flow past the sensor. For instance, when the manure is very thick the manure at the bottom of the siphon can stay stationary.

### Funnel

With the funnel design all the manure is caught after being dumped from the collector. The manure is guided through the same exit which always makes sure that all manure flows past the sensor.

Adding a box to the end of the funnel helps with mounting the sensor but also allows to add an adjustment lid. With this lid the throughput can be adjusted to ensure that the sensor is always covered by enough manure.

### Conclusion

It was chosen to proceed with the funnel with box solution since it forces all the manure past the sensor and makes sure that only fresh manure is measured. Prototyping should show if this is the correct decision.

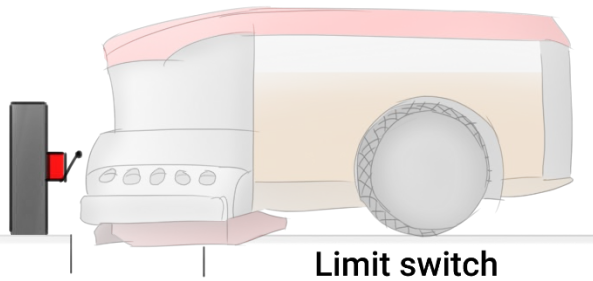

Limit switch

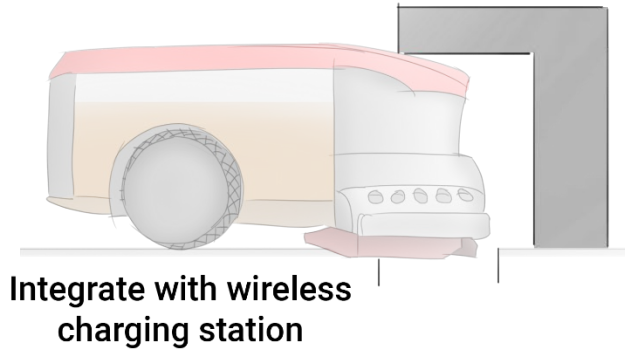

Integrate with wireless charging station

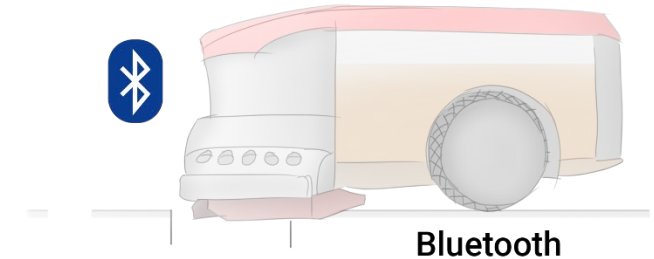

Bluetooth

## Ideation

## How to activate the sensor to start measuring?

When the collector starts dumping the manure, the sensor should start measuring. The method of activation should be very consistent in a barn environment.

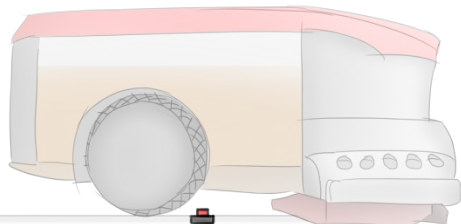

Floor switch

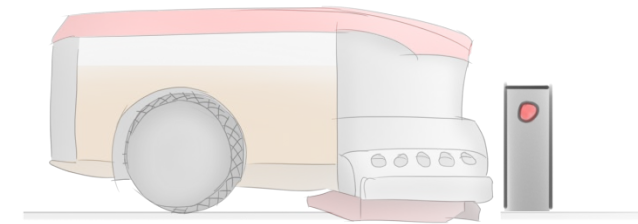

Laser / ultrasonic sensor gate

### Limit switch

A limit switch is put in front of the collector. The collector will push it when it drives over the dump pit. Some adjustments are necessary allowing the switch to be setup correctly. Though adding a switch always add an extra point of failure especially mechanical switches.

### Floor switch

A switch is placed at the floor which will be pushed when the collector drives on top of it. The floor is often covered in manure which makes this concept not very suitable for in a barn environment.

### Wireless charging station

The wireless charging station already has a detection system that allows it to start charging. Not all collectors have a charging station at the dump pit though.

### Bluetooth

The computer that facilitates the collector already has Bluetooth in it. The sensor also has Bluetooth already built in. The collector could send a message to the sensor to start measuring. No mechanical components necessary which makes it ideal for in a barn environment.

### Laser/ultrasonic gate

The sensor could also be activated by a laser or ultrasonic gate. Either by interrupting the laser or by measuring the distance with the ultrasonic sensor, the NIRS sensor can be activated.

### Conclusion

In the final product the sensor should be activated by Bluetooth since this adds no mechanical part to the setup. Mechanical parts are prone for error in a harsh barn environment where there is manure that can mess with moving parts.

## 6. Prototyping

To create a better understanding of what it takes to integrate a NIRS sensor into a dump pit it was chosen to create a prototype. With the help of the ID Cards from Loughborough University (Pei, 2009) it was chosen to create a functional model. Described as: captures the key functional features and underlying operating principles. This type of model was chosen because it can help proof the value of manure monitoring data. When the NIRS sensor is calibrated, several of these models can be placed at different barns to determine the potential of manure monitoring before fully committing into designing this product.

To gather results from the prototyping phase, several research questions were created:

- How big does the hole of the funnel design need to be to allow sufficient manure flow?
- Will manure stick to the lens of the NIRS sensor over time hindering data collection?
- Is the data that comes from the NIRS sensor in combination with the collector representative for the herd?
- Is the data that comes from the NIRS sensor valuable for the farmer?



## 6.1 Design

The prototype is based around the funnel with box concept described earlier. It is important that this functional model fits both Sphere farm and general dump pits to provide flexibility in testing. This design was the easiest to install on both farms and could even be added to farms that already have a siphon from a Sphere setup.

That's why it was chosen to make two brackets that could be fitted over the dump pit where the funnel will be hanging from (Figure 39 #1). This way brackets can be designed for all existing dumping pits while allowing to reuse the funnel.

Another requirement for the design was that the sensor head should be able to be fitted both on the left side and on the right side of the funnel. Since the dump pit is often next to a wall it differs where there is space for the electrical box. Therefore the sensor mount can be removed and placed on either side of the prototype (Figure 39 #2) allowing the electrical box to be placed on both sides.

Since it is unknown what the size of the funnel throughput needs to be, it was chosen to make it adjustable. This will make sure the funnel is applicable for multiple variants of manure, thick and more liquid manure. For this purpose, a slider was added to the throughput (Figure 40 #3).

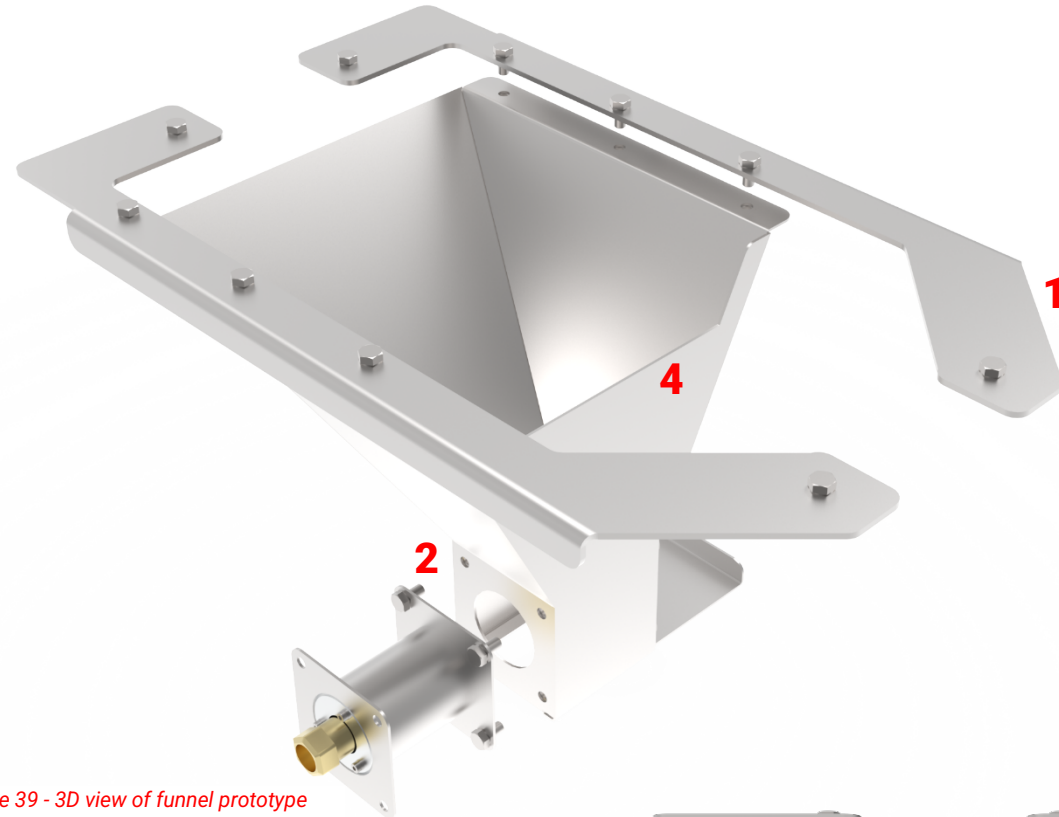

Figure 39 - 3D view of funnel prototype

Since the collector is working on a tight schedule it shouldn't be hindered while dumping. If the funnel ever gets constipated an overflow should exist (Figure 39 #4). This will allow the collector to keep dumping even when the funnel isn't working.

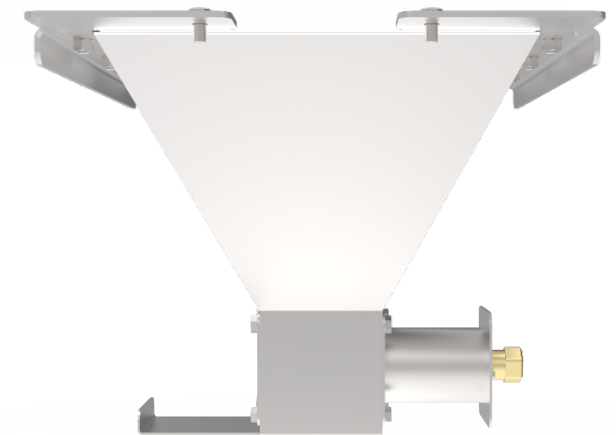

Figure 40 - Front view of funnel prototype

## 6.2 Setup

The first farm the prototype was tested at is a Sphere farm. The prototype was fixed using the existing bolt holes in the Sphere siphon (Figure 41). This allowed for easy installation without modifying the dumping pit. The funnel was hanging inside the siphon without hindering its core functionality (Figure 43).

In the final product the sensor should be activated by Bluetooth that is available inside the Collector and the sensor. But for the prototype it was chosen to activate the sensor by a switch that was mounted to the charging station (Figure 42) since it was quicker to integrate. Slots in the mounting plate of the switch allowed the sensor to be adjusted to where the Collector activates it.

Between the switch and the sensor an Arduino was used to allow for easy adjustments of the timings. When the switch is activated by the Collector it takes a couple of seconds before the manure start flowing. Starting the sensor early could lead to inaccurate results. This is changeable in the hardware of the sensor, but this requires help from the sensor's supplier. The code for the Arduino can be found in appendix 5.



Figure 41 - Setup overview

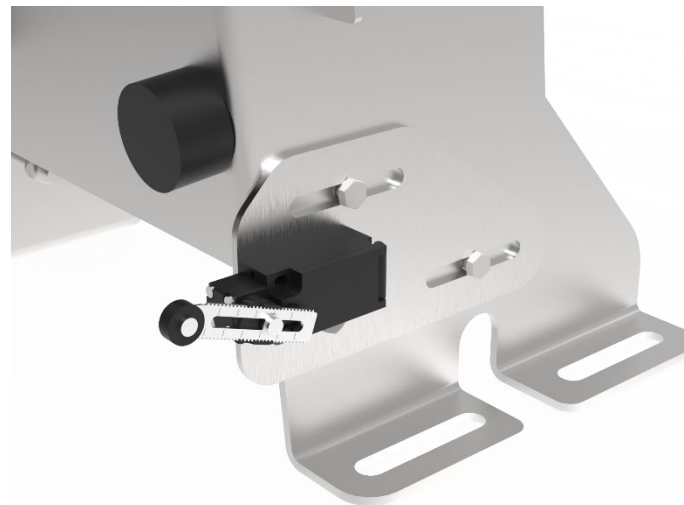

Figure 42 - Sensor activation switch



Figure 43 - Setup side intersection

## 6.3 Results

Mounting the prototype in the dump pit was easy, with reusing already existing mounting holes (Figure 46). This limited the time necessary for installation.

### Sensor mounting

The funnel fitted as expected inside the existing Sphere siphon (Figure 45). Alignment with the collector dumping hole was also correct (Figure 47). As well as the space that was reserved for the electrical box.

### Funnel throughput

Though while trying to adjust the funnel throughput, it was found that the manure from the Sphere farm was too thick to seep through the output hole (Figure 44). The Collector filled the funnel and then stopped dumping because the manure was held up. This prototype might work in a non-Sphere farm since the manure there is more liquid due to the mix with urine.

### Overflow

At the same time, the constipation of the funnel served a good purpose in checking if the overflow was working. After the funnel filled up the overflow worked for some time, but eventually the dumping of the Collector stopped. Meaning that the overflow is not big enough and gives too much back pressure.

### Iteration ideas

The funnel design in this size seems to not be useable on Sphere farms. On location, mounting the sensor directly in the Sphere siphon seemed like an interesting direction to explore.



Figure 46 - Mounting of the prototype



Figure 45 - Funnel inside the Sphere siphon



Figure 47 - Collector in front of the funnel prototype



Figure 44 - Manure stuck in funnel prototype

## 6.4 Iteration

Because the funnel design did not work with the thick manure from the Sphere farm, it was decided to create a bracket to put the sensor directly in the Sphere siphon.

The bracket that was designed earlier was modified with an extension to mount the sensor just under the manure surface (Figure 49).

It was also necessary to modify the sensor head since it was not fully waterproof from the back. This is something that is fixed in newer iterations of the sensor head. The adaptor that was created for the funnel design was used for this (Figure 50).

The sensor was then refitted inside the dumping pit and was receiving fresh manure from the collector that dumped it on top of the sensor (Figure 51).

The switch to activate the sensor was mounted to the charging station with the designed bracket and tuned to be activated by the Lely Collector (Figure 52).



Figure 48 - Iterated setup of NIRS sensor



Figure 49 - Modified sensor mount



Figure 51 - Sensor mounted inside the Sphere siphon



Figure 50 - Modified waterproof sensor head



Figure 52 - NIRS sensor activation switch

## 6.5 Results

The sensor was left to operate autonomously at barn for around 3 weeks. During this time results were gathered to answer the research question that were set for this prototype. Several other conclusions were found as well and will be discussed in this chapter.

### Manure build-up

Firstly, after 2 weeks of being submerged into the manure it was found that the lens of the sensor showed signs of manure build-up. During meetings with the sensor manufacturer the idea was that when the manure flowed past the sensor every few hours, there would be no build-up.



*Figure 53 - Manure build-up on lens of sensor.*

In the usecase referred to by the manufacturer the manure is pumped past the sensor with high pressure. This could be an explanation why in this setup the build-up doesn't occur. The conclusion is that the sensor lens needs to be cleaned every now and then to ensure proper measuring results.

### Temperature problems

During the 3 weeks of testing the sensor stopped working for a couple of days when the temperature dropped below 5 degrees Celsius. The manufacturer was contacted to discuss the problem and explained that the sensor iteration that was used contained a bug. The sensor would stop activating when its temperature dropped below 20 degrees Celsius. The manure in the dump pit is normally warmer than this, but because of snow and freezing temperatures this bug was hindering normal operation. The manufacturer was convinced that in newer iterations of the sensor head this wouldn't be a problem.

### Lighting bug

Another bug that hindered smooth operation of the sensor head was that every couple thousands of measurements the light used to generate the reflectance wouldn't turn on. This would result in incorrect measurements.

Once this also happened during the reference measurement. This resulted in multiple incorrect results until the reference measurement eventually was executed again and fixed itself.

The manufacturer was contacted and was aware of this problem. Again, he was convinced that in a newer iteration of the sensor head this was fixed.

### Mirror problems

In the last week of operation, the sensor started to give all incorrect results. In the sensor head there is mounted a mirror which rotates to generate the reference measurements. This mirror was detached from the servo that rotated it and the mirror was

permanently in front of the sensor. This was not fixable so the results from the last week of operation became unusable.

### Measuring results

Since there was not generated a calibration line for the manure monitoring parameters the results of the measurements were of limited value. Only the calibration lines for nitrogen, phosphorus and potassium could be used which are ecological measurements.

The Collector at the test barn was driving through 2 herds of cows. One dry herd and one milk giving herd. The measurements were split between herds and shown in a graph on the next page. The dotted lines represent the real measurements while the normal lines represent a 12-hour running average.

Even though the results are not usable for feed optimization they still show that some trends can be accurately monitored inside the manure with a NIRS sensor (Figure 55). Not a lot of extreme outliers were seen in comparison to the trend line.

The measurements through the milk herd consisted of multiple routes. One route past each row of cow beds. These routes have been measured individually. In Figure 55 all these routes were combined, but in Figure 54 a single route was plotted. The single route graph shows less outliers, which could mean that cow's stay in their own row of beds for longer.

Due to the problems during measuring a maximum of 4 continuous days of results was gathered.

### NPK measurements - Milk herd - Combined routes - 4 days

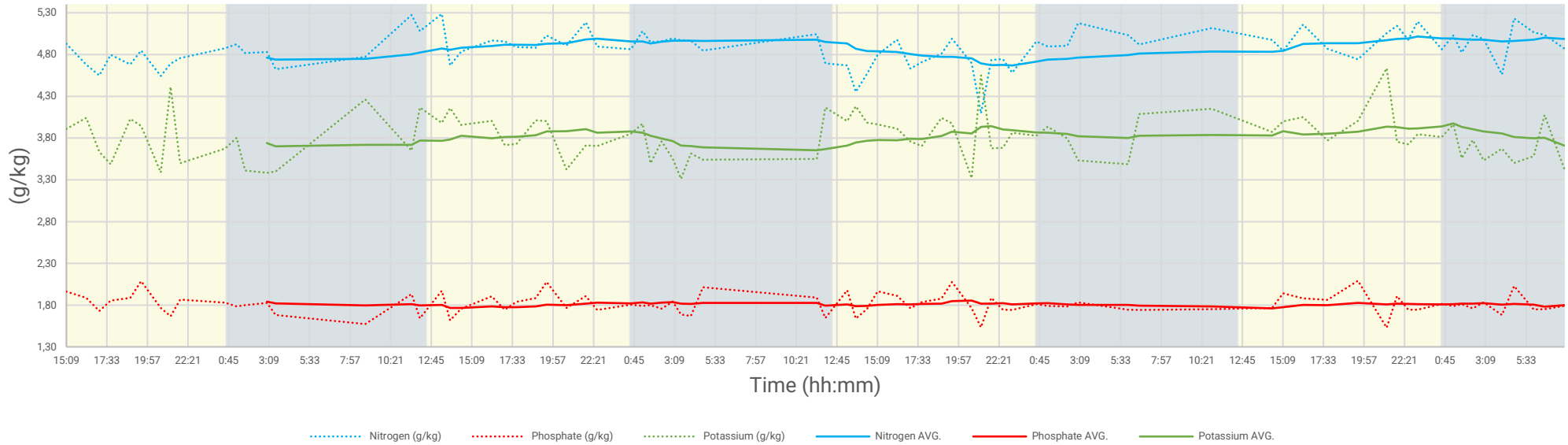

Figure 55 - NPK measurements - Milk herd - Combined routes - 4 days

### NPK measurements - Milk herd - Single route - 4 days

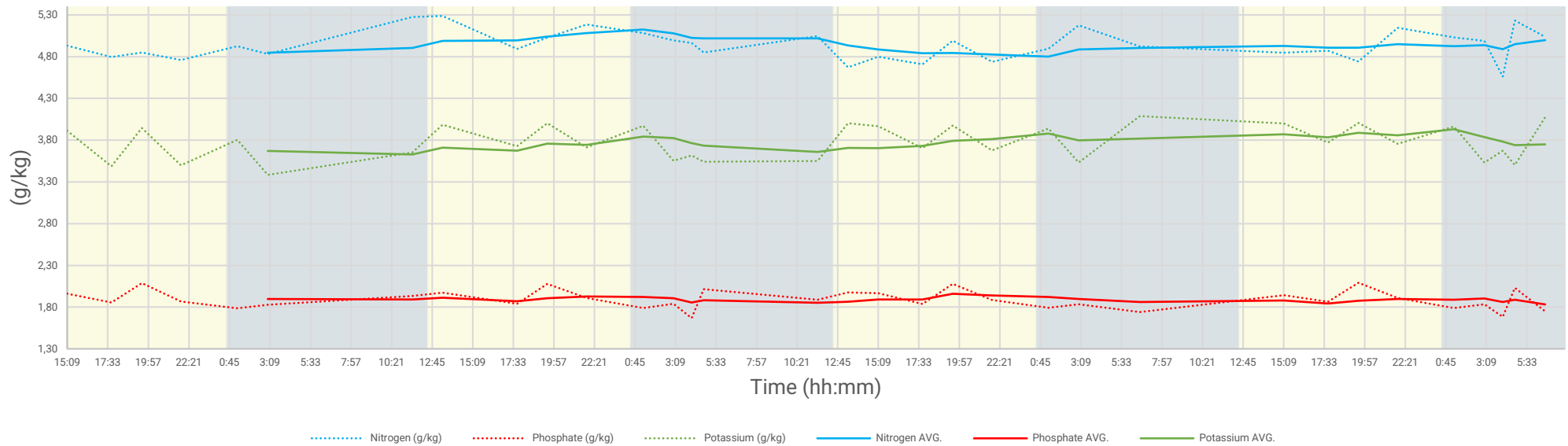
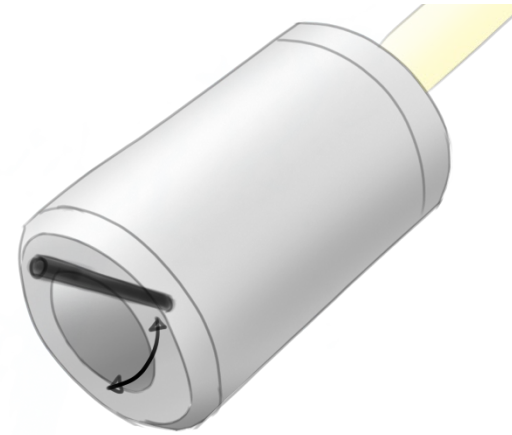

Figure 54 - NPK measurements - Milk herd - Single route - 4 days

## 6.6 Design improvements



Spray with water



Window wiper

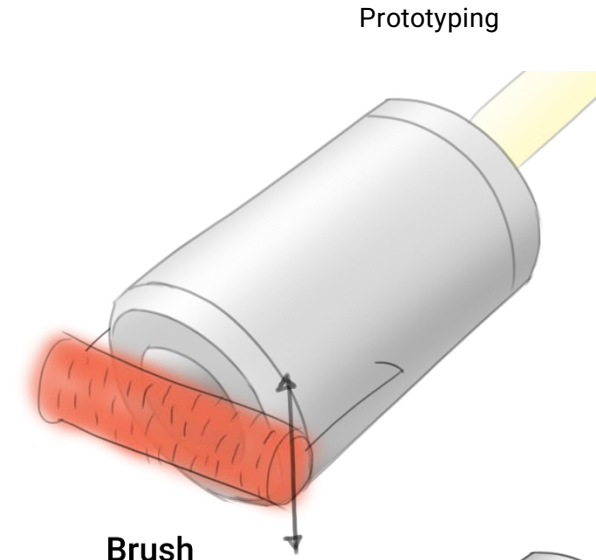

Brush

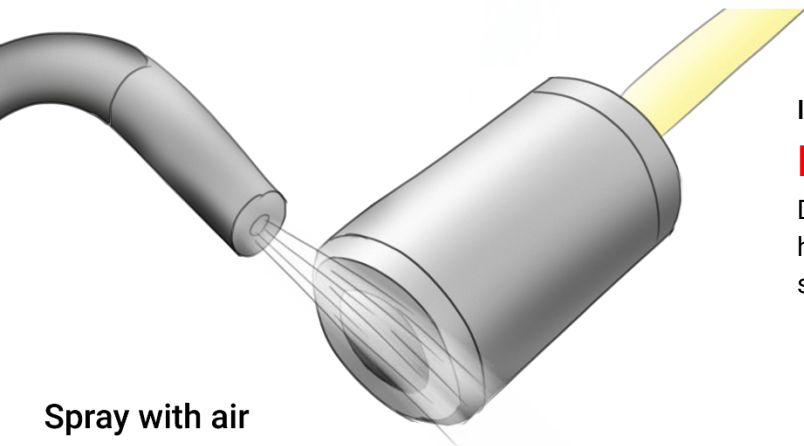

Spray with air

### Ideation

## How to keep the NIRS sensor lens clean?

During the prototyping phase it was found that the NIRS sensor head doesn't stay clean over longer periods of time while being submerged inside manure.

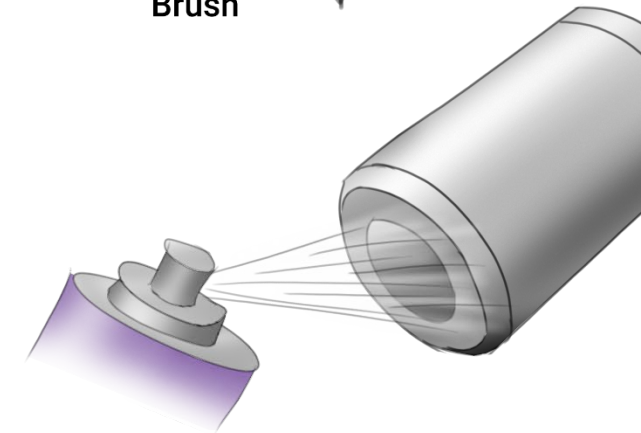

Hydrophobic coating

To solve this problem some ideas were generated that could work with the sensor head. During the analyses phase of this project, it was found that mechanical solutions are prone to failure inside a barn environment due to the harsh conditions.

Therefore, solutions like the water/air spray and hydrophobic coating have the preference. More research is needed to find out what the best solution is to keep the sensor lens clean over longer periods of time.

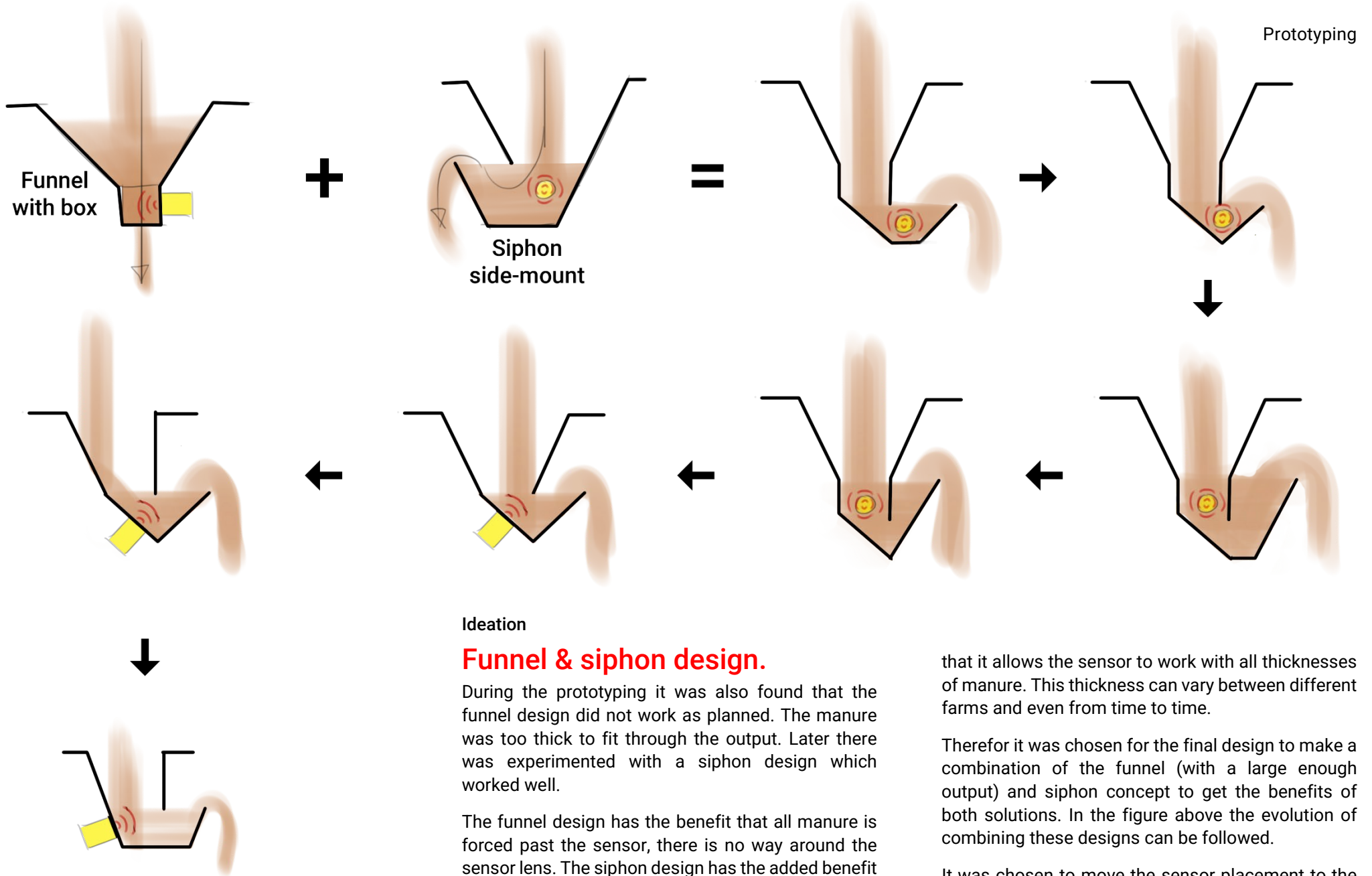



# 7. Final design

To come to the final design, all information gathered throughout this project was combined. The product will be called the Lely Manure Check.

## 7.1 Integration

The design of the integration of the sensor is largely based on the first prototype that was tested (Figure 57). During the prototyping phase some limitations of the design were found that were reconsidered to come to the final design.

### Mounting

The mounting of the Manure Check inside the dumping pit will work with 2 mounting brackets. These brackets will span over the dumping pit and provide the mounting holes that the funnel will connect to (Figure 56).

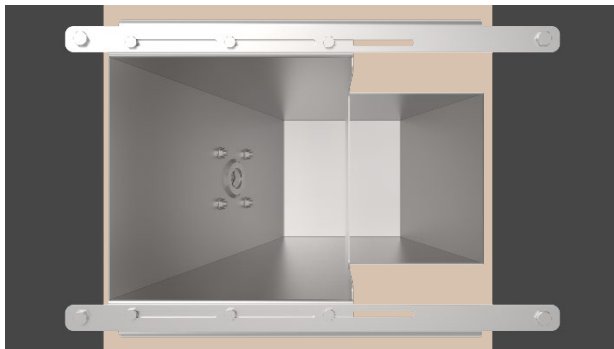

Figure 56 – Top view of Lely Manure Check inside dumping pit

The dumping pit for the Lely Collector has a standard size of 60cm which the brackets size is based on.

The brackets are made from 5mm thick stainless steel to prevent breaking when a person or a cow steps on them. To fasten the brackets into the concrete, concrete anchors are used to allow quick installation.

# Lely Manure Check

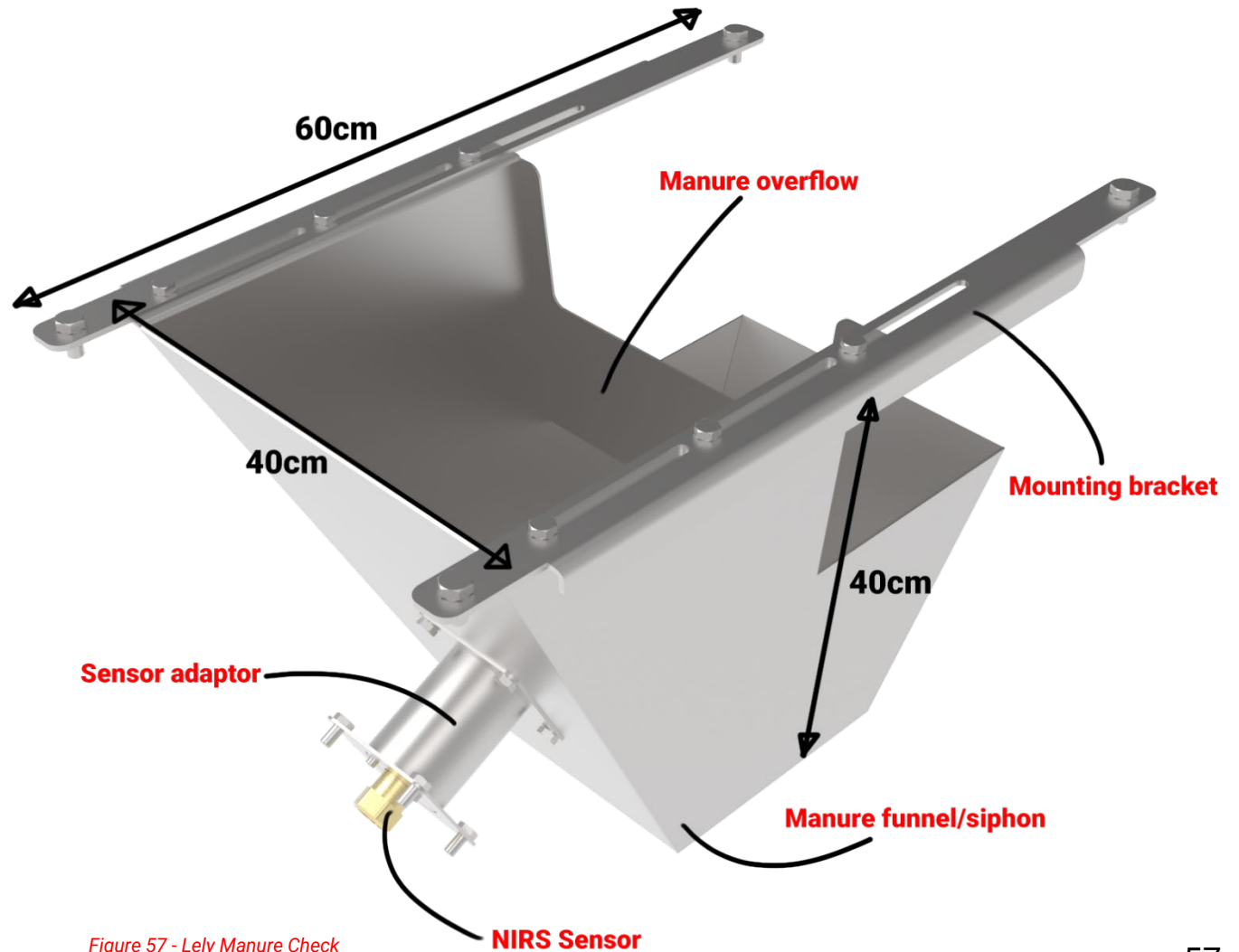

Figure 57 - Lely Manure Check

## Manure flow

For the sensor to get valuable results it is important that it has access to fresh manure. This manure will be dropped into the funnel by the Lely Collector. The funnel concept was found to have the best potential for always receiving fresh manure but when the funnel concept was tested it didn't allow the manure to flow freely because of the limited output. The final design therefore has larger output of which the size has been inspired by the Sphere siphon, a proven concept in the field (Figure 58).

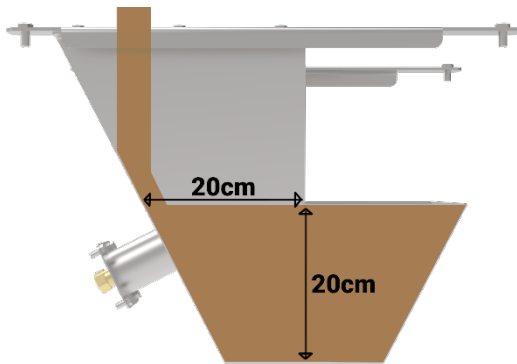

Figure 58 - Manure flow inside the Manure Check

The width of the funnel is based on the width of the dumping hole of the Lely Collector. During the prototype evaluating it was found that hardly any manure dropped to the side of the funnel shape.

The funnel concept was combined with the siphon concept to allow the sensor to always be covered in manure. Due to the siphon, the thickness of the manure will also have no effect on this.

With the final design the sensor is moved to the back of the funnel. This placement allows the sensor to be better in line with the manure flow.

## Sensor mounting

The sensor head has a flange which fits the flange on the back of the adaptor. This adaptor is then mounted to the funnels backplate with four bolts (Figure 59).

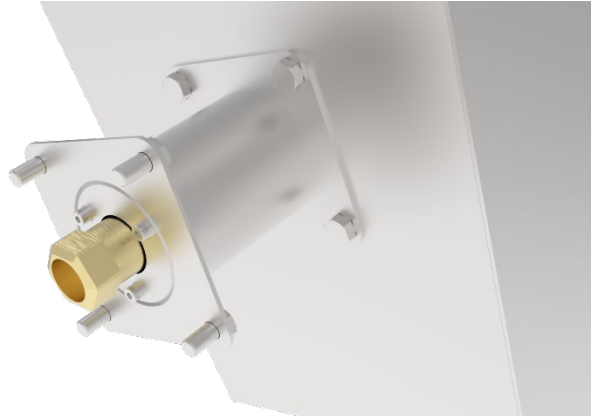

Figure 59 - Sensor mounted to backplate of funnel

The sensor lens sticks out 5mm past the backplate as per the requirements from the manufacturer (Figure 60).



Figure 60 - Sensor mounted in backplate

## Maintenance

To allow for maintenance the sensor is easily removable by loosening the bolts that connect it to the funnel backplate (Figure 59). The sensor can then be removed from the dump pit to be maintained in a manure free environment.

Since the sensor is mounted to the back of the funnel it might not be easy to reach the bolts keeping it in place. For that purpose, the top mounting bolts of the funnel are placed inside slots, which allows the funnel assembly to be moved back opening up space to reach for the bolts (Figure 61).



Figure 61 - Maintenance slots for top mounting bolts

## Overflow

The design of the funnel also features an overflow protection (Figure 57). If the siphon ever gets constipated the manure will find its way through a slot into the dumping pit. This allows the Collector to keep working and prevent manure build-up inside the barn. During the prototype testing the overflow gave too much back pressure which is why it has increased in size from 5cm to 10cm deep.

## 7.2 Manufacturing

It was chosen to make the funnel out of AISI 316 stainless steel because Lely has good experience with using this material inside the harsh barn environment.

Making the funnel with the help of plate steel offers a cost-efficient manufacturing process with limited investment costs. The parts are first laser cut and later welded together into their final form (Figure 62).

A manufacturing cost estimate was made using a system provided by Lely resulting in a price of €148. This is including all the required bending and welding. The price is excluding the NIRS sensor which has a current cost of around €3000 - €4000. Total this would make the manufacturing cost €3148 (Figure 63) but the price of the sensor is for 1 off and with unnecessary parts, so the actual price of the product will be lower.

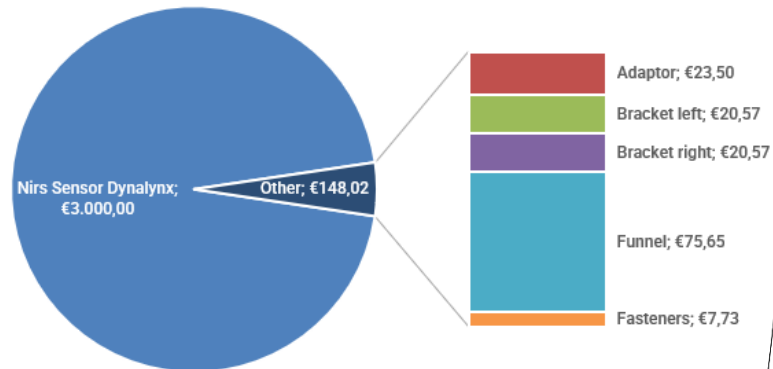

Figure 63 - Prices per part

The full price calculation can be found in appendix 6.

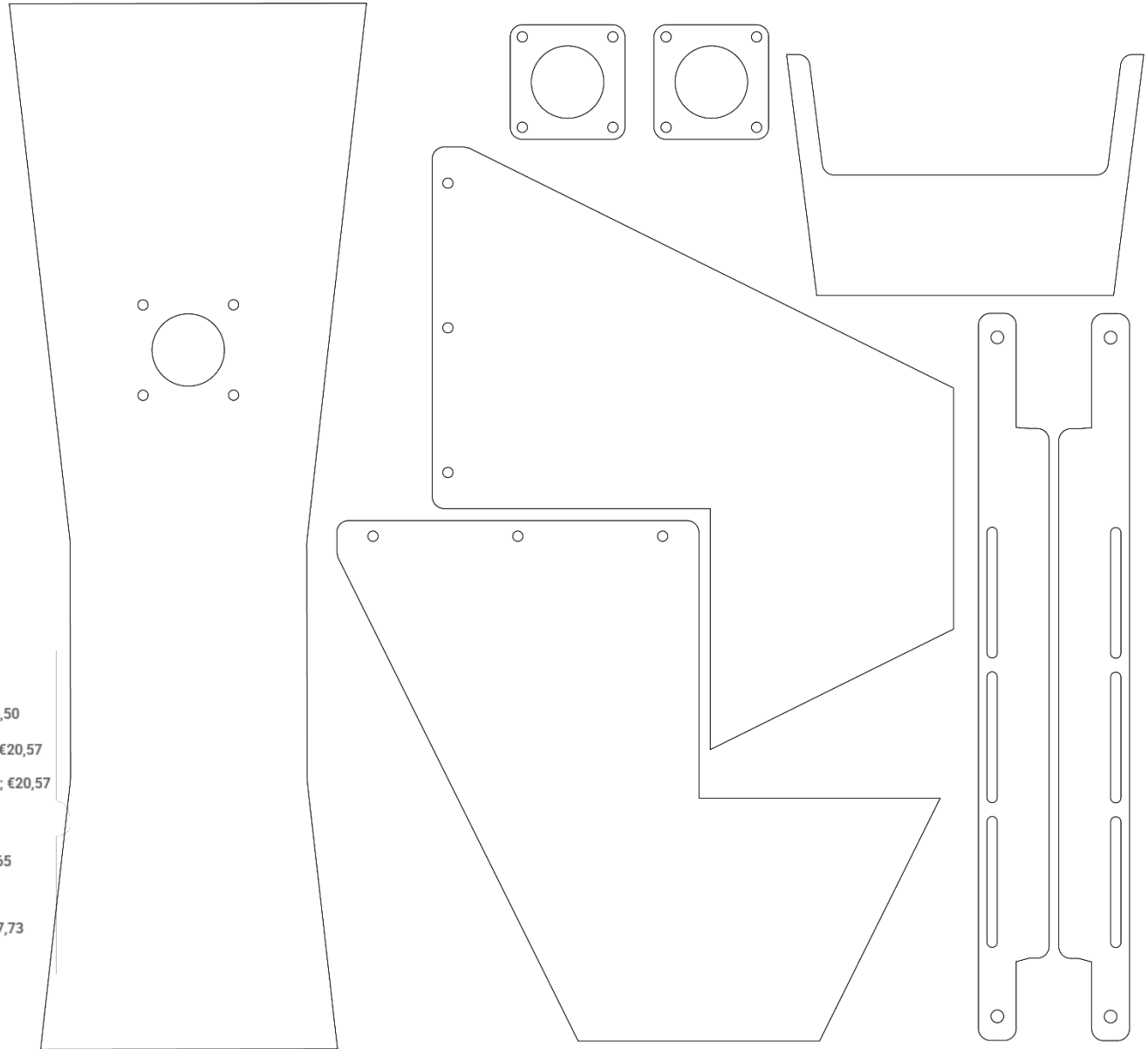

Figure 62 - Required plate steel parts for Manure Check

### 7.3 Manure monitoring

The NIRS sensor inside the Manure Check product will measure the parameters described in the overview below. Feed advisors consider below parameters as the most promising for manure monitoring.

After measuring the parameters will be sent to Lely where they will be converted into ration feedback for the farmer to help him improve feed efficiency and Income Over Feed Cost.

This feedback will be given to the farmer through the Lely Horizon application but can also be

automatically send to the Lely Vector automated feeding system. A start on the interface was made but during the process it was found that the interface should be a project on its own. The unfinished results of the interface ideation can be found in appendix 7.

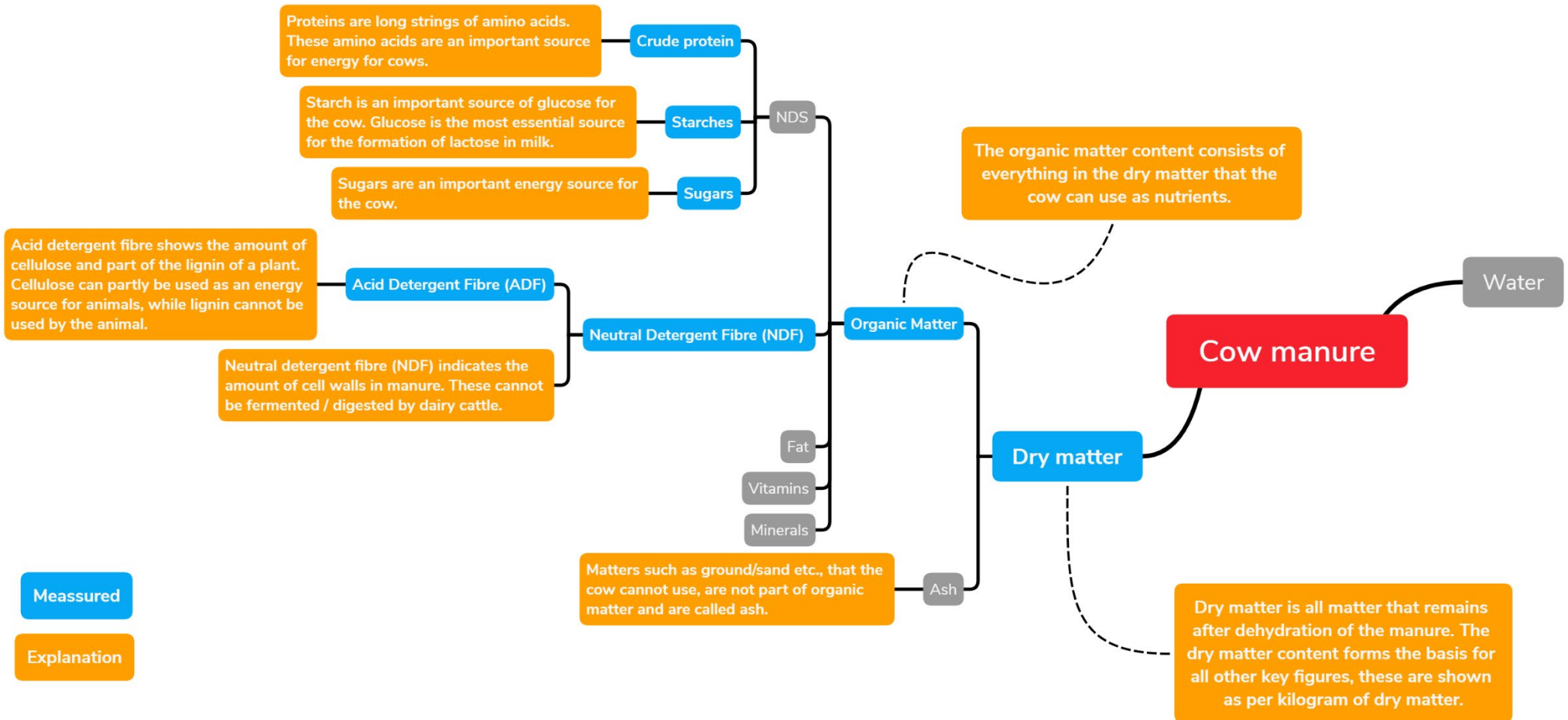

## 8. Conclusion

Determining if the designed product is an acceptable outcome for this project there will be looked at the original assignment as well as to the found list of requirements.

The original assignment for this project was:

*Design a product that monitors herd manure data in a barn using sensor technology and gives interpreted feedback to the farmer. To that end, investigate how, by automatically interpreting it and allowing interaction with it, manure data can enable the farmer to have more control over farm efficiency both financially and ecologically.*

The above-described final product does meet the goals set in the original assignment. It can monitor manure herd data using a NIRS sensor, measuring parameters that were found valuable by feed advisors. It can then interpret this data using a machine learning model and generate ration feedback from it. This feedback should help the farmer both financially and ecologically.

Though there are still a lot of questions unanswered for this product. Many aspects of the described product are still hypothetical. Will the calibration of the sensor succeed? Will the machine learning model generate valuable feedback for the farmer? Etc.

To answer these questions more research is necessary. The steps towards answering these questions are described in the next chapter where also a roadmap can be found for the future.

Next the described hypothetical final product will be evaluated on the found list of the requirements.

Green: Requirement has been met

Orange: Potentially met, but more research is needed

Red: Requirement has not been met

### Precision livestock farming

26. Feedback from product must be valuable to the farmer by:
  - a. improving business performance
  - b. improving animal welfare
  - c. improving farm sustainability
27. Feedback from product must help farmers with giving tailored care to larger amounts of animals.
28. Product should be applicable for receiving subsidization.

### Dairy cows

29. Feedback from product must give an overview of the distribution of a cow's required nutrients inside its current feed.
 

a. Fibre	b. Protein
c. Starch	d. Vitamins
e. Sugar	f. Minerals
g. Fat	
30. Feedback from product must help the farmer with calculating a ration for his herd.
31. Product should be suitable for Total Mixed Ration and Partial Mixed Ration farms.
32. Feedback from product must help the farmer with optimizing his herds ratio between fermentation and digestion.
33. Product must have an understanding what effect feed changes have on internal processes.

### Feed efficiency

34. Product feedback must show a comparison between the Table Book for Livestock Nutrient Requirements and the current ration.
35. Product feedback must help with optimizing Feed Efficiency.
36. Product feedback must help with optimizing Income Over Feed Costs.
37. Product feedback must show Feed Efficiency over time.
38. Product feedback must show Income Over Feed Costs over time.

### Interviews

39. Feedback from product must make the feed advisor obsolete.
40. Product should require as little interaction as possible for the farmer.
41. Farmer should be able to manually agree to every feed change.
42. Product should be able to communicate with the Lely Vector feed grabber / dispenser.

### Farm data

43. Feedback from product should integrate with other Lely products that provide data.
44. Feedback from product must improve upon the data already available.
45. Feedback from product must integrate with the Lely Horizon Dashboard.

### Barn environment

46. Product must be able to endure a barn environment.
  - f. Not hindered by manure build up.
  - g. Electrically waterproof.
  - h. Corrosion proof.
47. Product be cow-proof.
  - i. Withstand or limit cow impacts.

- j. Non destructible by cows.
  - i. Chewing
  - ii. Licking
- 48. Product should be easy to preform maintenance on.

### Manure monitoring

- 49. Sample rate of product should be at least once every 2 days.
- 50. Product should monitor compositional parameters.
  - a. Proteins
  - b. Dry matter
  - c. Organic matter
  - d. Fibres
  - e. Sugars
  - f. Starches

### Dump pit

- 11. Product should be flexible to fit different kind of dumping pits.
- 12. Product mustn't interfere with the charging station
- 13. Product mustn't interfere with the water station

### NIRS sensor

- 14. Should have a reflective calibration surface to counteract light degradation.
- 15. NIRS lights should be replaceable.
- 16. Lens should be covered with manure, no air bubbles.
- 17. Lens of NIRS sensor should be cleanable.
- 18. NIRS sensor should be cooled properly to prevent overheating.

### Dynalynx sensor

- 1. Sensor lens should extent 5mm.

### Data processing

- 2. Sensor should send its data over the internet to a database from Lely.

The list of requirements gives the same conclusion as the original assignment does. More research is needed. The question next is: is doing this research worth it for Lely?

During the analyses phase it was found that the PLF market is growing. There is a growing demand for PLF products because farming is becoming more and more strict due to environmental concerns. The developed final product can help with this. The Manure Check can help make cows more efficient making them more environmentally friendly.

Another aspect to consider is the benefit for the farmers. The Manure Check product has the potential to create extra profit for the farmer. The cost of the product will be low compared to the potential gain. Farmers are entrepreneurs, they will do everything to make their business as profitable as possible.

Both these factors make the Manure Check a desirable product for farmers. Thus, an interesting research direction for Lely.

The risk of failure that is involved can be refuted. Calibration of the NIRS sensor for the chosen parameters is deemed possible by multiple research papers. The value of the chosen parameters is substantiated by multiple feed experts. This proves that the opportunity is there for the research to succeed.

The overall conclusion of this project is that the Manure Check is a desirable and feasible product and that the research required to make this product work is worth it for Lely. The possible benefits outweigh the risks involved.

## 9. Recommendations

There are still many steps to take before a manure monitoring product can become a real consideration for farmers. In this chapter the steps Lely needs to take to develop such a product are described. An overview of these steps in the form of a roadmap can be found on the next page.

### Calibration

The first step Lely should take is trying to calibrate the NIRS for the parameters described earlier. This can start with a feasibility test to limit the investment risk (chapter 3.4 table 5). With the data of the feasibility test, research should be done on what kind of machine learning algorithm will perform best in converting the NIRS data into valid results.

When the feasibility test is successful there can be proceeded with a more thorough calibration which will result in a higher accuracy for the measured parameters (chapter 3.4 table 6).

When the manure monitoring product is finally launched, Lely should keep improving the accuracy of the sensor over time to increase the value and performance of their product.

### Value validation

With the inaccurate data after the feasibility calibration test, Lely should start researching what value the parameters can have for the farmer. This can be done by letting a feed advisor interpret the data and see what kind of performance gains can be made.

Later the value of feedback from the machine learning model can be validated. This feedback value should increase over time as the model is fed more data.

### Data gathering and model training

Lely should start gathering data from farms as soon as possible, so after the feasibility calibration test. The more data they feed into their future cow prediction model, the better the model will perform. More research should be done on what kind of machine learning model is best to generate feedback for the farmer.

### Product development

After the feasibility calibration test is successful, Lely should start improving the current design into a design that can be placed autonomously inside a farm for a long period of time. This way Lely can start gathering data which is important for the machine learning model training. This means that the provided solutions for periodically cleaning the lens of the sensor should be tested and developed.

Product development will then stop until the value is proven of the feedback machine learning model. This can be done with all the experience Lely has by keeping up the data gathering prototypes.

Sensor implementation is still an important topic to look at. The current form of the sensor is not very suitable for integration inside a manure monitoring product. Also, the cost can be reduced greatly by eliminating unnecessary components from the sensor assembly. An option to consider for Lely is developing their own NIRS sensor implementation around the sensor from Texas Instrument.

What should be taken into consideration also, is that by the time Lely starts developing this product the NIRS will be more advanced and probably integrated into a microchip, which will alter the possibilities of integration (Hakkel & Petruzzella, 2022). Integration options that are now considered impossible due to cost and size constraints should be reconsidered.

### Interface

More research should be done on what kind of feedback the farmer expects from a manure monitoring system and what kind of feedback can be generated. Then there should be looked at how to integrate and visualize this data in the Lely Horizon ecosystem.

### Morally

There is a risk involved with trying to fully optimize living animals, seeing them as systems with inputs and output. Lely should research the risk of too much optimization. Optimization that's goes at the expense of the health of the cows. Lely has the responsibility to monitor this possible dilemma and to prevent this from happening.

# 9.1 Roadmap

## Sensor calibration

**01** The most crucial step towards a manure monitoring product is making sure that the selected parameters can be measured. During this phase there will be tried to create a calibration line in order convert sensor data into qualitative data.

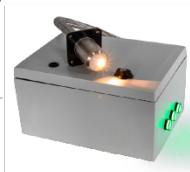

**02** Value validation

Next the value of the data that can now be generated needs to be validated. A feed advisor needs to interpret farm sensor data and create feedback for the farmer. With this feedback the farmer should be able have a better performing business.



## Data collection & Model development

**03** Now that the foundation for the product is laid, it is time to start working on training the feedback model. By tracking the manure data, ration changes and cow performance, the model should create an understanding of how a cow works. In time it should be able to replicate the feed advisor and generate it's own feed advise.



**04** Product development

Now that the model is generating value for the farmer with help of the sensor data, there can be proceeded to the real product. Previously all data is generated by prototypes that were mounted on test farms, supposedly this already provides experience what such a product should look like.



## Product release

**05** Now that the underlying technology is working and the product is ready and is able to monitor manure over an extended period of time, it's time for product release. Over the lifetime of the product the performance and therefore value of the product should keep increasing as it gathers more data to work with.



Phase 01	Phase 02	Phase 03	Phase 04	Phase 05
<b>Sensor calibration</b>				
Calibration feasibility test resulting in limited accuracy for parameters		Final calibration for parameters improving accuracy		Keep improving accuracy for parameters
<ul style="list-style-type: none"> <li>Send 200 samples to laboratory to get data necessary for calibration line.</li> <li>Create calibration line using machine learning and test the accuracy of parameter prediction.</li> </ul>	<b>Value validation</b>			
	Value validation with help of feed advisor and sensor data		Value validation for feedback models checked by feed advisor	Keep checking value for farmer, should improve over time
	<ul style="list-style-type: none"> <li>Create prototype that can collect data on farm inside dump pit.</li> <li>Collect data on the farm using the calibration line over a long period of time.</li> <li>Let feed advisor generate feedback with help of the collected data.</li> <li>Track performance of the farm business.</li> </ul>	<b>Data collection &amp; Model development</b>		
		Feed data from value validation into database and use to train model	Improve models with more data and by testing generated feedback	Keep collecting more data so that the prediction and feedback model keeps improving
		<ul style="list-style-type: none"> <li>Send 1000 samples to laboratory to get data necessary to improve accuracy of calibration line.</li> <li>Feed improved data into machine learning model to train cow performance prediction.</li> </ul>	<b>Product development</b>	
			Start working on product development with help of the experience from testing.	
			<ul style="list-style-type: none"> <li>Change from feed advisor feedback to model generated feedback.</li> <li>Check the value of the model generated feedback for business performance.</li> <li>Make sure that the feedback keeps improving with more data.</li> <li>Start development of product with help of the experience from earlier testing.</li> </ul>	
				<b>Product release</b>
				Release product to market.
				<ul style="list-style-type: none"> <li>Release the product to the market.</li> <li>Keep improving prediction and feedback performance (value) over the product lifetime.</li> </ul>
<p>Red flag: if not possible to create calibration line.</p>	<p>Red flag: no improved performance of cows.</p>	<p>Red flag: model cannot predict cow performance</p>		



# 10. Reflection

In this chapter I will be reflecting on the process of my graduation project and describing my personal experience with developing a manure monitoring system. Even though I'm satisfied with the result, there are some things that I would have done differently to make the project run more smoothly.

This project has been a big challenge for me. I have never done such a big project on my own. It strengthens your weaknesses that normally are countered by working together with other students.

## 10.1 Approach

I'm not the best in having a linear progression through my projects. Every project I have my ups and downs, working on your own makes it harder to get through difficult times. Something I would change about that is working more with week goals. I'll consider working in sprints next time which will help with achieving goals faster and give the satisfaction of reaching those.

Another thing that I would do differently is force myself to document better throughout the project. Documenting is not my favourite activity but doing all the documenting at the end of a project is even worse. Luckily halfway throughout the project I realized this and started documenting more but it's still something that can be done better next time.

Something that is one of my strengths is researching till I know everything. But this was very counterintuitive due to the short time span of this project. I should have left some question

unanswered and moved from the analyses phase earlier and identified possible knowledge gaps later. Now I have generated a lot of knowledge that I didn't need in the end.

## 10.2 Design choices

During this project I found out that I'm quite easy with the argumentation of design choices. In my head some choices are quite logical, but I learned that it's still important to substantiate these choices as for others they might not be as logical. This could be improved by discussing my choices better with peers and answering critical questions.

For instance, the choice of a sensor in this project. When I presented the choice, it didn't get the commentary back that I expected. For me it was clear as day that the NIRS sensor was the right direction but for others it was difficult to follow why. Sometimes I forget I'm very deep into the material and cannot express well enough what my underlying argumentation is. I think during this project I already improved this, but in future project this is still something I'll keep in mind and something I would still like to improve.

## 10.3 Prototyping

One choice that I regret making during this project was proceeding to fast to a fully (not) functioning prototype. In my enthusiasm to gather data from the farm and proving the products value I moved too fast in the prototyping process. One of the factors of this was the calibration of the sensor. Programming a neural network is something that I would enjoy a lot and using the value in the field seemed like a dream

come true. In the end the calibration didn't happen due to external factors and my prototype was 2 steps to farfetched. Looking back, I should have taken smaller steps in prototyping and should have realized that the project was probably too short to facilitate laboratorial results. Within the given timeframe I could have generated for value in the form of different design goals.

## 10.4 Conclusion

When I compare this project with my previous solo project, the bachelor end project, it went so much better. My planning was much better, my approach was more mature, and the result is of higher quality. Even though in this reflection I'm quite critical about myself I feel like I improved a lot. Even throughout this project. I'm happy with the result and even happier with identifying things that I can still improve upon. Sometimes I forget that everything is a learning process.

# 11. References

Aanpak Stikstof. (2022). *Vragen en antwoorden gericht opkopen van veehouderijen*. Retrieved from Aanpak Stikstof: <https://www.aanpakstikstof.nl/themas/landbouw/vragen-en-antwoorden/gericht-opkopen-van-veehouderijen>

Arnold, D. (1999). *Soil Moisture*. Retrieved from NASA Earth Science Office: <https://weather.msfc.nasa.gov/landprocess/>

Berckmans, D. (2004). *Automatic on-line monitoring of animals by precision livestock farming*. Leuven: Catholic University Leuven.

Boerenbusiness. (2015). *NIRS-techniek succesvol bevonden voor droge mest*. Retrieved from Boerenbusiness: <https://www.boerenbusiness.nl/tech/artikel/10866503/nirs-techniek-succesvol-bevonden-voor-droge-mest>

Campbell Scientific. (2022). *Turbidity*. Retrieved from Campbell Scientific: <https://www.campbellsci.com/turbidity>

CBS, & RIVM. (2019). *Stikstofdepositie*. Opgehaald van Centraal Bureau Statistiek: <https://www.cbs.nl/nl-nl/dossier/dossier-stikstof/stikstofdepositie>

Dutch dairy association. (2022). *Cattle feed*. Retrieved from Dutch dairy association: <https://www.nzo.nl/en/quality/cattle-feed/>

Dynalynx. (2022). *Dynalynx*. Retrieved from Dynalynx: <https://www.dynalynx.nl/>

EI Sensor. (2022). *What is a Thermistor?* Retrieved from EI Sensor: <https://www.ei-sensor.com/what-is-a-thermistor/>

Eurofins Laboratories. (2022). *Ultraviolet/Visible/Near Infrared Spectroscopy (UV/VIS/NIR)*. Retrieved from Eurofins Laboratories: <https://www.eag.com/techniques/spectroscopy/uv-vis-spectroscopy/>

Evangelista, C., Basiricò, L., & Bernabucci, U. (2021). *An Overview on the Use of Near Infrared Spectroscopy (NIRS)*. Viterbo: MDPI.

Farnell. (2020). *Farnell*. Retrieved from Farnell: <https://nl.farnell.com/texas-instruments/dlpnirnanoevm/eval-board-dlp2010nir-dlp-spectrometer/dp/3125557>

Fierce Electronics. (2019). *What is a Gas Sensor?* Retrieved from Fierce Electronics: <https://www.fierceelectronics.com/sensors/what-a-gas-sensor>

Global Industry Analysts Inc. (2021). *Precision Livestock Farming - Global Market Trajectory & Analytics*. Global Industry Analysts Inc.

Hakkel, K., & Petruzzella, M. (2022). *Integrated near-infrared spectral sensing*.

Hulsen, J., Aerden, D., & Rodenburg, J. (2014). *Feeding signals - A practical guide to feeding dairy cows for health and production*. Roodbont.

IBM. (2022). *Big data analytics*. Retrieved from IBM: <https://www.ibm.com/analytics/big-data-analytics>

Kay, J. (2022). *What's in a feed?* Retrieved from DairyNZ: [https://www.dairynz.co.nz/feedright-module-3/story\\_html5.html](https://www.dairynz.co.nz/feedright-module-3/story_html5.html)

Manitoba. (2015). *Properties of Manure*.

Pei, E. (2009). *Building a common language of design representations for industrial designers & engineering designers*.

Queensland Government. (2013, March). *Managing for healthy rumen function*. Retrieved from Queensland Government - Department of Agriculture and Fisheries: <https://www.daf.qld.gov.au/business-priorities/agriculture/animals/dairy/nutrition-lactating-cows/healthy-rumen-function>

Rijksoverheid. (2022). *Kan ik subsidie krijgen om mijn veehouderij te verduurzamen?* Retrieved from Rijksoverheid: <https://www.rijksoverheid.nl/onderwerpen/veehouderij/vraag-en-antwoord/kan-ik-subsidie-krijgen-om-mijn-veehouderij-te-verduurzamen>

Ritchie, H., & Roser, M. (2019, November). *Meat and Dairy Production*. Retrieved from Our world in data: <https://ourworldindata.org/meat-production>

Schooten, H. v., & Dirksen, H. (2013). *Meten van voerefficiëntie voor betere benutting eigen*

- ruwvoer*. Wageningen: Wageningen UR Livestock Research.
- Secretariat, Climate & Clean Air Coalition. (2022). Retrieved from Global Methane Pledge: <https://www.globalmethanepledge.org/>
- Sensorex. (2019, September 9). *Types of pH Sensors: What You Need to Know*. Retrieved from Sensorex: <https://sensorex.com/2019/09/09/ph-sensors-need-to-know>
- ThermoFisher Scientific. (2020). *pH measurement handbook*. ThermoFisher Scientific.
- Trent, D. (2022). *Strain Gauge Load Cell Basics*. Retrieved from Load Cell Central: <https://www.800loadcel.com/load-cell-and-strain-gauge-basics.html>
- Ulderink, D.-J. (2017). *Voerefficiëntie: het essentiële kengetal*. Laag Zuthem: Aeres Hogeschool Dronten.
- United States Department of Agriculture. (2013). *Soil Electrical Conductivity*. Retrieved from Natural Resources Conservation Service: [https://www.nrcs.usda.gov/Internet/FSE\\_DOCUMENTS/nrcs142p2\\_053280.pdf](https://www.nrcs.usda.gov/Internet/FSE_DOCUMENTS/nrcs142p2_053280.pdf)
- University of Guelph. (2022). *Total Mixed Ration (TMR)*. Retrieved from Ontario Veterinary College: [https://ovc.uoguelph.ca/ruminant\\_health\\_management/total-mixed-ration-tmr](https://ovc.uoguelph.ca/ruminant_health_management/total-mixed-ration-tmr)
- VanSaun, R., & White, R. (2020). Feed Efficiency in Lactating Cows and Relationship to Income Over Feed Costs. *Penn State*.
- Vranken, E., & Berckmans, D. (2017). Precision livestock farming for pigs. *Animal Frontiers*, 32-37.
- Wageningen university & research. (2022, February). *Methaan*. Retrieved from <https://www.wur.nl/nl/Dossiers/dossier/Methaan-1.htm>
- World Health Organization. (1996). *Total dissolved solids in Drinking-water*. Retrieved from World Health Organization: [https://www.who.int/water\\_sanitation\\_health/dwq/chemicals/tds.pdf](https://www.who.int/water_sanitation_health/dwq/chemicals/tds.pdf)
- Yan, M., Liu, K., Zhibin, G., & Xinkai, X. (2018). *Background Augmentation Generative Adversarial Networks (BAGANs): Effective Data Generation Based on GAN-Augmented 3D Synthesizing*.

# 12. Appendix

## 1. Design brief



Personal Project Brief - IDE Master Graduation

Manure monitoring at dairy farms using sensor technology. \_\_\_\_\_ project title

Please state the title of your graduation project (above) and the start date and end date (below). Keep the title compact and simple. Do not use abbreviations. The remainder of this document allows you to define and clarify your graduation project.

start date 20 - 09 - 2021 \_\_\_\_\_ 25 - 02 - 2022 \_\_\_\_\_ end date

### INTRODUCTION \*\*

Please describe, the context of your project, and address the main stakeholders (interests) within this context in a concise yet complete manner. Who are involved, what do they value and how do they currently operate within the given context? What are the main opportunities and limitations you are currently aware of (cultural- and social norms, resources (time, money,...), technology, ...).

The Netherlands has committed itself in a European context to protect nature areas against an excess of nitrogen. Earlier this year, a law was passed to ensure that nitrogen levels in 74% of the vulnerable nature areas no longer exceed the standard by 2035. Agriculture is one of the major nitrogen emitters, responsible for more than 36% of the total of the Netherlands (2019, CBS). To reach the set goal, policy changes have made farming stricter and as a result less viable. Farmers now have to take many (expensive) measures to combat emissions. Innovative smart farming solutions are used/needed to make agriculture viable again while also complying with current and future regulations.

The client for this project Lely, is a company that focuses on solutions for smart farming which they describe as: affordable, practical, safe, profitable, efficient, and sustainable. Over the last few years, they have released multiple products that help farmers to make their farm future proof.

To improve efficiency, dairy farmers monitor the inputs and outputs of their cows based on data collected by sensors. Currently the main sources for this data are the given food and information about the milk (composition and volume). This data helps the farmer make better decisions regarding animal welfare and feeding schedules. However, one of the outputs is currently not monitored, namely the manure.

The manure of the cow can contain additional nutritional information. Dairy cattle have a nutrient excretion rate of around 50 – 90% which is influenced by overfeeding. By monitoring the manure of a herd, the farmer can reduce nutrient excretion by receiving better and new feedback regarding feed efficiency. To fill this knowledge gap, currently, around every 6 weeks a feed advisor visits the farm. This consultant checks the animals and periodically analyses the manure by sending a sample to a lab. Afterwards he gives advice on how to proceed with a tailor-made feeding schedule.

On-farm manure sensors are already widely available by competitors, but not for the purpose of improving feed efficiency or animal welfare. The so-called Near Infrared (NIR) -sensor is currently used to monitor the amount of nutrition in manure at the time of spraying the land. By measuring the nutrition levels in the manure and altering the amount of manure sprayed per square meter, a higher level of efficiency can be reached.

Since Lely is already analysing milk and feeding data this offers an innovative opportunity. The monitoring of manure. Lely could develop a separate product or add a sensor to one of their current barn products. By having full access to the combined data set of the sensors, Lely can offer more tailored feedback to the farmer.

space available for images / figures on next page

IDE TU Delft - E&SA Department /// Graduation project brief & study overview /// 2018-01 v30 Page 3 of 7

Initials & Name RWH van Nieuwenhuizen Student number 4358988

Title of Project Manure monitoring at dairy farms using sensor technology.



Personal Project Brief - IDE Master Graduation

introduction (continued): space for images



image / figure 1: Farmers protesting against stricter regulations.



image / figure 2: Current Lely autonomous vehicle for feeding.

IDE TU Delft - E&SA Department /// Graduation project brief & study overview /// 2018-01 v30 Page 4 of 7

Initials & Name RWH van Nieuwenhuizen Student number 4358988

Title of Project Manure monitoring at dairy farms using sensor technology.



**PROBLEM DEFINITION \*\***

Limit and define the scope and solution space of your project to one that is manageable within one Master Graduation Project of 30 EC (= 20 full time weeks or 100 working days) and clearly indicate what issue(s) should be addressed in this project.

Farming is becoming more and more strict due to policy changes driven by environmental means. This forces farmers to innovate to keep up with current and future regulations while also staying viable. Therefore, dairy farmers are already using a lot of data from their animals to make better decisions regarding well-being and feed efficiency.

Data is available on what the cow eats (input), what the cow transforms to milk (output) but there is a gap in data on manure (output), which can be highly beneficial to the farmer. Currently the farmer makes use of a feed advisor to bridge this knowledge gap which leads to a tailor-made feeding schedule. But this consultant only comes by every 6 weeks and occasionally sends a manure sample to the lab for checking.

The farmer could benefit with more up-to-date data on the manure from his herd. He already receives feedback from the milk data through an application. Adding more information to this system could lead to better feedback. Allowing the farmer to be more efficient with feeding and looking after the welfare of his animals.

It is known that manure contains vital information regarding feed efficiency and animal welfare. But currently it is unknown on what scale this extra data can benefit the farmer. There are no comparable products that generate this data. Also, no research has been done on what can be done with manure samples from cattle herds.

**ASSIGNMENT \*\***

State in 2 or 3 sentences what you are going to research, design, create and / or generate, that will solve (part of) the issue(s) pointed out in "problem definition". Then illustrate this assignment by indicating what kind of solution you expect and / or aim to deliver, for instance: a product, a product-service combination, a strategy illustrated through product or product-service combination ideas, ... In case of a Specialisation and/or Annotation, make sure the assignment reflects this/these.

Design a product that monitors herd manure data in a barn using sensor technology and gives interpreted feedback to the farmer. To that end, investigate how, by automatically interpreting it and allowing interaction with it, manure data can enable the farmer to have more control over farm efficiency both financially and ecologically.

A possible outcome of the project could be a product service combination. For instance, a device that is placed in an existing dump put at the farm that has sensors to collect periodical manure data. This device must be able to collect and create samples and analyse these. The data from the sensors is then interpreted by using analytics and converted into real-time usable feedback for the farmer.

The farmer will use an app where he can find this data and its interpretation. The service with the app will create more useful interpretations over time as Lely learns more about data patterns of dairy farms. Namely by collecting large amounts of data on cows Lely will get a better understanding of how to optimize for feed efficiency.



**PLANNING AND APPROACH \*\***

Include a Gantt Chart (replace the example below - more examples can be found in Manual 2) that shows the different phases of your project, deliverables you have in mind, meetings, and how you plan to spend your time. Please note that all activities should fit within the given net time of 30 EC = 20 full time weeks or 100 working days, and your planning should include a kick-off meeting, mid-term meeting, green light meeting and graduation ceremony. Illustrate your Gantt Chart by, for instance, explaining your approach, and please indicate periods of part-time activities and/or periods of not spending time on your graduation project, if any, for instance because of holidays or parallel activities.

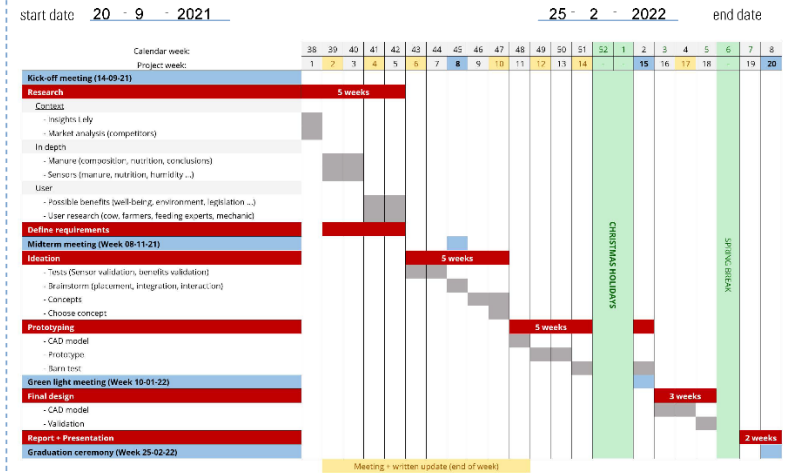

This project will start with in-depth research into the context and some important topics such as manure composition and sensor types. Before moving to the ideation, the following research questions should be answered:

- What type of data can be beneficial for the farmer?
- What type of data can be measured? What kind of sensor(s) should be used?
- How will this data be measured?
- How will this data be converted to feedback for the farmer?
- What is the expected effect of the feedback?
- How will the farmer interact with this feedback/data?

These questions will be answered using a combination of literature research, user research and the use of experts. With the help of literature and experts a global comprehension of manure and it's monitor capabilities/benefits will be determined. User research will help with determining how the farmer will interact with this data. Finally a calculation will be made with an estimate on the expected effect of this project.

Then it will move on to ideation which will be presented at the mid-term presentation so that a good discussion can be held. Multiple concepts of product-service combinations will be created which the farmer can use to gain useful feedback. The concepts should provide a global description of the sensors used and a data-processing pipeline. When the final concept is chosen, it's very important to start quickly on validating the sensor. Especially since a prototype will be built using this sensor so that interpretation of real results can be validated. At the green light meeting the last results of the prototype testing will be shown and afterwards there will be started on the final design, integrating all requirements.



## Personal Project Brief - IDE Master Graduation

### MOTIVATION AND PERSONAL AMBITIONS

Explain why you set up this project, what competences you want to prove and learn. For example: acquired competences from your MSc programme, the elective semester, extra-curricular activities (etc.) and point out the competences you have yet developed. Optionally, describe which personal learning ambitions you explicitly want to address in this project, on top of the learning objectives of the Graduation Project, such as: in depth knowledge a on specific subject, broadening your competences or experimenting with a specific tool and/or methodology, ... . Stick to no more than five ambitions.

2 years ago, for the course AED (advanced embodiment design) I already did a project for Lely and really liked the subject of automation in the agriculture sector. It's an innovative sector where there is still lots to discover. A lot of farmers really like technology and innovative solutions which for me makes it very compelling. They make use of drones to scan their crops and even use autonomous vehicles to work their land.

This kind of project also really fits my strengths and weaknesses, I enjoy embodiment design, but I generally dislike fuzzy front-end design. Within this project I can focus more on prototyping, embodiment design and electronics while leaving enough time to do research as well. I'm really looking forward to making an Arduino prototype to test in a real barn environment.

The love for a hands-on approach can also be seen in my various previous university projects. My design-cycle often consists of ideation, test/prototype, reflect and repeat. This gives me the ability to come up with fast and valid results especially in the embodiment design phase. Something I would like to improve upon by using better methods that fit this approach.

A big interested that I have as well is programming, I've done web design, app development and hardware projects. In the past this has helped me a lot with prototyping and to understand projects where hardware and software are combined. Something that can help me with this project as well.

In the same way the topic of big data interests me as well, collecting all this sensor data and seeing what sort of conclusions can be made from that. Can pattern recognition be used to find abnormalities in the data for instance? I have never done big data analyses before, but I hope to learn some of that in this project if I have the time. I have done the minor Software and did some AI programming that I might be able to use for this.

### FINAL COMMENTS

In case your project brief needs final comments, please add any information you think is relevant.

## 2. Livestock nutrient requirements

% fat % protein kg milk	3,50 3,03		3,75 3,18		4,00 3,32		4,25 3,45		4,50 3,60		4,75 3,75		5,00 3,88	
	VEM	DVE	VEM	DVE	VEM	DVE	VEM	DVE	VEM	DVE	VEM	DVE	VEM	DVE
1	5730	160	5750	160	5760	170	5780	170	5800	170	5810	170	5830	170
2	6140	200	6170	210	6210	210	6240	220	6270	220	6310	220	6340	230
3	6550	250	6600	250	6650	260	6700	270	6750	270	6800	280	6850	280
4	6960	290	7030	300	7100	310	7160	320	7230	320	7300	330	7360	340
5	7370	340	7460	350	7540	360	7620	370	7710	380	7790	390	7880	400
6	7790	380	7890	390	7990	410	8090	420	8190	430	8290	440	8390	450
7	8200	420	8320	440	8440	450	8560	470	8680	480	8800	500	8910	510
8	8620	470	8760	490	8890	500	9020	520	9160	540	9300	560	9430	570
9	9040	510	9190	530	9340	550	9490	570	9650	590	9800	610	9960	630
10	9460	560	9630	580	9800	600	9970	620	10140	650	10310	670	10480	690
12	10300	650	10500	680	10710	710	10910	730	11120	760	11330	790	11530	810
14	11140	750	11390	780	11630	810	11870	840	12110	870	12360	910	12600	940
16	11990	840	12280	880	12550	920	12830	950	13110	990	13390	1030	13670	1060
18	12850	940	13170	980	13480	1020	13790	1060	14110	1110	14430	1150	14740	1190
20	13710	1040	14070	1090	14420	1130	14760	1180	15120	1230	15480	1280	15830	1320
22	14580	1140	14970	1190	15360	1240	15740	1290	16140	1350	16540	1400	16920	1450
24	15450	1240	15880	1300	16310	1360	16730	1410	17160	1470	17600	1530	18020	1590
26	16330	1340	16800	1410	17260	1470	17720	1530	18190	1600	18670	1670	19130	1730
28	17210	1440	17720	1520	18220	1590	18720	1650	19230	1720	19750	1800	20250	1870
30	18090	1550	18640	1630	19180	1700	19720	1770	20270	1850	20830	1940	21370	2010
32	18980	1660	19570	1740	20160	1820	20730	1900	21320	1990	21920	2080	22500	2150
34	19880	1760	20510	1860	21130	1940	21750	2030	22380	2120	23020	2220	23640	2300
36	20780	1870	21450	1970	22110	2070	22770	2150	23450	2260	24130	2360	-	-
38	21690	1990	22400	2090	23100	2190	23800	2280	24520	2390	25240	2500	-	-
40	22600	2100	23350	2210	24100	2320	24830	2420	25590	2530	-	-	-	-
42	23520	2210	24310	2330	25100	2440	25870	2550	26680	2680	-	-	-	-
44	24440	2330	25270	2450	26100	2570	26920	2690	-	-	-	-	-	-
46	25360	2440	26240	2580	27110	2710	27970	2830	-	-	-	-	-	-
48	26290	2560	27220	2700	28130	2840	-	-	-	-	-	-	-	-
50	27230	2680	28200	2830	29150	2970	-	-	-	-	-	-	-	-

Norms for the feed requirement of dairy cattle in barn feeding.

Body weight: 650 kg.

The stated units: FUM/day (Energy requirement: feed unit milk), g DVE/day (Intestinal

Digestible Protein) and kg milk/day

### 3. Interview questions

#### Eigen bedrijf

- Kan je wat vertellen over jezelf?
  - Hoe lang in het vak?
  - Hoe ben je in het vak terecht gekomen?
  - Passies
- Kan je wat vertellen over je eigen bedrijf?
  - Hoe ziet boerderij eruit?
    - Aantal koeien?
- Welke producten gebruik je?
  - Lely, andere leveranciers
  - Lely testboerderij
    - Interesse in technologie en innovatie?

#### Voeren

- Hoe werkt het voeren nu op jouw bedrijf?
  - Automatisch
  - Voerbox
  - Melkrobot
- Doe je zelf rantsoenberekeningen?
- Welke gegevens geef je daarvoor door?
- Wat voor aanpassingen maak je aan het rantsoen en hoe vaak?

#### Voedingsadviseur

- Hoe vaak komt er een voedingsadviseur langs?
- Hoe gaat die adviseur te werk?
  - Mestzeef
  - Voelen, ruiken, zicht
  - Laboratorium
    - Graskuil
    - Mest

- Is hij onafhankelijk of van een voedingsleverancier?
- Wat is je ervaring hiermee?
  - Teveel duur voer?

#### Voerefficiëntie

- Wat weet je van voerefficiëntie optimalisatie?
- Welke informatie gebruik om je voer efficiëntie te verbeteren?
  - Melkdata?
  - Voedingsdata?
    - Compositie
  - Uiterlijk/gedrag koe
  - Mest?
- Hoe gebruik je deze informatie? Kan je deze zelf interpreteren?
  - Voedingstabellen?

#### Kosten baten

- In hoeverre stuur je hierop ten opzichte van voer efficiëntie?
  - Goedkoop over
    - Minder melk
- Houd je bij hoeveel elke soort voer je kost?
  - Wat reken je voor gras?
- Reken je dit uit per koe?

#### Mest

- Houd je zelf de mest in de gaten?
  - Individueel?
  - Groepsniveau?
- Waar let je op bij de mest?
- Wat doe je met die informatie?

#### Metten aan mest

- Welke parameters zou jij interessant vinden?
  - PH waarde

- (Ruw) Eiwit
- Zetmeel
- Vezels
  - NDF
  - ADF
- Droge stof
- Organische stof
- Suikers
- Groepsniveau of individueel?
- Zou een voerefficiëntie verbetering van 0.1 realistisch lijken voor jou door meer gegevens te hebben over de mest?
  - Er is nu geen controle of de rantsoenberekeningen ook daadwerkelijk kloppen.

#### Feedback

- Waar verwacht je eventueel op te kunnen besparen door middel van mest metingen?
  - Duur voer?
- Wat voor feedback zou je verwachten van mest metingen?
  - Data stream, parameters
    - Grafieken
    - Rapport
  - Terugkoppeling naar voedingsexpert
  - Rantsoen aanpassingen
  - Feedback automatisch verwerkt



## 4. Basic regression: Predict manure composition

### Initialize modules

```
from datetime import datetime
import matplotlib.pyplot as plt
import numpy as np
import pandas as pd
```

```
# Make NumPy printouts easier to read.
```

```
np.set_printoptions(precision=3, suppress=True)
pd.set_option('display.max_columns', None)
```

```
import tensorflow as tf
```

```
from tensorflow import keras
from tensorflow.keras import layers
```

Set labels to remove and select label to train for.

```
targets = ["N", "P", "K"]
selected = "N"
epochs = 100
```

### Get data

Import data from data.csv in root directory.

```
path = './data.csv'
column_names = ["902", "907", "912", "918", "923", "928", "933", "938", "945", "950", "955", "960", "966", "971", "976", "982", "987", "993", "998", "1003", "1008", "1013", "1018", "1024", "1029", "1034", "1040", "1045", "1050", "1055", "1061", "1066", "1071", "1076", "1081", "1086", "1091", "1096", "1102", "1107", "1112", "1117", "1122", "1127", "1132", "1138", "1143", "1147", "1152", "1157", "1162", "1167", "1172", "1178", "1183", "1187", "1192", "1197", "1202", "1207", "1213", "1217", "1222", "1227", "1232", "1236", "1241", "1246", "1252", "1256", "1261", "1266", "1270", "1275", "1280", "1286", "1290", "1295", "1300", "1304", "1309", "1313", "1318", "1324", "1328", "1333", "
```

```
1337", "1342", "1347", "1351", "1357", "1361", "1366", "1370", "1375", "1379", "1384", "1388", "1394", "1398", "1403", "1407", "1412", "1416", "1421", "1426", "1431", "1435", "1439", "1444", "1448", "1453", "1457", "1462", "1467", "1471", "1475", "1480", "1484", "1488", "1493", "1498", "1502", "1507", "1511", "1515", "1519", "1524", "1529", "1533", "1537", "1542", "1546", "1550", "1554", "1558", "1564", "1568", "1572", "1576", "1580", "1584", "1588", "1594", "1598", "1602", "1606", "1610", "1614", "1618", "1622", "1627", "1631", "1635", "1639", "1643", "1647", "1652", "1657", "1660", "1664", "1668", "1672", "1676", "1680", "1684", "1689", "1693", "1697", "1701"] + targets
```

```
dataset = pd.read_csv(path, index_col=0, names=column_names, sep=';')
dataset.tail()
```

### Split the data into training and test sets

```
train_dataset = dataset.sample(frac=0.9, random_state=0)
test_dataset = dataset[train_dataset.shape[0]:]
print(f"Training Dataset: {train_dataset.shape[0]} items\nTest Dataset: {test_dataset.shape[0]} items")
```

Training Dataset: 9 items

Test Dataset: 1 items

### Split features from labels

Separate the target value—the "label"—from the features. This label is the value that you will train the model to predict.

```
train_features = train_dataset.copy()
test_features = test_dataset.copy()
```

```
for target in targets:
    if target == selected:
        train_labels = train_features.pop(selected)
        test_labels = test_features.pop(selected)
    else:
```

```
train_features.pop(target)
test_features.pop(target)
```

### Inspect the data

```
train_dataset.describe()
```

### Plot absorbance spectra

```
fig, axes = plt.subplots(ncols=2, figsize=(16, 5), sharey=True)
train_features.transpose().plot(ax=axes[0], title="Absorption Spectra (Training Data)", xlabel="Wavelength (nm)", ylabel="Absorbance", legend=False)
test_features.transpose().plot(ax=axes[1], title="Absorption Spectra (Test Data)", xlabel="Wavelength (nm)", ylabel="Absorbance", legend=False)
```

```
<AxesSubplot:title={'center': 'Absorption Spectra (Test Data)'}>
```

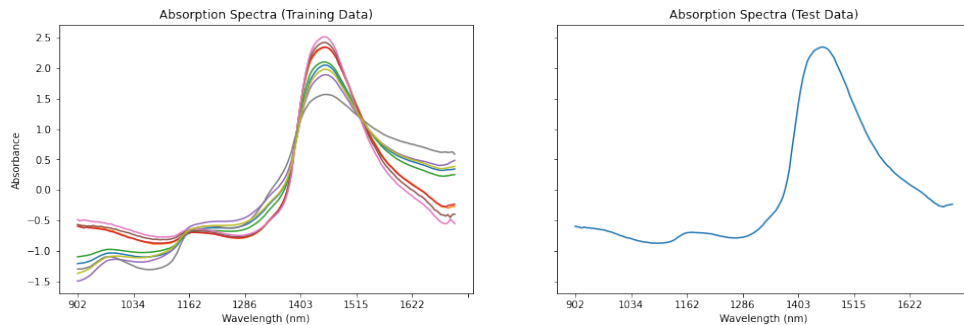

## Normalization

In the table of statistics it's easy to see how different the ranges of each feature are:

```
train_features.describe().loc[['mean', 'std']]
```

## The Normalization layer

The `tf.keras.layers.Normalization` is a clean and simple way to add feature normalization into your model.

The first step is to create the layer:

```
normalizer = tf.keras.layers.Normalization(axis=-1)
```

Then, fit the state of the preprocessing layer to the data by calling `Normalization.adapt()`:

```
normalizer.adapt(np.array(train_features))
```

When the layer is called, it returns the input data, with each feature independently normalized:

```
normalized = pd.DataFrame(data=normalizer(train_features[0:2]).numpy(), columns=train_features.columns)
```

```
fig, axes = plt.subplots(ncols=2, figsize=(16, 5), sharey=True)
train_features[0:2].transpose().plot(ax=axes[0], title="Absorption Spectra (Training Data)", xlabel="Wavelength (nm)", ylabel="Absorbance", legend=False)
normalized.transpose().plot(ax=axes[1], title="Absorption Spectra (Normalized)", xlabel="Wavelength (nm)", ylabel="Absorbance", legend=False)
```

```
<AxesSubplot:title={'center': 'Absorption Spectra (Normalized)'}>
```

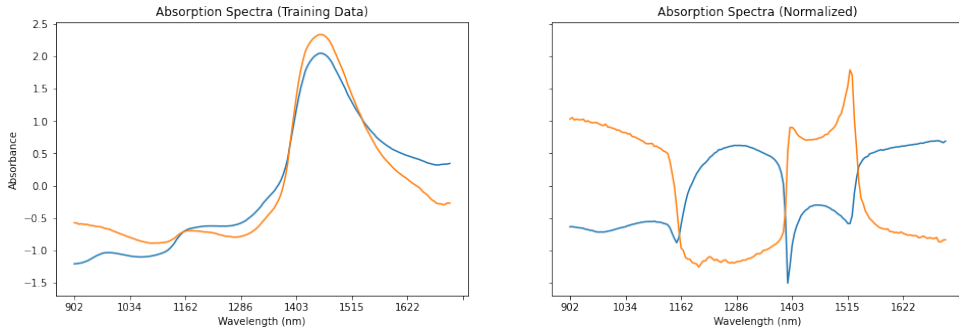

## Regression with a deep neural network (DNN)

### Regression using a DNN and multiple inputs

```

model = keras.Sequential([
    normalizer,
    layers.Dense(64, activation='relu'),
    layers.Dense(32, activation='relu'),
    layers.Dense(1)
])

model.compile(loss='mean_absolute_error',
              optimizer=tf.keras.optimizers.Adam(0.001))

model.summary()

Model: "sequential_3"
    
```

Layer #	(type)	Output Shape	Param
normalization_3	(Normalizat	(None, 170)	341
dense_9	(Dense)	(None, 64)	10944

dense_10	(Dense)	(None, 32)	2080
dense_11	(Dense)	(None, 1)	33

---

=====  
=====  
Total params: 13,398  
Trainable params: 13,057  
Non-trainable params: 341

---

Init TensorBoard for visualization.

```

logdir="logs/fit/" + datetime.now().strftime("%Y%m%d-%H%M%S"
)
callback = keras.callbacks.TensorBoard(
    log_dir=logdir, histogram_freq=1)

%%time
history = model.fit(
    train_features,
    train_labels,
    validation_data=[test_features, test_labels],
    verbose=0, epochs=epochs,
    callbacks=[callback])

CPU times: total: 8.36 s
Wall time: 8.89 s

plt.plot(history.history['loss'], label='Loss')
plt.plot(history.history['val_loss'], label='Validation Loss')
plt.xlim([0, epochs])
plt.xlabel('Epoch')
plt.ylabel(f'Error [{selected}]')
plt.legend()
plt.grid(True)
    
```

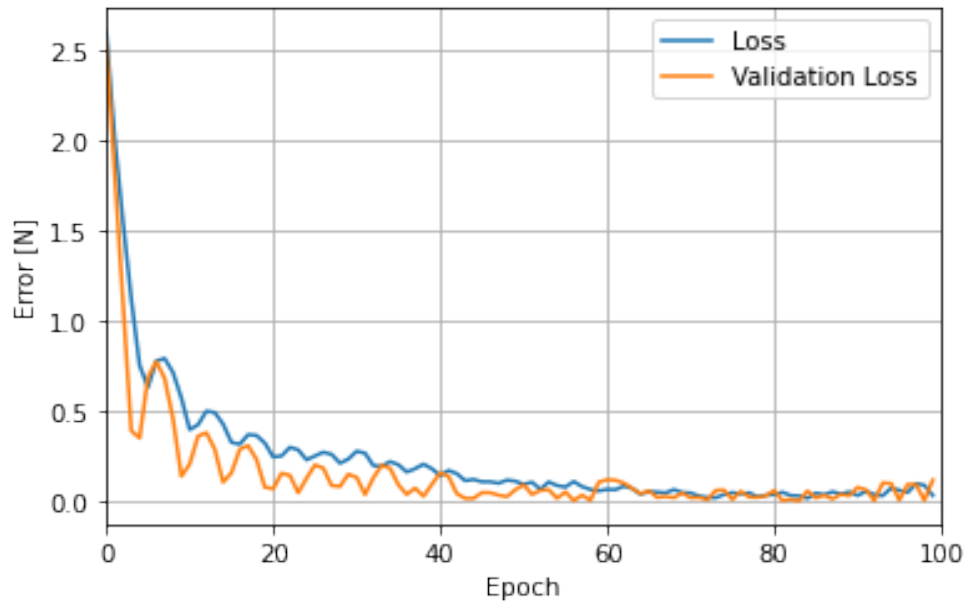

### Performance

```
test_results = {}
test_results['Training Data'] = model.evaluate(train_features,
train_labels, verbose=0)
test_results['Validation Data'] = model.evaluate(test_features,
test_labels, verbose=0)
```

```
pd.DataFrame(test_results, index=[f'Mean absolute error [{selected}]']).T
```

	Mean absolute error [N]
Training Data	0.07817
Validation Data	0.11677

### Make predictions

```
test_predictions = model.predict(test_features).flatten()
```

```
plt.axes(aspect='equal')
plt.scatter(test_labels, test_predictions)
```

```
plt.xlabel(f'True Values [{selected}]')
plt.ylabel(f'Predictions [{selected}]')
lims = [0, 5]
plt.xlim(lims)
plt.ylim(lims)
plt.plot(lims, lims)
```

```
[<matplotlib.lines.Line2D at 0x208b2326580>]
```

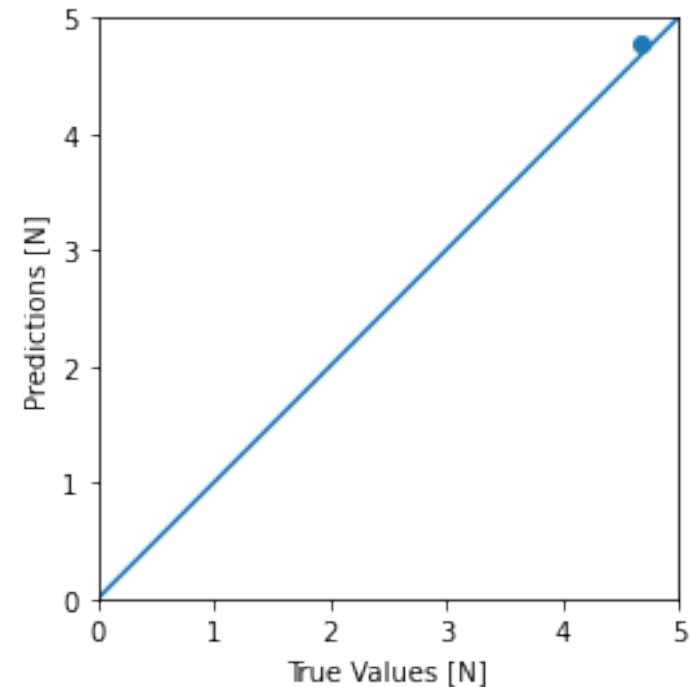

```
error = test_predictions - test_labels
plt.hist(error, bins=25)
plt.xlabel(f'Prediction Error [{selected}]')
plt.ylabel('Count')
```

```
Text(0, 0.5, 'Count')
```

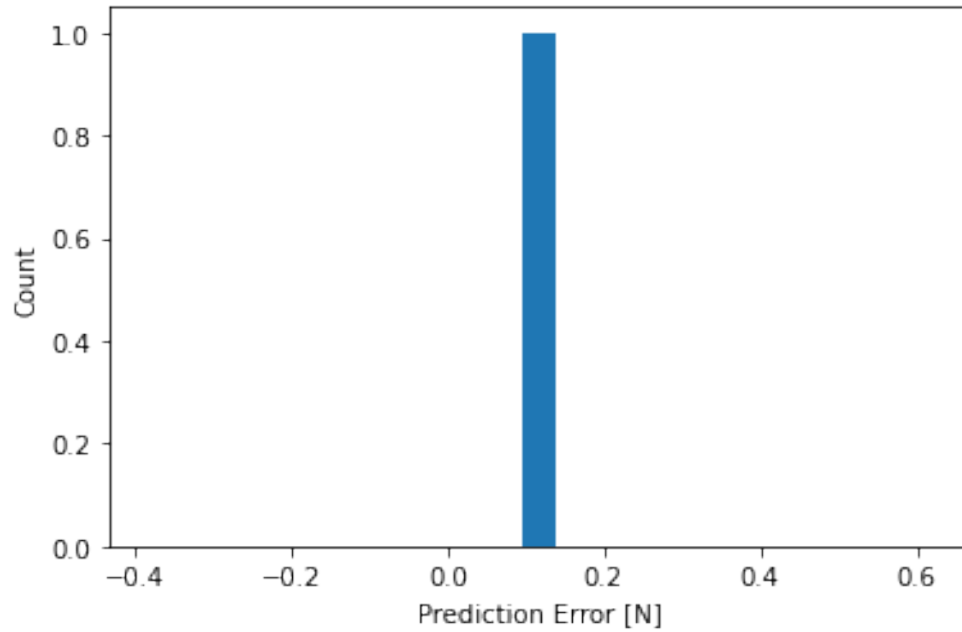

If you're happy with the model, save it for later use with `Model.save`:

```
save = input("Do you want to save this model (yes)?")
if save == "yes":
    model.save(f'Model {selected} - {datetime.now().strftime(
me("%d-%m-%y - %H%M"))}')')
```

## 5. Arduino code for test setup

```

byte relaisPin = 8;
byte switchPin = 5;
byte ledPin = 13;
int before = 1000;
int timer = 8000;
bool previous = LOW;

void setup() {
  pinMode(relaisPin, OUTPUT);
  pinMode(switchPin, INPUT_PULLUP);
  pinMode(ledPin, OUTPUT);
}

void loop() {
  if (!digitalRead(switchPin) && previous == LOW)
  {
    int var = 0;
    while (var < before && !digitalRead(switchPin)) {
      delay(10);
      var++;
    }

    if (!digitalRead(switchPin)) {
      digitalWrite(relaisPin, HIGH);
      delay(100);
      digitalWrite(relaisPin, LOW);
      digitalWrite(ledPin, HIGH);

      var = 0;
      while (var < timer && !digitalRead(switchPin)) {
        delay(10);
        var++;
      }

      digitalWrite(relaisPin, HIGH);
      delay(100);
      digitalWrite(relaisPin, LOW);
      digitalWrite(ledPin, LOW);
    }
  }
  previous = !digitalRead(switchPin);
}

```

6. Cost calculation

# Cost Estimate Report

Cost Model: EQAG

BOM	
BOM Name	
Company Part Number	MM_SENSOR_MOUNT_ASSEMBLY
Description	mm_sensor_mount_assembly
Organization	INTERNAL ROOT
Organization ID	DUNS1
Revision	-
Saved BOM Version	
BOM Source	Windchill PDMLink

Cost Status	
Cost Rollup Estimate	€148,02
Target Cost	€0,00
Cost Estimate Status	NO DATA
Deviation	
Difference	
Cost Estimate Confidence	84
Part Cost	€148,02
Cost to Assemble	€0,00
Cost Hierarchy	EQAG

PRESENTATIE SHEET	
Guess	€ 7
Quoted	€ 0
Calculated	€ 140
ERP	€ 1
Confidence level	84%
Total	€ 148

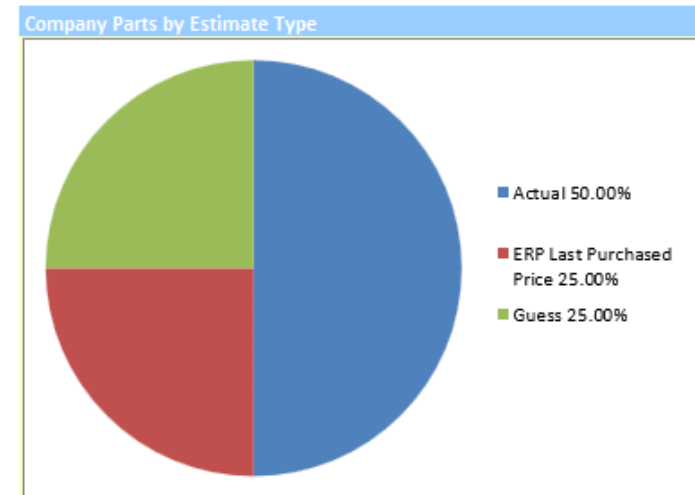
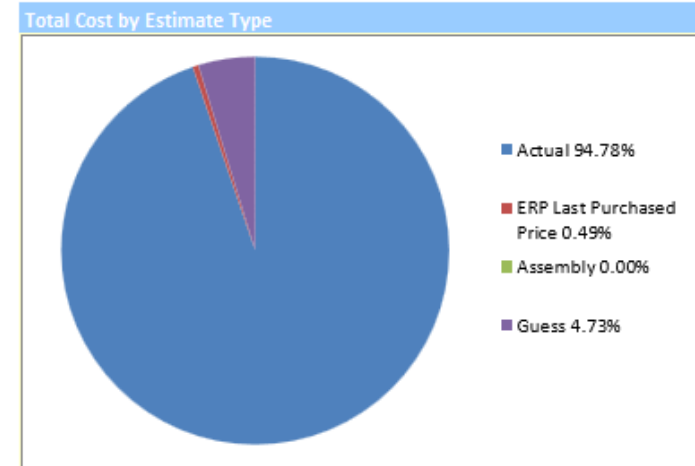

## Structured BOM

Level	Part Number	Name	Quantity	Unit	Part Cost	Cost To Assemble	Total Cost
							€148,0
1,00	MM_SENSOR_MOUNT_ASSEMBLY	mm_sensor_mount_assembly	1,00	each			2
2,00	9-1036-0046-2	9.1036.0046.2	10,00	each	€0,30		€3,00
2,00	9-1057-0074-3	9.1057.0074.3	6,00	each	€0,06		€0,34
2,00	9-1113-0174-5	9.1113.0174.5	8,00	each	€0,05		€0,39
2,00	9-1114-SL-0	9.1114.SL.0	4,00	each	€1,00		€4,00
2,00	MM_BRACKET_LEFT_01	mm_bracket_left_01	1,00	each	€20,57		€20,57
2,00	MM_BRACKET_RIGHT_01	mm_bracket_right_01	1,00	each	€20,57		€20,57
2,00	MM_FUNNEL_01	mm_funnel_01	1,00	each	€75,65		€75,65
2,00	MM_SENSOR_ADAPTER_ASSEMBLY	mm_sensor_adapter_assembly	1,00	each	€23,50		€23,50
3,00	MM_SENSOR_ADAPTER_01	mm_sensor_adapter_01	2,00	each			€0,00
3,00	MM_SENSOR_ADAPTER_PIPE_01	mm_sensor_adapter_pipe_01	1,00	each			€0,00

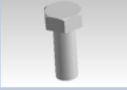

Company Part Filter

Title	Description CAD	Picture	Confidence level	Estimate Type	Quantity	Unit	Target Cost	Cost Estimate	Difference	Total Cost	Date Modified
BOLT	M 8 x 20 DIN933-A2-2 S/S		100%	ERP Last Purchased Price	8,00	EA		€0,05		€0,39	23-1-2022
SOCKET HEAD SCREW	M 8 x 16 DIN912-A2 S/S		100%	ERP Last Purchased Price	6,00	EA		€0,06		€0,34	22-1-2022
			85%	Actual	1,00	EA	€20,57	€20,57	€0,00	€20,57	12-4-2022
			85%	Actual	1,00	EA	€75,65	€75,65	€0,00	€75,65	12-4-2022
			85%	Actual	1,00		€23,50	€23,50	€0,00	€23,50	12-4-2022
		x	85%	Actual	1,00	EA	€20,57	€20,57	€0,00	€20,57	12-4-2022
NUT	WELD, M8 DIN929 S/S-A4		70%	Guess	10,00	EA		€0,30		€3,00	12-4-2022
BOLT	FIXANKER , M10x90		70%	Guess	4,00	EA		€1,00		€4,00	15-12-2020









7. Feedback dashboard ideation

HEALTH DASHBOARD

HEALTH

RATION

BUSINESS

ECO

OPERATION

### ATTENTION NEEDED

Date	Message	<input type="checkbox"/>
01-02-2022	Cow 4 - abnormal low activity levels	<input type="checkbox"/>
29-01-2022	Cow 8 - breeding status has changed to in heat	<input type="checkbox"/>
24-01-2022	Cow 124 - milk production is below expected	<input type="checkbox"/>

### DIETARY REFERENCE INTAKE

Component	Current Intake (kg/day)	Reference Intake (kg/day)
Dry Matter	~18	~22
Energy	~12	~15
Protein	~10	~8
Fibre	~15	~18
Minerals	~5	~4

### COW LIST

Number	Age	Weight	Breeding	Milk	Rumen	Activity
1	6,7y	574kg	open	31,78L	healthy	healthy
2	8,0y	653kg	open	31,78L	healthy	healthy
3	10,0y	608kg	open	31,78L	healthy	healthy
4	4,3y	551kg	open	31,78L	healthy	unhealthy
5	2,6y	655kg	open	31,78L	healthy	healthy
6	1,8y	567kg	open	31,78L	healthy	healthy
7	5,9y	659kg	open	31,78L	healthy	healthy
8	3,5y	681kg	in heat	31,78L	healthy	healthy
9	7,2y	603kg	open	31,78L	healthy	healthy
10	6,1y	569kg	open	31,78L	healthy	healthy
11	3,2y	629kg	pregnant	31,78L	healthy	healthy
12	4,9y	612kg	open	31,78L	healthy	healthy
13	5,2y	673kg	open	31,78L	healthy	healthy
14	7,4y	617kg	open	31,78L	healthy	healthy

