

APPENDIX

SNIFFTRAIL

The new way of interaction with your senior dog
by implying nose work and impulse control training

Master thesis
Heidi Sunjoo Lee

Appendix A. Symptoms of the senior dogs' aging	4
Appendix B. Brain Storming	6
Appendix C. How-To's	7
Appendix D. Result of Survey	10
Appendix E. Three examples of nose work	12
Appendix F. Prototype testing with senior dogs	13
Appendix G. Prototype proposal for AMFI student	14
Appendix H. Manufacturing steps	18
Appendix I. Evaluation Instruction	23
Appendix J. Result of Evaluation	27

Appendix A. Symptoms of the senior dogs' aging

Most of information is from a book 'The original dog bible' (Mehus-Roe, 2009).

- Physical Changing

Hearing : Some dogs experience hearing loss when getting older. Generally hearing loss is serious before the owner notices this issue since slight hearing loss is hard to evaluate with dogs. The symptoms that can show hearing loss are when the dog was unaware of a person's approach, startled when touched, inherently reacted, or the dog is no longer obeying commands (Mehus-Roe, 2009). Some interaction with the dog such as hand gestures, clapping hands, stomping and light signal can help reduce the effects.

Vision : Cataracts are common in older dogs. A study found out that 60 percent of senior dogs having cataracts(Puotinen, 2002). According to the conducted study, dogs have lost up to about 80 percent of their eyesight easily trick their owners into thinking their dog can still see like when they are young. It is only when that last 20 percent of vision starts to go in both eyes that owners mostly realize their dog is losing sight. (Colitz, McCalla & Mejia-Fava, n.d.)

Hair : Both muzzle and facial hair begin to turn to gray, while their hair coat become thin, white and dull. However, this can be a sign of disease or nutritional insufficiency too. Fatty acid supplements can help repair some of the cuticles of the coat. Older dogs need to get groomed more often than the younger dogs, with particular attention to the anal area for hygiene. Grooming is a good opportunity to do a body-check on older dogs.

Skin : The skin of older dogs becomes thinner, and is more prone to injury. Some older dogs have multiple non aggressive tumors on the skin, which do not need to be removed unless easily traumatized. Sometimes, cancerous tumors occur on the skin. Dry skin is also a common problem for older dogs.

Joint : Aging dogs need extra care to prevent worsening of their joints. The functionality of joints can be improved with proper nutritional supplements, fatty acids, and supportive remedies, such as mild exercise and muscle training help dogs. However, arthritis is a common phenomenon with older dogs. Arthritis for dogs in general cause slight stiffness, but can worsen and reduce their mobility. For instance, dogs can have difficulty going up and down stairs, jumping, or walking.

Intervertebral disc disease (IVDD): Inter vertebral disc disease (IVDD)(also known as "slipped disc"), gives dogs intolerable pain and often cause strong immobility. In the beginning, signs that a dog is bothered by IVDD can be subtle. The symptoms are such as a hesitation about going up or down stairs, nail disarrange, an arched back, or a tense belly. IVDD causes compression of the spinal cord and leads to debility (Mehus-Roe, 2009), pain and can cause paralysis. Senior dogs often get IVDD because of gravity, or wrong posture.

Organs : When dogs are getting older, not only their immune system is getting weaker, but also their organs. For instance, decreasing heart, kidney, an liver function, reduced lung capacity, urinary incontinence, and prostrate enlargement, are common problems.

Nutrition : *"In general, their maintenance energy requirement decreases by about 20%. Because their activity usually decreases as well, their energy needs are decreased by another 10-20%."*(Zorn, 2013). Dogs become less sharp, and metabolism will slow down. Therefore they gain weight in their senior age. The senior dog may eat less and sleep more than he has at other times of his life. Changing the diet, such as more natural foods, and giving smaller portions will relieve their digestive system and assure an absorption of nutrients.

Dental care : As the dog ages, they easily accumulate plaque. Chewing on dry food, like bones or chew-able treats, can be a way for slowing this process down.

- Behavioral changing

Disorientation : When a dog its body condition changes, their behavior will change too. Movement of senior dogs is getting slower due to a decline in their oxygen-carrying capacity. At this staged, instead of an active game, they are more comfortable with a relaxed ramble. However, even their physical capabilities decrease, senior dogs still appreciate to play with their owners. It is important to monitor the amount of exercise so it fits your dog.

Sleep cycle : The sleep cycle is mostly normal with aging dogs. However, sensory changes, such as hearing or eyesight loss, affect the dog's depth of sleep. Cognitive dysfunction or other types of central nervous system disorders and medicines for that disease also can affect dog's sleep cycle.

Social behavior: Some dogs change their social relationships with human and other animals as they are getting old. Some dogs may become more tenacious and overly dependent, while others become less interested in friendship or interaction in general.

Cognitive dysfunction : Some behavior proves cognitive dysfunction; a change in interactivene, elimination, or navigational practices, and attendant with aging. In the 1990s, conducted studies identified brain changes in older dogs were similar to brain changes shown in human patients with Alzheimer's disease. Moreover, the study was performed to detect learning and memory shortage in older dogs. Recently these studies have processed on even for younger dogs to understand the influence of aging on the brain of the dogs entirely(Overall, 2002).

- Mental Changing

Anxiety : *"13 of the 26 dogs, ten years or older, were diagnosed with separation anxiety."* (Overall, 2013) Anxiety disorders increase with age. Separation anxiety is one of the most common examples of an anxiety disorder that increases as cognitive function diminish (or with dementia). Cognitive changes associated with age can also be signs of separation anxiety. Behavioral changes related to anxiety are common with older dogs.

Phobia : Changing body conditions, sensory decline, cognitive dysfunction, and anxiety can advance to fears and phobias. Some older dogs suffer from fears and phobias of noise, going outdoors, entering certain areas or certain types of surfaces.

Aggression : An increase in the dog its aggressive behavior comes from a variety of factors, such as appetite, (in)mobility, cognition, senses, pain, etc. These factors can all lead to increased aggression. Aggression to other animals can happen when an older dog becomes weaker or less confident, or it can arise from the dog its anxiety or sensitivity as he ages. (Web MD, n.d.)

Self-esteem : With body malfunction, the senior dog its Self-esteem will change too. When they face their body condition is worsening, they often get nervous and intimidated. When they get a low self-esteem, their emotions may move to a state of dormancy or depression.

Appendix B. Brain Storming

coggle

made for free at coggle.it

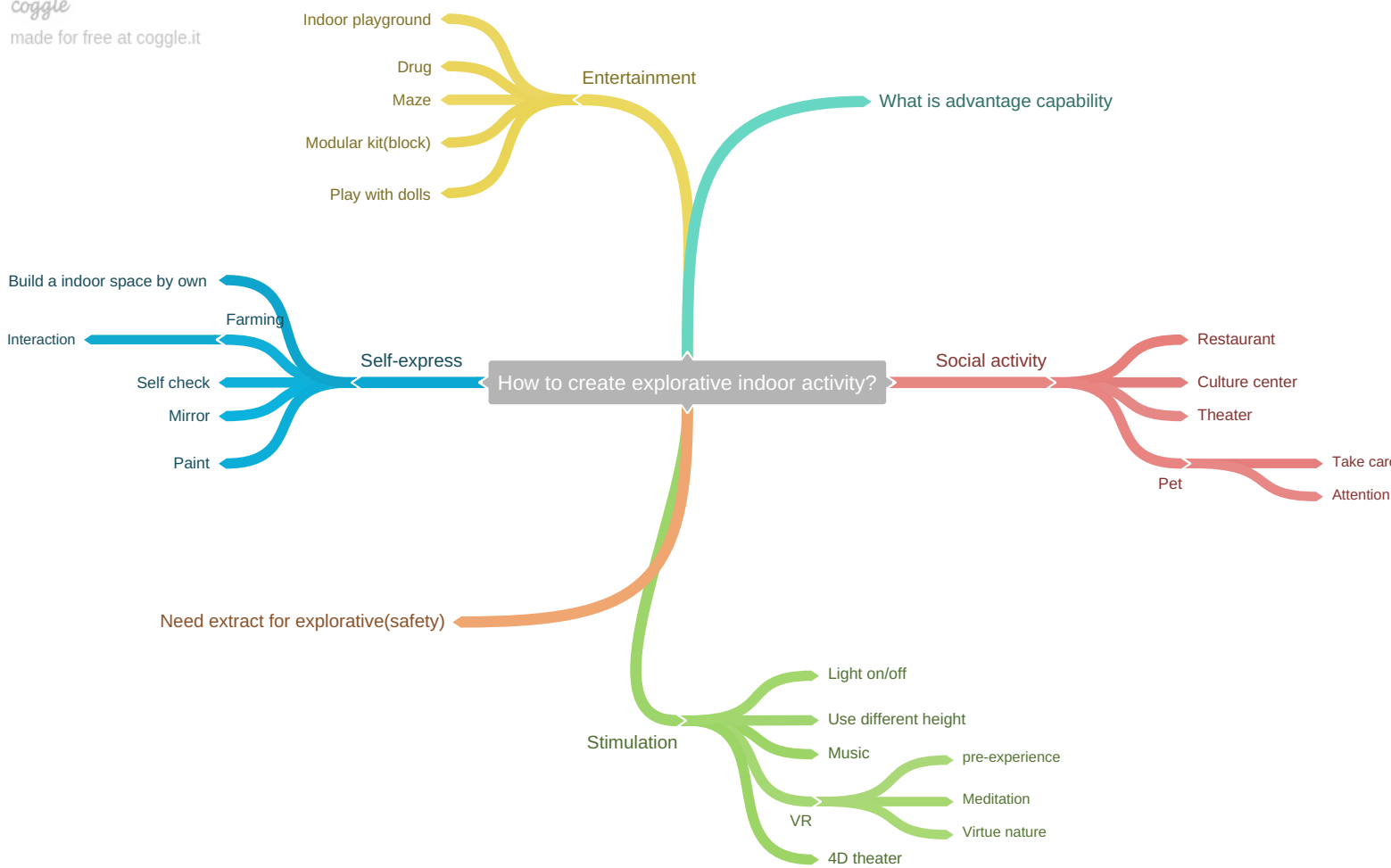

Appendix C. How-To's

HOW-TO'S; THE SENIOR DOG

How-To's Questions	Answers
How to make them feel relief?	<ul style="list-style-type: none"> Achievement Set a goal Co-creation Forgetting/distracting Automation Warm hug
How to make them feel pride about themselves?	<ul style="list-style-type: none"> Compliment Reward/prize/treat Achieve Need more scientific research
How to inspire senior dogs?	<ul style="list-style-type: none"> New input Challenge Stimulation(smell/touch/taste) Extra trigger for hearing and sight (Since they are losing it) Faith Support what they can't do any anymore (climbing
How to make them feel secure?	<ul style="list-style-type: none"> Voice/touch/smell/familiar sense of owner/house/object/ place/trimming Ritual Habit
How to make them feel related?	<ul style="list-style-type: none"> Eat together Talk(communicate) Same fashion style Do activity together(traveling, walk, etc)
How to make senior dogs excited?	<ul style="list-style-type: none"> Ball Doll Treat/cooking Friend/Family Walking
How to increase their cognition?	<ul style="list-style-type: none"> New delicious treat(Fresh, Home made) Sensory challenge Physical support
How to protect their instinct?	<ul style="list-style-type: none"> Avoid humanization Interact with other dog(socialize) Watch animal behavior Natural environment

HOW-TO'S; THE OWNERS

How-To's Questions	Answers
How to show their love to dog?	Treat Hug/kiss/pat Attention(positive) Walk/activities Stay together
How to support their senior dog?	Buy stair(instead of jumping) Accessories for physical relief Food for senior More dog houses/pillows First aid kit for senior dog
How to be sure their senior dog is safe at home?	Remote control camera Ask neighbors/dog sitters Home tracking GPS tracking
How to be sure their dog is aging well?	Visit vet occasionally Recognize symptoms in early stage Let their owner know when their dog is aging Self diagnose
How to get support(knowledge) about senior dogs?	Google Ask vet New product Book/media Neighbor who has old dog App
How to easily install and uninstall the product?	Clear manual in product Know permanent fixer Easy to handle for one person Movability
How to maintain the product?	Cleaning Repare some part Taking care in proper way
How to dispose the product?	
How to prevent bad aging of senior dog?	Accept and know the current situation of senior dog Change together with senior dog Make people notice regular check time Know how to take care senior dog
How to get/buy the product for senior dog?	Online Pet store Free sample Youtube Include with essential product for dog

HOW-TO'S; MARS AND CHINESE GOVERNMENT

How-To's Questions

How-To's Questions

How to expand market in China?

How to display the product?

How to communicate with their consumers?

How to make manufacturing steps simple?

How to connect the product to Mars brand image?

How to pass the regulation?

How to reduce production fee?

How to promote the product?

How to easily install and uninstall the product?



How to maintain the product?

Appendix D. Result of Survey

Name	Age	Gender	City	Job	Dogs Name	Dogs Gender	Dogs' Age	Breed	Dogs Meaning to You	How You Meet Each Other	Shining Moment	Representative Emotions 0-7	Empathy Level 0-7
Qiu Fengying	78	Female	Xiayang	Housewife	Meina	Female	13	Poodle	Pet	A good friend gave her to me as a present.	Make me happy when I am upset.	cherish	1
Sun Lin	36	Female	Shanghai	Office Staff	Tiger	Male	9	Poodle	A companion to my family, I hope he can stay healthy and have a long life to be with us.	I used to be afraid of dogs. I didn't realize the friendly and cute part of a dog until that once I had to stay with a Poodle in a small space and get along with him. Then the fear turned to be willingness to interact with them. Three months later, I bought 2-month Tiger from one of my friend. I didn't dare to hold him, so I asked a friend of mine to help me take him to my home	There are a lot. There was a time when the whole family was out for traveling. It was the first time that we had a foster care service at the pet shop. When we were back to pick him up, I was so sorry to see him like that, with red traces around his eyes. I don't even know whether it's blood or tears even now. I think he suffered during those days, thinking he was discarded by me. When I saw him, I promise that I won't ever leave him alone. Perhaps he didn't even drink or eat well, he couldn't even jump onto the sofa when we took him back home, which used to be his favorite spot where he can sit beside me and put his head on my leg.	love, thankful, cherish	6
Chris	30	Female	Shanghai	HR	LuLu	Male	11	Scotch Collie	My brother	My neighbor gave him to me when he was a puppy.	When he had a surgery in the hospital.	cherish	5
Wu Danyun	49	Female	Hangzhou	Executive Director	LuLu 174 means tiny deer 小鹿	Male	13	Chihuahua	My second son	He was my uncle's, who later gave him to me.	I was heart-broken when he was diagnosed to have a incurable heart disease at age of 9, doctor told me he could only have two and a half years to live. However, Lulu is still having a happy life with our extra care and encouragement.	affectionate	5
Zhang Jiachun	25	Female	Shanghai	Designer	Doudou	Female	12	Unknown	the closest family member 4E the most loyal friend	It was by chance, my dad brought her back from a ragpicker person	Every time I went back home she will run to welcome me happily. He plays hide and seek with me, lies beside me when sleeping, comes to accompany me when I am alone.	Grateful, for her everyday companion.	5
Li Qianjin	52	Male	Wuhan	Engineer	Xiao Bai 14 little white 小白	Male	7	Bichon Frise	My younger son	We brought him back from a breeder in Beijing	When you play with him using a tennis ball, he gets happy and naughty. His eyes begging for a hug when he gets exhausted after playing	cherish	6
Zhao Hua	58	Female	Yinchuan	Railway Staff	Xiaomi	Female	9	Schnauzer	Companion	I found her homeless on the way back home	Every time I went back home from traveling, she was so excited and would run towards me. When she is sleeping on the sofa, it's really cute.	cute, contempt	7

Differences	When Realized aging	How You Treat Him/Her Differently	How to Support	Representative Emotions Now	Empathy Levels Now	Attitudes to Pet Care Industry in China	Issues and How to Improve
Eyes got blur, smelly, and move slowly	13	Not really	Give support as much as possible	cherish	5	I rarely went there	Making money shouldn't be the priority
His fur fades, teeth and digestion don't work as well as before. But he understands you better, like a human, follow your call, doesn't run around randomly like a kid, even if sometimes he runs far, he will turn his head back to see you.	It happens gradually, without any specific moment.	Ever since my child was born, I have less time to play with him, I feel a little sorry, but I really care about him.	If he's sick we take him to the hospital, it's also a life. We bought him the best pet food, stop feeding him anything that is unhealthy for him, even though he is still greedy. Proper exercise, we try to accompany him as much as we can. We give him more time to hang out and play with his dog friends.	I still love him, and I feel grateful for that he accompanied me during my long long time of being single.	5	Hard to find those who are really professional and with authorities.	Mostly are private small business, without many professional medical care staffs. Pet hospitals with nice environment are just too few, professional foster care organizations are even fewer.
quieter and more attached to humans, Blurry eyes	when I am less and less being together with him.	Let him stick with me more.	I often carefully monitor his food intake.	grateful, cherish, affection	7	Very very expensive, and there are very few authentic hospitals	the industry should be more regulated with rules, the certification of vets should be more transparent and public.
teeth dropping off, ears and eye sights doesn't work well, walk slowly, cannot jump onto stairs, more stubborn than before	when he was 10	I indulge him more, and say more nice things to praise him.	I love him more, keep telling him how much I love him, and ask a particular person to take care of him when I am not at home.	I am grateful for his companion, cherish every day we have together.	5	The medical service is in poor management, and the staffs lack sense of responsibility and medical ethics.	more professional management
He doesn't like to run around that much any more, walks slowly, spends longer time sleeping, gets more and more attached to human.	last year	We take care of him more carefully	Try our best, feed him with proper food, go outside together more often.	cherish, really really cherish her, meanwhile also grateful	5	Not very thoughtful, and too expensive.	They should be more widely available and covering broader areas. The price should be more reasonable, then I can often bring my dog there for body check.
The temper gets milder and he understands you better.	when he's 5	not really	I spend more time with him.	cherish	7	Rarely go there	The service hasn't covered enough areas, should be more widely available and more developed.
Not that active as she was before, prefer to stay quiet.	After she got 7 year-old, she became less excited towards anything, and less active	not really	Pay more attention to her diet, when she has inconvenience moving, I will cuddle her.	cherish	7	nothing special	the charging is not regulated, not professional enough.

Appendix E. Three examples of nose work

1. Paper nose work	2. Blanket nose work	3. Paper cup nose work
		
<p>prepare hand size papers Put one small treat in the paper and crumple the paper disperse or hide a crumpled paper</p>	<p>Hide treats in the blanket Encourage a dog to find the treat by himself/herself</p>	<p>Put treats in a paper cup Fold multiple paper cups Encourage a dog to find the treat by himself/herself</p>

Appendix F. Prototype testing with senior dogs

Benji (13)



Daisy(10)



Dazzle(12)



Kiki(8)



Nelson(13)



Nora(11)



Jill(13)



Appendix G. Prototype proposal for AMFI student

DELFT UNIVERSITY OF TECHNOLOGY

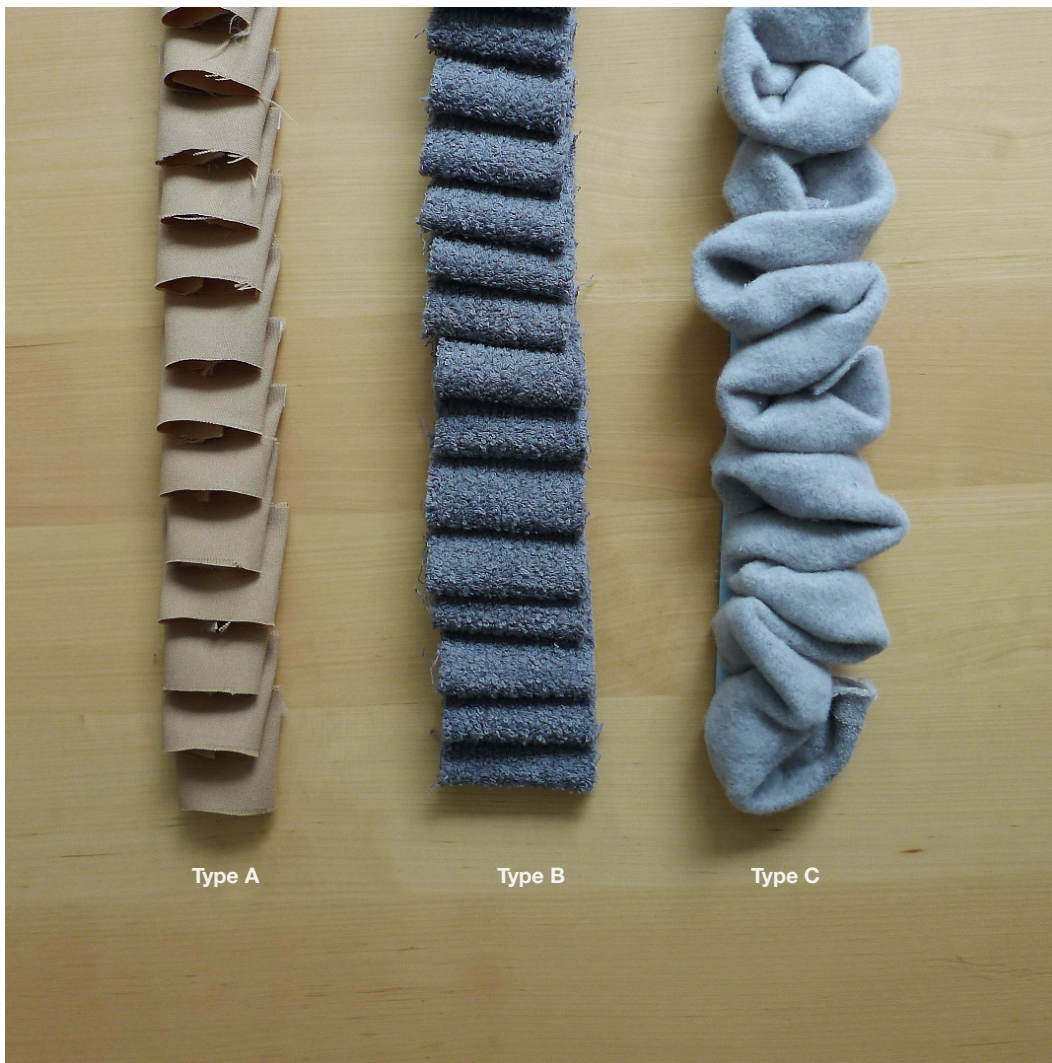

Project Proposal

Prepared for: Heidi Lee, Dear my old friend.

EXECUTIVE SUMMARY

Objective

It is an indoor interior element that provoke cognitive ability of senior dogs that are losing eyesight. It provides **guiding direction** with **unique fabric tracks** by the use of different designs (and material). The track targets the moment when they are confused with their physical changing. It has special fabric features, which make it an easy to hide treats, intuitive to use, and let loose curiosity.

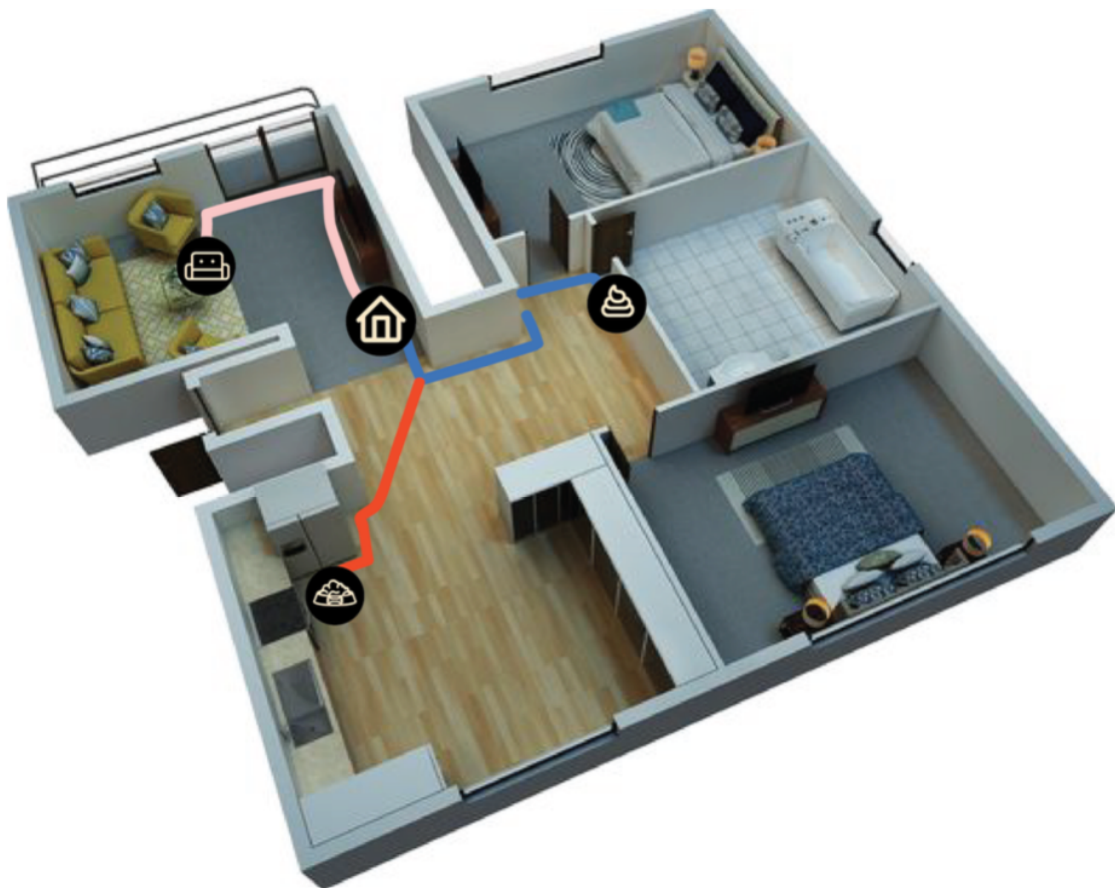

Goals

Build prototype which are having size of

Type A - 50*1000 mm

Type B - 50*1000 mm

Type C - 50*1000 mm

Type # - 50*4000 mm

Every 500 mm the product has closed part.

and

2 Corner parts



The product has three layers, which are Top, Base, and Adhesion.

Top layer has three different types of design (Type A, B, C).

Base layer is thick fabric.

Adhesion is velcro.

These three layers need to be merged and professionally finished.

Detailed sizes, patterns, and manufacturing methods will be discussed during the meeting.

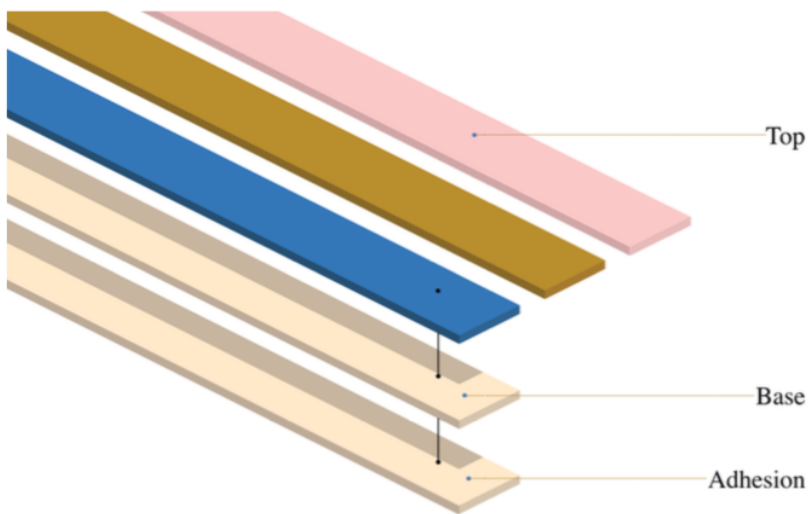

Budget

- The hourly wage is 13 euro (same as a student assistant)
- The project budget is sponsored by TU Delft
- The material(fabric) will be provided

Appendix H. Manufacturing steps

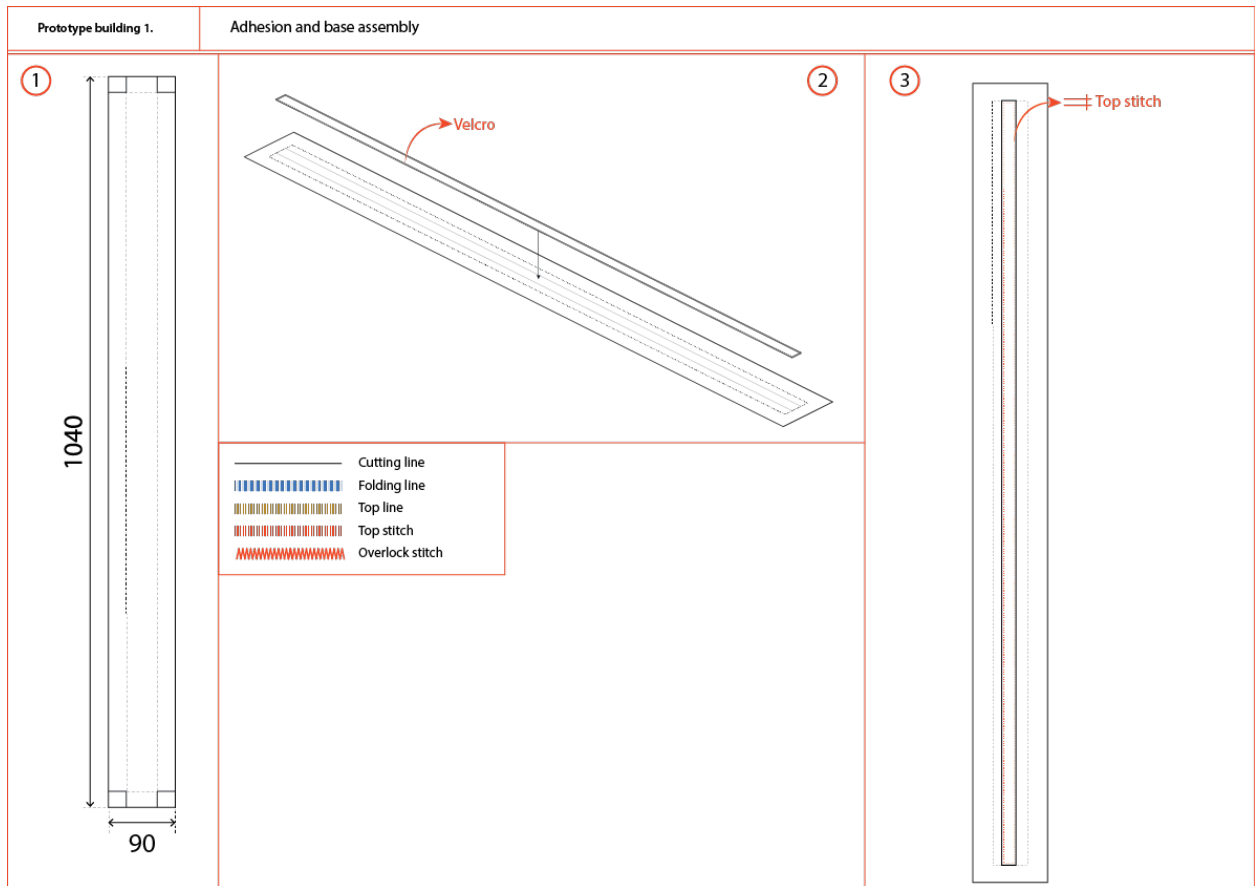

At first, the fabric and velcro for the adhesion and base layer are cut to size. One meter of velcro is placed on the base fabric, and fixated with a top stitch. This is done three times.

During prototyping, it became clear that the base layer needed to be split into two pieces of fabric so all the stitches could be hidden, and the top layer could be attached more easily.

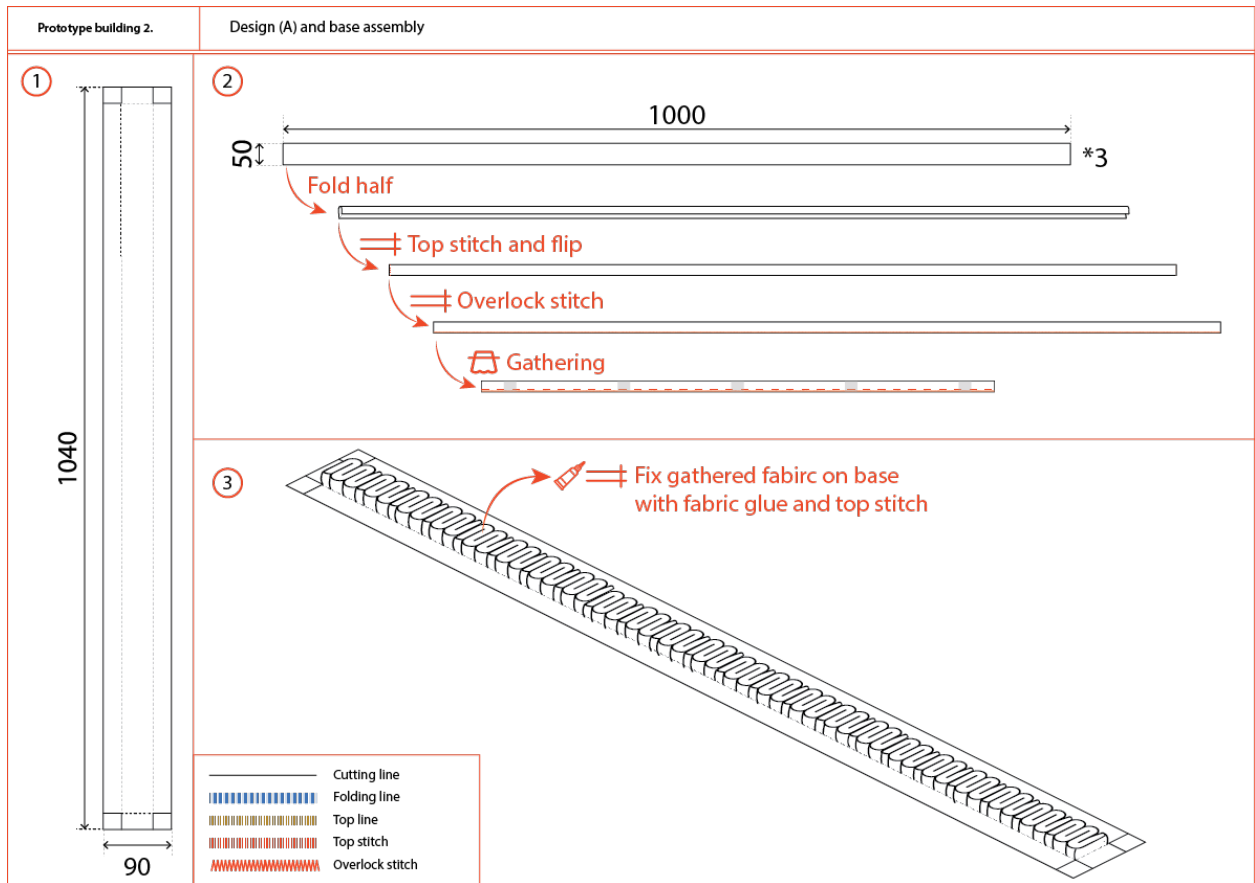

Design A is inspired by the shape of the ocean (Chapter 4.1.). To make the top layer, three thin pieces of organic fleece are cut and folded into half on the long side edge, and then fixated on the side and bottom with a top stitch to close all sides and flipped. When the part is flipped, the stitch cannot be seen from the outside. The bottom of the folded fabric strips will be secured with an overlock stitch to make it stronger. To create a wave like effect, a thread is tacked through the folded fabric strip, and pulled to create a frill. This process is called ‘gathering.’ The gathered material is secured to the top part of the base layer by a small amount of fabric glue and a top stitch.

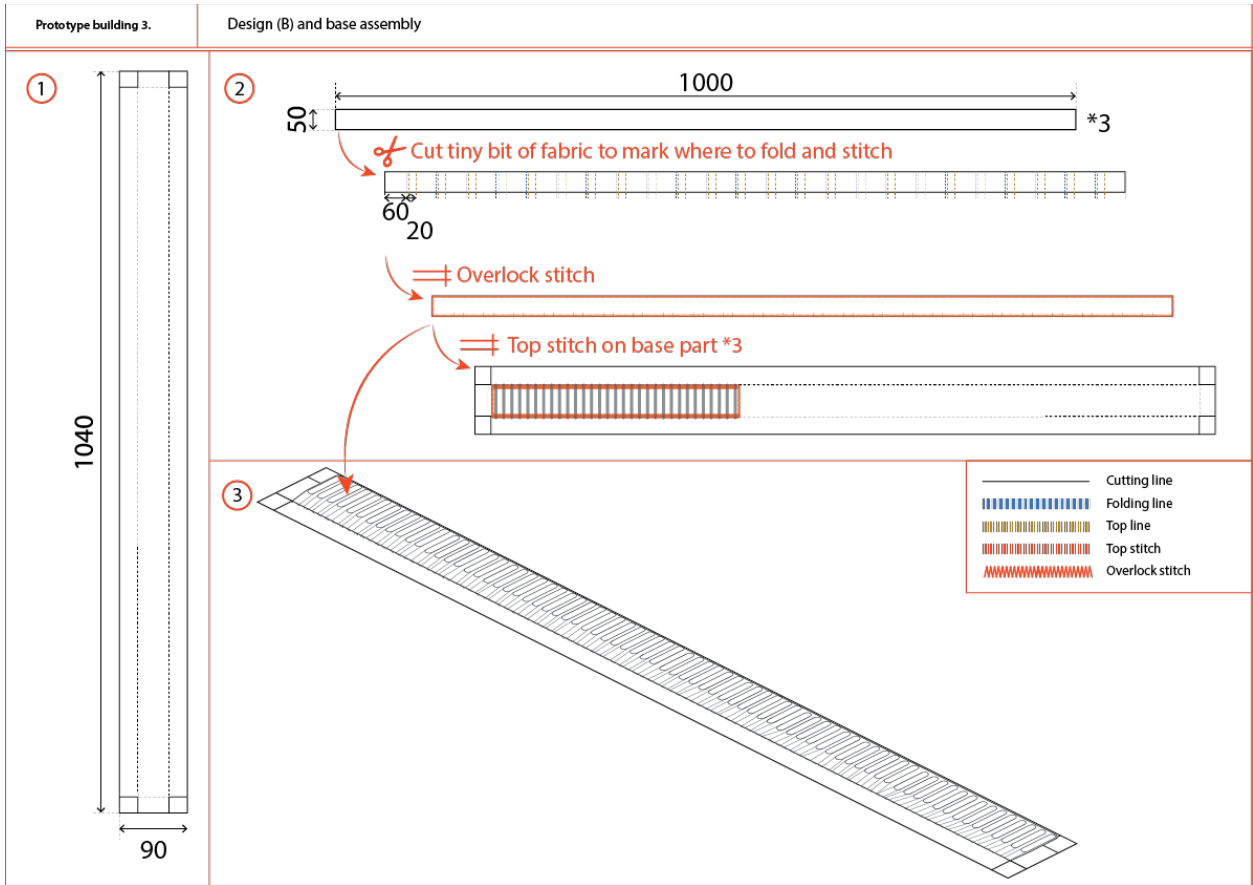

Design B is mimicking the shape of a Canyon. To make this top layer, three thin strips of nontoxic cotton cut and given a notch (mark) using a scissor. In a real manufacturing process, a hot notcher is an ideal tool to do this. All sides of the fabric strips are closed with an overlock stitch, this step makes the fabric stronger and prevent unraveling. The strips are then placed onto of the top base layer, and folded into a canyon pattern by following the notched marks. A top stitch is used to connect the two.

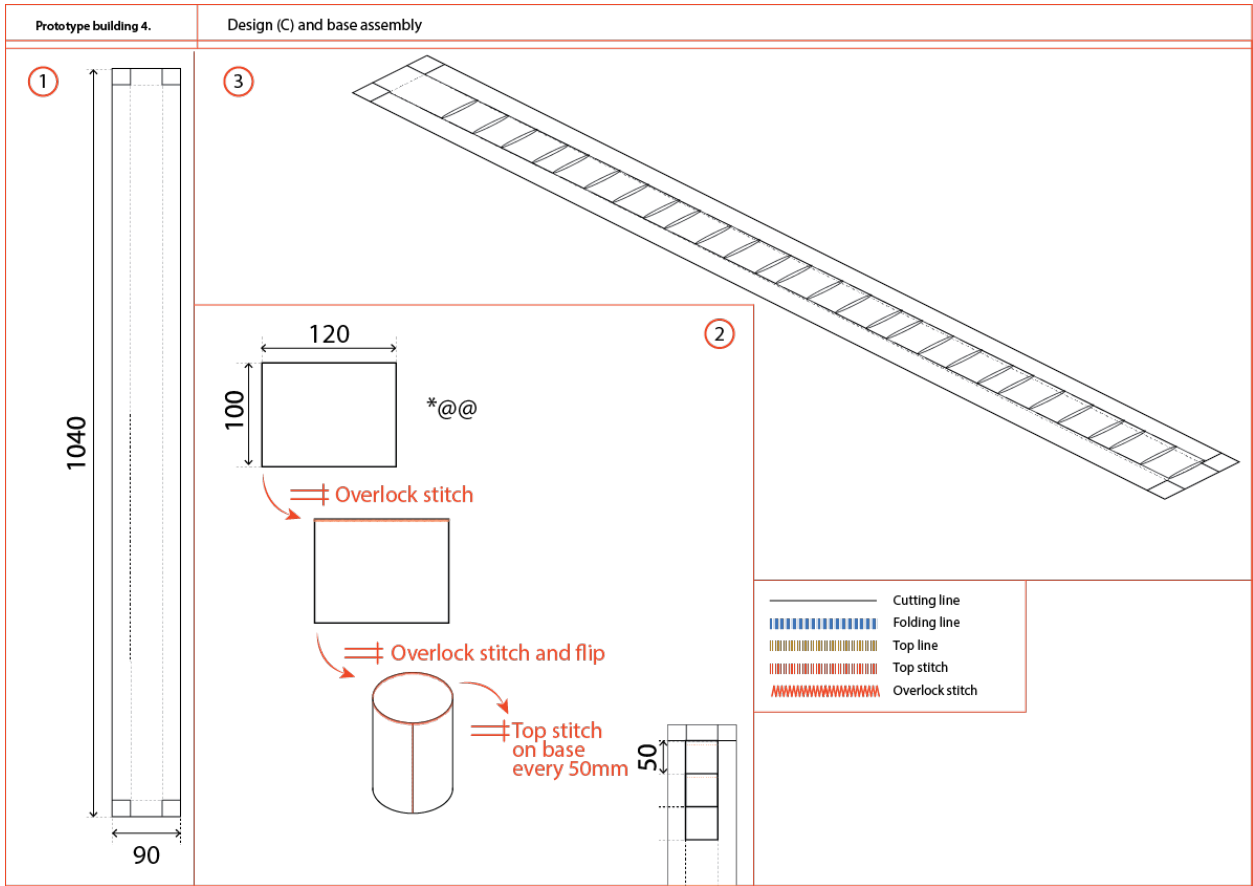

The last top, design C, is based on the shape of a dessert. Square pieces of organic cotton are cut and finished with a top stitch, folded in half and stitched on one side with a top stitch to create a cylinder. The cylinders are sewn to the top base layer every 50mm with a top stitch to create a pattern of overlapping cylinders.

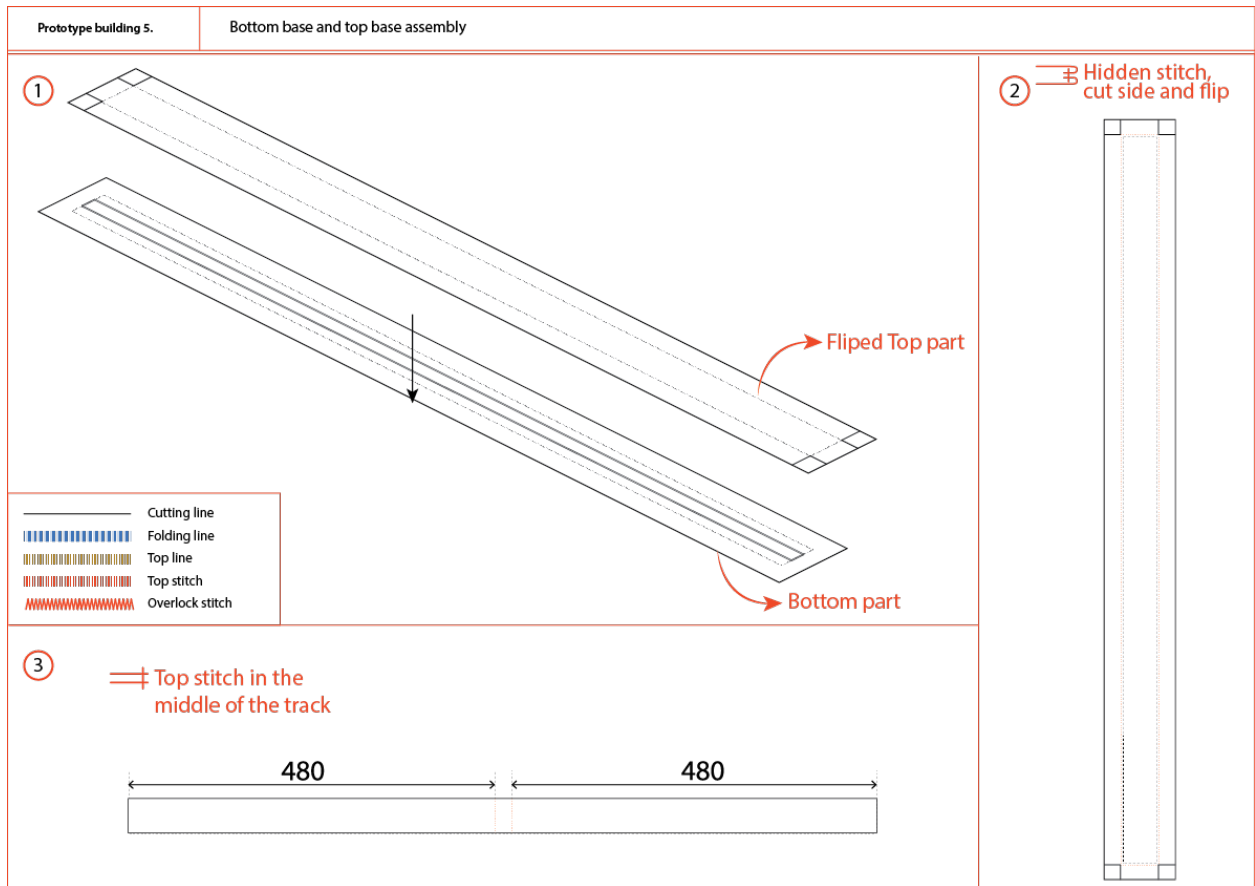

The final step is to cut unnecessary side and corner material to create a clean finish. After all separate assemblies were ready, the top layer assemblies are sewn to the bottom assemblies with a hidden stitch. Two top stitches are placed in the middle of the product to create a cutting space that will not unravel so the product can be cut into two to create a shorter module.

Appendix I. Evaluation Instruction

DEAR, MY OLD FRIEND

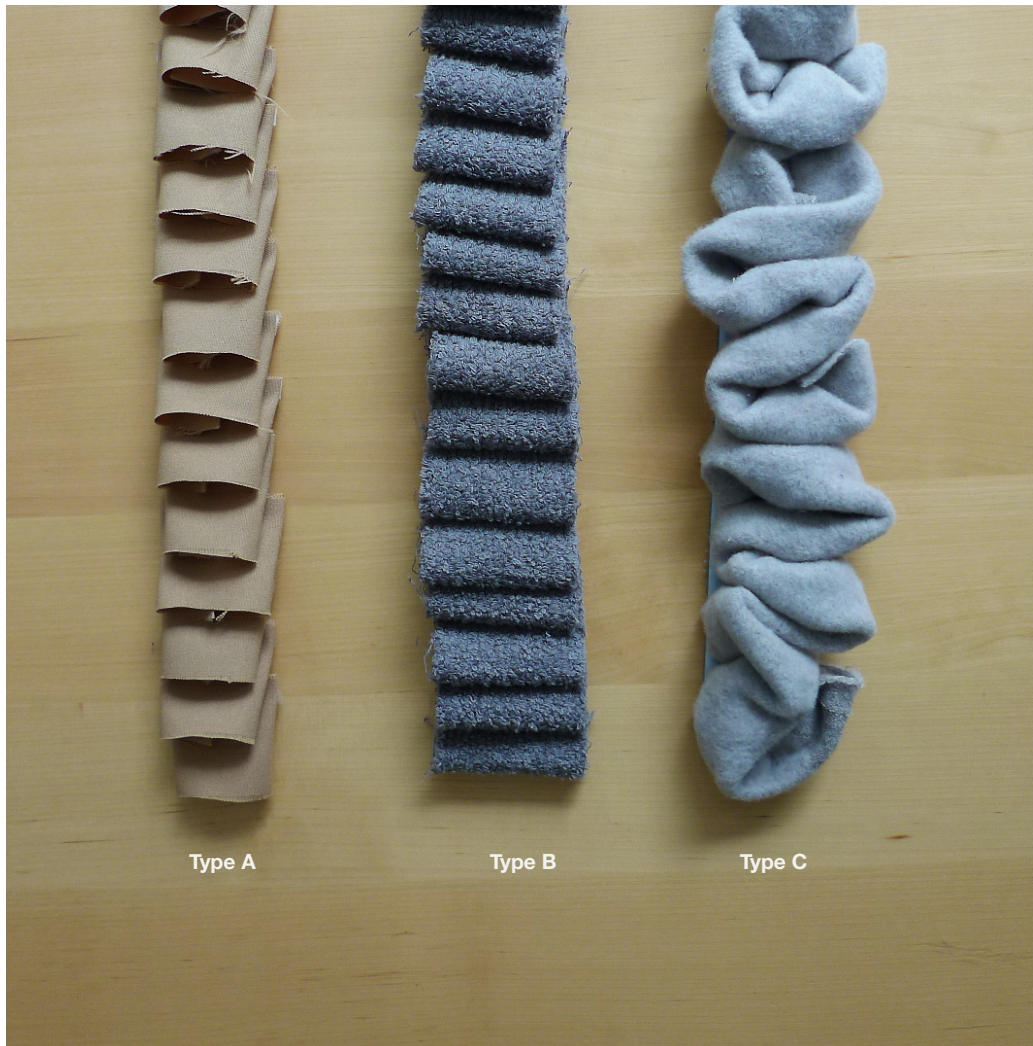

Evaluation Instruction

Prepared for: Lei Zhang
Prepared by: Heidi Lee
October 5, 2017

Thank you, Lei, for participating!
 The evaluation will split into three.
 It will be
 first, Usability,
 second, Acceptance,
 and third, Aesthetic.

Usability Test

For the first "Usability" test, this test is for prove increased interaction between you and Lulu.
 There is a manual in the paper bag, what looks like this.
 (The one in the bag is draft, so there is no written explanation)
 You will need small treats for this evaluation session and of course it will be nice if you can record video during the session.

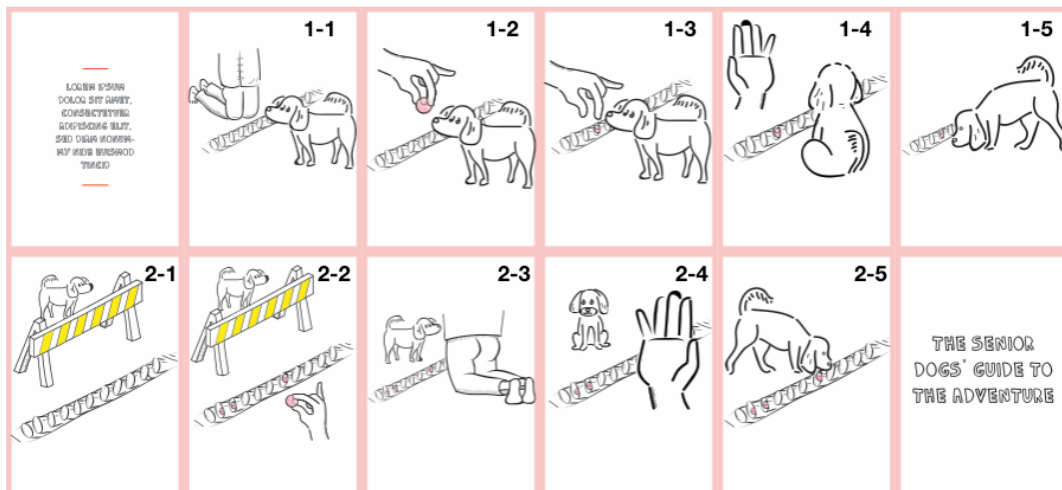

1. Fix one of the bridge on the floor (use scotch tape)
2. Follow the direction
 - (1) 1-1. Put the bridge between you and your dog
 - (2) 1-2. Show a treat to your dog
 - (3) 1-3. Hide a treat in the bridge
 - (4) 1-4. Give him/her easy order(such as wait, sit, etc) or wait until he/she gets calm
 - (5) 1-5. When he/she gets calm make him/her search the treat

Have some term(few hours or even a day) after first training.

- (6) 2-1. Make your dog stay way from the bridge. Put him/her in other room
 - (7) 2-2. Hide treats in the bridge. Your dog still can't see or come near around to the bridge
 - (8) 2-3. Bring your dog close to the bridge
 - (9) 2-4. He/she will try to sniff on the bridge, however, make them stop and give him/her simple order or wait until he/she gets calm
 - (10)2-5. When he/she gets calm make him/her search the treat
3. You can repeat this several times
 4. Please fill the online survey form

Acceptance Test

The second test is, Acceptance. This test is to see if the dogs really can use the product. Please attach the product next the wall. Something looks like in this image.

(A product what you have now is much shorter than the image, therefore, it doesn't have to be connected)

You will need small treats for this evaluation session and of course it will be nice if you can record video during the session.

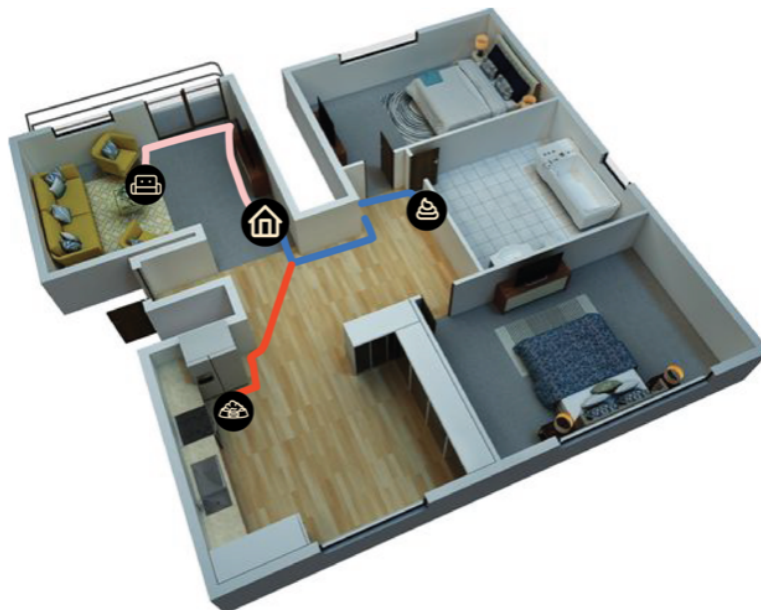

-
1. Put all three bridges next to the wall
 2. Hide same amount of treats in each bridge
 3. Record a video how your dog response and interact with the bridge
 4. You can repeatedly put treats in the bridge like, once every day.
 5. Observe your dog how to response and interact with the bridge when even treat isn't in the bridge.
 6. Please fill the online survey form

Aesthetic Test

The last but least test will be an Aesthetic test.
It is easier than other test.

1. See and feel the product A,B, and C
2. Pleas fill online survey form.

Appendix J. Result of Evaluation

J.1. Usability test result

Is the training new way of interaction to you and your dog?

2 responses

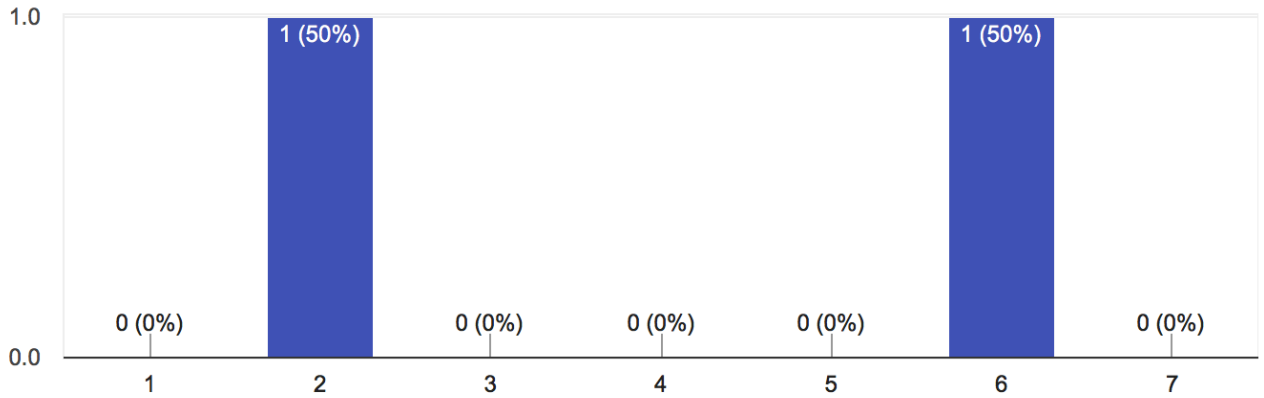

Did you trip over the bridge?

2 responses

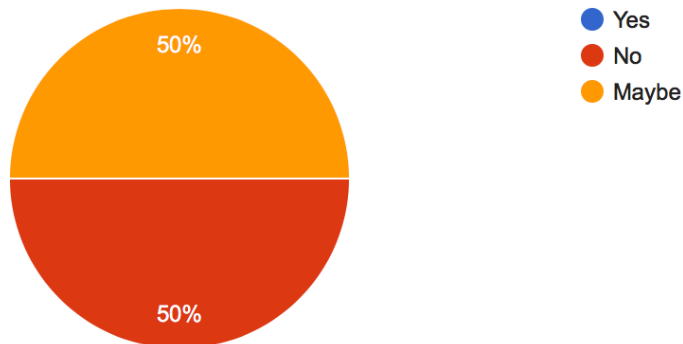

Was the bridges easy to install and remove from the floor?

2 responses

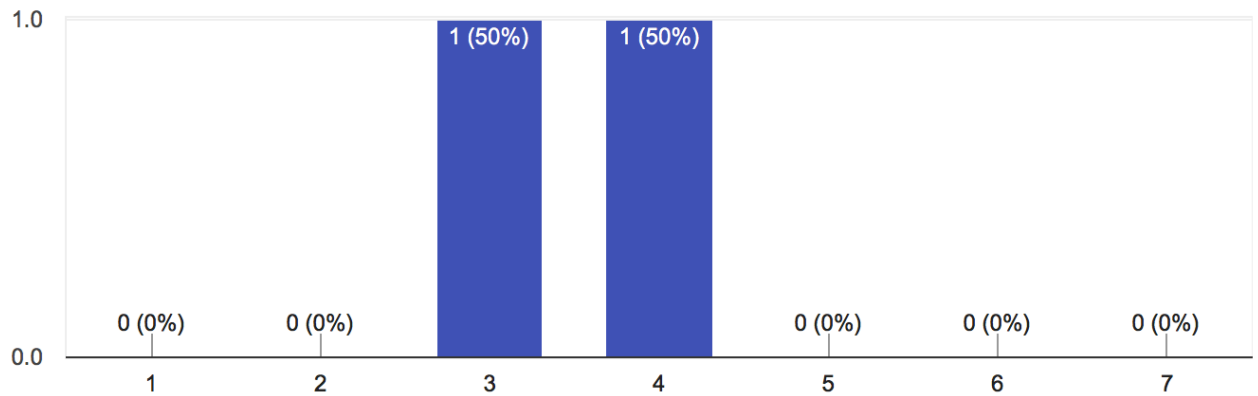

Are those bridges fit with interior of your house?

2 responses

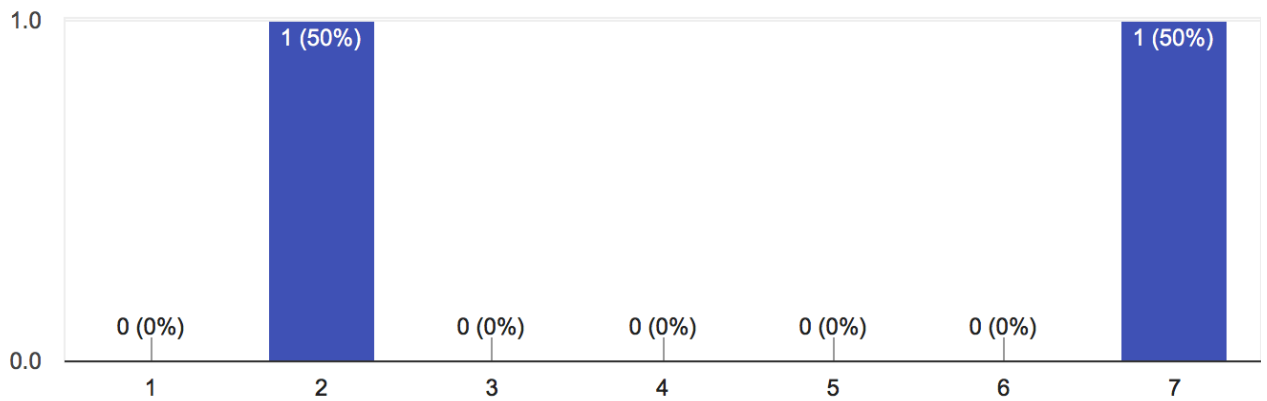

Was that easy to hide treats over the bridge?

2 responses

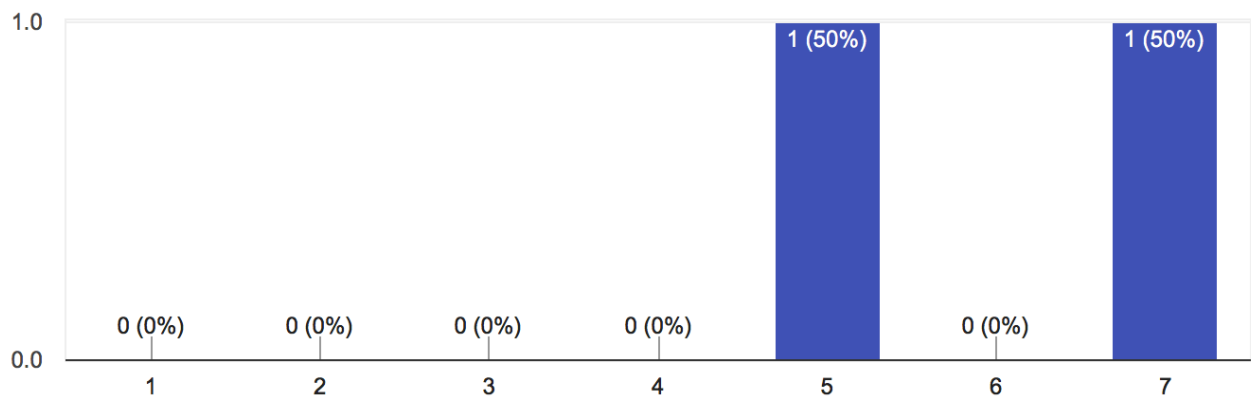

Do you think the training improved the relationship between you and your dog?

2 responses

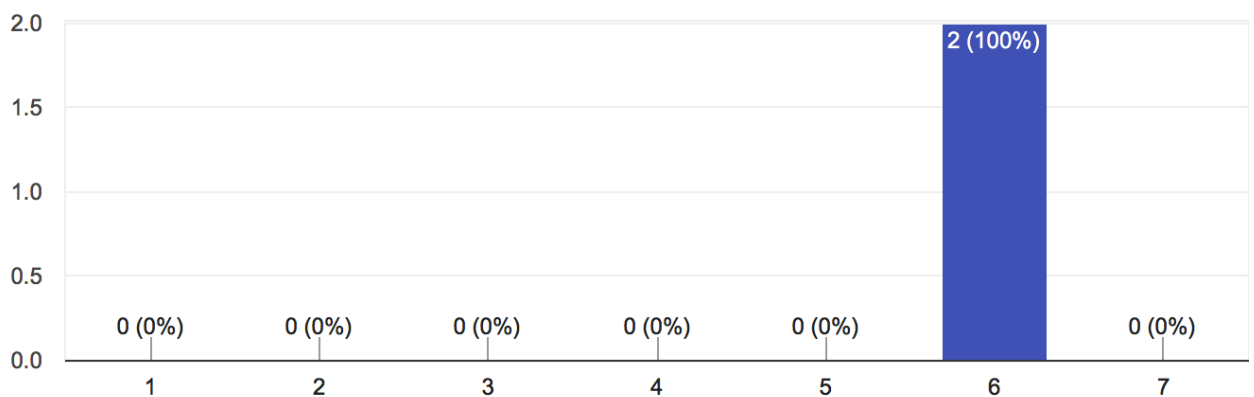

Are the training and the product helpful for your old dog?

2 responses

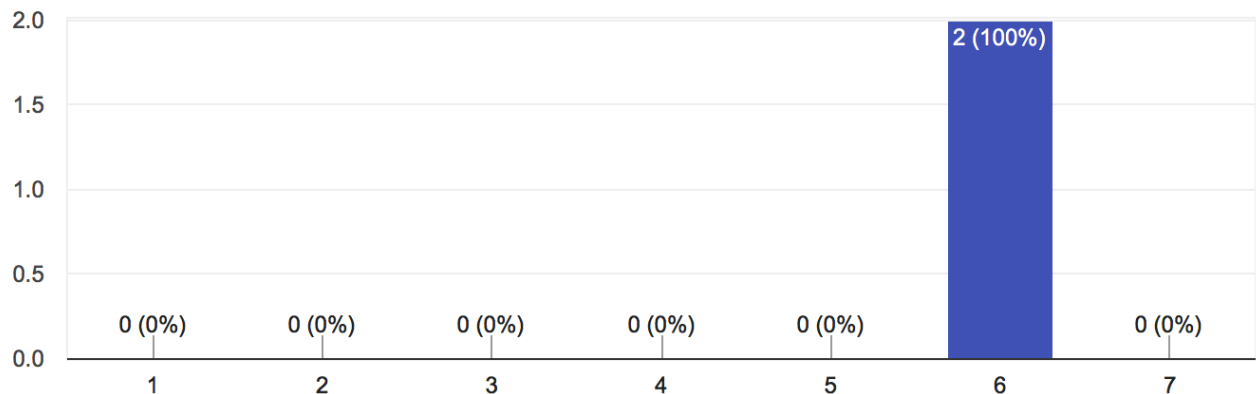

If it is helpful or not helpful, why?

2 responses

Although it was a bit confusing to my dog at the very beginning, he seemed to really enjoy it as a game, he was really focusing on doing something, which was not very common at his age. It is way more difficult to get his attention and keep him staying interested nowadays, but it seemed that he just wanted to have more playing with it. My mom was really happy to see her old baby having fun with something even though she didn't get the point of the initial purpose of the design. She said when she have some spare time, she would love to play with lulu in that way (of course the design needs to be improved regarding usability). The idea really brought up Lulu's enthusiasm (usually it's only for girls), and it was nice to see him achieving something with his own abilities.

yes its fitting because he always like snack games and his smell ability is still good. Also, if i install the game for him he can finish it without my help (if he gets to know the toy better), because it doesn't get stuck (unlike a ball under the couch). Its like my other snack hiding games but better (safer, softer and more challenging (takes longer)

I would like to have something that he can play over a long time too though. Also, something like automatic installing would be nice if he is home alone. Something washable is also nice, but i think this toy as it is now doesn't get too dirty at first sight). As long as it doesn't get too wet for me to touch it :D

Please freely describe your insight, thoughts, recommendation, and feeling for the product.

2 responses

For him how these three look didn't really matter, but according to my observation, the flappy one made it easier to get the food out of it.

i felt that there were differences in difficulty

J.2. Acceptance test result

Did your dog has an interest in the bridge in first sight?

2 responses

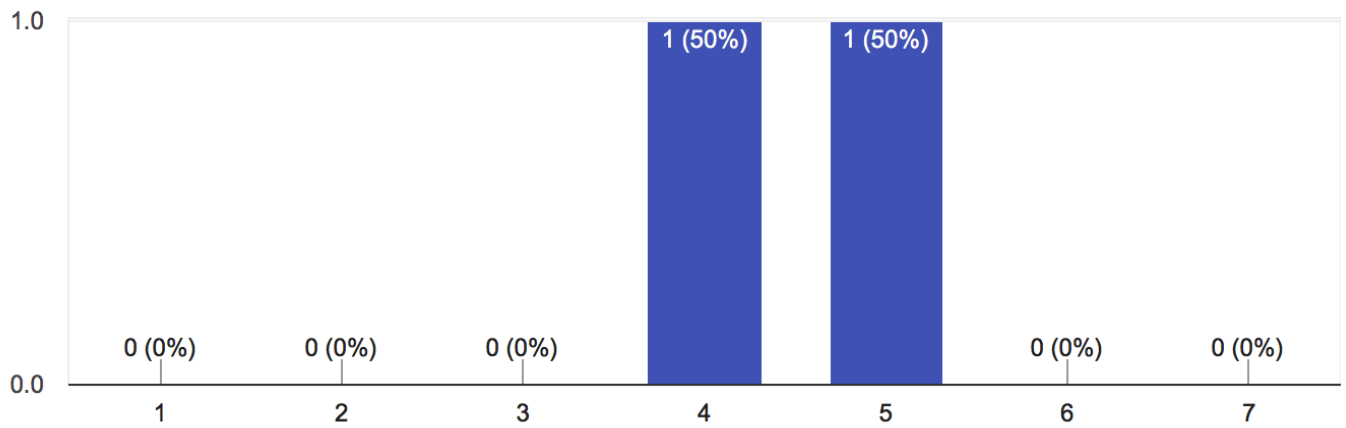

Which bridge is your dog's favorite?

2 responses

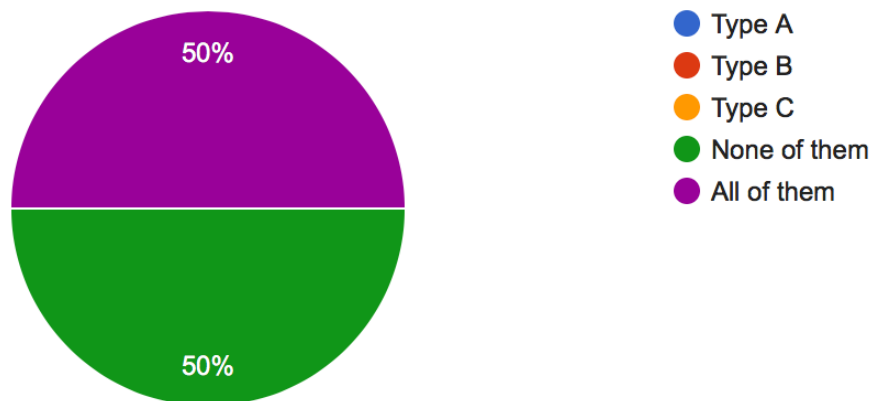

Does your dog can sniff and follow the bridge?

2 responses

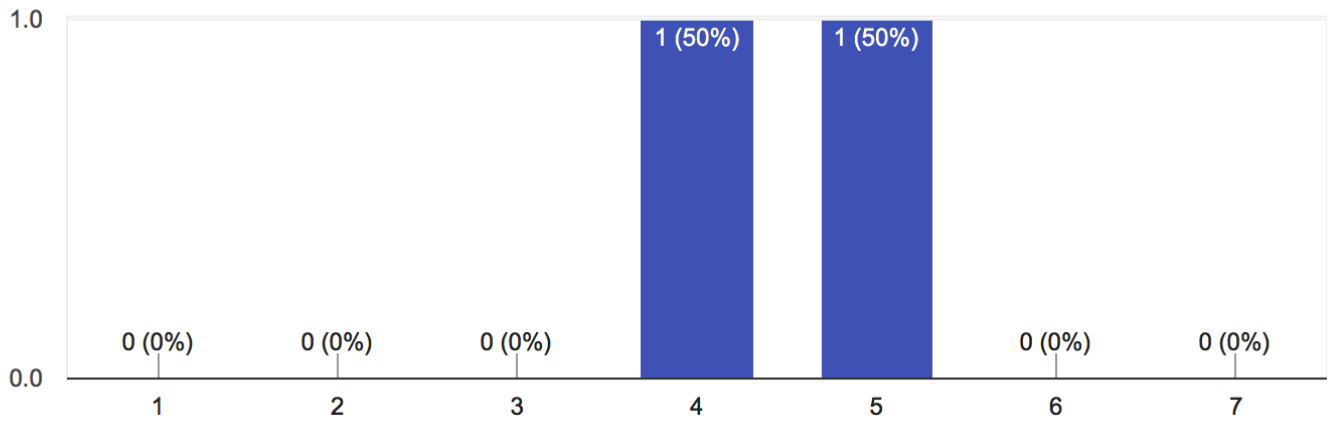

Does your dog understand bridges?

2 responses

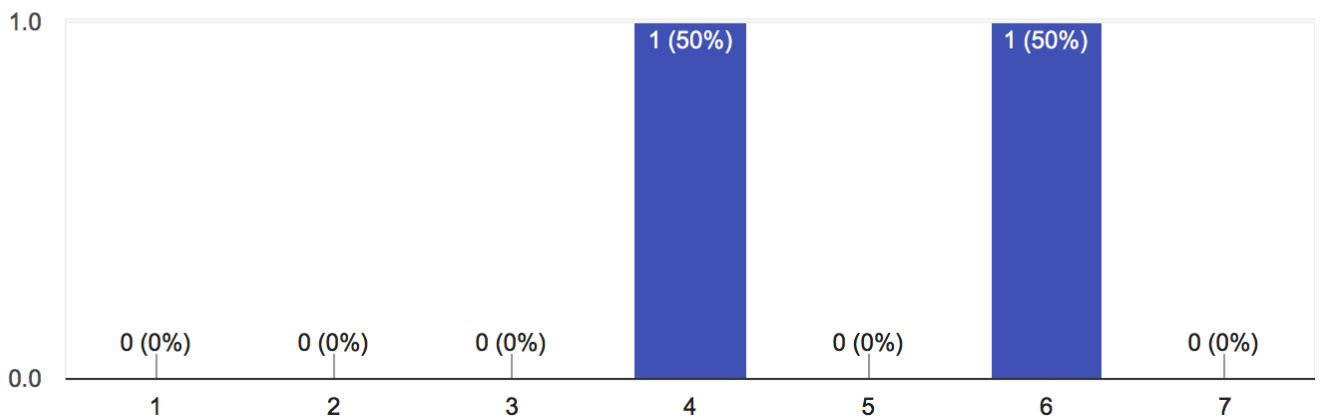

Are these bridges safe/harmless for your dog?

2 responses

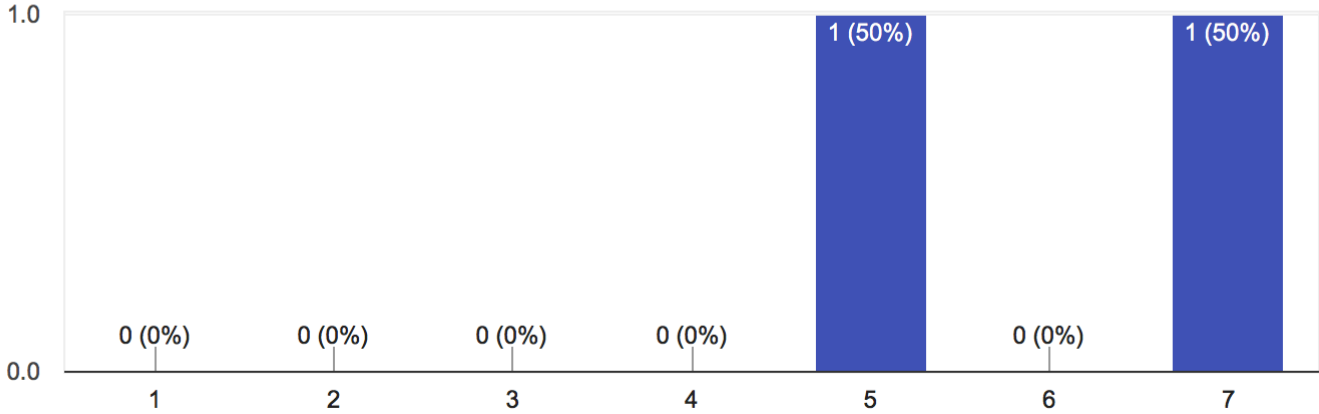

J.3. Aesthetic test result

Imagine these product is attached in your house flooring, how much does it fit in your house? Do you think these products are aesthetically pleasing?

12 responses

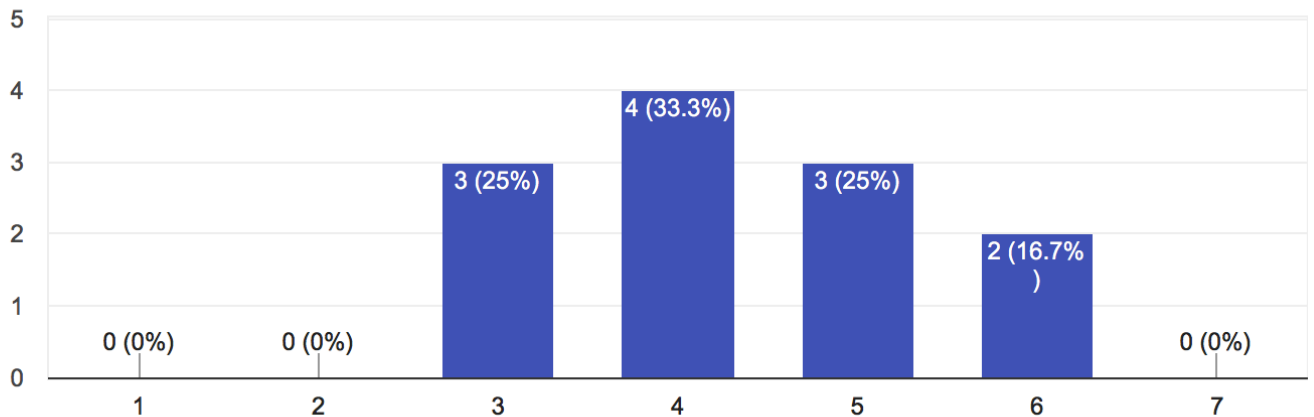

Why do you think this product is pretty or ugly?

12 responses

- looks too tough, too wide, material is okay
- interior decoration; wooden furniture(red or brown)
- not very big house, prefer clean floor
- material is soft, warm.
- Too big
- simple house, wooden furniture.
- I don't like it crossing the corridors, wooden floor
- It will be a fun
- No style in my house decoration. Too fancy. Looks like a picture from Pinterest
- floor; same color, fading
details are too rough
- Decoration=dark color, brown, wood color. lil bit different. mold= dark brown. the color is between brown and gray. nice to hide dirt.

Color; Do you think this product

11 responses

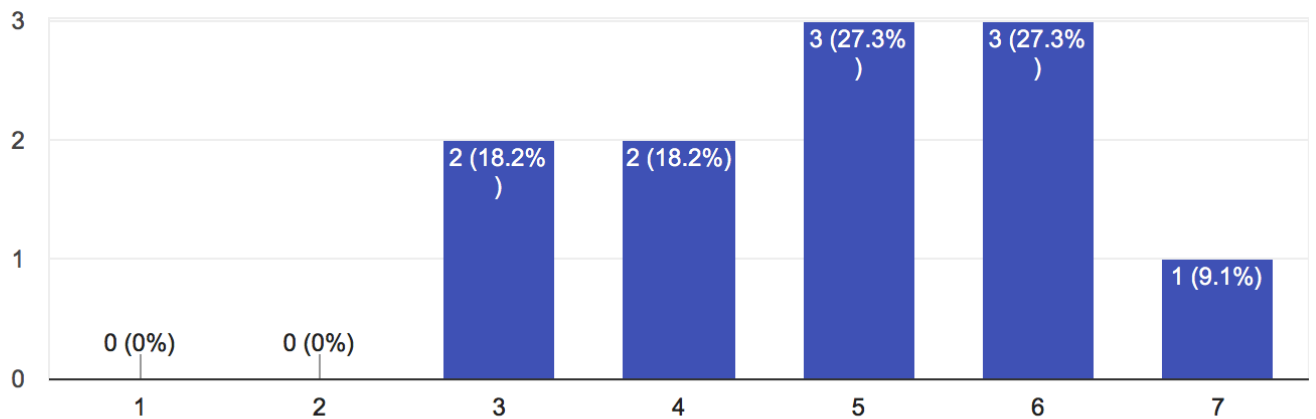

Why do you think this product is pretty or ugly?

11 responses

- too grayish, lighter gray will fit more with the house
- (red or brown)
- just gray, not meaning for gray color, green or yellow are more positive
- same color as floor.
- trustful color
- Floor is dark brown, suits, harmonious
- floor is red wood, color should be warmer.
- neutral color
- It will be harmonious with my house, not popping out
- fits most of decoration style
- Not really warm. Should be more warm.

Material

11 responses

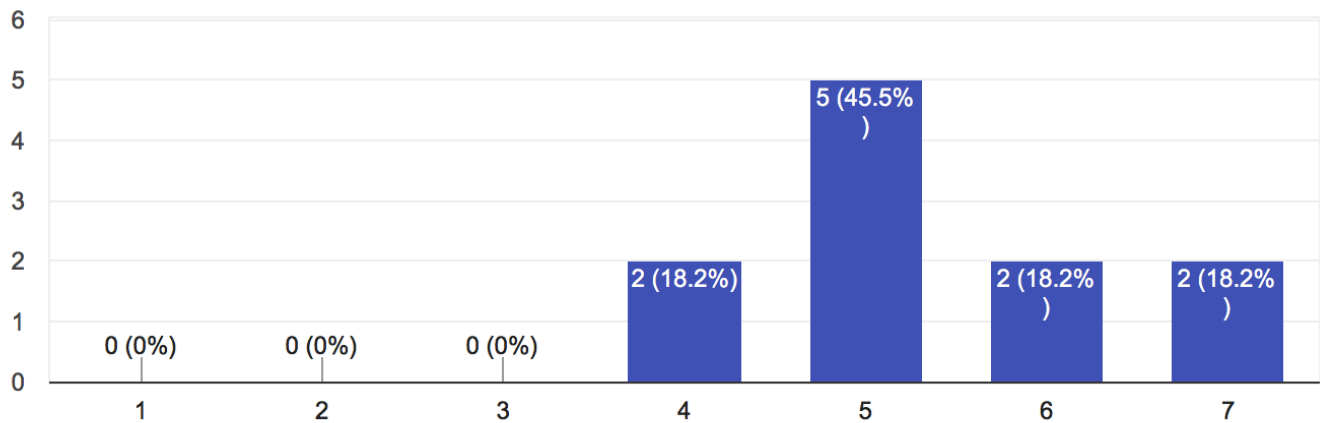

Why do you think this product is pretty or ugly?

11 responses

- difference, texture
- fleece is the best, cylinder is the worst(not interesting), specific texture is interesting
- interesting, make me feel good.
- Soft feeling(fleece)
- Fleece has 보푸라기
- Like fleece, baby; looks like mop
- Texture or material doesn't matter a lot. Thicker fabric better.
- looks collecting dust, but it is washable, it will be fine.
- baby;most organized, fleece is weird;looks like organ, saliva will soak. too light to flip
- fleece; soft feeling similar to furniture. Don like rough texture
- Fleece is the best, very nice feeling. organic texture. others are more functional product.

Form

11 responses

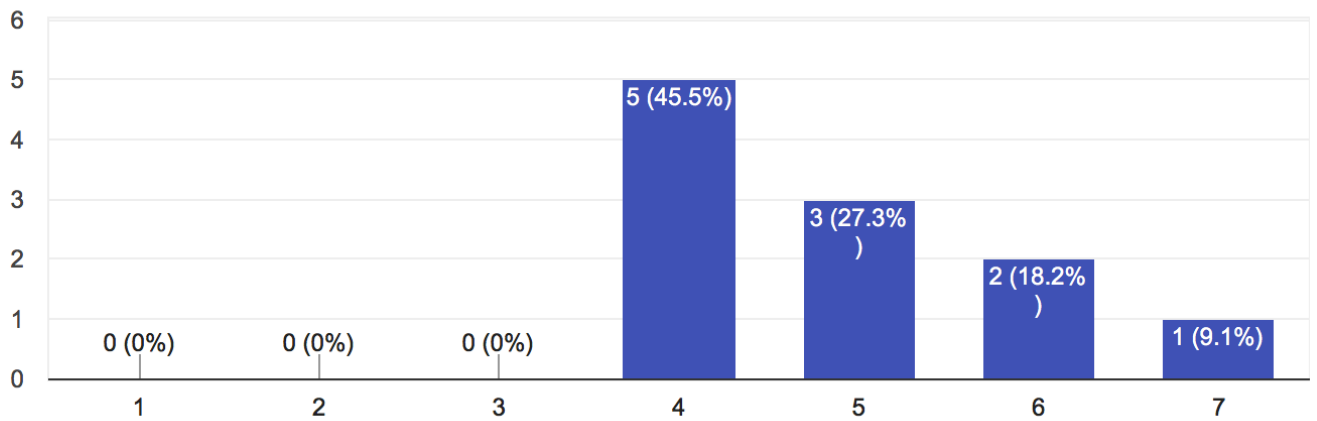

Why do you think this product is pretty or ugly?

11 responses

- dynamic, interesting
-
- organic shape is interesting.
- collecting dust.
- Boring, too much iteration
- Organic shape; makes me feel I want to touch it
- More simple design. It looks bit messy.
- looks fun
- baby&oragn;decorative, pant;not decorative.(5)
- fleece; consistent system-isa. I like consistency. bit of worrying of flip or tangle
- Too much decorative. Too much attention. Prefer Nordic style.



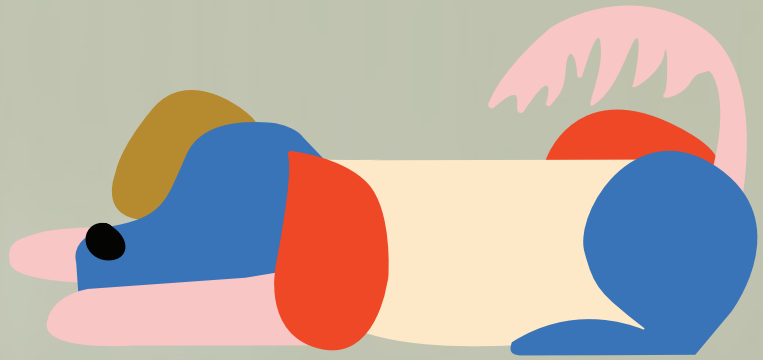

Master thesis
Heidi Sunjoo Lee