

Modern Families in Minervahaven

Frank van Vliet | 4276094 | 30.01.2020

T. Kupers, F. Adema, P.S. van der Putt





Concept
Building mass

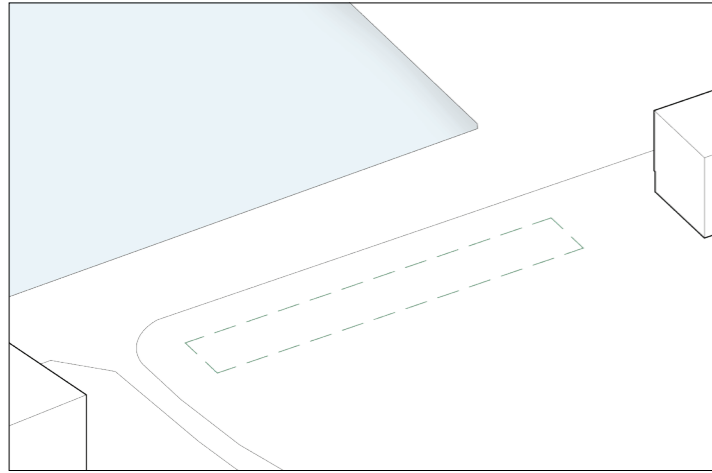

01. Site

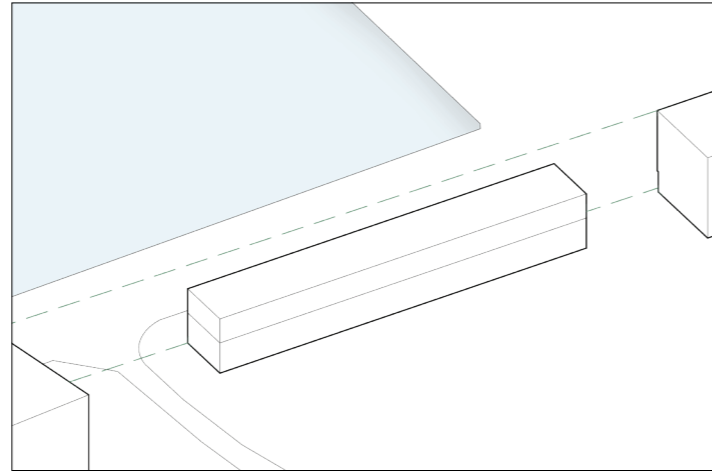

02. Basic massing

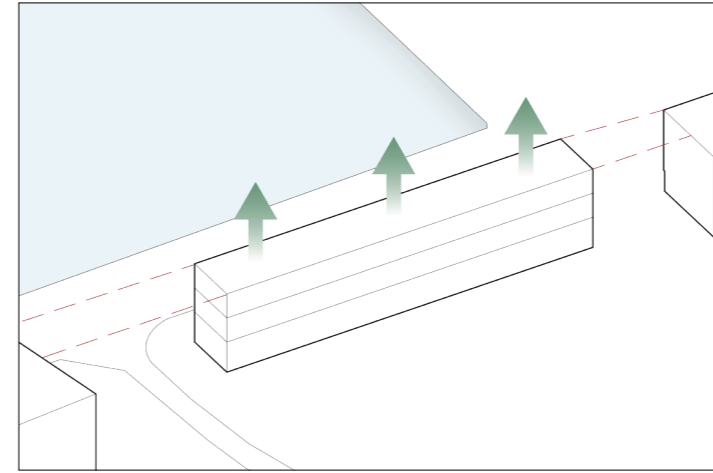

03. Height

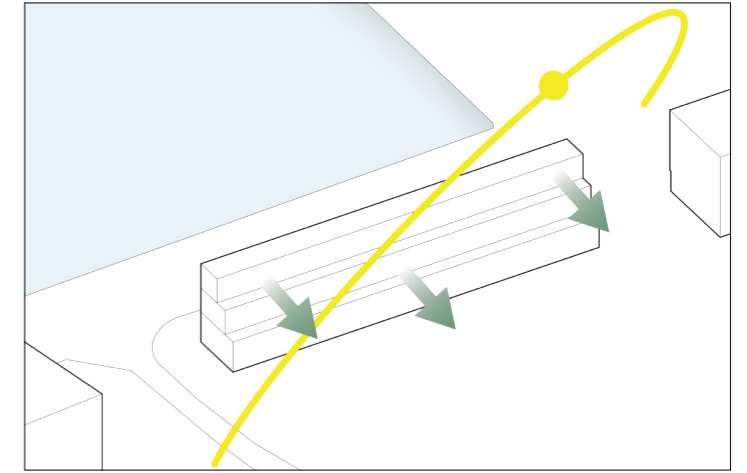

04. Opening up the volume

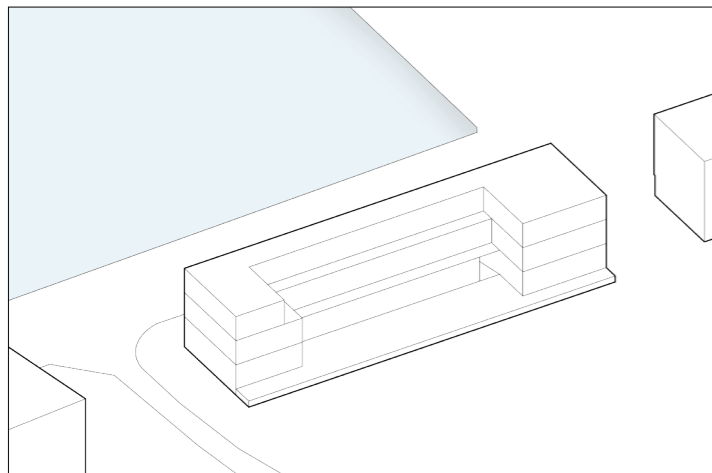

05. Enclosing collective spaces

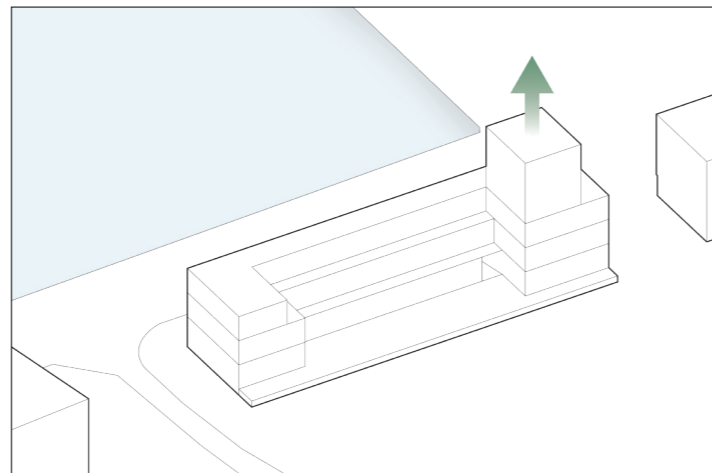

06. Finishing urban square

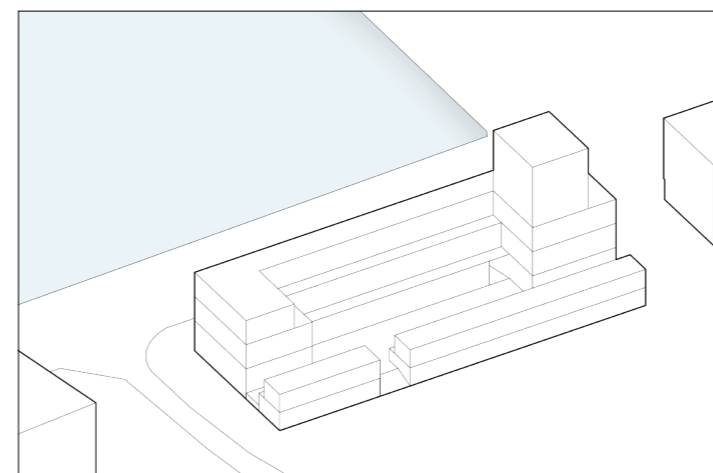

08. Framing collective garden

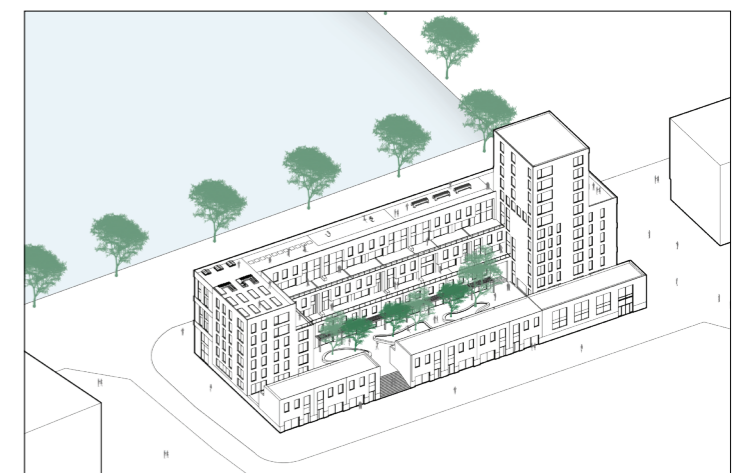

09. The building

Concept
Circulation

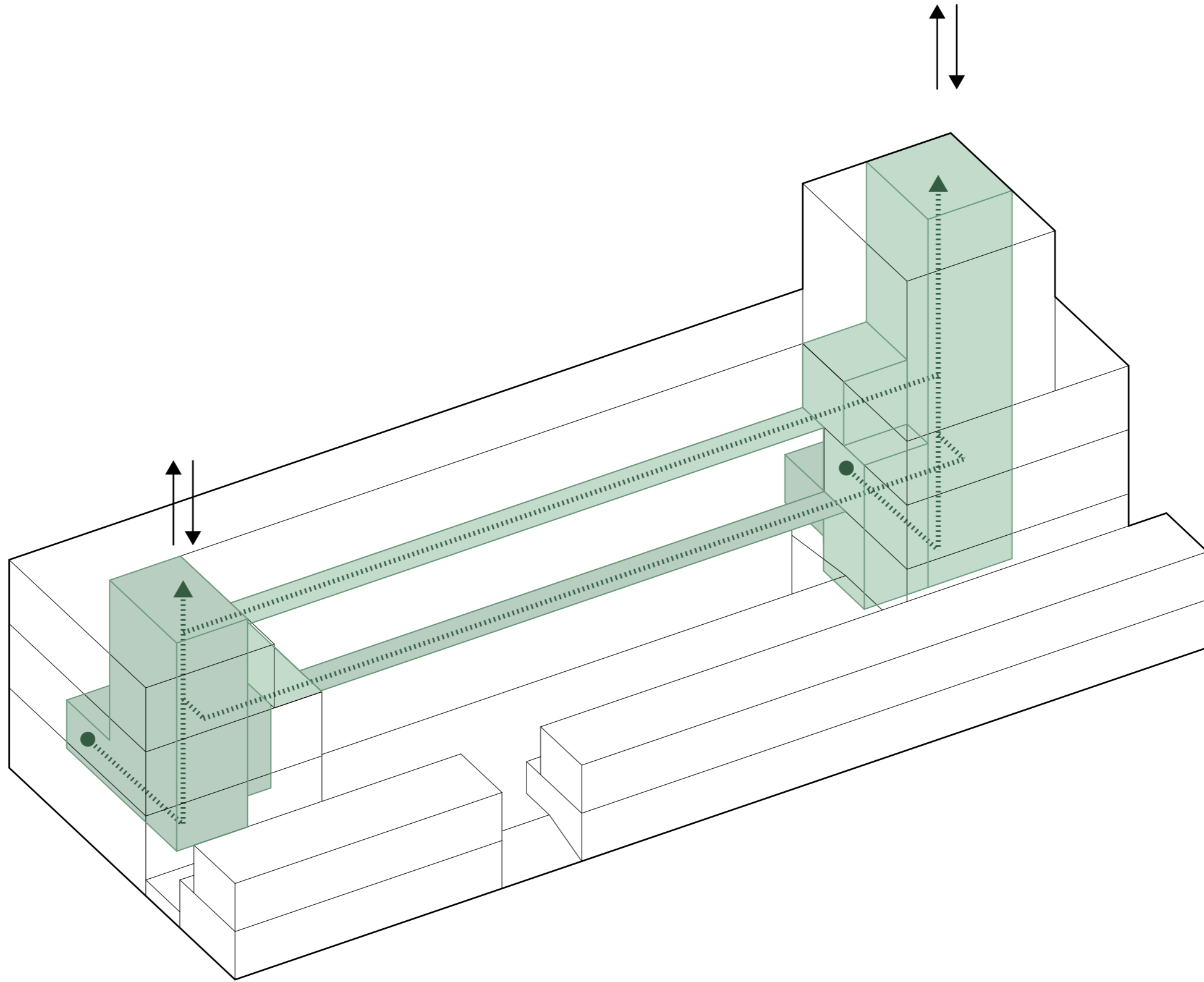

Concept
Places to play

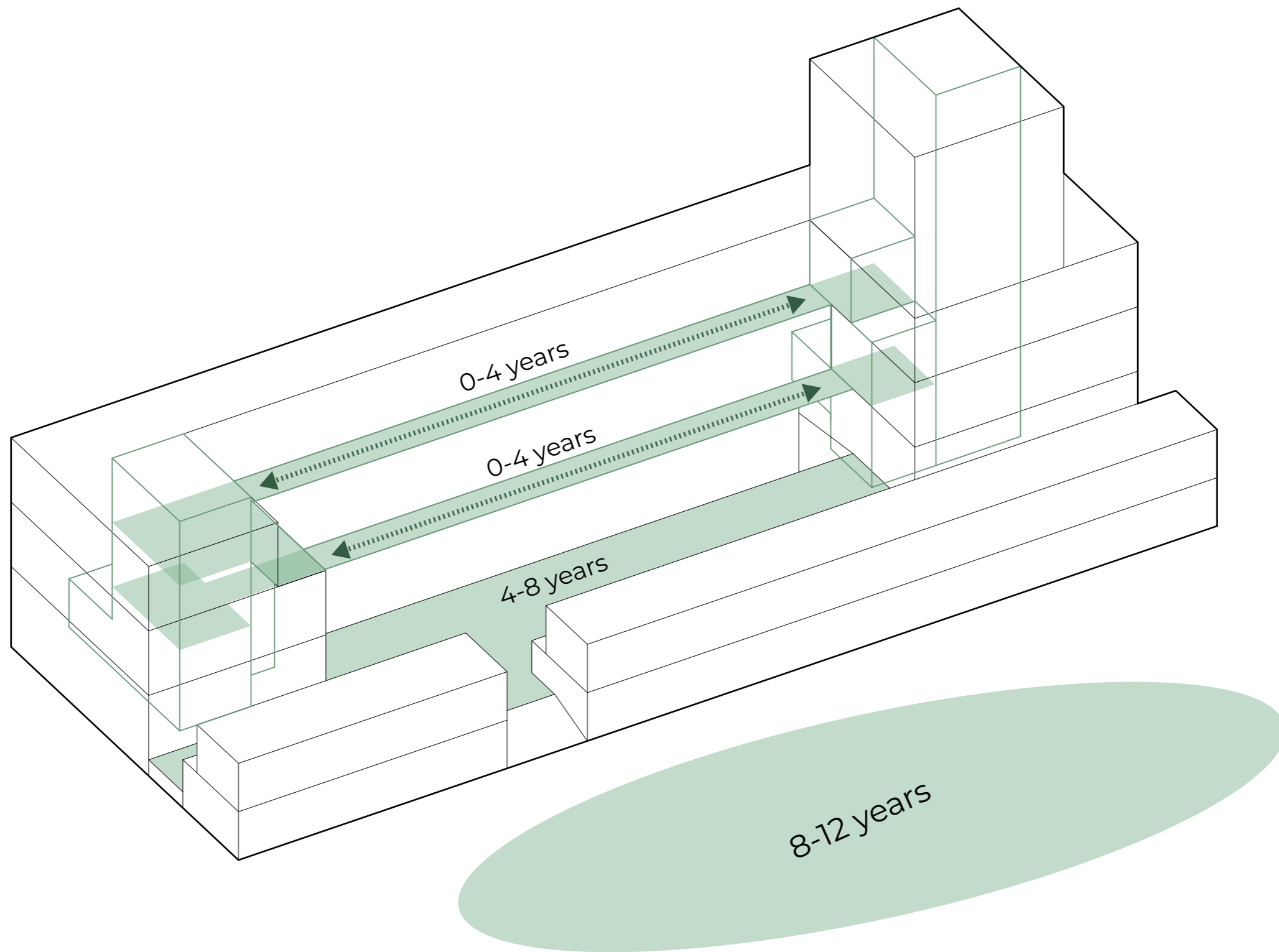

Sections

Section AA' 1:250

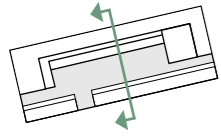

Sections

Section BB' 1:250

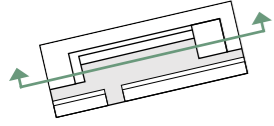

Situational drawing

Site 1:1000



Situational drawing

Site 1:500



Floorplans

Semi-basement 1:250

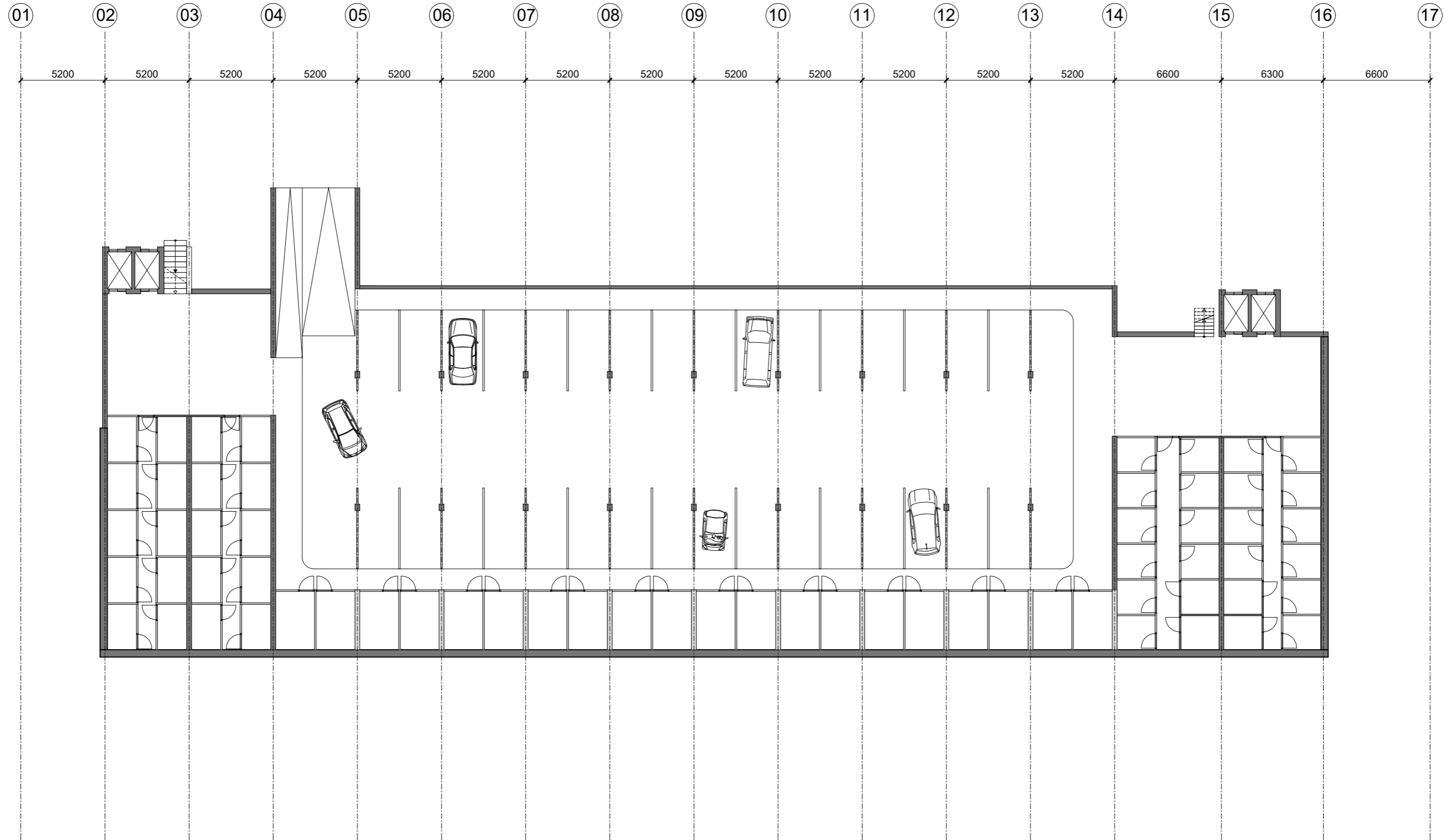

Floorplans

Ground floor 1:250

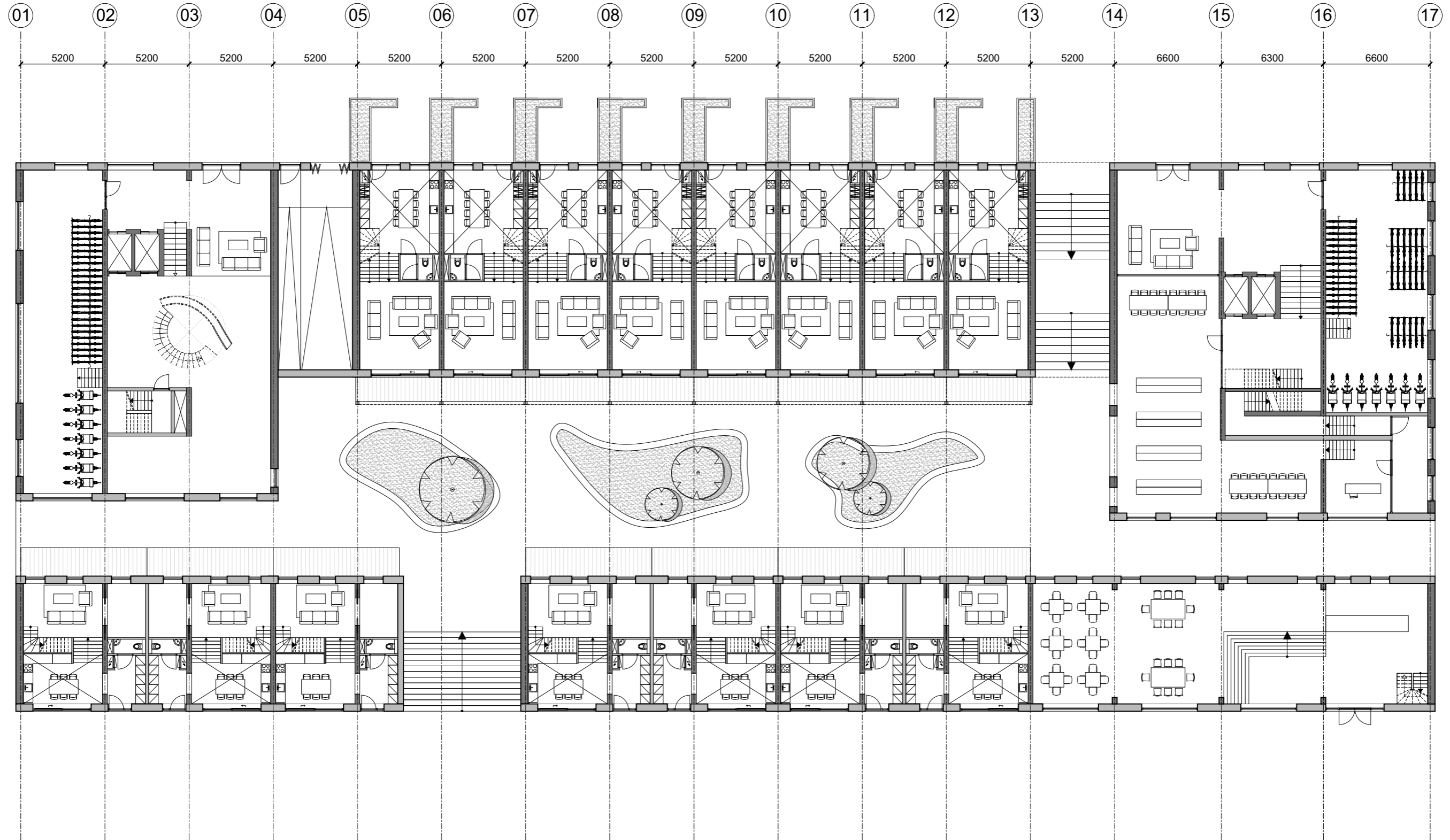

Floorplans

First floor 1:250



Floorplans

Second floor 1:250

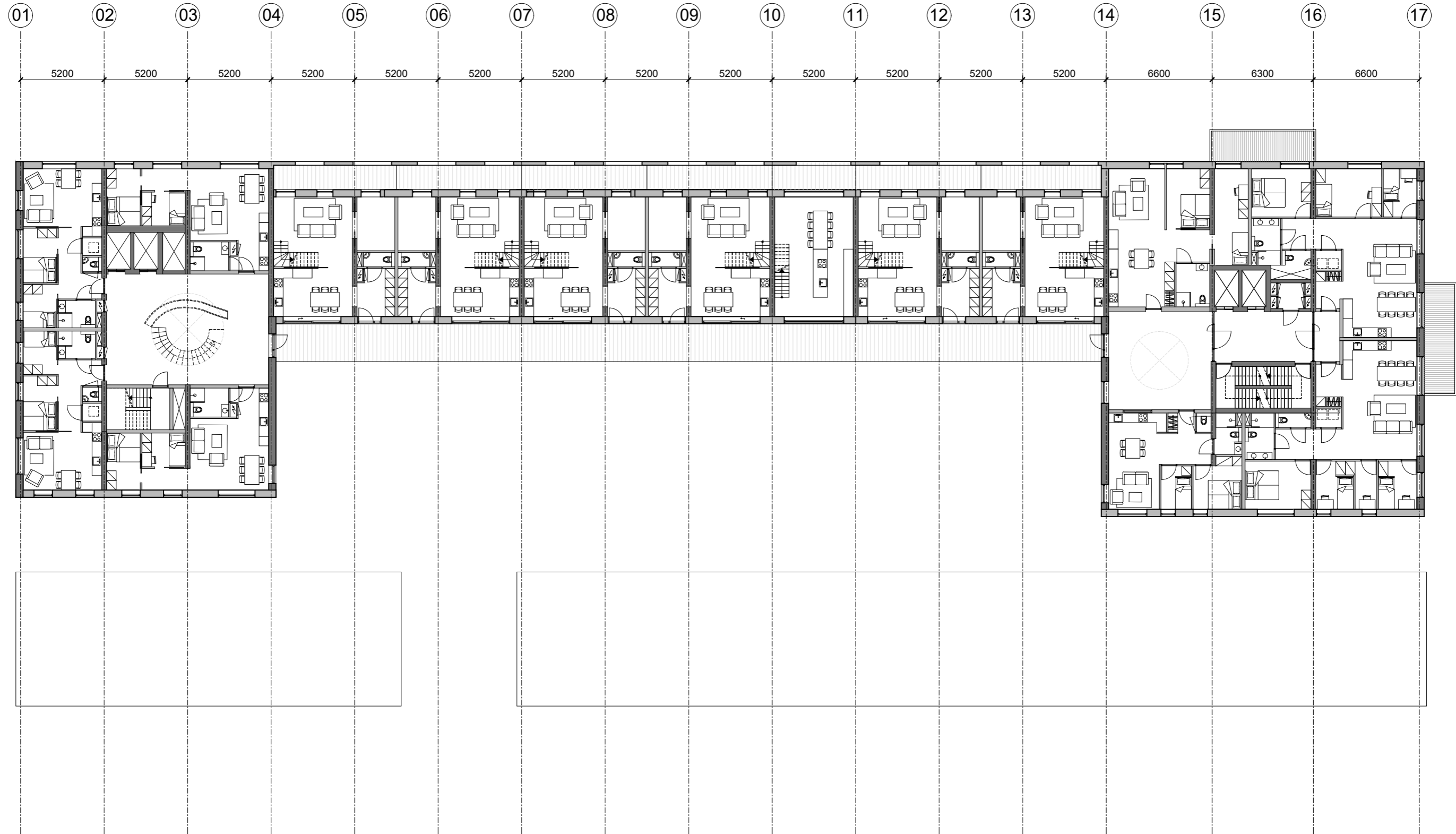

Floorplans

Fourth floor 1:250

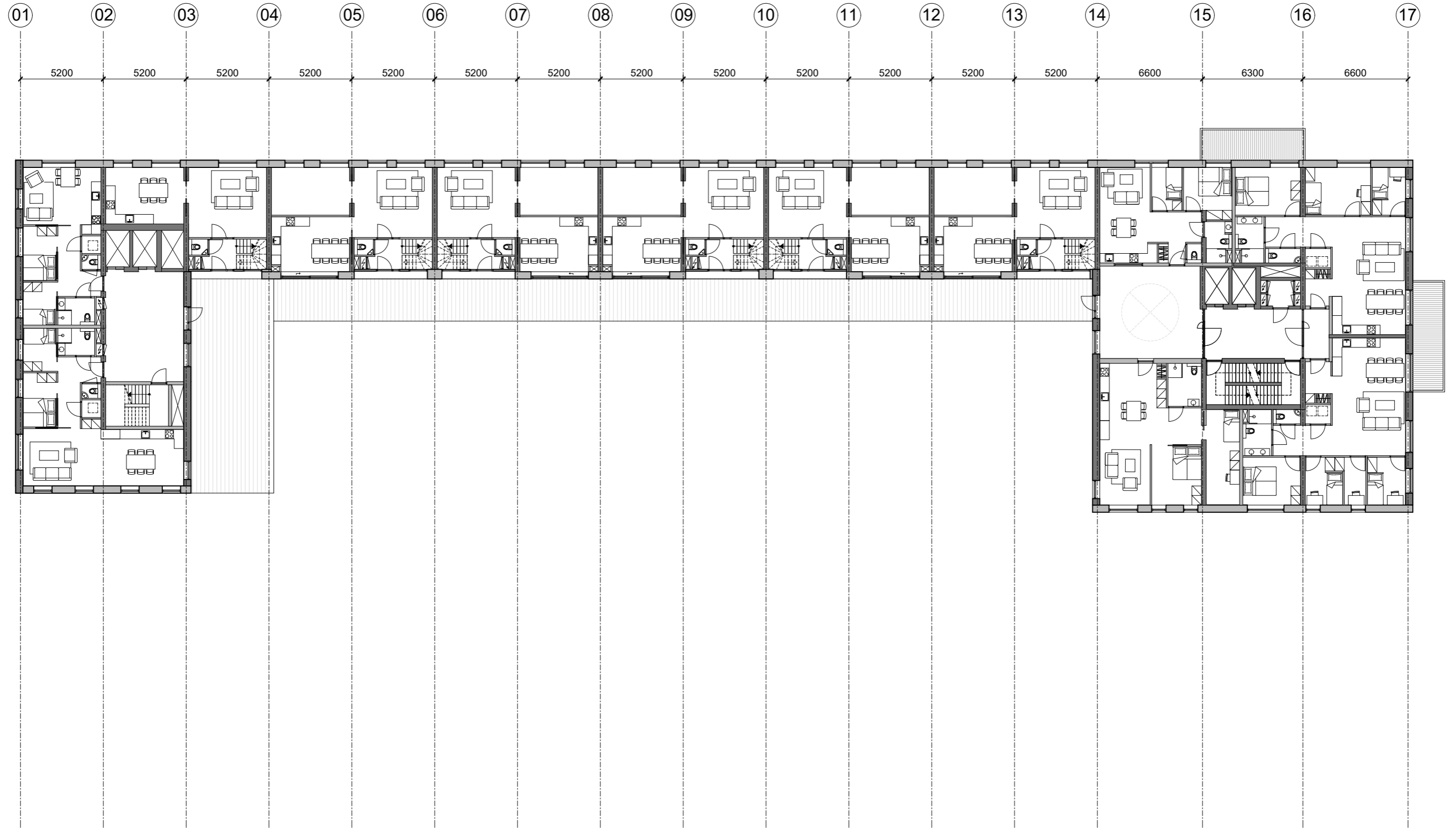

Floorplans

Sixth floor 1:250

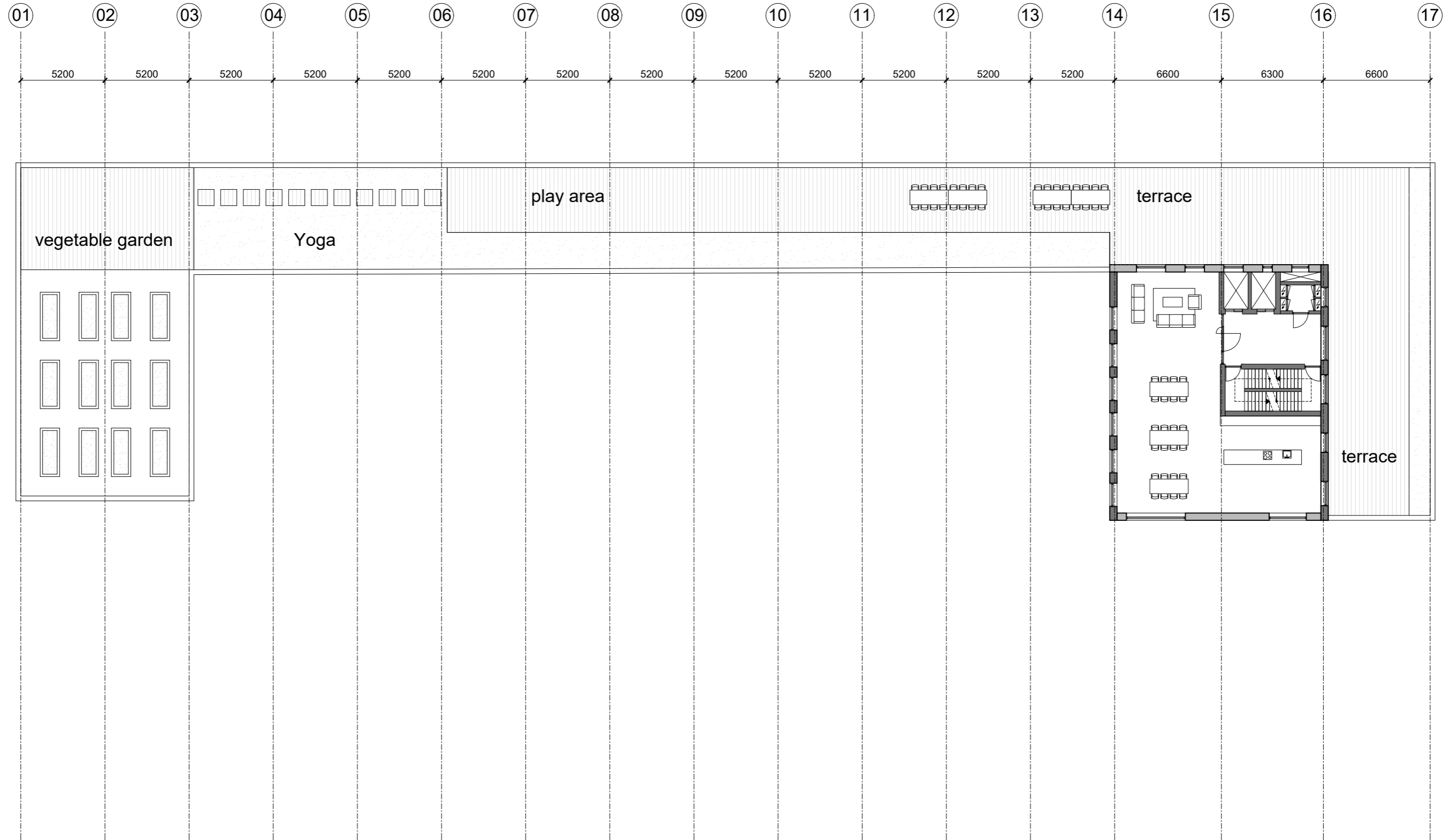

Floorplans

Seventh floor 1:250

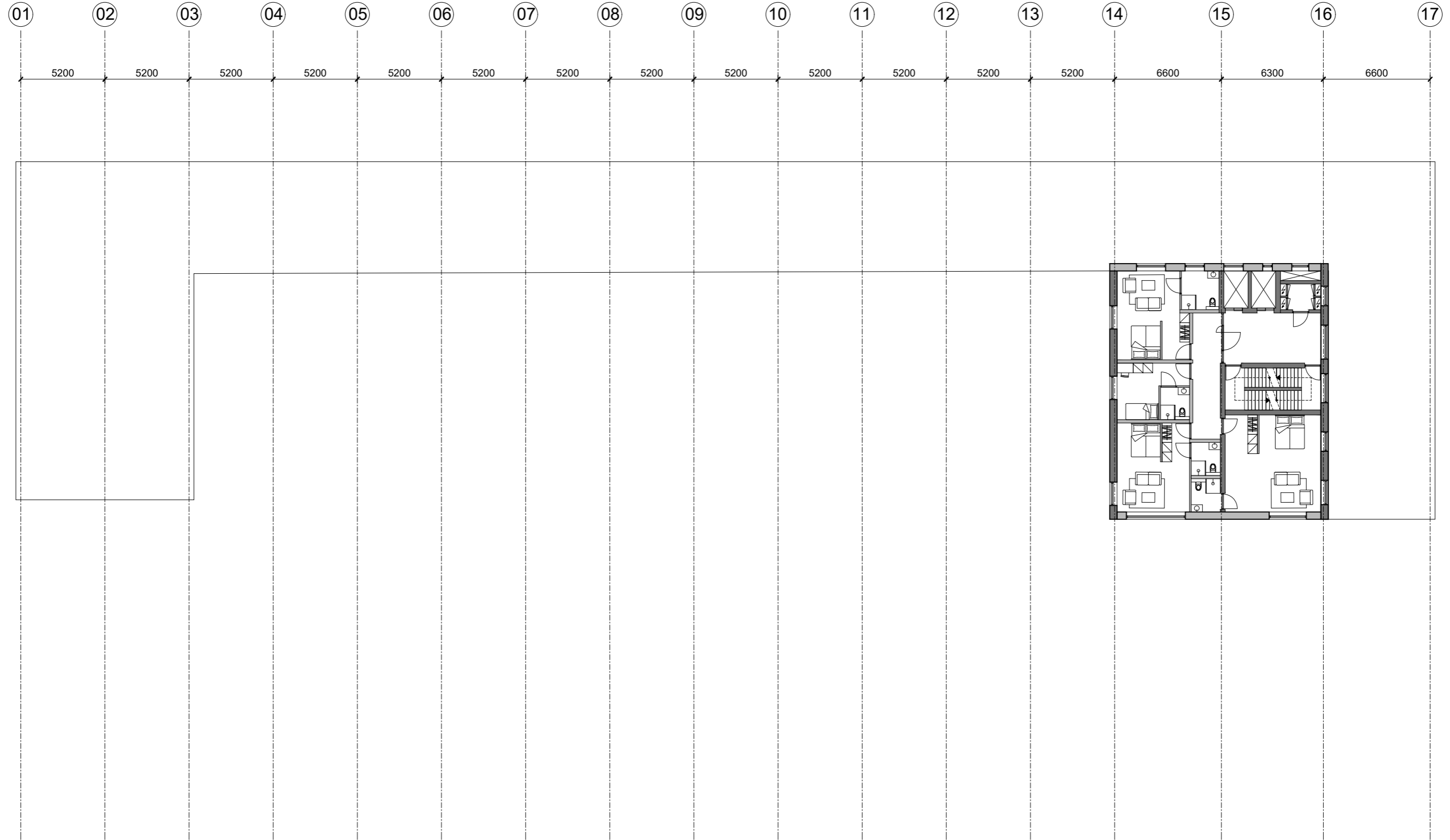

Typology

Dwelling

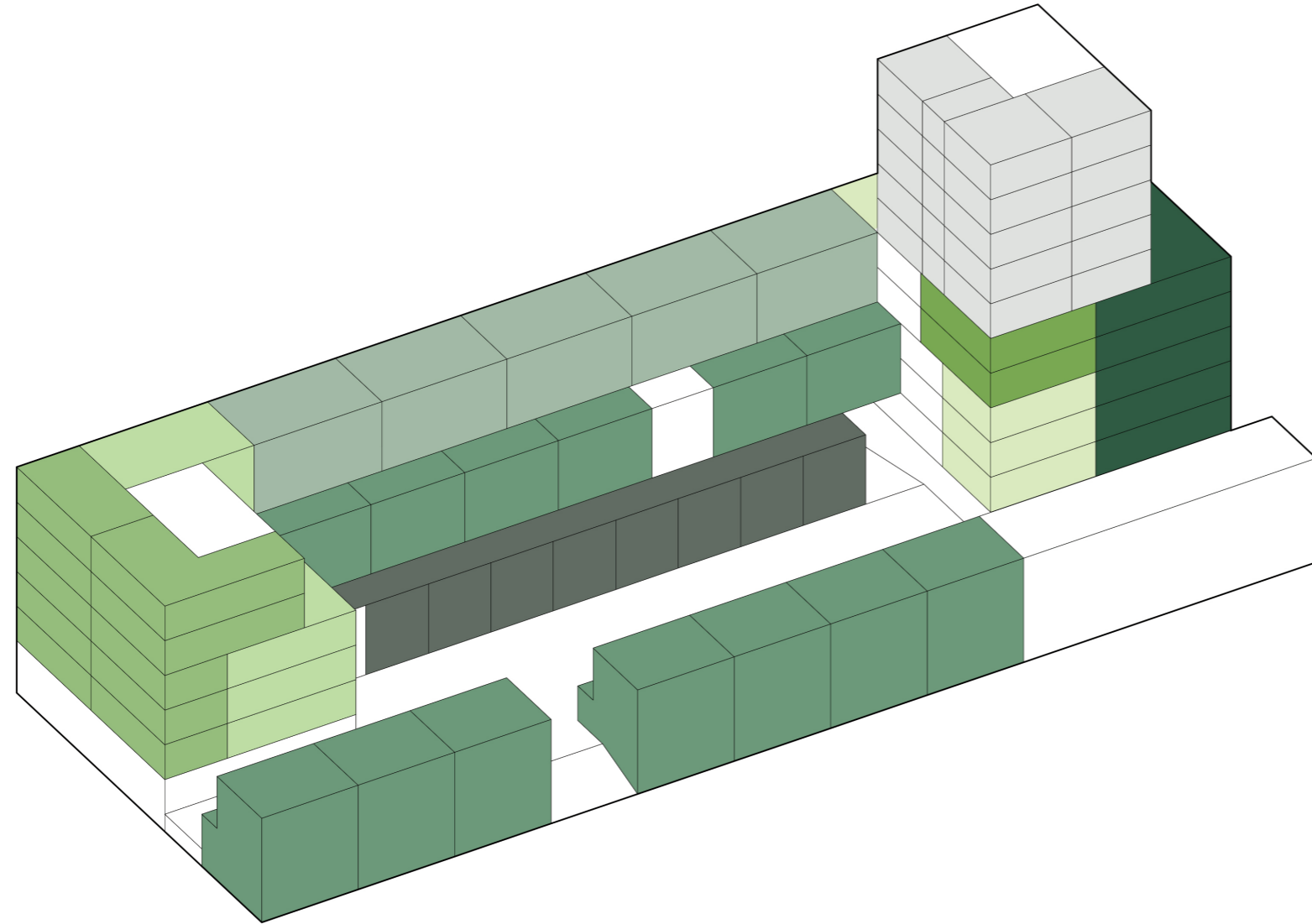

Apartment A

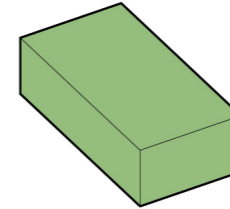

Apartment B

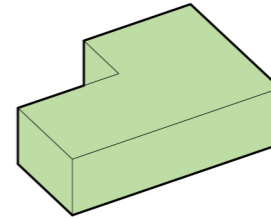

Apartment C

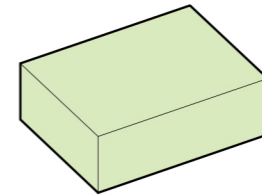

Apartment D

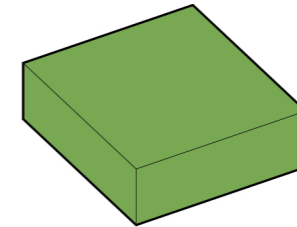

Apartment E

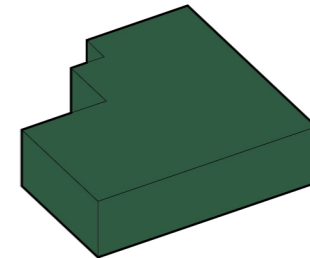

Duplex A

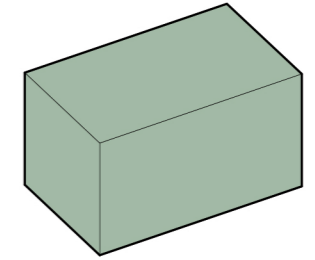

Duplex B

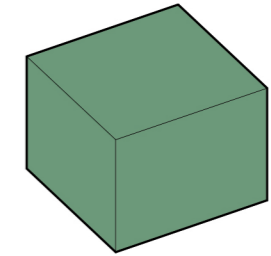

Duplex C

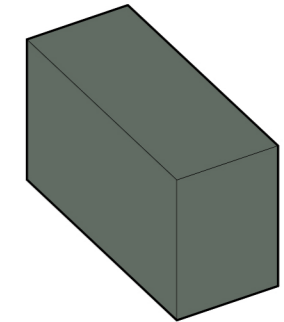

Parentshouse

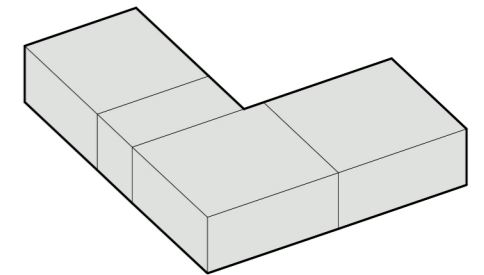

Typology

Duplexes



Dwelling types

Duplex C 1:100

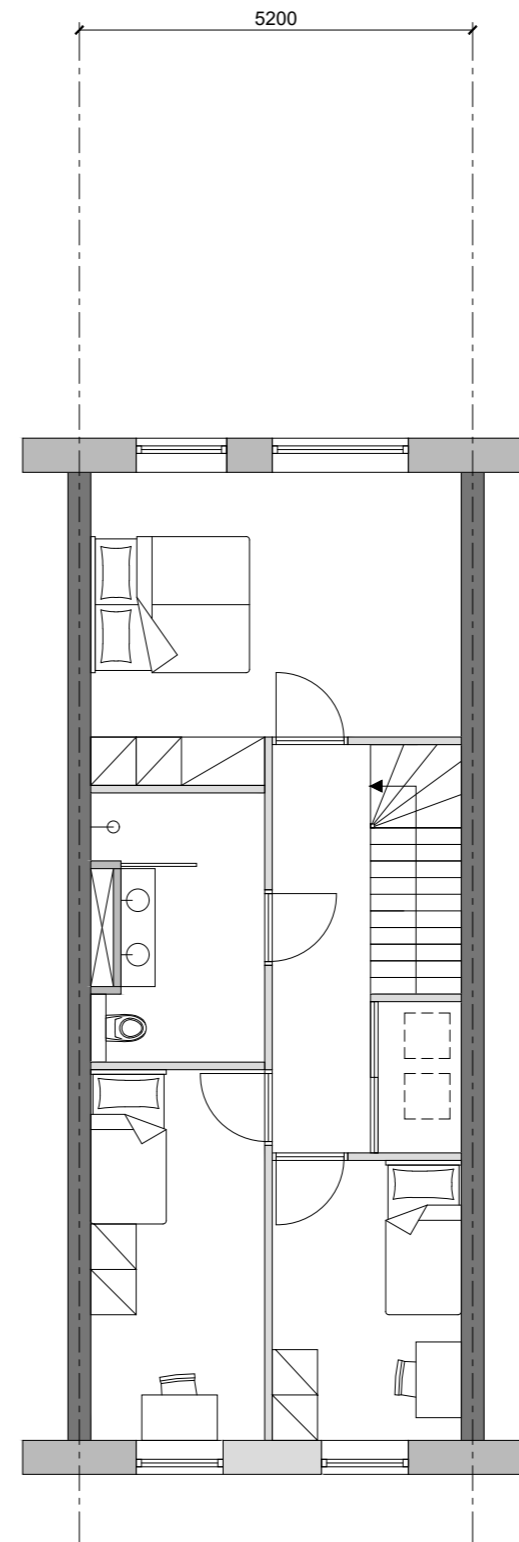
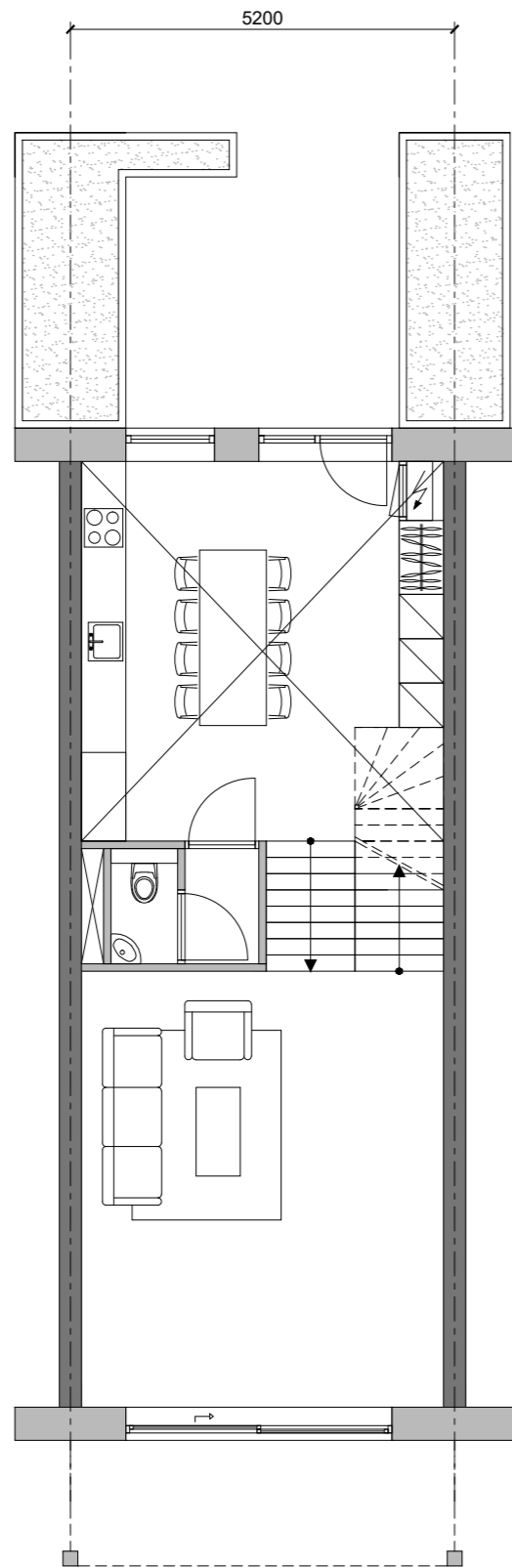

Dwelling types

Duplex B 1:100

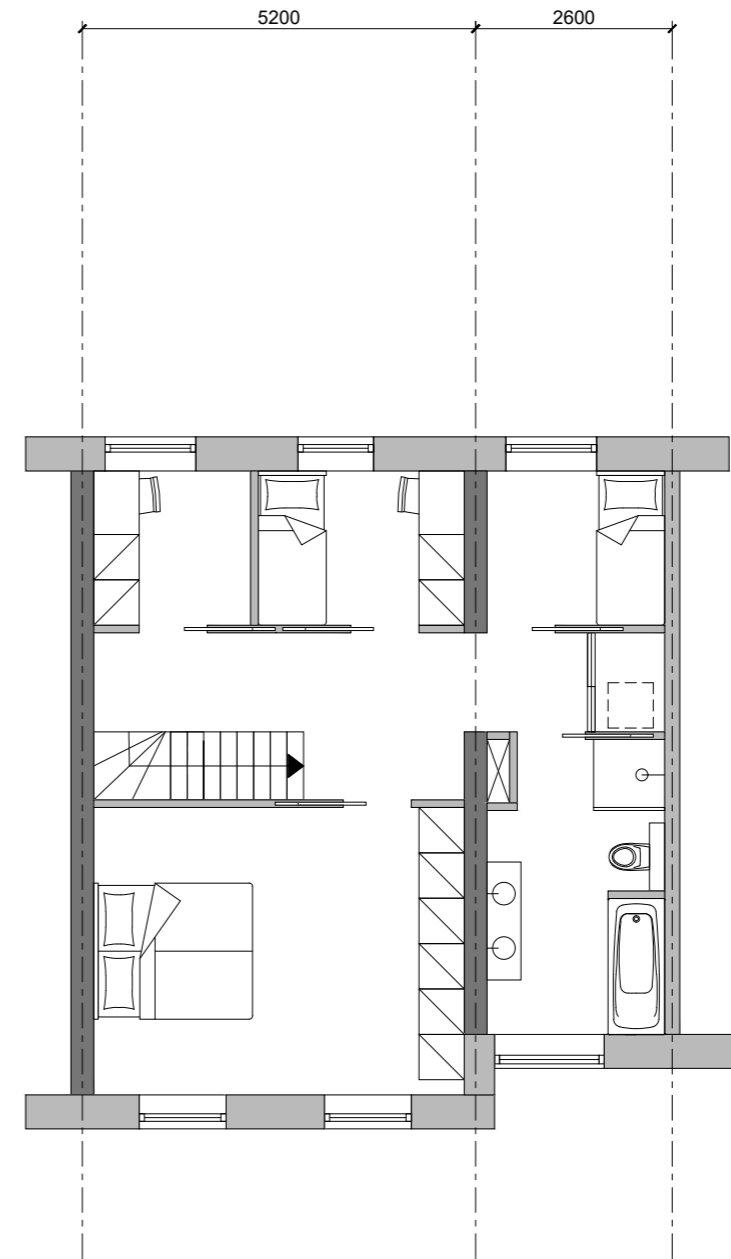
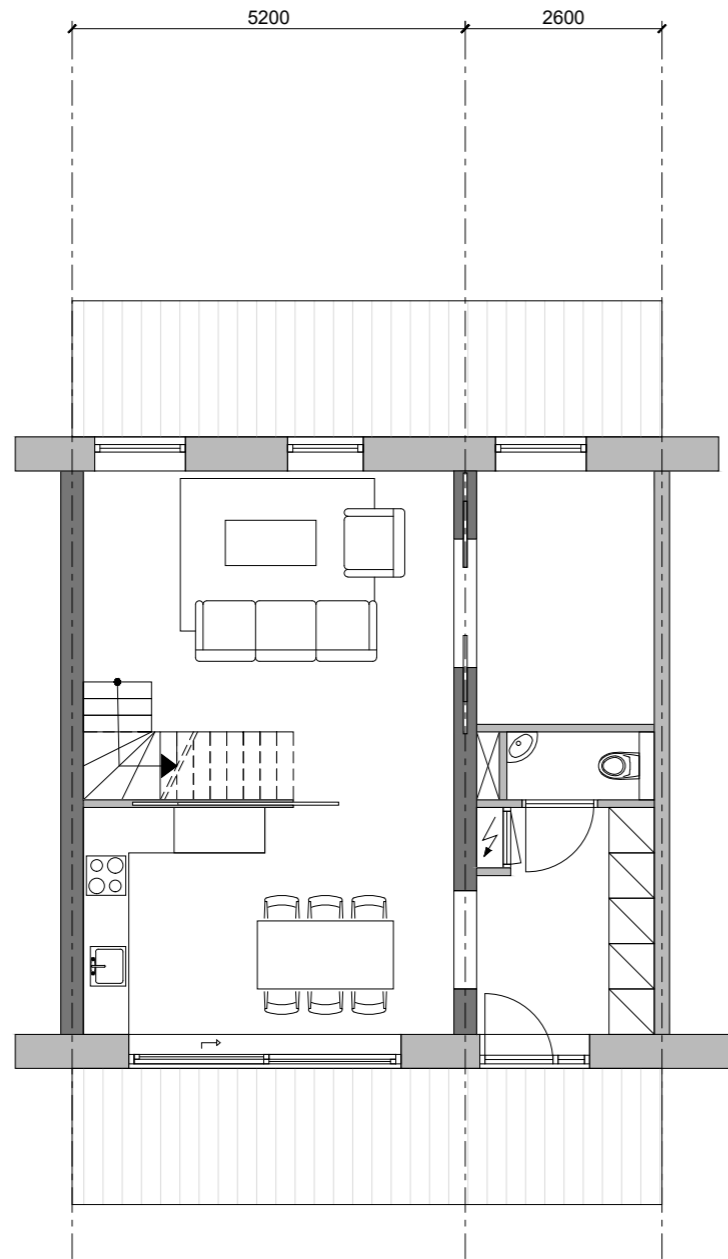

Dwelling types

Duplex A 1:100

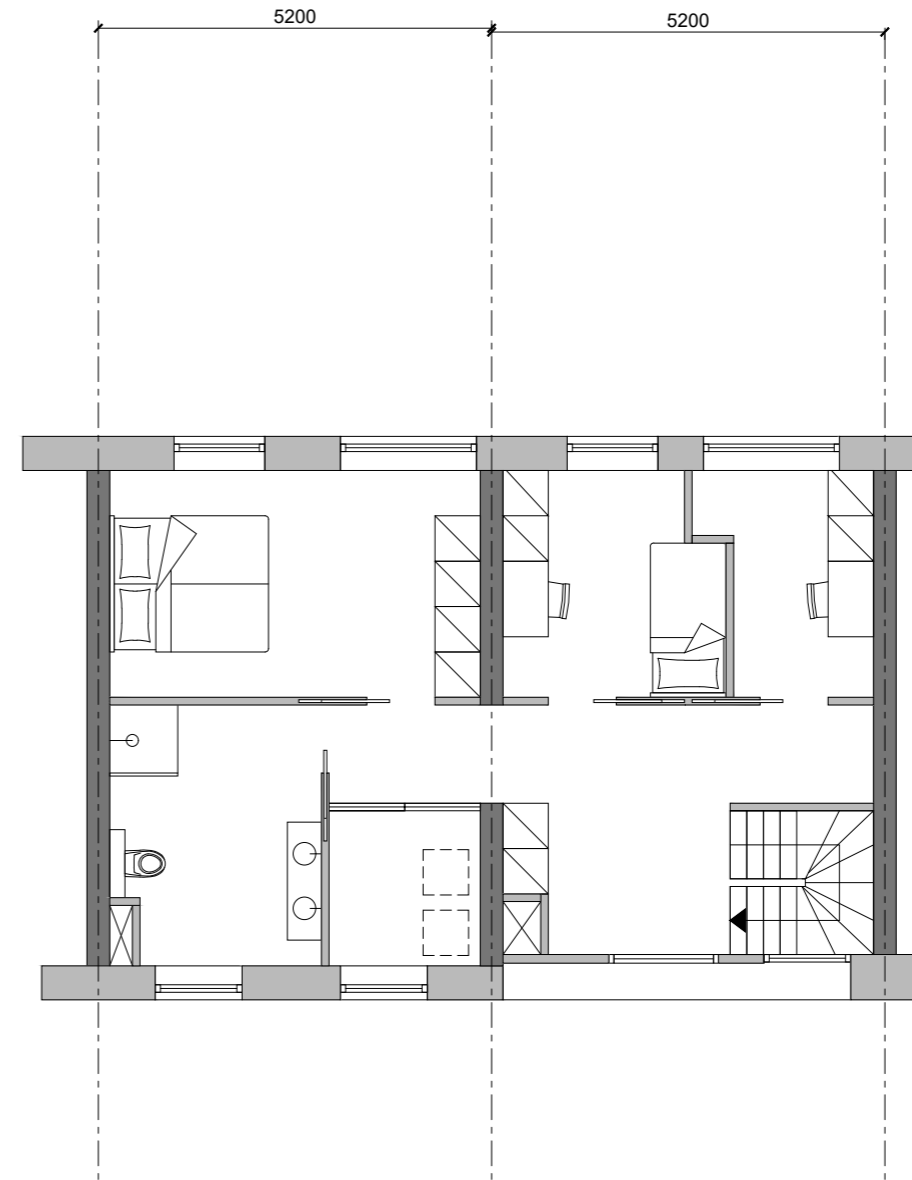
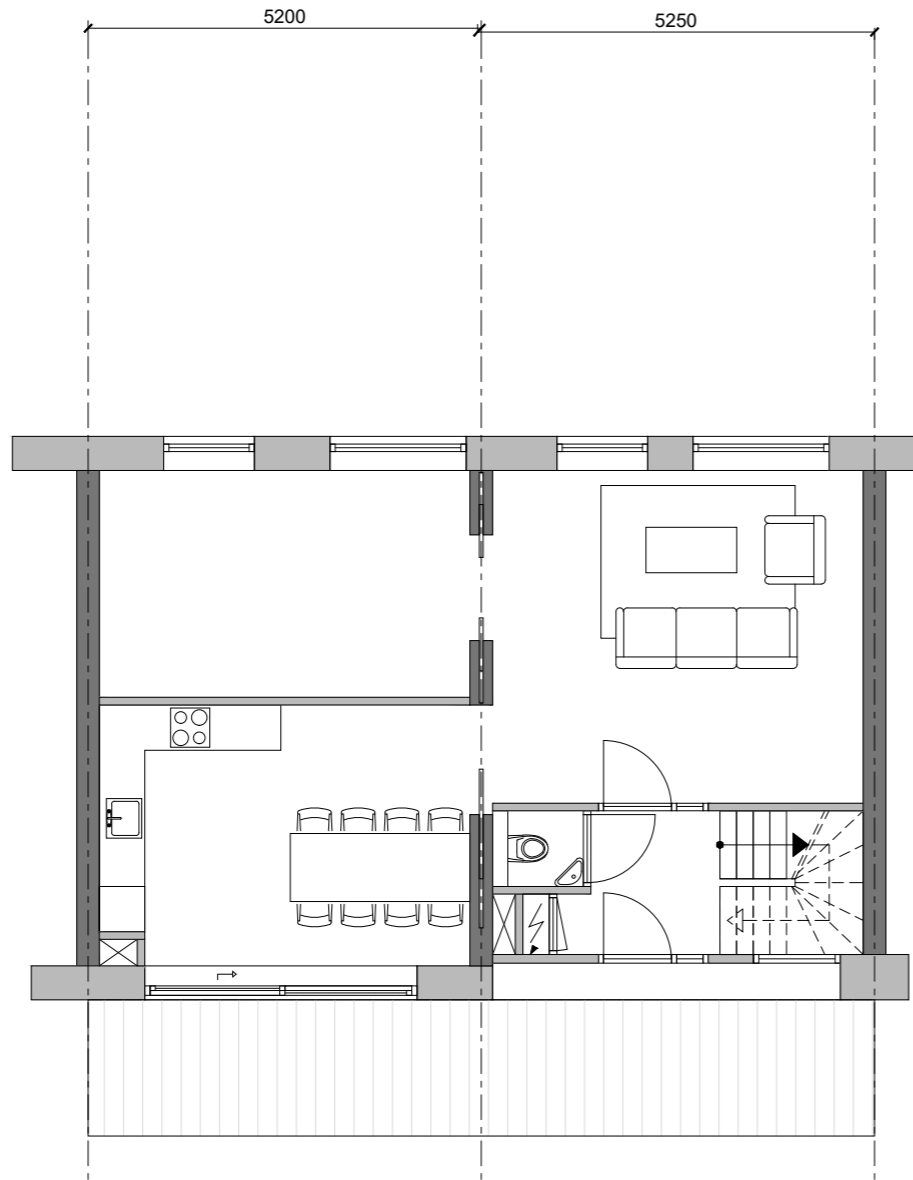

Dwelling types

Duplex B' 1:100

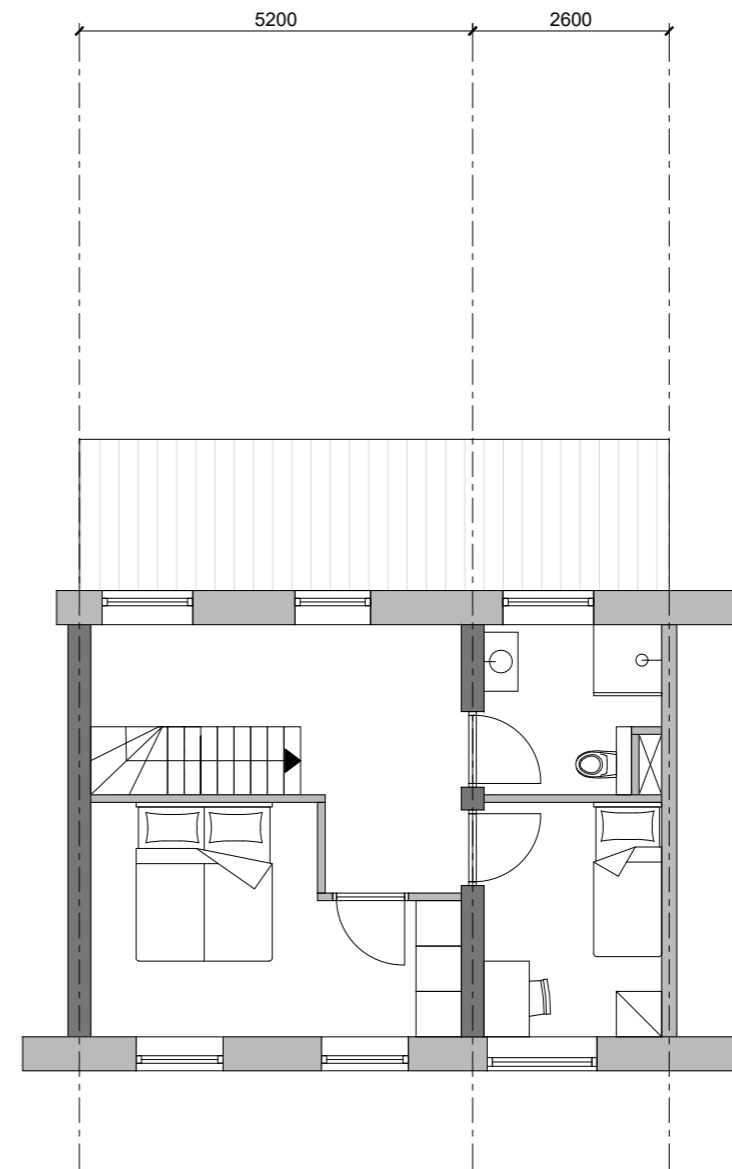
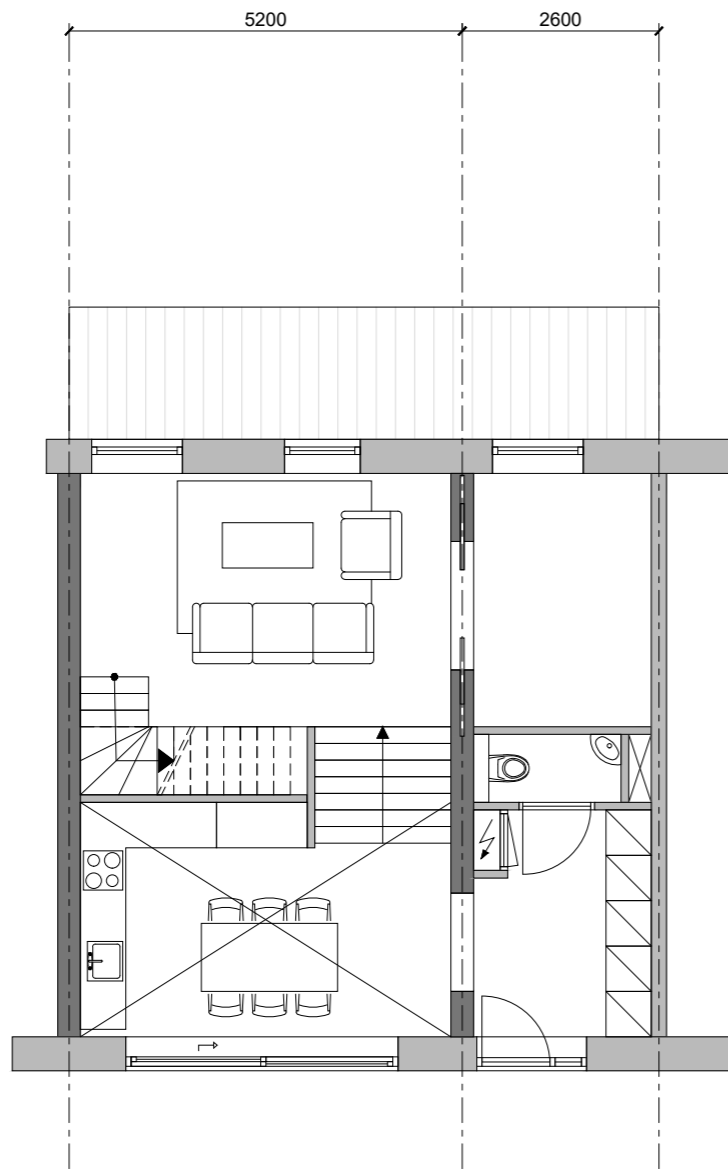

Typology

Apartments



Dwelling types

Apartments 1:100

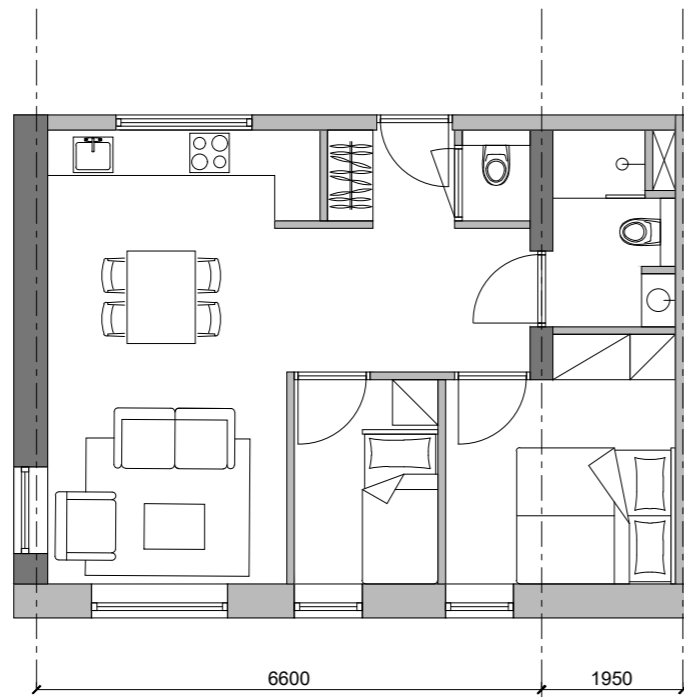

apartment C

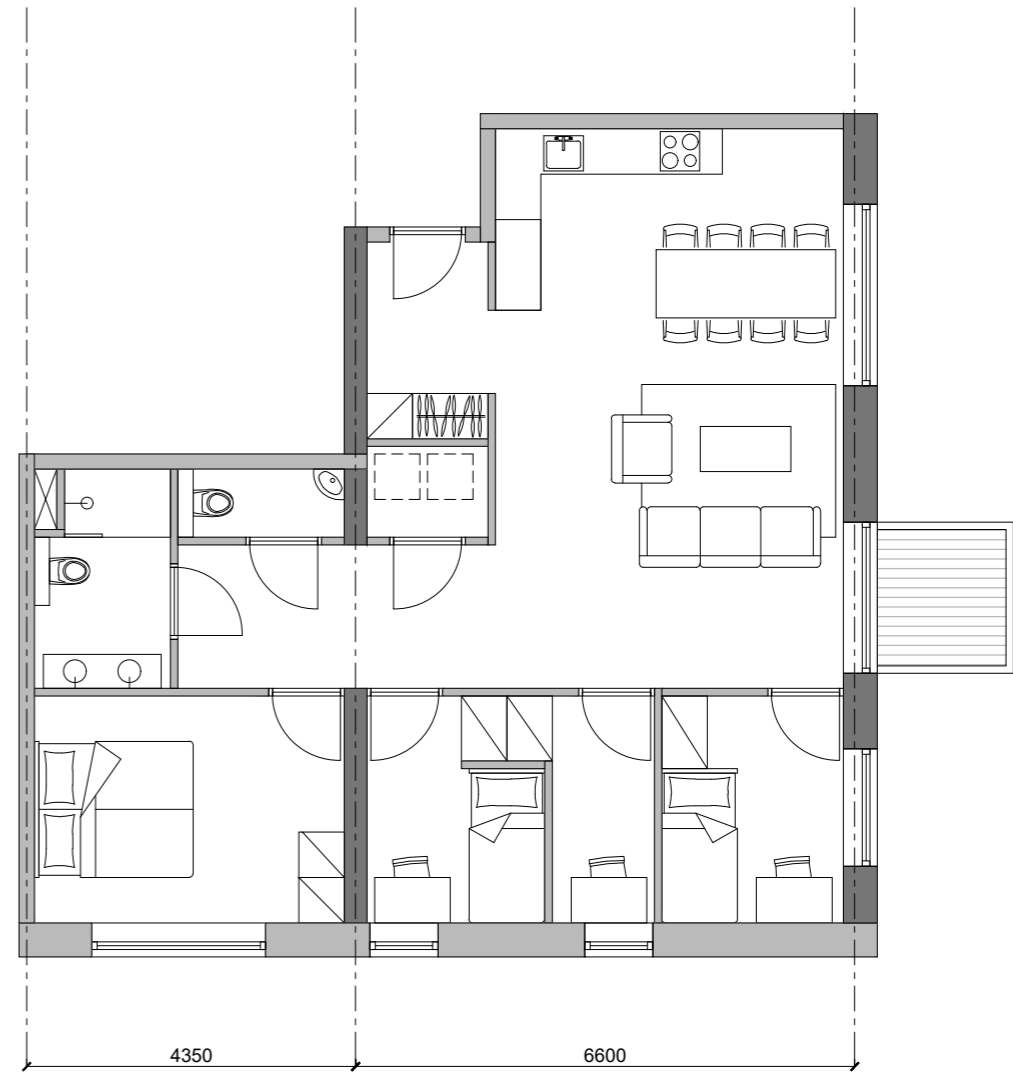

apartment E

Dwelling types

Apartments 1:100

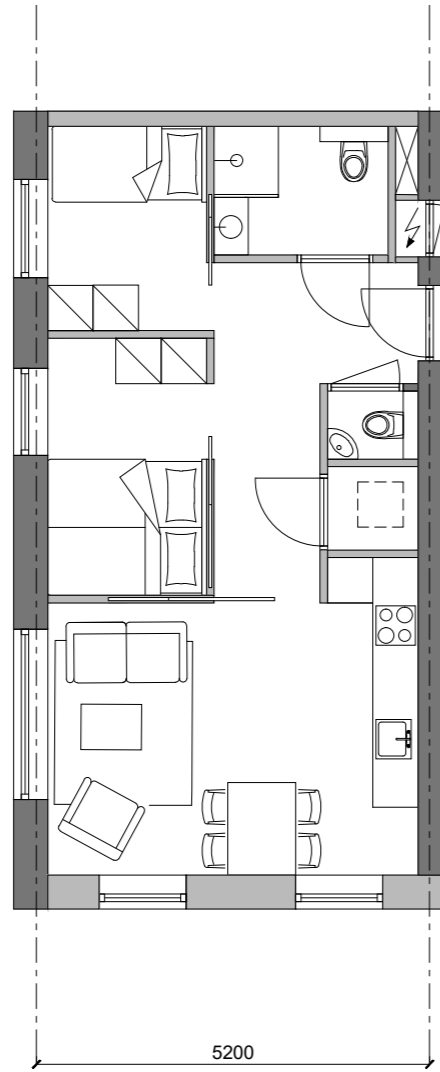

apartment A

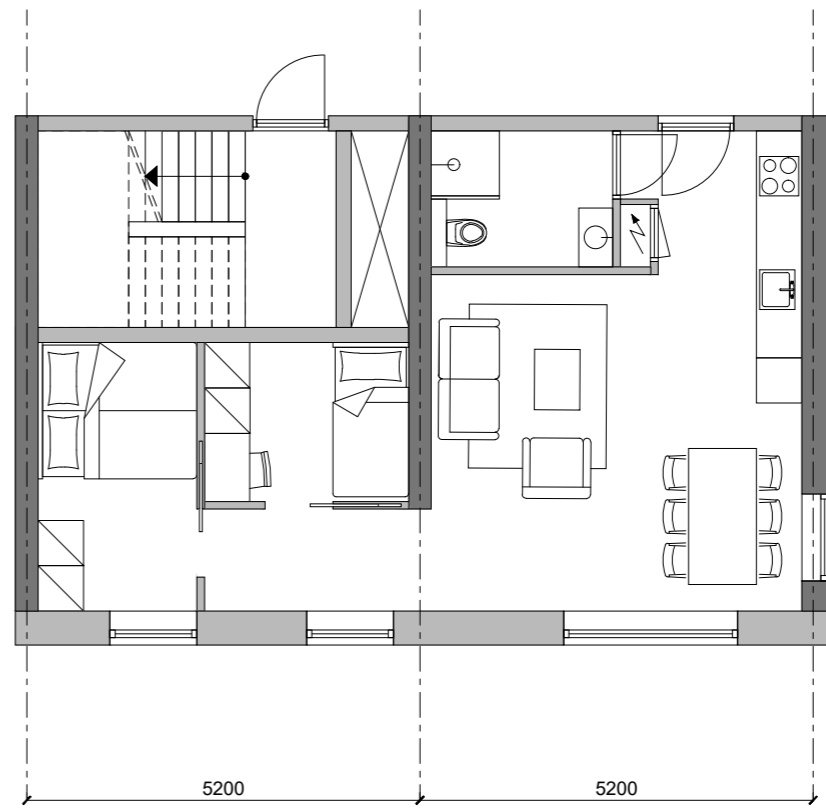

apartment B

Facade

North west facade 1:250



Facade

North east facade 1:250



Facade

South west facade 1:250



Facade

South east facade 1:250



Facade

Internal facade 1:250



Building technology

Facade fragment 1:50

13500 + P



10500 + P

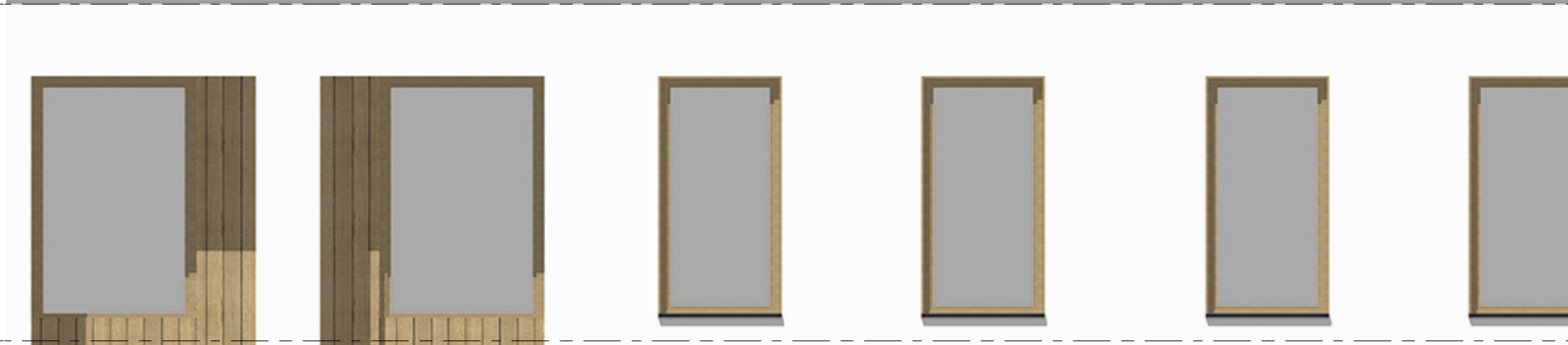

7500 + P



Building technology

Facade fragment 1:50

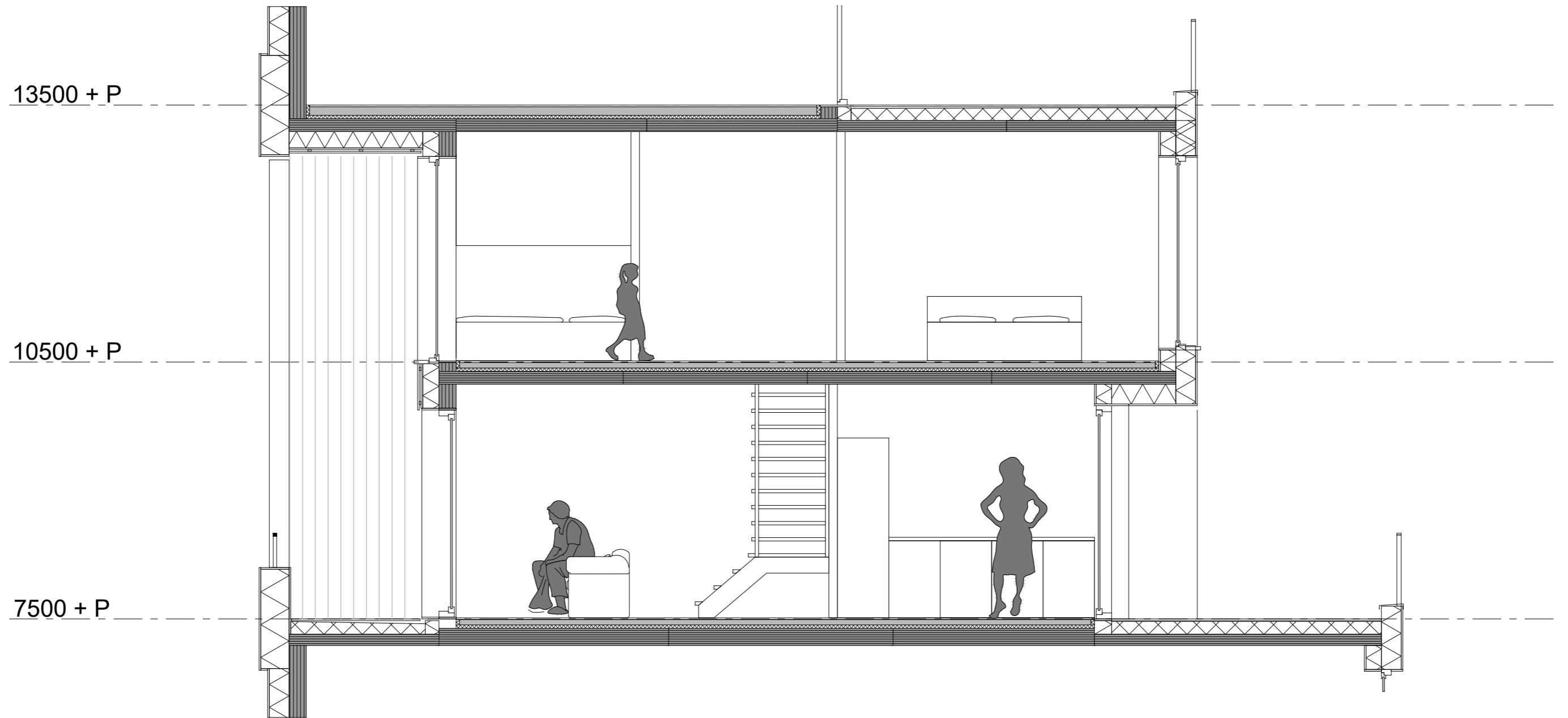

Building technology

Floorplan 1:50

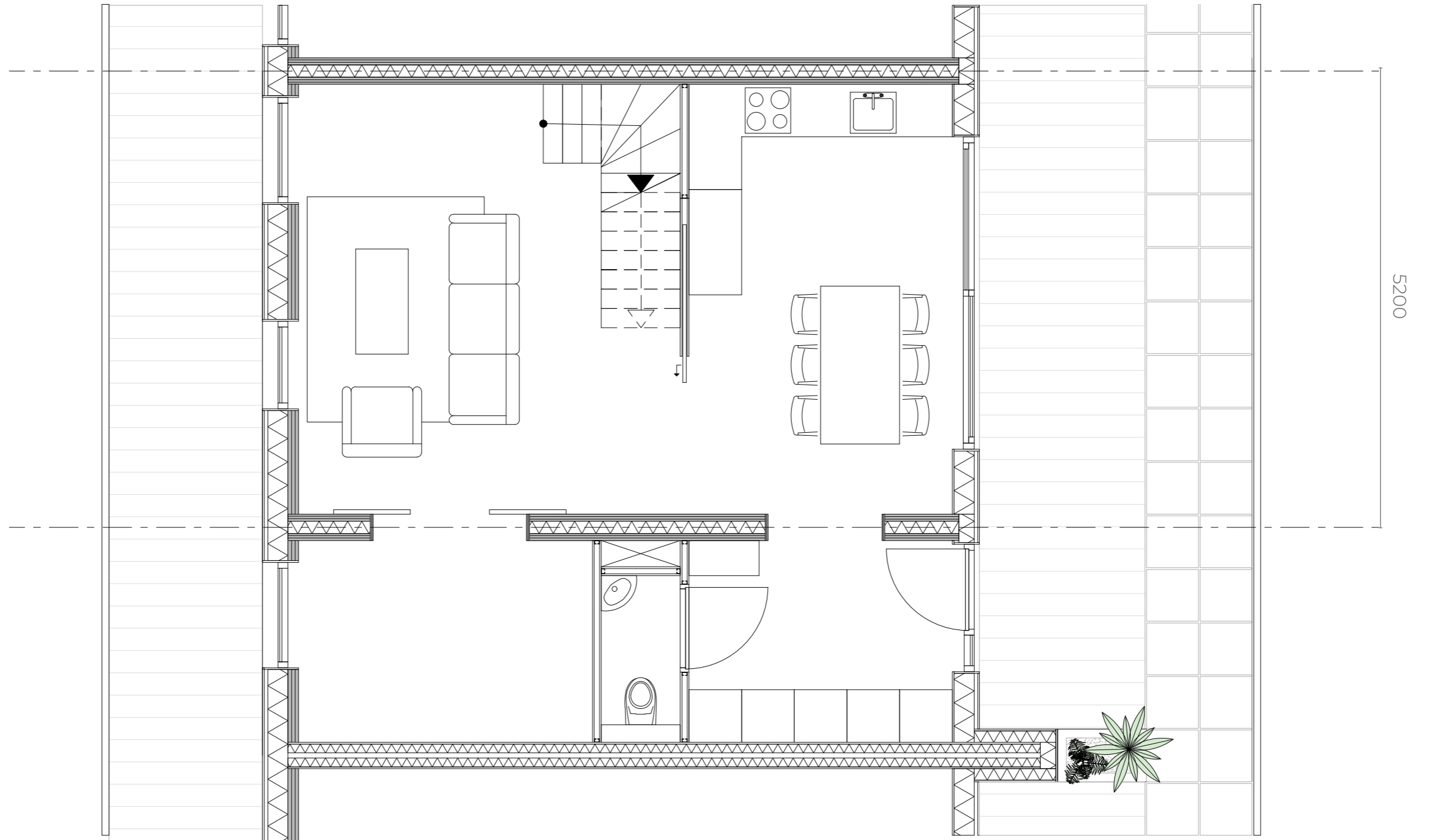

Building technology

Floorplan 1:50

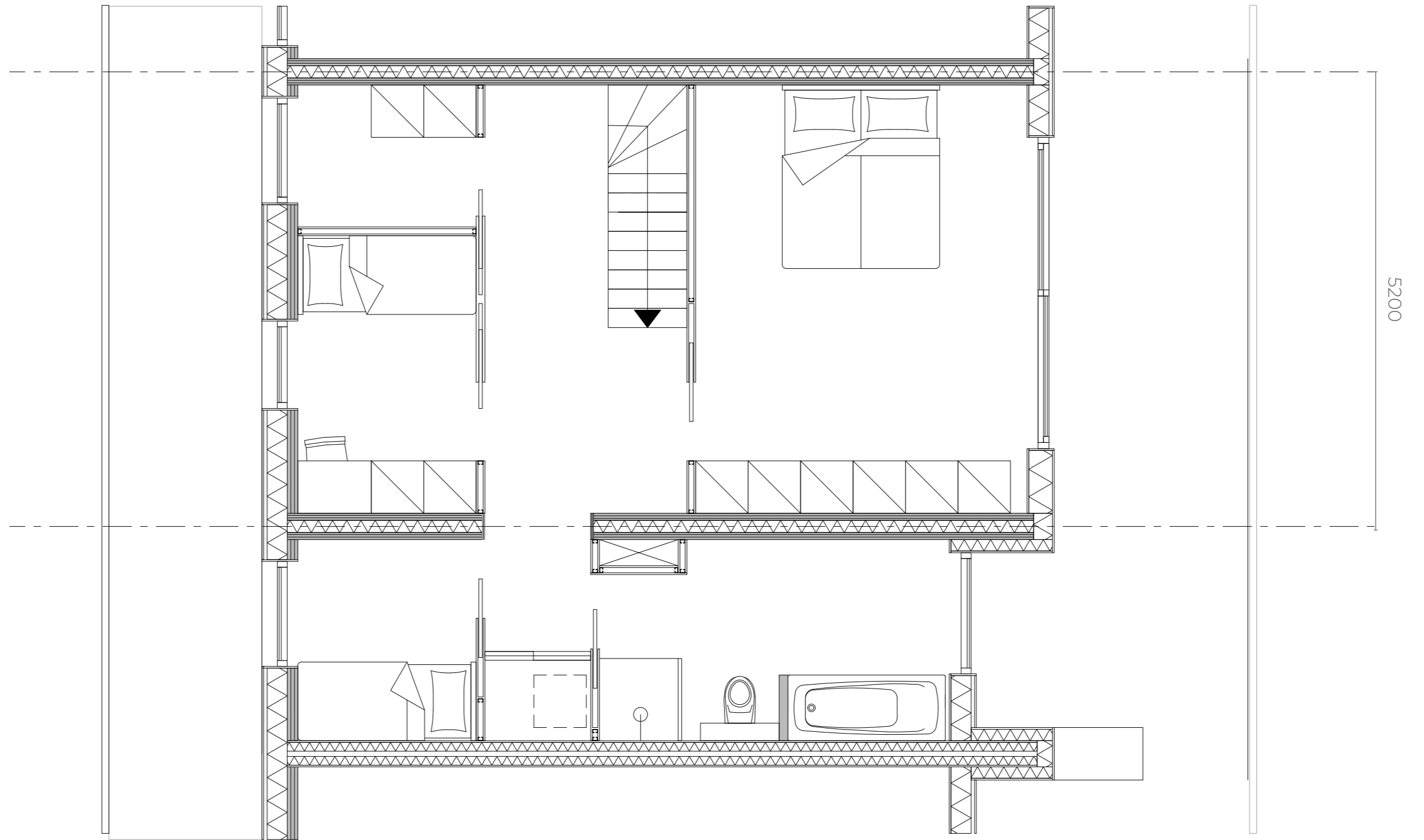

Building technology

Detail A 1:5

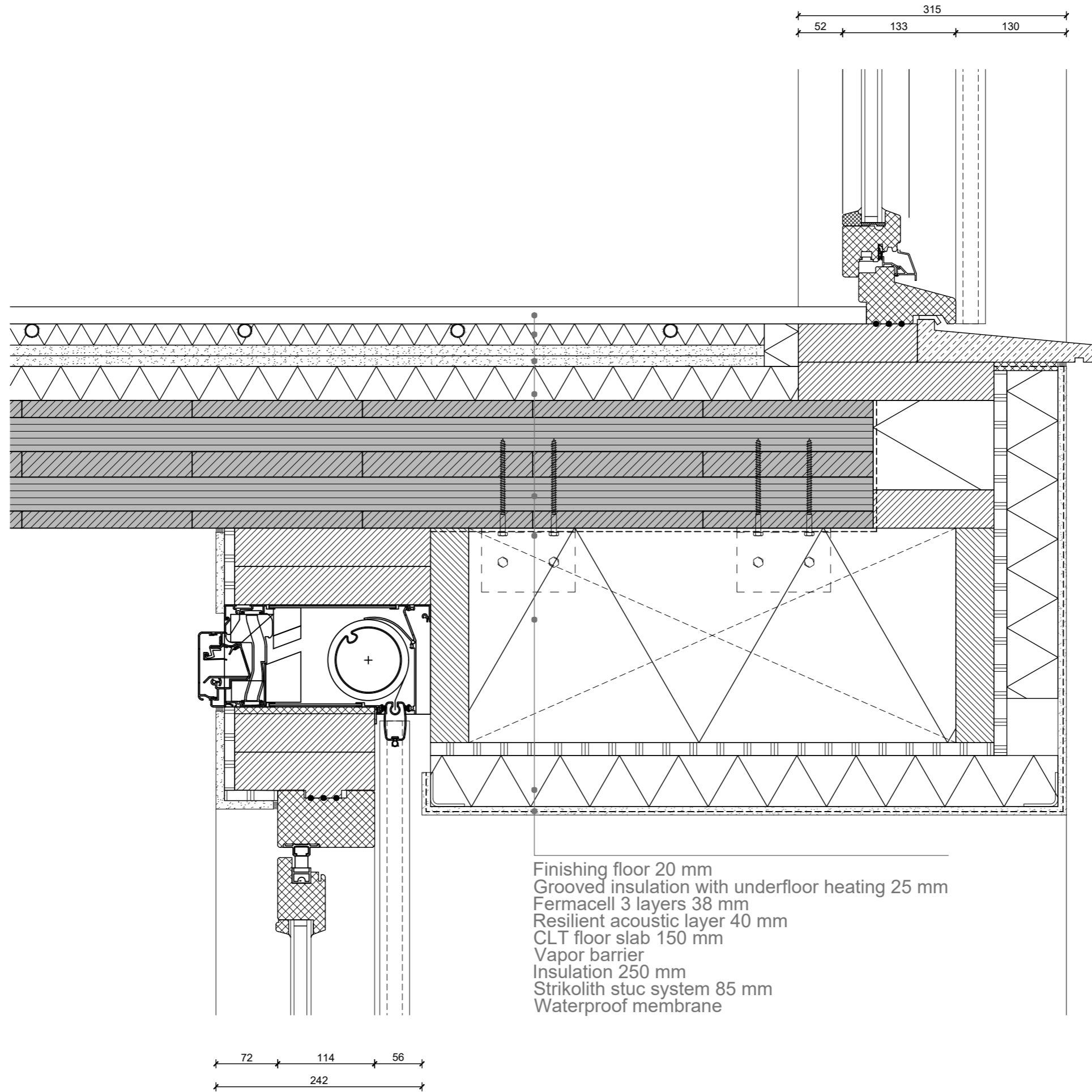

Building technology

Detail B 1:5

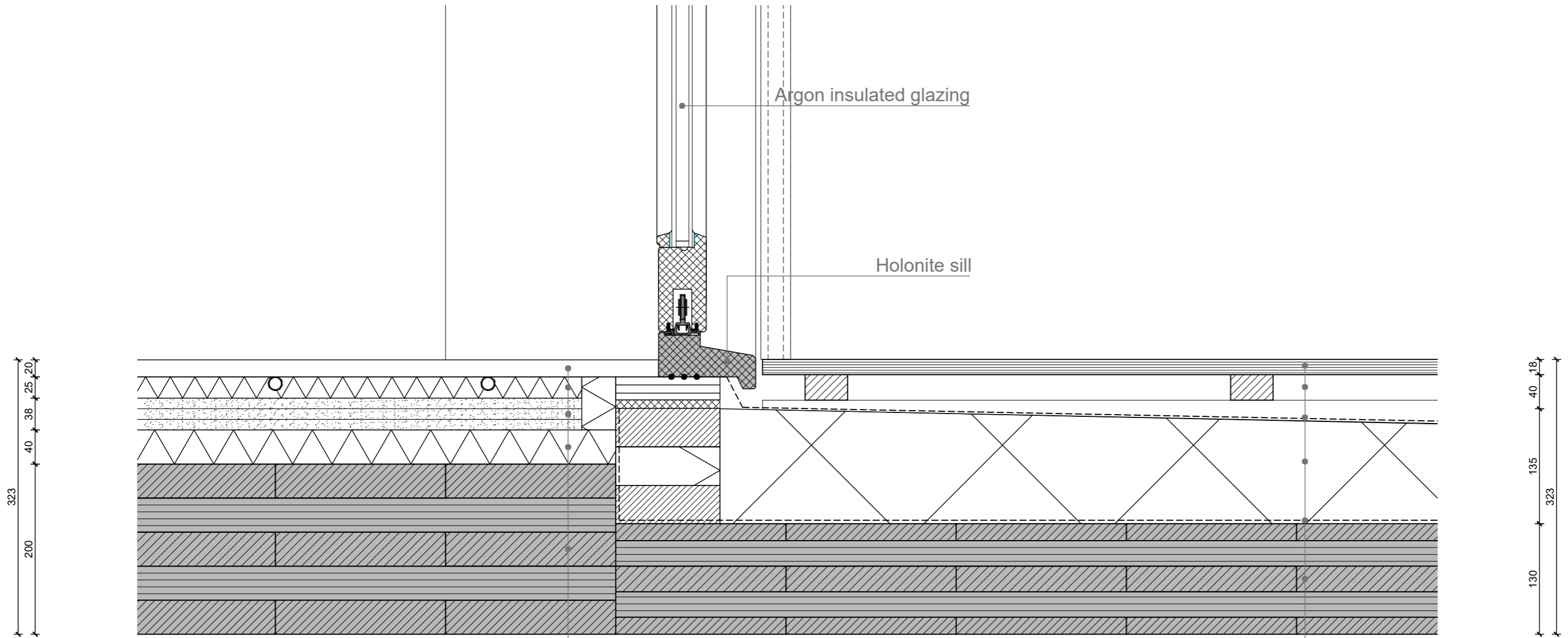

Finishing floor 20 mm
Grooved insulation with underfloor heating 25 mm
Fermacell 3 layers 38 mm
Resilient acoustic layer 40 mm
CLT floor slab 200 mm

Timber deck 18 mm
Timber structure 30 mm
Waterproof membrane
OPTIM-R Insulation 142 mm
Vapor barrier
CLT floor slab 135 mm

Building technology

Detail C 1:5

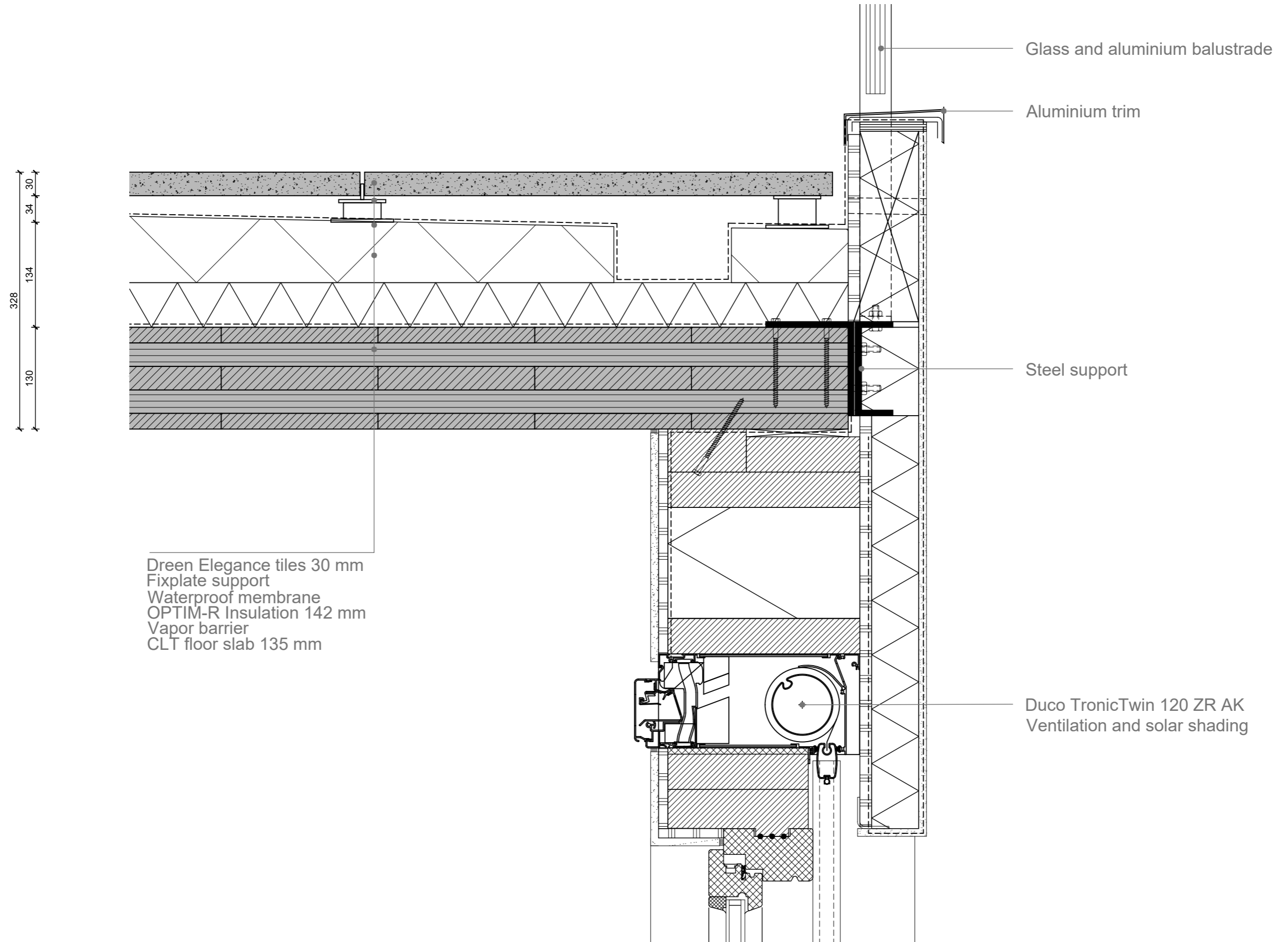

Building technology

Detail D 1:5

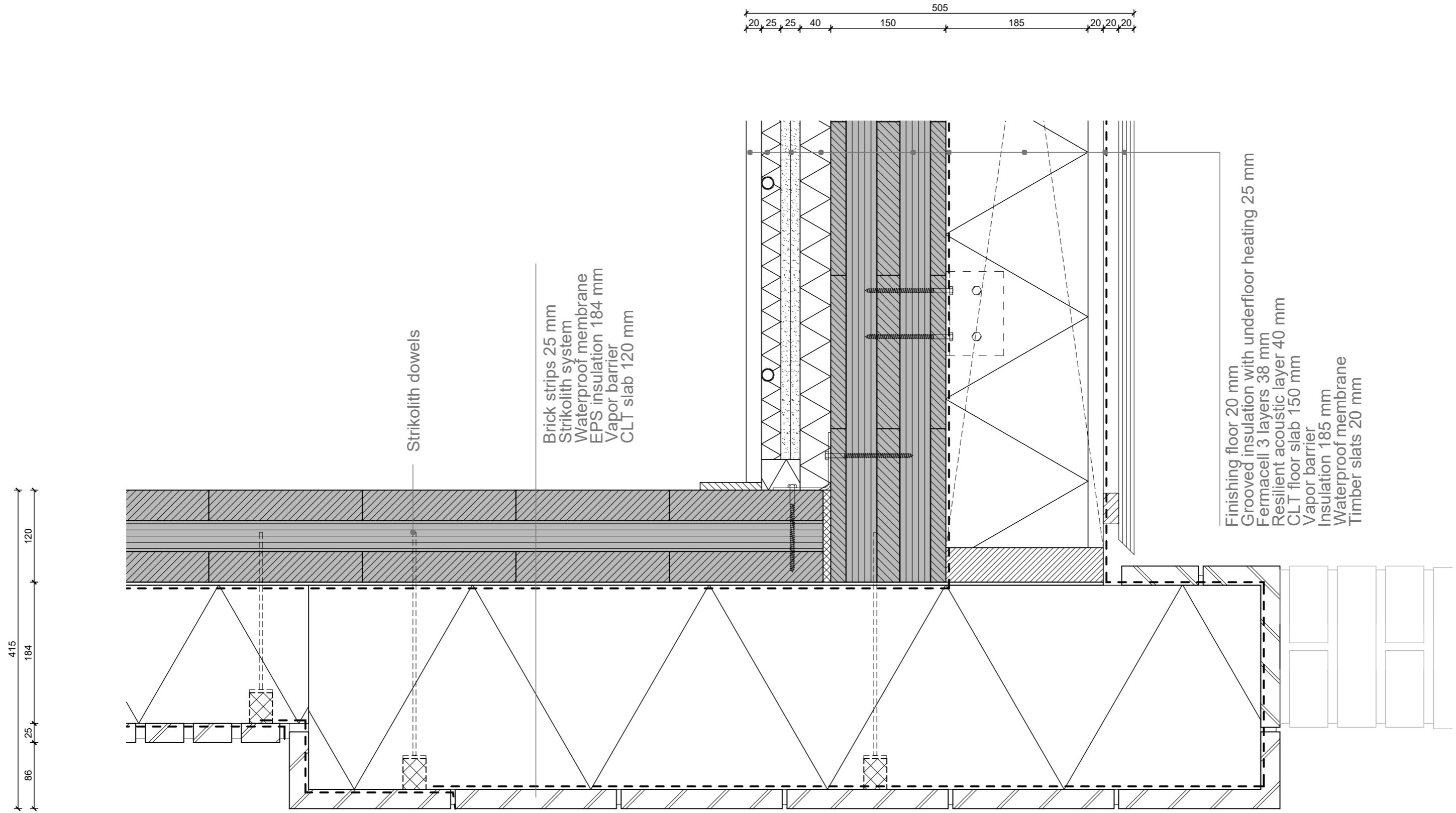

Structure

Construction diagram

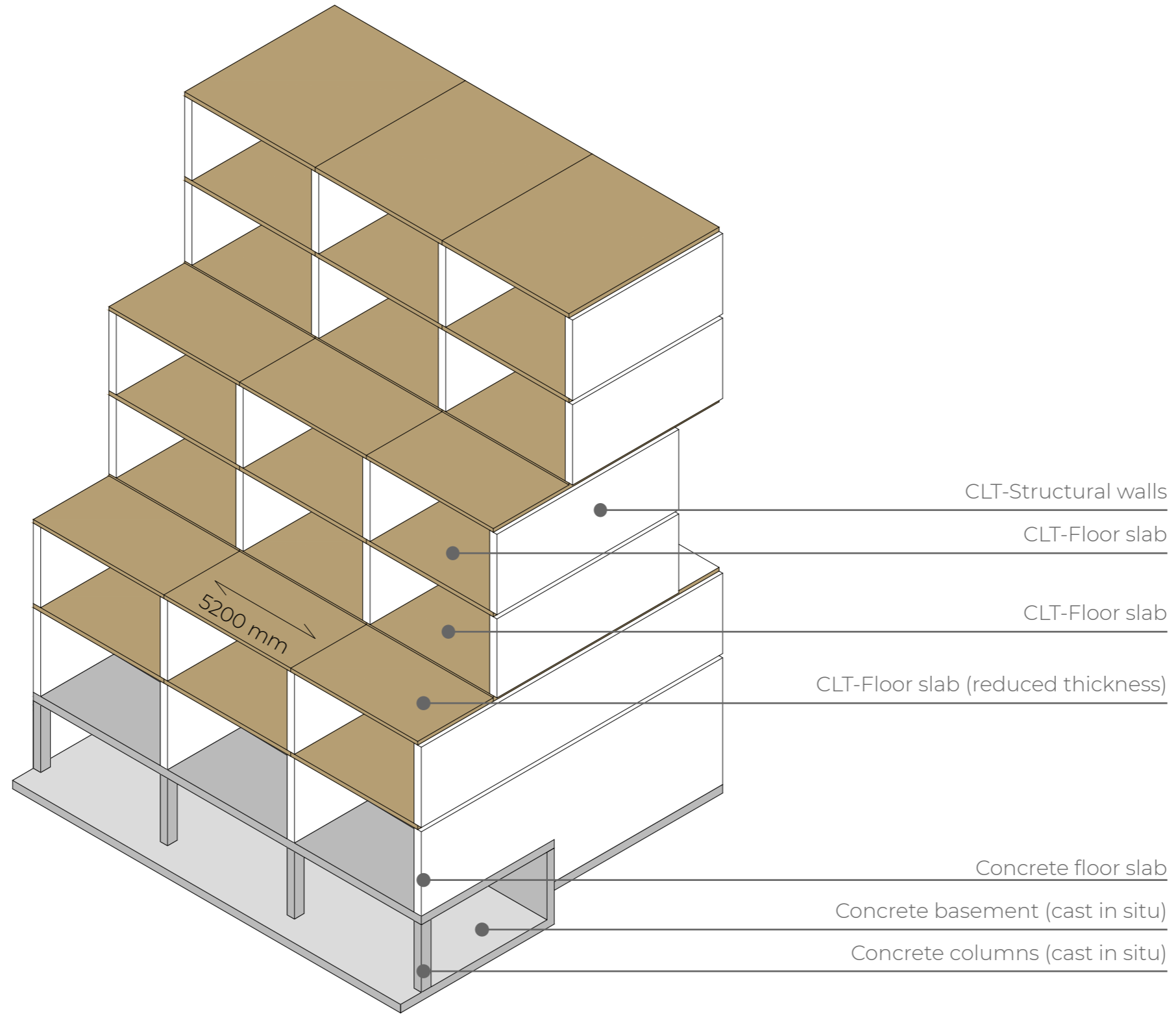

Climate

Climate principles

