

MSc 3 & 4 Public Realm Studio, Ankara| “EUtopia Ankara”

A Living Laboratory

CITY & BORDERS



OPEN SPACES





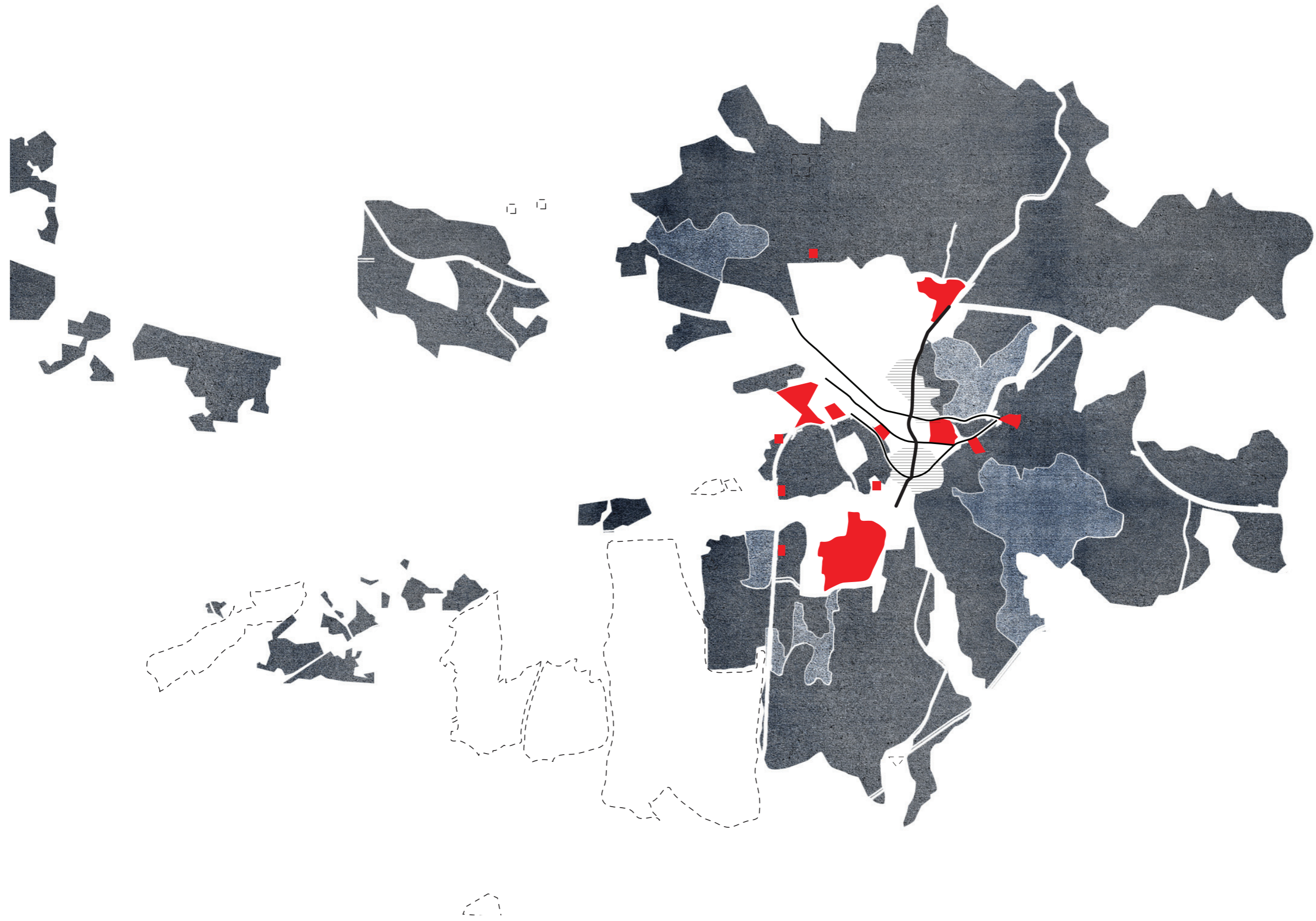

Nature
The Untouched Land

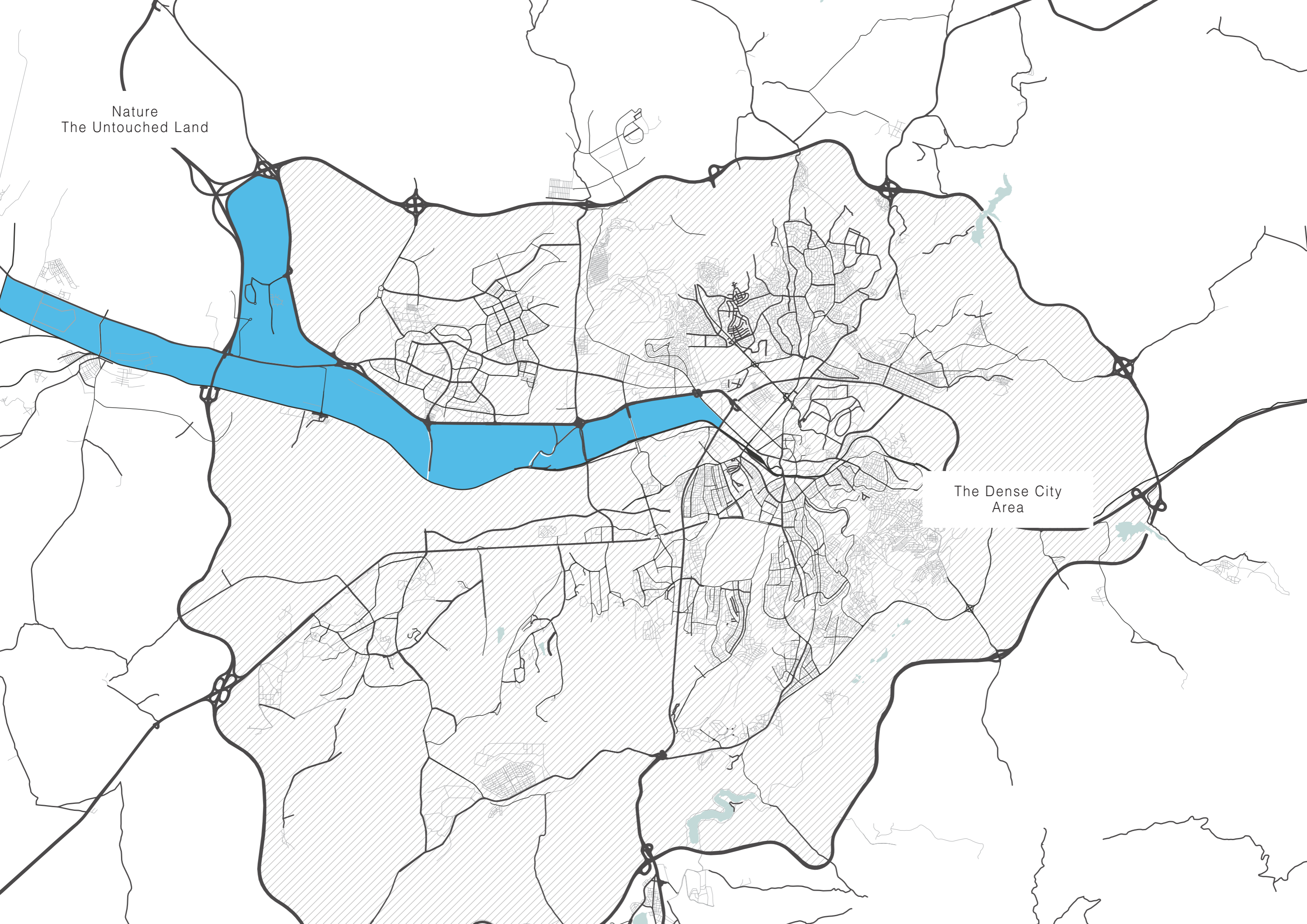

The Dense City
Area

CONNECTING LANDSCAPE INTERFACE

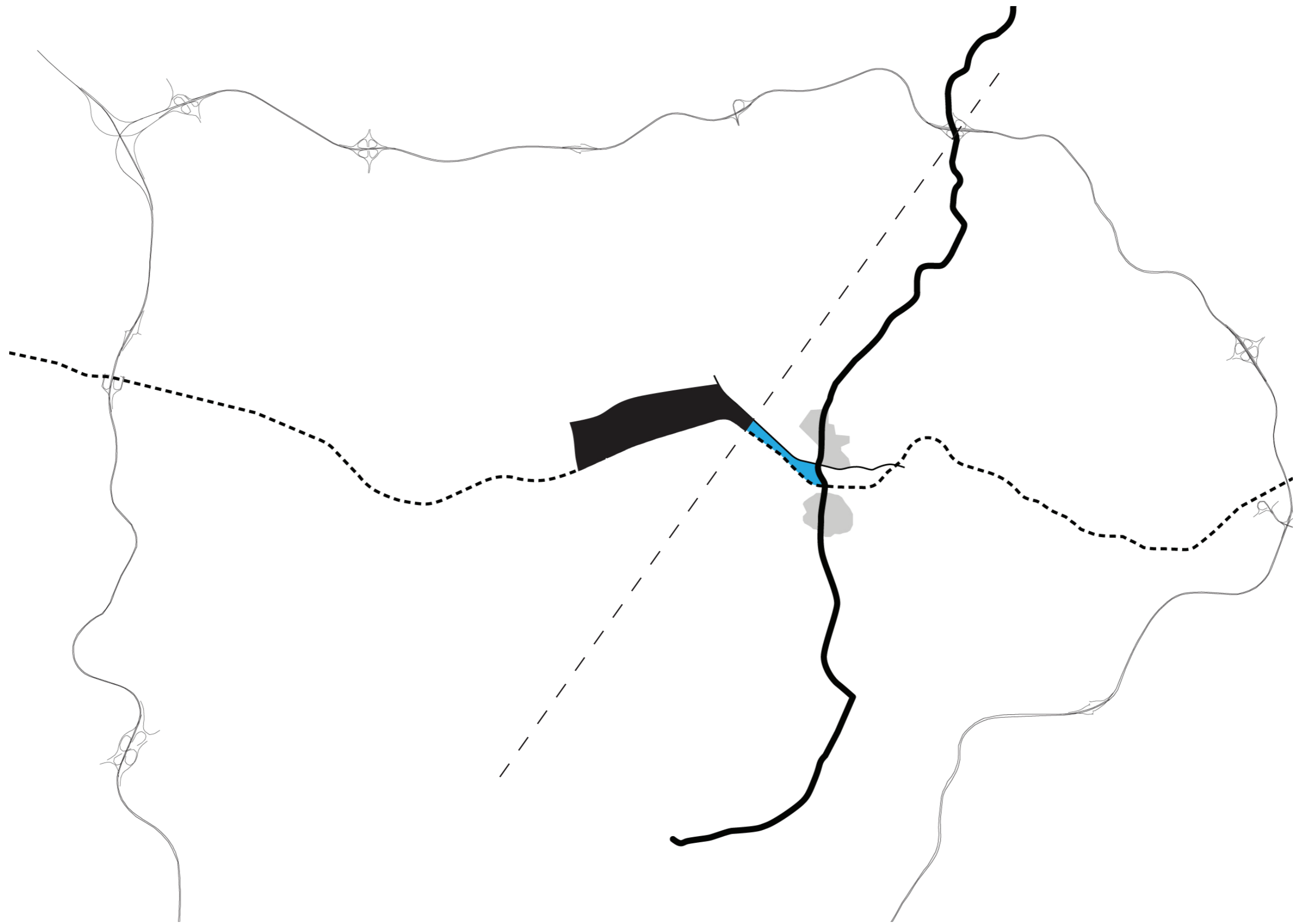

1. Hospital Complex
2. Medicinal Production
3. Medical Collection

Medical

1. Universities
2. [Research Institute & Laboratory](#)
3. Library & Archive
4. Seed Bank

Research & Educational

1. Market
2. Warehouses
3. Production House
4. Irrigation Facilities

Economic



CLIMATE & GROWING

Facilities



- Greenhouses
- Pavilion
- Botanical Research Centre
- Herbarium
- Arboretum
- Seed Bank

- Hothouse
- Greenhouses
- Pavilion
- National Plant Specimen Hall
- Plant Classification Laboratories
- Research Rooms
- Lecture hall

- Greenhouses
- Bird Center
- Restaurant
- Meeting Room
- Playground
- Waterfall
- Large fountain
- Square

Collections



- Spanish & American flora
- 30 000 Plants & Flowers
- Mediterranean Flora
- Tropical
- Temperate
- Desert

- Tropical & Subtropical plants
- Flowers
- Fruit trees
- Water plants
- Traditional Chinese Medicinal plants
- Aromatic plants
- Succulent Plants

- Banana
- Bougainvillea
- Lotus
- Orchids
- Succulent Plants
- Plum Trees
- Topiary Pieces

Location

Madrid, Spain

Ankara, Turkey

Beijing, China

Kawaguchi, Japan

Real Jardín Botánico de Madrid

Beijing Botanical Garden

Botanical Garden of Kawaguchi-City

Latitude

40.4131

39.9055

39.9203

Longitude

-3.6908

116.3958

141.2097



Europe

Asia

BOTANIC GARDEN & EDUCATION

Botanical Garden of TU Delft

The Bonn University Botanic Garden, Germany

Cambridge University Botanic Garden, England

The Singapore Botanic Gardens

The Arnold Arboretum of Harvard University

Royal Botanic Gardens, Kew

Central Park, New York

*0.025 km²
(25 000m²)*

0.095 km²

0.16 km²

0.75 km²

1.07 km²

1.21 km²

3.41 km²

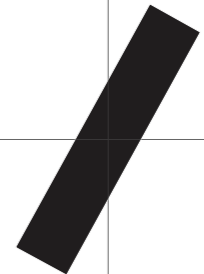
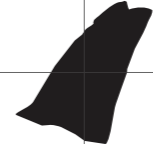
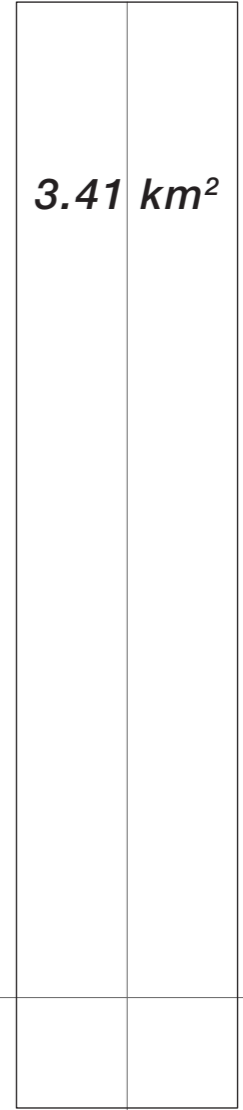
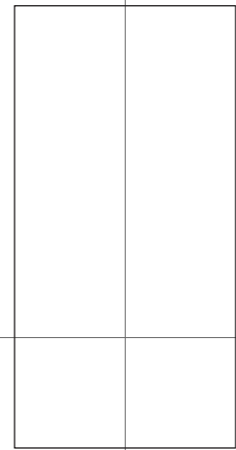
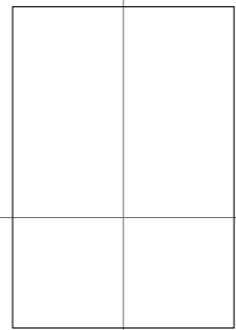
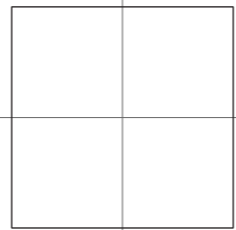
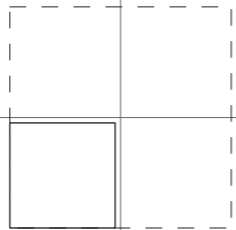
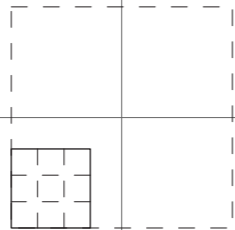
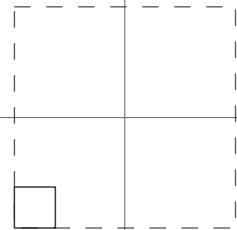

RESEARCH INSTITUTES
& DIMENSIONS

*Botanical Research
Institute of Texas*

*National Botanical
Research Institute
Lucknow*

*The Pennington
Biomedical
Research Center*

6500 m²

20 000 m²

37 400 m²

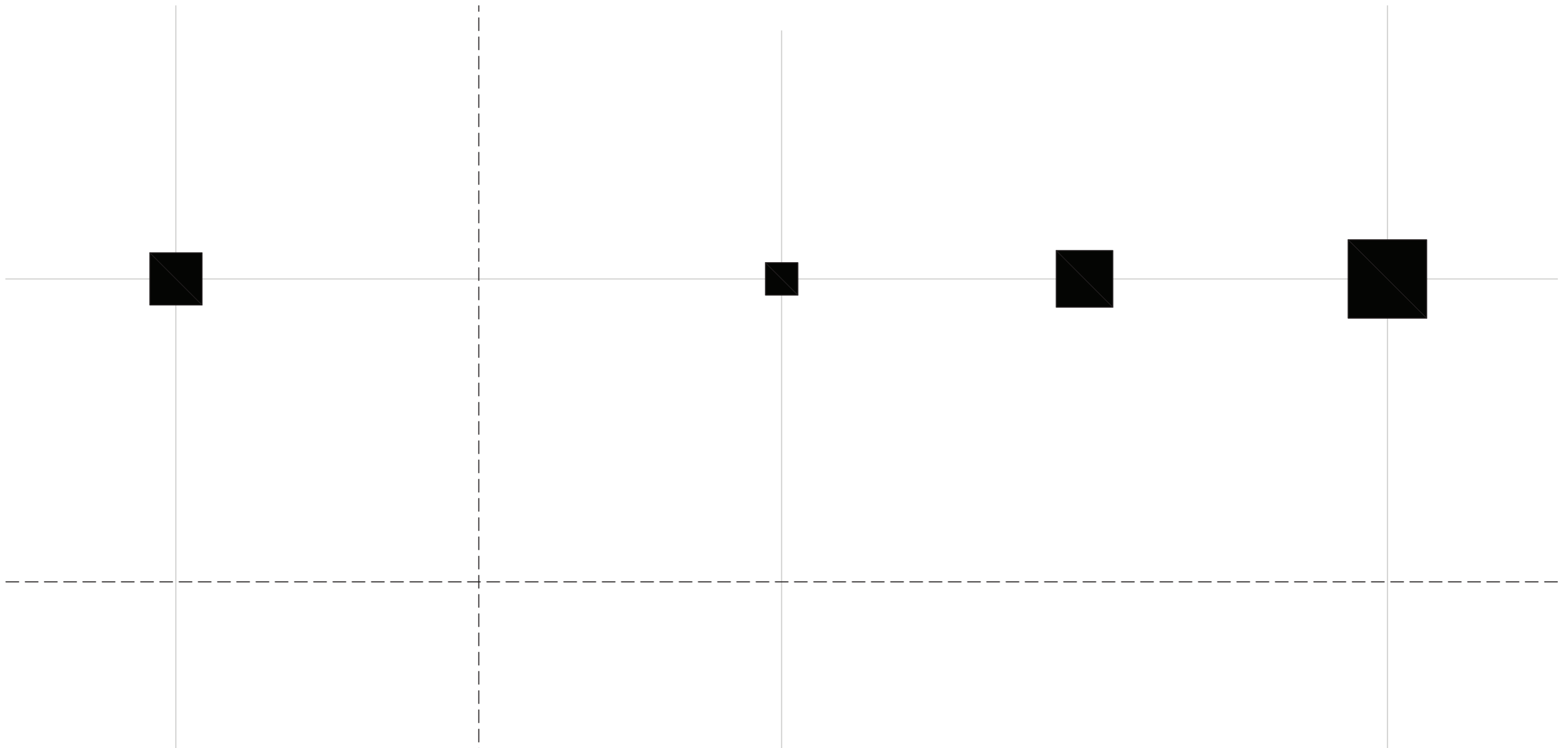

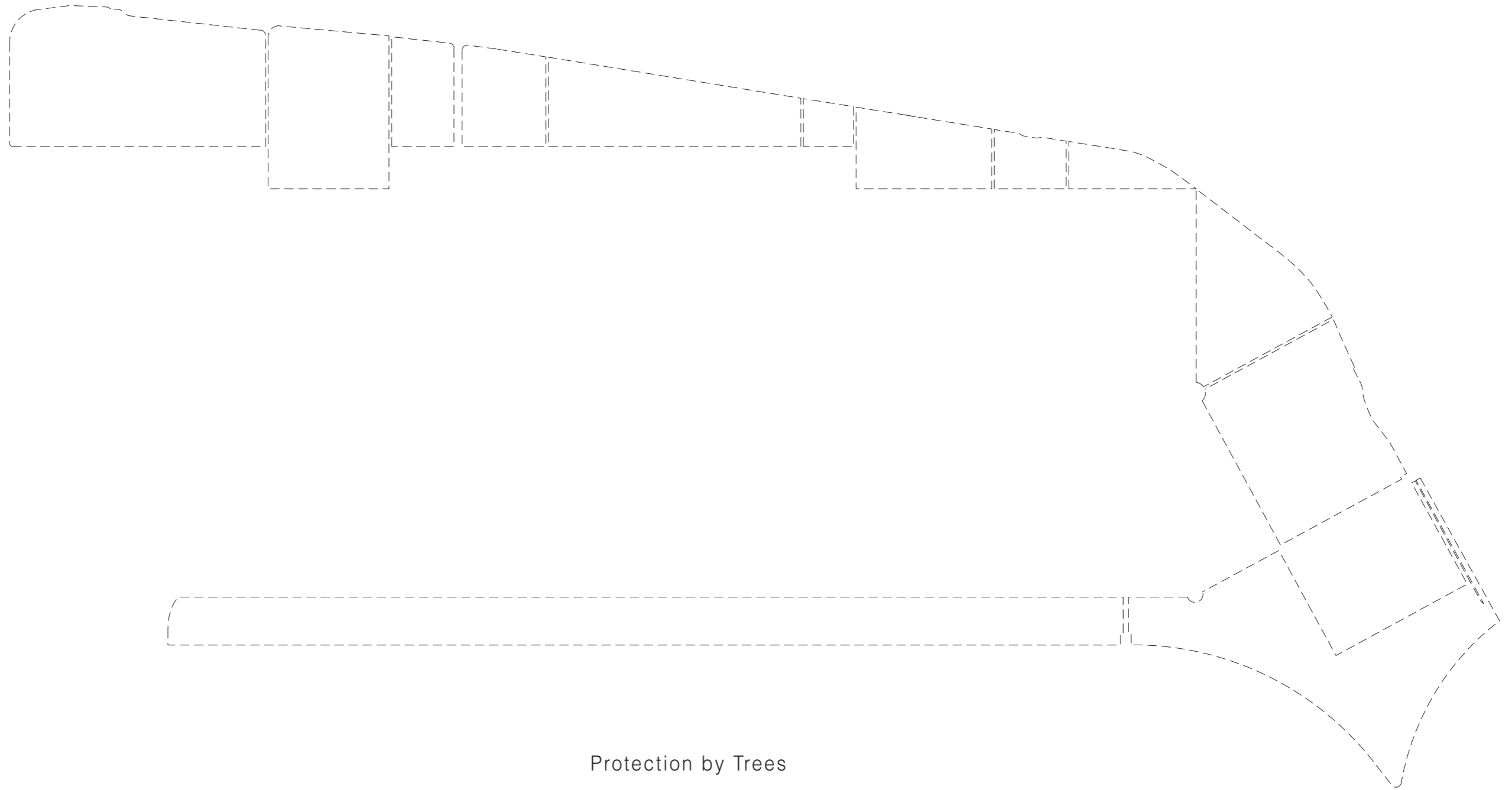

Protection by Trees

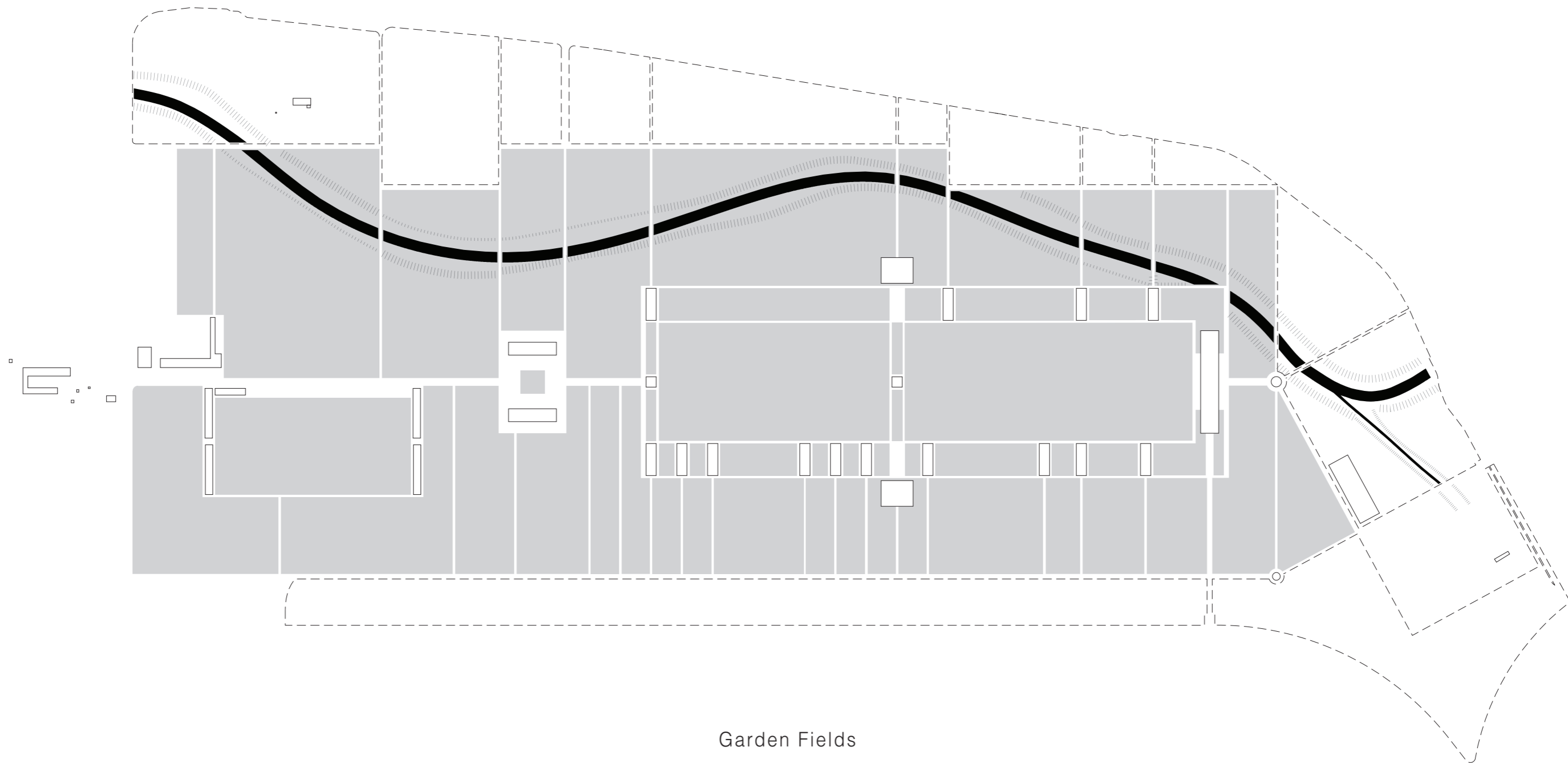

Garden Fields

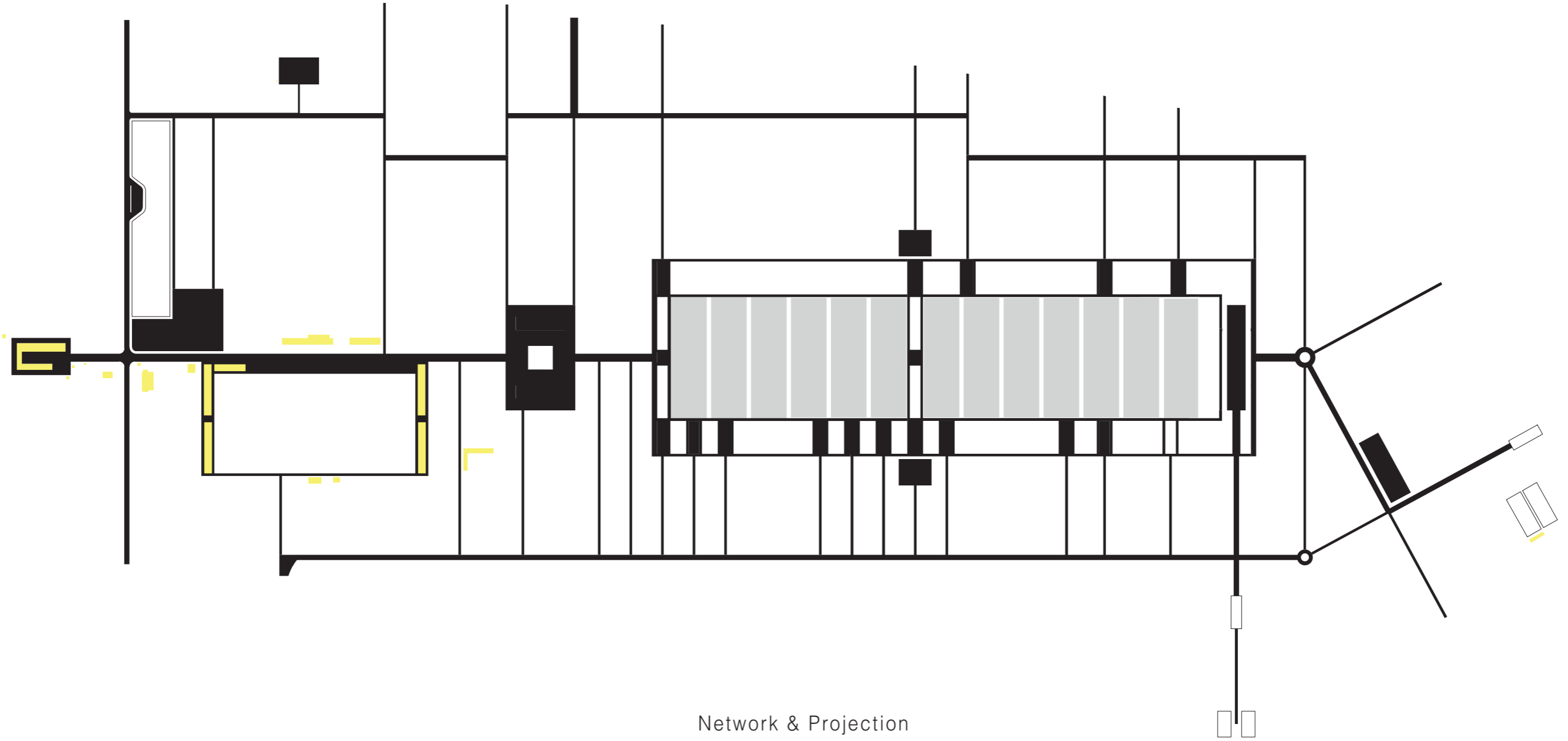

Network & Projection

Existing Museum & Visitors Center

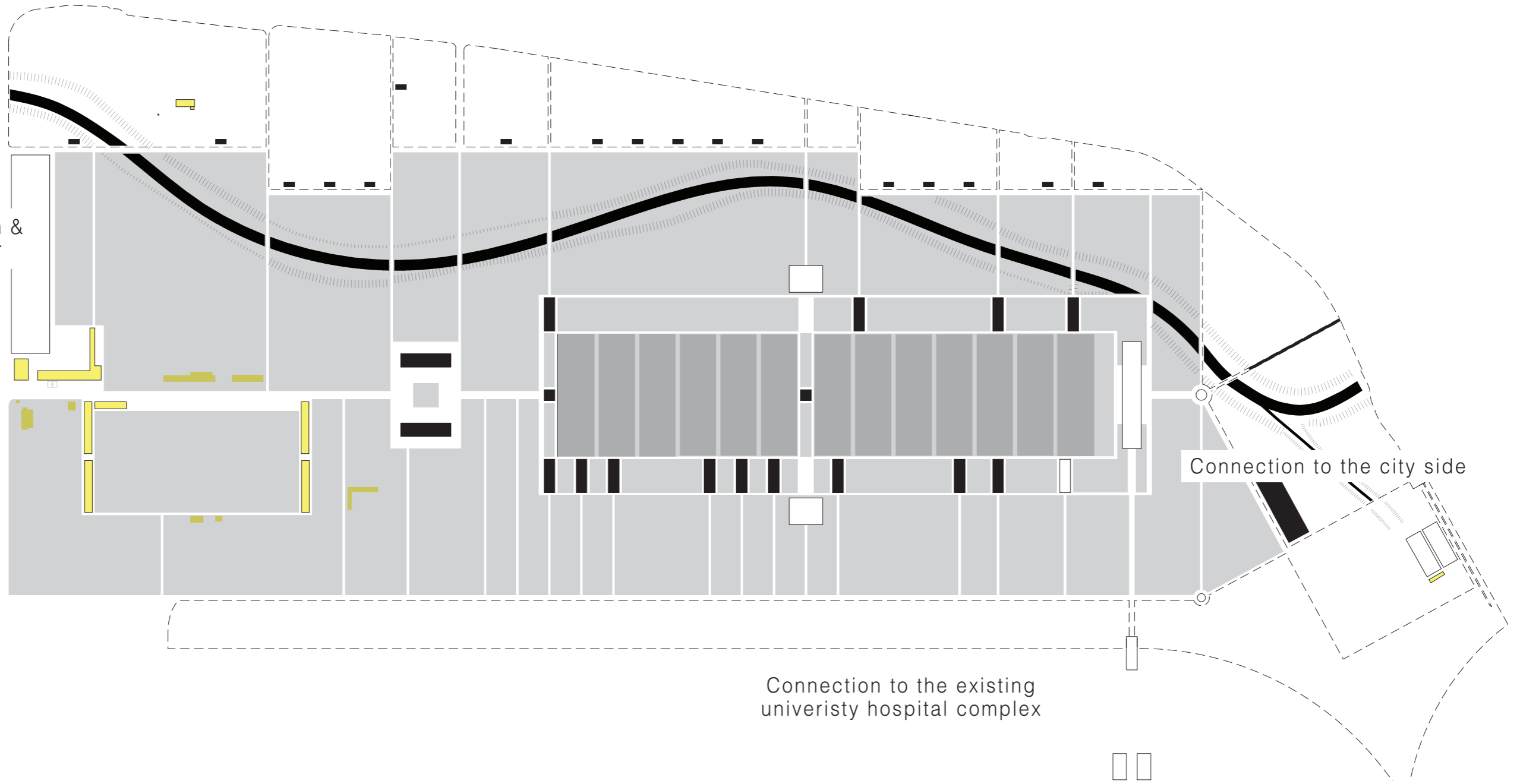

Connection to the city side

Connection to the existing univeristy hospital complex



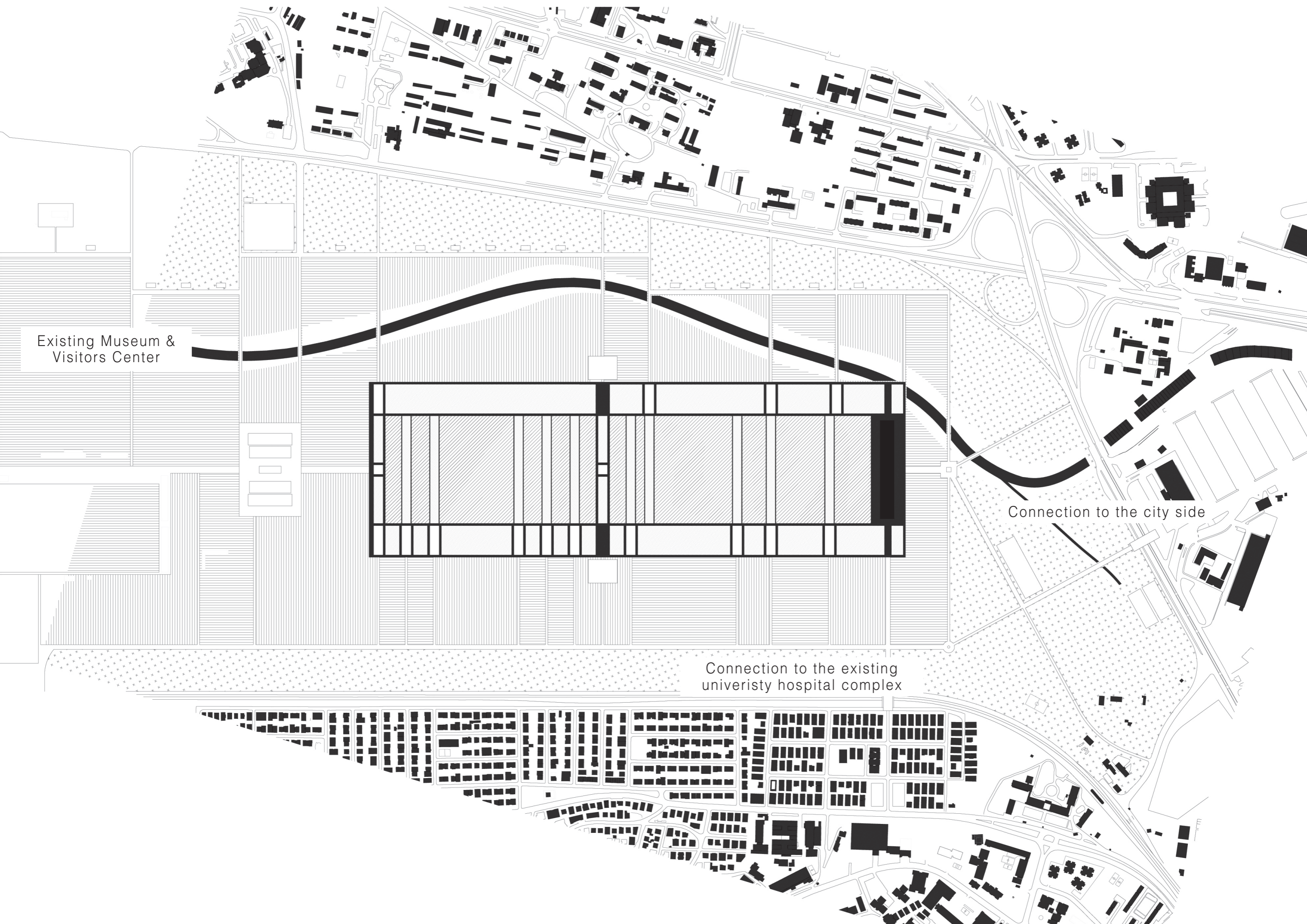

Existing Museum &
Visitors Center

Connection to the city side

Connection to the existing
univeristy hospital complex

LAYERS & PROJECTION

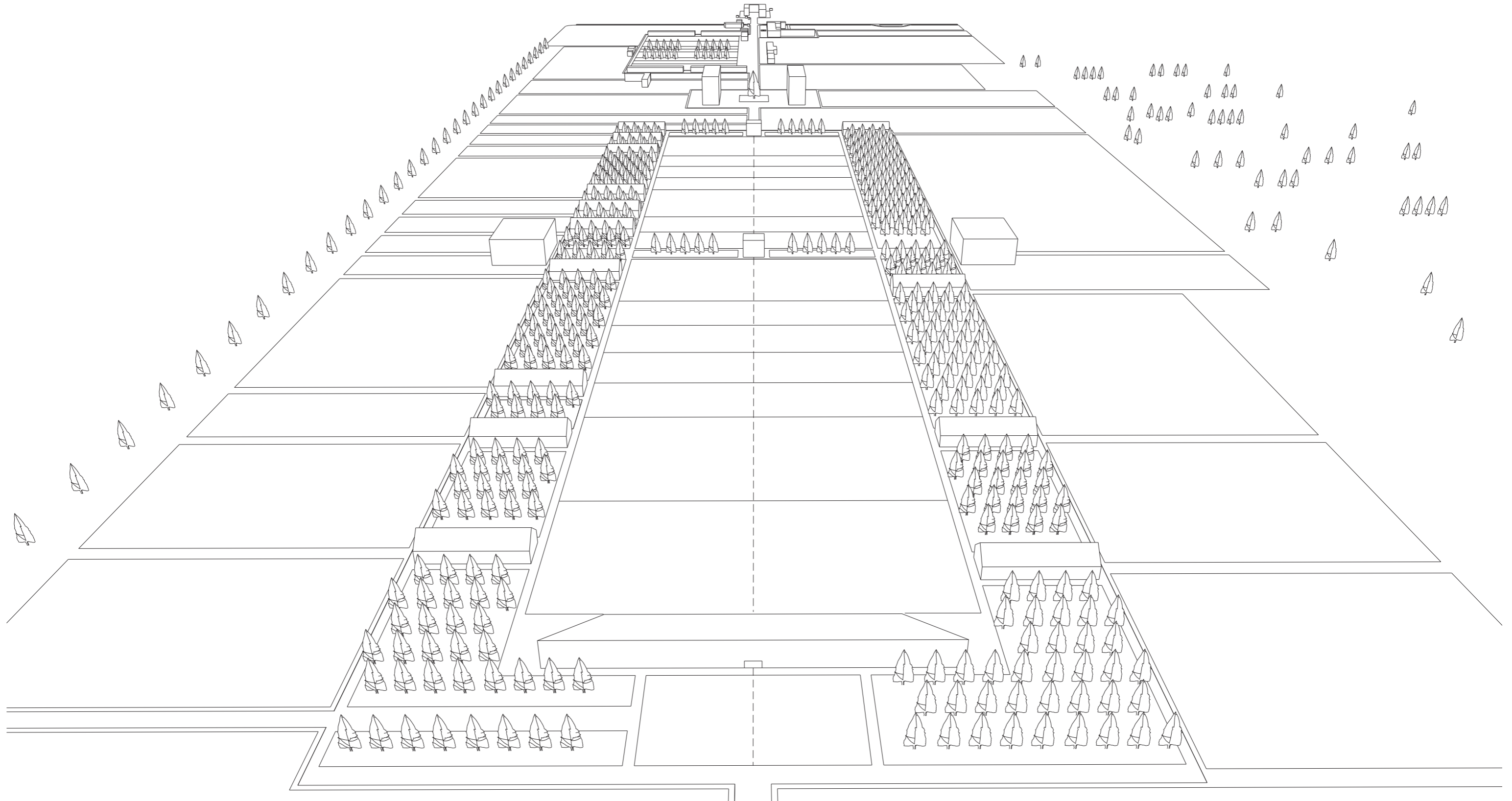

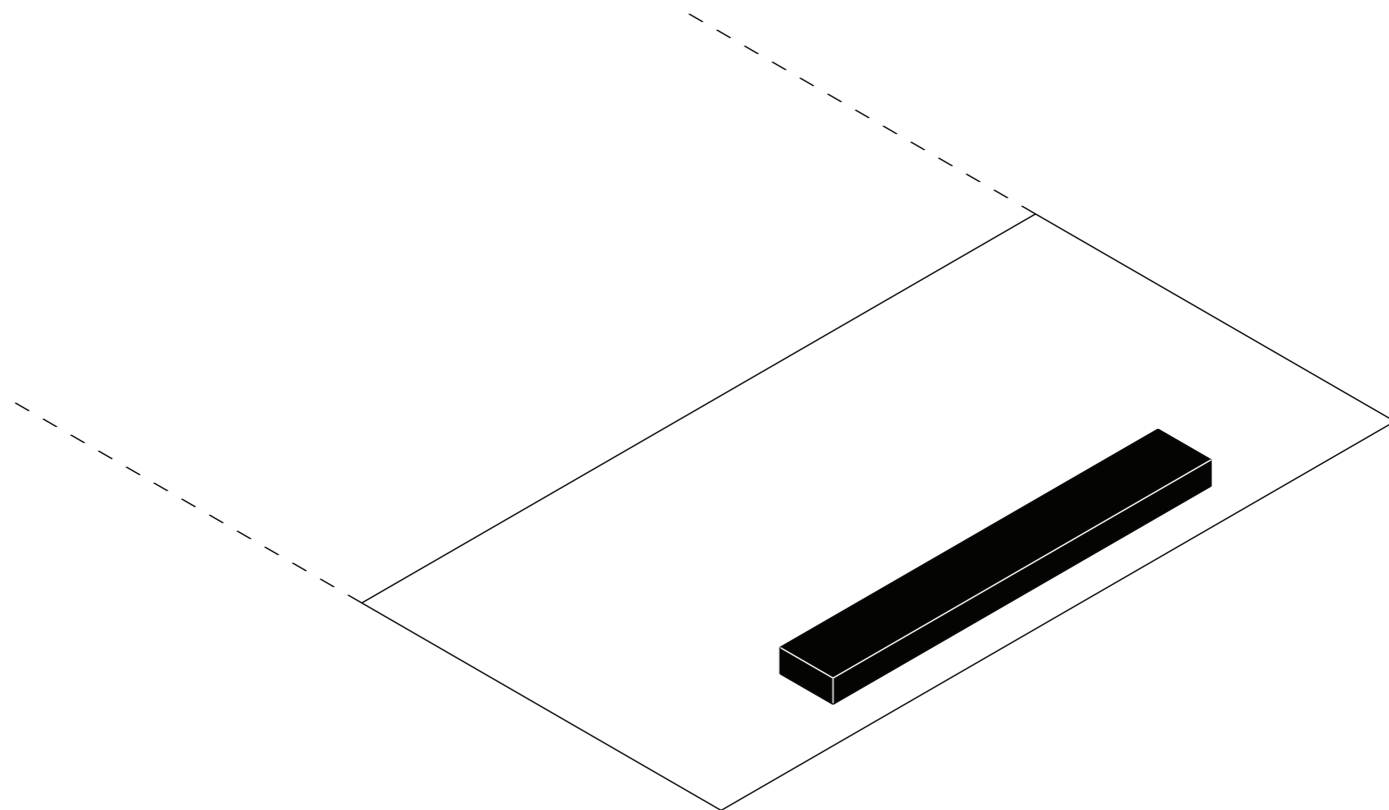

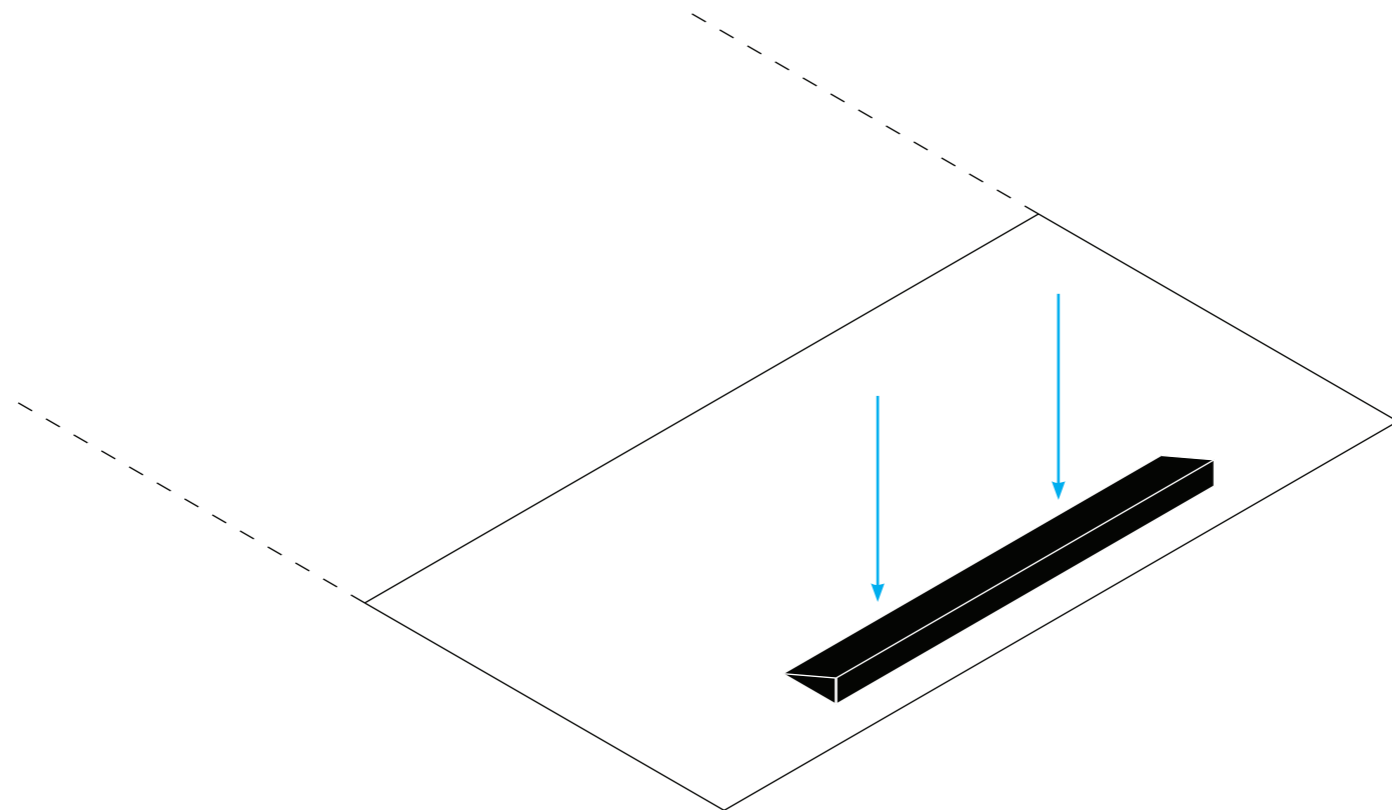

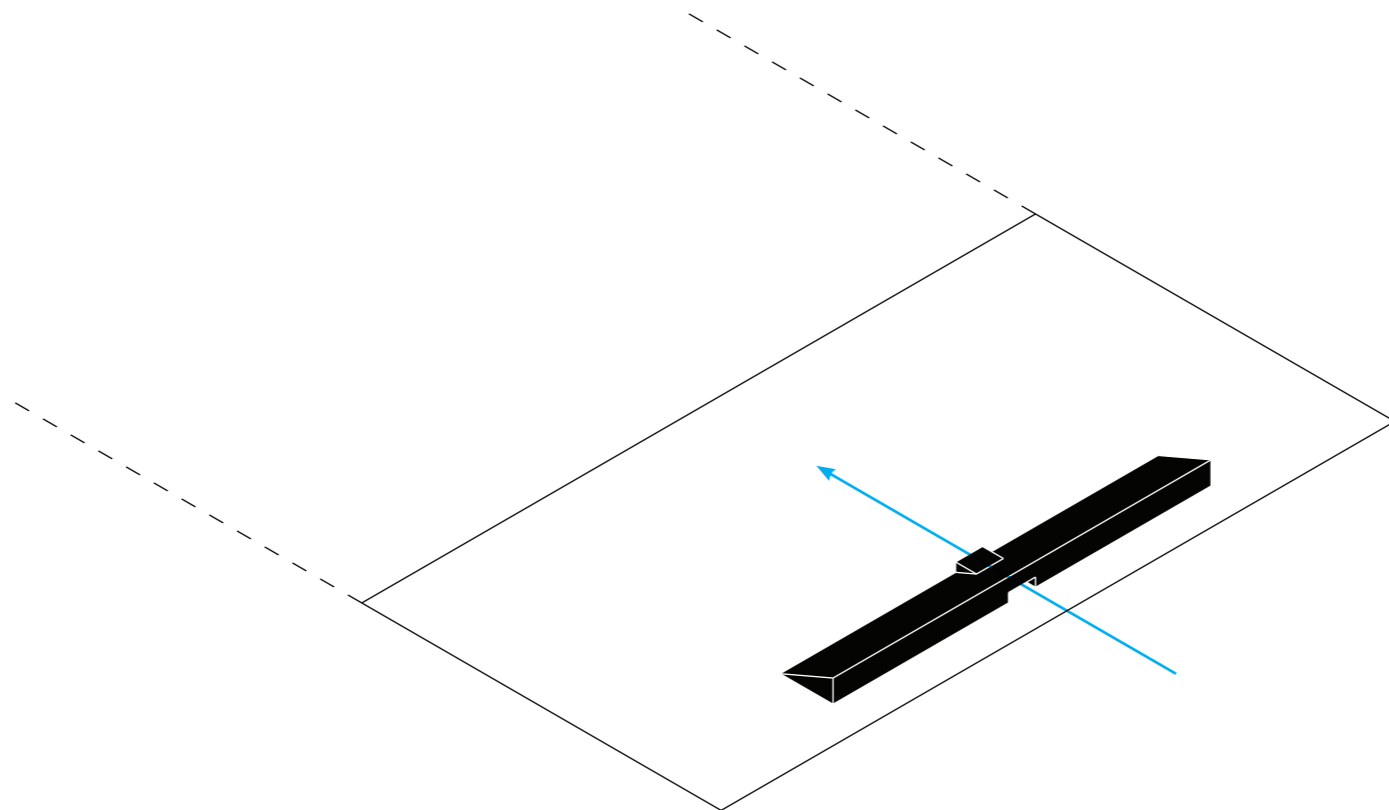

OPERATION & FLOW

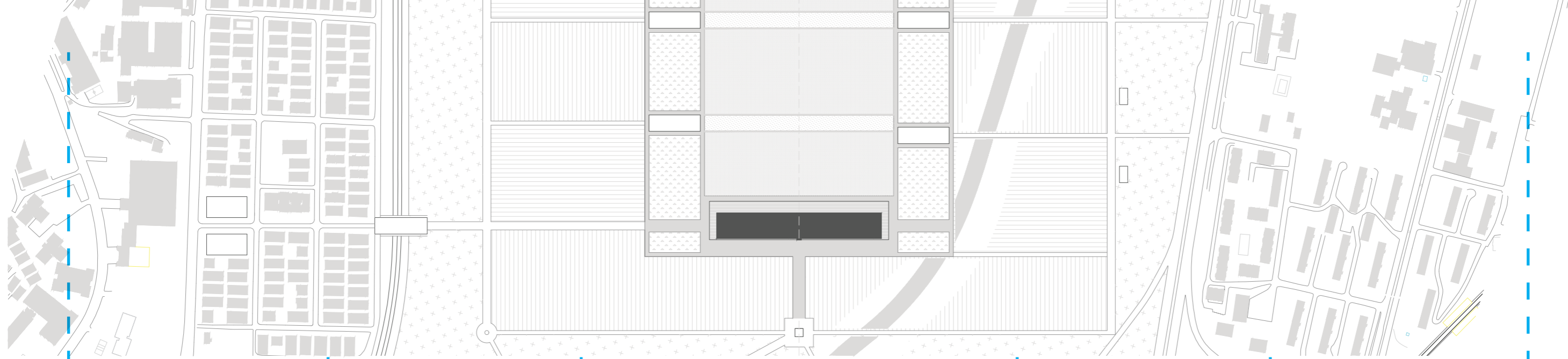

Samples in natural landscape

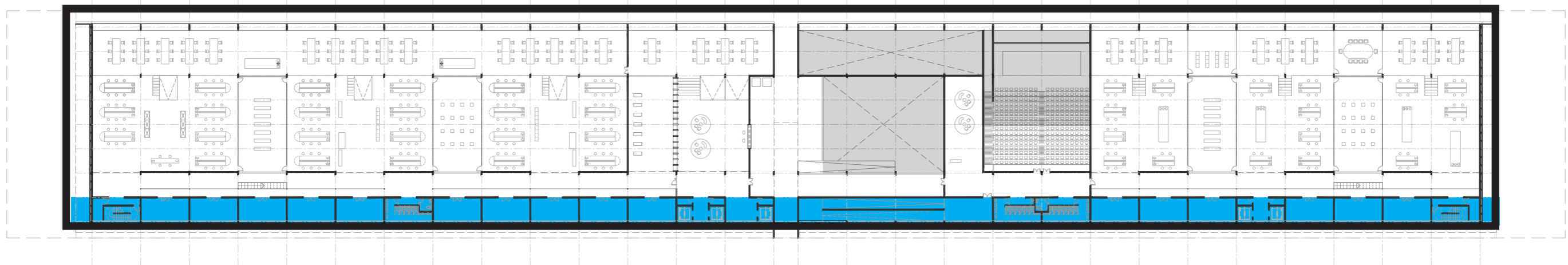
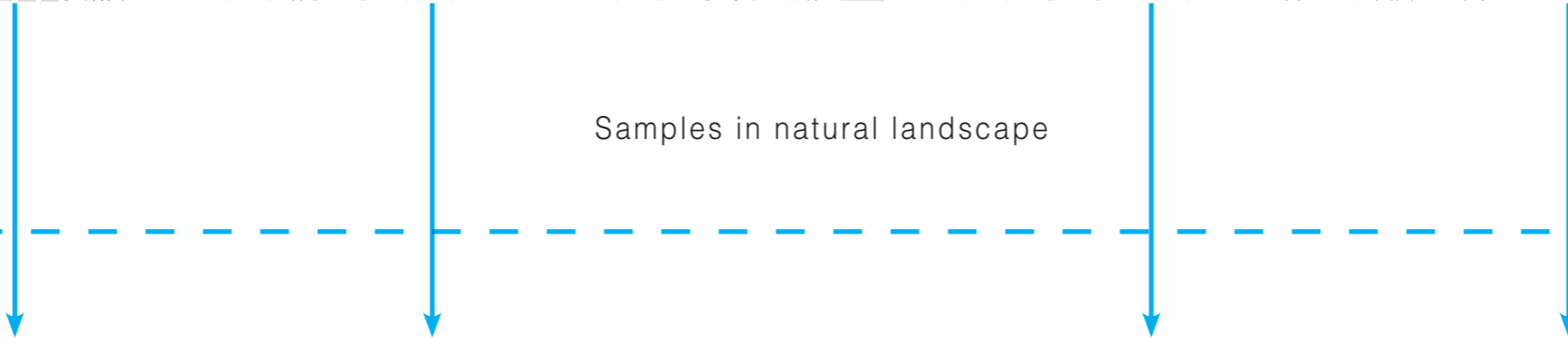

Samples under artificial control

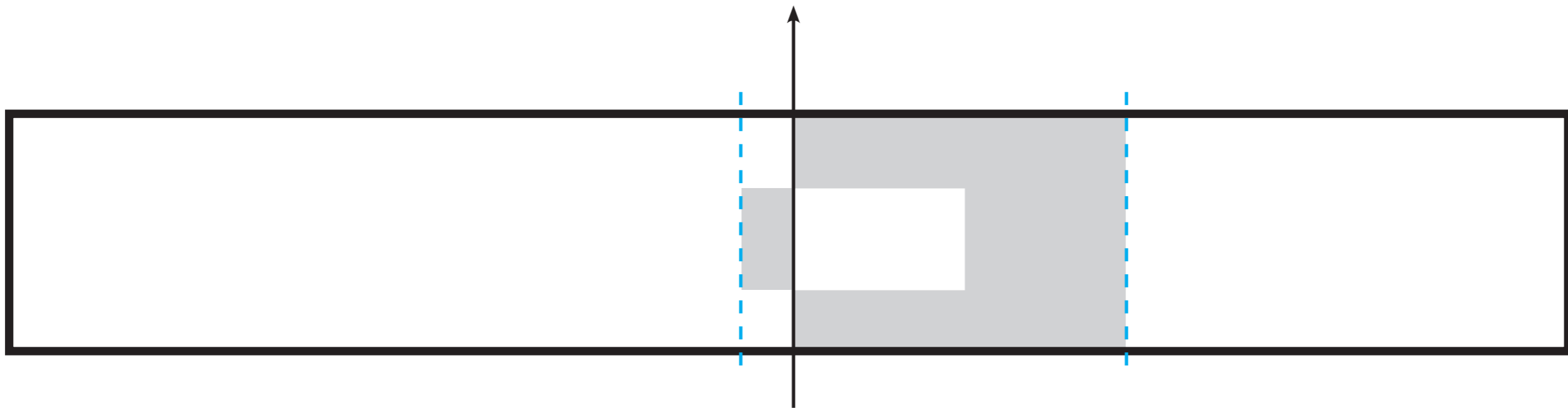

Public Programs





Library of Artifical Green



Skylight

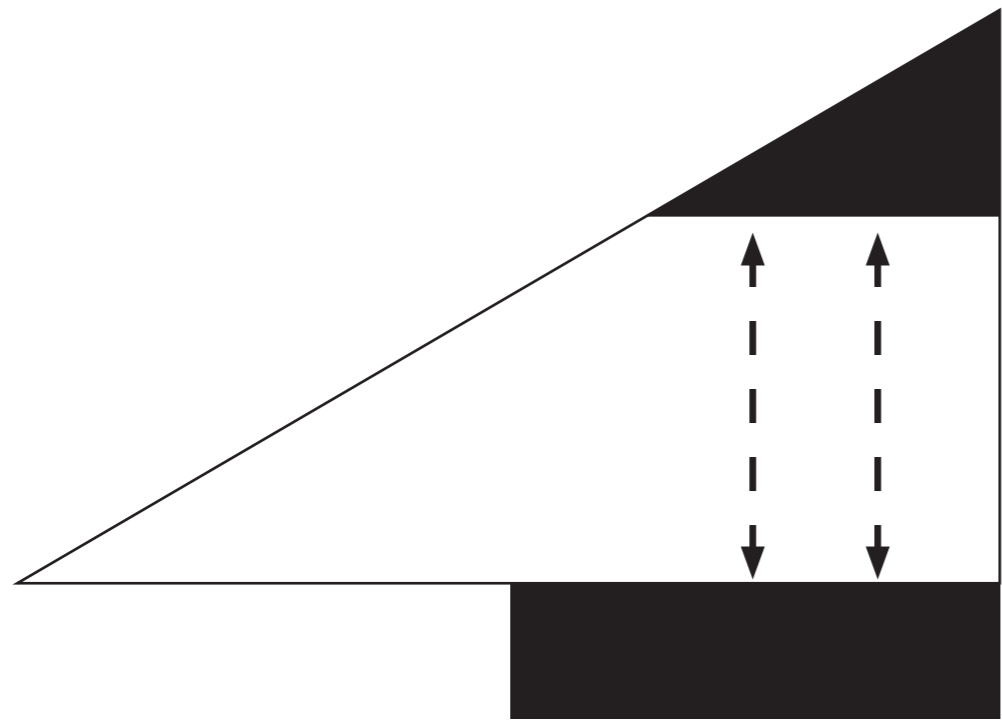

Service

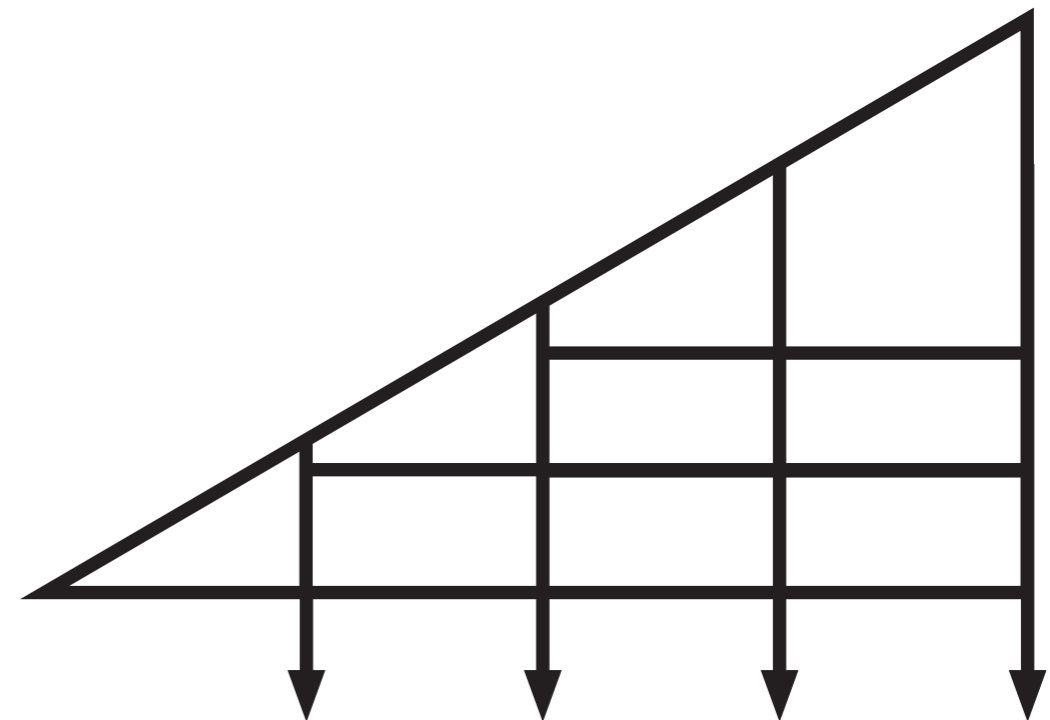

Timber Structural Frame

*General Dry Lab
& Office Section*

*General Wet
Lab Section*

*instrument Lab
Section*

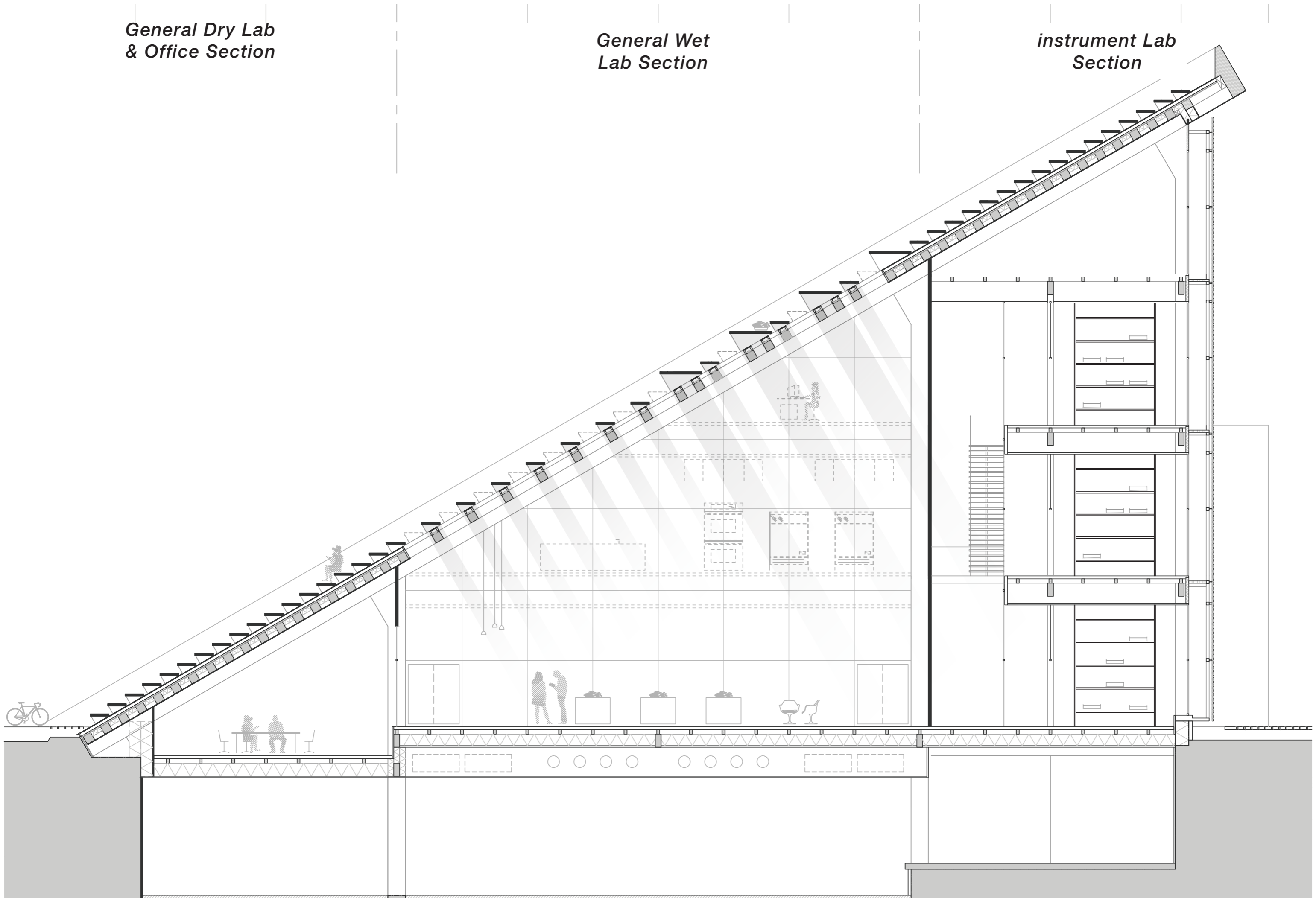

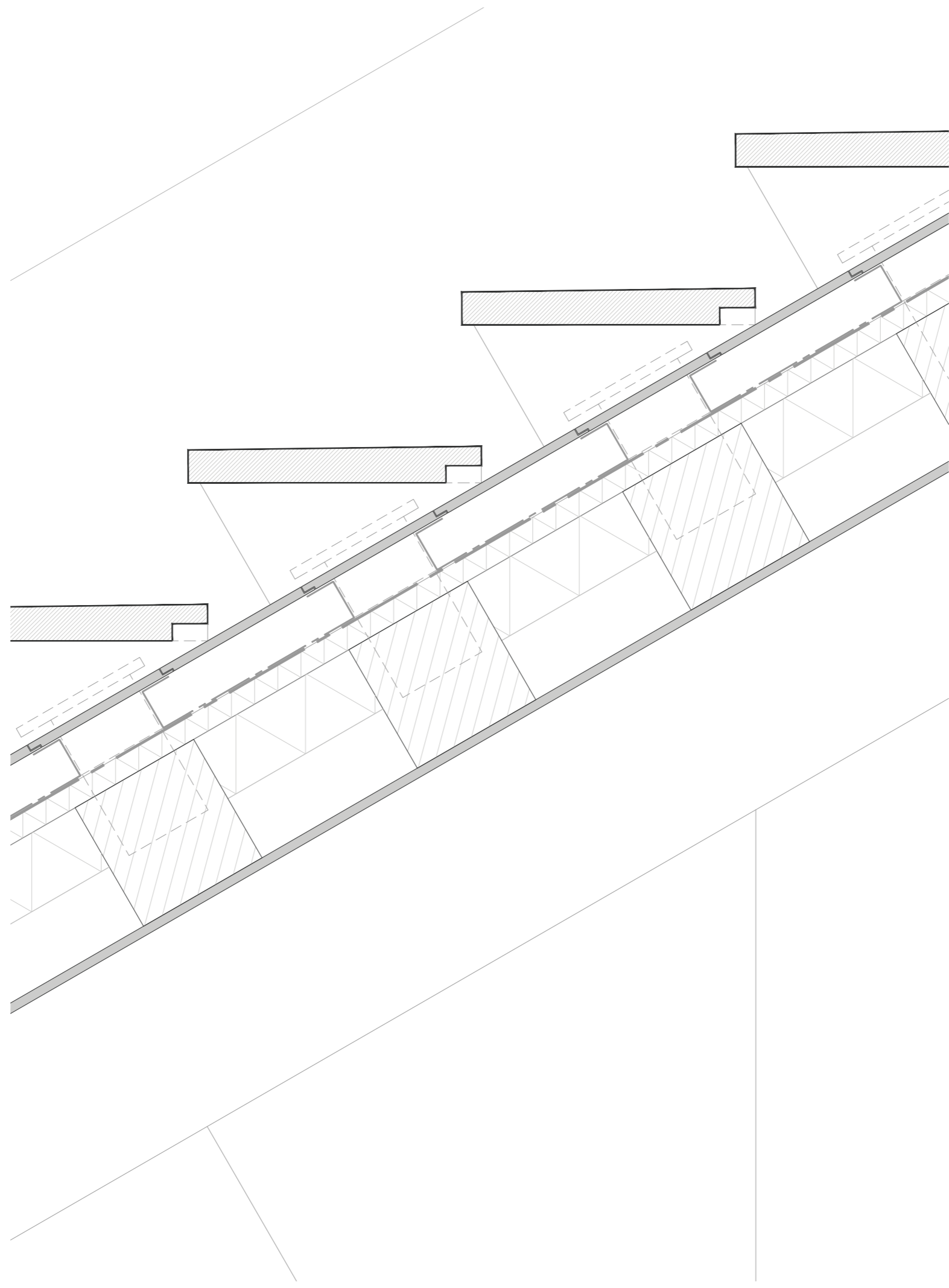

CONFIGURATIONS



Form



Pattern



Denisty



Scale



Interface

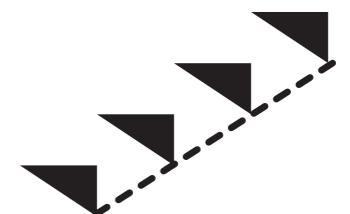

Visibility



Facade as a "viewfinder"

DENSITY & PATTERN

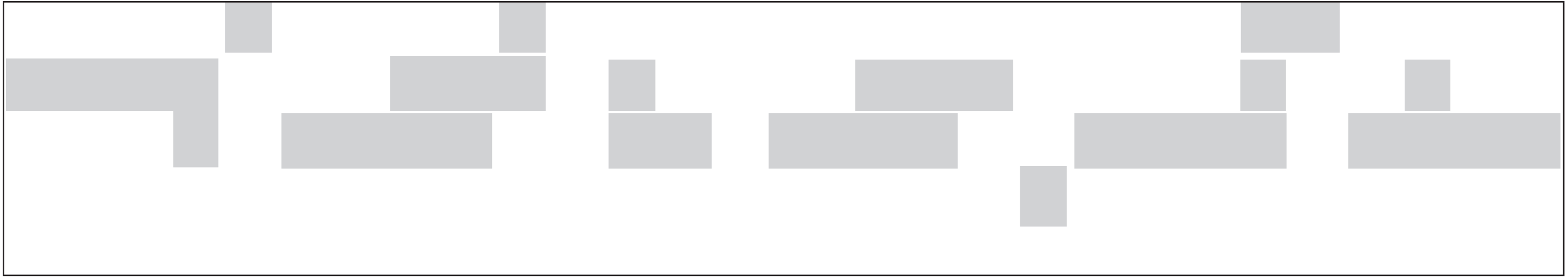



SCREEN FACADE

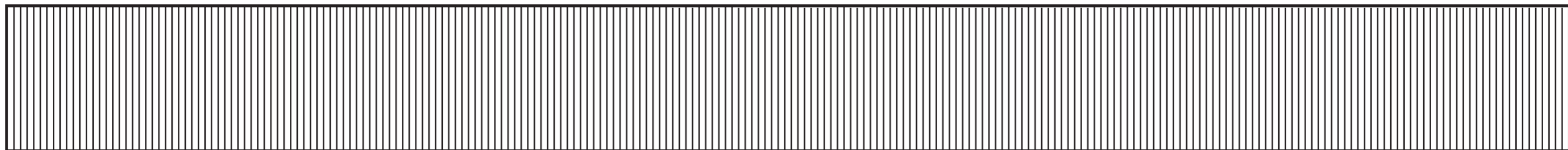
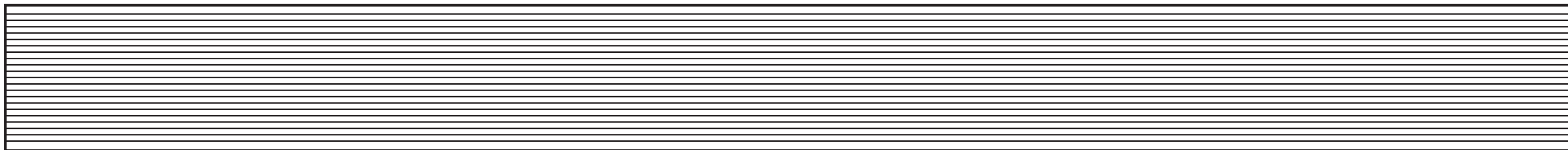

SCREEN FACADE



SCREEN FACADE

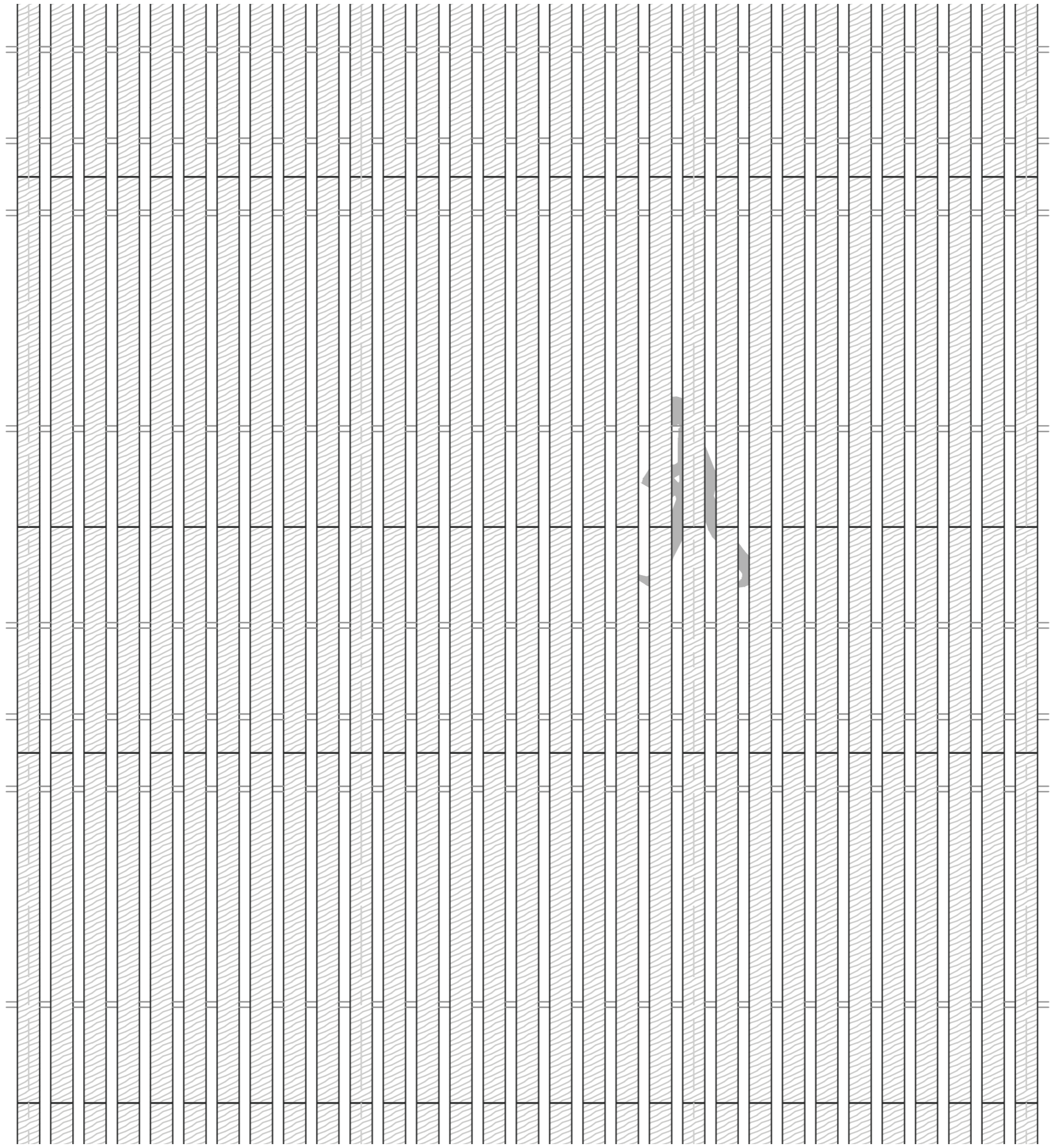

SCREEN FACADE

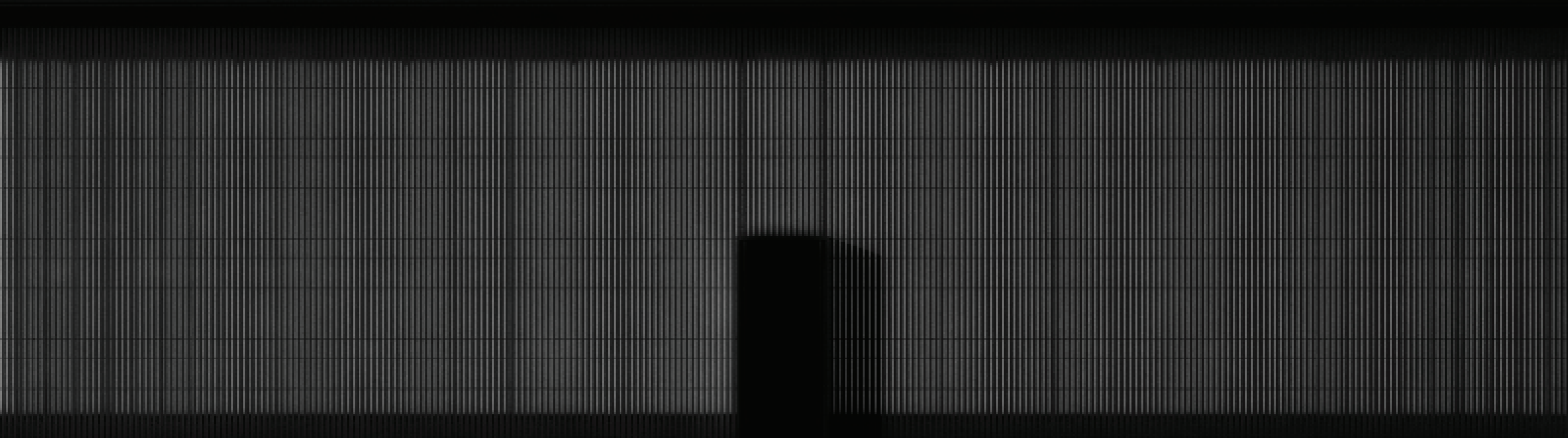

SCREEN FACADE



