

Cooperative Multi-Vessel Systems for Waterborne Transport

Chen, Linying

DOI

[10.4233/uuid:e0c3246b-5e6e-47f4-b012-3393fd47fc90](https://doi.org/10.4233/uuid:e0c3246b-5e6e-47f4-b012-3393fd47fc90)

Publication date

2019

Document Version

Final published version

Citation (APA)

Chen, L. (2019). *Cooperative Multi-Vessel Systems for Waterborne Transport*. [Dissertation (TU Delft), Delft University of Technology]. TRAIL Research School. <https://doi.org/10.4233/uuid:e0c3246b-5e6e-47f4-b012-3393fd47fc90>

Important note

To cite this publication, please use the final published version (if applicable).
Please check the document version above.

Copyright

Other than for strictly personal use, it is not permitted to download, forward or distribute the text or part of it, without the consent of the author(s) and/or copyright holder(s), unless the work is under an open content license such as Creative Commons.

Takedown policy

Please contact us and provide details if you believe this document breaches copyrights.
We will remove access to the work immediately and investigate your claim.

Cooperative Multi-Vessel Systems for Waterborne Transport

Linying CHEN

Cooperative Multi-Vessel Systems for Waterborne Transport

Proefschrift

ter verkrijging van de graad van doctor
aan de Technische Universiteit Delft,
op gezag van de Rector Magnificus prof.dr.ir. T.H.J.J. van den Hagen,
voorzitter van het College voor Promoties,
in het openbaar te verdedigen op maandag 18 november 2019 om 10.00 uur
door

Linying CHEN

Master of Science in Traffic Information Engineering and Control,
Wuhan University of Technology, Wuhan, China
geboren te Fujian, China.

Dit proefschrift is goedgekeurd door de promotoren:

Prof.dr. R. R. Negenborn

Prof.ir. J. J. Hopman

Samenstelling promotiecommissie:

Rector Magnificus

Prof.dr. R. R. Negenborn

Prof.ir. J. J. Hopman

voorzitter

Technische Universiteit Delft, promotor

Technische Universiteit Delft, promotor

Onafhankelijke leden:

Dr.ir. J. Szałpczyńska

Prof.dr.ir. P. Slaets

Prof.dr. J. van Hilligersberg

Prof.dr.ir. M. van Koningsveld

Prof.dr.ir. P. H. A. J. M. van Gelder

Gdynia Maritime University

KU Leuven

University of Twente

CiTG, Technische Universiteit Delft

TBM, Technische Universiteit Delft

The research described in this thesis was supported by the China Scholarship Council under grant 201406950041.

TRAIL Thesis Series T2019/15, The Netherlands TRAIL Research School TRAIL

P.O. Box 5017

2600 GA Delft

The Netherlands

E-mail: info@rsTRAIL.nl

Published and distributed by: Linying CHEN

Cover design: Linying CHEN

E-mail: ChenLinying@outlook.com

ISBN 978-90-5584-257-5

Keywords: Cooperative Multi-Vessel Systems, Autonomous Vessels, Vessel Train Formation, Cooperative Object Transport, Distributed Model Predictive Control.

Copyright © 2019 by Linying CHEN

All rights reserved. No part of the material protected by this copyright notice may be reproduced or utilized in any form or by any means, electronic or mechanical, including photocopying, recording or by any information storage and retrieval system, without written permission of the author.

Printed in The Netherlands

*“The person who does not consider what is still far off will not escape
being alarmed at what is near at hand.”*
人无远虑，必有近忧.

Confucius (551 BC – 479 BC), translated by Roger T. Ames

Preface

When I complete the thesis, I try to recall what I have experienced here in the Netherlands. Memories fade surprisingly quickly. However, the feeling that I am so lucky to have so many people supporting me will never be wiped. I would like to take this opportunity to express my appreciation to the people who have been important to me during my PhD life.

First of all, my great appreciation goes to my promoters, Prof. Rudy Negenborn, and Prof. Hans Hopman. Dear Rudy, I want to thank you from the very bottom of my heart for giving me hope in dark times. Thank you for providing me the opportunity to work in the Section of Transport Engineering and Logistics. Your encouragement and supports have made me become more confident in myself. I have greatly benefited from your creative thinking and organized working style. You showed me how to be a good supervisor, both in words and deeds. All in all, thank you for everything you have done for coaching me towards an independent researcher. Dear Hans, thank you for taking the time out of your busy schedule and providing valuable suggestions for my research. Meanwhile, I would like to sincerely thank Prof. Gabriël Lodewijks for being my promoter in the first year when I joined the Section of Transport Engineering and Logistics. It had been a year of hardship and self-doubt. Dear Gabriël, thank you for being so considerate.

I owe a lot of thanks to my master project supervisor, Prof. Jummin Mou. Dear Prof. Mou, thank you for your encouragement over the years. I am so lucky to have a teacher like you who is always pushing me beyond my limits to get me to perfection. Thank you for offering me the great opportunity to stay in TU Delft during my master study. It is an unforgettable experience, and it is the turning point of my life. The experience broadened my horizons and lit a fire in my heart. I also want to thank Prof. Han Ligteringen for the invitation and supervision during the six months. Your patience and attention to detail have impressed me deeply. Also, I would like to express my gratitude to Dr. Tsz Leung Yip. Dear Dr. Yip, Yamin and I had a great time when worked with you in Hong Kong. Most importantly, I have learned how to be tough when a manuscript had been rejected.

Moreover, I would like to thank all colleagues in the Section of Transport Engineering and Logistics. Wenjing Guo, Qingqing Zeng, Qingsong Zeng, Xiao Lin, Wenbin Ma, Zongchen Li, Zhe Du, Zhikang Deng, Yunpeng Yan, Yimeng Zhang, Jie Cai, Breno Beirigo and Johan Los, I really enjoyed the lunch time together with you. Many thanks go to my friends, Yang Zhou, Wen Zhang, Pengfei Chen, Zhaolong Li, Huarong Zheng, Jialun Liu, Shijie Li, Xing Chang, Qu Hu, Xiao Liang, Chenguang Liu and Kai Wang, for sharing the enjoyable times. It has been a delight for me to work with Ali Haseltalab, Vittorio Garofano, Dr. Bilge Atasoy, and Dr. Vasso Reppa. I have greatly benefited from our cooperation.

Also, I would like to thank the people who I worked with during their MSc projects and literature assignments: Maurits van Pampus, Abhilash Devaraju, Laurien van Cappelle, Matteo Schiaretti and Ke Li. I would like to thank the secretaries, Dineke, Patty, Monique, Anouk, and Pauline, for always being kind and helpful, especially when I forgot my campus card. Lots of thanks go to Ir. Dick Mensch for helping me translate the summary in the warmest July ever in the Netherlands.

In addition, I acknowledge the efforts of the members of my PhD committee and their constructive remarks.

Finally, to my dearest family, 感谢我的父亲陈日辉和母亲林巧媚一直以来对我的关爱。感谢我的姐姐, 陈琳艳和陈琳妍, 你们对我的无条件支持让我能没有后顾之忧地去追求自己的梦想。感谢我的侄女, 周筱涵, 你眼里崇拜的光让我努力成为更好的自己。感谢我的所有亲属和朋友对我关心和支持。

To my beloved fiancé, Yamin Huang, thank you for staying by my side from the first moment we met. Happiness, sadness, toughness, joyfulness, all the things that we have experienced, we will experience together for the rest of our life.

Linying Chen,
Delft, July 2019.

Contents

Preface	vii
1 Introduction	1
1.1 Background	1
1.2 Problem statement	2
1.3 Research questions	6
1.4 Research approach	7
1.5 Research scope	7
1.6 Thesis outline	10
2 Survey on Cooperative Control of ASVs for Waterborne Transport	13
2.1 Categorization of cooperative control of ASVs	13
2.2 Vessel-to-Vessel cooperation at the local layer	16
2.2.1 Cooperative collision avoidance	16
2.2.2 Formation control	22
2.2.3 Cooperative manipulation	29
2.2.4 Discussion	30
2.3 Vessel-to-Infrastructure cooperation at the local layer	30
2.3.1 V2I cooperation at a terminal	31
2.3.2 V2I cooperation at a lock	31
2.3.3 V2I cooperation at an intersection	32
2.3.4 Discussion	32
2.4 Cooperation at the network layer	32
2.5 Conclusions	33
3 Framework of Cooperative Multi-Vessel Systems	35
3.1 Cooperative Multi-Vessel Systems	35
3.2 Model predictive control framework for controller design for an ASV	37
3.2.1 Dynamic model of an ASV	37
3.2.2 Formulation of the control problem	39
3.2.3 Linearization error analysis	42
3.3 Negotiation framework for cooperation	44
3.3.1 Formulation of the cooperative control problem	44
3.3.2 Generic negotiation framework	47
3.4 Conclusions	51

4	Vessel Train Formations	53
4.1	Control objectives and assumptions	53
4.2	Serial iterative DMPC for Vessel Train Formations	55
4.2.1	Control structure	55
4.2.2	Formulation of the VTF problem	55
4.2.3	Serial iterative negotiation framework	59
4.3	Simulation experiments: Sensitivity analysis	62
4.3.1	Simulation setup	63
4.3.2	Impact of updating sequence	63
4.3.3	Impact of responsibility parameter	66
4.3.4	Scalability	67
4.4	Simulation experiments: VTF in Port of Rotterdam	68
4.4.1	Comparison of Position-based VTF and Speed-based VTF	68
4.4.2	Comparison of VTF and Eco-VTF	78
4.5	Conclusions	81
5	Cooperative Floating Object Transport	83
5.1	System model	83
5.1.1	Dynamic models of the ASVs and the floating object	83
5.1.2	Towline model	84
5.2	Multi-layer negotiation framework for CFOT	86
5.2.1	Control structure	86
5.2.2	MPC controller design	87
5.2.3	Control allocation	89
5.2.4	Multi-layer negotiation framework	91
5.3	Simulation experiments	92
5.3.1	Simulation setup	94
5.3.2	Results and discussion	95
5.4	Conclusions	101
6	Cooperative Multi-Vessel Systems in Waterway Networks	107
6.1	Transport in waterway networks	107
6.1.1	Characteristics of transport in waterway networks	107
6.1.2	Cooperative framework	108
6.2	Cooperation of vessels in waterway segments	110
6.3	Cooperative waterway intersection scheduling	111
6.3.1	Intersection modeling	111
6.3.2	Scheduling for an isolated intersection	111
6.3.3	Cooperation among interconnected intersections	113
6.4	CMVSS in urban waterway networks	113
6.5	Simulation experiments	115
6.5.1	Simulation setup	115
6.5.2	Intersection crossing	115
6.5.3	CMVS in a waterway network	119
6.6	Conclusion	128

7	Conclusions and future research	131
7.1	Conclusions	131
7.2	Future research	137
	Bibliography	141
	Glossary	157
	Samenvatting	163
	Summary	167
	Curriculum vitae	171
	TRAIL Thesis Series publications	173

Chapter 1

Introduction

In this chapter, we introduce the research background and problems, followed by the research questions, approach, and the scope of this thesis. The outline of the thesis is described in the end.

1.1 Background

Economic development is currently putting enormous pressure on transport systems. The demand for freight transport is likely to grow over the next decades [46]. If roads and railways are the major means of transport to handle the growth, they will face frequent congestion. In densely populated regions, like cities, road networks are already confronted with congestion and capacity problems. Meanwhile, waterways still have plenty of capacity to transport more goods [45, 134]. Waterborne transport could offer an environment-friendly alternative in terms of both energy consumption and noise emissions [148]. To meet the transportation demand and maintain sustainable development, promoting waterborne transport has gained increasing attention.

Many methods have been proposed to improve the performance of waterborne transport to make it more attractive from different perspectives, such as optimizing the design of vessels [69], removing bottlenecks in waterway network [43], improving utilization of infrastructures [56, 177]. With the rapid development of information and communication technologies, Autonomous Surface Vessels (ASVs) are recently drawing much attention [92, 189]. Applying ASVs is believed to be an innovation to contribute to the safety and efficiency of waterborne transport.

Safety is one of the most concerning parts in the waterborne transport system. Ship accidents might cause remarkable negative social and economic impact, e.g., pollution, congestion, or even blocking of the waterways. For instance, in January 2018, the oil tanker SANCHI collided with the bulk carrier CF CRYSTAL in the East China Sea, resulting in the leakage of condensate oil and consequent fire and explosions and eventual sinking of SANCHI [110]. The financial damage of the sinking is around USD 110 million, and the environmental damage is enormous [138]. The main cause is that the duty officers on both vessels failed to make a full appraisal of the situation and of the risk of collision. In fact,

most ship accidents are due to human errors. Figure 1.1 shows the main causes of ship accidents between 2005 and 2014 in Dutch inland waterways [117]. More than 70% of accidents are caused by human errors, such as operation and communication errors. For ASVs, tasks, such as detection of obstacles, estimation of the risk, and communication, etc., can be done without humans. Thus, applying autonomous vessels could benefit in reducing the number of accidents.

From the perspective of efficiency, ASVs could improve the efficiency of waterborne transport with the help of intelligent path planning and better motion control methods. Compared with human-operated vessels, ASVs search for shorter paths (approximate the shortest path) and the deviations from the reference paths are much smaller [183, 186]. Moreover, communication and coordination with infrastructures also make it possible for ASVs to minimize the waiting time at ports, locks, etc. [92].

1.2 Problem statement

While acknowledging the benefits that autonomy may have, applying ASVs cannot solve all the problems.

In current waterborne transport systems, vessels do not actively coordinate their actions with others. This may lead to some problems. Firstly, when encountering other vessels, vessels may misunderstand the intentions of other vessels, which may lead to oscillation [172], and even collisions [84]. Figure 1.2 shows the ship accidents occurred in Dutch inland waterways during 2005-2014. The places that shipping accidents frequently occurred are the areas where Vessel-to-Vessel (V2V) and Vessel-to-Infrastructure (V2I) interactions increase, such as the Port of Rotterdam, the Port of Amsterdam, and intersections. Secondly, when the traffic becomes denser, the number of multi-vessel encounters increases. Each vessel acting on her own way may cause inefficiency, even chaos. Moreover, many vessels arriving at a position, such as a port or a lock, at the same time may lead to congestions and long waiting time. Figure 1.3 shows the average time a vessel spends in the Port of Rotterdam. About 40% of the time is waiting time.

Cooperation can bring many benefits. Firstly, cooperation can enhance the safety of waterborne transport with communication among vessels. Through communication, vessel controllers can obtain additional information, such as data about the objects beyond the reach of sensors, the intentions of other vessels, etc. The additional information can assist vessel controllers in negotiating and collaborating with others to take effective actions. Secondly, transport efficiency can be greatly improved with cooperation. For instance, vessels can coordinate their voyage plans to avoid congestions at ports and locks [92]. Furthermore, when combining voyage planning with infrastructure scheduling, vessels can adjust their speed to arrive at a required time and make better use of infrastructure resources [91]. Thirdly, with cooperation, a group of vessels can carry out tasks more efficiently and effectively, such as search and rescue, ocean sampling, hydrographic survey, etc. [104]. Applications such as towing of large structures, underway replenishment, and tandem loading need cooperation, as well.

Therefore, optimizing the performance of waterborne transport system requires not only automation of the individual vessels but also cooperation among vessels.

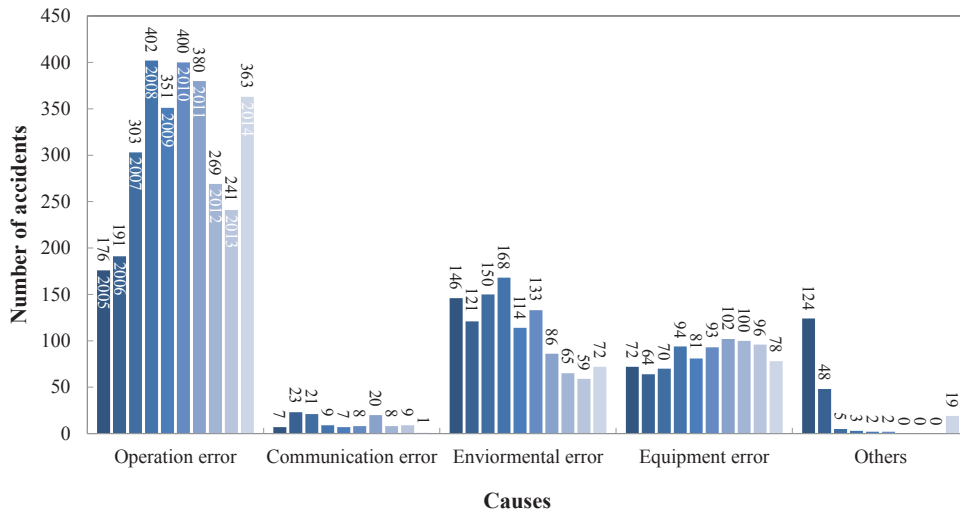

Figure 1.1: The causes of the shipping accidents in Dutch inland waterways during 2005-2014 (Data are from the Scheepsongevallendatabse (SOS-database) [145]; classification of the causes is presented in Table 1.1).

Table 1.1: Classification of accidents in Dutch inland waterways.

Cause	Including but not limited to . . .
Operation error	<ul style="list-style-type: none"> - Alcohol/drug use; - Wrong estimation; - Improper use of resources - Inattention; - Incapacitation/blackout; - Irresponsible behavior; - Incorrect procedure; - Fatigue.
Communication error	<ul style="list-style-type: none"> - Not listening watch; - Unclear explanation - Incorrect VHF channel; - Poor quality connection; - Language problems; - Wrong or not use VHF.
Environmental error	<ul style="list-style-type: none"> - Water movement; - Wind; - Current; - Poor visibility; - Obstacles under/above water; - Unmarked shoal; - Incorrect marking; - Floating objects; - Weather conditions; - False echoes.
Equipment error	<ul style="list-style-type: none"> - Engine Problems; - Rudder Problems; - Electrical Problems; - Navigation equipment problems; - Leaking pipe; - Broken hawsers; - Screw Problems; - Not closed lids / valves; - Light malfunction; - Exhaust problems.

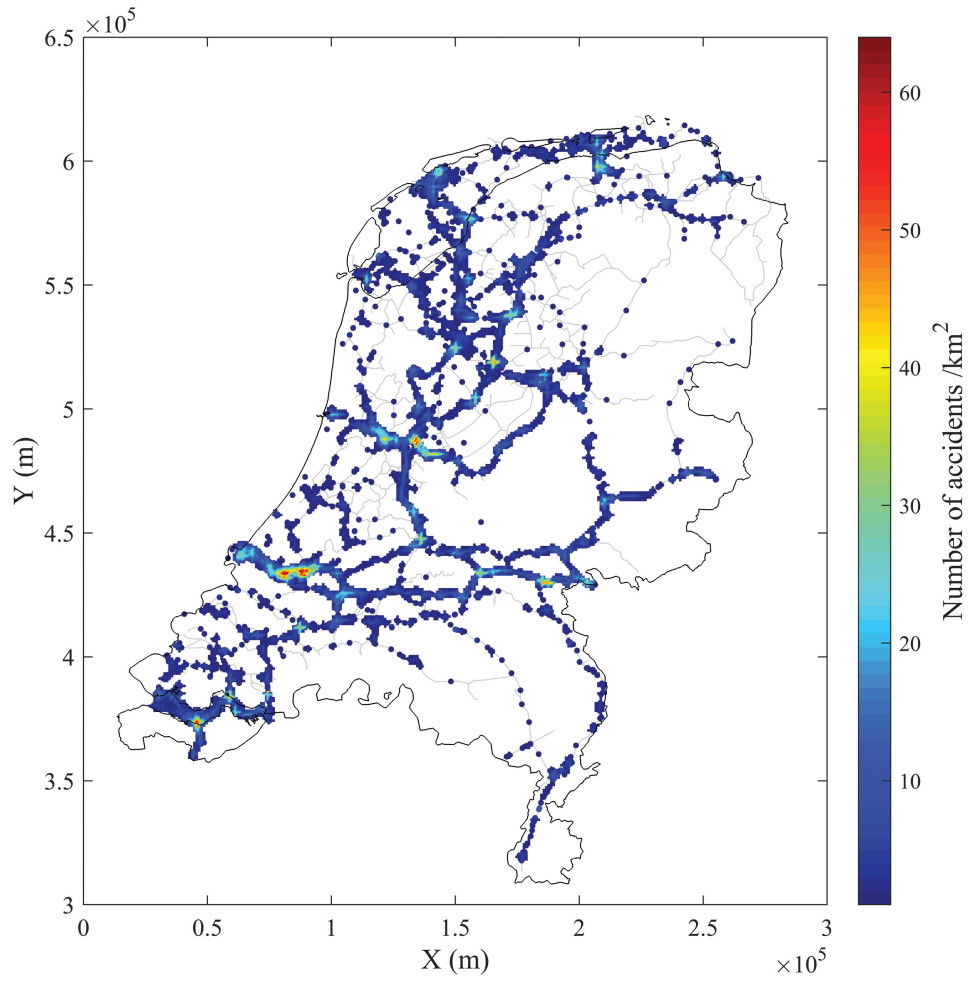

Figure 1.2: Location of the shipping accidents in Dutch inland waterways during 2005-2014. (Data are from the SOS-database [145])

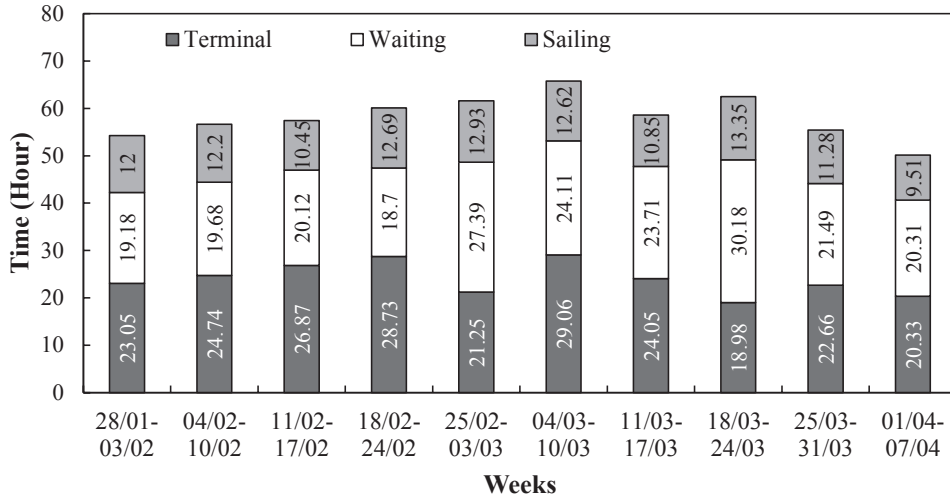

Figure 1.3: Average time spent in the Port of Rotterdam by container vessels (2019) [137].

Seeing the advantages that cooperative vessels may have, an increasing number of research proposed different methods for cooperation among vessels in the recent decade. Depending on the goals of cooperation, three types of research are found in the literature: formation control, cooperative collision avoidance and cooperative manipulation.

Formation control aims at steering a group of vessels to form a specific geometric configuration and move along a given path. Learning from the formation control of vehicles, most of the related studies for vessels employ three approaches [76], i.e., leader-follower architecture [3, 101, 153], behavioral methods [4], and virtual structures [77], while considering the characteristics of vessels and external disturbances.

In the research on cooperative collision avoidance, vessels only communicate and cooperate with others when there are collision risks. In existing non-cooperative collision avoidance methods, such as potential field [35], velocity obstacles [73], and optimization-based methods [184], vessels have to predict the actions that other vessels may take. Instead, in the methods for cooperative collision avoidance, vessels share their intentions. The actions of the involved vessels are determined by following a specific protocol [161] or negotiating through iterations [185].

However, the cooperative behavior of vessels transporting goods is neither typical formation control nor cooperative collision avoidance. When sailing in ports or waterways, it is not necessary for vessels to maintain a specific configuration. Nevertheless, collision avoidance is not the only interaction between vessels. For instance, vessels can share voyage plans to avoid a long waiting time at ports or locks; sailing in groups also help to keep the vessels being connected, especially when we consider the effective range of ship-borne sensors, which help them to deal with unexpected changes; another attractive advantage to motivate vessels sailing in groups is the potential of reduced energy consumption [11, 109].

Cooperative manipulation is the behavior that a fleet of vessels coordinate their actions to fulfill certain tasks, such as moving an object and towing a boom. There are usually

physical connections between the participants. Cooperative manipulation methods in the literature are usually for navigation assistance. Coordinating a fleet of vessels for long-distance transport is not mentioned. Besides, collision avoidance is usually not considered in this category of research.

Moreover, when looking into a waterway network, the interdependence of interconnected infrastructures is an important factor that should be considered. Improvement of the traffic situation at one infrastructure may lead to congestion at other infrastructures. However, little attention has been paid to Infrastructure-to-Infrastructure (I2I) interactions.

Compared to the newly started studies on the cooperation of vessels, the research on cooperative ground vehicles is relatively mature. Many methods have been proposed for the cooperative control of multi-agent systems, see [118, 123, 141] and the references therein. Regarding the similarity of vessels and vehicles, existing studies on cooperative driving of vehicles, such as platooning [94], can provide valuable references for the study of vessel coordination. Nevertheless, those methods and algorithms cannot directly be applied to the control of vessels. Firstly, the main focus of cooperative driving has been on longitudinal control [64, 116]. However, in practice, steering (lateral control) is regarded as the ordinary practice of seamen. Secondly, sideway speed and Coriolis force are not considered when controlling vehicles, while those are important factors when controlling vessels [54]. Thirdly, the movement of vessels is significantly affected by the external environment, such as wind, wave, and current, which brings more uncertainties in vessel motion control.

The lack of cooperative control methods for ASVs for improving the safety and efficiency of waterborne transport is the primary motivation of the research described in this thesis.

1.3 Research questions

The main research question addressed in this thesis is

How can the efficiency and safety of waterborne transport be improved through Vessel-to-Vessel and Vessel-to-Infrastructure communication and cooperation?

To address the main research question, the following key questions will be answered:

- Questions on state-of-the-art:
 1. Which types of cooperation have been investigated in existing research?
 2. Which methods have been used for the cooperative control of vessels and infrastructures for waterborne transport?
- Questions on cooperation among vessels:
 3. How can the interactions among ASVs be described using mathematical models?
 4. Which framework can be used to achieve agreements among a fleet of ASVs?
 5. How can the safety and efficiency of waterborne transport be improved through V2V cooperation?

- Questions on cooperation of vessels and infrastructures at a network level:
 6. How can the control of an infrastructure be formulated?
 7. How can the interdependence of the networked infrastructures be taken into consideration?
 8. How can the efficiency of waterborne transport be improved through V2I and I2I communication and cooperation?

1.4 Research approach

To address the research questions, *a synthesis of current knowledge on cooperative control of ASVs* is firstly provided. The survey on existing research provides a categorization of existing research and identifies knowledge gaps in control of multiple vessels.

The concept of the Cooperative Multi-Vessel System (CMVS) is then introduced. A CMVS is a system in which vessels utilize V2V, V2I, and I2I communication to negotiate and collaborate with each other for the aim of improving overall safety, efficiency, or for performing specific tasks. Through communication, those ASVs can have various form of cooperation for different objectives. Moreover, the maneuverability of vessels and the interdependence of the networked infrastructures are taken into consideration within the concept of CMVSs.

A generic negotiation framework is designed for achieving agreements among controllers. The framework is generic in several ways. Firstly, both serial and parallel, and even hybrid iterative schemes can be addressed under the framework. Secondly, the framework can be used for the consensus problems of heterogeneous controllers. The information proposed to be exchanged consists of the predicted trajectories or schedules over a prediction horizon. Therefore, the dynamics of ASVs need not necessarily to be the same, neither the operation models of the infrastructures.

Insights into the impact of the proposed CMVSs on the performance of waterborne transport are obtained. After developing the cooperative framework, the impact of different types of cooperations are discussed with simulation experiments.

Throughout the research, the performance of the proposed methods is assessed using case studies defined for the Port of Rotterdam and the canal network in Amsterdam, see Figure 1.4. These two areas are representative waterways, and they are also the areas where accidents often occur (see Figure 1.2). Two model vessels are used in the experiments, Delfia 1* [30] and CyberShip 2 [155], see Figure 1.5.

1.5 Research scope

Autonomous vessels have been developed for more than 20 years. Researchers use different expressions to describe autonomous vessels, such as unmanned surface vehicles, unmanned vessels, unmanned ships, autonomous surface vehicles, autonomous surface vessels, Autonomous surface craft, autonomous ships, autonomous vessels, etc. The term “unmanned” emphasizes that the vessel is operated without any crew on board, while the term “autonomous” emphasizes that the vessel could make decisions by itself. The International

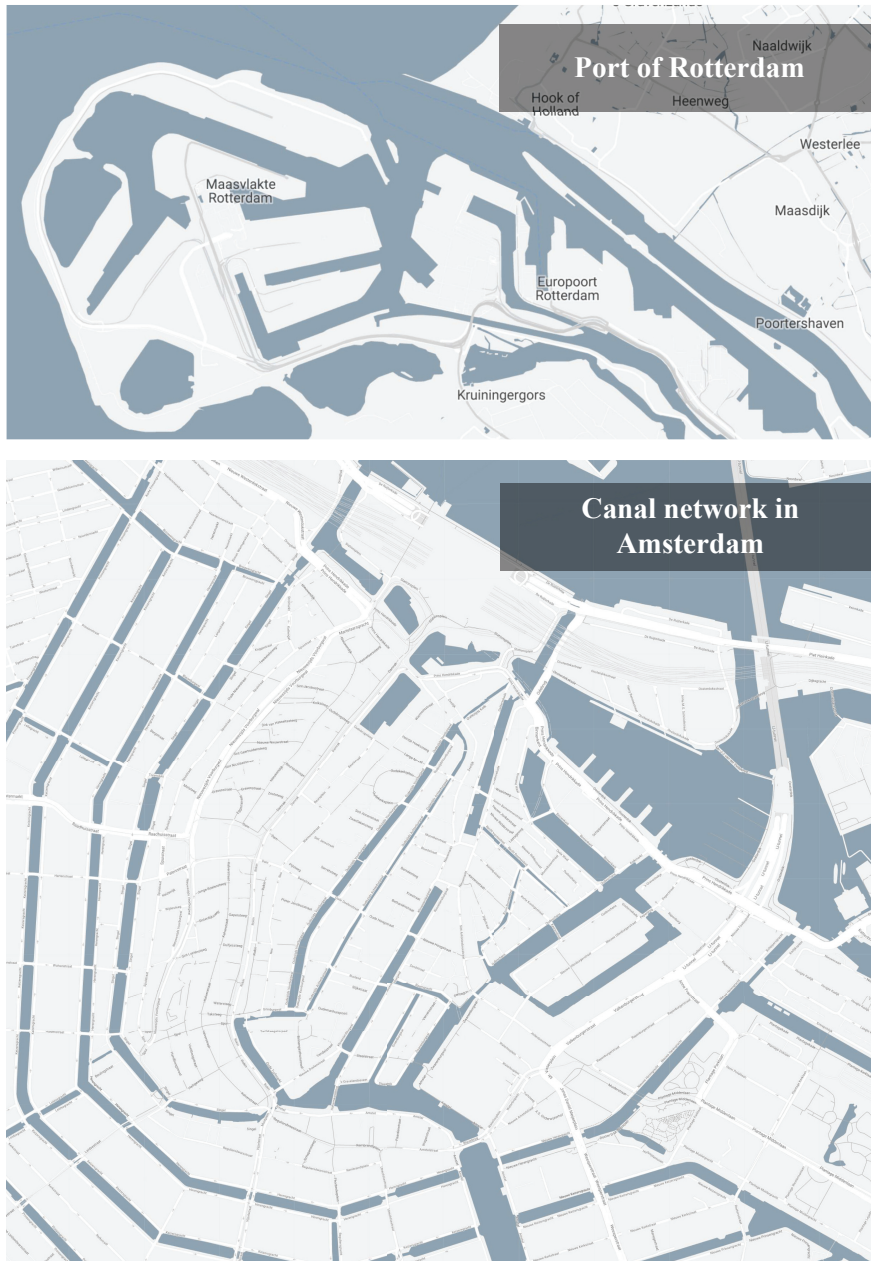

Figure 1.4: Simulation areas.

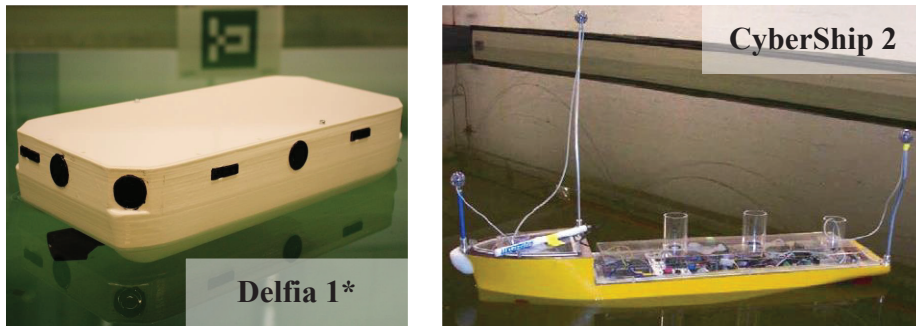

Figure 1.5: Delfia 1* and CyberShip 2.

Maritime Organization (IMO) uses “Maritime Autonomous Surface Ship (MASS)” to describe a ship which, to a varying degree, can operate independently of human interactions. The degrees of autonomy are organized as follows [79]:

- Ship with automated processes and decision support: Seafarers are on board to operate and control shipboard systems and functions. Some operations may be automated.
- Remotely controlled ship with seafarers on board: The ship is controlled and operated from another location, but seafarers are on board.
- Remotely controlled ship without seafarers on board: The ship is controlled and operated from another location. There are no seafarers on board.
- Fully autonomous ship: The operating system of the ship is able to make decisions and determine actions by itself.

In this thesis, *an ASVs is defined as the vessel which is able to make decisions and determine actions by itself*, i.e., a fully autonomous ship. Moreover, this thesis focuses on the motion control of the ASVs, i.e., to generate the desired trajectories and to determine the control forces and moments to be provided in order to follow the trajectories for certain control objectives.

Secondly, we focus on *the cooperation of fleets of ASVs*, named as a Cooperative Multi-Vessel System (CMVS). A CMVS is a system in which vessels utilize Vessel-to-Vessel (V2V) and Vessel-to-Infrastructure (V2I) communication to negotiate and collaborate with each other for the aim of improving overall safety, efficiency, or for performing specific tasks.

Thirdly, *the performance of waterborne transport in this thesis refers to safety and efficiency*. Safety is indicated by the distance between an ASV and other vessels or obstacles; efficiency is indicated by the travel time of each ASV and the total travel time of the fleets in a certain area, such as an intersection or a waterway network.

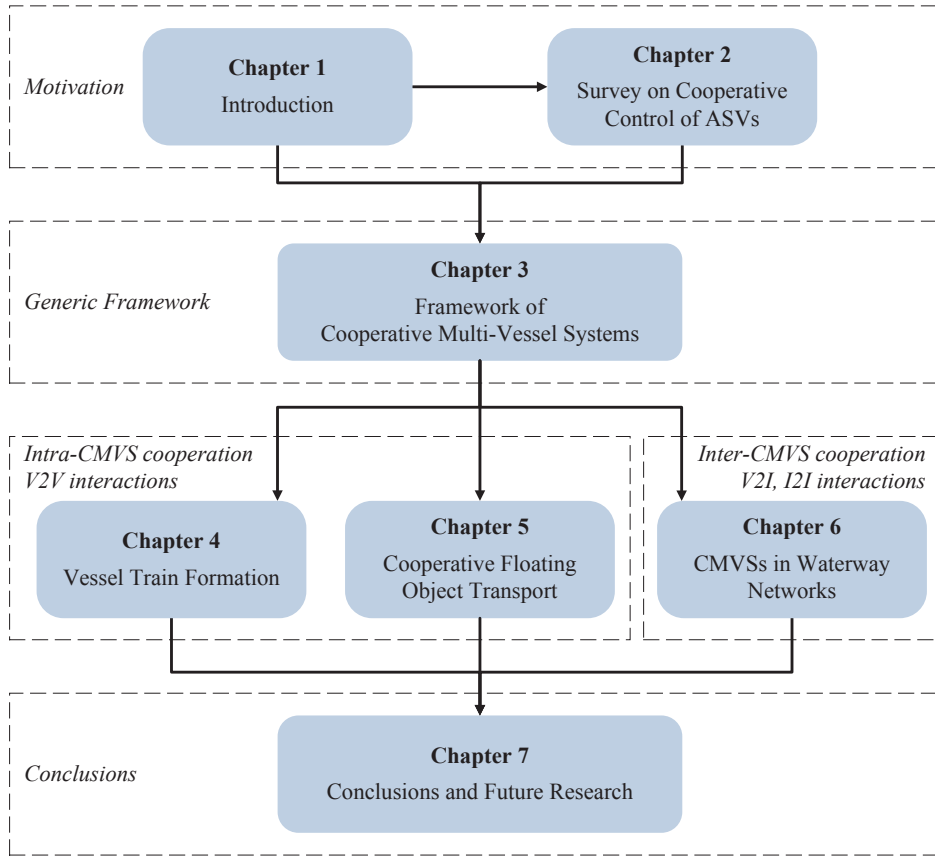

Figure 1.6: The outline of this thesis.

1.6 Thesis outline

Figure 1.6 provides an overview of the structure of this thesis:

- In **Chapter 2**, a survey on existing research on cooperative control of ASVs is given. The chapter also identifies the main research gaps and answers the research questions on the state-of-the-art.
- In **Chapter 3**, the concept of the Cooperative Multi-Vessel Systems is proposed. The dynamics of a CMVS are modeled based on graph theory. A predictive motion control framework is constructed for motion control of an individual vessel. Then, a generic negotiation framework based on the Alternating Direction of Multipliers Method (ADMM) is designed to deal with consensus problems among controllers.
- In **Chapter 4**, we in particular focus on the cooperation of vessels, i.e., so-called Vessel Train Formation (VTF) problem. The VTF problem considers not only cooperative collision avoidance but also the grouping of vessels. A controller based

on Model Predictive Control (MPC) is designed to control the motion of each ASV. A single-layer serial iterative scheme is adopted to achieve agreements among vessel controllers, which gains the benefits of reduced communication requirements and robustness against failures. The impact of information updating sequences and responsibility parameters are discussed. We furthermore analyze the scalability of the proposed method. Simulation experiments of a CMVS navigating from different terminals in the Port of Rotterdam to inland waterways are carried out to illustrate how safety and efficiency of waterborne transport can be improved using the proposed method.

- In **Chapter 5**, we investigate the control problem of Cooperative Floating Object Transport (CFOT), i.e., a group of ASVs coordinate their actions to transport floating objects. A multi-layer parallel iterative scheme is employed for the cooperation of ASVs in the object transport system. The cooperative control problem is formulated as the combination of several subproblems: trajectory tracking of the object, control allocation, and formation tracking of the ASVs. A coordinator at the higher level is responsible for two tasks: one is to determine the virtual forces to control the motion of the object; the other is to ensure that the commanded virtual control is produced jointly by the ASVs. Simulation experiments of the proposed cooperative system to move a large vessel sailing inbound the Port of Rotterdam are carried out to show the effectiveness of our method.
- In **Chapter 6**, we explore the potential of applying CMVS at the network level. We firstly consider the cooperation between ASVs and infrastructures at the node level. The coordinated problem of several fleets of ASVs passing through an intersection is formulated as Waterway Intersection Scheduling (WIS). The WIS helps to find a conflict-free schedule for the vessels from different directions. Then, the WIS is extended to network level as Cooperative Waterway Intersection Scheduling (CWIS), in which the interdependence of interconnected intersections are considered. Simulation experiments involving the scenarios in which ASVs sail in the canal network in Amsterdam are carried out to illustrate the effectiveness of the proposed approach.
- In **Chapter 7**, the main findings of this thesis are provided, including directions for future research.

Chapter 2

Survey on Cooperative Control of ASVs for Waterborne Transport

This chapter reviews existing research on cooperative control of Autonomous Surface Vessels (ASVs) and answers research questions regarding the state-of-the-art. The findings and conclusions of this chapter lay the foundation for the following chapters. Section 2.1 presents a hierarchical architecture of Vessel-to-Vessel (V2V), Vessel-to-Infrastructure (V2I), and Infrastructure-to-Infrastructure (I2I) cooperation in the waterborne transport system, and provides the categorizations for reviewing existing research. The methods for V2V and V2I cooperation at the local layer are reviewed in Section 2.2 and Section 2.3, respectively, followed by an overview of cooperations at the network layer in Section 2.4. Conclusions of this chapter is provided in Section 2.5.

Parts of this chapter have been published in [29].

2.1 Categorization of cooperative control of ASVs

The main function of waterborne transport is to fulfill the transport demand, i.e., to transport goods and/or people from one place to another. Two main components in waterway systems are vessels and infrastructures. Vessels are the means of transport. Infrastructures are necessary to guarantee sound navigation. For example, waterways provide navigable waters, and locks create stepped navigational pools with reliable depths.

Figure 2.1 provides a hierarchical architecture of cooperation in the waterborne transport systems. Three layers of cooperation are identified according to the range of communication and cooperation.

The individual layer is the basis layer where a controller controls the dynamics of a vessel. At this layer, a vessel controller does not communicate with other controllers. A vessel controller can obtain information about other vessels and surrounding environment via sensors. Based on the obtained information, the controller decides the trajectory and controls actuators, such as propellers and rudders, to make the vessel move towards the desired position. The research topics related to the control of vessels at this layer are motion planning and control. The main challenges are to describe and deal with the highly nonlinear

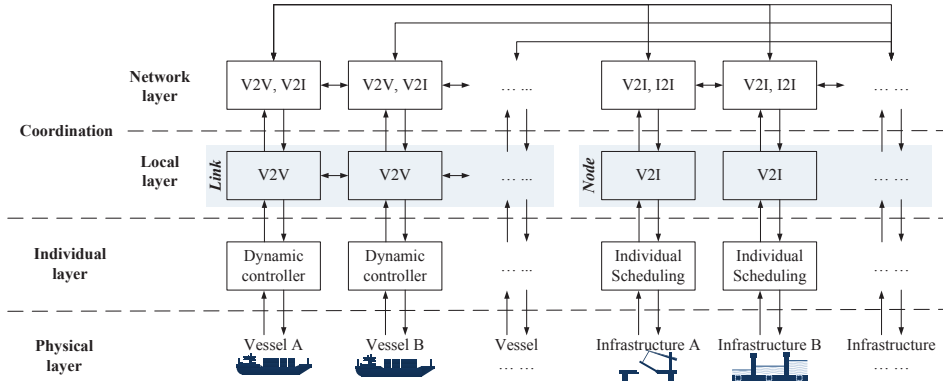

Figure 2.1: Hierarchical architecture of cooperations in waterborne transport systems.

dynamics of the vessels, and handling various control constraints. Moreover, the motion of vessels is strongly influenced by external disturbances, such as wind, wave, and current. How can the controller be robust against disturbances is also a challenging problem.

The local layer considers the V2V and V2I interactions, includes cooperation at links and nodes. Links refer to waterway segments where vessels have similar directions. The cooperation at links usually involves a fleet of vessels. The main task is to design coordination strategies so that local coordination can result in group cooperation. However, communication and connectivity are often limited. It is also difficult to decide what to communicate and when and with whom the communication takes place. Moreover, the problem becomes more complicated if some of the vessels are non-cooperative or fail to find their own solutions. Existing studies for V2V cooperation at links can be classified into three categories, i.e., cooperative collision avoidance, formation control, and cooperative manipulation.

Nodes refer to the places connecting waterway segments, such as a lock, a movable bridge, an intersection, a terminal. The cooperation in links mainly involves a small number of vessels. At nodes, infrastructure controllers making schedules with the predicted time of arrival reported by vessel controllers and also keep an eye on the state of the infrastructures (e.g., availability, waiting time and length of the line). In return, the operation schedules also have impact on vessel controllers decision making on departure time and speed choices. Studies that related to the cooperation at nodes mainly focus on the scheduling of the spatial and temporal resources of the infrastructures, i.e., determination of the order and the duration of each vessel occupying the available recourses.

When looking into a waterway network, the interdependence of interconnected infrastructures is an important factor that should be taken into consideration. Improvement of the traffic situation at one infrastructure may lead to congestion at other infrastructures. Moreover, the network structure makes it possible for vessels to choose different routes. If accidents or congestions occur in a certain area, there may be alternative routes.

Table 2.1 provides a comparison of the three layers. In the following sections, we review the cooperative methods for the control of vessels and infrastructures at the local and network layers. For motion control of an individual vessel, many papers have provided comprehensive reviews in related methods and techniques, such as [20, 104, 135, 162].

Table 2.1: Comparison of different layers of cooperation

Layer	Range	Comm.	Vessel	Infra.	Challenge	Topic
Network	A waterway network in an area; a port.	I2I, V2I	Many	Many	Interdependence of interconnected infrastructures; + <i>underneath challenges</i> .	Route choice; Coordinated scheduling.
	A lock; a movable bridge; an intersection; a terminal.	V2I	Many	One	Limit resources; uncertainties in arrivals; fairness; + <i>underneath challenges</i> .	Infrastructure scheduling.
Local	Node				Interaction modeling; communication and connectivity; consensus methods; non-cooperative participators; fault; + <i>underneath challenges</i> .	Cooperative collision avoidance; Formation control; Cooperative manipulation.
	Link	V2V	Several	None	Highly nonlinear dynamics; control constraints; disturbances.	
Individual	A vessel.	-	One	None		Motion planning and control.

Note: Comm.: Communication, including V2V, V2I, I2I communications;

Infra.: Infrastructure, such as a terminal, a lock, a movable bridge and an intersection.

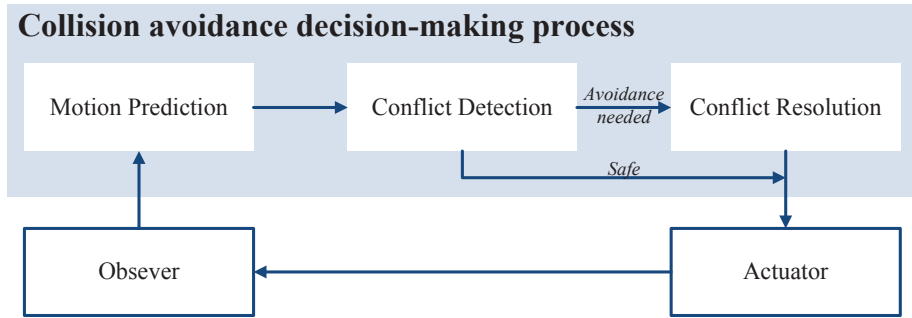

Figure 2.2: Collision avoidance decision-making process (adapted from [75]).

2.2 Vessel-to-Vessel cooperation at the local layer

Vessel-to-Vessel cooperation at the local layer involves vessels within a certain range that coordinate their behavior for improving safety and efficiency or for performing specific tasks. According to the objectives, V2V cooperation at the local layer can be divided into three types:

- *Cooperative collision avoidance* aims at finding collision-free trajectories for vessels through communication or predefined protocols. Vessels only cooperate with each other when collision avoidance is needed.
- *Formation control* Formation control aims at steering a fleet of vessels to form a specific geometric configuration.
- *Cooperative manipulation* aims at coordinating a fleet of vessels to perform certain tasks.

In the following part, the methods for the three types of cooperation are reviewed.

2.2.1 Cooperative collision avoidance

The determination of collision avoidance actions can be generally divided into three basic processes, namely Motion prediction, Conflict detection, and Conflict resolution [75], see Figure 2.2. Motion prediction is to estimate the future actions and trajectories of the Own Ship (OS) and the Target Ships (TSs), which is the basis for conflict detection and resolution. Conflict Detection is to check collision risk and launches collision warning if necessary; Conflict Resolution is to determine the evasive solutions. The future actions and trajectories of TSs can be predicted by the OS with certain assumptions (e.g., TSs keep a constant speed) or through communication with the TSs. Communication means the process of information broadcasting and receiving among the controllers.

Table 2.2: Categorization of collision avoidance methods

	Cooperation level		
	Cooperative	Non-cooperative	Competitive
Communication	Negotiation methods	Intention-aware methods	
Non-communication	Rule-based methods	Assumption-based methods	Game theoretical methods

Classification of cooperative collision avoidance methods

According to the existence of communication and the cooperation level a method can achieve, existing methods can be classified into five groups, as shown in Table 2.2.

Conventional collision avoidance methods usually do not consider the communication between controllers. *Assumption-based methods*, such as potential field [35] and velocity obstacles [74], predict the actions that other vessels may take either by assuming that other vessels sail with constant speed and heading [87, 128, 160] or according to holonomic or kinematic models [21].

Rule-based methods use pre-defined rules as the protocol to realized cooperation among controllers. Those approaches draw up rules on the actions that vessels should take under possible encounter situations. Vessels can coordinate their behavior through rule-compliant decision making.

Communication between vessels can provide additional information which is helpful for collision avoidance decision making. In the *Intention-aware methods*, controllers decide their collision avoidance actions according to the intentions broadcast by other controllers, such as turning directions, predictive trajectory, etc.

Different from the Intention-aware methods, *Negotiation methods* emphasize the close-loop information exchanges. After a controller broadcasting its decision, the actions that other controllers make based on this decision are sent to the controller as feedback. The controller will adjust its decision accordingly. In this way, agreements among the vessels controllers can be achieved through iterative negotiations.

Competition between vessels is seldom mentioned in existing research. In [113], the problem of collision avoidance between two vessels is modeled as a pursuit-evasion game between a faster elliptical pursuer and a more maneuverable circular evader. In [71], the authors present a method to model the decision-making process of the human operators according to the expected behavior of the TS. This method is based on the assumptions the TS takes different actions, i.e., a cooperative scenario in which the TS takes cooperative actions, zero acceleration behavior scenario in which the TS maintains its current course and heading, and the worst-case scenario in which the Ts is actively aiming to hit the OS. In [95–97], the authors applying the differential game model for collision avoidance considering the uncertainty of information and incomplete knowledge about other objects. In these papers, the collision avoidance problem is formulated as a differential game. However, it is challenging for this method to handle the encounter situations which involve more than two players [6].

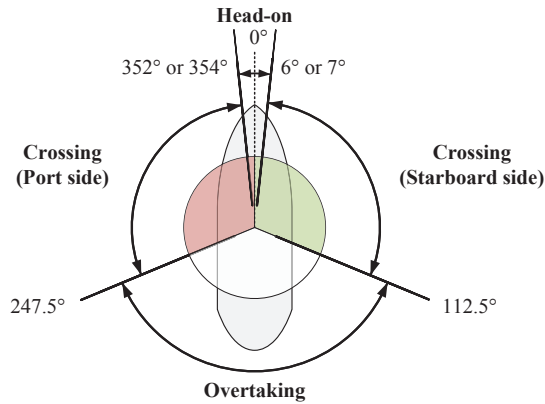

Figure 2.3: Encounter situations [78] (Head-on situation is the situation that any vessel coming towards a vessel on a roughly opposite course and roughly within half a point of the compass (6° or 7°) on either side of the bow [16]).

In this thesis, we focus on communication and cooperation among controllers. Thus, in the remaining of this section, Rule-based methods, Intention-aware methods and Negotiation methods, for cooperative collision avoidance are reviewed. Detailed reviews on collision avoidance technologies that do not consider cooperation among vessels can be found in [20, 75, 162].

Rule-based methods

The core of the Rule-based methods is to draw up rules that state the actions vessels should take under different situations. When vessels encounter, the controllers reorganize the encounter pattern and execute actions to comply with the corresponding rule accordingly.

The International Regulations for Preventing Collisions at Sea, 1972 (COLREGs) is the most widely used rule, such as in [161]. It sets out the navigation rules to be followed by vessels at sea to prevent collisions between two or more vessels. An overview of methods that consider COLREGs is provided in [149]. COLREGs divides the encounter situations of two vessels into three types, as shown in Figure 2.3. The rules of the road in COLREGs specify the maneuvers that should be taken when there is a risk of collision [78]:

- Rule 13: Overtaking.
 - (a) A vessel shall be deemed to be overtaking when coming up with another vessel from a direction more than 22.5 degrees abaft her beam.
 - (b) Any subsequent alteration of the bearing between the two vessels shall not make the overtaking vessel relieve her of the duty of keeping clear of the overtaken vessel.
- Rule 14: Head-on situation. When two power-driven vessels are meeting on nearly reciprocal courses so as to involve risk of collision each shall alter her course to starboard so that each shall pass on the port side of the other.

- Rule 15: Crossing situation. When two power-driven vessels are crossing, the vessel which has the other on her own starboard side shall keep out of the way and shall, if the circumstances of the case admit, avoid crossing ahead of the other vessel.
- Rule 16: Action by give-way vessel. Every vessel keeping out of the way of another vessel shall, so far as possible, take early and substantial action to keep well clear.
- Rule 17: Action by stand-on vessel. The stand-on vessel shall keep her course and speed, except two cases:
 - (a) the vessel required to keep out of the way is not taking appropriate action in compliance with these Rules;
 - (b) the vessels are so close that collision cannot be avoided by the action of the give-way vessel alone. The vessel which takes action in a crossing situation in accordance with case (a) of this Rule to avoid collision with another vessel shall not alter course to the port side of a vessel on her own port side.

However, COLREGs is written to train and guide safe human operations, and it heavily depends on human common sense in determining rule applicability as well as rule execution, especially when multiple rules apply simultaneously. In [7], the authors proposed a method using multi-objective optimization to capture the flexibility in COLREGs, including the flexibility of when a rule is applied and how it is applied. In [68], the authors carried out a quantitative analysis of COLREGs and seamanship to discriminate encounter situations, stages, and actions. Nevertheless, interpretation of COLREGs is still challenging. Furthermore, as applying ASVs will have significant impact on safety, security, and personnel (both on board and ashore), COLREGs needs to be updated. International Maritime Organization (IMO) is currently assessing existing IMO instruments to see how they might apply to vessels with varying degrees of automation, through a regulatory scoping exercise on Maritime Autonomous Surface Ships (MASS) [80].

Moreover, Rule-based methods are rest on the assumption that all the vessels follow the rules. However, it is possible that vessels in the same situation have different reorganization on the encounter pattern or the actions other vessels take in breach of the rules. The probability of violation of the rules is considered in [34]. The authors proposed a probabilistic approach for collision avoidance decision making based on a graphical model consisting of the maneuvering intent and evolution of system states.

Besides COLREGs, other rules can also be used as long as all the involved vessels agree to follow the rules. For instance, in [83], a Reciprocal Velocity Obstacles (RVO) method is introduced for sharing the responsibility for collision avoidance among two vessels. When two vessels encounter, the RVO method suggests that one vessel takes only half of the responsibility, and the other vessel reciprocates by taking the remaining half. However, those specific rules are usually only suitable for specific circumstances.

To conclude, Rule-based methods use a simple and direct way to coordinate the behavior of encountered vessels. Moreover, using Rule-based method to decide collision avoidance actions for an ASV will make an ASV more like a human-operated vessel, which can help the ASV be easier to integrate into the current transport system and to coordinate with human-operated vessels in the future mixed-traffic situation. However, there are some disadvantages when applying the rule-based method. Firstly, it is difficult to figure out all the

possible scenarios. Secondly, Rule-based methods are usually suitable for encounter scenarios with a single vessel only. Because encountering multiple vessels incorporates multiple rules, to find the unique solution to the avoidance problem is difficult [20]. Thirdly, as the rules limit the actions that a vessel controller can choose, the decisions the controller make are usually not optimal. In some cases, the controller even cannot find out rule-compliant actions, especially when a vessel is sailing in restricted waters. Lastly, as the rules are made ahead of time, vessel controllers, in fact, cannot adjust the rules to get better performances or handle emergencies. Thus, controllers using the rule-based method are just partially cooperative.

Communication-based methods

Communication-based methods are characterized by information exchanging among the controllers during decision-making. The information can be any information that can help the controllers make decisions, such as dynamic models of other vessels, turning intentions (port-side or starboard-side turnings), predictive trajectories, etc.

In the Intention-aware methods, each controller can only access its own sensors and actuators. All the vessels make decisions in a distributed way: each controller firstly broadcast their intentions, such as turning, trajectories to controllers within the communication range, and decisions are made based on the broadcast information. Controllers perform computation and broadcast their intentions in a predetermined sequence, see Figure 2.4. Since information is exchanged only once after a controller solved its problem, the amount of communication between agents is less, as well as the computation time. In [115], the authors proposed an Intention Exchange Support System to exchange navigational intentions (e.g., Port to Port passing) between encountered ships. In [85], a Single-layer sequential structure is applied for the cooperative control of a fleet of vehicles. The results show that the fleet objective can be improved by having some vehicles sacrifice their individual objectives. In [184], each controller makes decisions according to its own observations and the intentions of the other vessels, including speed, course, etc.

In Intention-aware methods, the control decision is non-cooperative. The controllers can only receive information from others, and there is no negotiation consensus during the decision-making process. Fully cooperative behavior requires all the involved controller to negotiate with each other and coordinate their behavior under a common goal. In Negotiation methods, the cooperative actions are determined through iterative negotiation. A controller can broadcast its own intentions and its expectations about other controllers, such as the actions that it wishes other controllers would take, the trajectory it prefers rather than the trajectory it computes. When a controller makes decisions, it takes other controllers expectation into consideration and adjusts the decisions it had made. Thus, such an iterative negotiation framework has a larger potential to achieve overall optimal performance [119].

Two types of control structures are used in Negotiation methods, i.e., Single-layer structure and Multi-layer structure.

In the Single-layer negotiation structure, every controller considers only its own part of the system. Controllers exchange their intentions through communication, see Figure 2.5. According to the order of communication, Single-layer negotiation structure can use two different schemes, i.e., parallel and serial [119, 150]. In parallel schemes, all the agents per-

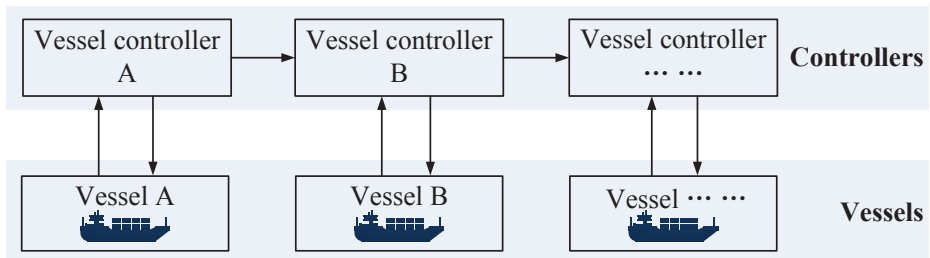

Figure 2.4: Structure of Intention-aware methods.

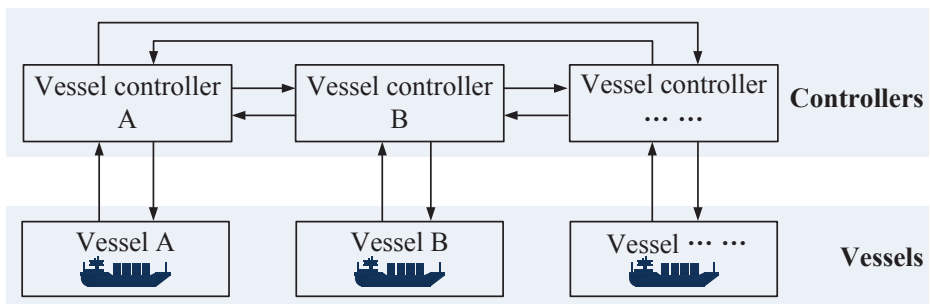

Figure 2.5: Structure of Single-layer negotiation methods.

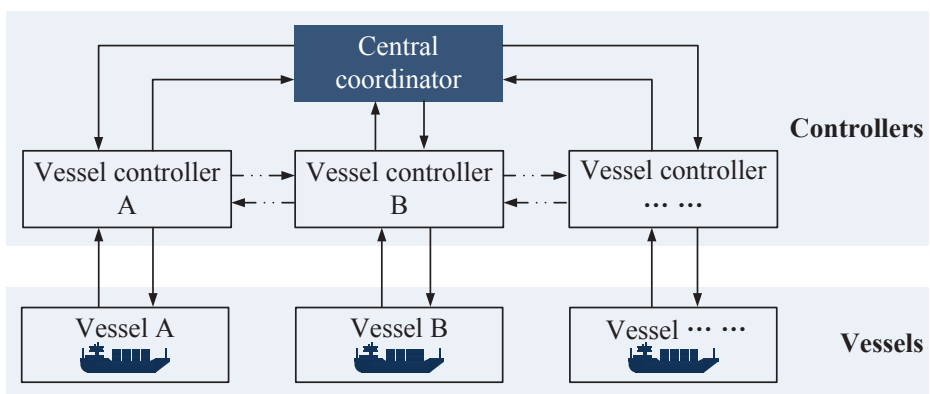

Figure 2.6: Structure of Multi-layer negotiation methods.

form computations at the same time. In the algorithm with the single-layer control structure proposed by [49], each subsystem computes optimal inputs for itself and all its neighbors. At each time step, the actions are the weighted average of the solutions calculated by the vessel itself and its neighbors. The single-layer parallel iterative scheme may lead to lack of convergence. Thus, in [119], a serial iterative scheme for transport networks is proposed. In the serial schemes, only one agent is performing computations at a time. Serial schemes have the advantage over the parallel schemes that agents make use of the most up-to-date information from their neighbors. It shows that the serial scheme has preferable properties in terms of solution speed, by requiring fewer iterations, and solution quality. In [24, 93], Single-layer serial iterative scheme is used for distributed coordination of vessels.

In the Multi-layer negotiation structure, a coordinator at the higher level coordinates the action of local controllers placed at a lower level, see Figure 2.6. In [188] and [189], a coordinator was responsible for the coupling collision avoidance constraints. Agreements among vessels were reached through iterations alternate between the coordinator and local path following controllers. The communication among controllers at the lower level may also exit. As the central coordinator has complete information about the whole system, a multi-layer negotiation structure can help the distributed methods find solutions which are closer to the solutions that a centralized controller calculates. At the same time, a multi-layer structure avoids the lack of convergence that a Single-layer structure may have.

In general, communication can provide the controllers with more information, including information beyond the range of sensors and intentions of other controllers. Through negotiation, Communication-based method can improve both local and overall performance. However, connectivity between the controllers is difficult to be guaranteed. How to deal with communication delays and packet losses is still a problem need to be solved. Moreover, the information being exchanged is provided by each controller. It is challenging to distinguish whether the information is reliable or not.

A comparison of the Rule-based method and Communication-based method is presented in Table 2.3

2.2.2 Formation control

Formation control aims at steering a group of vessels to form a specific geometric configuration and controlling their coordinated collective motion. There exists a large number of publications in the fields of cooperative and formation control of Multi-agent systems [22, 32, 89, 121, 123, 142, 152], Multiple Unmanned Vehicles [94, 103, 118, 141, 157], and Autonomous Underwater Vehicles [36]. In this part, we focus on the formation control of ASVs.

Classification of Formation control methods

According to different objectives, formation control can be divided into two processes:

- *Formation generation* aims at controlling a fleet of vessels located at random positions with arbitrary headings to form a specific geometric configuration.
- *Formation tracking* aims at controlling a fleet of vessels to follow a predefined trajectory while maintaining the geometric configuration.

Table 2.3: Comparison of the methods for cooperative collision avoidance.

	Rule-based method	Communication-based method
Cooperation	Partially cooperative	Partially cooperative (Single-layer sequential structure) Fully cooperative (Single/Multi-layer negotiation structure)
Basis	Pre-defined rules for possible situations, such as COLREGs.	Communication, information provided by other controllers.
Advantage	<ul style="list-style-type: none"> - Simple and direct; - Easy to understand for human; - Potential in coordinating rule-compliant ASVs and human-operated vessels. 	<ul style="list-style-type: none"> - Additional information beyond the reach of the sensors; - More accurate information about other vessels; - Balance between local and overall performance.
Disadvantage	<ul style="list-style-type: none"> - Difficult to figure out all possible situations; - Difficult to handling multi-vessel encounter situations; - Difficult to quantify descriptive rules; - Limit the actions that vessels can choose. 	<ul style="list-style-type: none"> - Challenges in communication and connectivity among the controllers, such as delays and packet losses; - Reliability of the provided information; - Long computation time; - Lack of convergence in certain circumstances.

According to whether or not desired formation shapes are explicitly prescribed, we get two types of formation control [121]:

- *Morphous formation co lack of convergent control*: Desired formations are explicitly specified by desired positions of agents, desired inter-agent displacements, desired inter-agent distances, etc. Formation generation and Formation tracking are all belonged to this type.
- *Amorphous formation control*: Without explicitly specified desired formations, desired behaviors such as cohesion, speed consensus, etc., are given for controllers. Representative research of this type is flocking.

Formation control methods are usually classified into three types, i.e., Leader–follower, behavioral, and virtual structure approaches [103, 157]:

- *Leader-follower approach*: A (virtual) leader is assigned to the formation, and other ASVs are designated as followers. The followers track the position of the leader with some prescribed offsets while the leader tracks its desired trajectory.
- *Behavioral approach*: Final control is derived from the weighting of the relative importance of several desired behaviors, such as cohesion, collision avoidance, formation keeping, etc.
- *Virtual structure approach*: The formation is considered as a single object, i.e., a virtual structure. The desired motion for the virtual structure is given. The desired motions for the ASVs are determined from that of the virtual structure.

Looking into the basic principle to determine the final control input, formation control methods usually use following three cooperative strategies:

- *Consensus-based method* achieves cooperation through controlling a group of agents toward some common states, such as heading, speed, average position, etc. There are not specified desired formation shapes. This category includes existing flocking approaches.
- *Relation-based method* determines the control inputs for each ASV according to the desired relative distance, orientation, or position of the ASV to a preset point (a leader or target). Above mentioned Leader-follower approach belongs to this category.
- *Position-based method* calculates paths for each ASV according to the desired configuration, and the formation is achieved when each ASV converges to its desired position. Above mentioned Virtual structure approach belongs to this category.

An overview of the literature for formation control of ASVs is presented in Table 2.4. Formation control has two tasks, motion control, and cooperative strategy design. Proportional Integral Derivative (PID) Control, Sliding Mode Control, and Model Predictive Control are frequently used to control the motion of each ASV. Back-stepping technique is often used for designing stabilizing controls for the ASVs considering the nonlinear dynamics. Lyapunov-based approaches are used to prove the system stability. In the research that external disturbances and uncertainties are considered, Fuzzy Logic, Disturbance Observer and Neural Networks are used to estimate the disturbances.

Table 2.4: Overview of formation control methods

Ref.	Main method	Amorphous	Morphous		Cooperative strategy		Uncertainties and disturbances	Obstacle avoidance
			Formation generation ¹	Formation tracking ²	Consensus-based	Relation-based		
[139]	Sliding Mode Method, Flock-centering, Lyapunov method	Flocking (6)			Average position			PF (Dispersion)
[180]	Back-stepping, Exponential remapping	Target sensing (2)		→		•		
[100]	Neural Network, Extended State Observer	Target tracking (3)		∪		•	+	
[4]	Null-Space-Based Behavioral Control		○ (8)	→		•	+	PF (Dispersion)
[76, 77]	PD control, Lagrangian approach		△ (3)	↔		•		
[47]	Nonlinear Model Predictive Control		⋯ (2 and 3)			•	+	PF (Variation)
[40, 41]	Lyapunov techniques		△ (3)			•		
[182]	Input-output linearization technique		□ (4)			•		
[48]	Sliding Mode Method		□ to △ (6)			•	+	
[10, 17, 127]	Line-of-Sight, Nonlinear cascade theory		△ (3)	→		•		
[15]	Nonlinear cascade theory, Back-stepping		△ (3)	↔		•	+	
[3]	Adaptive nonlinear control, Lyapunov stability, Back-stepping		⋯ (3)	∪		•	+	
[112]	Sliding Mode Method, Lyapunov's direct method		△ (3)	∪		•		
[153]	Adaptive robust control techniques, Neural Network		∧ (5)	∪		•	+	
[165]	Gradient-based adaptive control, Sliding Mode Method		□ (4)	∪		•		
[105]	Feedback control, Lyapunov stability		△ (3)	↔		•		
[159]	Sliding Mode Method, Back-stepping		∧ (5)	→		•	+	

Table 2.4 Continued: Overview of formation control methods

Ref.	Main method	Amorphous	Morphous		Cooperative strategy			Uncertainties and disturbances	Obstacle avoidance
			Formation generation ¹	Formation tracking ²	Consensus-based	Relation-based	Position-based		
[107, 108]	Neural network, Back-stepping, minimal learning parameter		$\Delta, \dots (3)$	\rightsquigarrow		\bullet		+	
[99]	Line-of-Sight, Nonlinear cascaded theory		$:(5)$	\cup			\bullet		
[154, 164]	Feedback control, Back-stepping		$\dots (3)$	\rightsquigarrow			\bullet	+	
[57]	Sliding Mode Method, radial basis function Neural Network		$\dots (5)$	\rightsquigarrow			\bullet	+	
[101, 102]	Fast marching method		$\Delta (3)$	\rightsquigarrow			\bullet	PF (Variation)	
[37]	Passivity-based techniques, radial basis function Neural Network, Lyapunov theory		$\dots (4)$	\rightsquigarrow			\bullet	+	
[38]	Back-stepping, Lyapunov direct method, Potential Function		$\circ (10)$	\rightsquigarrow			\bullet		
[39]	Back-stepping, Lyapunov direct method, Potential Function		$\dots (7)$	\rightsquigarrow			\bullet		
[63]	Line-of-Sight, Neural Network, Back-stepping		$\dots (3)$	\cup		Speed	\bullet	+	
[130]	Echo state network		$\dots (5)$	\cup		Speed	\bullet	+	
[129]	Recurrent Neural Network		$\dots (5)$	\rightsquigarrow		Speed	\bullet	+	
[131]	Recurrent Neural Network		$\Delta (5)$	\rightarrow		Speed	\bullet	+	
[179]	Feedback control, Neural Network		$\dots (3)$	\cup		Speed	\bullet	+	
[59]	Back-stepping		$\dots (3)$	\rightsquigarrow		Path parameter	\bullet	+	
[31]	Back-stepping		$\Delta (4)$	\cup		Path parameter	\bullet		
[33]	Back-stepping		$\dots (4)$	\odot		Path parameter	\bullet		

¹ $\Delta, \square, \circ, \triangle, \nabla$ represent the shape of the formation; \dots and $:$ represent an in-line and a queue formation; The number in $()$ indicates the number of ASVs.

² $\rightarrow, \rightsquigarrow, \cup, \cup, \cup, \odot$ represent a straight path, a curved path, a circular path, an elliptical path, and a generic closed curved path.

Most studies only consider Inter-formation collision avoidance. Distance control constraints and potential functions are often used to avoid colliding with formation mates. Other obstacles, such as other ASVs not within the formation and static obstacles, are usually considered before the formation is achieved. For the obstacles in the reference paths, the ASVs use shape variation or dispersion and re-generation during trajectory tracking. Potential Function (PF) approach is the most frequently used method when considering obstacles.

Consensus-based methods

The main idea behind Consensus-based methods is that each ASV's state is driven towards the states of its neighbors. A typical example is so-called flocking behavior: a group of agents move or go together in a crowd. Basic models of flocking behavior are controlled by three rules [143]:

- Cohesion: stay close to nearby neighbors;
- Separation: avoid collisions with nearby neighbors;
- Alignment: match velocity with nearby neighbors.

A common form of control inputs using Consensus-based method is so-called local voting protocol:

$$u_i = \sum_{j \in N_i} w_{ij} (x_j - x_i), \quad (2.1)$$

where u_i is the control input of ASV i ; w_{ij} is the weights; N_i is the neighbor of ASV i , which is the set of ASVs that form the formation with ASV i ; x_i and x_j are the states of ASV i and j that need to be synchronized. The state can be the average position (flocking centering protocol), speed and/or heading (velocity matching protocol). In [139], the flocking strategy is designed based on the average positions and distance variances of swarm members. The strategy leads to a cohesion behavior of the ASVs without a specific formation shape. Potential function is designed for avoiding collision between swarm members. When avoiding obstacles in the path, the swarm will disperse and re-generate.

As the consensus-based method aims at making the difference between the state of an ASV and those of its neighbors equal to zero, this method cannot guarantee that the ASVs form a specific formation. Thus, the consensus-based method is usually combined with path following and distance keeping methods.

In [63, 129–131, 179], formation tracking is divided into two steps: one is to steer each ASV to track a given spatial path; the other is to synchronize the speed of each ASV in order to maintain the desired formation pattern. In [59], a path-following controller is derived to force each ASV to follow a reference path subject to constant disturbances. The speeds of the vehicles are adjusted so as to synchronize the positions of the corresponding virtual targets. In [31, 33], path following is achieved through driving the value of the orbit function to the nominated value while formation motion along orbits is accomplished by forcing relative arc-lengths to the reference values. In [3], a nonlinear adaptive controller is designed that yields convergence of the trajectories of the closed-loop system to the path in

the presence of constant unknown ocean currents and parametric model uncertainty. ASV cooperation is achieved by adjusting the speed of each ASV along its path according to its relative position with other ASVs.

Relation-based method

A Relation-based method decides the actions each ASV should take according to the relative distance, orientation, or position to a prescribed point. The determination of control inputs can be described with following equation:

$$u_i = \arg \min_{u_i} \sum_{j \in N_i} w_{ij} \left\| (x_j - x_i) - r_{ij}^d \right\|, \quad (2.2)$$

where r_{ij}^d is the desired relative distance, orientation, or position.

The Relation-based method is usually used to solve the Leader-follower problem, in which each ASVs maintains a prescribed relative position of a (virtual) leader. In [15, 47, 48, 153, 159], a virtual leader with a global path planner determines the gross path of the formation, and then each ASV controls its relative position with respect to the leader(s). In [105], the virtual-leader formation structure is adopted. The desired position of the ASVs is calculated such that the virtual-leader follows a reference path.

Another application of the Relation-based method is target-tracking, i.e., to track a moving target and maintain a certain relative distance. In [100], a bounded controller is designed to solve this problem when only the instantaneous motion of target is available. In [180], the authors use this method to keep the target within a cone-like sensing field.

Position-based method

Position-based method is similar to the Virtual Structure method. Firstly, the formation is regarded as a rigid body. The desired position of each ASV is calculated according to the desired geometric configuration and the path that the formation need to follow. The desired formation is achieved by making each ASV follow its own path. Position-based method can be described using the following equations:

$$P_i^* = Conf(P_{j \in N_i}, P_{\text{Formation}}^*), \quad (2.3)$$

$$u_i = \arg \min_{u_i} \|P_i - P_i^*\|, \quad (2.4)$$

where P_i and P_i^* are the position and desired position of ASV i ; $P_{\text{Formation}}^*$ is the reference path that the formation should follow; $Conf(\cdot)$ indicates the desired geometric configuration.

In [154], a formation is viewed as a flexible system (as one unit) that maneuvers along a parametrized path. The formation is ensured when the individual ASVs converge to their positions in the formation and stay at their respective paths. In [164], the authors used a similar method, and the capability of handling a severe single vessel failure is illustrated for path-following behavior.

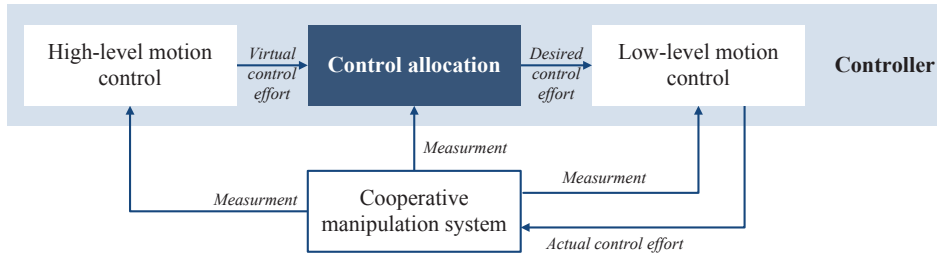

Figure 2.7: Generic control structure of cooperative manipulation.

2.2.3 Cooperative manipulation

Cooperative manipulation is the behavior that a fleet of vessels coordinate their actions to fulfill certain tasks, such as moving an object and towing a boom. Cooperative manipulation with Multi-Robot Systems has been studied for decades. Many coordination strategies have been proposed. A comprehensive summary of recent advancements in Multi-Robot Systems for Cooperative manipulation is provided in [171].

A generic structure of cooperative manipulation is shown in Figure 2.7. Firstly, a high-level motion control algorithm computes the virtual control effort (i.e., forces and moments) in order to meet the overall control objectives. Secondly, a control allocation algorithm decides the effort each vessel should provide such that they jointly produce the desired virtual control efforts. Thirdly, low-level control algorithms may be used to control each individual vessel via its actuators. In this structure, control allocation is the main problem that needs to be solved for cooperative manipulation. Control allocation is usually represented as an optimization problem considering saturation or other limitations of the vessels. An overview of control allocation methods can be found in [81]. According to the tasks, Cooperative manipulation can be divided into three types, i.e., Cooperative Object Transport, Caging, and Self-Assembly.

Cooperative Object Transport requires the cooperation of a fleet of vessels to move an object to the desired state (e.g., course, speed, position). In existing research, a typical application of Cooperative Object Transport is the manipulation of large vessels with multiple tugboats. In [9, 14, 44] control strategies that enable a barge to track a reference trajectory or orientation using a swarm of autonomous tugboats are discussed. In those papers, the tugboats are attached to the barge and apply forces at some fixed incident angles. The tugboats appear in essence as independent azimuth thrusters. In [50, 51], the initial position of the members is arbitrary. Nonetheless, once contact is established, the location of the tugboats are time-invariant. Moreover, only rotational motion is considered. The tugs are normal to the surface of the vessel to provide torque to rotate the vessel from current orientation to the desired orientation. In those papers, the attitude of the tugboats is not considered. The heading of tugboats usually differs sharply from the path direction, which is inefficiency while moving the object. Besides, collision avoidance is not considered in those papers.

Caging indicates the application that two ASVs are connected by a rope or boom to trap and transport something. It is usually used to collect liquid on the water, such as spilling oil.

In [8, 60, 132], a Caging system consisting of two ASVs is proposed for oil skimming and cleanings. In [5], two ASVs are connected to each other with a flexible floating rope. They coordinate with each other to capture a floating target from a given location and transport it to a designated position.

In [122, 126], the problem of Self-Assembly of large teams of autonomous robotic boats into floating platforms is investigated. Small self-propelled ASVs dock together and form connected structures with controllable variable stiffness. These structures can self-reconfigure into arbitrary shapes limited only by the number of rectangular elements assembled in brick-like patterns. The Roboat project [114] proposes to make the ASV units join together to create floating bridges and stages for alleviating congestion on Amsterdam's centuries-old bridges and canal-side streets.

2.2.4 Discussion

In existing research for V2V cooperation at the local layer, three types of research have been found according to the objectives of cooperation, namely, cooperative collision avoidance, formation, and cooperative manipulation. Cooperative collision avoidance methods pay more attentions on navigation safety. Vessels communicate when collision avoidance is needed. Different from Cooperative collision avoidance, in the problems of formation control, vessels have to keep in touch for maintaining desired configurations. Various methods have been proposed, such as Consensus-based, Relation-based, and Position-based methods. Distance control constraints and potential functions are often used to avoid colliding with formation mates. Collision avoidance with other obstacles, such as other ASVs not within the formation and static obstacles, are usually considered before the formation is formed or achieved using shape variation or dispersion and re-generation during trajectory tracking. Regarding cooperative manipulation, there are usually physical connections between the participants. Problems related to Cooperative Object Transport, Caging, and Self-Assembly have been investigated in existing research. Mostly, collision avoidance is not considered in this category of research.

When sailing in ports, waterways, or canals, it is not necessary for vessels to maintain a specific configuration. Nevertheless, collision avoidance is not the only interaction between vessels. Thus, for improving safety and efficiency, a generic concept for waterborne transport is needed. Moreover, cooperative manipulation methods in the literature are usually for navigation assistance. Coordinating fleets of ASVs for long-distance transport is not mentioned.

2.3 Vessel-to-Infrastructure cooperation at the local layer

V2I cooperation at the local layer aims at minimizing the time that vessels needed to pass through an infrastructure, such as a lock, a movable bridge, an intersection, or a terminal. Vessels passing through those infrastructures can be regarded as occupying time and space resources. Thus, the main problem that needs to be solved is the allocation of resources and time slots. The scheduling of the infrastructures is usually formulated as different types of scheduling problems, i.e., mapping of jobs to machines and processing times, such as

Single Machine Problems, Parallel Machine Problems, Job Shop Problems, etc. Algorithms for solving the scheduling problems are introduced in [133].

2.3.1 V2I cooperation at a terminal

For waterborne transport in ports, V2I cooperation is mainly related to the operations of terminal equipment. Two related topics are berth allocation and quay crane assignment and scheduling. Berth allocation refers to the decision process of assigning a berth position to a vessel. Quay crane assignment and scheduling decide which quay cranes are assigned to the vessel for loading and unloading operations. Quay crane assignment depends on the accessibility and availability of cranes at the berth. Optimizations on the operations of terminals have also been studied extensively in the literature. For an overview of the studies on the operations at a terminal, we refer to [158].

2.3.2 V2I cooperation at a lock

For inland shipping, locks are the infrastructures receiving the most attention as they are usually the main bottlenecks in waterway networks [43]. A lock has at least one chamber but may consist of multiple parallel chambers of different dimensions. Each chamber has a limited capacity and lockage duration. The lock scheduling problem considers the order in which a number of vessels should be transferred through a lock. Different congestion solving strategies for the Upper Mississippi River are discussed in [18, 19]. A generalized lock scheduling problem and an overview of methods to solve the lock scheduling problem can be found in [173, 177].

Processing a vessel to pass through a lock requires two decisions: determining a position for the vessel and setting a starting time for the lockage operation. Thus, the lock scheduling problem can be divided into two sub-problems, namely, Vessel Placement Problem and Lockage Scheduling Problem.

The Vessel Placement Problem aims at minimizing the number of lockage needed to place all vessels. The VPSP includes two steps. The first step is to decide the sequence of vessels that should be placed, which is determined by the service policy, such as first come first serve or shortest processing time first. Currently, most locks are managed by means of a first come first serve policy, i.e., vessels are handled in the order they arrive. In [168, 169], the authors investigate various strategies which are applied in vessel scheduling and report that shortest processing time first yields a smaller system-wide delay than the classical first come first serve policy. The second step is to decide how to arrange the vessels in a chamber. Generally, it is reminiscent of the classic 2D bin packing problem where a set of rectangular items (vessels) needs to be positioned inside as few rectangular bins (lockage) as possible [173]. In [176], the authors provide a complete mathematical model for the ship placement problem and compare an exact decomposition method and a multi-order best fit heuristic method for computing the solutions.

The Lockage Scheduling Problem deals with chamber assignment and lockage operation planning. This problem is often modeled as a parallel machine scheduling problem where chambers map to machines and lockage to jobs [125, 173]. In [174], a number of (meta-)heuristics for minimizing both the water usage of the lock and the waiting time of

all the vessels are presented. In [175], the authors focus on the determination of the order in which a number of vessels should be transferred through a lock. The authors identify the problem as the identical parallel machine scheduling problem with sequence dependent setup times and release dates. A heuristic method is presented for solving the lock scheduling in this specific setting.

2.3.3 V2I cooperation at an intersection

Few studies focus on the problem of intersection crossing of vessels. Vessels passing through intersections is comparable to the situation of vehicles crossing non-signalized intersections. In the field of road transport, intersection crossing is one of the most challenging problems and attracts much attention. Related research can provide valuable references for the studies on intersection crossing of vessels.

An intersection is a shared resource that a limited number of vehicles want to utilize at the same time [23]. An intersection controller needs to solve a resource allocation problem to avoid conflicts. In the method cooperative resource reservation, the intersection is modeled as a collection of tiles. Vehicles need to reserve the tiles on their planned route for certain time slots and pass the intersection according to the reservation [2]. Another method is to modify the trajectories (velocity) to minimize overlap and evacuation time [62] or maximize the capacity [58]. A review of cooperative intersection management systems for road transport can be found in [23].

2.3.4 Discussion

V2I cooperation at the local layer usually refers to the scheduling problems of infrastructures. The main problem that needs to be solved is the allocation of resources and time slots. Related research usually focuses on the scheduling for terminals and locks. Few studies focus on the problem of intersection crossing of vessels. However, there are many intersections in waterway networks. Vessels in such networks have to frequently interact with vessels from different directions. Intersections are also the place where accidents frequently occur. Thus, the interactions of vessels at the intersections need to be investigated for safety and efficiency of inland shipping.

2.4 Cooperation at the network layer

Cooperation among vessels and infrastructures at the network layer is related to the distribution of traffic flow and the determination of routes and departure time of vessels in waterway networks.

A traditional planning problem that closely related to the cooperation at the network layer is the Vehicle Routing Problem (VRP). VRP calls for the determination of the optimal set of routes to be performed by a fleet of vehicles to serve a given set of customers, and it is one of the most important and studied combinatorial optimization problems [170]. Considerable research has been done to solve the VRP and its variants. Details about Vehicle Routing are provided in [13, 86, 170].

In the literature, only a few studies focus on the interactions among vessels and infrastructures in inland waterway networks. In [26], the route choice behavior of vessels in an inland waterway network is investigated based on historical data. In [167], the scheduling problems for locks in sequence are studied, which show the interdependence of infrastructures. To the best of our knowledge, there is no study that focuses on cooperative control of vessels in an inland waterway network.

Some of the existing research related to the network layer cooperation consider vessels sail in a large seaport. In the port, each vessel has to visit a sequence of terminals. Two research topics are investigated. One is the so-called Inter-Terminal Transport (ITT). ITT refers to the transportation of goods between terminals within a port [166]. Conventionally, ITT usually involves dispatching and routing of Automated Guided Vehicles (AGV) or Automated Lift Vehicles (ALV). In [187], the authors proposed to use a fleet of waterborne AGVs to handle a set of emerging ITT requests for many advantages, such as reliable performance, handling the expected large throughput instead of exploiting limited land, energy saving for terminals with longer distances by land than by water, etc. In this paper, a closed-loop scheduling and control approach for a fleet of waterborne AGVs is proposed: by solving a pick-up and delivery problem, a sequence of terminals to visit for each waterborne AGV is generated; a cooperative distributed model predictive control method is applied to control the waterborne AGVs to execute the schedules safely and accurately. The other type of research on cooperation in ports is the Vessel Rotation Planning Problem (VRPP), i.e., which decides the sequence of multiple terminals that an inland vessel visits in the port area. In [42], the VRPP is firstly proposed, in which the terminal and vessel operators cooperate with each other to obtain better alignment. In [92], the authors compare four approaches to solve the VRPP, which concerns deciding on the optimal sequence of vessel visits to different terminals in a large seaport.

To conclude, few studies focus on the cooperative control of vessels and infrastructures in waterway networks. Most research focuses on VRPs when taking the network structures into account. Some research concentrates on the ITT and VRPP in a port which can be regarded as a small waterway network. However, research that considers the interdependence of interconnected infrastructures is lacking in general.

2.5 Conclusions

This chapter answers the research questions on state-of-the-art (Questions 1 and 2), i.e., which types of cooperation have been investigated and what methods have been proposed for waterborne transport in existing research. We first proposed a hierarchical architecture of cooperations in the waterborne transport systems. Three layers of cooperation are identified according to the range of communication and cooperation. The individual layer is the basis layer where a controller controls the dynamics of an individual vessel. The local layer considers the V2V and V2I interactions, including cooperation at a link (e.g., a waterway segment) and a node (e.g., an intersection, an individual infrastructure). The network layer considers not only V2V and V2I interactions but also the interdependence of interconnected infrastructures, i.e., I2I interactions. In existing research for V2V cooperation at the local layer, methods for cooperation of multiple vessels have been proposed for different objec-

tives, i.e., collision avoidance, formation, and cooperative manipulation. However, a generic concept for improving the safety and efficiency of waterborne transport is still needed. Existing literature on V2I cooperation at the local layer mostly considers the scheduling of locks and terminals. Few studies focus on the problem of intersection crossing of vessels. The review on existing research for transport in waterway networks reveals that research considering the interdependence of interconnected infrastructures is lacking in general.

Based on these findings, the following chapter (Chapter 3) proposes the concept of the Cooperative Multi-Vessel System for improving safety and efficiency in waterway networks. A generic negotiation framework is proposed to deal with consensus problems among controllers. Different communication and control structures for the applications of Vessel Train Formation, Cooperative Floating Object Transport, and Intersection Crossing are investigated in the subsequent chapters (Chapter 4 - 6) based on the proposed negotiation framework.

Chapter 3

Framework of Cooperative Multi-Vessel Systems

In the previous chapter, we demonstrated different layers of cooperation in the waterborne transport system, and reviewed the existing methods. We found that a generic concept for waterborne transport is needed for Vessel-to-Vessel (V2V), Vessel-to-Infrastructure (V2I), and Infrastructure-to-Infrastructure (I2I) cooperation in waterway networks. In this chapter, the concept of the Cooperative Multi-Vessel System (CMVS) is proposed. A predictive motion control framework is constructed for motion control of a vessel. Then, a generic negotiation framework based on the Alternating Direction of Multipliers Method (ADMM) is designed to deal with consensus problem among different controllers. The motion control framework and the negotiation framework will be used in the following chapters.

The chapter is structured as follows. In Section 3.1, the concept of CMVS is introduced and modeled. In Section 3.2, the dynamics of an individual Autonomous Surface Vessel (ASV) is presented, followed by the motion control framework based on MPC. A successively linearized model is used to predict the states. Simulation experiments are carried out to analyze the linearization errors. Section 3.3 provides a generic negotiation framework to coordinate heterogeneous controllers. The main conclusions are summarized in Section 3.4.

Parts of this chapter have been published in [24, 30]

3.1 Cooperative Multi-Vessel Systems

A CMVS is a system in which Autonomous Surface Vessels (ASVs) utilize V2V and V2I communication to negotiate and collaborate with each other for the aim of improving overall safety, efficiency, or for performing specific tasks. The concept, CMVS, includes the three layers of cooperation in waterborne transport mentioned in Chapter 2: motion controller controls the dynamic of each ASV at the individual layer, while cooperating with other ASV controllers at the coordination layer with V2V communication; V2I communication and cooperation at the links and nodes help to solve the conflicts at the infrastructures; through the network level communication, I2I cooperation is taken into account for safety and efficiency improvement of the whole waterborne transport system.

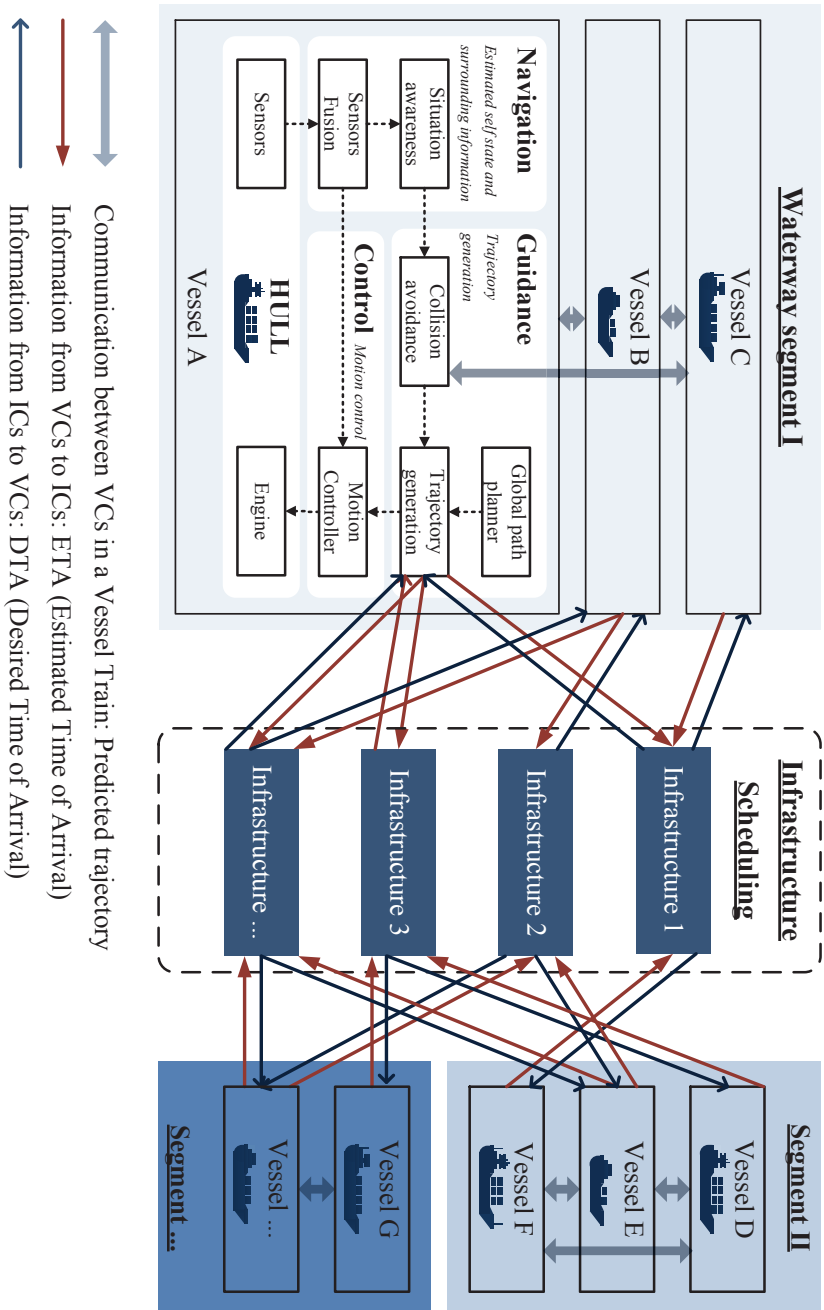

Figure 3.1: Cooperative Multi-Vessel System in waterway networks.

A framework for the cooperative control of vessels in waterway networks is presented in Fig. 3.1. We introduce two types of controllers: a Vessel Controller (VC) for the control of an ASV, and an Infrastructure Controller (IC) is responsible for solving the conflicts of vessels at an infrastructure.

A vessel controller uses sensors to get self-state information (e.g., position, speed, and heading), environmental information (e.g., wind speed and directions, current velocity) and information on obstacles. Based on the obtained information, the Navigation system creates pictures of the current situation and informs the Guidance system of collision risks. Combining with the predetermined global path, optimal trajectories with specified objectives and constraints can be determined. The commands are sent to actuators for autonomous navigation.

When approaching an infrastructure, VCs report their Estimate Time of Arrival (ETA) to the IC. Then, the IC makes conflict-free schedules and informs those vessels the Desired Time of Arrival (DTA) by solving the scheduling problem. After passing through the infrastructure, vessels sailing in the same waterways form new vessel trains for safe navigation. The communication and cooperation of vessels in different fleets are realized through ICs. Similarly, the ICs communicate and cooperate with each other by exchanging information with VCs.

All the controllers within a CMVS form the controller set, $\mathcal{V} = \{1, 2, \dots, n\}$. Due to the limitations of sensors, controllers can only receive and broadcast information over a limited range. Thus, given an interaction range $r_i > 0$, a controller only communicates and interacts with controller in this range (i.e., its neighbors). The set of the neighbors of controller i is

$$\mathcal{N}_i = \{j \in \mathcal{V} : \|P_j - P_i\|_2 \leq r_i\}, \quad (3.1)$$

where \mathcal{N}_i is the set of the neighbors of controller i ; P_j is the position of ASV j .

A CMVS can be represented by a graph $\mathcal{G} = (\mathcal{V}, \mathcal{E})$ that consists of a set of vertices and edges. Controllers \mathcal{V} are the vertices. The set of edges \mathcal{E} represents the communication and interaction possibilities between the controller and its neighbors:

$$\mathcal{E} = \{(i, j) : i, j \in \mathcal{V}, \|P_i - P_j\|_2 \leq \min(r_i, r_j), j \neq i\}. \quad (3.2)$$

3.2 Model predictive control framework for controller design for an ASV

This section presents the dynamic model of an ASV and the general control framework for the design of a VC.

3.2.1 Dynamic model of an ASV

For vessels, six different motion components are used to determine the position and orientation in six degrees of freedom (DOF), defined as surge, sway, heave, roll, pitch, and yaw. Figure 3.2 shows the six components with a body-fixed reference frame.

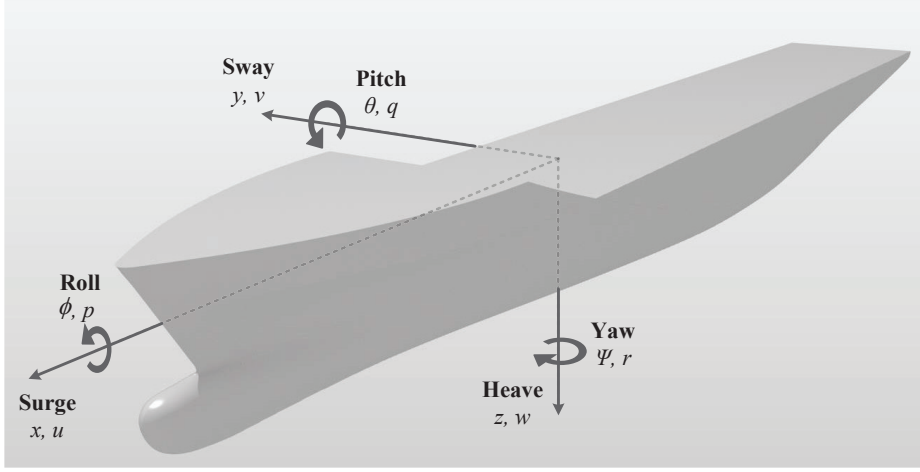

Figure 3.2: The body-fixed reference frame.

In this thesis, we focus on the motion of vessels in the horizontal plane. we consider *multiple heterogeneous ASVs* whose dynamics are described with a 3 DOF model proposed in [54], with varying parameter values:

$$\dot{\eta}_i = R(\psi_i)v_i \quad (3.3)$$

$$M_i \dot{v}_i = -C_i(v_i)v_i - D_i v_i + \tau_i, \quad (3.4)$$

where $R(\psi_i)$ is a rotation matrix,

$$R(\psi_i) = \begin{bmatrix} \cos(\psi_i) & -\sin(\psi_i) & 0 \\ \sin(\psi_i) & \cos(\psi_i) & 0 \\ 0 & 0 & 1 \end{bmatrix},$$

$\eta_i = [x_i^N, y_i^N, \psi_i]^T$ are coordinates x_i^N , y_i^N , and heading angle ψ_i in the North-East-Down coordinate system; $v_i = [u_i^B, v_i^B, r_i^B]^T$ are surge and sway velocities u_i^B , v_i^B , and yaw rate r_i^B in Body-fixed reference frame; $\tau_i = [\tau_{u_i}, \tau_{v_i}, \tau_{r_i}]^T$ are forces τ_{u_i} , τ_{v_i} , and moment τ_{r_i} ; M_i is the system inertia matrix, including rigid-body and added mass matrices, $M_i = M_{RB,i} + M_{A,i}$, where¹

$$M_{RB,i} = \begin{bmatrix} m_i & 0 & 0 \\ 0 & m_i & 0 \\ 0 & 0 & I_{z_i} \end{bmatrix}, \quad M_{A,i} = \begin{bmatrix} -X_{\dot{u}i} & 0 & 0 \\ 0 & -Y_{\dot{v}i} & -Y_{\dot{r}i} \\ 0 & -N_{\dot{v}i} & -N_{\dot{r}i} \end{bmatrix};$$

C_i is the Coriolis-centripetal matrix, including rigid-body and added mass Coriolis-centripetal

¹The hydrodynamic derivatives follow the notations in [156], hereinafter the same.

matrices, $C_i = C_{RB,i} + C_{A,i}$, where

$$C_{RB,i} = \begin{bmatrix} 0 & 0 & -m_i v_i \\ 0 & 0 & m_i u_i \\ m_i v_i & -m_i u_i & 0 \end{bmatrix}, \quad C_{A,i} = \begin{bmatrix} 0 & 0 & Y_{\dot{v}_i} v_i + Y_{\dot{r}_i} r_i \\ 0 & 0 & -X_{\dot{u}_i} u_i \\ -(Y_{\dot{v}_i} v_i + Y_{\dot{r}_i} r_i) & X_{\dot{u}_i} u_i & 0 \end{bmatrix};$$

D_i is the damping force. In this thesis, we consider a linear damping force which can be expressed as

$$D_i = \begin{bmatrix} -X_{ui} & 0 & 0 \\ 0 & -Y_{vi} & -Y_{ri} \\ 0 & -N_{vi} & -N_{ri} \end{bmatrix}.$$

With $x_i = [\eta_i^T, v_i^T]^T$ and τ_i the system state and input, respectively, the dynamic model (3.3)-(3.4) can be expressed as

$$\begin{aligned} \dot{x}_i &= f_i(x_i, \tau_i) \\ &= \begin{bmatrix} \mathbf{0}^{3 \times 3} & R_i(\psi_i) \\ \mathbf{0}^{3 \times 3} & M_i^{-1}(-C_i(v_i) - D_i) \end{bmatrix} x_i + \begin{bmatrix} \mathbf{0}^{3 \times 3} \\ M_i^{-1} \end{bmatrix} \tau_i. \end{aligned} \quad (3.5)$$

In this thesis, the dynamic model (3.5) is discretized with a sample time T_s :

$$x_i(k+1) = x_i(k) + \int_{kT_s}^{(k+1)T_s} f_i(x_i(k), \tau_i(k)) dt. \quad (3.6)$$

3.2.2 Formulation of the control problem

Model predictive control

MPC is a form of control in which the control action is obtained by solving on-line, at each sampling instant, a finite horizon optimal control problem in which the initial state is the current state of the system. Optimization yields a finite control sequence, and only the first control action in this sequence is applied [140]. MPC has been popular in practical applications since its very early days [111]. MPC has been applied to vessel path following [186], heading control [90], and collision avoidance [1]. Besides, DMPC (Distributed Model Predictive Control) has many advantages for the control of large-scale networked systems [119].

For waterborne transport, MPC methods also have many advantages:

- MPC has the capability of handling constraints on actions, states, and outputs, and it is able to control the system with multiple inputs and multiple outputs;
- The maneuverability of vessels is limited. MPC makes decisions based on predictions over the future horizon. This predictive property is beneficial to detect conflicts at an early stage.
- MPC considers the latest available measurement of the system's state and up-to-date information regarding disturbances, which provides MPC methods the capability, to a certain extent, to be robust against disturbances and uncertainties.

- MPC can handle structural changes, such as sensor and actuator failures, changes in system parameters, and system structure by adapting the control strategy on a sample-by-sample basis.

Therefore, we consider MPC as a suitable approach for controller design for ASVs in the CMVS.

Linear prediction model

The basic concept of MPC is using a dynamic model to forecast system behavior, and then optimizing the forecast to produce the best decision. Thus, at each time step, a prediction model that predicts the future system state based on the inputs and current state is needed.

The dynamics described in (3.6) are, however, highly nonlinear. If this nonlinear model is directly used to design the MPC controller, the MPC online predictions and optimizations would be too time-consuming for real-time control. Therefore, the successively linearized model presented in [186] is adopted in this paper.

At each time step, the controller calculates a sequence of control inputs for the whole prediction horizon, after which the control input for the first control sample will be implemented. In the next step, as a start point, the control sequence is shifted one sample with an additional of zeros at the end. Using this extended control sequence as seed input $\tilde{\tau}^e(k)$, we can obtain the seed state $\tilde{x}^e(k)$ with (3.6), where

$$\tilde{\tau}_i^e(k) = \begin{bmatrix} \tau_i^e(k|k) \\ \tau_i^e(k+1|k) \\ \vdots \\ \tau_i^e(k+H_p-1|k) \end{bmatrix}, \quad \tilde{x}_i^e(k) = \begin{bmatrix} x_i^e(k+1|k) \\ x_i^e(k+2|k) \\ \vdots \\ x_i^e(k+H_p|k) \end{bmatrix},$$

where $\tilde{\tau}$ represents the sequence of the corresponding variables over the prediction horizon H_p ; $\cdot(k+l|k)$, $l \in \mathbb{Z}$, $1 \leq l \leq H_p$, indicates the value of the corresponding variable at step $k+l$ set at time step k , i.e., $\tau_i^e(k|k)$ is the seed control input of time step k for the linearization at time step k ; $x_i^e(k+l|k)$ is the seed state of time step $k+l$ for the linearization at time step k .

By applying Taylor's theorem, we can obtain the approximate state of time step $k+1$:

$$x_i(k+1|k) = x_i^e(k+1|k) + A_i(k|k)(x_i(k|k) - x_i^e(k|k)) + B_i(k|k)(\tau_i(k|k) - \tau_i^e(k|k)), \quad (3.7)$$

where $x_i(k|k)$ is the approximate state of ASV i at time step k , which is equals to the real state of ASV i , i.e., $x_i(k|k) = x_i(k)$; $A_i(k|k) = \frac{\partial f_i}{\partial x_i} \Big|_{x_i^e(k|k)}$, $B_i(k|k) = \frac{\partial f_i}{\partial \tau_i} \Big|_{x_i^e(k|k)}$ are the Jacobian matrices according to the seed state and seed input.

Thus, the prediction of the state over the prediction horizon H_p is

$$\tilde{x}_i(k) = \tilde{x}_i^e(k) + \tilde{A}_i(k)(x(k) - \tau^e(k)) + \tilde{B}_i(k)(\tilde{\tau}(k) - \tilde{\tau}^e(k)), \quad (3.8)$$

where $\tilde{x}_i(k)$ and $\tilde{\tau}(k)$ are the predictive state and control input over the prediction horizon,

i.e.,

$$\tilde{x}_i(k) = \begin{bmatrix} x_i(k+1|k) \\ x_i(k+2|k) \\ \vdots \\ x_i(k+H_p|k) \end{bmatrix}, \quad \tilde{\tau}_i(k) = \begin{bmatrix} \tau_i(k|k) \\ \tau_i(k+1|k) \\ \vdots \\ \tau_i(k+H_p-1|k) \end{bmatrix},$$

where $x_i(k+l|k)$ is the prediction made at time step k about the state x_i at time step $k+l$; $\tau_i(k+l|k)$ is the control input for time step $k+l$ decided at time step k . \tilde{A}_i and \tilde{B}_i are the predictive matrices, i.e.,

$$\tilde{A}_i(k) = \begin{bmatrix} A_i(k|k) \\ A_i(k+1|k)A_i(k|k) \\ A_i(k+2|k)A_i(k+1|k)A_i(k|k) \\ \vdots \\ \prod_{l=0}^{H_p-1} A_i(k+l|k) \end{bmatrix},$$

$$\tilde{B}_i(k) = \begin{bmatrix} B_i & 0 & \dots & 0 & 0 \\ A_i(k+1|k)B_i & B_i & \dots & 0 & 0 \\ A_i(k+2|k)A_i(k+1|k)B_i & A_i(k+2|k)B_i & \dots & 0 & 0 \\ \vdots & \vdots & \ddots & \vdots & \vdots \\ \prod_{l=1}^{H_p-1} A_i(k+l|k)B_i & \prod_{l=2}^{H_p-1} A_i(k+l|k)B_i & \dots & A_i(k+H_p-1|k)B_i & B_i \end{bmatrix}.$$

Thus, each time step, for VC i , MPC determine the actions that optimize the performance over the prediction horizon by solving an optimization problem: minimize an objective function in terms of control inputs over the prediction horizon and subject to certain constraints on states and control inputs, i.e.,

Problem \mathcal{A} :

$$\text{minimize } J_i(\tilde{x}_i(k), \tilde{\tau}_i(k)) \quad (3.9)$$

$$\text{subject to } \forall i_i \in \mathcal{V}, \forall l \in \mathbb{Z}, 1 \leq l \leq H_p :$$

$$x_i(k+l|k) \in \mathcal{X}_i, \quad (3.10)$$

$$\tau_i(k+l|k) \in \mathcal{T}_i, \quad (3.11)$$

$$\text{Dynamics described by (3.8),} \quad (3.12)$$

where $J_i(\tilde{x}_i(k), \tilde{\tau}_i(k))$ represent the objective function of time step k . Frequently used objective functions consist of following objectives and any combination of them, including but not limited to:

- to follow a reference path/trajectory/heading;
- to keep a certain distance with a predetermined object;
- to save fuel consumption, etc.

\mathcal{X}_i and \mathcal{T}_i denotes the state and control constraints. There are various state and control constraints, such as

- maneuverability, e.g., ranges of speed, heading, forces;
- collision avoidance;
- navigability, etc.

3.2.3 Linearization error analysis

The successively linearized model introduced in Section 3.2.2 is based on Taylor's theorem. Therefore, the performance of approximation is influenced by the differences between the seed inputs and real inputs. In this part, we analyze the errors that are brought by linearization through simulation experiments. The linearization error is defined as the difference between the position P_l calculated by the linearized model (3.8), and the position P_{nl} calculated by the nonlinear model (3.6).

Simulationn setup

In the simulation experiments, the ASV has the same dynamics with the model vessel CyberShip 2. The motion of the ASV is controlled by the MPC controller proposed in this section with a path following objective function:

$$\text{minimize } J_i(\tilde{x}_i(k), \tilde{\tau}_i(k)) = \sum_{l=1}^{H_p} \left(\alpha \|\eta_i(k+l|k) - w_i(k+l)\|_2^2 + \gamma \|\tau_i(k+l-1|k)\|_2^2 \right) \quad (3.13)$$

$$\text{subject to } \forall i \in \mathcal{V}, \forall l \in \mathbb{Z}, 1 \leq l \leq H_p :$$

$$v_{i,\min} \leq v_i(k+l|k) \leq v_{i,\max}, \quad (3.14)$$

$$\tau_{i,\min} \leq \tau_i(k+l|k) \leq \tau_{i,\max}, \quad (3.15)$$

where $v_{i,\min}$ and $v_{i,\max}$ are the minimum and maximum linear and angular velocities; $\tau_{i,\min}$ and $\tau_{i,\max}$ are the minimum and maximum control inputs; $w_i(k+l)$ is the reference position and heading at time step $k+l$; α and γ are the weights. The value of these parameters in simulation is provided in Table 3.1.

Two scenarios are considered to analyze the errors brought by successive linearization.

- Scenario 1: impact of initial seed input and state

The ASV following the different paths with the same successively linearized model with the same seed state at the first time step. The reference paths are shown in Figure 3.3(a). The angle between the seed trajectory and the reference path is increased from 0° to 180° with an interval of 10° .

- Scenario 2: impact of shape turnings

The reference path the ASV need to follow has a turning angle increasing from 0° to 180° with the interval 10° , as shown in Figure 3.3(b).

Table 3.1: Parameter setting

Parameter	Value	Unit
α	$diag[1, 1, 3]$	-
γ	1	-
$v_{i,\min}$	$[0, -1, -20\pi/180]^T$	(m/s, m/s, rad/s)
$v_{i,\max}$	$[1, 1, 20\pi/180]^T$	(m/s, m/s, rad/s)
$\tau_{i,\min}$	$[-2, -2, -1.5]^T$	(N, N, Nm)
$\tau_{i,\max}$	$[2, 2, 1.5]^T$	(N, N, Nm)
H_p	10	(s)

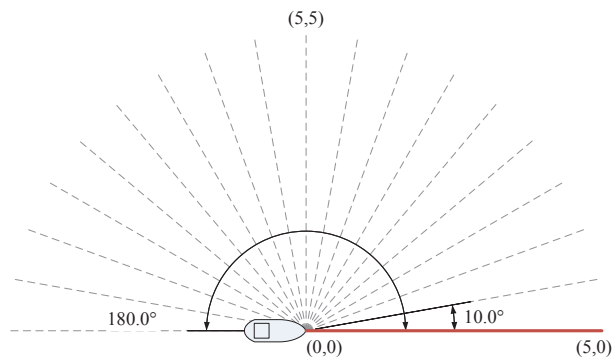

(a) Reference paths in Scenario 1

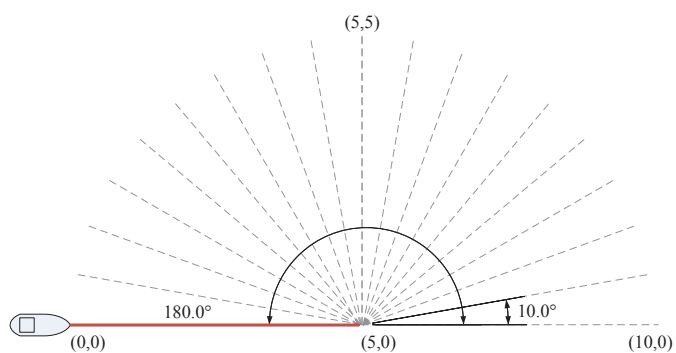

(b) Reference paths in Scenario 2

Figure 3.3: Reference paths in the simulation experiments (The thick red line in each sub-figure is the seed trajectory for linearization in the first time step).

Results and discussion

Results of Scenario 1 are presented in Figure 3.4. In this case, the maximum linearization error arises in the first time step. The maximum linearization errors in the situation that the ASV follows different reference paths are presented in Figure 3.4(a). The maximum error increases when the angle between the seed path and the reference path increases. However, the successive linearization method can make use of the most up-to-date information and adapt the linear model according to the control input determined in the first time step. In this way, the deviations between the seed path and reference path become smaller. Thus, the linearization error reduces dramatically in the second time step, see Figure 3.4(b).

Simulation results for Scenario 2 are presented in Figure 3.5. Figure 3.5(a) shows an increasing tendency the maximum error with the turning angle. Large linearization errors arise when the ASV take turning actions, see Figure 3.5(b). The main reason is that the differences between the seed state and reference state become larger at the moment when the controllers decide to take turning actions. Nevertheless, the errors are small during the simulation experiment.

In Figure 3.6, the box plots of the errors over a prediction horizon in the surge, sway, and heading are provided. Because in a time step, the prediction of the state is based on the previous prediction, the linearization error accumulates in one prediction horizon. Nevertheless, the linearization errors at the first time step of the prediction horizon are always small.

To conclude, the accuracy of the successively linearized model is influenced by two factors: the differences between the seed state and the reference state, and the smoothness of the reference path. Owing to the property of making use of the latest state of the system, the successively linearized model can make adjustments quickly. This property provides the linearized model the required accuracy for the motion control of ASVs.

3.3 Negotiation framework for cooperation

In a waterway network, the decisions one controller makes are influenced by the actions that other controllers take: a VC needs the information from other VCs to decide its collision avoidance actions, and it also needs the DTA from ICs to decide the trajectory; an IC is informed that the ASVs will arrive and their ETA when it makes schedules. All the controllers are closely connected. When a controller changes its schedule or trajectory, other controllers have to adjust theirs accordingly. To reach an agreement, a negotiation framework is needed.

3.3.1 Formulation of the cooperative control problem

In a CMVS, each controller decides on which actions to take by solving its own optimization problem. As mentioned, the problem that a controller needs to solve is influenced by the actions its neighbors take, i.e., the optimization problems are connected. The interconnections between the control problems can be indicated by so-called *interconnecting variables*. For example, in the scenario of collision avoidance between ASV i and ASV j , the interconnecting variables between ASV i and ASV j are their trajectories.

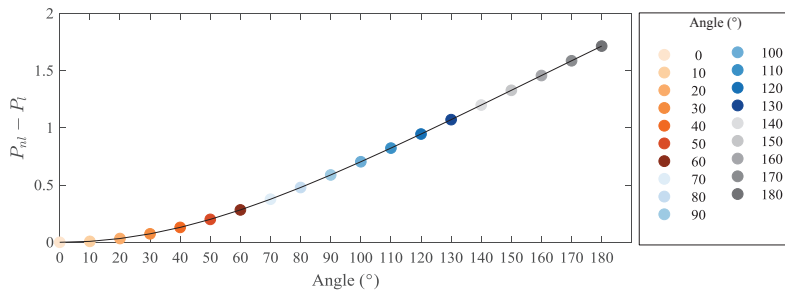

(a) Maximum linearization error (the first time step) in Scenario 1.

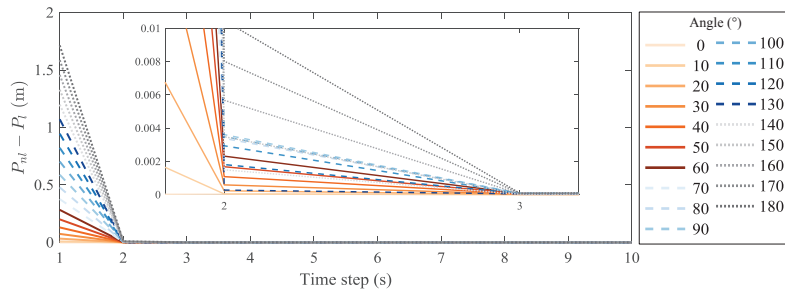

(b) Linearization error for each time step in Scenario 1.

Figure 3.4: Simulation results in Scenario 1.

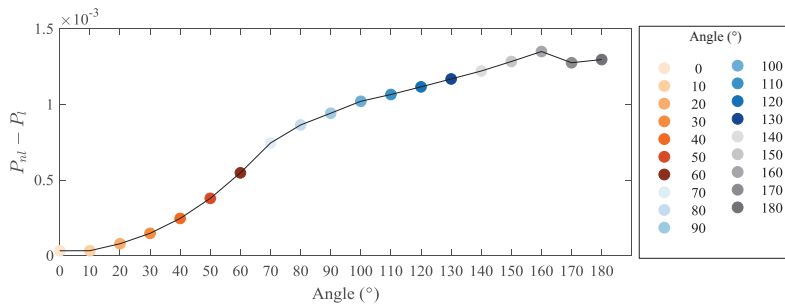

(a) Maximum linearization error in Scenario 2.

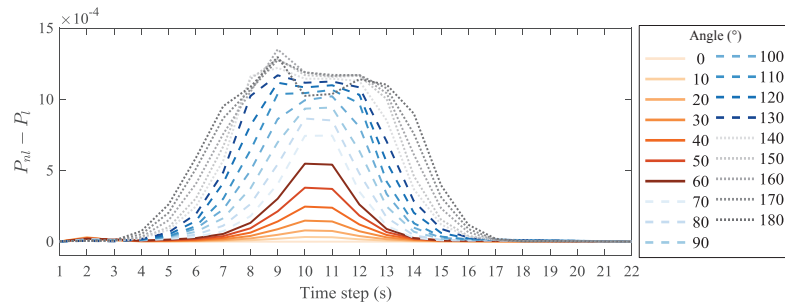

(b) Linearization error for each time step in Scenario 2.

Figure 3.5: Simulation results in Scenario 2.

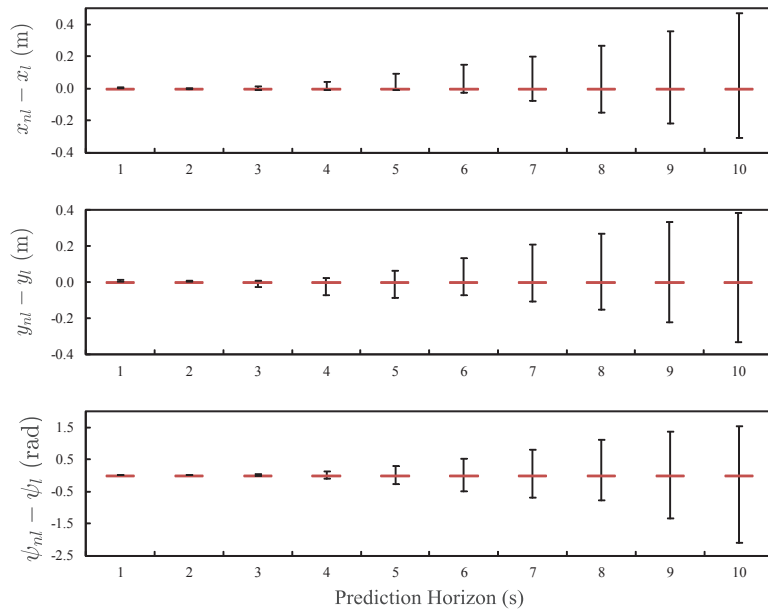

(a) Linearization errors over a prediction horizon in Scenario 1

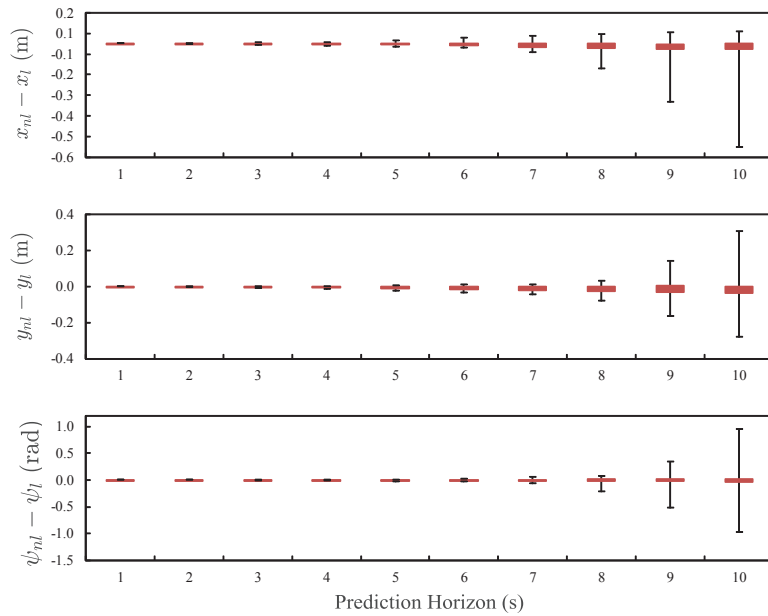

(b) Linearization errors over a prediction horizon in Scenario 2

Figure 3.6: Linearization errors in positions and heading over a prediction horizon².

²In Figure 3.6, the bottom and top edges of the red box in the middle indicate the 25th and 75th percentiles, respectively. The whiskers indicate the minimum and maximum values.

The interconnecting variables are subject to some constraints depending on the state and input of all the involving controllers, such as the constraint of the minimal distance between two ASVs in the collision avoidance scenario. The constraints are named as *coupling constraints*.

A controller computes its optimal actions by solving an optimization problem and broadcasts the corresponding interconnecting variables that it expects. In this way, the interconnecting variables each controller broadcasts are the optimal decisions for itself. However, those variables may worsen the situation of other controllers in the cooperative system. Therefore, negotiations are needed to find the solutions that are acceptable to all the controllers through iterations.

Remark 3.1 In a distributed system with multiple controllers, an agreement is achieved when the interconnecting variables each controller computes lives up to the expectation of other controllers. \square

Thus, the overall cooperation problem can be expressed as

Problem \mathcal{B} :

$$\text{minimize } \sum_{a \in \mathcal{N}} J_a(x_a(k), u_a(k)) \quad (3.16)$$

subject to $\forall a \in \mathcal{N}, \forall b \in \mathcal{N}_a :$

$$y_a(k) = h(x_a(k), u_a(k)), \quad (3.17)$$

$$y_a(k) = z_a(k), \quad (3.18)$$

$$g(x_a(k), u_a(k), z_b(k)) \leq 0, \quad (3.19)$$

where $J(x_a(k), u_a(k))$ and ζ_a indicate the objective and constraints of controller a , including VCs and ICs; $x_a(k)$ and u_a are the state and control variable of controller a , respectively; $y_a(k)$ indicates the interconnecting variables that controller a computes; z_a indicates the interconnecting variables of controller a that other controllers expect; $g(x_a, u_a, z_b)$ is the coupling constraint, involving the state and the control variables of controller a and the expected interconnecting variables of its neighbor $b \in \mathcal{N}_a$.

In a CMVS, when a controller is solving its own optimization problem, it assumes that other controller will take the actions they broadcast. Therefore, the interconnecting variables about a controller that other controllers expected equals to the value it broadcasts, i.e., z_a is a copy of y_a that controller a broadcast in the latest iteration.

Remark 3.2 In a CMVS, an agreement is achieved when decisions each controller computes with the most up-to-date information of other controllers are the same as the actions that it broadcast in the latest iteration. \square

3.3.2 Generic negotiation framework

The additive objective in Problem \mathcal{B} enable the problem to be solved by solving several separated problems. Each controller only has to handle its own objective and constraints. ADMM is one of the widely applied methods to solve the consensus problems in such a

way. ADMM is an algorithm that is intended to blend the decomposability of dual ascent with the superior convergence properties of the method of multipliers [12]. The first step of this method is to form the augmented Lagrangian of the optimization problem. Because currently no proof of convergence is known for ADMM with non-quadratic penalty terms [12], quadratic penalty terms are employed here:

$$\begin{aligned} & L\left([u_a(k)]_{a \in \mathcal{N}}, [y_a(k)]_{a \in \mathcal{N}}, [z_a(k)]_{a \in \mathcal{N}}, [\lambda_a(k)]_{a \in \mathcal{N}}, [\rho_a]_{a \in \mathcal{N}}\right) \\ &= \sum_{a \in \mathcal{N}} \left(J_a(x_a(k), u_a(k)) + \lambda_a(k)^T (y_a(k) - z_a(k)) + \rho_a/2 \|y_a(k) - z_a(k)\|_2^2 \right), \end{aligned} \quad (3.20)$$

where ρ_a is penalty parameter and $\lambda_a(k)$ is a dual variable.

A general form consensus optimization based on ADMM consists of iterations of following three steps, i.e., minimization of the local variable, minimization of the interconnecting variable and a dual variable update:

$$\begin{aligned} y_a^s(k) = \arg \min_{y_a(k)} & \left(J_a(x_a(k), u_a(k)) + \lambda_a^{s-1}(k)^T (y_a(k) - z_a^{s-1}(k)) \right. \\ & \left. + \rho_a/2 \|y_a(k) - z_a^{s-1}(k)\|_2^2 \right), \end{aligned} \quad (3.21)$$

$$z^s(k) = \arg \min_{(k)} \left(\sum_{a \in \mathcal{N}} \left(-\lambda_a^{s-1}(k)^T z_a(k) + \rho_a/2 \|y_a^s(k) - z_a(k)\|_2^2 \right) \right), \quad (3.22)$$

$$\lambda_a^s(k) = \lambda_a^{s-1}(k) + \rho_a (y_a^s(k) - z_a^s(k)), \quad (3.23)$$

where \cdot^s is the corresponding variable at the s th iteration; $z^s(k)$ is a linear function of z_a .

In [12], a reasonable termination criterion is provided to stop the iterations considering the optimality conditions:

$$\|R_{\text{pri}}^s\|_2 = \sum_{a \in \mathcal{N}} \|y_a^s - z_a^s\|_2 \leq \varepsilon_{\text{pri}}^s, \quad (3.24)$$

$$\|R_{\text{dual}}^s\|_2 = \sum_{a \in \mathcal{N}} \|z_a^s - z_a^{s-1}\|_2 \leq \varepsilon_{\text{dual}}^s, \quad (3.25)$$

where R_{pri}^s and R_{dual}^s are the primal and dual residual at iteration s ; $\varepsilon_{\text{pri}}^s$ and $\varepsilon_{\text{dual}}^s$ are feasibility tolerances, which are determined by

$$\varepsilon_{\text{pri}}^s = \sqrt{N n_{\text{cnt}}} \varepsilon^{\text{abs}} + \varepsilon^{\text{rel}} \max \left\{ \sum_{a \in \mathcal{N}} \|y_a^s(k)\|_2, \|z_a^s(k)\|_2 \right\}, \quad (3.26)$$

$$\varepsilon_{\text{pri}}^s = \sqrt{N n_{\text{cnt}}} \varepsilon^{\text{abs}} + \varepsilon^{\text{rel}} \sum_{a \in \mathcal{N}} \|\lambda_a(k)^s\|_2, \quad (3.27)$$

where N is the number of controllers, n_{cnt} is the size of interconnecting y_a ; $\varepsilon^{\text{abs}} > 0$ and $\varepsilon^{\text{rel}} > 0$ are the absolute tolerance and relative tolerance, respectively. The choice of the tolerances depends on the scale of the values of control inputs.

In this conventional ADMM framework, (3.21) and (3.23) can be calculated independently in parallel by each controller. The update of the interconnection variable (3.22)

Algorithm 3.1: ADMM-based multi-layer negotiation framework

```

1 for  $s = 1 : S$  do
2   for  $a = 1 : N$  do
3     // Controller  $a$  solves a local control problem
4      $y_a^s(k) := \arg \min_{y_a(k)} \left( J_a(x_a(k), u_a(k)) + \lambda_a^{s-1}(k)^T (y_a(k) - z_a^{s-1}(k)) \right.$ 
5        $\left. + \rho_a/2 \|y_a(k) - z_a^{s-1}(k)\|_2^2 \right)$ ;
6     // Send  $z_a^s(k)$  to the coordinator
7   end
8   // The coordinator updates the interconnecting variable
9    $z^s(k) := \arg \min_{z_a(k)} \left( \sum_{a \in \mathcal{N}} \left( -\lambda_a^{s-1}(k)^T z_a(k) + \rho_a/2 \|y_a^s(k) - z_a(k)\|_2^2 \right) \right)$ ;
10  // The coordinator send  $z^s(k)$  to the controllers
11  for  $a = 1 : N$  do
12    // Controller  $a$  updates the Lagrangian multipliers
13     $\lambda_a^s(k) := \lambda_a^{s-1}(k) + \rho_a (y_a^s(k) - z_a^s(k))$ ;
14  end
15  // The coordinator updates primal and dual residual and checks
16  // the stopping criteria
17   $\|R_{\text{pri}}^s(k)\|_2 := \sum_{a \in \mathcal{N}} \|y_a^s(k) - z_a^s(k)\|_2$ ;  $\|R_{\text{dual}}^s(k)\|_2 := \sum_{a \in \mathcal{N}} \|z_a^s(k) - z_a^{s-1}(k)\|_2$ ;
18  if  $\|R_{\text{pri}}^s(k)\|_2 \leq \varepsilon_{\text{pri}}^s(k)$  and  $\|R_{\text{dual}}^s(k)\|_2 \leq \varepsilon_{\text{dual}}^s(k)$  then Stop iteration;
19 end

```

usually involves information of all controllers. which is carried out by a central coordinator. Based on this, a negotiation framework using a multi-layer control structure is presented in Algorithm 3.1.

From Remark 3.2, we can find that in the consensus problem of a CMVS, Problem \mathcal{B} , the interconnecting variable z is a collection of the information broadcast by all the controllers, i.e, $z = \{z_1, z_2, \dots, z_n\}$, which decouples across the subsystems. Therefore, the update of z can be decomposed as updates of z_i and be carried out each controller using its own information, as well as the updates of the primal and dual residual. Therefore, the update of the interconnecting variable z in (3.22) can be rewritten as:

$$z_a^s(k) = \arg \min_{z_a(k)} \left(-\lambda_a^{s-1}(k)^T z_a(k) + \rho_a/2 \|y_a^s(k) - z_a(k)\|_2^2 \right), \quad (3.28)$$

which can be further simplified as

$$z_a^s(k) = y_a^s(k) + \lambda_a^{s-1}(k)/\rho_a. \quad (3.29)$$

Therefore, a single-layer negotiation framework for the consensus problem with separable interconnecting variables is proposed in this research, see Algorithm 3.2.

Algorithm 3.2: Single-layer negotiation framework

```

1 for  $s = 1 : S$  do
2    $jdg^s(k) := 0; N_{\text{jump}}^s(k) := 0;$ 
3   for  $a = 1 : N$  do
4     // Controller  $a$  solves a local control problem
5      $y_a^s(k) := \arg \min_{y_a(k)} \left( J_a(x_a(k), u_a(k)) + \lambda_a^{s-1}(k)^T (y_a(k) - z_a^{s-1}(k)) \right.$ 
6        $\left. + \rho_a/2 \|y_a(k) - z_a^{s-1}(k)\|_2^2 \right);$ 
7     if solution do not exist then
8        $y_a(k)^s := y_a(k)^{s-1}; N_{\text{jump}}^s(k) := N_{\text{jump}}^s(k) + 1;$ 
9     end
10    // Controller  $a$  updates the interconnecting variable and
11    Lagrange multiplier
12     $z_a^s(k) := y_a^s(k) + \lambda_a^{s-1}(k)/\rho_a.$ 
13     $\lambda_a^s(k) := \lambda_a^{s-1}(k) + \rho_a (y_a^s(k) - z_a^s(k));$ 
14    // Controller  $a$  update primal and dual residual and checks
15    its own stopping criteria
16     $R_{\text{pri},a}^s(k) := u_a^s(k) - z_a^s(k); R_{\text{dual},a}^s(k) := z_a^s(k) - z_a^{s-1}(k);$ 
17    if  $\|R_{\text{pri},a}^s(k)\|_2 \leq \varepsilon_{\text{pri},a}^s$  and  $\|R_{\text{dual},a}^s(k)\|_2 \leq \varepsilon_{\text{dual},a}^s$  then
18       $jdg^s(k) := jdg^s(k) + 1;$ 
19    end
20    // Iteration stopping check
21    if  $jdg^s(k) = N$  and  $N_{\text{jump}}^s(k) = 0$  then Stop iteration;
22    // Communication
23    if Scheme = Serial then Broadcast  $z_a^s(k), jdg^s(k)$  and  $N_{\text{jump}}^s(k);$ 
24    end
25    if Scheme = Parallel then Broadcast  $z_a^s(k), jdg^s(k)$  and  $N_{\text{jump}}^s(k);$ 
26  end
27 end

```

Compared with Algorithm 3.1, Algorithm 3.2 has the following characteristics:

- Firstly, in Algorithm 3.2, all the updating of variables can be carried out independently for each controller a . Iterations are alternating between the coordinator and each vessel until agreements have been reached. At least 3 times of information exchange are needed in Algorithm 3.1. On the contrary, there is no coordinator in Algorithm 3.2. The final agreement is achieved when the trajectory that a vessel finds is the same as the one it sends to others in the former iteration. Information only needs to be exchanged once.
- Secondly, the single-layer distributed framework provides a vessel the freedom to join or leave a CMVS. It also makes the proposed algorithm robust against failures of an individual vessel. For example, when a controller fails to find a solution, it can keep the solution found at the former iteration (Line 7), and other vessels will try to find the solutions.

- Thirdly, Algorithm 3.2 can be serial or parallel according to the timing of information exchange and computation (Line 20 and Line 22). A comparison of parallel and serial control schemes has been presented in [120]. In the parallel scheme, all the controllers perform computations at the same time. Thus, when a controller performs computation at iteration s , it uses the information that the other controllers provide at the last iteration $s - 1$. The scheme enjoys the advantage of parallel computation. However, because of the potential conflicts of objectives, the solutions may not converge when there is no central coordinator. On the contrary, in the serial scheme, only one controller is performing computations at a time. The controller performs computation using the most up-to-date information during the same iteration. For example, at iteration s , if controller b carries out computation before controller a , controller a use the information broadcast by controller b at current iteration s and information of other controllers at the last iteration s , at the last iteration $s - 1$. The serial scheme has preferable properties in terms of solution speed, by requiring fewer iterations, and solution quality [120].

3.4 Conclusions

In this chapter, based on the findings of the previous chapter, we propose the concept of Cooperative Multi-Vessel System for the cooperative behaviors among vessels and infrastructures in waterway networks. Two types of controllers are introduced: a VC for the control of an ASV, and an IC is responsible for solving the conflicts of vessels at an infrastructure.

MPC is used to design motion controllers for ASVs for its receding horizon principle which is beneficial to deal with conflicts and to against disturbances and uncertainties. An MPC-based control framework is developed with a successively linearized prediction model. Simulation experiments are carried out to show that the linearized model can provide the required accuracy for the motion control of ASVs.

A generic negotiation framework based on the ADMM is designed to deal with consensus problem among different controllers. The framework is generic in several ways. Firstly, both serial and parallel, and even hybrid iterative schemes can be addressed under the framework. Secondly, the framework can be used for the consensus problems of heterogeneous controllers. Controllers decide their actions according to the information provided by other controllers in the cooperative system. Therefore, the dynamics of ASVs need not necessarily to be the same, neither the operation models of the infrastructures.

This chapter partially answers Research Questions 3 and 4. The motion control framework and the negotiation framework will be used for the cooperative control of VCs and ICs at different cooperation layers in the following chapters.

Chapter 4

Vessel Train Formations

In the previous chapter, we introduced the model predictive control framework for the control of an Autonomous Surface Vehicle (ASV) and a generic negotiation framework for the cooperation of controllers in a Cooperative Multi-Vessel System (CMVS). In this chapter, we in particular focus on the cooperation between ASVs in a CMVS at the link level, i.e., in a waterway segment. The Vessel-to-Vessel (V2V) cooperation is formulated as a Vessel Train Formation (VTF) problem. The VTF problem considers not only cooperative collision avoidance but also the grouping of vessels. The VTF problem is solved with the proposed Distributed Model Predictive Control (DMPC) framework and the negotiation framework with a serial iterative scheme.

This chapter is organized as follows. In Section 4.1, the control objectives and assumptions for controller design for the VTF problem are presented. Subsequently, the VTF problem is formulated and solved with a serial iterative negotiation framework in Section 4.2. the impact of different factors, such as information exchanging sequences, responsibility parameters, and the scalability of the proposed method, are analyzed in Section 4.3, followed by a simulation experiment of a CMVS traveling from the Port of Rotterdam to inland waterways. Finally, the conclusions are given in Section 4.4.

Parts of this chapter have been published in [24, 27].

4.1 Control objectives and assumptions

The cooperative behavior of vessels in a CMVS for transporting goods is neither typical formation tracking nor cooperative collision avoidance. When sailing in ports, waterways, or canals, it is not necessary for vessels to maintain a specific configuration. Nevertheless, collision avoidance is not the only connection between vessels. For instance, vessels can share voyage plans to avoid a long waiting time at ports or locks; sailing in groups also help to keep the vessels being connected, especially when we consider the effective range of ship-borne sensors, which help them to deal with unexpected changes; another attractive advantage to motivate vessels sailing in groups is the potential of reduced drag forces and energy consumption [11, 77].

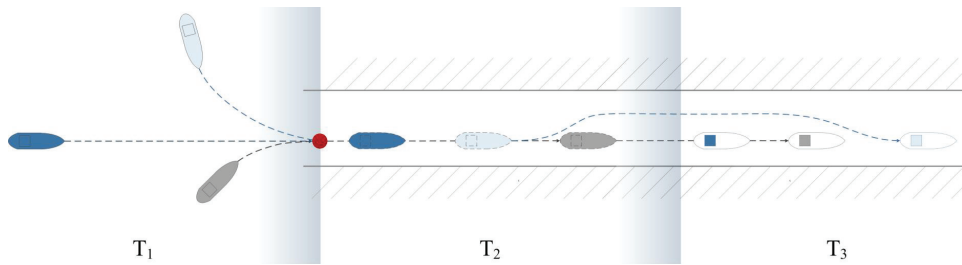

Figure 4.1: Vessel train formation.

In waterway networks, navigable waters are usually indicated as narrow corridors with the banks as boundaries. Moreover, when navigating, vessels follow some rules and regulations. For the sake of safety, these rules specify the types of maneuvers that should be taken in certain situations. For example, most of the inland waterways regulations suggest vessels to sail along the starboard side [146]. Therefore, the cooperative sailing of vessels in inland waterways will result in train-like formations. The train-like formations are flexible. Vessels can change their positions in the fleet, which means that lateral operation, i.e., overtaking, is allowed. Figure 4.1 is provided as an example. The three vessels meet at the entrance of a waterway from different directions at T_1 ; after the primary vessel train forming at T_2 , the second vessel starts overtaking; the new vessels train is formed at T_3 . We, therefore, name the cooperative behavior of vessels in waterways as moving into a *Vessel Train Formation*.

Vessels usually have predetermined origins, destinations, and paths. In order to exchange information and enjoy the benefits of sailing together, vessels in a CMVS attempt to stay close to each other. At the same time, vessels should not collide with others. Thus, in the VTF problem, Vessel Controllers (VCs) have the following objectives:

- (1) Path following: attempt to follow the predetermined paths;
- (2) Aggregation: attempt to stay close to nearby vessels;
- (3) Collision avoidance: avoid collisions with nearby vessels.

In the following sections, we design a serial iterative method for the VTF control of a CMVS. The fleets of cooperative vessels can be used for transportation in inland waterways or canal networks. For example, a CMVS consisting of small vessels can replace the work of a large vessel with the following advantages. Firstly, small vessels have lower requirements on waterway dimensions than large vessels. Thus, using fleets can greatly improve the accessibility of waterborne transport networks. Secondly, small vessels have more alternative routes when congestions occur. Consequently, using small vessels helps to relieve the pressure on locks, and to enhance the robustness of waterway networks. Thirdly, goods on large vessels for inland shipping usually have ports of call. This may lead to the problems of inefficiency and low utilization rate. Alternatively, applying fleets can evade these issues with more flexible schedules.

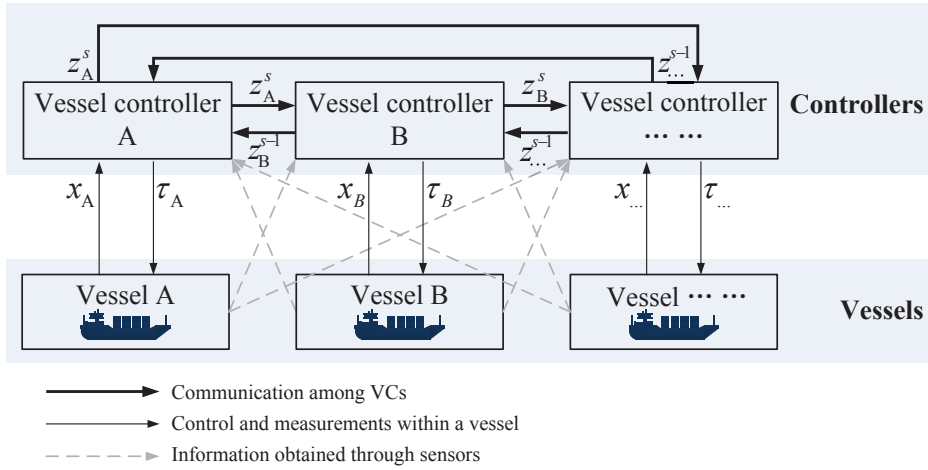

Figure 4.2: Control structure for VTF.

4.2 Serial iterative DMPC for Vessel Train Formations

In this section, we firstly introduce a single-layer control structure for solving the VTF problem. After designing the MPC controller for each ASV, a serial iterative negotiation framework is provided for the cooperation of VCs in a CMVS.

4.2.1 Control structure

In reality, a VC can only determine actions for the ASV that it controls and gather information about itself and nearby vessels through sensors. Therefore, a single-layer control structure is employed for VTF control, see Figure 4.2. Each VC make decisions according to its own state and external information gathered by sensors. VCs communicate with each other on their expectations of the evolution of the whole system.

4.2.2 Formulation of the VTF problem

According to the motion control framework presented in Section 3.2, each VC make decisions by solving an optimization problem. Therefore, the optimization problem for VTF control that aims at achieving the above-mentioned three objectives is formulated underneath.

Among the three objectives, path following can be achieved through minimizing the difference between the actual position of the ASV and a reference position; collision avoidance can be realized by making the distance between the ASVs larger than a predefined safety distance (the minimum distance that a vessel should keep away from other vessels). For the aim of aggregation, two methods can be used. One is the so-called Position-based VTF formulation, which immediately aims at making the distances between ASVs within a certain range. The other method to achieve aggregation is to make the speed of the vessels

become consensus when the distance between them is on a predetermined threshold, named as Speed-based VTF formulation. Once the speeds of the vessels within the CMVS are the same, the distances between them become constant. The following are the two types of formulation.

Position-based VTF formulation

For the aim of making the relative distance between the ASVs to be within a certain range, the objective function of the above-mentioned three VTF objectives is as follows:

$$J_i^{\text{Pb}}(\tilde{\tau}_i(k)) = \sum_{l=1}^{H_p} \sum_{j \in N_i} \left(\alpha^{\text{Pb}} \|\eta_i(k+l|k) - w_i(k+l)\|_2^2 + \beta^{\text{Pb}} \|d_{ij_i}(k+l|k) + \delta_{ij}(k+l|k)\|_2^2 + \gamma^{\text{Pb}} \|\tau_i(k+l-1|k)\|_2^2 \right), \quad (4.1)$$

where the three parts in the equation represent trajectory following, aggregation and control efforts, respectively: α^{Pb} , β^{Pb} and γ^{Pb} are the weights; H_p is the length of the prediction horizon; l is the l th time step in the prediction horizon; $\eta_i(k+l|k)$ is the prediction made at k about the position and heading of vessel i at $k+l$ according to the linearized dynamic model (3.8); $w_i(k+l)$ is the reference at $k+l$, including trajectory and heading; $d_{ij_i}(k+l|k)$ is the distance between ASV i and ASV j calculated by ASV i , $d_{ij_i}(k+l|k) = \|P_i(k+l|k) - P_{j_i}(k+l|k)\|_\infty$; $P_i(k+l|k)$ is the prediction made at k about the position of vessel i at $k+l$, and $P_{j_i}(k+l|k)$ is the position of of ASV j that controller i received; δ_{ij} is a slack variable introduced for aggregation of ASV i and j , $-\Upsilon \leq \delta_{ij}(k+l|k) \leq \Upsilon$; Υ is the aggregation range, $\Upsilon = \min(\Upsilon_1, \Upsilon_2, \dots, \Upsilon_n)$, Υ_i is the communication range of i ; $\tau_i(k)$ indicates control input over the prediction horizon.

Speed-based VTF formulation

Different from the position-based formulation, to achieve speed consensus, vessels controllers communicate not only their predicted trajectories but also predictive speed. The objective for speed control is transformed as the aim of following the speed consensus state. The speed consensus state, $\vartheta_{N_i}(k+l|k) = [\bar{P}_i(k+l|k), \bar{\psi}_i(k+l|k)]$, consist of the position $\bar{P}_i(k+l|k)$ and heading $\bar{\psi}_i(k+l|k)$, at $k+l$ calculated according to the average speed of neighbors of vessel i at k . The speed consensus position \bar{P}_i is calculated with a double integrator dynamics, $\bar{P}_i(k+l|k) = P_i(k) + l\bar{v}_i(k)$. $\bar{v}_i(k)$ is the consensus velocity, with a magnitude equals to the desired consensus speed and direction to new waypoint, i.e.,

$$\|\bar{v}_i(k)\|_2 = \frac{\left(\hat{v}_i(k) + \sum_{l=1}^{H_p} \sum_{j \in N_i} \|[u_j(k+l|k), v_j(k+l|k)]^T\|_2 \right)}{N_{N_i} + 1}, \quad (4.2)$$

where $\hat{v}_i(k)$ is the planned speed of i , N_{N_i} is the number of neighbors. The speed consensus heading is determined according to \bar{P}_i , and the changes between heading should be within the range $[-\pi, \pi]$.

Accordingly, the objective function of the VTF problem using the Speed-based formulation is as follows:

$$J_i^{\text{Sc}}(\tilde{\tau}_i(k)) = \sum_{l=1}^{H_p} \sum_{j \in N_i} \left(\alpha^{\text{Sc}} \|\eta_i(k+l|k) - w_i(k+l)\|_2^2 + \beta^{\text{Sc}} \|\eta_i(k+l|k) - \vartheta_{N_i}(k+l|k)\|_2^2 + \gamma^{\text{Sc}} \|\tau_i(k+l-1|k)\|_2^2 \right), \quad (4.3)$$

where α^{Sc} , β^{Sc} and γ^{Sc} are the weights for trajectory following, speed consensus and control.

Control problem for VTF controller design

Let the objective function $J_i(\tilde{\tau}_i(k)) = J_i^{\text{Pb}}(\tilde{\tau}_i(k))$ or $J_i(\tilde{\tau}_i(k)) = J_i^{\text{Sc}}(\tilde{\tau}_i(k))$, the control problem that VC i needs to solve for determining the actions is as follows:

Problem \mathcal{C} :

$$\text{minimize } J_i(\tilde{\tau}_i(k)) \quad (4.4)$$

$$\text{subject to } \forall i \in \mathcal{VT}_i, \forall j \in N_i, \forall l \in H_p :$$

$$v_{i,\min} \leq v_i(k+l|k) \leq v_{i,\max} \quad (4.5)$$

$$\tau_{i,\min} \leq \tau_i(k+l|k) \leq \tau_{i,\max} \quad (4.6)$$

$$d_{ij|i}(k+l|k) \geq d_{ij,\text{safe}} \quad (4.7)$$

$$y_i \in \Xi \quad (4.8)$$

$$\text{Dynamics described by (3.8),} \quad (4.9)$$

where \mathcal{VT}_i is the vessel train that consist of multiple ASVs, N_i is the set of neighbors of vessel i , $N_i = \{j \in \mathcal{V} : \|P_j - P_i\|_2 \leq \Upsilon_i\}$; $v_{i,\min}$, $v_{i,\max}$ and $\tau_{i,\min}$, $\tau_{i,\max}$ are the constraints on states and control inputs; Ξ indicates navigable waters.

According to [144], Problem \mathcal{C} can be transferred into a mixed integer linear programming problem with the collision avoidance constraint 4.7 being rewritten as

$$\forall k \in T, \forall l \in H_p : \begin{cases} d_{ij|i}^{x^+}(k+l|k) \geq d_{\text{safe}} - \kappa \phi_{ij|i,1}(k+l|k), \\ d_{ij|i}^{y^+}(k+l|k) \geq d_{\text{safe}} - \kappa \phi_{ij|i,2}(k+l|k), \\ d_{ij|i}^{x^-}(k+l|k) \geq d_{\text{safe}} - \kappa \phi_{ij|i,3}(k+l|k), \\ d_{ij|i}^{y^-}(k+l|k) \geq d_{\text{safe}} - \kappa \phi_{ij|i,4}(k+l|k), \\ \sum_{g=1}^4 \phi_{ij|i,g}(k+l|k) \leq 3, \end{cases} \quad (4.10)$$

where $d_{ij|i}^{x^+}(k+l|k)$, $d_{ij|i}^{y^+}(k+l|k)$, $d_{ij|i}^{x^-}(k+l|k)$, and $d_{ij|i}^{y^-}(k+l|k)$ are the distance between vessel i and j that vessel i measured in four directions $+X$, $+Y$, $-X$, and $-Y$, respectively; κ is a positive number that is much larger than any position or velocity in the problem. $\phi_{ij|i,g}$, $g = 1, 2, 3, 4$, are the binary variables.

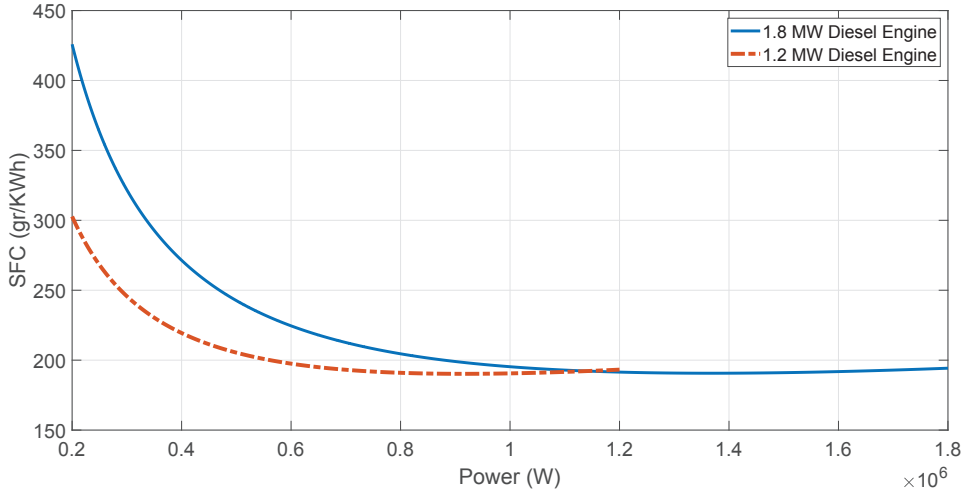

Figure 4.3: SFC curve of two diesel engines with different power ratings [27].

Control problem for Eco-VTF controller design

According to [27, 65], the fuel efficiency of a diesel engine with regard to the produced power is presented using the Specific Fuel Consumption (SFC) curve of the engine:

$$SFC(P_{en}) = \frac{a^{\text{SFC}}}{P_{en}} + b^{\text{SFC}} P_{en} + c^{\text{SFC}}, \quad (4.11)$$

where P_{en} is the delivered mechanical power; a^{SFC} , b^{SFC} and c^{SFC} are parameters dependent on the diesel engine specifications. The SFC curves of two diesel engines are shown in Figure 4.3. The figure indicates that under low power loading the diesel engine is inefficient. As the load increases, the efficiency increases, and in high loading conditions it decreases.

To guarantee the fuel efficiency, the power should be within the efficient region in the SFC curve. Power is a function of the control force and moment (details can be found in [66]), i.e.,

$$P_{en,i}(k) = \ell(x_i(k), \tilde{\tau}_i(k)). \quad (4.12)$$

Thus, there is a range of control force and moment, as well as speed, that can make the diesel engine more efficient, and reduce the fuel consumption.

In a vessel train, there can be several vessels with different specifications that ranged from vessel size and shape to power ratings. As a result, their suitable operating profiles might differ. To enable fuel efficiency, we propose the concept of Eco-VTF, in which the vessels can sail with the most efficient speed for the overall vessels.

Eco-VTF leads to a consensus on speed for the vessel train that is optimal for all the vessels subject to their operational objectives and efficiency specification. Therefore, in the

Eco-VTF problem, the optimization problem that each vessel needs to solve is as follows:

$$\text{minimize } J_i(\tilde{\tau}_i(k)) + \sum_{l=1}^{H_p} \xi \|\tau_i(k+l-1|k) - \zeta_i(k+l-1|k)\|_2^2 \quad (4.13)$$

$$\text{subject to } \tau_{i,\text{low}}^{\text{eff}} \leq \zeta_i(k+l-1|k) \leq \tau_{i,\text{up}}^{\text{eff}}, \quad (4.14)$$

constraints in Problem \mathcal{C} ,

where ξ is the weight of fuel efficiency; $\zeta_i(k+l-1|k)$ is a slack variable introduced for keeping the control input within a certain range; $\tau_{i,\text{low}}^{\text{eff}}$ and $\tau_{i,\text{up}}^{\text{eff}}$ is the lower and upper boundary of the fuel efficient control inputs.

4.2.3 Serial iterative negotiation framework

Negotiation framework

In Problem \mathcal{C} , information about the neighbors is involved for aggregation and collision avoidance, both of which need the predicted trajectories of the neighbors (hereinafter, we use Position-based formulation as an example). Therefore, the interconnecting variables that link the control problems of the VCs are the predicted trajectories (for Speed-based formulation, the interconnecting variables are predicted trajectories and speed). That is, the information being exchanged is the predicted trajectory of the ASVs over the prediction horizon, i.e., $\tilde{P}_i(k)$.

A serial iterative scheme is used for the negotiations among VCs in the VTF problem. The main reason is that the ASVs in the same vessel train are within a close range. Due to limited navigable waters and the constraints on maneuverability, the VCs usually do not have many choices. As only one vessel performs computations at a time step in the serial iterative scheme, vessels can have the most up-to-date information from their neighbors. Compared with the method with a parallel iteration scheme as proposed in [188], fewer iterations are needed to reach agreements. Moreover, using a serial scheme avoids the lack of convergence that the parallel scheme without a coordinator may have. Making use of the most up-to-date information and the property of fast convergence make the serial scheme more suitable for the VTF problem.

With the serial iterative scheme, the predicted trajectories of P_{ji} in (4.1) and (4.10)) updates as follows:

$$P_{ji}^s(k+l|k) = \begin{cases} P_j^s(k+l|k) & j \in N_i, j \text{ solves its problem before } i, \\ P_j^{s-1}(k+l|k) & j \in N_i, j \text{ solves its problem after } i. \end{cases} \quad (4.15)$$

The predicted trajectory of an ASV is determined by the control input $\tau_i(k)$. As the dynamic model (3.6) of an ASV is time-invariant, same control inputs result in same trajectory. Thus, $z_i^s(k)$ in Algorithm 3.2 (Line 20) is a copy of the input that vessel i determined for previous iteration, i.e., $z_i(k)^s = \tilde{\tau}_i(k)^{s-1}$. Therefore, the overall consensus problem for

VTF is formulated as follows:

$$\text{minimize } \sum_{i \in \mathcal{VT}_i} J_i(\tau_i(k)) \quad (4.16)$$

$$\text{subject to } \tau_i(k) = z_i(k). \quad (4.17)$$

As suggested by [12, 67, 181], a varying penalty parameter helps to improve the convergence in practice, as well as making performance less dependent on the initial choice of the penalty parameter. Therefore, in this research, the scheme proposed in [67] is adopted:

$$\rho_i^s = \begin{cases} 2\rho_i^{s-1} & \text{if } \|R_{\text{pri},i}^s\|_2 > 10\|R_{\text{dual},i}^s\|_2, \\ \rho_i^{s-1}/2 & \text{if } \|R_{\text{dual},i}^s\|_2 > 10\|R_{\text{pri},i}^s\|_2, \\ \rho_i^{s-1} & \text{otherwise.} \end{cases} \quad (4.18)$$

Therefore, according to the generic negotiation framework proposed in Section 3.2, the VTF control of vessels in a vessel train \mathcal{VT}_i at each time step k consists of the steps in Algorithm 4.1.

The tolerance in Line 18, $\varepsilon_{\text{pri},i}^s$ and $\varepsilon_{\text{dual},i}^s$ means that when the iteration stops, there is still a difference between $u_i(k)$ and $z_i(k)$. Although the difference is small, it may make the trajectories that a vessel actually choose deviate from the trajectories it sends to others. To guarantee that the collision avoidance constraints are satisfied, we make an adjustment on the safety distance over the prediction horizon. We find out the largest trajectory deviation under the worst situation in which the deviation of the first control input equals to the tolerance, i.e.,

$$u_{d_{\text{fix}}} = \begin{bmatrix} d_{\text{fix}} & d_{\text{fix}} & \underbrace{0 \ \cdots \ 0}_{2 \times (H_p - 1)} \end{bmatrix}^T, \quad (4.19)$$

$$d_{\text{fix}} = \sqrt{Nn_u \varepsilon^{\text{abs}} + \varepsilon^{\text{rel}} \|u_{\text{max}}\|}. \quad (4.20)$$

Then, the deviation is added to the safety distance:

$$\tilde{d}_{\text{safe}} = \mathbf{1}^{H_p} d_{\text{safe}} + \tilde{B}_i u_{d_{\text{fix}}}. \quad (4.21)$$

Therefore, even if it is the worst situation, the collision avoidance constraints still can be met, see Figure 4.4.

Responsibility sharing

In the serial iterative framework shown in Algorithm 4.1, a vessel assumes that the vessels updating later keep their previous trajectories. Thus, it should take actions to meet all the constraints. Therefore, two main characteristics of Algorithm 4.1 are as follows:

- The updating sequence influences the final solutions, i.e., vessels updating later have higher priority;
- Vessels make decisions based on the information that others send.

Algorithm 4.1: Serial iterative negotiation framework for VTF

```

1 for  $s = 1 : S$  do
2    $jd_g^s(k) := 0; N_{\text{jump}}^s(k) := 0;$ 
3   for  $i = 1 : N$  do
4     // VC  $i$  solves a local control problem
5      $\tau_i^s(k) := \underset{\tau_i(k)}{\text{argmin}} \left( J_i(x_i(k), \tau_i(k)) + \lambda_i^{s-1}(k)^T (\tau_i(k) - z_i^{s-1}(k)) \right.$ 
6        $\left. + \rho_i^{s-1}/2 \|\tau_i(k) - z_i^{s-1}(k)\|_2^2 \right);$ 
7     if solution do not exist then
8        $\tau_i(k)^s := \tau_i(k)^{s-1}; N_{\text{jump}}^s(k) := N_{\text{jump}}^s(k) + 1$ 
9     end
10    // VC  $i$  updates the interconnecting variable, Lagrange
11    multiplier and the expected state
12     $z_i^s(k) := \tau_i^s(k) + \lambda_i^{s-1}(k)/\rho_i^{s-1};$ 
13     $\lambda_i^s(k) := \lambda_i^{s-1}(k) + \rho_i^{s-1} (\tau_i^s(k) - z_i^s(k));$ 
14     $ZX_i^s := f_i(x_i(k), z_i^s(k));$ 
15    // VC  $i$  updates primal and dual residual and checks its own
16    stopping criteria
17     $R_{\text{pri},i}^s(k) := \tau_i^s(k) - z_i^s(k);$ 
18     $R_{\text{dual},i}^s(k) := z_i^s(k) - z_i^{s-1}(k);$ 
19     $\varepsilon_{\text{pri},a}^s := \sqrt{Nn_u} \varepsilon^{\text{abs}} + \varepsilon^{\text{rel}} \max \{ \|\tau_a^s\|_2, \|z_a^s\|_2 \};$ 
20     $\varepsilon_{\text{dual},a}^s := \sqrt{Nn_u} \varepsilon^{\text{abs}} + \varepsilon^{\text{rel}} \|\lambda_a^s\|_2;$ 
21    if  $\|R_{\text{pri},i}^s(k)\|_2 \leq \varepsilon_{\text{pri},i}^s$  and  $\|R_{\text{dual},i}^s(k)\|_2 \leq \varepsilon_{\text{dual},i}^s$  then  $jd_g^s(k) := jd_g^s(k) + 1;$ 
22    // VC  $i$  updates the penalty parameter
23    case  $\|R_{\text{pri},i}^s\|_2 > 10 \|R_{\text{dual},i}^s\|_2$  do  $\rho_i^s := 2\rho_i^{s-1};$ 
24    case  $\|R_{\text{dual},i}^s\|_2 > 10 \|R_{\text{pri},i}^s\|_2$  do  $\rho_i^s := \rho_i^{s-1}/2;$ 
25    // Iteration stopping check
26    if  $jd_g^s(k) = N$  and  $N_{\text{jump}}(k)^s = 0$  then Stop iteration;
27    // Communication
28    VC  $i$  broadcasts  $ZX_i^s, jd_g^s(k)$  and  $N_{\text{jump}}^s(k)$ 
29  end
30 end

```

[†] This algorithm may fail if an obstacle is within an inevitable collision distance the first time it is detected. In fact, this kind of obstacles is also difficult or even impossible to avoid in current human-operated practice. Therefore, we make following assumptions: 1) the initial state of a vessel is feasible; 2) when an obstacle is detected by a vessel at the first time, it is avoidable (for details about inevitable collision states, the interested reader can refer to [55, 124]).

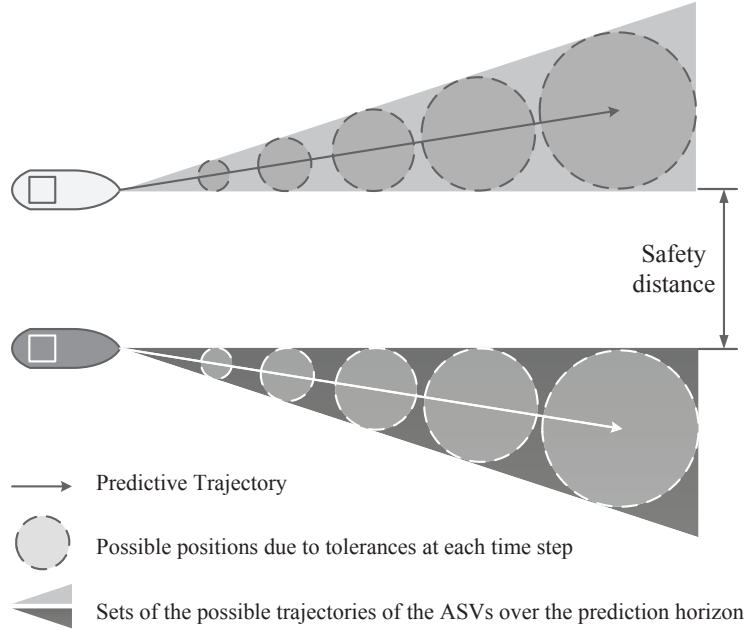

Figure 4.4: Adjustment on safety distance due to feasibility tolerances.

According to the characteristics, two methods are used to share the responsibility of cooperation. One is to change the updating sequence, such as updating alternately from the first to the last, and then reverser, or updating randomly. The other is to change the information that the vessels broadcast. It is worth to note that the trajectories that a vessel broadcasts are not necessary to be the solution of the optimization problem. Vessels can share the responsibility of collision avoidance by broadcasting trajectories that they prefer. Therefore, we introduce a responsibility parameter φ_i in the global variable updating (Line 10 in Algorithm 4.1). Thus, the global variable z_i is updated as follows:

$$z_i^s(k) := \varphi_i u_i^s(k) + (1 - \varphi_i) z_i^{s-1}(k) + \lambda_i^{s-1}(k) / \rho_i, \quad \sum_{i=1}^n \varphi_i \geq 1, \quad 0 \leq \varphi_i \leq 1. \quad (4.22)$$

A smaller responsibility parameter φ_i indicates that the vessel is more willing to keep its original trajectory. Therefore, at each iteration, the predicted trajectory it sends to others is closer to its original one.

4.3 Simulation experiments: Sensitivity analysis

In this section, simulation experiments are carried out to analyze the impact of different information updating sequences and so-called responsibility parameters. Moreover, we analyze the scalability of the proposed method.

Table 4.1: Simulation set ups

Parameter	u_{\max}	u_{\min}	p_{\max}	p_{\min}	d_{safe}	r
Value	1 m/s ²	0 m/s ²	3 m/s	0 m/s	10 m	20 m
Parameter	H_p	α	β	γ	ε^{abs}	ε^{rel}
Value	10	10	0	1	10 ⁻³	10 ⁻³

The experiments are carried out with Matlab 2016a. The optimization problems of the controllers are solved by ILOG CPLEX Optimization Studio (Version 12.6.3). The experiments are run on a PC with a dual-core 3.2GHz Intel(R) Core(TM) i5-3470U CPU and 8GB of RAM.

4.3.1 Simulation setup

To concentrate on the serial iterative framework, the ASVs are assumed to have the double integrator dynamics, i.e.,

$$p_i(k+1) = p_i(k) + q_i(k), \quad (4.23)$$

$$q_i(k+1) = q_i(k) + u_i(k), \quad (4.24)$$

where $p_i, q_i, u_i \in \mathbb{R}$ denote the position, velocity and acceleration of vessels i , respectively.

In Section 4.3.2 and Section 4.3.3, a head-on scenario of two vessels is simulated to analyze the impact of information updating sequences and responsibility parameters. In the simulation, Vessel 1 moves from (0, 0) to (0, 300), and Vessel 2 moves from (0, 300) to (0, 0). Section 4.3.4 provides the relations between computation time, the number of iterations, and the number of vessels in a CMVS. The setup of the simulation experiments is listed in Table 4.1.

4.3.2 Impact of updating sequence

Four different updating sequences are tested to analyze the impact of updating sequence: a) in order (1 → 2); b) in reverse (2 → 1); c) alternately (1 → 2 → 2 → 1); d) randomly choose from (1 → 2) and (2 → 1).

Figure 4.5 zooms in the trajectories of the two vessels under the head-on situation with different updating sequences. The results are compared with the trajectories when using a centralized controller. When the vessels update in order or in reverse, one vessel gives ways to the other. With the alternative order and the random order, both vessels have to take actions. However, the performance of the algorithm with a random order is uncertain. Sometimes it is the one that is closest to the centralized controller, while sometimes it can be the one with the worst performance. In Figure 4.5, the trajectories of vessels in the case with the random order is the results of one experiment. The results of the case exchanging randomly shown in Figure 4.6 – 4.8 are the average of results of 20 experiments.

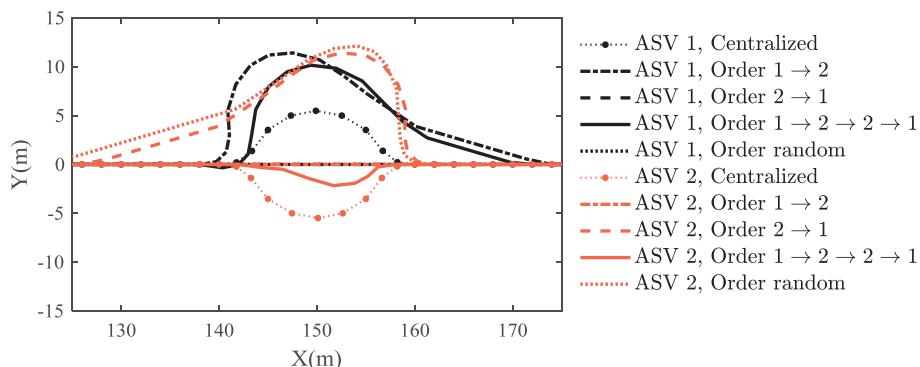

Figure 4.5: Trajectories of each vessel with different updating sequences.

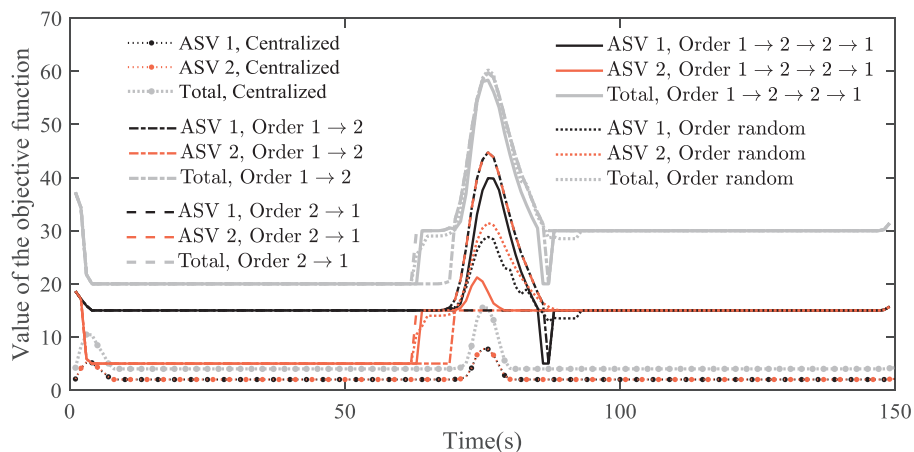

Figure 4.6: Objective value of each vessel with different updating sequences.

The value of the the objective function of each ASV and the overall costs are shown in Figure 4.6. In the cases that the ASVs updates in order and in reverse, the overall costs are almost the same while the local costs are exchanged. The local costs of the vessels in the case when they iterate alternately is closer to each other than the above two cases. However, the vessel that computes earlier at the first time step still has higher costs. Moreover, the total cost increases in the case of updating iteratively.

Figure 4.7 shows the distance between two ASVs. Under all the situations, the collision avoidance constraints are always met, i.e., the distances between the two ASVs are larger than the predefined safety distance.

Figure 4.8 provides the information of computation time and the number of iterations that is needed at each time steps during 60 s – 90 s when the collision avoidance occurs.

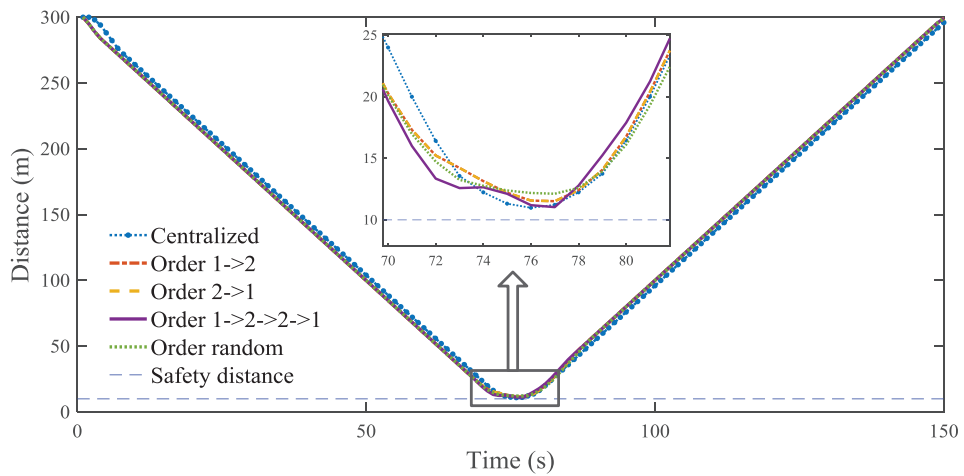

Figure 4.7: Relative distance with different updating sequences.

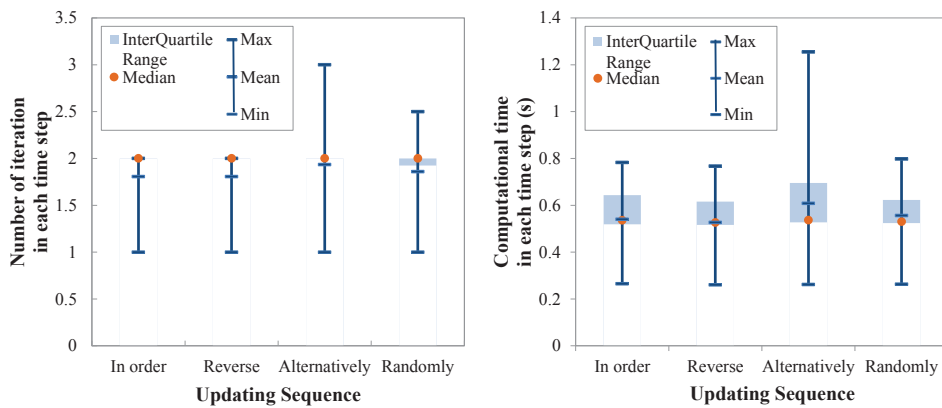

Figure 4.8: Number of iterations and computation time in each time step with different updating sequences¹.

Using the alternately and randomly updating sequences, more iterations are needed to reach an agreement. As a consequence, the computation time increases slightly.

To sum up, with the proposed serial iterative algorithm, the vessel which computes earlier should give priority to the vessels which update later. Applying the alternative or random order can reduce inequality, but more iterations are needed as a sacrifice.

¹In Figure 4.8 and the hereafter, the bottom and top edges of the Inter-quartile indicate the 25th and 75th percentiles, respectively.

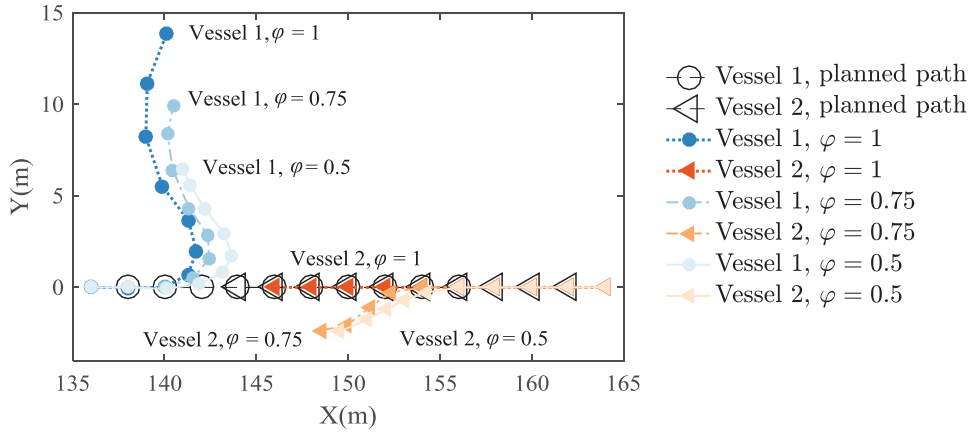

Figure 4.9: Broadcast trajectories of the vessels using different responsibility parameters (1st iteration).

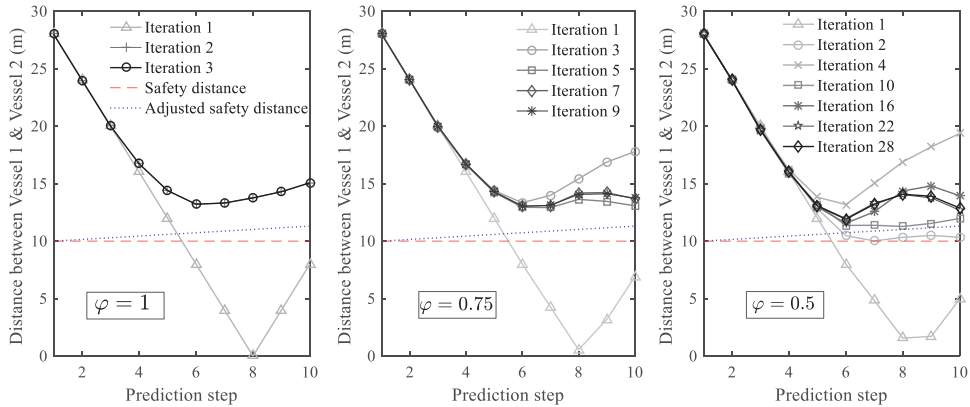

Figure 4.10: Predicted distance evolution.

4.3.3 Impact of responsibility parameter

Figure 4.9 shows the broadcast trajectories of two vessels when they encountered with different responsibility parameters. With $\varphi_1 = \varphi_2 = 1$, the earlier updated vessel (Vessel 1) has to take actions for collision avoidance, while Vessel 2 can keep its planned path. When φ_i decreases, the trajectory that Vessel 1 broadcasts does not satisfy the safety constraint. Therefore, Vessel 2 has to deviate from its original path. The trajectory that Vessel 2 provides might still satisfy the safety constraint, so the next iteration starts. Figure 4.10 shows how safety is achieved through iterations at the time step $k = 67$ s. The smaller φ_i is, the more iterations are needed to reach an agreement.

The simulation results of the experiments with different responsibility parameters are shown in Figure 4.11 – 4.12. In the simulation, $\varphi_1 = \varphi_2 = \varphi$. With a smaller responsibility

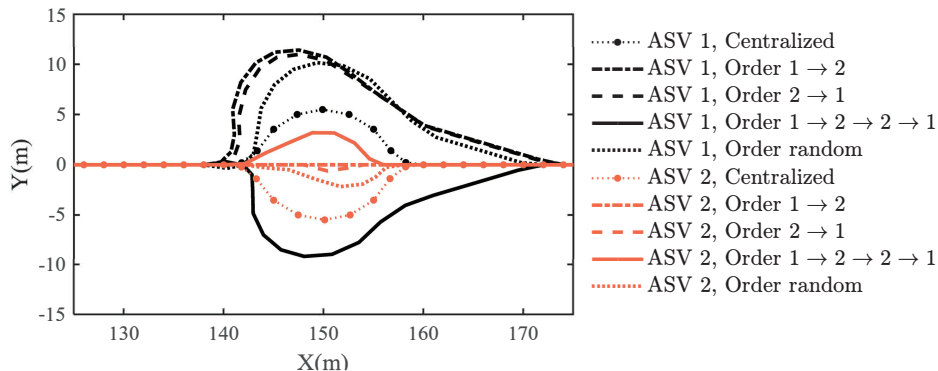

Figure 4.11: Trajectories of vessels using different responsibility parameters.

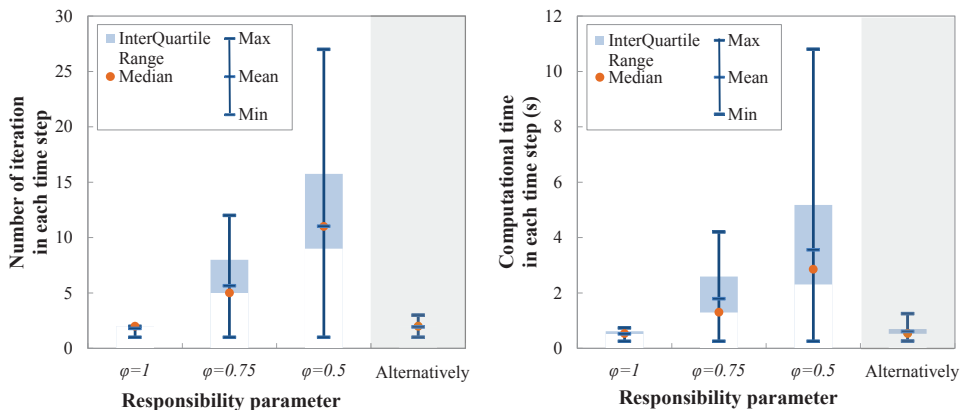

Figure 4.12: Number of iterations and computation time with different responsibility parameters.

parameter, the number of iterations needed in each time step increases significantly. In Figure 4.12, the number of iterations and computation time of the algorithm updating iteratively are also provided. Compared with the case with alternative updating order, the computation time is much longer in the case with a small responsibility parameter. Therefore, we chose the alternatively updating algorithm for the subsequent experiments.

4.3.4 Scalability

To have an insight into the scalability of the proposed algorithm, we carried out a series of simulation experiments. In the experiments, vessels follow the paths shown in Figure 4.13. The number of vessels in a CMVS increases from 2 to 30. A vessel joins the vessel train once it arrives at (0, 0).

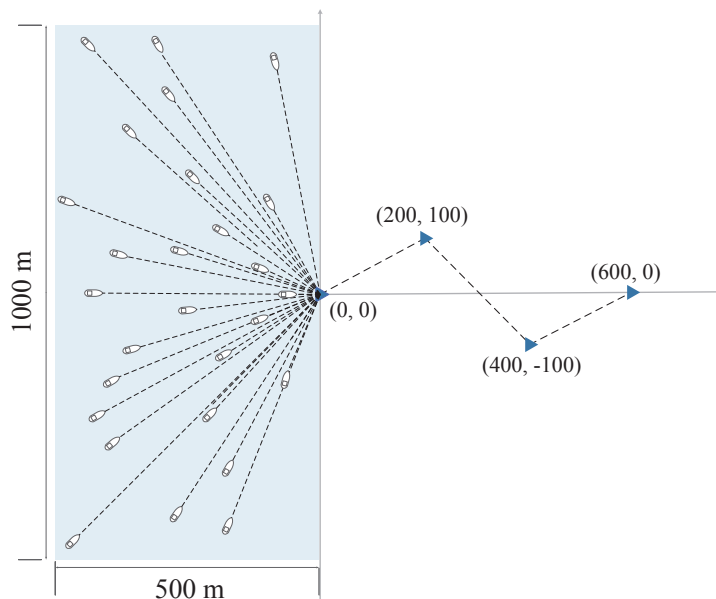

Figure 4.13: Reference paths in the scalability tests.

The minimum, maximum, mean value and median of the number of iterations and computation time at each time step are presented in Figure 4.14 and 4.15. Both the number of iterations and computation time show growing tendencies. However, the increase in iterations is gradual. Iterations are used to solve the conflicts among the vessels. Because of the train-like formation, the conflicts do not increase even though the number of vessel increases. On the contrary, because the number of constraints in the Problem \mathcal{C} increase with the number of formation mates, the computation time increases significantly. However, even when the number of vessels in a CMVS is up to 30, the maximum computation time is less than 70 s. Moreover, as we mentioned, the vessels in a CMVS are the vessels that (temporally) have the same path or can pass through locks and bridges together. Therefore, the number of vessels in a CMVS is usually less than 10.

4.4 Simulation experiments: VTF in Port of Rotterdam

In this section, simulation experiments on the scenarios in which a CMVS consists of 5 vessels navigating from five different terminals in the Port of Rotterdam to an inland waterway is presented.

4.4.1 Comparison of Position-based VTF and Speed-based VTF

Simulation setup

In the following experiments, we compare the differences between Position-based VTF and Speed-based VTF. The simulation area is shown in Figure 4.16. Five vessels start from

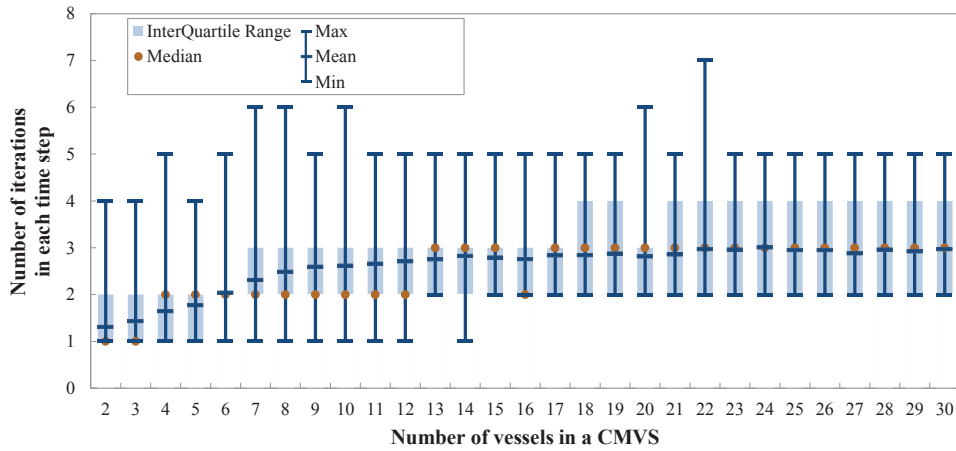

Figure 4.14: Number of iterations when the number of vessels in a CMVS increases.

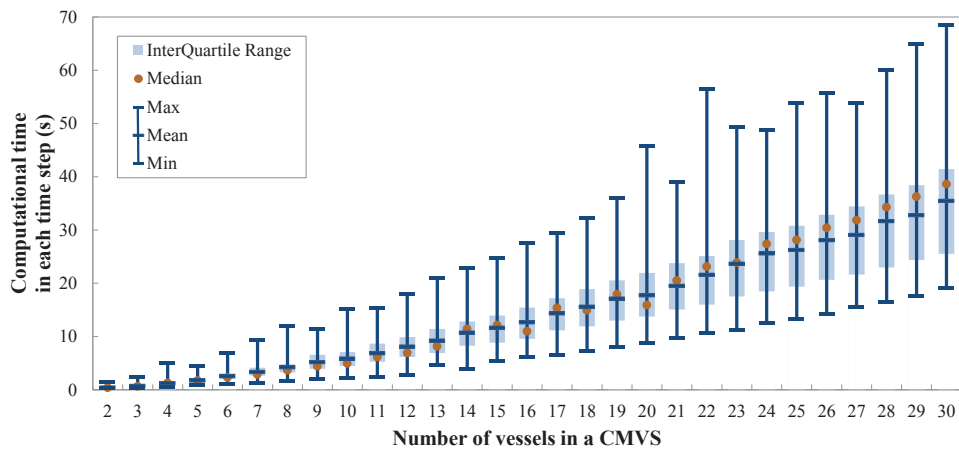

Figure 4.15: computation time when the number of vessels in a CMVS increases.

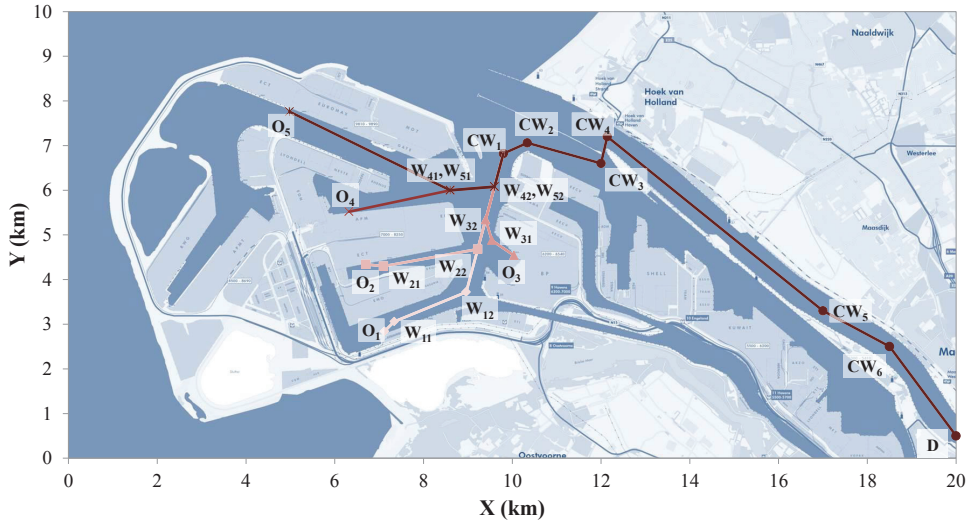

Figure 4.16: Simulation area. Map is from [136].

Table 4.2: Origins, destination and waypoints in the simulation

Node	X	Y	Node	X	Y	Node	X	Y	Node	X	Y
O_1	7.12	2.84	W_{11}	7.34	3.06	W_{12}	8.96	3.72	CW_3	12	6.6
O_2	6.7	4.34	W_{21}	7.1	4.3	W_{22}	9.22	4.68	CW_4	12.14	7.2
O_3	10.04	4.54	W_{31}	9.54	4.88	W_{32}	9.4	5.34	CW_5	17	3.3
O_4	6.32	5.52	W_{41}, W_{51}	8.6	6	CW_1	9.8	6.82	CW_6	18.5	2.5
O_5	4.98	7.76	W_{42}, W_{52}	9.6	6.08	CW_2	10.34	7.06	D	20	0.5

† CW means common waypoints.

different terminals ($O_1 \dots O_5$), and they navigate together through the inland waterways. The vessels have reference paths which are indicated by waypoints. The position of the origins, waypoints and the destination are listed in Table 4.2.

The algorithm that we use is the serial iterative ADMM-based DMPC presented in Section 4.2. The update order is iteratively from the first to the last and from the last to the first. The initial speed of ASV 1–5 are 0.6 m/s, 0.4 m/s, 0.3 m/s, 0.5 m/s, and 0.7 m/s, respectively. They set off from different terminals at time step 1 s, 1 s, 25 s, 1 s, and 10 s.

Two model vessels are used in the simulation, Delfia 1* and CyberShip 2. The hydrodynamic parameters of the two model vessels are in Table 4.3. The ASVs with odd numbers have the same setting with Delfia 1*, while the ASVs with even numbers have the same setting with CyberShip 2. The models are scaled-up according to Froude scaling law with a scaling factor 1 : 70. According to the scaling law, the multiplication factors for length, force, moment and time are 70, 70^3 , 70^4 , and $\sqrt{70}$, respectively. Parameters needed in the simulation are given in Table 4.4.

Table 4.3: Hydrodynamic parameters for Delfia 1* and CyberShip 2^a

	Delfia 1*	CyberShip 2 ^b		Delfia 1*	CyberShip 2
m	3.345	23.80	N_v	0.50439	0.1052
I_z	0.031	1.760	N_r	-0.22243	-1.900
x_g	0.0	0.046	$X_{\dot{u}}$	-0.2310	-2.0
X_u	-2.734	-0.7225	Y_v	-1.334	-10.0
Y_v	-4.60250	-0.8612	Y_r	0.0	0.0
Y_r	0.79546	-0.1079	N_r	-0.110	-1.0

^a The hydrodynamic derivatives follow the notations in [156];

^b Parameters for CyberShip 2 are from [155].

Table 4.4: Parameter setting

	Parameter	Value
ASV 1, 3, 5	Model	Delfia 1*
	Width	0.185 m
	Length	0.38 m
	$v_{i,\max}$	$[0.75, 0.75, 30\pi/180]^T$
	$v_{i,\min}$	$[0, -0.75, -30\pi/180]^T$
	$\tau_{i,\max} = -\tau_{i,\min}$	$[2, 2, 2]^T$
	$d_{i,\text{safe}}$	0.38 m
ASV 2, 4	Model	CyberShip 2
	Width	0.29 m
	Length	1.255 m
	$v_{i,\max}$	$[0.65, 0.65, 20\pi/180]^T$
	$v_{i,\min}$	$[0, -0.65, -20\pi/180]^T$
	$\tau_{i,\max} = -\tau_{i,\min}$	$[2, 2, 2]^T$
	$d_{i,\text{safe}}$	1.255 m
MPC controller design	H_p	10
	α	diag[5,5,25]
	β	2
	γ	5
ADMM	ε^{rel}	10^{-4}
	ε^{abs}	10^{-3}

^a When two ASVs encountered, the safety distance between ASV i and ASV j is $d_{i,j,\text{safe}} = (d_{i,\text{safe}} + d_{j,\text{safe}})/2$.

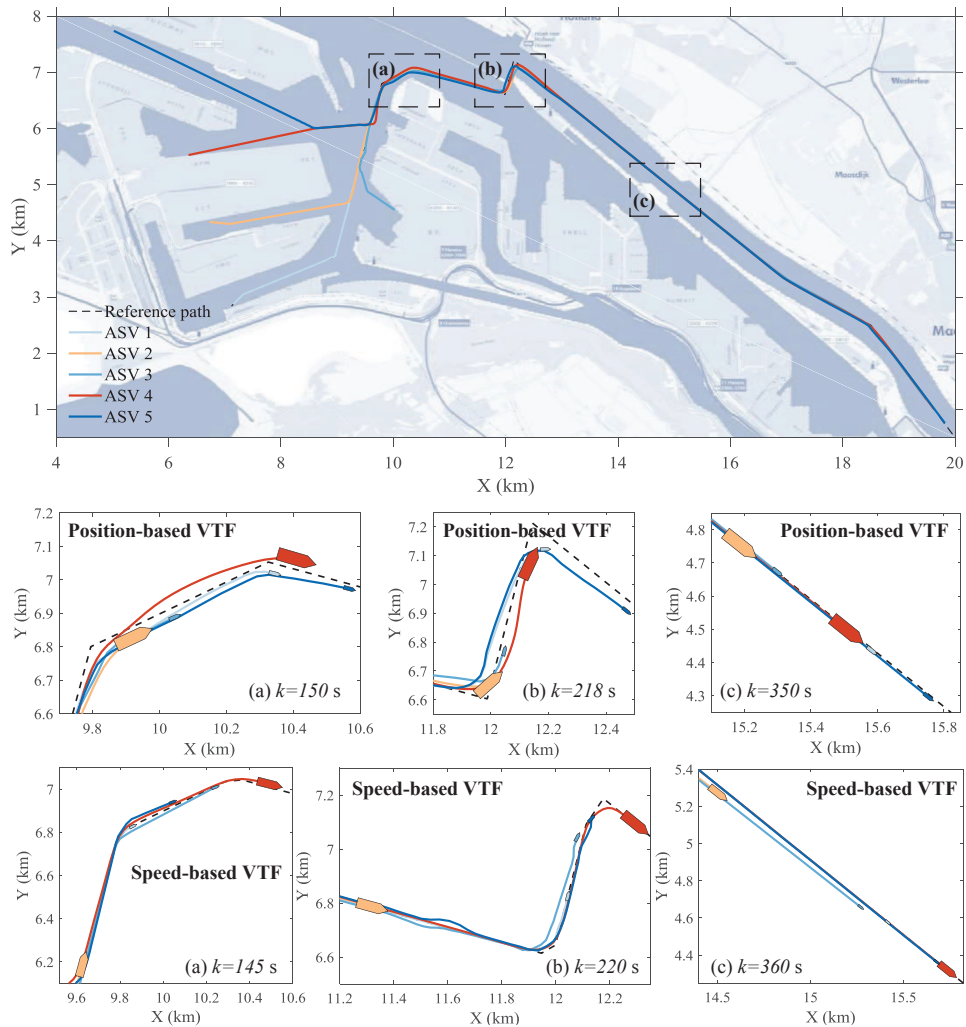

Figure 4.17: Trajectories of the ASVs.

Results and discussion

The trajectories of the five ASVs are shown in Figure 4.17. The vessels follow the reference paths using the proposed method, and they deviate from the given path at the bends to avoid collisions. The ASVs form a vessel train after they enter the same waterway segment. When applying the Position-based formulation, more overtaking behaviors occur than using the Speed-based formulation, see the screenshots at different time steps in the figure. For ASVs using the Speed-based formulation, once the vessel train is formed, the order of the ASVs seldom changes. Moreover, as the ASVs in Speed-based VTF aim at speed consensus, their relative distances are larger than ASVs in Position-based VTF.

Figure 4.18 and Figure 4.19 show the linear and angular velocities and the control inputs of each ASV using the two VTF formulations. The figures show that the ASVs in the two formulations use different strategies to join the vessel trains. For Position-based VTF, an ASV firstly accelerates (e.g., ASV 1) or decelerates (e.g., ASV 4) to reduce the distances with its neighbors. To keep their distance within a certain range, the velocities of the ASVs become consensus at the end. For Speed-based VTF, an ASV adopts a speed that is close to the average speed immediately when it joins the vessel train. For both methods, at the bends, vessels need to take actions frequently, such as at time step $k = 150$ s and $k = 220$ s. Then, after the vessels enter the straight segment, the speed of the vessels becomes consensus, and the distances between the vessels become constant. The fluctuation in the speed of the ASVs in Position-based VTF is larger than the vessels in Speed-based VTF. The main reason is that the ASV controllers have only the information about the predictive positions of other vessels. Each vessel has its own planned speed. If the distances with its neighbors are within the aggregation range, the controller prefers the planned speed. However, once the distance is out of the range, vessels will decelerate or accelerate to stay closer to its neighbors. On the contrary, in Speed-based VTF, the ASVs in the vessels train have information about the speed of the neighbors. Their speed is close to the average speed. Thus, fewer changes are needed.

Figure 4.20 provides the relative distances among the ASVs. Due to the effective communication, for both methods, vessels can timely respond to the velocity changes that other VCs make. Consequently, although the distances between vessels are fluctuating when vessels navigate through the bends, they are always larger than the safety distance. When applying the Position-based formulation, the relative distances between the ASVs (Figure 4.20(a)) are larger than the relative distances in when using the Speed-based formulation (Figure 4.20(b)). The main reason is that the objective of the Speed-based formulation is to make the speed of the ASVs become consensus, other than keeping them within a specific range, as mentioned above. Moreover, as the vessels hold the aim of trajectory tracking, the speed of the vessels in the Speed-based formulation has small deviations for balancing the objectives of following their own paths and speed consensus.

The number of iterations and computation time at each time step are provided in Figure 4.21. For Position-based VTF, at each time step, vessels can find the solution within 10 iterations. The computation time keeps the same pattern with the number of iterations: when the number of iterations increases, the computation time increases. The computation time is less than 5 s, which means that the optimization problem is solved within the sampling time. It is worth to mention that, when the vessel train is formed, fewer input changes, fewer iterations and therefore, less computation time are needed. For the Speed-based VTF, more iterations are needed, as well as the computation time.

Figure 4.22 uses the time step $k = 251$ s in the Position-based VTF as an example to show how the primal and dual residuals evolve over iterations. The primal residual records the differences between the expected trajectory and the predicted trajectory, i.e., $\|\tau_i^s - z_i^s\|^2$. The dual residual records the differences between the expected trajectory at iteration s and the expected trajectory at iteration $s - 1$, i.e., $\|z_i^s - z_i^{s-1}\|^2$. At the time step $k = 251$ s, the primal residual meets the stopping criteria at the first iteration, while the dual residual is still larger than the stopping criteria. Through iterative negotiations, both primal and dual residuals decrease and finally meet the stopping criteria.

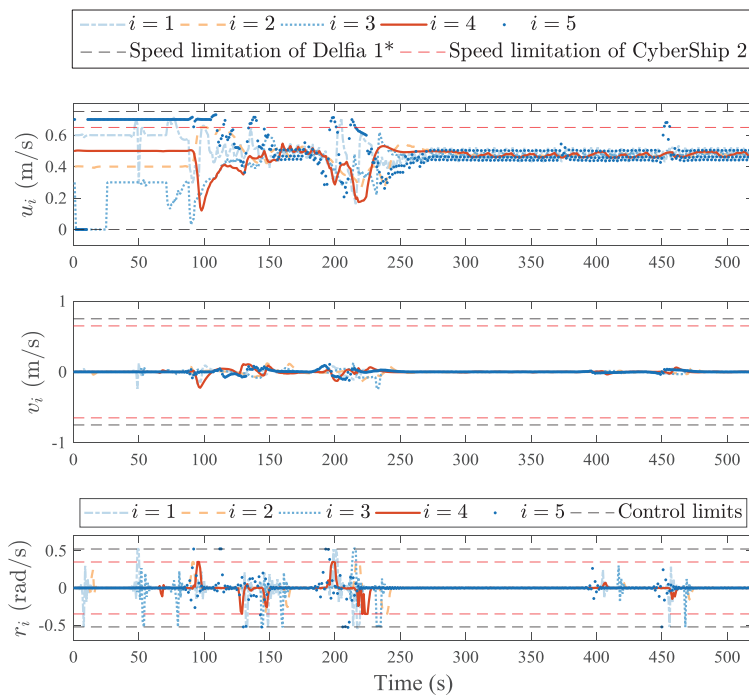

(a) Linear and angular velocities of the ASVs using Position-based VTF.

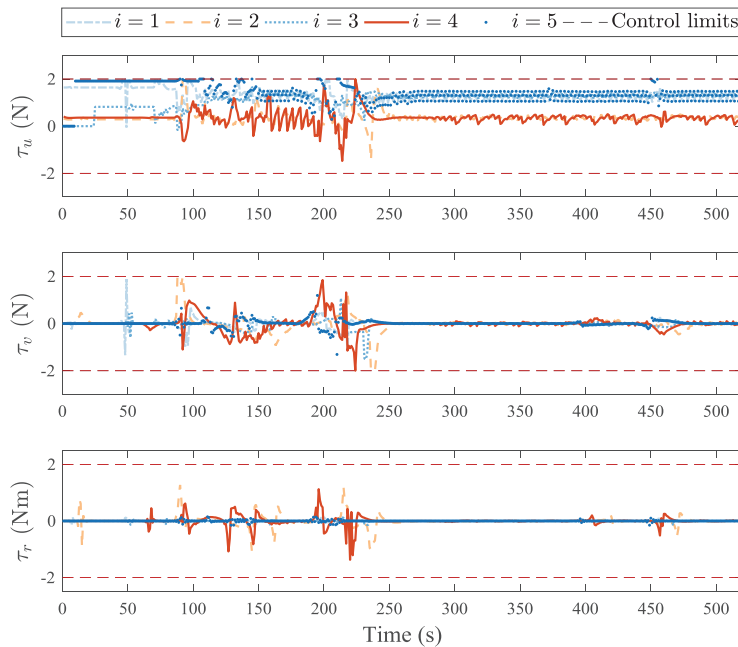

(b) Forces and moment of the ASVs using Position-based VTF.

Figure 4.18: Velocity and control input of the ASVs using Position-based VTF.

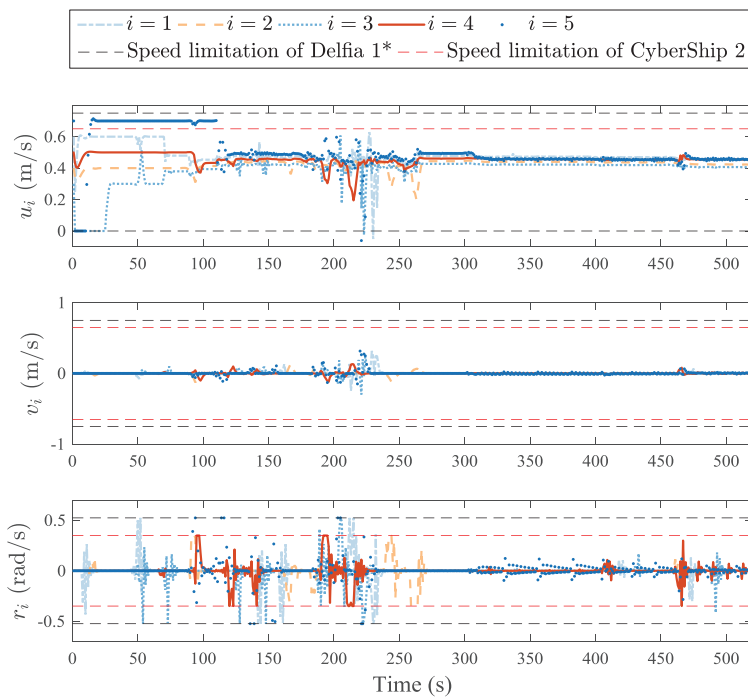

(a) Linear and angular velocities of the ASVs using Speed-based VTF.

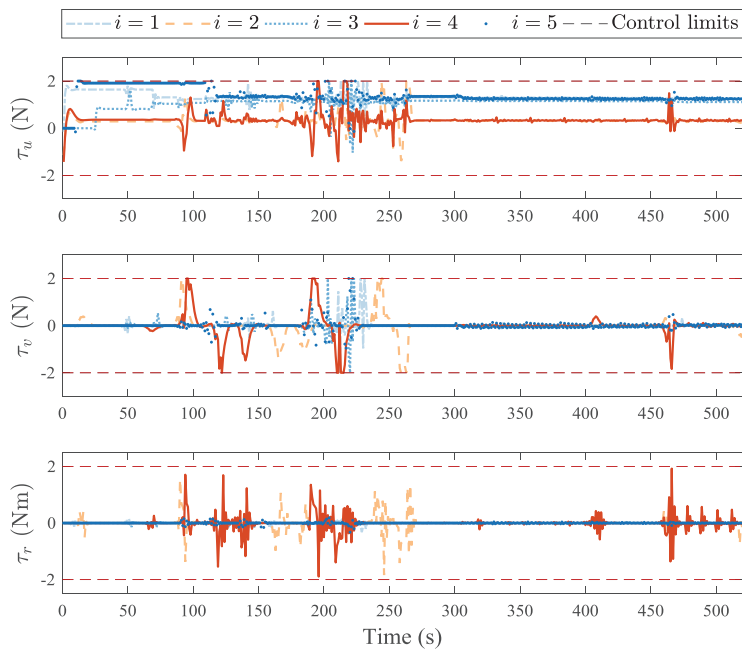

(b) Forces and moment of the ASVs using using Speed-based VTF.

Figure 4.19: Velocity and control input of the ASVs using using Speed-based VTF.

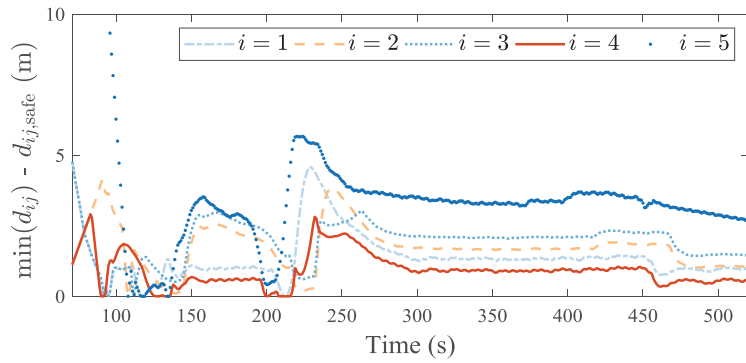

(a) Distance between an ASV and its nearest neighbor using Position-based VTF.

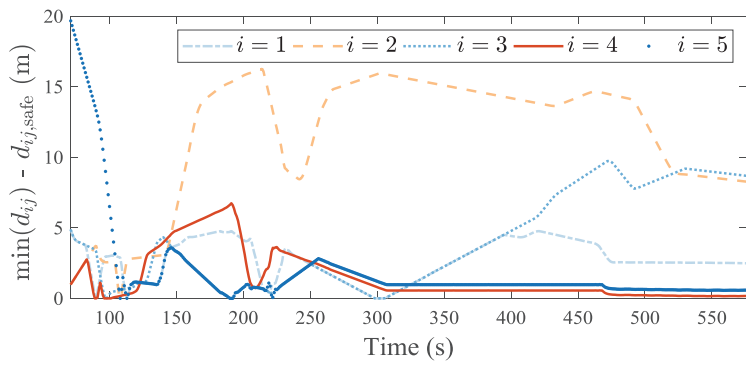

(b) Distance between an ASV and its nearest neighbor using Speed-based VTF.

Figure 4.20: Distance between an ASV and its nearest neighbor.

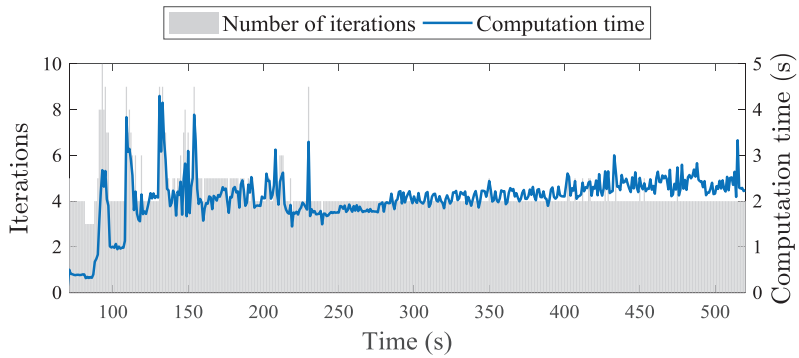

(a) Computation time and number of iterations using Position-based VTF.

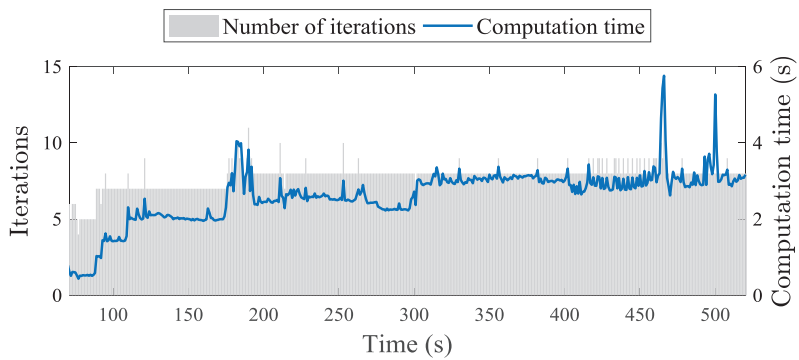

(b) Computation time and number of iterations using Speed-based VTF.

Figure 4.21: Computation time and number of iterations.

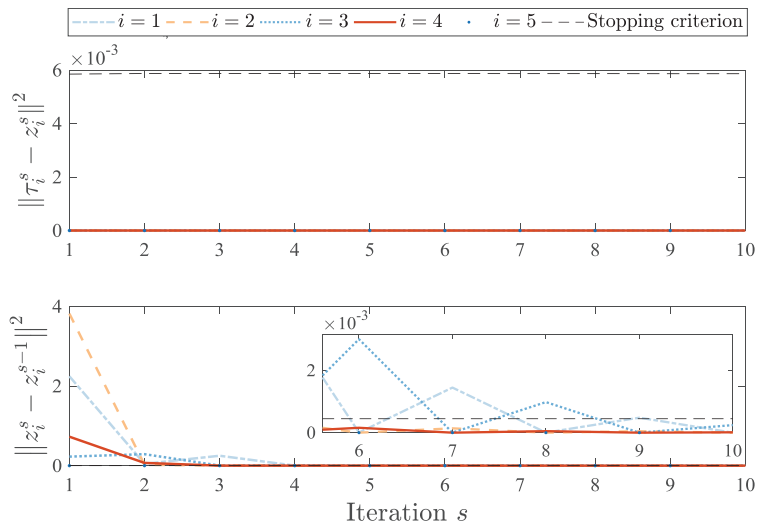

Figure 4.22: Primal and Dual Residual at time step $k = 251$ s using Position-based VTF.

Table 4.5: ASVs in simulation

		ASV 1	ASV 2	ASV 3	ASV 4	ASV 5
Max power (MW)	Engine	2.04	1.76	1.8	1.20	2.72
	Battery ^a			20% DC		
Efficiency Power	Lower	50%	70%	75%	70%	50%
	Upper	85%	90%	95%	90%	85%
Efficiency Force (N)	Lower	0.6751	1.3932	0.7613	1.0792	0.8178
	Upper	0.8846	1.5926	0.8647	1.2337	1.0717

^a During low power demand periods, the battery is used.

Table 4.6: Parameters of the SFC curves

ASV NO.	Engine	a (gr.KWh)	b (gr/KWh ²)	c (gr/KWh)
1	2.04 MW diesel engine	4.67×10^7	1.01×10^{-5}	147.1
2	1.76 MW diesel engine	6.30×10^7	3.42×10^{-5}	98.23
3	1.8 MW diesel engine	6.45×10^7	3.45×10^{-5}	96.21
4	1.2 MW diesel engine	3.68×10^7	4.40×10^{-5}	109.60
5	2.72 MW diesel engine	6.23×10^7	7.58×10^{-6}	147.1

4.4.2 Comparison of VTF and Eco-VTF

Simulation setup

In the following experiments, we compare the results of VTF and Eco-VTF. In the simulation, the five ASVs have different engine settings. In both VTF and Eco-VTF, the Speed-based formulation is applied. We assume that each ASV has a propeller at the bow which provides surge force, and a bow thruster which provides yaw moment. The sway forces for the five ASVs equal to 0. The models are scaled-up according to Froude scaling law with a scaling factor 1 : 30 regarding the engine specifications. Settings about the engine of each ASV are shown in Table 4.5 and Table 4.6. For Eco-VTF, the weight for fuel efficiency is set as $\xi = 25$. Other parameters of the ASVs are the same as the settings in the experiments presented in Section 4.4.1.

Results and discussion

Vessels using VTF have higher fuel consumption rates (FCRs) (Figure 4.23) and therefore, higher total fuel consumption (Figure 4.24). The FCRs of vessels using Eco-VTF are lower and their changes are smaller than the situation when applying VTF control. The initial planned speed of ASV 1 and ASV 5 are relatively fast. Thus, large differences exist in the FCRs of ASV 1 and 5 under the two different situation. On the contrary, the planned speed of ASV 2 and ASV 4 are low, and thus, their FCRs are similar. However, the peak values of the FCRs when ASV 2 and ASV 4 are using Eco-VTF are still smaller than the FCRs when they are using VTF.

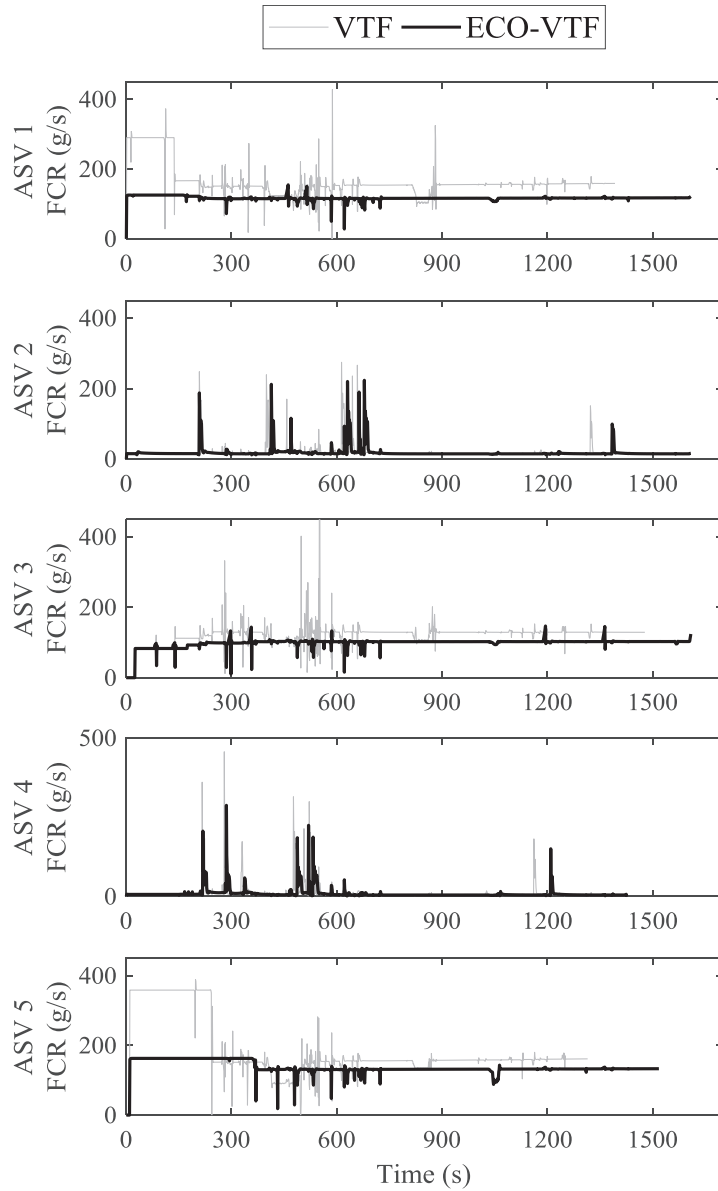

Figure 4.23: Fuel consumption rate of each ASV.

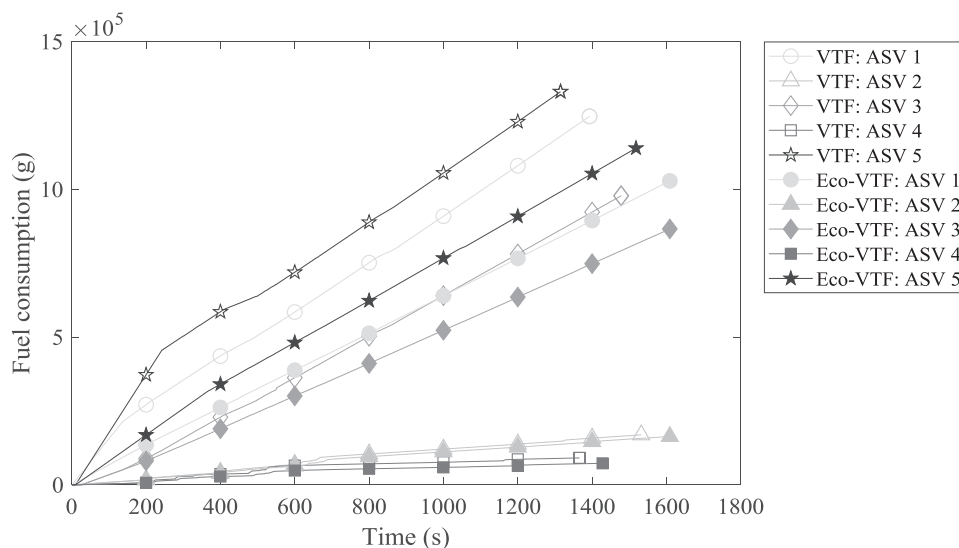

Figure 4.24: Total fuel consumption of each ASV.

Table 4.7: Comparison of the simulation results

		ASV 1	ASV 2	ASV 3	ASV 4	ASV 5
VTF	Average Speed (m/s)	0.44	0.39	0.36	0.42	0.48
	Average FCR (g/s)	163.49	20.18	120.87	12.21	184.75
	Fuel $\times 10^5$ (g)	12.47	1.69	9.78	0.91	13.31
Eco-VTF	Average Speed (m/s)	0.37	0.37	0.33	0.40	0.42
	Average FCR (g/s)	116.75	18.60	98.30	9.35	137.07
	Fuel $\times 10^5$ (g)	10.29	1.64	8.66	0.73	11.40
Difference ^a	Average Speed (m/s)	-0.07	-0.02	-0.03	-0.02	-0.06
	Average FCR (g/s)	-46.74	-1.58	-22.57	-2.86	-47.68
	Fuel $\times 10^5$ (g)	-2.19	-0.05	-1.12	-0.18	-1.91
FCR improvement ^b		-28.6%	-7.8%	-18.7%	-23.4%	-25.8%
Fuel improvement		-17.5%	-3.2%	-11.5%	-19.9%	-14.4%

^a Difference=Eco-VTF – VTF;

^b Improvement=Difference/VTF.

Table 4.7 provides the comparison of average speed, average FCR, and total fuel consumption of the experiments using VTF and Eco-VTF. The average speed of ASVs using Eco-VTF is slightly lower than the ASVs using VTF. However, a significant amount of fuel saving can be obtained by using Eco-VTF, especially for the ASVs with higher maximum engine power, such as ASV 1 and ASV 5.

4.5 Conclusions

This chapter, in particular, focuses on the cooperation between ASVs in a Cooperative Multi-Vessel System (CMVS) at the link level, i.e., in a waterway segment. The cooperation of vessels at the link level is formulated as a Vessel Train Formation (VTF) problem. Two types of formulations are proposed, namely, Position-based VTF and Speed-based VTF. Moreover, the problem of enabling fuel-efficient Vessel Train Formation, Eco-VTF, is investigated. According to the generic motion control framework presented in Chapter 3, an MPC controller is designed for each ASV to achieve the three VTF objectives, i.e., path following, aggregation, and collision avoidance. The agreements among the vessels are achieved with a single-layer serial iterative negotiation framework. In addition, sharing the responsibility of cooperation by changing the order of information updating and by introducing the responsibility parameter are illustrated.

Simulations are carried out to analyze the impact of information updating sequence and responsibility parameter on overall and individual solutions. Applying the alternative or random order can reduce inequality, although at the price of more iterations and longer computation time. Similarly, a smaller responsibility parameter helps to balance the changes that vessels make, while the number of iterations and computation time increase considerably. The scalability of the proposed algorithm is analyzed, as well. The increase in the number of vessels has more impacts on computation time than the number of iterations. The train-like formation reduces the demand for collision avoidance. Consequently, the proposed method is capable of solving the VTF problem online within the sampling time when the number of vessels in a CMVS increases to 30. To show the potential of our method, we further simulate the scenario in which a CMVS consisting of five vessels navigates from the Port of Rotterdam to inland waterways. We compare the results of Position-based VTF and Speed-based VTF. Both methods can successfully steer the vessels from different origins to form a vessel train. Due to the effective communication, vessels can timely respond to the velocity changes that others make. Position-based VTF can keep the ASVs within a smaller range, while Speed-based VTF has fewer fluctuations in the speed of each ASV. Besides, the fuel consumption of vessels using VTF and Eco-VTF are compared, as well. A significant amount of fuel-saving can be obtained by using the Eco-VTF method.

This chapter partially answers the research questions on cooperation among vessels, namely, Research Questions 3-5. In this chapter, we focus on the flexible version of Vessel-to-Vessel (V2V) cooperation in a CMVS. In the subsequent chapter, another type of V2V cooperation with strict formation keeping constraint for performing specific tasks is investigated with the proposed generic negotiation framework. Interactions between vessel trains and Vessel-to-Infrastructure cooperations are addressed in Chapter 6.

Chapter 5

Cooperative Floating Object Transport

In the previous chapter, we discussed a flexible form of Vessel-to-Vessel (V2V) cooperation within a Cooperative Multi-Vessel System (CMVS) at the link level. This chapter focuses a closely cooperative form of V2V interaction, named as Cooperative Floating Object Transport (CFOT), i.e., utilizing a team of ASVs to transport a larger floating object, such as a large vessel, a barge or an offshore platform. The object and the ASVs are connected with towlines, and the ASVs maintain the formation when moving the object. Based on the generic negotiation framework proposed in Chapter 3, a multi-layer DMPC method is employed to achieve consensus among the ASVs.

This chapter is organized as follows. In Section 5.1, we describe the cooperative object transport system being studied. The dynamic model of ASVs and the floating object, and a model of towline are introduced. Subsequently, the control strategy for object transport is proposed in Section 5.2. We design a multi-layer cooperative control scheme, and an ADMM-based DMPC framework is proposed to reach consensus on the following actions to be taken among the controllers. In Section 5.3, the scenarios in which the proposed cooperative system move a large vessel sailing inbound the Port of Rotterdam are simulated to show the effectiveness of the proposed method. Main findings are provided in Section 5.4.

Parts of this chapter have been published in [28].

5.1 System model

In this section, the model of a formation-based cooperative object transport system is constructed. The dynamic models of the ASVs, the floating object, and towlines are introduced.

5.1.1 Dynamic models of the ASVs and the floating object

Cooperative object transport requires the coordination and synchronization of pushing or pulling forces by a group of ASVs in order to transport objects. In this research, we use a

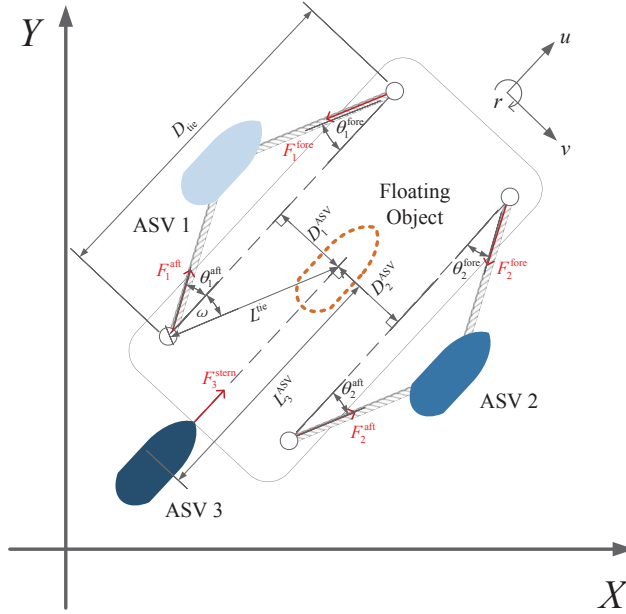

Figure 5.1: Configuration of the ASVs for cooperative object transport.

triangular configuration as an example to illustrate the proposed framework. The method can also be used for other configurations.

The geometric configuration of the ASVs is shown in Figure 5.1: ASV 1 and 2 are located symmetrically on the starboard side and the portside of the object; the line between the object and ASV 3 is perpendicular to the line between ASV 1 and 2. With this configuration, the surge and sway forces to move the object are provided by the three ASVs, while the moment to change the heading of the object is provided by ASV 1 and 2. Thus, the problem of object transport becomes the problem of coordinating the three ASVs to provide forces for moving the object following a reference path while keeping formation.

To calculate the forces and moment that are needed to move the object, the object is treated as a virtual vessel. The dynamics of the ASVs and the virtual vessel are described with the 3 DOF model (3.6) introduced in Section 3.2

5.1.2 Towline model

At each time step, the object, towlines and ASVs are in mechanical equilibrium. The forces provided by each ASV are applied to the towlines, and then, the forces are transferred along the towlines to the object. In this research, we focus on the horizontal plane. Denote the forces along the towlines on the horizontal plane as $F(k) = [F_1^{fore}(k), F_1^{aft}(k), F_2^{fore}(k), F_2^{aft}(k), F_3^{stern}(k)]^T$, the relation between the forces that are needed to move the object $\tau^*(k)$

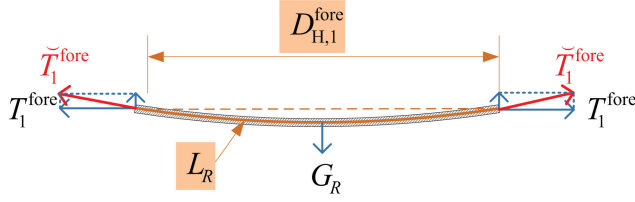

Figure 5.2: Tension on a towline.

and F is

$$\tau^*(k) = \Gamma(k)F(k), \quad (5.1)$$

where $\tau^* = [\tau_u^*, \tau_v^*, \tau_r^*]^T$ and $\Gamma(k)$ is the transformation matrix,

$$\Gamma(k) = \begin{bmatrix} -\cos(\theta_1^{\text{fore}}(k)) & \cos(\theta_1^{\text{aft}}(k)) & -\cos(\theta_2^{\text{fore}}(k)) & \cos(\theta_2^{\text{aft}}(k)) & 1 \\ -\sin(\theta_1^{\text{fore}}(k)) & -\sin(\theta_1^{\text{aft}}(k)) & \sin(\theta_2^{\text{fore}}(k)) & \sin(\theta_2^{\text{aft}}(k)) & 0 \\ -L^{\text{tie}} \sin(\theta_1^{\text{fore}}(k) + \omega) & L^{\text{tie}} \sin(\theta_1^{\text{aft}}(k) + \omega) & L^{\text{tie}} \sin(\theta_2^{\text{fore}}(k) + \omega) & -L^{\text{tie}} \sin(\theta_2^{\text{aft}}(k) + \omega) & 0 \end{bmatrix},$$

where $\theta_i^{\text{fore}}(k)$ and $\theta_i^{\text{aft}}(k)$ are the angles between the towlines and central line of the object, whose subscript and superscript indicate different towlines, see Figure 5.1; ω is the angle of the segment between two ties and the center of mass of the object; L^{tie} is the distance from the center of mass of the object to the segment between the ties.

We assume that the towlines have a uniform density. Due to gravity, the towline will be shaped as a curve. In Figure 5.2, we use the towline that connects the fore tie at the object and ASV 1 as an example: T_1^{fore} is the tension in the horizontal direction; $\tilde{T}_1^{\text{fore}}$ is the tension on the towline; G_R and L_R are the gravity and the length of the towline; $D_{H,1}^{\text{fore}}$ is the horizontal distance between the two ends of the towline. Different models have been proposed to calculate the tension on the towline, such as in [53, 163]. In this research, a catenary model is applied considering the mass and the elasticity of the towline [163]:

$$T_1^{\text{fore}}(k) = \left(D_{H,1}^{\text{fore}}(k) - 2 \frac{T_1^{\text{fore}}(k)}{\varpi} \sinh^{-1} \left(\frac{\varpi L_R / 2}{T_1^{\text{fore}}(k)} \right) \right) \frac{EA^{\text{CS}}}{L_R}, \quad (5.2)$$

where ϖ is the density of the towline; E is the so-called Young's modulus of the towline. A^{CS} is the cross-sectional area of the towline.

At the same time, because ASV 1 is connected to the object with two towlines, the distances between the ASV and its connected ties should also meet the Law of Cosines, i.e.,

$$\cos \theta_1^{\text{fore}}(k) = \frac{(D_{H,1}^{\text{fore}}(k))^2 + D_{\text{tie}}^2 - D_{H,2}^{\text{aft}}(k)^2}{2D_{H,1}^{\text{fore}}(k)D_{\text{tie}}}. \quad (5.3)$$

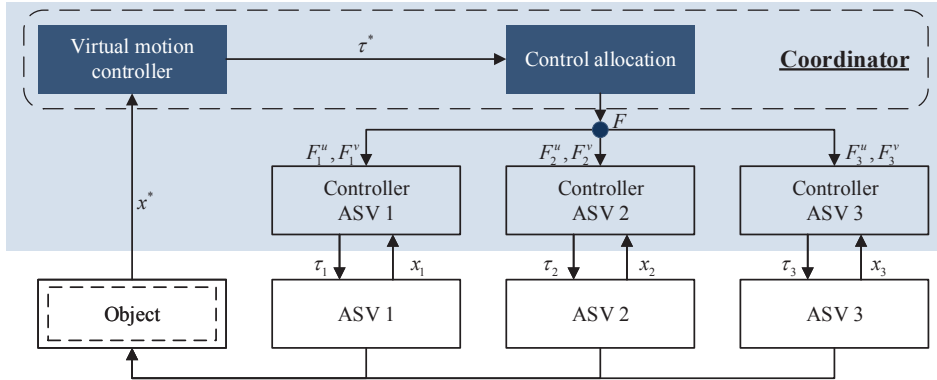

Figure 5.3: Multi-layer DMPC for cooperative object transport.

5.2 Multi-layer negotiation framework for CFOT

MPC has been popular in practical applications since its early days [111]. For waterborne transport, MPC methods also have many advantages, especially when considering the predictive property of MPC methods [24]. Moreover, MPC considers the latest available measurement of the system's state and up-to-date information regarding disturbances, which provides the MPC methods the capability, to a certain extent, to be robust against disturbances. Besides, DMPC (Distributed Model Predictive Control) has many advantages for the control of large-scale networked systems [119]. Therefore, we consider DMPC as a suitable approach to carry out the task of object transport.

In this section, we propose a DMPC approach for cooperative object transport. We firstly introduce a multi-layer control structure for the object transport system. Then, we formulate the control problems and design the MPC controller for the object that is regarded as a virtual vessel. An optimization-based control allocation method is presented to determine the forces that each ASV should provide. In the end, an iterative negotiation framework is provided for the cooperation of the controllers.

5.2.1 Control structure

Figure 5.3 illustrates a multi-layer structure for the control of the object transport system. A coordinator at the higher level is responsible for two tasks: one is to determine the virtual forces to control the motion of the object (τ^*); the other is to compute the forces (F_i^u and F_i^v) that ASV i should provide, which ensures that the commanded control τ^* is produced jointly by the ASVs. Then, ASV controller i determines its own control τ_i according to its own state x_i while providing the required forces. The actions that the ASVs take decide the final state of the object, i.e., x^* . The function of the coordinator can be fulfilled either by one of the ASV controllers or an additional controller on the object or one of the ASVs or on the shore.

5.2.2 MPC controller design

Reference trajectory generation

To calculate the forces and moment that are needed to make the object following a predetermined path, the object is regarded as a virtual vessel, whose dynamics can be described using (3.6). One of the tasks of the coordinator is to control the motion of this virtual vessel to track a predetermined path.

The reference path is usually generated by discretizing the segments between the waypoints with the double integrator dynamics and a constant speed \hat{v} , i.e., $P(k+1) = P(k) + \hat{v}$, where $P(k)$ is the reference position at k , see the orange dots in Figure 5.4(a).

In the task of object transport, ASVs keep formation while navigating. The reference state that each ASV should track includes the desired position and heading, i.e., $w_i(k) = [P_i(k)^T, \psi_i(k)^T]^T$. The initial reference trajectory can be calculated according to the geometric relations shown in Figure 5.1, and the reference heading of the ASVs is equal to the required heading of the object. Thus, the reference state of ASV i at the time step k is a function of the reference state of the object $w_i^*(k)$, denoted as

$$w_i(k) = g_i(w^*(k)). \quad (5.4)$$

However, if we connect the waypoints directly, there might be abrupt changes in the trajectories of the ASVs, see Figure 5.4(a). Thus, we smooth the connection between two segments with the kinematic interpolation proposed in [106].

After discretizing the segments with the double integrator dynamics, a connection between a start state in the segment $Wp_{i-1} \rightarrow Wp_i$ and an end state in the segment $Wp_i \rightarrow Wp_{i+1}$ is made with a changing velocity. The acceleration during this period K is formulated as a linear function of time in order to describe object acceleration as smooth motion, i.e., $a(t) = b + mt$. The position and velocity can be expressed as

$$p(t) = p_0 + \int_0^t v(t)dt, \quad (5.5)$$

$$v(t) = v_0 + \int_0^t (b + mt)dt, \quad (5.6)$$

where $v(t)$ is the corresponding velocity.

Accordingly, given the start position and velocity $[P(k), v(k)]$ and the end position and velocity $[P(k+K), v(k+K)]$, we can obtain a smooth connection between two segments without any abrupt changes in speed or direction, see Figure 5.4(b).

The smoothed reference trajectory between origin and destination is represented by a sequence of positions. The trajectory of each ASV can be calculated by (5.4), accordingly. At each time step, each ASV controller and coordinator finds the reference position which is closest to its current position and use the subsequent positions over the predictive horizon as the reference trajectory.

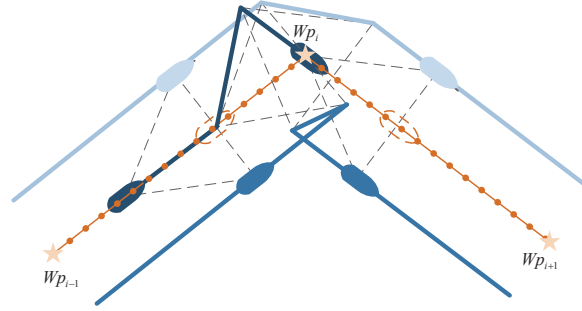

(a) Trajectory indicated by waypoints.

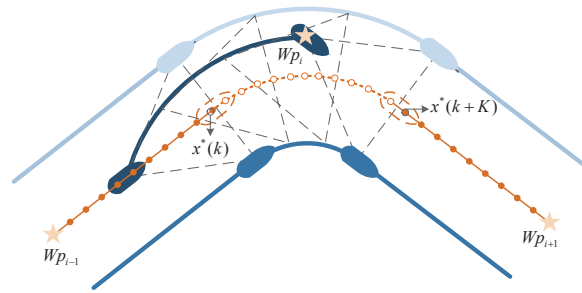

(b) Smooth trajectory with kinematic interpolation.

Figure 5.4: Reference trajectory generation.

Control Problem

The virtual control effort that is required to control the object to track the reference trajectory are determined by solving the primal optimization problem:

Problem \mathcal{D} :

$$\text{minimize } J^*(\tau^*(k)) = \sum_{l=1}^{H_p} \left(\alpha^* \|\eta^*(k+l|k) - w^*(k+l)\|_2^2 + \gamma^* \|\tau^*(k+l-1|k)\|_2^2 \right) \quad (5.7)$$

subject to $\forall i \in \mathcal{V}, \forall l \in H_p$:

$$x^*(k|k) = x^*(k), \quad (5.8)$$

$$v_{\min}^* \leq v^*(k+l|k) \leq v_{\max}^*, \quad (5.9)$$

$$\tau_{\min}^* \leq \tau^*(k+l|k) \leq \tau_{\max}^*, \quad (5.10)$$

$$d_{*i|*}(k+l|k) \geq d_{*i,\text{safe}}, \quad (5.11)$$

$$P^*(k+l|k) \in \Xi, \quad (5.12)$$

$$\text{dynamics described by (3.8) over the predictive horizon,} \quad (5.13)$$

where α and γ are the weights; H_p is the predict horizon; l is the l th time step in the prediction horizon; $\eta^*(k+l|k)$ is the prediction made at time step k about the position and heading of the object at time step $k+l$; $w^*(k+l)$ is the reference at time step $k+l$, including trajectory and heading; $d_{*i|*}(k+l|k)$ is the distance between ASV i and the object with the information sent by ASV i , $d_{*i|*}(k+l|k) = \left\| P^*(k+l|k) - P_{i|*}(k+l|k) \right\|_{\infty}$; $P^*(k+l|k)$ is the prediction made at time step k about the position of the object at time step $k+l$, and $P_{i|*}$ is the position of the ASV i that the object received; $d_{*,i,\text{safe}}$ is the safety distance of the object; Ξ a set of position in navigable waters, i.e., spaces which are collision-free considering static obstacles; $\tau^*(k)$ indicates control input over the prediction horizon, i.e., $\tau^*(k) = [\tau^*(k|k)^T, \tau^*(k+1|k)^T, \dots, \tau^*(k+H_p-1|k)^T]^T$.

Problem \mathcal{D} can be transferred into a mixed integer linear programming problem when the collision avoidance constraint (5.11) is rewritten as (4.10) with the binary variables.

5.2.3 Control allocation

The virtual control effort needed to move the object, $\tau^*(k)$, is provided by the 3 ASVs through the towlines. There is actuator redundancy when considering the whole system, i.e., the cooperative object transport system is an over-actuated system. Here, we use an optimization-based allocation method to compute a control input that ensures that the commanded virtual control $\tau^*(k)$ is produced jointly by the ASVs.

We formulate the objective function for control allocation as minimizing the forces along the towlines, considering the total forces that the ASVs can provide, while producing required forces. Thus, the control allocation problem involves solving the following nonlinear optimization problem:

Problem \mathcal{E} :

$$\text{minimize } \sum_{l=1}^{H_p} \|F(k+l|k) - \hat{F}\|_2^2 \quad (5.14)$$

subject to $\forall i \in \mathcal{V}, \forall l \in H_p :$

$$\tau^*(k+l|k) = \Gamma(k+l|k)F(k+l|k), \quad (5.15)$$

$$0 \leq F(k+l|k) \leq F_{\max}, \quad (5.16)$$

$$\theta_{\min} \leq \theta_i^{\text{fore/aft}}(k+l|k) \leq \theta_{\max}, \quad (5.17)$$

$$D_{H,\min} \leq D_{H,i}^{\text{fore/aft}}(k+l|k) \leq D_{H,\max}, \quad (5.18)$$

$$\text{towline model described by (5.2) and (5.3),} \quad (5.19)$$

where, $F(k+l|k)$ is the prediction made at time step k about the forces transferred by the towlines at time step $k+l$; \hat{F} is the forces that transferred by the towlines when $\tau^* = 0$ while the ASVs are keeping a preferred configuration. Γ transformation matrix between τ^* and F ; F_{\max} is the maximum forces on the towline.

Subsequently, the forces each ASV should provide are decomposed into two components in surge and sway direction (F_i^u, F_i^v) in its own body-fixed frame. Figure 5.5 illustrate

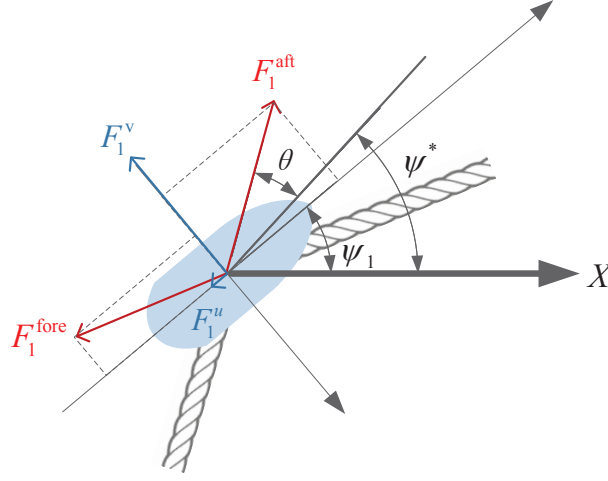

Figure 5.5: Force diagram of ASV 1.

the decomposition using ASV 1 as an example, i.e.,

$$\begin{bmatrix} F_1^u(k) \\ F_1^v(k) \end{bmatrix} = T_i(\psi_i(k), \psi^*(k)) \begin{bmatrix} F_i^{\text{fore}}(k) \\ F_i^{\text{aft}}(k) \end{bmatrix}, \quad (5.20)$$

where $T_i(\psi_i(k), \psi^*(k))$ is the transformation matrix,

$$T_i(\psi_i(k), \psi^*(k)) = \begin{bmatrix} -\cos(\theta_i^{\text{fore}}(k) + \Delta\psi_i(k)) & \cos(\theta_i^{\text{aft}}(k) - \Delta\psi_i(k)) \\ -\sin(\theta_i^{\text{fore}}(k) + \Delta\psi_i(k)) & -\sin(\theta_i^{\text{aft}}(k) - \Delta\psi_i(k)) \end{bmatrix}, \quad (5.21)$$

where $\Delta\psi(k) = \psi_i(k) - \psi^*(k)$. For smoother and more efficient object transport, the reference heading of the ASVs and the objects are set as the desired heading of the object, i.e., the path direction. Therefore, the differences between the heading of the object and the ASVs are small, i.e., $\Delta\psi_i(k) \approx 0, \forall k$, and small-angle approximation can be used to simplify (5.21).

For each ASV, it should not only follow its own reference trajectory to keep the required relative distance with the object, but also provide required forces to move the object. Accordingly, the control problem that the ASV controller i needs to solve is formulated as follows:

Problem \mathcal{F} :

$$\text{minimize } J_i(\tau_i(k)) = \sum_{l=1}^{H_p} (\alpha \|\eta_i(k+l|k) - w_i(k+l)\|_2^2 + \gamma \|\tau_i(k+l-1|k)\|_2^2) \quad (5.22)$$

subject to $\forall i, j \in \mathcal{V}, i \neq j, \forall l \in H_p$:

$$v_{i,\min} \leq v_i(k+l|k) \leq v_{i,\max}, \quad (5.23)$$

$$\tau_i(k+l|k) + F_i^{\text{tow}}(k+l|k) \geq \tau_{i,\min}, \quad (5.24)$$

$$\tau_i(k+l|k) + F_i^{\text{tow}}(k+l|k) \leq \tau_{i,\max}, \quad (5.25)$$

$$R^{-1}(\psi^*(k+l|k))\eta_i(k+l|k) \geq P_i^* - \varepsilon^{\text{con}}, \quad (5.26)$$

$$R^{-1}(\psi^*(k+l|k))\eta_i(k+l|k) \leq P_i^* + \varepsilon^{\text{con}}, \quad (5.27)$$

$$d_{ij|i}(k+l|k) \leq d_{ij,\text{safe}}, \quad (5.28)$$

$$P_i(k+l|k) \in \Xi, \quad (5.29)$$

$$\text{dynamics described by (3.8) over the predictive horizon,} \quad (5.30)$$

where $F_i^{\text{tow}}(k+l|k)$ indicates the prediction at k about the forces made that the ASV i provide at $k+l$, $F_i^{\text{tow}}(k) = [F_i^u(k), F_i^v(k), 0]$; P_i^* is the corresponding position of ASV i in the Body-fixed reference frame of the object according to desired configuration and the towline model (5.2). For example, for ASV 1, after calculating $D_{H,1}^{\text{aft}}(k)$, the distance between the tie and the center of mass of the ASV 1, according to the tension on the towline, the position of ASV 1 can be calculated as

$$P_1^*(k) = D_{H,1}^{\text{aft}}(k) \begin{bmatrix} -\cos(\theta_1^{\text{fore}}(k)) \\ \sin(\theta_1^{\text{fore}}(k)) \\ 0 \end{bmatrix} + \begin{bmatrix} L_1^{\text{ASV}} \\ D_{\text{tie}}/2 \\ 0 \end{bmatrix}, \quad (5.31)$$

where D_{tie} is the length between two ties that are connected to ASV 1.

In constraints (5.26) and (5.27), we set a tolerance for formation keeping for the following reasons. Firstly, the ASVs and the object are connected with ropes. The ASVs are possible to have small fluctuations around the desired positions. Secondly, in the optimization, we use a linearized model to predict the dynamics of the ASVs and the object. The actual states inevitably differ from the predictions. The tolerance can help to avoid the situation that the optimization problem at the first iteration is infeasible at each time step. Thirdly, the tolerance relaxes the need for formation keep, which can help to avoid frequent control changes and is beneficial for fast convergence to agreements.

5.2.4 Multi-layer negotiation framework

Combined overall control problem

The ideal situation is that the ASVs follow the reference state and provide the required forces that the coordinator informs them. However, the ASVs may fail to follow the reference paths when they are providing the required forces, due to actuator saturation or other physical limitations. As mentioned in Section 2, the positions of the ASVs determine the final position of the object. This means that when the ASVs cannot achieve the desired state, the object cannot achieve its desired state, either. Thus, the forces needed to move the object also change, and so are the forces each ASV needs to provide. Therefore, the ASV controllers and the coordinator needs to negotiate with each other to reach an agreement.

The agreements among the ASVs are achieved when the expected trajectory of the object calculated based on the ASVs and the predicted trajectory that the coordinator calculated become consensus. Therefore, the combined overall control problem for the object

transport system can be formulated as follows:

Problem \mathcal{H} :

$$\text{minimize } \sum_{i=1}^3 J_i(\tau_i(k)) + J^*(\tau^*(k)) \quad (5.32)$$

subject to $\forall i \in \mathcal{V}$:

$$\eta_i(k) = h_i(\eta^*(k)), \quad (5.33)$$

$$\eta^*(k) = h_i^{-1}(\eta_i(k)), \quad (5.34)$$

where (5.33) indicates that the predicted trajectory of ASV i equals the expected trajectory calculated according to the predicted trajectory of the object and their geometric relation; and vice versa, (5.34) indicates the the predicted trajectory of the object equals the expected trajectory of the object calculated according to the predicted trajectory of ASV i . $h_i(\cdot)$ indicates the geometric relation between the object and the ASVs considering the desired formation and the towline model described by (5.2) and (5.3).

Multi-layer iterative negotiation framework

ADMM has been widely used for consensus problems with separable objective functions [12]. ADMM scheme takes the form of a decomposition-coordination procedure, in which the solution is found through iterations of solving some sub-problems.

The objective function in Problem \mathcal{H} can be separated into two parts related to local trajectory following of the ASVs and the shared trajectory following of the object. We introduce two interconnecting variables to link the two parts: the expected trajectory of the ASV i that calculated according to the predicted trajectory of the object, $z_i^*(k) = h_i^{-1}(\eta_i(k))$; the expected trajectory of the object that calculated according to the predicted trajectory of ASV i , $z_i(k) = h_i(\eta^*(k))$. Agreements among the ASVs and the coordinator are achieved in an iterative way, see Algorithm 5.1.

For ASV controller i , each step is carried out independently in parallel. Each ASV controllers uses the information about the interconnecting variables from the most recent iteration. The computation of coordinator and ASVs controllers is in serial order.

5.3 Simulation experiments

In this section, simulation experiments of the scenarios in which the cooperative object transport system move a large vessel sailing inbound the Port of Rotterdam are carried out to show the potential of the proposed method. Both static and dynamic obstacles are considered in the simulation. We compare the results of two settings: one is constant configuration ignoring the dynamics of towlines; the other is time-varying configuration considering the nonlinear towline model.

Simulation experiments are carried out with Matlab 2016a. Linear optimization problems are solved by ILOG CPLEX Optimization Studio (Version 12.6.3), and nonlinear optimization problems are solved by IPOPT [178], with the solution that is found in former

Algorithm 5.1: Multi-layer iterative negotiation framework for CFOT

```

1 for  $s = 1 : S$  do
2    $jdg^s(k) := 0; N_{\text{jump}}^s(k) := 0;$ 
3   for  $i = 1 : N$  do
4     // ASV controller  $i$  determines its own predicted trajectory
4     // by solving following problem:
5      $\tau_i^s(k) :=$ 
5      $\arg \min_{\tau_i(k)} \left( J_i(\tau_i(k)) + \lambda_i^{s-1}(k)^T (\eta_i(k) - z_i^{s-1}(k)) + \rho_i/2 \|\eta_i(k) - z_i^{s-1}(k)\|_2^2 \right);$ 
6     if solution do not exist then
7        $\tau_i(k)^s := \tau_i(k)^{s-1}; N_{\text{jump}}^s(k) := N_{\text{jump}}^s(k) + 1$ 
8     end
9   end
10  // The coordinator calculates the expected trajectory of
10  // object
11   $z_i^*(k) := h_i^{-1}(\eta_i(k));$ 
12  // The coordinator solves the following problem and updates
12  // the predicted trajectory of the object
13   $\tau^{*s}(k) := \arg \min_{\tau^*(k)} \left( J^*(\tau^*(k)) + \sum_{i=1}^3 \left( -\lambda_i^{s-1}(k)^T \tau^*(k) + \rho_i/2 \|z_i^{*s}(k) - \eta_i(k)\|_2^2 \right) \right);$ 
14  // The coordinator calculates the expected position and
14  // heading  $z_i^s$  of each ASV and updates the forces each ASV
14  // should provide
15   $z_i(k) = h_i(\eta^*(k));$ 
16  for  $i = 1 : N$  do
17    // ASV controller  $i$  updates the local dual variable and the
17    // primal and dual residual and tolerance
18     $\lambda_i^s(k) := \lambda_i^{s-1}(k) + \rho_i (\eta_i^s(k) - z_i^s(k))$ 
19     $R_{\text{pri},i}^s(k) := \eta_i^s(k) - z_i^s(k);$ 
20     $R_{\text{dual},i}^s(k) := z_i^s(k) - z_i^{s-1}(k);$ 
21     $\varepsilon_{\text{pri},i}^s(k) := \sqrt{Nn_u} \varepsilon^{\text{abs}} + \varepsilon^{\text{rel}} \max \{ \|\eta_i^s(k)\|_2, \|z_i^s(k)\|_2 \};$ 
22     $\varepsilon_{\text{dual},i}^s(k) := \sqrt{Nn_u} \varepsilon^{\text{abs}} + \varepsilon^{\text{rel}} \|\lambda_i^s(k)\|_2;$ 
23    if  $\|R_{\text{pri},i}^s(k)\|_2 \leq \varepsilon_{\text{pri},i}^s$  and  $\|R_{\text{dual},i}^s(k)\|_2 \leq \varepsilon_{\text{dual},i}^s$  then  $jdg^s(k) := jdg^s(k) + 1;$ 
24    // ASV controller  $i$  updates the penalty parameter
25    case  $\|R_{\text{pri},i}^s(k)\|_2 > 10 \|R_{\text{dual},i}^s(k)\|_2$  do  $\rho_i^s := 2\rho_i^{s-1};$ 
26    case  $\|R_{\text{dual},i}^s(k)\|_2 > 10 \|R_{\text{pri},i}^s(k)\|_2$  do  $\rho_i^s := \rho_i^{s-1}/2;$ 
27  end
28  // Iteration stopping check
29  if  $jdg^s(k) = N$  and  $N_{\text{jump}}(k)^s = 0$  then Stop iteration;
30 end

```

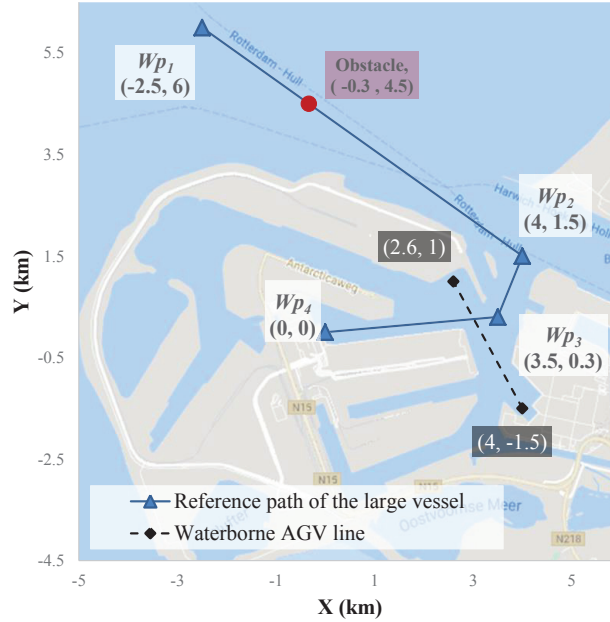

Figure 5.6: Reference paths in the simulation experiments.

iteration as a starting point. The experiments are run on a PC with a dual-core 3.2 GHz Intel(R) Core(TM) i5-3470U CPU and 8 GB of RAM.

5.3.1 Simulation setup

In the scenario that we consider, three ASVs transport a floating object (e.g., a non-autonomous large vessel) from the North Sea to a terminal in the Port of Rotterdam, see Figure 5.6. ASVs have to transport the object following the path indicated by waypoints. An obstacle, e.g., a disabled vessel at anchor, is located on the reference path. In the port, so-called waterborne AGVs are employed for inter-terminal transport [185]. The waterborne AGV (Automated Guided Vehicles) is set as sailing with a constant speed, 0.35 m/s, with higher priority than the proposed CFOT system. The reference path of the object has overlap with the Waterborne AGV path, as indicated in Figure 5.6. When encountering with the waterborne AGV, the proposed cooperative ASVs should give way. The coordinates of waypoints, obstacle, and waterborne AGV path are provided in Table 5.1.

Two cases are considered in the simulation:

- Constant configuration: in this case, the towlines are regarded as straight lines ignoring the mass. The relative distances between ASVs and the object are predetermined as 1.255/2 m for ASV 1, 2 and 1.255 m for ASV 3.
- Time-varying configuration: in this case, the relative distances between the ASV 1, 2 and the object are determined by the towline model, (5.2) and (5.3), and the relative positions between the ASV 3 and the object is 1.255 m.

Table 5.1: Waypoints and the position of the obstacle

Coordinates	Waypoint	X (km)	Y (km)
Reference path	Wp_1	-2.5	6
	Wp_2	4	1.5
	Wp_3	3.5	0.3
	Wp_4	0	0
Static obstacle		-0.3	4.5
Waterborne AGV	Origin	2.6	1
	Destination	4	-1.5

For the ASVs, the parameters are scaled-up according to the Froude scaling law with a scaling factor $\chi = 1 : 100$. According to the scaling law, the multiplication factors for length, force, moment and time are χ, χ^3, χ^4 , and $\sqrt{\chi}$, respectively. For the object, the scale factor is 1:200 when calculating related data. Related parameters in the simulation are given in Table 5.2. The simulation results provided underneath are shown with $\chi = 1 : 100$.

5.3.2 Results and discussion

In both cases, the trajectories of the ASVs and the object are similar. The trajectories of the ASVs and the object in case 1 are shown in Figure 5.7. The snapshots show how the ASVs avoid collision with the static obstacles and the Waterborne AGV while maintaining the required formation. Safety is further confirmed by Figure 5.8. For both the object and the ASVs, their distances with the static obstacle and the Waterborne AGV are larger than the corresponding safety distances.

Figure 5.9 shows the path following performance of the proposed cooperative system. In both cases, mostly, the ASVs can move the object along the reference path. Deviations occur when the object and the ASVs have to depart from the path to avoid obstacles.

Figure 5.10 provides the distance between the ASVs and the object in the two cases. In the figure, $L_i^{\text{ASV}}(k)$ is the required distance. When the towline model is considered, $L_i^{\text{ASV}}(k)^2 = D_{H,i}^{\text{fore}}(k)^2 + D_{\text{tie}}^2 - 2D_{H,i}^{\text{fore}}(k)D_{\text{tie}} \cos(\theta_i^{\text{fore}}(k) + \omega)$. In the case that the ASVs have a constant configuration (Figure 5.10(a)), the ASVs can keep the required distances with the object when the object is following a straight path. When turning actions are needed, such as for collision avoidance, deviations arise. However, the deviations are all within the predetermined tolerance. On the contrary, when the required configuration is changing according to the towline model, the differences between the actual distances and the required distances always exist, see Figure 5.10(b).

The heading differences between the ASVs and the object are shown in Figure 5.11. Mostly, the headings of the three ASVs stay aligned with the object. When the sharp turning is needed, e.g., at time step $k = 56$ s, ASV 3 have larger differences in heading with the object than the other two ASVs. This is mainly because the distance between ASV 3 and the object is larger than the others. The state changes of the object are enlarged when calculating the expected trajectory of ASV 3. Thus, ASV 3 needs larger changes in position and headings than ASV 1 and ASV 2 for configuration keeping.

Table 5.2: Parameter setting

	Parameter	Value
ASV	Width	0.29 m
	Length	1.255 m
	v_{\max}	$[0.7, 0.7, 20\pi/180]^T$
	v_{\min}	$[0, -0.7, -20\pi/180]^T$
	$\tau_{\max} = -\tau_{\min}$	$[10, 10, 2]^T$
	$d_{i,\text{safe}}^a$	1.255/2 m
Object	Width	0.29×2 m
	Length	1.255×2 m
	v_{\max}	$[0.7, 0.7, 10\pi/180]^T$
	v_{\min}	$[0, -0.7, -10\pi/180]^T$
	$\tau_{\max} = -\tau_{\min}$	$[15, 15, 2]^T$
	$d_{i,\text{safe}}^a$	1.255×2 m
ASV configuration	$D_{1,2}^{\text{ASV}}$	1.255/4 m
	L_3^{ASV}	1.255 m
	ω	25°
	θ_{\min}	20°
	θ_{\min}	30°
	$D_{H,\min}$	73 m
	$D_{H,\max}$	77 m
	$\varepsilon^{\text{con}^b}$	$[0.01, 0.01, 0]^T$
Towline (in full-scale)	L_R	76 m
	ϖ	12 kg/m
	EA^{CS}	9.2×10^8 N
	F_{\max}	1×10^7 N
Trajectory generation	K	20 s
	\hat{v}	0.5 m/s
MPC controller design	H_p	10
	α	diag[10,10,50]
	γ	5
ADMM	ε^{rel}	10^{-3}
	ε^{abs}	10^{-3}

^a When two ASVs encountered, the safety distance between ASV i and ASV j is $d_{i,j,\text{safe}} = (d_{i,\text{safe}} + d_{j,\text{safe}})/2$.

^b The determination of the tolerances takes three factors into consideration: the linearization error analysis in Section 3.2.3, the extension of a steel wire rope ($\leq 0.2\%$ the length [52]), and the computation time.

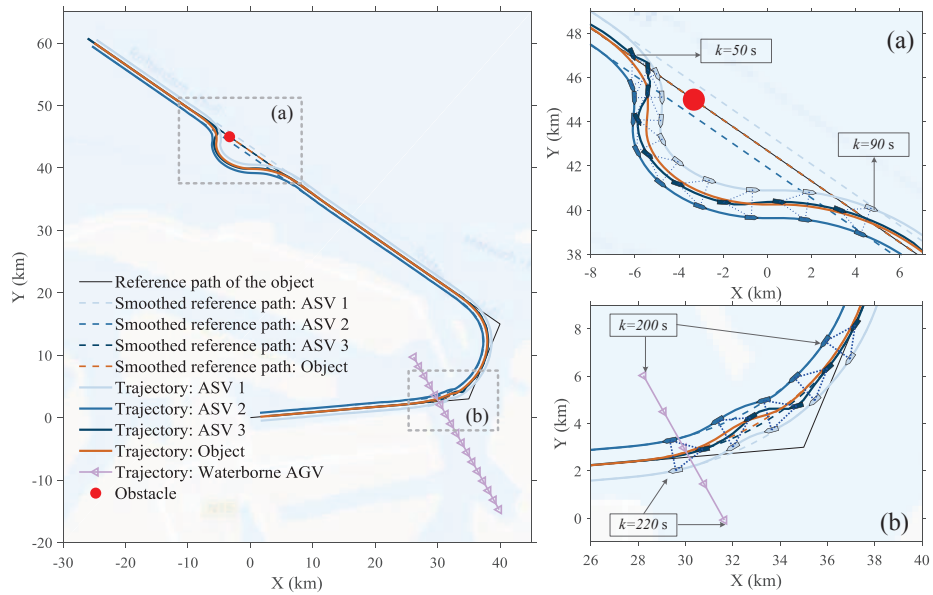

Figure 5.7: Trajectories of the ASVs and the object.

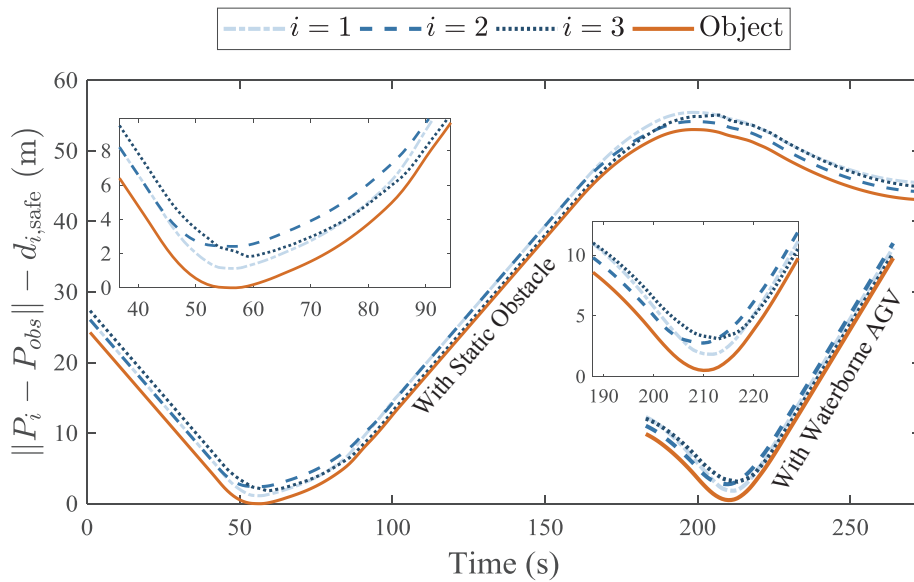

Figure 5.8: Distances with the static obstacle and the Waterborne AGV.

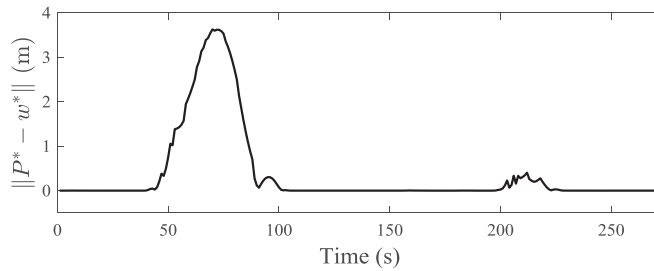

Figure 5.9: Tracking error of the object.

Figure 5.12 provides the forces along the towlines. To produce the required forces, the horizontal distance between the two ends of each towline, ranging from 73 m to 77 m, and angles between the towlines and the object, ranging from 20° to 30° , change accordingly, see Figure 5.13 and 5.14.

Figure 5.15 shows the number of iterations and computation time needed for the ASVs to achieve consensus at each time step. If the reference related positions between the ASVs and the object are constant (Figure 5.15(a)), mostly, agreements are achieved in two iterations, within 1 s, which is shorter than the sampling time, 1 s in simulation and 10 s in full scale. The short computation time shows the potential to apply the proposed cooperative framework in reality. At time step k , the first solution each ASV finds is an extension of the solution at time step $k - 1$. That is to say, an ASV prefers to follow the trajectories that it sends to other controllers. This property can also be used to deal with the communication delays, packet loss or connection failure: a controller i can assume that an ASV j follows the predicted trajectories it broadcast at time step k until the controller i receives an update on the state of ASV j . However, if the nonlinear towline model is integrated into the framework, the computation time increased dramatically, see Figure 5.15(b). The computation time does not have the same trend with the number of iterations any more. The most time-consuming part is to solve the nonlinear control allocation problem. Some methods may help to meet the real-time requirement under this circumstance, such as adopting a sampling time that is larger than the computation time or using a more suitable optimization algorithm or a computer with stronger calculation capability.

The time step $k = 124$ s is one of the steps in which most iterations are needed to obtain agreements when the ASVs have a time-varying configuration. Figure 5.16 shows how the primal and dual residuals evolve over iterations at this time step. The primal residual records the differences between the expected trajectory and the predicted trajectory, i.e., $\|\eta_i^s - z_i^s\|^2$. The dual residual records the differences between the expected trajectory at iteration s and the expected trajectory at iteration $s - 1$, i.e., $\|z_i^s - z_i^{s-1}\|^2$. Through iterative negotiations, both primal and dual residuals decrease and finally meet the stopping criteria.

The linear and angular velocities of the object and ASVs are given in Figure 5.17. Surge and sway velocities of the ASVs and the object are the same when they are on the straight path. However, when the object takes turning actions, to keep the formation, the ASVs at different positions have to accelerate or decelerate accordingly.

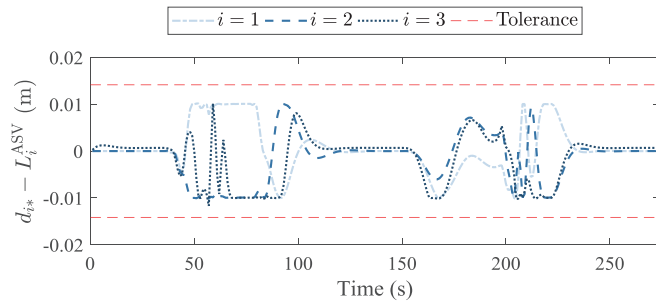

(a) Relative distance between ASVs and the object with a constant configuration.

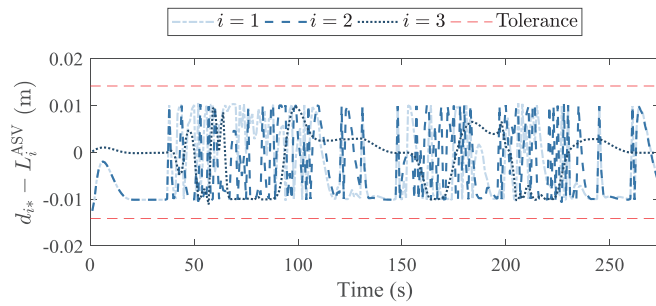

(b) Relative distance between ASVs and the object with a time-varying configuration.

Figure 5.10: Relative distance between ASVs and the object.

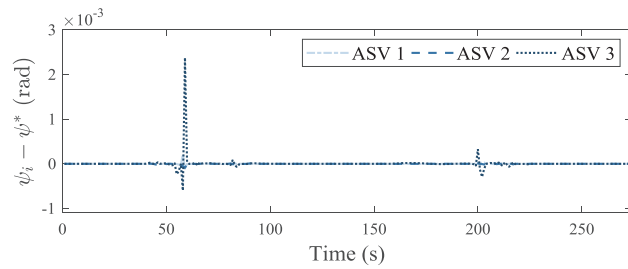

(a) Heading differences between each ASV and the object with a constant configuration.

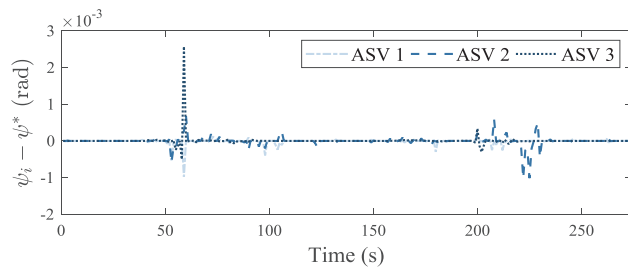

(b) Heading differences between each ASV and the object with a time-varying configuration.

Figure 5.11: Formation keeping performance.

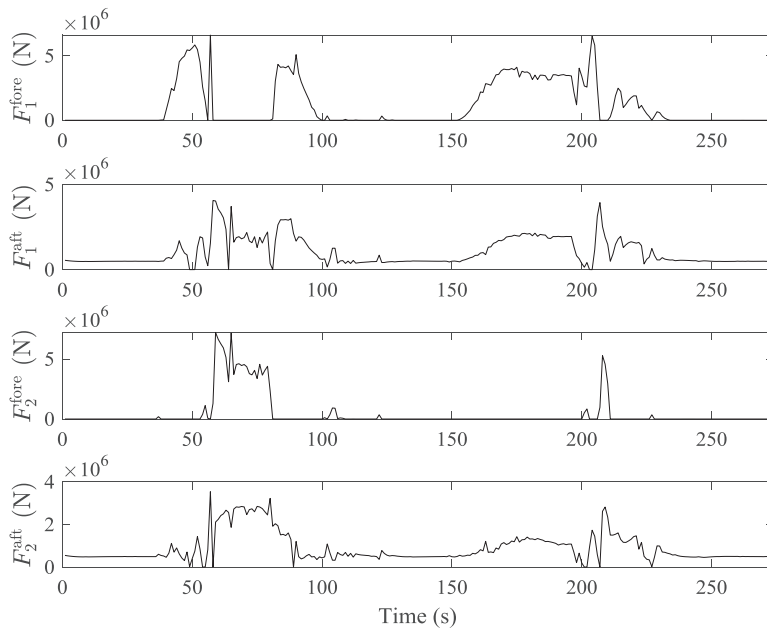

Figure 5.12: Forces along the towlines.

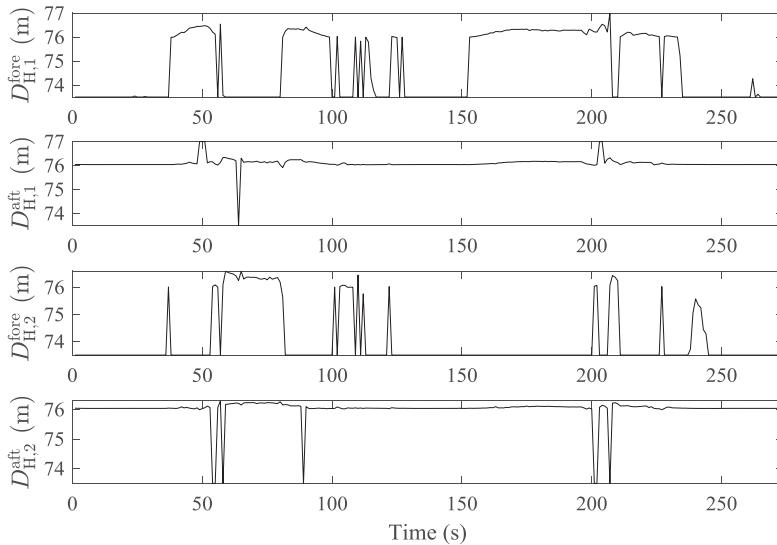

Figure 5.13: Horizontal distance between the two ends of each towline.

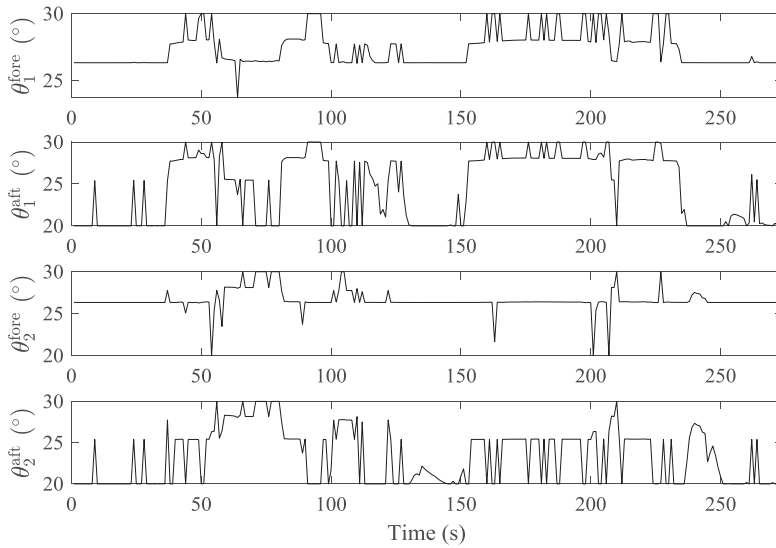

Figure 5.14: Angles between the towlines and the central line of the object.

Figure 5.18 and Figure 5.19 show the forces and moment each ASV provide. The solid red lines are the total forces and moment that an ASV provides, including the forces to move the objects and the forces and moment the ASV need to keep formation (the blue dot lines). The limitations on maximum and minimum forces and moments are all met. The results indicate that ASV 3 is the main source which provides the surge force for the object, while ASV 1 and 2 provide the moment when turning actions are needed.

5.4 Conclusions

This chapter focuses on the problem of Cooperative Floating Object Transport (CFOT), i.e., a group of ASVs coordinate their actions to transport floating objects. We propose a formation-based CFOT system with a multi-layer control structure. The cooperative transport problem is divided into three sub-problems, trajectory tracking of the object, control allocation, and formation tracking of the ASVs. A simulation involving moving a large vessel sailing inbound the Port of Rotterdam is carried out to show the effectiveness of the proposed cooperative framework. The results show that the proposed CFOT system can transport the floating object along a predefined trajectory and avoid potential static and dynamic obstacles.

This chapter and Chapter 4 answer the research questions on cooperation among vessels, i.e., Research Questions 3 - 5, by investigating two different types of interactions between ASVs. The framework proposed in Chapter 3 is used for the negotiation among controllers. The influences of V2V cooperation on safety and efficiency of transport are addressed through simulation experiments. In the subsequent chapter, studies on Vessel-to-Infrastructure cooperation and Infrastructure-to-Infrastructure cooperation are illustrated.

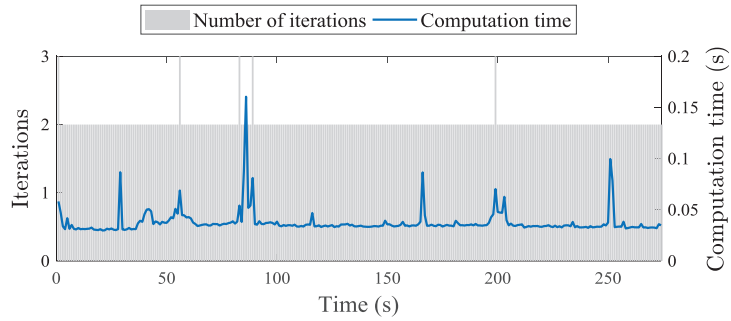

(a) Computation time and number of iterations with a constant configuration.

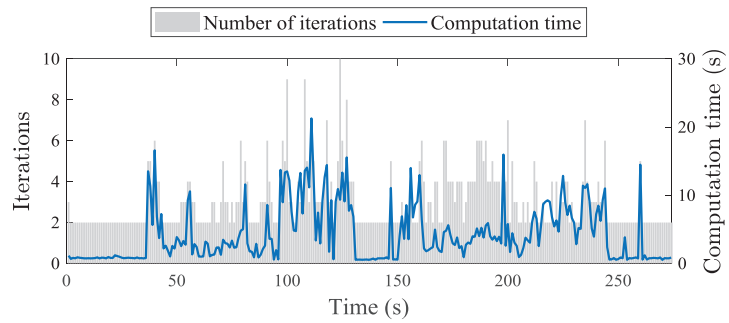

(b) Computation time and number of iterations with a time-varying configuration.

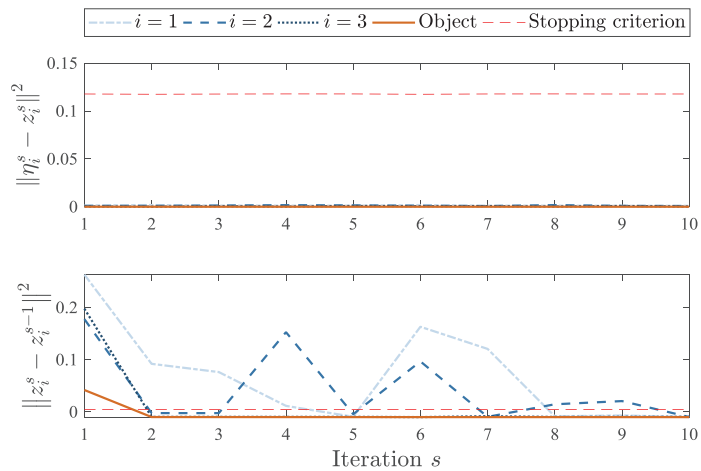
Figure 5.15: Computation time and number of iterations.*Figure 5.16: Evolution of the primal and dual residual at time step $k = 124$ s with a time-varying configuration.*

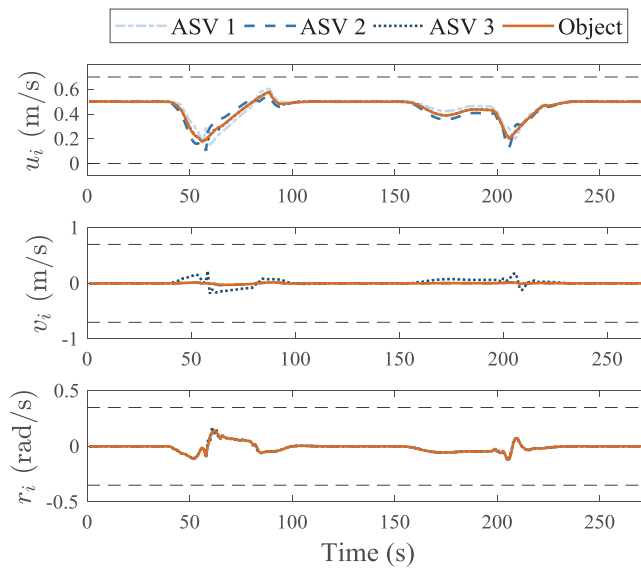

(a) Linear and angular velocities of the ASVs and the object with a constant configuration.

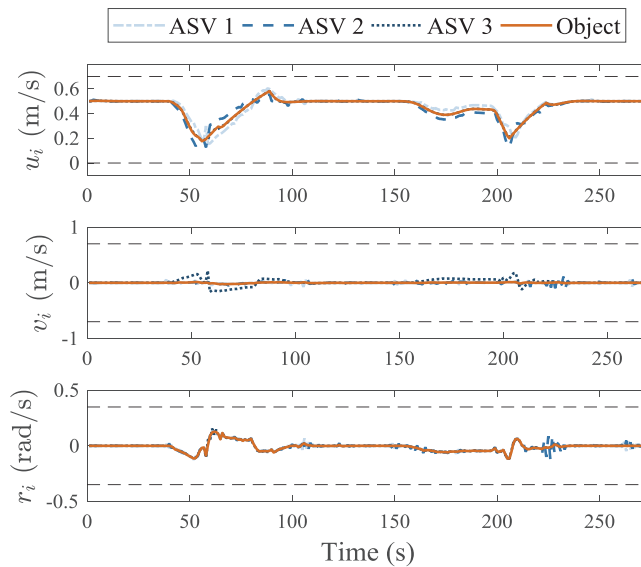

(b) Linear and angular velocities of the ASVs and the object with a time-varying configuration.

Figure 5.17: Linear and angular velocities of the ASVs and the object.

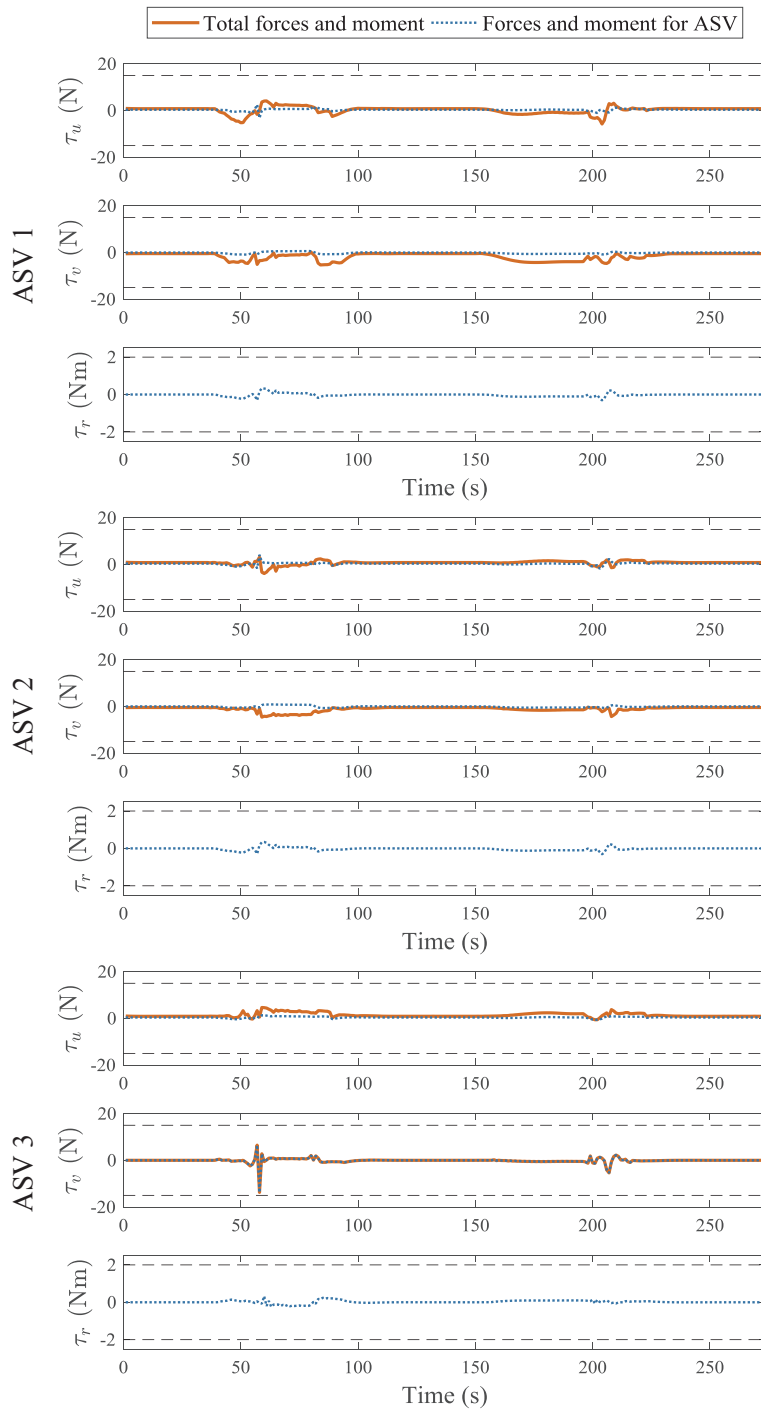

Figure 5.18: Forces and moment of each ASV with a constant configuration.

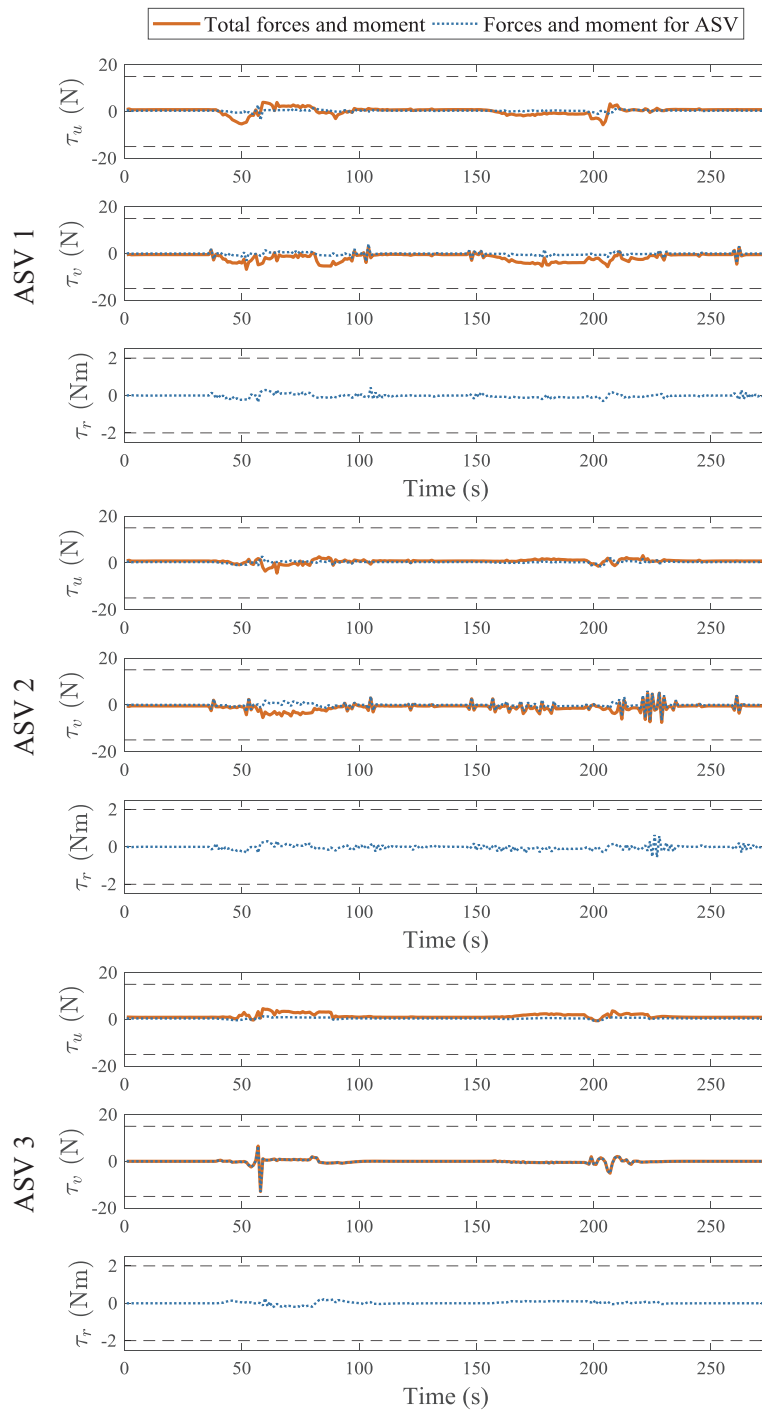

Figure 5.19: Forces and moment of each ASV with a time-varying configuration.

Chapter 6

Cooperative Multi-Vessel Systems in Waterway Networks

In the previous chapters, we proposed a single-layer and a multi-layer negotiation framework for two forms of Vessel-to-Vessel (V2V) cooperation within a Cooperative Multi-Vessel System (CMVS). In this chapter, we look into the control problem for Vessel-to-Infrastructure (V2I) cooperation and Infrastructure-to-Infrastructure (I2I) cooperation in waterway networks. The coordinated problem of several fleets of ASVs passing through an intersection is formulated as Waterway Intersection Scheduling (WIS). The WIS helps to find a conflict-free schedule for the vessels from different directions. Then, the WIS is extended to network level as Cooperative Waterway Intersection Scheduling (CWIS), in which the interdependence of interconnected intersections are considered.

This chapter is organized as follows. Section 6.1 introduces the main characteristics of transport in waterway networks. Then, the problems that need to be solved for the cooperation of controllers in urban waterway networks are given in Section 6.1.2. The control problems of V2V cooperation in segments, V2I cooperation at an intersection, and I2I interactions at the network level are formulated and solved in Section 6.2 and Section 6.3, respectively. These two sections result in the cooperative control of vessels in urban waterway networks in Section 6.4. In Section 6.5, simulation experiments of vessels in an individual intersection and a canal network of Amsterdam are presented to assess the proposed framework. The conclusions are summarized in Section 6.6.

Parts of this chapter have been published in [25, 30].

6.1 Transport in waterway networks

6.1.1 Characteristics of transport in waterway networks

In densely populated regions, like cities, road networks are often confronted with congestion and capacity problems. Many cities have considerable waterway resources, such as Amsterdam, Rotterdam, and Utrecht in The Netherlands, and cities in Jiangsu and Zhejiang, East China (Figure 6.1). Waterway transport could offer an environment-friendly alternative in



Figure 6.1: Urban waterway networks in Amsterdam (left) and Jiangsu (right) [61]

terms of both energy consumption and noise emissions [148]. However, nowadays, the urban waterway networks are mostly used for leisure, tourism, and passenger public transportation. Urban waterways have great potential in cargo transport to relieve the congestion in the overloaded road networks.

The transport in urban waterway networks has the following characteristics. Firstly, the waterways are narrow and with low depth. Limited vertical clearance caused by non-removable bridges is also one of the characteristics. Secondly, the origins and destinations of the vessels are more dispersed compared with sea-going and inland shipping. Therefore, small dimension vessels are required for accessibility and flexibility. However, applying small vessels will increase the traffic density, which increases the trajectory conflicts between vessels. Moreover, as shown in Figure 6.1, there are many intersections in waterway networks. Vessels in such networks have to interact with vessels from different directions frequently. Consequently, in waterway networks, cooperation among vessels becomes extremely important.

6.1.2 Cooperative framework

With the generic framework presented in Section 3.1, a framework for the cooperative control of vessels in waterway networks is shown in Figure 6.2. We introduce two types of controllers: a Vessel Controller (VC) for the control of an individual ASV, and an Intersection Controller (IC) for solving the conflicts of vessels at an intersection. A vessel controller uses sensors to get self-state information (e.g., position, speed, and heading), environmental information (e.g., wind speed and directions, current velocity) and information of obstacles. Based on the obtained information, the Navigation system creates pictures of the current situation and informs the Guidance system of collision risks. Combined with the predetermined global path, optimal trajectories with specified objectives and constraints can be determined. The commands are sent to actuators for autonomous navigation.

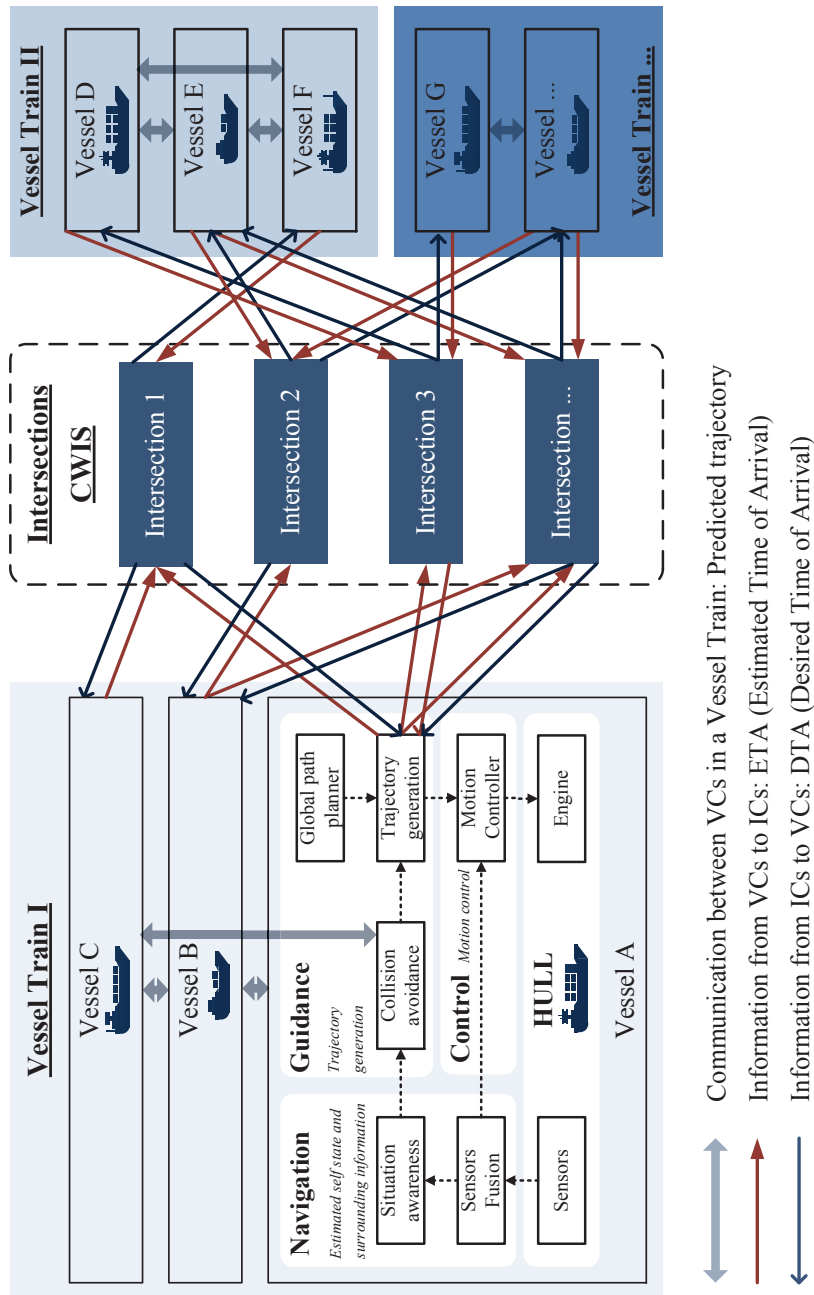

Figure 6.2: Cooperative Multi-Vessel System in urban waterway networks.

The cooperation of CMVS in the waterway network can be divided into two parts: segment sailing and intersection crossing. The ASVs in the same waterway segment form a vessel train. They share the information about their predicted trajectories, which help them make better decisions on distance keeping with others and to benefit from sailing in groups at a closer distance. When approaching an intersection, VCs report their Estimated Time of Arrival (ETA) to the IC. Then, the IC makes conflict-free schedules and informs those vessels the Desired Time of Arrival (DTA) at the intersection by solving the Waterway Intersection Scheduling (WIS) problem. After passing through the intersection, vessels sailing in the same waterways then form new vessel trains for safe navigation. The communication and cooperation of vessels in different vessel trains are realized through ICs. Similarly, the ICs communicate and cooperate with each other by exchanging information with VCs.

6.2 Cooperation of vessels in waterway segments

When ASVs are sailing in waterway segments, only V2V interactions are involved. Thus, the serial iterative method for Vessel Train Formation (VTF) proposed in Chapter 4 is applied for the control of vessels in waterway segments.

By adjusting the weights of the three parts in objective functions and constraints, Problem \mathcal{C} can also be used to describe the control problem of ASVs under following situations:

- Path Following: if the vessel is the only vessel in the waterway, the vessel has the only objective, path following;
- VTF: if more than one vessel is sailing in the waterway, both aggregation rule, and collision avoidance constraint should be considered;
- Intersection Crossing: if multiple (more than one) vessels are passing through an intersection, collision avoidance constraint is considered while the aggregation rule is ignored.

Cooperative control for ASVs in a vessel train \mathcal{VT}_i at each time step k consists of the steps in Algorithm 6.1.

Algorithm 6.1: Cooperation of vessels in waterway segments

- 1 VC $i \in \mathcal{VT}_i$ determines the control input $\tau_i^s(k)$ by solving the Augmented Lagrange form of Problem \mathcal{C} with $y_{ji}^s = \begin{bmatrix} \mathbf{I}^{2 \times 2} & \mathbf{0}^{2 \times 4} \end{bmatrix} ZX_i^s(k)$:

$$\tau_i^s(k) = \arg \min_{\tau_i(k)} \left(J_i(\tau_i(k)) + (\lambda_i^{s-1})^T (\tau_i(k) - z_i^{s-1}(k)) + \rho_i/2 \|\tau_i(k) - z_i^{s-1}(k)\|_2^2 \right);$$
 - 2 VC i updates the global variable $z_i^s(k)$, Lagrange multipliers $\lambda_i^s(k)$, primal residual $R_{\text{pri},i}^s$ and dual residual $R_{\text{dual},i}^s$;
 - 3 VC i updates interconnecting variable $ZX_i^s(k)$ according to Equations (3.6), and send it to other VCs;
 - 4 The next VC j repeats Step 1-3 until all the VCs finish computation;
 - 5 Each VC moves on to the next iteration $s + 1$ and repeat Step 1-4 until the stopping criteria is met.
-

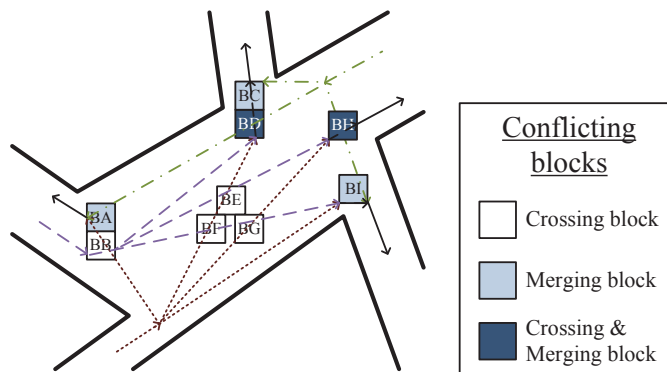

Figure 6.3: conflicting blocks at an intersection

6.3 Cooperative waterway intersection scheduling

As mentioned, the scheduling of intersection crossings is, in fact, a resource allocation problem. In this section, an intersection is modeled with conflicting blocks. The problem of scheduling the order of the ASVs passing through an intersection is formulated. When looking into the waterway networks, the cooperation between intersection controllers is achieved through iterative negotiations.

6.3.1 Intersection modeling

A vessel passing through the intersection along the path can be regarded as occupying space resources for a certain period. Figure 6.3 gives an example of paths in an intersection. Two relations of overlapping paths are crossing and merging. Therefore, there are three types of conflicting blocks: the blocks in which paths cross each other, the blocks in which paths merge into one, and the blocks in which both crossing and merging occur.

6.3.2 Scheduling for an isolated intersection

One method to avoid conflicts is to set a rule that during the time slot in which one vessel occupies a block, other vessels cannot enter the block. In this way, the WIS problem can be formulated as a job shop scheduling problem, in which several jobs need to be processed by a number of machines in a given order. The aim is to minimize the makespan, i.e., the time required to let all vessels pass through the intersection, under the following conditions:

- Sequential constraint: a vessel passes through the blocks in a predetermined sequence;
- No-wait constraint: a vessel does not stop when it leaves a block;
- Disjunctive constraint: other vessels cannot enter a block until the vessel occupying the block has left it.

Therefore, the WIS problem can be formulated as follows:

Problem \mathcal{H} :

$$\text{minimize } T_{\max} \quad (6.1)$$

$$\text{subject to } \forall i, j \in \mathcal{V}, i \neq j, \forall m, n \in \mathcal{B}, n = m + 1 :$$

$$T_{\max} \geq s_{im} + t_{im}, \quad (6.2)$$

$$s_{im} \geq Ea_i, \quad (6.3)$$

$$\frac{d_{im}}{v_{i,\max}} \leq t_{im} \leq \frac{d_{im}}{v_{i,\min}}, \quad (6.4)$$

$$s_{in} = s_{im} + t_{im} + T_{i,m \rightarrow n}, \quad (6.5)$$

$$\frac{d_{i,m \rightarrow n}}{v_{\max}} \leq T_{i,m \rightarrow n} \leq \frac{d_{i,m \rightarrow n}}{v_{\min}}, \quad (6.6)$$

$$s_{jm} \geq s_{im} + t_{im} \text{ OR } s_{im} \geq s_{jm} + t_{ja}, \quad (6.7)$$

$$s_{jm} \geq s_{im} + t_{i,\text{safe}} \text{ OR } s_{im} \geq s_{jm} + t_{j,\text{safe}}, \quad (6.8)$$

$$s_{jm} + t_{jm} \geq s_{im} + t_{im} + t_{j,\text{safe}} \text{ OR } s_{im} + t_{im} \geq s_{jm} + t_{jm} + t_{i,\text{safe}}, \quad (6.9)$$

where \mathcal{V} is the set of vessels that will pass through the intersection within a certain period; \mathcal{B} is the set of conflicting blocks; block n is the block next to block m . In (6.1), T_{\max} is the makespan, i.e., the total time needed for all vessels to pass through the intersection. Therefore, it is larger or equal to the passing time of each vessel at each block, i.e., the sum of the arrival time of vessel i at block m (s_{im}) and the time vessel i need to pass through block m (t_{im}) in (6.2). Equation (6.3) represents that, for each vessel i , there is the earliest arrival time Ea_i ; t_{im} is determined by (6.4), where d_{im} is the length of the path that vessel i need to pass through block m . Equation (6.5) is for the sequential and no-wait constraint. $T_{i,m \rightarrow n}$ is the time needed from block m to n , which also relates to the distance between block m and n ($d_{i,m \rightarrow n}$) and velocity limitations ($v_{i,\max}$ and $v_{i,\min}$), see (6.6). Equation (6.7) represents the disjunctive constraint. Equation (6.8) represents that the interval between the arrival time of the vessels at the same block should larger than a predefined safe time interval $t_{i,\text{safe}}$; the same constraint holds for the situation when vessels leave the blocks, i.e. (6.9). $t_{i,\text{safe}}$ is calculated by safe distance $d_{i,j,\text{safe}}$ and the velocity of the vessel, i.e., $t_{i,\text{safe}} = \frac{d_{i,j,\text{safe}}}{d_{ia}/t_{ia}}$.

Job shop scheduling problems are usually formulated as Mixed Integer Programming (MIP) problems[82]. A small-size MIP problem can be solved within a reasonable amount of time. Thus, our WIS problem is formulated as an MIP problem with the constraints (6.7), (6.8) and (6.9) replaced by the following constraints:

$$\begin{cases} s_{im} + t_{im} \leq s_{jm} + \kappa(1 - \chi_{ij,m}) \\ s_{jm} + t_{jm} \leq s_{im} + \kappa\chi_{ij,m} \end{cases} \quad (6.10)$$

$$\begin{cases} s_{im} + t_{i,\text{safe}} \leq s_{jm} + \kappa(1 - \chi_{ij,m}) \\ s_{jm} + t_{j,\text{safe}} \leq s_{im} + \kappa\chi_{ij,m} \end{cases} \quad (6.11)$$

$$\begin{cases} s_{im} + t_{im} + t_{j,\text{safe}} \leq s_{jm} + t_{jm} + \kappa(1 - \chi_{ij,m}) \\ s_{jm} + t_{jm} + t_{i,\text{safe}} \leq s_{im} + t_{im} + \kappa\chi_{ij,m}, \end{cases} \quad (6.12)$$

where κ is an arbitrarily large number, $\kappa \gg \sum_{i \in \mathcal{V}} \sum_{m \in \mathcal{B}} t_{im}$, and $\chi_{ij,m}$ is a binary variable,

$$\chi_{ij,m} = \begin{cases} 1, & \text{if vessel } i \text{ passes block } m \text{ before } j, \\ 0, & \text{otherwise.} \end{cases} \quad (6.13)$$

6.3.3 Cooperation among interconnected intersections

The coupling variables connecting the WIS problems of the intersection in a waterway network are the earliest arrival times of the vessels at the intersections. When a vessel has to pass through a sequence of intersections, the schedule that the IC make have impact on the earliest arrival time at the subsequent intersection. The segments connecting the intersections can provide buffers where vessels can accelerate or decelerate to arrive at the DTA at the intersections.

In the CWIS problem for the intersections in a waterway network, the negotiation framework proposed in Section 6.4 is used to obtain agreements among the ICs regarding coupling variables. The objective and constraints of each IC are formulated in Problem \mathcal{D} . The information being exchanged consists of the earliest arrival time, which can be calculate as follows:

$$\forall i \in \mathcal{V}, \forall p, q \in \mathcal{D}_i : \\ ETA_{ilq} = DTA_{ilp} + T_{ilp} + \frac{d_{i,p \rightarrow q}}{\widehat{v}_i}, \quad (6.14)$$

$$Ea_{ilq} = ETA_{ilq} - BT_{i,p \rightarrow q}, \quad (6.15)$$

where C_i is the sequence of intersections that vessel i has to pass through; p and q are two adjacent intersections in the sequence, and vessel i passes through intersection p earlier than intersection q ; ETA_{ilq} is the ETA of vessel i at intersection q , it is the arrival time if vessel i keeps its planed velocity; DTA_{ilp} is the DTA of vessel i that IC of intersection p calculated; T_{ilp} is the total travel time of vessel i passing through intersection p ; $d_{i,p \rightarrow q}$ is the distance from p to q ; \widehat{v}_i is the planned velocity of vessel i used to calculate initial reference path; $BT_{i,p \rightarrow q}$ is the buffer time buffer time for vessel i sailing from intersection p to intersection q with acceleration ($BT_{i,p \rightarrow q} > 0$) or deceleration ($BT_{i,p \rightarrow q} < 0$).

To sum up, at each time step k , CWIS consists of the steps in Algorithm 6.2.

6.4 CMVSs in urban waterway networks

As mentioned in Section 6.3, the cooperation of CMVS in the waterway network can be divided into two parts: segment sailing and intersection crossing. In previous sections, VTF is designed for safe navigation in waterway segments utilizing the communication and cooperation among ICs. CWIS is proposed for reducing the conflicts at intersections considering V2I and I2I communication and cooperation. Assembling the two parts, the cooperation of ICs and VCs in a waterway network can be realized with Algorithm 6.3.

Algorithm 6.2: Cooperative Waterway Intersection Scheduling

- 1 Each IC p determines the control input $u_p^s(k)$ by solving the Augmented Lagrange form of Problem \mathcal{C} with $Ea_{i|q}^s = ZX_p^{s-1}(k)$:

$$u_p^s(k) = \arg \min_{u_p(k)} \left(T_{p,\max}(u_p(k)) + (\lambda_p^{s-1})^T (u_p(k) - z_p^{s-1}(k)) + \rho_p/2 \|u_p(k) - z_p^{s-1}(k)\|_2^2 \right);$$
 where u_p is the control input of intersection p , $u_p = [s_{11} \cdots s_{im}]^T, [t_{11} \cdots t_{im}]^T]^T$, $\forall m \in \mathcal{B}_p, \forall i \in \mathcal{V}_p$, \mathcal{B}_p is the conflicting blocks in p , and \mathcal{V}_p is the set of vessels passing p ;
- 2 IC p update the global variable $z_p^s(k)$, Lagrange multipliers $\lambda_p^s(k)$, primal residual $R_{\text{pri},p}^s$ and dual residual $R_{\text{dual},p}^s$;
- 3 IC p update the interconnecting variable $ZX_p^s(k)$ according to (6.14) and (6.15), and send it to other ICs;
- 4 After all the ICs finish computation, move on to the next iteration $s + 1$ and repeat Step 1-3 until the stopping criteria are met.

Algorithm 6.3: CMVSs in waterway networks

- 1 ICs carry out CWIS to determine the DTA of the vessels at each intersection;
- 2 VCs generate the reference w_i .
The reference trajectory y_i are calculated according to the DTA with a double integrator dynamics: $y_i(k+1) = y_i(k) + \widehat{v}_i(k)$. The reference heading is determined according to y_i , and the changes between heading are within the range $[-\pi, \pi]$;
- 3 In each time step k , for each vessel train \mathcal{VT}_i :
 - (a) if there is no vessel, no actions need to be taken;
 - (b) if there is one vessel, the VC control the ASV for the aim of path following;
 - (c) if there is more than one vessel, the VCs set $\beta = 1$ if the \mathcal{VT}_i is in segments, and set $\beta = 0$ if the \mathcal{VT}_i is in intersections, then the VCs control the ASVs for VTF;
- 4 Each VC updates the state of the ASV with (3.6), and send the earliest arrival time to the ICs;
- 5 ICs check if the earliest arrival time of each vessel meets its DTA, if not, ICs carry out CWIS and inform the VCs the new DTA;
- 6 ICs and VCs repeat Step 2-5 until all the vessels arrive their destinations.

6.5 Simulation experiments

In this section, simulation experiments are carried out to illustrate the potential of the proposed approach. We firstly consider a situation in which some vessels cannot meet the DTA and rescheduling is triggered. Then, a simulation of CMVSs crossing an intersection is presented to illustrate how WIS helps to improve the efficiency of waterborne transport. The results are compared with a baseline scenario in which vessels avoid collision using a revised version of Generalized Velocity Obstacle (GVO) proposed in [74], and pass through the intersection based on the First In First Out (FIFO) rule. In the end, simulation results of CMVSs in a canal network of Amsterdam are provided.

6.5.1 Simulation setup

ASVs

Two model vessels are used in the experiments, Delfia 1* and CyberShip 2. The models are scaled-up according to Froude scaling law with a scaling factor 1 : 16: the multiplication factors for length, force, moment and time are 16, 16^3 , 16^4 , and $\sqrt{16}$, respectively. Detail settings are given in Table 6.1. Each ASV is controlled by an MPC controller. The predictive horizon is $H_p = 7$. The weights in the objective function of the VTF problem in (4.1) are

$$\alpha = \begin{bmatrix} 10 & 0 & 0 \\ 0 & 10 & 0 \\ 0 & 0 & 30 \end{bmatrix}, \quad \beta = \begin{cases} 0 & \text{for VTF} \\ 1 & \text{for intersection crossing,} \end{cases} \quad \gamma = 3.$$

In the VTF control, iterative updating sequence is adopt. The absolute tolerance and relative tolerance for negotiation are $\varepsilon^{\text{abs}} = 10^{-3}$ and $\varepsilon^{\text{rel}} = 10^{-3}$. In CWIS, the velocity range for scheduling is $[0.9\hat{v}_i, \hat{v}_i]$.

Research area

A part of the canal network in Amsterdam is selected as the research area, see Figure 6.4. There are four intersections in this network, including a general intersection (Intersection A), a large intersection (Intersection B), a dispersed intersection (Intersection C) and a small intersection (Intersection D). The conflicting blocks in each intersection are also provided in the figure.

For each waterway segment, a buffer zone is set to adjust the reference trajectories of the ASVs. The navigable waters are defined by the boundary of the waterways, which are described by straight lines. The safety distance between the boundary and an ASV is the width of the ASV. Some segments in the network are one-way, which are set as wide enough for the ASVs to overtake others.

6.5.2 Intersection crossing

In this part, simulation experiments of an intersection (Intersection B in Figure 6.4) are carried out to illustrate the WIS problem. Nine conflicting blocks are set for the intersection. Firstly, we consider a delay scenario in which some ASVs cannot arrive on time, and the

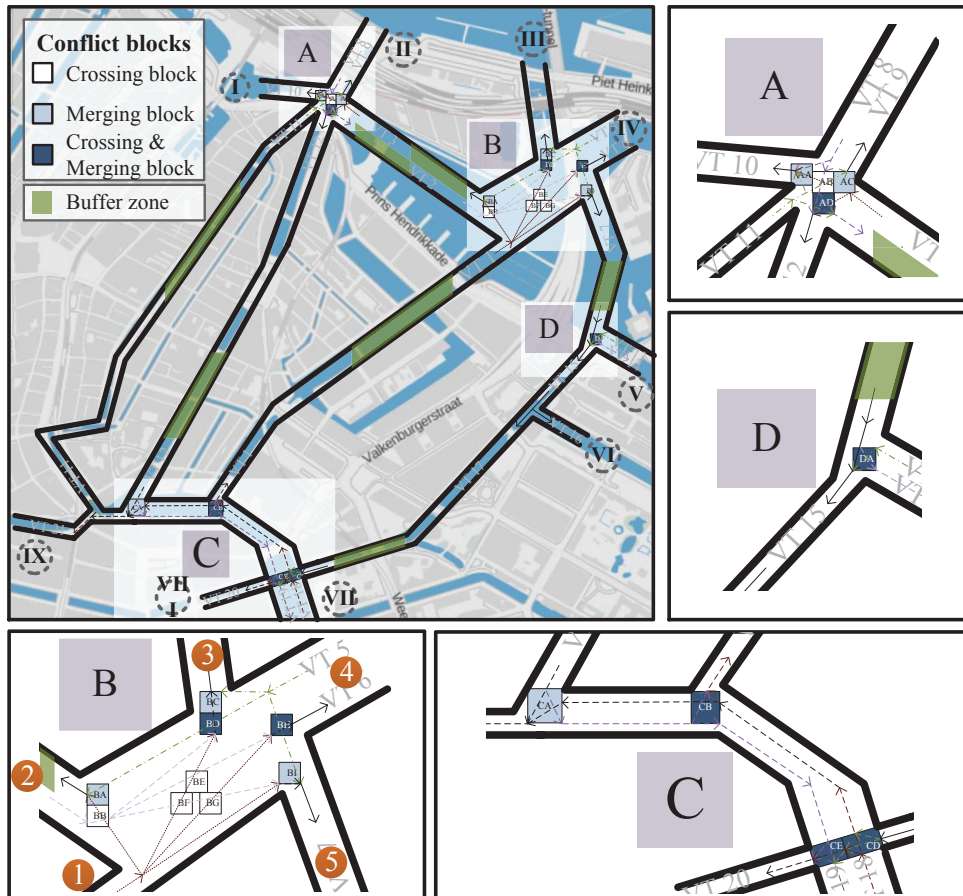

Figure 6.4: Waterway network in simulation [147].

Table 6.1: Parameter setting

		Delfia 1*		CyberShip 2		
		Scaled model	Full scale (1 : 16)	Scaled model	Full scale (1 : 16)	
ASV	v_{\max}	$\begin{bmatrix} \text{m/s} \\ \text{m/s} \\ \text{rad/s} \end{bmatrix}$	$\begin{bmatrix} 0.75 \\ 0.75 \\ 20\pi/180 \end{bmatrix}$	$\begin{bmatrix} 3 \\ 3 \\ 20\pi/180 \end{bmatrix}$	$\begin{bmatrix} 1 \\ 1 \\ 15\pi/180 \end{bmatrix}$	$\begin{bmatrix} 4 \\ 4 \\ 15\pi/180 \end{bmatrix}$
	v_{\min}	$\begin{bmatrix} \text{m/s} \\ \text{m/s} \\ \text{rad/s} \end{bmatrix}$	$\begin{bmatrix} 0 \\ -0.75 \\ -20\pi/180 \end{bmatrix}$	$\begin{bmatrix} 0 \\ -3 \\ -20\pi/180 \end{bmatrix}$	$\begin{bmatrix} 0 \\ -1 \\ -15\pi/180 \end{bmatrix}$	$\begin{bmatrix} 0 \\ -4 \\ -15\pi/180 \end{bmatrix}$
	\widehat{v}_i [m/s]		0.6	2.4	0.8	3.2
	τ_{\max}	$\begin{bmatrix} \text{N} \\ \text{N} \end{bmatrix}$	$\begin{bmatrix} 6 \\ 6 \end{bmatrix}$	$\begin{bmatrix} 24576 \\ 24576 \end{bmatrix}$	$\begin{bmatrix} 6 \\ 6 \end{bmatrix}$	$\begin{bmatrix} 24576 \\ 24576 \end{bmatrix}$
	$-\tau_{\min}$	$\begin{bmatrix} \text{N} \\ \text{Nm} \end{bmatrix}$	$\begin{bmatrix} 6 \\ 3 \end{bmatrix}$	$\begin{bmatrix} 24576 \\ 196608 \end{bmatrix}$	$\begin{bmatrix} 6 \\ 3 \end{bmatrix}$	$\begin{bmatrix} 24576 \\ 196608 \end{bmatrix}$

^a When two ASVs encountered, the safety distance between ASV i and ASV j is $d_{i,j,\text{safe}} = (d_{i,\text{safe}} + d_{j,\text{safe}})/2$.

Table 6.2: Origins and destinations for the ASVs.

ASV No.	Destination			
	2	3	4	5
Origin 1	[18;26;8]	[14;6;1]	[25;7;9]	[4;19;22]
Origin 2	-	[27;2;11]	[28;20;29]	[13;10;17]
Origin 4	[3;30;21]	[23;24;5]	-	[15;12;16]

rescheduling is triggered. Then, we carry out a comparison between the scenario in which CMVSs cross intersection B and a baseline simulation. In the baseline simulation, the ASVs avoid collisions using a revised version of the GVO method proposed in [74] and the FIFO rule for intersection crossing. GVO algorithms have been employed to various vehicles for collision prevention, such as wheeled robots, unmanned aerial vehicles, and ASVs. The details about the revised GVO method refer to [30].

Delay scenario

We simulate the situation in which 30 ASVs are passing through Intersection B. The origins and destinations of the ASVs are given in Table 6.2. The ASVs with odd numbers have the same setting as Delfia 1*, while the ASVs with even numbers have the same setting as CyberShip 2. The ASVs from the same origin are sorted from numbers low to high and set off with a time interval of 16s. The first ASVs from Origin 1, 2 and 3 start at $k = 0$ s, and the first ASV from Origin 4 start at $k = 120$ s. Then, ASV 7, 11, 14, and 28 arrive at the intersection 60 s later than their initial ETA.

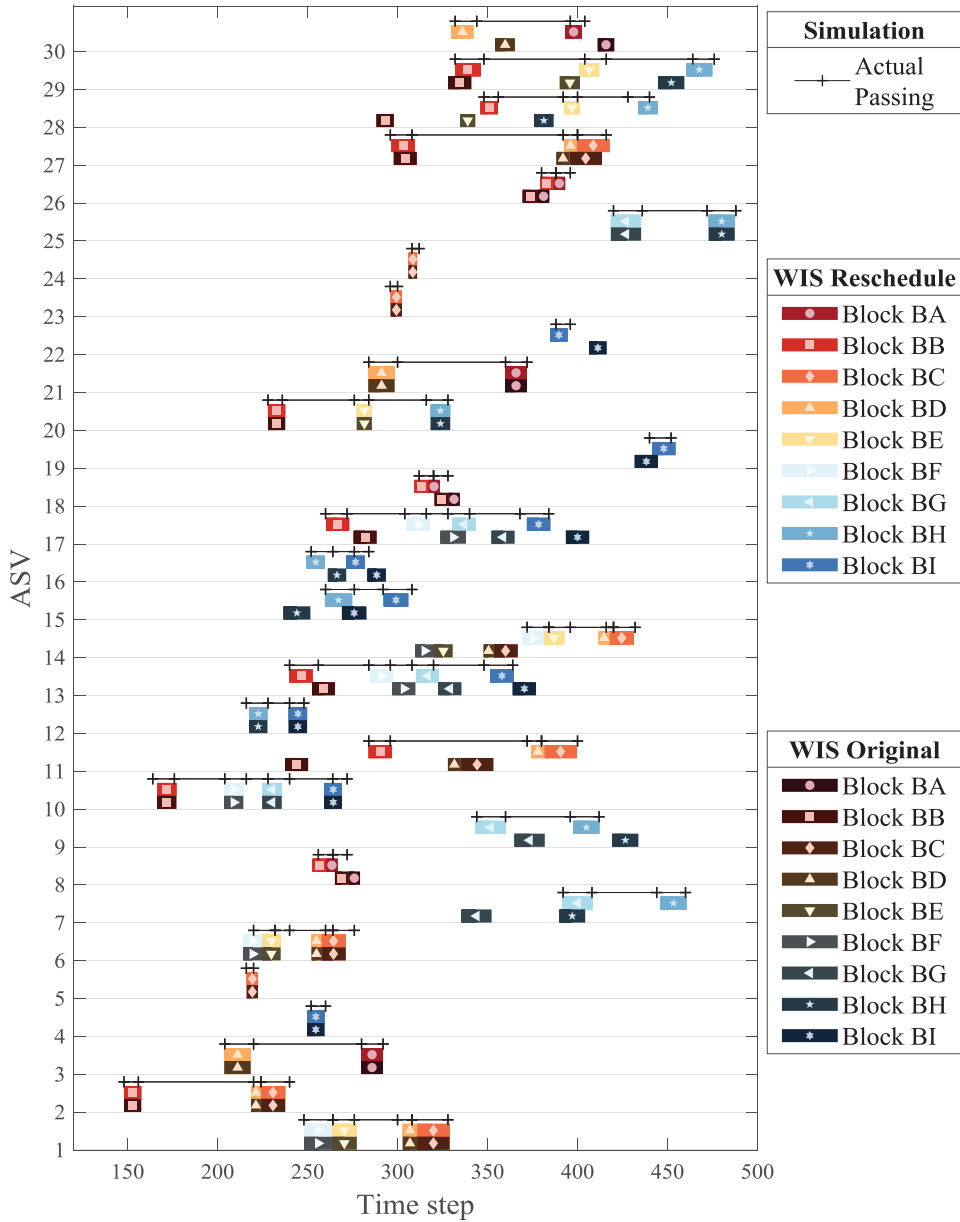

Figure 6.5: WIS results and actual passing time in the simulation.

The original and rescheduling WIS results are shown in Figure 6.5. The changes in the ETA of ASV 7, 11, 14, and 28 change not only the DTA of themselves but also other ASVs. The rescheduling that the IC carries out contributes to improving the utilization rate of the intersection. Although some ASVs arrive later, the time that is needed for all the ASVs to pass through is the same: the last ASV leaves at 488 s. The actual passing time of each ASV is given, as well. Mostly, the ASVs can arrive at the desired positions at the desired time. However, there are still small differences between the actual passing time and the scheduled time. The main reason is that WIS is continuous, while the VTF and simulation are discrete.

Comparison with the GVO method

Figure 6.6 – Figure 6.9 show the comparison of the simulation results of CMVS and GVO. In Figure 6.6, ASVs in CMVSs overtake others at the segments to change their orders in the vessel trains. Then, the ASVs pass through the intersection smoothly. On the contrary, ASVs using the GVO method take collision avoidance actions both in the segments and in the intersection. The collision avoidance actions also lead to larger deviations from the predetermined path, especially when the ASVs are crossing the intersection, see Figure 6.7. In the figure, path following error refers to the distance between the position of an ASV and the straight line joining two adjacent waypoints. Figure 6.7 also provides a comparison of tracking performance of Delfia 1* and CyberShip 2. With either CMVS or GVO, Delfia 1* have smaller path following errors than CyberShip 2.

Figure 6.8 and 6.9 show the linear and angular velocities of the ASVs. For better trajectory tracking, ASVs in CMVSs adjust their velocities more frequently. Moreover, as GVO aims at keeping current velocity, the changes in velocities are smaller. However, adding yaw rate results in a small choice set, which sometimes makes VCs cannot find a solution using GVO. Thus, the constraint on the yaw rate is not considered in the simulation. Thus, at some time step, the yaw rate exceed the limit when using the GVO method. Moreover, as GVO uses target velocity as the control input, the constraints on force and moment are not considered, either.

Table 6.3 provides the intersection passing time and total travel time of each vessel. In general, the efficiency is improved for both individual vessel and the waterway network when applying CMVSs. For most of the vessels, sailing in CMVSs not only saves time to pass through the intersection but also shorten the total travel time. Some ASVs make sacrifices, such as ASV 7, ASV 9, and ASV 22.

6.5.3 CMVS in a waterway network

In the experiment, we simulate the situation that 50 ASVs sail in the waterway network shown in Figure 6.4. The origin and destination of each ASV are provided in Table 6.4.

The four ICs achieve an agreement after 11 iterations. Figure 6.10 shows the differences between the earliest arrival time and DTA of each vessel through iterations. Considering the buffer time that the segments can provide, the DTA of each ASV at each intersection is later than its earliest arrival time when the iteration stops, i.e., $DTA - ETA - BT \geq 0$. Figure 6.11 shows the CWIS results of the first iteration, while Figure 6.12 shows the CWIS results of the last iteration when all the ICs agrees on the schedules.

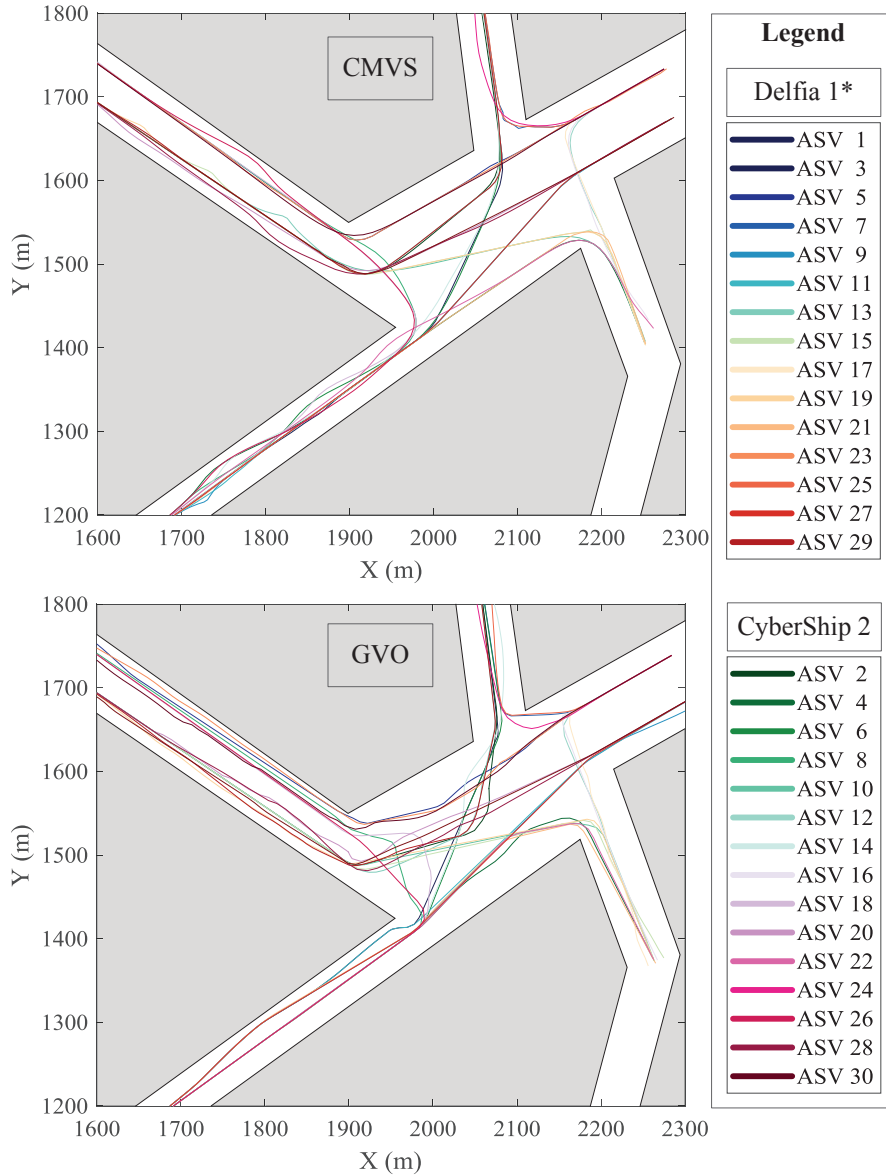

Figure 6.6: Comparison of the trajectories of ASVs using CMVS and GVO.

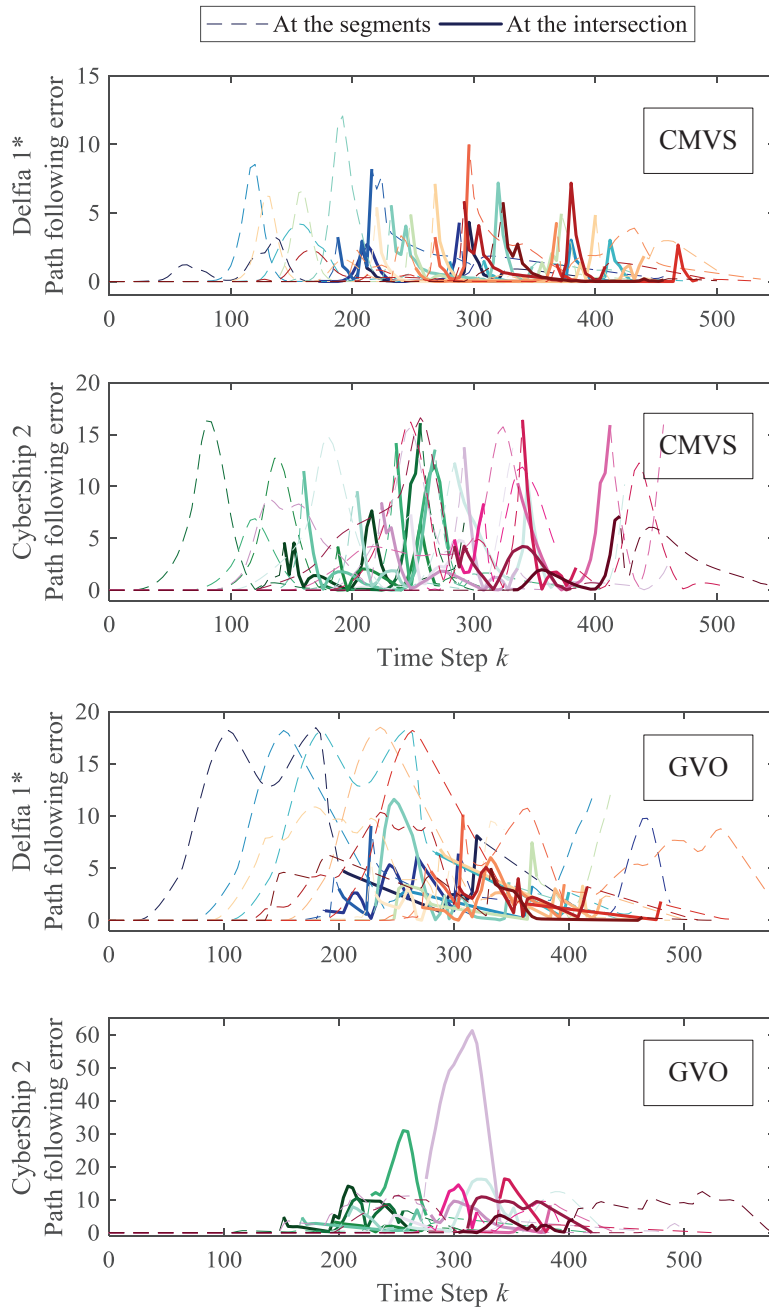

Figure 6.7: Comparison of path following errors of ASVs using CMVS and GVO. For the legend, see Figure 6.6.

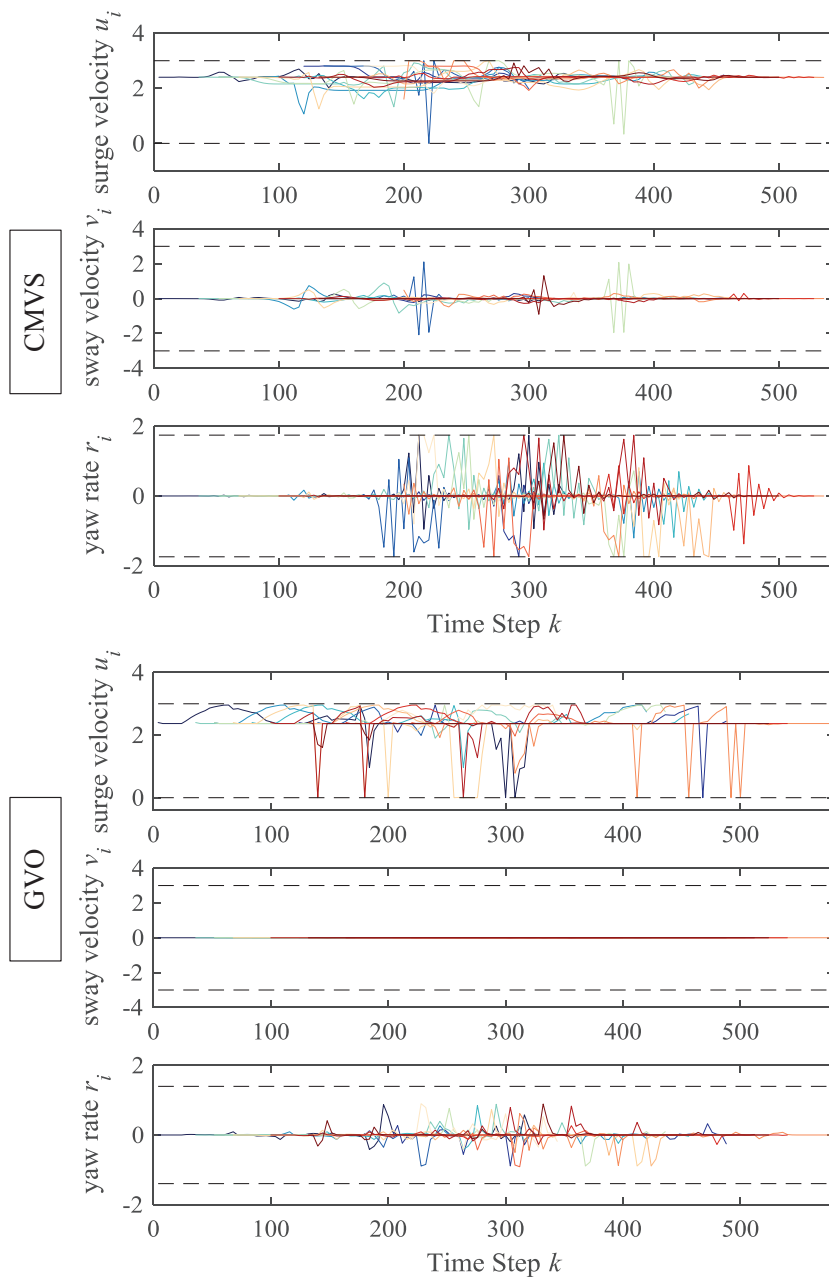

Figure 6.8: Linear and angular velocities of the ASVs that have the same dynamics with Delfia 1* using the proposed method and the GVO method. For the legend, see Figure 6.6.

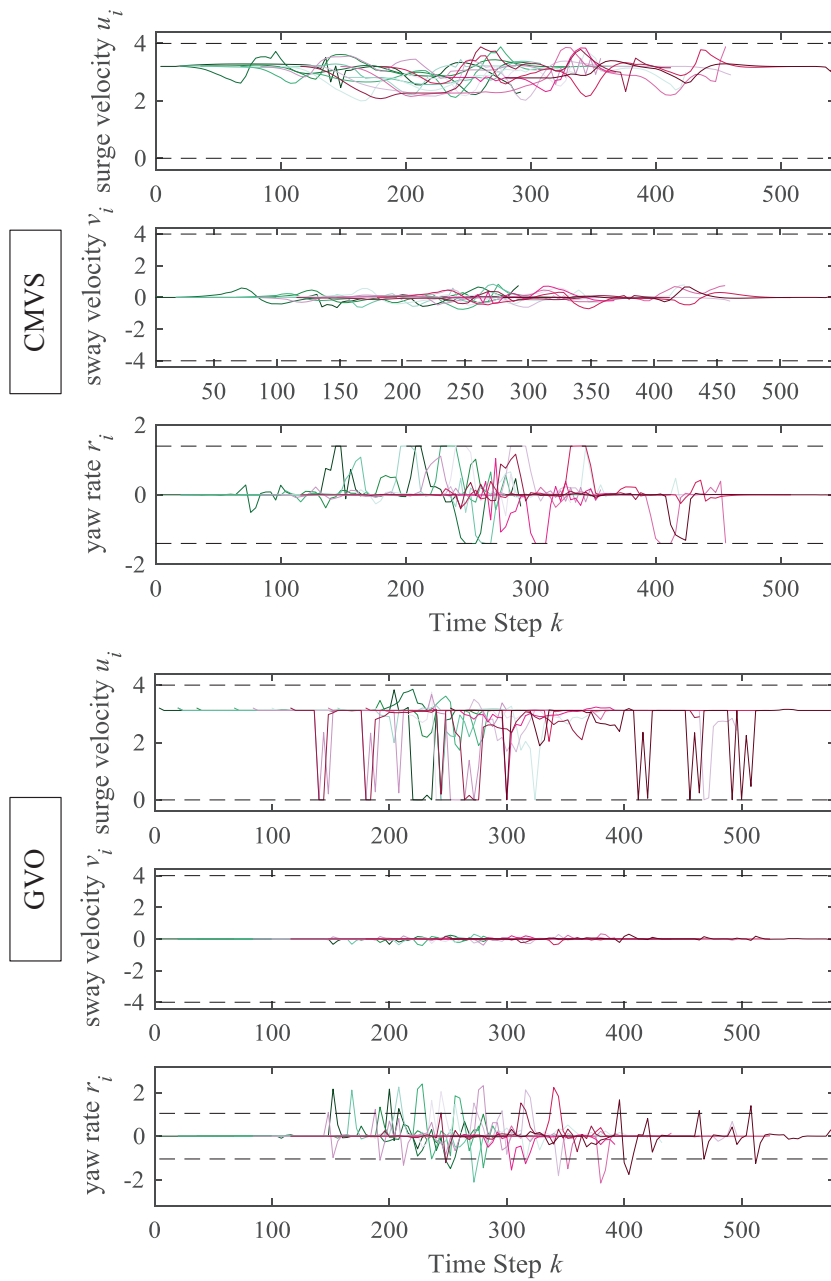

Figure 6.9: Linear and angular velocities of the ASVs that have the same dynamics with CyberShip 2 using the proposed method and the GVO method. For the legend, see Figure 6.6.

Table 6.3: Comparison of the travel time of the two methods.

No.	CMVS		GVO		Difference	
	Intersec- tion [s]	Total [s]	Intersec- tion [s]	Total [s]	Intersec- tion [s]	Total [s]
ASV 1	116	408	128	424	-12	-16
ASV 2	88	292	120	340	-32	-48
ASV 3	116	340	124	368	-8	-28
ASV 4	80	284	84	296	-4	-12
ASV 5	28	168	36	188	-8	-20
ASV 6	84	300	92	324	-8	-24
ASV 7	116	392	124	372	-8	20
ASV 8	44	336	56	356	-12	-20
ASV 9	120	388	124	376	-4	12
ASV 10	108	292	112	312	-4	-20
ASV 11	116	400	124	416	-8	-16
ASV 12	40	140	48	152	-8	-12
ASV 13	124	380	132	388	-8	-8
ASV 14	80	328	104	336	-24	-8
ASV 15	60	176	56	176	4	0
ASV 16	44	140	52	164	-8	-24
ASV 17	132	396	136	424	-4	-28
ASV 18	40	344	72	384	-32	-40
ASV 19	100	368	104	376	-4	-8
ASV 20	100	276	108	344	-8	-68
ASV 21	116	340	132	384	-16	-44
ASV 22	76	312	84	296	-8	16
ASV 23	28	168	36	184	-8	-16
ASV 24	24	140	40	160	-16	-20
ASV 25	116	368	124	380	-8	-12
ASV 26	40	328	52	348	-12	-20
ASV 27	116	392	120	416	-4	-24
ASV 28	96	296	116	352	-20	-56
ASV 29	132	368	140	396	-8	-28
ASV 30	88	268	108	328	-20	-60
Average	85.6	304.27	96.27	325.33	-10.67	-21.07
Makespan	340	544	348	588	-8	-44

^a Difference=CMVS-GVO.

Table 6.4: Origin and destination of each ASV in a waterway network.

ASV No.	Origin				
	II	IV	V	VII	
I	32	[42;28]	-	[44;15;1]	
II	-	[17;41]	-	[36;23;2]	
III	[40;22]	47	-	[4;18]	
IV	[34;35]	-	-	[24;39]	
Destination	V	6	14	-	13
	VI	3	[46;8]	49	-
	VII	[16;11;30]	[5;48]	27	-
	VIII	[45;33]	[29;21]	[50;26]	9
	IX	[7;38]	[25;37;31]	[43;19]	[20;10;12]

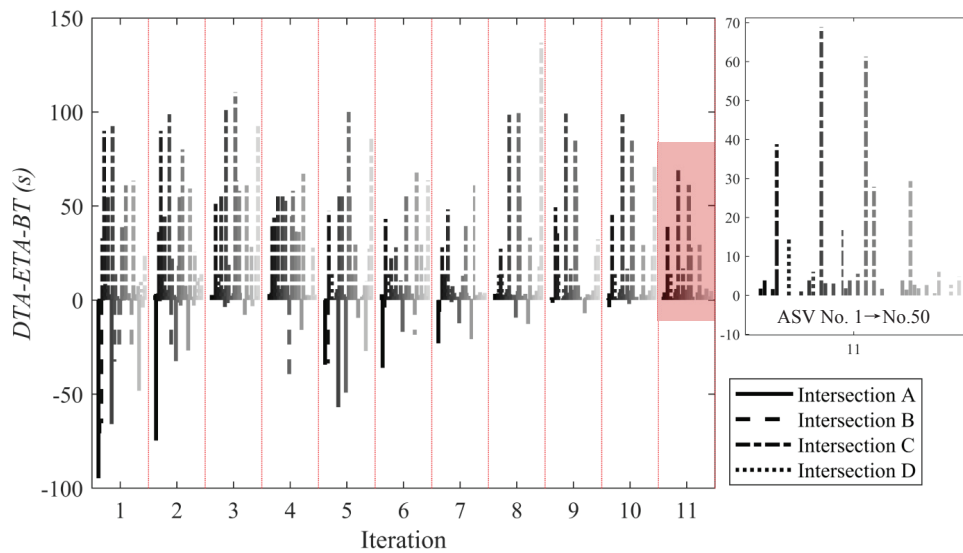

Figure 6.10: Difference between DTA and ETA in each iteration.

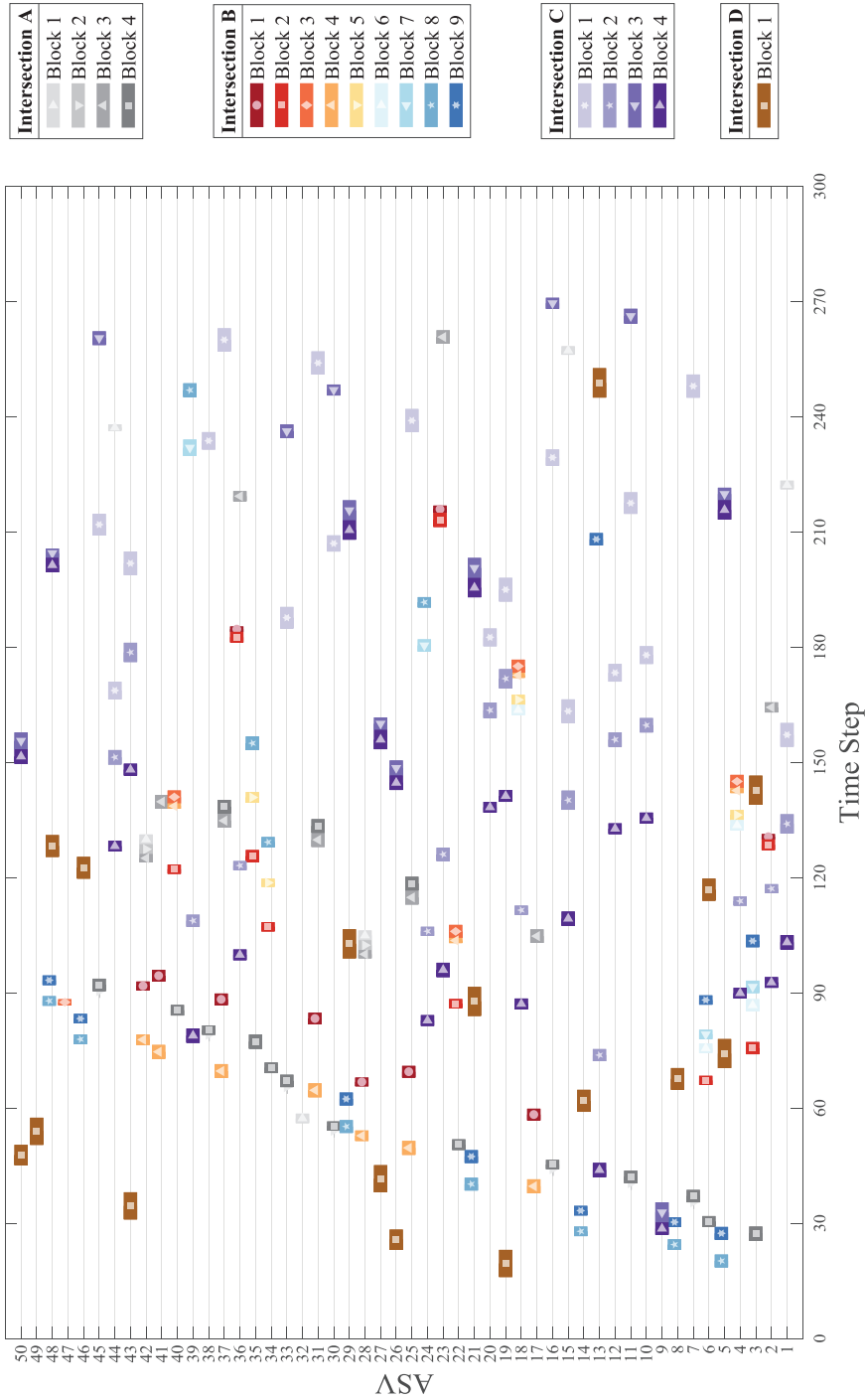

Figure 6.11: CWIS results of the first iteration.

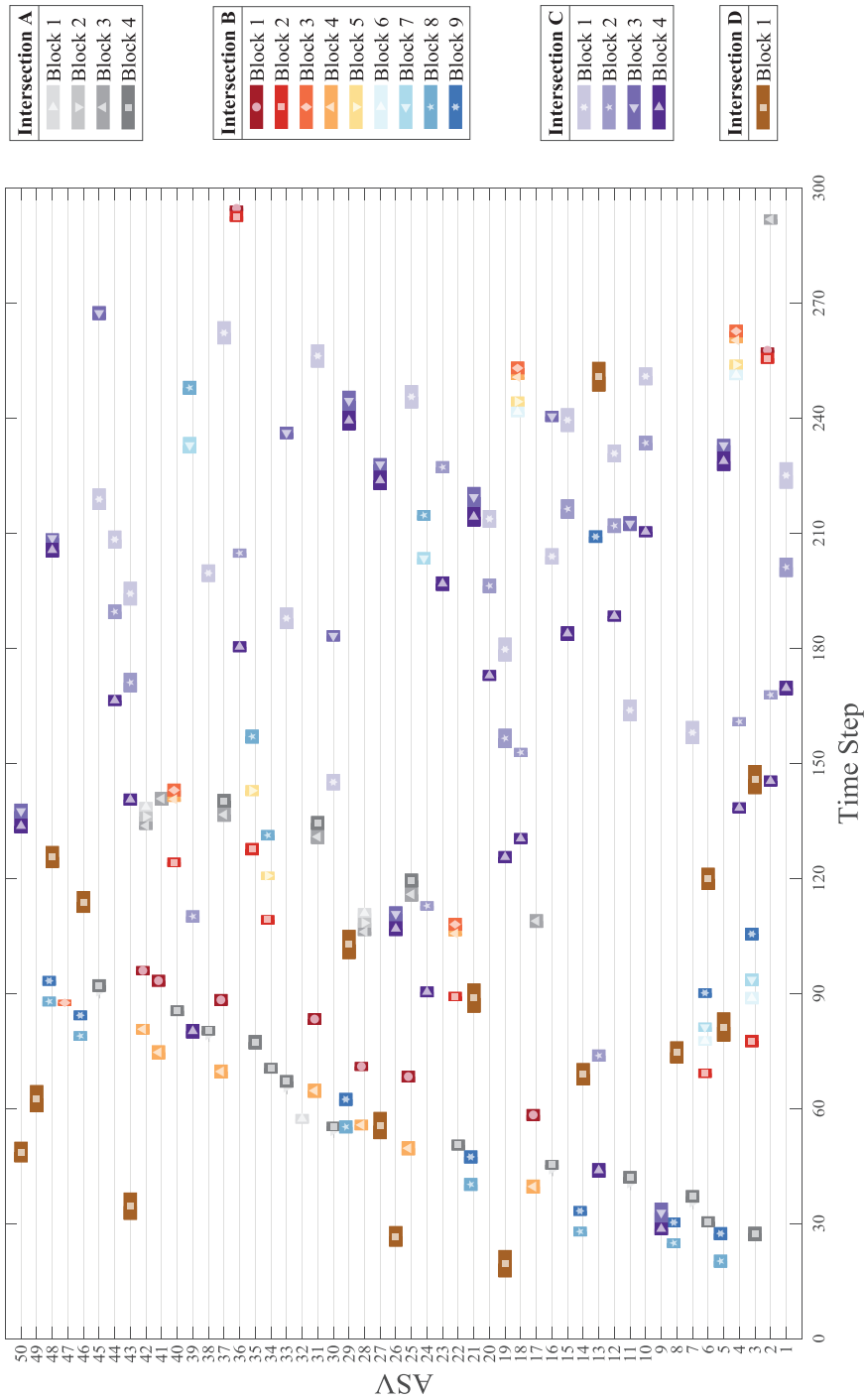

Figure 6.12: CWIS results of the last iteration.

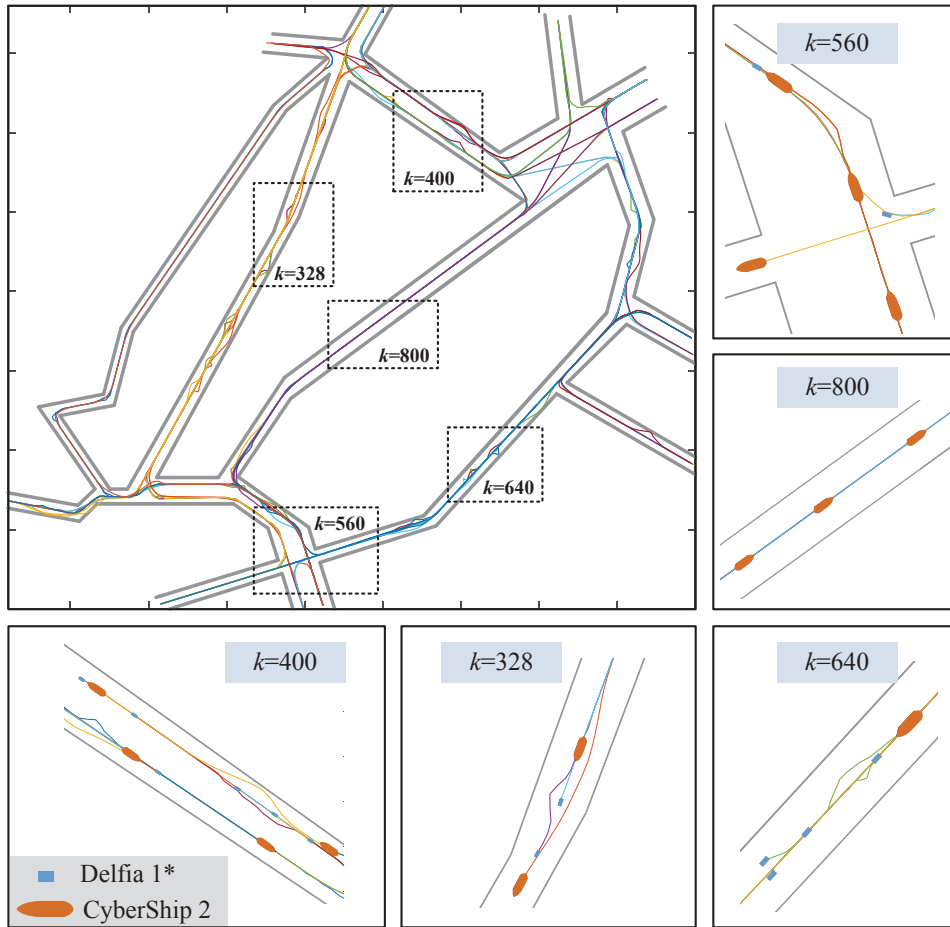

Figure 6.13: Trajectories of the ASVs in a urban waterway network.

Figure 6.13 provides the trajectory of each ASV and screen-shots at certain time steps. After passing through an intersection, the ASVs form new vessel trains, see subfigure (a). In segments, The ASVs overtake others to change their orders in a vessel train to meet the DTA of next intersection, see subfigure (b). Moreover, the WIS helps the ASVs to use the space between two adjacent ASV efficiently. For example, in subfigure (c), a Delfia 1* merges into the flow using the gap between two vessels. Due to the speed difference, most of the time, vessels prefer to form vessel train with the ASVs that have the same dynamics, such as vessels in subfigure (d) and (e).

6.6 Conclusion

This chapter answers the questions on cooperation of vessels and infrastructures at a network level (Research Questions 6 - 8). We explore the potential of applying fleets of co-

operative ASVs to improve the safety and efficiency of transport in waterway networks. We propose a framework consisting of Vessel Train Formation (VTF) and Cooperative Waterway Intersection Scheduling (CWIS) for the cooperative control of ASVs. The serial iterative negotiation framework proposed in Chapter 4 are applied to control the vessels in the same waterway segment to form a vessel train. The coordinated problem of several fleets of ASVs passing through an intersection is formulated as Waterway Intersection Scheduling (WIS). A parallel iterative framework is employed to solve the CWIS problem for the negotiation among Intersection Controllers (ICs) considering the interdependence of interconnected infrastructures.

Simulation experiments of vessels sailing in the canal network in Amsterdam are carried out to illustrate the effectiveness of the proposed framework. In the simulation of an individual intersection, experiments are presented involving the scenarios in which up to 30 ASVs are passing through an intersection. Rescheduling is triggered when some vessels cannot arrive on time. The rescheduling contributes to using time and space resources efficiently. Consequently, the total time that is needed for all the vessels to pass through the intersection does not increase. Moreover, we compare the cooperative situation with the proposed CMVSs with a baseline situation. In the baseline situation, vessels avoid collisions using the Generalized Velocity Obstacle (GVO) method and cross the intersection with a First In First Out rule. The results show that: the proposed method has better path following performance; the GVO method has fewer velocity changes; CMVSs helps to reduce the makespan and total travel time. In the end, a simulation of vessels sailing in the canal network in Amsterdam is presented to show the cooperation among ICs.

Chapter 7

Conclusions and future research

In this thesis, we focus on the cooperative system that consists of fleets of Autonomous Surface Vessels (ASVs), named as a Cooperative Multi-Vessel System (CMVS). A motion control framework based on Model Predictive Control (MPC) and a generic negotiation framework have been proposed to utilize Vessel-to-Vessel (V2V), Vessel-to-Infrastructure (V2I), and Infrastructure-to-Infrastructure (I2I) communication to enable ASVs to negotiate and cooperate for the aim of improving overall safety, efficiency, or for performing specific tasks.

This last chapter concludes the thesis. The main findings and the answers to the research questions are summarized in Section 7.1. Subsequently, directions for future research are provided in Section 7.2.

7.1 Conclusions

The main objective of this thesis is to answer the main research question:

How can the efficiency and safety of waterborne transport be improved through Vessel-to-Vessel and Vessel-to-Infrastructure communication and cooperation?

To address this question, we propose the concept of Cooperative Multi-Vessel System (CMVS). We introduce two types of controllers: a Vessel Controller (VC) for the control of an ASV, and an Infrastructure Controller (IC) is responsible for solving the conflicts of vessels at an infrastructure. A predictive motion control framework is constructed for motion control of a vessel. Then, a generic negotiation framework based on the Alternating Direction of Multipliers Method (ADMM) is designed to deal with consensus problem among different controllers. The motion control framework and the negotiation framework are used for the control of VCs and ICs at different cooperation layers in Chapter 4 - 6, as shown in Table 7.1.

More specifically, the key questions that related to the main research question are answered as follows.

Table 7.1: Characteristics of cooperation of vessels and infrastructures that have been addressed in this thesis.

	Form of cooperation	Layer	Communication	Control structure	Negotiation	Objectives
Chapter 4	Vessel Train Formation	Link	V2V	Single-layer	Serial	Path following, Aggregation
Chapter 5	Cooperative Floating Object Transport	Link	V2V	Multi-layer Decentralized	Hybrid: ASVs: Parallel; ASV-Coordinator: Serial	Path following, Formation keeping
Chapter 6	Waterway Intersection Scheduling	Node	V2I	Centralized	-	Minimizing makespan
Chapter 6	Cooperative Waterway Intersection Scheduling	Network	I2I	Single-layer	Parallel	Minimizing makespan, Reducing conflicts

Answers to the questions on state-of-the-art

1. *Which types of cooperation have been investigated in existing research?*

In Chapter 2, we carried out a survey on existing research on cooperative control of multiple ASVs. Hierarchical architecture of cooperations in the waterborne transport systems is proposed to categorize different layers of cooperation in waterway networks. Three layers of cooperation are identified according to the range of communication and cooperation. The individual layer is the basis layer where a controller controls the dynamics of an individual vessel. The local layer considers the V2V and V2I interactions, including cooperation at a link (e.g., a waterway segment) and a node (e.g., an intersection, an individual infrastructure). The network layer considers not only V2V and V2I interactions but also the interdependence of interconnected infrastructures, i.e., I2I interactions.

In the existing research for V2V cooperation at the local layer, methods for cooperation of multiple vessels have been proposed for different objectives, such as collision avoidance, formation, cooperative manipulation. However, when sailing in ports, waterways, or canals, it is not necessary for vessels to maintain a specific configuration. Nevertheless, collision avoidance is not the only interaction between vessels. Thus, for improving safety and efficiency, a generic concept for waterborne transport is needed.

Existing literature on V2I cooperation at the local layer mostly considers the scheduling of locks and terminals. Few studies focus on the problem of intersection crossing of vessels. However, there are many intersections in waterway networks. Vessels in such networks have to interact with vessels from different directions frequently. Intersections are also the place where accidents frequently occur.

Review on existing research for transport in waterway networks reveals that little attention has been paid to I2I cooperation. Existing studies often focus on Vehicle Routing Problems when taking the network structure into account. Some research related to the network layer cooperation consider vessels sailing in a large seaport. However, research that considers the interdependence of interconnected infrastructures is lacking in general.

2. *Which methods have been used for the cooperative control of vessels and infrastructures for waterborne transport?*

For V2V cooperation at the local layer, three types of studies in the literature have been reviewed, namely, Cooperative collision avoidance, Formation control, and Cooperative manipulation.

According to the existence of communication and the cooperation level a method can achieve, existing methods can be classified into five groups. *Assumption-based methods* do not consider the communication between controllers. This group of methods predicts the actions that other vessels may take either by assuming that other vessels sail with constant speed and heading or according to holonomic or kinematic models. *Rule-based methods* use pre-defined rules as the protocol to realized cooperation among controllers. Those approaches draw up rules on the actions that vessels

should take under possible encounter situations. Vessels can coordinate their behavior through rule-compliant decision making. In *Intention-aware methods*, controllers decide their collision avoidance actions according to the intentions broadcast by other controllers, such as turning directions, predictive trajectory, etc. *Negotiation methods* emphasize close-loop information exchanges. After a controller making broadcasting its decision, the actions that other controllers make based on this decision are sent to the controller as feedback. The controller will adjust its decision accordingly. In this way, agreements among the vessels controllers can be achieved through iterative negotiation.

Regarding the formation control of vessels, three cooperative strategies are employed. *Consensus-based method* achieves cooperation through controlling a group of agents toward some common states, such as heading, speed, average position, etc. There are not specified desired formation shapes. *Relation-based method* determines the control inputs for each ASV according to the desired relative distance, orientation or position of the ASV to a preset point (a leader or target). *Position-based method* calculates paths for each ASV according to the desired configuration, and the formation is achieved when each ASV converges to its desired position.

According to the tasks, Cooperative manipulation can be divided into three types, i.e., Cooperative Object Transport, Caging, and Self-Assembly. The methods for cooperative manipulation usually use a hierarchical structure: a high-level motion control algorithm computes the virtual control effort; a control allocation algorithm decides the effort each vessel should provide such that they jointly produce the desired virtual control efforts, and low-level control algorithms may be used to control each individual vessel via its actuators.

For V2I cooperation at the local layer, the main problem that needs to be solved is the allocation of resources and time slots. The scheduling of the infrastructures is usually formulated as different types of scheduling problems, i.e., mapping of jobs to machines and processing times, such as Single Machine Problems, Parallel Machine Problems, Job Shop Problems, etc.

For cooperation among vessels and infrastructures at the network layer, only a few studies apply scheduling algorithms for the distribution of traffic flow or to the determination of routes and departure time for vessels in inland waterway networks or large ports.

Answers to the questions on cooperation among vessels

3. How can the interactions among ASVs be described using mathematical models?

Chapter 4 and Chapter 5 discussed two types of cooperation among ASVs: Vessel Train Formation (VTF) for cooperative navigation in waterways, and Cooperative Floating Object Transport (CFOT) for cooperative task performing.

VTF describes the interactions between ASVs at the link level. Vessels usually have predetermined origins, destinations, and paths. In order to exchange information and enjoy the benefits of sailing together, vessels in a CMVS attempt to stay close to each other. At the same time, vessels should not collide with others. Therefore, we

defined three objectives in the VTF problem, i.e., path following, aggregation, and collision avoidance. Then, the VTF problem is formulated as a mixed integer linear programming problem, and each VC determines its cooperative actions by solving this problem.

CFOT represents a type of close interaction between ASVs for performing specific tasks. The aim is utilizing a team of ASVs to transport a larger floating object, such as a large vessel, a barge, or an offshore platform. The object and the ASVs are connected with towlines, and the ASVs maintain the formation when moving the object. We propose a multi-layer distributed control structure for the object transport system. With the designed scheme, the original cooperative transport problem is considered as the combination of several sub-problems: trajectory tracking of the object, control allocation, and formation tracking of the ASVs.

4. *Which framework can be used to achieve agreements among a fleet of ASVs?*

In Chapter 3, we propose the concept of Cooperative Multi-Vessel System for the cooperative behaviors among vessels and infrastructures in waterway networks. Two types of controllers are introduced: a VC for the control of an ASV, and an IC is responsible for solving the conflicts of vessels at an infrastructure. A VC uses sensors to get self-state information (e.g., position, speed, and heading), environmental information (e.g., wind speed and directions, current velocity) and information on obstacles. Based on the obtained information, the Navigation system creates pictures of the current situation and informs the Guidance system of collision risks. Combined with the predetermined global path, optimal trajectories with specified objectives and constraints can be determined. The commands are sent to actuators for autonomous navigation. When approaching an infrastructure, VCs report their Estimate Time of Arrival (ETA) to the IC. Then, the IC makes conflict-free schedules and informs those vessels the Desired Time of Arrival (DTA) by solving the scheduling problem. After passing through the infrastructure, vessels sailing in the same waterways form new vessel trains for safe navigation. The communication and cooperation of vessels in different fleets are realized through ICs. Similarly, the ICs communicate and cooperate with each other by exchanging information with VCs.

MPC is used to design motion controllers for ASVs for its receding horizon principle, which is beneficial to deal with conflicts and to against disturbances and uncertainties. An MPC-based control framework is developed with a successively linearized prediction model. In Chapter 4 - 6, this framework are for motion control for ASVs. A generic negotiation framework based on the ADMM is designed to deal with consensus problem among different controllers. The framework is generic in several ways. Firstly, both serial and parallel, and even hybrid iterative schemes can be addressed under the framework. Secondly, the framework can be used for the consensus problems of heterogeneous controllers. Controllers decide their actions according to the information provided by other controllers in the cooperative system. Therefore, the dynamics of ASVs need not necessarily to be the same, neither the operation models of the infrastructures. The negotiation framework is used to help VCs and ICs to reach consensus for cooperation at different layers in Chapter 4 - 6.

5. *How can the safety and efficiency of waterborne transport be improved through V2V cooperation?*

Simulation experiments are carried out to illustrate how the proposed controllers and frameworks improve the safety and efficiency of waterborne transport through V2V cooperation.

In Chapter 4, we simulate the scenario in which a CMVS consisting of five vessels navigates from the Port of Rotterdam to inland waterways. The proposed method successfully steers the vessels from different origins to form a vessel train. Due to the effective communication, vessels can timely respond to the velocity changes that others make. After the train-like formation is formed, the speed of the vessels become consistent, and the distances between vessels become constant. Moreover, simulation results show that a significant amount of fuel saving can be obtained by using the Eco-VTF method. Thus, CMVSs have the potential to enhance the safety of waterborne transport systems.

In Chapter 5, a simulation involving moving a large vessel sailing inbound the Port of Rotterdam is carried out to show the effectiveness of the proposed CFOT framework. The results show that the proposed cooperative system can transport the floating object along a predefined trajectory and avoid potential static and dynamic obstacles. Ultimately, this leads to methods that can also become useful for moving large vessels, barges, and off-shore platforms in future ports where both human-operated and autonomous vessels exist.

Answers to the questions on cooperation of vessels and infrastructures at a network level

6. *How can the control of an infrastructure be formulated?*

In Chapter 6, we use an intersection as an example to illustrate the control of infrastructure. The scheduling of intersection crossings is, in fact, a resource allocation problem. An intersection is modeled with conflicting blocks. A vessel passing through the intersection along the path can be regarded as occupying space resources for a certain period. With this setting, we formulated the Waterway Intersection Scheduling (WIS) as a job shop scheduling problem with three specific constraints, i.e., sequential constraint, no-wait constraint, and disjunctive constraint. By solving the job shop scheduling problem, the desired time of arrival (DTA) of the ASVs can be determined.

7. *How can the interdependence of the networked infrastructures be taken into consideration?*

In Chapter 6, the WIS is further extended to the network level as Cooperative Waterway Intersection Scheduling (CWIS). The interdependence of interconnected intersections is considered through the communication of the earliest arrival times of the vessels at the intersections. When a vessel has to pass through a sequence of intersections, the schedule that an IC makes have impact on the earliest arrival time at the subsequent intersections. The segments connecting the intersections can provide

buffers where vessels can accelerate or decelerate to arrive at the DTA at the intersections. The generic negotiation framework is employed to coordinate the ICs in a waterway network with a parallel scheme.

8. *How can the efficiency of waterborne transport be improved through V2I and I2I communication and cooperation?*

Simulation experiments of vessels sailing in the canal network in Amsterdam are carried out to illustrate the advantages of V2I and I2I communication and cooperation in Chapter 6. For WIS of an individual intersection, we simulate the scenario in which up to 30 ASVs are passing through an intersection. Rescheduling is triggered when some vessels cannot arrive on time. The rescheduling contributes to using time and space resources efficiently. Consequently, the total time that is needed for all the vessels to pass through the intersection does not increase. Moreover, we compare the cooperative situation with a baseline situation. In the baseline situation, vessels avoid collisions using the Generalized Velocity Obstacle (GVO) method and cross the intersection with a First In First Out rule. The results show that: the proposed method has better path following performance; the GVO method has fewer velocity changes; CMVSs helps to reduce the makespan and total travel time. In the end, a simulation of vessels sailing in the canal network in Amsterdam is presented to show the cooperation among ICs.

Moreover, with the proposed motion control and negotiation frameworks, CMVSs can be used for transportation in inland waterways or canal networks. For example, a CMVS consisting of small vessels can replace the work of a large vessel with the following advantages. Firstly, small vessels have lower requirements for waterway dimensions than large vessels. Thus, using fleets can significantly improve the accessibility of waterborne transport networks. Secondly, small vessels have more alternative routes when congestions occur. Consequently, using small vessels helps to relieve the pressure on locks, and to enhance the robustness of waterway networks. Thirdly, goods on large vessels for inland shipping usually have ports of call. This may lead to the problems of inefficiency and low utilization rate. Alternatively, applying fleets can evade these issues with more flexible schedules.

7.2 Future research

With respect to the proposed frameworks for cooperation in waterborne transport systems addressed in this thesis, challenging issues that require future research are as follows:

1. Vessel dynamics

The motion control framework proposed in this thesis strongly relies on the dynamic models of the vessels. In this thesis, we adopt a dynamic model of marine surface vehicles with three DOFs (surge, sway, and yaw) proposed in [54]. This model has been widely used for the motion control of ASVs. Besides, various models have been proposed to describe the dynamics of vessels [75]. However, no models can predict the dynamics of the vessels operating in real-life environments without any error,

as the dynamics are influenced by many factors, such as the shape of the hull, and dimension. Even for a vessel, its dynamics can be varying with different loads, sailing in shallow water, etc.[98, 151]. In particular, for varying and uncertain parameters in ASV models, more research work could be done using methods, such as on-line parameter identification [191], and adaptive method. Moreover, in maneuvering, a vessel experiences motion in 6 DOFs. The motion in all DOF is coupled. Therefore, motion models with 6 DOFs are needed to manoeuvre a vessel safely and accurately.

2. Interactions with non-cooperative participants

In this research, we assume that all the participants are autonomous and cooperative. However, the future waterborne transport system will be a system in which both human-operated vessels and autonomous vessels exist. Besides, some vessels may not be willing to broadcast their information. How can the controllers making decisions when the ASVs encounter those non-cooperative participants is a significant problem to be solved. Potential methods that can address this problem are listed as follows:

- (a) ASV controllers can determine collision avoidance actions by assuming those non-cooperative vessels will keep their own states, i.e., give priority to the non-cooperative vessels.
- (b) ASV controllers take actions which are which in compliance with existing rules for human-operated vessels, such as the International Regulations for Preventing Collisions at Sea (COLREGs).
- (c) ASV controllers make decisions based on the predicted trajectories of the non-cooperative participants according to historical data, such as AIS data [70] or vessel behavior models [190].
- (d) Human-machine interactions are receiving increasing attention in recent years [72]. Human-operated vessels can be equipped with human-machine interaction assistant systems, so that the officers on watch could also share information with ASV controllers.

3. Environmental disturbances and uncertainties

As mentioned in earlier literature [3, 76, 189], the dynamics of vessels are strongly influenced by environmental disturbances, such as wind, waves, and currents. Although the predictive property of MPC benefits the control of the ASVs under disturbances, more efforts are needed to analyze the influences of external disturbances. Future research will address how to deal with those uncertainties, e.g., by considering the integration of Robust MPC ideas [189].

4. Communication constraints and failure

Communication constraints, such as delays, packet loss, or connection failure, should be considered in future research when applying CMVSSs in practice. Though communication limitations are not considered in this thesis, the proposed method is capable of handling those problems: a controller assumes that an ASV follows the predicted trajectories it broadcast until receiving an update.

5. Hydrodynamic effect

In the VTF proposed in this research, vessels stay close to each other. Hydrodynamic effects between vessels are strong. Moreover, vessels sailing in V-shape may reduce the drag force, and therefore, this type of formation may help to reduce fuel consumption [11, 109]. However, the optimal formation of the ASVs that balancing energy saving and safety needs further studies. Besides, when considering the application of ASVs in narrow canal networks, the hydrodynamic effects between ASVs and bank also need to be investigated [88].

6. Theoretical analysis

The proof of the recursive feasibility and stability is not considered in this study. As mentioned in [111], stability and recursive feasibility of MPC is usually achieved in two different ways: imposing conditions on the terminal cost and/or constraint set, and extending the horizon. However, a formal recursive feasibility and stability analysis of distributed MPC is still challenging.

7. Comparison with alternative cooperative methods

Although the methods for cooperative control of multiple vessels are few, cooperation in multi-agent systems has been studied for decades [152]. Some of the techniques may be applied to ASVs. The frameworks discussed in this thesis should be compared with other cooperative methods to determine the advantages and disadvantages of each other. The proposed method can be improved by combining the best of several techniques.

8. Physical experiments

Physical experiments can be carried out to make steps towards real-world application. In this thesis, as well as in much existing research for ASVs, the effectiveness of the methods are assessed through simulation experiments. In order to apply CMVSS in reality, it is important to assess the effectiveness of the proposed methods with physical experiments.

Bibliography

- [1] M. Abdelaal, M. Fränzle, and A. Hahn. Nmpc-based trajectory tracking and collision avoidance of underactuated vessels with elliptical ship domain. *IFAC-PapersOnLine*, 49(23):22 – 27, 2016.
- [2] M. Ahmane, A. Abbas-Turki, F. Perronnet, J. Wu, A. El Moudni, J. Buisson, and R. Zeo. Modeling and controlling an isolated urban intersection based on cooperative vehicles. *Transportation Research Part C: Emerging Technologies*, 28:44–62, 2013.
- [3] J. Almeida, C. Silvestre, and A. Pascoal. Cooperative control of multiple surface vessels in the presence of ocean currents and parametric model uncertainty. *International Journal of Robust and Nonlinear Control*, 20(14):1549–1565, 2010.
- [4] F. Arrichiello, S. Chiaverini, and T. I. Fossen. Formation control of underactuated surface vessels using the null-space-based behavioral control. In *Proceedings of the 2006 IEEE/RSJ International Conference on Intelligent Robots and Systems*, pages 5942–5947, Beijing, China, October 2006.
- [5] F. Arrichiello, H. K. Heidarsson, S. Chiaverini, and G. S. Sukhatme. Cooperative caging and transport using autonomous aquatic surface vehicles. *Intelligent Service Robotics*, 5(1):73–87, Jan 2012.
- [6] T. Basar and G. J. Olsder. *Dynamic Noncooperative Game Theory*. Society for Industrial and Applied Mathematics, Philadelphia, PA, United States of America, 1999.
- [7] M. R. Benjamin, J. J. Leonard, J. A. Curcio, and P. Newman. A method for protocol-based collision avoidance between autonomous marine surface craft. *J. Field Robotics*, 23:333–346, 2006.
- [8] S. Bhattacharya, H. Heidarsson, G. S. Sukhatme, and V. Kumar. Cooperative control of autonomous surface vehicles for oil skimming and cleanup. In *Proceedings of the 2011 IEEE International Conference on Robotics and Automation*, pages 2374–2379, Shanghai, China, May 2011.
- [9] B. Bidikli, E. Tatlicioglu, and E. Zergeroglu. Robust dynamic positioning of surface vessels via multiple unidirectional tugboats. *Ocean Engineering*, 113:237 – 245, 2016.

- [10] E. Børhaug, A. Pavlov, E. Panteley, and K. Y. Pettersen. Straight line path following for formations of underactuated marine surface vessels. *IEEE Transactions on Control Systems Technology*, 19(3):493–506, 2011.
- [11] L. Borst. Determination of optimal platooning formation based on energy consumption. Technical Report 2019.TEL.8336, Delft University of Technology, January 2019.
- [12] S. Boyd, N. Parikh, E. Chu, B. Peleato, and J. Eckstein. Distributed optimization and statistical learning via the alternating direction method of multipliers. *Foundations and Trends in Machine Learning*, 3(1):1–122, 2011.
- [13] K. Braekers, K. Ramaekers, and I. Van Nieuwenhuysse. The vehicle routing problem: State of the art classification and review. *Computers & Industrial Engineering*, 99: 300 – 313, 2016.
- [14] D. Braganza, M. Feemster, and D. Dawson. Positioning of large surface vessels using multiple tugboats. In *Proceedings of the 2007 American Control Conference*, pages 912–917, New York City, USA, July 2007.
- [15] M. Breivik, V. E. Hovstein, and T. I. Fossen. Ship formation control: A guided leader-follower approach. In *Proceedings of the 17th IFAC World Congress*, pages 16008 – 16014, Seoul, Korea, 2008.
- [16] V. M. Bukaty and S. U. Morozova. On determination of the head-on situation under rule 14 of COLREG-72. In *International Journal on Marine Navigation and Safety of Sea Transportation*, volume 4, pages 277–282, 2010.
- [17] M. Burger, A. Pavlov, E. Borhaug, and K. Y. Pettersen. Straight line path following for formations of underactuated surface vessels under influence of constant ocean currents. In *Proceedings of the 2009 American Control Conference*, pages 3065–3070, St. Louis, Missouri, USA, June 2009.
- [18] J. F. Campbell, L. D. Smith, D. C. Ii Sweeney, R. Mundy, and R. M. Nauss. Decision tools for reducing congestion at locks on the Upper Mississippi river. In *Proceedings of the 40th Annual Hawaii International Conference on System Sciences (HICSS'07)*, pages 56–56, Waikoloa, Big Island, HI, USA, 2007.
- [19] J. F. Campbell, L. D. Smith, and D. C. Sweeney. A robust strategy for managing congestion at locks on the upper mississippi river. In *Proceedings of the 42nd Hawaii International Conference on System Sciences*, pages 1–10, Waikoloa, Big Island, HI, USA, 2009.
- [20] S. Campbell, W. Naeem, and G. W. Irwin. A review on improving the autonomy of unmanned surface vehicles through intelligent collision avoidance manoeuvres. *Annual Reviews in Control*, 36(2):267–283, 2012. ISSN 1367-5788.
- [21] M. Candeloro, A. M. Lekkas, and A. J. Sørensen. A voronoi-diagram-based dynamic path-planning system for underactuated marine vessels. *Control Engineering Practice*, 61:41 – 54, 2017.

- [22] Y. Cao, W. Yu, W. Ren, and G. Chen. An overview of recent progress in the study of distributed multi-agent coordination. *IEEE Transactions on Industrial Informatics*, 9(1):427–438, Feb 2013.
- [23] L. Chen and C. Englund. Cooperative intersection management: A survey. *IEEE Transactions on Intelligent Transportation Systems*, 17(2):570–586, 2016.
- [24] L. Chen, J. J. Hopman, and R. R. Negenborn. Distributed model predictive control for vessel train formations of cooperative multi-vessel systems. *Transportation Research Part C: Emerging Technologies*, 92:101–118, 2018.
- [25] L. Chen, J. J. Hopman, and R. R. Negenborn. Intersection crossing of cooperative multi-vessel systems. In *Proceedings of the 15th IFAC Symposium on Control in Transportation Systems*, pages 379–385, Savona, Italy, June 2018.
- [26] L. Chen, J. Mou, and H. Ligteringen. Route choice model in inland waterway network: A case study in China. In *Transportation Research Board 97th Annual Meeting*, Washington DC, United States, January 2018.
- [27] L. Chen, A. Haseltalab, V. Garofano, and R. R. Negenborn. Eco-VTF: Fuel-efficient vessel train formations for all-electric autonomous ships. In *Proceedings of the 2019 European Control Conference*, pages 1–8, Naples, Italy, June 2019.
- [28] L. Chen, J. J. Hopman, and R. R. Negenborn. Distributed model predictive control for cooperative floating object transport with multi-vessel systems. *Ocean Engineering*, 191:1–16, 2019.
- [29] L. Chen, J. J. Hopman, and R. R. Negenborn. Survey on cooperative control of vessels for waterborne transport. *submitted to a journal*, 2019.
- [30] L. Chen, Y. Huang, H. Zheng, J. J. Hopman, and R. R. Negenborn. Cooperative multi-vessel systems in urban waterway networks. *IEEE Transactions on Intelligent Transportation Systems*, PP(99):1–14, 2019.
- [31] Y. Chen and P. Wei. Coordinated adaptive control for coordinated path-following surface vessels with a time-invariant orbital velocity. *IEEE/CAA Journal of Automatica Sinica*, 1(4):337–346, 2014.
- [32] Y. Q. Chen and Z. Wang. Formation control: a review and a new consideration. In *Proceedings of the International Conference on Intelligent Robots and Systems*, pages 3181–3186, Macau, China, November 2005.
- [33] Y. Y. Chen and Y. P. Tian. Formation tracking and attitude synchronization control of underactuated ships along closed orbits. *International Journal of Robust and Nonlinear Control*, 25(16):3023–3044, 2015.
- [34] Y. Cho, J. Han, and J. Kim. Intent inference of ship maneuvering for automatic ship collision avoidance. In *Proceedings of the 11th IFAC Conference on Control Applications in Marine Systems, Robotics, and Vehicles (CAMS 2018)*, pages 384 – 388, Opatija, Croatia, September 2018.

- [35] R. Daily and D. M. Bevly. Harmonic potential field path planning for high speed vehicles. In *Proceedings of the 2008 American Control Conference*, pages 4609–4614, Seattle, Washington, USA, June 2008.
- [36] B. Das, B. Subudhi, and B. Pati. Cooperative formation control of autonomous underwater vehicles: An overview. *International Journal of Automation and Computing*, 13(3):199–225, 2016.
- [37] F. G. Ding, B. Wang, and Y. Q. Ma. Adaptive coordinated formation control for multiple surface vessels based on virtual leader. In *Proceedings of the 35th Chinese Control Conference (CCC)*, pages 7561–7566, Chengdu, China, July 2016.
- [38] K. D. Do. Practical formation control of multiple underactuated ships with limited sensing ranges. *Robotics and Autonomous Systems*, 59(6):457 – 471, 2011.
- [39] K. D. Do. Formation control of underactuated ships with elliptical shape approximation and limited communication ranges. *Automatica*, 48(7):1380 – 1388, 2012.
- [40] W. Dong. Cooperative control of underactuated surface vessels. *IET Control Theory Applications*, 4(9):1569–1580, Sep. 2010.
- [41] W. Dong and J. A. Farrell. Formation control of multiple underactuated surface vessels. *IET Control Theory Applications*, 2(12):1077–1085, 2008.
- [42] A. M. Douma. *Aligning the Operations of Barges and Terminals Through Distributed Planning*. PhD thesis, University of Twente, Enschede, The Netherlands, 2008.
- [43] Economic Commission for Europe. Inventory of most important bottlenecks and missing links in the E waterway network. Technical Report ECE/TRANS/SC.3/159/Rev.1, Economic Commission for Europe, Inland Transport Committee, United Nations, 2013.
- [44] J. Esposito, M. Feemster, and E. Smith. Cooperative manipulation on the water using a swarm of autonomous tugboats. In *Proceedings of the 2008 IEEE International Conference on Robotics and Automation*, pages 1501–1506, Pasadena, California, USA, May 2008.
- [45] European Commission. Naiades II: Towards quality inland waterway transport. Technical Report COM(2013) 623, European Commission, 2013.
- [46] European Commission. The European Union explained: Transport. Technical report, European Commission, 2014.
- [47] F. Fahimi. Non-linear model predictive formation control for groups of autonomous surface vessels. *International Journal of Control*, 80(8):1248–1259, 2007.
- [48] F. Fahimi. Sliding-mode formation control for underactuated surface vessels. *IEEE Transactions on Robotics*, 23(3):617–622, 2007.

- [49] F. Farokhi, I. Shames, and K. H. Johansson. Distributed MPC via dual decomposition and alternative direction method of multipliers. In J. M. Maestre and R. R. Negenborn, editors, *Distributed Model Predictive Control Made Easy*, volume 69 of *Intelligent Systems, Control and Automation: Science and Engineering*, pages 115–131. Springer, Netherlands, 2014.
- [50] M. Feemster, J. Esposito, and J. Nicholson. Manipulation of large objects by swarms of autonomous marine vehicles. Part 1-Rotation. In *Proceedings of the 38th South-eastern Symposium on System Theory*, pages 255–259, Cookeville, TN, USA, March 2006.
- [51] M. G. Feemster and J. M. Esposito. Comprehensive framework for tracking control and thrust allocation for a highly overactuated autonomous surface vessel. *Journal of Field Robotics*, 28(1):80–100, 2011.
- [52] K. Feyrer. *Wire Ropes: Tension, Endurance, Reliability*. Springer-Verlag Berlin Heidelberg, 2015.
- [53] A. Fitriadhy and H. Yasukawa. Course stability of a ship towing system. *Ship Technology Research*, 58(1):4–23, 2011.
- [54] T. I Fossen. *Handbook of Marine Craft Hydrodynamics and Motion Control*. John Wiley & Sons Ltd, United Kingdom, 2011.
- [55] T. Fraichard and H. Asama. Inevitable collision states -A step towards safer robots? In *Proceedings of the 2003 International Conference on Intelligent Robots and Systems*, pages 388–393, Las Vegas, NV, USA, 2003.
- [56] J. Froese. Safe and efficient port approach by vessel traffic management in waterways. In C. Ocampo-Martinez and R. R. Negenborn, editors, *Transport of Water versus Transport over Water*, volume 58 of *Operations Research/Computer Science Interfaces Series*, pages 281–296. New York: Springer, 2015.
- [57] M. Fu, L. Yu, Y. Wang, and J. Jiao. A cross-coupling control approach for coordinated formation of surface vessels with uncertain disturbances. *Asian Journal of Control*, 20(6):2370–2379, 2018.
- [58] H. Ghaffarian, M. Fathy, and M. Soryani. Vehicular ad hoc networks enabled traffic controller for removing traffic lights in isolated intersections based on integer linear programming. *IET Intelligent Transport Systems*, 6(2):115–123, 2012.
- [59] J. Ghommam and F. Mnif. Coordinated path-following control for a group of underactuated surface vessels. *IEEE Transactions on Industrial Electronics*, 56(10):3951–3963, 2009.
- [60] J. M. Giron-Sierra, A. T. Gheorghita, G. Angulo, and J. F. Jimenez. Towing a boom with two usvs for oil spill recovery: Scaled experimental development. In *Proceedings of the 13th International Conference on Control Automation Robotics Vision (ICARCV)*, pages 1729–1734, Singapore, Dec 2014.

- [61] Google Maps, 2018. URL <https://www.google.com/maps/@31.2953034,120.5609974,14.38z>.
- [62] J. Gregoire, S. Bonnabel, and A. de La Fortelle. Optimal cooperative motion planning for vehicles at intersections. In *Proceedings of the 2012 IEEE Intelligent Vehicles Symposium Workshop on Navigation, Accurate Positioning and Mapping for Intelligent Vehicles*, pages 1–6, Alcalá de Henares, Spain, 2012.
- [63] N. Gu, D. Wang, Z. Peng, and L. Liu. Adaptive bounded neural network control for coordinated path-following of networked underactuated autonomous surface vehicles under time-varying state-dependent cyber-attack. *ISA Transactions (In Press)*, 2019.
- [64] M. R. Hafner, D. Cunningham, L. Caminiti, and D. Del Vecchio. Cooperative collision avoidance at intersections: Algorithms and experiments. *IEEE Transactions on Intelligent Transportation Systems*, 14(3):1162–1175, 2013. ISSN 1524-9050.
- [65] A. Haseltalab and R. R. Negenborn. Predictive on-board power management for all-electric ships with dc distribution architecture. In *Proceedings of OCEANS 2017*, pages 1–8, Aberdeen, UK, June 2017.
- [66] A. Haseltalab and R. R. Negenborn. Model predictive maneuvering control and energy management for all-electric autonomous ships. *Applied Energy*, 251:1–27, 2019.
- [67] B. S. He, H. Yang, and S. L. Wang. Alternating direction method with self-adaptive penalty parameters for monotone variational inequalities. *Journal of Optimization Theory and Applications*, 106(2):337–356, 2000.
- [68] Y. He, Y. Jin, L. Huang, Y. Xiong, P. Chen, and J. Mou. Quantitative analysis of colreg rules and seamanship for autonomous collision avoidance at open sea. *Ocean Engineering*, 140:281 – 291, 2017.
- [69] R. G. Hekkenberg. Technological challenges and developments in european inland waterway transport. In C. Ocampo-Martinez and R. R. Negenborn, editors, *Transport of Water versus Transport over Water*, volume 58 of *Operations Research/Computer Science Interfaces Series*, pages 297–313. Springer, New York, USA, 2015.
- [70] S. Hexeberg, A. L. Flåten, B. H. Eriksen, and E. F. Brekke. AIS-based vessel trajectory prediction. In *Proceedings of the 20th International Conference on Information Fusion*, pages 1–8, Xi’an, China, July 2017.
- [71] S. P. Hoogendoorn, W. Daamen, Y. Shu, and H. Ligteringen. Modeling human behavior in vessel maneuver simulation by optimal control and game theory. *Transportation Research Record*, 2326(1):45–53, 2013.
- [72] Y. Huang. *Collision Avoidance System for Supporting Situational Awareness: Human-Machine Interaction*. PhD thesis, Delft University of Technology, Delft, the Netherlands, 2019.

- [73] Y. Huang, P. H. A. J. M. van Gelder, and Y. Wen. Velocity obstacle algorithms for collision prevention at sea. *Ocean Engineering*, 151:308–321, 2018.
- [74] Y. Huang, L. Chen, and P. H. A. J. M. van Gelder. Generalized velocity obstacle algorithm for preventing ship collisions at sea. *Ocean Engineering*, 173:142 – 156, 2019.
- [75] Y. Huang, L. Chen, P. Chen, R. R. Negenborn, and P. H. A. J. M. van Gelder. Ship collision avoidance methods: State-of-the-art. *Safety Science*, 121:451–473, 2020.
- [76] I. A. F. Ihle. *Coordinated Control of Marine Craft*. PhD thesis, Norwegian University of Science and Technology, Trondheim, Norway, 2006.
- [77] I. A. F. Ihle, J. Jouffroy, and T. I. Fossen. Formation control of marine surface craft: A lagrangian approach. *IEEE Journal of Oceanic Engineering*, 31(4):922–934, Oct 2006.
- [78] International Maritime Organization. Convention on the international regulations for preventing collisions at sea. <http://www.imo.org/en/About/conventions/listofconventions/pages/colreg.aspx>, 1972.
- [79] International Maritime Organization. IMO takes first steps to address autonomous ships, 2018. URL <http://www.imo.org/en/MediaCentre/PressBriefings/Pages/08-MSC-99-MASS-scoping.aspx>.
- [80] International Maritime Organization. Autonomous shipping, 2019. URL <http://www.imo.org/en/MediaCentre/HotTopics/Pages/Autonomous-shipping.aspx>.
- [81] T. A. Johansen and T. I. Fossen. Control allocation – A survey. *Automatica*, 49(5): 1087 – 1103, 2013.
- [82] W. Y. Ku and J. C. Beck. Mixed integer programming models for job shop scheduling: A computational analysis. *Computers & Operations Research*, 73(Supplement C): 165–173, 2016. ISSN 0305-0548.
- [83] D. K. M. Kufoalor, E. F. Brekke, and T. A. Johansen. Proactive collision avoidance for asvs using a dynamic reciprocal velocity obstacles method. In *Proceedings of the 2018 IEEE/RSJ International Conference on Intelligent Robots and Systems (IROS)*, pages 2402–2409, Madrid, Spain, October 2018.
- [84] P. Kujala, M. Hänninen, T. Arola, and J. Ylitalo. Analysis of the marine traffic safety in the gulf of finland. *Reliability Engineering & System Safety*, 94(8):1349 – 1357, 2009. ISSN 0951-8320.
- [85] Y. Kuwata and J. P. How. Cooperative distributed robust trajectory optimization using receding horizon milp. *IEEE Transactions on Control Systems Technology*, 19(2): 423–431, 2011.
- [86] G. Laporte. The vehicle routing problem: An overview of exact and approximate algorithms. *European Journal of Operational Research*, 59(3):345 – 358, 1992.

- [87] A. Lazarowska. A new deterministic approach in a decision support system for ships trajectory planning. *Expert Systems with Applications*, 71:469 – 478, 2017. ISSN 0957-4174.
- [88] C. K. Lee and S. G. Lee. Investigation of ship maneuvering with hydrodynamic effects between ship and bank. *Journal of Mechanical Science and Technology*, 22 (6):1230–1236, 2008.
- [89] F. L. Lewis, H. Zhang, K. Hengster-Movric, and A. Das. *Cooperative Control of Multi-Agent Systems: Optimal and Adaptive Design Approaches*. Springer-Verlag London, 2014.
- [90] G. Li, A. Yamashita, H. Asama, and Y. Tamura. An efficient improved artificial potential field based regression search method for robot path planning. In *Proceedings of the 2012 IEEE International Conference on Mechatronics and Automation*, pages 1227–1232, Chengdu, China, August 2012.
- [91] S. Li, H. Zheng, R. R. Negenborn, and G. Lodewijks. Coordination for efficient transport over water. In *Proceedings of the 19th IEEE International Conference on Computer Supported Cooperative Work in Design (CSCWD)*, pages 389–394, Calabria, Italy, May 2015.
- [92] S. Li, R. R. Negenborn, and G. Lodewijks. Distributed constraint optimization for addressing vessel rotation planning problems. *Engineering Applications of Artificial Intelligence*, 48:159 – 172, 2016.
- [93] S. Li, J. Liu, and R. R. Negenborn. Distributed coordination for collision avoidance of multiple ships considering ship maneuverability. *Ocean Engineering*, 181:212 – 226, 2019.
- [94] S. E. Li, Y. Zheng, K. Li, L. Y. Wang, and H. Zhang. Platoon control of connected vehicles from a networked control perspective: Literature review, component modeling, and controller synthesis. *IEEE Transactions on Vehicular Technology (Early Access)*, pages 1–16, 2017.
- [95] J. Lisowski. Game control methods in avoidance of ships collisions. *Polish Maritime Research*, 19(Special):3–10, 2012.
- [96] J. Lisowski. Comparison of dynamic games in application to safe ship control. *Polish Maritime Research*, 21(3):3–12, 2014.
- [97] J. Lisowski. The sensitivity of state differential game vessel traffic model. *Polish Maritime Research*, 23(2):14–18, 2016.
- [98] J. Liu, R. Hekkenberg, E. Rotteveel, and J. J. Hopman. Literature review on evaluation and prediction methods of inland vessel manoeuvrability. *Ocean Engineering*, 106:458 – 471, 2015.
- [99] L. Liu, D. Wang, Z. Peng, and T. Li. Modular adaptive control for los-based cooperative path maneuvering of multiple underactuated autonomous surface vehicles. *IEEE Transactions on Systems, Man, and Cybernetics: Systems*, 47(7):1613–1624, 2017.

- [100] L. Liu, D. Wang, Z. Peng, C. L. P. Chen, and T. Li. Bounded neural network control for target tracking of underactuated autonomous surface vehicles in the presence of uncertain target dynamics. *IEEE Transactions on Neural Networks and Learning Systems*, 30(4):1241–1249, 2019.
- [101] Y. Liu and R. Bucknall. Path planning algorithm for unmanned surface vehicle formations in a practical maritime environment. *Ocean Engineering*, 97:126 – 144, 2015.
- [102] Y. Liu and R. Bucknall. The angle guidance path planning algorithms for unmanned surface vehicle formations by using the fast marching method. *Applied Ocean Research*, 59:327 – 344, 2016. ISSN 0141-1187.
- [103] Y. Liu and R. Bucknall. A survey of formation control and motion planning of multiple unmanned vehicles. *Robotica*, 36(7):1019–1047, 2018.
- [104] Z. Liu, Y. Zhang, X. Yu, and C. Yuan. Unmanned surface vehicles: An overview of developments and challenges. *Annual Reviews in Control*, 41:71 – 93, 2016.
- [105] Z. Liu, Y. Wang, and X. Yang. Information consensus-based formation control of unmanned surface vehicles. In *Proceedings of the 36th Chinese Control Conference (CCC)*, pages 8074–8077, Dalian, China, July 2017.
- [106] J. A. Long. Kinematic interpolation of movement data. *International Journal of Geographical Information Science*, 30(5):854–868, 2016.
- [107] Y. Lu, G. Zhang, Z. Sun, and W. Zhang. Adaptive cooperative formation control of autonomous surface vessels with uncertain dynamics and external disturbances. *Ocean Engineering*, 167:36 – 44, 2018.
- [108] Y. Lu, G. Zhang, Z. Sun, and W. Zhang. Robust adaptive formation control of underactuated autonomous surface vessels based on mlp and dob. *Nonlinear Dynamics*, 94(1):503–519, 2018.
- [109] M. H. A. Majid and M. R. Arshad. Hydrodynamic effect on v-shape pattern formation of swarm autonomous surface vehicles (ASVs). *Procedia Computer Science*, 76:186 – 191, 2015.
- [110] Maritime Safety Administration of P.R. China. Report on the investigation of the collision between M.T. SANCHI and M.V. CF CRYSTAL in East China Sea on 6 January 2018. Technical report, May 2018. URL <https://www.mardep.gov.hk/en/msnote/pdf/msin1817anx1.pdf>.
- [111] D. Q. Mayne. Model predictive control: Recent developments and future promise. *Automatica*, 50(12):2967 – 2986, 2014.
- [112] W. Meng, C. Guo, and Y. Liu. Nonlinear sliding mode formation control for underactuated surface vessels. In *Proceedings of the 10th World Congress on Intelligent Control and Automation*, pages 1655–1660, Beijing, China, July 2012.

- [113] T. Miloh. The game of two elliptical ships. *Optimal Control Applications and Methods*, 4(1):13–29, 1983.
- [114] MIT and AMS Institute. Roboat, 2018. URL <http://roboat.org/>.
- [115] R. Miyake, J. Fukuto, Y. Niwa, and M. Minami. A user test of automatic navigational intention exchange support system using an intelligent ship-handling simulator. In *Proceedings of the 9th IFAC Conference on Control Applications in Marine Systems*, pages 97 – 102, Osaka, Japan, September 2013.
- [116] J. Monteil, R. Billot, J. Sau, and N. E. El Faouzi. Linear and weakly nonlinear stability analyses of cooperative car-following models. *IEEE Transactions on Intelligent Transportation Systems*, 15(5):2001–2013, 2014. ISSN 1524-9050.
- [117] Movares Projectteam MNV’13. Monitoring nautische veiligheid 2013. Technical report, Rijkswaterstaat Water, Verkeer en Leefomgeving, Afdeling Veiligheidsmanagement en Verkeersveiligheid, 2013.
- [118] R. M. Murray. Recent research in cooperative control of multivehicle systems. *Journal of Dynamic Systems, Measurement, and Control*, 129(5):571–583, 2007.
- [119] R. R. Negenborn and J. M. Maestre. Distributed model predictive control: An overview and roadmap of future research opportunities. *IEEE Control Systems Magazine*, 34(4):87–97, 2014.
- [120] R. R. Negenborn, B. De Schutter, and J. Hellendoorn. Multi-agent model predictive control for transportation networks: Serial versus parallel schemes. *Engineering Applications of Artificial Intelligence*, 21(3):353 – 366, 2008.
- [121] K. K. Oh, M. C. Park, and H. S. Ahn. A survey of multi-agent formation control. *Automatica*, 53:424 – 440, 2015.
- [122] I. O’Hara, J. Paulos, J. Davey, N. Eckenstein, N. Doshi, T. Tosun, J. Greco, J. Seo, M. Turpin, V. Kumar, and M. Yim. Self-assembly of a swarm of autonomous boats into floating structures. In *Proceedings of the 2014 IEEE International Conference on Robotics and Automation (ICRA)*, pages 1234–1240, Hong Kong, China, May 2014.
- [123] R. Olfati-Saber, J. A. Fax, and R. M. Murray. Consensus and cooperation in networked multi-agent systems. *Proceedings of the IEEE*, 95(1):215–233, Jan 2007.
- [124] R. Parthasarathi and T. Fraichard. An inevitable collision state-checker for a car-like vehicle. In *Proceedings of the 2007 IEEE International Conference on Robotics and Automation*, pages 3068–3073, Roma, Italy, April 2007.
- [125] W. Passchyn, S. Coene, D. Briskorn, J. L. Hurink, F. C. R. Spieksma, and G. Vanden Bergh. The lockmaster’s problem. *European Journal of Operational Research*, 251(2):432–441, 2016.
- [126] J. Paulos, N. Eckenstein, T. Tosun, J. Seo, J. Davey, J. Greco, V. Kumar, and M. Yim. Automated self-assembly of large maritime structures by a team of robotic boats. *IEEE Transactions on Automation Science and Engineering*, 12(3):958–968, 2015.

- [127] A. Pavlov, E. Børhaug, E. Panteley, and K. Y. Pettersen. Straight line path following for formations of underactuated surface vessels. In *Proceedings of the 7th IFAC Symposium on Nonlinear Control Systems*, pages 521 – 526, Pretoria, South Africa, August 2007.
- [128] E. Pedersen, K. Inoue, and M. Tsugane. Simulator studies on a collision avoidance display that facilitates efficient and precise assessment of evasive manoeuvres in congested waterways. *Journal of Navigation*, 56(3):411427, 2003.
- [129] Z. Peng, J. Wang, and D. Wang. Containment maneuvering of marine surface vehicles with multiple parameterized paths via spatial-temporal decoupling. *IEEE/ASME Transactions on Mechatronics*, 22(2):1026–1036, 2017.
- [130] Z. Peng, J. Wang, and D. Wang. Distributed containment maneuvering of multiple marine vessels via neurodynamics-based output feedback. *IEEE Transactions on Industrial Electronics*, 64(5):3831–3839, 2017.
- [131] Z. Peng, J. Wang, and D. Wang. Distributed maneuvering of autonomous surface vehicles based on neurodynamic optimization and fuzzy approximation. *IEEE Transactions on Control Systems Technology*, 26(3):1083–1090, 2018.
- [132] F. J. Pereda, H. G. de Marina, J. M. Giron-Sierra, and J. Jimenez. Towards automatic oil spill confinement with autonomous marine surface vehicles. In *Proceedings of the 2011 IEEE OCEANS*, pages 1–6, Santander, Spain, June 2011.
- [133] M. L. Pinedo. *Scheduling: Theory, Algorithms, and Systems*. Springer, Cham, 2016.
- [134] T. Platz and G. Klatt. *Inland Waterway Transport: Challenges and Prospects*, chapter The role of inland waterway transport in the changing logistics environment, page 37. Routledge, 2017.
- [135] R. Polvara, S. Sharma, J. Wan, A. Manning, and R. Sutton. Obstacle avoidance approaches for autonomous navigation of unmanned surface vehicles. *Journal of Navigation*, 71(1):241256, 2018.
- [136] Port of Rotterdam Authority. Copyright free port map high resolution, June 2017. URL <https://www.portofrotterdam.com/en/downloads/graphical-maps/port-of-rotterdam>.
- [137] Port of Rotterdam Authority. Barge performance monitor, 2019. URL <https://www.portofrotterdam.com/nl/zakendoen/logistiek/verbindingen/barge-performance-monitor>.
- [138] Fangli Qiao, Guansuo Wang, Liping Yin, Kan Zeng, Yuanling Zhang, Min Zhang, Bin Xiao, Shumin Jiang, Haibo Chen, and Ge Chen. Modelling oil trajectories and potentially contaminated areas from the sanchi oil spill. *Science of The Total Environment*, 685:856 – 866, 2019.
- [139] Z. Qin, Z. Lin, D. Yang, and P. Li. A task-based hierarchical control strategy for autonomous motion of an unmanned surface vehicle swarm. *Applied Ocean Research*, 65:251 – 261, 2017.

- [140] J. B. Rawlings and D. Q. Mayne. *Model Predictive Control: Theory and Design*. Madison, USA: Nob Hill Publishing, 2015.
- [141] W. Ren and R. W. Beard. *Distributed Consensus in Multi-vehicle Cooperative Control*. Springer, London, UK, 2008.
- [142] W. Ren and Y. Cao. *Distributed coordination of multi-agent networks: emergent problems, models, and issues*. Springer Science & Business Media, 2010.
- [143] C. W. Reynolds. Flocks, herds and schools: A distributed behavioral model. *ACM SIGGRAPH Computer Graphics*, 21(4):25–34, 1987.
- [144] A. Richards and J. P. How. Aircraft trajectory planning with collision avoidance using mixed integer linear programming. In *Proceedings of the 2002 American Control Conference*, pages 1936–1941, Anchorage, AK, USA, 2002.
- [145] Rijkswaterstaat. Scheepsongevallenregistratie, 2015. URL <https://www.rijkswaterstaat.nl/zakelijk/verkeersmanagement/scheepvaart/scheepsongevallenregistratie/index.aspx>.
- [146] Rijkswaterstaat. Binnenvaartpolitiereglement, 2017. URL <http://wetten.overheid.nl/BWBR0003628/2017-01-01>.
- [147] Rijkswaterstaat. Map of waterways, August 2018. URL <https://waterinfo.rws.nl/#!/kaart/waterhoogte-t-o-v-nap/>.
- [148] J. Rohcsá and G. Simongáti. The role of inland waterway navigation in a sustainable transport system. *Transport*, 22(3):148–153, 2007.
- [149] M. Salous, A. Hahn, and C. Denker. COLREGs-coverage in collision avoidance approaches: Review and identification of solutions. In *Proceedings of the 12th International Symposium on Integrated Ships Information Systems & Marine Traffic Engineering Conference*, pages 1–10, Hamburg, Germany, September 2016.
- [150] R. Scattolini. Architectures for distributed and hierarchical model predictive control – A review. *Journal of Process Control*, 19(5):723 – 731, 2009.
- [151] O. Schlichting. Ship resistance in water of limited depth - resistance of seagoing vessels in shallow water. *Jahrbuch der STG*, 35:127–148, 1934.
- [152] J. S. Shamma. *Cooperative Control of Distributed Multi-Agent Systems*. John Wiley & Sons Ltd, England, 2007.
- [153] K. Shojaei. Leader-follower formation control of underactuated autonomous marine surface vehicles with limited torque. *Ocean Engineering*, 105:196 – 205, 2015. ISSN 0029-8018.
- [154] R. Skjetne, S. Moi, and T. I. Fossen. Nonlinear formation control of marine craft. In *Proceedings of the 41st IEEE Conference on Decision and Control*, volume 2, pages 1699–1704, Las Vegas, NV, USA, Dec 2002.

- [155] R. Skjetne, T. I. Fossen, and P. V. Kokotović. Adaptive maneuvering, with experiments, for a model ship in a marine control laboratory. *Automatica*, 41(2):289–298, 2005.
- [156] Society of Naval Architects and Marine Engineers. Nomenclature for treating the motion of a submerged body through a fluid. Technical Report Technical and research bulletin NO.1-5, 1952.
- [157] A. Soni and H. Hu. Formation control for a fleet of autonomous ground vehicles: A survey. *Robotics*, 7(4), 2018.
- [158] R. Stahlbock and S. Voß. Operations research at container terminals: a literature update. *OR Spectrum*, 30(1):1–52, 2008.
- [159] Z. Sun, G. Zhang, Y. Lu, and W. Zhang. Leader-follower formation control of under-actuated surface vehicles based on sliding mode control and parameter estimation. *ISA Transactions*, 72:15 – 24, 2018.
- [160] R. Szlapczynski and J. Szlapczynska. A method of determining and visualizing safe motion parameters of a ship navigating in restricted waters. *Ocean Engineering*, 129: 363 – 373, 2017.
- [161] C. K. Tam and R. Bucknall. Cooperative path planning algorithm for marine surface vessels. *Ocean Engineering*, 57:25–33, 2013.
- [162] C. K. Tam, R. Bucknall, and A. Greig. Review of collision avoidance and path planning methods for ships in close range encounters. *Journal of Navigation*, 62(3): 455–476, 2009.
- [163] J. Tao, L. Du, M. Dehmer, Y. Wen, G. Xie, and Q. Zhou. Path following control for towing system of cylindrical drilling platform in presence of disturbances and uncertainties. *ISA Transactions (In Press)*, 2019.
- [164] C. F. L. Thorvaldsen and R. Skjetne. Formation control of fully-actuated marine vessels using group agreement protocols. In *Proceedings of the 50th IEEE Conference on Decision and Control and European Control Conference*, pages 4132–4139, Orlando, FL, USA, December 2011.
- [165] T. S. Tiang and M. N. Mahyuddin. Cooperative formation control algorithm of a generic multi-agent system applicable for multi-autonomous surface vehicles. In *Proceedings of the 2016 IEEE International Conference on Underwater System Technology: Theory and Applications (USYS)*, pages 133–138, Penang, Malaysia, Dec 2016.
- [166] K. Tierney, S. Voß, and R. Stahlbock. A mathematical model of inter-terminal transportation. *European Journal of Operational Research*, 235(2):448 – 460, 2014. ISSN 0377-2217.
- [167] C. J. Ting and P. Schonfeld. Integrated control for series of waterway locks. *Journal of Waterway, Port, Coastal, and Ocean Engineering*, 124(4):199–206, 1998.

- [168] C. J. Ting and P. Schonfeld. Efficiency versus fairness in priority control: Waterway lock case. *Journal of Waterway, Port, Coastal, and Ocean Engineering*, 127(2):82–88, 2001.
- [169] C. J. Ting and P. Schonfeld. Control alternatives at a waterway lock. *Journal of Waterway, Port, Coastal, and Ocean Engineering*, 127(2):89–96, 2001.
- [170] P. Toth and D. Vigo. *Vehicle Routing: Problems, Methods, and Applications*. Society for Industrial and Applied Mathematics, 2014.
- [171] E. Tuci, M. H. M. Alkilabi, and O. Akanyeti. Cooperative object transport in multi-robot systems: A review of the state-of-the-art. *Frontiers in Robotics and AI*, 5:59, 2018.
- [172] J. Van den Berg, M. Lin, and D. Manocha. Reciprocal velocity obstacles for real-time multi-agent navigation. In *Proceedings of the IEEE International Conference on Robotics and Automation (ICRA 2008)*, pages 1928–1935, California, USA, May 2008.
- [173] J. Verstichel. *The Lock Scheduling Problem*. PhD thesis, Katholieke Universiteit Leuven, Leuven, Belgium, 2013.
- [174] J. Verstichel and G. V. Berghe. A late acceptance algorithm for the lock scheduling problem. In S. Voß, J. Pahl, and S. Schwarze, editors, *Logistik Management*, pages 457–478, Heidelberg, 2009. Physica-Verlag HD. ISBN 978-3-7908-2362-2.
- [175] J. Verstichel, P. De Causmaecker, and G. Vanden Berghe. Scheduling algorithms for the lock scheduling problem. *Procedia - Social and Behavioral Sciences*, 20:806 – 815, 2011.
- [176] J. Verstichel, P. De Causmaecker, F. C. R. Spieksma, and G. Vanden Berghe. Exact and heuristic methods for placing ships in locks. *European Journal of Operational Research*, 235(2):387 – 398, 2014.
- [177] J. Verstichel, P. De Causmaecker, F. C. R. Spieksma, and G. Vanden Berghe. The generalized lock scheduling problem: An exact approach. *Transportation Research Part E: Logistics and Transportation Review*, 65:16 – 34, 2014.
- [178] A. Wächter and L. T. Biegler. On the implementation of an interior-point filter line-search algorithm for large-scale nonlinear programming. *Mathematical Programming*, 106(1):25–57, 2006.
- [179] H. Wang, D. Wang, and Z. Peng. Neural network based adaptive dynamic surface control for cooperative path following of marine surface vehicles via state and output feedback. *Neurocomputing*, 133:170 – 178, 2014.
- [180] J. Wang, J. Y. Liu, and H. Yi. Formation control of unmanned surface vehicles with sensing constraints using exponential remapping method. *Mathematical Problems in Engineering*, 2017, 2017.

- [181] S. L. Wang and L. Z. Liao. Decomposition method with a variable parameter for a class of monotone variational inequality problems. *Journal of Optimization Theory and Applications*, 109(2):415–429, 2001.
- [182] W. Xie, B. Ma, T. Fernando, and H. Ho-Ching Iu. A new formation control of multiple underactuated surface vessels. *International Journal of Control*, 91(5):1011–1022, 2018.
- [183] Z. Yan, C. Deng, D. Chi, T. Chen, and S. Hou. Path planning method for uuv homing and docking in movement disorders environment. *The Scientific World Journal*, 2014, 2014.
- [184] J. Zhang, D. Zhang, X. Yan, S. Haugen, and C. G. Soares. A distributed anti-collision decision support formulation in multi-ship encounter situations under colregs. *Ocean Engineering*, 105:336 – 348, 2015.
- [185] H. Zheng. *Coordination of Waterborne AGVs*. PhD thesis, Delft University of Technology, 2016.
- [186] H. Zheng, R. R. Negenborn, and G. Lodewijks. Predictive path following with arrival time awareness for Waterborne AGVs. *Transportation Research Part C: Emerging Technologies*, 70:214–237, 2016.
- [187] H. Zheng, R. R. Negenborn, and G. Lodewijks. Closed-loop scheduling and control of Waterborne AGVs for energy-efficient inter terminal transport. *Transportation Research Part E: Logistics and Transportation Review*, 105:261 – 278, 2017.
- [188] H. Zheng, R. R. Negenborn, and G. Lodewijks. Fast ADMM for distributed model predictive control of cooperative Waterborne AGVs. *IEEE Transactions on Control Systems Technology*, 25(4):1406–1413, 2017.
- [189] H. Zheng, R. R. Negenborn, and G. Lodewijks. Robust distributed predictive control of Waterborne AGVs –a cooperative and cost-effective approach. *IEEE Transactions on Cybernetics*, 48(8):2449–2461, 2018.
- [190] Y. Zhou, W. Daamen, T. Vellinga, and S. Hoogendoorn. Review of maritime traffic models from vessel behavior modeling perspective. *Transportation Research Part C: Emerging Technologies*, 105:323 – 345, 2019.
- [191] M. Zhu, A. Hahn, Y. Q. Wen, and W. Q. Sun. Optimized support vector regression algorithm-based modeling of ship dynamics. *Applied Ocean Research*, 90:101842, 2019.

Glossary

Conventions

The following conventions are used in this thesis for notation and symbols:

- A capital case character typeset in calligraphics, e.g., \mathcal{N} represents a set.
- A subscript i , j , or a of a variable, e.g., x_i , x_j , x_a refers to a variable of a controller i , j or a , respectively.
- Subscripts including max and min of a variable, e.g., v_{\max} and v_{\min} , represent the maximum and minimum value of the variable, respectively.
- A superscript s of a variable, e.g., x^s , refers to the variable at the iteration s .
- A superscript T e.g., x^T represents that a transpose is taking place.
- A tilde over a variable, e.g., \tilde{x} , indicates a variable specified over a prediction horizon.
- A bar over a variable, e.g., \bar{v} , indicates the average value of the variable.
- A variable followed by $(k+l|k)$, i.e., $\tau_i(k+l|k)$, indicates the prediction of the variable at time step $k+l$ made at time step k .

List of symbols and notations

Below follows a list of the most frequently used symbols and notations in this thesis.

a	numbering of the controllers
$a^{\text{SFC}}, b^{\text{SFC}}, c^{\text{SFC}}$	SFC parameters dependent on the diesel engine specifications
A^{CS}	cross-sectional area of the towline
A_i, B_i	Jacobian matrices according to the seed state and seed input for the successively linearized model of ASV i
\mathcal{B}_p	set of the conflicting blocks in intersection p
$BT_{i,p \rightarrow q}$	buffer time for vessel i sailing from intersection p to intersection q

$C_i, C_{RB,i}, C_{A,i}$	Coriolis-centripetal matrix, rigid-body Coriolis-centripetal matrix, and the added mass Coriolis-centripetal matrix of ASV i
C_i	sequence of intersections that vessel i has to pass through
$d_{ij i}$	distance between ASV i and ASV j calculated by ASV i
$d_{ij i}^{x^+}, d_{ij i}^{y^+}, d_{ij i}^{x^-}, d_{ij i}^{y^-}$	distance between ASV i and j that ASV i measured in the four directions $+X, +Y, -X,$ and $-Y,$ respectively
d_{safe}	safety distance
d_{im}	length of the path that ASV i need to pass through the block m
$d_{i,m \rightarrow n}$	distance between block m and n
$d_{i,p \rightarrow q}$	distance from intersection p to intersection q
$D_{H,1}^{\text{fore}}$	horizontal distance between the two ends of the towline
$DTA_{i p}$	DTA of vessel i that IC of intersection p calculated
D_i	damping force of ASV i
E	Young's modulus of the towline
Ea_i	earliest arrival time
$ETA_{i q}$	ETA of vessel i at intersection q
$f_i(x_i, \tau_i)$	continuous nonlinear dynamic model of ASV i
$F = [F_1^{\text{fore}}, F_1^{\text{aft}}, F_2^{\text{fore}}, F_2^{\text{aft}}, F_3^{\text{stern}}]^T$	forces along the towlines on the horizontal plane
F_{max}	maximum forces on the towline
$g(x_a, u_a, z_b)$	coupling constraint of controller a and its neighbor $b \in \mathcal{N}_a$
G_R	gravity of the towline
$\mathcal{G} = (\mathcal{V}, \mathcal{E})$	a graph consists of a set of vertices \mathcal{V} and a set of edges \mathcal{E}
$h_i(\cdot)$	function that describes the geometric relation between the object and the ASVs
H_p	prediction horizon
i, j	numbering of the vessels
$J_i, J_i^{\text{Pb}}, J_i^{\text{Sc}}$	objective function of ASV i
k	discrete time step
l	time step in the prediction horizon
L_R	length of the towline
L^{tie}	distance from the center of mass of the object to the segment between the ties
m, n	numbering of the conflicting blocks

$M_i, M_{RB,i}, M_{A,i}$	inertia matrix, rigid-body mass matrix, and the added mass matrix of ASV i
n_{cnt}	size of the interconnecting variable y_a
N	number of controllers in a CMVS
\mathcal{N}	set of controllers in a CMVS
\mathcal{N}_i	set of the neighbors of controller i
p, q	numbering of the intersections in a waterway network
$P_{\text{en},i}$	delivered mechanical power
P_i	position of ASV i
$P_{j i}$	position of ASV j that controller i received
\bar{P}_i	speed consensus position
P_l	position calculated with linearized dynamic model
P_{nl}	position calculated by nonlinear dynamic model
r_i	interaction range of controller i
r_{ij}^d	desired relative distance, orientation, or position
R	a rotation matrix
$R_{\text{pri}}, R_{\text{dual}}$	primal and dual residual
s	sth iteration
s_{im}	arrival time of vessel i at block m
$t_{i,\text{safe}}$	safe time interval
t_{im}	time vessel i need to pass through block m
$T_{i,m \rightarrow n}$	time needed from block m to n
T_{ip}	total travel time of vessel i passing through intersection p
T_1^{fore}	tension of the towline that connects the fore tie at the object and ASV 1 in the horizontal direction
$\tilde{T}_1^{\text{fore}}$	tension on the towline that connects the fore tie at the object and ASV 1 in the horizontal direction
T_{max}	makespan, the total time needed for all vessels to pass through the intersection
u_p	control input of intersection p
\hat{v}	initial planned speed for generating reference path
$\mathcal{V} = \{1, 2, \dots, n\}$	set of vessels within a CMVS
\mathcal{V}_p	set of vessels passing intersection p
\mathcal{VT}_ι	vessel train ι
w_i	reference state, including reference position and heading

$x_i = [\eta_i^T, v_i^T]^T$	system state of ASV i
\tilde{x}^e	seed state for the successively linearized model of ASV i
\mathcal{X}_i	state constraints of ASV i
y_a	interconnecting variables that controller a computes
z_a	interconnecting variables of controller a that other controllers expect
α, β, γ	weights in the objective function
$\alpha^{\text{Pb}}, \beta^{\text{Pb}}, \gamma^{\text{Pb}}$	weights for trajectory following, aggregation and control efforts in Position-based VTF formulation
$\alpha^{\text{Sc}}, \beta^{\text{Sc}}, \gamma^{\text{Sc}}$	weights for trajectory following, speed consensus and control efforts in Speed-based VTF formulation
ξ	weight of fuel efficiency
$\eta_i = [x_i^N, y_i^N, \psi_i]^T$	coordinates x_i^N, y_i^N , and heading angle ψ_i of ASV i in the North-East-Down coordinate
$\bar{\psi}_i$	consensus velocity
$v_i = [u_i^B, v_i^B, r_i^B]^T$	surge and sway velocities u_i^B, v_i^B , and yaw rate r_i^B of ASV i in the Body-fixed reference frame of ASV i
$v_{i,\min}, v_{i,\max}$	minimum and maximum linear and angular velocities of ASV i
$\tau_i = [\tau_{u_i}, \tau_{v_i}, \tau_{r_i}]^T$	control input of of ASV i , including surge and sway forces τ_{u_i}, τ_{v_i} , and moment τ_{r_i}
$\tau_{i,\min}, \tau_{i,\max}$	minimum and maximum control inputs
$\tau_{i,\text{low}}^{\text{eff}}, \tau_{i,\text{up}}^{\text{eff}}$	lower and upper boundary of the fuel efficient control inputs
$\tau^* = [\tau_u^*, \tau_v^*, \tau_r^*]^T$	forces and moment that are needed to move the floating object
$\tilde{\tau}^e$	seed input for the successively linearized model of ASV i
\mathcal{T}_i	control constraints of ASV i
δ_{ij}	slack variable for aggregation of ASV i and j
ζ_i	slack variable introduced for fuel efficiency
ρ_a	penalty parameter for controller a
λ_a	dual variable for controller a
φ_i	responsibility parameter of ASV i in the negotiation framework
$\ell(\cdot)$	function for calculating the power to produce required control force and moment
$\varepsilon^{\text{abs}}, \varepsilon^{\text{rel}}$	absolute tolerance and relative tolerance
$\varepsilon_{\text{pri}}, \varepsilon_{\text{dual}}$	feasibility tolerances for primal and dual residuals
$\theta_i^{\text{fore}}, \theta_i^{\text{aft}}$	angles between the towlines and central line of the object, whose subscript and superscript indicate different towlines

ω	angle of the segment between two ties and the center of mass of the floating object
ϖ	density of the towline
ϑ_{N_i}	Speed consensus state
κ	an arbitrarily positive large number
$\chi_{i,j,m}$	binary variables for WIS problem
$\phi_{i j l,g}$	binary variables for collision avoidance constraints
Γ	transformation matrix between τ^* and F
Υ	the aggregation range
Ξ	navigable waters

List of abbreviations

The following abbreviations are used in this thesis.

ADMM	Alternating Direction of Multipliers Method
AGV	Automated Guided Vehicles
ALV	Automated Lift Vehicles
ASV	Autonomous Surface Vessel
CMVS	Cooperative Multi-Vessel System
CWIS	Cooperative Waterway Intersection Scheduling
COLREGs	International Regulations for Preventing Collisions at Sea
DMPC	Distributed Model Predictive Control
DTA	Desired Time of Arrival
ETA	Estimate Time of Arrival
FIFO	First In First Out
GVO	Generalized Velocity Obstacle
I2I	Infrastructure-to-Infrastructure
IC	Infrastructure Controller
IMO	International Maritime Organization
ITT	Inter-Terminal Transport
MASS	Maritime Autonomous Surface Ship
MIP	Mixed Integer Programming
MPC	Model Predictive Control
OS	Own Ship
PF	Potential Function
PID	Proportional Integral Derivative
RVO	Reciprocal Velocity Obstacles
SFC	Specific Fuel Consumption
SOS-database	Scheepsongevallendatabase
TS	Target Ship

V2V	Vessel-to-Vessel
V2I	Vessel-to-Infrastructure
VC	Vessel Controller
VRP	Vehicle Routing Problem
VRPP	Vessel Rotation Planning Problem
VTF	Vessel Train Formation
Waterborne AGV	Waterborne Autonomous Guided Vessel
WIS	Waterway Intersection Scheduling

List of optimization problems

Below follows the main optimization problems formulated in this thesis.

Problem \mathcal{A}	Generic motion control problem in the Model Predictive Control framework
Problem \mathcal{B}	Generic cooperation problem in the negotiation framework
Problem \mathcal{C}	Optimization problem for VTF control
Problem \mathcal{D}	Optimization problem for calculating the required control to move the floating object
Problem \mathcal{E}	Optimization problem for control allocation for Cooperative Floating Object transport
Problem \mathcal{F}	Optimization problem for motion control of the ASVs for Cooperative Floating Object transport
Problem \mathcal{G}	Overall control problem for Cooperative Floating Object transport
Problem \mathcal{H}	Optimization problem for Waterway Intersection Scheduling

Samenvatting

Coöperatieve Meer-Vaarttuig-Systemen voor transport over water

Het Autonome Oppervlakte Vaarttuig (E. Autonomous Surface Vessel, ASV) is een innovatie die bijdraagt aan de veiligheid en de efficiëntie van het transport over water; er wordt de laatste tijd veel aandacht aan besteed. Voor het optimaliseren van systemen voor transport over water is het niet alleen nodig dat de individuele vaartuigen worden geautomatiseerd, maar ook de samenwerking tussen de vaartuigen. Ten eerste: onjuiste interpretatie van de plannen van ontmoetende vaartuigen kan leiden tot oscillatie en aanvaringen. Ten tweede: als het drukker wordt kan het leiden tot inefficiëntie en zelfs tot chaos, als elk vaartuig op zichzelf handelt. Ten derde: conflicterende programmas van individuele vaartuigen kunnen leiden tot inefficiënt gebruik van de infrastructuur. Daarnaast kunnen grotere efficiëntie en operationele capaciteit worden gerealiseerd met samenwerkende ASVs dan met individueel opererende.

Doel van dit onderzoek is verbetering van de efficiëntie en de veiligheid van het transport over water door Vaarttuig-Vaarttuig- (V2V), Vaarttuig-Infrastructuur- (V2I) en Infrastructuur-Infrastructuur- (I2I) communicatie en samenwerking. Er wordt een opzet gegeven van een Coöperatief Meer-Vaarttuig Systeem (CMVS) en van een framework voor het ontwerp van een bewegingsregeling voor ASVs volgens het principe van modelgebaseerd voorspellend regelen (MPC). Er wordt een generiek framework voorgesteld voor de onderhandeling en de samenwerking van ASVs, met het doel de overall veiligheid en de efficiëntie te verbeteren, of voor het uitvoeren van specifieke taken. De onderhandelingsmethodiek is gebaseerd op de 'Alternating Direction of Multipliers Methode' (ADMM). Het framework voor de regeling van de bewegingen en het framework voor de onderhandelingen worden gebruikt voor V2V-, V2I- en I2I-samenwerking op verschillende niveaus. Er zijn vier types samenwerking onderzocht: het vormen van vaartuigtreinen (E. Vessel Train Formation, VTF), gecoördineerd transport van drijvende objecten (E. Cooperative Floating Object Transport, CFOT), de verkeersplanning op een knooppunt van waterwegen (E. Waterway Intersection Scheduling, WIS) en gecoördineerde verkeersplanning op een knooppunt van waterwegen (E. Cooperative Waterway Intersection Scheduling, CWIS).

Algemene opzet en regelframework

Er worden in systemen voor het transport over water drie niveaus onderscheiden, afhankelijk van het bereik van communicatie en samenwerking. De individuele laag is de basislaag waar een regelaar de bewegingen van een individueel vaartuig aanstuurt. De lokale laag betreft V2V en V2I interacties, waaronder samenwerking op een tak (segment van een vaarweg) en in een knoop (een knooppunt van waterwegen of een element van de infrastructuur). De netwerklaag betreft niet alleen V2V en V2I interacties, maar ook de onderlinge afhankelijkheid van verbonden delen van de infrastructuur, d.w.z. I2I interacties.

Het CMVS-concept wordt voorgesteld voor de coöperatieve regeling van vaartuigen en infrastructuur in netwerken van waterwegen, op verschillende niveaus. Er worden twee types regelingen geïntroduceerd: een regeling voor een individueel vaartuig (E. Vessel Controller, VC) en een Infrastructuur Controller (EC), die verantwoordelijk is voor het oplossen van conflicten van vaartuigen op een deel van de infrastructuur. Voor de sturing van ASVs wordt MPC gebruikt wegens het principe van de schuivende horizon, wat gunstig is voor de behandeling van conflicten en ook om bestand te zijn tegen verstoringen en onzekerheden. Er is een op MPC gebaseerd framework ontwikkeld voor de opzet van VCs met een succesief gelineariseerd voorspelmodel. De communicatie en coöperatie van vaartuigen in verschillende vloten vinden plaats met ICs. Analoog communiceren en werken ICs met elkaar samen door informatie uit te wisselen met VCs.

Een op ADMM gebaseerd generiek onderhandelingsframework is opgezet voor de afstemming tussen de verschillende regelaars. Dit framework is op verschillende manieren generiek. In de eerste plaats kunnen zowel seriële als parallelle en zelfs hybride iteratieve structuren worden opgenomen. Ten tweede kan het framework worden gebruikt voor het overleg tussen verschillende soorten regelaars. De regelaars stellen hun acties vast overeenkomstig de informatie welke ze in het overlegsysteem krijgen van andere controllers. Het is daarom niet nodig dat de dynamica van verschillende ASVs gelijk is, noch is het nodig dat de operatiemodellen van verschillende delen van de infrastructuur overeenkomen.

Intra-CMVS V2V coöperatie

Het gebruik van het voorgestelde framework voor de regeling van de bewegingen en het onderhandelingsframework leiden tot twee types V2V samenwerking voor ASVs in een CMVS: VFT (Vessel Train Formation) voor coöperatieve navigatie op waterwegen en CFOT (gecoördineerd transport van drijvende objecten) voor het uitvoeren van specifieke taken. VTF beschrijft de interacties tussen ASVs op het niveau van een tak in het netwerk. Er zijn drie doelstellingen gedefinieerd voor het VTF-probleem: pad volgen, aggregatie en voorkomen van aanvaringen. Het VTF-probleem kan op twee manieren worden geformuleerd, overeenkomstig de manier waarop wordt geaggregeerd: een formulering op basis van de positie en een formulering op basis van de snelheid. Daarnaast wordt een methode Eco-VTF gepresenteerd, waarbij efficiëntie van brandstofgebruik wordt nagestreefd. Er wordt een serieel interactief rekenschema gebruikt om consensus tussen de VCs te bereiken. Er zijn simulatie-experimenten uitgevoerd om na te gaan hoe de veiligheid en de efficiëntie verbeteren door de voorgestelde controllers en frameworks. Zowel met positie-gebaseerd VTF als met snelheid-gebaseerd VTF worden vaartuigen met succes vanuit verschillende uitgangsposities geleid voor het vormen van een vaartuigtrein. Door de effectieve commu-

nicatie kunnen vaartuigen tijdig reageren op snelheidsveranderingen van andere vaartuigen. Nadat het treintje vaartuigen is gevormd, worden de snelheden van de vaartuigen gelijk en blijven de afstanden tussen de vaartuigen gelijk. Bovendien blijkt dat door gebruik van de Eco-VTF-methode een significante hoeveelheid brandstof kan worden bespaard.

CFOT betreft een vorm van nauwe samenwerking tussen ASVs voor het uitvoeren van specifieke taken. Doel is het benutten van een team ASVs voor het transport van een groot drijvend object, zoals een groot vaartuig, een duwbak of een offshore platform. Het object en de ASVs zijn verbonden met sleepkabels en tijdens het verplaatsen van het object blijven de ASVs in formatie. Er wordt voor dit probleem een meerlaags gedistribueerd regelsysteem voorgesteld. Met het ontworpen schema wordt het oorspronkelijke coöperatieve transportprobleem beschouwd als de combinatie van verschillende deelproblemen, het volgen van het pad door het object, inzet van regeling en routing van de ASV-formatie. Simulatie-experimenten laten zien dat met het voorgestelde coöperatieve systeem het object kan worden verplaatst volgens een van te voren gedefinieerd pad, met vermindering van potentiële statische en dynamische obstakels.

Inter-CMVS V2I and V2V coöperatie

Als voorbeeld om de inter-CMVS interactie te illustreren wordt een knooppunt gebruikt. Het knooppunt wordt gemodelleerd met conflicterende blokken. Het passeren van een knooppunt door een vaartuig kan worden beschouwd als het innemen van ruimte gedurende een zekere tijd. Het plannen van het passeren van het knooppunt (E. Waterway Intersection Scheduling, WIS) kan dus worden geformuleerd als een toewijzingsprobleem (E. resource allocation problem). Er worden drie beperkingen geformuleerd ter voorkoming van conflicten: m.b.t. volgorde, niet-wachten en beschikbaarheid. Door het oplossen van het WIS-probleem kunnen de gewenste aankomsttijden (E. desired time of arrival, DTA) van de ASVs worden bepaald. Er zijn experimenten uitgevoerd waarin tot 30 ASVs het knooppunt passeren. Het schema wordt opnieuw berekend als een of meer vaartuigen niet op tijd kunnen zijn. Door de herberekening worden tijd en ruimte efficiënter gebruikt. Daardoor neemt de totale tijd af, die nodig is om alle vaartuigen het knooppunt te laten passeren. De coöperatieve situatie met de CMVSen is vergeleken met een basissituatie. In de basissituatie worden aanvaringen vermeden met de 'Generalized Velocity Obstacle' methode (GVO) en vaartuigen passeren het knooppunt volgens het 'First In First Out' principe. De resultaten laten zien dat in de nieuwe methode het te volgen pad beter wordt gevolgd; bij de GVO-methode zijn er minder snelheidsveranderingen; door CMVSen wordt de tijd die nodig is voor de afwikkeling van het verkeer en de totale vaartijd beperkt; een simulatie van verkeer op het water in het centrum/Oosterdok van Amsterdam laat de samenwerking tussen ICs zien.

In verband met infrastructuur in een netwerk is de WIS verder uitgebreid tot netwerkniveau als Coordinated Waterway Intersection Scheduling (CWIS). De onderlinge afhankelijkheid van verbonden knooppunten wordt gerepresenteerd door de uitwisseling van de vroegste aankomsttijden van de vaartuigen op knooppunten. Als een vaartuig een serie knooppunten moet passeren, heeft de planning die een IC maakt invloed op de vroegste aankomsttijden bij achtereenvolgende knooppunten. De segmenten tussen de knooppunten kunnen werken als buffers waar vaartuigen kunnen versnellen of vertragen om op de ge-

wenste tijd aan te komen bij de knooppunten. Het generieke onderhandelingsframework wordt gebruikt voor het coördineren van de ICs in het waterwegennetwerk. Met simulaties van vaartuigenbewegingen in het centrum/Oosterdok van Amsterdam zijn de voordelen van V2I en I2I communicatie en coöperatie geïllustreerd.

Samenvattend: in dit proefschrift worden V2V, V2I en I2I coöperatie van CMVs onderzocht, ter verbetering van veiligheid en efficiëntie van het transport over water. Er worden een framework voor voorspellende snelheidsregeling en een generiek onderhandelingsframework voor de afstemming tussen de regelaars voorgesteld. Verschillende toepassingen van de twee frameworks geven inzicht in de invloed van CMVs op de prestaties van systemen voor transport over water. Er zijn vier types coöperatie en de toepassing ervan in de haven van Rotterdam en in het centrum/Oosterdok van Amsterdam onderzocht: het vormen van vaartuigtreinen (E. Vessel Train Formation, VTF), gecoördineerd transport van drijvende objecten (E. Cooperative Floating Object Transport, CFOT), de verkeersplanning op een knooppunt van waterwegen (E. Waterway Intersection Scheduling, WIS) en gecoördineerde verkeersplanning op een knooppunt van waterwegen (E. Cooperative Waterway Intersection Scheduling, CWIS).

Summary

Cooperative Multi-Vessel Systems for Waterborne Transport

The Autonomous Surface Vessel (ASV) is an innovation to contribute to the safety and efficiency of waterborne transport and recently drawing much attention. However, optimizing the performance of waterborne transport system requires not only automation of the individual vessels but also cooperation among vessels. Firstly, misunderstanding of the intentions of the encountering vessels may lead to oscillation and even collisions. Secondly, when the traffic becomes denser, each vessel acting on her own way may cause inefficiency, even chaos. Thirdly, conflicting time schedules could lead to inefficient utilization of infrastructure resources. Moreover, compared to an individual ASV, higher efficiency and operational capability can be realized by a team ASVs working in a cooperative fashion.

This thesis aims at improving the navigation efficiency and safety of waterborne transport through Vessel-to-Vessel (V2V), Vessel-to-Infrastructure (V2I) and Infrastructure-to-Infrastructure (I2I) communication and cooperation. We propose the concept of Cooperative Multi-Vessel System (CMVS). A control framework based on Model Predictive Control (MPC) is constructed to design motion controller for ASVs. A generic negotiation framework based on the Alternating Direction of Multipliers Method (ADMM) is proposed for the negotiation and collaboration of ASVs for the aim of improving overall safety, efficiency, or for performing specific tasks. The motion control framework and the negotiation framework are used for V2V, V2I, and I2I cooperation at different layers. Specifically, four types of cooperation are investigated, i.e., Vessel Train Formation (VTF), Cooperative Floating Object Transport (CFOT), Waterway Intersection Scheduling (WIS), and Cooperative Waterway Intersection Scheduling (CWIS).

Generic concept and control framework

Three layers of cooperation in waterborne transport systems are identified according to the range of communication and cooperation. The individual layer is the basis layer that a controller controls the dynamics of an individual vessel. The local layer considers V2V and V2I interactions, including cooperation at a link (e.g., a waterway segment) and a node (e.g., an intersection, an individual infrastructure). The network layer considers not only V2V and V2I interactions but also the interdependence of interconnected infrastructures,

i.e., I2I interactions.

The concept of CMVS is proposed for cooperative control of vessels and infrastructures at different layers in waterway networks. We introduce two types of controllers: a Vessel Controller (VC) for the control of an ASV, and an Infrastructure Controller (IC) is responsible for solving the conflicts of vessels at an infrastructure. MPC is used for motion control of the ASVs because of its receding horizon principle, which is beneficial to deal with conflicts and to be robust against disturbances and uncertainties. An MPC-based control framework is developed with a successively linearized prediction model for the design of VCs. The communication and cooperation of vessels in different fleets are realized through ICs. Similarly, the ICs communicate and cooperate with each other by exchanging information with VCs.

A generic negotiation framework based on the ADMM is designed to deal with consensus problem among different controllers. The framework is generic in several ways. Firstly, both serial and parallel, and even hybrid iterative schemes can be addressed under the framework. Secondly, the framework can be used for the consensus problems of heterogeneous controllers. Controllers decide their actions according to the information provided by other controllers in the cooperative system. Therefore, the dynamics of ASVs need not necessarily to be the same, neither the operation models of the infrastructures.

Intra-CMVS V2V cooperation

Applications of the proposed predictive motion control framework and the negotiation framework are lead to two types of V2V cooperation among ASVs within a CMVS: VTF for cooperative navigation in waterways, and CFOT for performing specific tasks.

VTF describes the interactions between ASVs at the link level. We defined three objectives in the VTF problem, i.e., path following, aggregation, and collision avoidance. Two formulations of the VTF problem are proposed according to the ways to achieve aggregation, namely, Position-based formulation and Speed-based formulation. Moreover, a method, Eco-VTF, that considers fuel efficiency is presented. A serial iterative scheme with the proposed negotiation framework is employed to achieve consensus among the VCs. Simulation experiments are carried out to test How the proposed controllers and frameworks improve the safety and efficiency of waterborne transport through vessel-vessel cooperation. Both Position-based VTF and Speed-based VTF successfully steer the vessels from different origins to form a vessel train. Due to the effective communication, vessels can timely respond to the velocity changes that others make. After the train-like formation is formed, the speed of the vessels become consistent, and the distances between vessels become constant. Moreover, simulation results show that a significant amount of fuel saving can be obtained by using the Eco-VTF method.

CFOT represents a type of close interactions between ASVs for performing specific tasks. The aim is utilizing a team of ASVs to transport a large floating object, such as a large vessel, barge, or offshore platform. The object and the ASVs are connected with towlines, and the ASVs maintain the formation when moving the object. We propose a multi-layer distributed control structure for the object transport system. With the designed scheme, the original cooperative transport problem is considered as the combination of several sub-problems: trajectory tracking of the object, control allocation, and formation

tracking of the ASVs. Simulation experiments show that the proposed cooperative system can transport the floating object along a predefined trajectory and avoid potential static and dynamic obstacles.

Inter-CMVS V2I and V2V cooperation

An intersection is adopted as an example to illustrate the interactions between CMVSs. An intersection is modeled with conflicting blocks. A vessel passing through the intersection along the path can be regarded as occupying space resources for a specified period. Thus, the scheduling of intersection crossing sequences, i.e., WIS, is formulated as a resource allocation problem. Three specific constraints are set to avoid conflicts of the vessels, i.e., sequential constraint, no-wait constraint, and disjunctive constraint. By solving the WIS problem, the desired time of arrival (DTA) of the ASVs can be determined. Experiments involving the scenarios in which up to 30 ASVs are passing through an intersection. Rescheduling is triggered when some vessels cannot arrive on time. The rescheduling contributes to using time and space resources efficiently. Consequently, the total time that is needed for all the vessels to pass through the intersection does not increase. Moreover, we compare the cooperative situation with the proposed CMVSs with a baseline situation. In the baseline situation, vessels avoid collisions using the Generalized Velocity Obstacle (GVO) method and cross the intersection with a First In First Out rule. The results show that: the proposed method has better path following performance; the GVO method has fewer velocity changes; CMVSs helps to reduce the makespan and total travel time. In the end, a simulation of vessels sailing in the canal network in Amsterdam is presented to show the cooperation among ICs.

Considering the networked infrastructures, the WIS is further extended to network level as CWIS. The interdependence of interconnected intersections is considered through the communication of the earliest arrival times of the vessels at the intersections. When a vessel has to pass through a sequence of intersections, the schedules that an IC makes have impact on the earliest arrival time at the subsequent intersections. The segments connecting the intersections can provide buffers where vessels can accelerate or decelerate to arrive at the DTA at the intersections. The generic negotiation framework is employed to coordinate the ICs in a waterway network with a parallel scheme. Simulation experiments of vessels sailing in the canal network in Amsterdam are carried out to illustrate the advantages of V2I and I2I communication and cooperation.

In summary, this PhD thesis investigates V2V, V2I, and I2I cooperation of CMVSs for improving the safety and efficiency of waterborne transport. A predictive motion control framework and a generic negotiation framework are proposed to achieve consensus among controllers. Different applications of the two frameworks provide insights into the impact of CMVSs on the performance of waterborne transport systems. Specifically, four types of cooperation and their applications to Port of Rotterdam and metropolitan area of Amsterdam are investigated, i.e., Vessel Train Formation (VTF), Cooperative Floating Object Transport (CFOT), Waterway Intersection Scheduling (WIS), and Cooperative Waterway Intersection Scheduling (CWIS).

Curriculum vitae

Linying Chen was born on April 2, 1989, in Ningde, Fujian, China. She received the B.Sc. degree in maritime administration from Wuhan University of Technology, Hubei, China, and the B.Sc. degree in international economics and trade from Wuhan University, Hubei, China, in 2011. At the same year, she started her master study at Wuhan University of Technology, under the supervision of Prof. Junmin Mou. In 2012, she spent six months as a visiting student at the Department of Hydraulic Engineering, Delft University of Technology, under the supervision of Prof. Han Ligteringen. She obtained her M.Sc. degree in Traffic Information Engineering and Control from Wuhan University of Technology in 2014.

Sponsored by the China Scholarship Council, Linying Chen started her PhD research in November 2015 at the Department of Maritime Technology and Transport, Delft University of Technology, under the supervision of Prof. Rudy. R. Negenborn and Prof. Hans (J. J.) Hopman. During her PhD research, she worked on the concept of Cooperative Multi-Vessel Systems for improving safety and efficiency of waterborne transport systems. Her main research interests include autonomous vessels, cooperative control of multi-agent systems, model predictive control, and their application in waterborne transport systems.

Publications

Journal papers

1. **L. Chen**, Y. Huang, H. Zheng, J. J. Hopman, and R. R. Negenborn. Cooperative multi-vessel systems in urban waterway networks. *IEEE Transactions on Intelligent Transportation Systems*, PP(99): 1-14, 2019.
2. **L. Chen**, J. J. Hopman, and R. R. Negenborn. Distributed model predictive control for cooperative floating object transport with multi-vessel systems. *Ocean Engineering*, 191: 1-16, 2019.
3. **L. Chen**, J. J. Hopman, and R. R. Negenborn. Distributed model predictive control for vessel train formations of cooperative multi-vessel systems. *Transportation Research Part C: Emerging Technologies*, 92: 101–118, 2018.
4. **L. Chen**, T. L. Yip, and J. Mou. Provision of Emission Control Area and the impact on shipping route choice and ship emissions. *Transportation Research Part D: Transport and Environment*, 58: 280-291, 2018.

5. **L. Chen**, R. R. Negenborn, Y. Huang, and J. J. Hopman. Survey on cooperative control of vessels for waterborne transport. *Submitted to a journal*, 2019.
6. Y. Huang, **L. Chen**, P. Chen, R. R. Negenborn and P. H. A. J. M. van Gelder. Ship collision avoidance methods: State-of-the-art. *Safety Science*, 121: 451-473, 2020.
7. Y. Huang, **L. Chen**, and P. H. A. J. M. van Gelder. Generalized velocity obstacle algorithm for preventing ship collisions at sea. *Ocean Engineering*, 173: 142–156, 2019.

Conference papers

1. **L. Chen**, A. Haseltalab, V. Garofano, and R. R. Negenborn. Eco-VTF: Fuel-efficient vessel train formations for all-electric autonomous ships. In *Proceedings of the 2019 European Control Conference (ECC 2019)*, pages 1–8, Naples, Italy, June 2019.
2. **L. Chen**, J. J. Hopman, and R. R. Negenborn. Intersection crossing of cooperative multi-vessel systems. In *Proceedings of the 15th IFAC Symposium on Control in Transportation Systems (CTS 2018)*, pages 379–385, June 2018.
3. **L. Chen**, R. R. Negenborn, G. Lodewijks. Path planning for autonomous inland vessels using A*BG. In *Proceedings of the 7th International Conference on Computational Logistics (ICCL 2016)*, Lisbon, Portugal, pages 65-79, September 2016.
4. A. Devaraju, **L. Chen**, R. R. Negenborn. Autonomous surface vessels in ports: Applications, technology and port infrastructures. In *Proceedings of the 9th International Conference on Computational Logistics (ICCL 2018)*, pages 86-105, Vietri sul Mare, Italy, October 2018.
5. L. E. van Cappelle, **L. Chen**, R. R. Negenborn. Survey on ASV technology developments and readiness levels for autonomous shipping. In *Proceedings of the 9th International Conference on Computational Logistics (ICCL 2018)*, pages 106-123, Vietri sul Mare, Italy, October 2018.
6. M. Schiaretti, **L. Chen**, R. R. Negenborn. Survey on autonomous surface vessels: Part I - A new detailed definition of autonomy levels. In *Proceedings of the 8th International Conference on Computational Logistics (ICCL 2017)*, Southampton, UK, pages 219-233, October 2017.
7. M. Schiaretti, **L. Chen**, R. R. Negenborn. Survey on autonomous surface vessels: Part II - Categorization of 60 prototypes and future applications. In *Proceedings of the 8th International Conference on Computational Logistics (ICCL 2017)*, Southampton, UK, pages 234-252, October 2017.

TRAIL Thesis Series

The following list contains the most recent dissertations in the TRAIL Thesis Series. For a complete overview of more than 250 titles see the TRAIL website: www.rsTRAIL.nl.

The TRAIL Thesis Series is a series of the Netherlands TRAIL Research School on transport, infrastructure and logistics.

Chen, L., *Cooperative Multi-Vessel Systems for Waterborne Transport*, T2019/15, November 2019, TRAIL Thesis Series, the Netherlands

Kerkman, K.E., *Spatial Dependence in Travel Demand Models: Causes, implications, and solutions*, T2019/14, October 2019, TRAIL Thesis Series, the Netherlands

Liang, X., *Planning and Operation of Automated Taxi Systems*, T2019/13, September 2019, TRAIL Thesis Series, the Netherlands

Ton, D., *Unravelling Mode and Route Choice Behaviour of Active Mode Users*, T2019/12, September 2019, TRAIL Thesis Series, the Netherlands

Shu, Y., *Vessel Route Choice Model and Operational Model Based on Optimal Control*, T2019/11, September 2019, TRAIL Thesis Series, the Netherlands

Luan, X., *Traffic Management Optimization of Railway Networks*, T2019/10, July 2019, TRAIL Thesis Series, the Netherlands

Hu, Q., *Container Transport inside the Port Area and to the Hinterland*, T2019/9, July 2019, TRAIL Thesis Series, the Netherlands

Andani, I.G.A., *Toll Roads in Indonesia: transport system, accessibility, spatial and equity impacts*, T2019/8, June 2019, TRAIL Thesis Series, the Netherlands

Ma, W., *Sustainability of Deep Sea Mining Transport Plans*, T2019/7, June 2019, TRAIL Thesis Series, the Netherlands

Alemi, A., *Railway Wheel Defect Identification*, T2019/6, January 2019, TRAIL Thesis Series, the Netherlands

Liao, F., *Consumers, Business Models and Electric Vehicles*, T2019/5, May 2019, TRAIL Thesis Series, the Netherlands

Tamminga, G., *A Novel Design of the Transport Infrastructure for Traffic Simulation Mod-*

- els, T2019/4, March 2019, TRAIL Thesis Series, the Netherlands
- Lin, X., *Controlled Perishable Goods Logistics: Real-time coordination for fresher products*, T2019/3, January 2019, TRAIL Thesis Series, the Netherlands
- Dafnomilis, I., *Green Bulk Terminals: A strategic level approach to solid biomass terminal design*, T2019/2, January 2019, TRAIL Thesis Series, the Netherlands Feng, Fan, *Information Integration and Intelligent Control of Port Logistics System*, T2019/1, January 2019, TRAIL Thesis Series, the Netherlands
- Beinum, A.S. van, *Turbulence in Traffic at Motorway Ramps and its Impact on Traffic Operations and Safety*, T2018/12, December 2018, TRAIL Thesis Series, the Netherlands
- Bellsolà Olba, X., *Assessment of Capacity and Risk: A Framework for Vessel Traffic in Ports*, T2018/11, December 2018, TRAIL Thesis Series, the Netherlands
- Knapper, A.S., *The Effects of using Mobile Phones and Navigation Systems during Driving*, T2018/10, December 2018, TRAIL Thesis Series, the Netherlands
- Varotto, S.F., *Driver Behaviour during Control Transitions between Adaptive Cruise Control and Manual Driving: empirics and models*, T2018/9, December 2018, TRAIL Thesis Series, the Netherlands
- Stelling-Kończak, A., *Cycling Safe and Sound*, T2018/8, November 2018, TRAIL Thesis Series, the Netherlands
- Essen, van M.A., *The Potential of Social Routing Advice*, T2018/7, October 2018, TRAIL Thesis Series, the Netherlands
- Su, Zhou, *Maintenance Optimization for Railway Infrastructure Networks*, T2018/6, September 2018, TRAIL Thesis Series, the Netherlands
- Cai, J., *Residual Ultimate Strength of Seamless Metallic Pipelines with Structural Damage*, T2018/5, September 2018, TRAIL Thesis Series, the Netherlands
- Ghaemi, N., *Short-turning Trains during Full Blockages in Railway Disruption Management*, T2018/4, July 2018, TRAIL Thesis Series, the Netherlands
- Gun, van der J.P.T., *Multimodal Transportation Simulation for Emergencies using the Link Transmission Model*, T2018/3, May 2018, TRAIL Thesis Series, the Netherlands
- Van Riessen, B., *Optimal Transportation Plans and Portfolios for Synchromodal Container Networks*, T2018/2, March 2018, TRAIL Thesis Series, the Netherlands
- Saeedi, H., *Network-Level Analysis of the Market and Performance of Intermodal Freight Transport*, T2018/1, March 2018, TRAIL Thesis Series, the Netherlands
- Ypsilantis, P., *The Design, Planning and Execution of Sustainable Intermodal Port-hinterland Transport Networks*, T2017/14, December 2017, TRAIL Thesis Series, the Netherlands
- Han, Y., *Fast Model Predictive Control Approaches for Road Traffic Control*, T2017/13, December 2017, TRAIL Thesis Series, the Netherlands
- Wang, P., *Train Trajectory Optimization Methods for Energy-Efficient Railway Operations*, T2017/12, December 2017, TRAIL Thesis Series, the Netherlands