

High-throughput parallel SPM for metrology, defect and mask inspection

H. Sadeghian^{*ab}, R. W. Herfst^a, T. C. van den Dool^a, W. E. Crowcombe^a, J. Winters^a, G. F. I. J. Kramer^a,

^aNetherlands Organization for Scientific Applied Research, TNO, Stieltjesweg 1, 2628 CK, Delft, the Netherlands; ^bDept. of Precision and Microsystems Engineering, Delft University of Technology, 2628 CD, delft, The Netherlands

ABSTRACT

Scanning probe microscopy (SPM) is a promising candidate for accurate assessment of metrology and defects on wafers and masks, however it has traditionally been too slow for high-throughput applications, although recent developments have significantly pushed the speed of SPM [1,2]. In this paper we present new results obtained with our previously presented high-throughput parallel SPM system [3,4] that showcase two key advances that are required for a successful deployment of SPM in high-throughput metrology, defect and mask inspection. The first is a very fast (up to 40 lines/s) image acquisition and a comparison of the image quality as function of speed. Secondly, a fast approach method: measurements of the scan-head approaching the sample from 0.2 and 1.0 mm distance in under 1.4 and 6 seconds respectively.

Keywords: Scanning Probe Microscopy, defect inspection, high-throughput metrology, mask inspection

1. INTRODUCTION

As the semiconductor industry is fast approaching the 10 nm node, demands on metrology tools are becoming ever more stringent. New methods for accurate assessment of metrology and defects on wafers and masks are emerging. A promising candidate for this is scanning probe microscopy (SPM), but it has traditionally been too slow for high-throughput applications. Recent developments have significantly pushed the speed of SPM [1,2], but we think that for real high-throughput parallelization is needed as well. Previously we presented a high-throughput parallel SPM system [3,4], here we will present new results obtained with this system that illustrate two key that advances are required for the successful deployment of this new class of systems.

1. Very fast (up to 40 lines/s) image acquisition: measurements of a dense line pattern on TiN (EUV mask) and a comparison of the image quality as function of speed.
2. A fast approach method: measurements of the scan-head approaching the sample from 0.2 mm distance in under 1.4 seconds and 1.0 mm distance in under 6 seconds.

The parallel SPM system consists of many miniaturized SPM (MSPM) heads that together can scan a relatively large sample, such as wafer or mask. Recently one such MSPM including an arm to accurately position it has been realized. A CAD drawing of the whole arm with MSPM and a photograph of the scan-head are shown in

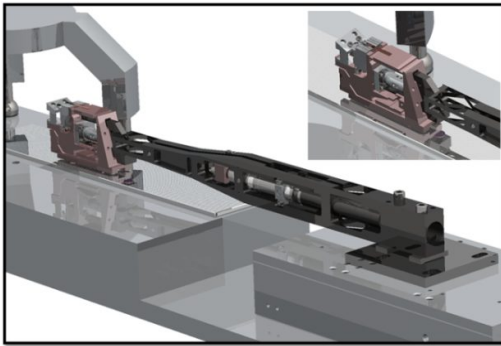

(a)

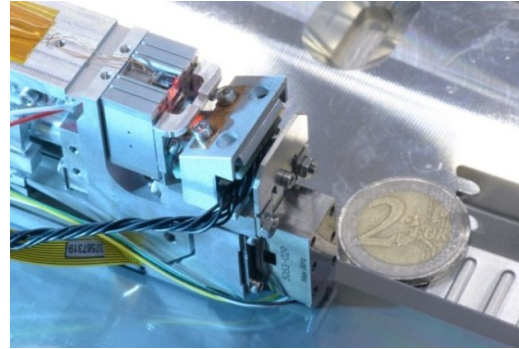

(b)

Figure 1: (a) CAD illustration of one positioning arm that carries the MSPM. The inset shows the MSPM under a different angle. (b) Picture of Miniaturized SPM demonstrator, where the z-stage, cantilever holder, approach motor, and the PCB with quadrant cell for the OBD can be seen.

The system has two critical sub-systems: a high speed parallel positioning unit [1] and high speed MSPM. The MSPM is a miniature scanning probe microscope (Size $\sim 70 \times 19 \times 45$ mm³) with a bandwidth of ~ 45 KHz and a vertical stroke of $2.1 \mu\text{m}$. The Optical Beam Deflection (OBD) used for read-out of the probe has a noise floor of $15 \text{ fm}/\sqrt{\text{Hz}}$ and a bandwidth of more than 3 MHz, which allows the use of ultra-high frequency cantilevers. During a scan, the MSPM remains stationary while the sample is moved on an XY stage.

2. IMAGE ACQUISITION PERFORMANCE

In

Figure 2 scans of a dense (350 nm pitch) line pattern are shown for several different scan-speeds. The test sample consisted of 70 nm high TaN lines on top of a 50 nm Ru layer on a Si carrier wafer, a SEM picture of which can be seen in

Figure 3. As can be seen, the image quality does not degrade significantly when going to higher scan-speeds. The lines in the SEM picture seem broader than in the AFM result, this is because the SEM contrast is mainly due to which material is at certain position, while AFM contrast is mainly sensitive to topography.

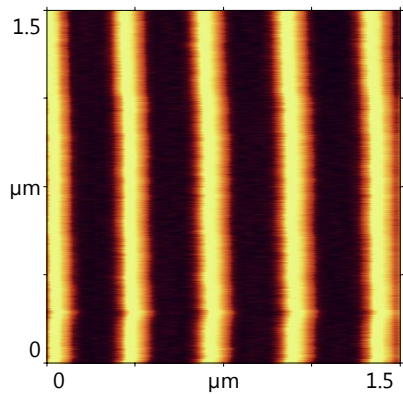

(a)

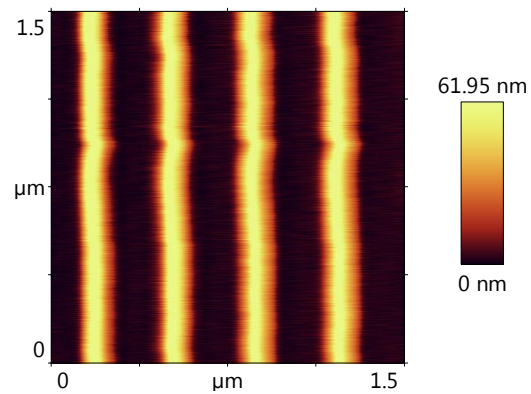

(b)

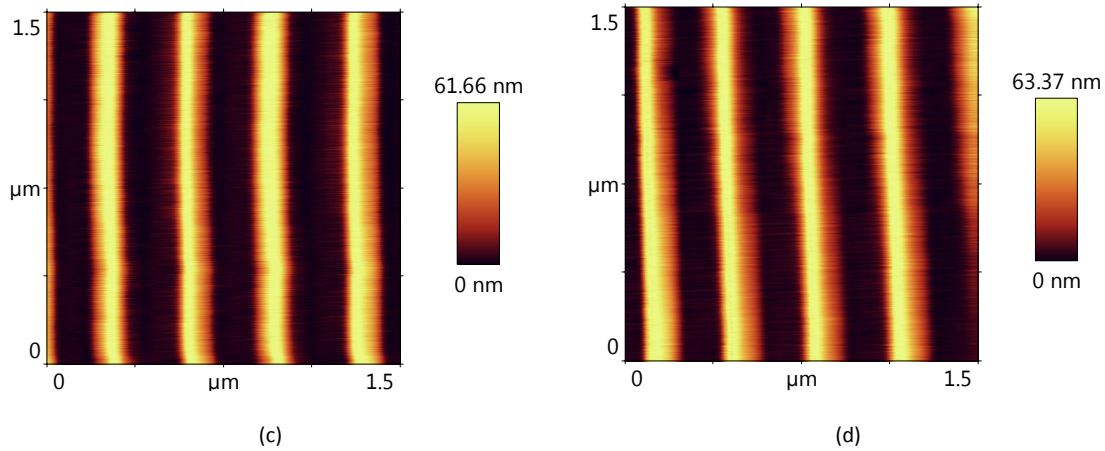

Figure 2. Scans of a dense lines pattern of TaN on a Si carrier wafer, 1.5x1.5 micrometer, 512x512 pixels, 350 nm pitch using an Olympus OMCL-AC55TS-R3 probe (1.976 MHz resonance frequency). (a) 10 lines/s. (b) 20 lines/s. (c) 30 lines/s. (d) 40 lines/s.

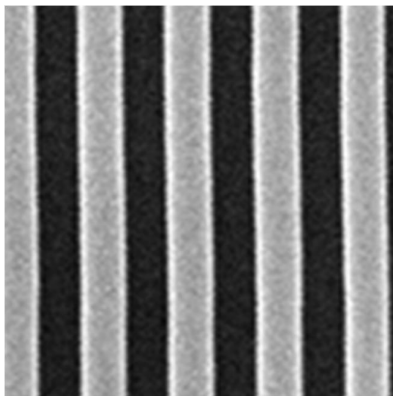

Figure 3. 1.5x1.5 μm SEM picture of the dense lines shown in Figure 2.

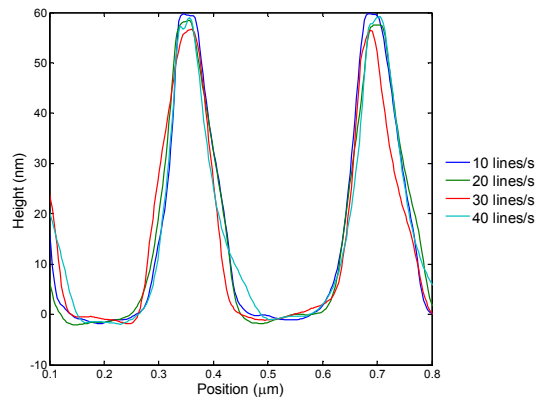

Figure 4. Detailed cross-section at 10 – 40 lines/s (from center of Figure 2). While there is some variation in the measured profile, even at 40 lines/s the system is not limited to slew-rate or bandwidth of the z-stage and feedback loop

When we plot a cross-section of the lines (Figure 4) we see that although there is some variation in between measurements, even at 40 lines/s the system is limited to neither the slew-rate nor the bandwidth of the z-stage and feedback loop. When we calculate the maximum slew-rate in the shown measurement from the slope of the feature and the line-rate of the measurement we get a slew-rate of 46 $\mu\text{m/s}$. This is much lower than the maximum slew rate which is determined by current output of the amplifier (100 mA), stroke of the piezo used to drive the z-stage (2.1 μm for a 150V change of input voltage) and capacitance of the piezo (60 nF): this results in a system z slew rate of $(100 \text{ mA} \cdot 2.1 \mu\text{m}) / (150 \text{ V} \cdot 60 \text{ nF}) = 23 \text{ cm/s}$.

The high usable (~ 45 kHz) bandwidth of the system is the result of the use of fast cantilevers, fast FPGA based lock-in amplifier, low noise of the OBD system, and fast z-stage of which the first resonance frequency lies above 45 kHz. This high performance of the z-actuator is due to its stiff guidance and use of counterbalance mass. Figure 5a shows the frequency response of the z-actuator. For this test, a polytec laser vibrometer was used to measure the movement of the z-stage while sweeping the frequency of a sinewave voltage driving the z-stage's piezos. Up to 30 kHz, the frequency spectrum is virtually flat, and the first resonance peak is above 45 kHz. Figure 5b showcases the low-noise capability of the OBD; here the thermal noise peak at the first resonance frequency of a Nanoworld Arrow UHF cantilever is shown. As can be seen, deflection noise is about $16 \text{ fm}/\text{Hz}^{0.5}$, which is comparable to the values reported by Fukuma et al. [5].

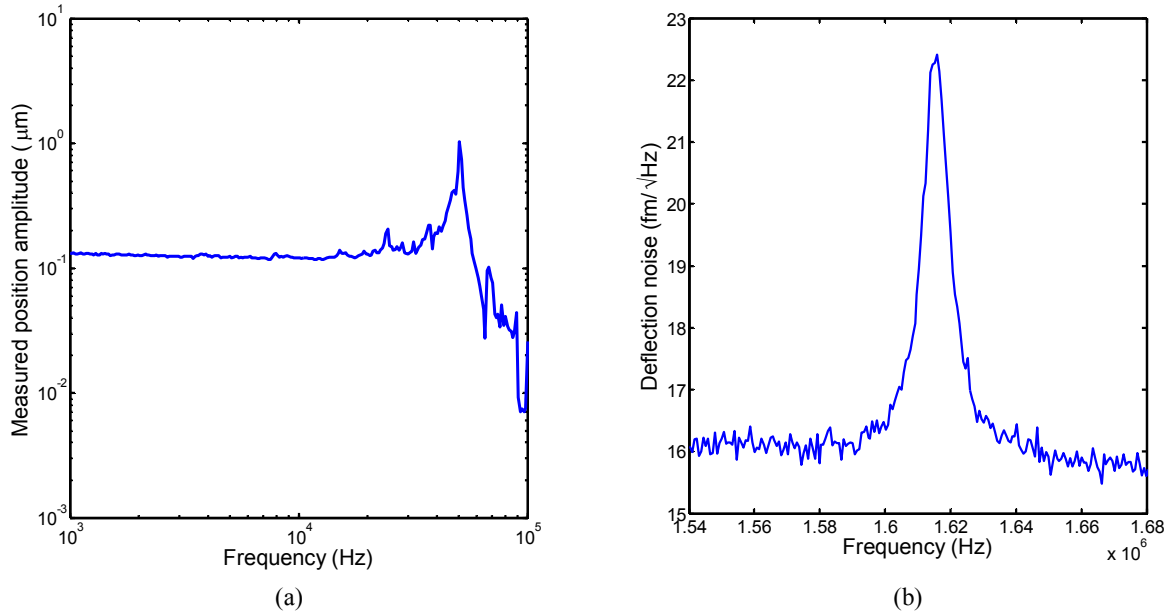

Figure 5: (a) Measured frequency spectrum of the z-scanner. (b) Measured thermal noise spectrum of a high frequency Nanoworld Arrow UHF AFM probe.

3. FAST APPROACH RESULTS

Apart from a high scanning speed, throughput of the parallel SPM can also be limited by the time it takes to bring the MSPM towards the sample. Since a $2.1 \mu\text{m}$ stroke of the fast z-stage is not sufficient for coarse adjustment of the distance between a sample and the cantilever, an approach stage moves the whole assembly of z-stage and OBD system in the z-direction. For this the approach motor in quick succession makes steps of about $1 \mu\text{m}$ while the z-stage is fully extended and a dither piezo drives the cantilever at a resonance frequency. If during a step of the approach motor the amplitude of the cantilever is reduced by a small amount (usually set to 15 – 35%), the z-stage quickly retracts the z-stage and the fast approach is stopped, thereby preventing a crash. The system then tries to achieve the actual amplitude set-point by extending the z-stage again. If needed, at this point the system switches to a more conservative approach method where after each step of the stepper-motor the z-stage is scanned from fully retracted until the cantilever is engaged with the sample.

In

Figure 6 the fast approach of the MSPM towards the sample is shown for an initial distance of 0.2 an 1.0 mm. During the majority of the approach, the cantilever is not influenced by the sample and the z-stage remains fully extended. As it comes into contact, the z-stage retracts and the approach motor stops. For about 0.1 seconds residual vibrations of the

MSPM that were excited during approach are being compensated by the z-stage, after which the system stabilizes. For 0.2 mm initial distance, the system is engaged as well as fully stable in under 1.4 seconds, for 1.0 mm initial distance it takes less than 6 seconds.

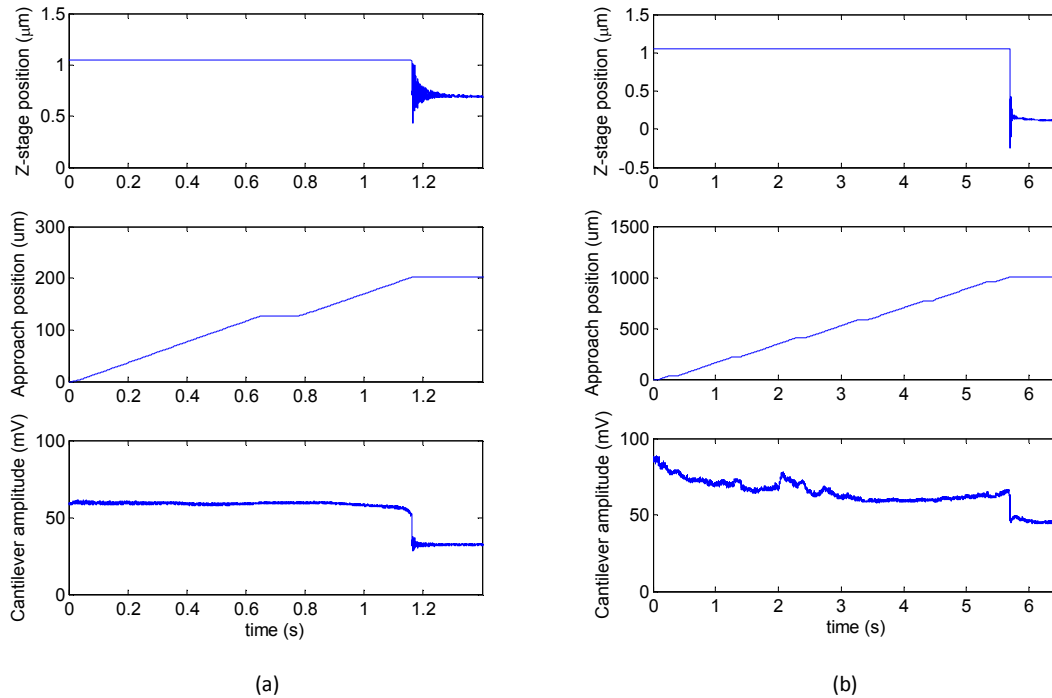

Figure 6. Fast approach of scan-head towards the sample showing position of the fast z-stage, approach motor position, and cantilever amplitude. (a) initial distance 0.2 mm. (b) initial distance 1.0 mm.

4. CONCLUSIONS

We presented measurements illustrating two key advances that are required for successful high-throughput parallel SPM systems: very fast image acquisition and a very rapid approach of the sample by the scan-head. Because of low-noise ($\sim 15 \text{ fm/Hz}^{0.5}$) OBD, and high ($\sim 45 \text{ kHz}$) bandwidth of the system image acquisition at speeds of 40 lines/s is possible with high image quality. From a distance of 1.0 mm, the system can engage and be ready for image acquisition in under 6 seconds.

REFERENCES

- [1] Jason Osborne, Shuiqing Hu, Haiming Wang, Yan Hu, , Jian Shi, Sean Hand, Chanmin Su, “High-speed atomic force microscopy for patterned defect review”, Proc. SPIE 8681, Metrology, Inspection, and Process Control for Microlithography XXVII, 86813C, San Jose, 2013.

- [2] Takeshi Fukuma, Yasutaka Okazaki, Noriyuki Kodaera, Takayuki Uchihashi and Toshio Ando, "High resonance frequency force microscope scanner using inertia balance support", *Appl. Phys. Lett.*, vol. 92, p. 243119, 2008.
- [3] H. Sadeghian ; T. C. van den Dool ; W. E. Crowcombe ; R. W. Herfst ; J. Winters ; G. F. I. J. Kramer ; N. B. Koster , "Parallel, miniaturized scanning probe microscope for defect inspection and review", *Proc. SPIE 9050, Metrology, Inspection, and Process Control for Microlithography XXVIII*, 90501B, (April 2, 2014)
- [4] H. Sadeghian, N. B. Koster, T. C. van den Dool, "Introduction of a high throughput SPM for defect inspection and process control", *Proc. SPIE* , vol. 8681, p. 868127, 2013.
- [5] T. Fukuma, M. Kimura, K. Kobayashi, K. Matsushige, H. Yamada, "Development of low noise cantilever deflection sensor for multienvironment frequency-modulation atomic force microscopy", *Review of Scientific Instruments* 76 (5) (2005) 053704.