

## A novel lifetime prediction for integrated LED lamps by electronic-thermal simulation

Sun, Bo; Fan, Xuejun; Ye, Huaiyu; Fan, Jiajie; Qian, Cheng; van Driel, Williem; Zhang, G.Q.

**DOI**

[10.1016/j.ress.2017.01.017](https://doi.org/10.1016/j.ress.2017.01.017)

**Publication date**

2017

**Document Version**

Accepted author manuscript

**Published in**

Reliability Engineering & System Safety

**Citation (APA)**

Sun, B., Fan, X., Ye, H., Fan, J., Qian, C., van Driel, W., & Zhang, G. Q. (2017). A novel lifetime prediction for integrated LED lamps by electronic-thermal simulation. *Reliability Engineering & System Safety*, 163, 14-21. <https://doi.org/10.1016/j.ress.2017.01.017>

**Important note**

To cite this publication, please use the final published version (if applicable).  
Please check the document version above.

**Copyright**

Other than for strictly personal use, it is not permitted to download, forward or distribute the text or part of it, without the consent of the author(s) and/or copyright holder(s), unless the work is under an open content license such as Creative Commons.

**Takedown policy**

Please contact us and provide details if you believe this document breaches copyrights.  
We will remove access to the work immediately and investigate your claim.

# A Novel Lifetime Prediction for Integrated LED Lamps by Electronic-Thermal Simulation

Bo Sun, Xuejun Fan, Huaiyu Ye, Jiajie Fan, Cheng Qian, Williem van Driel, Guoqi Zhang

## ABSTRACT

In this paper, an integrated LED lamp with an electrolytic capacitor-free driver is considered to study the coupling effects of both LED and driver's degradations on lamp's lifetime. An electrolytic capacitor-less buck-boost driver is used. The physics of failure (PoF) based electronic thermal simulation is carried out to simulate the lamp's lifetime in three different scenarios: Scenario 1 considers LED degradation only, Scenario 2 considers the driver degradation only, and Scenario 3 considers both degradations from LED and driver simultaneously. When these two degradations are both considered, the lamp's lifetime is reduced by about 22% compared to the initial target of 25,000 hours. The results of Scenario 1 and 3 are close to each other. Scenario 2 gives erroneous results in terms of luminous flux as the LED's degradation over time is not taken into consideration. This implies that LED's degradation must be taken into considerations when LED and driver's lifetimes are comparable.

**Key Words:** Lifetime Prediction, LED, LED Driver, Electronic-Thermal Simulation, Degradation.

## Abbreviations and Acronyms

LED	Light Emitting Diode
PoF	Physics of Failure
T-droop	Temperature-droop
J-droop	Current-droop
FEA	Finite Element Analysis

## Notation

$\Phi_{lm}(t)$	Absolute luminous flux at time $t$
$\Phi_0$	Absolute luminous flux at $t=0$
$\beta$	LED depreciation rate
$A_\beta$	Pre-factor of LED's depreciation
$E_{a,\beta}$	LED's activation energy
$T_j$	Junction temperature of LED
$I(t)$	LED's current at time $t$
$V_f$	LED's forward voltage
$\eta(t)$	LED's efficacy at time $t$
$\eta_0$	Efficacy factor of LED
$a$	Linear non-radiative recombination rate of LED
$b$	Radiative recombination rate of LED
$c$	3rd-order non-radiative recombination rate of LED
$n$	Average carrier density of LED
$A_e$	Linear non-radiative current coefficient of LED
$B_e$	Radiative current coefficient of LED
$C_e$	3rd-order non-radiative current coefficient of LED
$V_{ref}$	LED driver's reference voltage
$R_{ref}$	LED driver's overall resistance
$R_0$	Initial LED driver's resistance
$T_D$	LED driver temperature
$A$	LED driver degradation rate
$A_0$	LED driver degradation rate factor
$E_{a,D}$	LED driver overall activation energy
$N$	LED's ideality factor
$I_s$	LED's saturation current
$R_s$	LED's equivalent series resistance
$R_{s0}$	LED's equivalent series resistance factor

$A_s$	Temperature coefficient of equivalent series resistance of LED
$I_{s0}$	Saturation current factor of LED
$A_I$	Temperature coefficient of saturation current of LED
$A_N$	Temperature coefficient of ideality factor of LED
$B_N$	Non-thermal coefficient of ideality factor of LED
$C$	Ratio of radiative power and luminous flux
$P_{in}$	Input power of LED driver
$P_D$	Thermal power of LED driver
$P_L$	LED's thermal power

## I. INTRODUCTION

Light Emitting Diode (LED) has been regarded as one of the most promising lighting solutions due to its energy efficiency, flexible controllability and long lifetime [1-3]. An LED lamp is a complex system which is mainly comprised of an LED light source, a driver, control gears, secondary optical parts and heat dissipation components [3]. The LED light source often has a lifetime as long as 25,000 - 100,000 hours [1-3]. However, the LED driver has a much shorter life, in particular, when electrolytic capacitors are utilized [4-6]. Many studies have focused on the degradation analysis of LEDs only, without taking consideration of the LED driver's degradation [2, 7-11]. For example, a test method has been developed to accelerate of luminous flux depreciation of LED lamps or luminaires by an elevated temperature [2]. Degradations of LEDs in the high temperature-humidity environment have been studied [7, 8]. The LED color shift by optical materials has been investigated [9, 10]. **A life prediction method for LED considering real mission profiles has been developed [12].**

For the driver's degradation, if the driver's lifetime is much shorter than LED's life, LEDs' degradation may not be significant for prediction the system's lifetime, as the eventual lifetime of the entire system is determined by driver's lifetime. With such an assumption, a physics-of-

failure (PoF) based lifetime prediction methodology for LED drivers has been developed [4]. However, little research considers both degradations of the driver and LEDs in an integrated LED lamp.

Numerous reliability assessment methodologies have been developed to consider the degradations of a complex system. For instance, the general path models have been well established and widely used in reliability assessment [13-16], owing to their ease of use. As the requirement of reality, many stochastic process approaches have been developed in recent years [17-21]. For LED systems, the Gamma process and copula function have been applied to model the reliability [22]. The Wiener process has been used to predict the LEDs' lumen depreciation and color shift [23]. Moreover, the reliability block diagram method is developed for degradation analysis of complex systems [24]. A stochastic modeling framework has been investigated for interactions among degradations of components of a system [25]. These statistical reliability models and methods need to collect large amounts of data experimentally. Recently, using the Physics of Failure (PoF) simulations as virtual tests to collect data for reliability assessment have attracted increasing research attention. For instance, the degradation distribution models, degradation path models and SPICE simulations have been integrated for a tolerance design [15]. A multi-physics simulation method has been used to predict the performance of an LED driver during degradations of semiconductor devices [26].

For an integrated lamp, in which the LED light source and driver are assembled together, both degradations of the LEDs and the driver will affect each other through the ever-changing of temperature distributions and current during operation. Therefore, it is necessary to use the electronic thermal simulation to determine the electronic and thermal characteristics as a function of time. In this paper, an integrated LED lamp with an electrolytic capacitor-free driver is considered to study the coupling effects of both LEDs and driver's degradations on lamp's lifetime. An electrolytic capacitor-less buck-boost driver is used as it has a comparable lifetime with LEDs. Such a driver is integrated with a commercial LED light bulb for lifetime study. Circuit simulations are carried out to obtain the power distributions and current to LEDs. Thermal simulations are performed subsequently based on power distribution to obtain the temperature distribution of the LED lamp, in particular, the LED junction temperature and driver's overall temperature. The lumen flux depreciation as a function of time can then be obtained. The interaction of these two degradations is studied with several scenarios.

This paper is organized as follows. Section II describes the degradation models used for LEDs and driver respectively. In Section III, a selected driver circuit and the corresponding electronic model is introduced. The thermal simulation for the selected LED lamp is described in Section IV. Section V describes and explains the integrated simulation methodology and flowchart. In Section VI, several scenarios are analyzed to predict the lifetime of the lamp and the effects of both degradations. Section VII concludes this work finally.

## II. DEGRADATION MODELS

### A. LED Light Source

The exponential model is applied to describe lumen depreciation in the constant junction temperature  $T_j$  and the constant driving current  $I$  as follows [2]:

$$\Phi_{lm}(t) = \Phi(I) \cdot e^{-\beta(T_j)t} \quad (1)$$

where  $t$  is time,  $\Phi_{lm}$  is the absolute luminous flux at time  $t$ ,  $\Phi(I)$  is the luminous flux factor that is a function of current  $I$ , and the depreciation rate  $\beta$  follows the Arrhenius Equation [6]:

$$\beta(T_j) = A_\beta \cdot e^{-E_{a,\beta}/(\kappa T_j)} \quad (2)$$

where,  $A_\beta$  is the prefactor, and  $E_{a,\beta}$  is the activation energy of LEDs.  $\Phi(I)$  in Eq.(1) can be described by the following function [27]:

$$\Phi(I) = \eta(I) \cdot I \cdot V_f \quad (3)$$

where  $\eta(I)$  is LED's efficacy at current  $I$  and  $V_f$  is the forward voltage which is a function of junction temperature and current.

The efficacy  $\eta$  is affected by both temperature droop (T-droop) and current droop (J-droop) [28, 29]. However, in high current status, the T-droop becomes negligible in comparison with the J-droop. Thus,  $\eta$  can be assumed approximately as a function of the J-droop [29]:

$$\eta = \eta_0 b n^2 / (a n + b n^2 + c n^3) \quad (4)$$

where  $\eta_0$  is the efficacy factor,  $a$  and  $c$  are the linear and the 3rd-order non-radiative recombination rates,  $b$  is the radiative recombination rate, and  $n$  is the average carrier density of LED, which is proportional to the current  $I$ , hence the efficacy can be described the following function:

$$\eta(I) = \eta_0 B_e I / (A_e + B_e I + C_e I^2) \quad (5)$$

where  $\eta_0$ ,  $A_e$ ,  $B_e$  and  $C_e$  are dependent on the LED's properties dependent on materials and structure.

Combine Eq.(1), (3) and (5), the luminous flux in the ever-changing junction temperature  $T_j(t)$  and current  $I(t)$  can be described by the following function [30]:

$$\Phi_{lm}(t) = \eta_0 \cdot \frac{B_e I(t)^2}{A_e + B_e I(t) + C_e I(t)^2} \cdot V_f \cdot e^{-\int_0^t \beta(T_j(x)) dx} \quad (6)$$

The derivation of Eq.(6) is shown in the Appendix A. System conditions,  $I(t)$ ,  $V_f$ , and  $T_j(t)$ , depend on structure and materials' properties of the lamp and circuit, and can be determined by the electronic thermal simulations. The physical characteristics of the selected LED,  $\eta_0$ ,  $A_e$ ,  $B_e$ ,  $C_e$ ,  $A_\beta$  and  $E_{a,\beta}$ , are invariables, and can be extracted by experiments. In this work,  $\eta_0$ ,  $A_e$ ,  $B_e$ , and  $C_e$  were determined experimentally for the selected LED, and their values are shown in Table Appendix A-I.

$A_\beta$  and  $E_{a,\beta}$  will be adjusted through a parametric study in Section V.

### B. LED Driver

Literature [31, 32] have shown that the on-state resistance of MOSFETs of an LED driver increases with aging process, leading to the degradation of output current. The study in [33] also indicates that the transistor declines during operation, and brings a decreasing output current. In the present work, the driver's degradation in terms of the output current is considered. The effective output current  $I$  can be represented by the following equation:

$$I(t) = V_{ref} / R_{ref} \quad (7)$$

where  $V_{ref}$  is a constant reference voltage, and  $R_{ref}$  is the overall current control resistance. Research in [26] has shown that the resistance of current control device degrades linearly with time. Thus, a linear degradation model for the overall current control resistance  $R_{ref}$  is assumed:

$$R_{ref}(t) = R_0 \cdot [1 + A(T_D) \cdot t] \quad (8)$$

where  $R_0$  is the initial resistance,  $T_D$  is the overall driver temperature and the degradation rate  $A$  follows the Arrhenius Equation:

$$A(T_D) = A_0 \cdot e^{-E_{a,D}/(\kappa \cdot T_D)} \quad (9)$$

where,  $A_0$  is the degradation rate factor and  $E_{a,D}$  is the overall activation energy of LED driver. If the driver temperature  $T_D$  changes continuously in time  $t$ , Eq.(8) can be deduced to an integration form, as follows

$$R_{ref}[t, T_D(t)] = R_0 \cdot \int_0^t [1 + A(T_D(x)) \cdot x] \cdot dx \quad (10)$$

where, the driver temperature  $T_D(t)$  is a system condition, and can be determined by electronic thermal simulations. Among the physical characteristics of the selected driver,  $R_0$  can be determined by the initial output current of the driver,  $E_{a,D}$  and  $A_0$ , which control the driver degradation, will be adjusted through the parametric study in Section V.

## III. ELECTRONIC SIMULATIONS

An electrolytic capacitor-free buck-boost converter, as shown in Fig. 1, is selected as the LED driver. This type of LED driver is one of the most commonly used drivers in lighting applications [34]. In this work, the driver's switching frequency is 300 kHz, the input voltage range is 9 to 20 Vdc, the rated output current is 400 mA, the duty cycle is 25%, and the rated output power is 6.0W. Device models in the driver, which are provided by a public database [35], have been validated and verified.

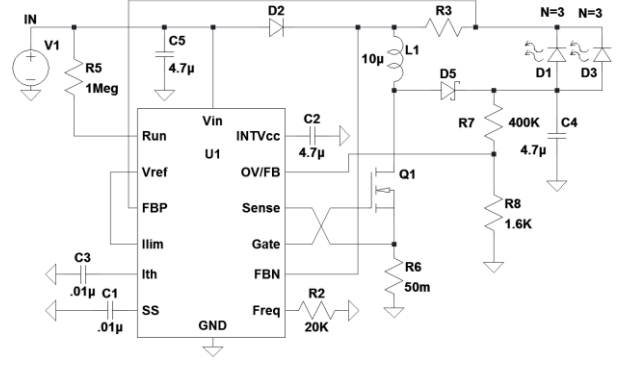

Fig.1 The Electrolytic Capacitor-Free Buck-Boost LED Driver

A temperature-dependent LED degradation model is considered in circuit simulations. The LED's forward voltage  $V_f$  can be described by [27]:

$$V_f[I(t), T_j(t)] = N \cdot \kappa \cdot T_j(t) \cdot \ln\left[\frac{I(t)}{I_s} + 1\right] + R_s \cdot I(t) \quad (11)$$

where,  $N$  is the ideality factor,  $I_s$  is the saturation current,  $R_s$  is the equivalent series resistance. Literature [36] suggests that the electronic characteristics of LEDs after seasoning is not affected by aging time, but strongly affected by junction temperature  $T_j$ . Thus, the  $R_s$ ,  $I_s$  and  $N$ , are considered as the functions of junction temperature  $T_j$  as following, according to Literature [27, 37, 38]:

$$R_s[T_j(t)] = R_{s0} \cdot [1 + A_s \cdot T_j(t)] \quad (12)$$

$$I_s[T_j(t)] = I_{s0} \cdot T_j^2(t) \cdot e^{-A_i \cdot T_j(t)} \quad (13)$$

$$N[T_j(t)] = T_j(t) / [A_N \cdot T_j(t) + B_N] \quad (14)$$

The power distribution of the entire circuit can be obtained by circuit simulations. The thermal power of the LED light source  $P_L$  is the difference between input power and optical power of LED:

$$P_L(t) = I(t) \cdot V_f[I(t), T_j(t)] - C \cdot \Phi_{lm}(t) \quad (15)$$

where  $C$  is the ratio of optical power and luminous flux.

The thermal power of the driver  $P_D$  is the sum of heat from all components in the driver. Thus,  $P_D$  equals to the difference between total input power and total output power of the driver:

$$P_D(t) = P_{in}(t) - I(t) \cdot V_f[I(t), T_j(t)] \quad (16)$$

where  $P_{in}$  is the total input power.

## IV. THERMAL SIMULATIONS

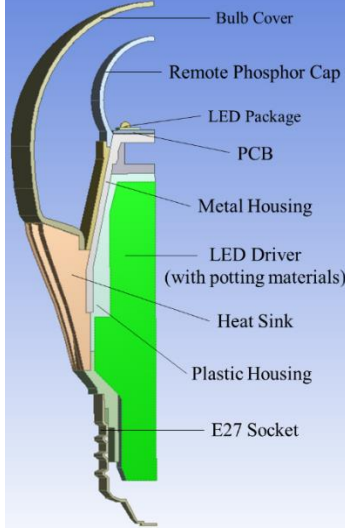

Fig.2 The Model of The selected (a) LED Lamp

This work selects a commercial LED light bulb as the carrier. Fig. 2 displays the lamp's structure, in which the geometrical information and material properties can refer to the literature [39-42]. An electrolytic capacitor-free buck-boost converter, as shown in Fig.1, is used as the driver to replace the original one. The heat generated by both LEDs and the driver determine the junction temperature of LED as well as the driver's temperature. Therefore, system-level finite element analysis is conducted to obtain the temperature distributions.

In this thermal finite element model, the driver and its potting materials as a whole are considered as a volume (green portion in Fig. 2). All thermal power dissipated by each individual component in Fig. 1 is summed together and uniformly distributed over the surface. The driver's temperature,  $T_D$ , is taken from the maximum temperature of the surface.

## V. SIMULATION FLOWCHART

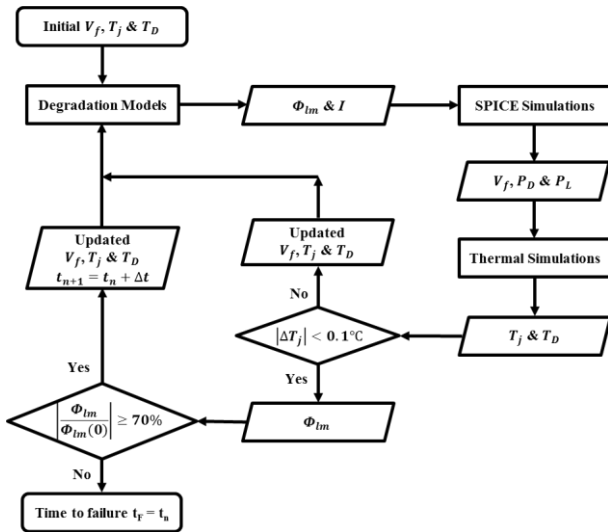

Fig.3 Flowchart of the Electronic-Thermal Simulation

Fig.3 illustrates the flowchart of the electronic thermal simulation in the present study. The simulation

process begins with the initial guess of  $T_j$  and  $T_D$  and the initial LED's forward voltage  $V_f$ , from which the degradation models in Eq.(6) and (10) can be applied to obtain the luminous flux  $\Phi_{lm}$ , and the current  $I$ . Then the electronic simulations are performed to update  $V_f$  and obtain the power dissipations by Eq.(11), (15) and (16). Subsequently, the thermal simulations are performed to update  $T_j$  and  $T_D$ . Such a simulation process loop is performed iteratively until the error between values of  $T_j$  in two consecutive steps is less than 0.1K, as shown in Fig. 3. Then light output can be calculated using Eq.(6).

Generally, the useful lifetime of LED lighting products is typically given in terms of the expected operating hours until light output has depreciated to 70% of initial levels [2]. If this threshold is not reached, the aging time  $t$  advances to a small increment  $\Delta t$ . Since the temperatures update  $T_j$  and  $T_D$  are not known at  $t + \Delta t$ , the above iteration process repeats. The time increment  $\Delta t$  in this work is assumed to be 1000 hours. When time  $t = t_F$ , and the  $\Phi_{lm}$  has depreciated to 70% of the initial value, the simulation stops, and  $t_F$  is considered as the lifetime of the LED lamp.

## VI. RESULTS AND DISCUSSIONS

### A. Lamp's Initial Temperature Distributions

Firstly, considering the lamp's operation conditions with an ambient room temperature of 298K and a natural convective heat transfer coefficient of 5W/m<sup>2</sup>K, the electronic-thermal simulation is performed to obtain the initial LED junction temperature  $T_j(0)$  and the driver temperature  $T_D(0)$ . As shown in Table I. The simulation results agree well with the experimental data [40, 41]. Table I also gives the targeted temperatures of  $T_j$  and  $T_D$  for this lamp design. It can be seen that initial temperatures of both LEDs and driver are within the design requirement.

Table I Temperature Distributions

	Predicted Initial Temperature	Targeted Temperature
$T_j$	351.8K	358K
$T_D$	318.4K	328K

### B. Definition of Different Scenarios

LED is usually selected to have a desired lifetime at the initial temperature of operation. In the present study, the LED with a lifetime of 25,000 hours at the initial LED junction temperature is selected. The driver is also selected to have a 25,000 hours lifetime at the initial temperature  $T_D$ . Table II lists the parameters to be used to satisfy the selection requirement.

Table II Designed Parameters

Parameters	Values	Parameters	Values
$A_\beta$	$2.834 \times 10^{-1}$	$E_{\alpha,\beta}$	0.3eV
$A_0$	$3.591 \times 10^{-1}$	$E_{\alpha,D}$	0.7eV

For LED, this means that the selected LED will have luminous flux above 70% of initial levels before 25,000hours if the LED's junction temperature and current

remain unchanged during operation. For LED driver, it implies that the output current from the driver will not decrease by 10% of the initial value at the constant initial driver temperature  $T_D(0)$ . However, the LED junction temperature, and the driver temperature will change continuously with time, due to the simultaneous degradations of both LEDs and driver. Ultimately, this will affect the actual lifetime of the lamp.

Three scenarios are therefore defined. Scenario 1 considers the LED depreciation only, Scenario 2 considers the driver degradation only, while Scenario 3 considers both degradations from LEDs and driver simultaneously, as summarized in Table III.

Table III Three Scenarios

Case	LEDs	Driver
Scenario 1	25,000hrs lifetime at the constant $T_j(0)$	No degradation
Scenario 2	No degradation	25,000 hrs lifetime at the constant $T_D(0)$
Scenario 3	25,000hrs lifetime at the constant $T_j(0)$	25,000 hrs lifetime at the constant $T_D(0)$

### C. Results and Discussions

**LED Current.** Fig.4 shows the relative LED current with respect to the initial value in each scenario as a function of operation time. For Scenario 1, as the driver's degradation is not considered, the LED current maintains at its initial value (the driver is a constant current converter with no degradation). For Scenario 2 the LED current drops 10% at 25000 hours. When two degradations co-exist simultaneously, the LED current drops a little more, about 11% at 25,000 hours.

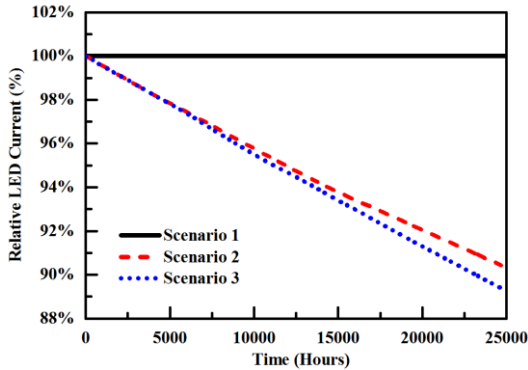

Fig.4 The LED Current of Each Scenario

**LED Junction Temperature.** Fig.5 displays the LED junction temperature in each scenario. The LED junction temperature increases with time for Scenarios 1, but decreases for Scenario 2. However, the LED's junction temperature does not change much for Scenario 3 with both degradations considered. This is because that driver's current decreases over time (in Fig.4), thus less power is provided to LEDs. On the other hands, when LED's degradation is considered, more thermal power is generated as the efficacy of LED decreases. These two effects eventually cancel out the impact on LED's junction temperature.

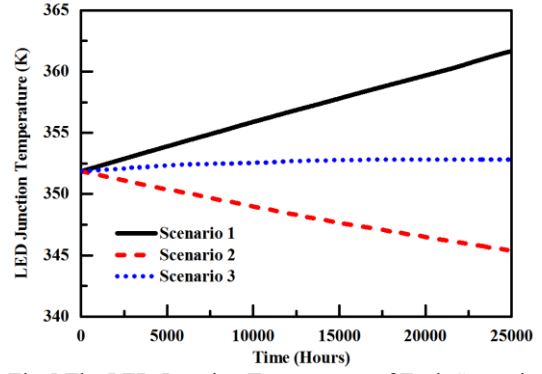

Fig.5 The LED Junction Temperature of Each Scenario

**Driver's Temperature.** Fig.6 indicates the driver's temperatures for three scenarios. Similarly, the driver's temperature increases with time in Scenarios 1, but decreases in Scenario 2, and does not change much for Scenario 3.

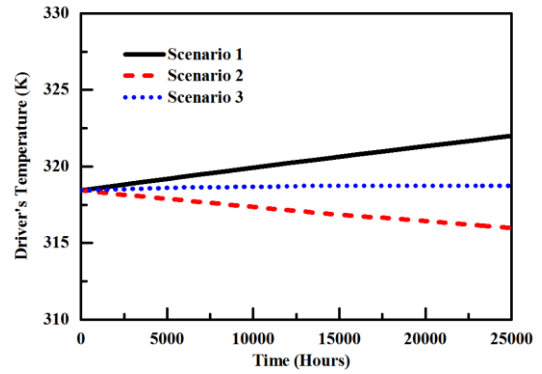

Fig.6 The Driver's Temperature of Each Scenario

**Lumen Maintenance and Lifetime.** Fig.7 shows the lumen maintenance over time for three scenarios. The lumen maintenance drops significantly with time for Scenario 1. As the driver does not degrade in this scenario, the luminous flux depreciation is due to the LEDs' degradation over time, and is further accelerated by the increase of the LED junction temperature over operation process. For Scenario 2, the lumen depreciation is not significant even though the driver may be near the end of its lifetime at 25,000 hours. It can be seen, from Fig.4 and Fig.5, that under Scenario 2, both LED current and LED junction temperature drops significantly. However, the lumen output does not change as much as temperature and current, as Scenario 2 does not consider the LED degradation over time. For Scenarios 3, when both degradations are considered, the lumen output decreases with time significantly, in spite of the little change in the LED junction temperature, shown in Fig.5 The lumen depreciation in Scenario 3 is attributed to the combined effects of the reduced current in LED, due to driver degradation, and the lumen depreciation on time, due to LEDs' degradation.

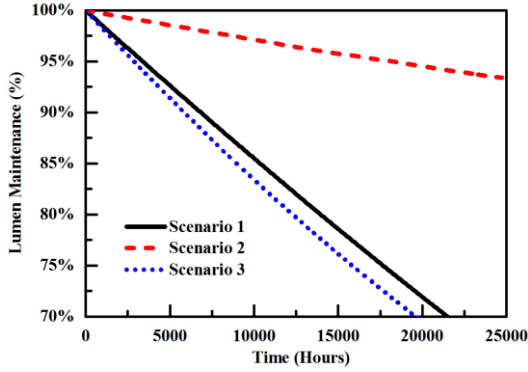

Fig.7 The Lumen Maintenance and for Each Scenario

Table IV summarizes the lifetime prediction for these three scenarios. It can be seen that when driver and LED's degradations are considered, the LED lamp's lifetime is reduced by about 22% compared to the initial target of 25,000 hours. From this table, it can be found that the results of Scenario I and III are close to each other. This implies that without considering driver's degradation (Scenario I), the predicted lamp lifetime may just underestimate a bit. The underlying mechanism is that the driver's degradation will reduce the LED's junction temperature so that LED's temperature does not rise as much as that LED degradation only. For Scenario 2, a lifetime of 25,000 hours is taken since the LED current would drop by 10% of its initial value at that time. This indicates that the driver's failure will occur, even though LEDs' degradation is not considered. It implies that LEDs' degradation should be taken into account when driver's lifetime is comparable to LED's lifetime. Otherwise, the luminous flux depreciation prediction would be inaccurate using Scenario 2, as shown in Fig.7.

Scenario	Lifetime
Scenario 1	21500 hrs
Scenario 2	25000 hrs
Scenario 3	19600 hrs

## VII. CONCLUSIONS

In this paper, an integrated LED lamp with an electrolytic capacitor-free driver is considered to study the coupling effects of both LED and driver's degradations on LED lamp's lifetime. An electrolytic capacitor-less buck-boost LED driver is used, as it has a comparable lifetime with the LED. Circuit simulations are carried out to obtain the power distributions and output current and the voltage to LEDs. Thermal simulations are subsequently performed based on power distribution to obtain the temperature distributions of the LED lamp, in particular, LED junction temperature and driver's overall temperature. The lumen flux depreciation as a function of time can then be obtained. Three scenarios are considered: Scenario 1 considers LED degradation only, Scenario 2 considers the driver degradation only, and Scenario 3 considers both degradations from LED and driver simultaneously.

In Scenario 1, the LED current stays at its initial value as the driver does not degrade. As a result, the LED

junction temperature and the driver's temperature increase with operation time, which would accelerate the LED's degradation, and thus reduce the lumen maintenance further.

In Scenario 2, the LED current decreases over time due to the driver's degradation. As a result, the LED junction temperature and the driver's temperature decrease with operation time. However, Scenario 2 gives erroneous results in terms of luminous flux as the LED's degradation over time is not taken into consideration. This implies that LED's degradation must be taken into considerations when both LED and driver's lifetimes are comparable.

In Scenario 3, the LED current decrease with operation time, but the LED junction temperature and the driver's temperature do not change much. This is because that driver's output current decreases over time, thus less power is provided to LED. On the other hands, when LED's degradation is considered, more thermal power is generated as the efficacy of LED decreases. These two effects eventually cancel out the impact on the LED junction temperature. Nonetheless, because of the combined effects of the reduced current in LEDs and the lumen dependence on time, the LED lamp's lifetime is reduced significantly.

## ACKNOWLEDGEMENT

The authors would like to acknowledge the support of the National High-Tech Research and Development Program of China (863 Program, Grant No.: 2015AA03A101) and International Science and Technology Cooperation Program of China (Grant No.: 2015DFG52110).

## APPENDIX

### A. Derivation of The LED Degradation Model

In a constant junction temperature and current, the lumen depreciation of an LED can be described by the following function [6]:

$$\Phi_{lm}(t) = \Phi(I) \cdot e^{-\beta(T_j)t} \quad (A1)$$

If the LED junction temperature  $T_j(t)$  and current  $I(t)$  change as functions of time  $t$ , the deviation of lumen depreciation from time  $t$  to time  $t + \Delta t$  can be described by:

$$\ln \Delta \Phi_{lm}[T_j(t), \Delta t] / \Phi[I(t)] = -\beta[T_j(t)] \cdot \Delta t \quad (A2)$$

Thus, when  $t$  is from time 0 to time  $x$ , the accumulated lumen depreciation can be described by:

$$\ln \frac{\Phi_{lm}[T_j(t), x]}{\Phi[I(t)]} = \sum_0^x \ln \frac{\Phi_{lm}[T_j(t), \Delta t]}{\Phi[I(t)]} = \sum_0^x -\beta[T_j(t)] \cdot \Delta t \quad (A3)$$

In the integral form, the accumulated lumen depreciation can be described by:

$$\Phi_{lm}[T_j(t), x] / \Phi[I(t)] = e^{\int_0^x -\beta[T_j(t)] \cdot dt + C_{lm}} \quad (A4)$$

The boundary condition is:

$$\Phi_m[T_j(0),0]/\Phi[I(0)]=1 \quad (\text{A5})$$

Thus,  $C_{lm} = 0$ , as a result:

$$\Phi_m(x) = \Phi[I(t)] \cdot e^{-\int_0^x \beta[T_j(t)] \cdot dt} \quad (\text{A6})$$

### B. Parameter Extraction of LED Models

The physical parameters of the lumen depreciation model and the electronic model of the LED,  $C$ ,  $\eta_0$ ,  $A_e$ ,  $B_e$ ,  $C_e$ ,  $R_{s0}$ ,  $A_s$ ,  $I_{s0}$ ,  $A_l$ ,  $A_n$  and  $B_n$ , need to be determined experimentally. Ten selected high power LED packages were tested in eight junction temperature levels, from 293K to 363K. Each sample was placed on a thermal plate inside a 50cm integrating sphere system. Then, the transient electronic and optical characteristics of each sample, including current, forward voltage, luminous flux, and efficacy, are measured at different junction temperature levels. For each junction temperature, the transient current of each sample sweeps from 200mA to 350mA. As shown in Fig.B, the measured I-V characteristics were fitted by Eq.(11) to (14), whereas the efficacy was fitted by Eq.(5) by the least square method, obtaining these physical parameters of the LED models. Table A-I summarizes the averaged values of the model parameters. The details of tests and parameter extractions can refer to the literature [30].

Table A-I Physical Parameters of The LED Light Source

Parameters	Values	Parameters	Values
$R_{s0}$	$5.914 \times 10^{-1}$	$I_{s0}$	$4.786 \times 10^5$
$A_l$	$1.274 \times 10^{-1}$	$A_s$	$6.699 \times 10^{-4}$
$A_n$	1.240	$C$	$4.087 \times 10^{-3}$
$B_n$	$-2.882 \times 10^2$	$\eta_0$	$1.456 \times 10^2$
$A_e$	0.999	$C_e$	$2.138 \times 10^3$
$B_e$	$1.406 \times 10^3$		

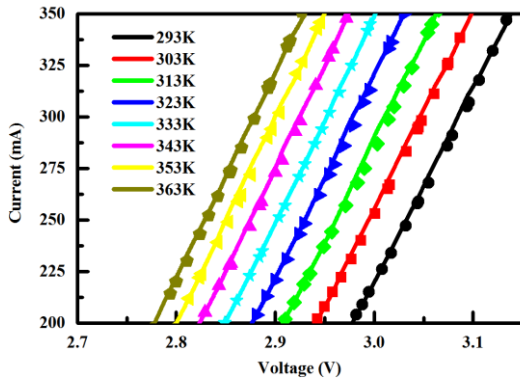

Fig.B Test Results of The Selected LEDs

## REFERENCE

- [1] J. Fan, K. C. Yung, and M. Pecht, "Prognostics of lumen maintenance for High power white light emitting diodes using a nonlinear filter-based approach," *Reliability Engineering & System Safety*, vol. 123, pp. 63-72, 2014.
- [2] C. Qian, X. J. Fan, J. Fan, C. A. Yuan, and G. Q. Zhang, "An Accelerated Test Method of Luminous Flux Depreciation for LED Luminaires and Lamps," *Reliability Engineering & System Safety*, vol. 147, pp. 84-92, 2015.
- [3] W. D. van Driel and X. J. Fan, *Solid state lighting reliability: components to systems* vol. 1: Springer Science & Business Media, 2012.
- [4] B. Sun, X. J. Fan, C. Qian, and G. Q. Zhang, "PoF-Simulation-Assisted Reliability Prediction for Electrolytic Capacitor in LED Drivers," *IEEE Transactions on Industrial Electronics*, vol. 63, pp. 6726-6735, 2016.
- [5] B. Sun, X. J. Fan, C. A. Yuan, C. Qian, and G. Q. Zhang, "A degradation model of aluminum electrolytic capacitors for LED drivers," in *Thermal, Mechanical and Multi-Physics Simulation and Experiments in Microelectronics and Microsystems (EuroSimE), 2015 16th International Conference on*, 2015, pp. 1-4.
- [6] S. Koh, C. Yuan, B. Sun, B. Li, X. J. Fan, and G. Q. Zhang, "Product level accelerated lifetime test for indoor LED luminaires," in *Thermal, Mechanical and Multi-Physics Simulation and Experiments in Microelectronics and Microsystems (EuroSimE), 2013 14th International Conference on*, 2013, pp. 1-6.
- [7] J. Huang, S. W. Koh, D. Yang, X. Li, X. J. Fan, and G. Q. Zhang, "Degradation Mechanisms of Mid-power White-light LEDs under High Temperature-Humidity Conditions," *IEEE Transactions on Device & Materials Reliability*, vol. 15, pp. 1-1, 2015.
- [8] J. Huang, D. S. Golubović, S. W. Koh, D. Yang, X. Li, X. J. Fan, and G. Q. Zhang, "Rapid degradation of mid-power white-light LEDs in saturated moisture conditions," *IEEE Transactions on Device and Materials Reliability*, vol. 15, pp. 478-485, 2015.
- [9] G. Lu, W. D. van Driel, X. J. Fan, M. Y. Mehr, J. Fan, K. Jansen, and G. Q. Zhang, "Degradation of Microcellular PET reflective materials used in LED-based products," *Optical Materials*, vol. 49, pp. 79-84, 2015.
- [10] G. Lu, M. Y. Mehr, W. van Driel, X. J. Fan, J. Fan, K. Jansen, and G. Q. Zhang, "Color shift investigations for LED secondary optical designs: Comparison between BPA-PC and PMMA," *Optical Materials*, vol. 45, pp. 37-41, 2015.
- [11] J. Fan, C. Qian, K. C. Yung, X. J. Fan, G. Q. Zhang, and M. Pecht, "Optimal Design of Life Testing for High-Brightness White LEDs Using the Six Sigma DMAIC Approach," *IEEE Transactions on Device and Materials Reliability*, vol. 15, pp. 576-587, 2015.
- [12] X. Qu, H. Wang, X. Zhan, F. Blaabjerg, and H. S. H. Chung, "A Lifetime Prediction Method for LEDs Considering Real Mission Profiles," *IEEE Transactions on Power Electronics*, vol. PP, pp. 1-1, 2016.
- [13] F. Haghighi and S. J. Bae, "Reliability Estimation from Linear Degradation and Failure Time Data With Competing Risks Under a Step-Stress Accelerated Degradation Test," *IEEE Transactions on*, vol. 64, pp. 960-971, 2015.
- [14] Z. Wang, H. Fu, and Y. Zhang, "Analyzing degradation by an independent increment process," *Quality and Reliability Engineering International*, vol. 30, pp. 1275-1283, 2014.
- [15] G. Zhai, Y. Zhou, and X. Ye, "A Tolerance Design Method for Electronic Circuits Based on Performance Degradation," *Quality and Reliability Engineering International*, vol. 31, pp. 635-643, 2015.
- [16] Z. S. Ye and M. Xie, "Stochastic modelling and analysis of degradation for highly reliable products," *Applied Stochastic Models in Business and Industry*, vol. 31, pp. 16-32, 2015.
- [17] C. Zhang, X. Lu, Y. Tan, and Y. Wang, "Reliability demonstration methodology for products with Gamma Process by optimal accelerated degradation testing," *Reliability Engineering & System Safety*, vol. 142, pp. 369-377, 2015.
- [18] J. Y. Chiang, Y. Lio, and T. R. Tsai, "Degradation Tests Using Geometric Brownian Motion Process for Lumen



- Degradation Data," *Quality and Reliability Engineering International*, vol. 31, pp. 1797-1806, 2015.
- [19] Z.-S. Ye, N. Chen, and Y. Shen, "A new class of Wiener process models for degradation analysis," *Reliability Engineering & System Safety*, vol. 139, pp. 58-67, 2015.
- [20] W. Peng, Y.-F. Li, Y.-J. Yang, H.-Z. Huang, and M. J. Zuo, "Inverse Gaussian process models for degradation analysis: A Bayesian perspective," *Reliability Engineering & System Safety*, vol. 130, pp. 175-189, 2014.
- [21] Z. Ye, M. Revie, and L. Walls, "A load sharing system reliability model with managed component degradation," *Reliability, IEEE Transactions on*, vol. 63, pp. 721-730, 2014.
- [22] H. Hao, C. Su, and C. Li, "LED Lighting System Reliability Modeling and Inference via Random Effects Gamma Process and Copula Function," *International Journal of Photoenergy*, vol. 2015, 2015.
- [23] J. Huang, D. S. Golubović, S. Koh, D. Yang, X. Li, X. Fan, and G. Zhang, "Degradation modeling of mid-power white-light LEDs by using Wiener process," *Optics express*, vol. 23, pp. A966-A978, 2015.
- [24] L. Ding, H. Wang, K. Kang, and K. Wang, "A novel method for SIL verification based on system degradation using reliability block diagram," *Reliability Engineering & System Safety*, vol. 132, pp. 36-45, 2014.
- [25] L. Bian and N. Gebrael, "Stochastic modeling and real-time prognostics for multi-component systems with degradation rate interactions," *IIE Transactions*, vol. 46, pp. 470-482, 2014.
- [26] S. Tarashioon, W. van Driel, and G. Zhang, "Multi-physics reliability simulation for solid state lighting drivers," *Microelectronics Reliability*, vol. 54, pp. 1212-1222, 2014.
- [27] E. F. Schubert, T. Gessmann, and J. K. Kim, *Light emitting diodes*: Wiley Online Library, 2005.
- [28] D. S. Meyaard, Q. Shan, J. Cho, E. F. Schubert, S.-H. Han, M.-H. Kim, C. Sone, S. J. Oh, and J. K. Kim, "Temperature dependent efficiency droop in GaInN light-emitting diodes with different current densities," *Applied Physics Letters*, vol. 100, p. 081106, 2012.
- [29] J. Piprek, "Efficiency droop in nitride - based light - emitting diodes," *physica status solidi (a)*, vol. 207, pp. 2217-2225, 2010.
- [30] B. Sun, X. J. Fan, W. v. Driel, T. Michel, J. Zhou, and G. Q. Zhang, "Lumen Decay Prediction in LED Lamps," presented at the IEEE International Conference on Thermal, Mechanical and Multi-Physics Simulation and Experiments in Microelectronics and Microsystems, Montpellier, 2016.
- [31] S. Lan, C. M. Tan, and K. Wu, "Reliability study of LED driver—A case study of black box testing," *Microelectronics Reliability*, vol. 52, pp. 1940-1944, 2012.
- [32] S. Lan, C. M. Tan, and K. Wu, "Methodology of reliability enhancement for high power LED driver," *Microelectronics Reliability*, vol. 54, pp. 1150-1159, 2014.
- [33] X. Shao, "Research on Reliability Assessment Method of The LED Driver Power Supply," Master of Engineering, School of Electrical Engineering, Harbin Institute of Technology, Harbin, China, 2012.
- [34] P. Fang and Y. F. Liu, "An electrolytic capacitor-free single stage Buck-Boost LED driver and its integrated solution," in *Applied Power Electronics Conference and Exposition (APEC), 2014 Twenty-Ninth Annual IEEE*, 2014, pp. 1394-1401.
- [35] Linear Technology Corporation. (2014). *LTwiki*. Available: [http://ltwiki.org/?title=Main\\_Page](http://ltwiki.org/?title=Main_Page)
- [36] B. Hamon, B. Bataillou, A. Gasse, and G. Feuillet, "N-contacts degradation analysis of white flip chip LEDs during reliability tests," in *Reliability Physics Symposium, 2014 IEEE International*, 2014, pp. FA. 1.1-FA. 1.6.
- [37] H.-T. Chen, S.-C. Tan, and S. Hui, "Color variation reduction of GaN-based white light-emitting diodes via peak-wavelength stabilization," *Power Electronics, IEEE Transactions on*, vol. 29, pp. 3709-3719, 2014.
- [38] M. Hudait and S. Krupanidhi, "Doping dependence of the barrier height and ideality factor of Au/n-GaAs Schottky diodes at low temperatures," *Physica B: Condensed Matter*, vol. 307, pp. 125-137, 2001.
- [39] Y. Huaiyu, K. S. Wee, W. Jia, and H. W. Van Zeijl, "Dynamic thermal simulation of high brightness LEDs with unsteady driver power output," in *Thermal, Mechanical and Multi-Physics Simulation and Experiments in Microelectronics and Microsystems (EuroSimE), 2012 13th International Conference on*, 2012, pp. 1/5-5/5.
- [40] X. Perpina, R. Werkhoven, M. Vellvehi, X. Jorda, J. Kunen, J. Jakovenk, P. Bancken, and P. Bolt, "LED driver thermal design considerations for solid-state lighting technologies," in *Thermal, Mechanical and Multi-Physics Simulation and Experiments in Microelectronics and Microsystems (EuroSimE), 2012 13th International Conference on*, 2012, pp. 1/5-5/5.
- [41] J. Jakovenko, J. Formánek, V. Janiček, M. Husák, and R. Werkhoven, "High power solid state retrofit lamp thermal characterization and modeling," *Radioengineering*, vol. 21, pp. 231-238, 2012.
- [42] J. Jakovenko, R. Werkhoven, J. Formanek, and J. Kunen, "Thermal simulation and validation of 8W LED Lamp," in *Thermal, Mechanical and Multi-Physics Simulation and Experiments in Microelectronics and Microsystems (EuroSimE), 2011 12th International Conference on*, 2011, pp. 1/4 - 4/4.