

**Document Version**

Final published version

**Licence**

CC BY

**Citation (APA)**

Jonkman, S. N., Curran, A., & Bouwer, L. M. (2024). Floods have become less deadly: an analysis of global flood fatalities 1975–2022. *Natural Hazards*, 120(7), 6327–6342. <https://doi.org/10.1007/s11069-024-06444-0>

**Important note**

To cite this publication, please use the final published version (if applicable). Please check the document version above.

**Copyright**

In case the licence states “Dutch Copyright Act (Article 25fa)”, this publication was made available Green Open Access via the TU Delft Institutional Repository pursuant to Dutch Copyright Act (Article 25fa, the Taverne amendment). This provision does not affect copyright ownership.

Unless copyright is transferred by contract or statute, it remains with the copyright holder.

**Sharing and reuse**

Other than for strictly personal use, it is not permitted to download, forward or distribute the text or part of it, without the consent of the author(s) and/or copyright holder(s), unless the work is under an open content license such as Creative Commons.

**Takedown policy**

Please contact us and provide details if you believe this document breaches copyrights. We will remove access to the work immediately and investigate your claim.



# Floods have become less deadly: an analysis of global flood fatalities 1975–2022

S. N. Jonkman<sup>1,2</sup> · A. Curran<sup>1,3</sup> · L. M. Bouwer<sup>4</sup>

Received: 7 November 2023 / Accepted: 23 January 2024  
© The Author(s) 2024

## Abstract

Floods are amongst the most frequent disasters in terms of human and economic impacts. This study provides new insights into the frequency of loss of life at the global scale, mortality fractions of the population exposed to floods, and underlying trends. A dataset is compiled based on the EM-DAT disaster database covering the period 1975 until 2022, extending previous studies on this topic. Flood impact data are analysed over spatial, temporal and economic scales, decomposed in various flood types and compared with other natural disasters. Floods are the most frequent natural disasters up to 1000 fatalities, and flash floods lead to the highest mortality fractions per event, i.e. the number of deaths in an event relative to the exposed population. Despite population growth and increasing flood hazards, the average number of fatalities per event has declined over time. Mortality fractions per event have decreased over time for middle- and high-middle-income countries, but increased for low-income countries. This highlights the importance of continuing and expanding risk reduction and adaptation efforts.

**Keywords** Fatalities · Floods · Mortality · Trends · Disaster risk reduction

## 1 Introduction

The Global Risk Report by the World Economic Forum (2023) highlights extreme weather as one of the most severe threats facing the world, alongside climate action failure and infectious diseases. Analyses of the global trends in extreme weather events and their societal, economic and ecological impacts are important for understanding local risks and options for reducing these threats (Kreibich et al. 2022). Life-threatening and existential

---

✉ S. N. Jonkman  
s.n.jonkman@tudelft.nl

<sup>1</sup> Department of Hydraulic Engineering, Faculty of Civil Engineering and Geosciences, Delft University of Technology, Delft, The Netherlands

<sup>2</sup> Institute for a Disaster Resilient Texas (IDRT), Texas A&M University at Galveston, Galveston, USA

<sup>3</sup> HKV Consultants, Delft, The Netherlands

<sup>4</sup> Climate Service Center Germany (GERICS), Helmholtz-Zentrum Hereon, Hamburg, Germany

extreme weather risks are being widely discussed in the scientific literature because of uncertainties in impact trends and underlying causes, such as anthropogenic climate change (Pielke 2021; Huggel et al. 2022). Moreover, fatalities from natural hazards are the top priority for guiding policy on disaster risk reduction: the Global Target A of the Sendai Framework aims to substantially reduce global disaster mortality by 2030 (UNDRR 2015). Information and analysis on this indicator, and understanding underlying causes and changes over time are therefore essential. The number of systematic studies into fatalities from disasters, however, is relatively limited, and there are multiple interpretations of past trends and their causes.

Some studies have focussed on global scale analysis of flood fatalities. Notably, fatalities from river floods have been analysed using insurance records (Jongman et al. 2015) and public databases (Tanoue et al. 2016; Zhang et al. 2021). Studies focussed on global fatalities from inland (Jonkman 2005) and coastal floods (Bouwer and Jonkman 2018), or several aggregated flood types (Hu et al 2018). Others focussed on specific aspects such as seasonal patterns in mortality (Alfieri et al. 2020) and benefits of flood loss prevention (Chen et al. 2020). Formetta and Feyen (2019) focus on vulnerability of a broader group of climate-related disasters and showed that mortality has decreased over time. These studies generally use global disaster databases such as EM-DAT which facilitates analyses into impacts from extreme weather events (Guha-Sapir et al 2013).

A key question is if and how flood impacts have changed over the last decades. Past studies find that while total global flood fatalities have increased (Jonkman 2005; Tanoue et al. 2016), the number of fatalities per event has decreased (Bouwer and Jonkman 2018, Hu et al. 2018). However, for better understanding of the relative impacts from flood events over time, not only the total fatality numbers, or fatalities per event, but also the mortality fraction—that is the number of deaths relative to the exposed population—is important. Existing studies, however, did not calculate mortality fractions per event and considered more limited time-periods. Mortality fractions per event are an indicator of relative vulnerability, which is often neglected in literature. This indicator allows analysis and comparison of vulnerability between countries and over time. Moreover, the frequency, scale, impacting mechanisms and level of mortality vary between different flood event types, but these aspects are often disregarded.

The objective of this study is to provide a comprehensive global analysis of flood fatalities over spatial, temporal and economic scales, decomposed into various flood types. We go beyond previous studies by (a) including and distinguishing between fatalities from different flood types (riverine, coastal and flash floods); (b) providing a comparison against other climate-related hazards; (c) calculating and analysing changes in total and averaged event fatalities, as well as mortality fractions per event and the relationship with income levels; and finally (d) extending the previous global study of Jonkman (2005) by more than 20 years of data, with recent years witnessing severe floods and fatalities in several countries.

In order to meet the objective, we developed a dataset of flood fatalities at the global scale, according to flood type, country(ies) affected and time of occurrence—for the period 1975–2022 (Curran et al. 2023). The principal basis is data from the widely used EM-DAT International Disaster Database, with quality checks, and additional information sources—particularly for coastal floods (see Sect. 2). Global impacts in terms of flood fatalities are analysed by flood type and compared with those of other disasters. We comprehensively analyse temporal trends and relate these to economic development and other factors (Sect. 3). The final Sect. 4 summarizes the main findings and discusses the limitations and implications of this work.

## 2 Approach: EM-DAT and the global flood fatalities dataset

This section outlines the data sources, data processing and methods used in the analyses in this study, as well as associated limitations.

### 2.1 The EM-DAT international disaster database

The primary data source for our study is the EM-DAT International Disaster Database collected by the Centre for Research on the Epidemiology of Disasters in Brussels—CRED at UC Louvain in Brussels, Belgium (Guha-Sapir et al. 2013; EM-DAT, 2023). The information in this database is collected from various international, governmental, commercial and NGO agencies. While the database stretches back to the year 1900, CRED was established in 1973, and more recorded events with increased detail are included in the database since that time. For this reason, the present study uses data starting from 1975.

For entry to the EM-DAT database (<https://www.emdat.be/database>), an event must fulfil at least one of the following criteria; 10 or more deaths reported, 100 or more people affected reported, a state of emergency is declared or international assistance is requested. This set of criteria ensures that also relatively small (flood) events, e.g. an event with 100 people affected and 1 fatality, will be included in the database. Each event is given a unique identifier related to the starting year and country of the event. Each recorded event has 50 fields that detail information about the type, location, impact, strength, and characteristics of the event, as well as the reason that it has been included (e.g. because it surpassed a certain threshold in terms of economic loss or fatalities). Not all fields may be completed.

### 2.2 The global flood fatalities dataset

We have used EM-DAT to develop a database of flood events with one or more fatalities, also distinguishing the various flood types (Curran et al. 2023). The dataset covers the period 1975–2022, thus updating the previous global analysis for the period 1975–2001 by Jonkman (2005) with 20 years of data. While many of the factors influencing trends in fatalities such as population growth and economic development are applicable to all natural disasters, anthropogenic climate change impacts only floods considered to have hydrological and meteorological causes. As we are interested in multiple drivers for changes in risk, including climate, we focus on flood types caused by extreme weather, for which frequency and impacts are expected to be affected by anthropogenic climate change through changes in extreme rainfall and changes in sea level, winds and extreme coastal surge levels (IPCC 2023). We have not included floods originating from tsunamis in our temporal analyses of floods as these have other causes. Dam failures are also not included as these have multiple causes that include hydrological extremes, but also deficiencies in design and operation and human actions (Proske 2021). These varying causes of dam failure floods are not reported in the EM-DAT database.

Statistics of flood fatalities are compared against those from other disaster types that are associated with extreme weather, specifically: (wind)storms, wildfires, extreme temperature, droughts and landslides.

Within EM-DAT, we have considered events from the following subgroups that are within the natural disasters group: hydrological (floods and landslides), meteorological (extreme temperature and storm) and climatological (drought and wildfire)—see (IRDR 2014) for definitions. We have classified the flood events by flood type, distinguishing riverine floods, coastal

floods, and a joint category of pluvial and flash floods caused by heavy local rainfall—see (Jonkman 2005) for definitions. In particular, we found that coastal flood events had to be selected within EM-DAT from two event types: storm surge/ coastal flood and storm/cyclone (Bouwer and Jonkman 2018). As coastal storms are often characterized with a combination of extreme winds, coastal surge and heavy rainfall, these events have been categorized in both the ‘flood’ and ‘storm’ categories within EM-DAT. For many of the events designated as ‘storms’, the main cause of fatalities is often considered to be flooding (Rappaport 2014). Storm winds may play a large role in economic damage during such events. We have reclassified a number of storm events as floods, either based on the event descriptions, or if they were included in previous study on coastal floods (Bouwer and Jonkman 2018). Also, other flood events have been reviewed based on the available metadata to verify if they were in the appropriate category and/or to assign a flood type. Figure 6 in the “Appendix” includes a schematic of the categorization process.

Table 1 gives an overview of the events included in the present study. In total 5582 flood events with one or more fatalities are included. We reclassified 592 of these events from the ‘storm’ category to the coastal or pluvial flood type using the process described above. Furthermore, our verifications and reviews resulted in three extra coastal and three extra flash flood events being added to the database of flood events (Table 3 in the Appendix). The verification and classification process also resulted in 34 events that could not be categorized as one of the flood types due to insufficient information.

### 2.3 Data processing and analyses

This section summarizes steps in our analysis as well as some important inputs and assumptions.

The basis are the reported numbers of fatalities and affected reported in EM-DAT for floods and other disasters. The total number is described as the number of people requiring immediate assistance due to the disaster. It also includes the number of injured and those requiring shelter due to their house being destroyed or heavily damaged during the disaster. (<https://doc.emdat.be/docs/data-structure-and-content/emdat-public-table/>, accessed Jan 22, 2024).

In this study we assumed that the number of affected people reported in EM-DAT equals the number of people exposed to the flood event as was done in previous studies (Jonkman 2005; Bouwer and Jonkman 2018). This could be a conservative estimate for estimating exposure; Some of the affected people may not be exposed directly to floodwaters, for example when they are evacuated before the flood or have been only exposed to wind effects in a coastal storm surge. We have analysed temporal trends in reported numbers of events (Sect. 3.1) and the numbers of fatalities and affected (Sect. 3.2). Both the absolute numbers of fatalities and affected, and the average numbers per event are analysed for a given year. In Sect. 3.1, we compute the average annual exceedance frequency of events with a certain number of fatalities over the 47 year period considered in the study. The significance of the (logarithmic) temporal trends reported in Sect. 3.2 is tested with a Mann Kendall test.

We have analysed mortality fractions per event by flood type (Sect. 3.3). Mortality fractions for an event ( $F_{D,i}$ ) were determined based on the below formula.

$$F_{D,i} = N_i / N_{\text{exp},i}$$

where  $N_i$ , number of fatalities for an event;  $N_{\text{exp},i}$ , number of exposed people for an event.

The mortality fraction is a metric of the relative vulnerability for an event. It expresses the sensitivity of impacts to a given flood hazard, and it can be used to compare regions and patterns in time. Based on the mortality fractions for single events, we computed average mortality for a set of events (e.g. floods in a single year, flood type and income group).

For the analysis of mortality by income group (Sect. 3.4), World Bank income data (<https://data.worldbank.org/>, accessed October 31 2023) have been appended to the database based on the country and year of the event. The GDP for an event depends on both the year of the event and the total GDP of the country affected. Note that the values are given in terms of 'Adjusted Income', which is the average income of the country affected by a flood hazard in USD, adjusted for inflation. The bands defining income classification (low, lower middle, higher middle, high) have also been taken from the above World Bank data.

## 2.4 Known issues and limitations

Any attempt to evaluate and categorize major disaster events comes with a number of issues, including biases in reporting of events over time (Jones et al. 2022).

In relation to time, there are more data available for more recent events (see also Sect. 3.1). This is mitigated by using (where appropriate) statistics averaged over all recorded events per year and by reporting mortality fraction per event as a metric of the severity of impact. We have also analysed the trends for the annual number of reported events and the average number of killed and affected per event for various alternative thresholds (more than 10, 100, 1000 fatalities).

For event categorization, even with the steps that were mentioned above, assigning a single category to an event like a hurricane which can cause flooding, wind damage and landslides is not clear-cut, and a known limitation of the study.

Some entries in EM-DAT show the number for 'Total Affected' to be less than 'Total Deaths', resulting in a mortality fraction above 1. For this reason, a minimum value for 'Total affected' has been set to the sum of fatalities, injured and affected.

An practical issue specific to the EM-DAT database is that no distinction is made between events where the numeric value of an attribute (e.g. fatalities or total damage) is not known and one in which the value is 0. In both cases the field is left blank. So, it is difficult to filter out flood events with 0 fatalities. Also for this reason only events with one or more reported fatalities are included in the analysis in this paper.

## 3 Results

### 3.1 Global flood fatalities and comparison to other disasters

Floods are generally the most frequent event type associated with one or more fatalities, compared to other natural disasters (Fig. 1, left panel). The most frequently occurring flood types are riverine and flash floods (Fig. 1, right panel).

Figure 1 (right panel) displays the number of reported flood events per year. Trend-lines are included to split the data into periods before and after the time that digital information became more widely available. Assuming two linear trends, it has been found that the year 2000 corresponds to a splitting point in which the combined regression error of those two trend lines is minimized. There is a strong increase in the

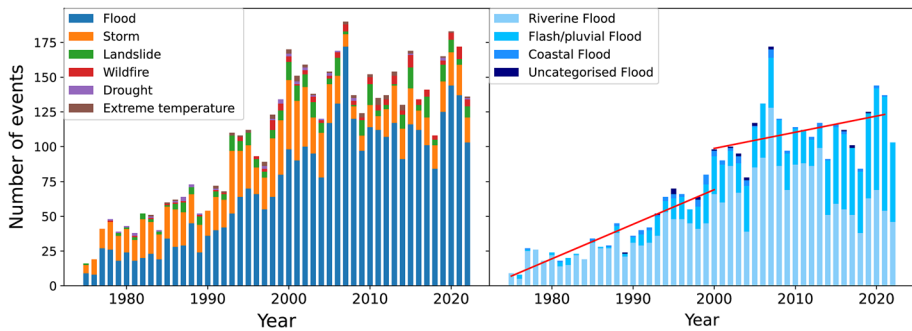

**Fig. 1** Number of disaster events (left) and flood events (right) with one or more fatalities as recorded in EM-DAT for the period 1975–2022

number of reported events until the year 2000 and increase in the yearly reported number of events slows down afterwards (Fig. 1, right panel).

We have also analysed the trends for the annual number of reported events for various alternative thresholds (more than 10, 100, 1000 fatalities), and the results are reported in Fig. 7 in the “Appendix”. For the period after the year 2000, this shows that there are an increase in the smaller events ( $\geq 1$  fatalities), a stabilization for medium events ( $\geq 10$ ) fatalities and a decrease of the annual number of large events ( $\geq 100$  fatalities).

The initial increase until the year 2000 is most likely due to extended and improved reporting and availability of information online in the digital age (Jonkman 2005; Tanoue et al. 2016; Jones et al 2022). Here, we account for this trend by reporting average number of fatalities as well as mortality fractions per event, besides the total annual numbers of fatalities and affected.

Table 2 summarizes the largest events in terms of fatalities in the database for various categories of disasters. Note that some events fall into multiple categories. The events with largest numbers of fatalities include the 1983 Sudan drought, the 1976 China earthquake, the Indian Ocean tsunami of 2004, and the Haiti earthquake in 2010. Some very deadly floods occurred in the form of coastal flood events in Bangladesh (1991) and Myanmar (2008), and catastrophic river floods in China (1975). Particularly due to these large events, it is found that most flood fatalities (around 85%) occurred in Asia.

Figure 2 (left panel) shows the average annual frequency of events with  $N$  or more fatalities for various natural hazards. What we observe from the left side of the figure is that floods are the most likely disaster amongst the geophysical and meteorological hazards to cause any given number of deaths up to 5000. Flood events with  $> 100$  deaths happen globally on average 10 times a year.

Riverine and flash floods are the most frequent flood type for flood events up to 1,000 fatalities (Fig. 2, right panel). These flood types combine to cause many relatively smaller events per year: around 60 events occur each year with 5 or more fatalities. Coastal floods from storms and tropical cyclones occur less frequently, but are dominant for events over 1,000 fatalities (see also Table 1). In the subsequent analysis, we focus on coastal and inland flood events with meteorological causes, as explained in the introduction.

**Table 1** Overview of number of records available within (adjusted) EM-DAT database

Subsets of total dataset	Number of records
Total number of singular natural disaster events in EM-DAT	23,892
Natural disaster events between 1975 and 2022	21,570
Natural disaster events with fatalities ( $\geq 1$ ) reported	17,459
Extreme weather events	9758
Storm	2514
Landslide	687
Drought	562
Wildfire	413
Extreme temperature	385
Flood	5582
Riverine	3913
Flash/pluvial	1508
Coastal	127
Uncategorized	34

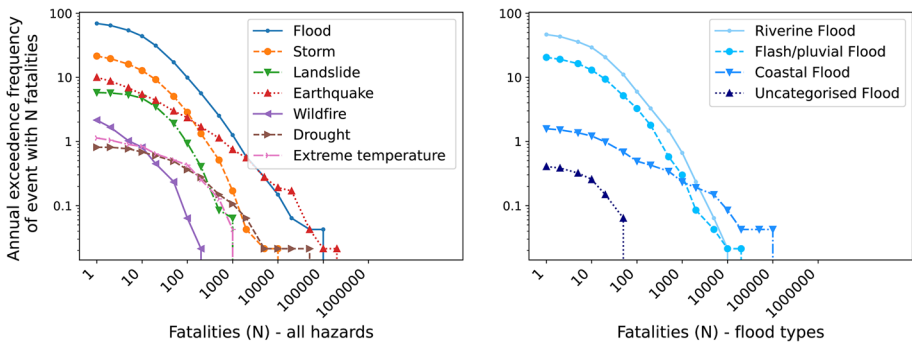

**Fig. 2** Frequency curves for disasters (left) and flood types (right) indicating the average annual exceedance frequency of events with a certain number of fatalities

### 3.2 Trends in flood fatalities and people affected

The trends for both the total global annual number of reported flood fatalities (left) and people affected (right) are shown in blue in Fig. 3 and appear to be static or slightly increasing. Using a Mann–Kendall test (alpha value of 0.05), it is shown that neither of these trends are statistically robust, with the test giving p-values of 0.75 and 0.1, respectively.

The average number of fatalities per event (left) and the average number of people affected per event (right) in each year are shown in red in Fig. 3, showing a statistically significant downward trend (Mann–Kendall test p-values of 0.001 and 0.025, respectively). This reduction in the average impact (both fatalities and people affected) per event can be attributed to a) changes in reporting over time and b) improved flood risk management—as is further explained below.

**Table 2** List of largest disaster events in database for various categories, ranked by total number of fatalities

Year	Disaster Category	Disaster Subcategory	Country/region	Fatalities	People Affected (mlns)	Direct Damage (10 <sup>6</sup> US\$)	Ranks		
							All events	Extreme Weather events	Flood events
1983	Drought	–	Sudan et al	450,000	1.7	–	1	1	
1976	Earthquake		China	242,000	0.41	5600	2		
2004	Earthquake	Geophysical (Tsunami)	Sri Lanka et al	226,408	0.24	500	3		1
2010	Earthquake		Haiti	222,570	0.37	8000	4		
1991	Flood	Coastal	Bangladesh	138,865	1.54	–	5	2	2
2008	Flood	Coastal	Myanmar	138,375	0.24	–		3	3
1981	Drought	–	Mozambique	100,000	0.47	–		4	
1999	Flood	Flash/pluvial	Venezuela	30,000	0.05	3160		5	4
1975	Flood	Riverine Flood	China	20,000	1.1	–			5

A potential change in reporting is that more smaller events are getting reported for more recent decades, leading to an overall decline over time in the average number of fatalities (and affected people) per event. We have analysed the annual number of reported events (see above) and the average number of killed and affected per event for various thresholds (more than 10, 100, 1000 fatalities). From the analysis, it appears that the average number of fatalities and affected per event decreases over time for all thresholds (Fig. 8 in the “Appendix”). This shows that the downward trend is robust. It is therefore expected that improved flood risk management practices over the last decades will have contributed to the downward trend in fatalities per event. This includes improved forecasting and flood early warning, increased protection in several places, and other forms of risk reduction. These are global trends measured in terms of reduced average impacts. Reports from individual events may clearly point out failures in risk management, e.g. lack of flood warning (also see Sect. 4).

### 3.3 Mortality fractions by flood type

Mortality fractions are used to indicate the severity in terms of lethality of natural hazard events and are important indicators of vulnerability and risk. These fractions allow comparing how lethal different events are in one location, or similar events between locations. These fractions are calculated by dividing the number of fatalities by the exposed population for each flood event (see Sect. 2.3). Figure 4 shows the conditional exceedance probability of the mortality fraction given that a certain event type occurs. The data is lognormally distributed using a Kolmogorov–Smirnov test ( $p$ -value of  $2.3e-238$ ). Flash floods generally lead to the highest event mortality fractions in any flood event, followed by riverine floods (for values of the mortality fraction below  $10^{-2}$ ). This order roughly follows the available early warning lead times, as flash floods flash floods generally occur with limited or no warning and limited time to respond. Conversely, windstorms leading to coastal

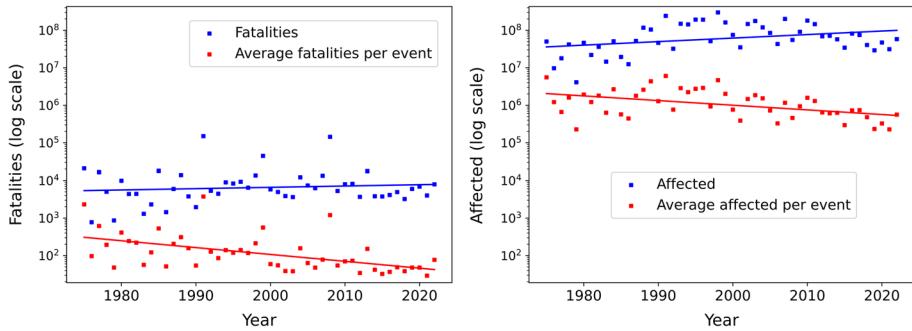

**Fig. 3** Trends in flood fatalities (left) and affected (right): yearly totals (blue) and averages per event (red)

flooding, and flooding in large river basins, can usually be forecasted multiple days in advance, with possibilities for warning and evacuations. Although the average event mortality fraction is the lowest for coastal floods, these events generally affect larger areas and populations than other floods, thus leading to higher overall impact. This is also illustrated by the fact that the right tail in the frequency–fatalities diagram in Fig. 2 (right panel) is dominated by coastal floods.

### 3.4 Trend in mortality fractions by income group

We analyse temporal changes in mortality fractions, by comparing the periods 1975–2000 and 2001–2022, for different countries grouped by income. There is no significant reduction in total mortality between both periods for the entire population of events. However, using one-way ANOVA tests, we observe that a statistically significant reduction in mortality fractions is experienced by middle- and high-middle-income countries (Fig. 5). Strikingly, low-income countries show slightly increased mortality fraction values. The change in event mortality for the high-income group is not statistically significant.

## 4 Discussion and conclusions

In our study, we find that the number of flood events has increased over time with a slower overall increase since 2000 and a decrease of the annual number of large events ( $\geq 100$  fatalities) since that year. The average number of people killed and affected per event has decreased over time. Since 1975, year-on-year declines of roughly 6 fatalities and over 30,000 persons affected per event are observed.

A key question is which drivers have caused these trends. Increased reporting and effects of climate change would lead to increasing numbers of flood events. Climate change would lead to more frequent flood events and higher intensities (IPCC 2023). Population

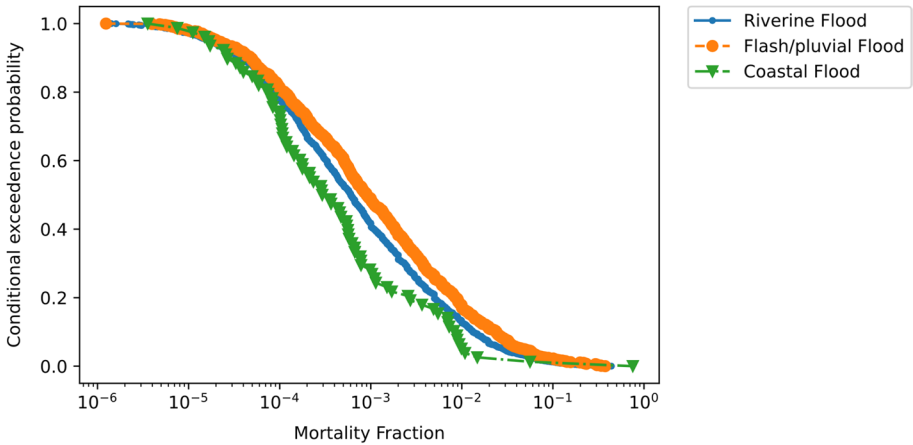

**Fig. 4** Conditional exceedance probability of mortality fractions given the occurrence of a certain flood type

and exposure growth would mainly result in increasing event impacts. Measures to reduce vulnerability, e.g. better warning and shelters, will lead to a reduction in the mortality fraction. Protective measures, such as flood defences, will prevent flood events or lower exposure by protecting parts of the population. Since all these factors change over time, mortality fractions and average impacts per event are considered key indicators for tracking relative impact of flood events. These indicators can be used to compare trends in different

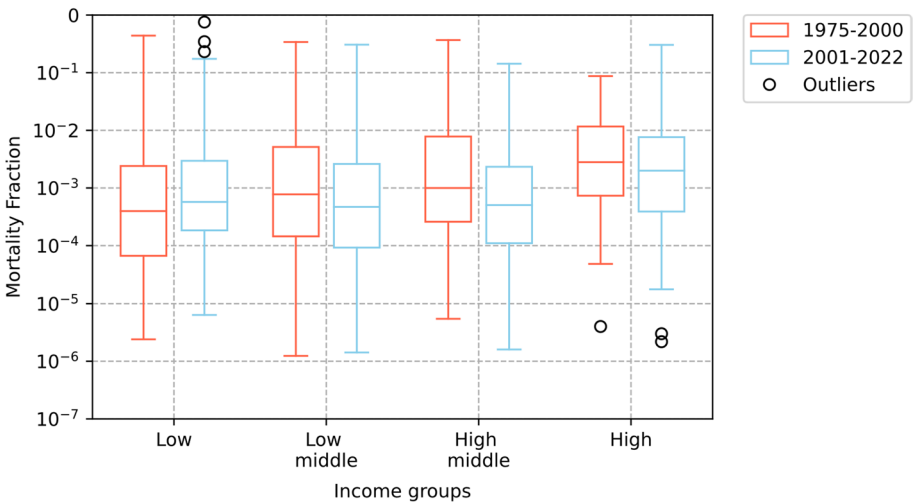

**Fig. 5** Boxplots showing flood mortality fraction distribution by income groups (according to World Bank classification) and temporal period. The boxplots show the median as a straight line, interquartile ranges as boxes, and ‘whiskers’ showing the limit of what is considered to be within the estimated distribution (i.e. not an outlier). Outliers are events that fall at a distance of more than twice the interquartile range from the median

countries, regions and income groups and are more time-consistent and robust metrics than total annual fatalities.

Note that the above effects are not fully independent: climate change could lead to stronger floods and higher impacts at the event level, but local adaptation through increased dike height and strength could prevent disasters in those locations.

It is striking that the total number of annual flood fatalities is rather constant over time, as there have been large changes in exposure in the past decades. Over the considered period, the global population has grown substantially from 4 to almost 8 billion people (source: <https://data.worldbank.org/indicator/SP.POP.TOTL>, accessed October 31 2023). Substantial part of this growth has taken place in flood prone areas along coasts and in river basins, leading to increases in the exposed population (Tellman et al. 2021; Rentschler et al. 2023).

A key cause for the resulting downward temporal trend in the average number of people killed per event concerns improved flood risk management practices over the last decades. This includes increased protection, better warning, forecasting and early warning communication and other forms of risk reduction. These are general trends; reports from recent individual events clearly point out failures in risk management. For example, for the deadly summer 2021 floods that affected multiple countries in North-western Europe most fatalities (more than 180) occurred in Germany, but flood warnings failed to reach most of the affected residents, and many were not prepared to act on the warning information (Thieken et al. 2023). At the same time, there are successful examples: in Bangladesh, improved forecasting, early warning and cyclone shelters, as well as improved coastal protection has led to progressively decreasing fatalities in similar cyclone-related coastal flooding (Paul 2009; Bouwer and Jonkman 2018). Also in the western world, improved flood protection, for instance, in the city of Hamburg after the 1962 flood disaster has avoided loss of life in more severe storm surge events in the years since (Kron and Müller 2019). Also, the New Orleans hurricane protection system that was built after the catastrophic flooding due to hurricane Katrina in the year 2005 has prevented flooding and loss of life during subsequent hurricanes, such as Isaac in 2012.

Our results confirm the finding that mortality from flood events has declined over time (Jongman et al. 2015; Tanoue et al. 2016; Formetta and Feyen 2019) and also show that average fatalities per event have declined for all flood types, and not just for large-scale coastal flood events (Bouwer and Jonkman 2018). However, we did not find statistically significant declining trends in the total annual number of people killed or affected per year on a global scale. The reduction of average impacts per event seems to be “compensated” by an increase over time of the number of reported events (Fig. 1) and the increased exposure due to population growth (see above). The trends in flood fatalities (a stabilization of the annual total and a decline in average fatalities per event) are opposed to trends in damages from weather-related extreme events (including floods) which have increased (Coronese et al. 2019). However, this damage increase is largely caused by increasing exposure of capital in urban areas (Bouwer 2019; Geiger and Stomper 2020).

Floods have become less lethal over time in many regions. Especially middle-income countries have succeeded in reducing mortality from flooding, while low-income countries have witnessed an increase after the year 2000 (Fig. 5). For high-income groups, we find no trend. In both cases, potential explanations may be the increased exposure in the floodplains. In low-income countries, people are increasingly moving into floodplains due to lack of available options without the implementation of substantial risk

reduction. In middle-income countries, increasing financial and other resources to protect and warn populations would lead to reduced vulnerabilities. This is different from the inverted U-shape in vulnerability, found in other studies for total mortality (Tanoue et al. 2016; Kellenberg and Mobarak 2008). Here we demonstrate the relationship between income level and mortality for average mortality fractions per event, which is a more robust indicator. The difference with other studies could be due to the fact that here we have recorded the mortality for the income group at the time of the event, so countries move from one income group to another over time. This accurately reflects the risk of the income level group at that time.

This study complements an earlier study (Jonkman 2005) on global patterns in loss of life, which considered the period 1975–2002. It extends the dataset beyond 2002 with 20 years of data and adds information on coastal floods for all years. While the 2005 study suggested a slight increase in the number of killed and affected per event, the present study shows a declining trend when the longer period 1975–2022 is considered. The 2005 study also highlighted a growth in the number of reported events up until 2002. The analyses in the present article show that an increase in reporting through wider availability of media and internet resources has played a role in the initial increase in reported events.

Our analysis is based on the publicly available global disaster database EM-DAT. A number of main issues included the consistency in reporting, the classification of combined coastal windstorm and flood events and the effects of data collection and reporting efforts on observed upward global temporal trends. Tracking global trends in vulnerability and disaster mortality—particularly in line with the goals of the Sendai Framework—requires a consistent data basis over time. It is thus important to minimize and correct for temporal trends in the analysis of disaster mortality statistics. Also, the use of the time-consistent indicators from this study (event mortality and average number of fatalities) can be utilized to monitor progress towards reducing risk and impacts from flooding and other disasters.

## Appendix

We have analysed the total number of events per year for various thresholds ( $\geq 1$ , 10, 100, 1000 fatalities, respectively) (Figs. 6, 7). For all categories there is a strong increase until the year 2000, with the most significant absolute increase for events with 1 or more fatalities. After the year 2000, there are still an increase in the smaller events ( $\geq 1$  fatalities), a stabilization for medium events ( $\geq 10$ ) fatalities and a decrease of the annual number of large events ( $\geq 100$  fatalities) (Table 3).

We have analysed temporal trends in average event impact for various thresholds (1, 10, 100, 1000 fatalities). Figure 8 shows the average number of fatalities per event (left) and affected (right) for a given year. For all categories a downward trend is found.

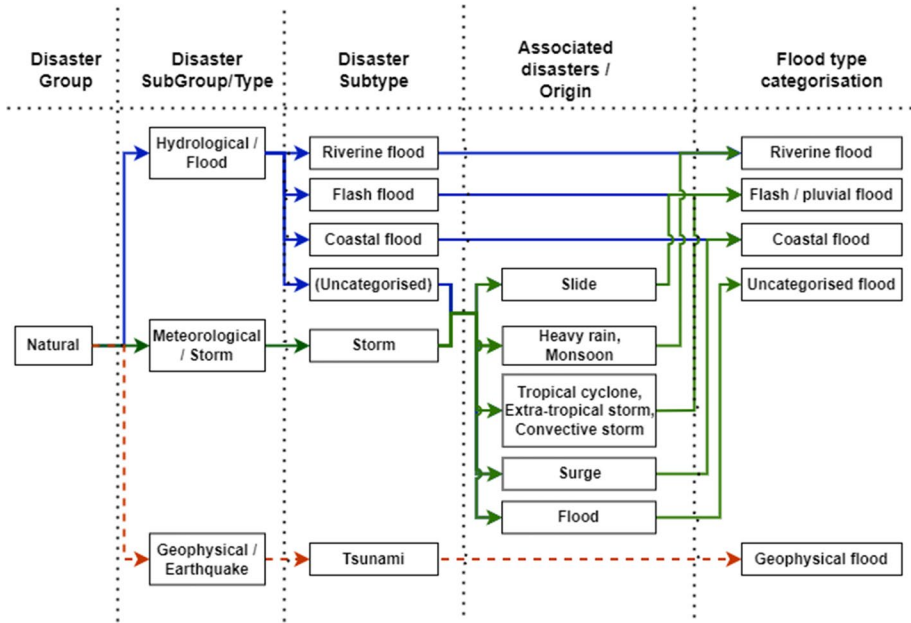

**Fig. 6** Categorization procedure for flood events based on EM-DAT attributes. The first four columns show the categories from EM-DAT, and the last column shows the flood type categories used in this paper. Tsunami events can also be retrieved from the database, but are not included in the present study

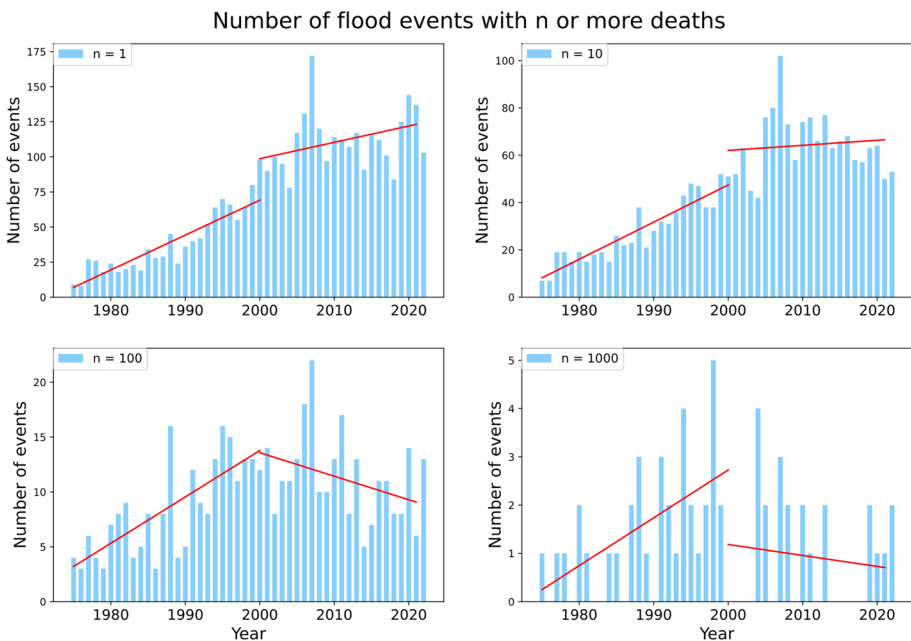

**Fig. 7** Reported number of fatal flood events per year and trendlines for various thresholds. Note that the vertical axes are not at the same scale

**Table 3** Manually reclassified events that have been added to the flood fatalities database

EM-DAT code (incl. year)	Countr(ies)	Storm name	Reclassified as	Fatalities	Affected (mln)
1979-0070	Dominican Republic	David/Frederick	Flash	1400	1.51
1984-0105	Philippines	Agnes/Undang	Coastal	1079	2.26
1984-0185	Philippines	June/Maring	Flash	1399	1.78
1997-0267	Vietnam/Thailand	Linda	Coastal	3859	1.08
1998-0345	Nicaragua	Mitch	Flash	14,609	2.12
2005-0567	Guatemala	Stan	Coastal	1074	2.52

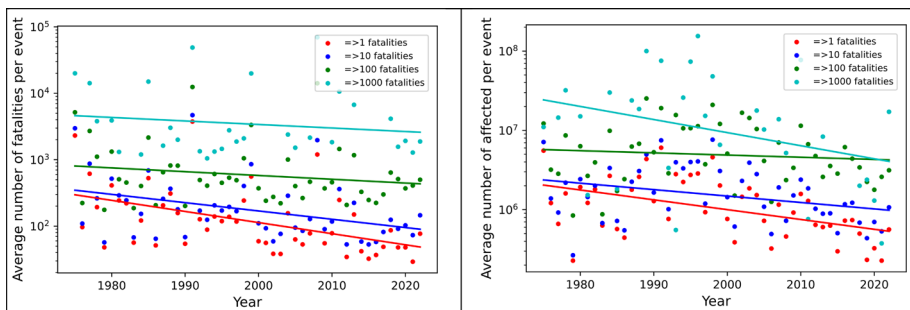
**Fig. 8** Average number of fatalities per event (left) and average number of affected per event (right) and trendlines

**Acknowledgements** Dr. Pieter van Gelder (TU Delft) is gratefully acknowledged for his advice on the statistical methods.

**Author contributions** SNJ developed the concept and method and contributed to and reviewed the analyses. AC created the database, contributed to the methods and performed the analyses. LMB has contributed to the methods and reviewed the analyses. All contributed to the writing of this manuscript and approved the final manuscript.

**Funding** S.N.J. is supported by the Hagler fellowship of Texas A&M University, the Pandemics and Disaster Preparedness Center (PDPC), and the Perspectief research programme “Future flood risk management technologies for rivers and coasts” with project number P21-23 (financed by the Domain Applied and Engineering Sciences of the Dutch Research Council (NWO)). L.M.B. is funded by the Helmholtz Association under the Programme “Changing Earth—Sustaining our Future”.

**Data availability** The dataset used for the analyses in this paper is made available in the 4TU Research Data repository and can be found under the citation (Curran et al. 2023).

## Declarations

**Competing interests** The authors have no relevant financial or non-financial interests to disclose.

**Open Access** This article is licensed under a Creative Commons Attribution 4.0 International License, which permits use, sharing, adaptation, distribution and reproduction in any medium or format, as long as you give appropriate credit to the original author(s) and the source, provide a link to the Creative Commons licence, and indicate if changes were made. The images or other third party material in this article are included in the article's Creative Commons licence, unless indicated otherwise in a credit line to the material. If material is not included in the article's Creative Commons licence and your intended use is not permitted by statutory regulation or exceeds the permitted use, you will need to obtain permission directly from the copyright holder. To view a copy of this licence, visit <http://creativecommons.org/licenses/by/4.0/>.

## References

- Alfieri L, Dottori F, Salamon P, Wu H, Feyen L (2020) Global modeling of seasonal mortality rates from river floods. *Earth's Future*. <https://doi.org/10.1029/2020EF001541>
- Bouwer LM (2019) Observed and projected impacts from extreme weather events: implications for loss and damage. In: Mechler R, Bouwer LM, Schinko T, Surminski S, Linnerooth-Bayer J (eds) *Loss and damage from climate change: concepts, principles and policy options*. Springer, Berlin, pp 63–82
- Bouwer LM, Jonkman SN (2018) Global mortality from storm surges is decreasing. *Env Res Lett* 13(1):014008
- Chen B, Shi F, Lin T, Shi P, Zheng J (2020) Intensive versus extensive events? Insights from cumulative flood-induced mortality over the globe, 1976–2016. *Int J Disaster Risk Sci* 11:441–451. <https://doi.org/10.1007/s13753-020-00288-5>
- Coronese M, Lamperti F, Keller K, Roventini A (2019) Evidence for sharp increase in the economic damages of extreme natural disasters. *PNAS* 116(43):21450–21455
- Curran A, Bouwer LM, Jonkman SN (2023) EMDAT disaster data used for article 'Floods have become less deadly: an analysis of global flood fatalities 1975–2022'. 4TU.ResearchData. doi: <https://doi.org/10.4121/eba1143f-adbe-4038-bac9-dae804a8b65a.v1>
- EM-DAT, CRED/UCLouvain (2024) Brussels, Belgium. [www.emdat.be](http://www.emdat.be). Accessed 22 Nov 2023
- Formetta G, Feyen L (2019) Empirical evidence of declining global vulnerability to climate-related hazards. *Glob Environ Change* 57:101920. <https://doi.org/10.1016/j.gloenvcha.2019.05.004>
- Geiger T, Stomper A (2020) Rising economic damages of natural disasters: trends in event intensity or capital intensity? *PNAS* 117(12):6312–6313
- Guha-Sapir D, D'Aoust O, Hoyois P (2013) The frequency and impact of natural disasters. In: Guha-Sapir D, Santos I, Borde A (eds) *The economics of natural disasters*. Oxford University Press, Oxford
- Hu P, Zhang Q, Shi P, Chen B, Fang J (2018) Flood-induced mortality across the globe: spatiotemporal pattern and influencing factors. *Sci Total Environ* 643:171–182
- Huggel C, Bouwer LM, Juhola S, Mechler R, Muccione V, Orlove B, Wallimann-Helmer I (2022) The existential risk space of climate change. *Clim Change* 174:8
- Intergovernmental Panel on Climate Change (IPCC) (2023) *Climate change 2023: synthesis report*. In: *Climate change 2023: synthesis report. Contribution of working groups I, II and III to the sixth assessment report of the Intergovernmental Panel on Climate Change* [Core Writing Team, H. Lee and J. Romero (eds.)]. IPCC, Geneva, Switzerland, pp 1–34
- IRDR (Integrated Research on Disaster Risk) (2014) *Peril classification and hazard glossary (IRDR DATA Publication No. 1)*. Beijing: Integrated Research on Disaster Risk
- Jones RL, Guha-Sapir D, Tubeuf S (2022) Human and economic impacts of natural disasters: can we trust the global data? *Sci Data* 9:572
- Jongman B, Winsemius HC, Aerts JC, Coughlan de Perez E, Van Aalst MK, Kron W, Ward PJ (2015) Declining vulnerability to river floods and the global benefits of adaptation. *PNAS* 112(18):E2271–E2280
- Jonkman SN (2005) Global perspectives on loss of human life caused by floods. *Nat Hazards* 34:151–175
- Kellenberg DK, Mobarak AM (2008) Does rising income increase or decrease damage risk from natural disasters? *J Urban Econ* 63(3):788–802
- Kreibich H, Van Loon AF, Schröter K, Ward PJ, Mazzoleni M, Sairam N et al (2022) The challenge of unprecedented floods and droughts in risk management. *Nature* 608(7921):80–86
- Kron W, Müller O (2019) Efficiency of flood protection measures: selected examples. *Water Policy* 21(3):449–467
- Paul BK (2009) Why relatively fewer people died? The case of Bangladesh's Cyclone Sidr. *Nat Hazards* 50, 289–304 (2009). <https://doi.org/10.1007/s11069-008-9340-5>

- Pielke R (2021) Economic ‘normalisation’ of disaster losses 1998–2020: a literature review and assessment. *Environ Hazards* 20(2):93–111
- Proske D (2021) The collapse frequency of structures. Springer Nature, Cham
- Rappaport EN (2014) Fatalities in the United States from Atlantic tropical cyclones: new data and interpretation. *Bull Am Meteor Soc* 95:341–346
- Rentschler J, Avner P, Marconcini M et al (2023) Global evidence of rapid urban growth in flood zones since 1985. *Nature* 622:87–92. <https://doi.org/10.1038/s41586-023-06468-9>
- Tanoue M, Hirabayashi Y, Ikeuchi H (2016) Global-scale river flood vulnerability in the last 50 years. *Sci Rep* 6:36021
- Tellman B, Sullivan JA, Kuhn C, Kettner AJ, Doyle CS, Brakenridge GR, Erickson TA, Slayback DA (2021) Satellite imaging reveals increased proportion of population exposed to floods. *Nature* 596:80–86
- Thieken AH, Bubeck P, Heidenreich A, von Keyserlingk J, Dillenaar L, Otto A (2023) Performance of the flood warning system in Germany in July 2021—insights from affected residents. *Nat Haz Earth Sys Sciences* 23:973–990
- United Nations Office for Disaster Risk Reduction (UNDRR) (2015). Sendai framework for disaster risk reduction 2015–2030. In: Proceedings of the 3rd United Nations World Conference on Disaster Risk Reduction (WCDRR), Sendai, Japan, 14–18 March 2015, pp 14–18
- World Economic Forum (2023) The global risks report 2023 18th Edition. World Economic Forum
- Zhang J, Xu W, Liao X, Zong S, Liu B (2021) Global mortality risk assessment from river flooding under climate change. *Environ Res Lett*. <https://doi.org/10.1088/1748-9326/abf87>

**Publisher’s Note** Springer Nature remains neutral with regard to jurisdictional claims in published maps and institutional affiliations.