

▼ + 9500  
Second Floor (2)

▼ + 5500  
First Floor (1)

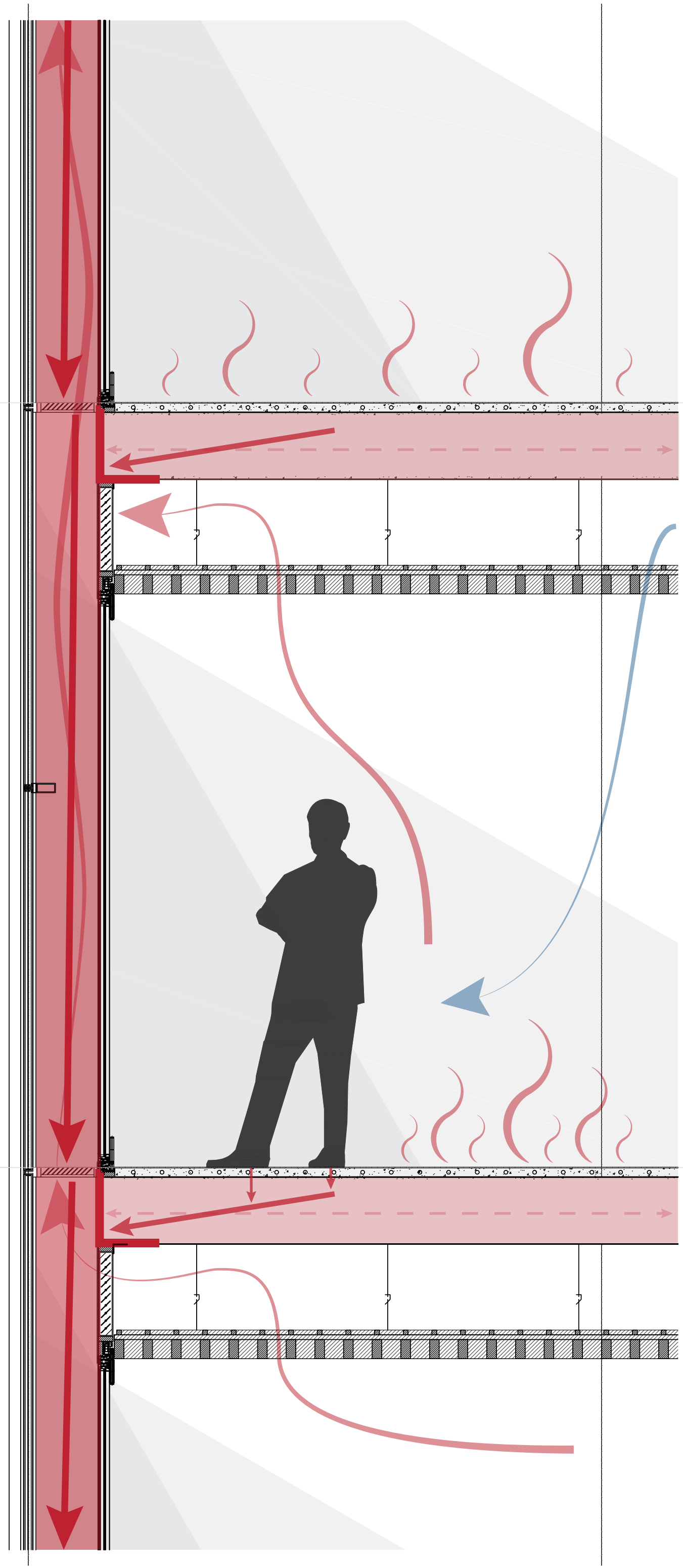

▼ + 9500  
Second Floor (2)

▼ + 5500  
First Floor (1)

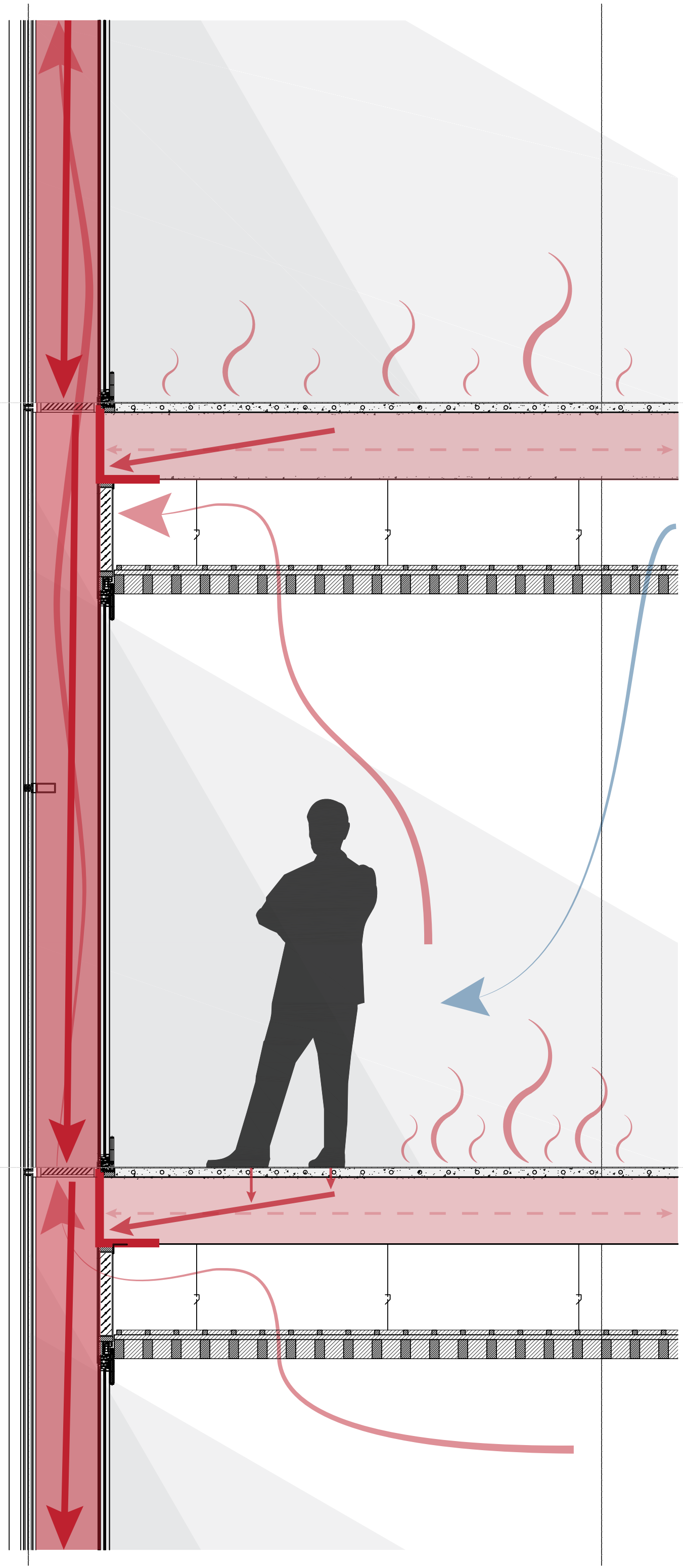

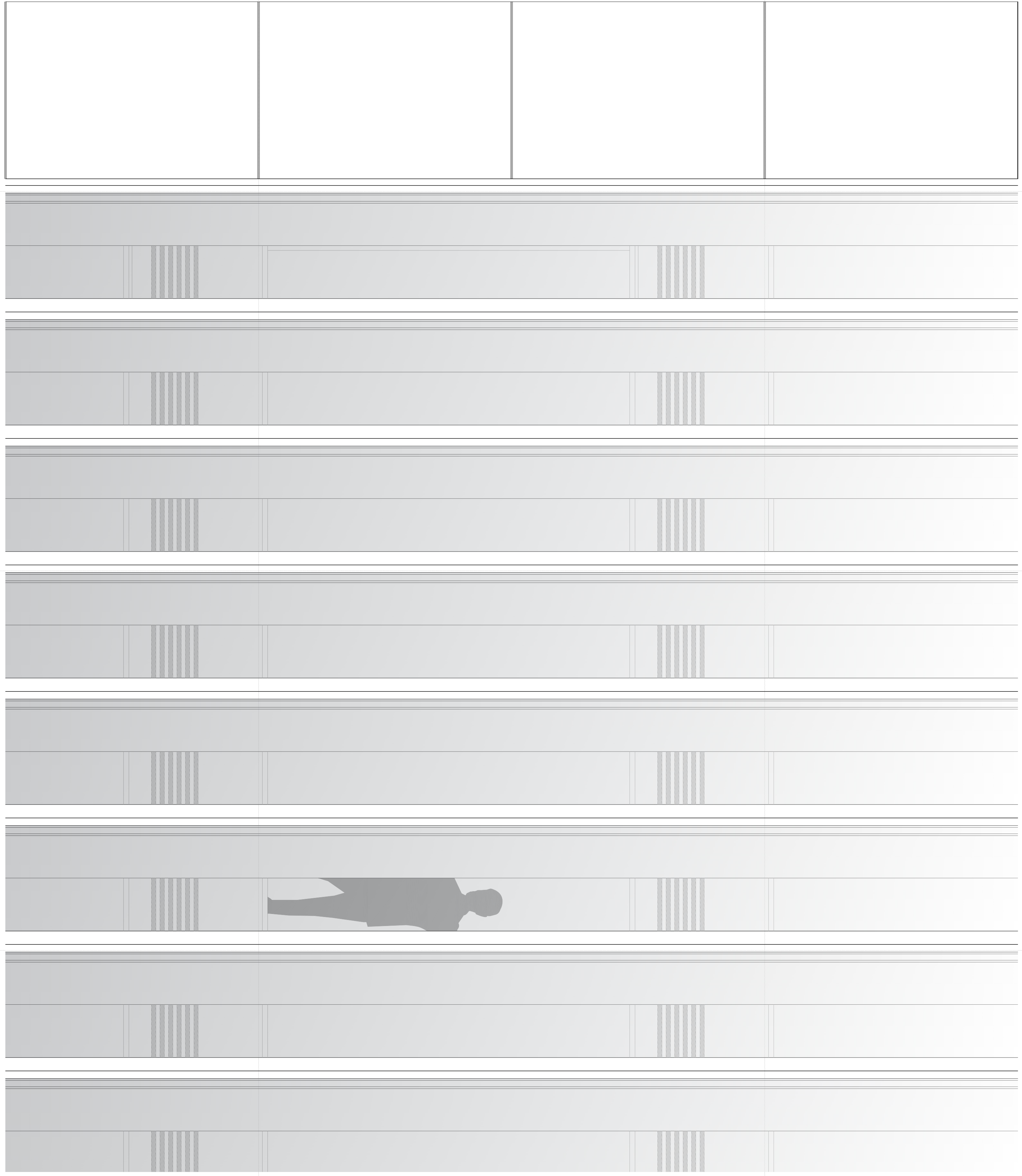
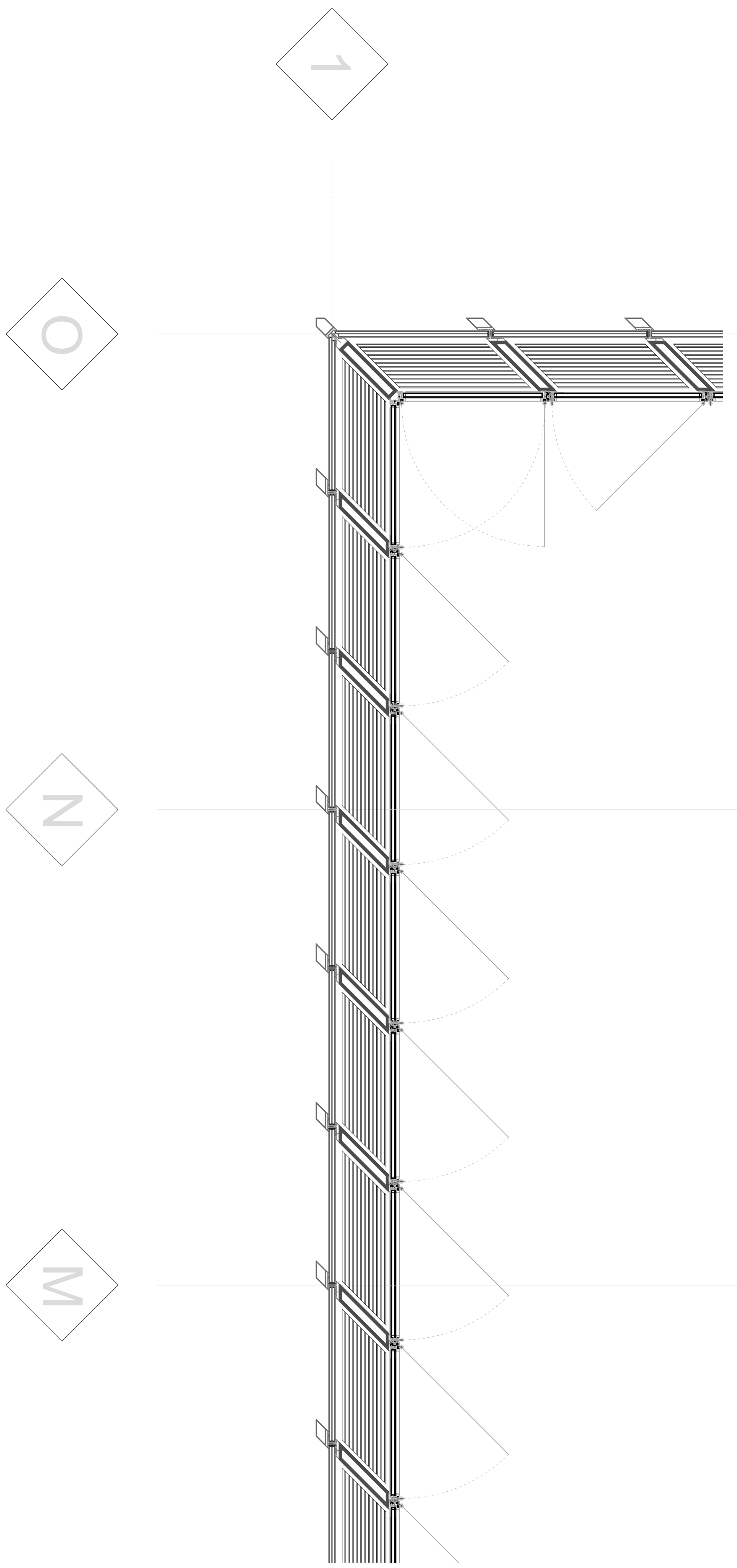

▲ + 5500  
First Floor (1)

▲ + 9500  
Second Floor (2)

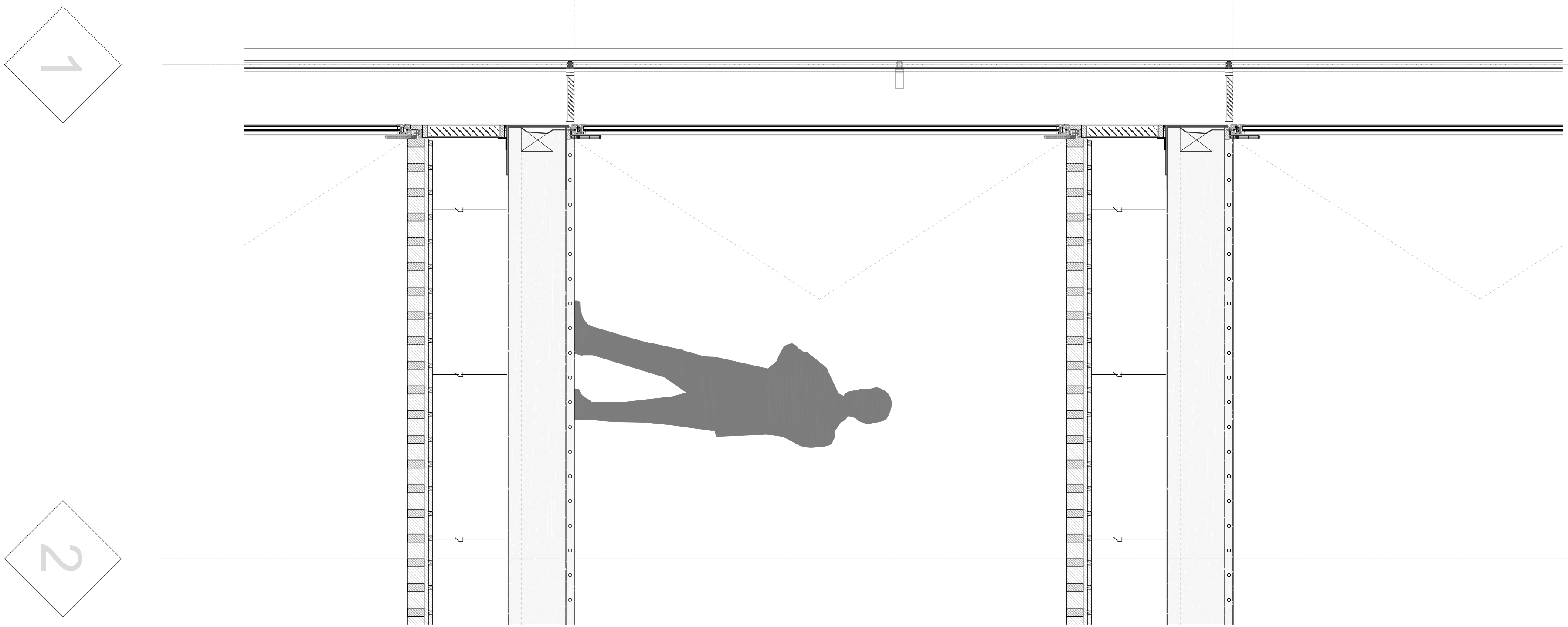



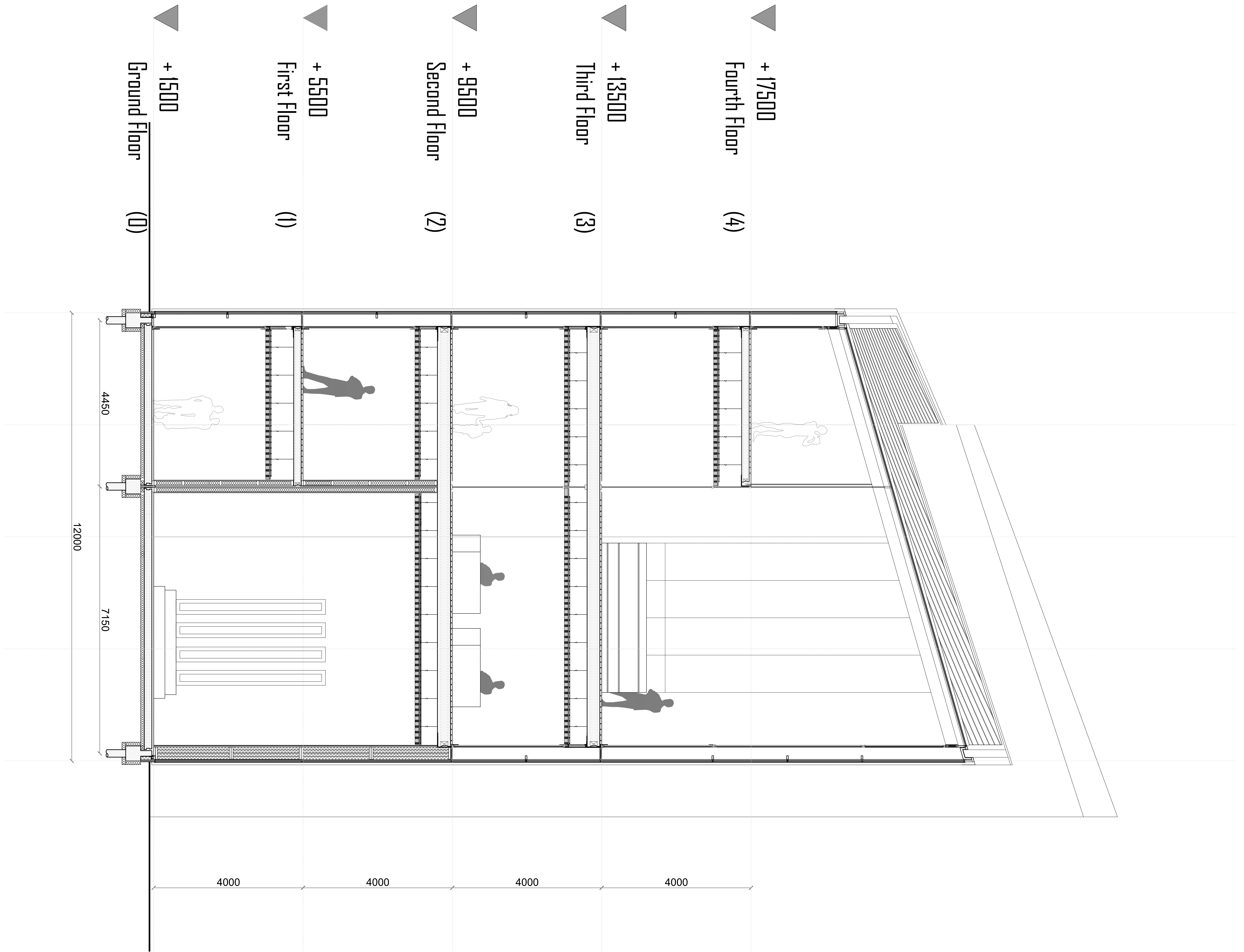

K

L

M

N

O

K

L

M

N

O

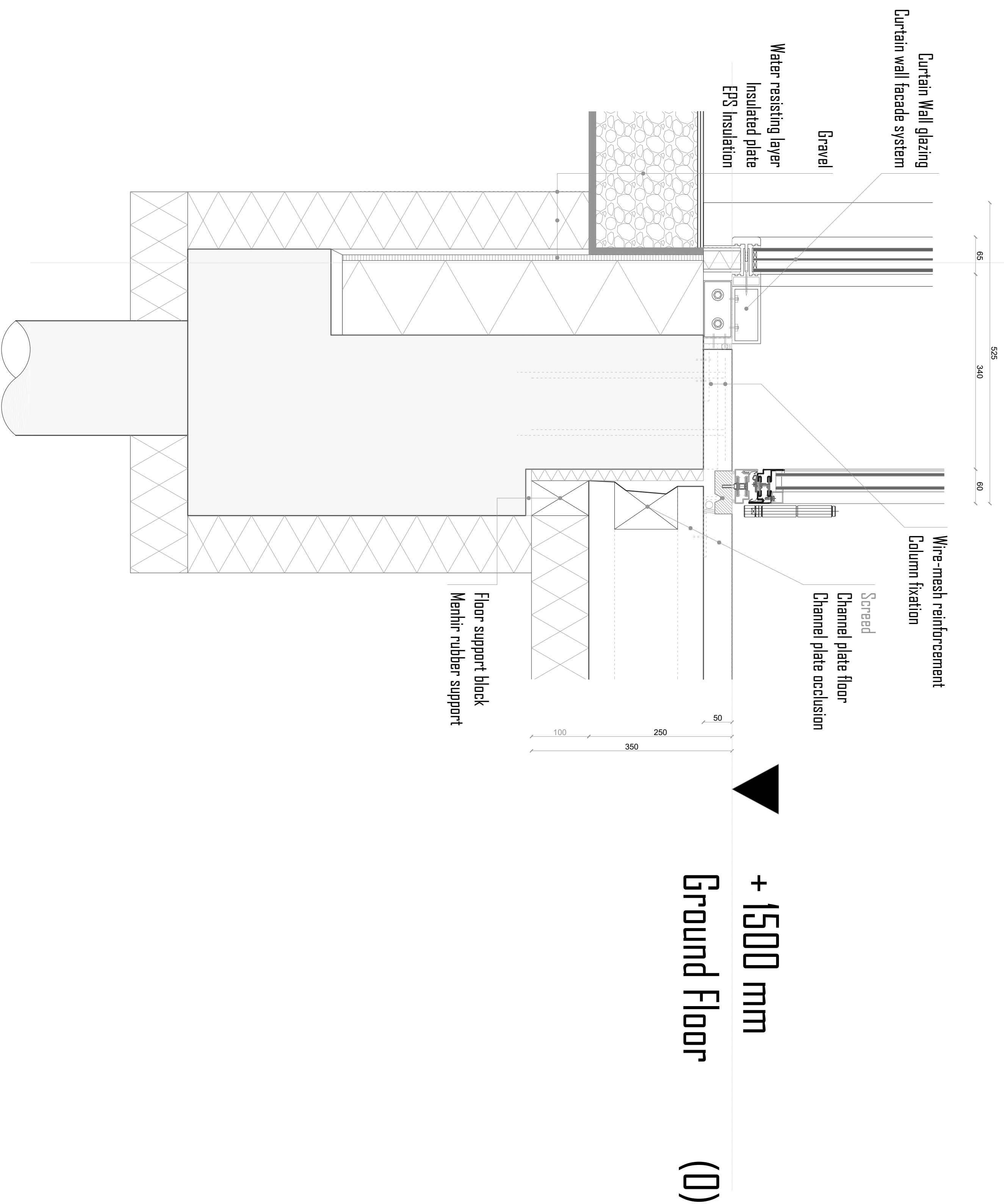



**+ 5500 mm**  
**First Floor**  
**(1)**

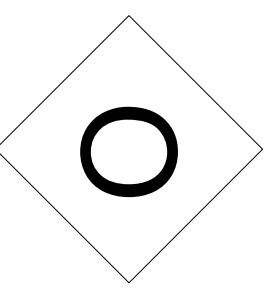
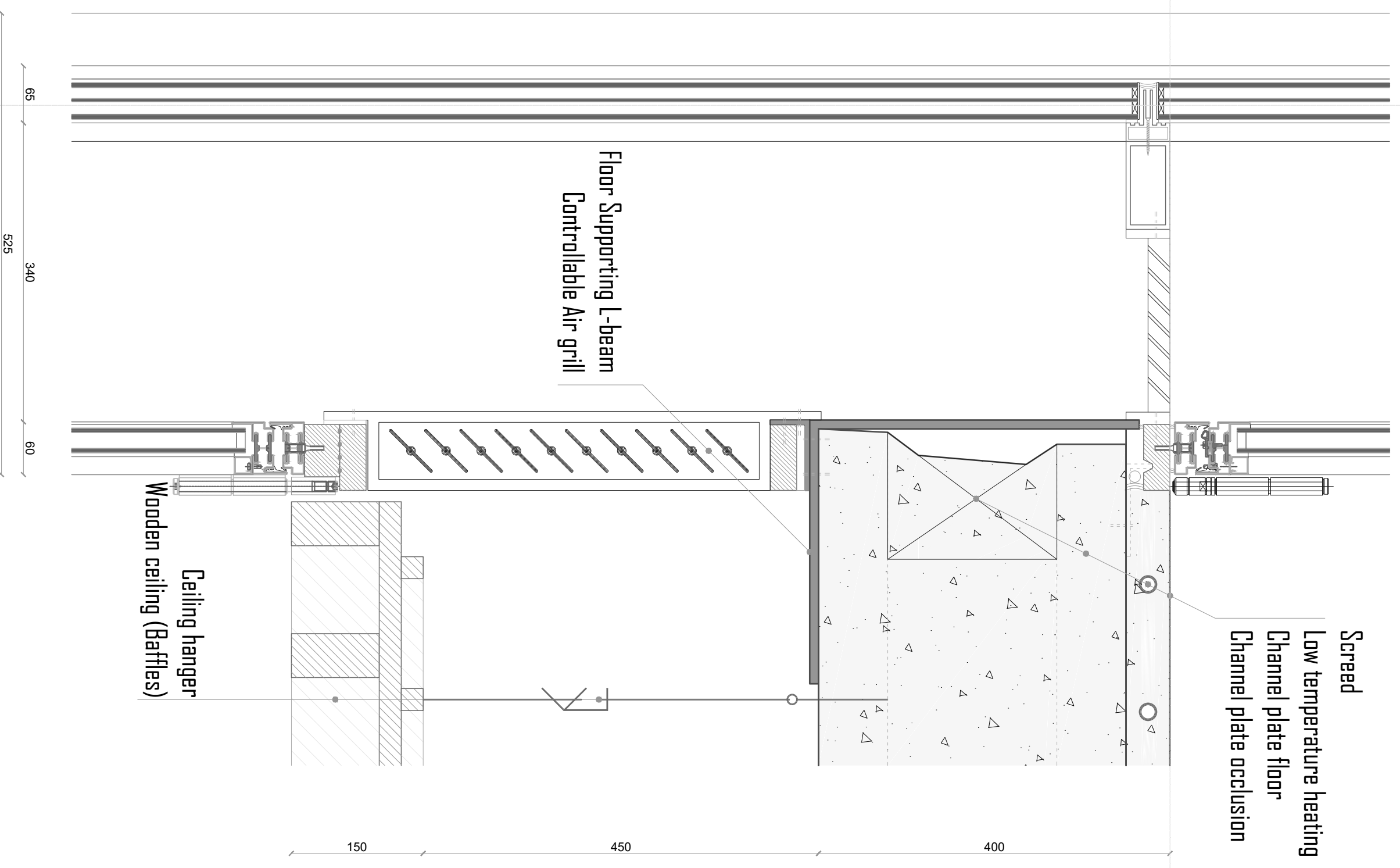

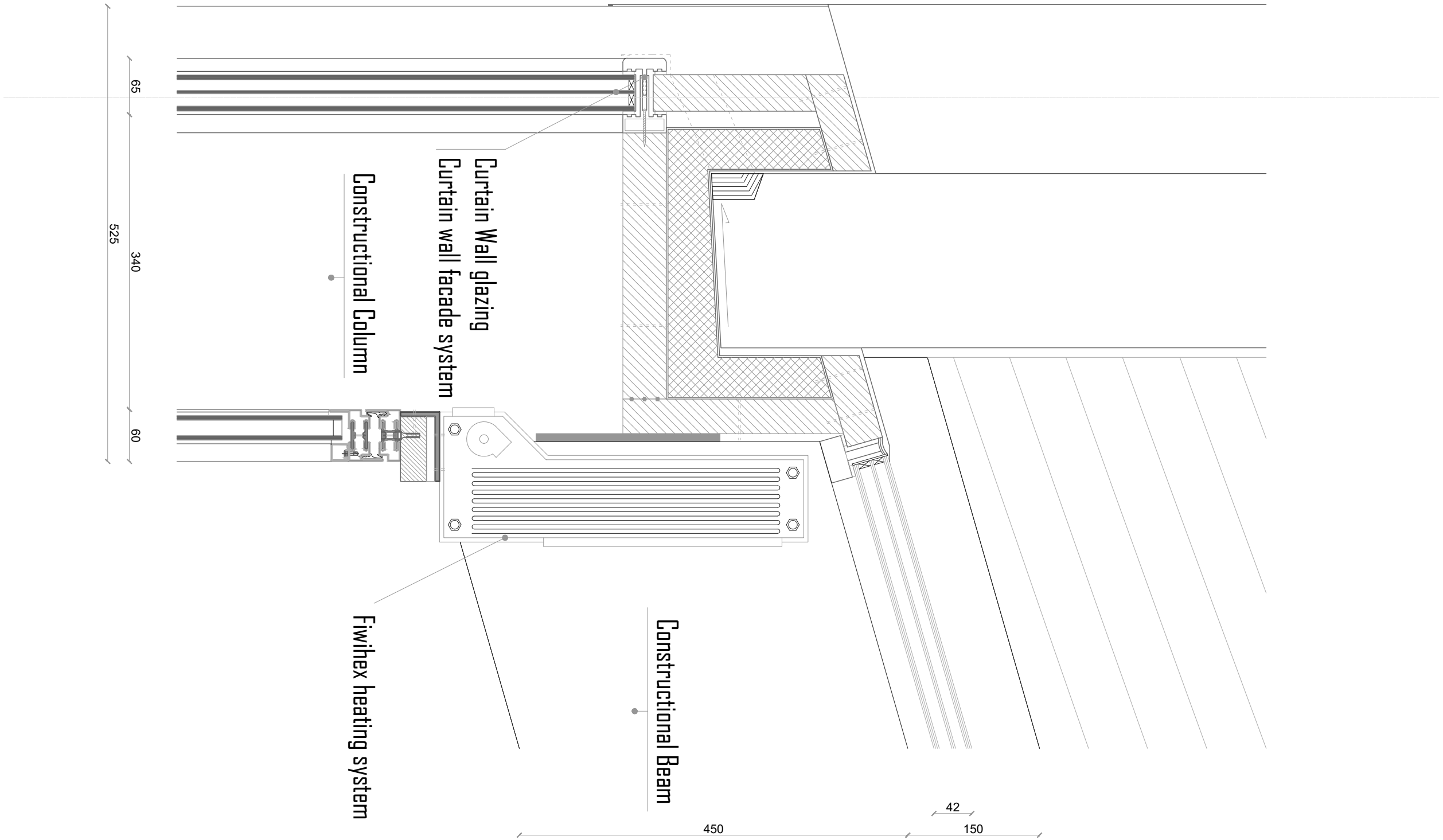
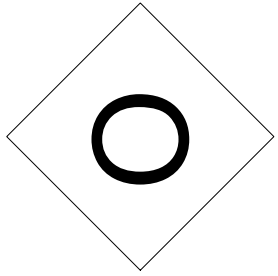

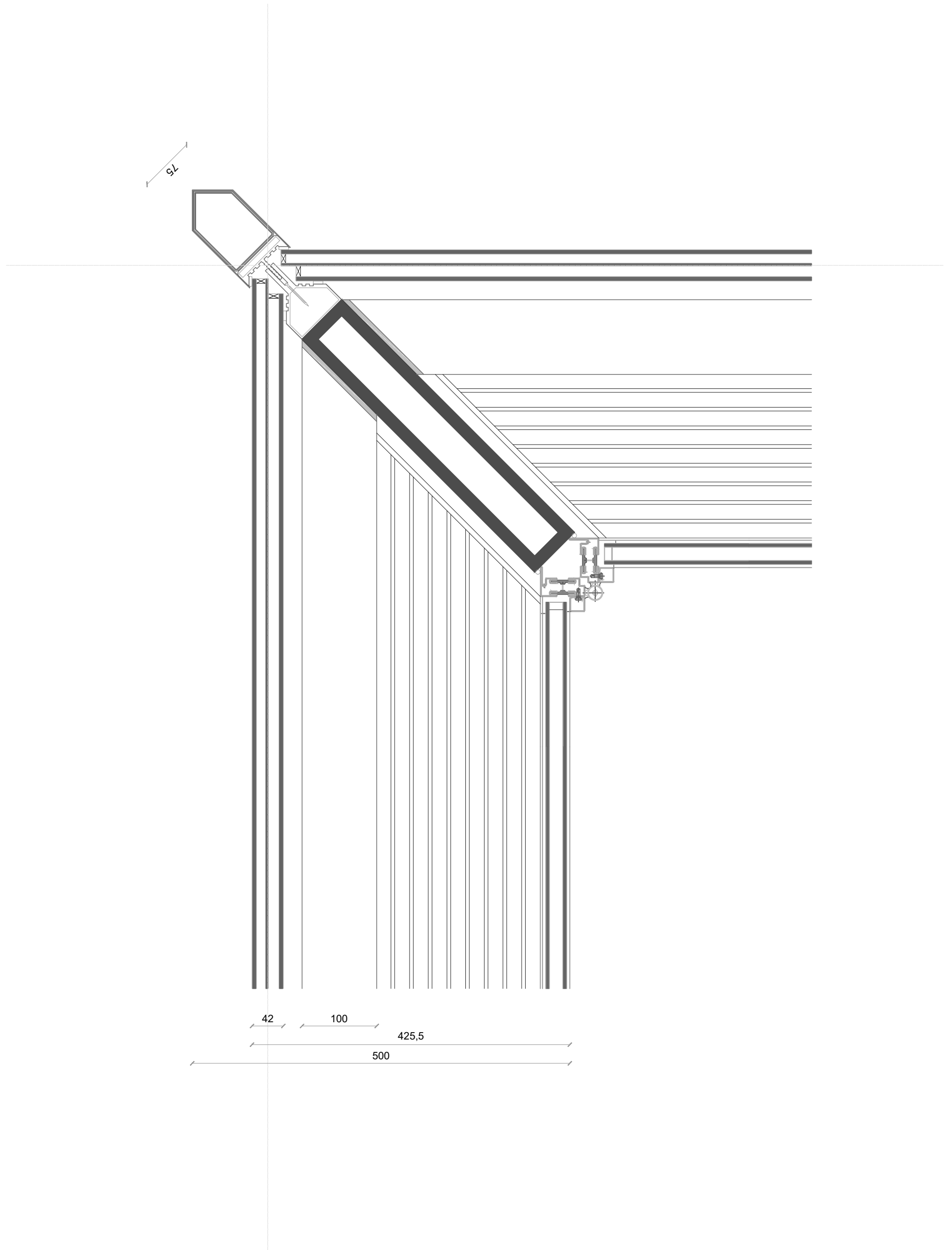
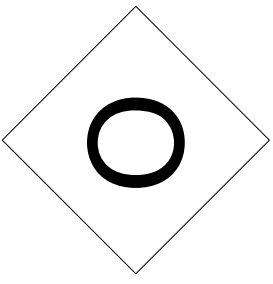
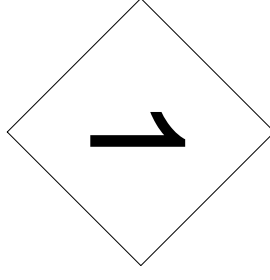

1

M

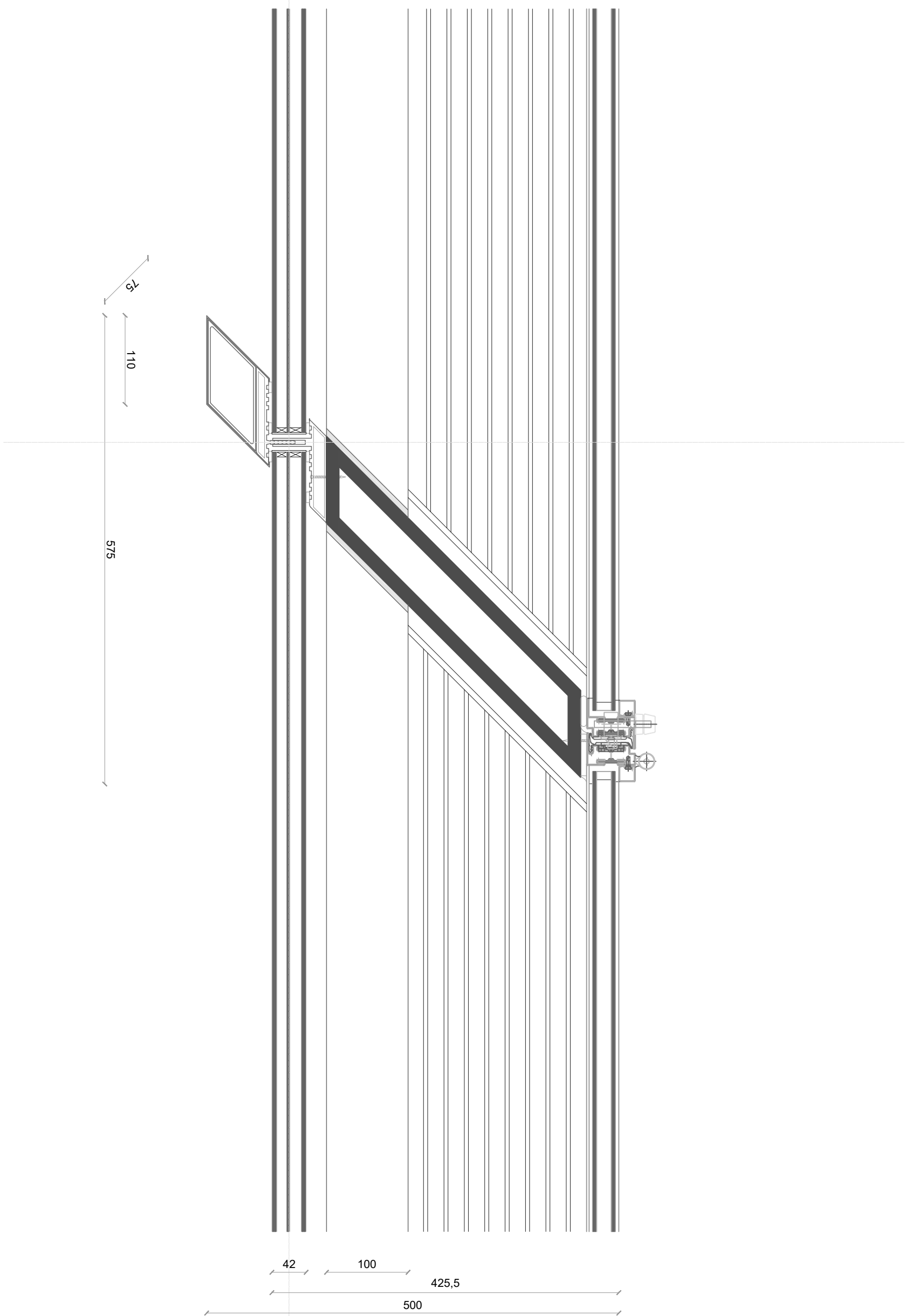

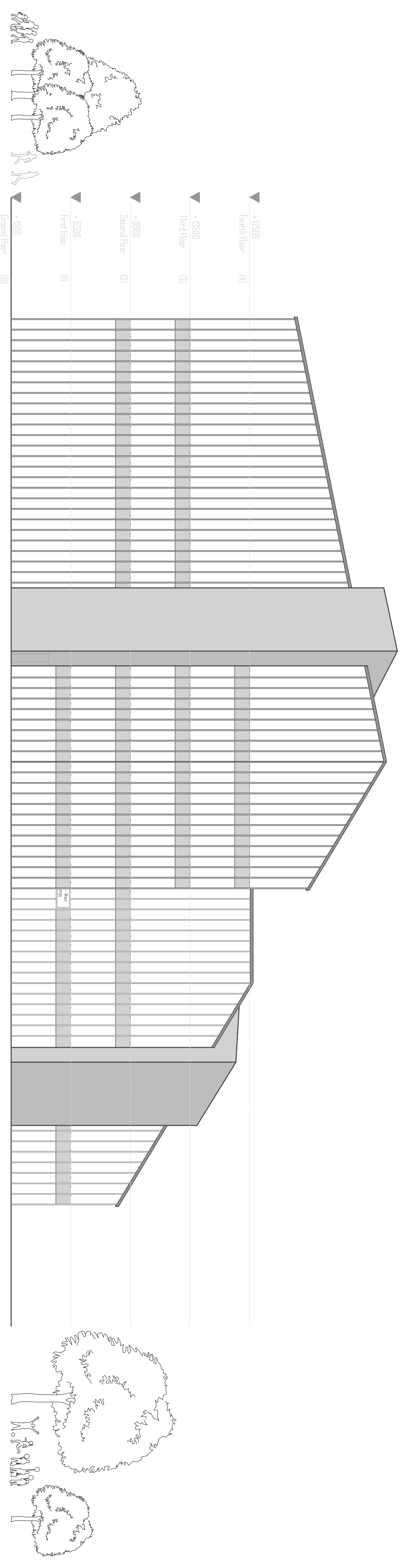

▼ +17500  
Fourth Floor (4)

▼ +13500  
Third Floor (3)

▼ +9500  
Second Floor (2)

▼ +5500  
First Floor (1)

▼ +1500  
Ground Floor (0)

N

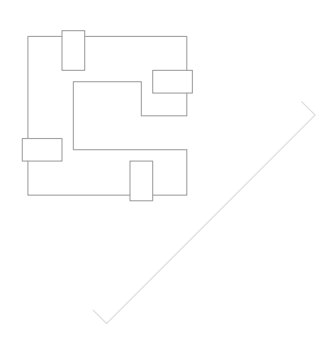

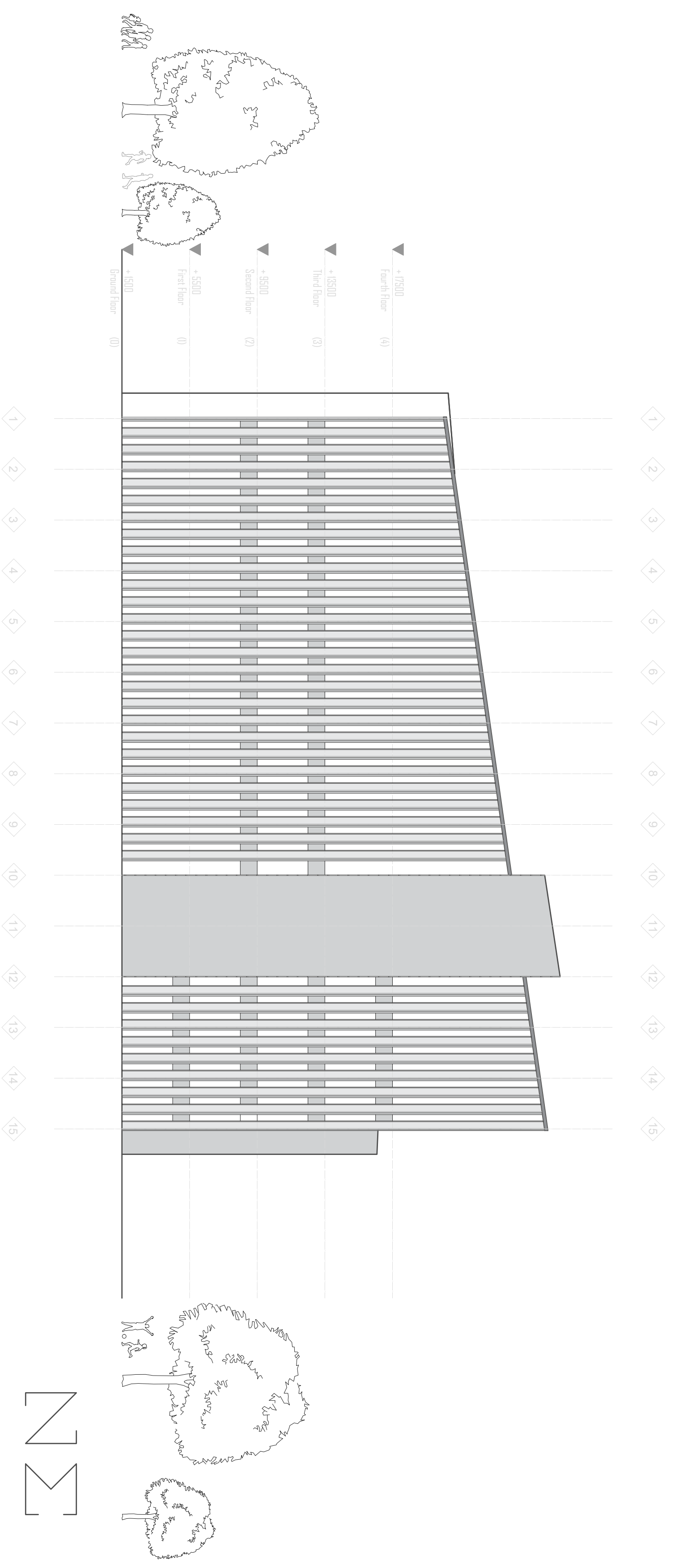
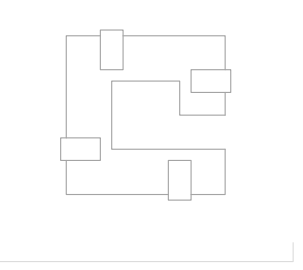

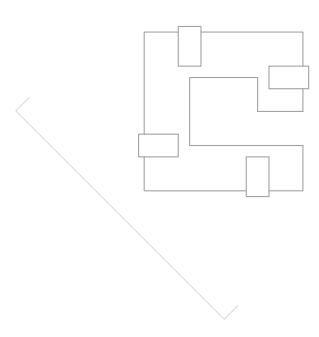
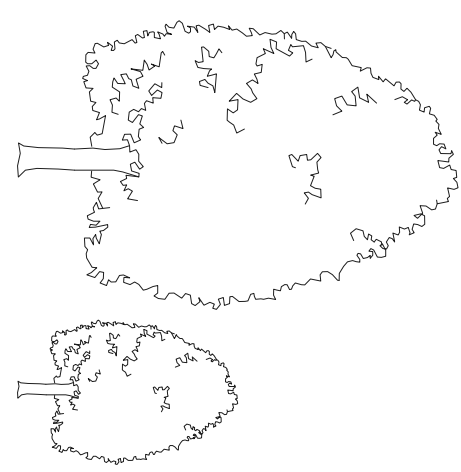
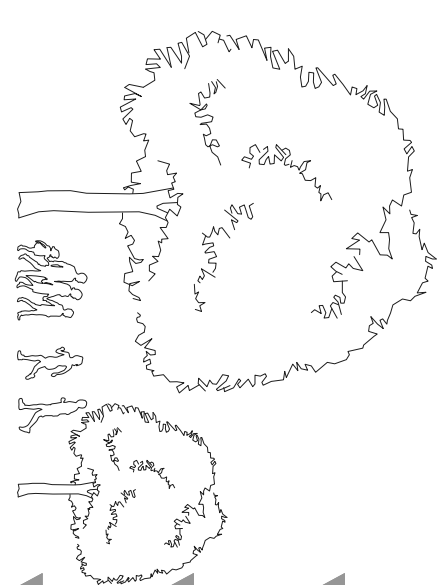
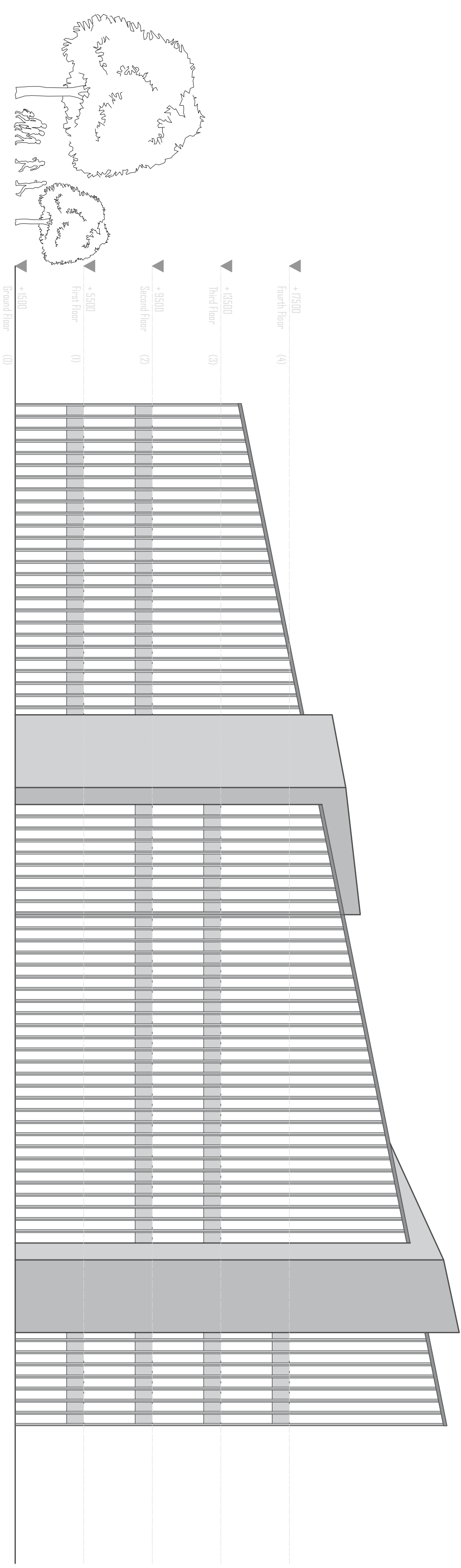



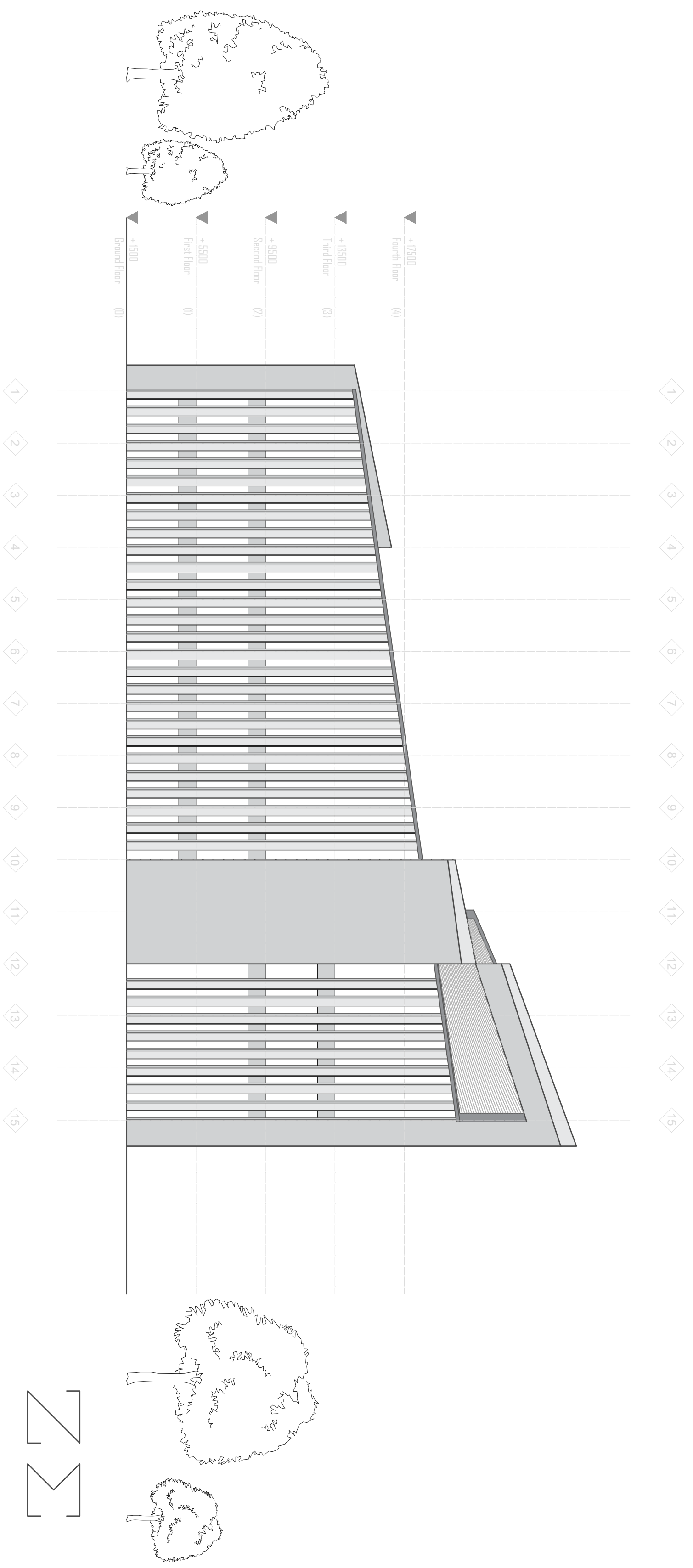
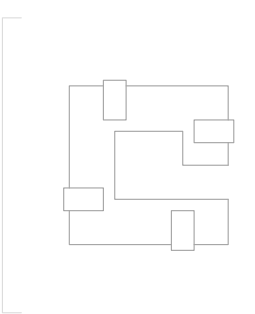

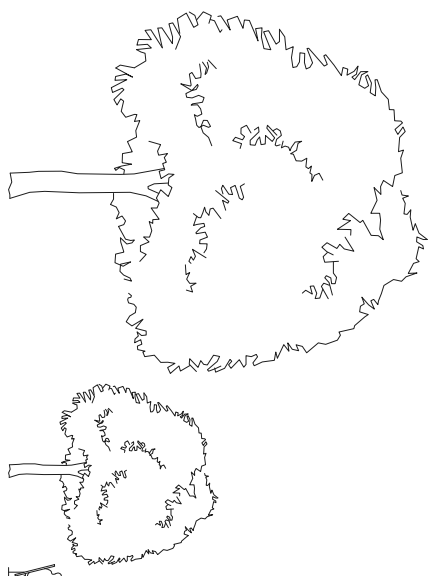

STREET

- ▼ +17500  
Fourth Floor (4)
- ▼ +13500  
Third Floor (3)
- ▼ +9500  
Second Floor (2)
- ▼ +5500  
First Floor (1)
- ▼ +1500  
Ground Floor (0)

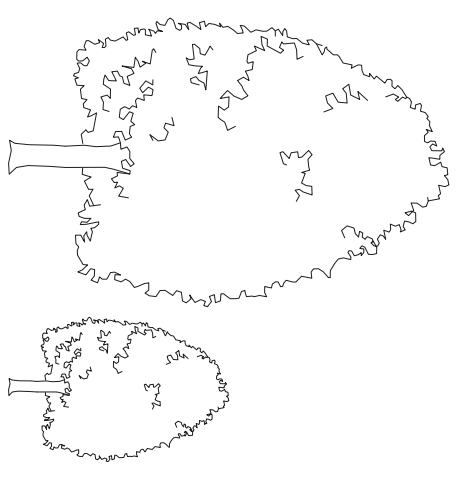
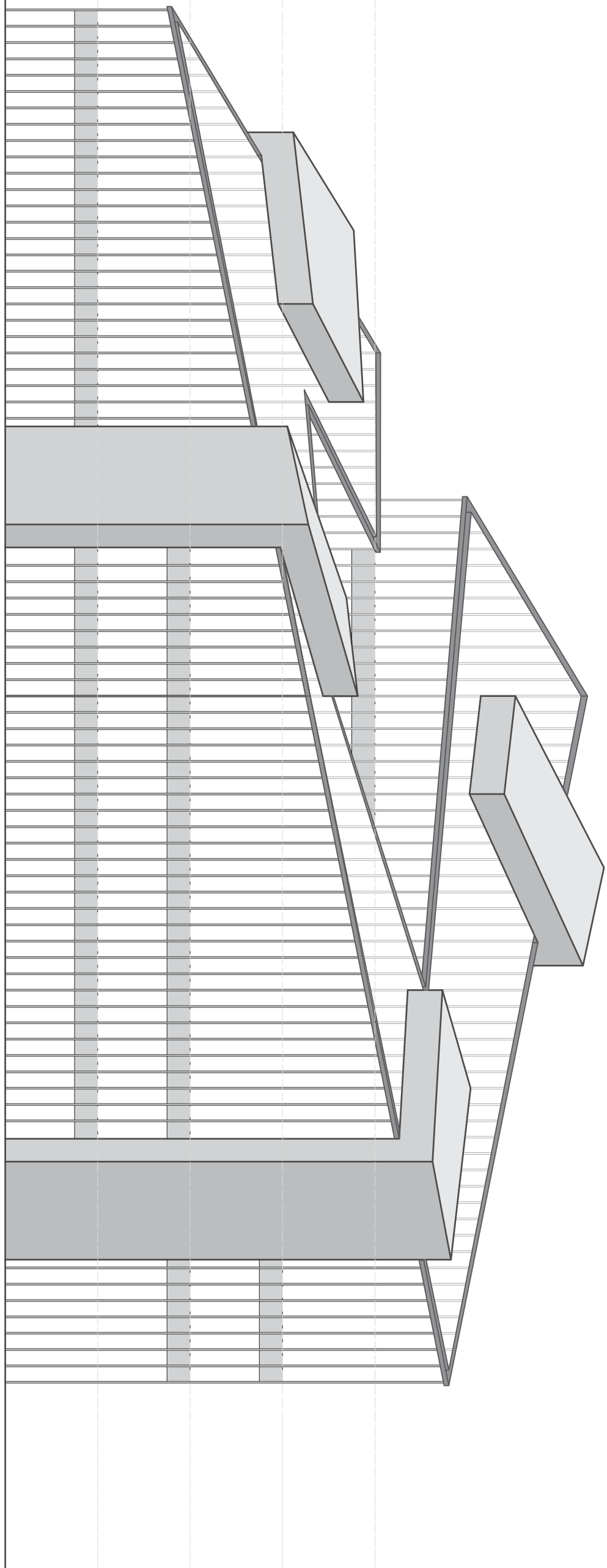

N

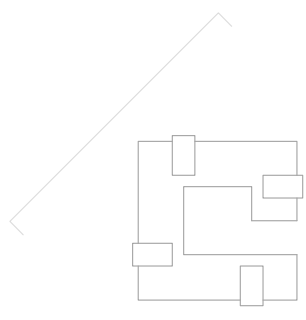

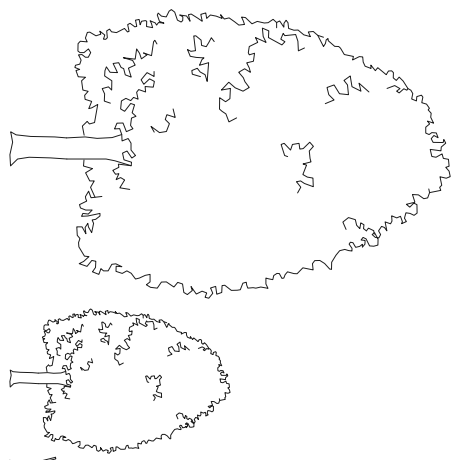
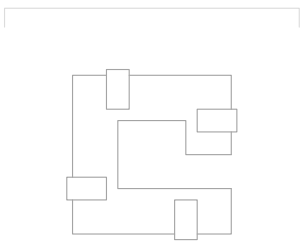

STREET

- Ground Floor (0) +1500
- First Floor (1) +5500
- Second Floor (2) +9500
- Third Floor (3) +13500
- Fourth Floor (4) +17500

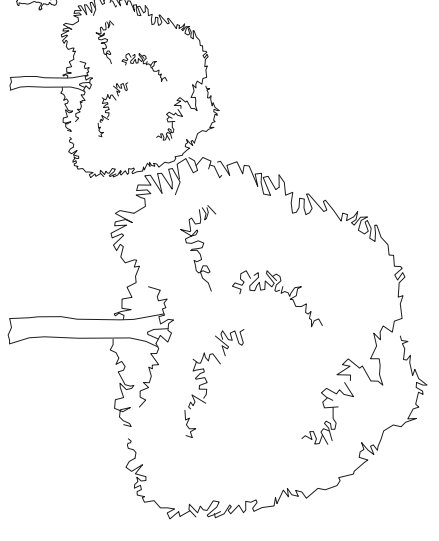
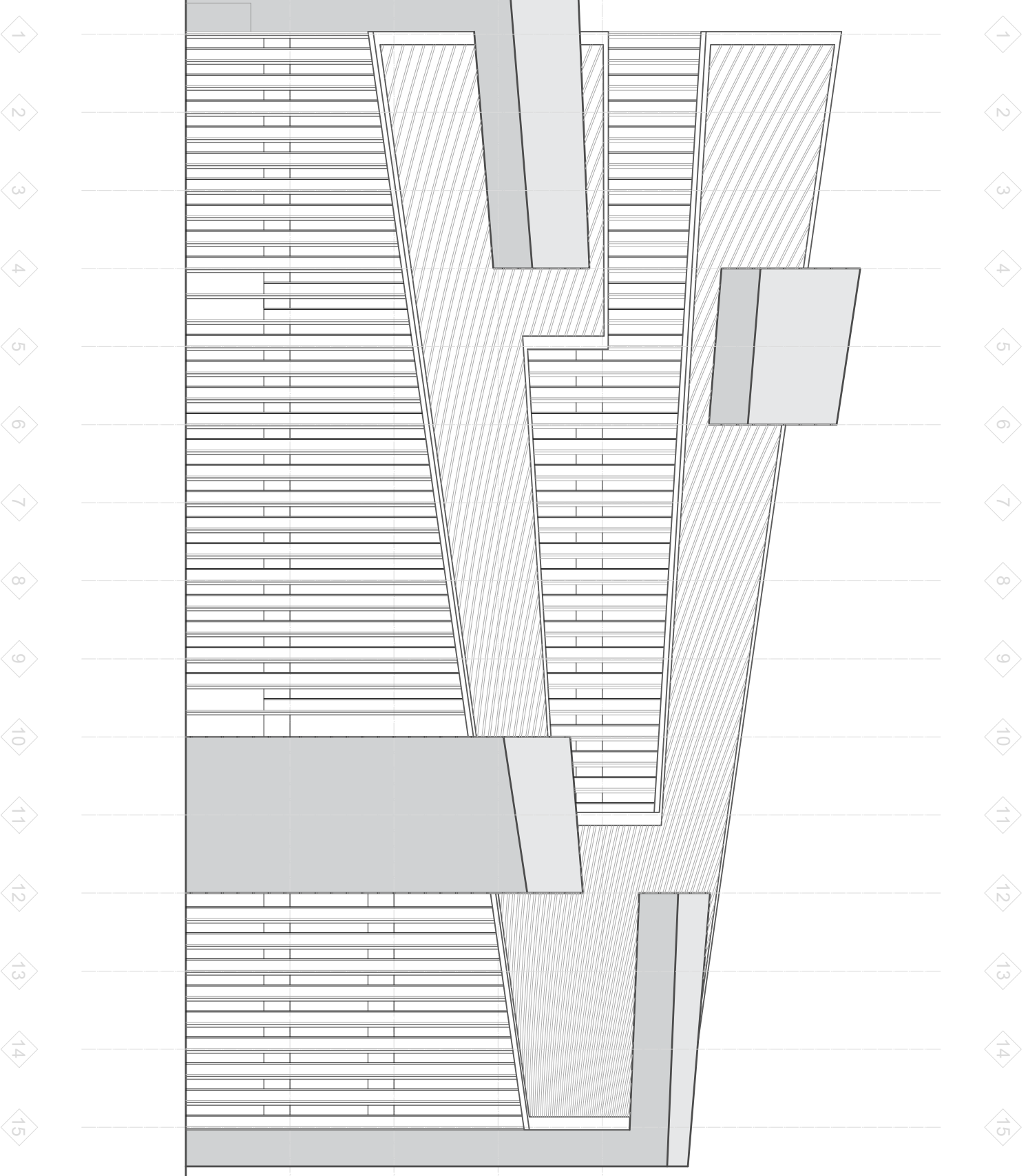

N  
M

