

Cooltower, Rotterdam

Structural behavior of a high-rise building on compressible soil.



Figure 1 Cooltower [source: Van Wilsum Van Loon [1]]

Tim Odijk
Student nr: 1504754
t.odijk@student.tudelft.nl

Graduation committee:
Prof. ir. D.A. Hordijk
ir. P. Lagendijk
ir. A.J. Robbemont
ing. H.J. Everts

TU Delft, chairman
TU Delft/ Aronsohn raadgevend ingenieurs
Zonneveld Ingenieurs
TU Delft/ ABT

Preface

This thesis is my final research to obtain the degree of Master of Science at Delft University of Technology.

This research investigates the structural behavior of a high-rise building on compressible soil, as can be found in Rotterdam. In order to do this research I needed to refresh and extend my knowledge on soil mechanics, and investigate the interaction between the soil and the structure. I learned a lot during this graduation project.

I would like to thank several people who were involved in this thesis. First of all I would like to thank my graduation committee consisting of prof. dr. ir. D.A. Hordijk, ir. P. Lagendijk, ir. A. Robbemont and ing. H.J. Everts for their input, support and remarks during the meetings. Furthermore I would like to thank Zonneveld Ingenieurs for the opportunity they give me to do my thesis at their office.

Last but not least I would thank everybody who supported me during the process of this thesis.

Delft, March 2017

Tim Odijk

Abstract

In Rotterdam underneath the first load bearing sand layer is a layer of compressible soil, called the "Kedichem" layer. Under this layer of compressible soil is another load bearing sand layer located, at approximately -50m NAP, but most of the buildings in Rotterdam are founded on the first loadbearing sand layer at approximately -23m NAP. Due to this most buildings undergo differential settlements caused by deformations in the Kedichem layer. This differential settlements causes an increase of internal forces in the structure.

Highrise buildings are causing higher deformations in the Kedichem layer because a highrise building has a large weight on a relative small area.

This thesis is a research of the behaviour of a highrise building on compressible soil. As a case study the Cooltower will be used. The Cooltower is a new to be build residential building with 34 storeys, located in Rotterdam. The height of the building is 102m, and the floorplan is 29x29m. The structure of the building is modeled in the structural software Scia Engineer. The differential settlements caused by the deformations in the Kedichem layer are introduced in the structural model by forces on a stiff spring element.

The deformations in the Kedichem layer are calculated by using a soil settlement program, called D-settlement.

Due to the deformations in the Kedichem layer the force flow in the structure will change. The force flow describes how the forces in the structure are distributed to the foundation. To calculate the final force flow it is needed to perform some iterations between the soil settlement software and the structural computer program.

It was investigated how the precast connections were influencing the total differential settlements in a structure. For this part of the research a 2D calculation was made. The research consisted out a high wall and a wide wall and each wall type consisted out of different variants where the precast concrete element were straight stacked or stacked in masonry configuration. Also different connections were investigated, for example a connection with welded steel plates or a connection between the elements by using a reinforced concrete connection.

The outcome of the 2D calculations is that the influence if the different connection types don't influence the interaction between the structure and the soil. The openings in the wall do influence the differential settlements in the structure.

After the 2D-calculations the complete structure of the Cooltower is modeled in Scia Engineer, and the settlement calculations were made. The building was divided in 5 building stages to model the time-dependent settlements in the soil settlement program. In this case a more accurate settlement calculation can be made.

The structure was examined if the structure still fulfills the requirements of the Eurocode. Some columns in the facade didn't resist the loads due to the settlements. It was calculated that the forces in the columns due to the settlements can be up to 15% of the forces in the column without the settlements in the Kedichem layer.

The settlements of the core and the façade differ the most. The vertical displacements of the core are higher than the settlements of the façade.

In order to reduce the differential settlements between the core and the facade the reaction forces of the core should be spread over a larger area or more load should be distributed from the core to the facade. Due to the small building plot of a high-rise building you don't have much space to spread the loads from the core over a much larger area because the facades are relative nearby. In order to

redistribute forces from the core to the facades the connection between the floor and facade and the connection between the floor and the core can be adjusted to redistribute forces.

For example you can make a hinged support at the core and a moment resisting connection at the facade. The disadvantage of this solution is that the forces in the floor will highly increase.

Another possibility is to change the stiffness of the facade. This can be done by adjusting the thickness and/or adjusting the Youngs modulus of the concrete of the facade.

The influence of the facade stiffness on the differential settlements was investigated. In order to do this there was a model that was considered as the basic model, a model with an increased stiffness of the facade and a model with a decreased stiffness of the facade. The influence of the differential settlements on the facade are researched in this part. There is a clear relation between the stiffness of the facade and the differential settlements in the facade. With this relation a prediction can be made of the differential settlements in the facade when the facade stiffness changes.

The main conclusion of this thesis is that it is difficult to create a general conclusion for the differential settlements due to the many factors that influence the differential settlements in the structure. Most of the researched topics in this thesis don't influence the differential settlements that much. The stiffness of the facade influences the behavior of the Cooltower on compressible soil the most. By making the facade twice as stiff, the differential settlements will be reduced by 37% on average. The conclusion is only valid for the Cooltower.

For the Cooltower the extra normal forces in the columns of the facade can be estimated to be 15% of the forces in the structure due to the permanent and the variable load. In preliminary design phase the structure can be designed with a unity check of 0,85.

There are some remarks for this research, for example the reduced stiffness of cracked concrete is not taken into account and also the creep of the concrete is not taken into account.

Table of content

Preface.....	2
Abstract	3
1) Introduction	8
1.1) Problem description	9
1.2) Research question	9
1.3) Boundary conditions	9
1.4) Possible outcomes.....	10
1.5) Brief description of the Cooltower.....	11
2) Reference projects	13
2.1) 100 Hoog	14
2.2) De Rotterdam	16
2.3) First Rotterdam	18
2.4) Maastoren, Rotterdam.....	20
2.5) Conclusion	22
3) Interaction between soil and structure.....	23
3.1) Settlements	25
3.2) Enter the stiffness of the structure in the soil settlement calculation program.....	27
3.2.1) Method 1:Contact shape factor	27
3.2.2) Method 2:Direct method	32
4) Connections in precast concrete.....	33
4.1) Connections.....	33
4.1.1) Horizontal connections between wall elements.....	34
4.1.2) Vertical connections between wall elements	35
4.2) Structural behavior of the connections	39
5) Theoretical research.....	41
5.1) Set up of the theoretical research	41
5.1.1) Loads	42
5.1.2) Material properties	42
5.1.3) Connections.....	43
5.1.4) Approach	45
5.2) Input data	46

5.3) Results D-settlement	54
5.4) Results Scia engineer high wall.	56
5.5) Results Scia engineer wide wall.	65
5.6) Conclusion	72
5.7) Further research.....	72
6) Architectural design of the Cooltower	73
7) Structural design of the Cooltower	78
7.1) Facade elements	78
7.2) Facade elements for a structure in masonry configuration.....	80
7.3) Structural design of the core.....	83
7.4) Structural design of the floors.....	85
8.) Input in Scia Engineer.....	86
8.1) Division of the tower.....	86
8.2) Materials	87
8.3) Loads	87
8.4) precast elements.....	89
8.5) Floors	89
8.6) Connections.....	91
8.6.1) Corner connections	91
8.6.2) Horizontal connections between the elements.....	93
8.6.3) Vertical connection stiffness	93
8.7) Stability calculation	94
8.7.1) Wind in x-direction.....	94
8.7.2) Wind in y-direction.....	96
8.8) Input D-settlement.....	98
8.8.1) Introduction of the loads to the subsoil.....	99
9.) Settlement calculation of the Cooltower.....	102
10.) Concrete checks	105
Check of the columns	105
Check of the lintels.....	105
Method.....	106
Column straight stacked elements.....	106
Lintels straight stacked elements.....	107
Columns masonry configuration	109

Lintels elements in masonry configuration	109
11.) Possible solutions	111
11.1) Changing the floor connections	112
11.1.1) Results applying the different floor connections on the Cooltower.....	115
11.2) Facade stiffness influence on the differential settlements.....	118
Straight stacked precast facade elements	119
Precast facade elements in masonry configuration	123
Conclusion	127
11.3) Other solutions.....	131
Use longer piles that go through the Kedichem layer.....	131
Raking piles.....	132
Different pile lengths.....	134
12) Conclusion and recommendations.....	135
13) References.....	138
Appendix A) Introduction of the forced displacements in Scia Engineer.....	139
Conclusion	141
Appendix B) Numerical comparison method 1(contact-shape factor) and method 2 (direct method) for the settlement calculation.....	142
B.1) Assumptions	142
B.2) Method 1, contact shape factor.....	142
B.3) Method 2, direct method.....	148
B.3) Conclusion	157
Appendix C) Choice of the structural FEM program.....	158
C.1) Set up of the research	158
C.1.1) Loads	158
A.1.2) Element division.....	158
C.1.3) Connections.....	159
C.2) Results AxisVM.....	160
C.3) Results Scia Engineer.....	161
C.4) Conclusion	162
Appendix D) Tables for concrete design.....	163

1) Introduction

High-rise buildings are getting more popular in the Netherlands. Due to the fact that the cities are quite dense the prices of land are increasing, making high-rise buildings more profitable. In the past it was thought that high-rise buildings were not possible to build because of the soil conditions in the Netherlands. Nowadays there is more knowledge about the soil, making high-rise structures possible, but there are still some questions left, such as the behavior of structures on compressible soil and especially how to deal with differential settlements in the structure.

This thesis focuses on the effect of differential settlements in a structure, and how to reduce them by adjusting the structure of the building.

As a case study the new to be build Cooltower will be used. The Cooltower is an apartment building of approximately 100m high, and will be constructed out of precast concrete elements. The structural system of the tower is a tube-in-tube structure.

The Cooltower is used as a case study, because it is expected that more of this kind of buildings will be constructed in the near future due to the fact that there is a shortage of living space and more people want to live in the city centre. Also cities want to upgrade their city centre, and an unwritten rule says that a city centre is successful when 10% of the total city population lives in the city centre [2]. Because of the density in the city centers high rise is the only option to build a high amount of apartments on a small plot. Also due to the density there is not much space for the building plot, so it is preferred to use precast concrete to reduce the size of the building plot and decrease the building time on site.

1.1) Problem description

In Rotterdam there is a compressible layer of soil underneath a sand layer with load bearing capacities. This compressible soil layer is called the layer of Kedichem and is located approximately between -30m N.A.P and -50m N.A.P. At some locations there is another load bearing sand layer located underneath the layer of Kedichem.

The Cooltower will be founded on the first layer of sand, above the layer of Kedichem. Due to the weight of the tower the layer of Kedichem will settle. The shape of the settlements is like a bowl, the settlements at the core of the building are higher than at the facade, and the settlements at midspan of the facade are higher than at the edges.

These settlements causing differential deformations in the structure, and due to this the stresses in the structure will increase.

If the differential settlements are high, structural damage will occur. Severe structural damage of the building occurs when the relative rotation β_x of the foundation is bigger or equal to 1/150 of the distance between the foundation elements.

Architectural damage occurs way earlier. Architectural damage already occurs when the relative rotation is in between 1/600 and 1/1000 of the distance between the elements. [3]

1.2) Research question

The research question of this thesis is: *How can the structure of a 100m high residential building be adjusted in order to reduce the differential settlements?*

In order to give an answer to this question the interaction between the precast elements and the foundation on compressible soil should be investigated. Also the precast element division and the connections between the elements should be investigated, because these influence the load path of the loads from the structure to the foundation.

1.3) Boundary conditions

The design of the Cooltower also consists out of a part of low-rise. This low-rise part will not be part of this research. This thesis is only focused on the design of the tower.

The design of the tower is still changing, when I started working on this thesis the height of the building is 100m, now the plans are made to make the tower 130m high. In this thesis the tower of 100m will be investigated.

1.4) Possible outcomes

There are a few possible outcomes of this research:

- It is possible to make the structure stiffer, so the forces in the structure will be redistributed and the structure settles more equal.
- The precast elements will be connected at a later stadium of the building process, so the elements can follow the settlements that will occur during construction of the tower.
- The foundation beam will get a precamber to compensate for the settlements.
- The foundation can be adjusted, by placing more piles at certain points where it is desired to have more load distributed to the soil.
- Jacking the structure is the most effective way to compensate for the differential settlements.

1.5) Brief description of the Cooltower

The Cooltower is an apartment building which will be built at Baan, in Rotterdam.

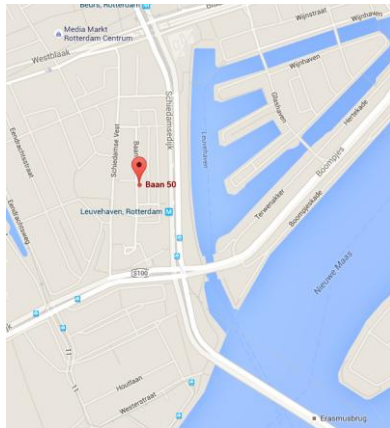

Figure 2 Location of the Cooltower [Google maps]

The tower will be completely built out of precast concrete elements, because there is not much space at the building site. The building will be built in the city centre of Rotterdam, between already existing structures.

The tower has a height of approximately 100m, with several types of apartments. Therefore the floors should be able to be freely divided, not limited by structural elements.

In order to achieve the open floor plan the stability system of the tower will be a tube in tube structure. The building has a load bearing core and a load bearing facade. Just a load bearing facade isn't enough for the structure, because at the entrance of the tower has a plinth that's more open. The design as known by Zonneveld Ingenieurs is shown in the figure below.

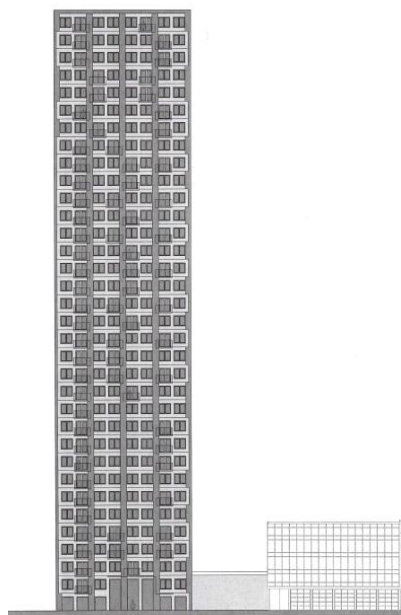

Figure 3 Cooltower

The tower is still in the preliminary design phase. The dimensions of the floor plan are roughly 26x26m. In this stage the tower has a height of 100m but there might be plans to extend the height of the tower to 130m.

The dimensions of the core are 6.6m x 10.8m

A new to be build parking garage and a gym will also be part of the design of the Cooltower, but this thesis focuses mainly on the high-rise structure.

The floors are made of precast concrete plates with a thickness of 260mm, without the finishing floor. In order to achieve plate action in the floors slot recesses are made in order to connect the reinforcement bars. These recesses will later be filled with concrete.

Figure 4 shows a typical floor plan of the building. This floor plan is according to the architects design, the structural design is different with a more closed facade. The yellow part is the location of the apartments, the blue part is for other purposes like corridors.

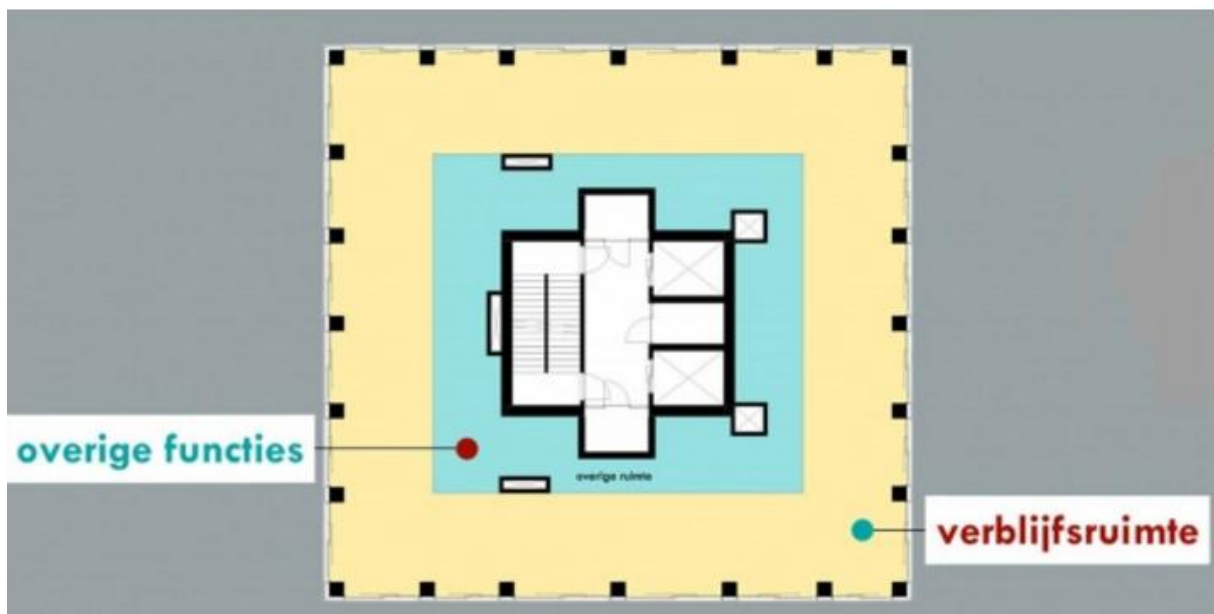

Figure 4 Typical floor plan Cooltower [Source: Van Wilsum van Loon[1]]

The floor plan is really open because there are a lot of different apartment sizes in each section of the building. The amount of apartments varies from 1 apartment up to 6 apartments on each floor.

2) Reference projects

The reference projects contain out of projects with a similar design or problems as the Cooltower. All reference projects are located in Rotterdam, because everywhere in Rotterdam there is a compressible soil layer present underneath the load bearing sand layer. In Amsterdam is also a compressible soil layer present under the load bearing sand layer, called the Eemkleipakket, but this layer is very local, and Amsterdam doesn't have that many high rise buildings.

The following reference projects will be discussed:

- 100 Hoog, a 100m high residential building in Rotterdam, near the future location of the Cooltower
- De Rotterdam, a 150m high residential/hotel/office building located next to the Erasmus bridge in Rotterdam. This building undergoes large differential settlements.
- First Rotterdam, a 125m high office building located near the central station in Rotterdam. This building also undergoes large differential settlements.
- Maastoren, Rotterdam is a 165m high office building located near the Erasmus bridge. This building is the highest building in the Netherlands

2.1) 100 Hoog

100 Hoog is an apartment building in Rotterdam. The building is comparable to the Cooltower, it also has a height of 100m and the dimensions of the floor plan are roughly the same. The tower is located near the same harbor as where the Cooltower will be build, so it can be assumed that the soil conditions are the same. This tower is also subjected to differential settlements due to the layer of Kedichem, and later in this research the contour plot of the settlements of 100 Hoog will be used to determine the settlements of the Cooltower.



Figure 5 100Hoog, Rotterdam [source: www.nieuws.top010.nl]

There is a big difference between the Cooltower and 100 Hoog. 100 Hoog is a tower built out of cast in situ concrete. Therefore it is easier to compensate for the settlements that already occur during the construction of the building.

Also the stability system of the tower is different. The 100 Hoog consists out of a concrete core and concrete shear walls.

The differential settlements were put into the structural program as forced displacements. These forced displacements caused redistribution of the forces, causing additional bending moments in the structure. The differential settlements only caused architectural problems, some structural floors were not horizontal. The floors were leveled by the finishing floor, this floor was applied at a late stage of the construction, so when the floors were applied the structure already developed 50-70% of its final settlements.

The differential settlements of 100 Hoog are on average 40mm between the core and the facade of the tower, with a maximum of approximately 52 mm between the core and the corner of the facade , see fig. 6

These settlements are due to the following loads on the soil:

Table 1 Loads 100 Hoog [4]

Location	Area	Loads	Preload due to former buildings
Tower	23mx30m	400kN/m ²	40 kN/m ²
Low-rise (Posthoornstraat)	85mx19m	105kN/m ²	30 kN/m ²
Low-rise (Wijnstraat)	23m x20m	65 kN/m ²	30 kN/m ²

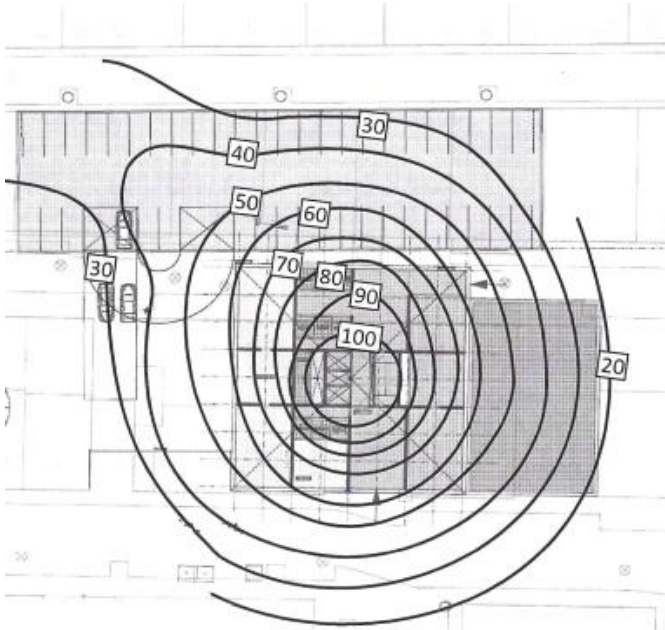

Figure 6 Settlement plot of 100 Hoog [4]

2.2) De Rotterdam

De Rotterdam is a building of 150m high, which contains apartments, offices a hotel and several restaurants [fig. 7]. The building is highly exposed to differential settlements, the cores settle way more than the perimeter of the building. The maximum differential settlements are approximately 200mm [fig. 9]



Figure 7 The Rotterdam

To deal with these differential settlements different measures were taken.

The basement floor has a precamber of 200mm near the cores and 140mm at the outer edges of the building. The floors above will be poured horizontally. After the core is settled, the floor of the basement is leveled.

Because the outer columns settle less than the core these columns will be jacked down, so the floors above the basement are also leveled.

Due to this jacking more loads will be pulled to the columns. Special attention was needed to deal with the change of the load path.

Because the settlements are shaped like a bowl there will be rotations in the foundation. These rotations cause extra bending moments and shear forces in the piles, walls and columns.

For the piles and walls it is possible to deal with the extra bending moments by adding extra reinforcement. This was not possible for the columns at -2 level because of the low floor to ceiling height. The solution was to disconnect the columns from the -1 level, so the column is not clamped at this level. In this case the length of which the column rotates is doubled, leading to a halving of the bending moments[5]. The loads on the soil are showed in figure 8. Each block has a size of 8.1m * 8.1m.3

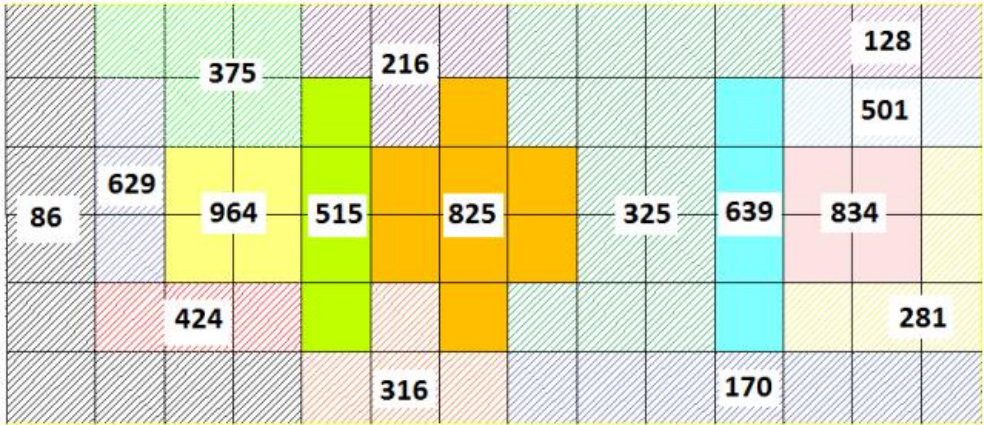

Figure 8 Block loads "The Rotterdam" [kN/m²] [6]

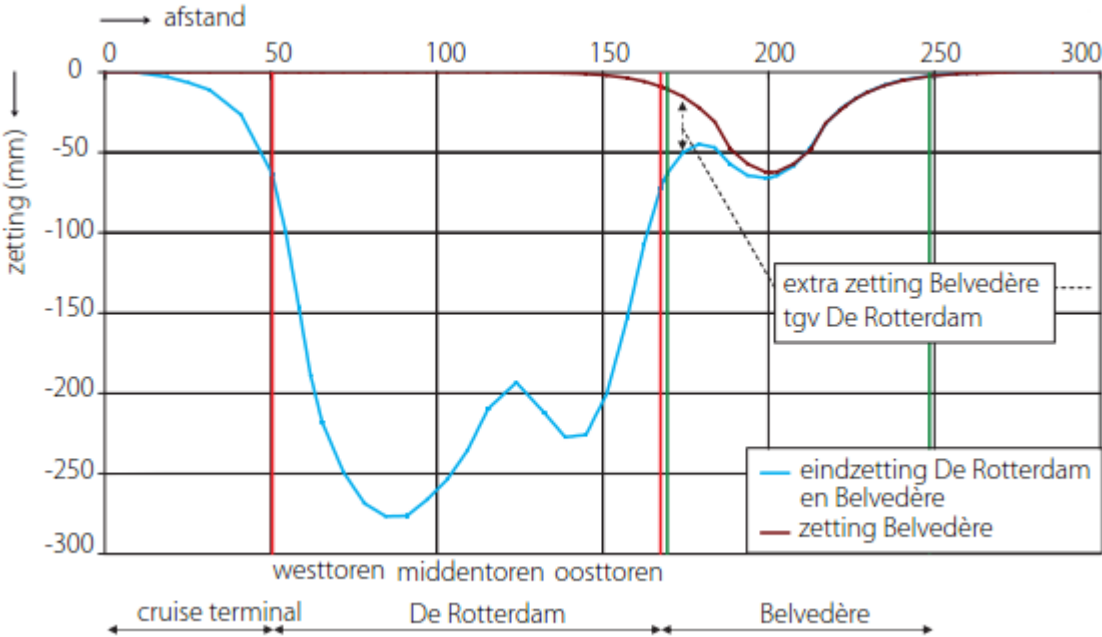

Figure 9 Final settlements "De Rotterdam" [7]

2.3) First Rotterdam

The First Rotterdam is a 125m high office building located near the central station in Rotterdam. The building is built up out of precast concrete.



Figure 10 Impression FIRST Rotterdam [Source: Maarsen Groep]

The building consists out a 125m high tower and a 7 storey low-rise part around it. The loads of the low-rise part are way less than the loads from the tower due to this the settlements of the low-rise building are a lot less than the settlements of the tower.

The load on the soil from the building is[23]:

Table 2 Load on the subsoil, First Rotterdam [23]

	Load new to be build part [kN/m ²]	Soil to be dig out to make the basement [kN/m ²]	Uplift water force [kN/m ²]	Resultant force on subsoil [kN/m ²]
Low rise	160	-46	-46	Ca 70
Core	514	-46	-46	Ca 420

Because the low-rise part is connected to the high rise part, additional measures are needed to compensate for the settlements differences. The differential settlements between the core of the tower and the facade of the low-rise part are approximately 100-110mm [fig. 11 and 12].

These settlement differences are compensated by giving some floors a precamber and by the use of jacks. Also the basement of the building is build out of segments, to prevent very high stresses in the concrete.

The jacks will be used to level the tower during the construction of the tower. After the construction of the tower the additional settlements will cause relative rotations. These rotations will be below the maximum value of 1:600. [8]

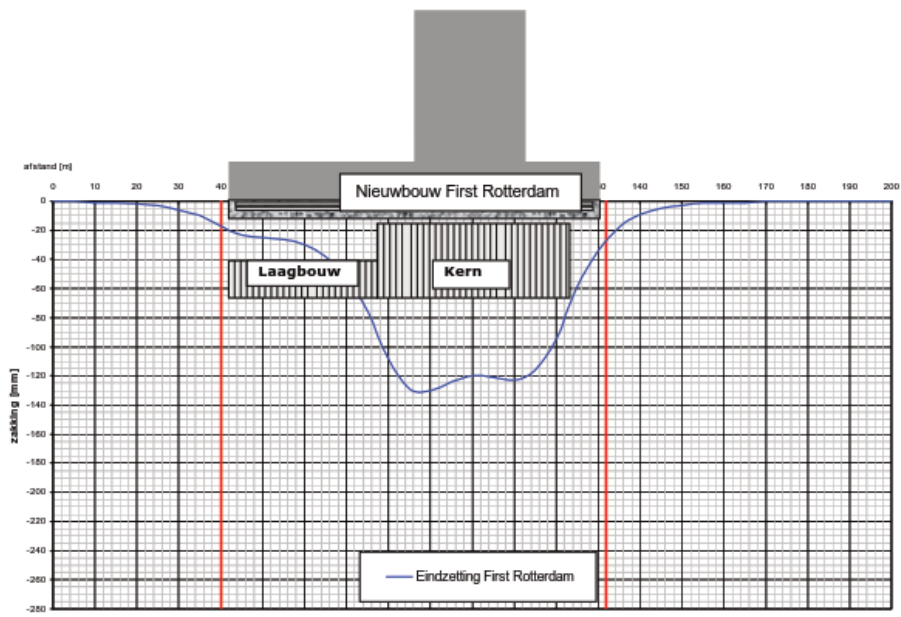

Figure 11 Settlements First Rotterdam, crossection over the length of the building pit. [23]

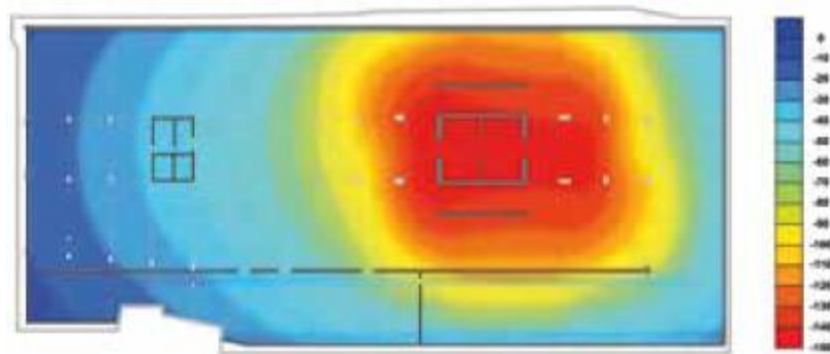

Figure 12 Plot settlements First Rotterdam [8]

2.4) Maastoren, Rotterdam

The Maastoren is located near de Rotterdam. With its height of 165m it is the highest building in the Netherlands.

The total settlements of the building were estimated to be 120-140mm, but the differential settlements are maximum 40mm. No extra measures were needed to compensate for the differential settlements, it was just an architectural problem that could be solved with the application of a non structural cement floor. The building is rather slender and stiff, so the additional settlements due to the settlement of the layer of Kedichem caused large bending moments in the structure. This was taken up by extra reinforcement in the walls, but due to the settlements cracks occurred in the walls in the basements.

The settlements of this building were monitored during the construction of the building. After the construction of the tower, the settlements were in a range of 65%-75% of the final settlements, just as expected.



Figure 13 Maastoren

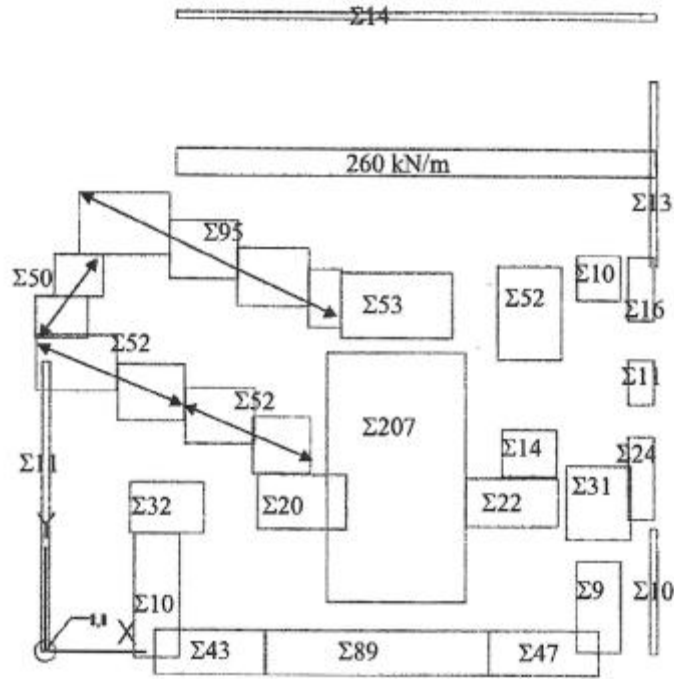

Figure 14 Schematization loads in MN for settlement calculation Maastoren [9]

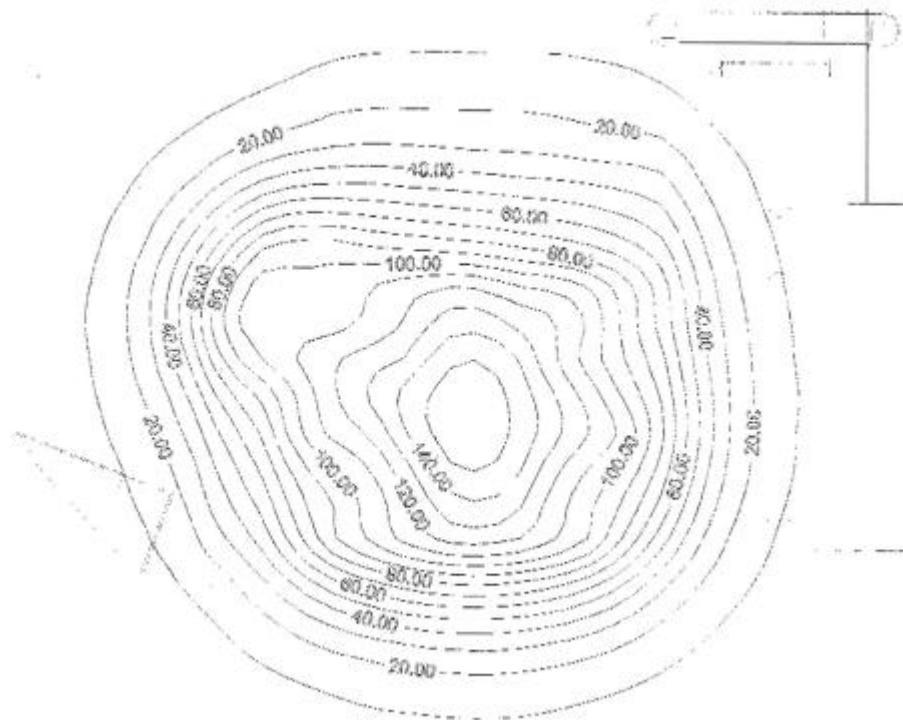

Figure 15 Contour plot settlements of Maastoren [in mm] [9]

2.5) Conclusion

Additional differential settlements in high rise buildings mainly causes problems when a part of the building is exposed to lower loads, for example the low-rise part of the First Rotterdam and the outer columns of the Rotterdam. In these cases jacks are used to compensate for the differential settlements.

When a building is rather slender, and the loads are more concentrated to the soil, the differential settlements are not that high in the building. Often only extra reinforcement is needed to take up the additional bending moments because the building acts stiff. The total settlements of these high buildings are quite high, and can cause problems to buildings in the area of the high-rise building. Especially in a dense city environment the settlements of the existing buildings near the high rise building can't be neglected.

Most of the high-rise buildings are made out of cast in situ concrete. With cast in situ concrete it is easier to compensate for the differential settlements that already occur during the construction phase of the building. With precast concrete it is a lot harder to compensate for the settlements during construction, because the elements are already made in a factory. In order to compensate for the differential settlements that occur during the construction phase of a precast building, extensive soil settlement calculations need to be made, and it is important to model the interaction between the soil and the structure.

3) Interaction between soil and structure

The interaction between the soil and the structure depends on the stiffness of the structure. The stiffness of the structure highly influences the effect of the differential settlements on the structure. The old Dutch code NEN-6743-1:2006 [10] contains indicative formulas to investigate if a structure acts like a stiff structure, a flexible structure or that the structure can't be categorized as completely stiff or completely flexible.

When a structure is completely flexible the differential settlements cause high deformations in the structure. The structure should be checked if the large displacements and rotations in the structure don't exceed the maximum allowable value provided by the Eurocode.

When a structure is completely stiff, the differential settlements cause no high differential displacements in the structure. Instead of high deformations, the forces in the structure will be redistributed in such way that the vertical displacements are equal. Due to the redistribution of the forces large bending moments will occur in the structure. The strength of the structure should be checked whether the stresses in the structure don't exceed the maximum value that can be taken up by the structure.

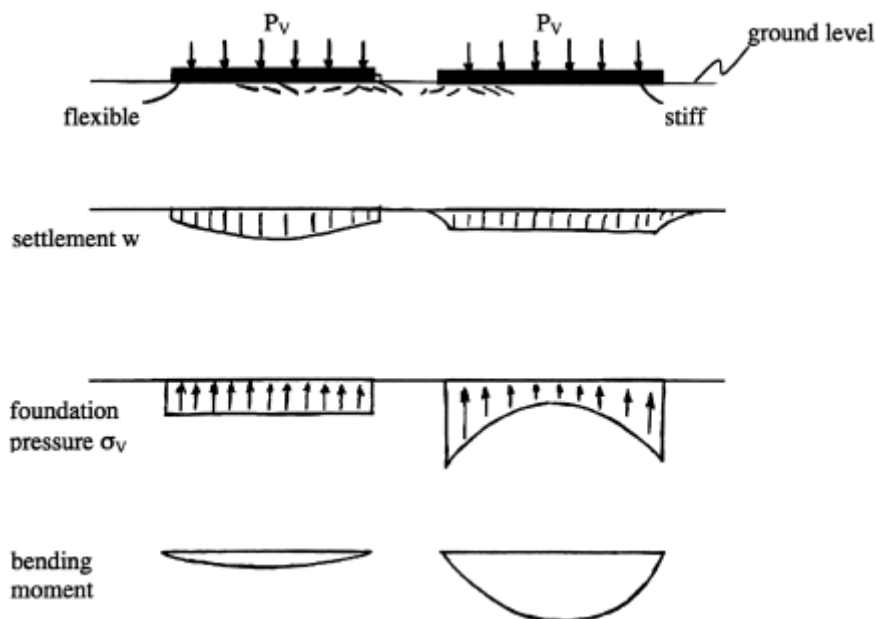

Figure 16 Behavior of a flexible and stiff foundation [11]

When a structure doesn't behave completely flexible or completely stiff, an iterative calculation should be made in order to investigate the interaction between the soil and the structure.

The Eurocode (NEN-EN 1997-1 [12]) doesn't contain the calculation to determine if the structure is stiff or flexible. The Eurocode only contains a prescription of the maximum allowable obliquity and relative rotation of the foundation. This obliquity is directly linked to the differential settlements and thus to the stiffness of the structure.

The maximum allowable relative rotation β in the serviceability limit state is 1:300-1:2000. This is a very wide range. In most cases a maximum rotation of 1:500 is sufficient. In this case no architectural damage will occur. [12]

For the ultimate limit state the maximum allowable relative rotation $\beta=1:150$. In this case there are already cracks in the building so from an architectural point of view the structure has already failed. When the relative rotation is higher as 1:150, the structure can collapse.

The values described above for the relative rotation apply for downwards bending. If the bending of the foundation is upwards (the settlements of the edges are higher than the settlements at midspan) the maximum relative rotation is half the values described above.

The maximum allowable relative rotation used in this thesis is 1:500. Irrespectively the stiffness of the building there will be an iterative calculation be made.

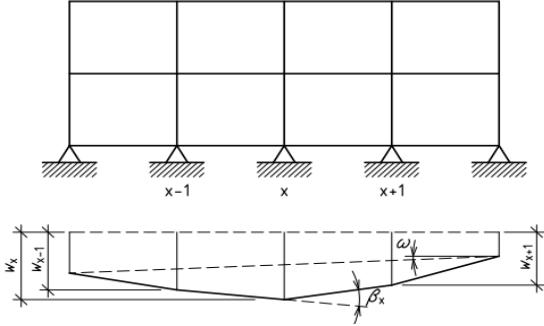

Figure 17 Graphical view relative rotation β [13]

3.1) Settlements

The static loads from the structure increase the stresses in the soil. Due to the increased stresses the layer of Kedichem will settle and these settlements will create differential settlements in the structure of the building. The soil underneath the core of the building acts less stiff than the soil at the edges, resulting in a bowl-shaped settlement plot.

The settlement of the foundation depends on the following factors:

- Elastic deformation of the pile
- Friction at the shaft
- Settlement of the subsoil
- Group action of a pile group

The total deformation is called w , where $w=w_1+w_2$

$$w_1=w_b+w_{el}$$

where: w_{el} = elastic deformation of the pile due to the compressive load

w_b = Displacement of the pile foot

w_2 = the settlement of the soil underneath the pile, and the extra deformation due to the group action of the pile group. This value includes the settlements in the layer of Kedichem.

In this research the pile stiffness of the pile is determined with the use of w_1 only. The stiffness of the statically loaded pile is 92000kN/m. This value of the pile stiffness is the same as the pile stiffness of the reference project 100 Hoog, because the loads are comparable and the soil conditions too. This pile stiffness is the stiffness of a "vibropaal" with a shaft dimension of $\varnothing 610\text{mm}$ and a pile tip dimension $\varnothing 730\text{mm}$. [4]

It is assumed in this thesis that the pile stiffness due to w_1 of 92000kN/m will not be changed in this thesis, because the change in pile loads will not lead to significant changes in the elastic deformation of the pile and the displacement of the pile foot. These changes are in a range of 2mm~4mm, and these changes are just a small part of the total displacement of the pile. The displacement of the pile due to w_2 is in a range of 70mm~120mm.

The value of w_2 is entered in the structural FEM program as a forced displacement. Due to the spreading of the loads on the layer of Kedichem the pile stiffness of the individual pile will not be affected by the settlements in the layer of Kedichem.

The value of w_2 is determined by the D-settlement calculations. The settlement calculated in D-settlement will be entered as a forced displacement in the structural model in Scia engineer. w_2 is in this case the deformation of the sand layer underneath the pile and the settlements of the layer of Kedichem. The value of w_2 is the result of the D-settlement calculation.

The forced displacement due to the settlements in the layer of Kedichem is entered in Scia Engineer by applying a concentrated load on a fictive block element. This block element is placed between the structure and the foundation (see appendix A). The dimensions of this block are : 1m x 1m x 1m and the Young's modulus is 1.000.000 [N/mm²]

The concentrated load applied on the block element is calculated by:

$$F_{\text{settlement}} = ((w * E * A) / L) / 1000 \text{ [kN]} \quad \text{where:}$$

- w=settlement calculated by D-settlement [mm]
- E=1.000.000 [N/mm²]
- A=1.000.000 [mm²]
- L=1000 [mm]

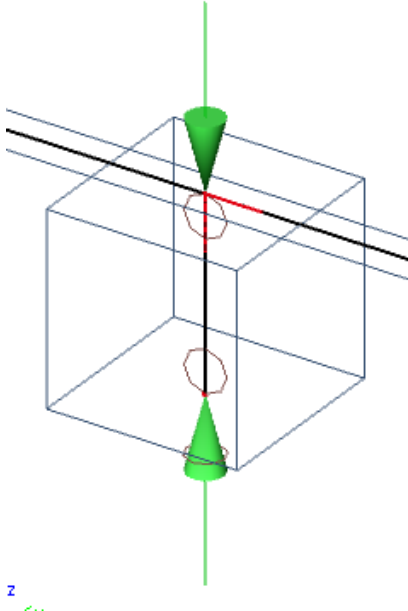

Figure 18 Block element to simulate displacements [Scia engineer]

The table below shows some example values of the applied load on the block element

Table 3 Example values applied load on block element

Displacement [mm]	Load [kN]
10	10.000.000
20	20.000.000
30	30.000.000
40	40.000.000
50	50.000.000

3.2) Enter the stiffness of the structure in the soil settlement calculation program

The stiffness of the structure can be entered in the soil settlement program in two different ways.

Method 1 is by using the contact shape factor, which will be described below.

Method 2 is by using a direct method, by using the actual stiffness as calculated by the structural program.

Both methods will be described below.

3.2.1) Method 1: Contact shape factor

The stiff or flexible behavior of a structure can be entered in a soil settlement calculation program by use of the contact shape factor α .

The contact shape factor (α -factor) determines in what way the load is distributed from the structure to the soil.

The α -factor is used to simulate the stiffness of the structure. When a structure is completely stiff the α -factor is equal to 0. In that case the structure is capable of redistributing the forces. When $\alpha=0$ the forces at the edges are 3 times the average pressure from the building, and at midspan no load is distributed from the structure to the soil [fig.19]. This causes the building to settle equally. Due to the redistribution of the forces the stresses in the structure will increase.

When a structure is completely flexible, the α -factor is equal to 1. When $\alpha=1$ the structure is not able to redistribute the forces. The forces are introduced to the subsoil as an equally distributed force. [fig 18] The magnitude follows directly from the weight calculations of the building. When $\alpha=1$ the forces will not be redistributed, instead the differential settlements are very large. The structure should be checked whether the maximum rotation of the foundation doesn't exceed the maximum value of 1:600 of the length between the foundation piles.

The α -factor influences the prescribed stress on the soil according to the following formula [13]:

$$q_{(x,z)} = P \left\{ \alpha + \frac{12(1-\alpha)}{(X+Z)} \left[X \left(\frac{z}{Z} \right)^2 + Z \left(\frac{x}{X} \right)^2 \right] \right\}$$

where:	$q_{(x,z)}$	prescribed stress [kN/m ²]
	P	magnitude of the load [kN/m ²]
	X	width of the load in x-direction [m]
	Z	width of the load in z-direction [m]
	α	contact shape factor [-]

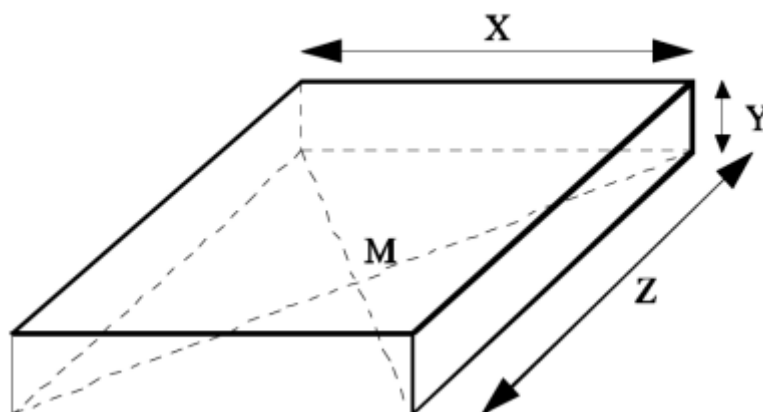

Figure 19 Orientation rectangular load in D-settlement [15]

The graphs below show in a graphical way how the load from the structure is distributed to the soil. The values of the parameters used to create this graphs are:

$$P=1,0 \text{ kN/m}^2$$

$$X=12 \text{ m}$$

$$Z=12 \text{ m}$$

α : varies

There are two ultimate situations. In the first situation the α -factor is equal to 1. In that case the load will be evenly distributed along the surface, as can be seen in the graph below.

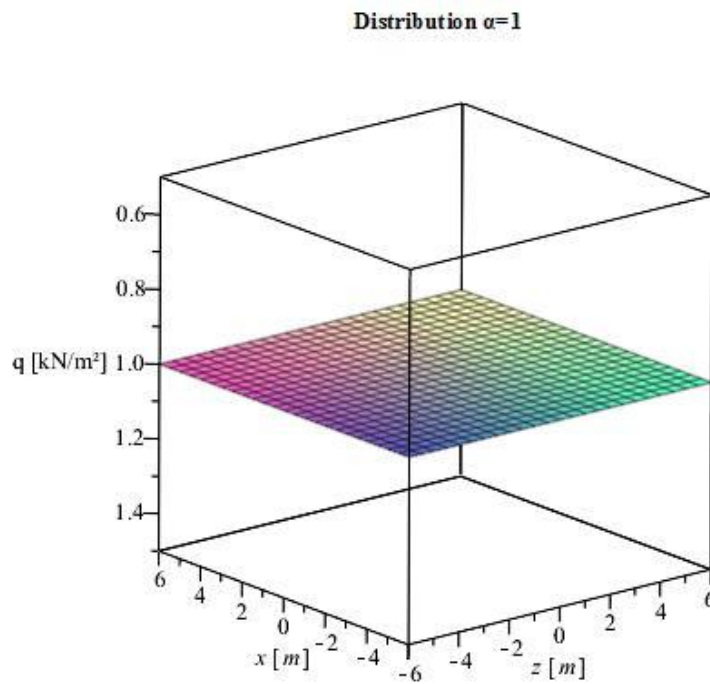

Figure 20 Prescribed stress with $\alpha=1$

The second ultimate situation is when the α -factor is equal to 0. In that case the load will be distributed in a parabolic way. In this situation the prescribed stress at midspan is 0 kN/m², and at the corners the prescribed stress $q=3$ kN/m² (3 times the value of P). At midspan at the edges the value of $q=1,5$ kN/m² (1,5 times the value of P)

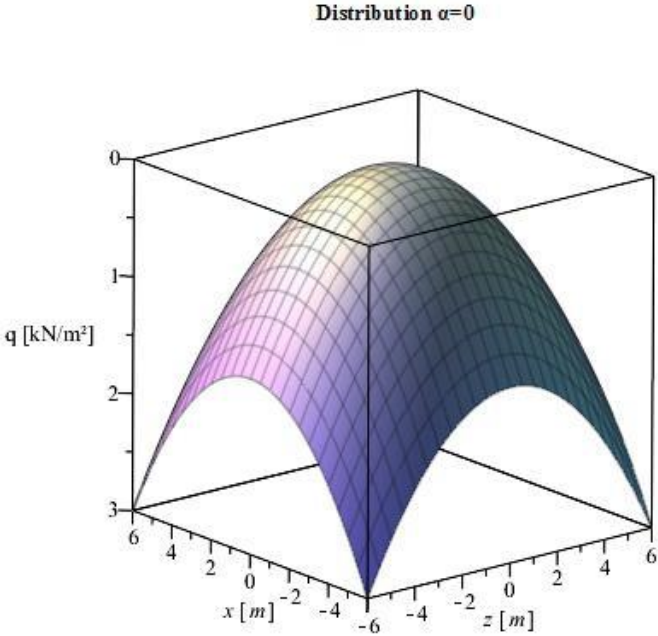

Figure 21 Prescribed stress with $\alpha=0$

In reality these values of α will never be achieved. In reality the value of α will be between 0 and 1. According to the reference projects an α -factor of 0,75 is used for slender high rise structures.

3.2.1.1) Determining the contact shape factor for a structure.

The determination of the contact shape factor is an iterative process, shown in the figure below.

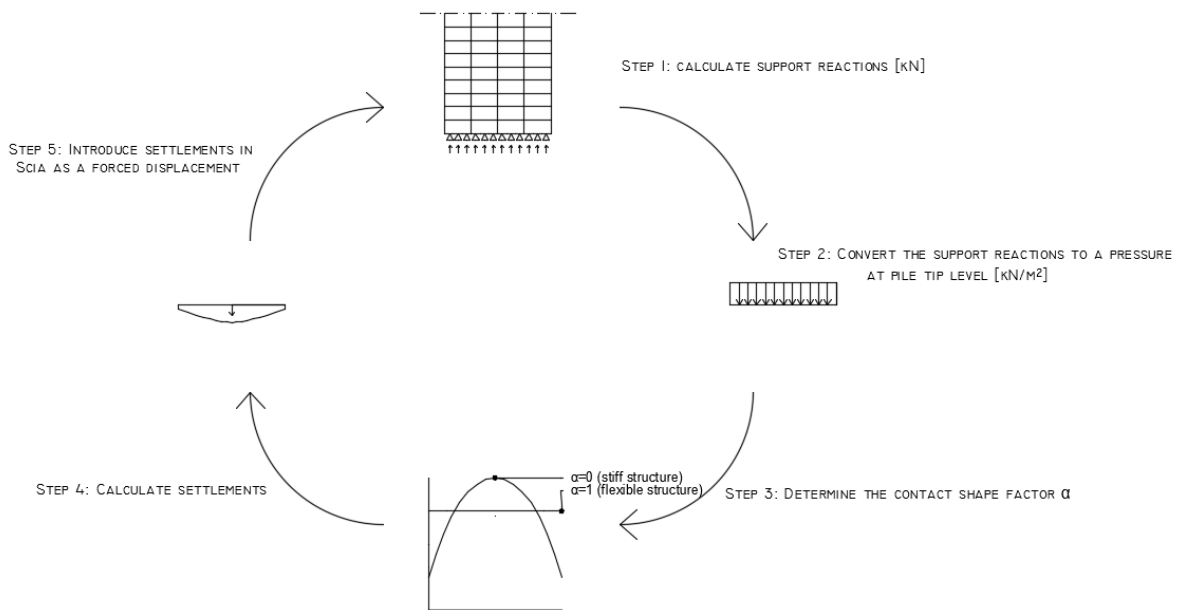

Figure 22 Flow diagram determination of the contact shape factor

Step 1: At first the support reactions of the structure are calculated when no settlements are entered in the structural model in Scia Engineer. This gives a value of the vertical support reaction in kN.

Step 2: The soil settlements are calculated with D-settlement. In D-settlement the loads will be entered as a stress on the subsoil. The unit is kN/m².

To convert the support reaction in Scia Engineer to a stress in D-settlement, the support reaction will be divided by the area where the load is applied.

This is the footprint of the structural element, plus the area over which the load is spread.

Step 3: Determining the contact shape factor.

In the first approach the stress is evenly distributed over the soil. This gives a contact shape factor of 1.0

For the iterations the formula $q_{(x,z)} = P \left\{ \alpha + \frac{12(1-\alpha)}{(X+Z)} \left[X \left(\frac{z}{Z} \right)^2 + Z \left(\frac{x}{X} \right)^2 \right] \right\}$

will be used to calculate the new contact shape factor. The initial stress P and the locations of x and z are known, the only unknown factor in this formula is the contact shape factor α .

The α -factor will be adjusted in order to achieve the values of the stresses on the soil calculated in step 2.

Step 4: With this stress on the soil and the contact shape factor a settlement calculation will be made in D-settlement.

Step 5: The calculated settlements will be entered in the structural model according to chapter 3.1, and a new structural calculation will be made. The settlements causes redistribution of the forces, so the support reactions will change.

This process continues until the settlements calculated by the settlement calculation don't differ from the previous settlement calculation.

In appendix B a numerical example of the settlement of a wall can be found

3.2.2) Method 2: Direct method

The contact shape factor α is a factor to simulate the stiffness of the structure. The formula to determine the α -factor assumes that the load distribution is either equal or has some parabolic shape.

In reality the load distribution doesn't have to be in a parabolic shape.

This is the weak point of the α -factor.

Another possibility to predict the settlements is to use the actual stiffness of the building as calculated by Scia engineer. In that case each support has its own block-load in D-settlement with an α -factor of 1.0. This area of the block-load is the area over which the reaction force from the pile is spread.

The contact shape factor of this small area is 1.0 because the load will be evenly distributed over the small area.

When this approach is used to calculate the settlements, the actual load distribution is entered in D-settlement. The load distribution is not "pushed" in a predetermined, parabolic shape as in the case when the α -factor is used.

3.2.2.1) Applying the direct method

The application of the direct method is also an iterative process.

Step 1: Calculate the support reactions of the structure. In the first approach the calculated support reactions are due to the permanent load on the building and the momentane part of the variable loads. The settlement calculation is calculated with the support reactions in the serviceability limit state.

Step 2: Convert the support reactions to stresses, by dividing the support reaction over the area in the soil that is influenced by the support reaction.

Step 3: Enter the stresses in a soil calculation program (D-settlement) and perform a settlement calculation.

Step 4: Enter the calculated settlements as a forced displacement in a structural calculation program (Scia Engineer), and go back to step 1.

This method contains less steps, but there is more data to be entered in the soil settlement program. By using the contact shape factor, only 1 block load for a complete wall can be used, where you use 5 block loads for a single wall in the direct method.

Also the direct method uses more iterations.

In appendix B a numerical example of the settlement of a wall can be found, for both the direct method and the contact shape factor method.

4) Connections in precast concrete

Precast concrete structures are structures consisting out of concrete elements. These elements are prefabricated in a factory and on the building site these elements will be mounted. In this case you save a lot of time and space at the building site.

In precast structures the connections between the elements needs extra attention. The connection determines the stiffness of the total structure, because the structure is as strong as its weakest link. So the connections determines the stiffness of the structure and thus influence the value of α in the settlement calculation.

4.1) Connections

There are several types of connections. There are structural and non-structural connections.

Structural connections transfer loads and non-structural connections don't play any role in transferring loads.

The non-structural connections will not be covered in this thesis.

The scheme below shows the different categories of connections.

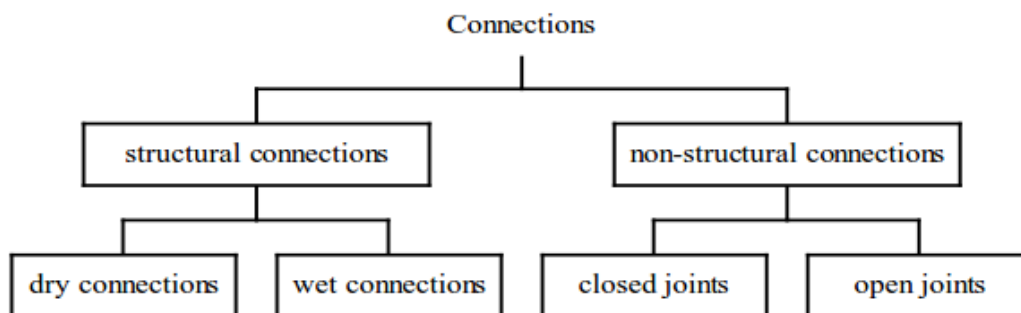

Figure 23 Overview connection types [14]

The wet connections contains mortar, which has to dry before a structural connection is obtained.

A dry connection doesn't need mortar. The connection can fulfill its function right after the connection is assembled. A dry connection is for example a welded connection between the elements.

For some connection types it is not clear in which category they fit. For example the connection with protruding bars. Some people classify this connection as a dry connection, because it can already take up some load right after the element is placed, and other people classify this connection as a wet connection because the full capacity of the connection to resist the loads is after the hardening of the mortar.

4.1.1) Horizontal connections between wall elements

There are several options which can be used to achieve a horizontal connection between precast elements. The most common used is the horizontal connection with protruding bars [fig. 22]

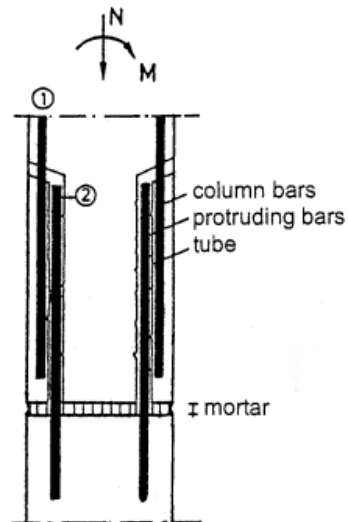

Figure 24 Protruding bars [14]

Another option is to use a bolted connection [fig 23] or a welded connection. For a bolted connection the tolerances are really low, because the threaded sockets are casted in the wall. Every socket should be at the correct place, there is almost no room for deviations.

The welded connection is a very labor intensive connection, which need skilled workers in order to provide a good connection, and compared to a connection with protruding bars the connection is less stiff because it is not welded over the complete length of the element.

In this thesis the horizontal connections will be therefore the connection with protruding bars, it is an easy to assemble connection which can deal with small deviations. and it is stiffer than a welded connection.

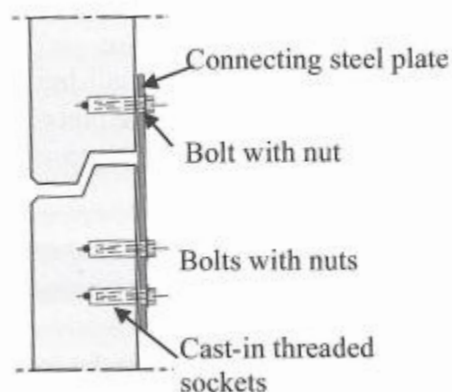

Figure 25 bolted connection [15]

4.1.2) Vertical connections between wall elements

There are several types of vertical connections possible.

- no connection: when the elements are stacked in a masonry configuration, and you have sufficient compression in your wall, it is possible to have no structural connection between the elements.

Wet connections

- Smooth reinforced connection

The smooth reinforced connection consist out of cast in stirrups. The stirrups of both elements overlap each other. In a later stadium extra reinforcement bars are added. The space between the elements will be filled with mortar.

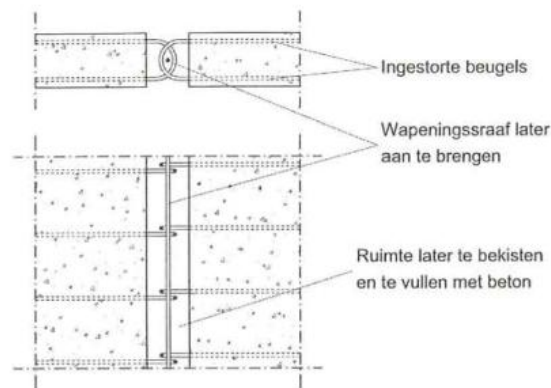

Figure 26 Smooth reinforced connection [16]

-Toothed reinforced connection

The toothed reinforced connection is quite similar to the smooth reinforced connection. The difference is that the edge of the element is not smooth, but toothed. In this case the mortar is better enclosed in the connection, and compression diagonals can be formed in the connection. Due to this the connection is better in dealing with shear forces.

This connection behaves more stiff compared to the smooth reinforced connection.

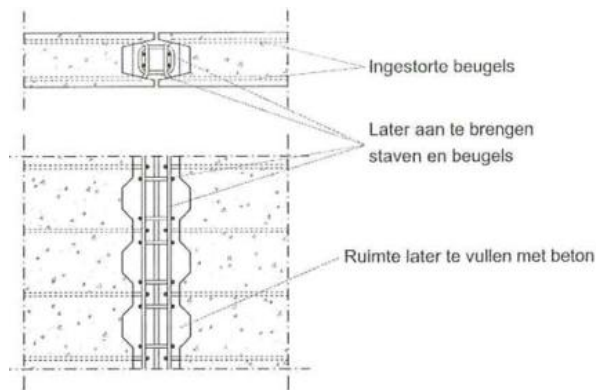

Figure 27 Toothed reinforced connection [16]

- Loop connection

The loop connection is a variant of the smooth reinforced connection. The loops are slightly set back, resulting in quite big ridges. These ridges can take up the force perpendicular to the joint.

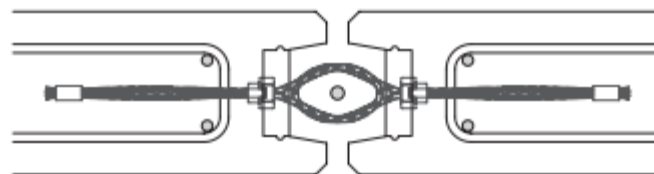

Figure 28 Loop connection [17]

Dry connections

- Welded cast in steel plates

The steel plates are casted into the concrete. Reinforcement bars are attached to the steel plate, to anchor the plate to the wall. The reinforcement bars are attached in multiple directions, to deal with different forces. At least two plates per element are needed.

A disadvantage of the welded connection is that the shear capacity is rather low compared to the wet connection.

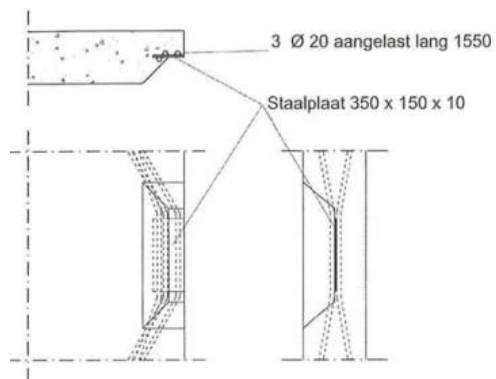

Figure 29 Example welded cast in steel plates connection [16]

- Welded cast in steel profile

This connection is similar to the welded cast in steel plates, but instead of plates a steel UNP profile is casted in the concrete wall. After placing the elements at both sides of the wall will be a weld-plate welded to the steel profile. So for this connection two welds are needed.

This connection is stiffer than the welded cast in steel plates, but still less stiff compared to the wet connection.

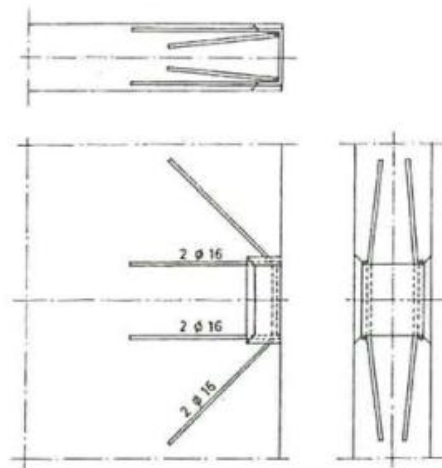

Figure 30 Example welded cast in UNP-profile connection [16]

4.2) Structural behavior of the connections

The structural parameters of the connections are determined in this chapter. The stiffness of the connections will be used in the structural program.

Shear stiffness

The shear stiffness will be determined by the formula:

$$k_x = v_{Rdi} / \delta \text{ (N/mm}^3\text{)}. [18]$$

Where v_{Rdi} is the calculation value of the shear stress, and δ is the deformation of the joint. Assumed is that the joint fails when the slip deformation is 1mm.

According to the Eurocode 1992-1-1[19] $v_{Rdi} = c \cdot f_{ctd} + \mu \cdot \sigma_n + \rho \cdot f_{yd} (\mu \cdot \sin(\alpha) + \cos(\alpha)) \leq 0,5 \cdot v \cdot f_{cd}$

where: c = Factor for the bond between the precast concrete and the freshly poured concrete,
 μ = factor for the roughness of the surface.
 σ_n = the minimal normal stress in the joint that can coincide with shear force, positive for pressure, whereby $\sigma_n < 0,6f_{cd}$ and negative for tension. It's advised to use $c \cdot f_{ctd} = 0$ when σ_n is in tension
 f_{ctd} = design tensile strength of the concrete
 ρ = reinforcement ratio
 α = the angle of the reinforcement
 v = reduction factor for the stiffness, $v = 0,6(1 - f_{ck}/250)$
 f_{ck} =the characteristic cylindrical concrete compression strength.

According to the Eurocode the values of c and μ can be determined as follows when there is no sufficient information available:

For a smooth reinforcement connection that is poured into a mould of steel, plastic or specially prepared wood, the edges of the element is considered very smooth. In this case $c = 0,025 - 0,10$ and $\mu = 0,5$.

The connection is classified as smooth when the concrete is poured into a sliding formwork, as an extruded surface or as a free surface without any treatment after vibrating. In this case $c = 0,2$ and $\mu = 0,6$

A surface is classified as rough when the roughness is at least 3mm and the distances in between are approximately 40mm. This can be achieved by raking the concrete. In this case $c = 0,4$ and $\mu = 0,7$.

For a profiled connection with serrations the values of c and μ are $c = 0,5$ and $\mu = 0,9$.

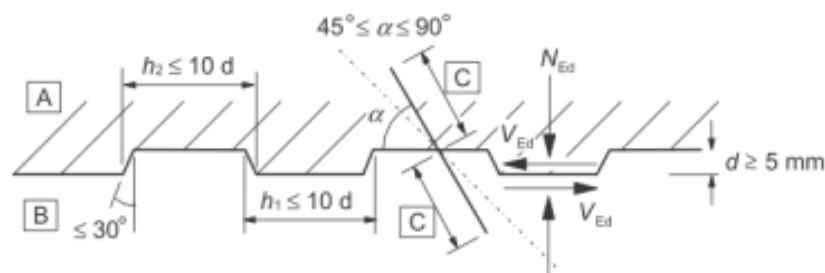

Figure 31 determination shear stiffness [Eurocode]

Because the shear stiffness also depends on the normal stress in the joint, the shear stiffness also varies over the height of the building.

The stiffness entered in the structural FEM program is calculated by:

$$K_x = k_x \cdot t$$

Normal stiffness

The normal stiffness of the connection is basically equal to the strength of the surrounding concrete, because the normal force is a compressive force. The dimension of the walls also influence the normal stiffness of the connection.

According to the study of ir. Van Keulen [18], the normal stiffness K_y can be calculated with the formula: $K_y = A \cdot E / (t \cdot 1m)$ [kN/m²]

where: K_y = connection stiffness

A = considered area

E = Young's modulus of the concrete

t = thickness of the connection

5) Theoretical research

The theoretical research contains four cases to understand the behavior of a structure on compressible soil. A stiff wall on a layer of compressible soil and a less stiff wall on compressible soil will be modeled. For each case a very high wall and a very wide wall will be investigated.

The less stiff wall is a schematization of a precast concrete wall. Several connections that are useful for the design of the Cooltower will be investigated.

The stiff wall will be schematized as a monolithic concrete wall.

The settlements of these elements will be calculated with the program D-settlement from Deltares, because a schematization of the soil in a structural program will get very unrealistic values.

5.1) Set up of the theoretical research

To compare the results between a monolithic wall and the precast wall, some parameters will be fixed for both cases.

The concrete class of the walls will be C50/60. All elements have an E-modulus of 24000 N/mm^2 (the mean E-modulus of concrete C50/60 divided by the safety factor).

The reinforcement steel is of class B500A.

The reduced E-modulus of cracked concrete will not be taken into account in this part of the research, but will be taken into account at a later stage of this thesis.

The thickness of the wall will be 300mm.

For the high wall the height of the wall will be 96m and the width will be 24m, so the slenderness will be 4:1.

The wide wall will be 96m wide and 24m high, so the slenderness will be 1:4.

The element size of the precast structure will be 3x6m.

The horizontal load is not part of the settlement calculation, because the horizontal load (wind load) is a very short term load and therefore not influencing the settlements in the deeper soil layers.

For the precast structure several connection types between the elements will be modeled, to investigate which connection type will be use full.

5.1.1) Loads

The vertical load will be the self weight of the wall, and the self weight of a floor with thickness 260mm and a span of 4m.

Also the variable floor loads will be put in the structural model.

Permanent loads

The mass of the concrete is $\rho=2500\text{kg/m}^3$.

-Wall: $25*0.3=$	7.5	kN/m ²
-Floor: $25*0.26*4=$	26.0	kN/m
-Finishing floor: $20*0.1*4=$	8.0	kN/m
- Facade cladding:	<u>1.0</u>	<u>kN/m² +</u>
Total permanent loads	<u>59.5</u>	<u>kN/m</u>

Variable loads

Variable floor load, residential building: $4*1.75=$ 7.5 kN/m

5.1.2) Material properties

Concrete	C50/60	$E_d=24000\text{ N/mm}^2$
Reinforcement steel	B500A	

5.1.3) Connections

The value of the connection stiffness which will be used in this part of the research will be as follows.

Horizontal connections

The horizontal connections used in this thesis will be a connection with protruding reinforcement bars. The effect of the strength of the connections on the differential settlements will be investigated.

For now in the theoretical research the values of the connection stiffness obtained in the research by Dick van Keulen and Jan Vamberský [20] will be used.

In this research the normal mortar connection, the weak mortar connection and the very weak mortar connection is used. The normal mortar connection represents a mortar connection with a mortar which has a stiffness equal to the surrounding concrete, and a 'normal' amount of reinforcement used.

The weak and the very weak mortar connections consist out of a mortar that is weaker than the surrounding concrete and have less reinforcement in it.

In the research by Dick van Keulen [21] the wall thickness is 500mm. In the theoretical research which is done in this thesis the walls thickness is 300mm. Therefore the stiffness of the connections have to be adjusted.

The values of the connection stiffness that are used in the theoretical research are:

Table 4 Connection stiffness

Connection type	Connection stiffness
Normal mortar connection	$K_x=1.08 \cdot 10^6 \text{ kN/m}^2$ $K_y=2.04 \cdot 10^7 \text{ kN/m}^2$
Weak mortar connection	$K_x=6.48 \cdot 10^5 \text{ kN/m}^2$ $K_y=1.62 \cdot 10^7 \text{ kN/m}^2$
Very weak mortar connection	$K_x=2.16 \cdot 10^5 \text{ kN/m}^2$ $K_y=1.20 \cdot 10^6 \text{ kN/m}^2$

Vertical connections

The vertical connections used in this thesis are:

- Smooth reinforced connection
- Toothed reinforced connection
- Welded cast in steel plates
- Welded cast in steel profile
- No vertical connection

For the theoretical research the results from the master thesis of Falger [16] are used. The stiffness of the connections are:

Connection type	Falger		Scia	
	Knn	Ktt	Kx	Ky
Smooth	1.31	38500	3.93E+5	5.77E+8
Toothed	3.6	38500	1.08E+6	5.77E+8
Welded plates	0.56	16460	1.68E+5	2.47E+8
Welded UNP profile	0.9	26450	2.70E+5	3.96E+8

Where: $K_x = K_{nn} \cdot t$

$K_y = K_{tt} \cdot A/d$

according to chapter 4.2

-No vertical connection:

When no vertical connection is applied the elements are stacked in a masonry configuration. The vertical connection $K_x = K_y = 0 \text{ kN/m}^2$.

5.1.4) Approach

The computer programs used for this research are:

- SCIA Engineer, for calculating the structure
- D-Settlement, for calculating the settlements of the structure

At first the structure will be modeled in Scia, the results of this calculation are support reactions. The forces of these support reactions will be put into D-settlement so the settlement of the structure will be calculated.

The settlements will be put in Scia again as a forced displacement. This displacement will be a new load case.

Due to this forced displacement the load distribution will be different, resulting into new support reactions in the structure. This support reactions will be put in D-settlement again, to re-calculate the settlements.

This process is an iterative process. From the literature study [11] it is enough to do two iterations.

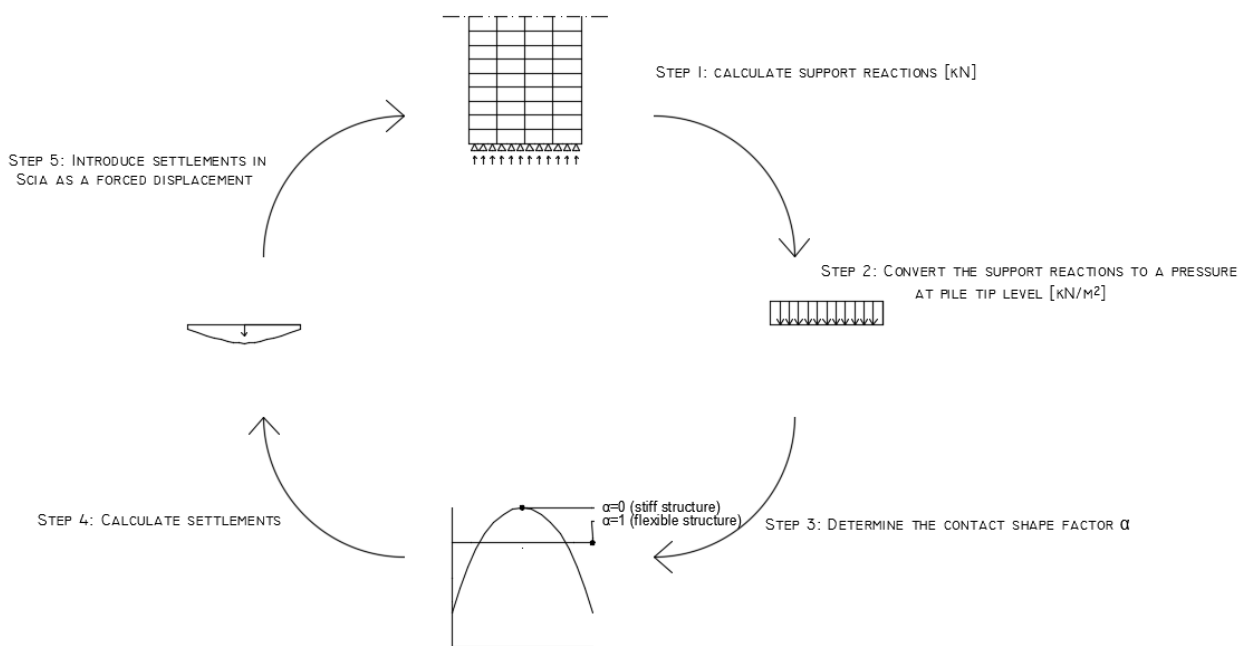

Figure 32 flow diagram iterative process for determining the contact shape factor

5.2) Input data

This chapter describes the data that was put in the software programs to investigate the behavior of a wall on compressible soil.

5.2.1) Scia engineer

In Scia engineer two different wall types are entered, each wall type has three variations resulting in 6 different walls.

The wall types are:

- high, closed wall
- high wall with window openings
- high wall with window openings and door openings

- wide, closed wall
- wide wall with window openings
- wide wall with window openings and door openings

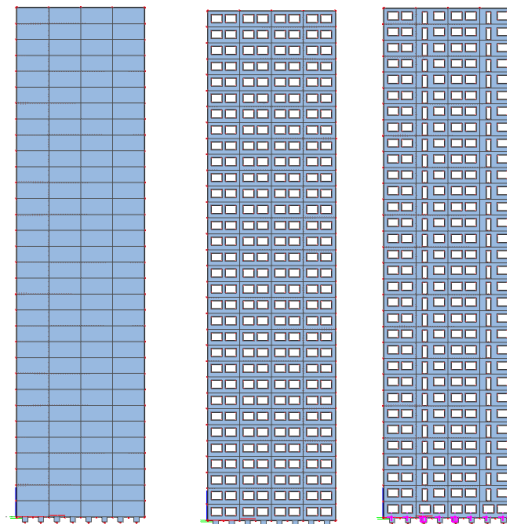

Figure 33 Alternatives high wall

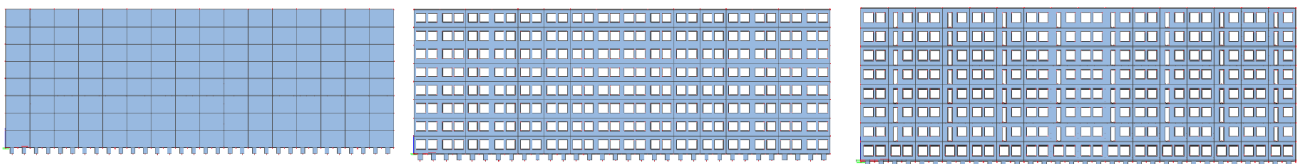

Figure 34 Alternatives wide wall

For each wall types a monolithic and a precast alternative is investigated. For the precast wall types the connection stiffness between the elements is varied, to simulate different connection types.

The connections that are investigated are:

- Open vertical joint, horizontal extruded reinforcement connection
- Vertical smooth reinforced connection, horizontal extruded reinforcement connection
- Vertical toothed reinforced connection, horizontal extruded reinforcement connection
- Vertical cast in welded plate connection, horizontal extruded reinforcement connection
- Vertical cast in welded steel profile connection, horizontal extruded reinforcement connection

For the wall with the open vertical joint also the influence of the stiffness of the horizontal connection on the differential settlements is investigated by applying the normal mortar connection, the weak mortar connection and the very weak mortar connection as described in chapter 6.1.3).

For the other precast alternatives the stiffness of the horizontal connections will be as the normal mortar connection described in chapter 6.1.3)

The element division and the location of the supports is shown in the figures below.

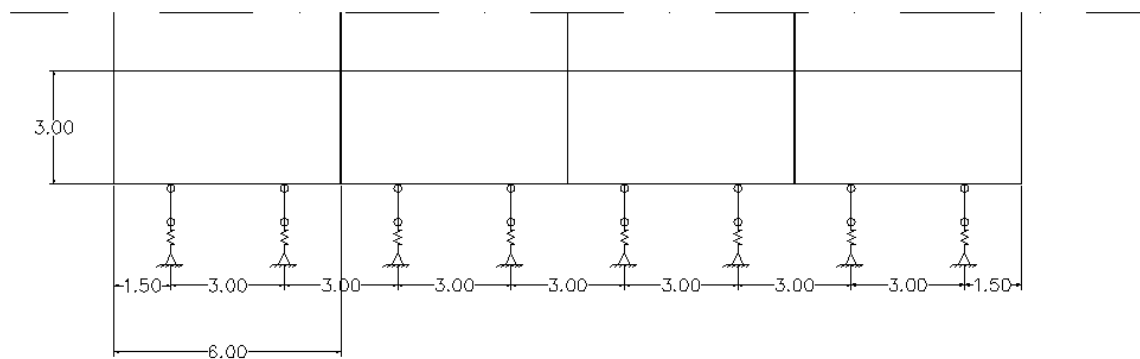

Figure 35 element division and locations of supports closed precast wall

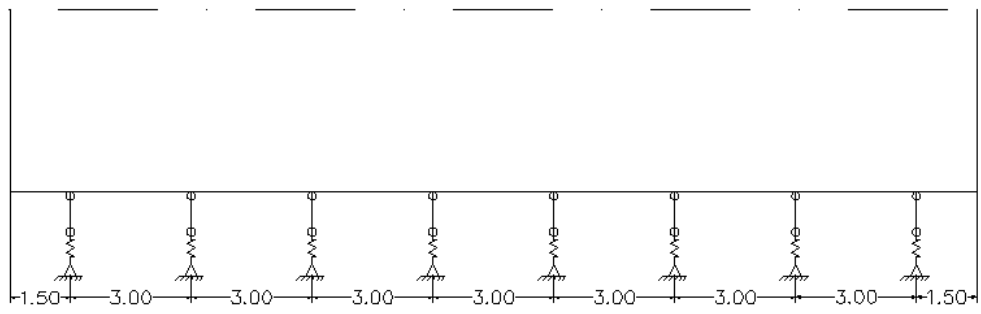

Figure 36 location supports closed monolithic wall

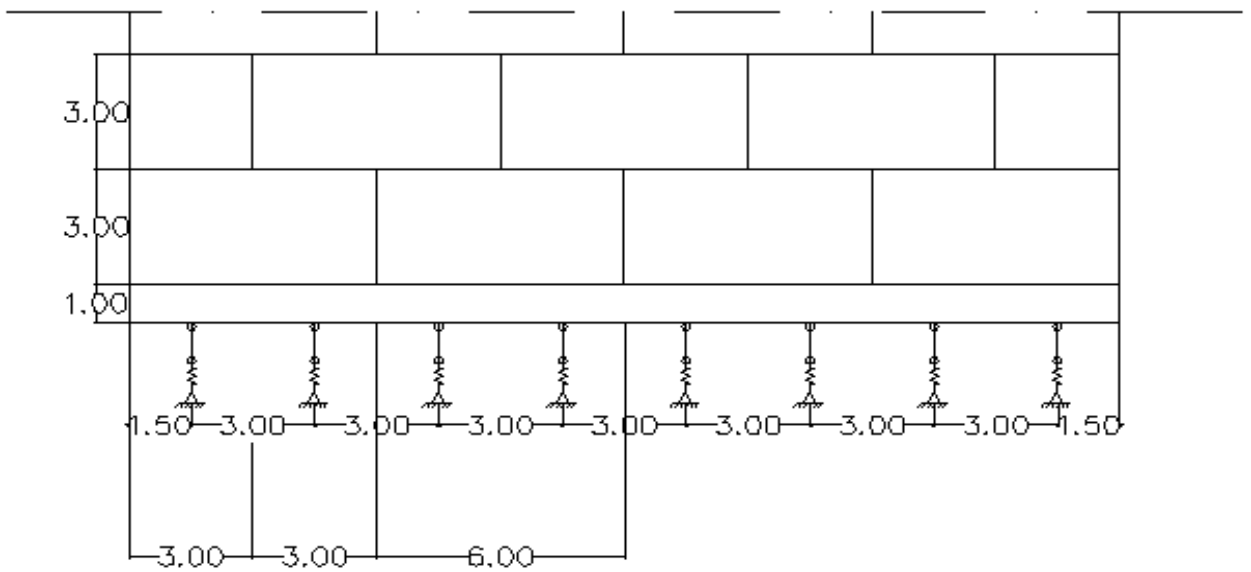

Figure 37 location supports precast wall with open vertical joint

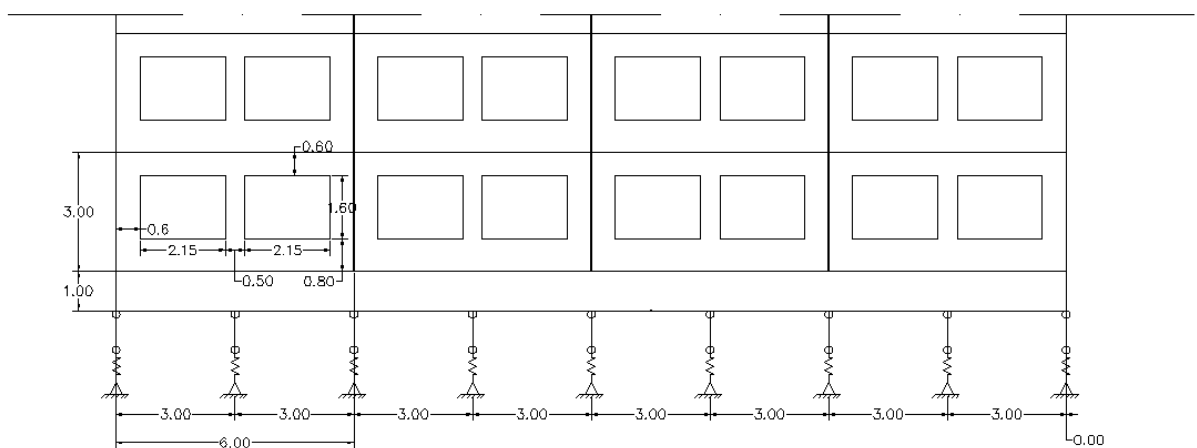

Figure 38 Precast wall with window openings

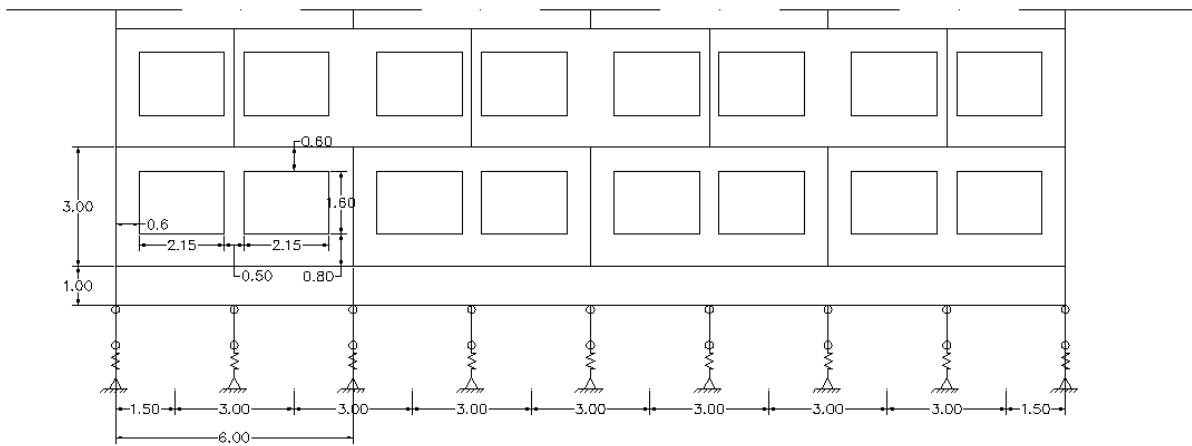

Figure 39 Precast wall with open vertical joints and window openings

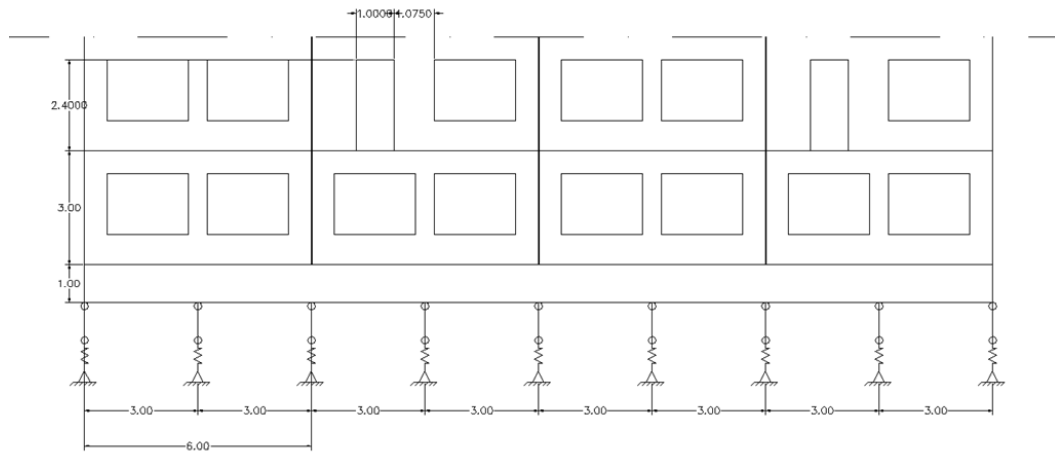

Figure 40 Wall with window and door openings

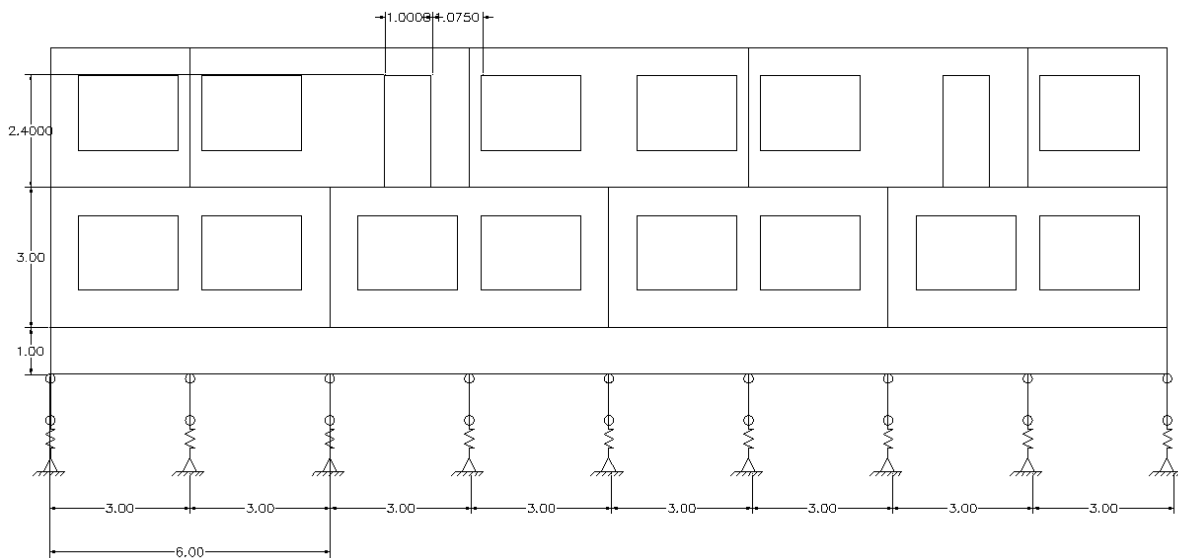

Figure 41 Precast wall with open vertical joints, window and door openings

5.2.2) Input D-settlement

In order to model the soil conditions in D-settlement data from other projects is used. The data from other projects were not complete, so data from reports made by Geomet [4], Mos Grondmechanica [9] and Deltares [22] are combined to make a realistic model.

The figure below shows the soil conditions as modeled in D-settlement for the high wall.

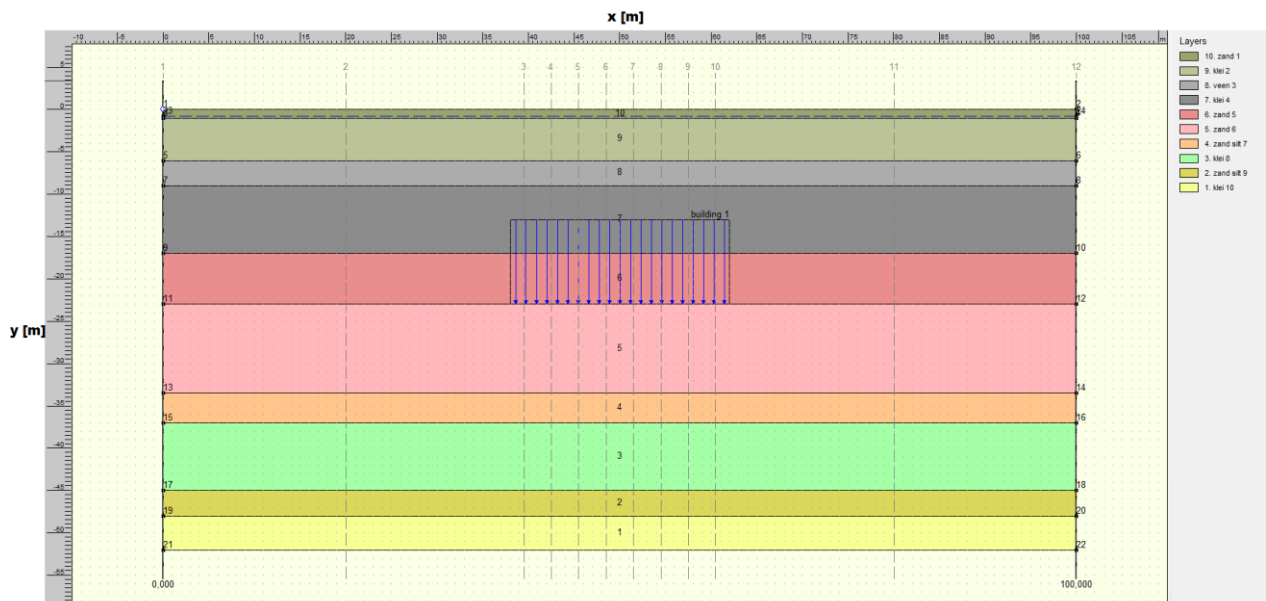

Figure 42 Overview input D-settlement

The layers with number 1 to 4 represent the layer of Kedichem.

The soil model is according to the method of Koppejan theory

The consolidation model is according to Terzaghi theory

The stress distribution is according the Buisman theory

Some assumptions are made for this model:

- the sand layers are drained
- the initial stress in the soil is not be taken into account, it is assumed that the soil is over consolidated. This means that in the past the stresses in the soil were higher than the stresses that will occur due to the new to be build tower.
- for all layers the over consolidation rate is $OCR=1.3$
- the end of consolidation is after 10.000 days.

Table 5 Soil parameters

Layer number	Y start [m]	Y End [m]	material	drained	Saturated weight [kN/m ³]	C _v [m ² /s]	C _p [-]	C _p '[-]	C _s [-]	C _s '[-]
10	0	-1	Zand 1	Yes	20	-	1	1	1	1
9	-1	-6	Klei 2	No	18	1E+1	1	1	1	1
8	-6	-9	Veen 3	No	17	1E+1	1	1	1	1
7	-9	-17	Klei 4	No	18	1E+1	1	1	1	1
6	-17	-23	Zand 5	Yes	20	-	1.5E+3	1.5E+3	1E+10	1E+10
5	-23	-33.5	Zand 6	Yes	10	-	1.5E+3	1.5E+3	1E+10	1E+10
4	-33.5	-37	Zand silt 7	Yes	20	-	2.65E+2	2.65E+2	3.2E+3	3.2E+3
3	-37	-45	Klei 8	No	18	8E-8	1.35E+2	7.5E+1	1.08E+3	8.5E+2
2	-45	-48	Zand silt 9	Yes	20	-	2.65E+2	2.65E+2	3.2E+3	3.2E+3
1	-48	-52	Klei 10	No	18	8E-8	1.05E+2	8E+1	8.4E+2	9.6E+2

The swell constants A_p and A_s are determined by the computer program.

The reaction forces from the Scia program are entered as a non uniform block load. The contact shape factor α in D-settlement is used to model the way how the forces from the structure are applied to the soil, as described in chapter 3.

The calculation results will be written to 'verticals', at each support location from the Scia model a vertical is placed to calculate the settlement at each support point. The position of the verticals is at the edge of the block load, as shown in the figures 46 and 47 on the next page

The magnitude of the block loads are:

Block load of the high wall: 400kN/m²

Block load of the wide wall is 100kN/m²

From reference projects the α -factor for a high-rise structure is 0.75, during the experiment this value seem to be reasonable for the high wall. It was expected that the wide wall behave more flexible, but after iterative calculations an α -factor of 0.75 is also reasonable for the wide wall.

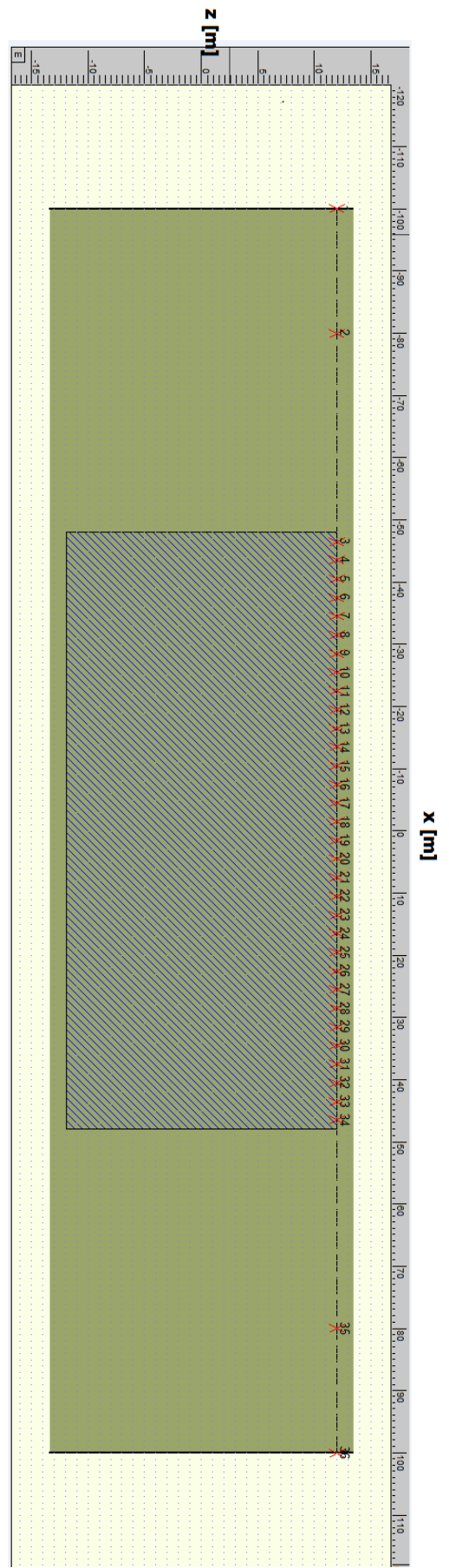

Figure 43 location of the verticals, wide wall

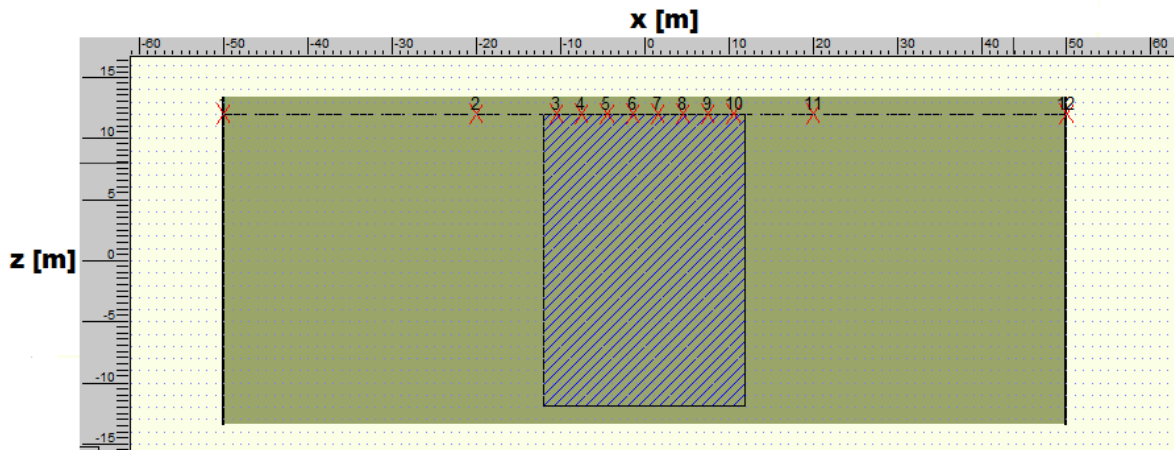

Figure 44 location of the verticals, high wall

5.3) Results D-settlement

Table 6 Settlements wide wall

X [m]	Settlements wide wall [mm]
-46,5	18
-43,5	21
-40,5	23
-37,5	25
-34,5	26
-31,5	27
-28,5	27
-25,5	27
-22,5	27
-19,5	27
-16,5	27
-13,5	27
-10,5	27
-7,5	27
-4,5	27
-1,5	27
1,5	27
4,5	27
7,5	27
10,5	27
13,5	27
16,5	27
19,5	27
22,5	27
25,5	27
28,5	27
31,5	27
34,5	26
37,5	25
40,5	23
43,5	21
46,5	18

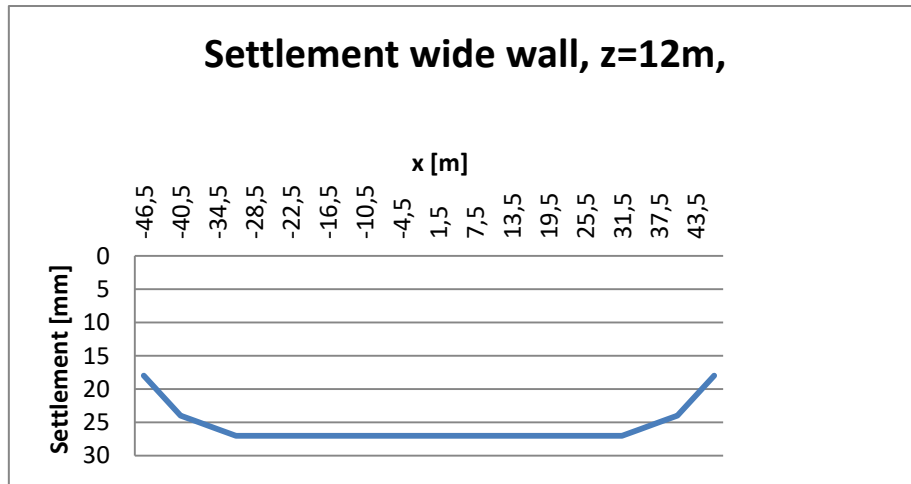

Figure 45 Settlements wide wall

Table 7 Settlements high wall

X [m]	Settlements high wall [mm]
-10,5	59
-7,5	70
-4,5	76
-1,5	79
1,5	79
4,5	76
7,5	70
10,5	59

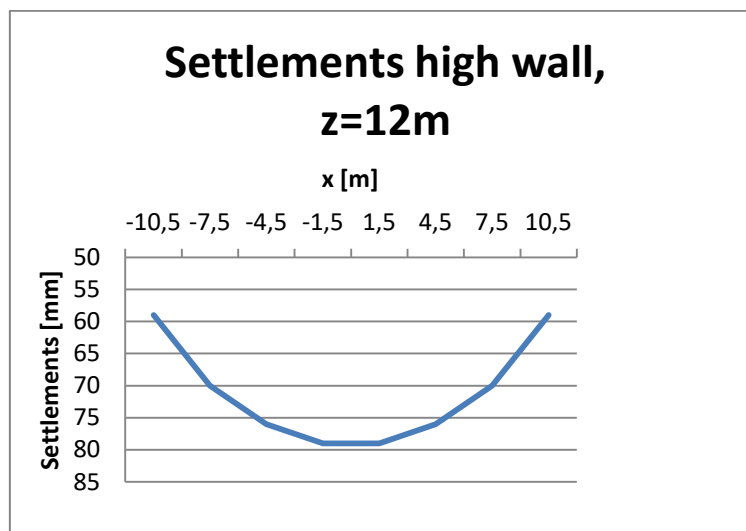

Figure 46 Settlements high wall

5.4) Results Scia engineer high wall.

The results from Scia engineer are divided by connection type. For each structure the displacements and the support reactions are investigated.

5.4.1) Results closed high wall

The graph of fig. 51 shows the initial displacement, without the forced displacement from the D-settlement calculation. All settlements are in a range of 1mm, which is neglect able. The differences in settlements within each structure are due to the fact that the supports are modeled as springs.

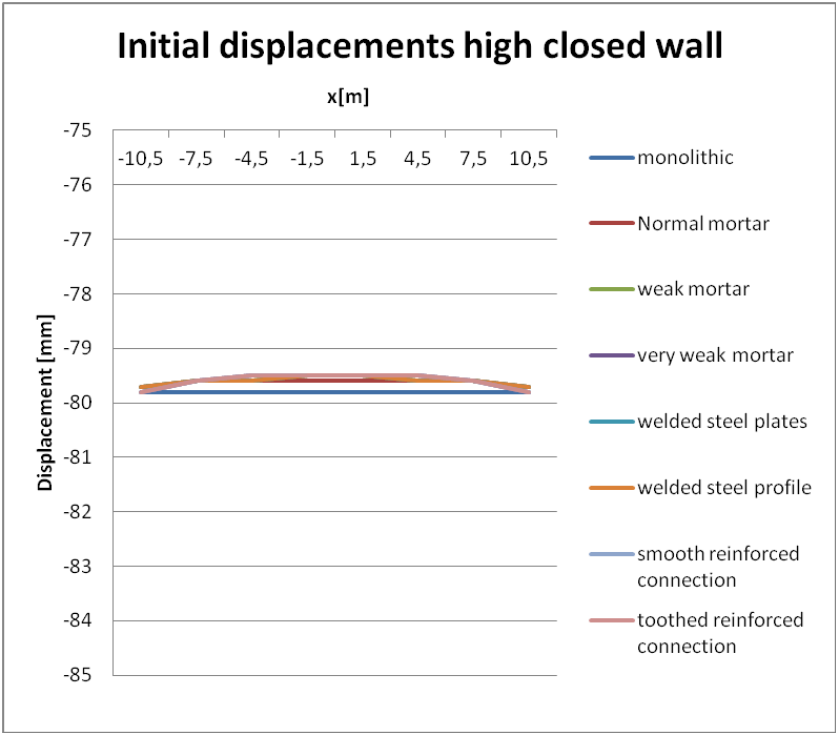

Figure 47 Initial displacements closed wall

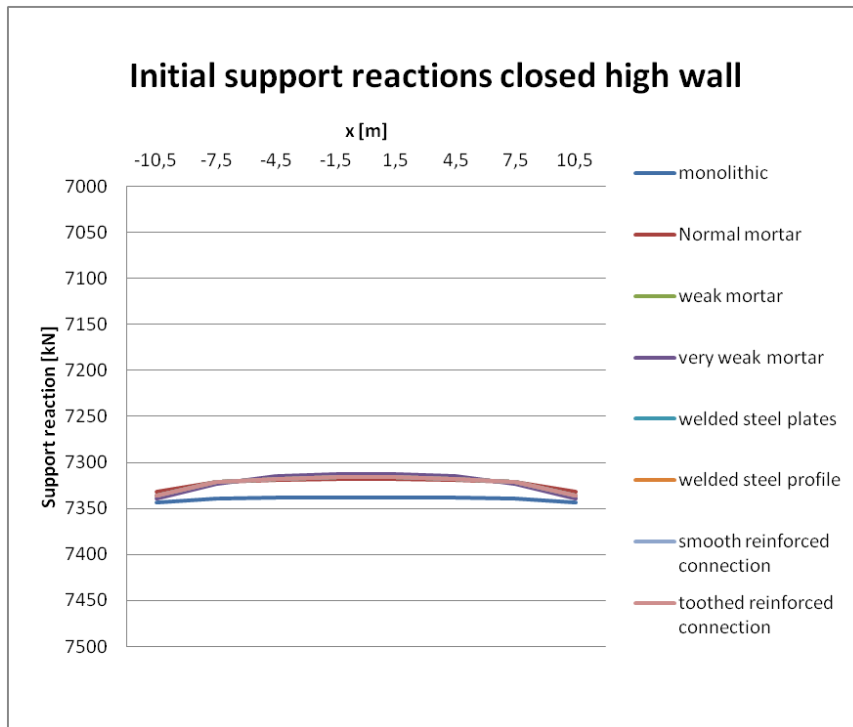

Figure 48 Initial force distribution closed wall

The graph in figure 52 shows the initial force distribution on the foundation. For the precast structures with the structural vertical joints there is a redistribution of the forces to the edges of the wall, but the difference between the lowest load and the maximum load is only 0.2% so this can be neglected. This redistribution is due to the fact that the supports are modeled as springs.

The settlements calculated in D-settlement are entered as a forced displacement in the Scia model, resulting in the displacement graph of figure 53.

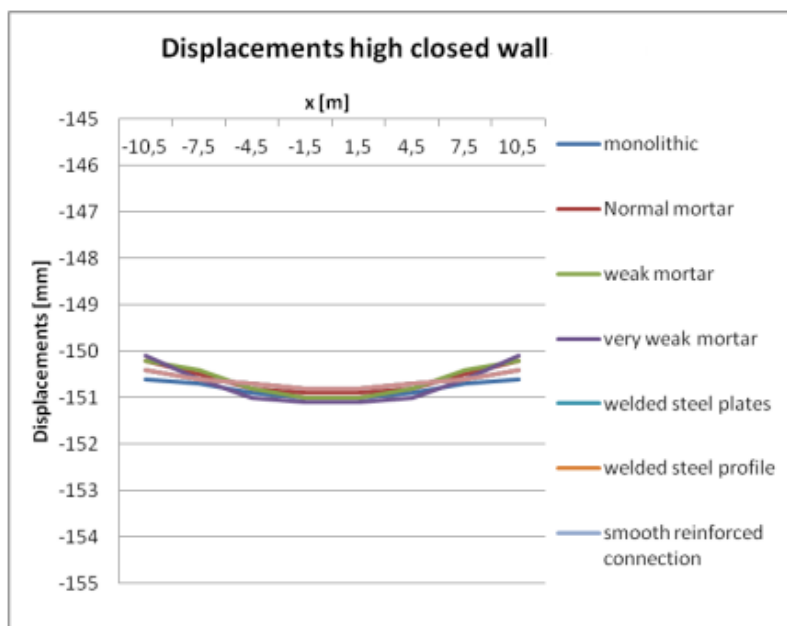

Figure 49 Displacements closed wall

The highest differential settlements will occur at the precast structures, but the maximum differential settlements are 1 mm. This small differential settlements can be neglected, the structure behaves like a rigid structure. This can also be seen in fig. 54. The forces are redistributed to the edges of the structure, just as expected for a rigid structure.

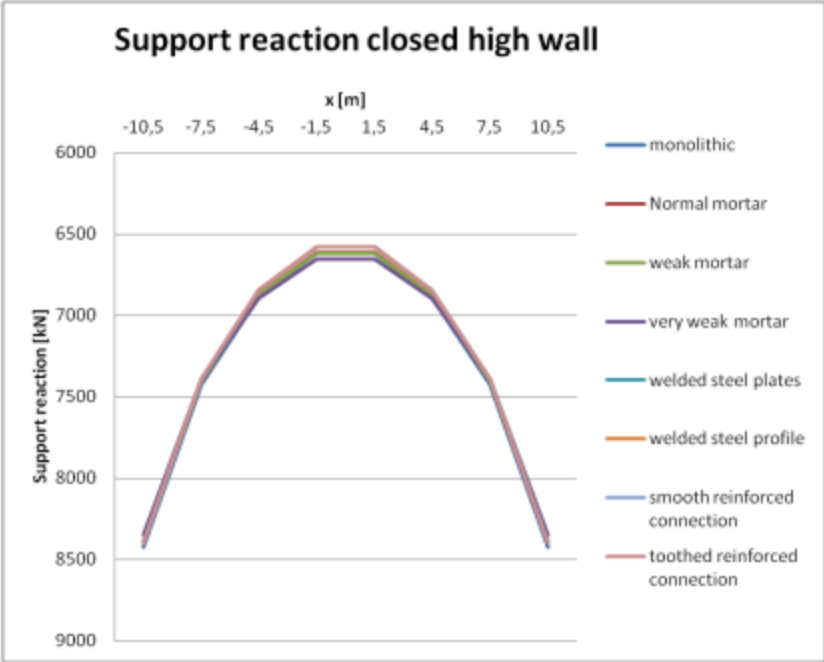

Figure 50 Force distribution closed wall

5.4.2) Results high wall with window openings.

The window openings reduce the stiffness of the structure. The initial displacements of figure 55 show that due to the spring stiffness of the piles and the window openings the differential settlements of the structures are already 5mm. The wave shapes in the displacement and support reaction graphs is due to the location of the openings, some supports carry more loads than other supports.

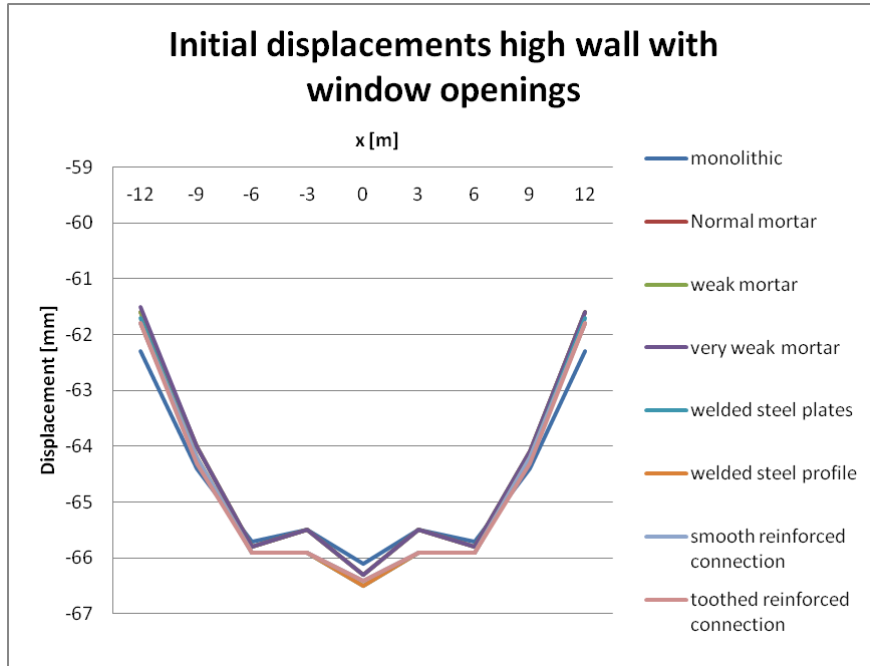

Figure 51 Initial displacement high wall with window openings

The initial load distribution [fig. 52] is a bit more constant than the initial differential displacements of the wall.

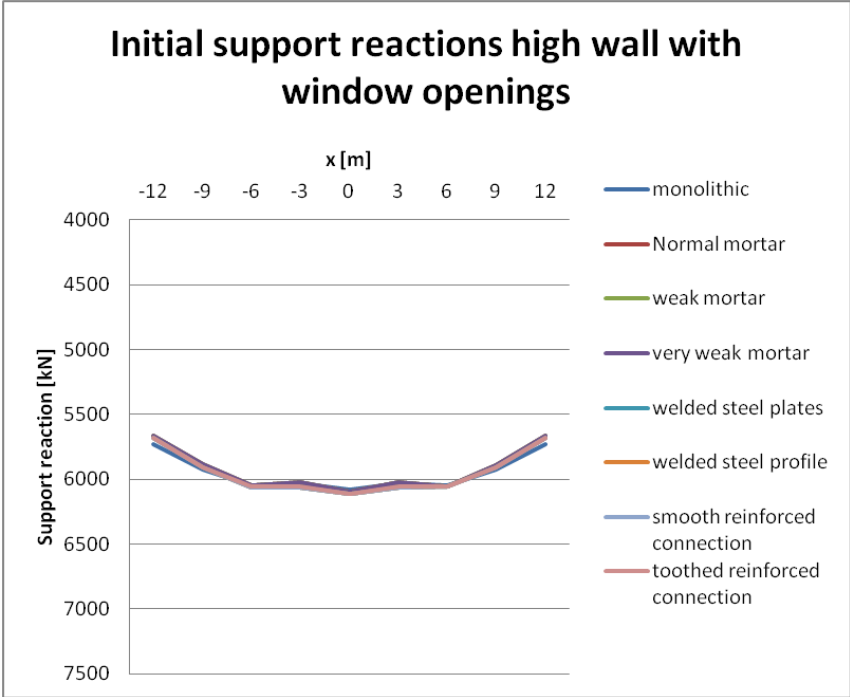

Figure 52 Initial force distribution high wall with window openings

Due to the forced displacements the displacement of the nodes changes. Every wall configuration undergoes differential displacements, but the differential displacements don't exceed the 10mm.

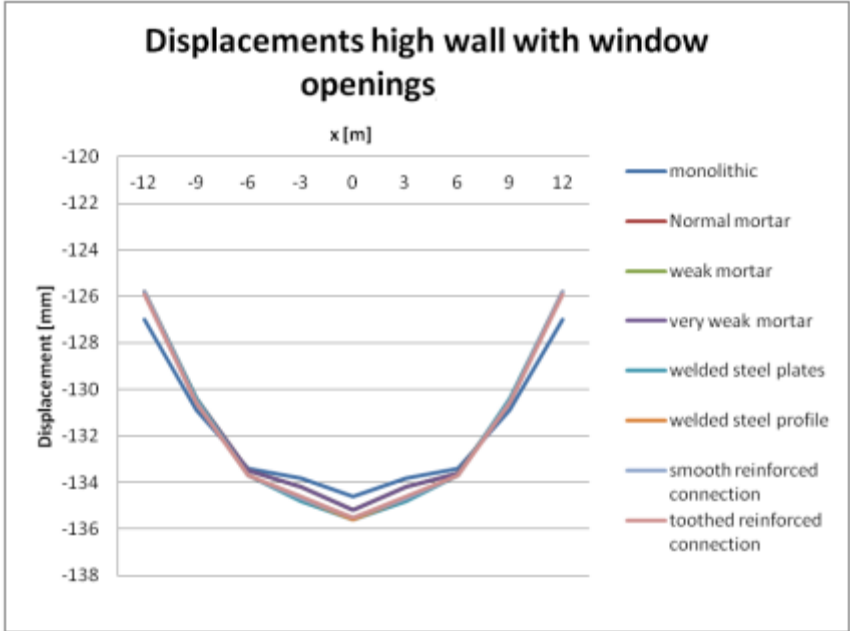

Figure 53 Displacements high wall with window openings

Although the wall acts less stiff due to the openings, the wall can still be classified as stiff.

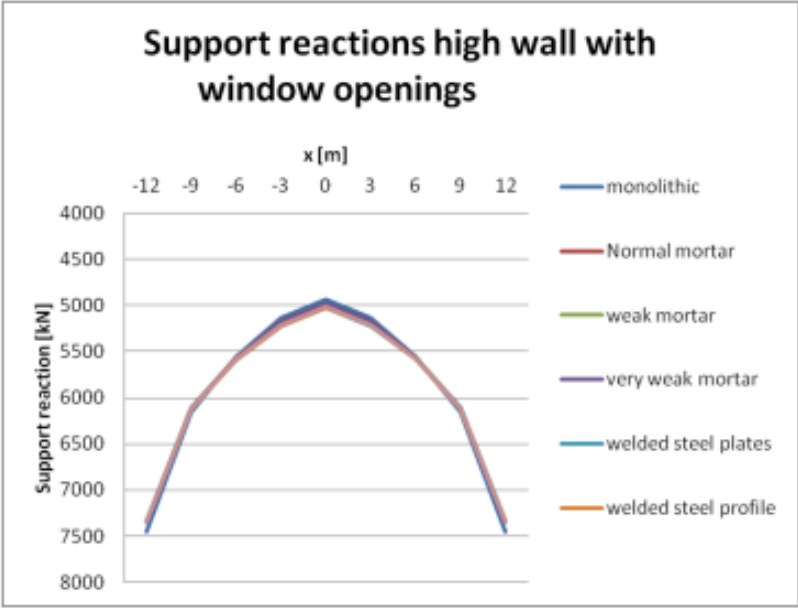

Figure 54 Force distribution high wall with window openings

5.4.3) Results high wall with window and door openings.

The change in the results of the high wall with window and door openings is due to the fact that the structure is not symmetric because of the openings. Although the shape of the settlements and support reaction graphs is different from the closed wall and the wall with only window openings, the minimum and maximum values of the settlements are the same.

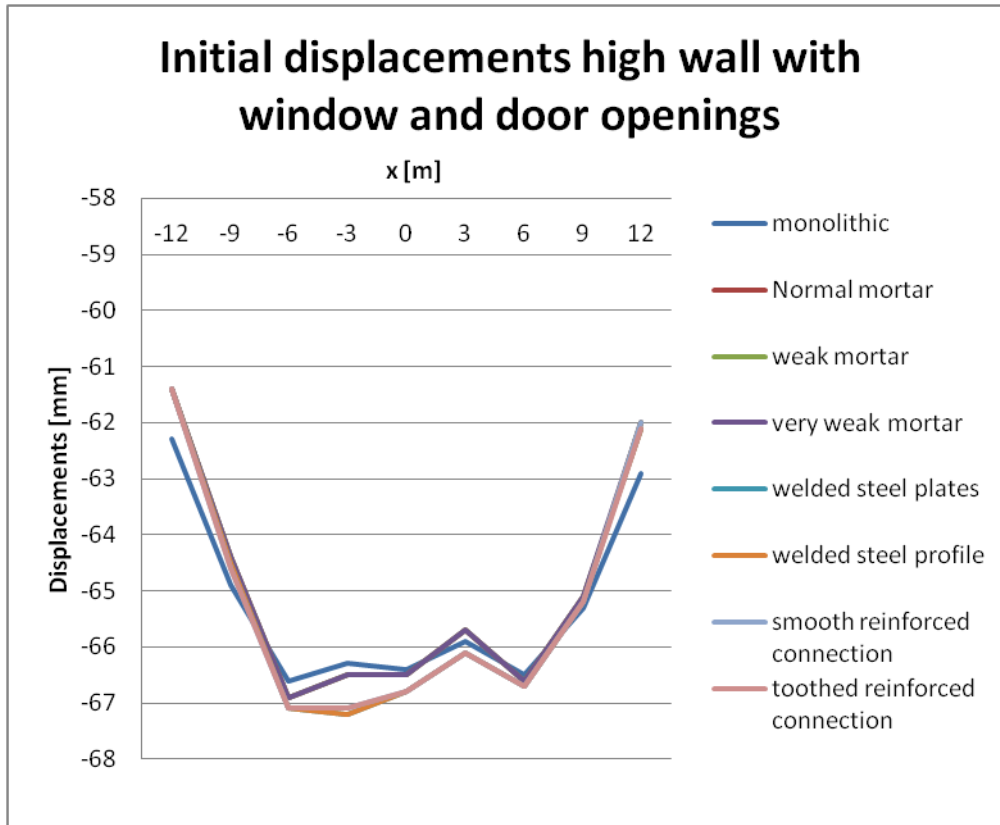

Figure 55 Initial displacements high wall with door and window openings

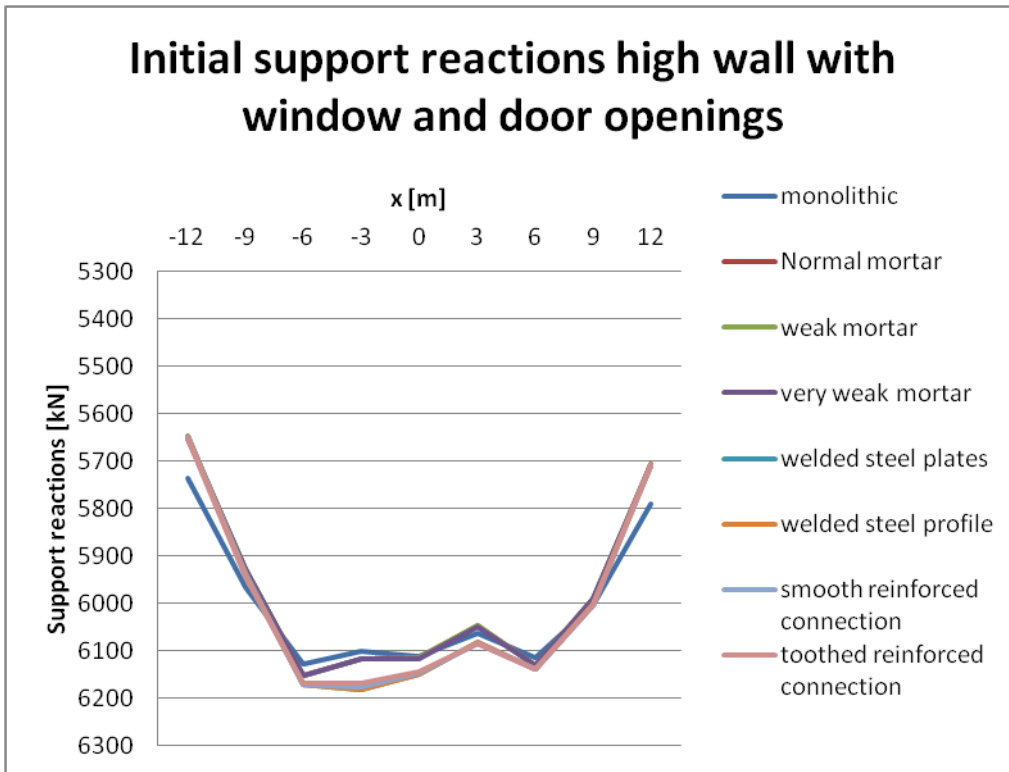

Figure 56 Initial force distribution high wall with window and door openings

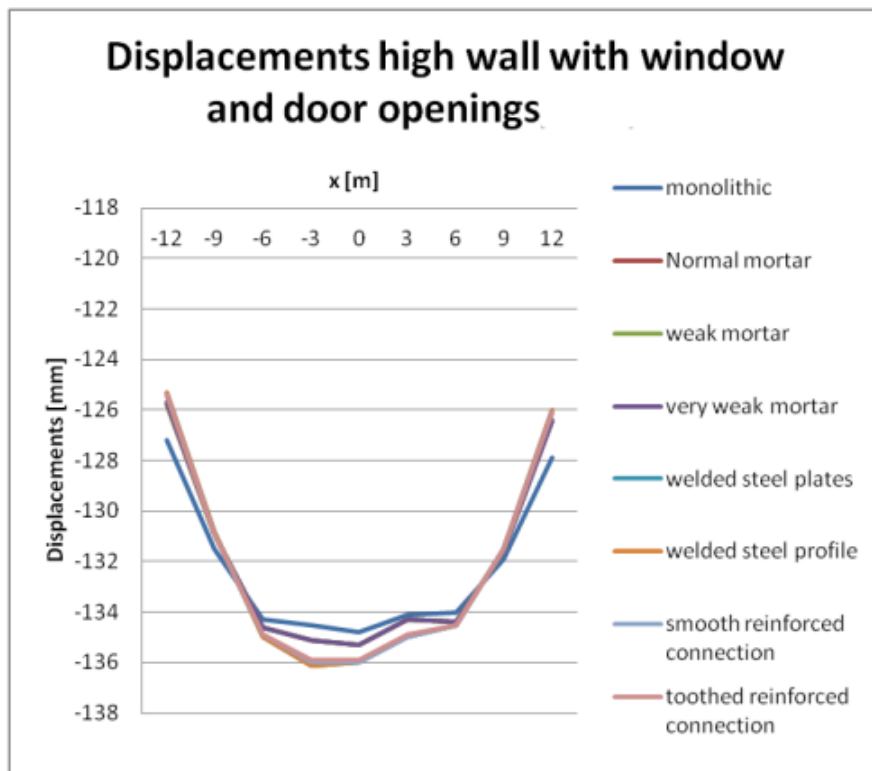

Figure 57 Displacements high wall with window and door openings

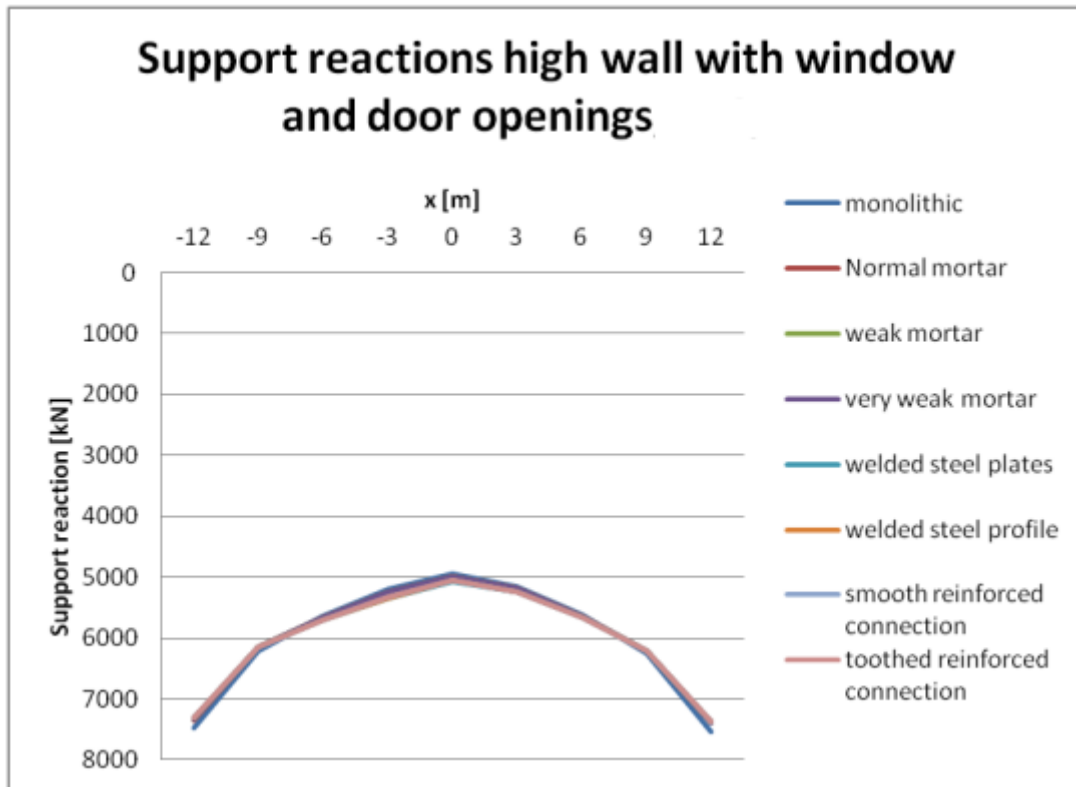

Figure 58 Force distribution high wall with window and door openings

Due to the settlements in the layer of Kedichem, the force distribution is more gradually. The redistribution of the forces is canceling the high peaks as seen in fig. 60

5.5) Results Scia engineer wide wall.

The results of the wide wall are shown below. Although the structure is meant to be a more flexible structure, the structure of the wide wall still behaves quite stiff.

5.5.1) Results closed wide wall

The closed wall has an even distributed initial displacement.

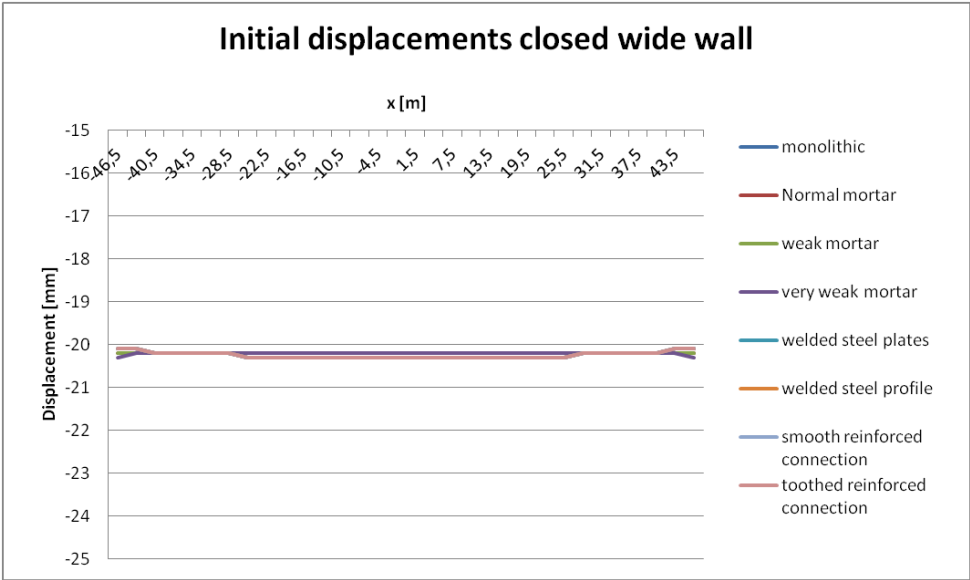

Figure 59 Initial displacement closed wide wall

The force distribution is more like a parabola, but the results are quite misleading because the difference between the maximum support reaction and the minimum support reaction is only 20kN, where the average support reaction is 1860kN, the difference between the minimum and maximum support reaction is only 1%.

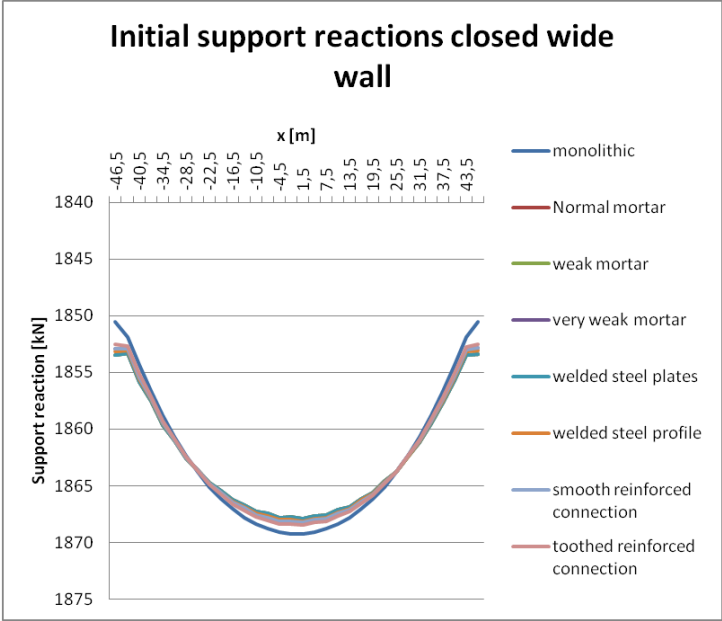

Figure 60 Initial force distribution closed wide wall

After the forced displacements are entered in the Scia structural model, the displacements of the walls slightly change. While there is a redistribution of the forces, the wall still settles as a flexible structure. But all differential settlements are in a range of 3mm.

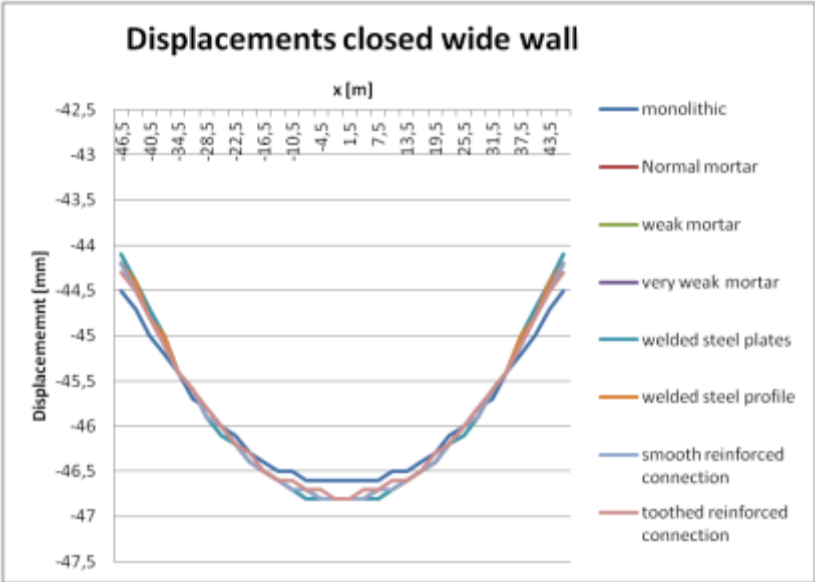

Figure 61 Displacements closed wide wall

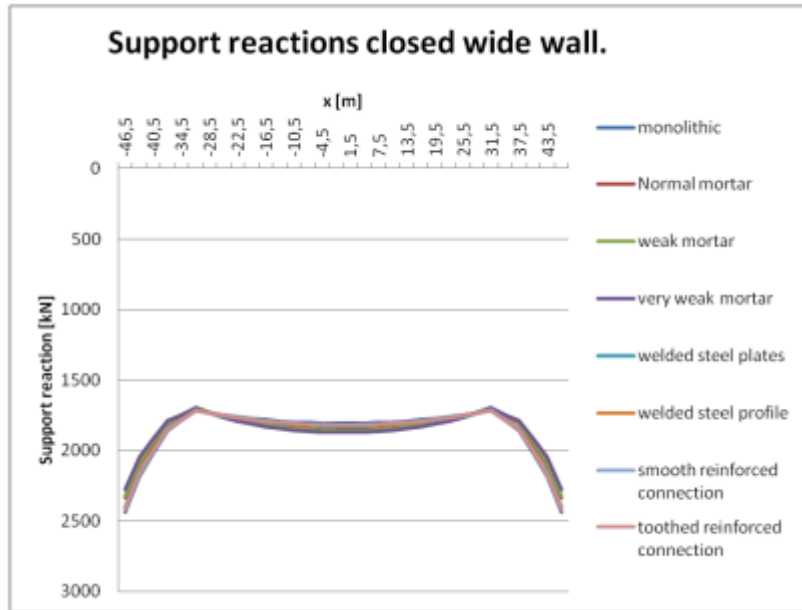

Figure 62 Force distribution closed wide wall

The redistribution of the forces is due to the fact that the settlements in the layer of Kedichem are less at the edge of the wall. At midspan the settlements are equal, so it can be seen that at midspan there is no redistribution of the forces.

5.5.2) results wide wall with window openings

The openings in the wall are not influencing the displacements and the force distribution of the wall, as can be seen in the graphs below.

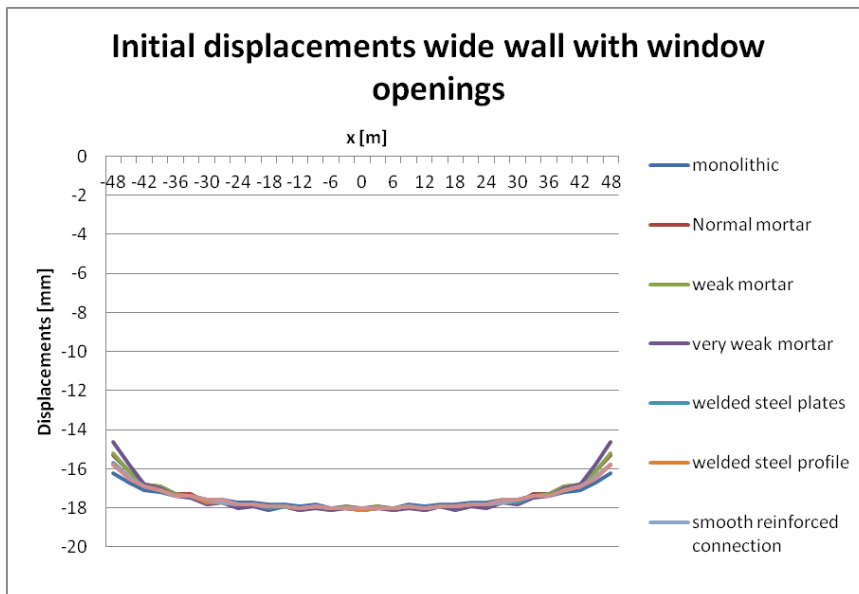

Figure 63 Initial displacements wide wall with openings

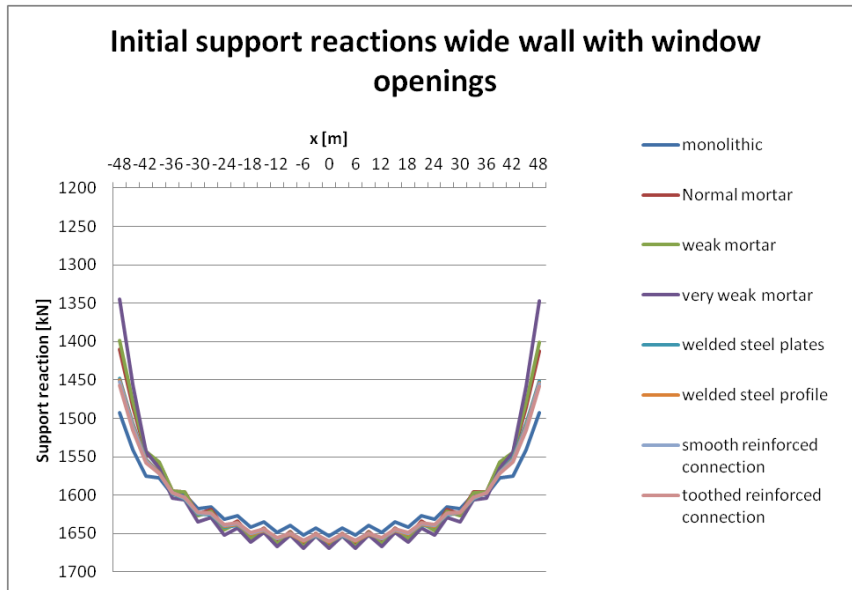

Figure 64 Initial force distribution wide wall with window openings

The displacements and the force distribution after applying the settlements of the layer of Kedichem are almost the same as for the closed wall, however there is a small difference in the force distribution.

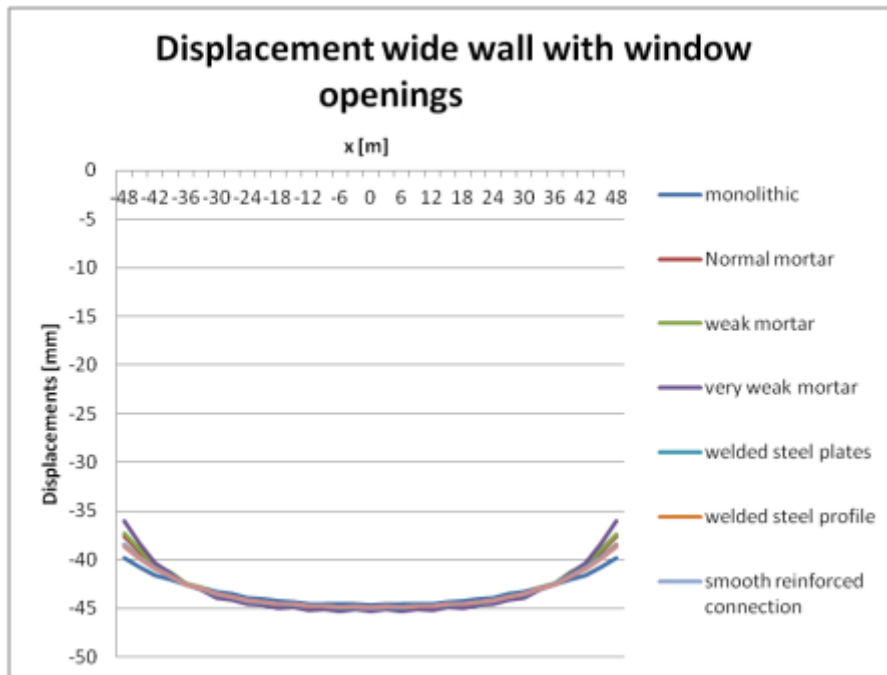

Figure 65 Displacements wide wall with window openings

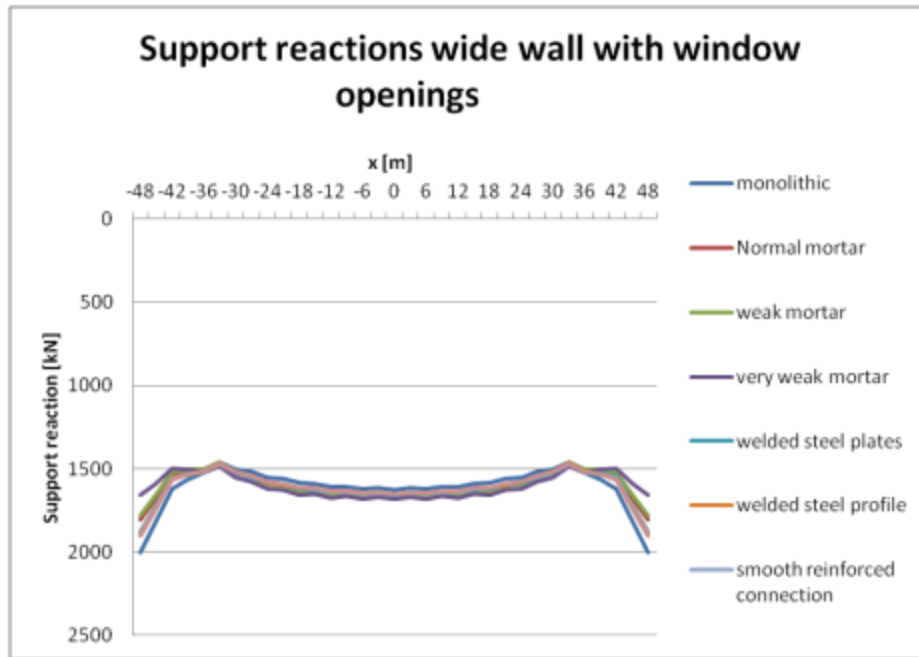

Figure 66 Force distribution wide wall with window openings

The force distribution is slightly different for the monolithic wall after applying the forced displacements, but this change is very small and can be neglected.

5.5.3) Results wide wall with window and door openings

Just as for the wall with the window openings, the displacements and redistribution of the force don't differ that much from the closed wall. However there are some peaks in the graphs due to the openings.

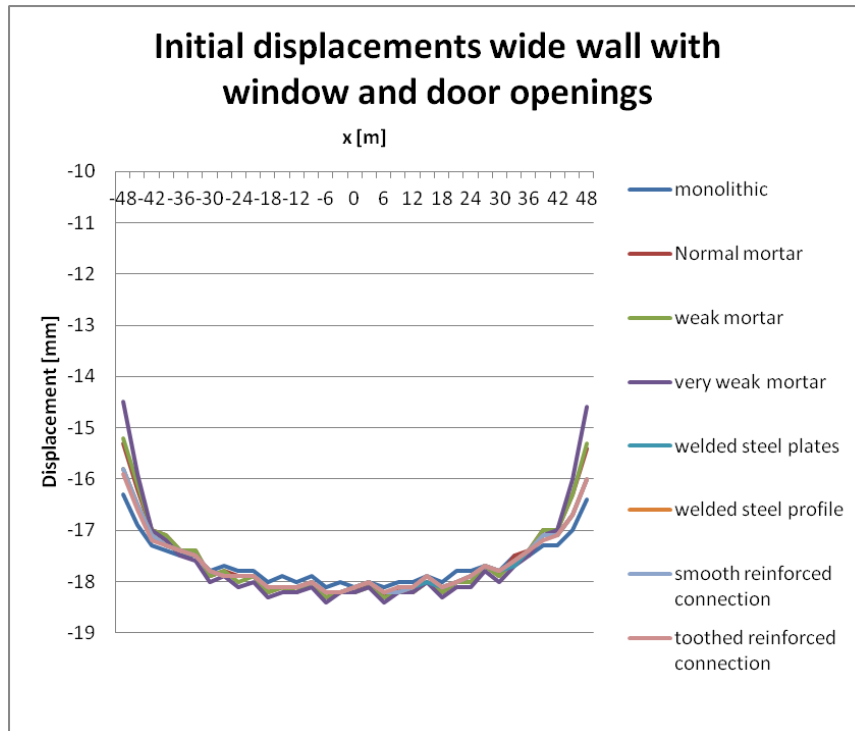

Figure 67 Initial displacements wide wall with door and window openings

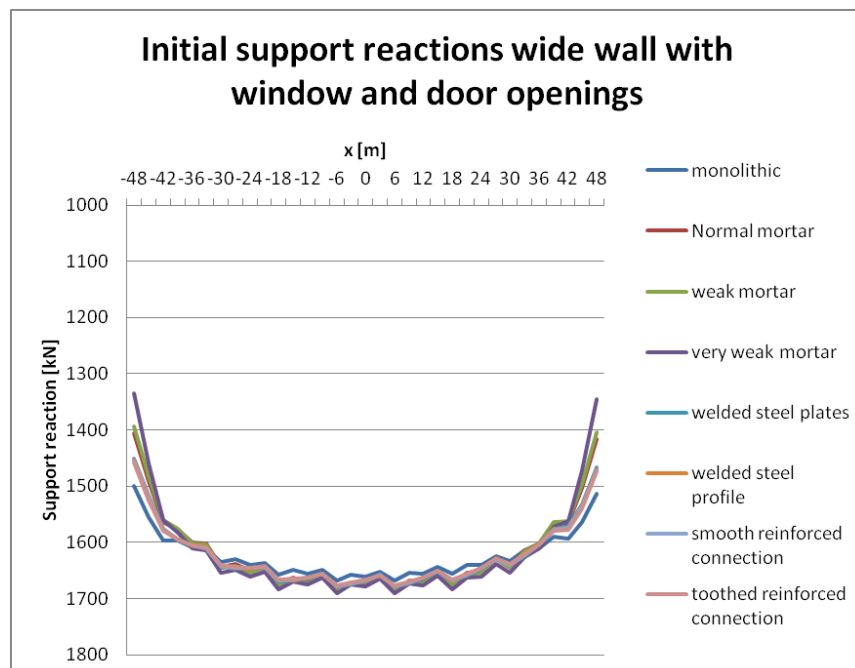

Figure 68 Initial force distribution wide wall with door and window openings

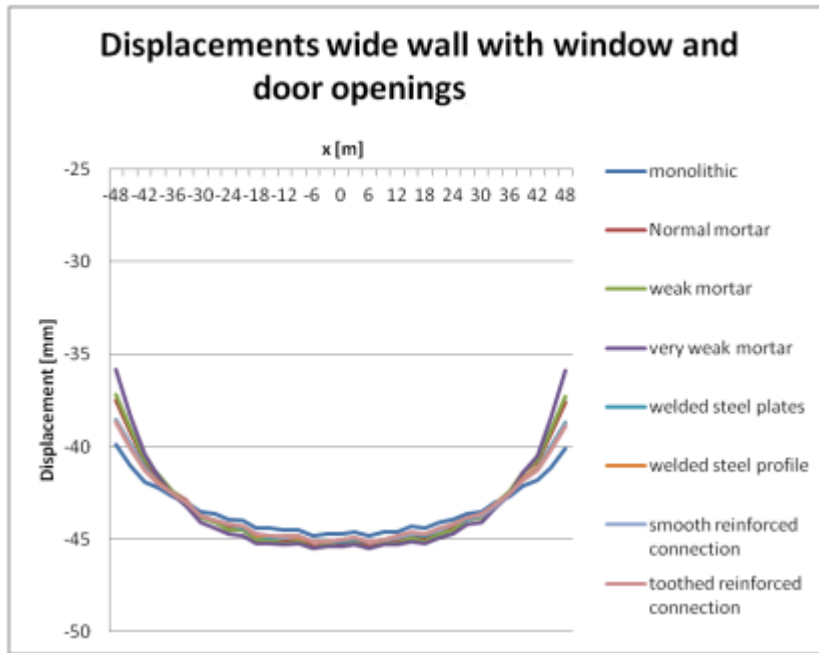

Figure 69 Displacements wide wall with door and window openings

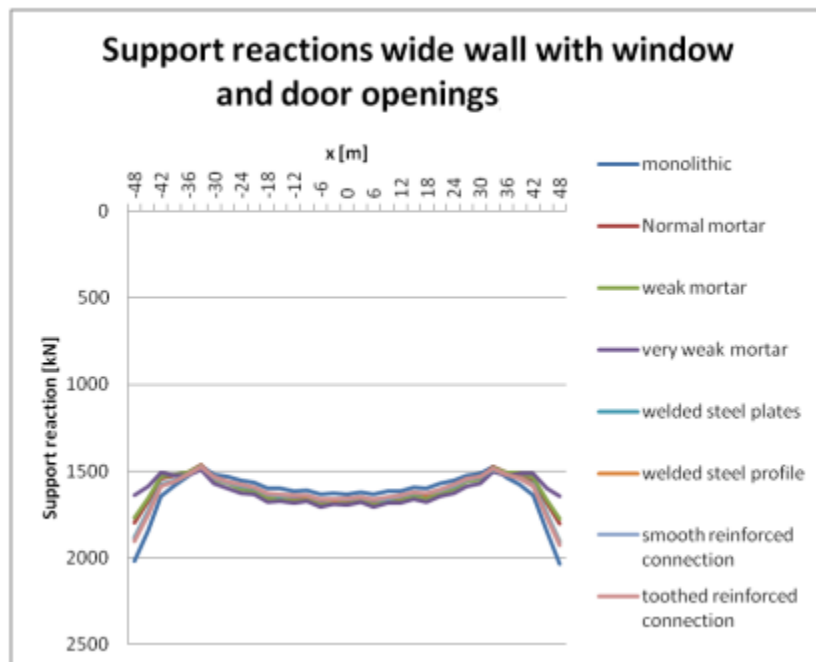

Figure 70 Force distribution wide wall with door and window openings

Basically for the wide wall there is no difference between the wall with window openings and the wall with window and door openings.

5.6) Conclusion

In the end the different connection types don't influence the stiffness of the wall that much. The location and size of the openings influence the stiffness of the wall the most, and therefore the response to differential settlements.

For the solution to reduce the differential settlements in a precast structure the structural behavior of the connections is not that important. The construction of the vertical connections will probably play a bigger role. For example when it is desired to assemble the connections at a later time during the construction process, some connection types will not be possible to make anymore.

In this part of the research the complete wall is created in 1 stage, so all the loads were present in 1 phase. In reality when a structure is build you have to deal with construction phases, which influence the settlement curve. When construction phases are entered in the settlement calculation program it is possible to investigate the possibilities of compensating the settlements during construction of the building, and to predict the settlements of the building when the building is in use.

5.7) Further research

There are some aspects not taken into account in this research which would probably influence the design of the tower.

For example the Young's modulus of the lintels is the same as the surrounding concrete, but it is possible for the lintels to be cracked. Therefore the lintels would have a reduced Young's modulus.

The stiffness for the connections as used in the theoretical research are determined from the research from others, just to study the behavior of the structure. In the next part the connections will be calculated.

The building would be built in stages. In each stage you can compensate the settlements from the previous stage. Therefore the stages should be modeled in the structural program, by using building phases.

6) Architectural design of the Cooltower

The design of the Cooltower that will be used for this thesis will be a tower of 102m high and a width of 26m. The tower has 34 storey's.

Due to the fact that the architect wants a diverse facade the floor plans differ a lot. Only 1 facade drawing and a list with the amount of apartments per floor was available. There are three types of floor divisions, a floor division with 3 apartments, 4 apartments and 6 apartments. For each of the apartment divisions a general floorplan was provided by the architect.

With this data the other 3 facades were drawn. In order to draw these facades some assumptions are made. These assumptions are:

- Each apartment has 1 balcony.
- There is no door opening right next to the corner of the building
- For each floor type (e.g. a floor with 6 apartments) the apartments have the same shape and are on top of each other.
- In order to avoid a large closed part of the facade at the storage areas of the tower, it is assumed that at the storages also window openings are located in the facade.

The drawings made by the architect contained some contradictions. For example in the facade drawing there is a large opening with a width of 9.6m, while in the floor plan this opening was only 6.4m wide.

Also some floor plans were not possible to create with the boundary condition that each apartment has 1 balcony.

For some floor plans the load bearing core needs to be rotated 90°.

To avoid these contradictions the original facade drawing made by the architect was modified. The picture on the next page shows the facade drawing as made by the architect and the facade drawing as used in this thesis.

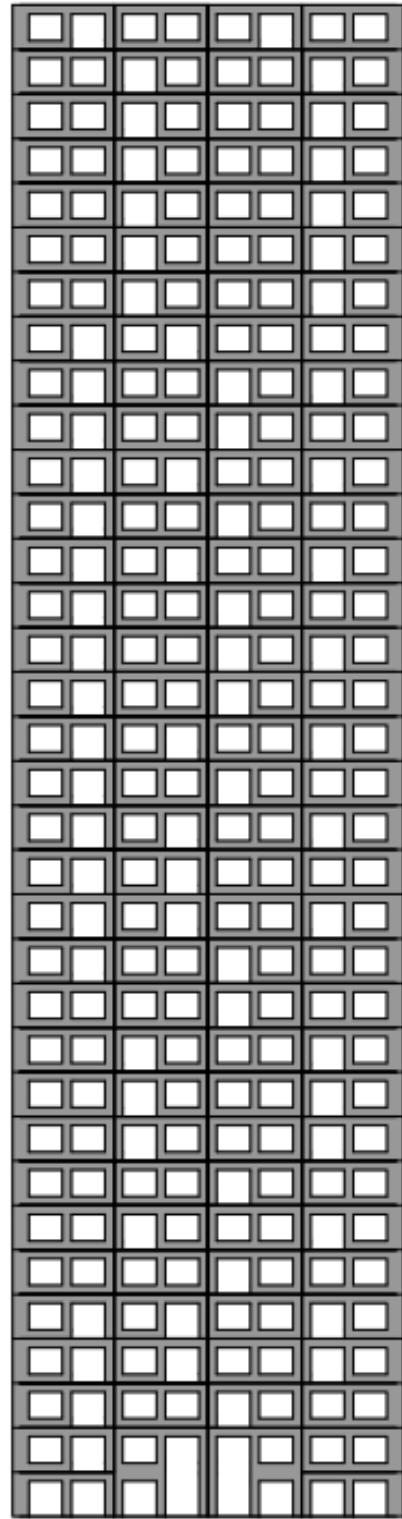

FRONT FACADE

Figure 71 Front facade after modifications

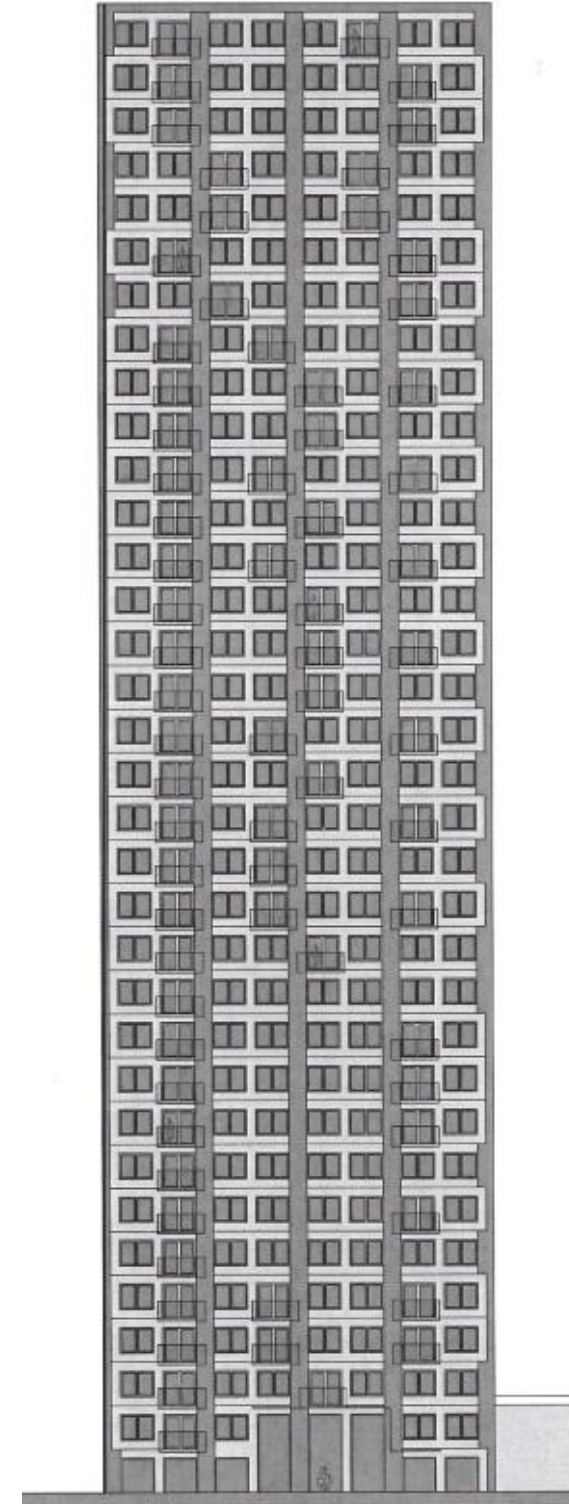
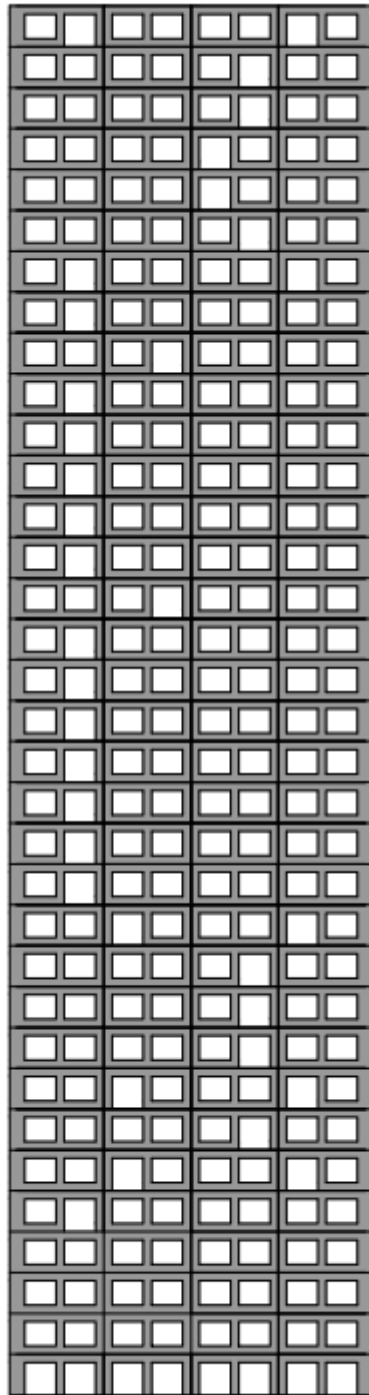
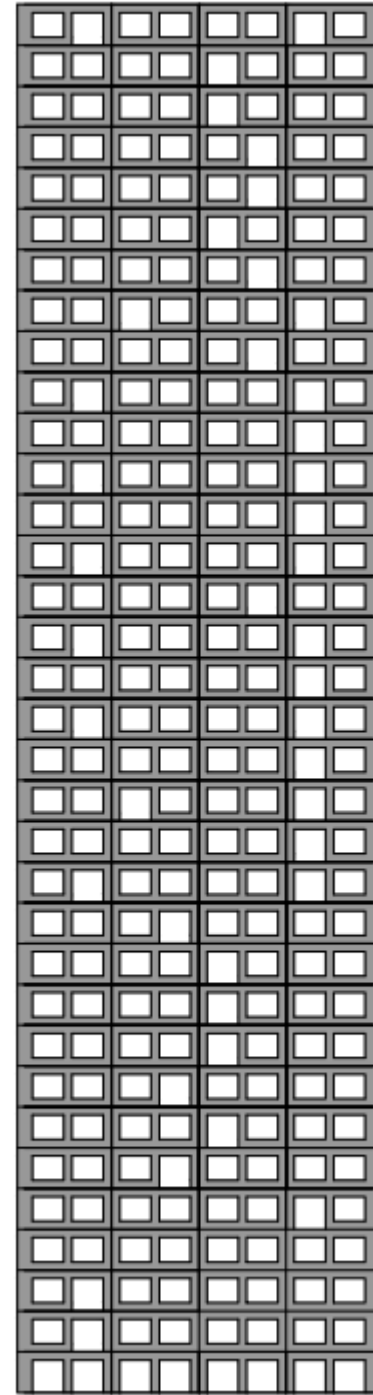

Figure 72 Front facade according to the architect



LEFT FACADE

Figure 73 Left facade



RIGHT FACADE

Figure 74 Right facade

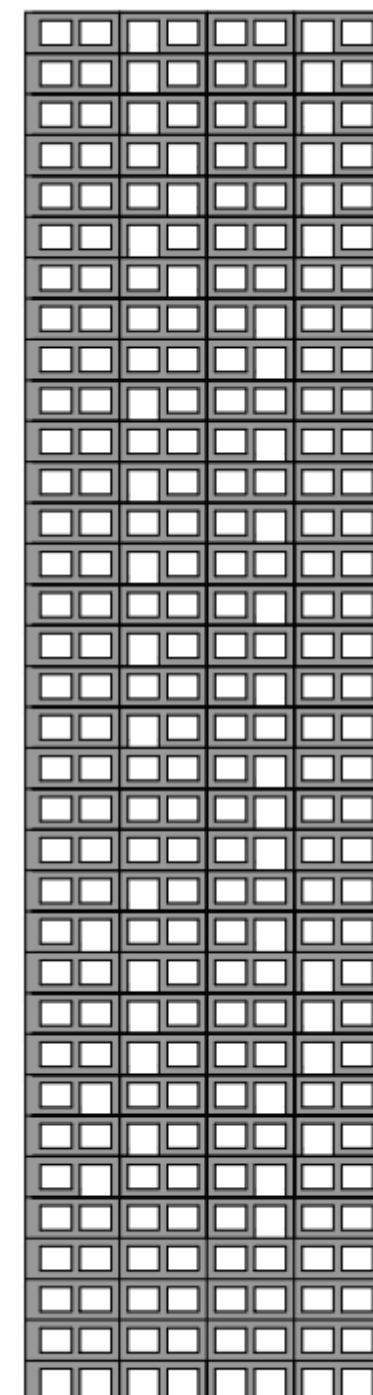

BACK FACADE

Figure 75 Back facade

The amount of apartments on each floor is given in the table below.

Floor	Amount of apartments
Ground floor	0
1st	2
2nd & 3rd	3
4th-32nd	6
33	4
Total amount of apartments	186

In order to fit these apartments in the tower and to create a diverse facade according to the drawn facades, the tower has 13 different floor plans.

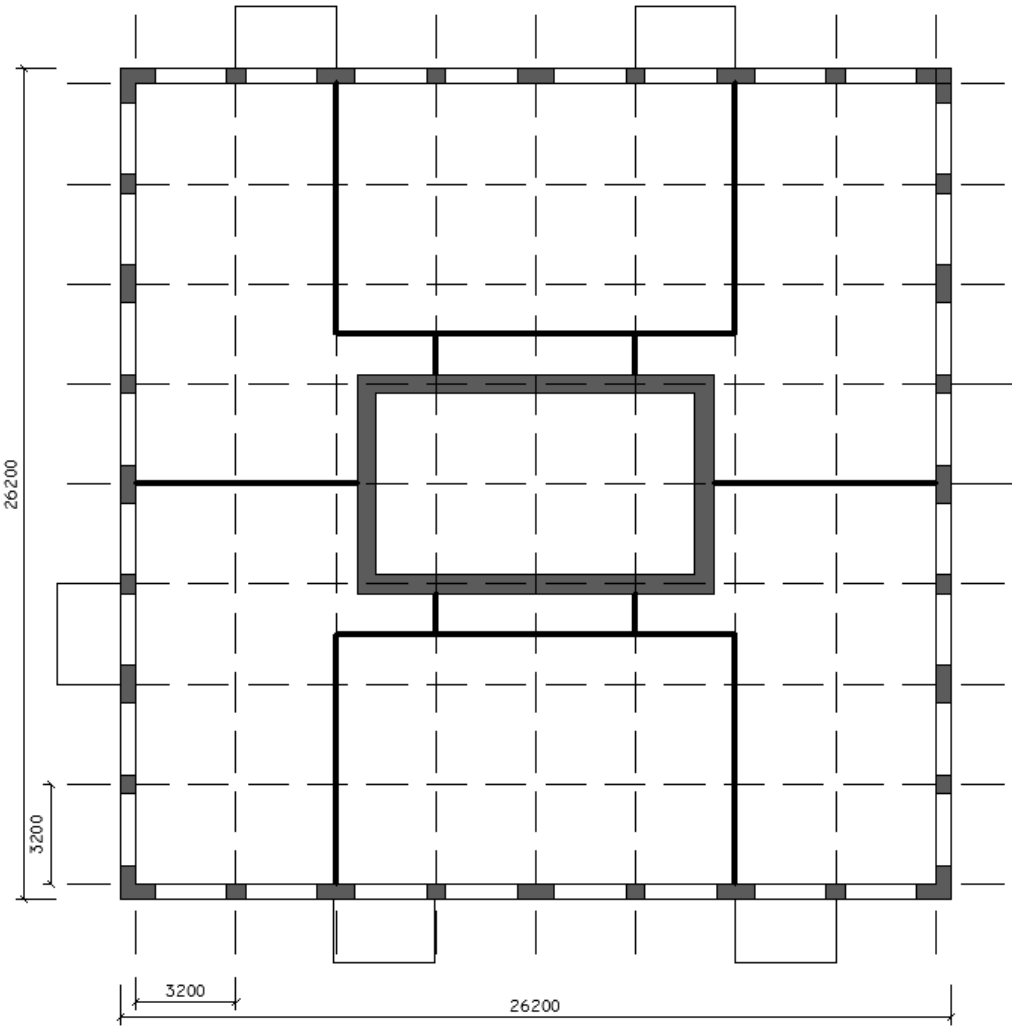
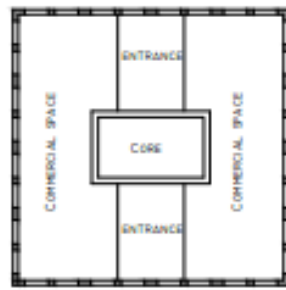
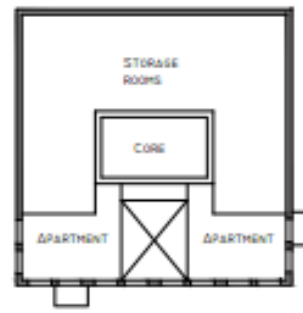

Figure 76 Typical floorplan



GROUND FLOOR



FLOOR: 1

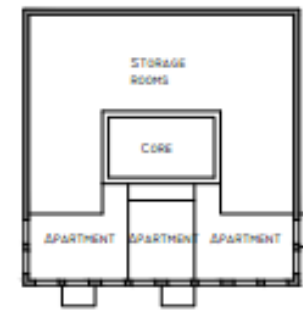

FLOOR: 2

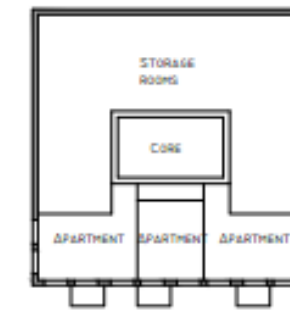

FLOOR: 3

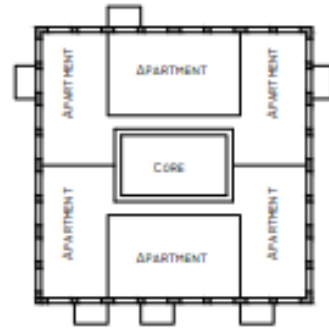

FLOOR: 4, 13, 17, 21, 23

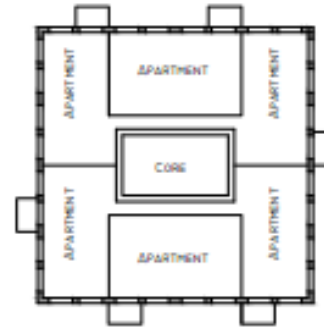

FLOOR: 6, 8, 9, 10, 28, 31, 32



FLOOR: 29, 30

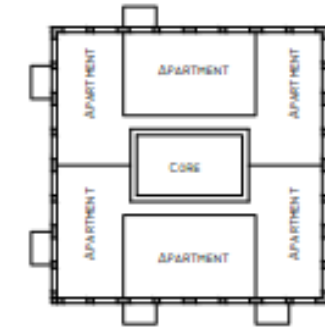

FLOOR: 15, 27

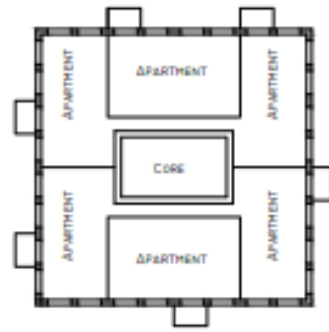

FLOOR: 5, 7, 11

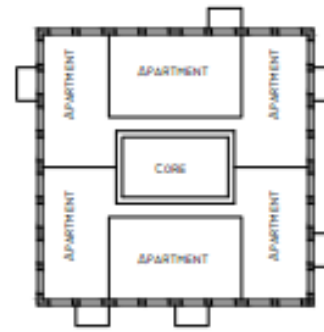

FLOOR: 12, 16, 18, 22, 24

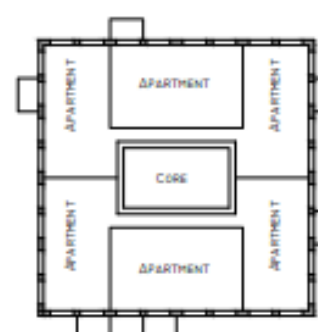

FLOOR: 14, 26

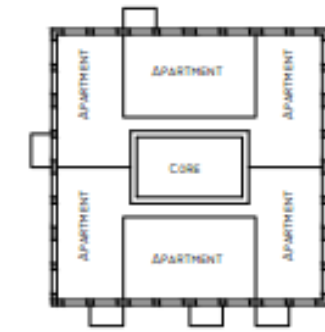

FLOOR: 19, 25

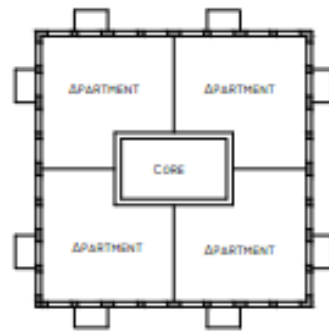

FLOOR: 33

Figure 77 Floorplans

7) Structural design of the Cooltower

The structure of the Cooltower consists entirely out of precast concrete.

7.1) Facade elements

This section describes the facade elements that are used for a configuration where the elements are stacked upon each other, with continuous vertical joints and continuous horizontal joint. When the elements are stacked in a masonry configuration the dimensions are slightly changed.

7.1.1) Elements used for the 1st floor and higher floors

The largest part of the facade can be constructed out of 7 different elements. These elements are used from the first floor and up.

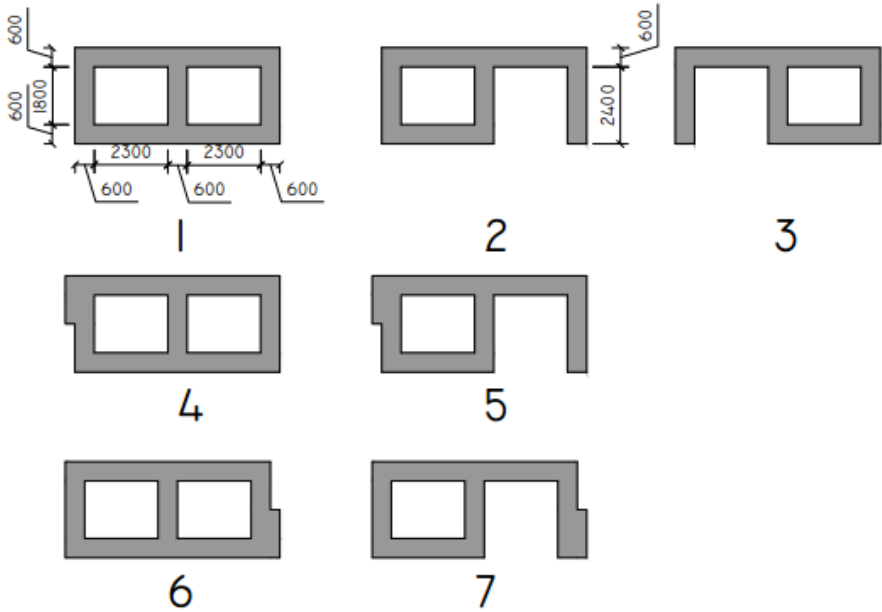

Figure 78 Elements 1st floor and up

If the facade cladding is not applied in the mould of the precast element, the mould of element 2 can be used for element 3 as well. Also the mould for element 4 and 6 are the same, and the mould for element 5 can be used for element 7 too.

7.1.2) Elements for the ground floor

Different elements will be used for the ground floor. The ground floor consists out of commercial spaces. These commercial spaces should be able to be freely divided. In order to achieve this the precast elements have large openings so the opening can be used as a door opening or as a shop window.

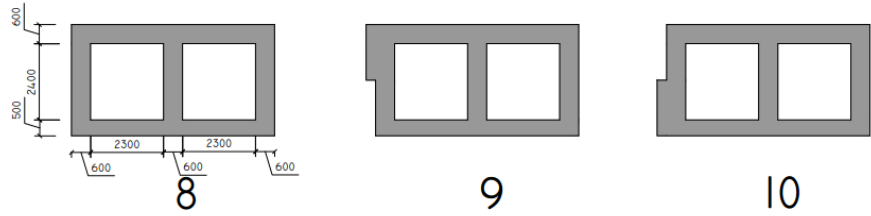

Figure 79 Elements ground floor

7.1.3) Elements for the main entrance

At the main entrance there is a large opening in the facade with a height of 2 storeys, as seen in figure 71, front facade.

The elements to achieve the opening are shown in the figure below.

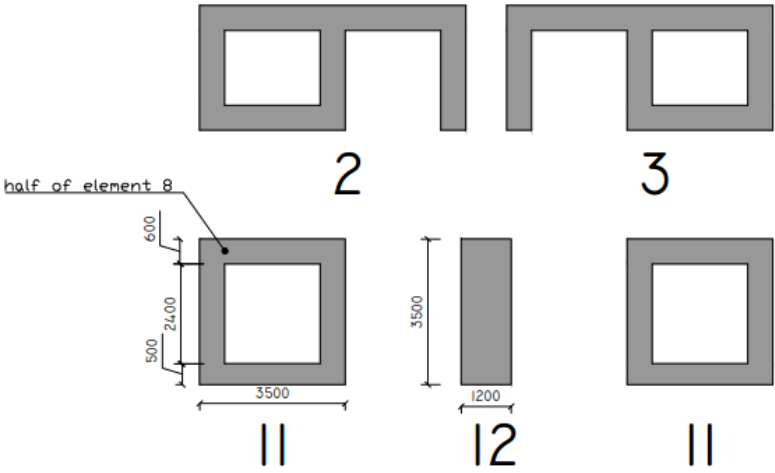

Figure 80 Elements to create the main entrance opening

7.2) Facade elements for a structure in masonry configuration

This section describes the elements used for a structure in masonry configuration. Most of the elements that are described in the previous section can be used for the masonry configuration as well, but there are some slight differences.

For the elements it is assumed that next to a connection between elements is a concrete pier with a width of 600mm.

An overview of the facades with elements stacked in a masonry configuration can be found on page 77.

7.2.1) Elements used for the 1st floor and higher floors

Mainly elements 1 to 7 as described in the previous section are used. Only at the corners elements with a width of 3200mm are used. The corner connections are showed in the figure below.

Note that the opening is slightly smaller than in the elements 1 to 7 described in the previous section.

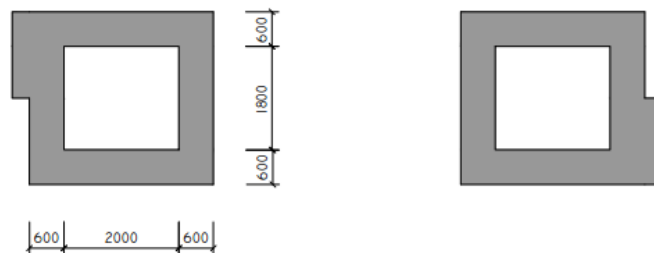

Figure 81 Edge elements masonry configuration

7.2.2) Elements for the ground floor

The elements described in section 6.2.1.2) can be used, but at the corners the elements can differ because the width of the element is 3200mm instead of 6400mm. The dimension of the corner elements is shown in the figure below.

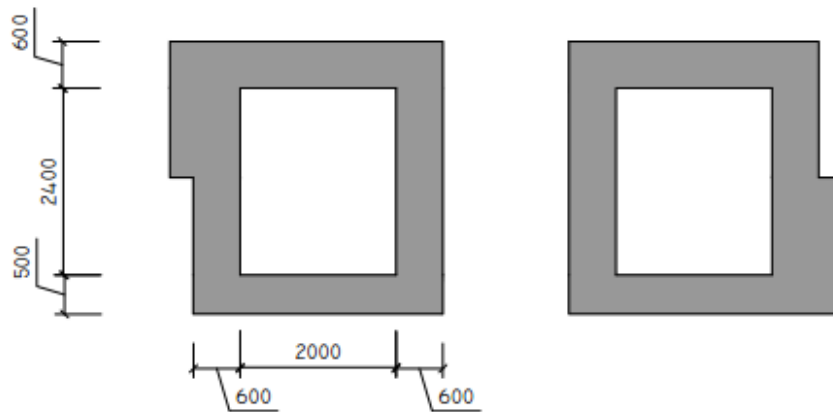

Figure 82 Corner elements ground floor masonry configuration

7.2.3) Elements for the main entrance

In comparison to the element division for the main entrance as described in section 7.1.3) the elements with number 11 will be removed and will be replaced by the elements in the figure below.

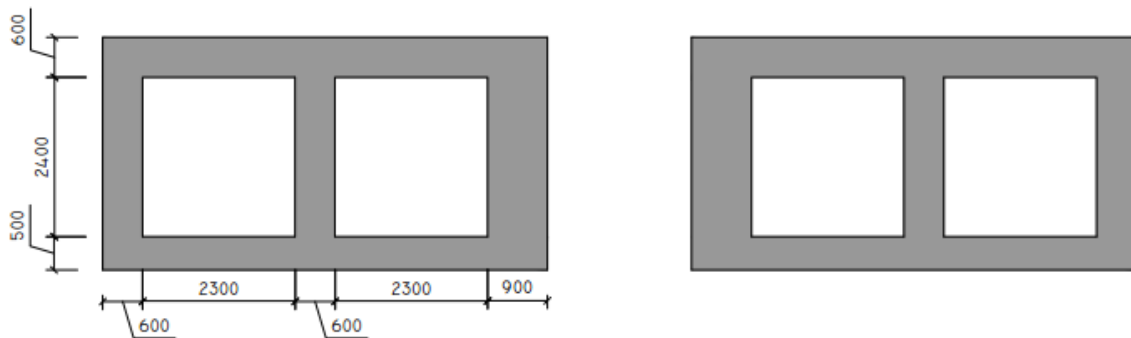
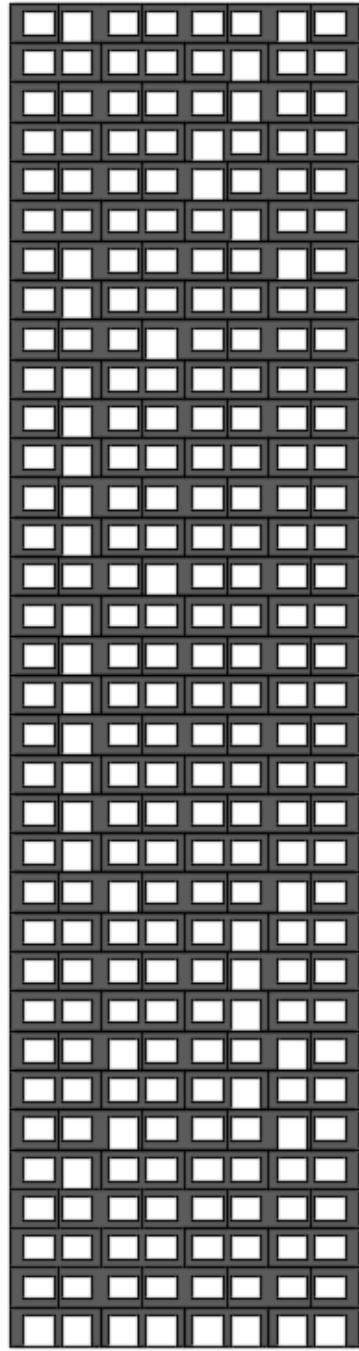
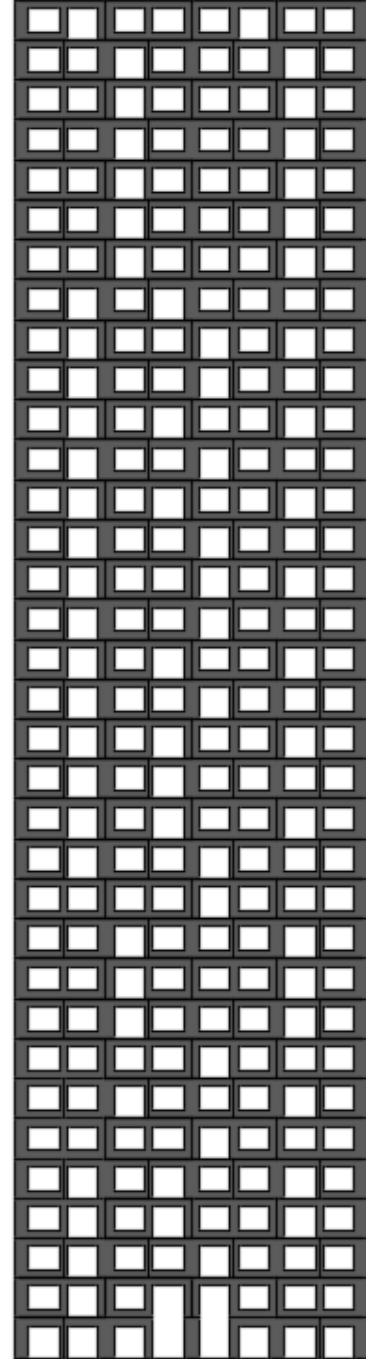

Figure 83 Main entrance elements masonry configuration



LEFT FACADE

Figure 84 Left facade, elements in masonry configuration



FRONT FACADE

Figure 85 Front facade, elements in masonry configuration

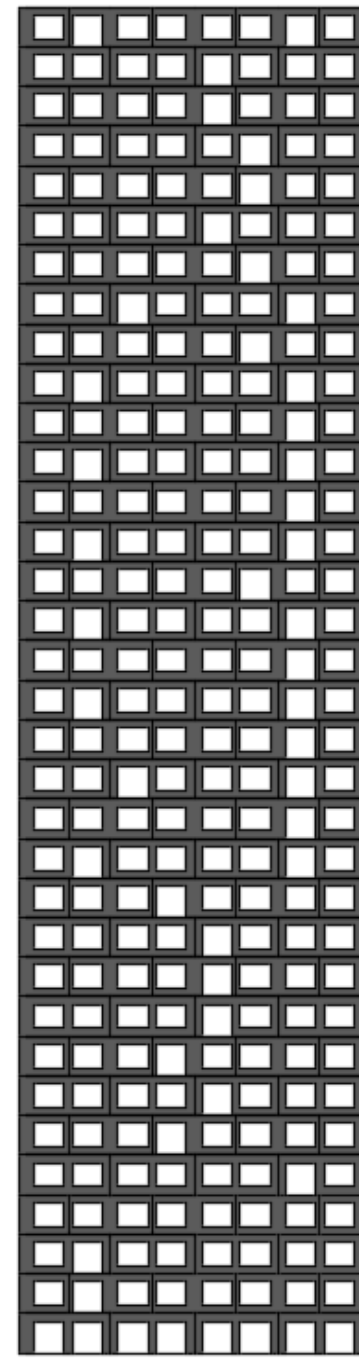

RIGHT FACADE

Figure 86 Right facade, elements in masonry configuration

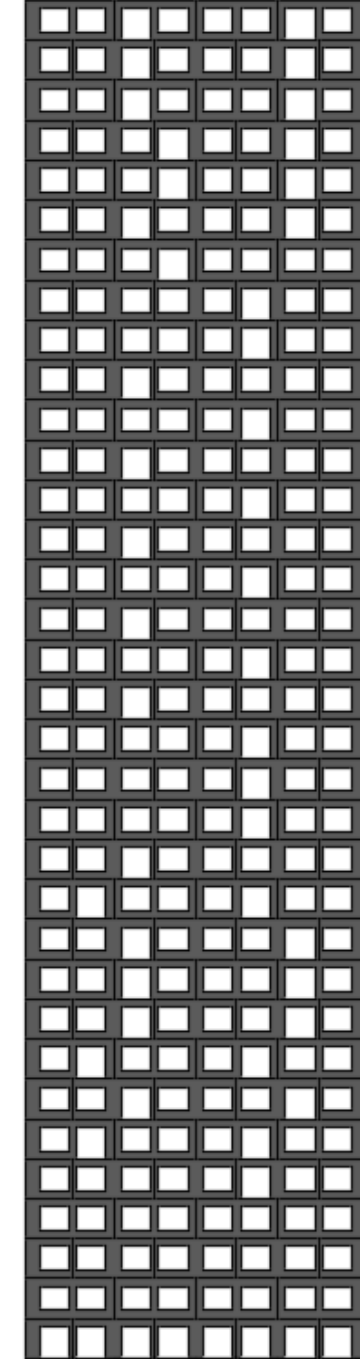

BACK FACADE

Figure 87 Back facade, elements in masonry configuration

7.3) Structural design of the core

The core is also made out of precast concrete elements. The core has a size of 10,2m x 6,6m.

The overview of the core walls is shown on the next page.

The core consists out of 5 different elements. The mould for the elements of the right core wall can also be used for the left core wall.

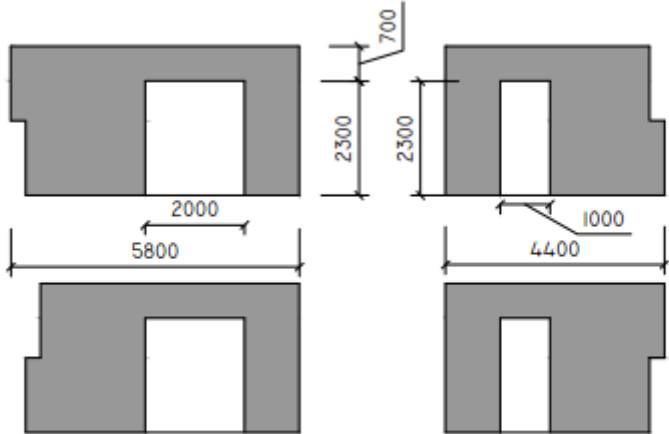

Figure 88 Elements front and back core

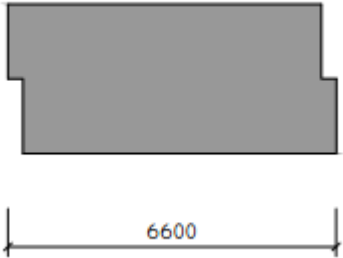

Figure 89 Element right and left core

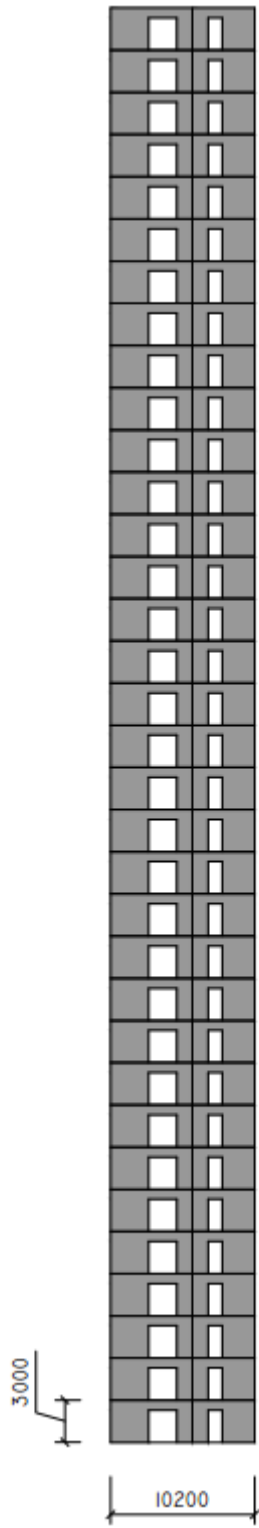

Figure 90 Front and back view core

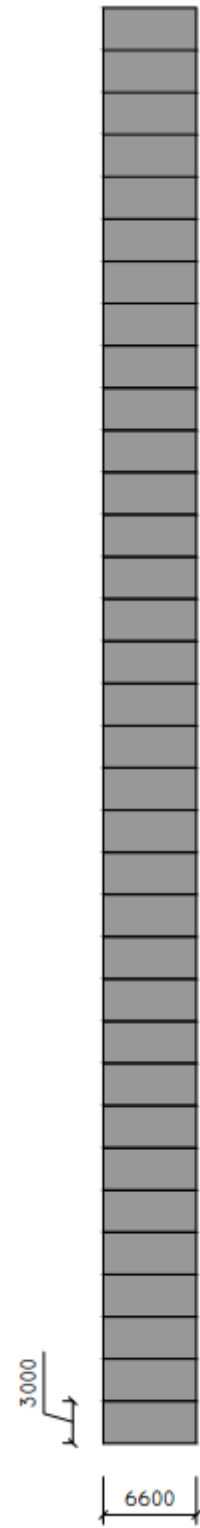

Figure 91 Right and left view core

7.4) Structural design of the floors

The floors are made out of precast prestressed slabs with a thickness of 260mm. On top of this floor is a reinforced concrete topping, to ensure the diaphragm action of the floor and to prevent progressive collapse of the structure, for example when a precast element is removed due to an extraordinary load.

The floors span according to the figure below.

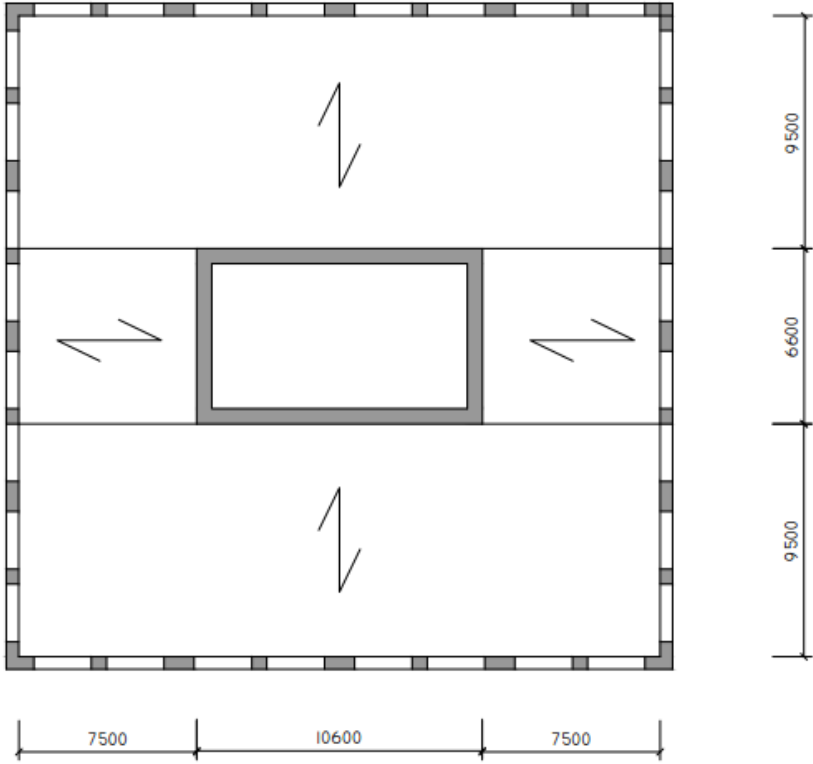

Figure 92 Floor spans

8.) Input in Scia Engineer

This chapter describes the way the structure as described in chapter 7) is modeled in Scia Engineer.

8.1) Division of the tower.

The tower is divided in different sections to model the building stages, because the weight of one storey doesn't influence the settlements of the building. Therefore it is chosen to divide the building into larger parts for the settlement calculations. The building is divided in 4 sections of 7 floors high and 1 part that consists out of 6 floors.

This division is also useful to look at a smaller scale at what is happening in the structure.

Section	Floors
1	0-6
2	7-13
3	13-20
4	21-27
5	28-34

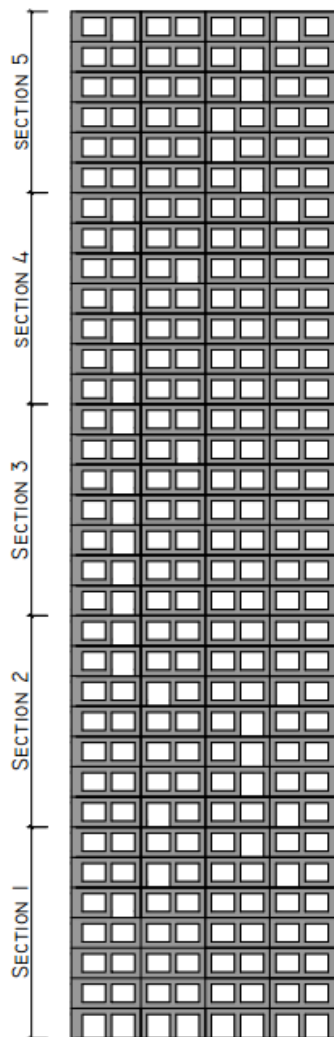

Figure 93 Section division Cooltower

8.2) Materials

Facade elements	concrete class C50/60	$E_{\text{uncracked}}=37000 \text{ N/mm}^2$ $E_{\text{cracked}}= 12000\text{N/mm}^2$
Core elements	concrete class C50/60	$E_{\text{uncracked}}=37000 \text{ N/mm}^2$ $E_{\text{cracked}}= 12000\text{N/mm}^2$
Floors	concrete class C50/60	$E_{\text{uncracked}}=37000 \text{ N/mm}^2$

8.3) Loads

Permanent loads

Facade

Precast facade element	thickness: 300mm	7.5kN/m ²
Facade cladding		1.0kN/m ²

Core

Core elements	thickness: 300mm	7.5kN/m ²
---------------	------------------	----------------------

Floor

Precast floor element	thickness: 260mm	6.5kN/m ²
structural topping	thickness: 50mm	1.25kN/m ²
finishing floor	thickness: 40mm	0.96kN/m ²
walls		0.75kN/m ²

Variable loads

Variable floor load	1.75kN/m ²
---------------------	-----------------------

Wind load

The windload is calculated according to Eurocode 1 (NEN-1991-1-4) [25]

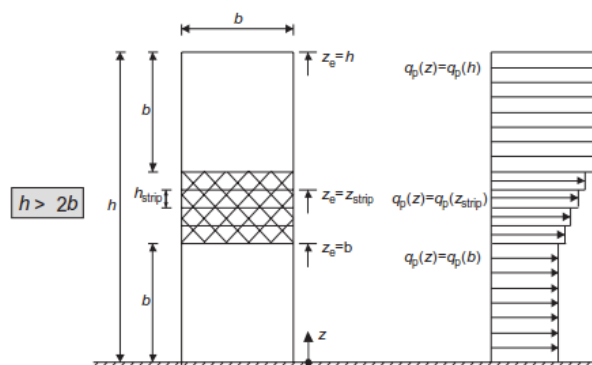

Figure 94 Windload on structure

The windload per meter of with of the structure is calculated by the formula

$$q = c_s c_d * c_f * q_{p, (ze)} * h$$

with: $c_s c_d$ = building factor
 c_f = force coefficient
 $q_{p, (ze)}$ = extreme windpressure
 h = floor to floor height.

The building is located in wind area 2, according to the Eurocode.
 The surrounding area is considered to be rural, due to the fact that the building is higher than the surrounding buildings. Due to this the windload might be over estimated.

The windload per floor can be found in the table below.

Table 8 Wind load per floor

floor	ze	qp(ze) [kN/m ²]	cscd	b	h	A	cf	q (width) [kN/m]
1	3	1,16	1	26,2	3	78,6	1,5	5,2
2	6	1,16	1	26,2	3	78,6	1,5	5,2
3	9	1,16	1	26,2	3	78,6	1,5	5,2
4	12	1,16	1	26,2	3	78,6	1,5	5,2
5	15	1,16	1	26,2	3	78,6	1,5	5,2
6	18	1,16	1	26,2	3	78,6	1,5	5,2
7	21	1,16	1	26,2	3	78,6	1,5	5,2
8	24	1,16	1	26,2	3	78,6	1,5	5,2
9	27	1,16	1	26,2	3	78,6	1,5	5,2
10	30	1,2	1	26,2	3	78,6	1,5	5,4
11	33	1,23	1	26,2	3	78,6	1,5	5,5
12	36	1,26	1	26,2	3	78,6	1,5	5,7
13	39	1,29	1	26,2	3	78,6	1,5	5,8
14	42	1,32	1	26,2	3	78,6	1,5	5,9
15	45	1,34	1	26,2	3	78,6	1,5	6,0
16	48	1,36	1	26,2	3	78,6	1,5	6,1
17	51	1,39	1	26,2	3	78,6	1,5	6,3
18	54	1,41	1	26,2	3	78,6	1,5	6,3
19	57	1,43	1	26,2	3	78,6	1,5	6,4
20	60	1,45	1	26,2	3	78,6	1,5	6,5
21	63	1,47	1	26,2	3	78,6	1,5	6,6
22	66	1,48	1	26,2	3	78,6	1,5	6,7
23	69	1,5	1	26,2	3	78,6	1,5	6,8
24	72	1,51	1	26,2	3	78,6	1,5	6,8
25	75	1,53	1	26,2	3	78,6	1,5	6,9
26	78	1,65	1	26,2	3	78,6	1,5	7,4
27	81	1,65	1	26,2	3	78,6	1,5	7,4
28	84	1,65	1	26,2	3	78,6	1,5	7,4
29	87	1,65	1	26,2	3	78,6	1,5	7,4
30	90	1,65	1	26,2	3	78,6	1,5	7,4
31	93	1,65	1	26,2	3	78,6	1,5	7,4
32	96	1,65	1	26,2	3	78,6	1,5	7,4
33	99	1,65	1	26,2	3	78,6	1,5	7,4
34	102	1,65	1	26,2	3	78,6	1,5	7,4

8.4) precast elements

The precast elements are divided in separate parts as can be seen in the figure below.

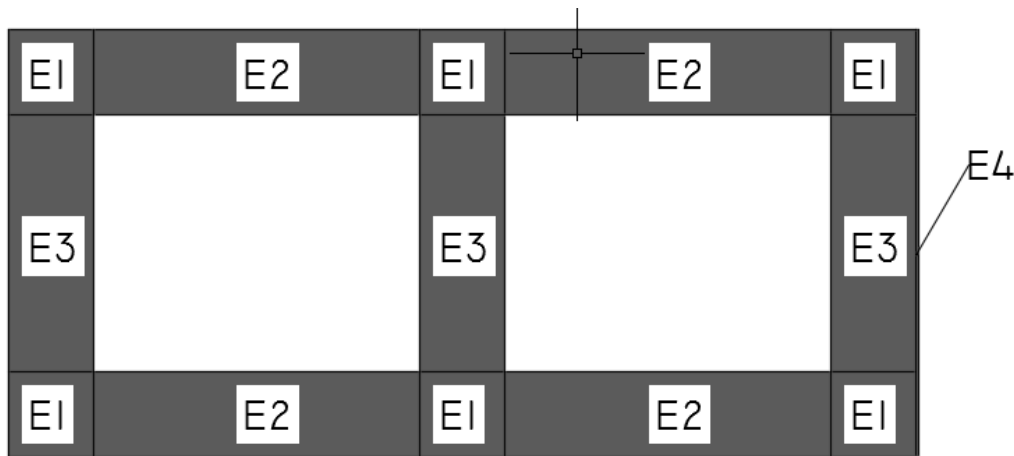

Figure 95 Division of a typical element into smaller sub-elements

Each part is made out of a different material, so it is easy to adapt the element for example when the element will crack.

In the figure the lintels with element E2 is modeled as cracked concrete.

The piers with element E3 is modeled as cracked concrete as well, because due to the horizontal load is realistic the piers will be loaded by a bending moment, and thus will crack.

The connection between the piers and lintels will not crack. These element, with element name E1 in the figure, will be modeled as uncracked concrete.

Also the connections are modeled as separate elements, element E4 in the figure.

The stiffness of the connection depends on the fact of the connection is loaded in tension or compression, and due to the fact that the connection is a separate element it is easy to see which connection should be adjusted. This element is also modeled in Scia Engineer in a different layer as the rest of the precast element, so it is possible to model building phases where the connection is not present yet.

The precast elements of the core are modeled as uncracked concrete, except for the lintels.

8.5) Floors

The floors are modeled as monolithic floors which span as can be seen in the figure below. The openings at the edges are made to ensure that the floor only spans in the drawn direction.

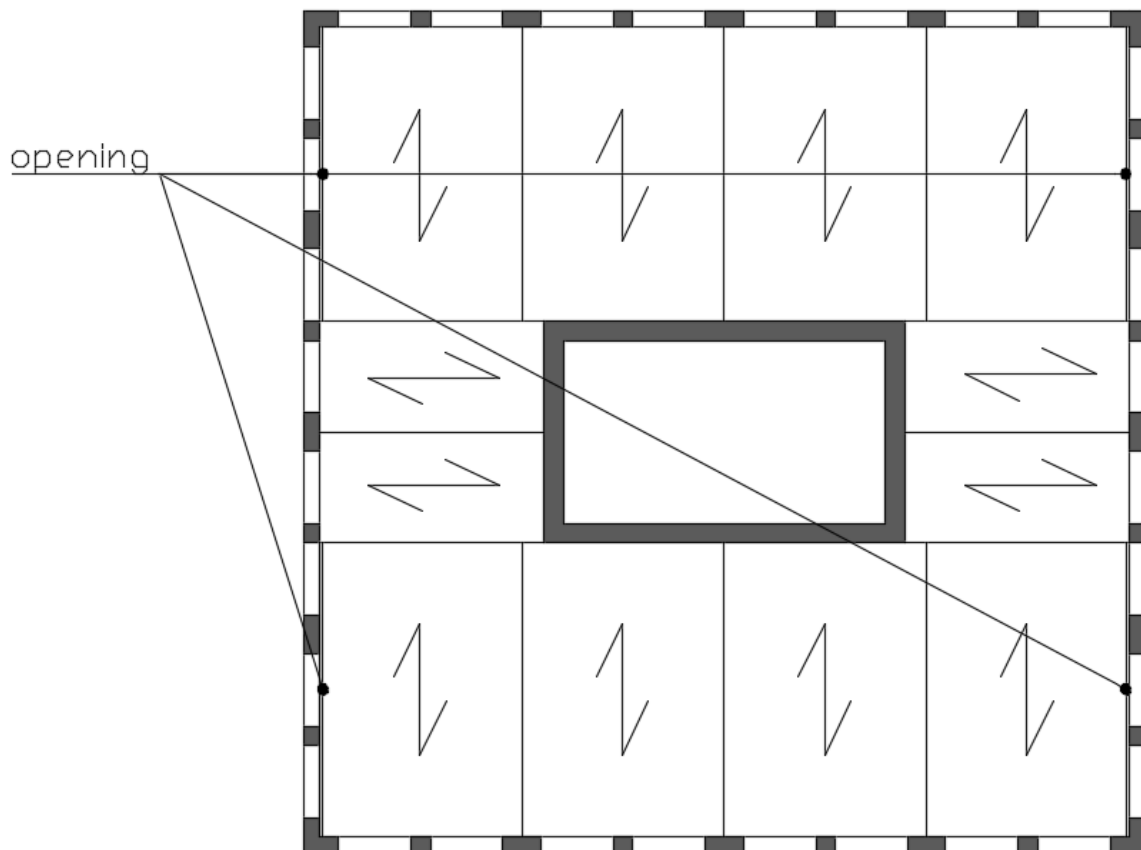

Figure 96 Floor division

At the location where a vertical connection between the precast facade elements is present, there is also a separation of the floor elements. Due to this separation it can be investigated if connection the precast facade elements at a later stage is beneficial to reduce the stresses in the structure due to the differential settlements, because the floors will not restrain the settlement of the facade elements.

8.6) Connections

8.6.1) Corner connections

The corner connections between the elements are halfway stacked connections. The elements have a setback at half of the height of the element. The now extended part of the element acts as a shear key. According to the master thesis of Tolsma [24] this connection for precast structures has the largest shear capacity.

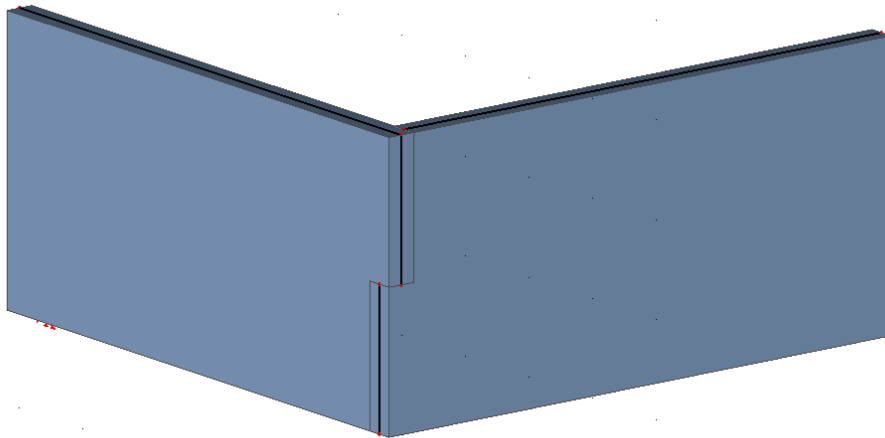

Figure 97 Interlocking halfway connection

In reality the Interlocking Halfway Connection (IHC) looks like the connection shown in the figure above.

When this connection is modeled in Scia Engineer, the precast elements are modeled as thin plates. This results in a connection between the elements that is really small, causing high stresses. The elements are only connected in 1 point, as can be seen in the figure below. The yellow dot is the position where the elements are connected.

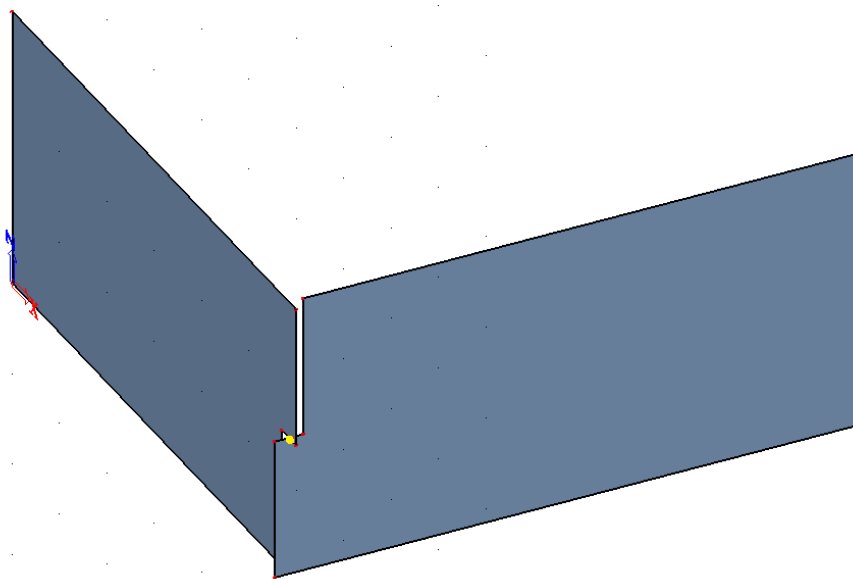

Figure 98 Model of the IHC in Scia Engineer

Due to this small connection and high stresses in the connecting point, the results of the Scia calculation are not realistic. Therefore it is chosen to smear the connection stiffness of the IHC over the full height of the element, as can be seen in the figure below. The figure below shows the model of the IHC connection between the front core and the right core, where the connection is also a separated element.

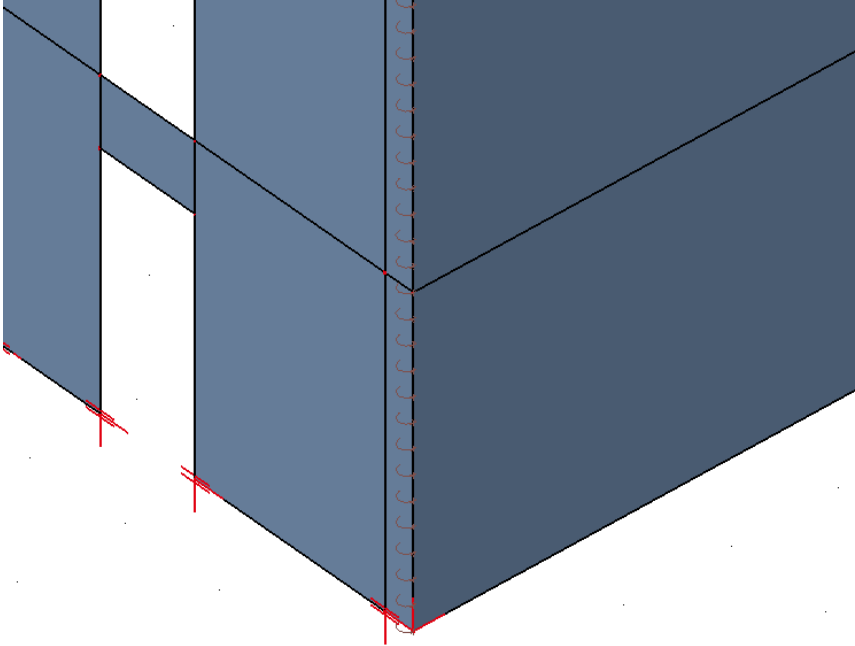

Figure 99 Scia model of the IHC between the front core and the right core.

The smeared stiffness of the connection is calculated by the formula:

$$K_{\text{smeared}} = K_{\text{discrete}} / h * d$$

Where:

- K_{smeared} = the smeared connection stiffness
- K_{discrete} = the actual connection stiffness
- h = height of the element
- d = thickness of the element.

8.6.2) Horizontal connections between the elements

The horizontal connection between the elements is a reinforced mortar connection.

The stiffness of the structure is calculated with the formulas from chapter 4.2)

The shear stiffness of the connection depends on the normal stress that is present in the connection. For each of the 5 sections the average normal stress in the horizontal connection is calculated.

For the normal stiffness of the connection the E-modulus of cracked concrete is used. This E-modulus is 12000N/mm²

The stiffness of the horizontal connection in each section is showed in the table below.

Table 9 Overview horizontal connection stiffness per section

section	floors	average normal stress [N/mm ²]	shear stiffness ux [kN/m ²]	normal stiffness uy [kN/m ²]
1	0-6	12	2,114E+06	2,10E+08
2	7-13	8,4	1,484E+06	2,10E+08
3	14-20	6	1,064E+06	2,10E+08
4	21-27	3,6	6,44E+05	2,10E+08
5	28-34	2	3,64E+05	2,10E+08

8.6.3) Vertical connection stiffness

The vertical connections between the precast elements is a connection with welded steel plates.

The stiffness of this connection is according chapter 6.1.3) and is equal for each section.

Welded steel plates connection	
ux [kN/m ²]	1,68E+05
uy [kN/m ²]	2,47E+06

8.7) Stability calculation

To determine the minimal thickness of the core elements and the facade, a stability calculation of the tower is made. This is a 2D calculation, where the floors are only present to transfer the load from the facade to the core.

The connections between the floor and the facade and the floor and the core are modeled as hinges. In this way the floor is only loaded with a normal force and any bending moments will not occur and will not influence the stiffness of the structure.

The horizontal connection between the elements is a reinforced mortar connection, and the vertical connection between the elements is a connection with welded steel plates.

8.7.1) Wind in x-direction

The windload from the wind in x-direction is taken up by the front and back facade and will be transferred by the floors to the core.

Only the a stability calculation for the front facade will be made because this is the weakest facade due to the larger amount of openings in the facade.

The input in Scia is as follows:

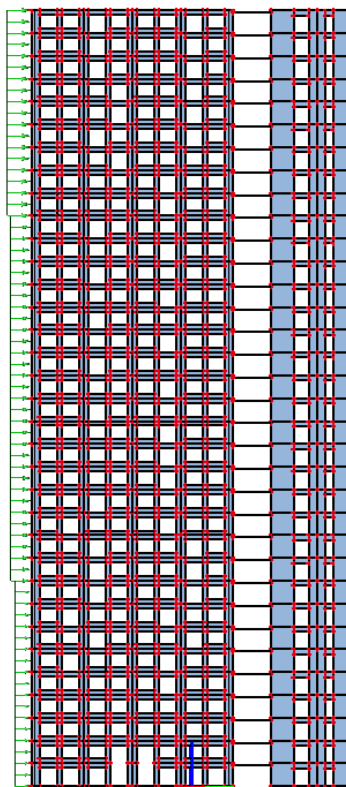

Figure 100 Input stability calculation Cooltower, front facade

The maximum displacement at the top of the tower is 167.9mm. This is with a thickness of the facade and core elements of 300mm.

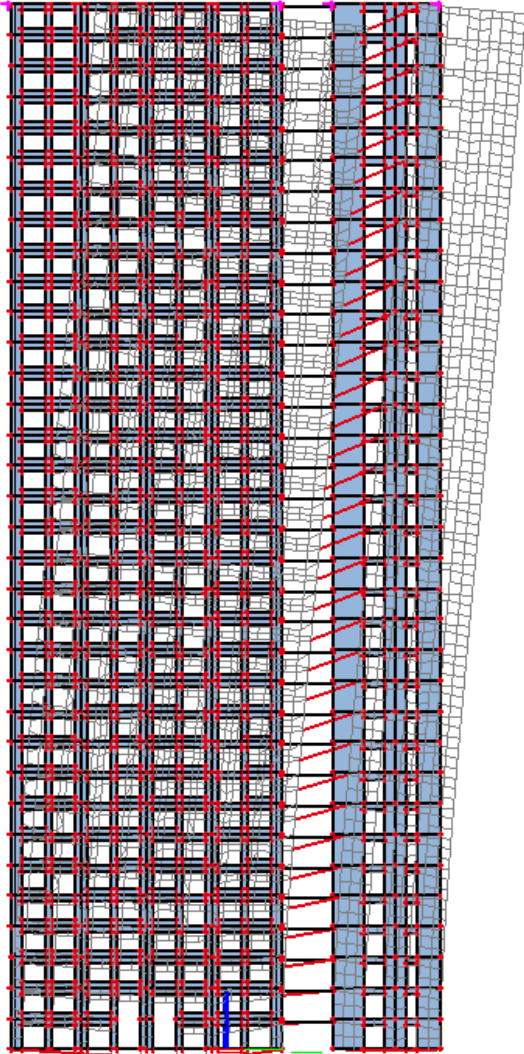

Figure 101 Displacements of the tower due to the wind in x-direction

The maximum displacement of 168mm is well below the maximum displacement of $H/500=204\text{mm}$.

For the stability in x-direction a thickness of the facade elements and core elements of 300mm is sufficient.

8.7.2) Wind in y-direction

The wind in y-direction will be taken up by the left and right facade, and the small closed part of the core. The left and right facade have the same amount of openings, so they have the same stiffness. Only the calculation of the right facade will be made.

The input in Scia is as follows:

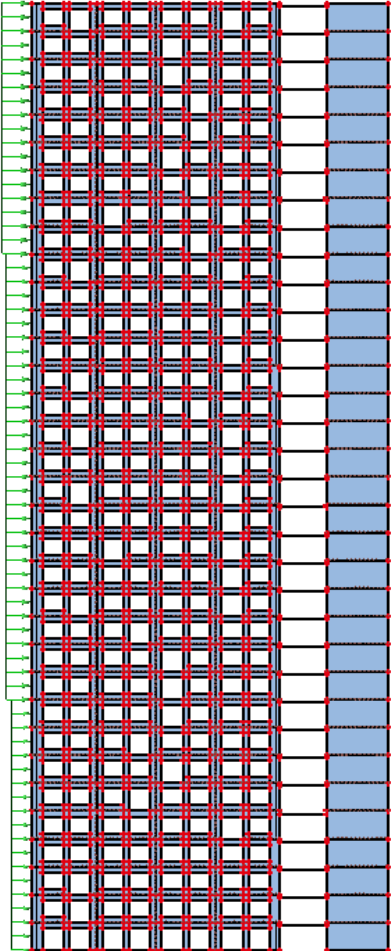

Figure 102 Input Scia stability in y-direction

The maximum displacement at the top, in case that the thickness of the facade and core elements is 300mm, is 173.5mm. This is lower than the maximum displacement of 204mm so the thickness of the facade and core elements is sufficient.

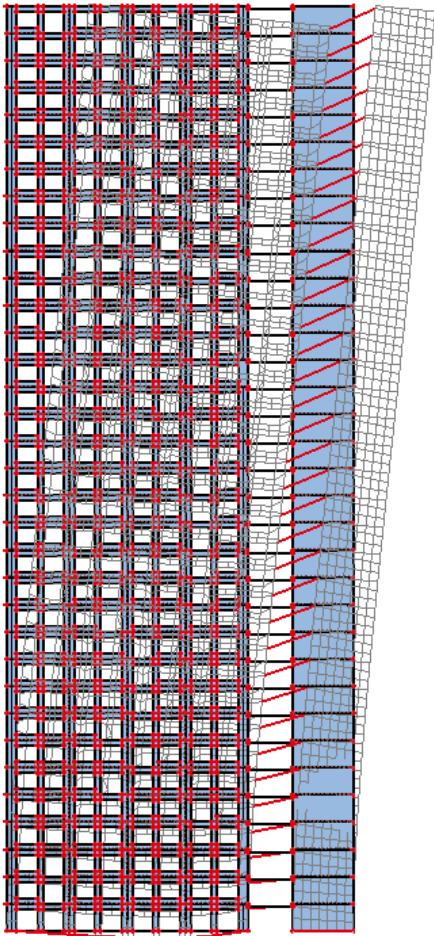

Figure 103 Deformed structure, wind in y-direction

8.8) Input D-settlement

The load is applied in D-settlement as a 13 different block loads. Each facade contains two block loads. The core and the corners where 2 facade elements meet are modeled as a separate block load.

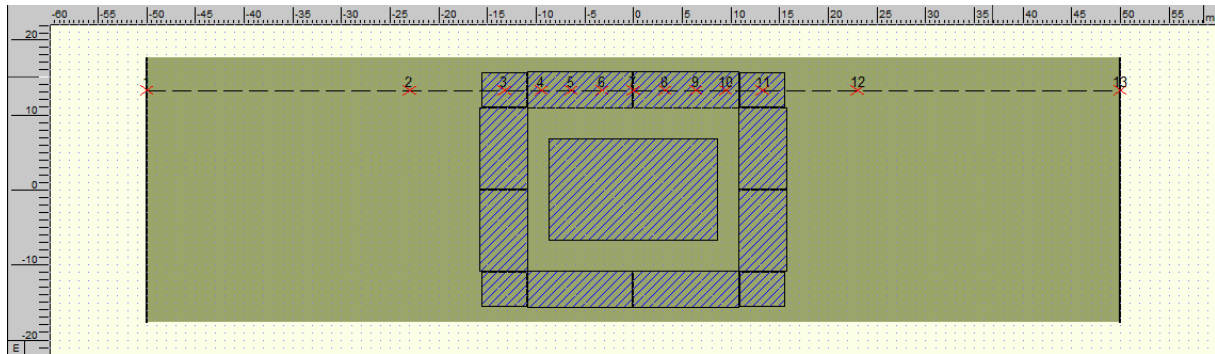

Figure 104 Input of the loads in D-settlement

The total weight of the building will not be introduced to the soil all at once. The load will be introduced in steps. The steps are according to the sections described in chapter 7.1)

The construction speed is 1 floor per week for the structure, and then another 7 months to finish the interior works and the finishing. The total building time is 62 weeks.

In section 8.6.1) describes the way how the load is divided in time steps and will be entered in D-settlement.

8.8.1) Introduction of the loads to the subsoil.

The wall has a length of 24m and a thickness of 0.3m. The spreading of the load can be found in figure 105.

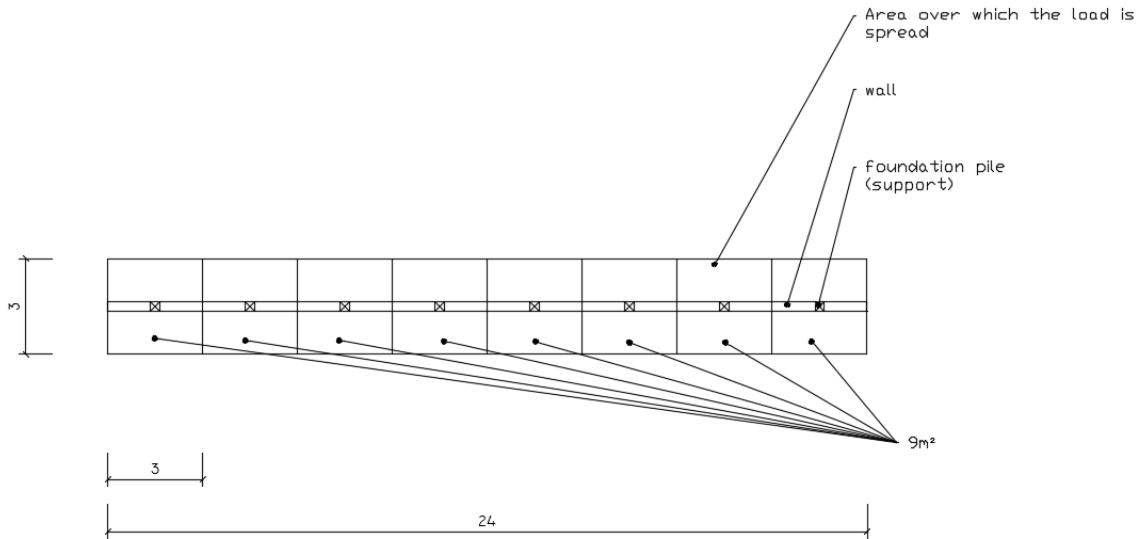

Figure 105 load spreading area

The total reaction forces from the supports is divided by the area of the load spreading at pile tip level.

This results in a pressure per storey of 15.4 kN/m². This is due to the permanent load only.

The figure below shows the real pressure on the subsoil (red line) and the load as it is entered in D-settlement (blue blocks). The blue blocks are the average pressure on the subsoil per time step of 7 weeks, according to the division of the tower in parts of 7 floors.

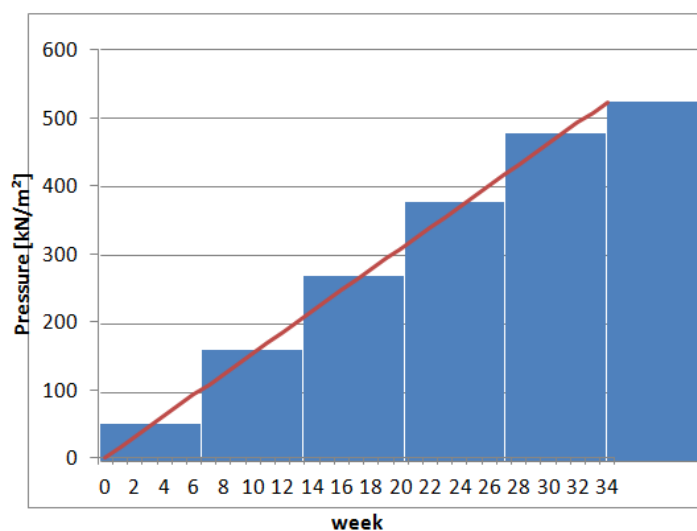

Figure 106 Permanent load introduced to the subsoil

After 34 weeks the permanent load on the structure is already introduced into the soil. After week 34 the finishing work of the tower continues for 28 weeks. In this period the electrical wiring and the pipes are installed and everything gets painted. It is assumed that this finishing works don't influence the permanent load of the structure. This finishing works last until week 62. After week 62 the residents can move to their apartment, and at this time the variable load is introduced to the subsoil.

The tables below show the load transferred to the soil per building step.

Table 10 Pressure on soil, facade

Step	Week	Pressure increase [kN/m ²]	Total pressure on soil [kN/m ²]	
step 1	week 0	53,9	53,9	
step 2	week 7	107,8	161,7	
step 3	week 14	107,8	269,5	
step 4	week 21	107,8	377,3	
step 5	week 28	100	477,4	
step 6	week 34	46,2	523,6	
step 7	week 62	63	586,6	variable load

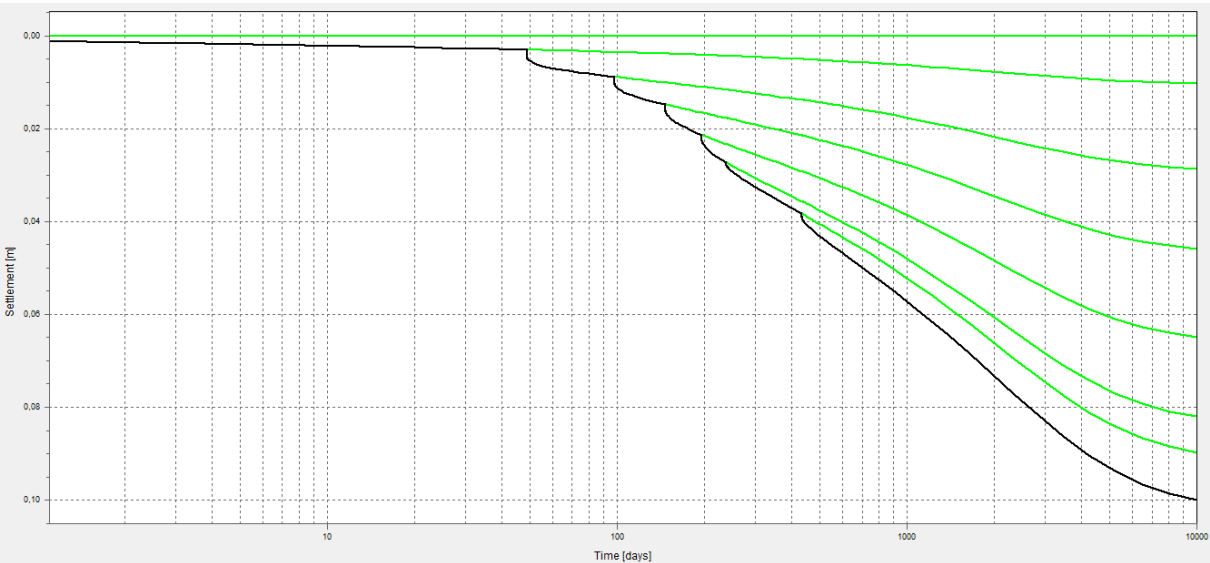

Figure 107 Time settlement diagram facade at midspan, facade

Table 11 Pressure on soil, core

Step	Week	Pressure increase [kN/m ²]	Total pressure on soil [kN/m ²]	
step 1	week 0	84,5	84,35	
step 2	week 7	168,7	253,05	
step 3	week 14	168,7	421,75	
step 4	week 21	168,7	590,45	
step 5	week 28	156,65	747,1	
step 6	week 34	72,3	819,4	
step 7	week 62	107	926,4	variable load

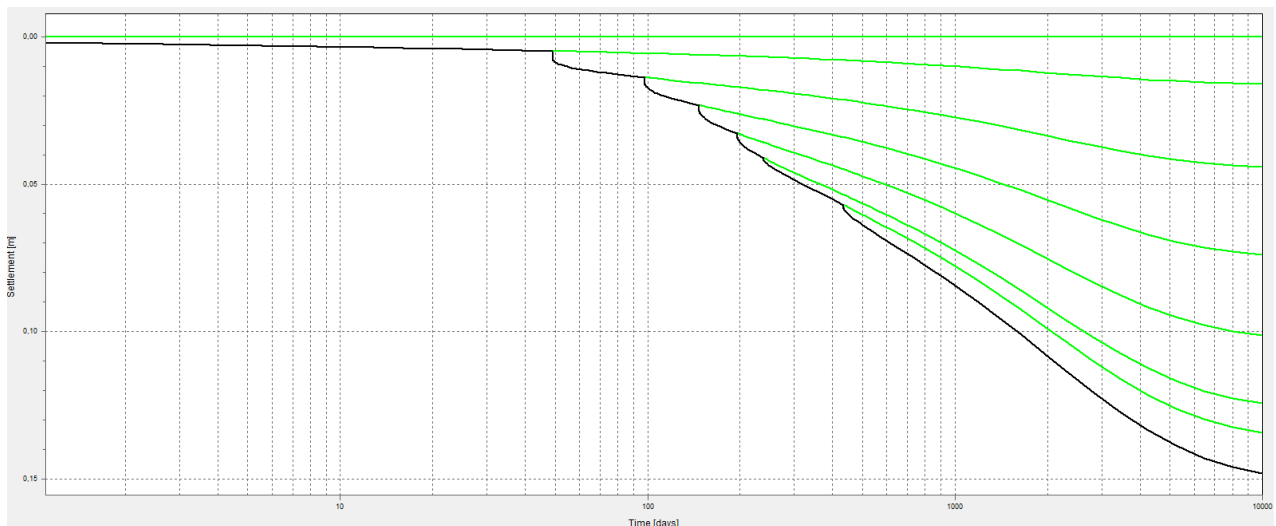

Figure 108 Time settlement curve, core at midspan

As can be seen in the time-settlement curves of the facade and the core, the differential settlements between the facade and the core is 50mm when no measures are taken.

The settlement of the facade after the building phase of the structure is 45% of the final settlements of the facade. The settlement of the core after the building phase is 65% of the final settlements of the core.

9.) Settlement calculation of the Cooletower.

The settlement of the Cooletower will be calculated by using the direct method as described in chapter 3.2.

The complete footprint of the tower will be divided in 13 block loads in D-settlement, as can be seen in the figure below.

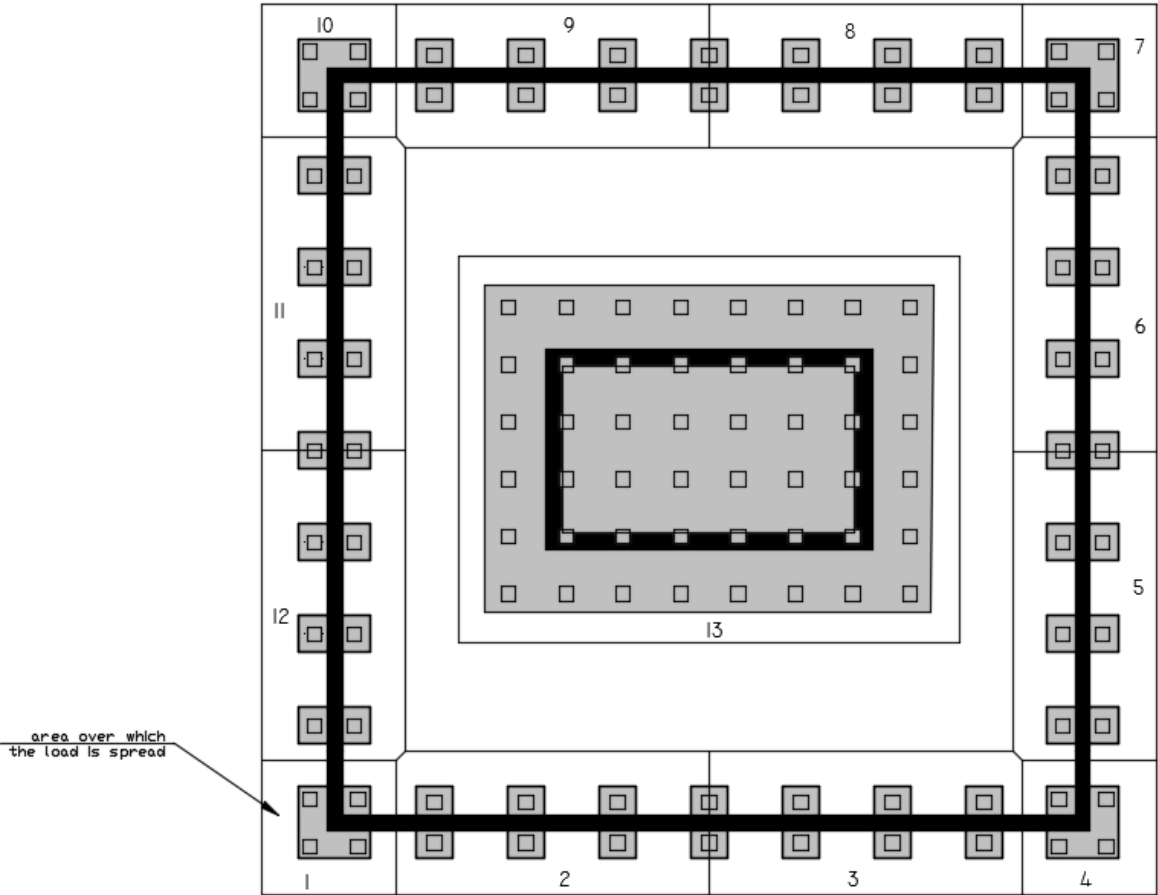

Figure 109 Block load division of the Cooletower in D-settlement

The area of each block is as follows:

Block number	Area [m ²]
1	21,75
2	54,68
3	54,68
4	21,75
5	54,68
6	54,68
7	21,75
8	54,68
9	54,68
10	21,75
11	54,68
12	54,68
13	236,25

In the initial calculation the floors are hinged connected to the facade and the core, so the facade and the core can settle apart from each other.

The settlements of the building are measured at the corners of the facade, at midspan of the facade and at the core. Because the stiffness of the core, the core settles evenly.

The differential settlements in the table are the settlement differences between the facade and the core.

In the initial situation, where the floors are hinged connected to the facade and the core, the settlements after 10.000 days are:

Hinged floor supports, elements straight stacked		
Position	Settlement [mm]	Differential settlement [mm]
Core	130	-
Facade corner	107	23
Midspan facade small floorspan	110	20
Midspan facade large floorspan	109	21

Hinged floor supports, elements stacked in masonry configuration		
Position	Settlement [mm]	Differential settlement [mm]
Core	131	-
Facade corner	105	26
Midspan facade small floorspan	112	19
Midspan facade large floorspan	110	21

The differential settlements between the core and the facade are the highest. The core settles evenly and the differential settlements in the facade are approximately 5mm. The differential settlements between the core and the facade can be 20~25mm.

10.) Concrete checks

The elements of the basic facade, the stiff facade and the facade with reduced stiffness will be checked whether the elements can take up the loads.

The checks will be quick checks to determine the feasibility of the structure.

The internal forces will be calculated in the ULS. The structure is of consequence class 3,=. The partial load factors are:

Permanent load: 1.5

Variable load: 1.65

Settlements 1.2

The strength class of the concrete is C50/60. The compression resistance of the concrete is $f_{cd}=50/1,5=33,3 \text{ N/mm}^2$

The environmental class is XC3, the concrete is outside with protection against rain.

The minimum coverage of the reinforcement is $c_{min}=20\text{mm}$, $\Delta c_{dev}=5\text{mm}$, so the total cover is $20+5=25\text{mm}$

The reinforcement is of class B500b, with a yield strength $f_{yd}=435\text{N/mm}^2$

Check of the columns

The columns will be checked if the maximum normal force can be taken up by the concrete. This will be done by the formula $N_{Rd}=A_c \cdot f_{cd}$ where A_c is the area of the concrete column and f_{cd} is the design compressive strength of the column.

Bending moments in the concrete columns will not be considered, it is assumed that the bending moments are not governing for the load bearing capacity of the columns. The columns will mainly be loaded by normal forces.

The shear capacity of the columns is calculated by the formula $v_{Ed}=V_{Ed}/b \cdot h$

$v_{Ed} \leq v_{Rd}$ where v_{Rd} will be determined by table 25 to 28 from the book 'Tabellen en grafieken, bijlage bij basiskennis beton'[26]

Check of the lintels

The lintels will be mainly loaded by bending moments and shear forces. The shear capacity of the lintels will be determined in the same way the shear capacity of the columns is determined.

The bending moment capacity of the lintel will be checked by checking if the needed reinforcement isn't larger than the maximum allowable reinforcement.

The needed reinforcement ratio will be calculated by the formula $A_s=M_{Ed}/(f_{yd} \cdot 0.9d)$

and the reinforcement ratio $\rho=A_s/b \cdot d$

The maximum reinforcement ratio that is allowed to be in the lintel is read from a table [26]

For C50/60 this maximum reinforcement ratio is 3.08%.

Method

Not all elements will be checked. The facade is divided by 5 parts, according the construction phases. For each part of the facade the maximum internal forces are calculated by using Scia Engineer. It is checked if the maximum forces can be taken by the structure. If the maximum forces can be taken by the structure, all elements of that building phase are good.

If some internal forces can't be taken by the structure, the structure will be investigated more into depth to check which elements don't fulfill the requirements.

At first all elements of a building phase are considered. If some don't fulfill the requirements, it will be checked which facade doesn't fulfill the requirements (front back, left or right facade) and then the elements in the governing facade will be checked to see which elements don't fulfill the requirements.

To level out high peaks in the internal forces, integration strips will be used in Scia Engineer. In this case the results of the 2D element will be presented as 1D element internal forces.

Column straight stacked elements

For the basic model the column width is 600mm and the thickness is 300mm. The maximum resistance $N_{R,d}=600*300*33,3/1000=6000\text{kN}$

Assumed is that a reinforcement ratio $\rho=2\%$ is enough for this structure. This corresponds with an area of the reinforcement steel of 3600mm^2 .

It is chosen to have reinforcement of $8\emptyset 25$, this reinforcement has an area of 3927mm^2 .

the reduced height $d=h-c-\emptyset_{\text{stirrup}}-\emptyset_{\text{reinforcement}}/2$.

It is chosen to have stirrups with a diameter $\emptyset 12$ thus $d=300-25-12-25/2=250\text{mm}$.

The minimal shear resistance for concrete C50/60 with $d=250\text{mm}$ is $0,65\text{ N/mm}^2$

These tables are in appendix D.

The maximum allowable shear force that can be taken by the column without any extra shear reinforcement is $0,65*600*250=97,5\text{kN}$.

If the shear force in the column is larger than $97,5\text{kN}$, additional shear reinforcement is needed.

The compression diagonals in the concrete will fail $v_{Rd, \max}=4.97\text{ N/mm}^2$ with an angle of the compression diagonals of 21.8° and $v_{Rd, \max}=7.2\text{ N/mm}^2$ in case the angle of the compression diagonals is 45° .

Lintels straight stacked elements

The lintels have a dimension of 300*600mm

$d = h - c - \phi_{\text{stirrup}} - \phi_{\text{reinforcement}}/2$. with $h=600$, $c=25$ mm, $\phi_{\text{stirrup}}=12$ mm, $\phi_{\text{reinforcement}}=25$ mm so $d=550$ mm

The minimum shear capacity of the lintels is $v_{Rd,\min} = 0.5 \text{ N/mm}^2$.

The compression diagonals in the concrete will fail $v_{Rd,\max} = 4.97 \text{ N/mm}^2$ with an angle of the compression diagonals of 21.8° and $v_{Rd,\max} = 7.2 \text{ N/mm}^2$ in case the angle of the compression diagonals is 45° , just the same as the columns.

Columns facade storey 1 to 7

The maximum allowable normal force in the elements is 6000kN

$N_{Ed, max} = 6805\text{kN}$ so the columns of building phase 1 don't fulfill the requirements. The maximum load is in a range of 6805kN for the front facade and 6300kN for the left facade. So it is not just the front facade elements don't fulfill the requirements.

The loads in the ultimate limit state for the front facade are:

Permanent load:	5648kN
Variable load:	349 kN
Settlements:	808 kN

The unity check of the column is 1,13 so the column will collapse. The unity check of the column without the settlements is 0,99 so the settlements cause the failure of the column. The loads due to the settlements are 13% of the total loads due to the permanent and the variable load only.

The peak shear force in the columns is 743kN. This corresponds with a $v_{Ed} = 743.000/250*600 = 4.96 \text{ N/mm}^2$. This can be taken by the concrete, so the dimensions of the column are good enough to withstand the shear force.

Lintels storey 1 to 7

The maximum bending moment in the lintels is 270kNm.

The needed reinforcement to take this bending moment is $A_s = 1255\text{mm}^2$. This is less than the maximum allowable reinforcement in the lintel, so the lintels can take the bending moments.

The maximum shear force in the lintels is 705kN. $v_{Ed} = 4.27\text{N/mm}^2$. The concrete diagonals will not fail with this value of v_{Ed} .

The lintels of the first construction phase are the lintels that have the largest internal forces, so all lintels of the structure can take up their internal forces.

Columns storey 8 to 14

The maximum normal force in the column of construction phase is $N_{Ed} = 5109\text{kN}$. This is less than the maximum allowable normal force $N_{Rd} = 6000\text{kN}$ so the columns can take up the load.

The maximum shear force is 622kN, this is less than the maximum shear force of construction phase 1, and that load could be taken by the columns.

All columns of construction phase 3,4, and 5 are loaded by loads less than the loads of construction phase 2, so all columns of construction phase 2,3,4 and 5 can take the loads. Only some columns of construction phase 1 can't take up the load. The figure below shows which columns are not sufficient. This pattern is for all facades. the red columns are not sufficient.

To increase the load bearing capacity of the columns the thickness of the bottom elements can be increased to 350mm or concrete with a higher strength class can be used.

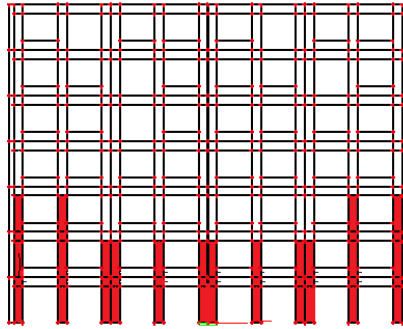

Figure 110 Overview not sufficient columns, storey 1 to 7

Columns masonry configuration

There are 3 different column types in the model with elements stacked in masonry configuration.

The first column is the wide column with a width of 1200mm. $N_{R,d} = 1200 \cdot 300 \cdot 33,3 = 12000 \text{ kN}$

The second is a normal column with dimensions similar as the columns in the model with straight stacked elements. $N_{R,d} = 6000 \text{ kN}$

There are also slender columns with a thickness of 300mm, these have a $N_{R,d} = 3000 \text{ kN}$.

The compression diagonals in the concrete will fail $v_{Rd, \max} = 4.97 \text{ N/mm}^2$ with an angle of the compression diagonals of 21.8° and $v_{Rd, \max} = 7.2 \text{ N/mm}^2$ in case the angle of the compression diagonals is 45° , just the same as the columns of the model with straight stacked elements

Lintels elements in masonry configuration

The lintels of the model with elements in masonry configuration have the same dimensions as the lintels of the model with straight stacked elements. Therefore they have the same load bearing capacity.

The minimum shear capacity of the lintels is $v_{Rd, \min} = 0.5 \text{ N/mm}^2$.

The compression diagonals in the concrete will fail $v_{Rd, \max} = 4.97 \text{ N/mm}^2$ with an angle of the compression diagonals of 21.8° and $v_{Rd, \max} = 7.2 \text{ N/mm}^2$ in case the angle of the compression diagonals is 45° .

Columns storey 1 to 7

The maximum load in the column of construction phase 1 is $N_{Ed}=6713\text{kN}$. This is more than the regular and small columns can withstand. This load is from the back facade.

The maximum force in the column of the right facade is 6435kN this is also too much for a regular and a small column.

The loads in the ultimate limit state for the front facade are:

Permanent load:	5488kN
Variable load:	351 kN
Settlements:	874 kN

The unity check of this column is 1,12. The unity check of the column without settlements is 0,97 so the settlements cause the failure of the column.

The loads due to the settlements are 15% of the total loads due to the permanent and the variable load only.

The peak shear force in the columns is 920kN . This load causes $v_{Ed}=6.14\text{ N/mm}^2$ At this loading the compression diagonals in the concrete will not fail if $\Theta=30^\circ$.

The columns of construction phase 1 have the highest internal forces, so the lintels of the other construction phases have a sufficient shear capacity.

Lintels storey 1 to 7

The maximum bending moment in the lintels is 213kNm . The required reinforcement to take up this bending moment is $A_s=990\text{mm}^2$. This is less than the maximum allowable reinforcement in the lintel, so the lintels can take the bending moments.

The maximum shear force in the lintel is 985kN . This corresponds with a $v_{Ed}=5.96\text{ N/mm}^2$

This can be taken up by the lintel. The concrete compression diagonal will not fail when the angle is 30° . But this solution needs a lot of reinforcement steel, $\varnothing 12-100$.

The lintels of other construction phases have lower internal forces, so these lintels fulfill the requirements.

Columns storey 8 to 14

The columns of construction phase 2 have a maximal normal force of 5810kN , this internal force is from a regular column, and is less than 6000kN so the column can withstand the load.

All columns of construction phase 3, 4 and 5 have lower internal forces, so these columns also fulfill the requirements.

The figure below shows the columns from construction phase 1 that don't fulfill the requirements.

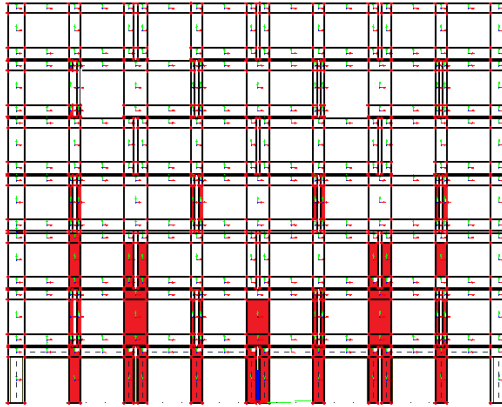

Figure 111 Columns with too low capacity, storey 1 to 7

If you compare figure 110 to figure 111 it can be seen that columns in the corners of the building with straight stacked elements don't fulfill the requirements, while the columns at the edges of the building in masonry configuration do fulfill the requirements. This is due to the fact that the elements that are straight stacked have a structural vertical connection so the loads can be redistributed through the vertical connection. The model with elements in masonry configuration have an open vertical connection, so the loads can't be redistributed through the connection, making the structure less stiff.

11.) Possible solutions

From the settlement calculation of chapter 9, the differential settlements between the core and the facade are the highest. In order to reduce the settlements between the core and the facade several options are possible:

- Change the floor connections so more floor load is distributed to the facade and less load is distributed to the core.
- Increase the foundation plate at the core and increase the amount of piles at the core so the core will settle less.
- Install the facade at a slightly lower level than the core, so the differential settlements between the core and the facade are less in the end.

11.1) Changing the floor connections

The differential settlements between the core and the facade are the highest. This can cause problems for non load bearing walls in the apartments, due to the settlements these walls can crack. To reduce these differential settlements, more load from the floors should be distributed from the core to the facade. The forceflow in the floors can be influenced by applying different support conditions at the floors ends, for example a hinged support at one end and a moment resisting support at the other end.

From theory the load distribution due to the settlements are:

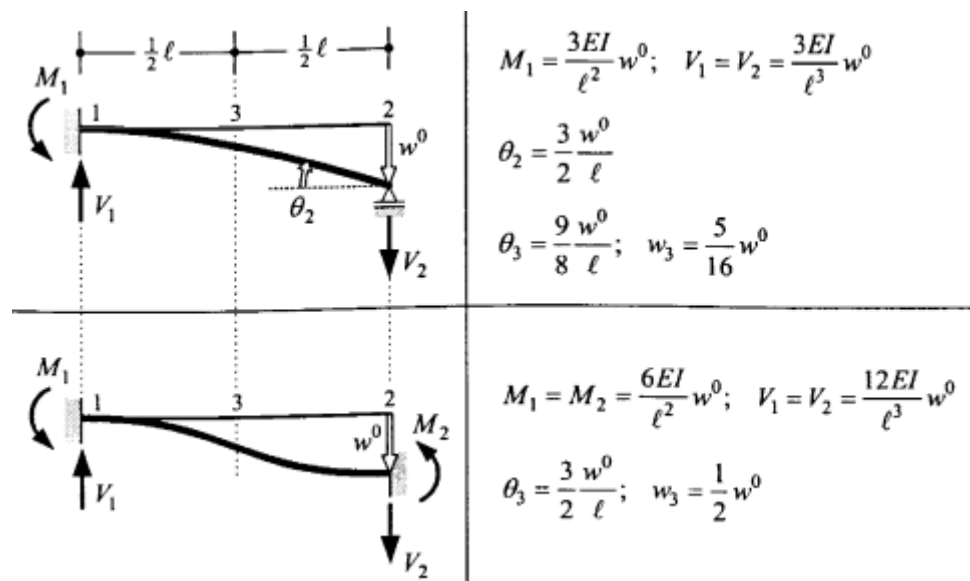

Figure 112 load distribution due to displacement

In the figure above w^0 = the differential settlement between the facade and the core.

E = young's modulus of the floor

I = Second moment of area of the floor

l = length of the floor

These standard standard formulas for settlements have to be combined with the standard formulas for a beam on two supports in order to get the total force distribution from the core to the facade.

Initial situation, floor supports are hinged.

In the initial situation the floors are hinged connected to the facade and the core. In this case the floor loads are evenly distributed to the wall and the facade. Due to the settlement, no extra bending moment is added to the floors, so the load distribution doesn't change.

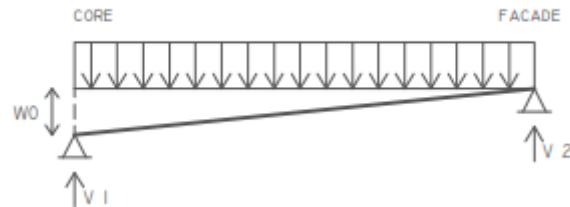

V_1 and V_2 in the figure above are both $\frac{1}{2} * q * l$

Situation 1: both sides are clamped connected to the floor

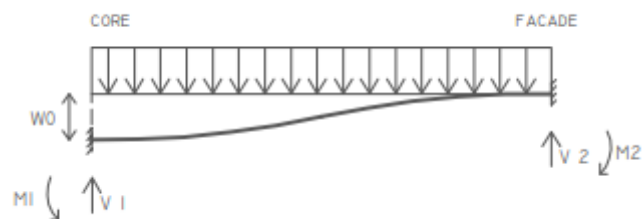

When both ends are clamped the vertical support reaction at the settled end will decrease.

In the figure above:

$$V_1 = \frac{1}{2} * q * l - \frac{12EI}{l^3} * w_0$$

$$V_2 = \frac{1}{2} * q * l + \frac{12EI}{l^3} * w_0$$

$$M_1 = \frac{1}{12} * q * l^2 - \frac{6EI}{l^2} * w_0$$

$$M_2 = \frac{1}{12} * q * l^2 + \frac{6EI}{l^2} * w_0$$

In comparison with the initial situation, where the floors are hinged connected to the facade and the core, a floorload of $\frac{12EI}{l^3} * w_0$ will be transferred from the core to the facade.

Situation 2: facade is clamped and the core is hinged connected to the floor

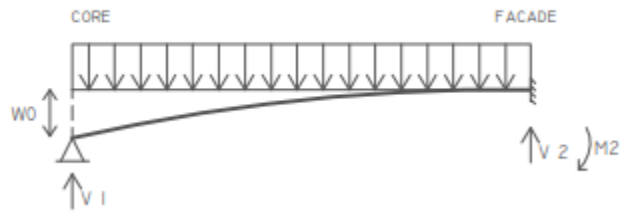

When the facade has a moment resisting connection and the core has a hinged connection, more load will be distributed to the facade.

In the figure above:

$$V_1 = \frac{3}{8} * q * l - \frac{3EI}{l^3} * w_0$$

$$V_2 = \frac{5}{8} * q * l + \frac{3EI}{l^3} * w_0$$

$$M_2 = \frac{1}{8} * q * l^2 + \frac{3EI}{l^2} * w_0$$

In this case there will already be more load distributed to the facade, even when no settlements will occur, and when the settlement occurs only more load will be distributed to the facade.

Conclusion

The best method to transfer more floor load to the facade is by using a moment resisting connection between the facade and the floor and a hinged connection between the floor and the core. In this case there will be already more load transferred to the facade when no settlements occur, and when the core settles even more loads will be transferred to the facade. In this case the differential settlements between the facade and the core will be reduced.

The differential settlements can't be reduced to 0 with this method, because if the differential settlement is 0 there will be no redistribution of the loads. The method of changing the floor connections is only useful to reduce already occurring differential settlements.

11.1.1) Results applying the different floor connections on the Cooltower.

The theory as described above is applied on the Cooltower, for both the straight stacked elements and the elements stacked in masonry configuration.

The results on the total settlements are shown in the table below.

Settlements straight stacked elements

Hinged floor supports		
Position	Settlement [mm]	Differential settlement [mm]
Core	130	-
Facade corner	107	23
Midspan facade small floorspan	110	20
Midspan facade large floorspan	109	21

Rigid floor supports			
Position	Settlement [mm]	Differential settlement [mm]	Reduction [%]
Core	127	-	
Facade corner	109	18	22%
Midspan facade small floorspan	112	15	25%
Midspan facade large floorspan	111	16	24%

Rigid floor support at the facade, hinged floor support at the core			
Position	Settlement [mm]	Differential settlement [mm]	Reduction [%]
Core	123	-	
Facade corner	110	13	43%
Midspan facade small floorspan	113	10	50%
Midspan facade large floorspan	112	11	48%

Settlements elements in masonry configuration

Hinged floor supports		
Position	Settlement [mm]	Differential settlement [mm]
Core	131	-
Facade corner	105	26
Midspan facade small floorspan	112	19
Midspan facade large floorspan	110	21

Rigid floor supports			
Position	Settlement [mm]	Differential settlement [mm]	Reduction [%]
Core	128	-	
Facade corner	106	22	15%
Midspan facade small floorspan	112	16	16%
Midspan facade large floorspan	111	17	19%

Rigid floor support at the facade, hinged floor support at the core			
Position	Settlement [mm]	Differential settlement [mm]	Reduction [%]
Core	124	-	
Facade corner	108	16	38%
Midspan facade small floorspan	114	10	47%
Midspan facade large floorspan	111	13	38%

Conclusion

The change of the way how the floor is connected to the facade and the core has a large effect on the differential settlements.

When a moment resisting connection between the facade and the floor and a hinged connection between the core and the floor is applied, the differential settlements between the core and the corner of the facade is reduced by 45% in comparison when both connections are hinged.

The differential settlements between the core and midspan of the facade is reduced by 50%.

More load is distributed from the core to the facade, so the differential settlements between the core and the facade will be reduced. But due to the change of the connection between the floor and the facade the internal forces in the floors and at the connections with the walls will be very high. It is not possible to put enough reinforcement in the concrete to deal with these internal forces, so it is not possible to change the connection between the facade and the floor without changing the dimensions of the floors and the facade.

11.2) Facade stiffness influence on the differential settlements

In this research the total settlements of the facade are not that important, it's the difference between the settlements that cause additional stresses in the wall elements. Therefore a relation between the facade stiffness and the differential settlements will be investigated. In order to do this a basic model will be used, a model with an increased stiffness and a model with a decreased stiffness will be used. The stiffness variations are created by changing the thickness of the facades and by changing the Young's modulus. The properties of the facades are shown in the table below.

Table 12 Facade properties

Model	Young's modulus [N/mm ²]	Thickness [mm]	Relative stiffness [-]
Basic	24000	300	1
Stiff	24000	600	2
Flexible	7200	250	0.25

The relative stiffness is the stiffness of the facade of the variant divided by the stiffness of the facade of the basic model.

Each of the facade properties is applied on a model with elements in a masonry configuration and a straight stacked configuration as described in chapter 7

The element configuration is for each model the same. The relative stiffness of the facade is linear depending on the Young's modulus and the thickness.

For each model the complete construction phases are modeled. The construction phases are described in chapter 8.

This chapter describes the relation between the differential settlements in the facade and the stiffness of the facade.

The settlements used in this part are the final settlements at t=10.000 days. It is tried to make a prediction of the final settlements in case the facade stiffness is changed.

The facades are named according to the picture below.

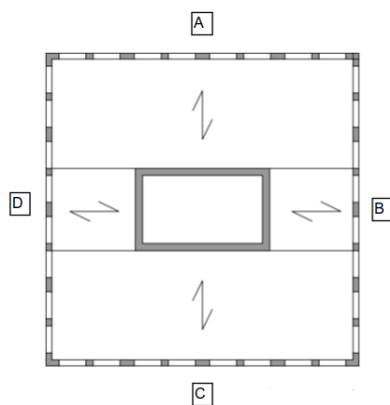

Figure 113 Facades

Straight stacked precast facade elements

The total settlements per wall are presented in the tables below.

Settlements basic model, facade A [mm]									
y\x[m]	-13,1	-9,6	-6,4	-3,2	0	3,2	6,4	9,6	13,1
13,1	107,4	107,6	108,7	109,4	110	109,4	108,7	107,6	107,7

Settlements basic model, facade B [mm]									
x\y[m]	-13,1	-9,6	-6,4	-3,2	0	3,2	6,4	9,6	13,1
13,1	107,7	108,8	111,1	113,2	114	113	110,8	108,1	106,5

Settlements basic model, facade C [mm]									
y\x[m]	-13,1	-9,6	-6,4	-3,2	0	3,2	6,4	9,6	13,1
-13,1	106	106,4	107,5	108,2	108,9	108,4	107,6	106,5	106,3

Settlements basic model, facade D [mm]									
x\y[m]	-13,1	-9,6	-6,4	-3,2	0	3,2	6,4	9,6	13,1
-13,1	107,4	108,7	111,1	113,2	114,1	113	110,6	107,9	106

The differential settlements will be described as the maximum value of the settlement in the facade minus the minimum settlement in the facade. The differential settlements are shown in the table below.

Facade	Differential settlement [mm]
A	2,6
B	6,3
C	2,9
D	8,1

The settlements of the stiff facade are shown below

Settlements stiff model, facade A [mm]									
y\x[m]	-13,1	-9,6	-6,4	-3,2	0	3,2	6,4	9,6	13,1
13,1	132	131,9	132,8	133,2	133,7	133,2	132,7	131,8	132

Settlements stiff model, facade B [mm]									
x\y[m]	-13,1	-9,6	-6,4	-3,2	0	3,2	6,4	9,6	13,1
13,1	132	132,1	133,6	134,9	135,5	134,8	133,2	131,3	130,8

Settlements stiff model, facade C [mm]									
y\x[m]	-13,1	-9,6	-6,4	-3,2	0	3,2	6,4	9,6	13,1
-13,1	130,7	130,7	131,6	131,8	132,4	132	131,6	130,6	130,8

Settlements stiff model, facade D [mm]									
x\y[m]	-13,1	-9,6	-6,4	-3,2	0	3,2	6,4	9,6	13,1
-13,1	132	132,2	133,8	135,3	135,8	135	133,3	131,5	130,7

The differential settlements are:

Facade	Differential settlement [mm]
A	1,7
B	4,7
C	1,7
D	5,1

The settlements of the flexible facade are shown below.

Settlements flexible model, facade A [mm]									
y\x[m]	-13,1	-9,6	-6,4	-3,2	0	3,2	6,4	9,6	13,1
13,1	100,4	102,1	104,6	106,4	107,4	106,4	104,6	102,1	100,7

Settlements flexible model, facade B [mm]									
x\y[m]	-13,1	-9,6	-6,4	-3,2	0	3,2	6,4	9,6	13,1
13,1	100,7	104	108,6	112,7	114,5	112,8	108,6	103,7	99,9

Settlements flexible model, facade C [mm]									
y\x[m]	-13,1	-9,6	-6,4	-3,2	0	3,2	6,4	9,6	13,1
-13,1	99,6	101,5	103,9	105,6	106,6	105,7	104	101,5	99,9

Settlements flexible model, facade D [mm]									
x\y[m]	-13,1	-9,6	-6,4	-3,2	0	3,2	6,4	9,6	13,1
-13,1	100,4	103,8	108,5	112,8	114,5	112,8	108,6	103,7	99,6

The differential settlements are:

Facade	Differential settlement [mm]
A	7
B	14,6
C	7
D	14,9

Results

The differential settlements are for each wall plotted to the relative stiffness of the wall. A trendline is added to check the relation between the relative stiffness of the wall and the differential settlements. The graph below shows this relation for each facade.

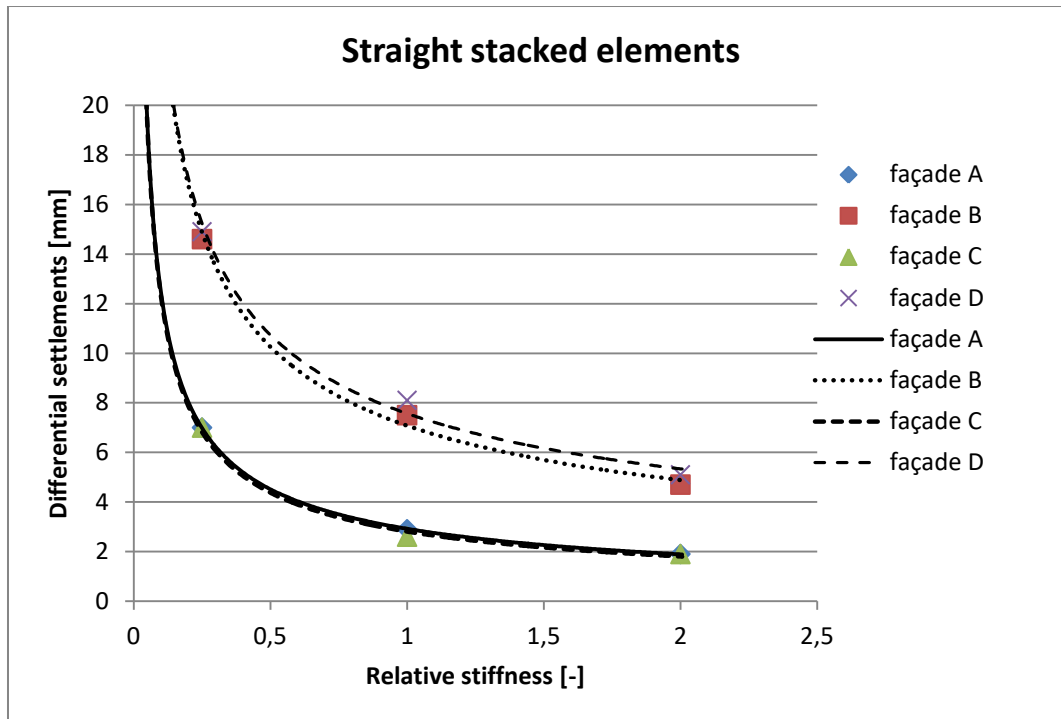

The trendline is drawn through the calculated points. The function of the trendline for each facade is given below.

$$\text{Facade A: } u=2,9221*x^{(-0,628)}$$

$$\text{Facade B: } u=7,0806*x^{(-0,536)}$$

$$\text{Facade C: } u=2,8104*x^{(-0,640)}$$

$$\text{Facade D: } u=7,5701*x^{(-0,505)}$$

Where u =differential settlement, between the minimum and maximum settlement in the facade
 x = relative stiffness of the facade

Precast facade elements in masonry configuration

The total settlements per wall are presented in the tables below.

Settlements basic model, facade A [mm]									
y\x[m]	-13,1	-9,6	-6,4	-3,2	0	3,2	6,4	9,6	13,1
13,1	105,4	108	110,6	111,9	112,8	112,1	111,1	108,7	105,7

Settlements basic model, facade B [mm]									
x\y[m]	-13,1	-9,6	-6,4	-3,2	0	3,2	6,4	9,6	13,1
13,1	105,7	109,1	111,9	113,6	114,4	113,1	110,8	107,3	104,9

Settlements basic model, facade C [mm]									
y\x[m]	-13,1	-9,6	-6,4	-3,2	0	3,2	6,4	9,6	13,1
-13,1	105,8	107,5	109,7	110,8	111,7	111,1	110,1	107,8	104,9

Settlements basic model, facade D [mm]									
x\y[m]	-13,1	-9,6	-6,4	-3,2	0	3,2	6,4	9,6	13,1
-13,1	105,4	108,5	111,9	113,4	114,3	113	110,7	107,8	105,8

The differential settlements will be described as the maximum value of the settlement in the facade minus the minimum settlement in the facade. The differential settlements are shown in the table below.

Facade	Differential settlement [mm]
A	7,4
B	9,5
C	6,8
D	8,9

The settlements of the stiff facade are shown below

Settlements stiff model, facade A [mm]									
y\x[m]	-13,1	-9,6	-6,4	-3,2	0	3,2	6,4	9,6	13,1
13,1	127,9	129,5	131,4	132	132,6	132	131,5	129,9	127,5

Settlements stiff model, facade B [mm]									
x\y[m]	-13,1	-9,6	-6,4	-3,2	0	3,2	6,4	9,6	13,1
13,1	127,5	130,3	132	132,8	133,2	132,3	130,8	128,6	128,4

Settlements stiff model, facade C [mm]									
y\x[m]	-13,1	-9,6	-6,4	-3,2	0	3,2	6,4	9,6	13,1
-13,1	130	129,8	130,8	131	131,7	131,3	130,9	129,8	128,4

Settlements stiff model, facade D [mm]									
x\y[m]	-13,1	-9,6	-6,4	-3,2	0	3,2	6,4	9,6	13,1
-13,1	127,9	129,8	131,8	132,9	133,5	132,7	131,4	129,7	130

The differential settlements are:

Facade	Differential settlement [mm]
A	5,1
B	5,7
C	3,3
D	5,6

The settlements of the flexible facade are shown below.

Settlements flexible model, facade A [mm]									
y\x[m]	-13,1	-9,6	-6,4	-3,2	0	3,2	6,4	9,6	13,1
13,1	92,8	98,7	104,2	107,3	108,8	107,4	104,5	99,4	93,2

Settlements flexible model, facade B [mm]									
x\y[m]	-13,1	-9,6	-6,4	-3,2	0	3,2	6,4	9,6	13,1
13,1	93,2	100,1	106	110	111,8	109,4	104,7	98,5	93

Settlements flexible model, facade C [mm]									
y\x[m]	-13,1	-9,6	-6,4	-3,2	0	3,2	6,4	9,6	13,1
-13,1	94,4	98,8	103,4	106,1	107,7	106,5	103,9	99,1	93

Settlements flexible model, facade D [mm]									
x\y[m]	-13,1	-9,6	-6,4	-3,2	0	3,2	6,4	9,6	13,1
-13,1	92,8	99,6	105,7	108,9	111,7	109,5	105	99,3	94,1

The differential settlements are:

Facade	Differential settlement [mm]
A	16
B	18,8
C	14,7
D	18,9

Results

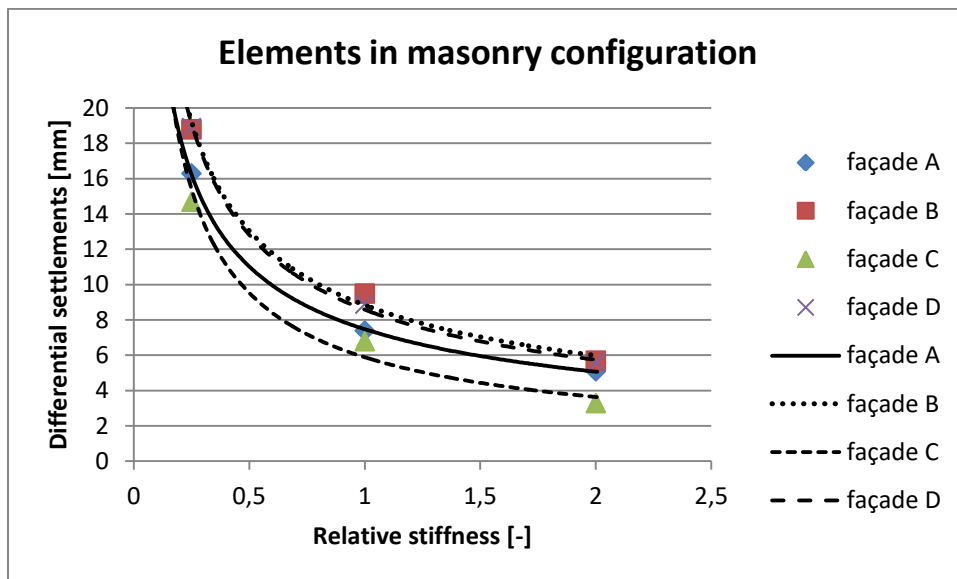

The functions of the trendlines are:

Facade A: $u=7,472*x^{-0,56}$

Facade B: $u=8,8342*x^{-0,562}$

Facade C: $u=5,8842*x^{-0,695}$

Facade D: $u=8,5753*x^{-0,579}$

Conclusion

The relation between the relative stiffness of the facade and the differential settlements can be described by the formula:

$$\Delta w = w_{\text{basic}} / \sqrt{\lambda} \quad \text{formula 1)}$$

where $\Delta w =$ differential settlement [mm]
 $w_{\text{basic}} =$ differential settlement of the basic model [mm]
 $\lambda =$ The relative stiffness [-]

Some values of the differential settlements are different than the values calculated with the formula above. This can be due to rounding errors. A lot of parameters are rounded. The loads which are put in from Scia Engineer into D-settlement are rounded. Also D-settlement calculates the settlement in the soil in whole millimeters, which are entered into Scia Engineer again.

This rounding of numbers can cause the differences between the calculated differential settlements according to the formula above and the calculated settlements of the building calculated in Scia Engineer.

In order to have a safe approach in predicting the differential settlements according to the described formula, the formula can be rewritten to:

$$\Delta w = (1 + w_{\text{basic}}) / \sqrt{\lambda} \quad \text{formula 2)}$$

This relation between the differential settlements and the relative stiffness of the facade should be further investigated. It can also be that this relation is only valid for the considered structure of the Cooltower.

In this case every settlement that's calculated in Scia Engineer is lower than the differential settlements calculated by $\Delta w = (1 + w_{\text{basic}}) / \sqrt{\lambda}$.

The differences are in a range of 1~2mm of the total differential settlement, and are all higher than the calculated settlements, so it's a safe approach.

The graphs below shows the relation between the differential settlements calculated with Scia Engineer, the differential settlements with formula 1) and the differential settlements calculated with formula 2)

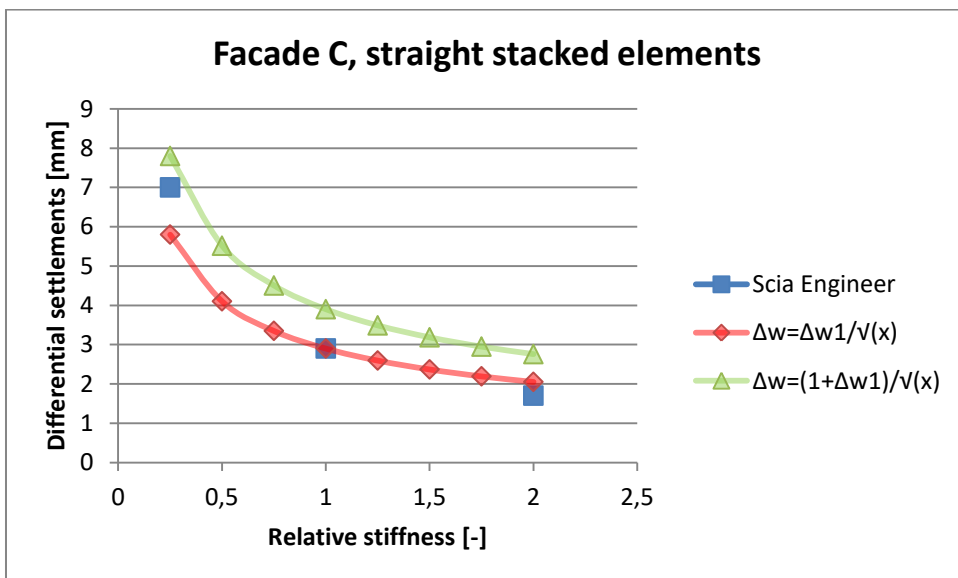
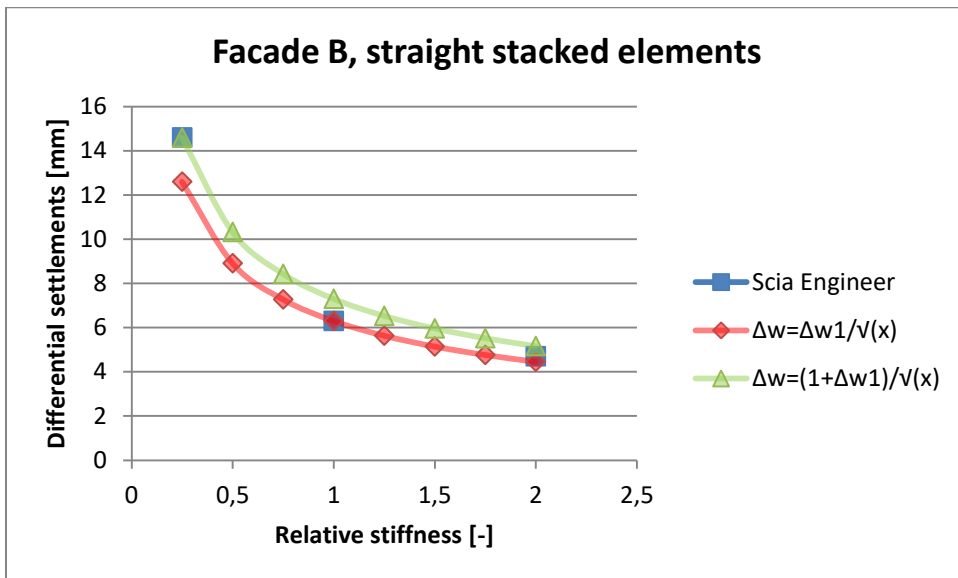
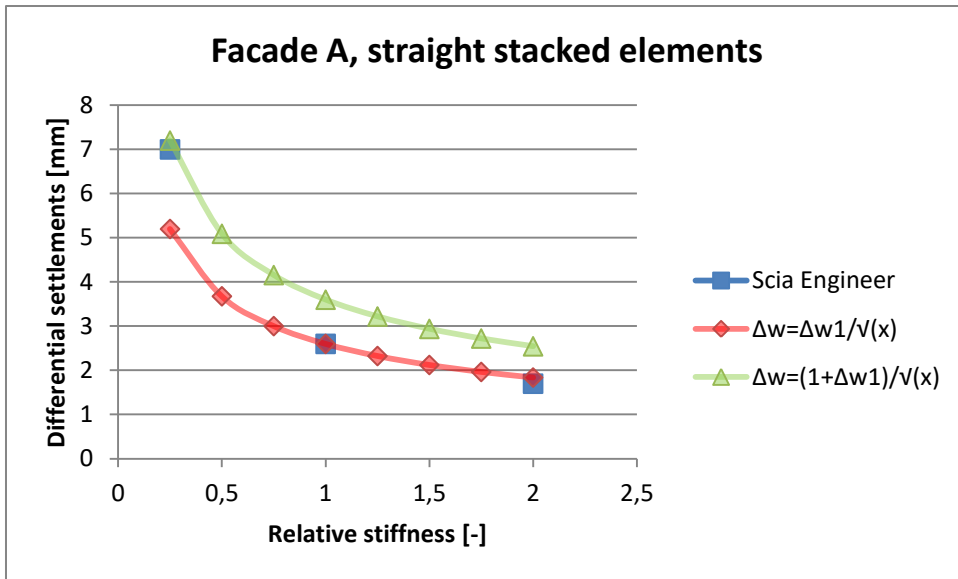

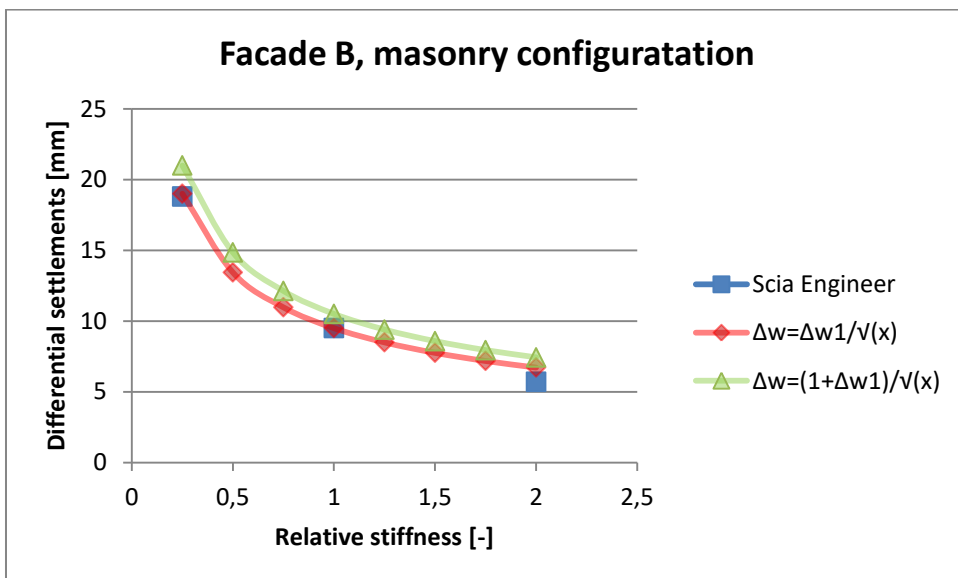
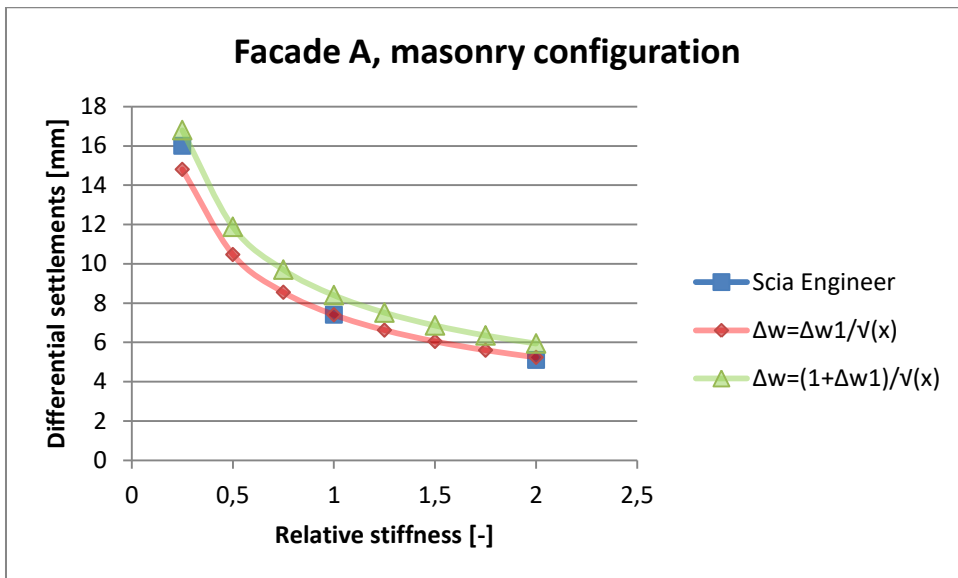
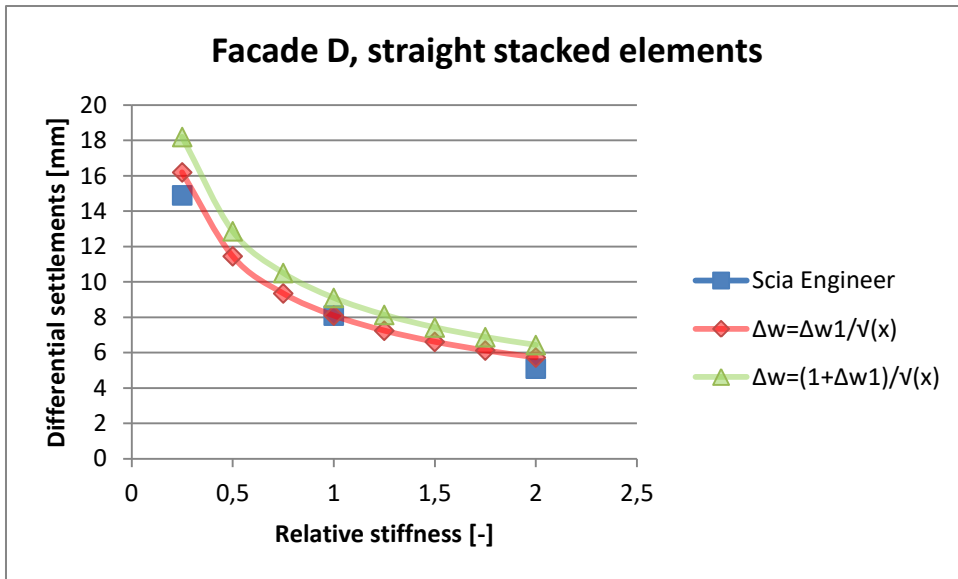

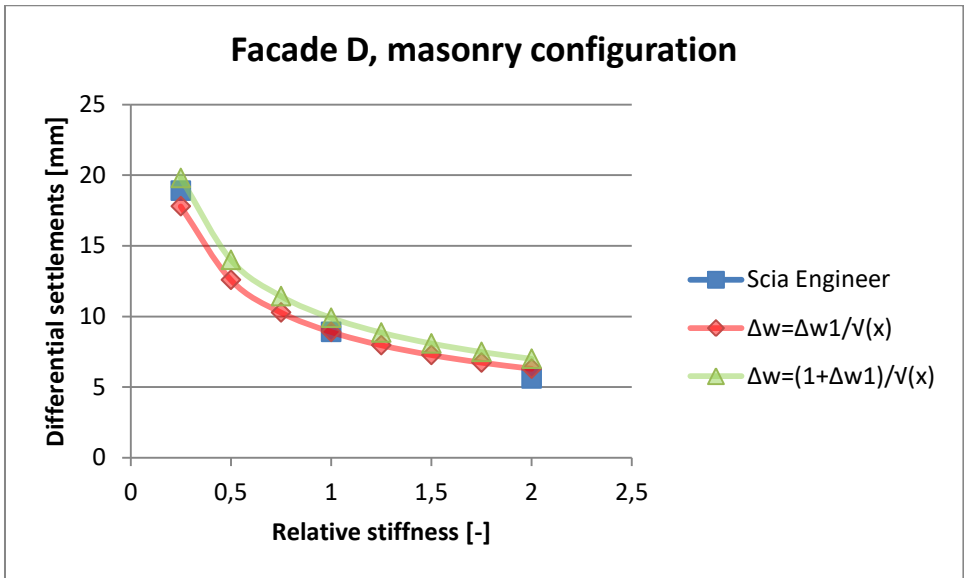
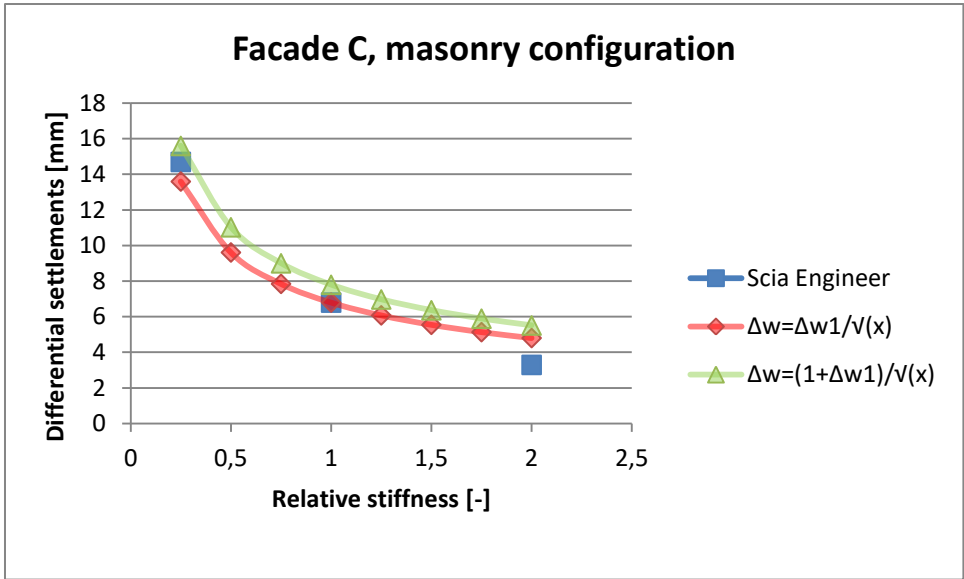

11.3) Other solutions

Also other options might reduce the differential settlements in the facade. This chapter will briefly explain these options.

The options that will be discussed are:

- using longer piles that go through the Kedichem layer
- using raking piles
- using different pile lengths

Use longer piles that go through the Kedichem layer

Underneath the layer of Kedichem, there is another sand layer that can bear the loads of the building.

When the used piles are going through the layer of Kedichem, the differential settlements due to settlements in the layer of Kedichem will not occur.

In order to construct a foundation that's going through the Kedichem layer, the piles need to be very long. The layer of Kedichem ends at approximately -50m N.A.P. so the piles need to be at least 50m long. These kind of piles are quite expensive, so basically this solution is usually not applied due to economical reasons.

In the city center of Rotterdam is a building called "Schielandshuis". This is an 17th century building, that is sensitive to settlements. Around this building there are several high-rise buildings. The foundation piles of this building go through the Kedichem layer, in order to prevent settlements of the "Schielandshuis".

Raking piles

By using raking piles, the load will be spread over a larger area in the subsoil. The stresses in the soil will be reduced, and due to this reduction of the stresses the total settlements will decrease.

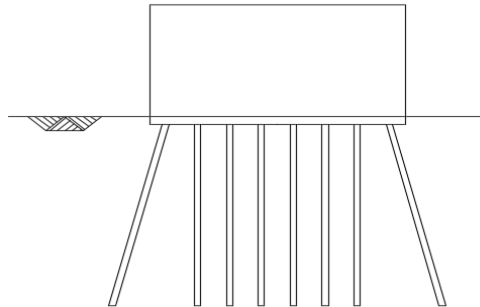

Figure 114 Raking piles

The settlement is calculated with the method of Terzaghi, Buisman, Koppejan formula.

This formula is: $\delta c = h * (\frac{1}{c_p} + \frac{1}{c_s} * \log(\frac{t}{t_0})) * \ln(\frac{pb+\Delta p}{pb})$

Where:

- δc = Settlement [mm]
- h= Thickness of the soil layer [mm]
- Cp= primary settlement coefficient [-]
- Cs= secondary settlement coefficient [-]
- t=time in days [days]
- t_0 = 1 day [days]
- pb= initial soil stress [N/mm²]
- Δp = increasement of the soil stress [N/mm²]

In words this equation says the settlement of the soil is a function of the height of the soil layer times the settlement coefficient times the time in days.

If raking piles are used, the area over which the load is spread in the subsoil will increase. Therefore Δp will decrease. All other constants in the formula above will not change, so only the term

$\ln(\frac{pb+\Delta p}{pb})$ will change.

The relation between the initial stress in the soil and the increasement of the soil stress is governing for the reduction of the total settlement.

When the increasement of the soil stress due to the building is far more than the initial stress in the soil, a reduction of the stress increasement is not causing a large difference in settlements in case no raking piles are used. A numerical example: assume that the initial stress in the soil is 100 kN/m² and the increasement of the soil stress due to the building is 400 kN/m². The factor $\ln(\frac{pb+\Delta p}{pb})$ will be $\ln(5)=1,609$. Now the load from the building is spread over a larger area, say 1.5 times the initial area over which the load is spread. The increasement of the stress in the soil will be $400/1.5= 267$ kN/m². The factor $\ln(\frac{pb+\Delta p}{pb})$ will be $\ln(367/100)=1,300$. The soil stress is reduced by 33% but the total settlement is reduced by 19%.

When the initial stress is higher than the increase of the stress in the soil due to the building, the use of raking piles is more efficient. If you assume the initial stress in the soil is 520 kN/m^2 , and the increase of the stress in the soil due to the building is 400 kN/m^2 the factor $\ln\left(\frac{pb+\Delta p}{pb}\right)$ will be 0,57. When the area over which the load from the building is spread over an area of 1,5 times the initial area over which the load was spread, the factor $\ln\left(\frac{pb+\Delta p}{pb}\right)$ will be 0.4143. This is a reduction of 27% compared to the initial value of $\ln\left(\frac{pb+\Delta p}{pb}\right)$, where the stress is reduced by 33%.

So when the initial stress in the soil is higher than the stress increase due to the new built building, the effect of spreading the loads over a larger area is more effective.

For the Cooltower this solution is not really suitable. By using raking piles at the facade, the facade will settle less, but at the core there is not much space to apply raking piles. So when raking piles are applied, the facade will settle less but the settlements of the core are not changed. This will cause an increase of the differential settlements between the core and the facade.

Different pile lengths

At the Kingdom Tower piles with different lengths are used. This caused that the piles are not in the influence width of each other. Basically multiple pile groups are created instead of one pile group. Due to the use of different pile lengths the differential settlements were highly reduced. In case of the Kingdom tower, the differential settlements are reduced from 70mm to 20mm, as seen in the picture below.

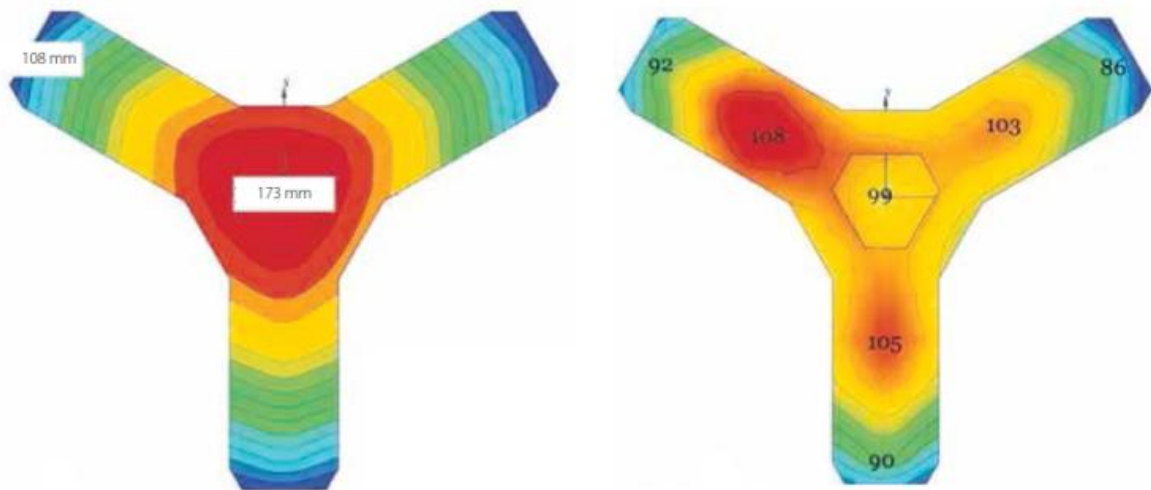

Figure 115 Differential settlements Kingdom Tower with and without different pile lengths [28]

The dimensions of the Kingdom tower are much larger than the dimensions of the Cooltower, so the piles are spread over a large area. In this case you can place piles that are not in the influence area of other pile groups.

The Cooltower is a smaller building on a compact building site, so the piles are placed closer to each other. In this case the piles of the pile group are in the influence area of each other. So by differing the pile lengths might not be very suitable to reduce the differential settlements for a tower on a compact building site.

12) Conclusion and recommendations

The main question that needs to be answered is: *Can a structure be adjusted to reduce the differential settlements caused by deformable soil.*

The settlements in the soil are depending on a lot of different factors. It depends on the stiffness of the soil, the stiffness of the building, the stiffness of the foundation and the force distribution in the structure. Therefore it is very hard to make an estimation of the settlements of the building during the design phase. Geotechnical calculations are needed to make a prediction of the total settlements.

The general conclusion of this research is that due to the many aspects that influence the differential settlements of the building it is very hard to make an estimation of the differential settlements of the building. The influence of the researched topics in this thesis on the differential settlements is quite small.

The connections between the facade elements don't influence the total stiffness of the structure, as is concluded from the 2D calculations. The openings in the facade influence the behavior of the structure on compressible soil the most.

The different element configurations for the facade influences the differential settlements of the facade. The facade built out of elements in masonry configuration acts less stiff than the facade with straight stacked elements. Therefore the differential settlements of the facade with elements in masonry configuration are slightly higher. This difference is caused by the vertical connections between the precast elements. In the facade with elements in masonry configuration there are no vertical connections between the elements. At the location of these vertical openings between the elements it is not possible to redistribute loads.

In the model with straight stacked elements there is a vertical connection between the elements, therefore the loads can be redistributed and the facade acts stiffer.

By adapting the floor connections it is possible to reduce the differential settlements between the facade and the core. Due to this change in floor connections, the internal forces will increase so the dimensions of the floors and the elements should be changed as well in order to be able to put enough reinforcement in the concrete. Therefore this solution is not really suitable.

The stiffness of the facade influences the differential settlements the most. When the facade is twice as stiff as the basic model that is used, the differential settlements will be reduced by 37% on average. When the stiffness of the facade is reduced to 25% of the initial stiffness of the facade, the differential settlements will be on average 2,2 times the differential settlements of the basic model.

The stiffness of the facades has the largest influence on the reduction of the differential settlements

Some aspects are not taken into account in the structural calculations. The creep of the concrete elements and the cracking of the concrete are not taken into account, but these aspects do influence the outcome of the calculations.

When the concrete is cracked the Youngs modulus will decrease, so the stiffness of the structure will be reduced. When the stiffness is reduced, the differential settlements will increase.

The creep of the concrete causes deformations in the concrete structure. When a structural calculation also contain creep effects of the concrete the deformations in the structure are larger than the case where the deformations are calculated taken in to account the Youngs modulus only.

The stiffness of the connection is also kept constant for each part of 7 floors of the structure. The cracking of the connection elements is also not taken into account, but in reality this will influence the stiffness of the structure.

In preliminary design, when the loads from the settlements are unknown, you can make an approximation of the loads due to the settlements. The loads caused by the differential settlements in the soil are approximately 10% to 15% of the loads caused by permanent and variable loads, where the variable loads are the momentane variable loads.

In preliminary design you can calculate the structure with a unity check of 0,85 instead of 1. In this case you already get some reserve capacity in the structure to deal with the loads caused by the differential settlements.

The change of the stiffness of the facade influences the differential settlements in the facade. When the first design is made and the settlements are calculated, it is possible to make an estimation of the reduction or increase of the differential settlements when the stiffness of the structure is changed. There is a relation between the relative stiffness and the differential settlements of a structure. This relation can be described by the formula:

$$\Delta u = (1 + \Delta u_1) / \lambda$$

where Δu = differential settlements adjusted wall [mm]
 Δu_1 = differential settlement of the basic model [mm]
 λ = relative stiffness [-]

The relative stiffness is the stiffness of the adjusted facade divided over the stiffness of the basic model you will use.

The constant 1 that is added to the differential settlement of the basic model is added to compensate for errors, so this formula gives for the considered structure a slightly higher value for the differential settlements than the differential settlements in the structure calculated with Scia Engineer.

This relation is only valid for the final settlements (settlements at $t=10.000$ days). This because the residual settlements after the completion of the structure still cause a change in force distribution in the structure.

This relation is valid for the used structure in this thesis, but it also has to be verified for other structures as well.

In this thesis the soil settlement calculations include the construction phases of the structure, to model the time depended settlements in the soil. If you're only interested in the final settlements of a structure, the weight of the total building can be entered at 1 time step. The settlements calculated in this way are slightly higher than the settlements that incorporate construction phases It saves a lot of time when the construction phases are not considered in the soil settlement calculation.

So in order to reduce differential settlements in a structure, the stiffness of the structure can be increased and an estimation of the new differential settlements can be made.

Also a soil model that incorporates the construction phases can be made to make a more detailed settlement calculation of the structure.

In this thesis the settlements are calculated by D-settlement, but also Plaxis can be used as well as D-pile group. The advantage of D-pile group is that the complete foundation can be modeled in this program, including interaction with the deeper soil layers.

Plaxis can also calculate complete foundations and the interaction between the piles and deeper soil layers.

Recommendations for further research.

-Creep of the concrete elements is not considered in this research, but creep causes an increase of the deformations of the structure.

-The cracking of the concrete should also taken into account in further research. Cracking of the concrete causes a reduction of the Youngs modulus, so the stiffness of the structure will be reduced. This reduction of the stiffness of the structure will increase the differential settlements of the structure.

- The results are valid for the considered structure, but it also needs to be checked whether the relation between the relative stiffness and the differential settlements hold for other structures as well.

- This thesis is focused on the complete structure and its behavior due to soil settlements. The calculations for the structure are not detailed. More research can be done with a more detailed calculation of the structure.

- Using raking piles might reduce the differential settlements in the structure. This is not studied during this thesis, but it might be interesting to research the effect of using raking piles on the differential settlements.

13) References

- [1] <http://www.vanwilsumvanloon.nl/architectuur/hoogbouw.html>
- [2] Hoge woongebouwen in de markt, Cement, 4:4-7,2006
- [3] A.W. Skempton, D.H. MacDonald, The allowable settlements of buildings, Structural paper no. 50, 10 may 1956
- [4] Zettingsberekening 100 Hoog, Geomet
- [5] ir. J. Fitoury, ir. J. Font Freide, Bijzondere oplossingen zettingen, Cement, 1:28-34, 2013
- [6] Eftychia Zoidi, Prediction of settlements for high-rise buildings on deformable soil, master thesis TU Delft, 2015
- [7] ir. J.J.M Font Freide, ir. D.P. Snijders, Verticale stad aan de Maas, Cement, 4:20-24, 2010
- [8] ir. J. Arts, ir. J. Luttmmer, In stijl omhoog, cement, 2:8-15, 2014
- [9] Zettingsberekening Maastoren, opdracht 055105, Mos Grondmechanica
- [10] NEN 6743-1:2006, Geotechniek- Berekeningsmethode voor funderingen op palen - Drukpalen
- [11] prof. ir. A.F. van Tol, Foundation Engineering and Underground Construction, TU Delft, 2006
- [12] NEN-EN 1997-1+C1:2012/NB:2012 Eurocode 7: Geotechnisch ontwerp- Deel 1: Algemene regels
- [13] Manual D-settlement, Deltares, 2014
- [14] Dictaat CIE 4281, Designing and Understanding Precast Concrete Structures in Buildings, TU Delft, 2012
- [15] FIB Bulletin 74, Planning and design handbook on precast building structures
- [16] M.M.J. Falger, Geprefabriceerde betonnen stabiliteitsconstructies met open verticale voegen in metselwerkverband, master thesis TU Delft, 2002
- [17] F van der Blij, Dipl. -ing. K. Klatt, Constructieve verbindingen met verbindingslus, Cement, 3:50-52, 2008
- [18] ir. D.C. van Keulen, EEM en prefab beton, Cement,3:60-65, 2014
- [19] NEN-EN 1992-1-1 Ontwerp en berekening van betonconstructies, deel 1 Algemene regels voor gebouwen
- [20] D.C. van Keulen, J. Vamberský, Design and displacements of precast concrete shear wall structures, TU Delft, 2013
- [21] Sven ten Hagen, literature study The Zalmhaven tower, Master thesis, TU Delft, 2012
- [22] drs. J.W.M Salemans, A.D. Hartman, Nieuwbouw Erasmus Medisch Centrum: geotechnisch advies, 2e fase grondonderzoek, Deltares, 2009
- [23] ir. H.L. Jansen, Funderingsadvies betreffende herontwikkeling "First Rotterdam", Fugro GeoServices, 2011
- [24] ir. K.V. Tolsma, Precast concrete cores in high-rise buildings, Master thesis, TU Delft, 2010
- [25] NEN-EN-1991-1-4+NB, Eurocode 1: Belastingen op constructies, deel 1-4 Algemene belastingen-windbelastingen.
- [26] Tabellen en grafieken, bijlage bij basiskennis beton, Aeneas media, 2016
- [27] dr. ir. drs. C.R. Braam, ir. P. Lagendijk, Constructieleer gewapend beton, Aeneas media 2011
- [28] ir. P. Lagendijk, Eenvoudige constructie hoogste gebouw ter wereld, Cement, 5:11-17, 2016

Appendix A) Introduction of the forced displacements in Scia Engineer

The results of the D-settlement calculation are applied as forced displacements in the Scia-model.

The settlement will be converted into a concentrated load, by using the formula:

$$F_{\text{settlement}} = ((w * E * A) / L) / 1000 \text{ [kN]} \quad \text{where:}$$

w = settlement calculated by D-settlement [mm]

$E = 1.000.000 \text{ [N/mm}^2\text{]}$

$A = 1.000.000 \text{ [mm}^2\text{]}$

$L = 1000 \text{ [mm]}$

This concentrated load will be put on a fictive element of $1\text{m} * 1\text{m} * 1\text{m}$ with a Young's modulus of $1.000.000 \text{ N/mm}^2$

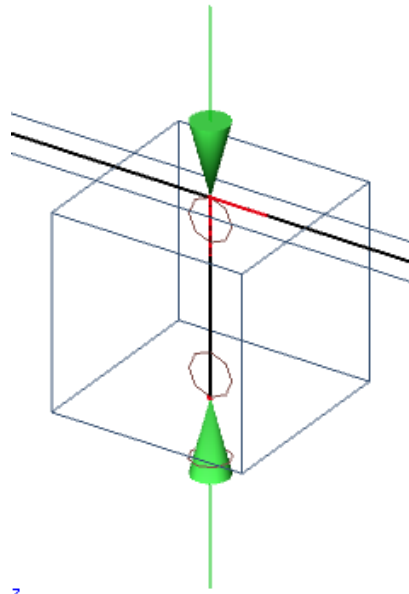

Figure 116 Fictive element to introduce the D-settlement results into Scia

There are two methods to model this force displacement in Scia Engineer:

Method 1: The location of the fictive element where the forced displacement will be introduced as a load is between the piles and the structure. In this case the piles have to be schematized as spring supports with a spring stiffness of the piles as calculated by a geotechnical calculation.

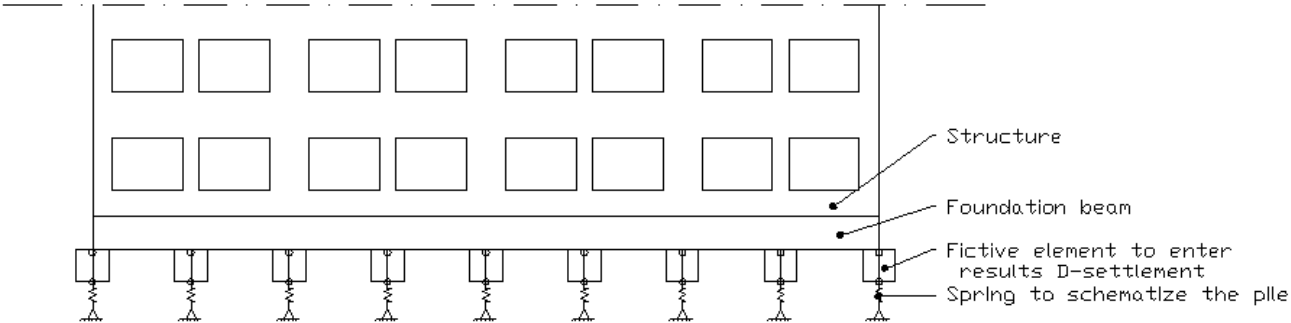

Figure 117 Method 1, fictive element to introduce the settlements is placed between piles and structure

In reality the forced displacement takes place under the pile tip, not between the structure and the piles. In method 2 the forced displacement is modeled underneath the piles.

Method 2: In order to apply the forced displacement underneath the piles, the piles have to be schematized as well. In that case the pile should be modeled as an element with a stiffness according to the calculated pile stiffness. The pile stiffness is modeled as an element with $A=1m*1m$, $L=1m$ and $E=92000kN/m^2$, in case the stiffness of the piles is 92000 kN/m. It is not possible to model the piles according to the actual dimensions of the pile, because the pile stiffness also depends on the soil conditions. In this case the support is not a spring but a pinned support, as seen in the figure below.

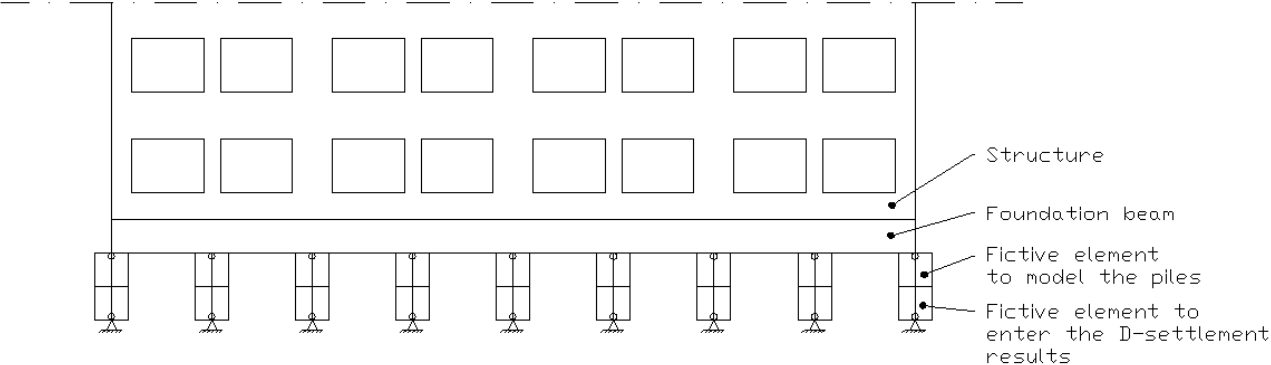

Figure 118 Method 2, settlements introduced under the piles

For a high wall with window openings a comparison between those schematizations is made. The results of the support reactions and the settlements of the structure are shown in the tables below.

Table 13 Support reactions

x	Method 1	Method 2
-12	7212,27	7212,31
-9	5975,9	5975,92
-6	5437,4	5437,41
-3	5061,54	5061,54
0	4863,74	4863,74
3	5061,87	5061,87
6	5433,5	5433,5
9	5979,8	5979,81
12	7212,73	7212,75

Table 14 Settlements

x	Method 1	Method 2
-12	-124,4	-124,4
-9	-129	-129
-6	-132,1	-132,1
-3	-133	-133
0	-133,9	-133,9
3	-133	-133
6	-132,1	-132,1
9	-129	-129
12	-124,4	-124,4

Conclusion

For the final results it doesn't matter which method is used to enter the settlements as calculated by D-settlement in Scia Engineer. But it is faster to use method 1, placing the fictive block element between the structure and the foundation and model the piles as springs, because in this case you don't have to add an additional element to model the piles.

Appendix B) Numerical comparison method 1 (contact-shape factor) and method 2 (direct method) for the settlement calculation.

B.1) Assumptions

The dimensions of the wall are 24m x 96m. The thickness of the wall is 300mm. The size of the elements is 6m x 3m with 2 window openings of 2.15m x 1.6m.

The horizontal connection between the elements is a connection with protruding bars. The stiffness of the connection is: $u_x = 1.08 \cdot 10^6 \text{ kN/m}^2$ and $u_y = 2.04 \cdot 10^7 \text{ kN/m}^2$

The vertical connection between the elements is a connection with welded steel plates. The stiffness of the connection is: $u_x = 1.68 \cdot 10^5 \text{ kN/m}^2$ and $u_y = 2.47 \cdot 10^8 \text{ kN/m}^2$ (see chapter 5.1.3)

The precast concrete elements are made of concrete class C50/60, with an E-modulus of 37300 N/mm^2 . No reduction of the E-modulus of cracked concrete is used.

The wall will carry 4m of floor. The floor has a thickness of 300mm

Loads: Only permanent loads will be applied on the structure.

Permanent load of a single precast element: $6[\text{m}] \cdot 3[\text{m}] \cdot 0.3[\text{m}] \cdot 25[\text{kN/m}^3] = 135[\text{kN}]$.

Permanent load floor: $4[\text{m}] \cdot 0.3[\text{m}] \cdot 25[\text{kN/m}^2] = 30 \text{ kN/m}$

B.2) Method 1, contact shape factor

Step 1

In step 1 the initial support reactions will be calculated in Scia. The initial support reactions are the support reactions due to the permanent load on the structure.

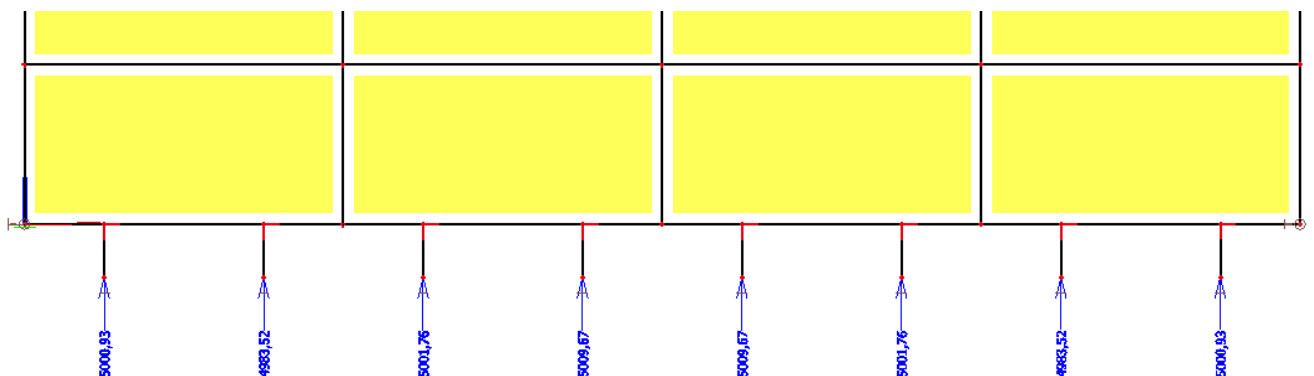

Figure 119 Initial support reactions

The initial support reactions are shown in the figure above.

The area over which the support reactions are spread are shown in the figure below.

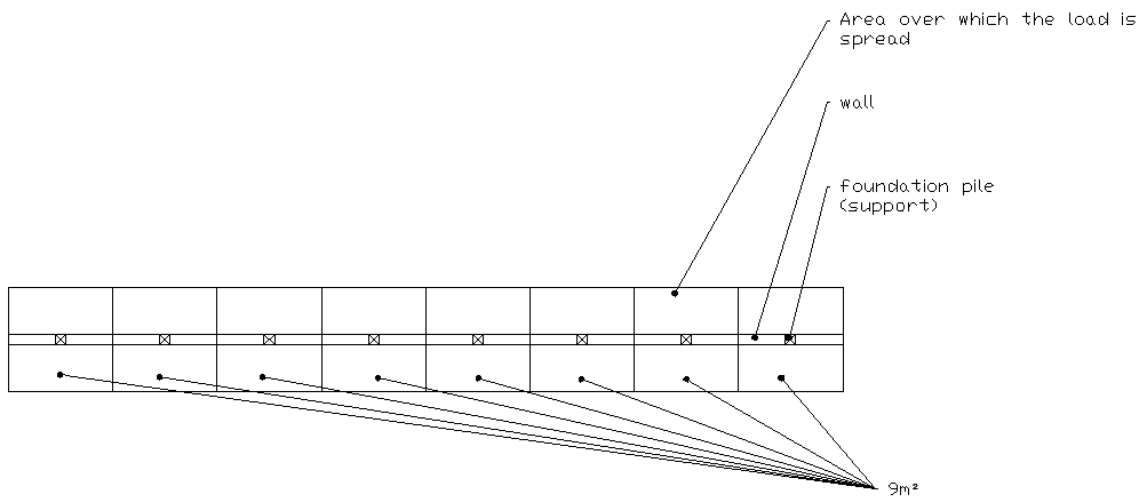

Figure 120 Load spread area

The table below shows the result of the first step. The column with P [kN/m²] shows the stress as entered in D-settlement.

x [m]	Rz [kN]	A [m ²]	P [kN/m ²]
-10,5	5000,93	9	556
-7,5	4983,52	9	554
-4,5	5001,76	9	556
-1,5	5009,67	9	557
1,5	5009,67	9	557
4,5	5001,76	9	556
7,5	4983,52	9	554
10,5	5000,93	9	556

Due to imperfections in the structure, the supports slightly differ from each other. But the differences are so small that is assumed that the stress on the soil is everywhere equal to 555 kN/m².

In the first approach the contact shape factor is 1,0.

Step 2

The results of step 1 are entered into D-settlement.

The settlements calculated by D-settlement are:

1st iteration	a=1
x [m]	u [mm]
-10,5	26
-7,5	31
-4,5	34
-1,5	35
1,5	35
4,5	34
7,5	31
10,5	26

Step 3

The settlements calculated in step 2 are entered as a forced displacement in Scia Engineer.

Due to the forced displacements the forces in the structure are redistributed, resulting in new support reactions.

The new support reactions due to the displacement calculated by D-settlement is shown in the table below.

x [m]	Rz [kN]	A [m ²]	q1 [kN/m ²]
-10,5	5939,94	9	660
-7,5	5079,6	9	564
-4,5	4570,92	9	508
-1,5	4405,41	9	489
1,5	4405,41	9	489
4,5	4570,92	9	508
7,5	5079,6	9	564
10,5	5939,94	9	660

Step 4

A new contact shape factor will be determined in order to fit the stress q_1 calculated by the first iteration.

In the formula $q_{(x,z)} = P \left\{ \alpha + \frac{12(1-\alpha)}{(X+Z)} \left[X \left(\frac{Z}{Z} \right)^2 + Z \left(\frac{x}{X} \right)^2 \right] \right\}$ the α -factor will be adjusted to give an as close as possible approximation to the actual stress that is calculated with Scia Engineer.

It is impossible to create a perfect fit from the actual load distribution as calculated in Scia and the theoretical load distribution from the formula. To determine the best fit of the actual load distribution and the theoretical load distribution, the least square method is used.

After the first iteration the contact shape factor is 0,66.

contact shape factor		0,66	
x [m]	q [kN/m ²] (actual)	q [kN/m ²] (theoretical)	
-10,5	916	918	
-7,5	553	615	
-4,5	410	431	
-1,5	342	367	
1,5	347	367	
4,5	402	431	
7,5	561	615	
10,5	912	918	

Step 5

The new contact shape factor of 0,66 is entered in D-settlement. The calculated settlements are as follows:

2nd iteration		a=0.66	
x [m]	u [mm]		
-10,5	25		
-7,5	30		
-4,5	33		
-1,5	34		
1,5	34		
4,5	33		
7,5	30		
10,5	25		

These settlements are entered again in Scia Engineer.

Step 6

The new support reactions calculated by Scia are as follows:

x[m]	Rz [kN]	A [m ²]	q [kN/m ²]
-10,5	7982,2	9	887
-7,5	4694,1	9	522
-4,5	3968,07	9	441
-1,5	3336,82	9	371
1,5	3389,7	9	377
4,5	3902,63	9	434
7,5	4769,16	9	530
10,5	7949,08	9	883

Step 7

The new contact shape factor is 0.69

contact shape factor		0,69
x [m]	q [kN/m ²] (actual)	q [kN/m ²] (theoretical)
-10,5	887	886
-7,5	522	609
-4,5	441	442
-1,5	371	384
1,5	377	384
4,5	434	442
7,5	530	609
10,5	883	886

The new settlements with the contact shape factor of 0.69 are:

3rd iteration		a=0.66
x [m]	u [mm]	
-10,5	26	
-7,5	31	
-4,5	33	
-1,5	34	
1,5	34	
4,5	33	
7,5	31	
10,5	26	

When these settlements are entered in Scia the support reactions will be:

x[m]	Rz [kN]	A [m ²]	q [kN/m ²]
-10,5	7993,3	9	877
-7,5	4788,1	9	532
-4,5	4032,3	9	448
-1,5	3411,6	9	379
1,5	3465,7	9	385
4,5	3969,4	9	441
7,5	4860,1	9	540
10,5	7875,6	9	875

The new contact shape factor will be 0.69

contact shape factor		0,69	
x [m]	q [kN/m ²] (actual)	q [kN/m ²] (theoretical)	
-10,5	877	886	
-7,5	532	609	
-4,5	448	442	
-1,5	379	384	
1,5	385	384	
4,5	441	442	
7,5	540	609	
10,5	875	886	

The final contact shape factor will be 0.69

B.3) Method 2, direct method

Initial situation

The reaction forces are evenly distributed, the table below shows the stress that is applied to the soil.

support reactions			
x [m]	Rz [kN]	A [m ²]	q D-settlement [kN/m ²]
-10,5	4998,87	9	555
-7,5	4995,9	9	555
-4,5	4999,58	9	556
-1,5	5001,52	9	556
1,5	5001,52	9	556
4,5	4999,58	9	556
7,5	4995,9	9	555
10,5	4998,87	9	555

These values are entered in D-settlement, the calculated settlements are:

Settlement calculation	
x [m]	w2 [mm]
-10,5	26
-7,5	31
-4,5	34
-1,5	35
1,5	35
4,5	34
7,5	31
10,5	26

These settlements are entered in Scia as a forced displacement.

Iteration 1

Due to the application of the settlements in Scia Engineer, the force distribution will change.

The new support reactions are:

support reactions			
x [m]	Rz [kN]	A [m ²]	q D-settlement [kN/m ²]
-10,5	8468,32	9	941
-7,5	5252,26	9	584
-4,5	3416,06	9	380
-1,5	2859,24	9	318
1,5	2859,24	9	318
4,5	3416,06	9	380
7,5	5252,26	9	584
10,5	8468,32	9	941

The settlements due to this new load distribution are:

Settlement calculation	
x [m]	w2 [mm]
-10,5	29
-7,5	31
-4,5	30
-1,5	30
1,5	30
4,5	30
7,5	31
10,5	29

Iteration 2

The new support reactions due to the new settlements are:

support reactions			
x [m]	Rz [kN]	A [m ²]	q D-settlement [kN/m ²]
-10,5	5663,73	9	629
-7,5	4298,57	9	478
-4,5	5018,32	9	558
-1,5	5015,26	9	557
1,5	5015,26	9	557
4,5	5018,32	9	558
7,5	4298,57	9	478
10,5	5663,73	9	629

Settlement calculation	
x [m]	w2 [mm]
-10,5	27
-7,5	31
-4,5	34
-1,5	35
1,5	35
4,5	34
7,5	31
10,5	27

Iteration 3

support reactions			
x [m]	Rz [kN]	A [m ²]	q D-settlement [kN/m ²]
-10,5	7984,9	9	887
-7,5	5433,69	9	604
-4,5	3571,69	9	397
-1,5	3005,6	9	334
1,5	3005,6	9	334
4,5	3571,69	9	397
7,5	5433,69	9	604
10,5	7984,9	9	887

Settlement calculation	
x [m]	w2 [mm]
-10,5	29
-7,5	31
-4,5	31
-1,5	30
1,5	30
4,5	31
7,5	31
10,5	29

Iteration 4

support reactions			
x [m]	Rz [kN]	A [m ²]	q D-settlement [kN/m ²]
-10,5	5819,35	9	647
-7,5	4472,94	9	497
-4,5	4503,72	9	500
-1,5	5199,87	9	578
1,5	5199,87	9	578
4,5	4503,72	9	500
7,5	4472,94	9	497
10,5	5819,35	9	647

Settlement calculation	
x [m]	w2 [mm]
-10,5	27
-7,5	31
-4,5	33
-1,5	35
1,5	35
4,5	33
7,5	31
10,5	27

Iteration 5

support reactions			
x [m]	Rz [kN]	A [m ²]	q D-settlement [kN/m ²]
-10,5	7829,27	9	870
-7,5	5259,33	9	584
-4,5	4086,29	9	454
-1,5	2821	9	313
1,5	2821	9	313
4,5	4086,29	9	454
7,5	5259,33	9	584
10,5	7829,27	9	870

Settlement calculation	
x [m]	w2 [mm]
-10,5	29
-7,5	31
-4,5	31
-1,5	31
1,5	31
4,5	31
7,5	31
10,5	29

Iteration 6

support reactions			
x [m]	Rz [kN]	A [m ²]	q D-settlement [kN/m ²]
-10,5	5965,72	9	663
-7,5	4633,04	9	515
-4,5	4688,32	9	521
-1,5	4708,8	9	523
1,5	4708,8	9	523
4,5	4688,32	9	521
7,5	4633,04	9	515
10,5	5965,72	9	663

Settlement calculation	
x [m]	w2 [mm]
-10,5	27
-7,5	31
-4,5	33
-1,5	34
1,5	34
4,5	33
7,5	31
10,5	27

Iteration 7

support reactions			
x [m]	Rz [kN]	A [m ²]	q D-settlement [kN/m ²]
-10,5	7682,91	9	854
-7,5	5099,22	9	567
-4,5	3901,68	9	434
-1,5	3312,07	9	368
1,5	3312,07	9	368
4,5	3901,68	9	434
7,5	5099,22	9	567
10,5	7682,91	9	854

Settlement calculation	
x [m]	w2 [mm]
-10,5	29
-7,5	31
-4,5	31
-1,5	31
1,5	31
4,5	31
7,5	31
10,5	29

The settlements are the same as the settlements in step 5, so step 7 is the final iteration step.

After 7 iteration steps, the final settlements are calculated. The settlements from step 7 are equally distributed over the length of the wall, this implies that the structure is infinitely rigid. This is not realistic, because a structure can't be infinitely stiff.

The settlements of iteration step 6 are far more realistic. These results implies that the structure has some flexibility.

The settlements from step 6 are:

Settlement calculation	
x [m]	w2 [mm]
-10,5	27
-7,5	31
-4,5	33
-1,5	34
1,5	34
4,5	33
7,5	31
10,5	27

These are the final settlements of the structure.

B.3) Conclusion

The final settlements from both methods is shown in the table below.

Settlement calculation		
x [m]	Method 1 (contact shape factor) w2 [mm]	Method 2 (direct method) w2 [mm]
-10,5	26	27
-7,5	31	31
-4,5	34	34
-1,5	35	35
1,5	35	35
4,5	34	34
7,5	31	31
10,5	26	27

The results from both methods are the same, only at the edges the settlements differ 1mm. This difference can also be less because of rounding of the calculated settlements, D-settlement calculates settlements without decimals.

For this case the method where the α -factor is optimized is the preferred method. The calculated settlements are accurate and it is a rather quick method to calculate the settlements.

The second method is more realistic, because the actual redistribution of the loads is entered in D-settlement, but this method takes more time to be calculated, because every single settlement has to be entered in SCIA Engineer.

In the case of this wall, the final load distribution had apparently a parabolic shape, but this doesn't have to be. In case the load distribution is not in a parabolic shape, the method where the actual load distribution is entered in D-settlement is more preferable to use, although this takes more time.

Appendix C) Choice of the structural FEM program.

Most of the calculations in this thesis will be made with use of a finite element program. There are several different FEM programs, but for this thesis only a comparison between AxisVM and Scia Engineer are made. Scia is chosen because most of the supervisors and the people working at Zonneveld Ingenieurs are familiar with that software, and AxisVM is chosen because older research concluded that this software is more suitable to calculate precast concrete structures. A small research study was done to compare AxisVM and Scia Engineer, and to try to reproduce the outcome of the research of Mr. Van Keulen and Mr. Vambersky. [20]

C.1) Set up of the research

In this research a comparison between a monolithic wall and a precast wall will be modeled. The walls will be 61.2m high, 30.6m wide and 400mm thick. The slenderness of the wall is calculated as the height divided over the width of the structure, so it will be 2:1. The concrete class is for the precast and the monolithic wall C40/50. The walls are clamped at the bottom.

The storey's of the building are 3.6m high.

The different models will be compared on the maximum displacements at the top of the wall. The displacements are calculated with a load combination of 1x the horizontal load and 1x the vertical load.

C.1.1) Loads

The vertical force on each storey is 35kN/m.

The horizontal force on each storey is 20kN/m.

These values are theoretic values, not based on actual loads.

A.1.2) Element division

The precast wall will consist out of elements with a height of 3.6m and a width of 7.2m or 3.6m.

The elements are in a masonry configuration, with open vertical connections.

C.1.3) Connections

The vertical connections are modeled as real openings of 20mm.

The connection stiffness of the horizontal connections is modeled as a normal mortar connection as described in the research of Van Keulen [20].

The dimensions of $K_{x, \text{AxisVM}}$ are written as kN/m/m to emphasize that the connections stiffness is in kN/m per meter of connection length.

The values of the connection stiffness are shown in the table below, where K_x is the shear stiffness, K_y is the normal stiffness and K_z is the out of plane shear stiffness. The rotational stiffness K_{xx} , K_{yy} and $K_{zz}=0$.

Connection stiffness	kN/m ²
K_x	1.8e+6
K_y	3.4e+7
K_z	1e+7

The orientation of the local axis of the connection is for both FEM programs the same [fig. 30 &31]



Figure 121 Orientation local axes of connections in AxisVM

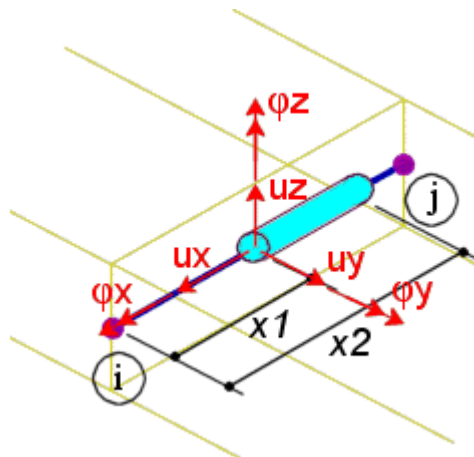

Figure 122 Orientation local axes of connections in Scia Engineer

C.2) Results AxisVM

AxisVM is a FEM program that is a user friendly FEM program, without a steep learning curve. The main advantage of AxisVM is the possibility of making non-linear connections between the precast elements. Also a lot of master theses and other examples are made with the use of AxisVM. A disadvantage of this software is that nobody in the committee is familiar with this software, and that the stiffness of the connection doesn't depend on the width of the connection. It is assumed that the connection width is equal to the thickness of the element.

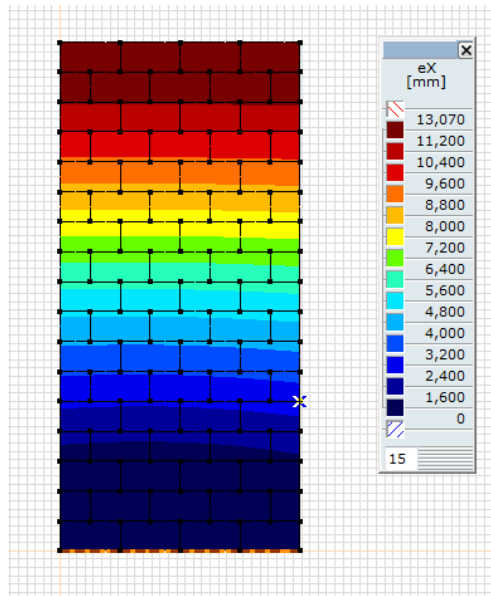

Figure 123 Monolithic wall AxisVM

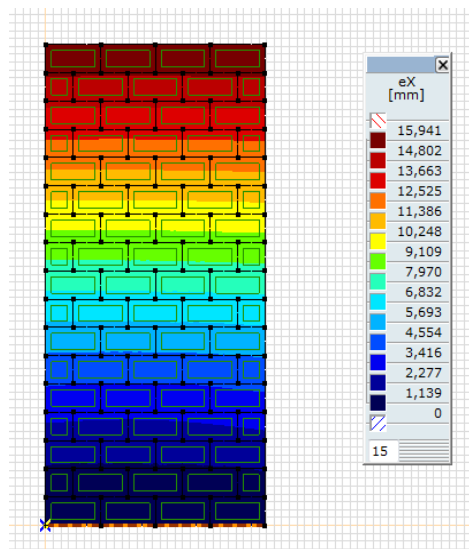

Figure 124 Precast wall AxisVM

C.3) Results Scia Engineer

Scia engineer is a FEM that is also quite user friendly, but there are a lot of hidden options in the program. The main advantage of using Scia engineer is that this is the program used by Zonneveld Ingenieurs and by other members of the committee, so they can help me when problems occur.

In Scia it is also possible to model non-linear elements, but this is hidden in the menu of the program.

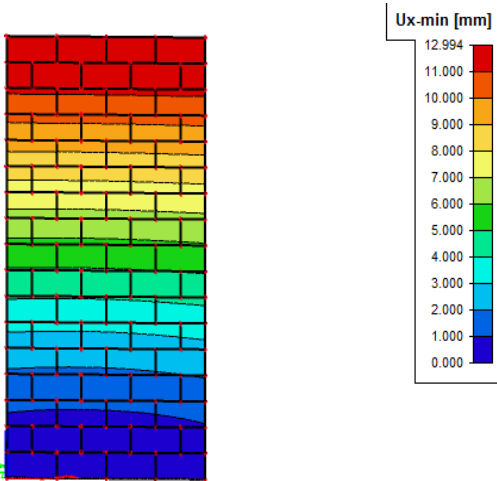

Figure 125 Monolithic Scia Engineer

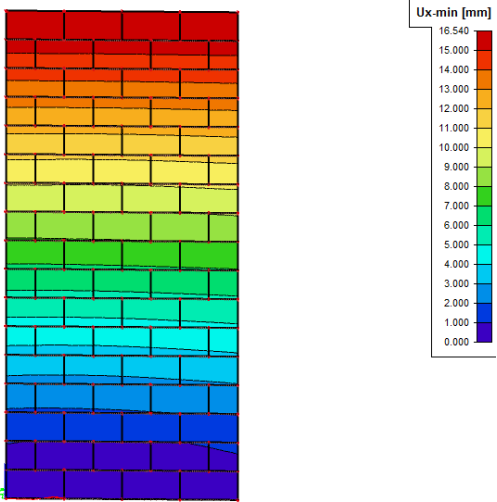

Figure 126 Precast Scia Engineer

C.4) Conclusion

In one master thesis there was a mistake made in the comparison between AxisVM and Scia Engineer[22]. The mesh-refinement should get special attention. AxisVM automatically refines the mesh when a hinged connection between two elements is made, in Scia Engineer the mesh-refinement should be entered manually. When the mesh-refinement is not applied in Scia, the differences between the results from AxisVM and Scia Engineer are around 6%-8%. This is not acceptable.

Table 15 Comparison horizontal displacements

	AxisVM	Scia Engineer	Relative difference (Scia Engineer /AxisVM) [-]
Monolithic wall	13.070 mm	12.994 mm	99%
Precast wall	15.941 mm	16.54 mm	103%

The differences between the results obtained from AxisVM and Scia Engineer are small. The largest difference is about 3%. This difference can be explained due to the different element shapes and the different mesh refinement of the elements at the location of the connections. The differences can be reduced by choosing an even finer mesh size and more mesh refinements in the Scia model, but due to this the calculation time will highly increase.

Appendix D) Tables for concrete design

The tables are from the book: Basiskennis beton, tabellen en grafieken

Tabel 25 Grenswaarden voor schuifspanning v_{min} in N/mm^2

	d (mm)	200	225	250	275	300	350	400	450	500	600	750
	k	2,00	1,94	1,89	1,85	1,82	1,76	1,71	1,67	1,63	1,58	1,52
sterkte- klasse	f_{ck} (N/mm^2)	v_{min} (N/mm^2)										
C20/25	20	0,44	0,42	0,41	0,39	0,38	0,36	0,35	0,34	0,33	0,31	0,29
C25/30	25	0,49	0,47	0,46	0,44	0,43	0,41	0,39	0,38	0,37	0,35	0,33
C30/37	30	0,54	0,52	0,50	0,48	0,47	0,45	0,43	0,41	0,40	0,38	0,36
C35/45	35	0,59	0,56	0,54	0,52	0,51	0,48	0,46	0,45	0,43	0,41	0,39
C40/50	40	0,63	0,60	0,58	0,56	0,54	0,52	0,49	0,48	0,46	0,44	0,41
C45/55	45	0,66	0,64	0,61	0,59	0,57	0,55	0,52	0,51	0,49	0,47	0,44
C50/60	50	0,70	0,67	0,65	0,62	0,61	0,58	0,55	0,53	0,52	0,49	0,46
C55/67	55	0,73	0,70	0,68	0,65	0,64	0,60	0,58	0,56	0,54	0,51	0,48

Tabel 26 Weerstand van beton-drukdiagonalen uitgedrukt in een spanning, $v_{Rd,max}$

	$\cot \theta$	2,50	2,14	1,73	1,43	1,19	1,00		
	θ	21,8°	25°	30°	35°	40°	45°		
sterkte- klasse	f_{ck} (N/mm^2)	$v_{Rd,max}$ (N/mm^2)							ν
C20/25	20	2,28	2,54	2,87	3,11	3,26	3,31	0,552	
C25/30	25	2,79	3,11	3,51	3,80	3,99	4,05	0,540	
C30/37	30	3,28	3,65	4,12	4,46	4,68	4,75	0,528	
C35/45	35	3,74	4,16	4,69	5,09	5,34	5,42	0,516	
C40/50	40	4,17	4,64	5,24	5,68	5,96	6,05	0,504	
C45/55	45	4,58	5,09	5,76	6,24	6,54	6,64	0,492	
C50/60	50	4,97	5,52	6,24	6,76	7,09	7,20	0,480	
C55/67	55	5,33	5,92	6,69	7,26	7,60	7,72	0,468	
uitgangspunten tabel: verticale dwarskrachtwapening $z = 0,9 d$ $\nu = 0,6 (1 - f_{ck}/250)$									