

DRAWING SET



CRAILOKWARTIER 1:1000



MASTERPLAN 1:500



EXISTING KITCHEN BUILDING

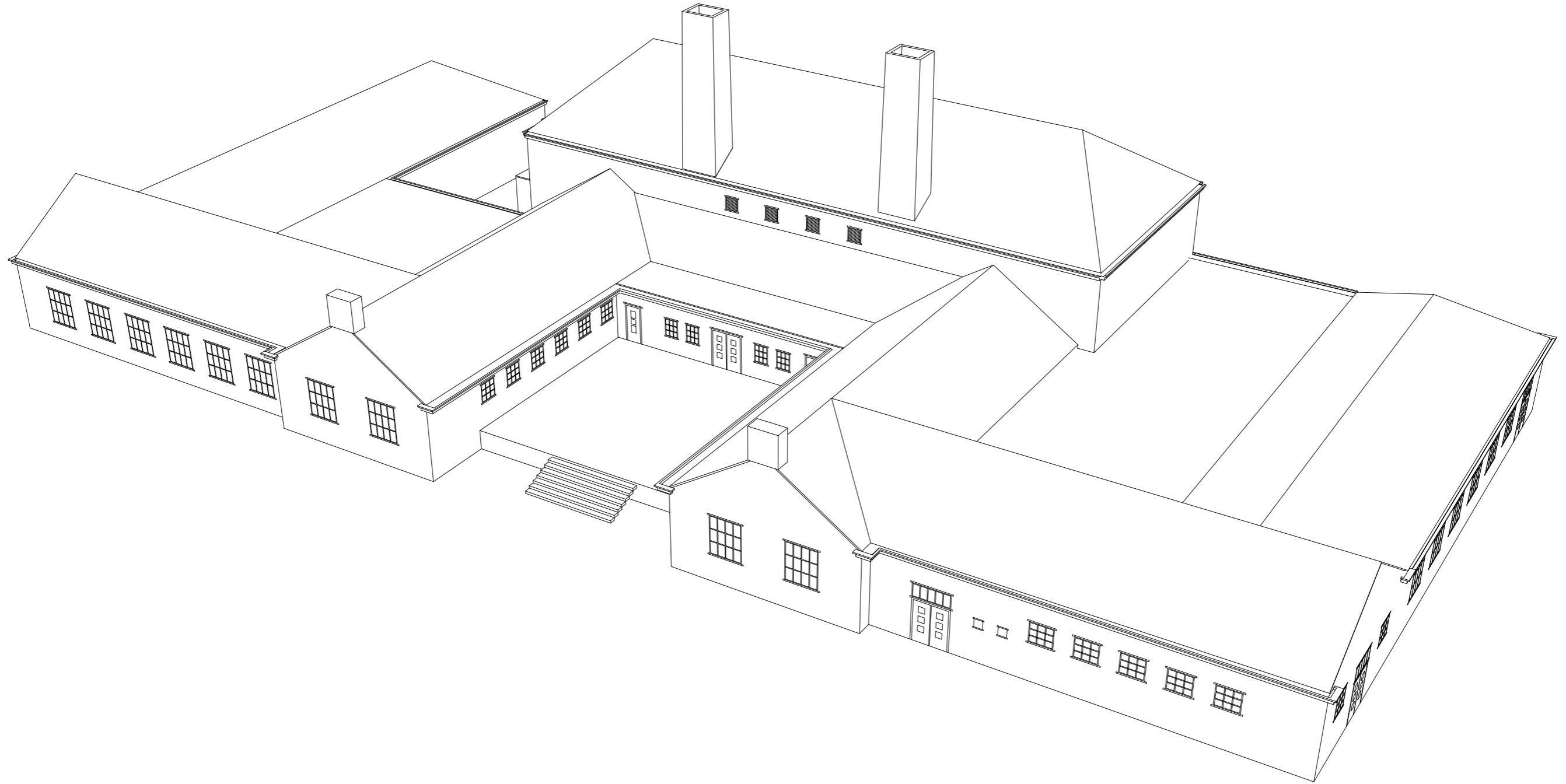

CONCEPT

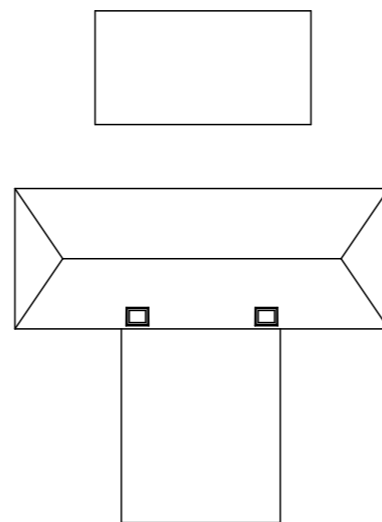
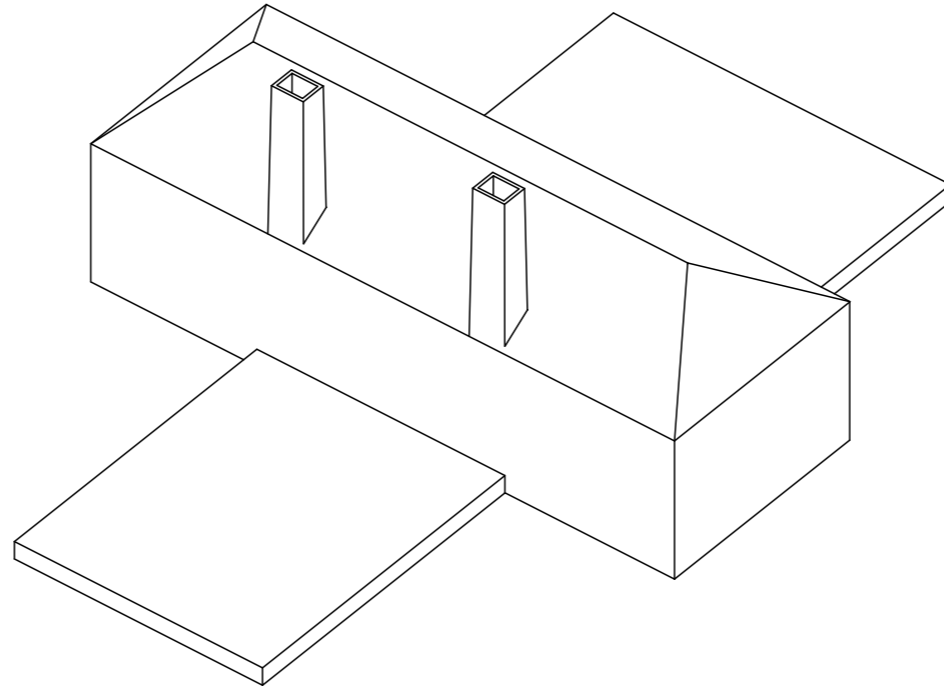

CONCEPT

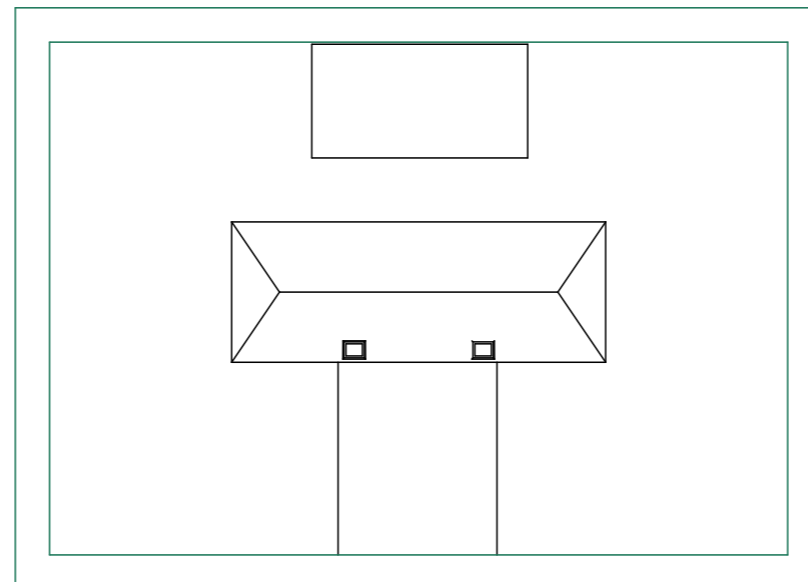
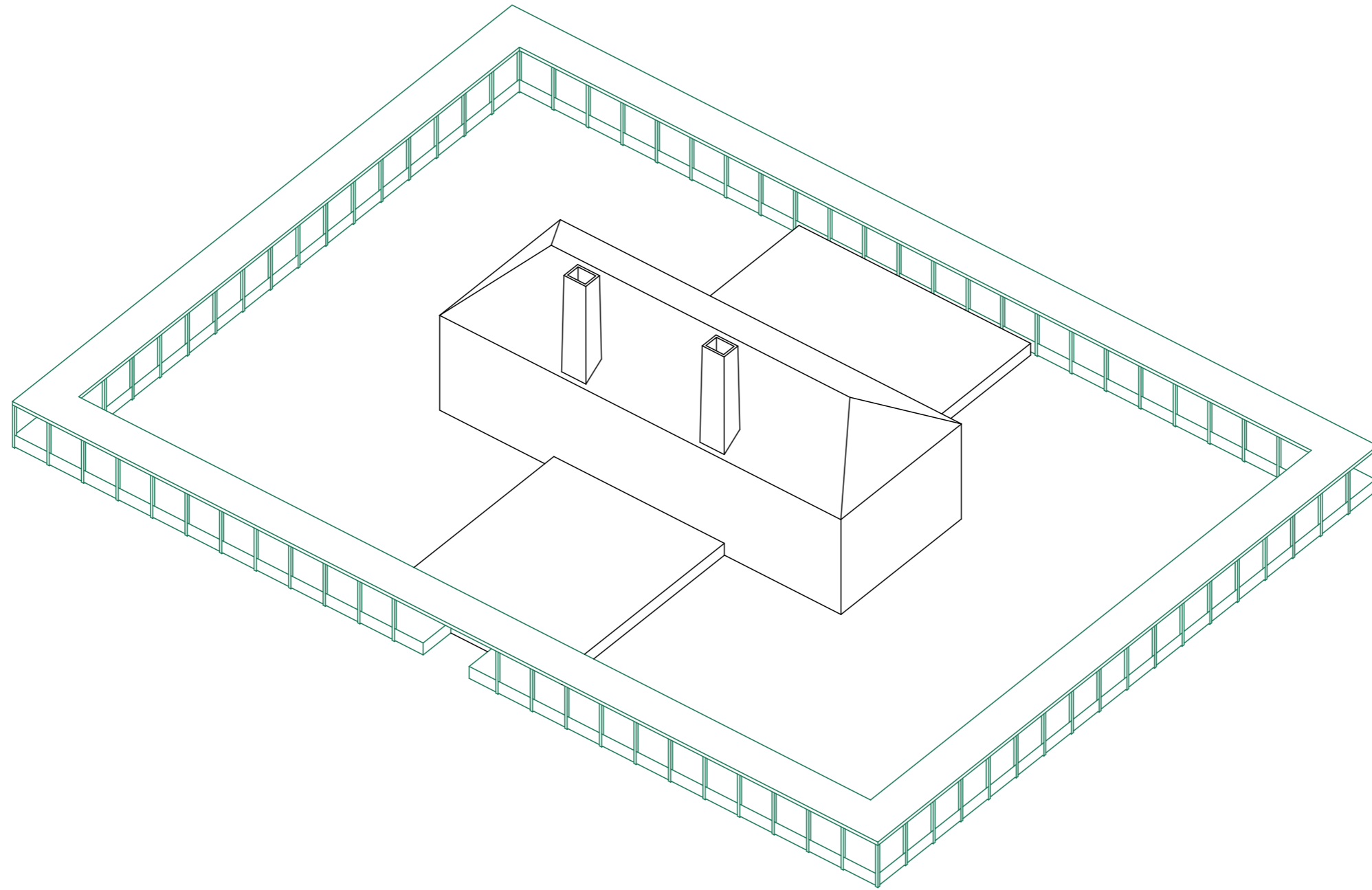

CONCEPT

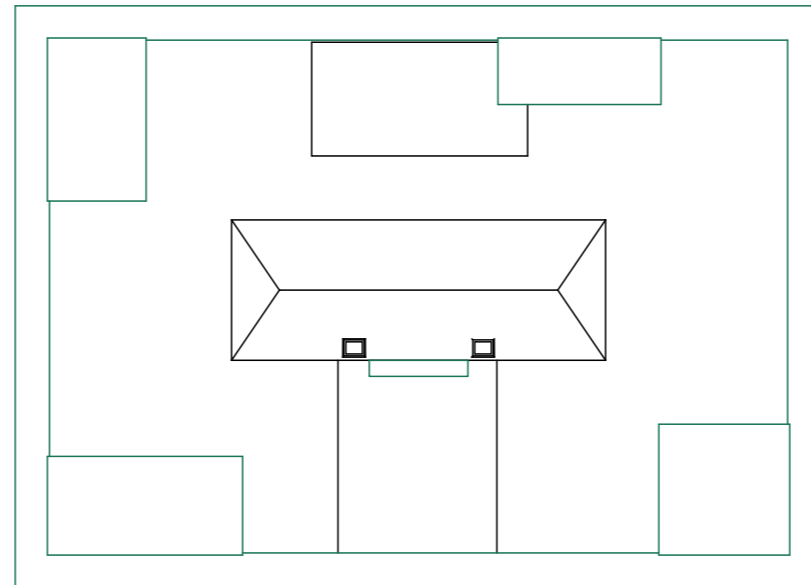
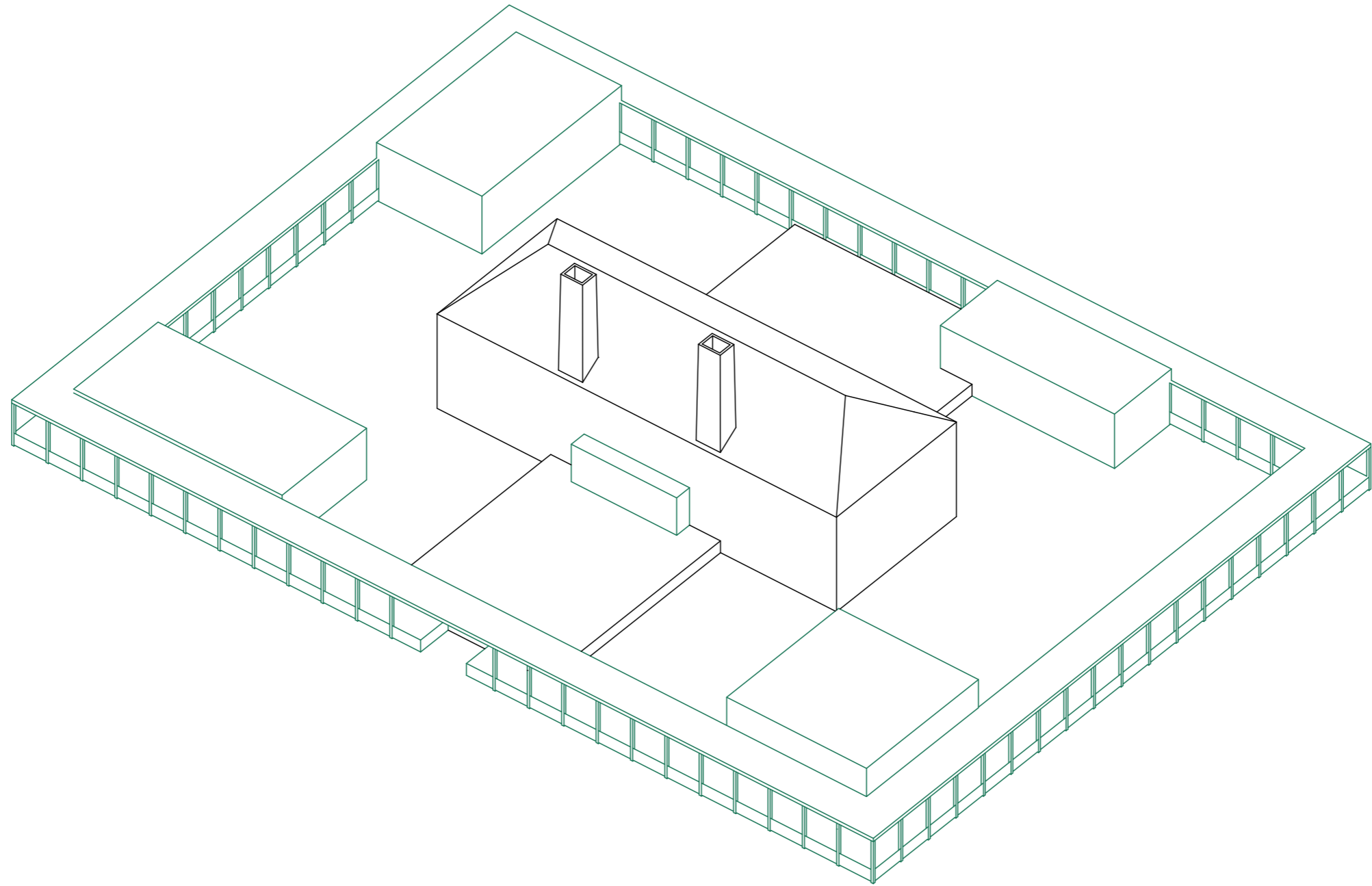

REDESIGN KITCHEN BUILDING

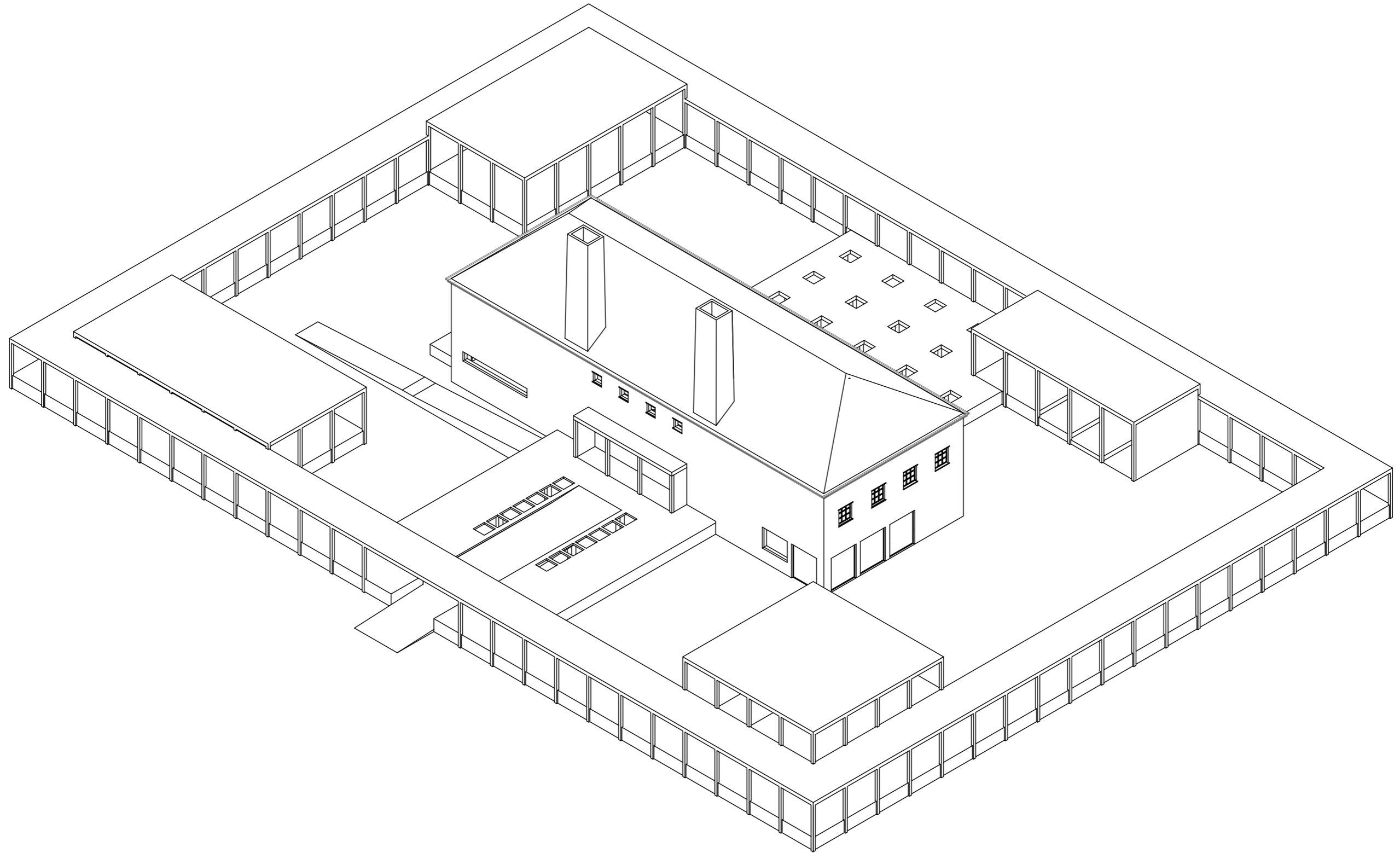

GROUND FLOOR 1:200

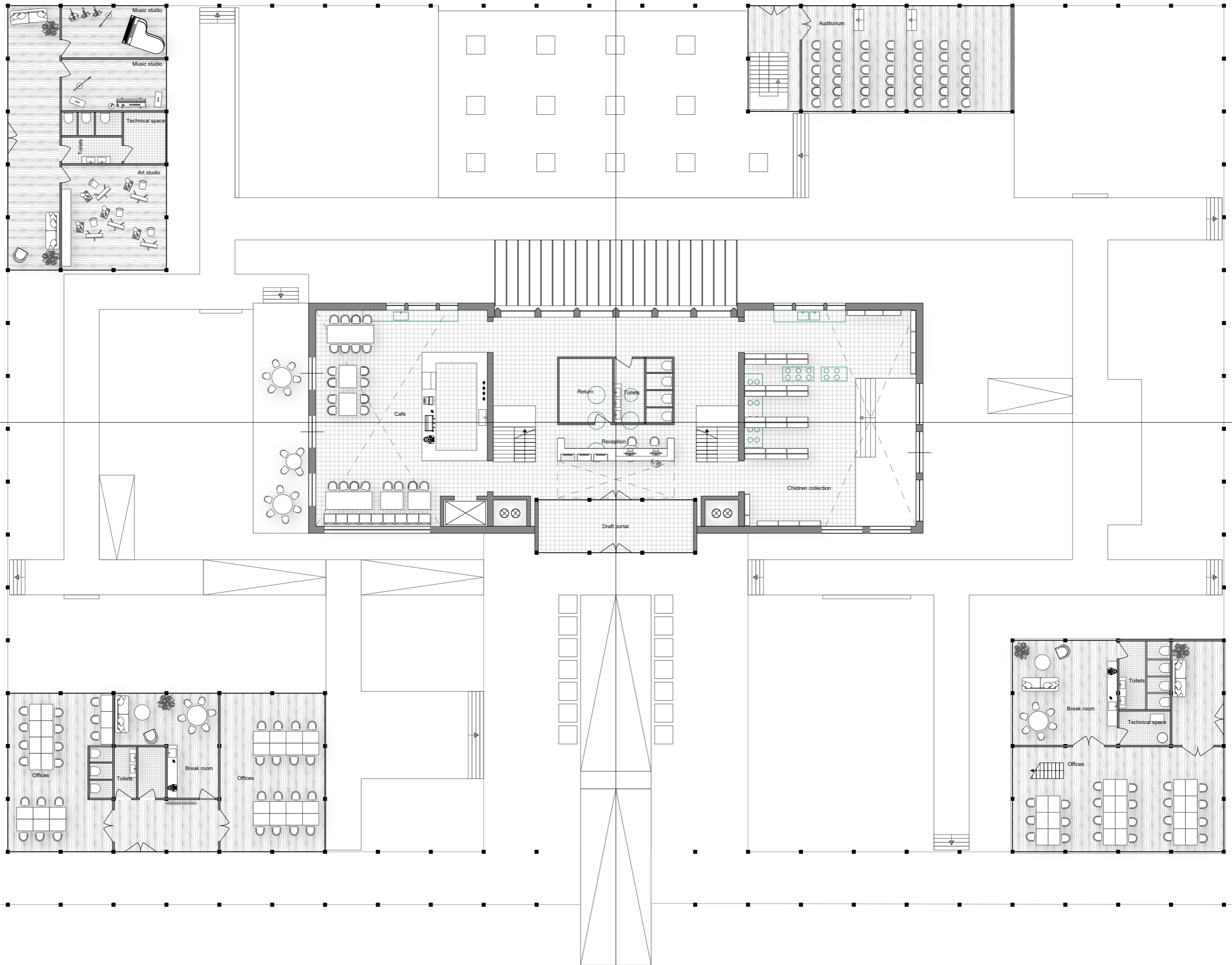

FIRST FLOOR 1:200

A''

B

B''

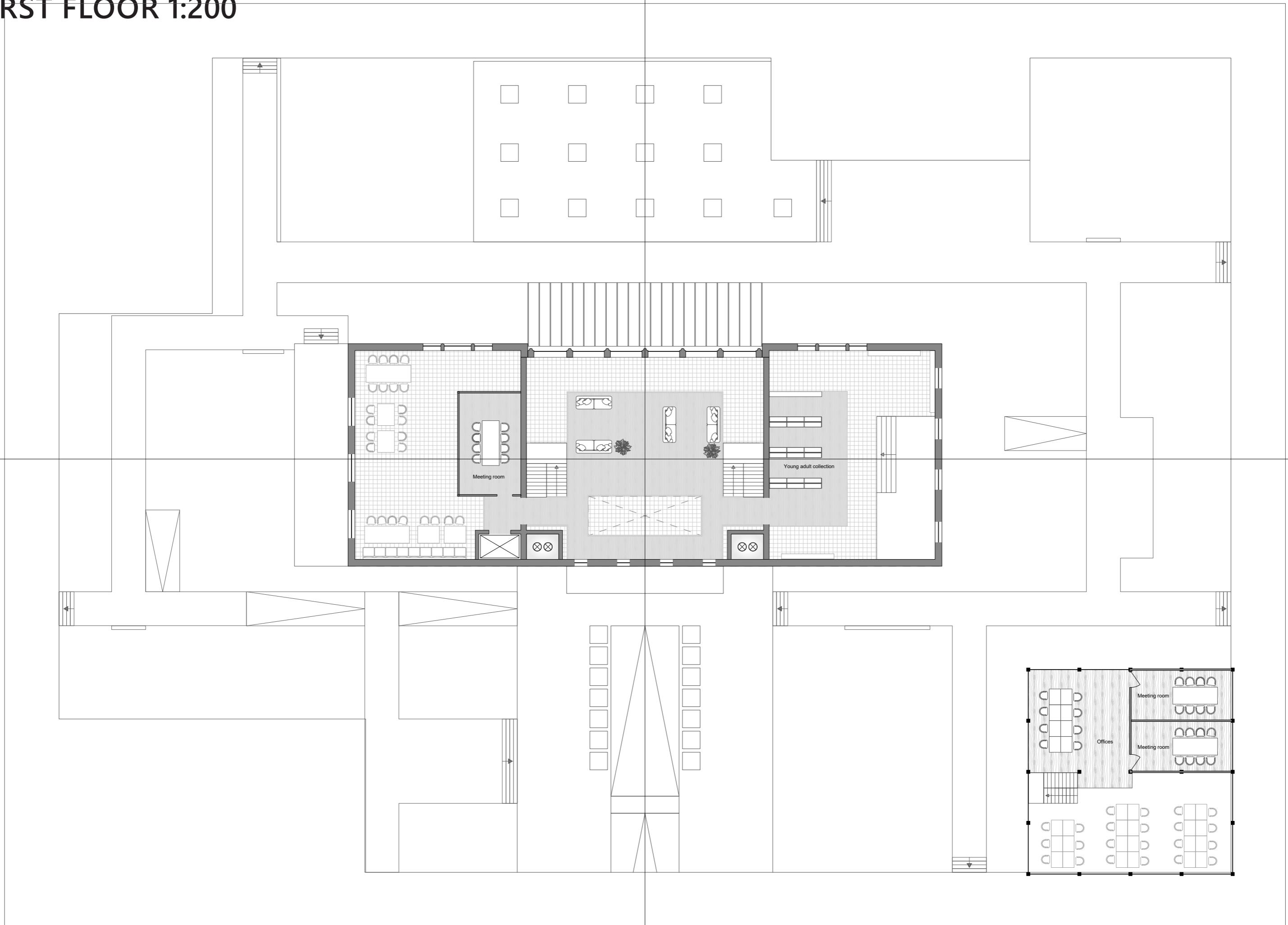

BASEMENT 1:200

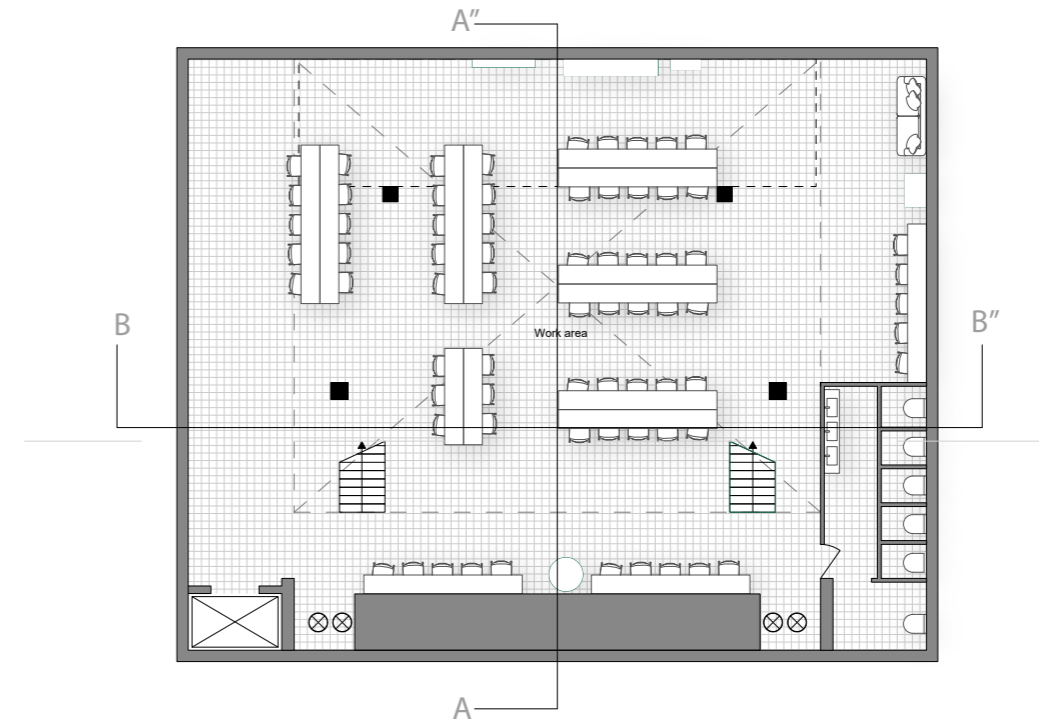
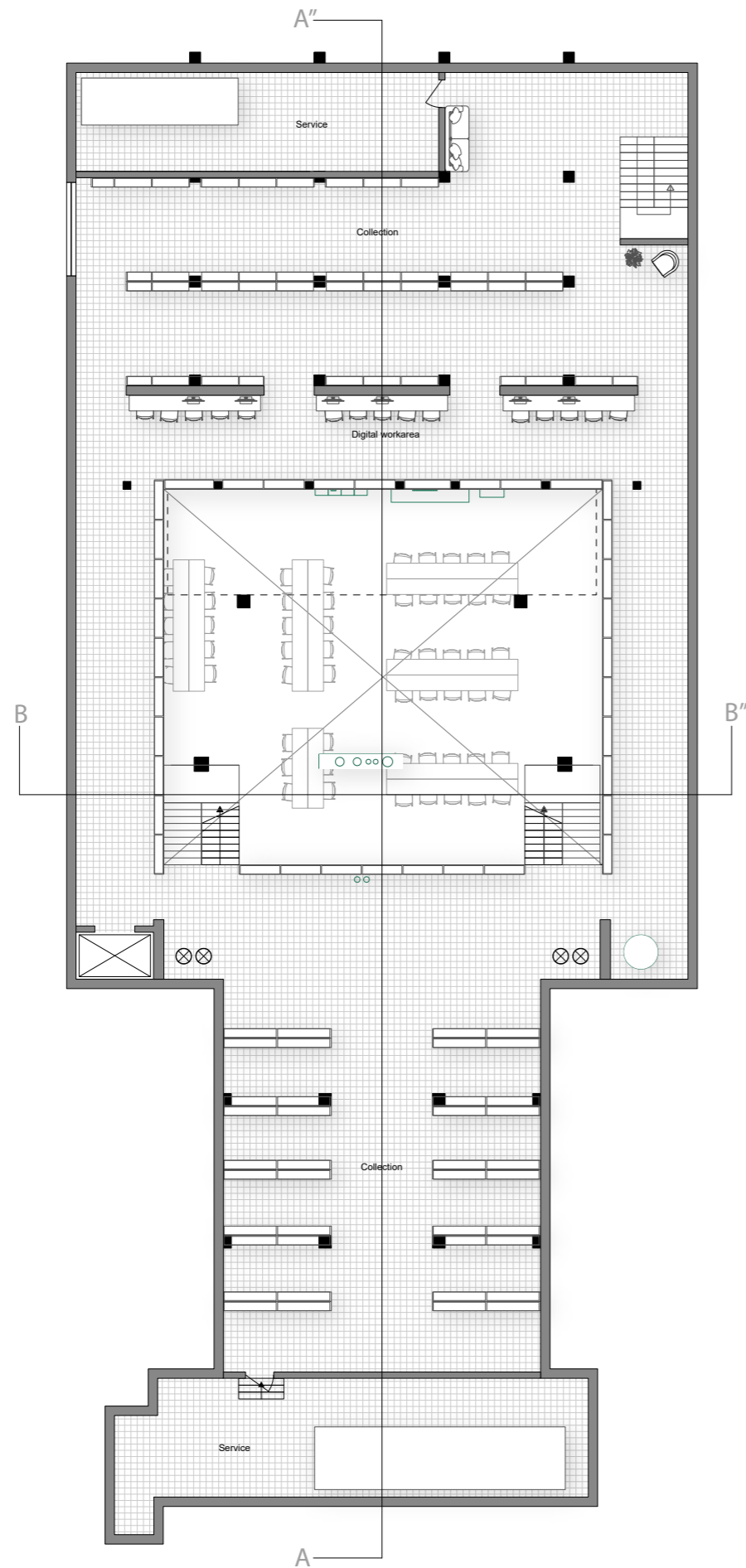

COURTYARD 1:250

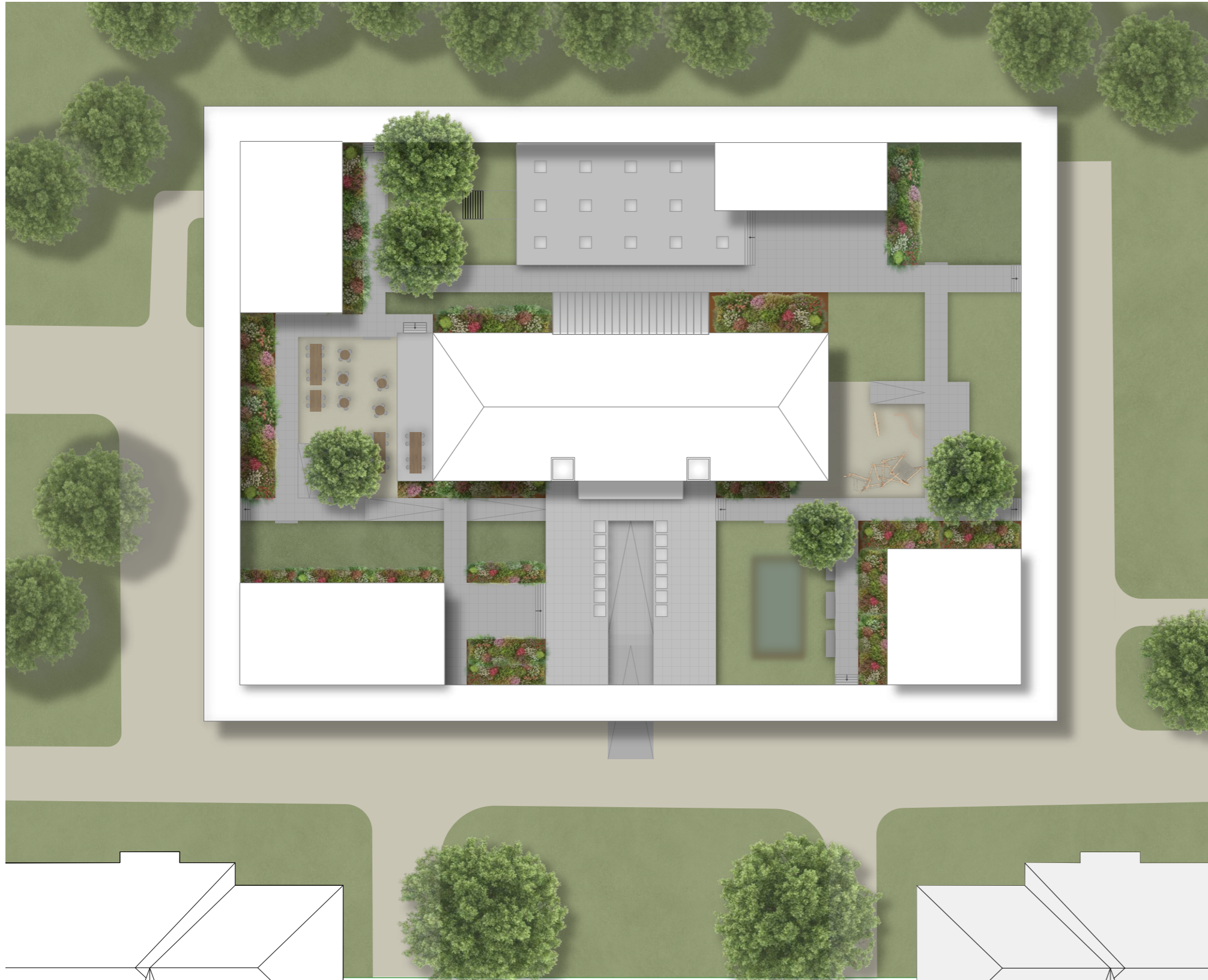

1:50

SECTIONS 1:200

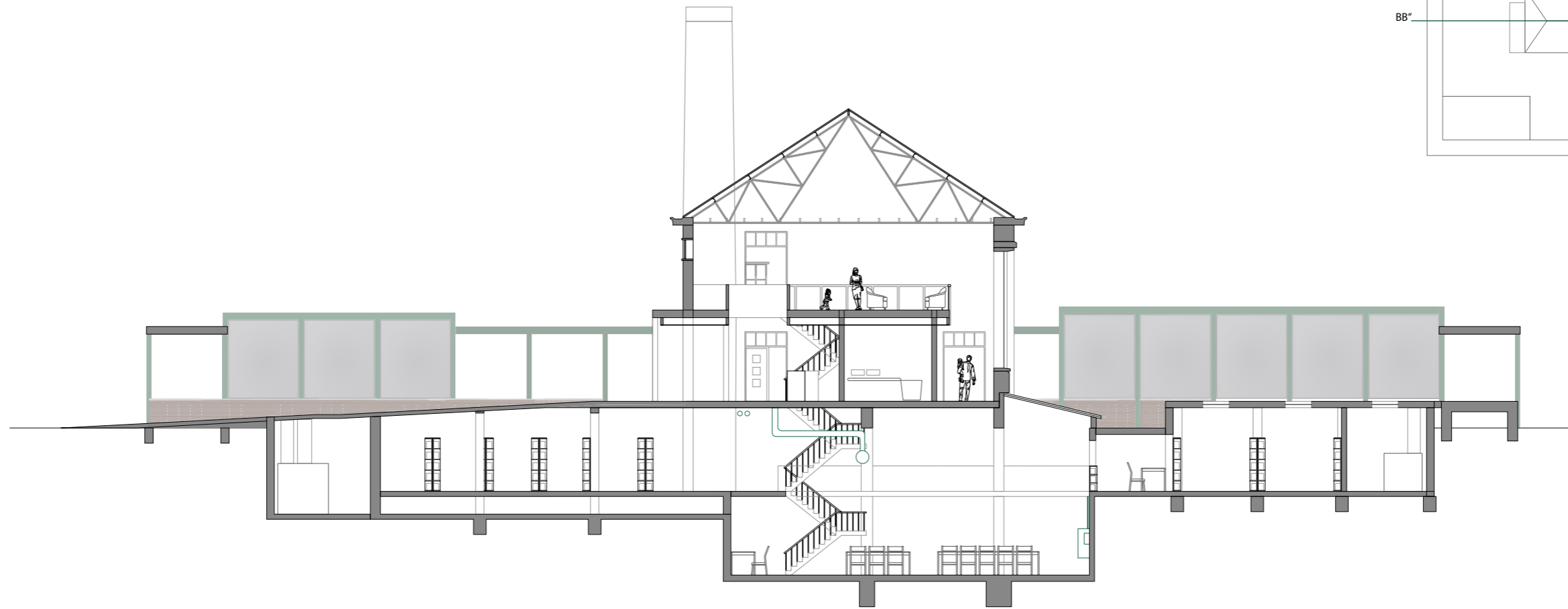
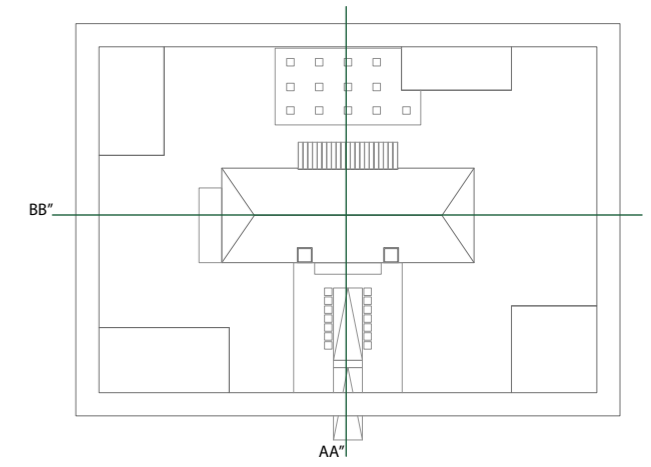

Section AA''



Section BB''

FACADE 1:200

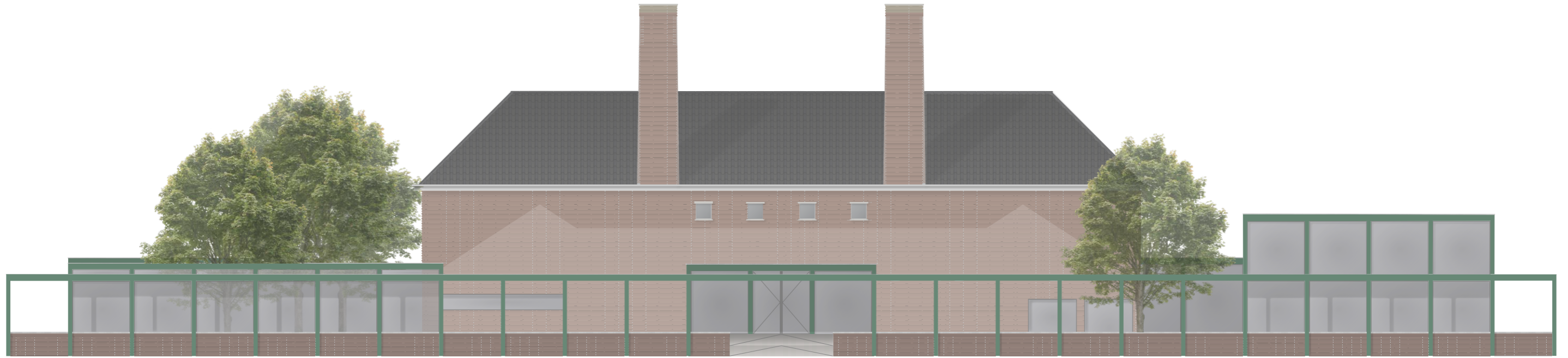

North-East

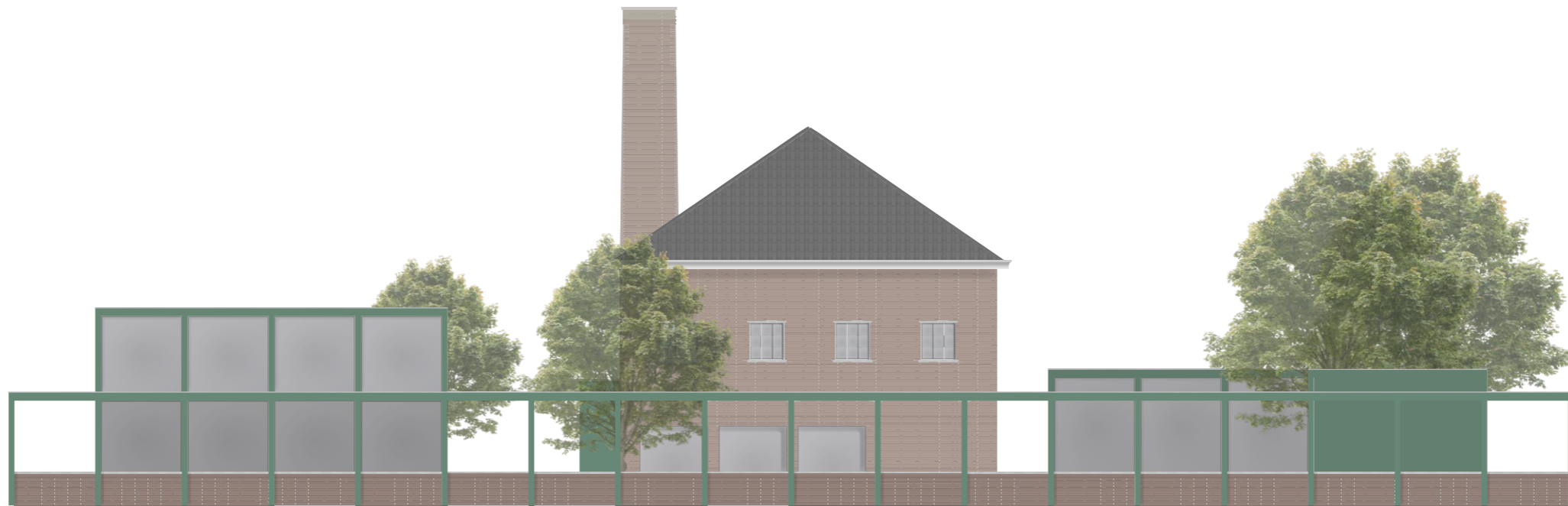

North-West

FACADE 1:200



South-West



South-East

INTERIOR 1:50



Basement



Reception



Children area









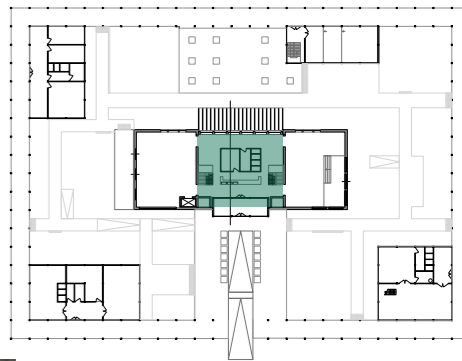

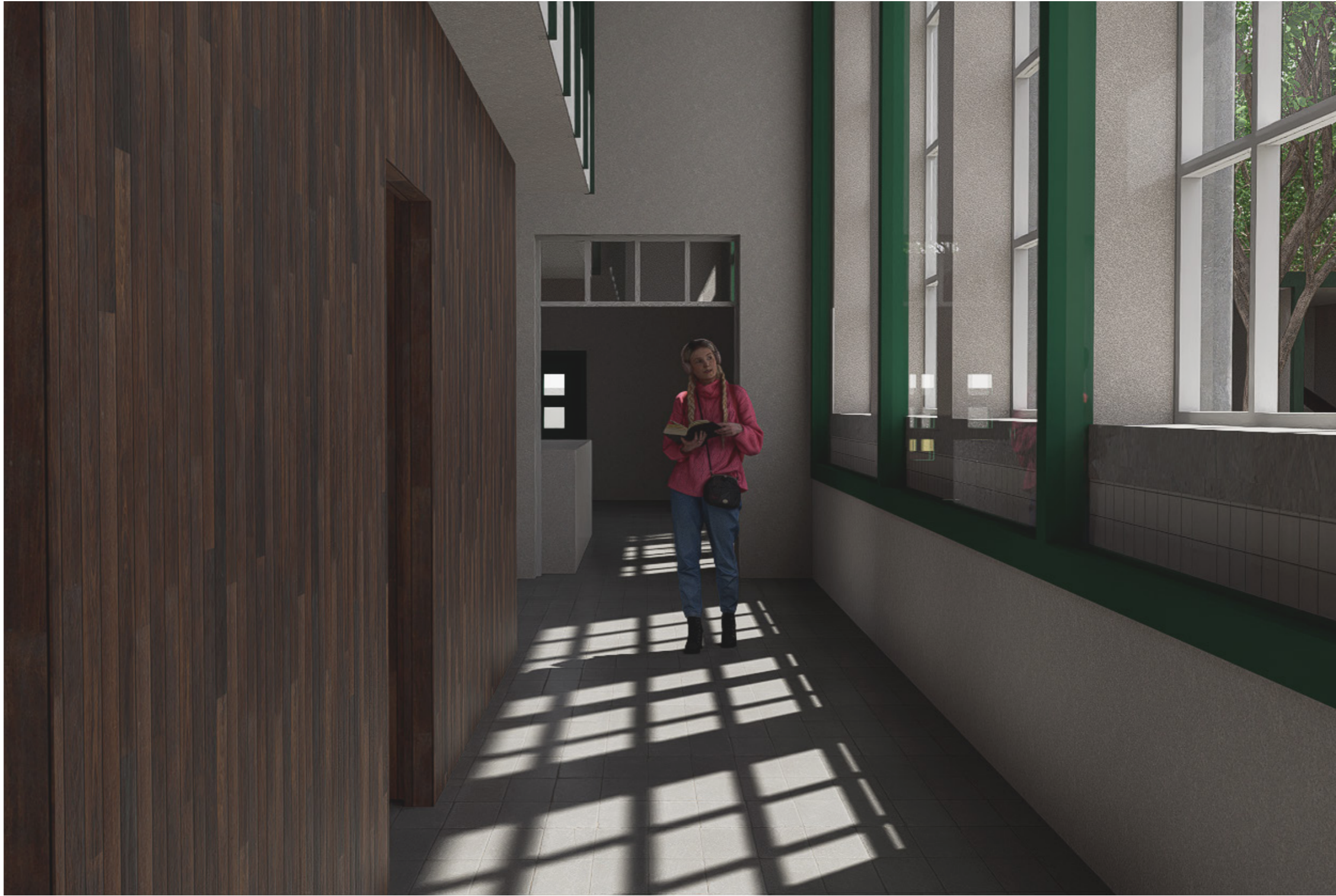
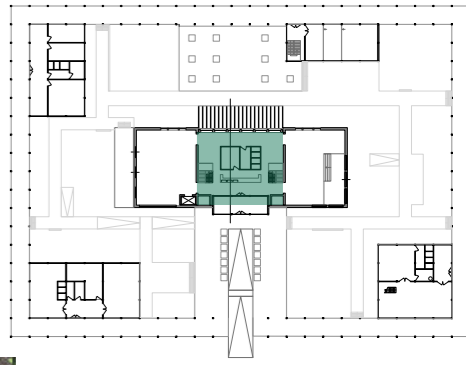

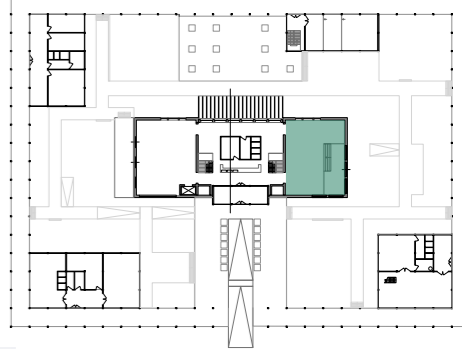

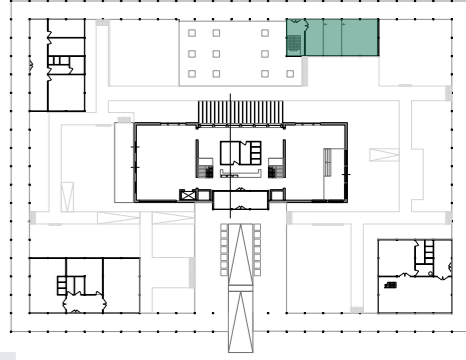

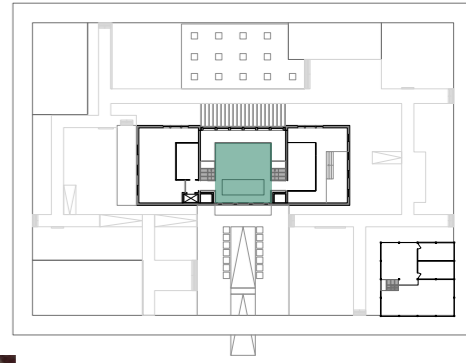

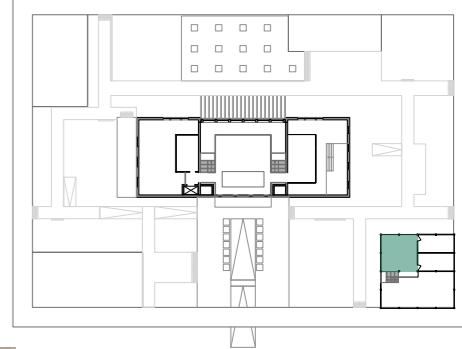

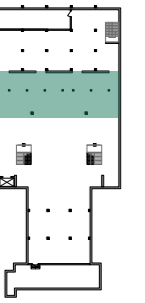

FACADE FRAGMENT 1:20 (RESCALED)

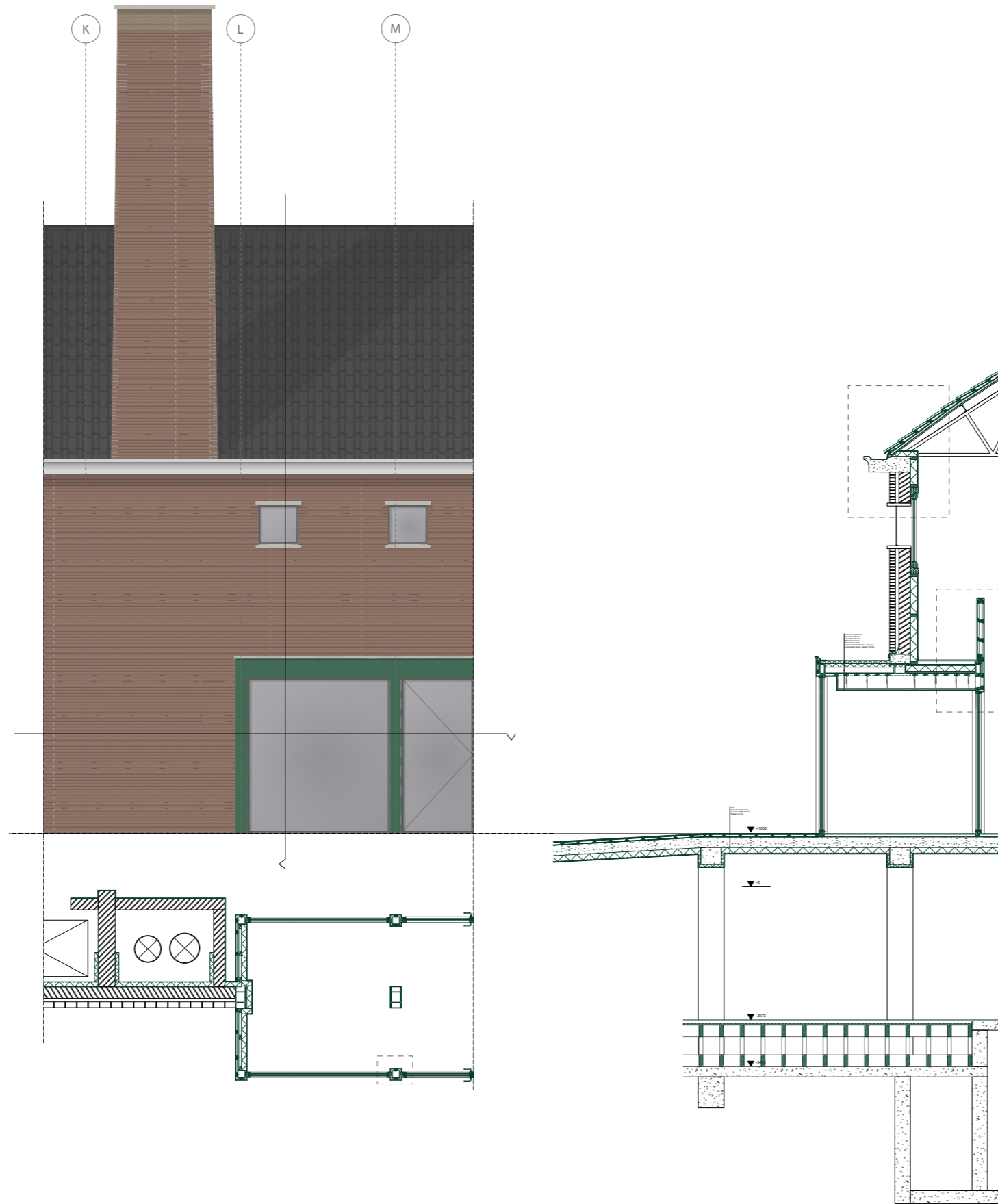

DETAILS 1:10

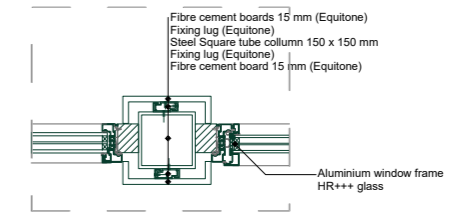
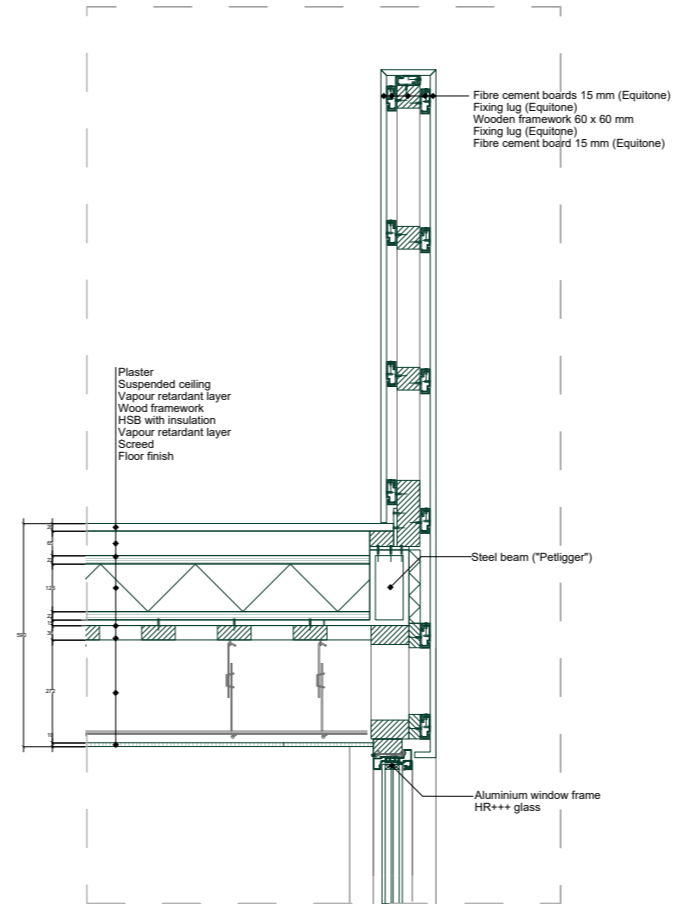
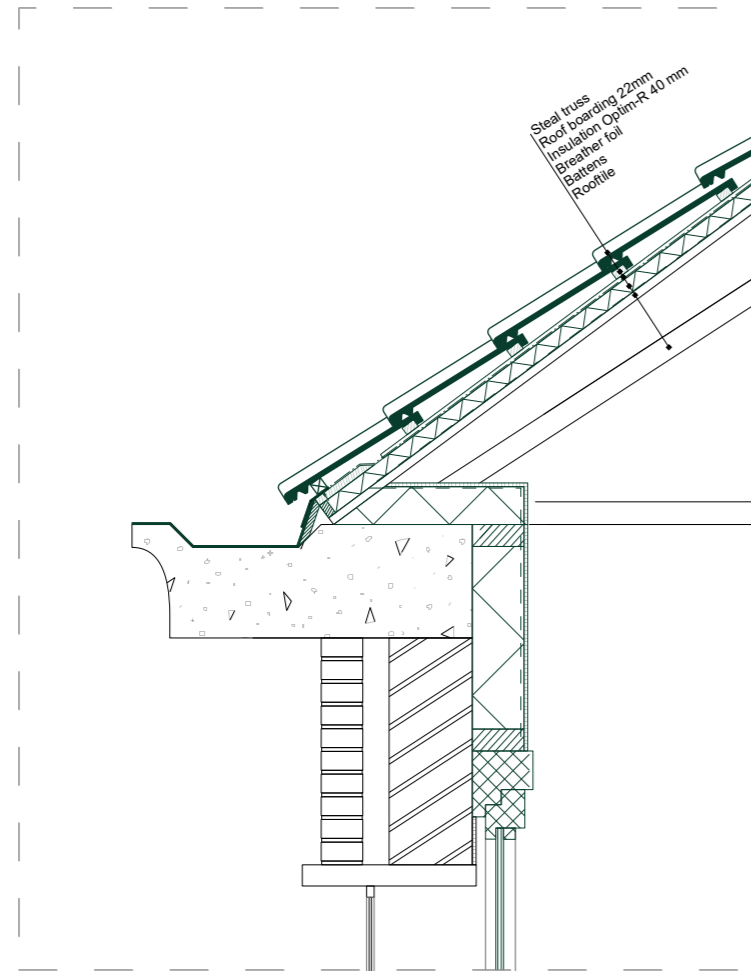

FACADE FRAGMENT 1:20 (RESCALED)

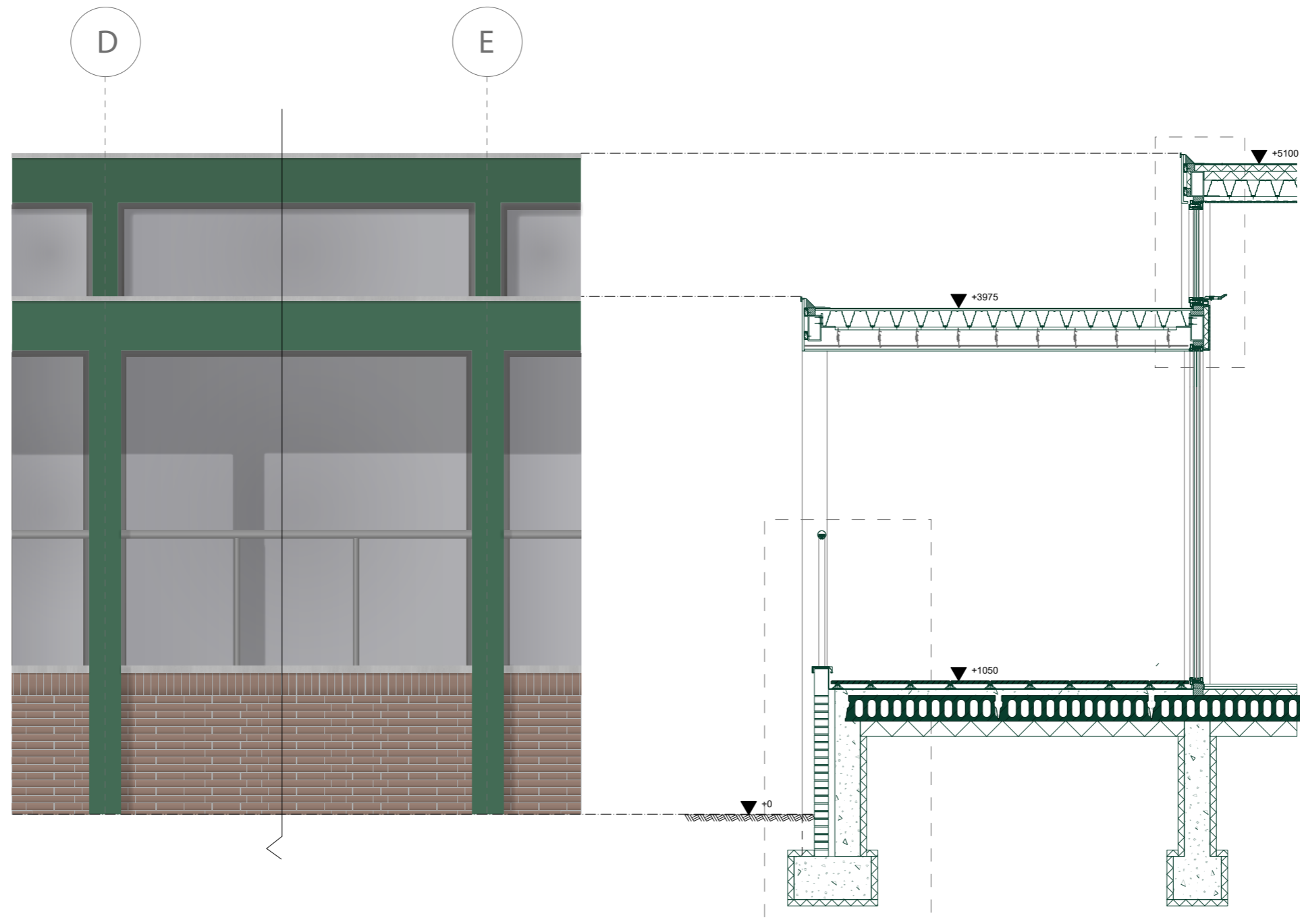

DETAILS 1:10

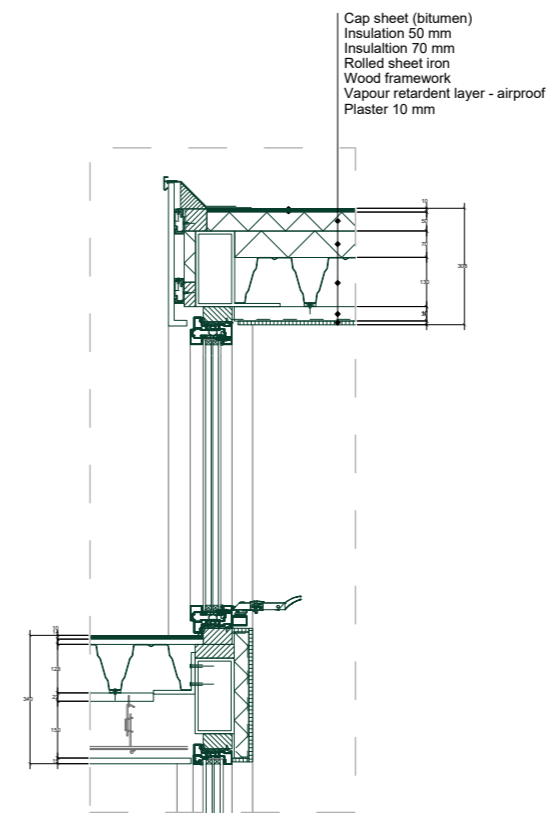
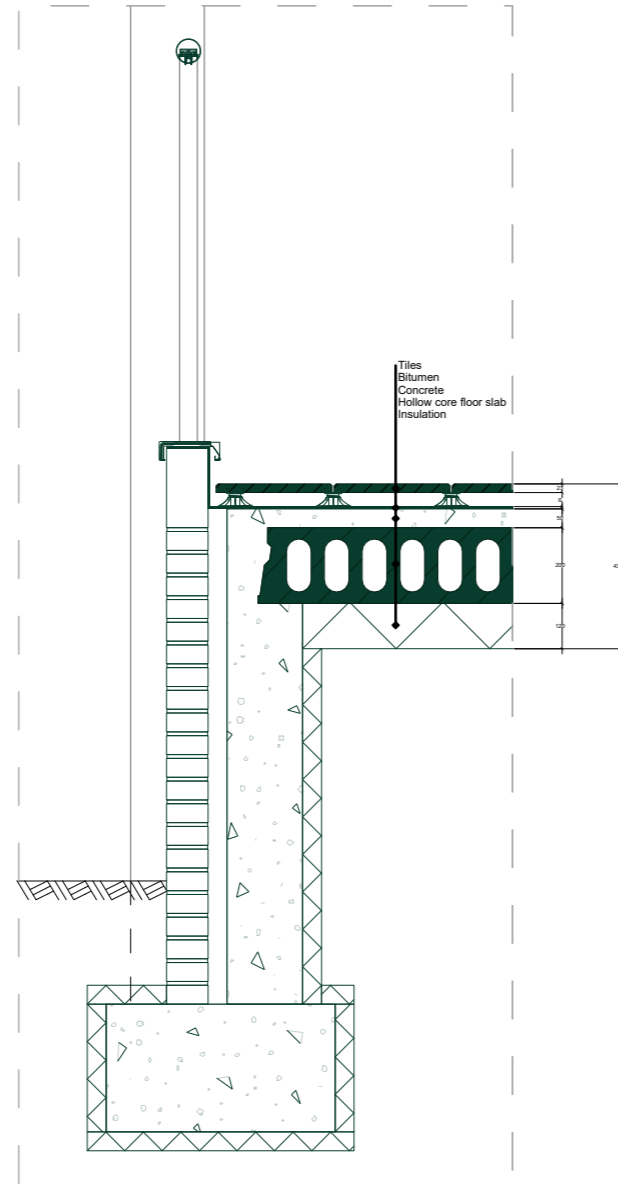

CONSTRUCTION

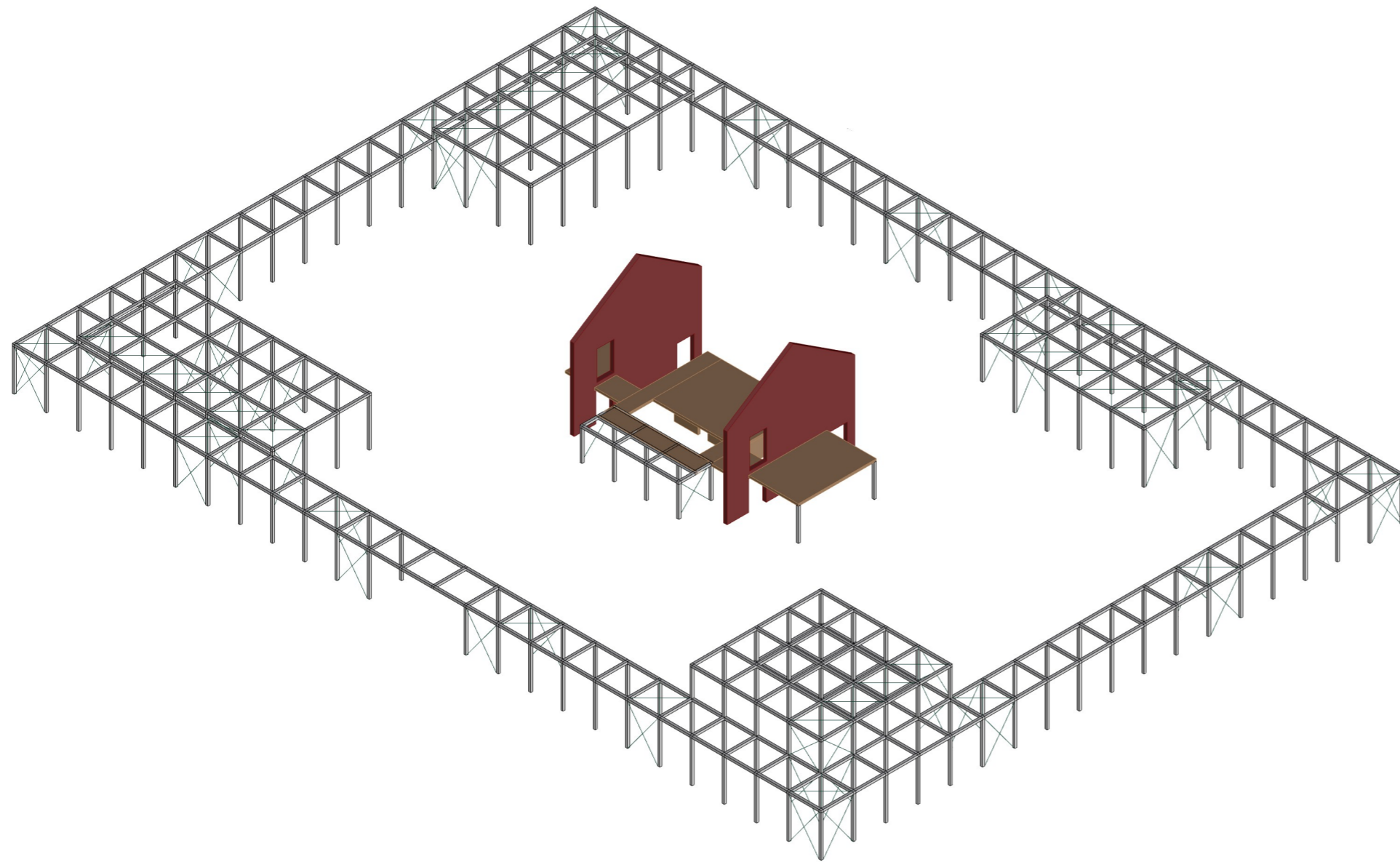

- Steel structure
- Existing load-bearing wall
- HSB

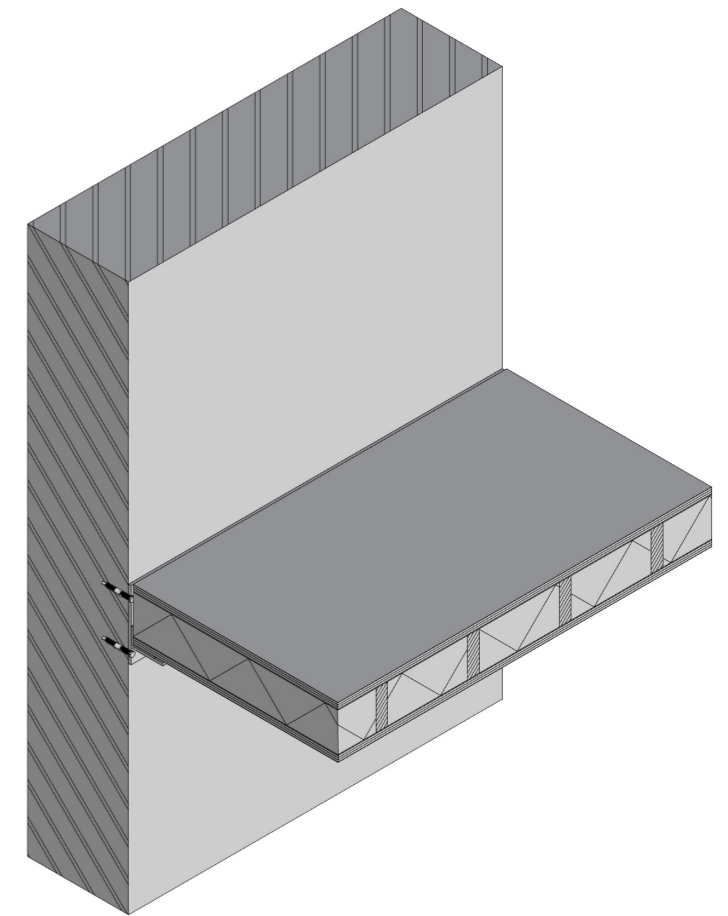
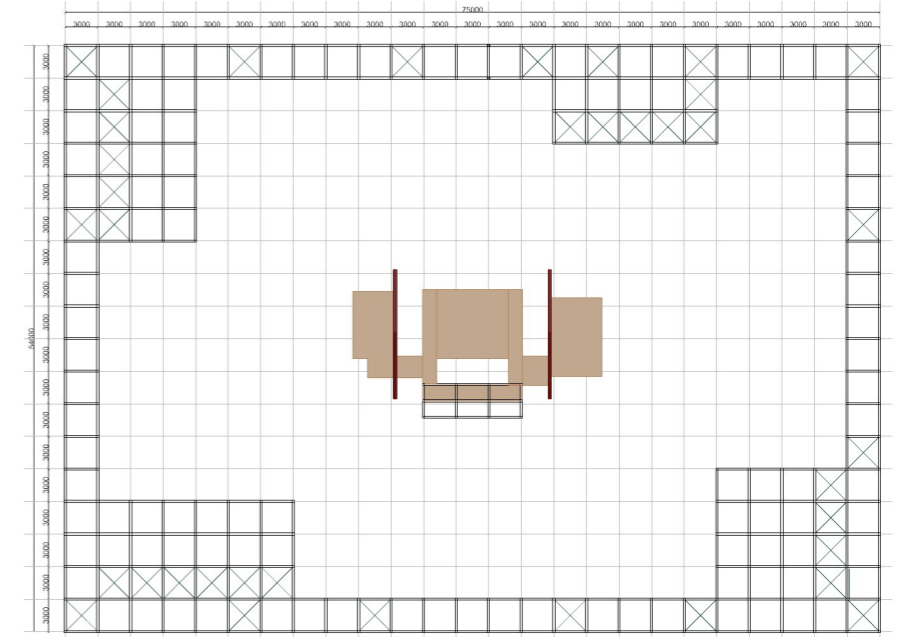

CLIMATE CONCEPT

