

3D Printing for Repair Guide

Bolanos Arriola, J.; van Oudheusden, A.A.; Flipsen, Bas; Faludi, Jeremy

DOI

[10.5074/t.2022.003](https://doi.org/10.5074/t.2022.003)

Publication date

2022

Document Version

Final published version

Citation (APA)

Bolanos Arriola, J., van Oudheusden, A. A., Flipsen, B., & Faludi, J. (2022). *3D Printing for Repair Guide*. TU Delft OPEN Publishing. <https://doi.org/10.5074/t.2022.003>

Important note

To cite this publication, please use the final published version (if applicable). Please check the document version above.

Copyright

Other than for strictly personal use, it is not permitted to download, forward or distribute the text or part of it, without the consent of the author(s) and/or copyright holder(s), unless the work is under an open content license such as Creative Commons.

Takedown policy

Please contact us and provide details if you believe this document breaches copyrights. We will remove access to the work immediately and investigate your claim.

3D Printing for Repair Guide

Julieta Bolaños Arriola, Alma van Oudheusden, Bas Flipsen & Jeremy Faludi



COLOPHON

This document is issued by the Faculty of Industrial Design Engineering, TU Delft, and is funded by Interreg North-West Europe within the ShaRepair project.

TU Delft

Faculty Industrial Design Engineering
Landbergstraat 15
2628 CE Delft
The Netherlands

Authors

Julieta Bolaños Arriola
Alma van Oudheusden
Bas Flipsen
Jeremy Faludi

Release date

May 2022

ISBN

E-book PDF: 978-94-6366-541-4
Paperback / softback: 978-94-6366-540-7
Doi: <https://doi.org/10.5074/t.2022.003>



This work is licensed under a [Creative Commons Attribution 4.0 International License](https://creativecommons.org/licenses/by/4.0/), except the following.

CC BY conditions are not applicable to figures 2 (p 5), 3 (p 6), 6 (p 8), 8 (p 9), 14 (p 16), 16 (p 18), 19 (p 20), 20 (p 21).

CONTENTS

Introduction.....	1
Disclaimer.....	4
Phase 1. Analyse	5
Product Architecture.....	6
Part Configuration	8
The BIG question: Is my part feasible for 3D printing?.....	12
Phase 2. (Re)design.....	13
Rethinking – FDM vs. IM	14
Redesign for FDM – Synthesize and Simplify.....	16
Digitizing	20
CAD modelling	26
Checklist – Is your part ready for 3D printing?	27
Phase 3. Manufacture.....	28
Material selection	28
Preparing the CAD file for 3D printing	30
Post-processing	33
Phase 4. Test.....	34
Testing the quality of a print	34
Testing specific attributes of a part	36
In-situ testing – Testing the part inside the product	39
What's next?.....	39
Recommended literature	41
Recommended videos	41
References	42

INTRODUCTION



Video 1: Intro 3DP4R process - [click here](#)

What is 3D printing for Repair?

Can it help you to repair your product?

This guide illustrates the 3D Printing for Repair (3DP4R) process. It provides repairers with guidelines and tools to produce 3D printable versions of the spare parts required to repair a product. In the guide, we provide guidance specific to Fused Deposition Modelling (FDM), since it is the most available and common technology for 3D printing. The information provided for the Analysis phase, Test phase, and much of the Redesign phase can be used with other technologies as well.

This guide was developed as part of the Sharepair [1] project, which offers a variety of tools and information to help and support the repair of products by do-it-yourself (DIY) and volunteer repairers. This guide is meant for anybody who is interested in trying to manufacture spare parts with 3D printing technologies, remakers, tinkerers, volunteer repairers, professional repairers, and everyone who is interested in repair initiatives.

The 3DP4R process consists of four phases: **Analysis**, **Redesign**, **Manufacture**, and **Test**, as shown in Figure 1. Before getting started with making your own parts, it is first necessary to find out how the product is broken and which part(s) needs to be replaced; this phase is called Failure Diagnosis. The failure diagnosis is not discussed in this document, but you can find more about it on the website [The Art Of Troubleshooting by Jason Maxham](#) [2].

Once the necessary parts to replace have been identified, they can be reproduced using the following phases:

1. **Analyse**. The analysis phase consists of 3 steps. First, the part should be analysed in relation to the product architecture, after which other necessary characteristics and performance requirements must be identified. After collecting all this information, the third step is to define whether the part is suitable for 3D printing or not.
2. **(Re)Design**. Once the part is defined as suitable for 3D printing, the part can be redesigned. The design of the part is modified to fit the requirements and constraints of the new manufacturing method (3D printing) and the used material. The new design is made into a digital 3D model of the component.
3. **Manufacture**. The design is prepared for 3D printing, the printing takes place, and any necessary post-processing is done to get the part ready to be installed in the product.
4. **Test**. The printed part is evaluated on its quality and performance. If the part fails, this will provide the necessary information to modify the design for a second try or more iterations.

This guide will describe these four phases in detail. Every chapter is accompanied by a short video which explains the phase and gets you kick-started with your project. You can click the YouTube link or scan the QR-code.

To follow this guide through the 3DP4R process, you will need the following materials:

- Broken product and identified part(s) to be replaced.
- Tools for disassembly, such as a screwdriver set, hair dryer to loosen glued connections, and prying tools like spudgers.
- Measuring tools, such as a caliper and kitchen scale.
- A digital camera, for documentation or for CAD modelling reference images. A phone camera is sufficient.
- A computer with the Slicing and 3D CAD program of your preference. In section [2.4 CAD modelling](#) we explain several available options.
- A 3D printer (FDM) and the [filament](#) of your choice.

This guide is always in progress. When you have suggestions, please send us an email at ShaRepair-SDE@tudelft.nl.

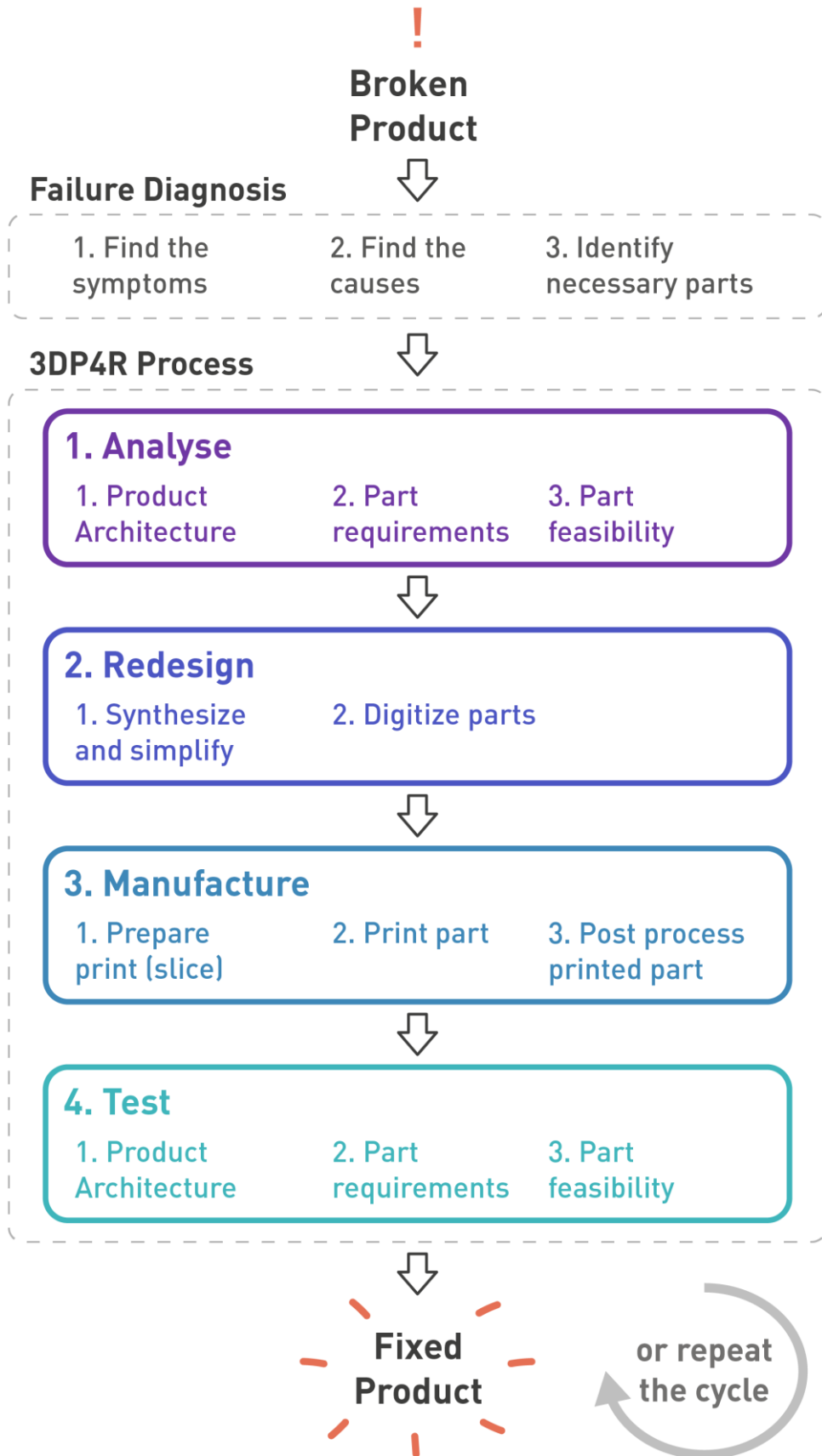

Figure 1 - 3DP4R process overview.

DISCLAIMER

- A. This guide involves tinkering with commercially sold appliances. Doing so may void warranties and can be hazardous if not done with care and appropriate safety measures. Always assess risk and refer to any manufacturers guidance before attempting to repair.
- B. Every 3D printed “copy” you make could infringe on copyright or Intellectual property (IP) of the Original Equipment Manufacturer (OEM). Before you share your result to an open online database, be aware of possible infringements.
- C. **Unplug all devices from power sources before disassembly.** Be aware of products that could contain heating elements or boiling water and let them cool down before any procedure.
- D. Beware of the disassembly steps and keep a record, for example through photographs, to properly reassemble the product at the end of a repair process. A bad reassembly could cause accidents such as short circuits, fires, and leakage, among others.
- E. 3D printed spare parts do not comply with the OEM’s quality standards and testing, and therefore are not guaranteed to function appropriately. Be especially careful with parts that need to withstand high forces, are spring-loaded, encounter electronics, need to withstand high temperatures, or contact water and/or food. Keep in mind that 3D printed parts are in general of lower quality than its original.
- F. This guide is provided for information purposes only. The authors of this guide and any referenced sources are not responsible for anything done in relation to this guide and the collection of guidance videos. The reader/viewer should understand and accept that the processes described in this guide (and videos) and the resulting 3D printed parts may pose a high risk of injury to the end user, as well as risk of injury to the individual repairing the device.
- G. By continuing to read, use this document, and/or watch the guidance videos, the reader/viewer undertakes to take appropriate steps to minimize risks of injury occasioned by the use and application of the information provided in these publications. Any and all losses, injuries or damages incurred by or resulting from the use of the information in this publication and/or guidance videos are the sole responsibility of the reader/viewer and end user.
- H. The reader/viewer and end user voluntarily, expressly, and completely release, forever discharge, and agree to defend, indemnify, and hold harmless, the Sharepair project and the authors of this document and all references, from any and all claims, demands, or causes of action, which are in any way connected with the use of the information contained in this publication and guidance video collection.

PHASE 1. ANALYSE



Video 2: The analysis phase – [click here](#)

What are the most important characteristics of your part?

Is your part feasible for 3D printing?

To find what is needed to replace your broken part, it is helpful to first make an analysis of your part. The Analysis phase consists of 3 main sections:

1. **Product Architecture**, where you analyse the relationship(s) between your component and the rest of the product.
2. **Part requirements**, where you analyse the part itself, including its function, original material, performance requirements, etc.
3. **Part feasibility**, where you can use the information collected on the 2 prior sections to answer the question, is it feasible to 3D print this component?

When analysing a component there are four possible cases you can come across:

- A. **The broken part may already be modelled** by another awesome remaker and shared via online databases like [Thingiverse](#) [3], [GrabCAD](#) [4] or [MyMiniFactory](#) [5]. You can find Sharepair developed parts [on the MyMiniFactory Sharepair account](#) [6].
- B. **The broken part is available and complete.** The process of reproducing the part will be simpler (see Figure 2). Follow the rest of this guide.
- C. **The broken part is available, but sections are missing or deformed.** You can glue/tape the part together momentarily to allow you to further analyse it, then continue to follow the rest of this guide. Note this is only a momentary solution and not the final fix. Figure 2 shows the level of difficulty depending on how much of the part is missing.
- D. **The broken part is missing.** Follow the rest of the guide but consider the process will be longer and harder. We recommend you to extract as much information and measurements as possible from the components surrounding your part, see the next section on [Product architecture](#). Additionally, we recommend you do a Google search of the component to have a better idea of what it looks like.

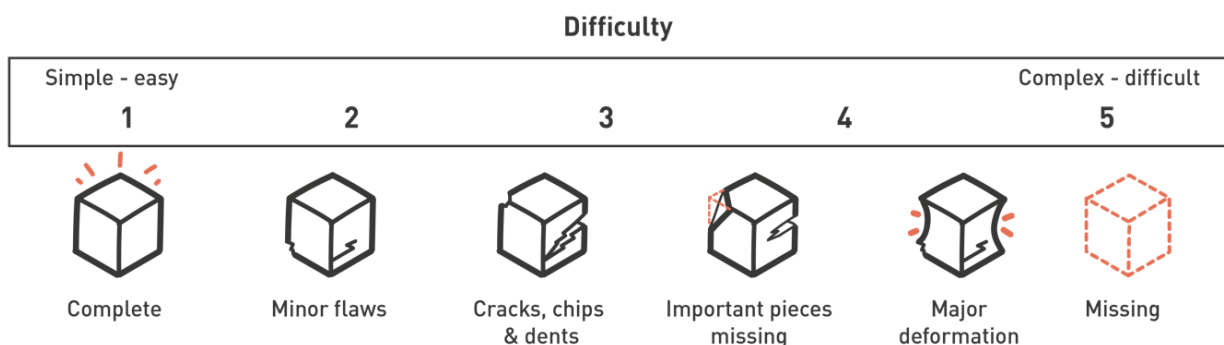

Figure 2 - Level of difficulty for part completeness, based on the Decomposition checklist in [Repair Using 3D Printing: 1 Decomposition](#) by thijsbeerkens [7], licensed under CC BY-SA 4.0.

PRODUCT ARCHITECTURE

During this phase you will find the minimum requirements of the broken part, like mechanical performance and its dimensions. In most cases, you will need to disassemble your product freeing up the broken part.

Please unplug all devices from the grid or any other power sources before starting the disassembly.

Track all your disassembly steps (take pictures) to remember the correct sequences and positions of the parts for reassembly. If you don't know where to start opening the device, try to find a video or disassembly guide on the web, made by one of your fellow repairers. The [iFixit website](#) [8] consists of a large repository of repair and disassembly guides. Once you extracted the component, you can start with your analysis by identifying the part function and observing how it relates to other components and sections of the product.

Identifying the part function

We first recommend you describe the part function, in the form of a *verb-noun pair*, which is a method we have found useful throughout our 3DP4R experiences. See the example below:

The switch lever [pushes] the [on/off button] of the kettle.

verb

noun

A function description will help you to understand and identify the systems and components your part is related to. E.g., the switch lever is directly related and acts on the on/off button. This means it probably is a moving part and works in relation to the electrical system of the product.

Identifying the physical relationship of your component to other parts

Next, we recommend describing how the part is related to other parts in the product architecture. These relationships consist of physical interfaces like the ones shown in Figure 3, pivoting points, press-fits, snap-fits, fasteners (such as bolts or screws), and shape continuity (which refers to how the component's geometry relates to the geometry of its immediate part).

Identify and list assembly and reference points that are critical for the part function and assembly to other parts (see Figure 3 below). Some of these features will most likely need accurate reproduction, while other elements may be simplified.

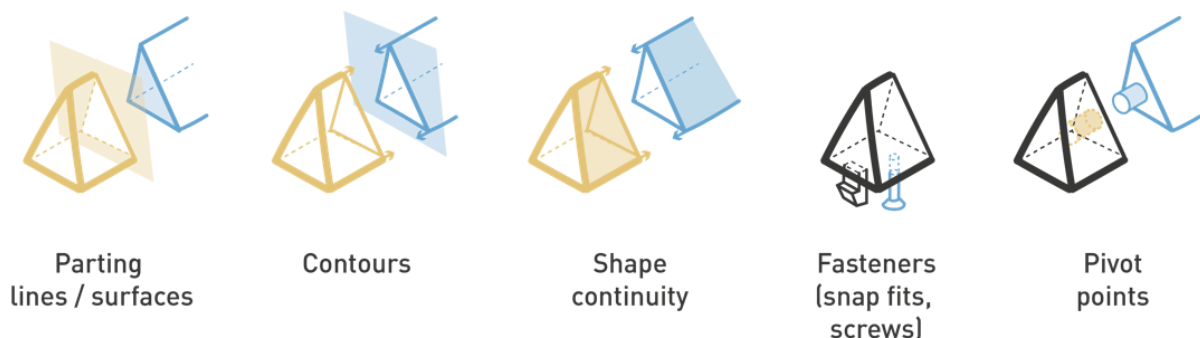

Figure 3 - Part relations, based on the Decomposition checklist in [Repair Using 3D Printing: 1 Decomposition](#) by thijsbeerkens [7], licensed under CC BY-SA 4.0.

Identifying the part fit requirements

Describe the necessary fit of your part in relation to other components, by considering how parts should fit to each other and what space is needed to re-assemble the part in the product. There are four main categories: moving parts, normal fit, push/press fit, and no fit (interference fit). Figure 4 shows the gap size that you should keep between two parts for each fit type. Interference fits can have a negative gap size.

Note that these gap sizes are a rule of thumb and that determining your part size also depends on the accuracy of your printer. Most FDM printers have an accuracy ranging between 0.1- 0.3 mm [9]. It is good to avoid generating gaps smaller than that. To ensure the right fit, it is good to do some test prints of the tight fitting sections before printing your final part.

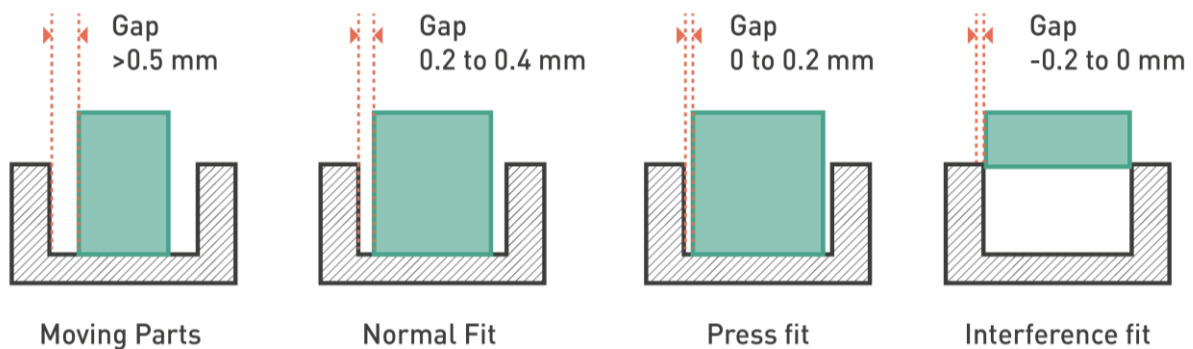
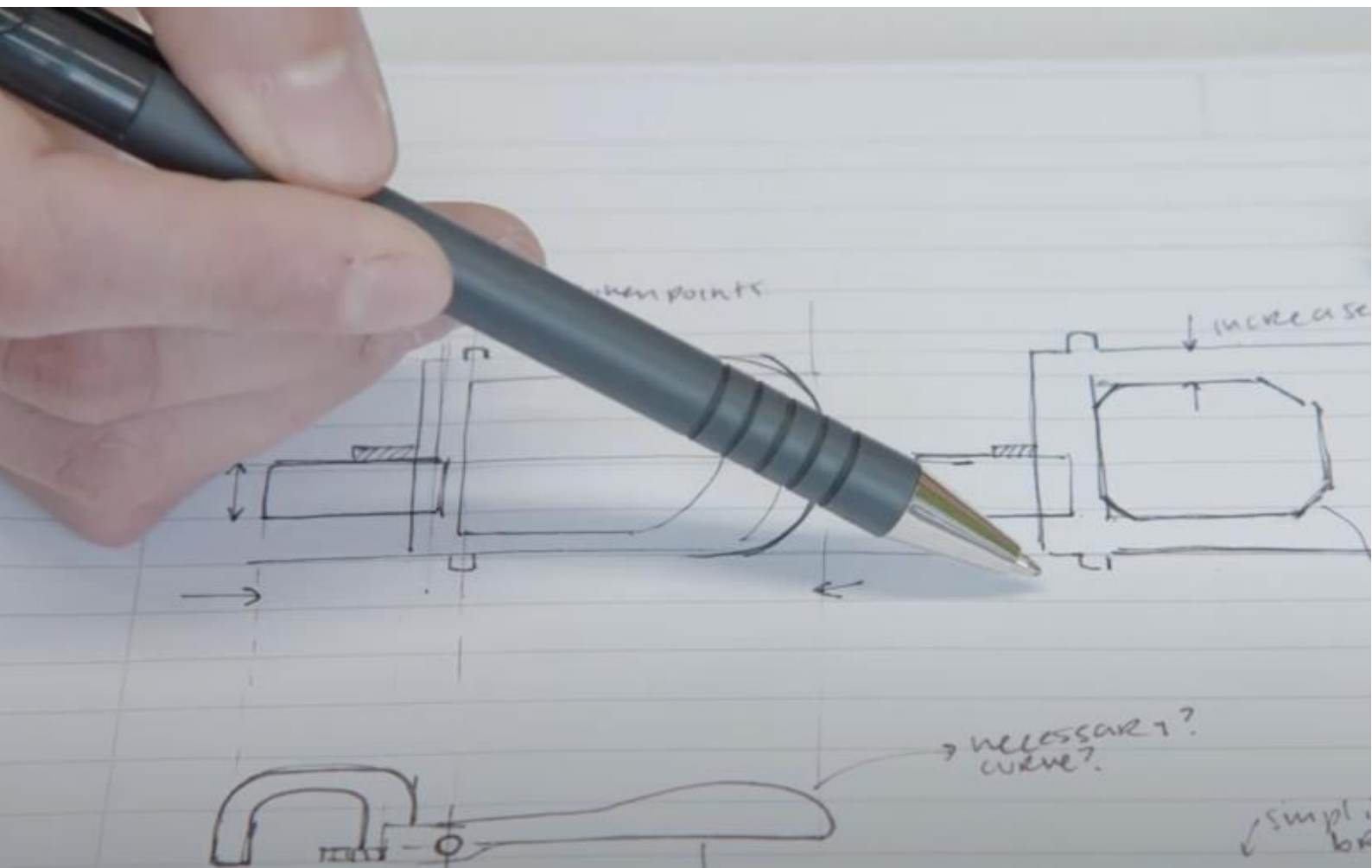

Figure 4 - Types of fit.

Note down all the collected information in a rough sketch of your part, which you can consult during other stages in the process (Figure 5). It is helpful to sketch orthogonal views (top, side, front, bottom, etc.) and annotate the dimensions, accuracy, and other important observations.

Figure 5 - Rough sketch of a part, its dimensions, and required accuracy.



PART CONFIGURATION

This section helps you to analyse the broken part with more detail according to its intrinsic characteristics (shapes, features, dimensions, etc.) and requirements.

Describing geometry class and complexity

Identify the type of geometry that composes the analysed part from simple to complex as described in Figure 6. Geometry class and complexity will influence how difficult it will be to measure and reproduce your parts. For example, measuring a complex curve or freeform shape will be difficult and time-consuming. The same goes for parts with a lot of additional bodies and/or features.







Difficulty				
Simple - easy 1	2	3	4	Complex - difficult 5
				
Flat (2D)	Simple geometry	Curved	Double curved	Freeform organic
				
Single body	Main body + features	Main body, additional body + features	Main body + several features	Main body, additional body + several features

Figure 6 - Level of difficulty - Geometry class, based on the Decomposition checklist in [Repair Using 3D Printing: 1 Decomposition](#) by thijsbeerkens [7], licensed under CC BY-SA 4.0.

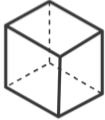
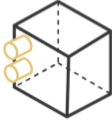
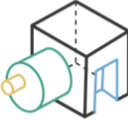
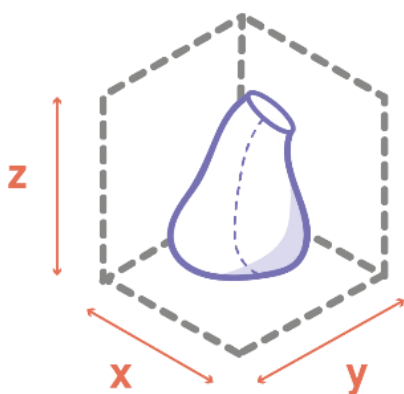

Figure 7 - Part general dimensions.

Identifying general dimensions, does my part fit in the printer?

Indicate the general dimensions of the part in x, y, and z by using a caliper. You can find further recommendations and instructions on how to use a caliper in the [Digitizing – Manual scanning](#) section of this document. It is useful to make a sketch to define the general part dimensions. You can think of general dimensions as a box in which your part fits, as shown in Figure 7. It is a lot easier to work with a part that fits in the printer, for example, an Ultimaker 2 has a max. print area of 220 x 220 x 200 mm. If your part is larger than your print area, you will have to split up your part and glue the sections afterwards. However, this will make your part weaker and the assembly more complex.

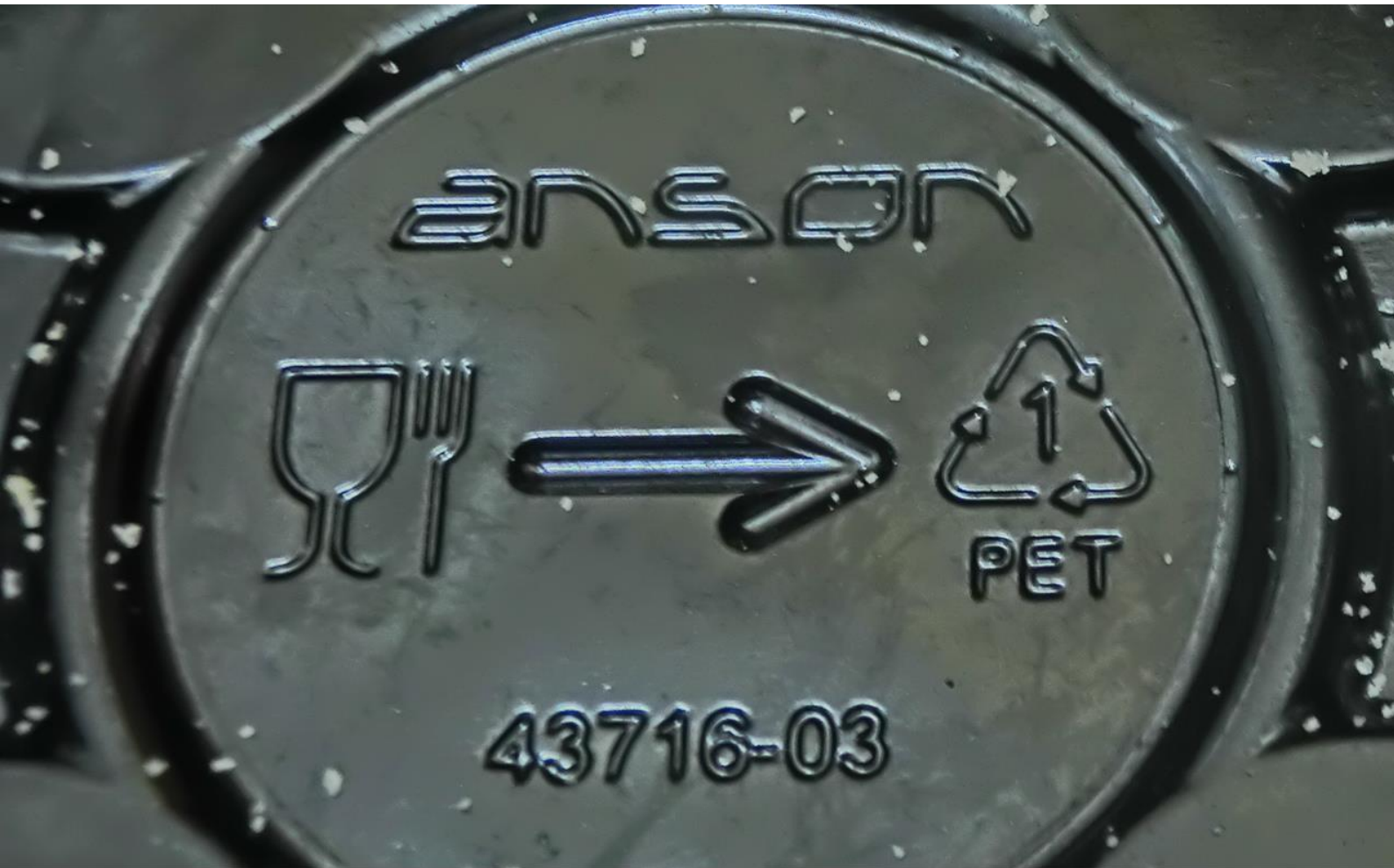

Figure 8 - "[Plastic food container in a Hong Kong market](#)" by Woakamkurhram [10], licensed under [CC BY-SA 3.0](#).

Identifying the original material & manufacturing method of your part

Find the original material and manufacturing method of the broken part. Identifying this information allows you to understand some of the functional and performance requirements of the part (e.g., the original part is made from PP because it must resist high temperatures). An example of how to identify different types of plastics is by seeing if the part has a plastic recycling code. You can find a list of codes [on the website of the Plastic soup foundation](#) [11]. Recycling codes can typically be found engraved at the bottom, such as shown in Figure 8.

Identifying and describing part requirements

The function of the part in relation to its context reveals important requirements and critical features. Identifying these requirements will allow you to:

- Redesign the part with 3D printing as a manufacturing method in mind.
- Simplify non-critical elements.
- Select an appropriate substitute 3D printable material
- Select necessary post-processing steps.

When selecting the relevant part requirements, also consider how you could test these requirements (see [Phase 4. Test](#)).

To identify the performance requirements of your part, you should indicate which of the following part requirements shown in Figure 9 apply to your part and specify the boundaries when relevant (e.g., resistance to heat: up to 90°C). Note that some of these part requirements can be challenging or almost impossible to achieve with 3D printing. For example, water tightness needs extra post-processing to fill in the gaps between layers. Also, no part will be truly food safe without extensive post-processing, as the layer gaps will absorb bacteria.

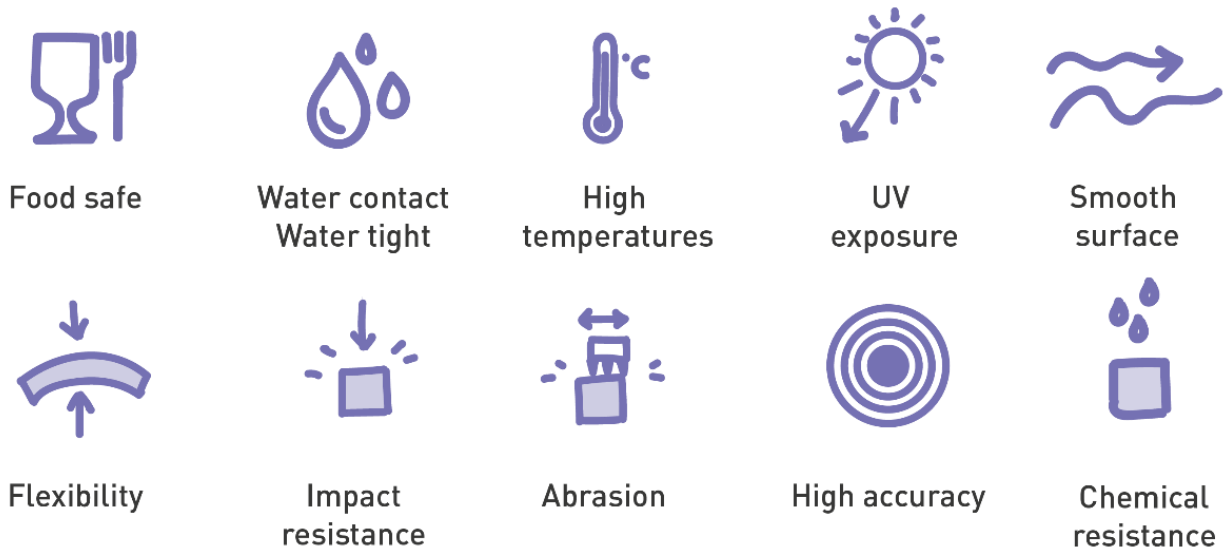

Figure 9 - Part requirements, based on the Decomposition checklist in [Repair Using 3D Printing: 1 Decomposition](#) by thijsbeerkens [7], licensed under CC BY-SA 4.0.

Next, identify and map the forces that you think your part should be able to withstand. It helps to make a small sketch of your part to identify where forces will be applied. This will help you to find the part sections that will need to be reinforced or that need other modifications. Figure 10 shows examples of how you can represent forces on the sketches of your part, using side, top, and bottom views.

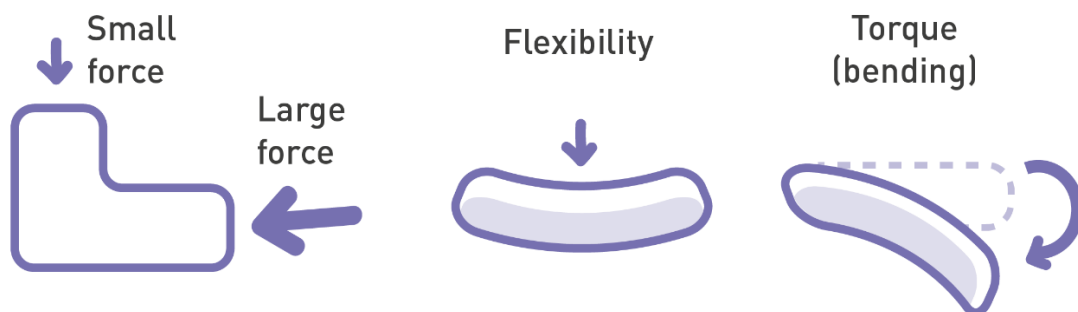

Figure 10 - Representing forces.

Additional part features

Besides reference points, there are more features that are important for a part to function. Think for example of drainage holes, textures, handles, etc. These are not related to any other part but could be very important for the part to work. You should also identify these and note them down on your sketch, so you include them in the redesign of your part.

Creating a List of Essential Elements

Now you can select and list down the features and requirements that are essential for the functionality of the part. Focus on those part features and requirements that are essential for your part to work and fit with the other components. This way you can eliminate non-essential elements of the part to simplify it for 3D printing. Doing this will make the Redesign phase easier, as you will not have to worry about recreating unnecessary complex geometry. Double curvatures are good examples of something to eliminate as it's often non-essential. Part relations such as pivoting points and fasteners however ARE things you should consider in your list of essential elements.

In Figure 11 you see an example of a kettle switch redesign, where the pivot points and the pushing head were maintained, but the original double curvature of the back was not considered an essential element.

Figure 11 - A broken kettle switch (left) and the redesigned 3D printed replacement (right).

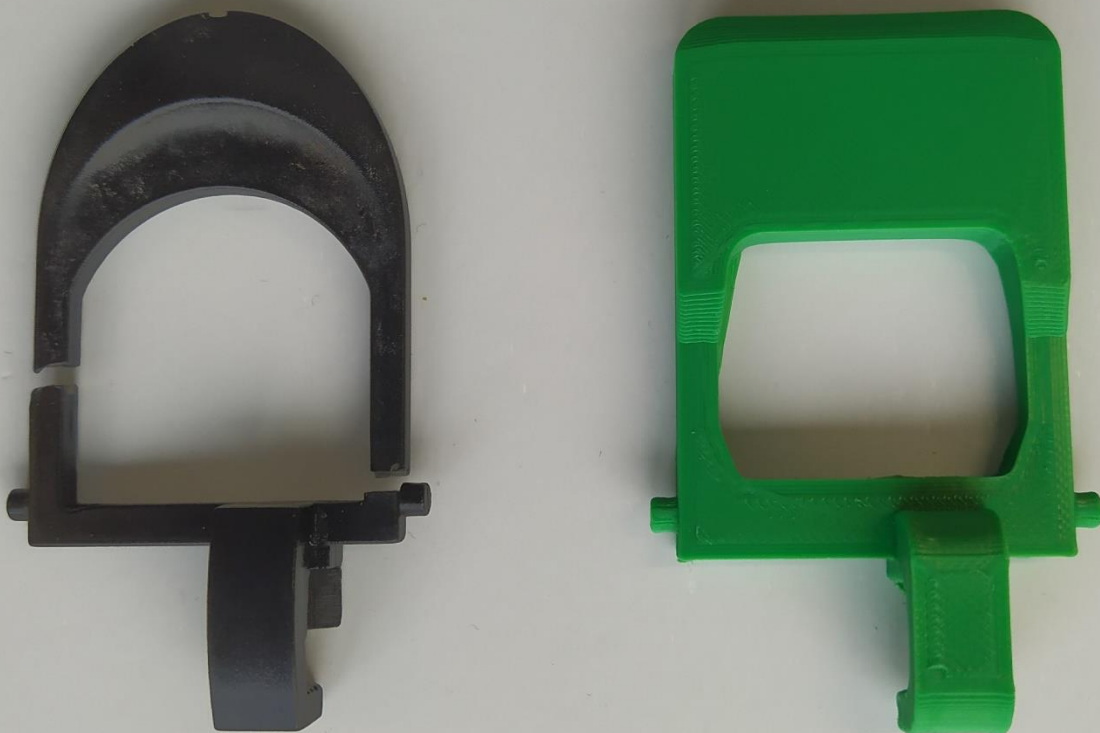

THE BIG QUESTION: IS MY PART FEASIBLE FOR 3D PRINTING?

Considering all the information you have collected during the Analysis phase, it is now time to ask yourself the big question: can I 3D print this part?

It is difficult to define exactly when you can 3D print a part or not, due to the large variety of parts, part requirements, printing methods, and materials. For some 3D printing methods or materials, it might be easier to achieve certain requirements than for others.

The part requirements that we recommend to avoid when using FDM printing are listed below. We recommend it to use it as a checklist to estimate whether your part is feasible for FDM printing.

YES **NO**

- | | | |
|--------------------------|--------------------------|-------------------------------------------------------------------------------------------------------------------------------------------------------------------------------------------------------------------------------------|
| <input type="checkbox"/> | <input type="checkbox"/> | Food contact. There are currently no FDM filaments that are certified for food contact, the part can get contaminated with heavy metals during printing, and the layer grooves give space for build-up of dirt and bacteria. |
| <input type="checkbox"/> | <input type="checkbox"/> | Large forces. Forces above the recommendations given on the technical data sheet of the printing material will lead to part failure. |
| <input type="checkbox"/> | <input type="checkbox"/> | High temperatures. Temperatures above the recommended max temperatures on the technical data sheet of the printing material will lead to part failure. |
| <input type="checkbox"/> | <input type="checkbox"/> | Accurate fit and/or small and fine detailing. Any details below < 0.3 mm will be difficult to obtain using FDM. |
| <input type="checkbox"/> | <input type="checkbox"/> | Smooth/low friction surfaces. The layers of the material are typically visible, A glossy smooth finish is difficult to achieve without extensive post-processing. |
| <input type="checkbox"/> | <input type="checkbox"/> | Complex curvatures. These are too difficult or inaccessible to measure. |
| <input type="checkbox"/> | <input type="checkbox"/> | Complex geometries. These are too difficult or inaccessible to measure. |
| <input type="checkbox"/> | <input type="checkbox"/> | Complex/inaccessible cavities. These are too difficult or inaccessible to measure. |

If you...

- answer **YES** to any of the elements of the checklist, then it is very likely that your part will fail, or that the process will be very time-consuming. We recommend finding spare part suppliers, or visiting a local Repair Café or repair shop so you can receive further guidance on what can be done to repair your product.
- can answer **NO** to all aspects, you can now move on to the Redesign phase! Some of the part requirements can be avoided by simplifying or redesigning the part for 3D printing.
- are unsure, the testing phase will be very important to find out if a certain feature or characteristic of your part can be 3D printed. You might need a few extra iterations to try out multiple designs and/or printer settings, or you can try to look up online how people tackled similar parts.

PHASE 2. (RE)DESIGN



Video 3: (Re)design phase - [click here](#)

What are the differences between injection moulding and 3D printing?

How do you design your part for 3D printing?

When attempting to design spare parts for 3DP it is important to consider that there will be significant performance differences between the original manufacturing method and material of your part (e.g. injection moulding of polypropylene), to the new ones (e.g., FDM of PLA). The part should be (re)designed to comply with the requirements of the new manufacturing method and material whilst maintaining its functional requirements. **This means it most likely cannot be an exact copy of the original part.**

Before you start your (re)design process, you should be able to identify the type of 3D printing technology that suits your part requirements best. Different technologies will have different design rules and manufacturing requirements that will influence the design of your part. Also, bear in mind which printing technologies you have available locally, or which possibilities you have in outsourcing your print to external service providers such as [Materialise](#) [12] and [Hubs](#) [13].

This guide focuses on reproducing parts with Fused Deposition Modelling (FDM), also known as Fused Filament Fabrication (FFF). For information regarding other printing technologies and choosing the right one for your needs we recommend consulting [Selecting the right 3D printing process by Hubs](#) [14].

The Redesign phase is divided in 3 sections:

1. **Rethinking – 3D printing vs. injection moulding**

Injection moulded parts are most likely suitable to be replaced by 3D printed parts. However, the mechanical and thermal performance of 3D printed “copies” is generally lower. This section will provide you with examples of performance differences between Injection Moulded parts and 3D printed copies, as well as tips to overcome redesign challenges.

2. **Redesign for FDM, synthesize and simplify**

Designing for FDM printing differs from designing for IM. In this section, specific information on how to redesign for FDM is provided.

3. **Digitizing**

To digitize your part in the computer, this section will provide you with different methods to capture the geometry of your part, like 3D scanning and manually measuring the part.

RETHINKING – FDM VS. IM

As mentioned above, the part needs to be (re)designed to respond to the characteristics of the new manufacturing method and the available material. Therefore, it is important to compare the original context with the new context. This includes material, manufacturing, configuration, design rules, etc. In this guide we will focus on the main differences between Injection Moulding (IM) vs Fused Deposition Modelling (FDM).

Figure 12 shows diagrams of the two different methods. Injection moulding is done by pushing molten plastic into a mould. The shape sets by cooling the plastic, and then pushing it out of the mould. 3D printing with FDM is done by depositing a plastic string, also called filament, layer upon layer through a moving printer head.

Injection moulding

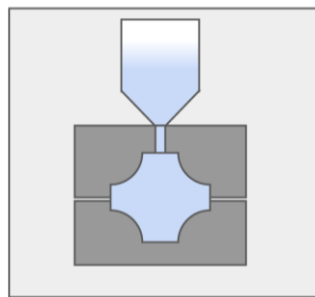

3D printing

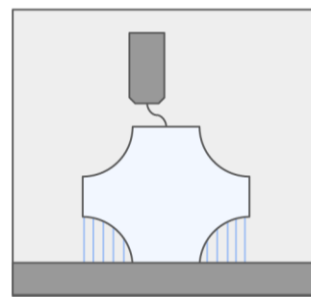

Figure 12 – The injection moulding process versus the Fused Deposition Modelling process.

Main performance differences between the two processes

One of the most important differences to consider between IM parts and 3DP parts is their internal structure as shown in Figure 13. An injection moulded part is a solid object with a high density. A 3D printed part on the other hand, is layered, and not completely solid. It has a near-solid shell with a certain infill pattern, resulting in a lower density. Even with a 100% infill, there will still be cavities and gaps inside your part. Of all the different 3D printing methods, SLA printing is arguably the closest we can get to injection moulding as it has a strong chemical bond between the layers.



Figure 13 - Internal Structure of IM parts and FDM parts.

With all these differences in mind you can start considering what kind of features need to be redesigned in your part for it to perform as expected. In Table 1, you will find examples of performance differences between IM parts and 3DP parts and potential design solutions for them.

Injection Moulding (IM)	3DP FDM using PLA	How to redesign
Intricate geometries, high level of detail	Level of detail limited by the accuracy of the printer and nozzle. Limitations due to printing direction and need for support material	Simplify unnecessary details. Keep tolerances above minimum layer height (differs by printer).
Typically, injection moulding has an accuracy of around 0.02 mm [15]. High precision injection moulding can have an accuracy between 0.01 and 0.001 mm [16]	Dimensional accuracy of $\pm 0.5\%$ (lower limit: ± 0.5 mm) Warping and shrinkage can occur which will change the dimensions of your part.	Simplify intricate geometries. Reduce the length of the sections or the number of elements where two parts relate to each other.
Can produce large parts	Most FDM printers have a maximum building size of around 220 x 220 x 200 mm. Industrial FDM printers can get as big as 1500 x 1000 x 700 mm.	Splitting parts and printing in two parts. The assembly of the two parts should be studied beforehand.
Can produce strong parts	Tensile strength defines how much a material can deform before it breaks. The tensile strength of FDM parts can be up to 55% to 62% of the tensile strength of the original part. Additionally, the tensile strength of FDM printed parts is different for each direction (anisotropic) because of the layered deposition of filament.	Fortify sections that are force loaded by increasing the dimensions locally and increase infill density. This will also increase the amount of material used. Keep the optimal printing orientation in mind during the design, as explained in the Printing Orientation section.
Can produce stiff parts	The Young's modulus defines how much a material can stretch before it deforms. The elasticity of FDM parts could be up to 47% of the original part's elasticity.	Increasing the infill density of a part to make a part less elastic. This will also increase the amount of material used.

Table 1 - FDM vs 3D printing - design solution.

REDESIGN FOR FDM – SYNTHESIZE AND SIMPLIFY

You have identified the essential functions and requirements of your part, and you understand the differences between 3D printing and injection moulding. Now, you can start ideating on potential solutions to solve the part requirements with 3D printing. This section will help you out in designing your part in such a way that it can be printed easily.

FDM printing design guidelines

Design for FDM differs from designing for IM. In Figure 14, you see the main design considerations for FDM as provided by 3D Hubs. More information about design for 3D printing can be found on the 3D Hubs website [Key design considerations for 3D printing](#) [17].



Supported walls	Unsupported walls	Support & overhangs	Embossed & engraved details	Horizontal bridges	Holes
Walls that are connected to the rest of the print on at least two sides.	Unsupported walls are connected to the rest of the print on less than two sides.	The maximum angle a wall can be printed at without requiring support.	Features on the model that are raised or recessed below the model surface.	The span a technology can print without the need for support.	The minimum diameter a technology can successfully print a hole.
					
0.8 mm	0.8 mm	45°	0.6 mm wide & 2 mm high	10 mm	Ø2 mm
Connecting /moving parts	Escape holes	Minimum features	Pin diameter	Tolerance	 3D HUBS
The recommended clearance between two moving or connecting parts.	The minimum diameter of escape holes to allow for the removal of build material.	The recommended minimum size of a feature to ensure it will not fail to print.	The minimum diameter a pin can be printed at.	The expected tolerance (dimensional accuracy) of a specific technology	
					
0.5 mm		2 mm	3 mm	±0.5% (lower limit)	

Figure 14 - Key considerations for FDM design. Retrieved from [3D Hubs Key design considerations for 3D printing](#) [17] Copyright © 2022 3D HUBS B.V., used with approval.

Optimizing part performance and printing time/material

As explained before, FDM printed parts are not typically solid. Printing solid parts requires high amounts of material and gives long printing times and often high costs. To optimise the printing process most parts are printed with solid shells and infill patterns [18], as shown in Figure 13 and Figure 27. You should take this into account when designing your parts, especially considering strength and stiffness. Following the FDM printing design guidelines will not only increase the chance of a successful print, but it will also reduce modelling time, printing time, and material use. It can also reduce the amount of necessary support material, which reduces post-processing time and delivers a better surface result.

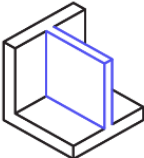
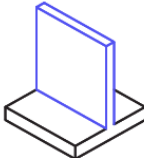
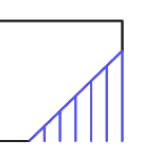
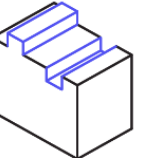
Figure 15 shows how small changes in the design and the printing orientation can make a great difference. Printing the original part design upright (left) gives a long printing time, a rough surface, and high material use, due to the use of rounded forms and the need for support material. Printing the original part upside down (middle) reduces the printing time and material use, but the resulting surface finish is even rougher. This might be fine for some parts, but other parts might need a smoother or more aesthetically pleasing finish. The redesigned part (right) can be printed upside down without needing support material, as it has been redesigned with a flat top. This resulted in a print with a much smoother surface, while further reducing printing time and material use.

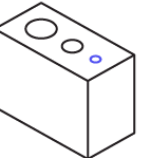
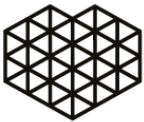
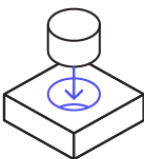
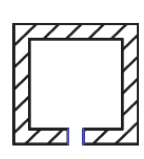
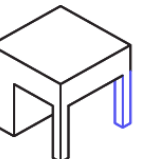
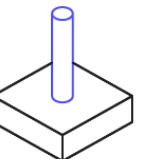
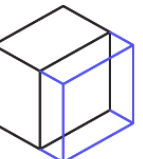
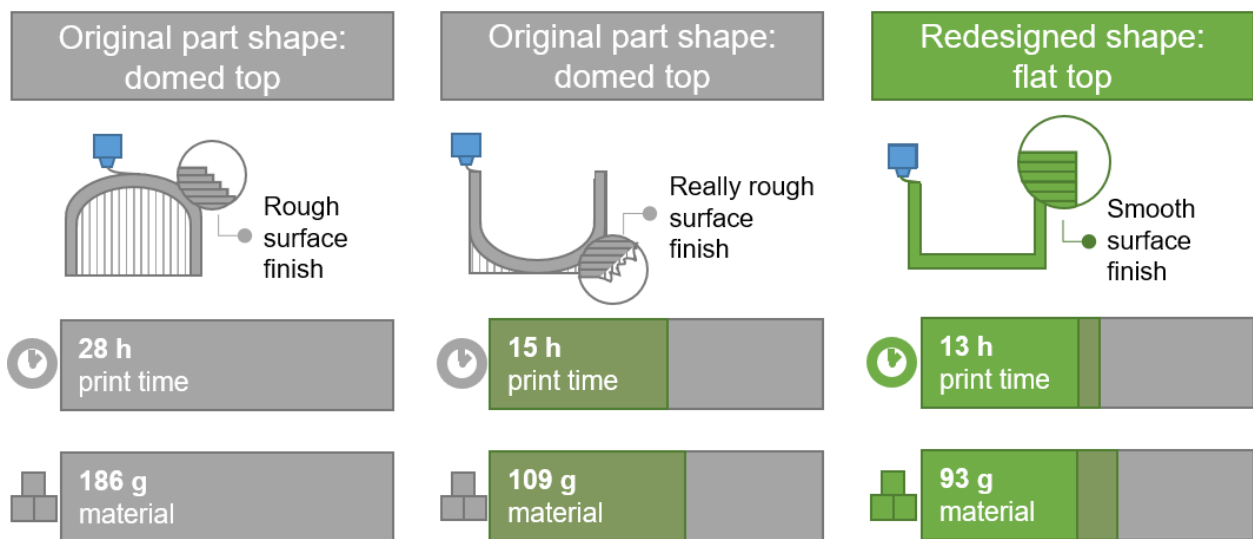

Figure 15 - Example of design recommendations to reduce printing time and material.

Printing orientation

In FDM printing, the orientation of the part during printing has a great impact on the strength of the part when it is bended or loaded. The printed material is strong along the printed layer, and weak between layers. This is because the adhesion between the layers is less strong than the strength of the material itself. With too much force, the layers can “peel off” of each other. Therefore, the way you orientate your part on the build plate during printing will influence the strength and stiffness of your part in each direction. As a designer, you can use this in your advantage while designing critical part sections. Make sure that sections which must withstand forces are oriented in the strongest position, as shown in

Figure 16. In some cases, there are multiple sections that require strength but that are pointed in different directions, such as for parts with snap fits. In that case, you can split the part to optimise the strength in these sections.

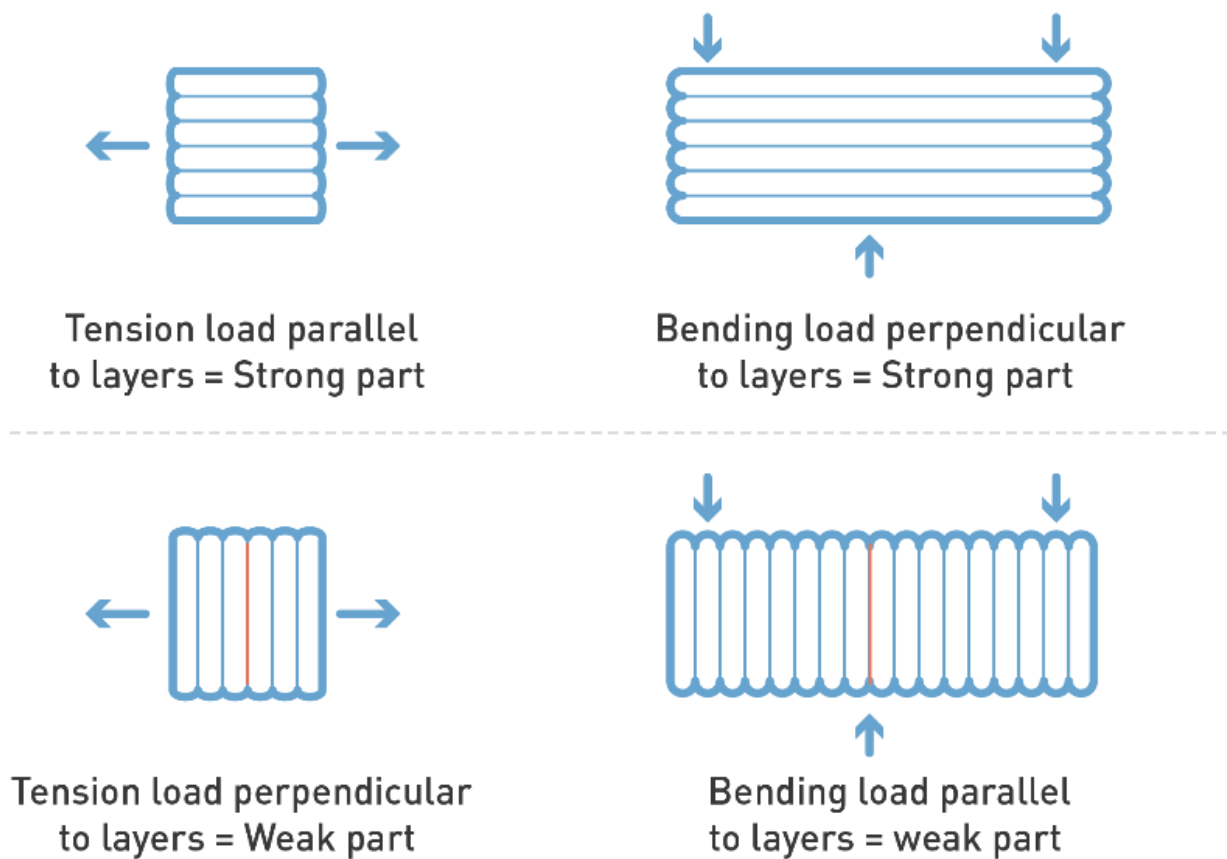

Figure 16 - Effects of printing direction on part performance. Retrieved from [3D Hubs How does part orientation affect a 3D print](#) [19]. Copyright © 2022 3D HUBS B.V., used with approval.

Simplifying part geometry to ease the designing and printing processes

We highly recommend you simplify your part as much as possible and only focus on critical and essential characteristics of the part you are working on. Remember to revisit the list of essential elements made during the analysis phase. The simpler your part is, the easier it will be to 3D model it and print it.

Figure 17 and Figure 18 show examples of the iterative simplification process for a kettle switch.

The original part on the left has some double curvature ornamental shape at the back, and an intricate geometry to press a button. These features are easy to implement when using the form freedom and precision of injection moulding. Also, the original part is made from ABS plastic, which makes it possible to make thin arm sections that should still be strong enough. The redesign on the right has a simplified geometry, which doesn't include the double curvature as it is not needed for good functioning of the part. By getting rid of the curvature, the simplified part becomes much easier to print. Additionally, the part is designed to lie flat on the build plate so no support material is needed. Finally, as the 3D printing material is weaker than the original material, the thickness of the arm section had to be increased to make the part strong enough. This is especially important as this section already broke in the original part.



Figure 17 - Original IM part and installed FDM printed part. Case study: kettle switch.

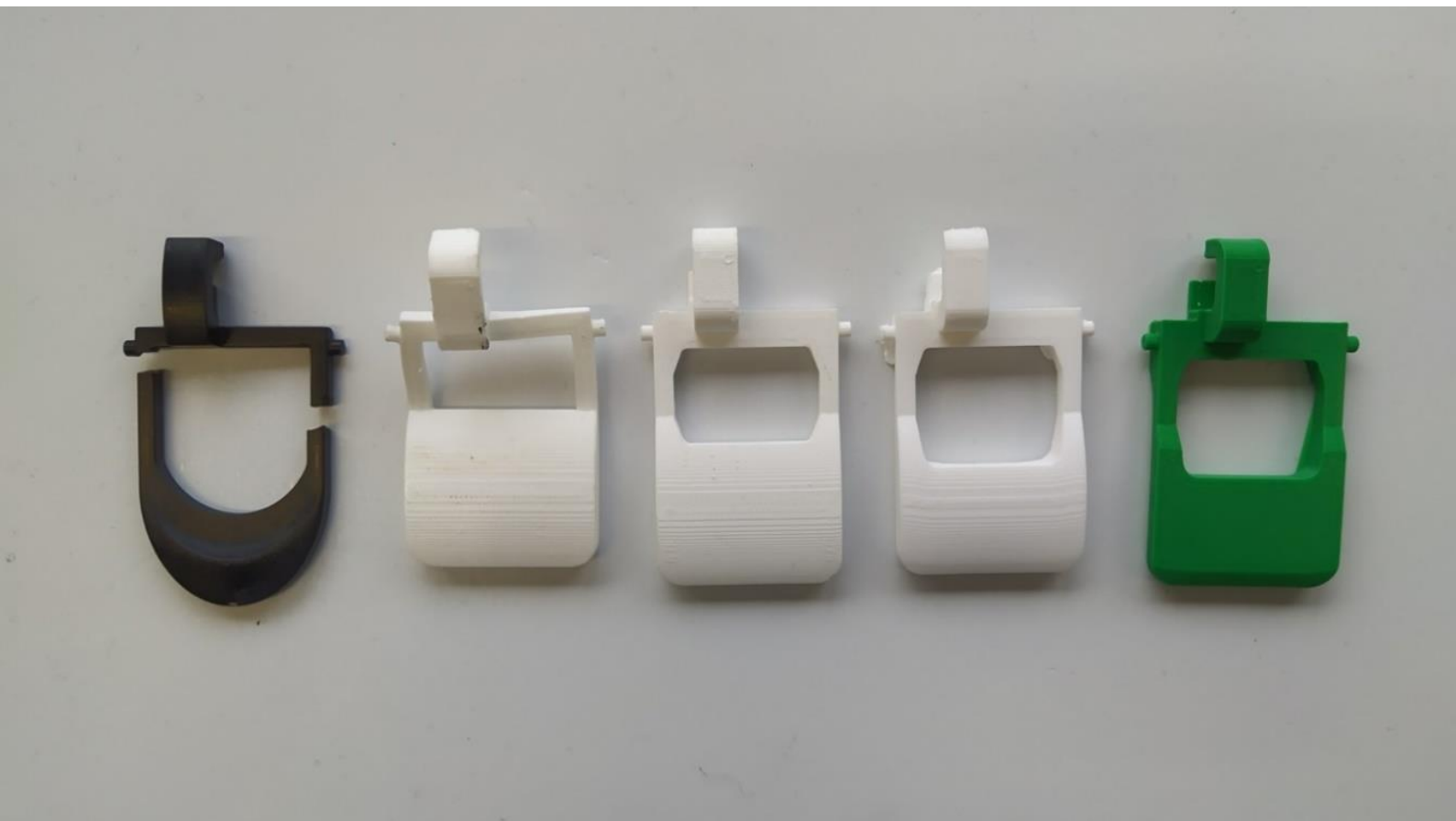

Figure 18 - Kettle switch iterations, and resulting FDM part (green) with simplified and modified geometry.



Video 4: Digitizing - [click here](#)

How do we go from a physical to a digital design?

What methods and tools can you use to digitize the geometry of your part?

Without a digital design, you cannot print the spare part. When the part is not made available by the company, or not available in an online database, you need to digitize your part yourself. You can make a digital “copy” of your part in various ways, such as using:

1. **Manual scanning:** use measuring tools, such as a caliper, to find the measurements of your part to model it in a 3D CAD program.
2. **3D digital scanning:** use scanning techniques like photogrammetry or a 3D scanner. 3D scanning **does not substitute the (re)design process**. You will still need 3D CAD modelling to fine-tune and optimise your part design for 3D printing.
3. **Photography guidance:** use an image as a reference for complex curves or shapes while modelling your part in a 3D CAD program.

Figure 19 shows a flow chart that could help you to find the right approach for your project.

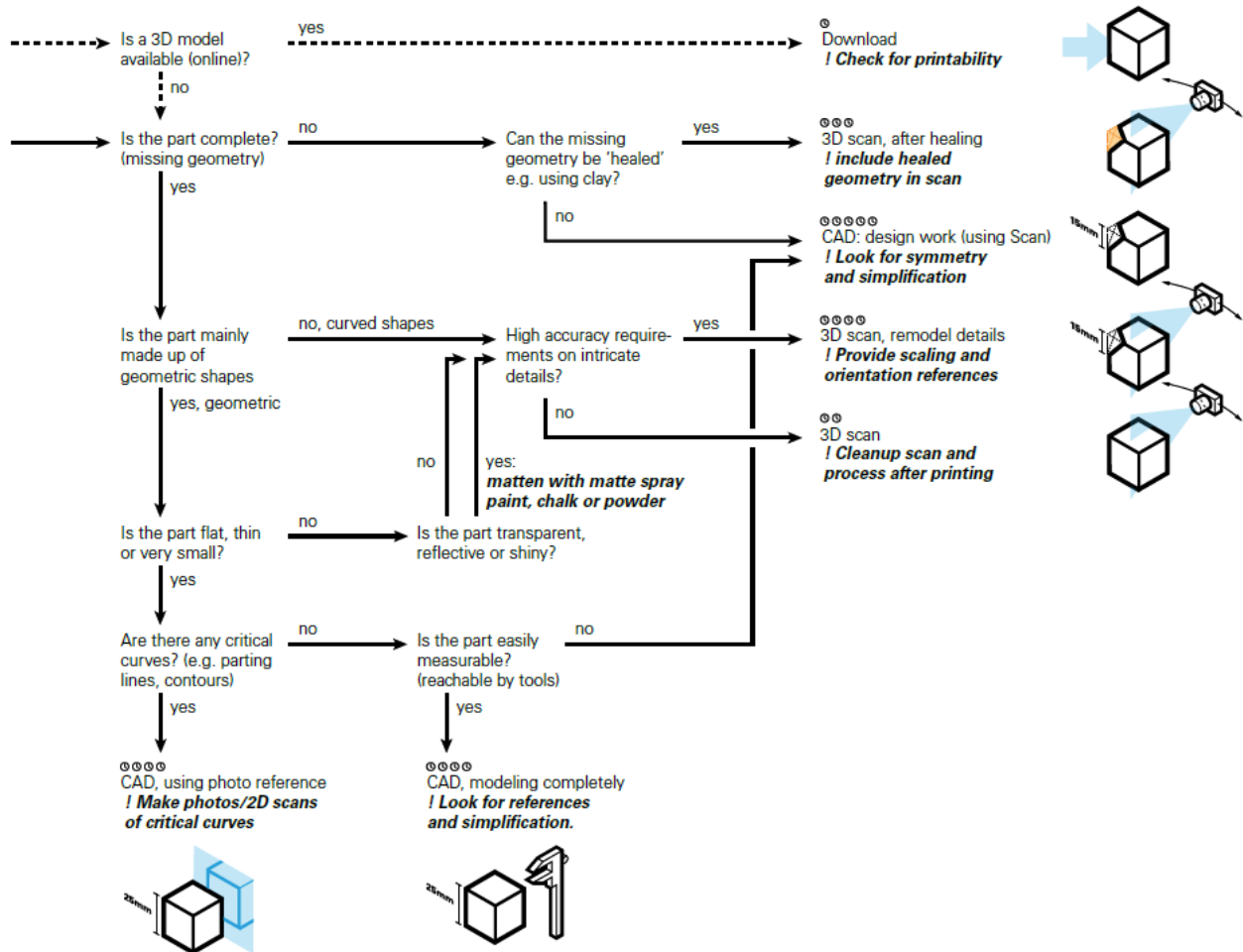

Figure 19 - Decision flowchart to select a digitizing method.
Used with approval of M. T. F. Beerkens [20].

Digital 3D scanning using photogrammetry

With photogrammetry, you rotate a camera around your part and take a lot of pictures at different angles as shown in Figure 20. All these pictures are then merged in special software to make a 3D model. This option can help you to get complex and organic shapes right. More information about using photogrammetry can be found in this Instructable developed by Thijs Beerkens: [3D Scanning](#) [21]. An open-source photogrammetry software you can use to scan an object is [MeshRoom](#) [22] an alternative option is [Regard3D](#) [23]. We also recommend watching the following tutorials: [Photogrammetry 2 by Prusa 3D by Josef Prusa](#) [24] and [Preserving Sculptures With 3D Scanning and 3D Printing by Caleb Kraft](#) [25].

Bear in mind that the quality of the 3D scanned part can be poor. Photogrammetry is a very time-consuming process and produces limited quality and details. The scanned file might need file-fixing in software such as Materialise Magics or Autodesk Netfab to fill holes or remove useless floating geometry. Additionally, scanned files are not always completely dimensionally accurate. Especially small objects or small parts are very inaccurate when using photogrammetry. Photogrammetry is best used when the parts include natural or double-curved forms which are essential for your part to function. We only recommend this approach when it is strictly necessary.

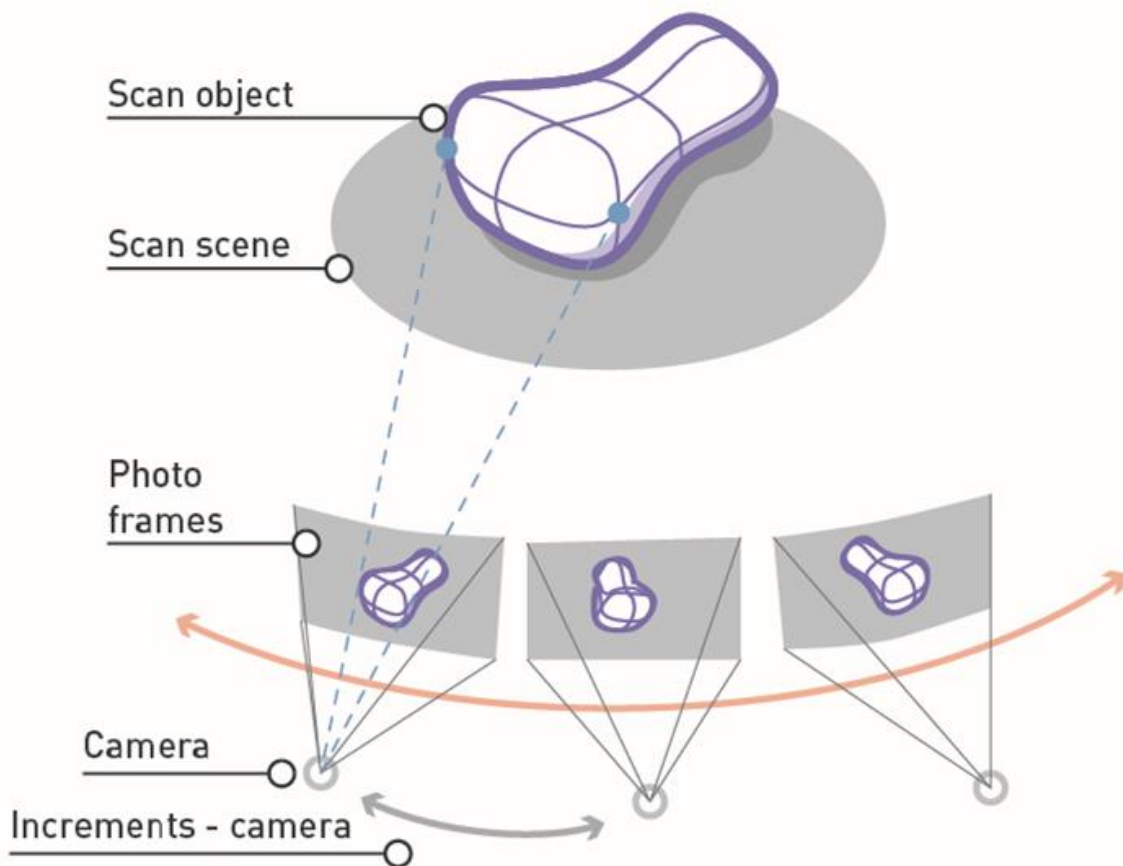

Figure 20 - Photogrammetry setup, based on [Repair Using 3D Printing: 2a 3D Scanning](#) by thijsbeerkens [21], licensed under CC BY-SA 4.0.

Manual scanning

The best option for digitizing your part is to measure your part by hand, and then model it in a 3D CAD program. When measuring a part for reproduction we recommend the following:

- Make manual sketches or take pictures that show the side, front, and top of the part.
- Take as many measurements as possible. Dimension every shape you find using the appropriate measuring tools (Table 2).
- Make measurements at an accuracy of at least 0.1mm. You can do this with an analogue caliper. You can see an example of how to use it in Figure 21.
- Take special note to all interfaces the part has with other parts in the product architecture. To make the part fit, these interfaces are essential.
- Analyse and identify reference points in your part to facilitate measuring.

Table 2 includes some useful measuring tools we recommend you use. If you need to measure a difficult shape or you don't have the right measuring tool available, you can always print your own measuring tools. You can do this by printing out different shapes and see which one fits best.

Caliper

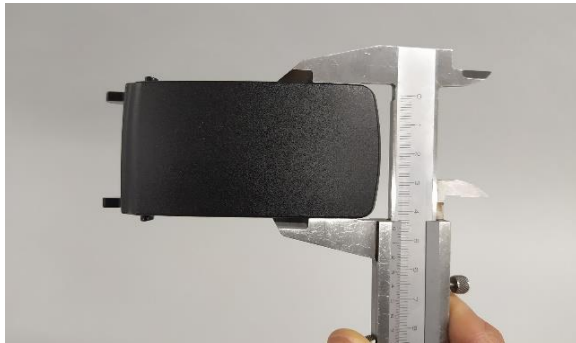

Good for measuring distances between external and internal edges.

Protractor



Good for measuring angles between two lines or edges.

Thread pitch gauge



Good for identifying the size of a thread. The sizes are predefined, and you find the best fit.

Radius gauge



Good for identifying the size of a concave or convex radius. The sizes are predefined, and you find the best fit.

Table 2 - Measuring tools.

Figure 21 shows examples of how to measure with a protractor and caliper.

A caliper measures the distance between these two external edges, using the external jaws marked in blue. Whenever you need to measure distances of internal edges, use the internal jaws, marked here in green. You can choose to use an analogue or digital caliper.

When using the analogue caliper make sure to read your measurements from 0 to 0, as indicated by the red arrows. In order to read the decimals and measure with an accuracy of 0.1mm, you should use the Vernier scale, marked in pink. In this example the distance between the 2 edges is 46.9 mm. We recommend the video by Bob Weld on [How to use a Metric Vernier Caliper](#) [26].

A protractor measures the angle between the edges of the component. The protractor blade is placed against the angle of the part, and the measured angle can be read at the end of the blade, as indicated by the orange arrow. Make sure that you select the correct measurement, based on whether the angle is acute ($< 90^\circ$) or obtuse ($> 90^\circ$). In this example, the protractor reads an angle of 120 degrees between the two yellow lines.

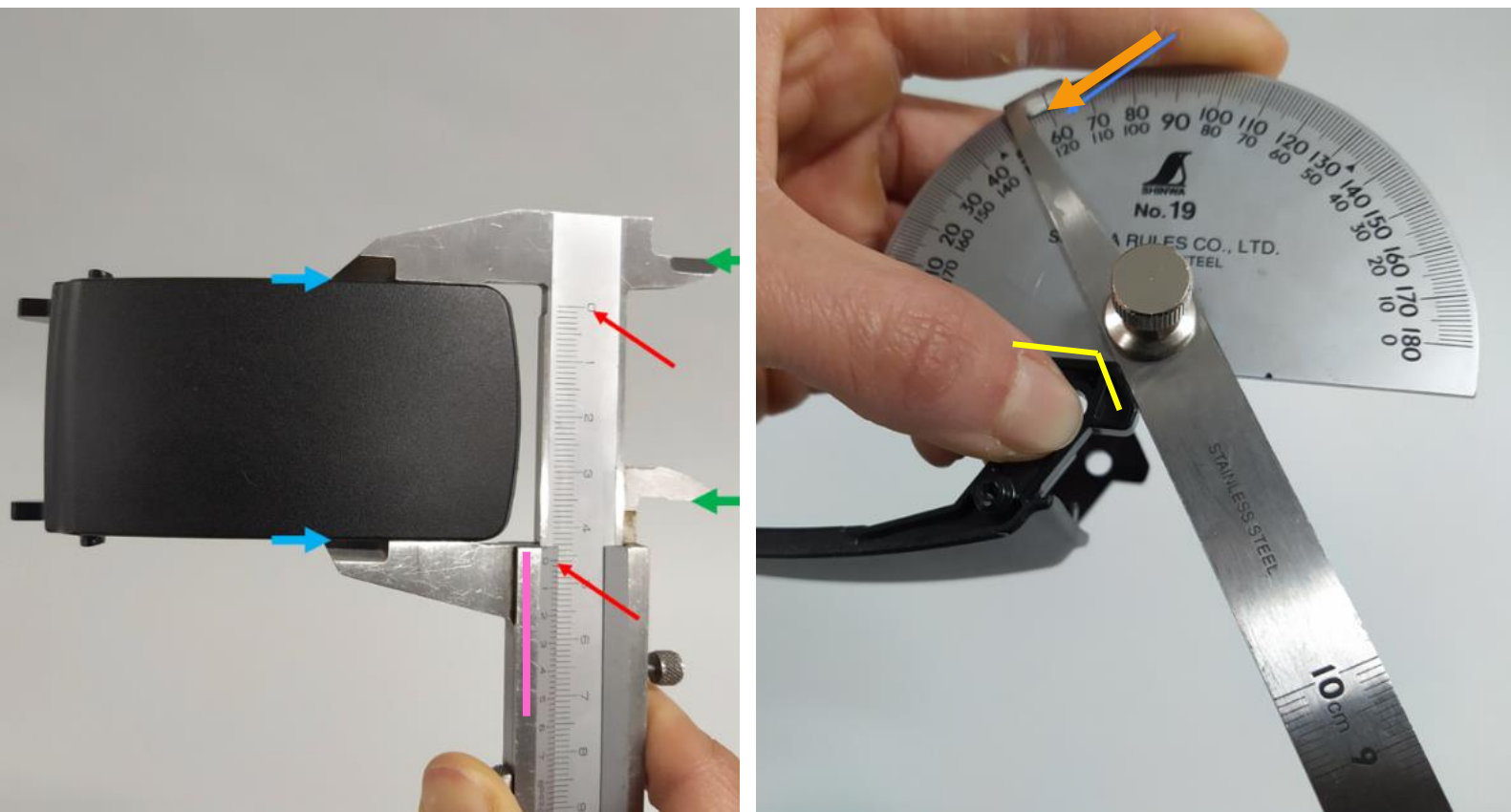

Figure 21 - Measuring distances with a caliper and measuring angles with a protractor.

Photography guidance

We recommend using photography guidance to capture complex shapes. You can take a picture of your part directly from above and use this as a background reference in your 3D CAD program. Make sure your picture is not skewed and provides an orthogonal view of the part, which means you should take pictures of the top, front, side or bottom as perpendicular to the object as possible. Figure 22 shows an example of a set up for making pictures of orthogonal views of your part.



Figure 22 - Set up to take pictures as perpendicular to the object as possible.

In Figure 23, you can find that the picture on the left is skewed and does not show an orthogonal view of your part. The picture on the right IS an orthogonal view and will be helpful when 3D modelling.



Figure 23 - Examples of correct and incorrect reference pictures.

In Figure 24 you will find an example of how you can make use of a reference photo in the background when CAD modelling. You can then trace the outlines of the product that would normally be too difficult to capture with manual scanning. In this example, we have included a caliper as a reference measurement, so we can scale the picture to 1:1 in the 3D CAD program and get the measurements of the object right.

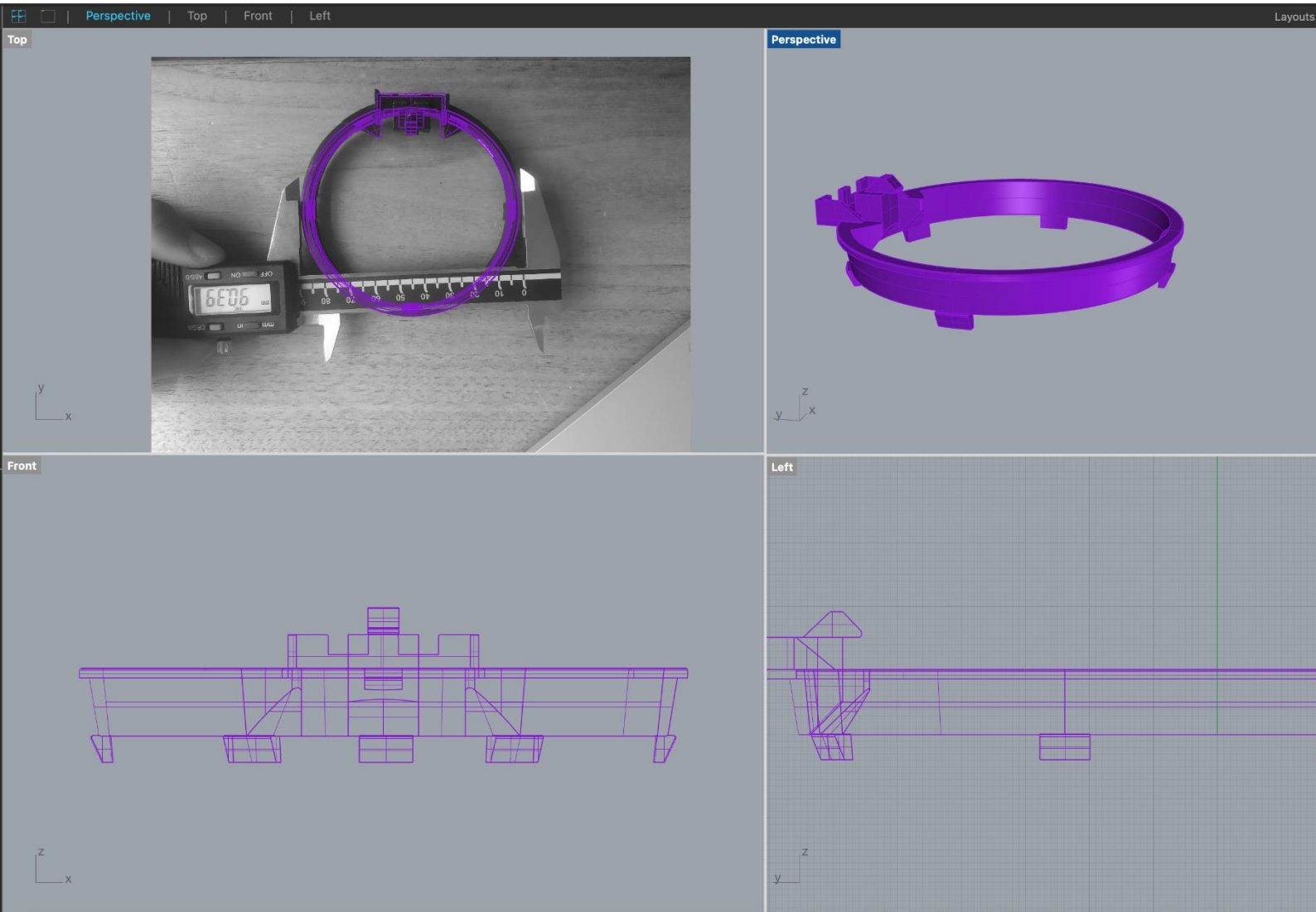

Figure 24 - Example of the use of photography guidance in CAD modelling software.



Video 5: CAD modelling - [click here](#)

What is 3D modelling?

How do I build my part in 3D modelling software?

After scanning or measuring the part, you must process the information by modelling the part in a 3D CAD program. CAD means Computer Aided Design. There are different ways to approach this process:

1. Non-experienced CAD users can make use of low-level 3D modellers like [TinkerCAD](#) [27] and [3D Slash](#) [28].
2. Experienced users can make use of
 - a. commercial CAD modellers like [SolidWorks](#) [29] or [Rhino](#) [30] & [Grasshopper](#) [31];
 - b. free-for-personal-use CAD modellers like [Fusion 360](#) [32] and [Onshape](#) [33];
 - c. open-source CAD modellers like [FreeCAD](#) [34].
3. Users with programming experience can make use of [OpenSCAD](#) [35], an open-source modeller using scripts as input for the CAD file. Very handy for producing parametric designs of your object and upload to [Thingiverse](#) [36] using the [Customizer app](#) [37].
4. When you have used scanning to digitize your object, you can improve and make it useful by “healing” it with [MeshMixer](#) [38]. This is not a 3D CAD modelling program, but it will help you to improve your scanning results.

This guide does not focus on teaching 3D modelling and only offers a few recommendations. We do offer general CAD modelling guidance in our [3DP4R Guidance videos](#) [39]. 3D modelling skills and available resources vary from person to person. To get started with the above-mentioned CAD programs, these tutorials are highly recommended:

1. TinkerCAD: [Getting Started with TinkerCAD for Adults](#) [40]
2. Fusion 360: [Fusion 360 Getting Started Tutorial](#) [41]
3. Onshape: [Onshape.com - Getting Started](#) [42]
4. FreeCAD: [FreeCAD for Beginners](#) [43]
5. OpenSCAD: [Open SCAD - Introduction Part 1 for New Users](#) [44]

CHECKLIST – IS YOUR PART READY FOR 3D PRINTING?

Before going into the following stages, and before confirming your design is ready and fit for 3D printing, we recommend following this checklist. Please make sure you have considered all the important aspects mentioned above from the Analysis and Redesign phases. If you have forgotten anything, adjust your design accordingly.

- I have considered [the difference between the original manufacturing method and 3D printing](#)
- I looked at the '[Key design considerations for 3D printing](#)'
- I have recreated all the [essential elements](#) in my part
- I have simplified the non-essential elements in my part
- I have considered the [printing orientation](#) of my part elements
- I have used the right tolerances to get [the right fit](#)
- I have considered all the [performance requirements](#) in my part design
- I have checked if [the measurements and scale](#) of my part are correct
- I have reinforced [weak sections](#) of the part if needed
- I have checked that my [CAD model](#) is a solid and not separate surfaces

PHASE 3. MANUFACTURE



Video 6: From Redesign to Manufacturing - [click here](#)

How does the 3D printing process work?

How can I design for 3D printing?

After analysing, (re)designing, and digitizing your part it is now time to manufacture it. The manufacturing process of a 3DP spare part can be split into three main stages:

1. **Selecting the material** and suitable printing technology (in the case of this guide, FDM).
2. Preparing the CAD file to be printed, commonly known as slicing.
3. **Post processing processes** the part requires after being printed to be ready for use.

All these stages require decision making that must be considered during the [Redesign phase](#). The decisions made for the manufacturing process should also correspond to the performance requirements that were defined for the spare part during the [Analysis phase](#).

MATERIAL SELECTION

Figure 25 will provide you with information to help you choose the right 3D printable material for FDM printing. The material should suit your part functional and performance requirements, which you previously identified during the Analysis phase.

Once you have selected a material, we recommend looking at the printing specifications provided by the material supplier on the Technical Data Sheet. These vary from one material to another. These aspects are relevant for you to double check to see if it meets your requirements. For example, the temperature requirements of the part should not exceed the maximum service temperature of the material. Also, on the Technical Data Sheet you will also find any specific printing recommendations. Following these printing recommendations will increase the chances of a successful printing process.

For more information about material selection we also recommend consulting [3D Hubs: FDM 3D printing materials compared](#) [45].

Material	1. Aesthetics		2. Strength and wear				4. Operating environment			6. Post. pros.	Cost	Printing difficulty
	1.a Aesthetic quality	1.b Colors	2.b Elasticity	2.b Strength	2.b Impact resistance	2.c Wear resistance	4.a Moisture sensitiveness	4.b Chemicals resistance	4.c Temperature resistance	6.b Workability		
PLA												
Tough PLA												
ABS												
Nylon												
TPU 95A												
PC												
PP												
Recycled PLA												
Recycled ABS												
Recycled PET												

Figure 25 - Filament material selection guidance. Used with approval of F. DeFazio.

PREPARING THE CAD FILE FOR 3D PRINTING

Once your model is ready, you will be able to export it into a format that can go into the slicing software, where it will be prepared for it to go into your 3D printer. Slicing is the procedure of processing your design into layers for it to be 3D printed.

If you do not have a 3D printer you can probably find a local printing service, such as a Fablab or Makerspace, that can print your design for you. They will inform you of the type of file you must submit together with other information to have your part printed.

3D printing steps

When you have a 3D printer at your service you will go through the following steps:

1. Export your 3D model to a file in the STL format (stereolithography), which is the most common format slicing program used to prepare the 3D model for 3D printing. Make sure that your part is properly scaled, and the exported file corresponds to the units you originally modelled with (e.g., if you modelled in millimeters make sure you export your file in millimetres).
2. Download the slicing software of your preference and install it in your computer. Depending on the printer you are using you will find different slicing software options that are compatible. We recommend [Cura from Ultimaker](#) [46], since it is free to use and compatible with several other printers. Figure 26 shows an example of what the screen for Cura looks like.
3. Once you have selected the printing settings and before exporting your file, verify the printing time and estimated material weight. You will use this information to test the quality of the print once it is ready. The example in Figure 26 shows an estimate of 7g of material and a printing time of 52 minutes.
4. Export your file into GCODE or UFP and load it into your printer using an SD card or USB stick (depending on the type of 3D printer you have).
5. Make sure your nozzle and material are installed, and that your printing bed is levelled. Also ensure the room you will be printing in is well ventilated, but that there is no draft or breeze. You should avoid placing your printer near an open door or window.
6. Start the file in your printer and check if the first layers are printing correctly and are adhering well to the printing bed. This is really important, as a printing failure is most likely to occur within the first few layers.
7. Once the print is done and the printer has cooled down, get the part out. You can now remove the support material and do any other post-processing necessary. Post processing operations are also explained below.

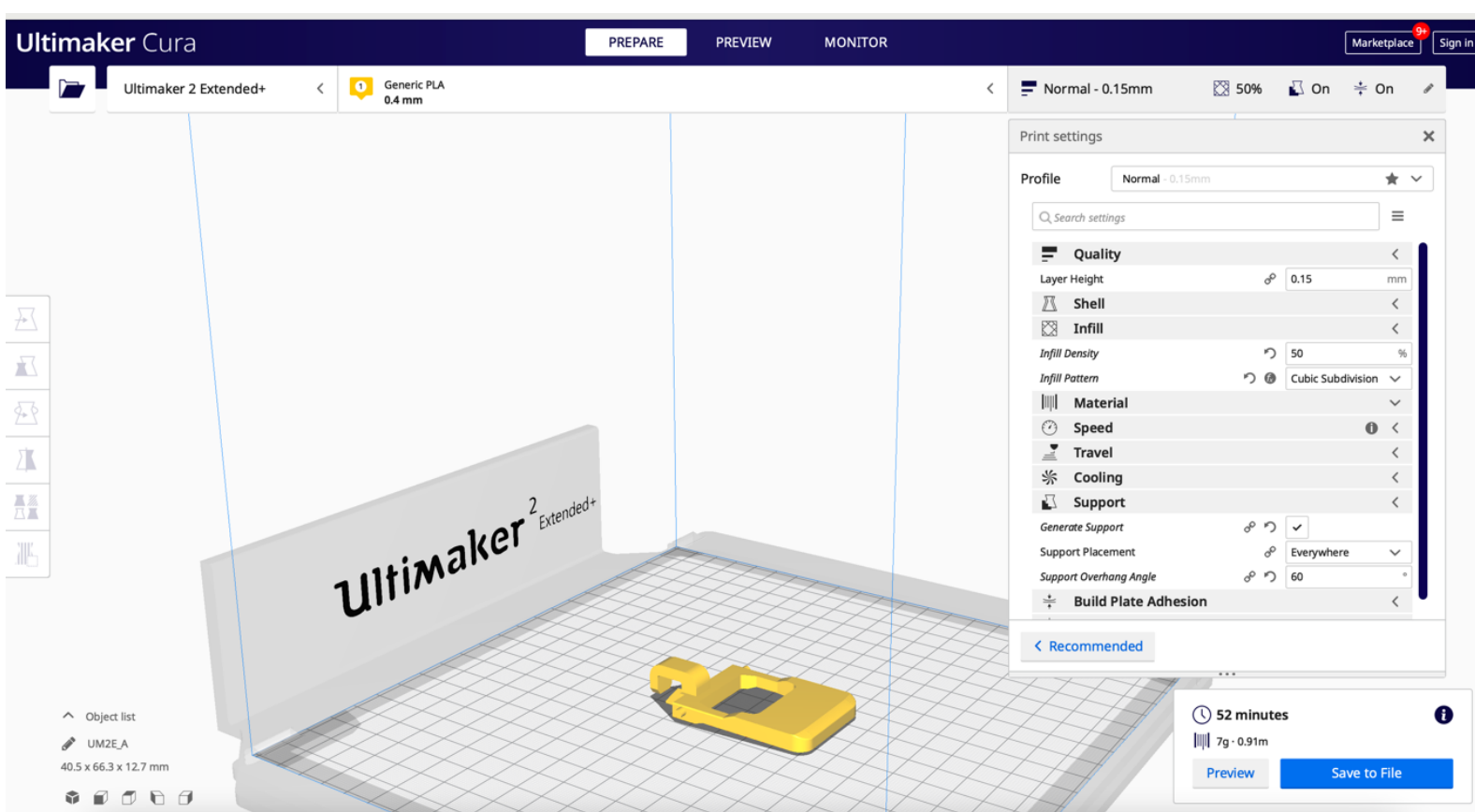

Figure 26 - Example of the use of slicing software in Ultimaker Cura.

Selecting printing settings

There are several printer settings which influence the success of the print, the performance of the part, and the time it will take to print. Here are a few examples of printer settings that should be defined beforehand and an explanation of their influence to the desired part performance:

- A. **Orientation (structure and support material):** Considering the strength requirements you previously identified during the [Analysis phase](#), and the use of support material, as described during the [Redesign phase](#), you can now select the best printing position for your part. Remember this will influence the use of material and printing time.
- B. **Print quality (layer height):** Based on accuracy and aesthetic requirements you previously identified, you can now select the desired print quality. A higher quality (lower layer height) gives a more detailed print, but has a longer printing time. You can also explore the possibilities of using a larger nozzle (if available) to reduce printing times. This can be useful for larger parts that don't have specific accuracy or detail requirements. The following list gives an example of the quality profiles for Ultimaker printers in Cura with the corresponding layer height:
 - a. Extra fine - 0.06 mm
 - b. Fine - 0.1 mm
 - c. Normal - 0.15 mm
 - d. Fast - 0.2 mm

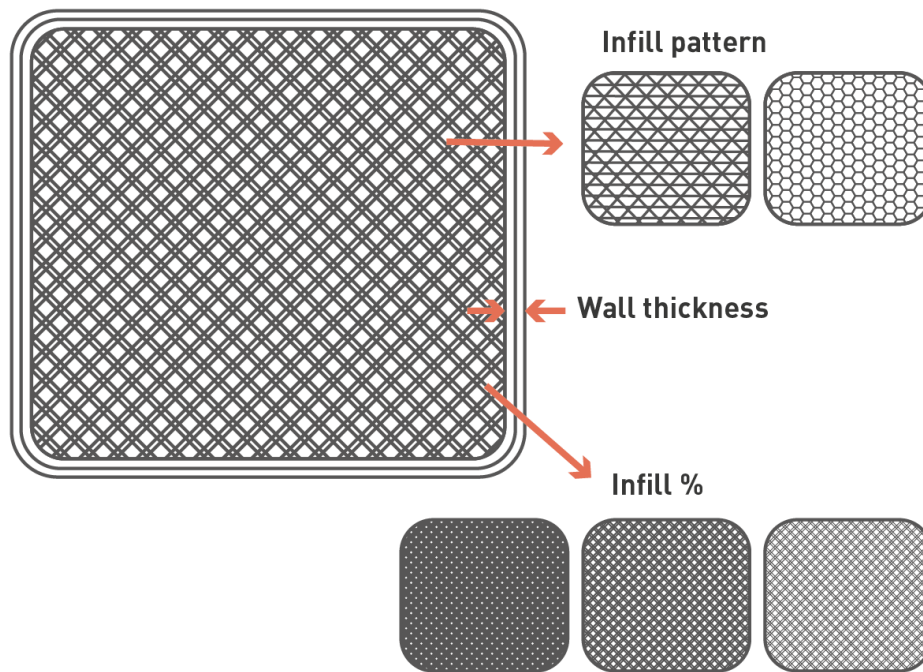

Figure 27 - Infill parameters.

- C. Shell thickness:** As explained during the [Redesign phase](#), 3D printed parts consist of a shell and an infill density and pattern. The shell is the outer walls of the 3D printed part, as shown in Figure 27. You should select a shell thickness that fits with the strength and stiffness requirements that you identified during the [Analysis phase](#) and [Redesign phase](#). Increasing your wall thickness is useful when you need a part to be stronger, this has a better effect than increasing infill density. It is recommended to define the wall thickness with multiples of the layer height you have selected to avoid gaps.
- D. Infill density:** You can determine how dense you want your part to be by determining the infill density (%). Increasing the infill density increases the part strength, but also the material use and the printing time. Printing a part 100% infill is possible, which can lead to a very sturdy and strong part. However, printing at a 100% infill is not always the best option. It leads to high material use and long printing times, and it can cause problems such as warping or shrinking during printing as a large amount of material needs to cool. Also, above 50% infill, the benefit of increasing infill is reduced; it is often not needed to exceed 75% infill. Therefore, 100% infill should mainly be considered for functional parts with high performance requirements. For other parts, especially non-load bearing parts, the standard 20% infill will already be sufficient [18, 47].
- E. Infill pattern:** Additional to the infill density, you can select the infill pattern. The infill pattern can be used to make strong parts without using too much material, or to make lightweight parts. Some infill patterns are structurally stronger or give an even distribution of strength, but take longer to print and use more material. Others produce a quicker print, but are weaker. Some patterns (3D cross for example) are good for producing flexible designs when using a flexible filament such as TPU or Flex. The recommended applications for the different infill patterns are stated in the slicing software. For more advanced infill options, we recommend [3DHubs: Selecting the optimal shell and infill parameters for FDM 3D printing](#) [18].

F. Support material. Depending on the geometry of your redesign part, you may have to select to have support material in some sections, as shown in Figure 28. If you have overhangs over 45° you will need support material, you can design your overhangs to use as little support material as possible. You can consider using soluble materials for the support (like PVA). This will only be possible if you have a printer that has two nozzles, and it also has its disadvantages, such as water absorption by the printed part.

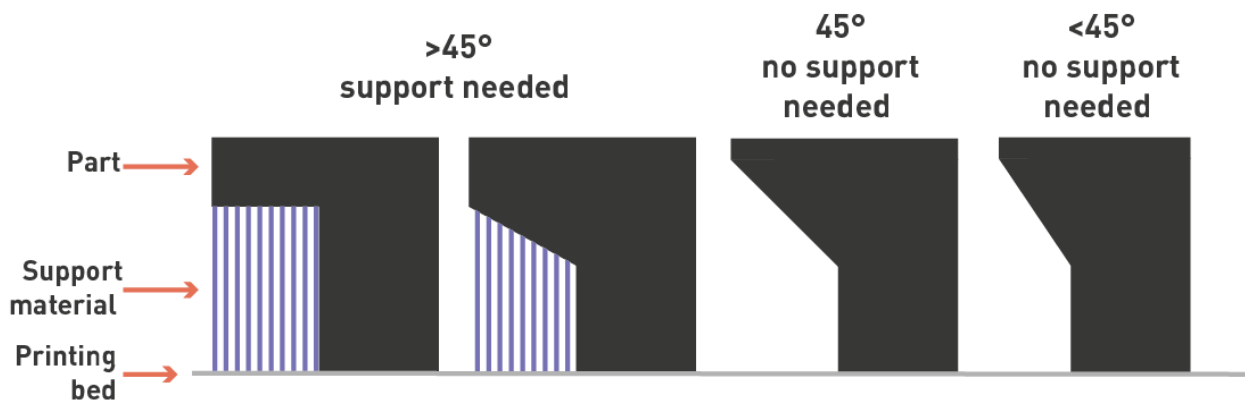

Figure 28 - Support material recommendations.

G. Build plate adhesion. Determine the type of adhesion shape according to the geometry of the part and accuracy requirements. Adding a brim or raft to your 3D print will increase the adhesion to the build plate and is always advised. Build plate adhesion is especially necessary when printing small parts. It also decreases warping of your print, which can deform or ruin your print. Brims are better when there is minimal but consistent contact with the build plate (for example, small flat parts). Rafts are better for parts with very poor contact with the build plate (for example, parts that are much taller than they are wide).

H. Material specific settings. Make sure to double check the material specifications that come from the provider in the Technical Data Sheet. Extrusion temperature or bed temperature, for example, can be different per material or brand.

POST-PROCESSING

There are a few post-processing actions you can do to finalize and further improve your printed part before you install it to repair your product. The following are a few examples:

- Surface quality and Aesthetics.** The first step to take is to remove all the support material. In addition to this, you can improve the quality of the surface of your part by using solvents, such as acetone and/or sanding down any deformations you may find. You can also choose to paint or apply other types of coating to your part. Our [Manufacturing guidance video](#) [48] provides examples of post processing options.
- Structure and assembly.** In some cases, you may have a gap or small defect on the surface of your part. You can choose to fill these by using plastic filler. In some cases, you may need glue to connect it, or to drill a hole so you can screw it together.
- Heat and strength resistance.** You can improve the heat resistance and mechanical performance characteristics of your part by annealing it. This is a heat treatment process where you “bake” your parts just below the melting point. We recommend reading more about this option in this Hackaday article: [Reforming 3D Prints With Salt And Heat](#) [49].

PHASE 4. TEST



Video 7: Testing phase - [click here](#)

Why is testing important?

What and how can I test?

Before installing and using your printed part, it is a good idea to evaluate how successful your part is. You can test it on its dimensional accuracy, aesthetics, and on the desired performance requirements. We recommend to check the performance requirements you identified and defined during the Analysis and Redesign phases and use this as a starting point for your test.

The part performance can be tested either outside or inside the product. Testing the part outside the product (in-lab test) will allow you to evaluate your part before placing it in the product. This type of testing is recommended when the part has high performance requirements, or when a part could lead to high-risk situations. Testing the part inside of the product (in-situ test) will allow you to see if it fits and works as expected. Additionally, it will allow you to estimate how long or how many times the part can perform its function before failing.

Always proceed with caution when using a 3D-printed part in a product, especially in high-risk applications (e.g., high forces, or in contact with electronics, heat, water, or food). Also, it should be kept in mind that parts can deteriorate over time. One successful (short) test does mean it will survive long-term use.

TESTING THE QUALITY OF A PRINT

First, you should test your part to check that the printing process went well and that the 3D printer is working correctly. Below, we describe different tests that we recommend you to do in order to assess the quality of your print.



Figure 29 - Same part printed in different materials, resulting in differences in surface quality. (right) Surface quality with PETG filament without following the TDS printing recommendations.

1. **Visual testing.** This test consists of visually evaluating the resulting part in order to assess whether the part has the desired aesthetic and surface quality characteristics. It will also allow you to identify any deformations or faults in the print. Take a good look at the surface quality of the part and check for gaps between the layers or very rough surfaces like the one on Figure 29. Check the overall geometry of the part and make sure no sections are deformed or warped. If you identify any of these problems, we recommend tuning your printer and verifying that the printing settings you selected match the recommended settings by the material producer on the technical data sheet.

2. **Dimensional accuracy.** In some cases, a 3DP part can have dimensional differences due to shrinkage or warping during the 3DP process.

You can assess the dimensional accuracy by measuring sections of the 3DP part with a caliper and comparing the results with the measurements of the original part or your CAD model.

If the part has important differences ($\pm 0.5\text{mm}$), or it does not fit in the product as you expected, we recommend you checking there were no scaling mistakes when exporting the STL file. For example, accidentally exporting in cm instead of mm. We also recommend verifying the nozzle size you are using is the correct one and to calibrate your printer before trying again.

3. **Weight testing.** This method will help you to determine whether the part was successfully printed with the expected quality or not.

After slicing your file, the slicing software will give you an estimate of the weight of the part. After the part is printed you can weigh it and compare this result to the weight the slicing software gave as an estimate. Keep in mind that the slicing software calculates the weight of ALL the material it will use to create the part, including support material. So, when comparing the two weights consider the loss from the support material you already removed or try to weigh it before removing the support material. If you find important differences between the two (any difference larger than 10%), we recommend verifying the extruder of your printer is working correctly and the nozzle has no blockage.

In Figure 30, the example shows the slicing software predicted 9 g in total and the weight of the part without support material is 8.5g. The difference is 0.5g (5.5%) between the slicing software estimate and the final 3DP part (even without support), so we can conclude this part was printed correctly.

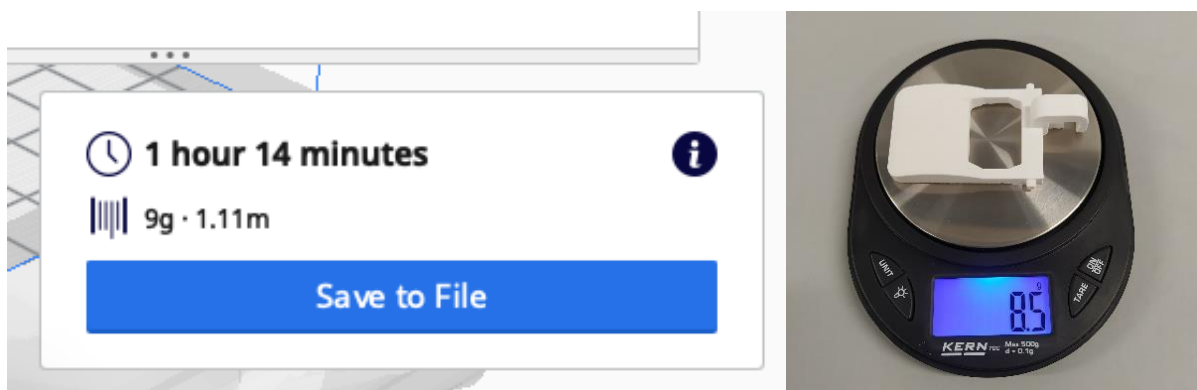

Figure 30 - Weight predicted by Ultimaker Cura, compared to the actual weight of the component without support material.

TESTING SPECIFIC ATTRIBUTES OF A PART

When testing specific attributes of a 3DP part it is necessary to determine a test method that will allow you to do the assessment. For some of the test methods discussed it is required to have access to specific lab equipment, like a column tensile and/or compression testing machine and force gauges. Some of the tests can also be performed with simple materials around your workshop or house to recreate some of the conditions of the context or use of your component. Examples of these are ovens, heat guns, tape, objects to be used as supports and weights.

The following are examples of attributes to test, and recommendations for testing methods you can use.

1. **Mechanical testing.** There are different mechanical properties you can test for: Elasticity, plasticity, stiffness, material behaviour under static loads, hardness, toughness, and fatigue. Examples of tests include tensile, compression, bending test, torsion, rupture, and impact tests. Figure 31 shows an example of a set up to test snap fits with a force gauge measuring the tensile and compression forces the snap fits can withstand. Figure 32 shows a home-made test to observe “creep” (the part and material deformation over time) with constant tension. You can see that the setup was arranged using simple materials, such as tape to hold the samples to the table, and water bags to act as the force that is applied to the material.
2. **Chemical resistance.** In cases where your part is exposed to chemicals such as soap, water, oils, or UV light, you can test if it will deform or lose its properties after being exposed to them. To test, you can expose the part to substances it is expected to withstand, and observe deformation or differences in surface quality, colour, etc. To accelerate this testing, you can use higher concentrations than would be expected in normal use. Mechanical testing can also be done after chemical exposure to identify any performance degradation.

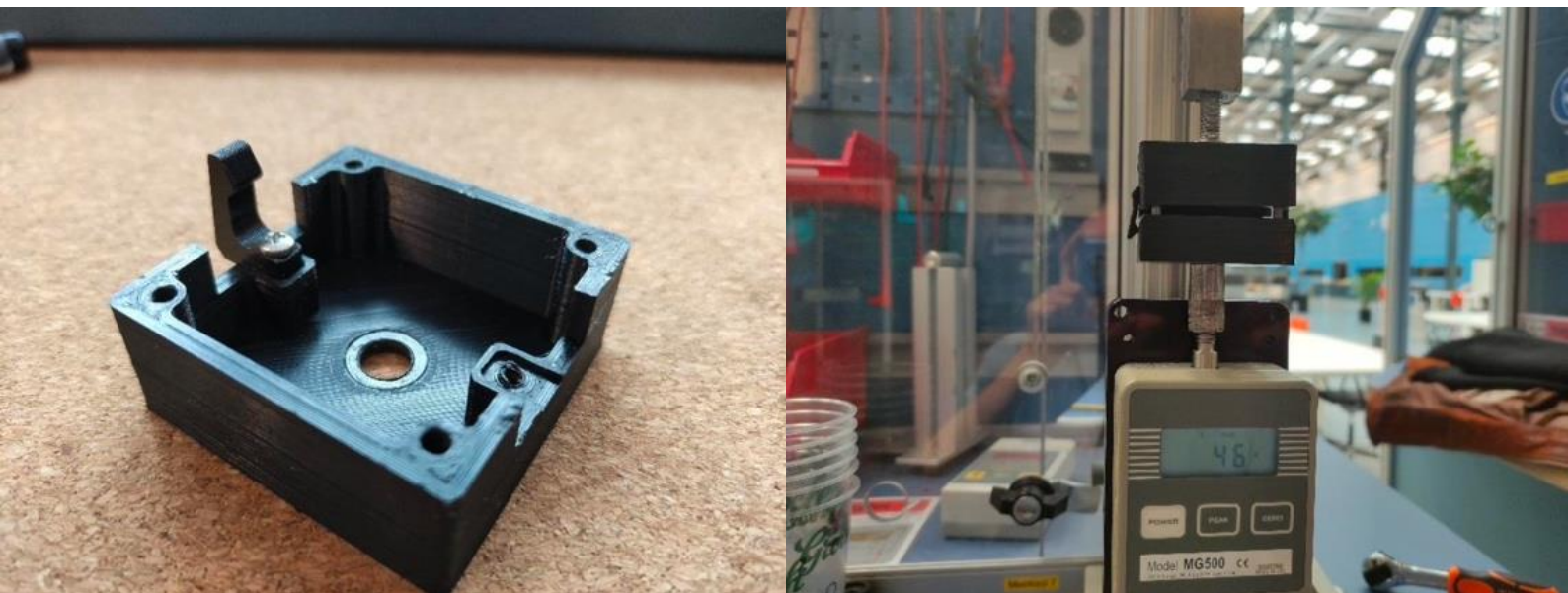

Figure 31 - (left) Jig and (right) force gauge with jig installed to measure tensile and compression forces on snap fits. Used with approval of M. Bakker, 2021.

Figure 32 - Home-made creep test, used with approval of N. Van Silfhout, 2020.



3. **Heat resistance testing.** If your part will have to withstand high temperatures or be close to components that get hot, we recommend testing it for temperature resistance before installing it in the product. This will allow you to identify if the part will be able to withstand normal use and avoid accidents caused by melted parts. Examples of testing methods are: Putting the part in an oven or submerging it in hot water for a certain amount of time. A heat gun or hairdryer can also be used for the testing, but temperature is less controllable. You can gradually increase the temperature and observe if the part deforms in any way. Mechanical testing can also be done after heat exposure to identify any differences in mechanical properties before and after. Figure 33 shows an example of a part melting after being exposed to hot air from a heat gun.



Figure 33 - Melted part after heat test. Used with approval of N. Van Silfhout, 2020.

IN-SITU TESTING – TESTING THE PART INSIDE THE PRODUCT

This type of testing focuses on assessing the 3DP part inside the product. It shows you the actual performance of the part, since it is exposed to the specific conditions of its normal use. This testing is essential to see if the repair is successful. Testing the part inside the product includes the fit of the part, the performance of the part, and the functionality of the repaired product.

1. **Dimensional and assembly testing inside the product.** Place the part inside the product and assess if the part fits correctly. See if it can be assembled into the product, or if the part dimensions or surface quality interfere with the function of the product. This is especially important for moving parts. Figure 34 shows examples of parts being tested inside products to see if the dimensions were captured correctly.
2. **Functional testing inside the product.** Place the part inside the product and assess if the part works or completes actions as expected. In Figure 34, you see examples of parts that are being tested for their function. The switch on the left is moved up and down to see if it activates the internal switch. The top ring on the right is tested for fit, but also tested as a pivot point and support for the lid of the kettle.
3. **Failure testing.** To do failure testing, you can ask yourself, how many times can the part perform its function before it breaks? This is especially interesting for moving parts. Operate the product several times revising the part integrity after each use. Note the number of times the part successfully operated before failure. Knowing our component can perform well on several occasions will give us an idea of its quality and find how to improve it in a following iteration if needed. A well-designed part could survive hundreds of use cycles, so it could be that your part does not fail during testing. However, it is good to keep in mind that even well-designed parts can eventually fail when using the product for a long time.

WHAT'S NEXT?

3D printing a part for repair can be very challenging. The success of the part will most likely depend on its complexity. You can expect to make mistakes and not get it right the first time. We recommend you noting down the positive and negative outcomes of the testing phase and try again, readjusting where needed. You can most likely solve it by adjusting your (re)design, but you can also explore options in the manufacturing process, such as a different material, printer, print settings, or post processing methods.

Figure 34 - Testing the fit and function of the top ring and switch inside the kettle.



RECOMMENDED LITERATURE

List of plastic codes from the Plastic Soup Foundation:

<https://www.plasticsoupfoundation.org/en/plastic-problem/what-is-plastic/recycling-codes/>

Selecting the right 3D printing process: <https://www.3dhubs.com/knowledge-base/selecting-right-3d-printing-process/>

3D printing design rules, 3DHubs: <https://www.3dhubs.com/knowledge-base/key-design-considerations-3d-printing/>

Effects of printing direction, 3DHubs: <https://www.hubs.com/knowledge-base/how-does-part-orientation-affect-3d-print/>

Material selection, 3D Hubs: <https://www.3dhubs.com/knowledge-base/fdm-3d-printing-materials-compared/>.

Selecting the optimal shell and infill parameters for FDM 3D printing, 3DHubs: <https://www.3dhubs.com/knowledge-base/selecting-optimal-shell-and-infill-parameters-fdm-3d-printing/>

Annealing recommendations, Hackaday: <https://hackaday.com/2020/09/23/reforming-3d-prints-with-salt-and-heat/>.

RECOMMENDED VIDEOS

Sharepair, 3DP4R Guidance videos by TU Delft and MMU:

https://www.youtube.com/watch?v=WTkv02Y1IP0&list=PLd5B-DYBILRq56MfWkOKzMJcCJnUampA&ab_channel=IDETUDelft

How to use a caliper, by Bob Weld:

https://www.youtube.com/watch?v=vkPlzmalvN4&ab_channel=WeldNotes.com.

Tutorial on photogrammetry:

- https://www.youtube.com/watch?v=1D0EhSi-vc&feature=emb_title&ab_channel=Prusa3DbyJosefPrusa
- <https://makezine.com/2020/12/01/preserving-sculptures-with-3d-scanning-and-3d-printing/>

Tutorials on 3D CAD Modelling:

1. TinkerCAD: <https://www.youtube.com/watch?v=n71PFgQ0z5A>
2. Fusion 360: <https://www.youtube.com/watch?v=Vkt7DN3GzQY>
3. Onshape: <https://www.youtube.com/watch?v=U5R33hR51Vw>
4. FreeCAD: https://www.youtube.com/watch?v=6JOITgw_T1Y
5. OpenSCAD: <https://www.youtube.com/watch?v=RUXHpnhfVy>

REFERENCES

- [1] "SHAREPAIR - Digital Support Infrastructure for Citizens in the Repair Economy - Project Summary," Interreg NWE Sharepair, 2021. [Online]. Available: <https://www.nweurope.eu/projects/project-search/sharepair-digital-support-infrastructure-for-citizens-in-the-repair-economy/>. [Accessed 15 December 2021].
- [2] J. Maxham, "The Art Of Troubleshooting," [Online]. Available: <https://artoftroubleshooting.com/>. [Accessed 1 February 2022].
- [3] Makerbot Thingiverse, "Thingiverse," MakerBot Industries, LLC , 2022. [Online]. Available: <https://www.thingiverse.com/tag:repair>. [Accessed 1 February 2022].
- [4] GrabCAD, "GrabCAD," Stratasys, 2022. [Online]. Available: <https://grabcad.com/library/tag/repair>. [Accessed 1 February 2022].
- [5] MyMiniFactory, "MyMiniFactory," MyMiniFactory, 2022. [Online]. Available: <https://www.myminifactory.com/category/brands-spare-parts>. [Accessed 1 February 2022].
- [6] "SHAREPAIR @ MyMiniFactory," MyMiniFactory, 2021. [Online]. Available: <https://www.myminifactory.com/users/SHAREPAIR>. [Accessed 15 December 2021].
- [7] M. T. F. Beerkens, "Repair Using 3D Printing: 1 Decomposition," Instructables, 2017. [Online]. Available: <https://www.instructables.com/Repair-Using-3D-Printing-1-Decomposition/>. [Accessed 15 December 2021].
- [8] iFixit, "Repair guides," iFixit, 2022. [Online]. Available: <https://www.ifixit.com/Guide>. [Accessed 1 February 2022].
- [9] Prusa, "FAQ - Frequently Asked Questions," Prusa Research a.s., 2021. [Online]. Available: https://help.prusa3d.com/en/article/faq-frequently-asked-questions_1932#. [Accessed 1 February 2022].
- [10] Woakamkurhram, "HK Plastic Recycling mark black food container Resin identification code 1 PET," Wikimedia Commons, 28 February 2014. [Online]. Available: https://commons.wikimedia.org/wiki/File:HK_Plastic_Recycling_mark_black_food_container_Resin_identification_code_1_PET_in_Feb-2014.JPG. [Accessed 15 December 2021].
- [11] Plastic Soup Foundation, "Recycling codes," Plastic Soup Foundation, [Online]. Available: <https://www.plasticsoupfoundation.org/en/plastic-problem/what-is-plastic/recycling-codes/>. [Accessed 1 February 2022].
- [12] Materialise, "Materialise," Materialise, 2022. [Online]. Available: <https://www.materialise.com/>. [Accessed 1 February 2022].
- [13] 3D HUBS B.V., "Hubs," 3D HUBS B.V., 2022. [Online]. Available: <https://www.hubs.com/>. [Accessed 1 February 2022].
- [14] A. B. Varotsis, "Selecting the right 3D printing process," 3D HUBS B.V., 2022. [Online]. Available: <https://www.3dhubs.com/knowledge-base/selecting-right-3d-printing-process/>. [Accessed 1 February 2022].
- [15] InjectionMoulding.org, "Plastic Injection Mould Making in China," InjectionMoulding.org, 2022. [Online]. Available: <http://www.injectionmoulding.org/plastic-injection-mould-making-in-china.html>. [Accessed 1 February 2022].
- [16] InjectionMoulding.org, "Precision Injection Moulding," InjectionMoulding.org, 2022. [Online]. Available: <http://www.injectionmoulding.org/precision-injection-moulding.html> . [Accessed 1 February 2022].

- [17] R. Brockotter, "Design Guidelines - Key design considerations for 3D printing," 3D Hubs, 2021. [Online]. Available: <https://www.hubs.com/knowledge-base/key-design-considerations-3d-printing/>. [Accessed 15 December 2021].
- [18] P. Cain, "Selecting the optimal shell and infill parameters for FDM 3D printing," 3DHubs B.V., 2021. [Online]. Available: <https://www.3dhubs.com/knowledge-base/selecting-optimal-shell-and-infill-parameters-fdm-3d-printing/>. [Accessed 15 December 2021].
- [19] B. Redwood, "Quick tips before you start - How does part orientation affect a 3D print," 3D Hubs, 2021. [Online]. Available: <https://www.hubs.com/knowledge-base/how-does-part-orientation-affect-3d-print/>. [Accessed 15 December 2021].
- [20] M. T. F. Beerkens, "Application of 3D printing in Repair," Delft University of Technology, 2017.
- [21] M. T. F. Beerkens, "Repair Using 3D Printing: 2a 3D Scanning," Instructables, 2017. [Online]. Available: <https://www.instructables.com/Repair-Using-3D-Printing-2a-3D-Scanning/>. [Accessed 15 December 2021].
- [22] AliceVision, "Meshroom," AliceVision, [Online]. Available: <https://alicevision.org/#meshroom>. [Accessed 15 December 2021].
- [23] Regard3D, "Regard3D," Regard3D, [Online]. Available: <http://www.regard3d.org/index.php>. [Accessed 15 December 2021].
- [24] P. 3. b. J. Prusa, "Photogrammetry 2 – 3D scanning with just PHONE/CAMERA simpler, better than ever!," YouTube, 7 December 2018. [Online]. Available: https://www.youtube.com/watch?v=1D0EhSi-vvc&ab_channel=Prusa3DbyJosefPrusa. [Accessed 15 December 2021].
- [25] C. Kraft, "Preserving Sculptures With 3D Scanning And 3D Printing," Make Community LLC, 1 December 2020. [Online]. Available: <https://makezine.com/2020/12/01/preserving-sculptures-with-3d-scanning-and-3d-printing/>. [Accessed 15 December 2021].
- [26] B. Weld, "How to Read a Metric Vernier Caliper," YouTube, 10 February 2017. [Online]. Available: https://www.youtube.com/watch?v=vkPlzmalvN4&ab_channel=WeldNotes. [Accessed 1 February 2022].
- [27] Autodesk TinkerCAD, "Autodesk TinkerCAD," Autodesk, Inc., 2021. [Online]. Available: <https://www.tinkercad.com/>. [Accessed 15 December 2021].
- [28] 3D Slash, "3D Slash," 3D Slash, 2021. [Online]. Available: <https://www.3dslash.net/index.php>. [Accessed 15 December 2021].
- [29] Dassault Systèmes SolidWorks Corporation, "SOLIDWORKS," Dassault Systèmes SolidWorks Corporation, [Online]. Available: <https://www.solidworks.com/>. [Accessed 15 December 2021].
- [30] Robert McNeel & Associates, "Rhino - Rhinoceros 3D," Rhinoceros, 2021. [Online]. Available: <https://www.rhino3d.com/>. [Accessed 15 December 2021].
- [31] Robert McNeel & Associates, "Rhino - Grasshopper," Rhinoceros, 2021. [Online]. Available: <https://www.rhino3d.com/6/new/grasshopper/>.
- [32] Autodesk Inc., "Fusion 360 for personal use," Autodesk Inc., 2021. [Online]. Available: <https://www.autodesk.com/products/fusion-360/personal>. [Accessed 15 December 2021].
- [33] Onshape Inc., "Onshape Free," Onshape Inc., 2021. [Online]. Available: <https://www.onshape.com/en/products/free>. [Accessed 15 December 2021].
- [34] The FreeCAD Team, "FreeCAD: Your own 3D parametric modeler," The FreeCAD Team, [Online]. Available: <https://www.freecadweb.org/>. [Accessed 15 December 2021].
- [35] M. Kintel, "OpenSCAD - The Programmers Solid 3D CAD Modeller," OpenSCAD, [Online]. Available: <http://openscad.org/index.html>. [Accessed 15 December 2021].

- [36] MakerBot Thingiverse, "Thingiverse," MakerBot Industries, LLC, [Online]. Available: <https://www.thingiverse.com/>. [Accessed 15 December 2021].
- [37] MakerBot Thingiverse, "Customizer," MakerBot Industries, LLC, 2021. [Online]. Available: <https://www.thingiverse.com/app:22>. [Accessed 15 December 2021].
- [38] Autodesk, Inc., "Autodesk Meshmixer: free software for making awesome stuff," Autodesk, Inc., 2020. [Online]. Available: <https://www.meshmixer.com/>. [Accessed 15 December 2021].
- [39] Sharepair, "3D Printing for Repair Guidance | 1. Intro," YouTube, 24 November 2021. [Online]. Available: https://www.youtube.com/watch?v=WTkv02Y1IP0&ab_channel=IDETUDeft. [Accessed 15 December 2021].
- [40] Make With Tech (MakeWithTech), "Getting Started with Tinkercad for Adults," YouTube, 8 February 2019. [Online]. Available: <https://www.youtube.com/watch?v=n71PFgQ0z5A>. [Accessed 15 December 2021].
- [41] Jayanam, "Fusion 360 Getting Started Tutorial," YouTube, 5 March 2019. [Online]. Available: <https://www.youtube.com/watch?v=Vkt7DN3GzQY>. [Accessed 15 December 2021].
- [42] bmgsTECH, "Onshape.com - Getting Started," YouTube, 24 February 2017. [Online]. Available: <https://www.youtube.com/watch?v=U5R33hR51Vw>. [Accessed 15 December 2021].
- [43] Make With Tech (MakeWithTech), "FreeCAD for Beginners | 3d Printing | Basics," YouTube, 2 July 2020. [Online]. Available: https://www.youtube.com/watch?v=6JOITgw_T1Y. [Accessed 15 December 2021].
- [44] Open-SCAD DIY3DTech, "Open SCAD - Introduction Part 1 for New Users!," YouTube, 12 February 2018. [Online]. Available: <https://www.youtube.com/watch?v=RUXHpmhfVyg>. [Accessed 15 December 2021].
- [45] 3d Matter, "FDM 3D printing materials compared," 3D HUBS B.V., 2021. [Online]. Available: <https://www.hubs.com/knowledge-base/fdm-3d-printing-materials-compared/>. [Accessed 15 December 2021].
- [46] Ultimaker BV, "Ultimaker Cura," Ultimaker BV, 2021. [Online]. Available: <https://ultimaker.com/software/ultimaker-cura>. [Accessed 15 December 2021].
- [47] Dwamena, "What is the Strongest Infill Pattern?," 3D Printerly, [Online]. Available: <https://3dprinterly.com/what-is-the-strongest-infill-pattern/>. [Accessed 2 February 2022].
- [48] Sharepair, "3D Printing for Repair Guidance | 6. From Redesign to Manufacture," YouTube, 24 November 2021. [Online]. Available: <https://www.youtube.com/watch?v=SrF8sYSJhgw>. [Accessed 15 December 2021].
- [49] A. Williams, "Reforming 3D Prints With Salt And Heat," Hackaday, 23 September 2020. [Online]. Available: <https://hackaday.com/2020/09/23/reforming-3d-prints-with-salt-and-heat/>. [Accessed 15 December 2021].

3D Printing for Repair Guide

Julieta Bolaños Arriola, Alma van Oudheusden, Bas Flipsen & Jeremy Faludi

Synopsis: This guide takes the reader through the 3D Printing for Repair (3DP4R) process. It consists of guidelines and tools to create a 3D printable version of spare parts needed for a product repair. 3D printing a spare part is more than just printing the original part. Instead, it is an iterative process in which the part is analysed, redesigned, manufactured, and tested, in order to come to a final part. This guide will describe these four phases in detail. The guide is meant for anybody who is interested in trying to manufacture spare parts with 3D printing technologies, remakers, tinkerers, volunteer repairers, professional repairers, and everyone who is interested in repair initiatives.

SHAREPAIR

TU Delft | Industrial Design Engineering



Biography: Julieta Bolaños is a PhD candidate the Circular Product Design research group at Delft University of Technology. Julieta has studied Industrial Design Engineering, after which she pursued her interests in sustainability and circular product design, working both in industry and research. Currently her work focusses on safe and circular design as well as design for repair using additive manufacturing techniques.

Alma van Oudheusden is a PhD candidate at the Circular Product Design research group at Delft University of Technology. She studied Industrial Design Engineering with a continuous interest in sustainability. As a PhD candidate, Alma combines her passion for sustainability with her love for research. Alma's main research focusses on the use of additive manufacturing techniques facilitating repair.

Bas Flipsen is an associate lecturer on Circular Product Design at Delft University of Technology. After studying Industrial Design Engineering, Bas worked as an ecodesigner after which he became an assistant professor at the faculty of Industrial Design Engineering. He focusses his research on system engineering, especially on the topic design for repair. Bas is a Comenius teaching fellow and teaches several bachelor and master courses in the field of sustainable design engineering.

Jeremy Faludi is an assistant professor at the Circular Product Design research group at Delft University of Technology. His research focuses on sustainable design methods, sustainable additive manufacturing, and sustainability metrics. Jeremy wrote the OECD's recommendations for green 3D printing policy, and the Additive Manufacturer Green Trade Association's first white paper. For sustainable design methods, he created Whole System Mapping and developed the VentureWell Tools for Design and Sustainability MOOC.



© 2022 TU Delft Open
ISBN 978-94-6366-541-4
DOI <https://doi.org/10.5074/t.2022.003>

textbooks.open.tudelft.nl