

\_Verdieping (1:200)

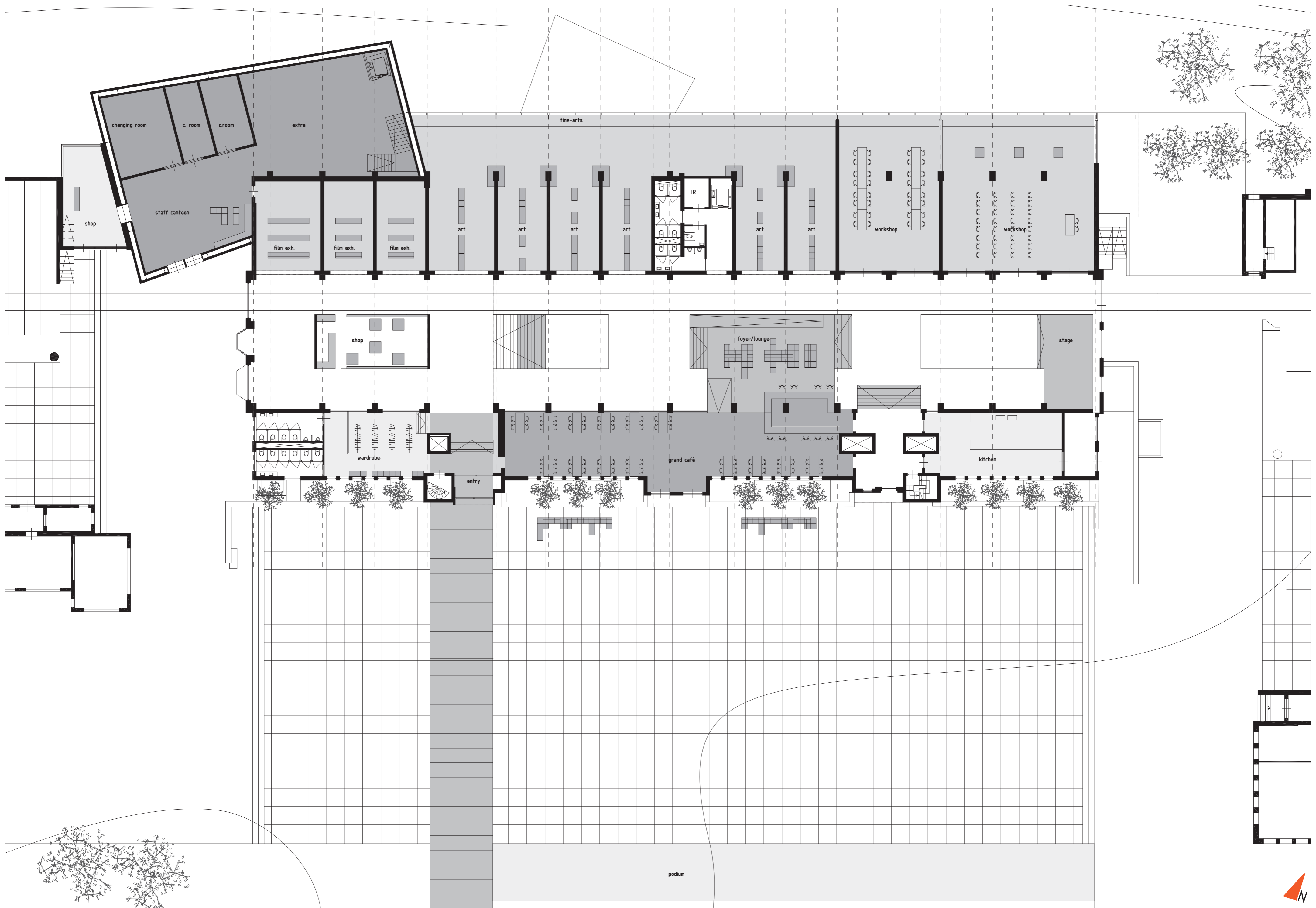

\_Begane grond (1:200)



\_Zuidgevel (1:200)



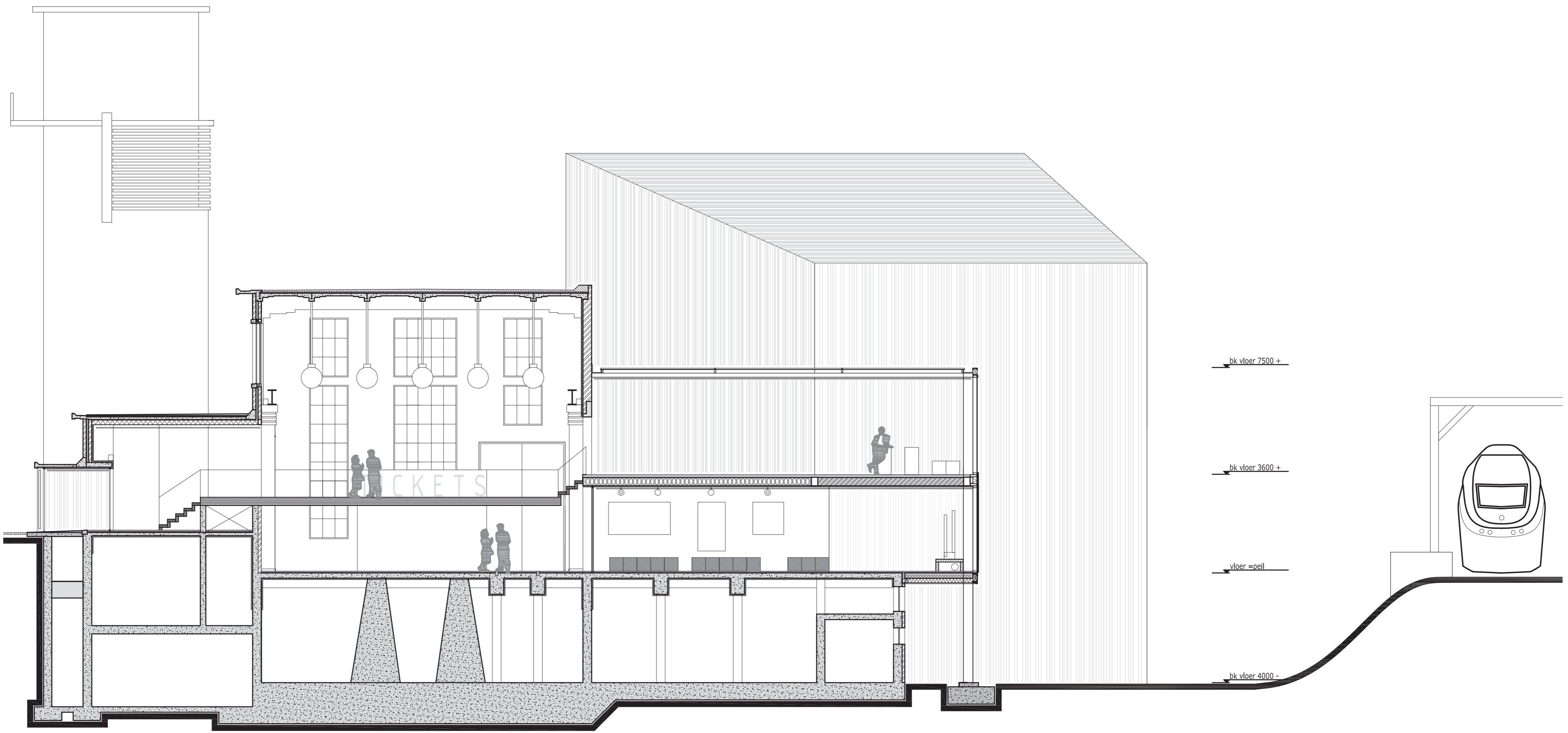

\_Dwarsdoorsnede (1:100)

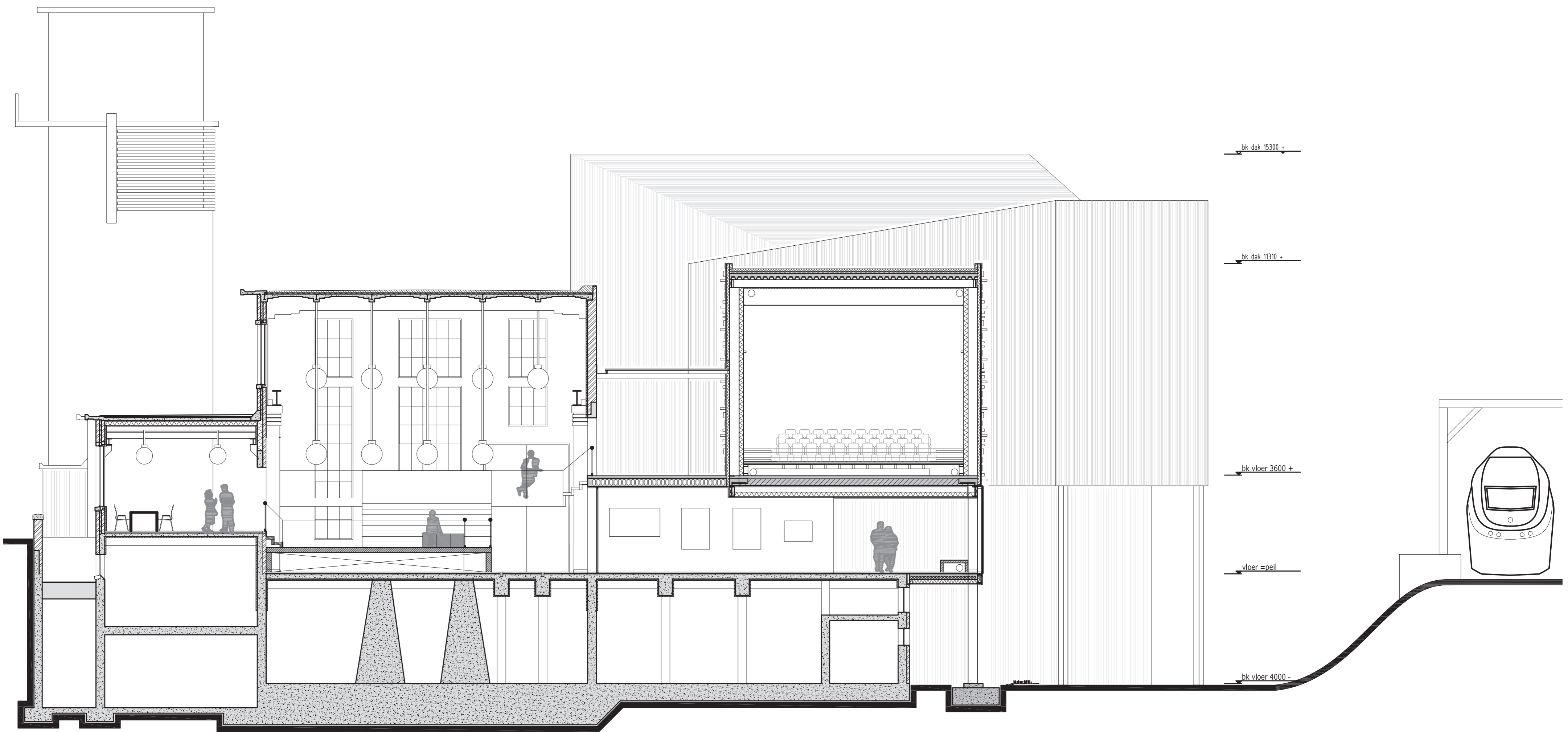

\_Dwarsdoorsnede (1:100)



\_Noordgevel (1:200)



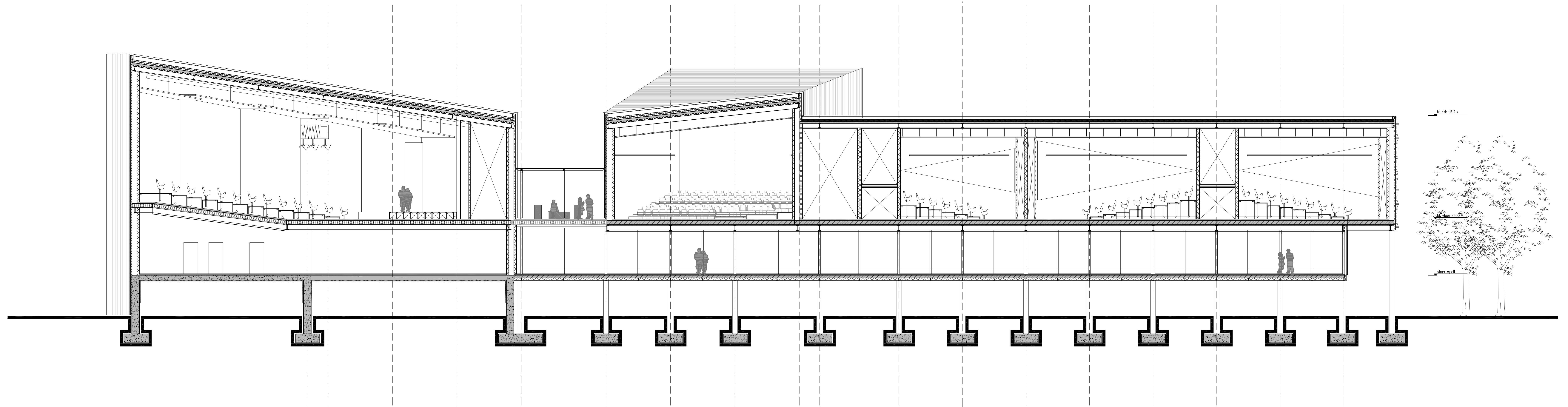

\_Langsdoorsnede (1:100)

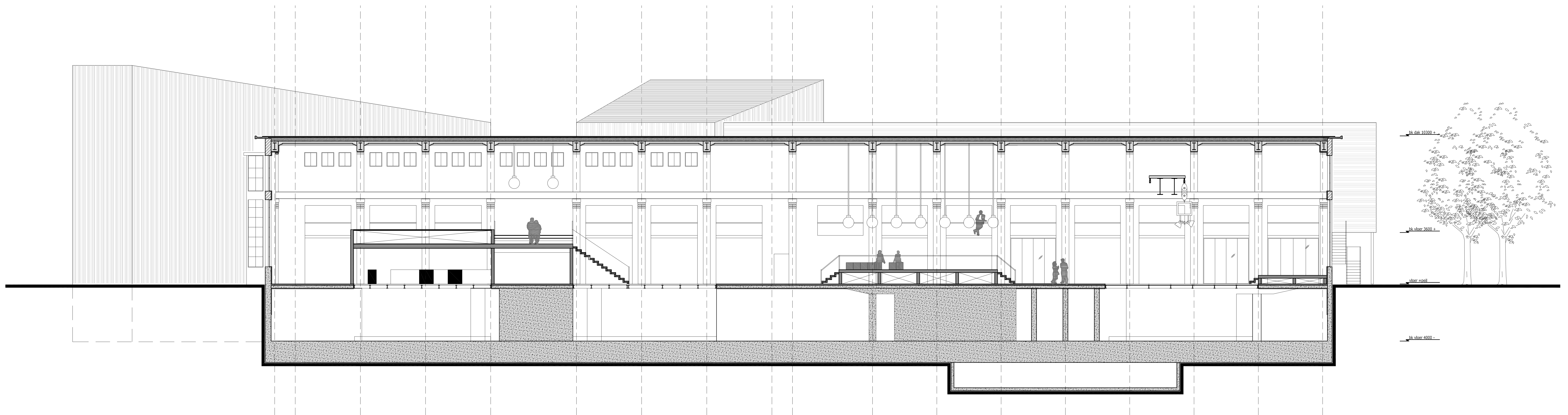

\_Langsdoorsnede (1:100)



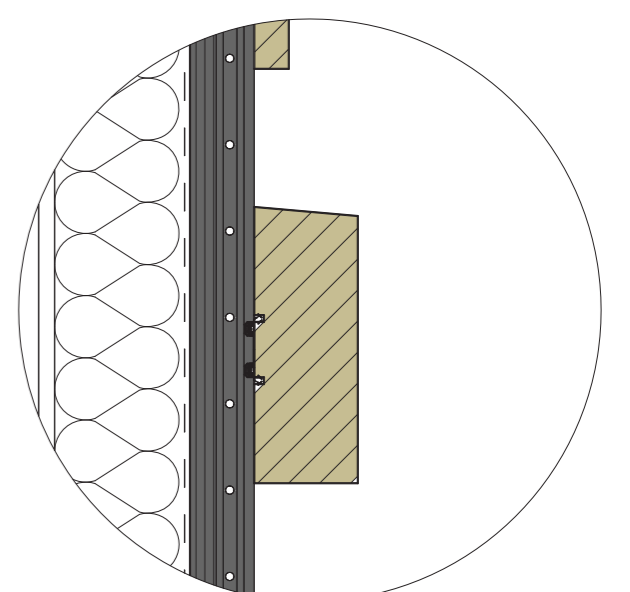
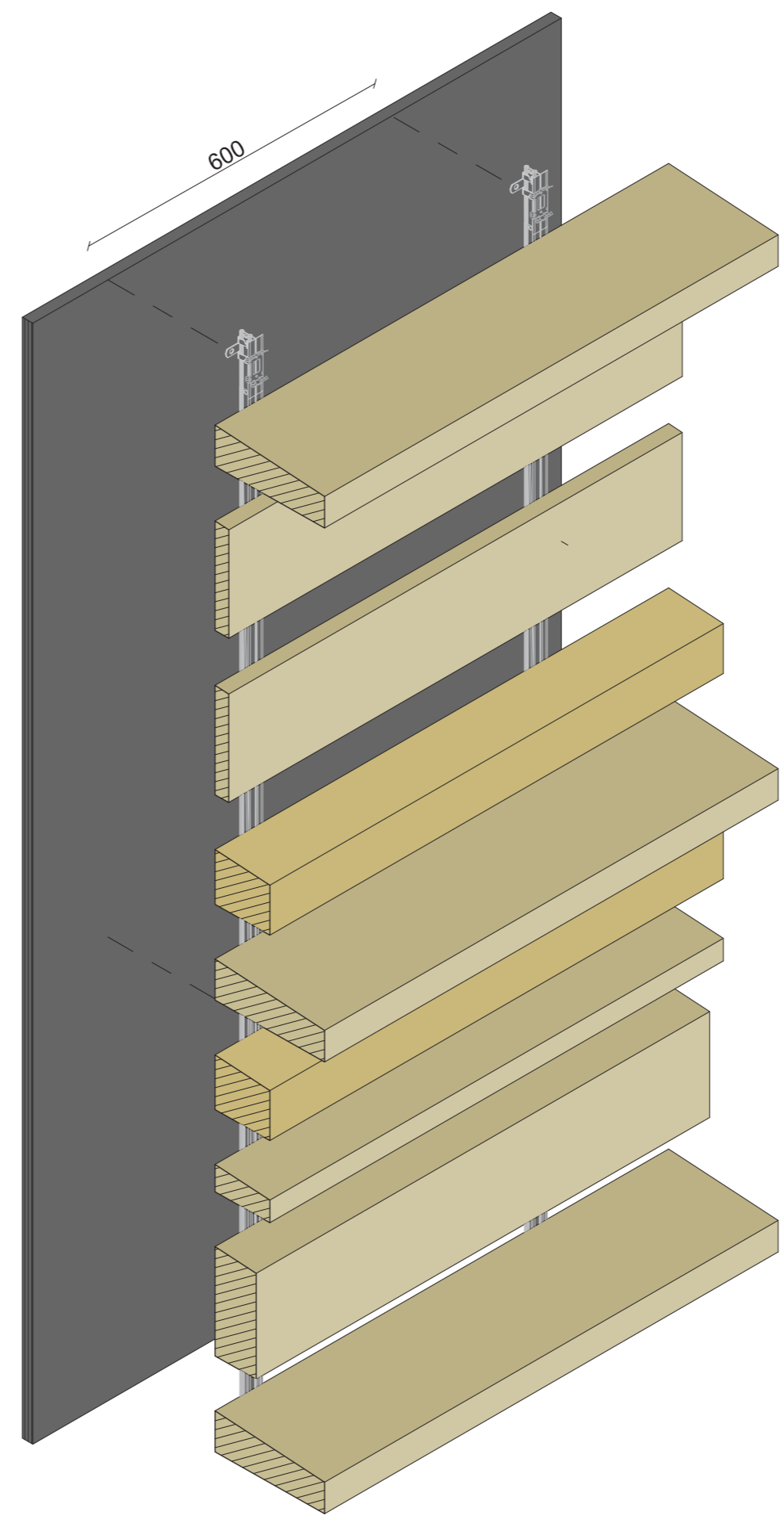
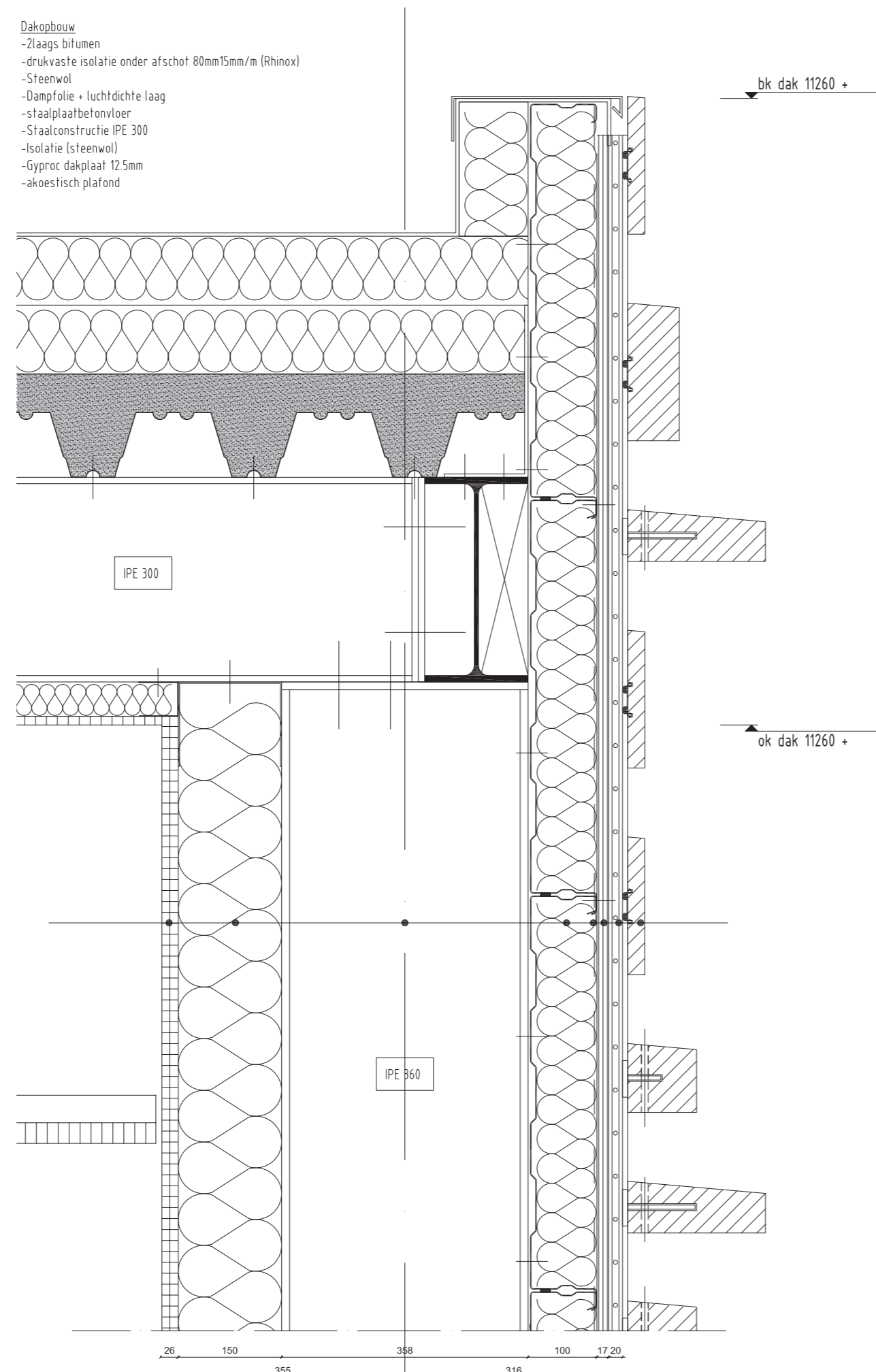
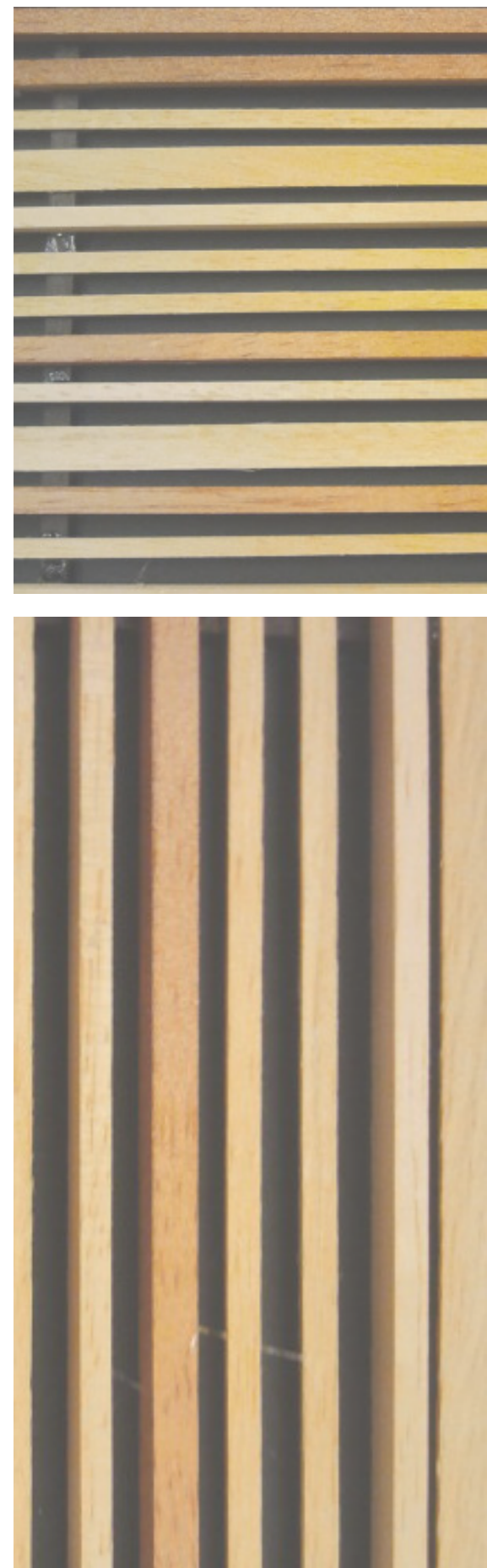

Detail 1 (1:5)

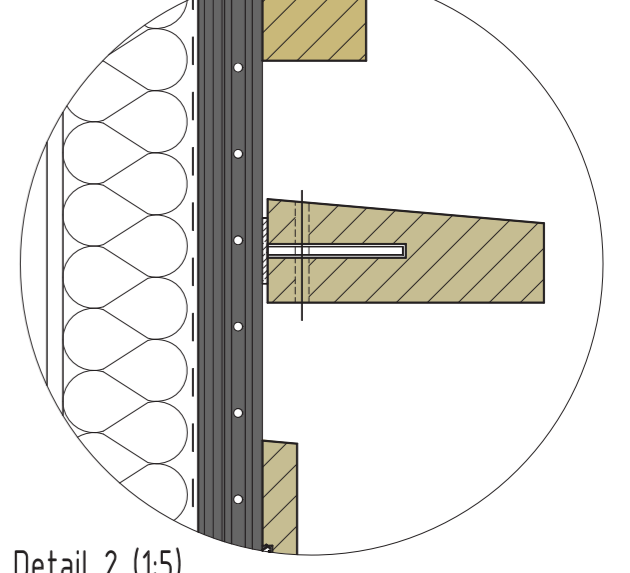

Detail 2 (1:5)

	Accoya
	Accoya
	Merbau
	Accoya
	Accoya

\_Gevelbekleding

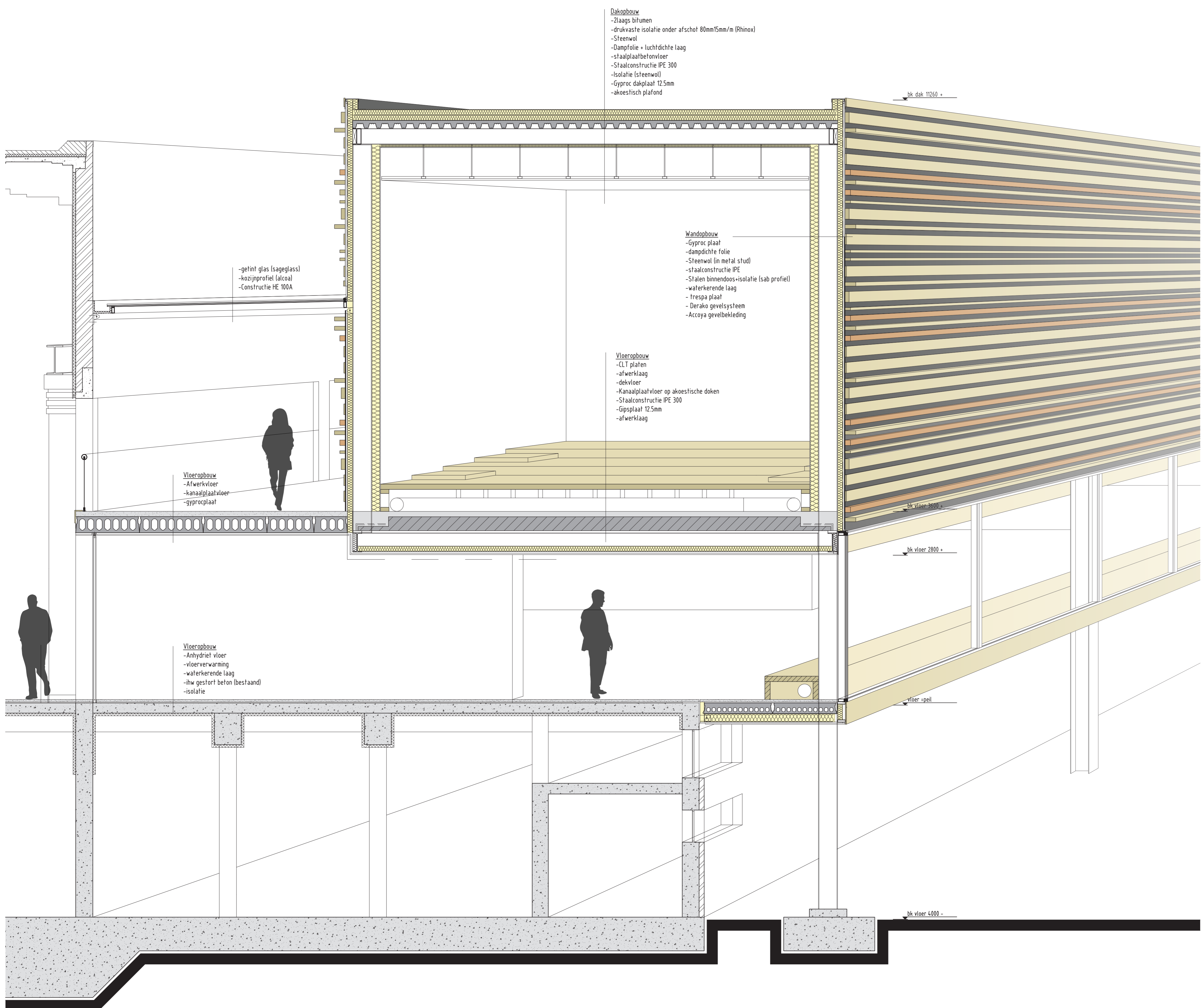

\_Gevelfragment (scale to fit)



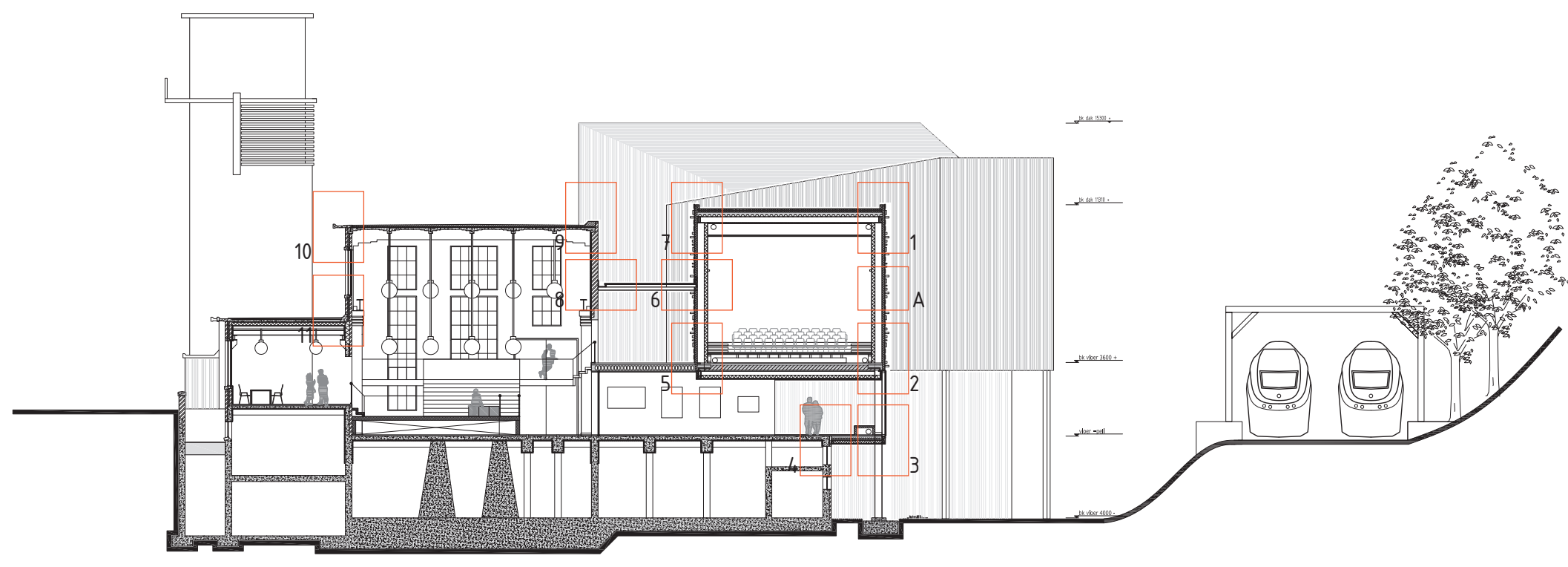

bk dak 11260 +

ok dak 11260 +

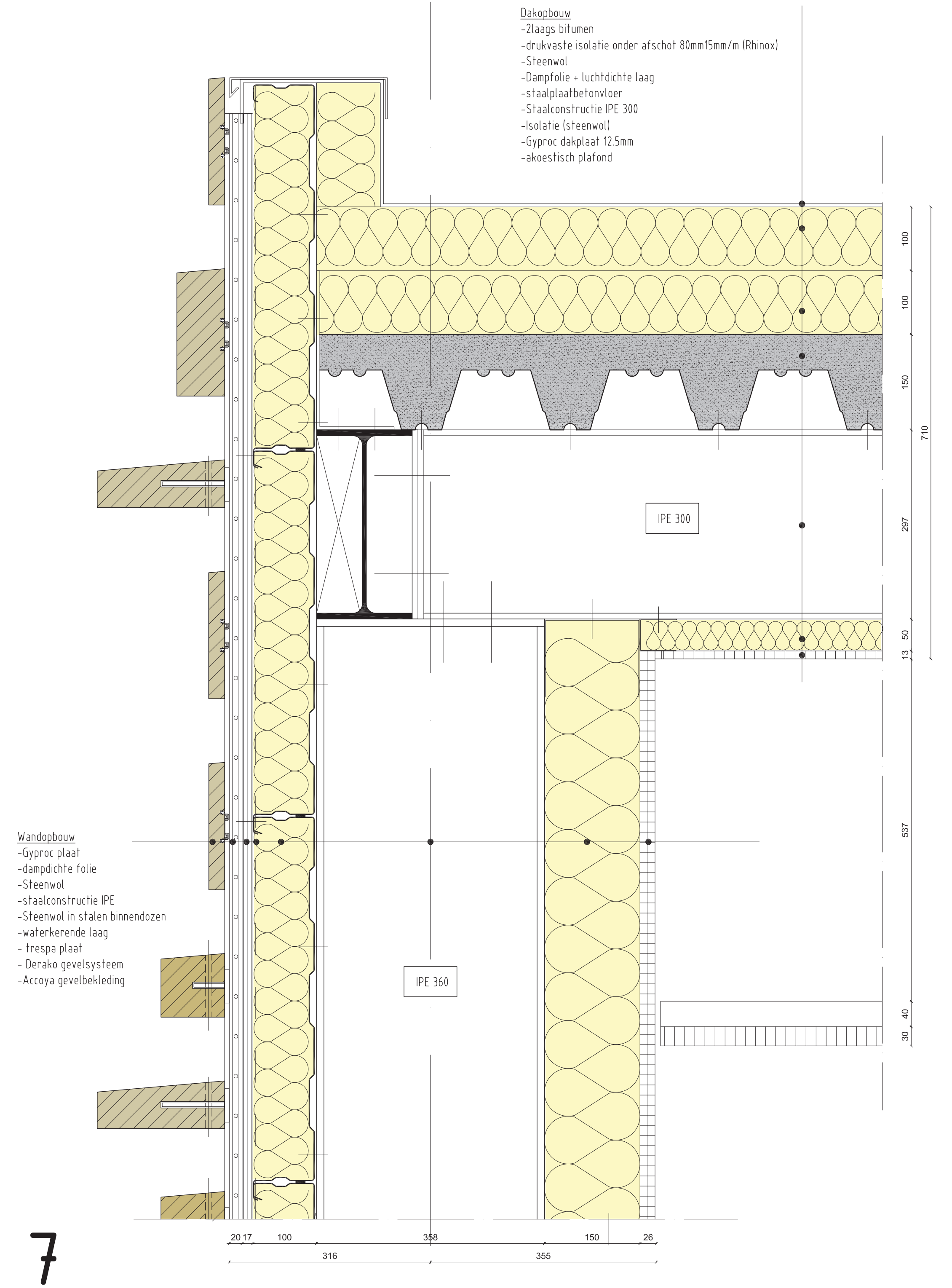

7

bk dak 7500 +

8

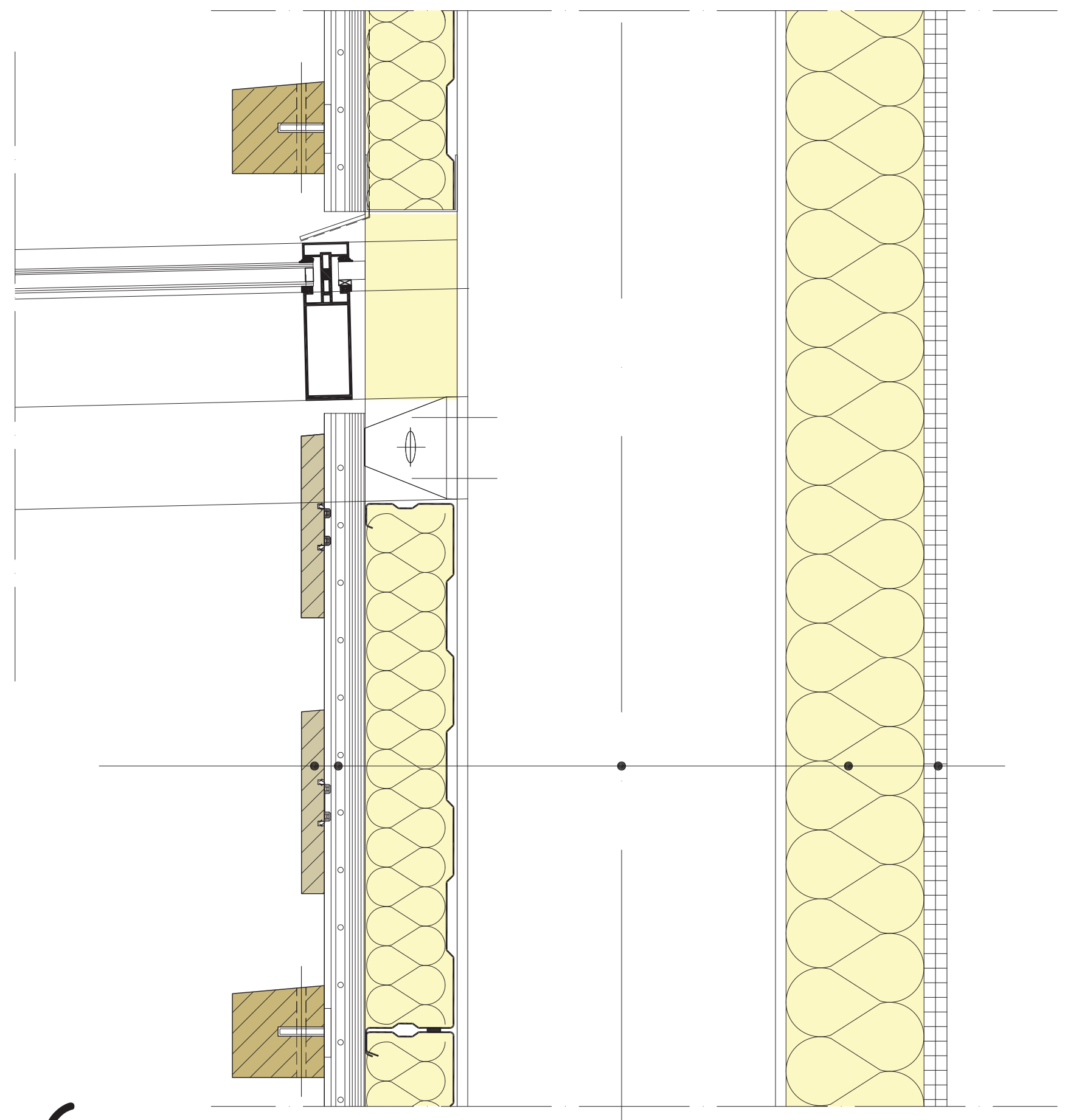
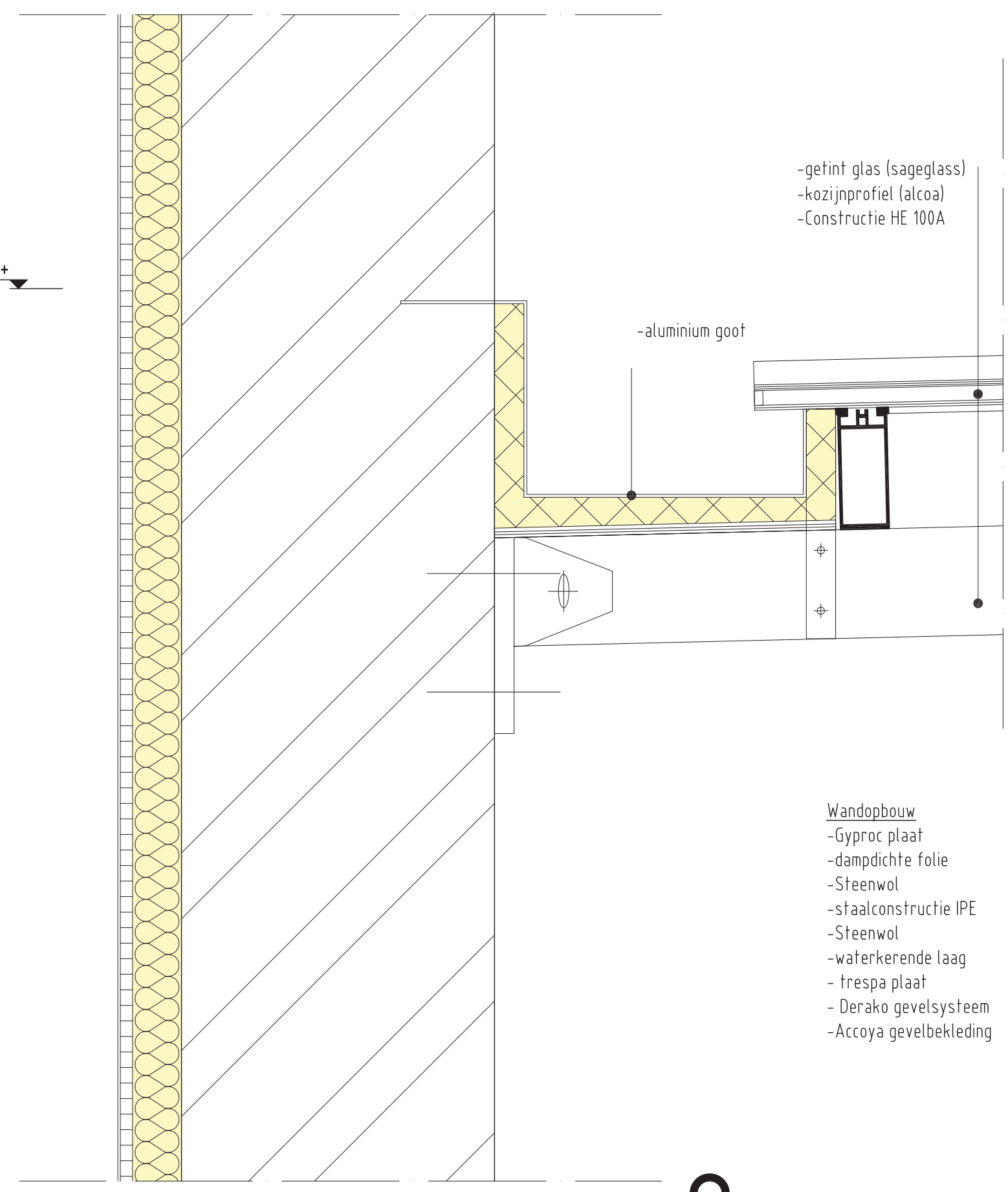

6

bk vloer 3880 +

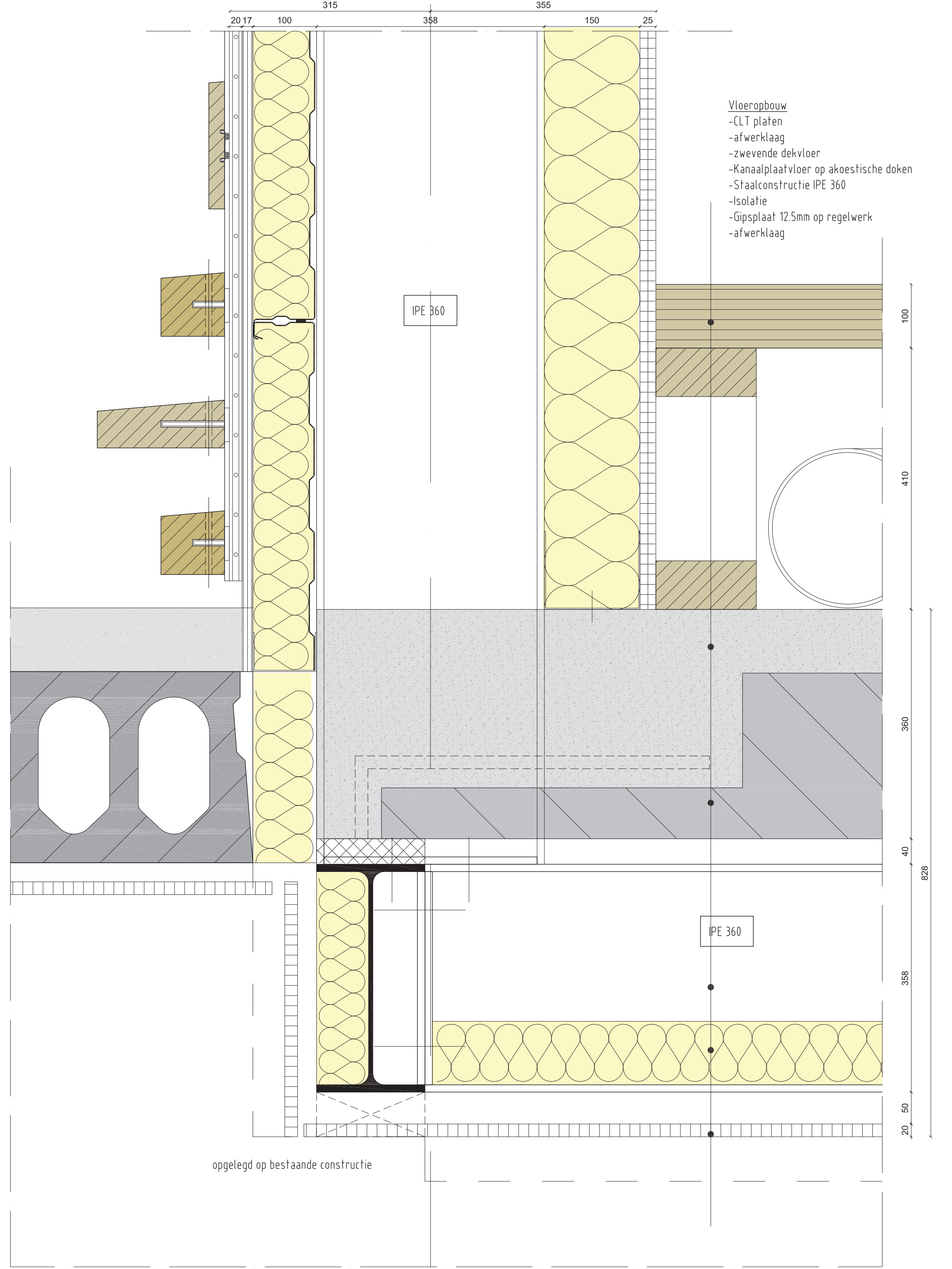

5



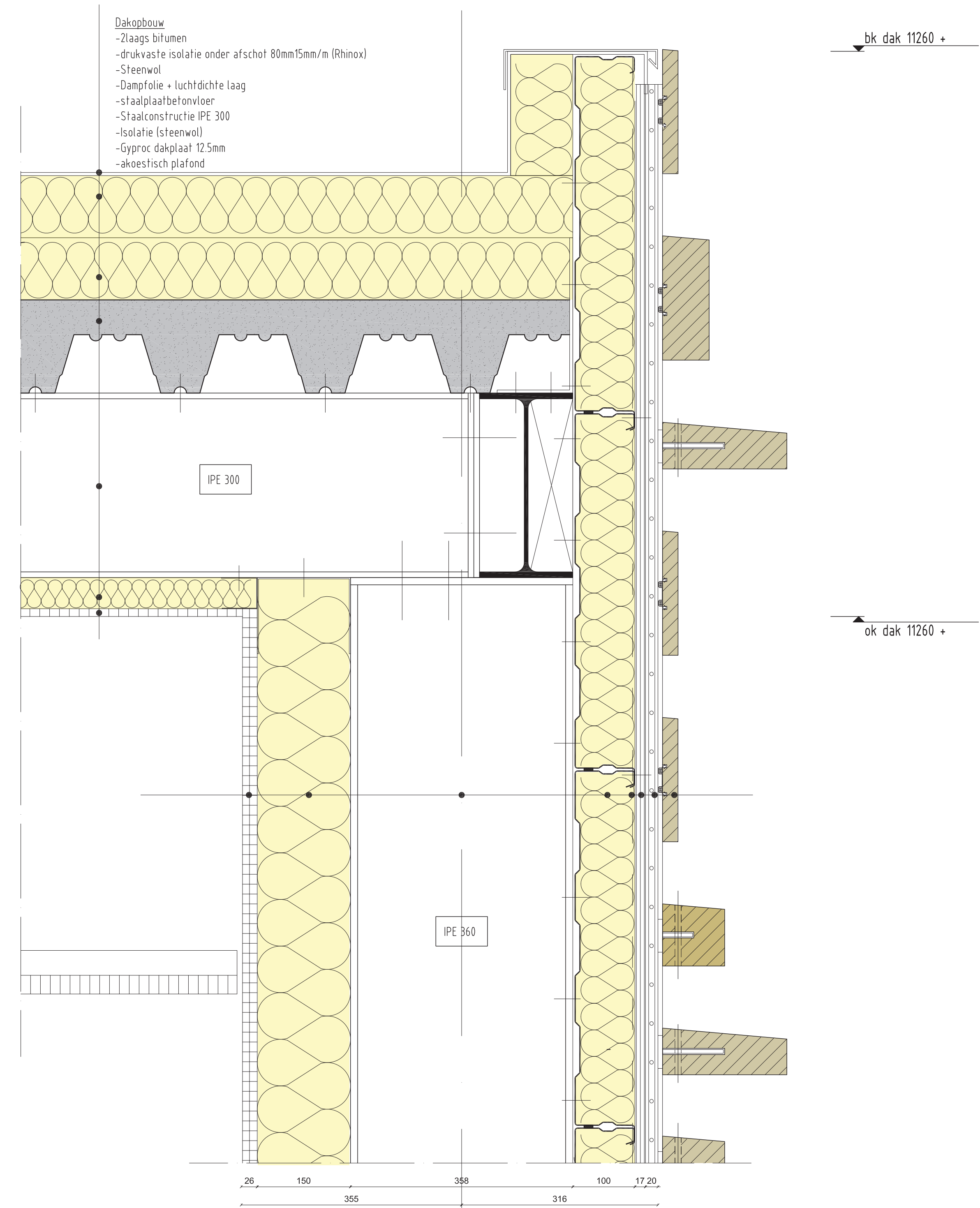
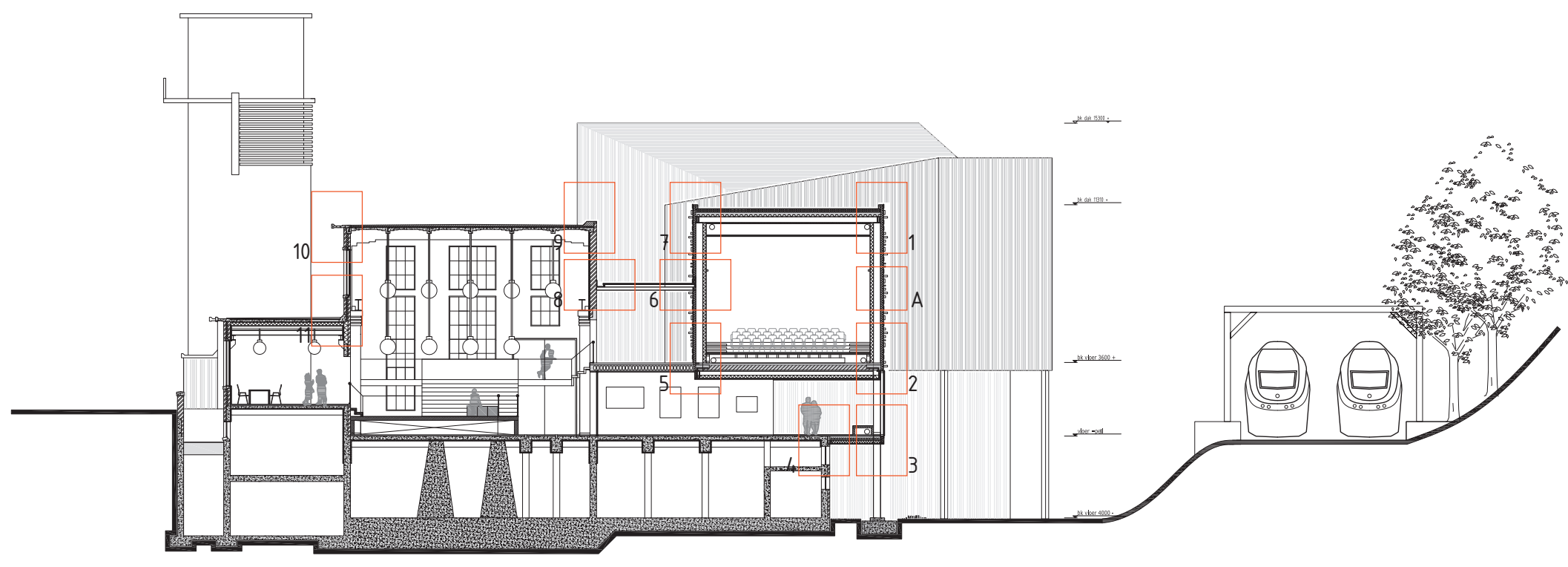

1

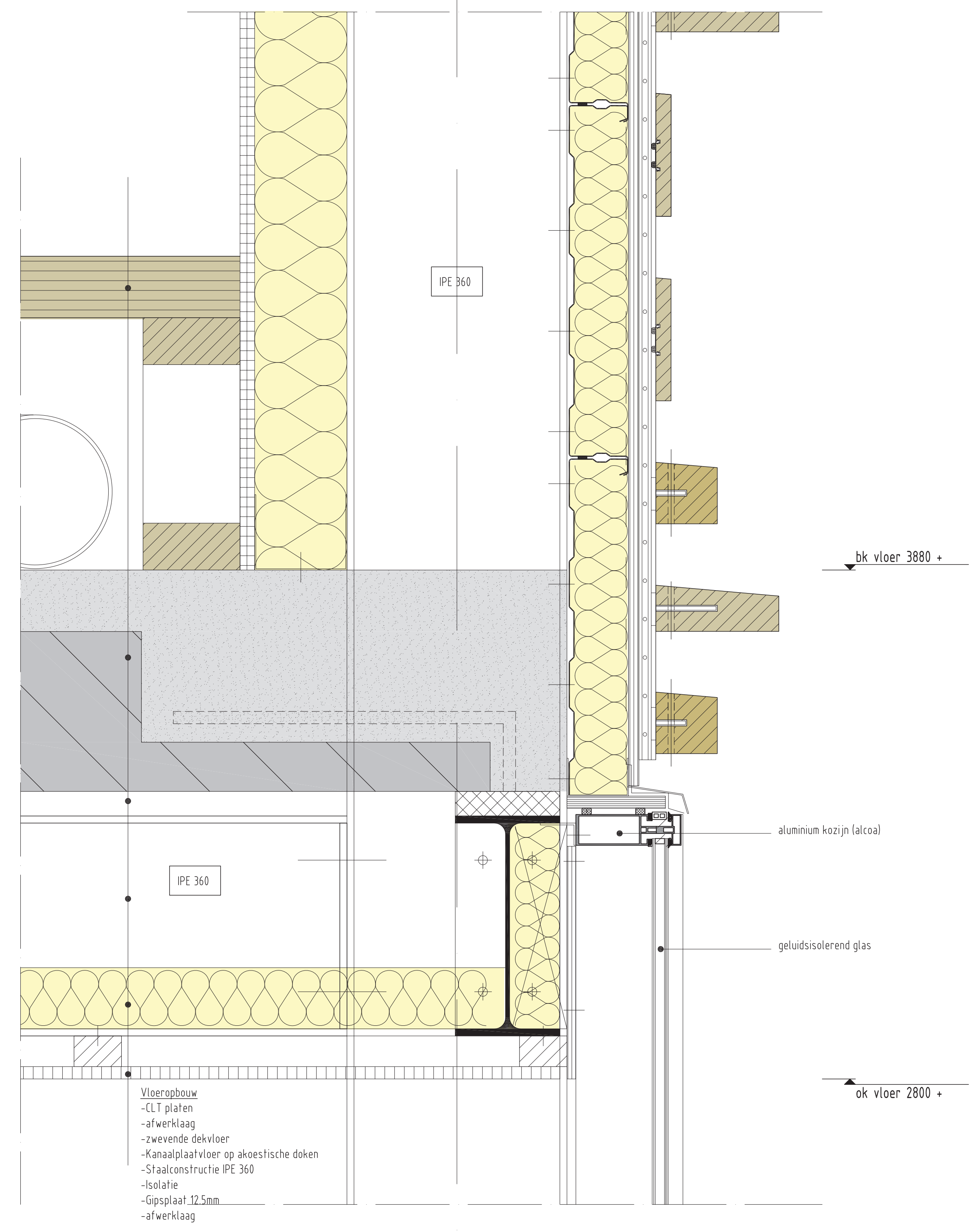

2

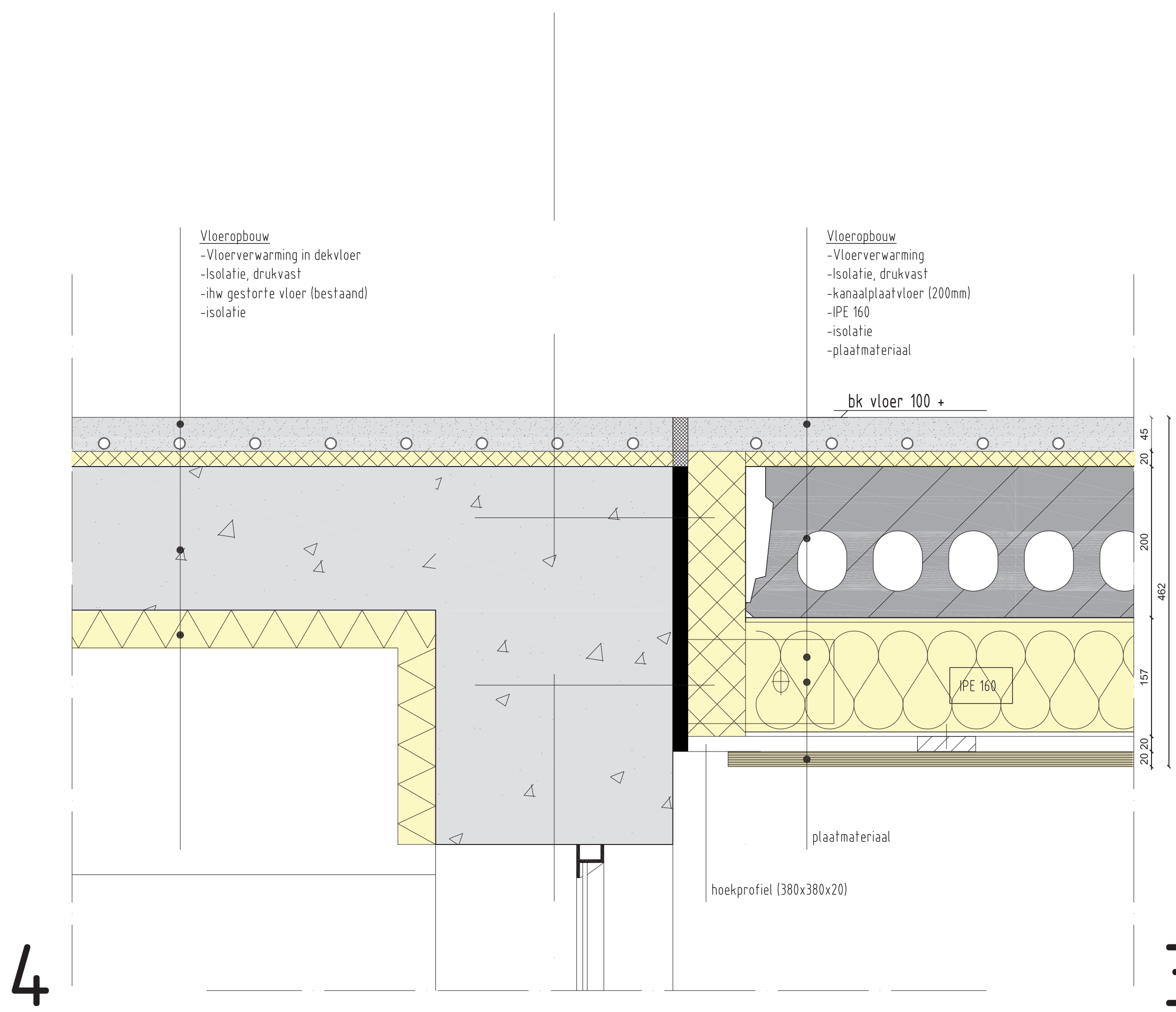

4

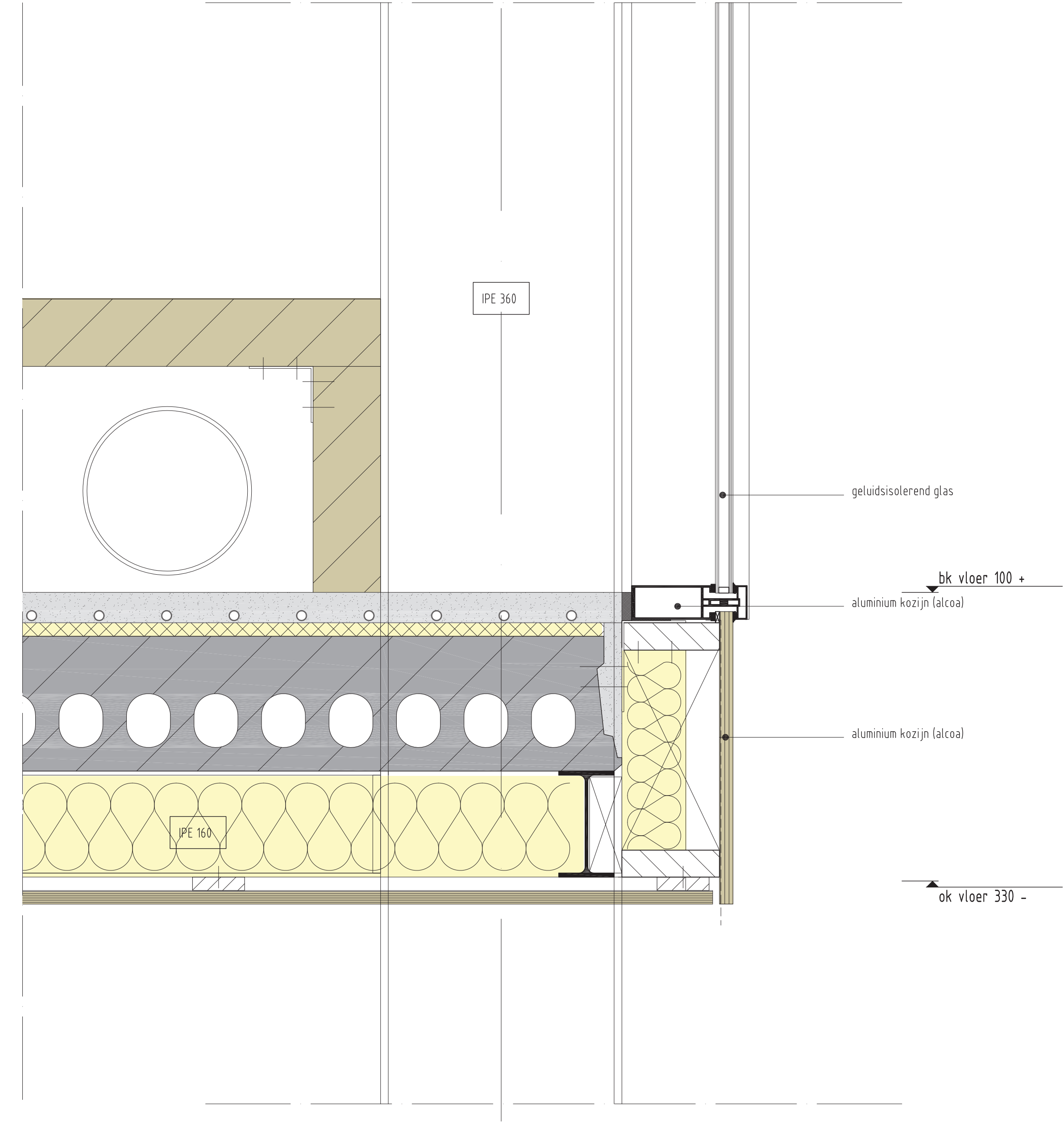

3