

## Research on conditional characteristics vision real-time detection system for conveyor belt longitudinal tear

Qiao, Tiezhu; Li, Xinyu; Pang, Yusong; Lü, Yuxiang; Wang, Feng; Jin, Baoquan

**DOI**

[10.1049/iet-smt.2017.0100](https://doi.org/10.1049/iet-smt.2017.0100)

**Publication date**

2017

**Document Version**

Accepted author manuscript

**Published in**

IET Science, Measurement and Technology

**Citation (APA)**

Qiao, T., Li, X., Pang, Y., Lü, Y., Wang, F., & Jin, B. (2017). Research on conditional characteristics vision real-time detection system for conveyor belt longitudinal tear. *IET Science, Measurement and Technology*, 11(7), 955-960. <https://doi.org/10.1049/iet-smt.2017.0100>

**Important note**

To cite this publication, please use the final published version (if applicable). Please check the document version above.

**Copyright**

Other than for strictly personal use, it is not permitted to download, forward or distribute the text or part of it, without the consent of the author(s) and/or copyright holder(s), unless the work is under an open content license such as Creative Commons.

**Takedown policy**

Please contact us and provide details if you believe this document breaches copyrights. We will remove access to the work immediately and investigate your claim.

# Research on conditional characteristics vision real-time detection system for conveyor belt longitudinal tear

Tiezhu Qiao<sup>1</sup>, Xinyu Li<sup>1\*</sup>, Yusong Pang<sup>2</sup>, Yuxiang Lü<sup>3</sup>, Feng Wang<sup>4</sup>, Baoquan Jin<sup>4</sup>

<sup>1</sup>Key Laboratory of Advanced Transducers and Intelligent Control System, Ministry of Education and Shanxi Province, Taiyuan University of Technology, Taiyuan 030024, China

<sup>2</sup>Section of Transport Engineering and Logistic, Faculty of Mechanical, Delft University of Technology, 2628 CD Delft, The Netherlands

<sup>3</sup>College of Physics and Optoelectronics, Taiyuan University of Technology, Taiyuan 030024, China

<sup>4</sup>Engineering Research Center for Measuring and Controlling Technology and Advanced Transducers of Shanxi Province, Taiyuan University of Technology, Taiyuan, China

\* E-mail: LEELXY0351@outlook.com

## Abstract:

Conveyor belt longitudinal tear is one of the most serious problems in coal mining. Existing systems cannot realise lossless and real-time detection for longitudinal tear of conveyor belt. Currently, visual detecting systems are proposed by many researchers and are becoming the future trend. A visual recognition system based on using laser and area light sources is designed in this study, which can recognise and count abrasions, incomplete-tears, and complete-tears. The advantage of the system is to prevent longitudinal tear based on multi-feature information. In the process of detecting conditional characteristics, laser and area light sources are responsible for enhancing contrast between conditional features and conveyor belt surface, meanwhile false corner filtration and single-point feature identification method are designed for improving recognition accuracy of the system. Compared with several current systems, the designed system has a better performance on recognising complex tear characteristics of conveyor belt, thus the problem of starting warning only based on single feature can be effectively avoided.

## 1 Introduction

Conveyor is one of the most important equipment in mining industry, whose operation condition may directly affect the safety of entire coal mine production. For the reason of complex working environment (gangue and iron mixed in coal) in mine, belt longitudinal tear, one of the most serious conveyor disaster, usually occurs near transshipment points of the conveyor. Once longitudinal tears occurred on conveyor belt, substantial coal can be wasted in the course of transportation, which may cause terrible economic loss to coal industry [1]. In the situation of severe tear, a part of belt can be desquamated and whipping constantly, which greatly threatens the safety of operators working in coal mine. Therefore, a mature system for preventing the occurrence of longitudinal tear and impeding further enlargement of existing tears has significant economic value and great significance of safety in production. To achieve the above system, a great number of creative achievements are proposed by splendid researchers in the past, such as built-in conductor system [2], roller-force system [3], ultrasonic system [4], X-ray system [5] and so on. Above systems try to detecting tears from variety of angles. However, there are some disadvantages of them. The build-in conductor system requires the reform of all conveyor belts, which is extremely expensive and difficult to be generalised. Roller-force system can only detect the pressure changes after complete tear, which cannot realise tear prevention. Because of the huge-complex noise in coal mining, ultrasonic system is difficult to receive echo (including longitudinal tear information). X-ray system may cause terrible damage to manipulators. Therefore, it is necessary to realise tear recognition in a new field.

With the continuous development of visual inspection technology, visual recognition system for conveyor belt detection is becoming greatly prominent because it has noncontact and real-time characteristics [6, 7]. Specifically, technological development can be divided into two aspects – algorithm and equipment. In the developing process of digital image-processing algorithm, massive methods associated with tear inspection have been designed, which establish theoretical basis for visual tear detection system.

Meanwhile, the development of equipment (especially CCD camera and computer) makes it possible to analyse vast high definition images in a short time, and promotes the visual tear detection system from theory to practice. The core of visual inspection system is using computer to process object images captured by CCD camera, and determining whether the detected objects have sensitive information required by the system. Researchers have designed several methods associated with longitudinal tear detection. Li and Miao proposed a discriminating method based on improved SSR algorithm for realising real-time tear detection [8]. Before that, Xue [9] researched sensor-based comprehensive detection method for belt longitudinal tear. However, in the field of vision recognition for preventing belt tear, mature system-design is lacking. Qiao and Liu proposed a system based on the combination of visible light and infrared vision [10]. This system uses infrared and light CCD camera to shoot the same position and detect belt tears by the combination of the two kinds of images. This system can identify complete-tear effectively and has certain tear warning ability, which is inspiring for follow-up research. However, the detection systems are dedicated to prevent belt tear only based on single feature detection.

In this paper, a system for detecting multi-features of conveyor belt surface by using laser and area light sources is designed. The designed system has the capability of real-time and non-contact detection, meanwhile, it can be remotely monitored and debugged. The operating principle of the whole system is shown as follows. The two kinds of light sources (laser light source and area light source) are responsible for feature contrast enhancement. A suited CCD camera can capture real-time characteristic images. This system can separate the original images for avoiding the problem of mutual interference between multi-features. Then, using improved Harris corner and Hough line detection algorithm to identify and count abrasions, incomplete-tears and complete-tears. According to the obtained characteristic information, early warning subsystem decides to take the appropriate actions (keep going, raise the alarm, and emergency shutdown) to the conveyor belt.

Compared with current detection system, the designed system has two obvious advantages. First, the combination of laser and area light sources is introduced into this system, which can roundly grasp multi-features of belt surface. Second, this system effectively avoid early warning mistakes caused by the error of single-feature recognition.

## 2 Visual recognition method

### 2.1 Image separation

There are serious mutual interference between multi-features on original images, thus a method for separating multiple features is necessary. Considering using the properties of the correspondence between features and grey values to realise the feature separation. As shown in Fig. 1, there are three obvious peaks in the grey level histogram of typical images captured by the CCD camera. With the increase of grey level, this three peaks orderly represent the grey level of dents, belt surface, and high-light lines. The grey level of the dents mainly below 75, meanwhile the grey level of high-light lines mainly beyond 175. According to above theory, original images can be divided into high-light lines image and dents images. Dents images can be used to identify abrasion, and high-light images can be used to identify complete-tears and incomplete-tears. The effect of image separation is shown in Fig. 2.

### 2.2 Corner detection

In high-light images, laser lines (shown as transverse high-light lines) will occur special distortions when it crosses through the tear features, which can be shown as breakages of the laser line. Meanwhile, any breakage must have corresponding corners on the endpoints of that, which represent a longitudinal tear. Therefore,

the detection of tear characteristics can be converted to the detection of corner points on the laser lines.

There are several kinds of corner detection algorithms at present, Fast and Harris algorithms are mainly used in academic research [11, 12]. Compared with Fast algorithm, Harris algorithm has stronger accuracy and stability [13, 14], which make it is possible to avoid the influence from burrs and dusts in the process of features recognition. However, Harris algorithm will be disturbed by pseudo-corners, which may cause false recognition. To solve this problem, an improved Harris corner detection algorithm with corner screening function is designed. The new algorithm not only aims to eliminate pseudo-corners; however, also realise correspondence of feature and feature points.

The corners detected by Harris algorithm constitute a collection  $A = \{a_1, a_2, a_3, \dots, a_n\}$ , which can be named as quasi-corner points. The characteristic of Harris algorithm shows that each quasi-corner has only one corresponding corner response function. Define a window  $E$  (matrix), whose centre point is  $a_i(x, y)$  and size is  $20 \times 20$ . If there are another corner points which are also detected in the matrix, define these corner points as  $a_{i+1}, a_{i+2}, \dots, a_{i+k}$ . Assume the corner response functions of  $k+1$  corners are  $R_i, R_{i+1}, \dots, R_{i+k}$ .

If present:

$$R_{i+s} = \max\{R_i, R_{i+1}, \dots, R_{i+k}\}, s \in [0, k] \quad (1)$$

Then only retain quasi-corner point  $a_{i+k}$ , and deletes all other quasi-corner points within the window. Repeat this filtering process for all quasi-corners within the image until any window of the image only retain a quasi-corner point. The rest corner points are defined as real-corner points. The position of real-corner points are marked as the arithmetic mean of the coordinates of all quasi-corner points in the same window, which can ensure that the

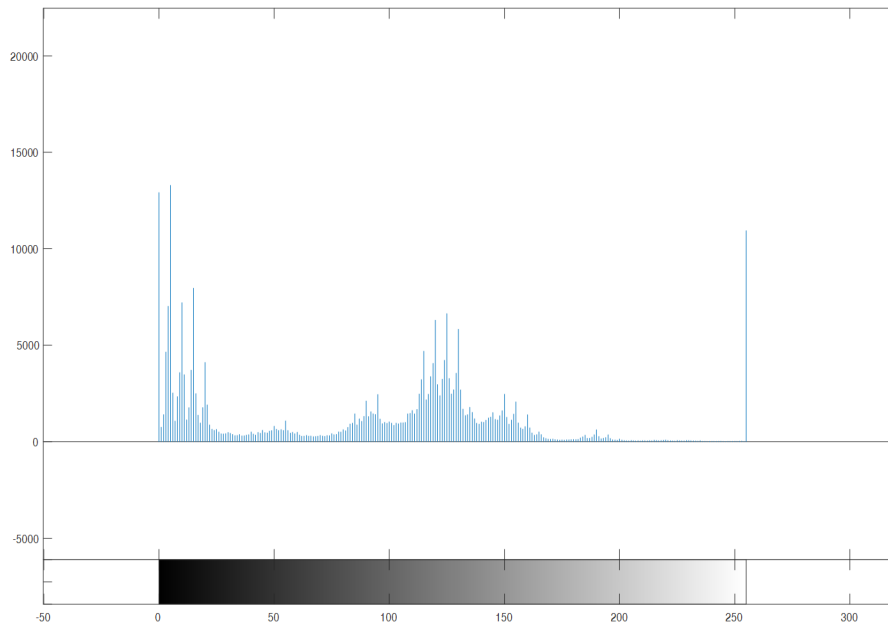

Fig. 1 Grey level histogram of original image

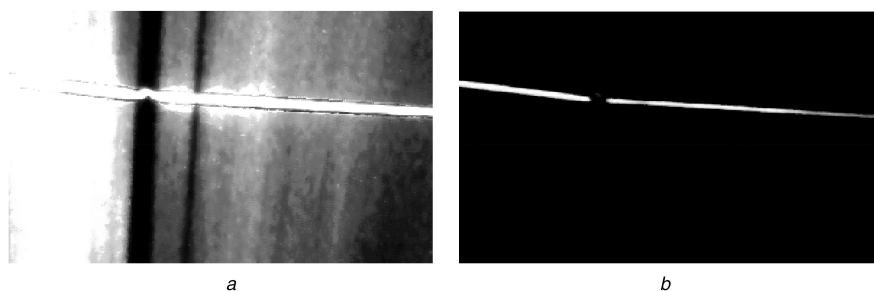

Fig. 2 Effect of image separation (a) Dents image, (b) High-light image

position of real-corner points is unbiased. The results of corner points selection are shown in Fig. 3.

A typical full tear feature in dents image needs four real-corners to confirm it. The error of detecting tear features occurs when the number of detected corners and typical identification corners are different. A feature point normalisation algorithm is designed for solving this problem. Feature point normalisation algorithm is similar to corner selection method. The experiments show that the slit width of typical tear on dents image cannot beyond 20 pixels. Therefore, expending the window size to 40×40, which has ability to realise one-to-one correspondence between features and presentation points. The above method can eliminate the problem which is caused by the wrong quantity of corner detection. All the filtered real-corners are defined as feature points. Hence there is a one-to-one relationship between the feature points and conditional characteristics of conveyor belt longitudinal tear. The effect of feature point normalisation algorithm is shown in Fig. 4.

### 2.3 Tear line detection

In high-light images, because of the area light source, the characteristics of complete tear in the conveyor belt can be shown as longitudinal high-light lines which angles of inclination are between 45° and 135°. In this paper, the detection of feature lines is completed by Hough line detection because of the adaptability of this method [15–18].

However, directly using Hough line detection method cannot get a satisfactory recognition effect because of the obstruction from the burr on the edge of the tear line. Using K3M skeleton algorithm to process the tear line and laser line [19–21]. The essence of above skeleton algorithm is realising conditional iterative deletion to the edge pixels of the high grey level image, and absorb the skeleton of the image. The burr at the edge of the tear line is eliminated in the process of skeleton algorithm, the linearity of the tear line can be well preserved. Define all frame pixels are set  $B = \{b_1, b_2, \dots, b_m\}$ , and structure a polar coordinate:

$$\lambda = x \cos \theta + y \sin \theta \quad (2)$$

Parameters  $\lambda$  and  $\theta$  can constitute a parameter space, and above polar coordinate performs as a sine curve in the parameter space. Put all the points in the set B into the parameter space. If there are s groups  $(\lambda, \theta)$  in the parameter space and each  $(\lambda, \theta)$  point meet at least 150 sine curves, and these points need to satisfy the next formula:

$$1 < -\frac{\cos \theta}{\sin \theta} < +\infty \cup -1 > -\frac{\cos \theta}{\sin \theta} > -\infty \quad (3)$$

The effects of tear line identification are shown in Fig. 5.

## 3 System design

The whole visual recognition system can be divided into three parts: early-stage image acquisition subsystem, data transmission subsystem and post-processing subsystem. The early-stage image acquisition subsystem is constituted by laser and area light sources (V-Light), CCD camera (Pointgrey CMLN-13S2M-CS), and a build-in supply power. The data transmission subsystem is constituted by suited ports and transmission lines. The post-processing subsystem is constituted by following modules: an image processing module and a real-time warning module. The whole visual recognition system and conveyor belt installed in the laboratory constitute the testing platform. The testing platform which has been set up as shown in Fig. 6.

The early-stage image acquisition subsystem is installed at the bottom of the conveyor belt transferring point, whose main detecting object is outer surface (extremely easy to occur tear accident). Specific installation method of it is shown in Fig. 7. A laser line vertically irradiates on the surface of the conveyor belt. To make up for the weak identification ability because of using single laser line, two area light sources are used to improve background brightness. A CCD camera is put under the conveyor belt with suited angle, which can provide qualified images with obvious conditional characteristics of conveyor belt longitudinal tear.

After the process of catching images, data will be transferred to the post-processing subsystem by a data transmission subsystem. The length ranges of data transmission subsystem are from a few

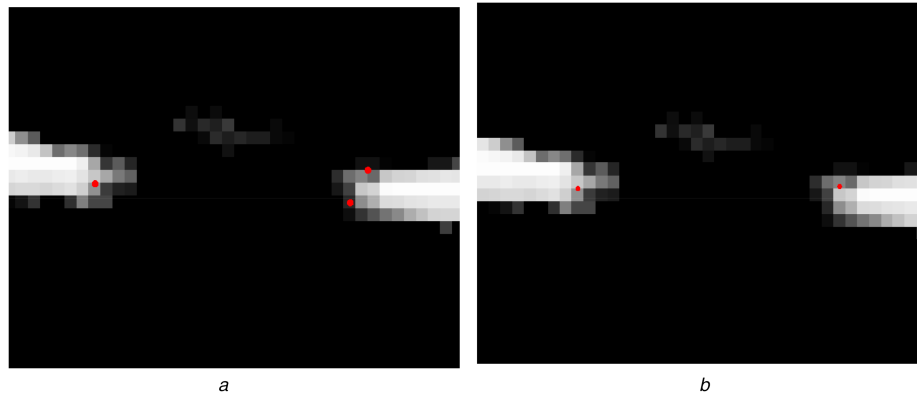

Fig. 3 Results of corner points selection (a) Pseudo – corner phenomenon, (b) Real – corner phenomenon

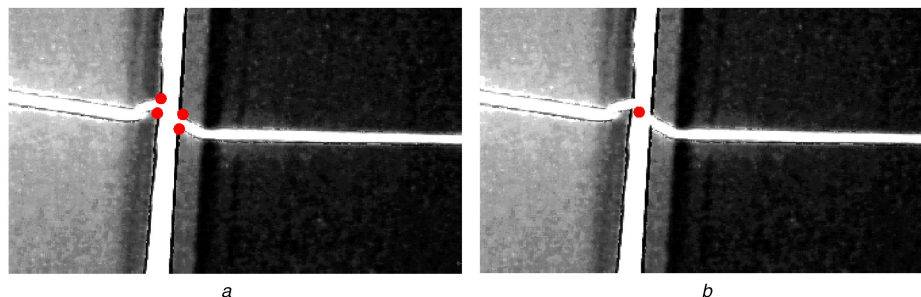

Fig. 4 Effect of feature point normalisation algorithm (a) Multi-feature point image, (b) Single-feature point image

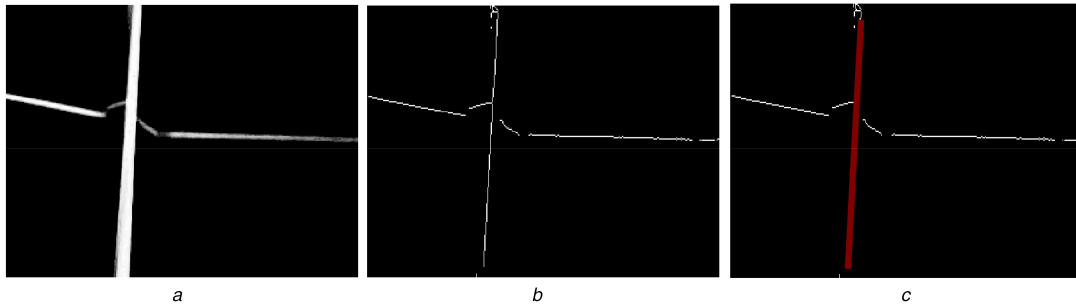

Fig. 5 Effects of tear line identification (a) Complete-tear image, (b) Complete-tear skeletal image, (c) Tear line identification image

hundred meters to several thousand meters rely on actual testing environment.

After receiving data from data transmission subsystem, the image processing module is responsible for the completion of detecting and counting surface features, which is completed by the combination of PC (2.94 Ghz CPU and 2.00 GB Memory) and Nvidia GPU acceleration module. Using Nvidia GPU acceleration module is an effective method in digital image processing in recent years. With the help of acceleration module, the image processing speed of PC can be accelerated to several times or even hundreds of times. The identification of conveyor belt conditional characteristics and the control information for the real-time warning module are realised in PC, and special data will be stored in the database of that. There are three control conditions transferred into the real-time warning module: keep running (in the condition of having no tears), starting an alarm (in the condition of only having incomplete-tears), stop immediately (in the condition of having complete-tears). The real-time warning module feedbacks control signal at real time, and adopts corresponding



Fig. 6 Testing platform

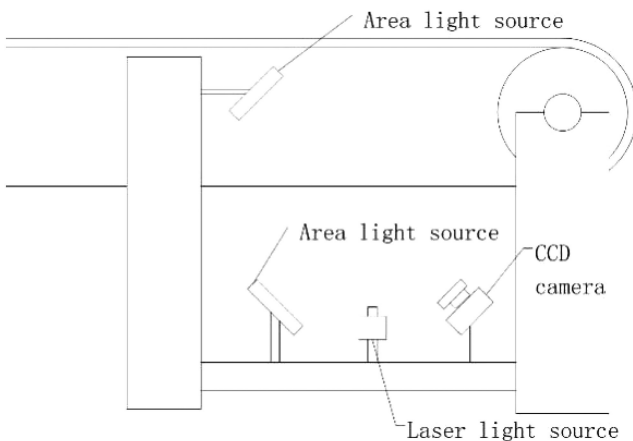

Fig. 7 Early-stage image acquisition system

control action to conveyer belt motor. The post-procission subsystem is installed in the central control room. The structure of the whole visual recognition system is shown in Fig. 8.

## 4 Experimental results

### 4.1 Experiment

The experiment is carried out based on the above testing platform. Specific experimental procedures are shown as follows. First, start the conveyer and keep it running reposefully. Then, the CCD camera capture the belt surface images irradiated by area and laser light sources. PC can realise real-time image collection by transmission line with standard interface and extract conditional features with the help of Nvidia GPU acceleration module. The extracted features serves as the basis of alarm signal sending to real-time warning module, the detection process flowchart is shown in Fig. 9.

In order to test the real effect of the system, a special test method is designed from two aspects in this paper. In the aspect of making tear feature, in a longitudinal direction on the surface of the belt, respectively, manufacturing complete-tears, incomplete-tears, and abrasions, which makes sure there is only one feature or no feature on each frame image eventually. In the aspect of confirming the number of images processed. The sampling frequency of Pointgrey CMLN-13S2M-CS is 30 frames. The operation period (the time of belt rotating one round) of test conveyer is about 4 s (under the condition of running speed is 3 m/s). Therefore, this test takes 120 consecutive images from the CCD camera as samples, and repeat the above experiment for three times for ensuring the reliability of it. It is worth to note that the image process is completed in real time because of the Nvidia GPU acceleration module, which can detect one image in 1.6 ms. Testing feature recognition rate by comparing the number of actual features and detected features. The results of counting experiment are shown in Table 1.

The notes of Table 1 are as follows.

Through the analysis of experimental results, the recognition rate for all kinds of features is more than 90%, which means the counting and detecting abilities of whole system are satisfactory. Actually, because of the particularity of the warning module, the changes in the number of detected features do not affect the operation of the alarm system. Specifically speaking, As long as the number of tear features is not zero, the warning module will act accordingly without considering the accurate number of them. In other words, the errors in detection just effect the time of sending warning signals, which do not influence overall detection results.

### 4.2 Error analysis

According to the statistical analysis of the two groups of experimental result, the problem of excessive counting is prominent in the process of complete-tear feature statistics. Tear features of the image is determined only when the laser line is sweeping through the characteristic and have corresponding distortions. However, the detection method of complete-tears is not dependent on the laser line, which means the number of detected images for complete-tears is excess. In other failure situations, the most important reason is that the thresholds of corner and line

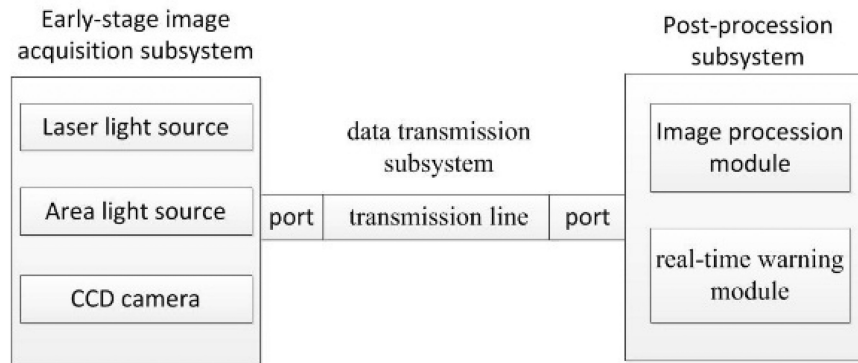

Fig. 8 System structure diagram

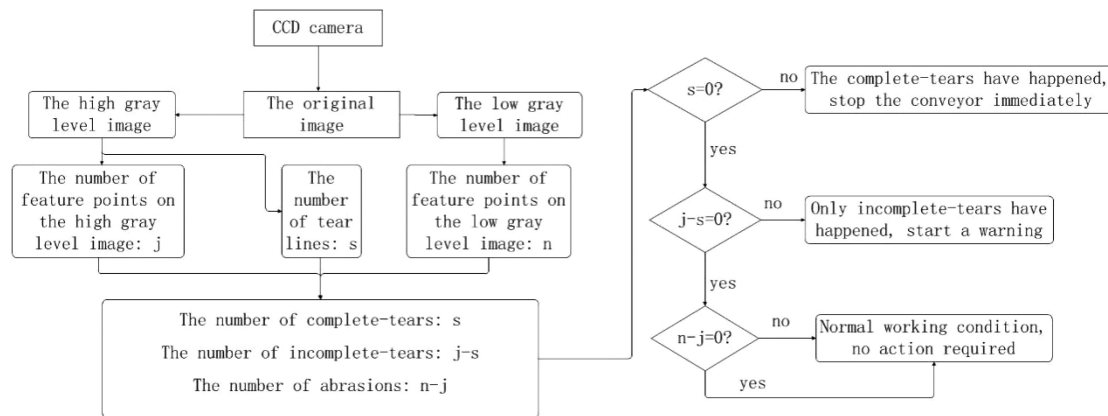

Fig. 9 Detection flowchart

Table 1 Experimental results

|    | R1 | R2 | R3 | R4 | D1 | D2 | D3 | D4 | O1 | O2 | O3 | A1, % | A2, % | A3, % |
|----|----|----|----|----|----|----|----|----|----|----|----|-------|-------|-------|
| E1 | 27 | 21 | 28 | 44 | 29 | 21 | 25 | 45 | 29 | 22 | 69 | 92.6  | 100   | 95.9  |
| E2 | 27 | 21 | 28 | 44 | 28 | 20 | 29 | 43 | 28 | 20 | 72 | 96.3  | 95.3  | 100   |
| E3 | 27 | 21 | 28 | 44 | 28 | 23 | 27 | 42 | 28 | 23 | 69 | 96.3  | 90.5  | 95.9  |

detection algorithm is artificially set, which lacks adaptive ability. Thresholds are relative low in order to be able to identify the desired features effectively, however, this choice also cause the experimental results affected by environmental factors, such as dust, and illumination changing.

Actually, in the process of dividing the original image according to grey level, the intersected threshold is also artificial and fixed. However, as the light intensity of area and laser light sources has been designed, different features of the original image do have enough grey level difference. Specifically, necessary information is almost completely preserved in the high and low grey level images. According to the above facts, there is no doubt that the effect of intersected threshold on feature detection can be negligible.

## 5 Conclusion

In this paper, a visual recognition system for conditional characteristics of conveyor belt longitudinal tear has been proposed, which can effectively get the real surface data of the conveyor belt and identify a variety of conveyor belt longitudinal tear features. Because the image captured by the CCD camera contains several kinds of features, thus this visual recognition system uses laser light sources and area light sources enhancing the contrast of multiple tear characteristics. Then, original images are separated into high-light images and dents images using improved

Harris corner detection method, skeleton algorithm and Hough line detection method to identify abrasions, incomplete-tears, and complete-tears form two kinds of images. In system testing, the proposed system has a great ability of multi-features recognition at the process of running conveyor belt. The whole system meets the requirement of real-time online state detection and avoids the problem of starting the alarm only rely on a single characteristic occurred on past detecting system. In the future research, with the help of the image feature extraction algorithm described in this paper, the proposed system can also further realise the identification of non-damage features such as the surface patches of conveyor belt. After the comprehensive analysis of damage and non-damage characteristics of the conveyor belt, the proposed system can realise the function of predicting service life of the conveyor belt.

## 6 Acknowledgment

This work was supported by the Shanxi Province Natural Science Foundation of China (grant no 201601D011059).

## 7 References

- [1] Wang, C., Zhang, J.: 'The research on the monitoring system for conveyor belt based on pattern recognition'. 1st Int. Conf. on Intelligent System and Applied Material (GSAM 2012), Taiyuan, 13-15 January 2012, pp. 622-625

- [2] Long, R., Rom, T., Hansel, W.: 'Long distance magnetic conveyor for precise positioning of ultracold atoms', *Eur. Phys. J. D.*, 2005, **35**, (1), pp. 125–133
- [3] Zhao, H., Wu, Y.: 'A new roller conveyor driven by linear motor'. 2nd Int. Conf. on Manufacturing Science and Engineering, Guilin, 09–11 April 2011, pp. 1517–1520
- [4] Dobrota, D.: 'Vulcanization of rubber conveyor belts with metallic insertion using ultrasounds'. 25th DAAAM Int. Symp. on Intelligent Manufacturing and Automation, Oldest Technical University, Vienna, Austria, 26–29 November 2014, pp. 1160–1166
- [5] Wang, J., Miao, C., Wang, W.: 'Research of X-ray nondestructive detector for high-speed running conveyor belt with steel wire ropes - art. no. 68331X'. Conf. on Electronic Imaging and Multimedia Technology V, Beijing, Peoples R China, 12–15 November 2007, pp. X8331–x8331
- [6] Yang, W., Zhang, X., Ma, H.: 'An inspection robot using infrared thermography for belt conveyor'. 13th Int. Conf. on Ubiquitous Robots and Ambient Intelligence (URAD), Xian, Peoples R China, 19–22 August 2016, pp. 400–404
- [7] Chang, Y.C., Sinha, G.: 'A visual basic program for ridge axis picking on DEM data using the profile-recognition and polygon-breaking algorithm', *Comput. Geosci.*, 2007, **33**, (2), pp. 229–237
- [8] Li, J., Miao, C.: 'The conveyor belt longitudinal tear on-line detection based on improved SSR algorithm', *Optik*, 2016, **127**, (19), pp. 8002–8010
- [9] Xue, Y.: 'Study on sensor-based comprehensive detector of conveyor belt bearing surface tearing'. Int. Conf. on Advanced Mechanical Engineering, Wuhan, 07-08 July 2012, pp. 174–179
- [10] Qiao, T., Liu, W., Pang, Y.: 'Research on visible light and infrared vision real-time detection system for conveyor belt longitudinal tear', *IET Sci. Meas. Technol.*, 2016, **10**, (6), pp. 577–584
- [11] Jeon, B.: 'CU depth decision based on FAST corner detection for HEVC intra prediction HEVC', *J. Broadcast Eng.*, 2016, **21**, (4), pp. 484–492
- [12] Nguyen, V.: 'A fast adaptive corner detection based on curvature scale space', *J. Korea Multimedia Soc.*, 2011, **14**, (5), pp. 622–631
- [13] Phil, H.: 'An improved Harris corner detector for efficient image matching', *J. Korean Soc. Imag. Sci. Technol.*, 2007, **13**, (3), pp. 204–214
- [14] Zeng, Q., Liu, L., Li, J.: 'Image registration method based on improved Harris corner detector', *Chin. Opt. Lett.*, 2010, **8**, (6), pp. 573–576
- [15] El Mejdani, M., Egli, R., Dubeau, F.: 'Old and new straight-line detectors: description and comparison', *Pattern Recognit.*, 2008, **41**, (6), pp. 1845–1866
- [16] Okuzono, T., Wakizako, H.: 'Object detect on using straight line matching in theta-rho space', *Electron. Commun. Jpn.*, 2010, **93**, (3), pp. 34–41
- [17] Havel, J., Dubska, M., Herout, A.: 'Real-time detection of lines using parallel coordinates and CUDA', *J. Real-Time Image Process.*, 2014, **9**, (1), pp. 205–216
- [18] Li, S.: 'Edge point grouping for line detection', *IEICE Trans. Inf. Syst.*, 2012, **E95D**, (6), pp. 1713–1716
- [19] Ho, L., Lee, j.: 'The enhanced thinning algorithm for extraction of feature point in fingerprint', *J. Korean Inst. Inf. Technol.*, 2006, **4**, (5), pp. 74–81
- [20] Tabedzki, M., Saeed, K., Szczepanski, A.: 'A modified K3M thinning algorithm', *Int. J. Appl. Math. Comput. Sci.*, 2016, **26**, (2), pp. 439–450
- [21] Saeed, K., Tabedzki, M., Rybnik, M.: 'K3M: A universal algorithm for image skeletonization and a review of thinning techniques', *Int. J. Appl. Math. Comput. Sci.*, 2010, **20**, (2), pp. 317–335