

DRAWINGS

MARIA ALEXIOU 4504003

TU Delft 2016-2017

FACADE PATTERNS FOR AMSTERDAM

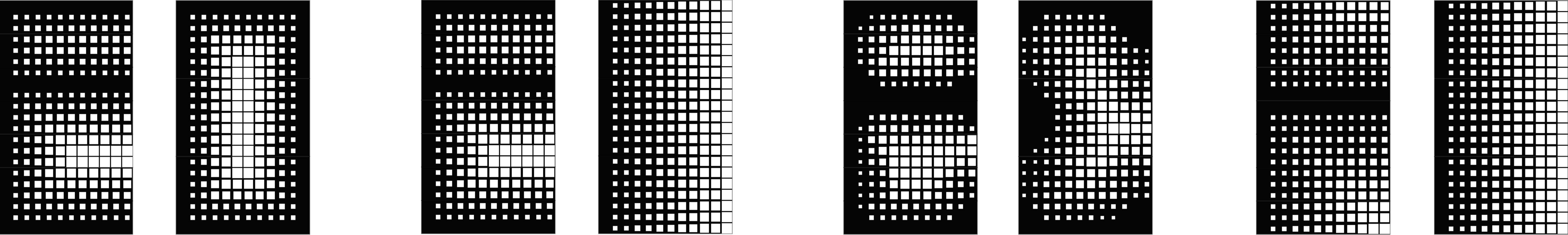

FACADE PATTERNS FOR ATHENS

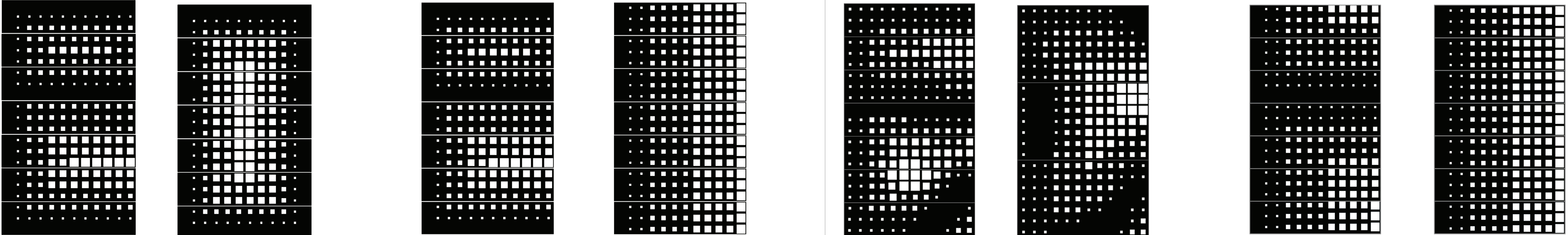

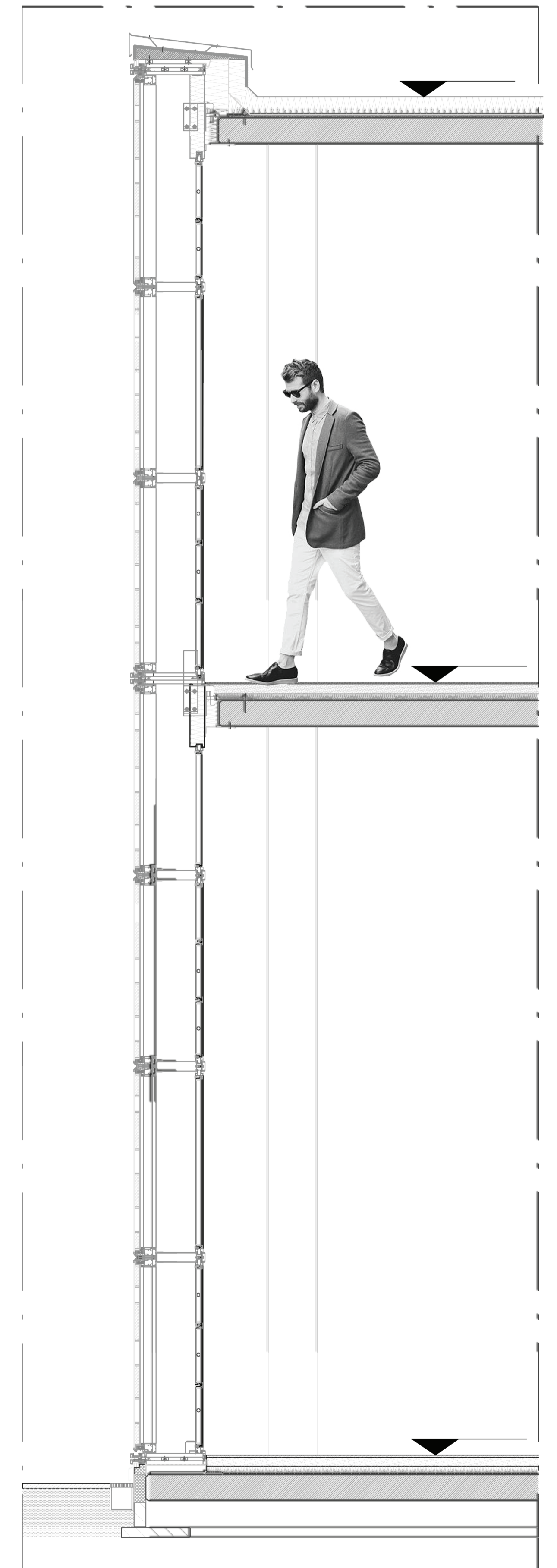
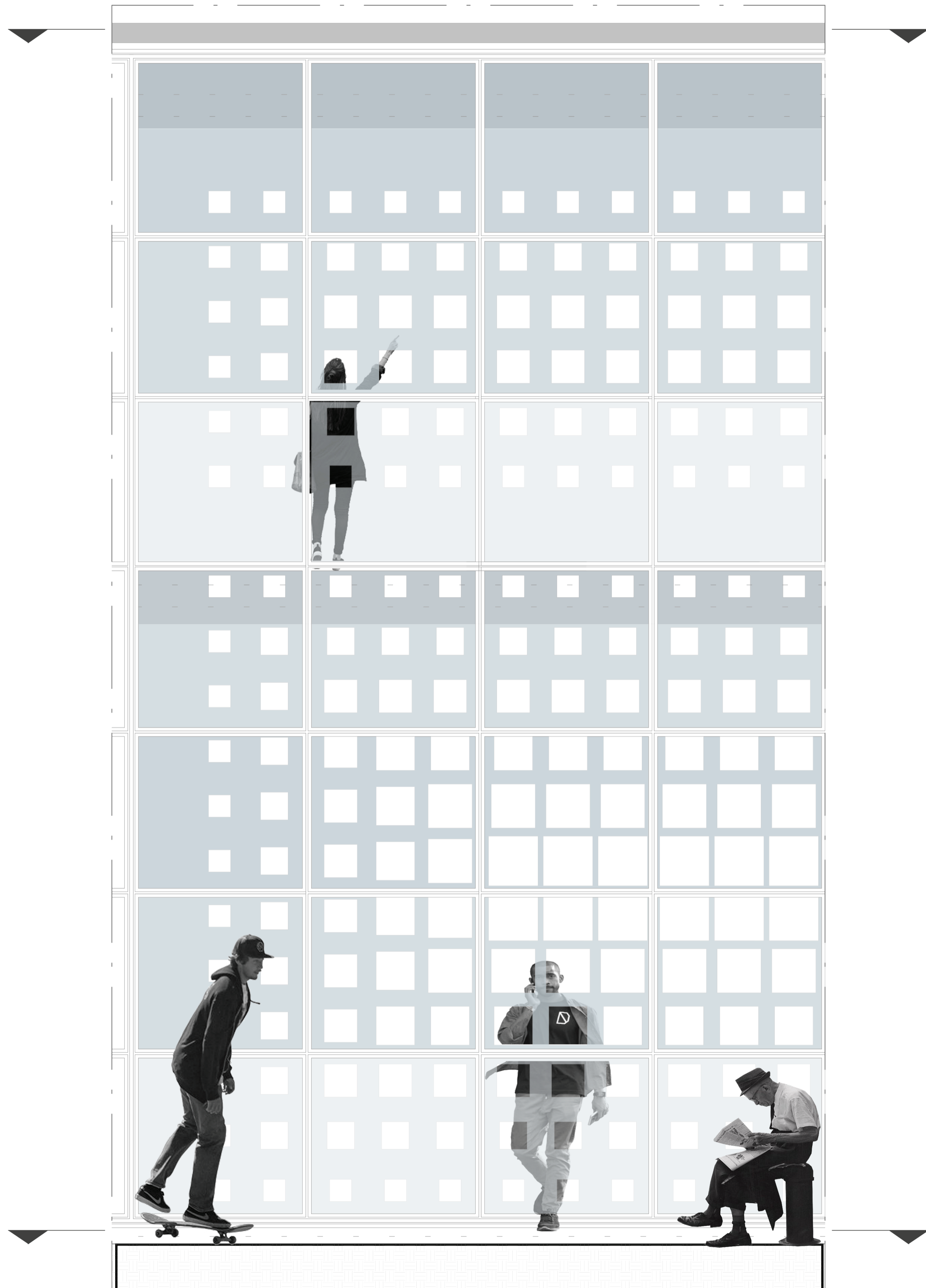

DETAILS

ROOF DETAIL

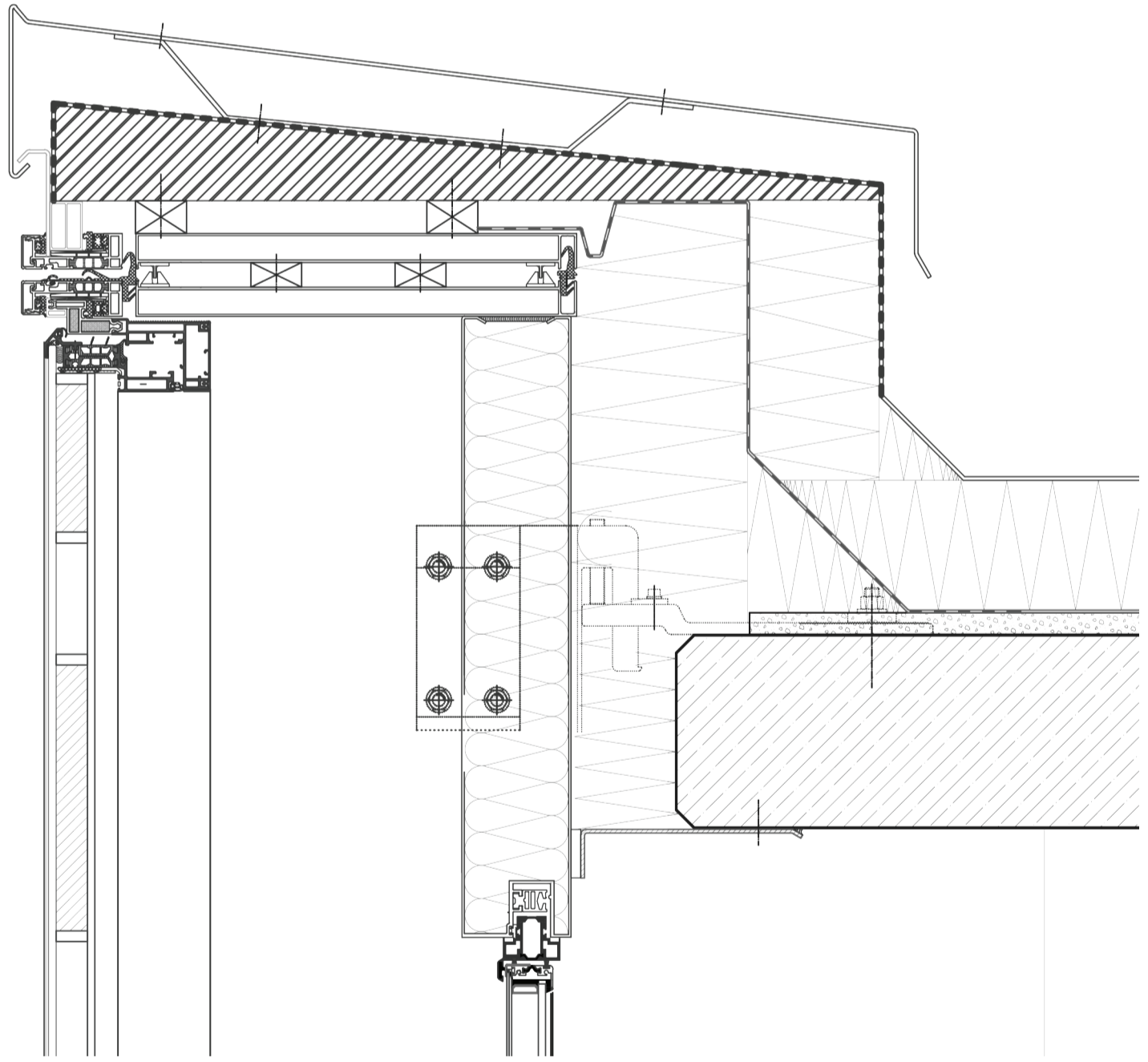

FACADE FIXING BRACKET

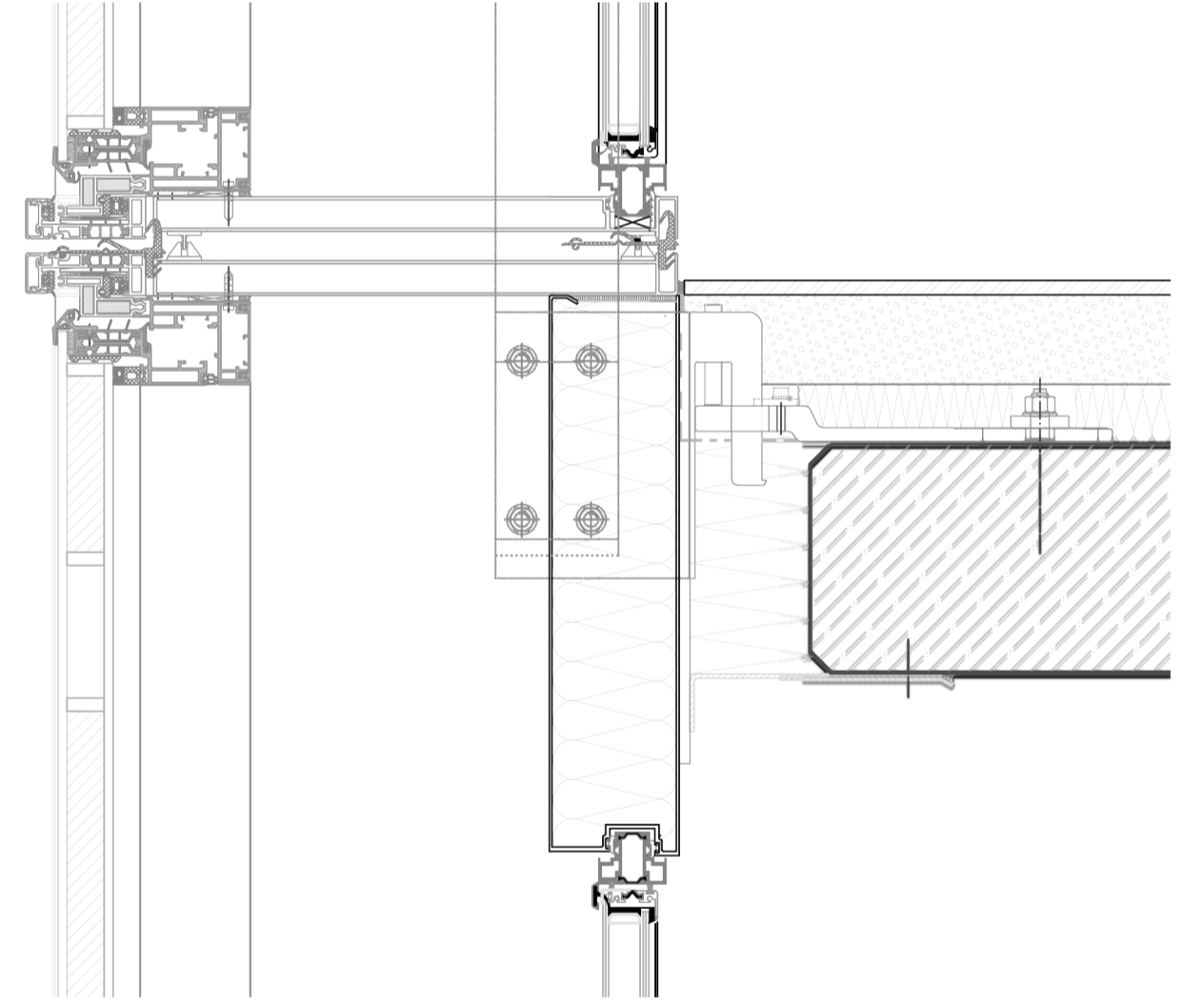

MODULAR PANEL

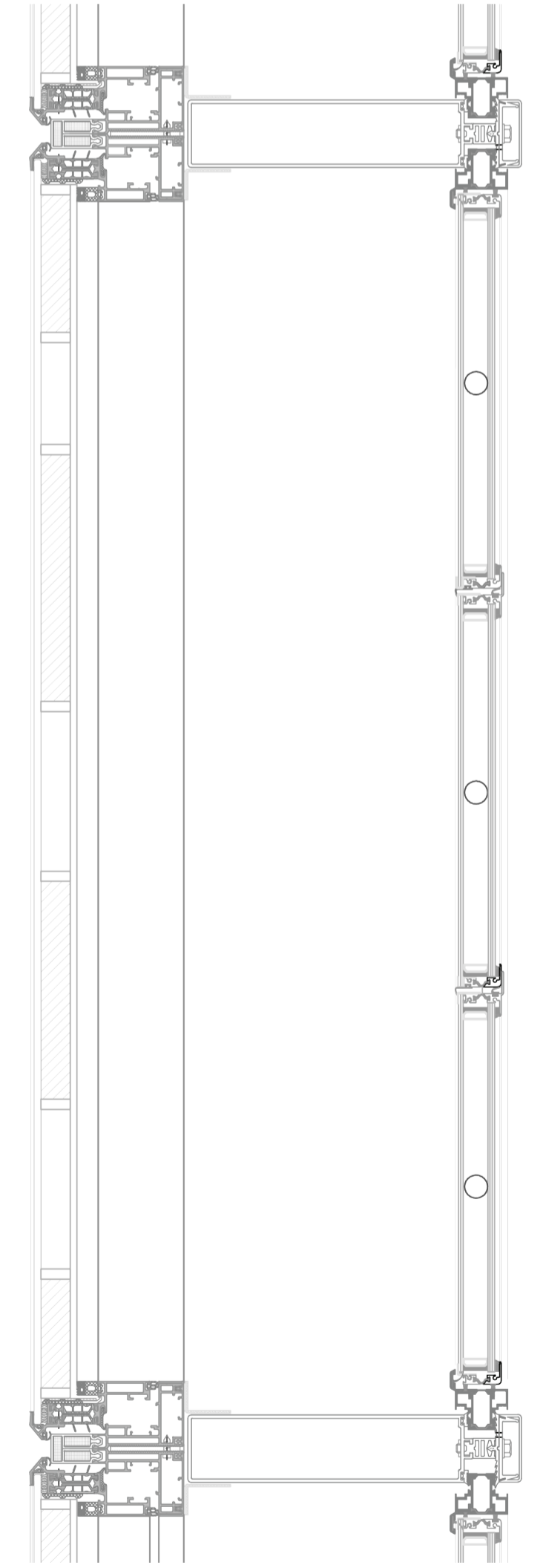

BOTTOM DETAIL

