

Ground floor

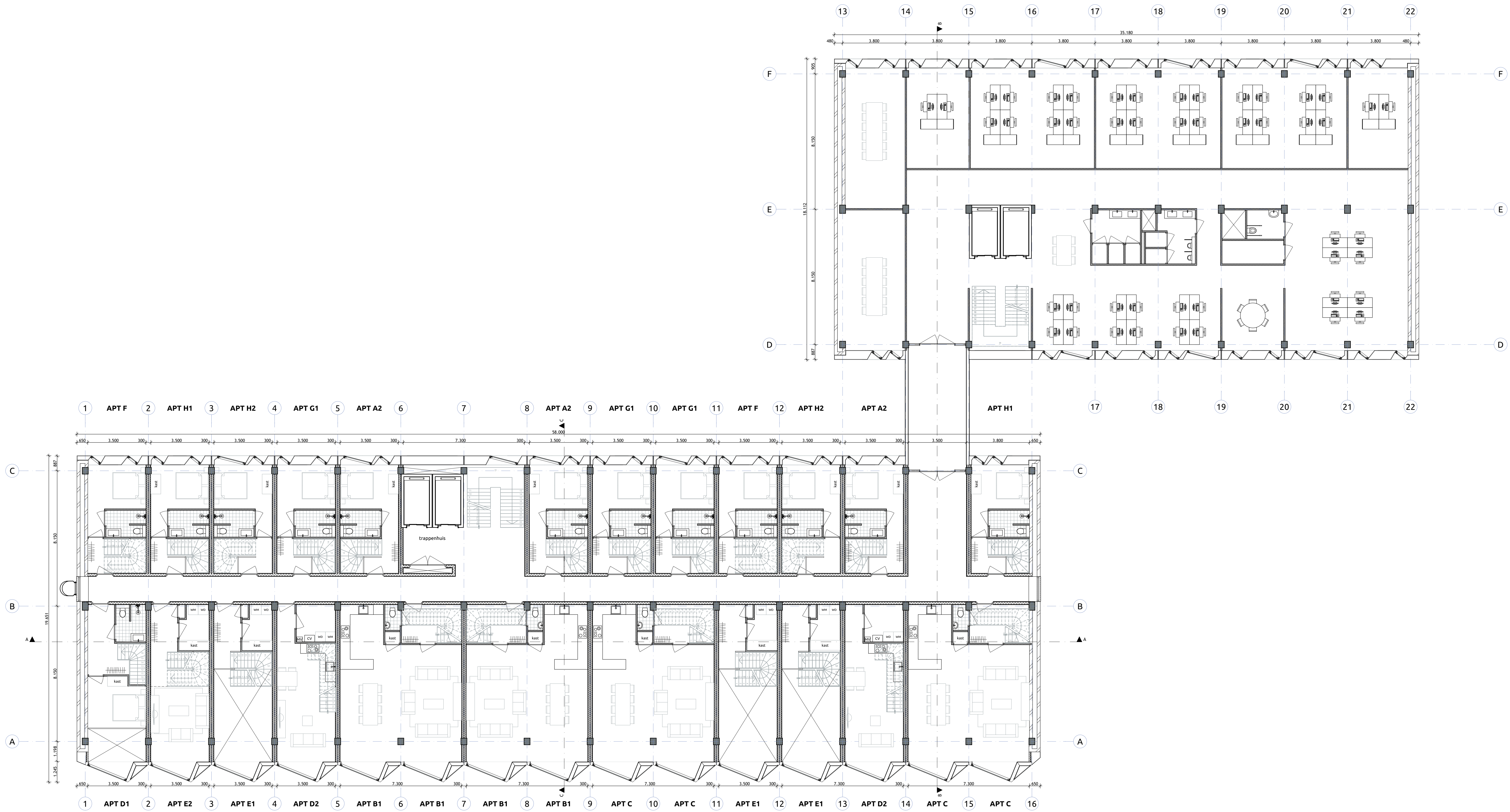

1st floor





2nd floor



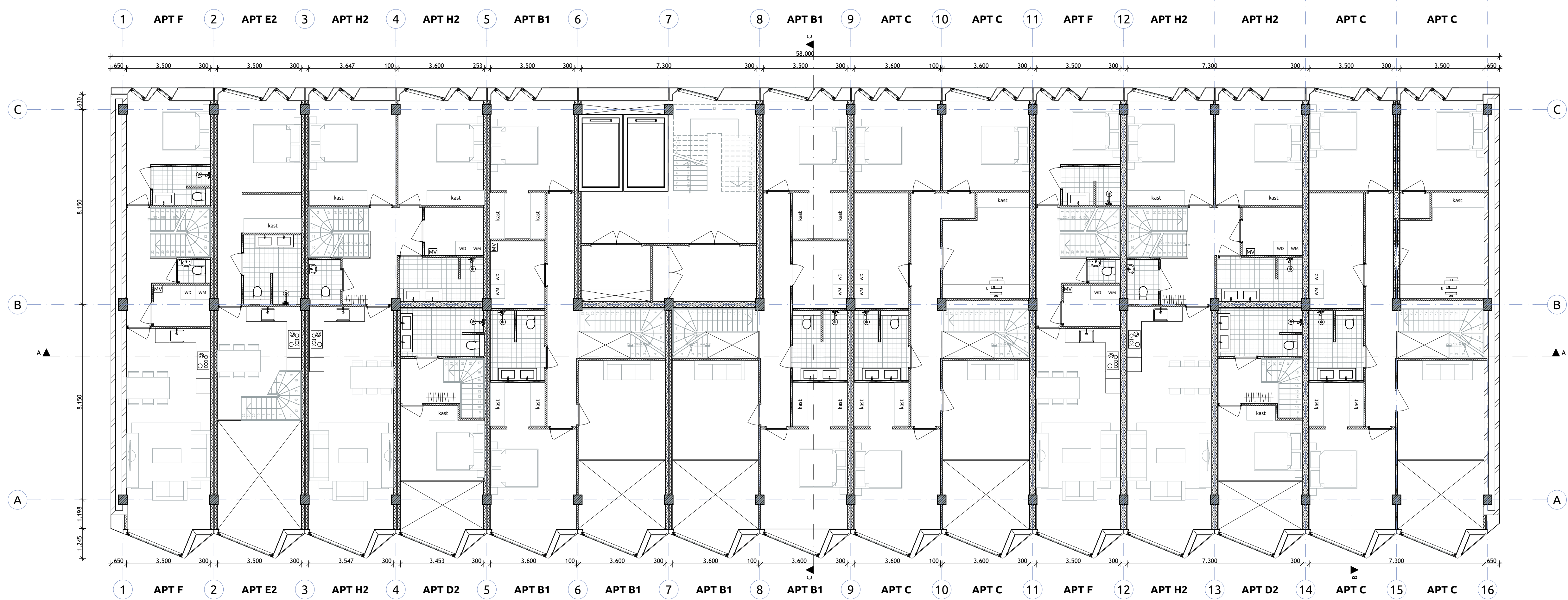

3rd floor



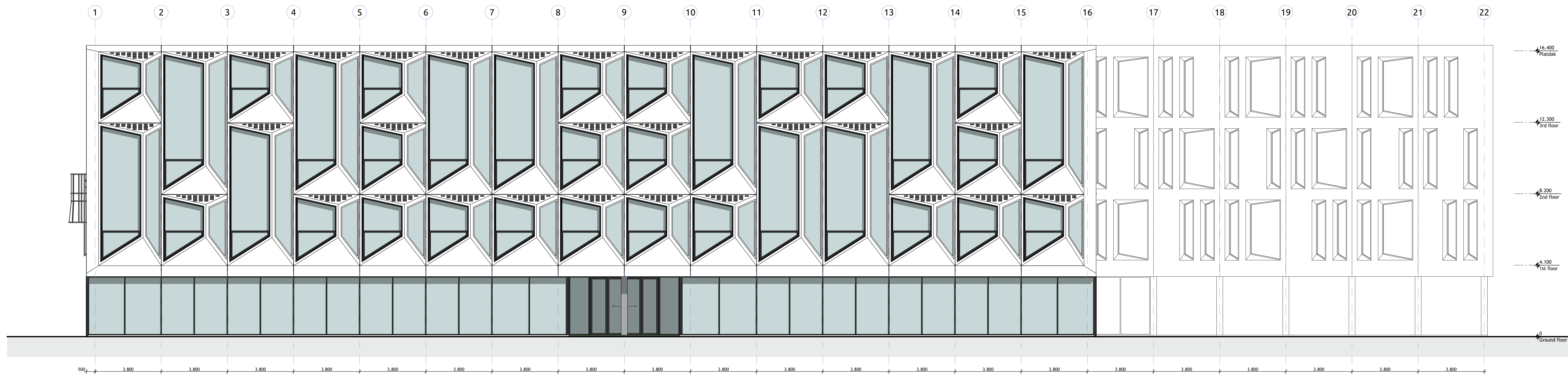

SOUTH-WEST ELEVATION



SOUTH-EAST ELEVATION



3D ELEVATION 01



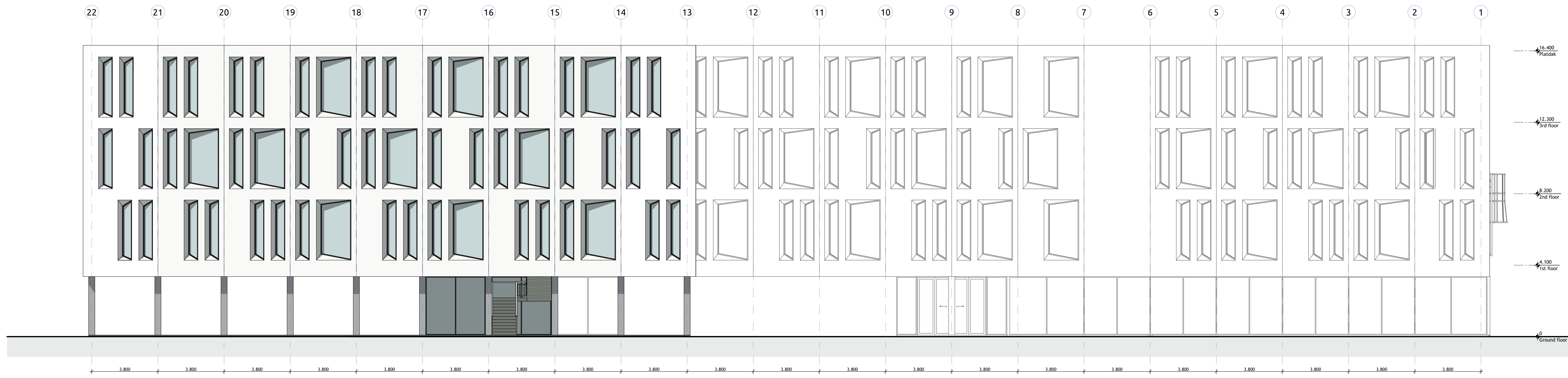

NORTH-EAST ELEVATION



NORTH-WEST ELEVATION



3D ELEVATION 02



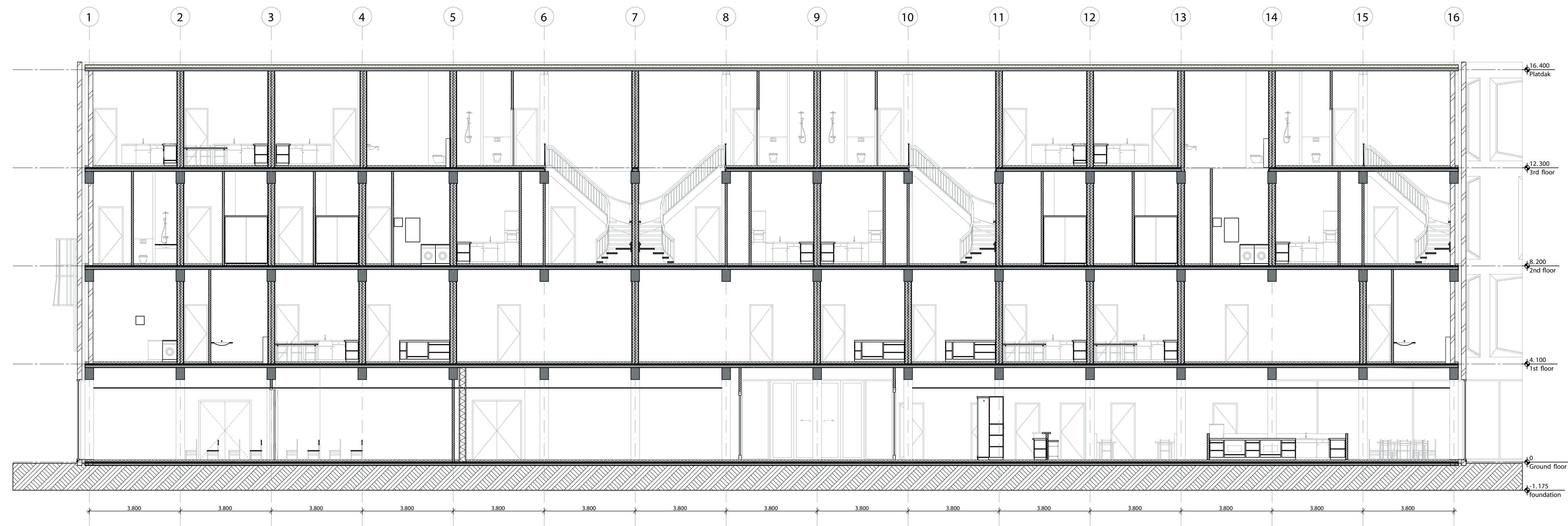

Longitudinal section A - A

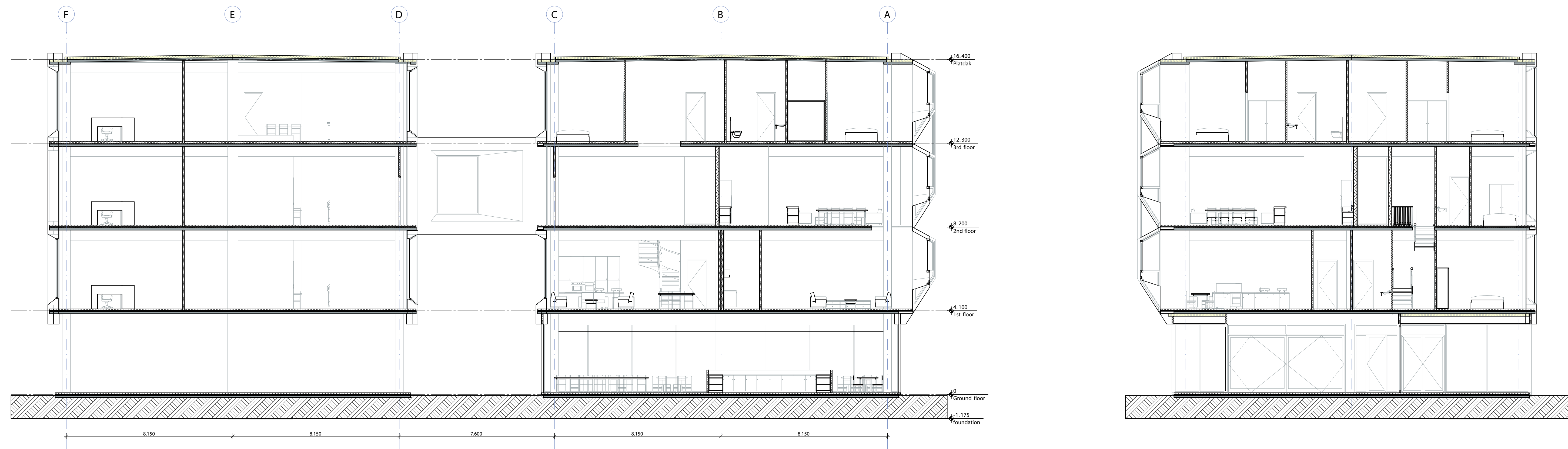

Cross section B - B



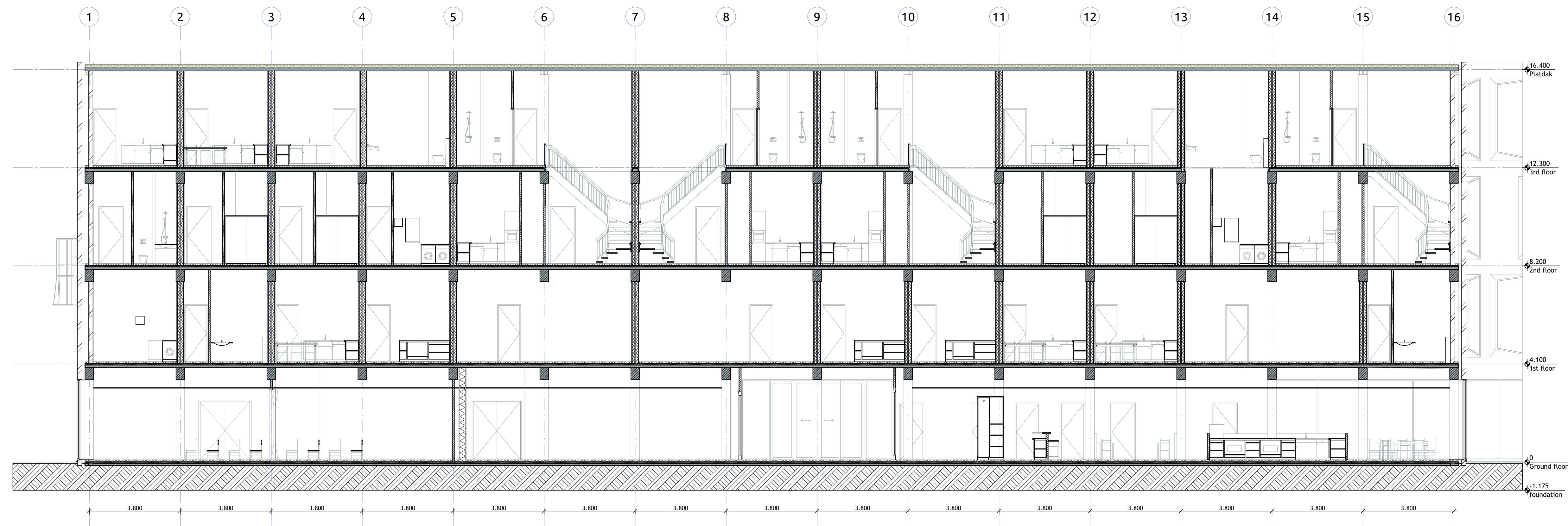

Longitudinal section A - A



Cross section B - B

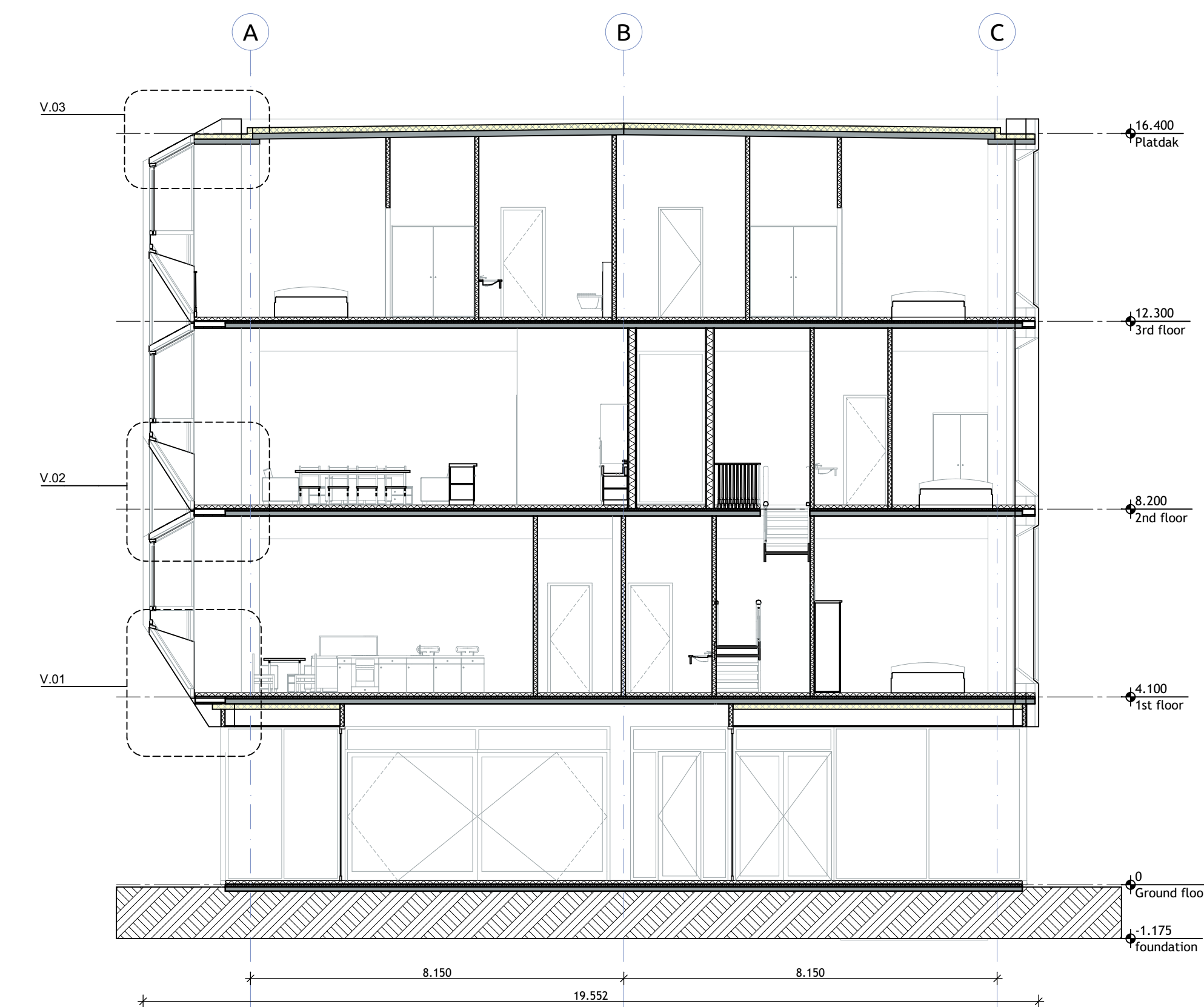

Cross section C - C



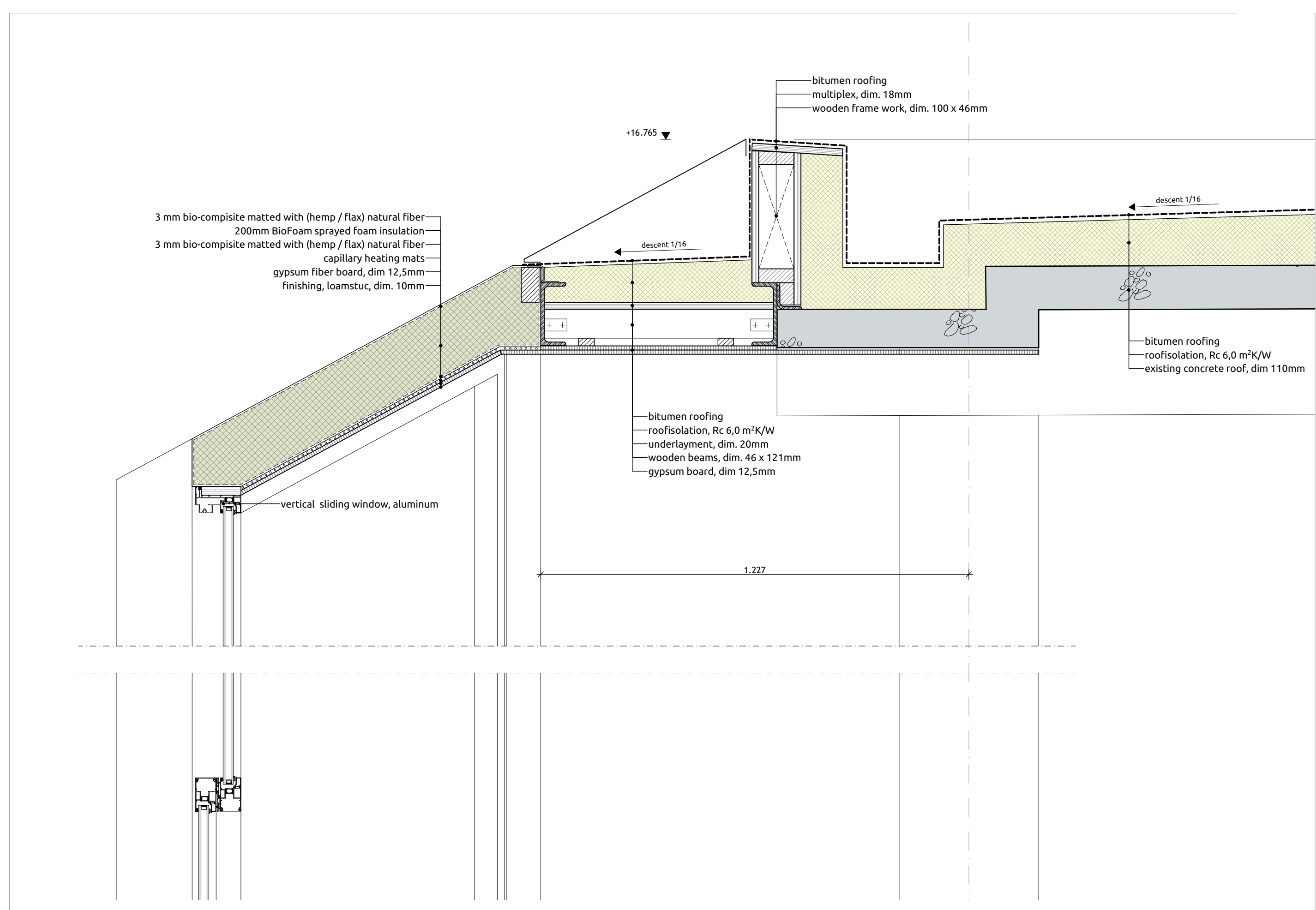

Detail V.03

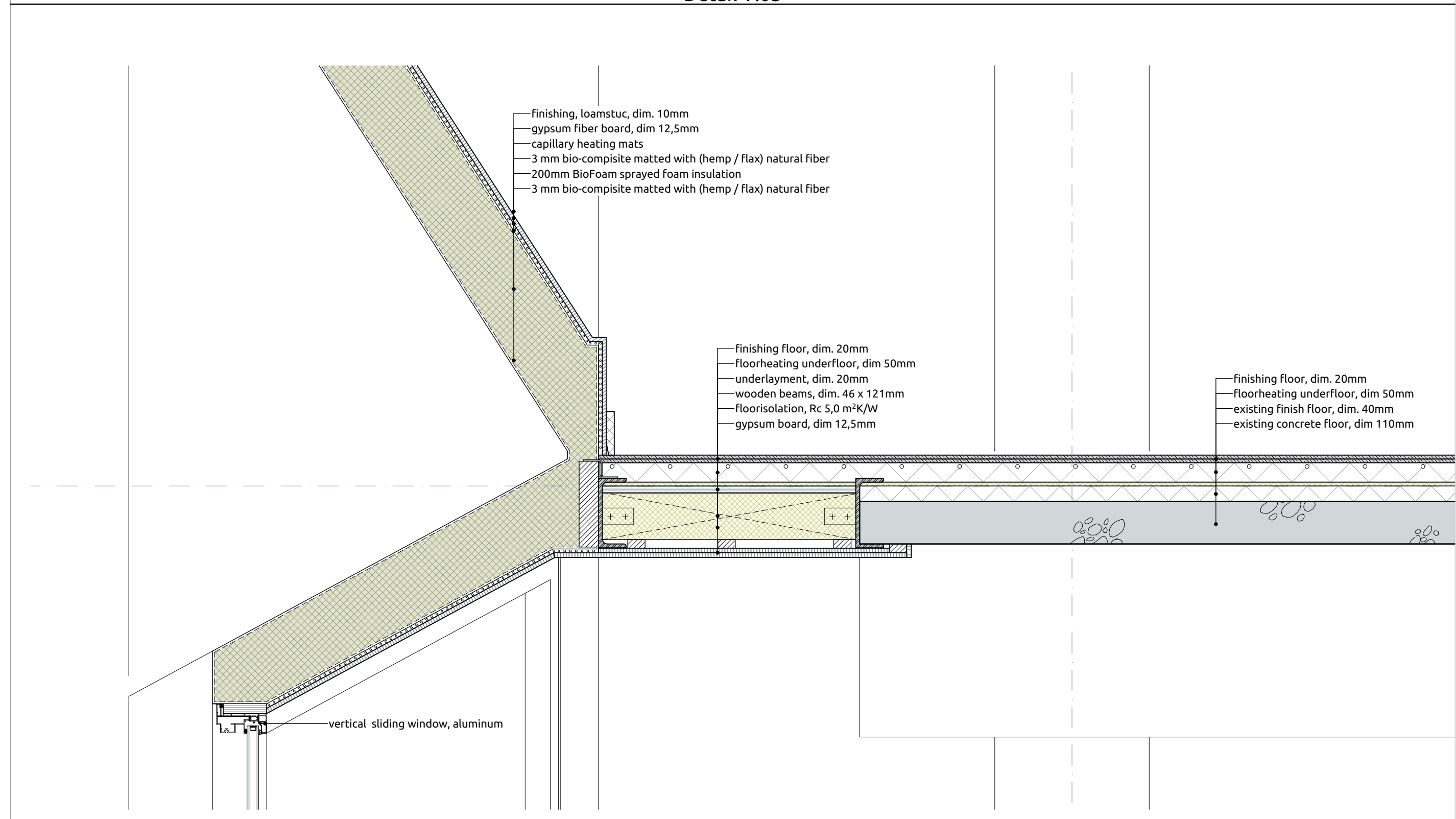

Detail V.02

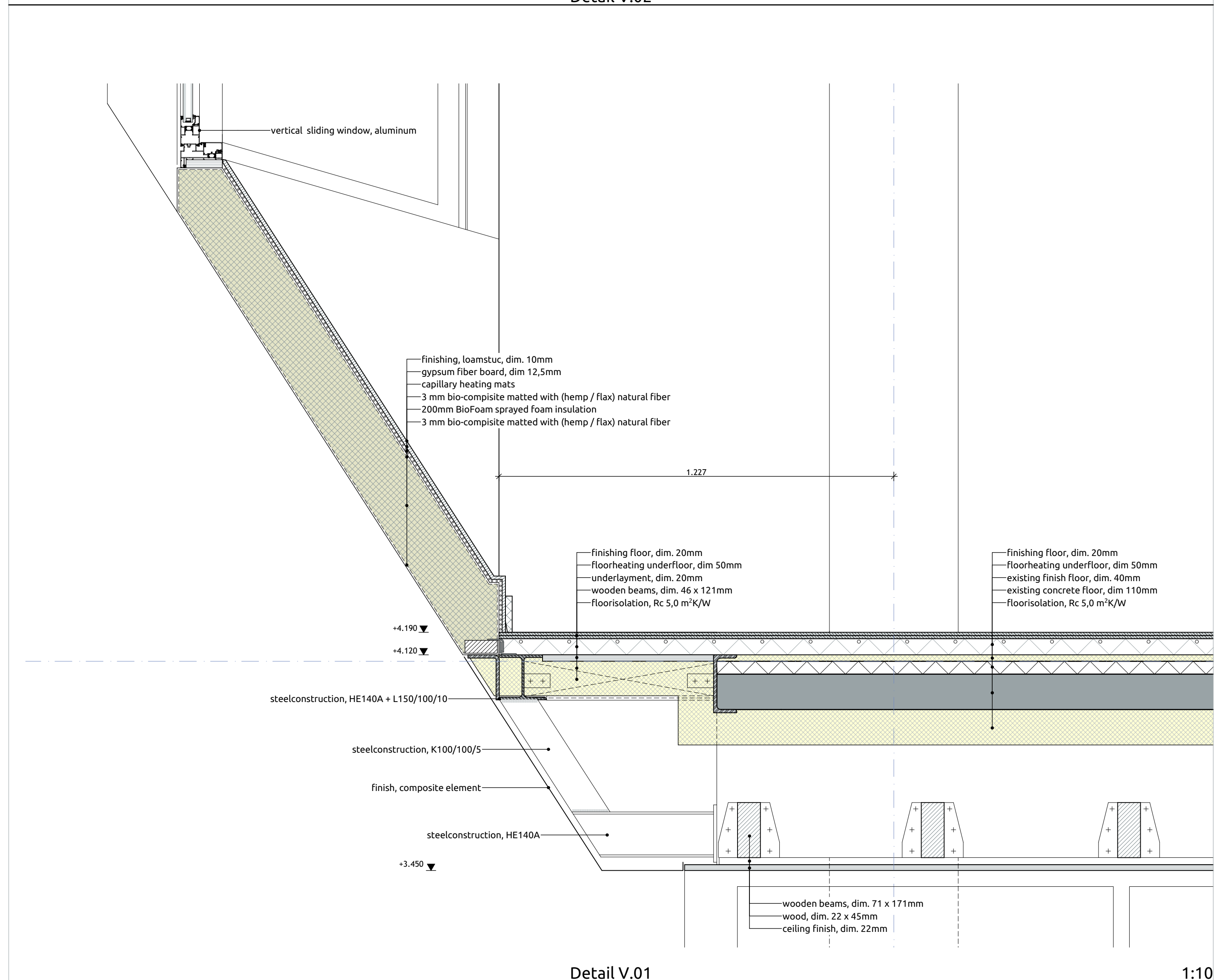

Detail V.01

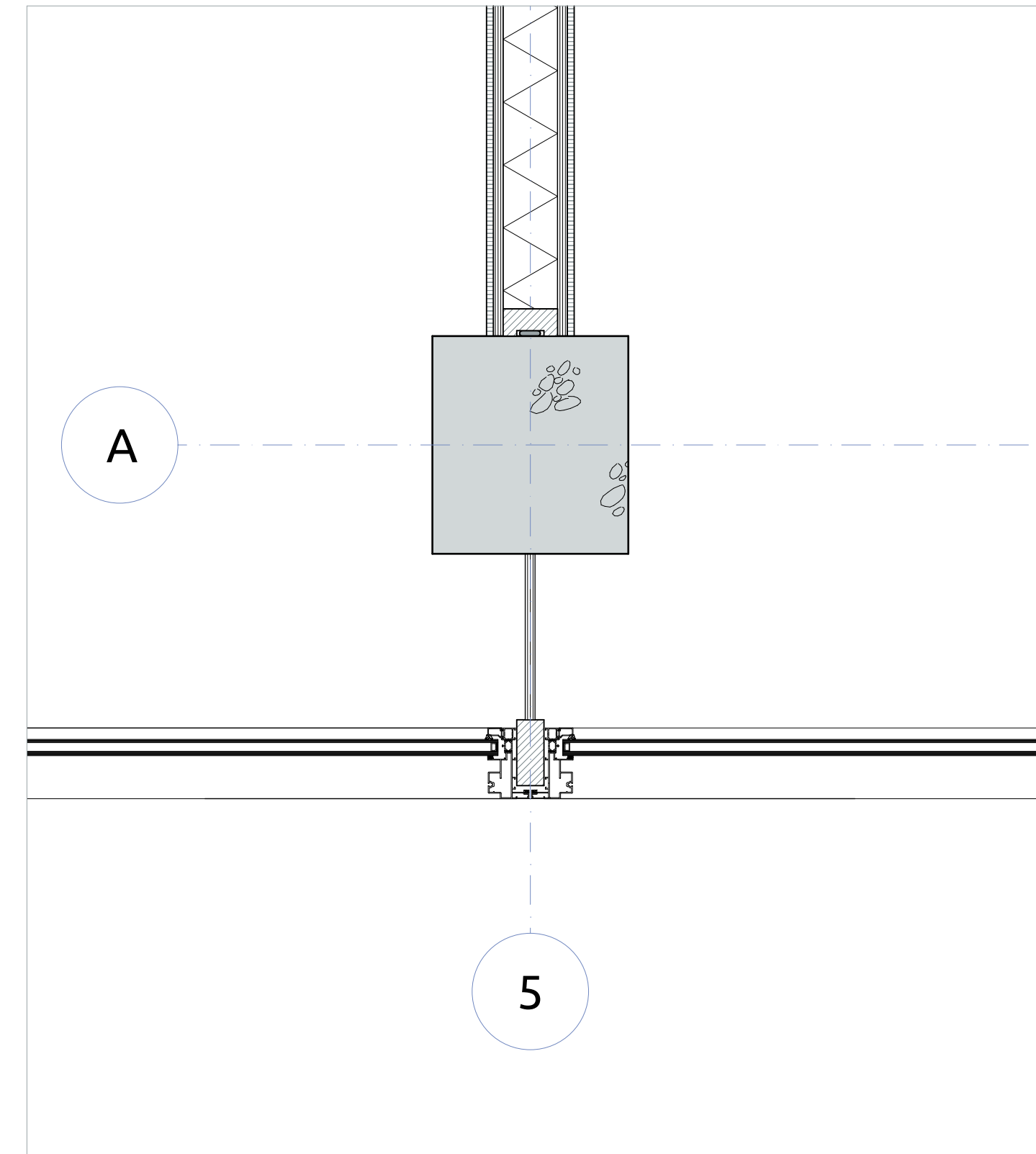

Detail H.01

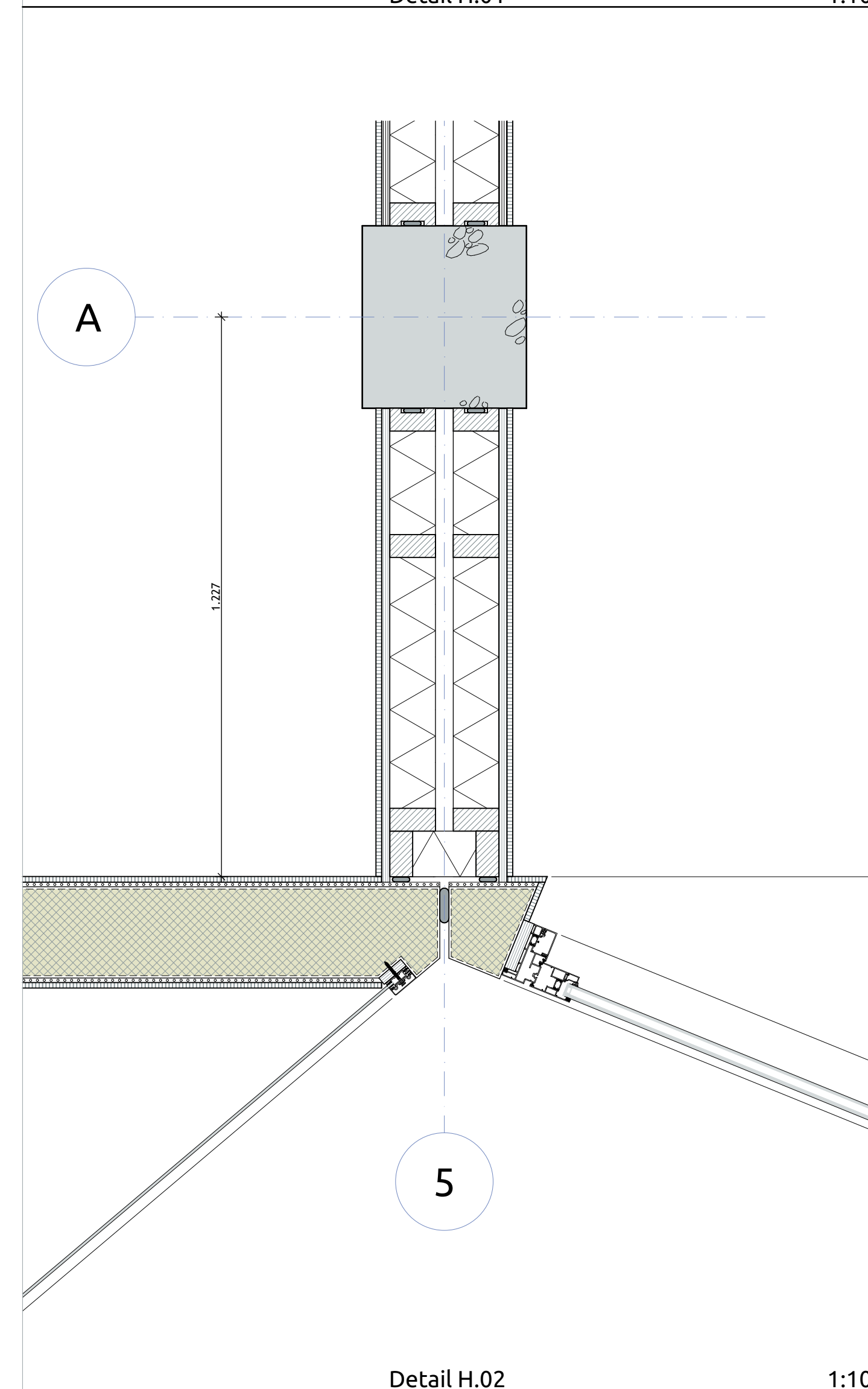

Detail H.02



Cross section C - C

1:50

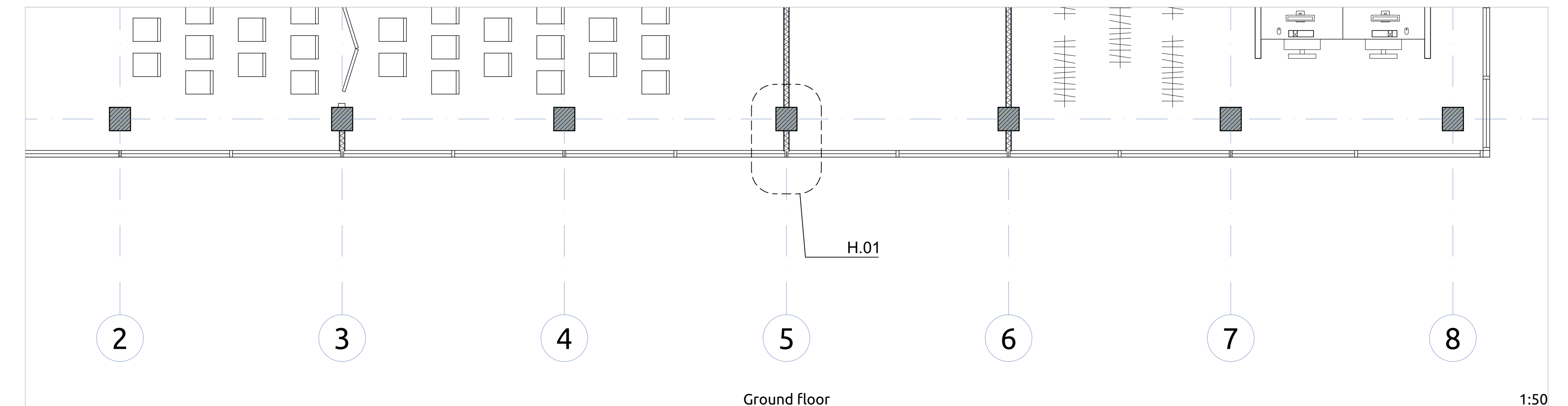

Ground floor

1:50

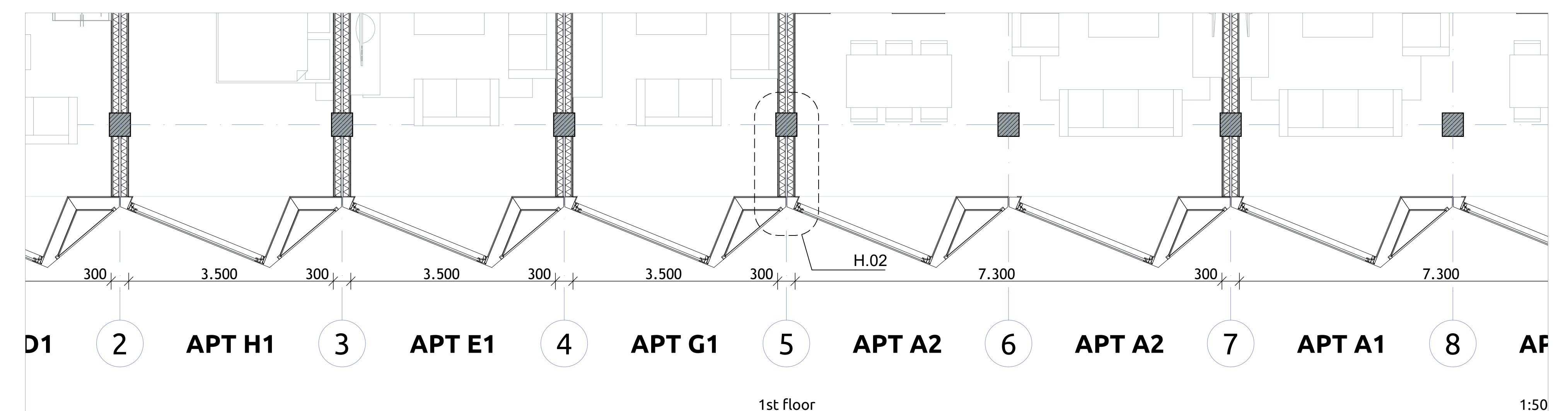

1st floor

1:50