

## Indoor navigation supported by the Industry Foundation Classes (IFC)

### A survey

Liu, Liu; Li, Bofeng; Zlatanova, Sisi; van Oosterom, Peter

#### DOI

[10.1016/j.autcon.2020.103436](https://doi.org/10.1016/j.autcon.2020.103436)

#### Publication date

2021

#### Document Version

Final published version

#### Published in

Automation in Construction

#### Citation (APA)

Liu, L., Li, B., Zlatanova, S., & van Oosterom, P. (2021). Indoor navigation supported by the Industry Foundation Classes (IFC): A survey. *Automation in Construction*, 121, Article 103436. <https://doi.org/10.1016/j.autcon.2020.103436>

#### Important note

To cite this publication, please use the final published version (if applicable). Please check the document version above.

#### Copyright

Other than for strictly personal use, it is not permitted to download, forward or distribute the text or part of it, without the consent of the author(s) and/or copyright holder(s), unless the work is under an open content license such as Creative Commons.

#### Takedown policy

Please contact us and provide details if you believe this document breaches copyrights. We will remove access to the work immediately and investigate your claim.



Contents lists available at ScienceDirect

## Automation in Construction

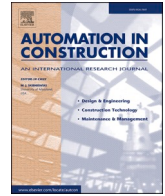
journal homepage: [www.elsevier.com/locate/autcon](http://www.elsevier.com/locate/autcon)

Review

## Indoor navigation supported by the Industry Foundation Classes (IFC): A survey

Liu Liu<sup>a</sup>, Bofeng Li<sup>a,\*</sup>, Sisi Zlatanova<sup>b</sup>, Peter van Oosterom<sup>c</sup><sup>a</sup> College of Surveying and Geo-Informatics, Tongji University, 1239 Siping road, Shanghai, China<sup>b</sup> Faculty of Built Environment, UNSW Sydney, Red Centre, Kensington Campus, 2052, NSW, Sydney, Australia<sup>c</sup> Faculty of Architecture and the Built Environment, Delft University of Technology, Delft, the Netherlands

## ARTICLE INFO

## Keywords:

Indoor navigation  
 Building information modeling  
 Industry Foundation Classes  
 Application review

## ABSTRACT

Building Information Modeling (BIM) represents a new technology which supports the creation and management of a construction project for buildings. The most well-known open BIM standard, the Industry Foundation Classes (IFC), provides the detailed 3D geometry and rich spatial semantics. It has drawn growing attention of researchers working in geographical information science (GIS). In many related applications, indoor navigation greatly benefits from IFC since it requires the information about building interiors. IFC provides the semantics and geometry of building, and topological relationships of building elements can be readily derived. These three types of information are extensively used in the research on indoor navigation. In this paper we review the current approaches, applications and solutions developed for different aspects of indoor navigation, and summarize the latest status about the use of IFC-based BIM for indoor navigation. In the literature regarding both IFC and indoor navigation, a total of 87 related papers are identified and categorized. 30 papers relate to the generation of indoor navigation models; 20 papers are about model conversion and data modeling on the basis of the IFC schema; 13 papers refer to IFC applications with dynamic environments; 14 papers focus on the support of IFC to indoor localization; and the other papers involve various topics such as visualization and network queries based on IFC. We find that the most active research direction is to generate navigation models from IFC data, yet there is no robust automation method of the generation. By discussing the pros and cons of the current applications, this paper suggests three new directions for further research on the IFC supports to indoor navigation. That is, researchers can further investigate the vertical dimension of the 3D geometry in IFC, facilitate the transformation from IFC to standardized indoor navigation models and manage real-time data with IFC to reflect indoor changes.

## 1. Introduction

As a recent and emerging new technology, Building Information Modeling (BIM) can be used as a building data repository for indoor navigation since it contains abundant spatial geometry, topological relationships, semantics and properties of building components. In addition to the physical and functional characteristics of indoor environments, BIM also depicts the facilities of the building. By BIM in this paper, we specifically refer to its standardized interoperable data model 'Industry Foundation Classes' created by *buildingSMART*, *i.e.*, IFC [1]. IFC is a data specification standard for BIM which promotes the interoperability on building representation, and the IFC format has been registered by ISO as ISO/PAS 16739 [1–3]. This standard aims for the

whole project life-cycle, *i.e.*, the 'plan', 'design', 'construct', 'operate' and 'maintain' phases. As standardized spatial data are the foundation for geographic information science (GIS), IFC is extensively considered a significant data source for indoor analysis. Indoor navigation is one of the important topics of indoor GIS, and IFC can support it with detailed information about construction elements and spaces. In the past decade, a spectrum of studies explore the use of IFC for different components of indoor navigation. For example, indoor information (such as spaces, doors and windows) is extracted and transformed into indoor navigation models [4,5]. Moreover, indoor positioning results can be mapped in a BIM to obtain the precise context for a user in the building [6]. In fact, BIM can provide high precision indoor maps, which also benefits for the current indoor mapping research [7,8]. As indoor navigation models can

\* Corresponding author.

E-mail addresses: [l.liu@tongji.edu.cn](mailto:l.liu@tongji.edu.cn) (L. Liu), [bofeng\\_li@tongji.edu.cn](mailto:bofeng_li@tongji.edu.cn) (B. Li).<https://doi.org/10.1016/j.autcon.2020.103436>

Received 2 November 2019; Received in revised form 2 September 2020; Accepted 13 September 2020

Available online 29 October 2020

0926-5805/© 2020 Elsevier B.V. All rights reserved.

be derived from IFC data, and thus indoor routing can be conducted in these models. IFC is also an ideal visualization platform for guidance since the details of directions and turns can be visualized on the 3D building geometry. However, the data model of IFC includes more than six hundred classes in different categories. It is not necessary to use all these classes for a specific application such as indoor navigation. Thus, it is intriguing to identify the essential classes and their possible applications. In this paper we reviewed different uses of IFC in navigation-oriented applications.

Indoor navigation is an activity where users (e.g., robots, humans or drones) navigate to specific locations in indoor environments. More specifically, pedestrian indoor navigation is a sophisticated task which aims to locate people inside a building using different sensor information, to compute and visualize navigable paths, possibly to provide verbal or textual guidance, and to track the movement with ‘out-of-range’ alerts. As IFC-Based BIM provides a complete description of indoor environments, indoor navigation can make use of IFC as input data. Pedestrian indoor navigation mainly involves five essential components: 1) indoor positioning and localization [6,9–11]; 2) indoor modeling for navigation purposes [12–15]; 3) indoor routing/path-planning [16–19]; 4) indoor guidance [20]; 5) human spatial cognition and wayfinding [21]. Indoor positioning is responsible for the user’s accurate location; indoor modeling generates navigation models (e.g., networks or discrete grids/voxels) from three-dimensional (3D) building models or indoor maps. Meanwhile, the derived navigation models need to inherit necessary location coordinates, spatial semantics, and room properties from the original 3D building models/maps; in these navigation models, the computation of indoor routing provides a pedestrian with a proper route to a given destination according to the user’s characteristics and request; indoor guidance services refer to a set of instructions (including distances, turns and directions) in both vocal and textual forms, which is based on the visualization of routing results in the building; the wayfinding of a pedestrian also needs a clear visualization and description of indoor configuration to orientate herself/himself, such as a signage system of the indoor environment. In addition, indoor navigation is also extended to evacuation route planning and path-finding for the first responders assigned to rescue tasks. For all the above components of indoor navigation, a comprehensive information model of buildings is required to represent the indoor environment and provide the information base to carry out these activities. However, *ad-hoc* data need to be elicited and transformed from IFC data since IFC is a huge database for diverse aspects of building. For instance, the architectural information represented in IFC is difficult for pedestrians to recognize and apprehend. A group of researchers have investigated the transformation from IFC to other different data models [22]. By this measure, a possible solution is to visualize an indoor road network/navigation network and the related facilities, and to superimpose the network on the 3D indoor spaces.

This paper gives an overview on the roles of IFC-Based BIM in the current indoor navigation applications, and suggests how to improve the organization way of employing IFC. According to the current related research, we investigated the uses of IFC for indoor navigation and elicited the directions to comprehensively integrate IFC into indoor navigation tasks. Currently a spectrum of studies shows different perspectives: 1) derivation of navigation models from IFC; 2) modeling adapting the IFC schema; 3) IFC for dynamic applications and 4) IFC for indoor localization. Though IFC is still evolving for architecture design and construction cooperation, different domain models are proposed to extend the IFC data model as well. This fact indicates that IFC needs to be further bridged with indoor applications.

The rest of the paper is organized as follows. Section 2 presents the research objective and methodology for literature review. Section 3 summarizes the support of the IFC schema for indoor navigation according to the official IFC documentations. Section 4 introduces the existing applications regarding the IFC uses for indoor navigation. Section 5 discusses the IFC functions for indoor navigation and presents the

challenges. Meanwhile, some suggestions are proposed to extend the current research (e.g., the suggested minimum set of IFC classes for indoor navigation). At last, Section 6 wraps up this paper with future work.

## 2. Research objective and review methodology

The objective of this study is to investigate the current uses of IFC-Based BIM in the studies of indoor navigation. Several sub-objectives are outlined as follows: 1) delineate state-of-the-art research in this field; 2) determine the different uses of various components of the IFC schema; 3) elicit the characteristics of the IFC schema for (pedestrian) indoor navigation; 4) identify the challenges among the potential applications of IFC for indoor navigation, considering the IFC’s capabilities and limitations; and (5) outline the technological gaps and potential uses of IFC for future research.

In this study we identified the most-relevant articles by two steps. First, a comprehensive literature search in terms of ‘title/abstract/keyword’ was conducted via search engines such as the databases of *Scopus*, *Web of SCI* and *Google Scholar*. Keywords included, but were not limited to, ‘BIM’ ‘BIM IFC’, ‘Indoor navigation’, ‘indoor modelling’, ‘indoor positioning’, ‘indoor pathfinding’. Accordingly, we received a comprehensive list of recently published research and implementation efforts on IFC data for indoor navigation. However, our investigation on the long list of papers showed that different journals generally have different publication interests and research topics, thus we decided to select the most-related journals and topics. The investigation was therefore restricted to research articles published in well-known and highly ranked journals and conferences in the fields of GIS, construction and built environments. These selected journals include *Advanced Engineering Informatics (AEI, H-Index 75)*, *Automation in Construction (AIC, H-Index 107)*, *Computers, Environment and Urban Systems (CEUS, H-Index 84)*, *Building and Environment (H-Index 138)*, and *International Journal of Geographical Information Science (IJGIS, H-Index 107)*. These journals are widely accepted by the research community in terms of high quality publications, and they have significant influence on the computer-supported management and services of built environments. Meanwhile, influential conference proceedings are considered, such as *ISPRS Annals* and *ISPRS Archives*.

In the second step of the literature search, we filtered and refined the above search result by the following selection criteria: 1) IFC applications only; and 2) the depth and extent of the navigation applications using IFC. We started this literature review from the point-view of data modeling basically, e.g., the data standard IFC for BIM. By following the above criteria, we excluded the papers which correspond to BIM technologies and software for construction, supply chain management and other architectural engineering issues. In addition, we excluded the research that uses IFC data only for geometric representations. By applying this process of academic literature review, we obtained the recently published research and implementation efforts on IFC data for indoor navigation.

We have reviewed 87 publications in this study, including 47 journal papers and 40 conference papers. The issue dates of these papers are mostly in the period 2007–2018. 36 papers explicitly contain the terms ‘BIM/building information modeling/building information models’ in their titles, and 5 other papers’ titles contain the word ‘IFC’. The remainders are relevant: they adopted IFC models in the context of indoor navigation, such as navigable network derivation, indoor modeling, indoor localization or monitoring. Fig. 1 presents the number of the papers in each year. From 2007 to 2013, the number of the related studies are stable at a low level. A large part of these publications occurred in the years of 2014 (20), 2015 (14) and 2016 (19). Then the number of publications decreased since 2017. Thus we consider the development of IFC for indoor navigation has gained much attentions between 2014 and 2016, yet the studies in this field may meet a bottleneck in recent years.

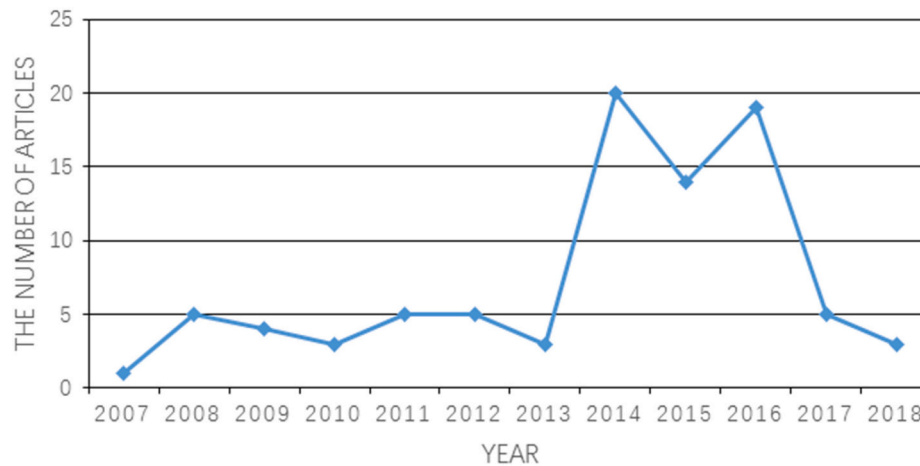

Fig. 1. Overview of the papers about IFC supporting indoor navigation.

Table 1 reveals the specific scopes of the IFC applications in these research. The most popular studies are on the generation methods of navigation models (30). The second large group of studies involve indoor localization with IFC data input (14). To obtain indoor spaces for navigation and other purposes, there are research to convert the IFC data to GIS environments (12). There are also studies on path-finding with IFC data (13), which is related to navigation models as well. In addition, some researchers develop their own data models on top of the IFC schema (8). We also checked some survey papers to learn the general development of BIM/IFC. A small group of publications (4) emphasize the intrinsic visualization capability of IFC for navigation-related contexts. The last group is about the query on indoor graph models, *i.e.*, a user-friendly data retrieval way of building information.

### 3. Utilizing IFC for indoor navigation

According to the official IFC documentations, in this section we first scrutinize the possible related classes to indoor navigation in the IFC model. In the next section we review the adopted classes in the literature citations. By comparing them and analyzing the gap, we propose our suggestions on the use of IFC classes in Section 5.

IFC serves as a data exchange format independent from specific platforms. So far there is no comprehensive introduction on the IFC uses in terms of indoor navigation purposes. IFC includes several hundred entity classes in an entity-relationship model [1], but only a relative small part is directly relevant for indoor navigation. In general, the essence of IFC for navigation involves the semantic definition of building elements, spatial relationships, and the quantities and properties of building components.

In order to assess the value of IFC-based BIM for indoor navigation, we present first the main part of the corresponding IFC classes (see Fig. 2). They are summarized from the version of IFC4x1. In general, IFC

Table 1

Detailed statistics of the scopes of the literature.

Scope*	Number
Navigation model generation from IFC	30
Indoor localization with IFC models	14
Model conversion for building space modeling	12
Indoor pathfinding	13
Data modeling on the basis of IFC	8
Survey	4
IFC visualization capability	4
Query based on indoor networks	2

\* The scope represents the dominant feature of a paper (*e.g.*, ‘navigation model generation’ over ‘visualization’).

describes the following construction properties: 1) building elements, such as wall, door, window and slab; 2) different levels of indoor spaces, such as room, storey, building and site; 3) the relations between different entities; 4) all kinds of processes in design, construction and maintenance; and 5) users and different parties. More specifically, the IFC model contains four layers which represent different levels of abstraction regarding a building. A more comprehensive introduction to IFC [23] has elaborated them and here we brief their related parts only.

The *Core Layer* provides basic notions and their relationships. The *Shared Layer* defines the intermediate modules between the *Core Layer* and different application domains. The *Domain Layer* defines self-contained entities organized with industry disciplines. The *Resource Layer* defines other supporting resource classes. These resource classes have to be referenced by the derived entities of *IfcRoot*.

The essential IFC classes for indoor navigation are summarized in a simplified UML class diagram in Fig. 2. The *Core Layer* contains the most abstract classes such as *IfcRoot*, *IfcObjectDefinition* and *IfcRelationship*. *IfcRoot* is the root class for all other entities; *IfcObjectDefinition* and its subclass *IfcObject* generalize the occurrences of objects and process; and *IfcRelationship* generalizes objectified relationships. The direct subclasses of *IfcObject* include *IfcActor* (various users), *IfcResource* (resources), *IfcGroup* (arbitrary group of objects) and its subclass *IfcZone* (aggregation of regions), and *IfcProcess* and its subclasses *IfcTask* (activities), *IfcEvent* and *IfcProcedure*.

The class *IfcProduct* is an abstraction of object regarding a spatial context. We identify its subclasses *IfcElement* and *IfcSpatialElement* for navigation purposes. The subclasses of *IfcElement* reflect different building components, including *IfcBuildingElement* (structural elements), *IfcTransportElement* (transportation objects such as elevator/escalator), *IfcFurnishingElement* (furniture), *IfcVirtualElement* (imaginary boundaries), *IfcDistributionElement*.

*IfcSpatialZone* represents functional areas in a building which may overlap the existing building decomposition. In other words, an instance of *IfcSpatialZone* (*e.g.*, a lighting zone with irregular boundaries) can link to different subdivisions of indoor space. The class *IfcSpatialStructureElement*, another subclass of *IfcSpatialElement*, depicts different spatial levels of indoor environments. These spatial levels are reflected by *IfcBuilding*, *IfcBuildingStorey* and *IfcSpace*.

The class *IfcRelationship* generalizes the objectified relationships between different IFC classes. We consider five subclasses of *IfcRelationship*, *i.e.*, *IfcRelAssociates* (association between external sources and objects), *IfcRelDecomposes* (‘part-to-whole’ or ‘whole-to-part’ relation), *IfcRelConnects* (connectivity of objects), *IfcRelDefines* (linking types/property sets to object instances) and *IfcRelAssigns* (a generation of ‘link’ between objects) [1,23]. For indoor navigation, *IfcRelAssociatesConstraint* can impose motion-related constraints on indoor spaces, and



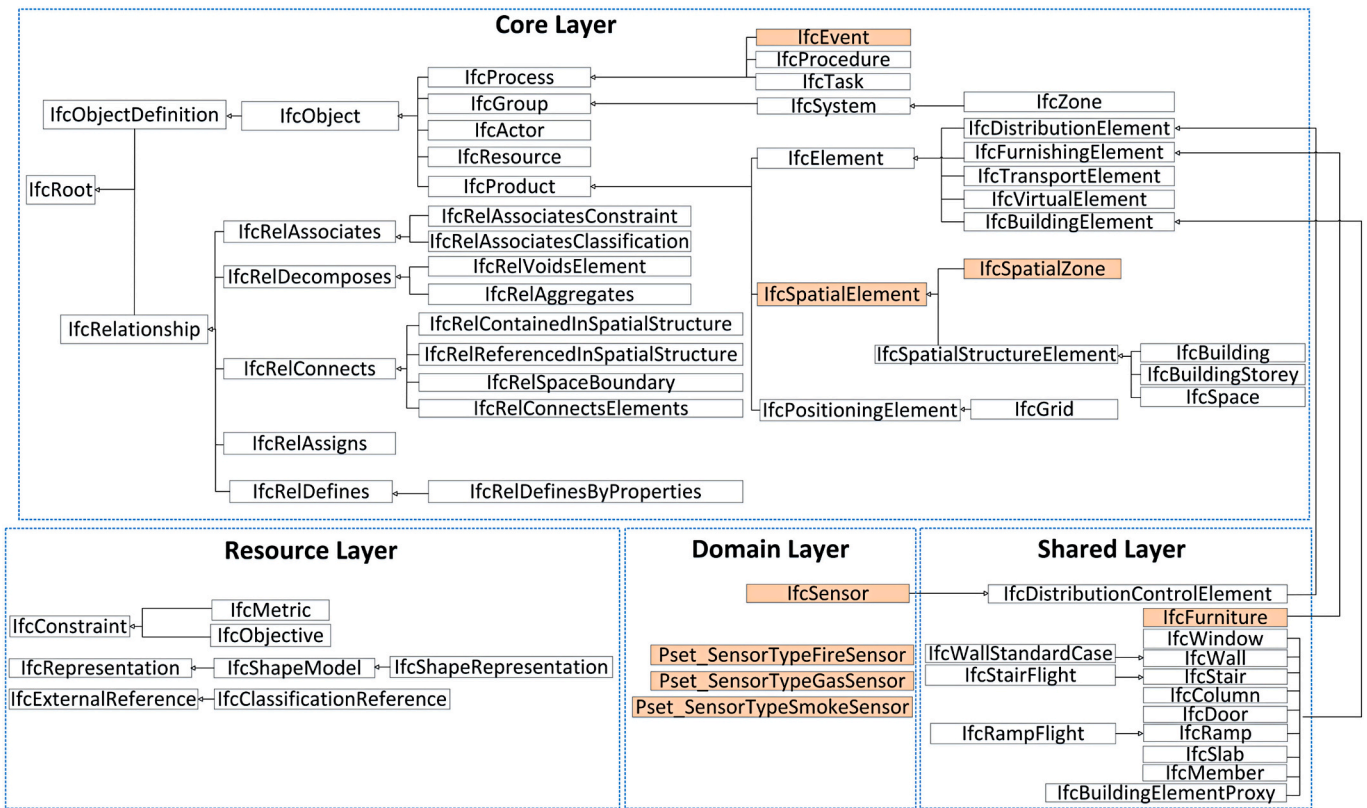

Fig. 2. The main IFC classes supporting indoor navigation. The highlighted classes are newly added in IFC4.

*IfcRelAssociatesClassification* can assign external semantic information to indoor spaces (e.g., the semantic tag ‘escape stair’ to a stair).

*IfcRelVoidsElement* and *IfcRelAggregates* are deemed important for indoor navigation. *IfcRelVoidsElement* assigns *IfcOpeningElement* (representing a void) to a related building element (e.g., a wall). This void relates to a filled element such as a door or window. Thus, *IfcRelVoidsElement* can be used to search the portal to a space. *IfcRelAggregates* refers to the composition/decomposition of buildings, such as several storeys aggregating to a building. *IfcRelContainedInSpatialStructure* reflects the containment of elements (e.g., obstacles) in a building structure (e.g., building/section/floor/room). *IfcRelReferencedInSpatialStructure* reveals the relationship of an element referenced by a building structure, such as a lift shaft referenced by several storeys [1]. *IfcRelSpaceBoundary* refers to the building elements which compose indoor space boundary (e.g., walls, see Fig. 3a). A virtual boundary can also be represented by an *IfcRelSpaceBoundary* instance (see Fig. 3b). *IfcRelConnectsElements* generalizes the connectivity between

building elements, such as the connection between stairs and slabs. These classes can facilitate the automation of navigation model generation with clear spatial relationships.

In the *Shared Layer*, the subclasses of *IfcBuildingElement* are the most relevant part for indoor navigation. They include navigable surfaces (*IfcSlab*), portals (*IfcDoor* and *IfcWindow*), transition spaces (*IfcStair* and *IfcRamp*), obstacles (*IfcWall*, *IfcWallStandardCase*, *IfcColumn*, *IfcFurniture*), temporary accessories (*IfcBuildingElementProxy*) and other structural elements to carry loads (*IfcMember*). *IfcDoor* (and sometimes *IfcWindow*) is considered the portal to a space, and it defines door dimensions, opening direction and door styles; *IfcStair* and *IfcStairFlight* represent the vertical walking passage between two floors; *IfcRamp* can be contained in a space/floor; and *IfcSlab* represents the floor surfaces of a storey. In some cases, *IfcBuildingElementProxy* and *IfcFurniture* (e.g., table, desk and chair) can be considered obstacles to be avoided. These classes all connect to the computation of route planning.



(a) *IfcRelSpaceBoundary* regarding physical boundary (wall)

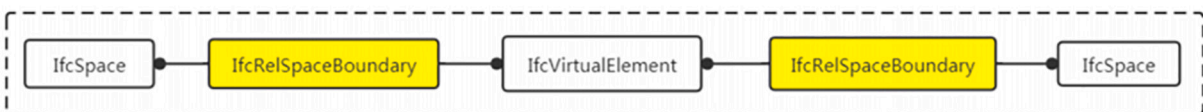

(b) *IfcRelSpaceBoundary* regarding imaginary boundary

Fig. 3. Two examples of *IfcRelSpaceBoundary* for walls and imaginary boundaries of space.

*IfcSensor* belongs in the *Domain Layer*. Except fire/gas/smoke/temperature sensors, this class can represent different sensors (Wi-Fi or Bluetooth) for indoor positioning/tracking. The related Psets (property set) of *IfcSensor* include *Pset\_SensorTypeFireSensor* (fire), *Pset\_SensorTypeGasSensor* (gas) and *Pset\_SensorTypeSmokeSensor* (smoke) (see Fig. 2). They can be applied to emergency cases.

The *Resource Layer* provides several classes for indoor navigation. *IfcConstraint* can reflect the motion limitations of users (e.g., elevator only) and the access permission of indoor spaces. *IfcMetric* and *IfcObjective* represent quantitative and qualitative constraints, respectively. *IfcClassificationReference* can be used to introduce external semantics/taxonomic systems. In this sense, we can label indoor spaces with different semantics in distinct classification systems (e.g., navigation functional semantics). *IfcShapeRepresentation* represents particular geometric representations of *IfcProduct* instances. Its attribute *RepresentationType* involves many predefined geometric types, such as *PointCloud*, *Surface*, *Surface2D*, *Surface3D*, *Tessellation*, *SweptSolid*, *B-Rep*, *CSG* and *BoundingBox*.

In Fig. 2 we have highlighted the classes newly proposed in IFC4. Specifically, *IfcEvent*, *IfcSpatialElement* and its subclass *IfcSpatialZone* are added in the *Core Layer*. In addition, the class *IfcFurniture* is included in the *Shared Layer* to define furnishings. IFC4 introduces the new *Domain Layer* where *IfcSensor* and the related property sets are presented in Fig. 2.

In this section, we present the essential IFC classes which can be applied to indoor navigation. The main function of IFC data is to precisely depict the indoor spatial environments and its elements and accessories. Meanwhile, the relationships between all the portions of a building are defined in the IFC schema. Therefore, IFC data can be used as the platform to support indoor localization system, to facilitate navigation network generation, and to visualize a user's route. Besides, IFC data also maintain different constraints regarding indoor spaces and users.

## 4. IFC uses in the literature

### 4.1. Overview

This section presents the specific applications which adopt the features of IFC. We have reviewed four directions of IFC applications: 1) IFC to navigation model; 2) IFC-based data models; 3) IFC for dynamic environments; and 4) IFC for indoor localization. We list the relationships

of the four parts in the rectangle boxes in Fig. 4. First, indoor environments are visualized with IFC data and then navigation models can be derived for path planning. IFC data can support the 3D visualization and attribute queries for indoor applications [24,25]. The most important components for indoor navigation are the spaces and construction elements. Their connectivity (e.g., via doors and windows) can be readily obtained and mapped to navigation models. Following that, path planning is conducted on the navigation models; second, new small data models are proposed by adapting or extending the IFC model for specific purposes; third, some studies intend to incorporate indoor dynamics with the navigation models derived from IFC-Based BIM. Moreover, indoor localization results can be visualized in either building data or navigation models. In the following subsections, we will specifically introduce the above four directions.

### 4.2. IFC to navigation models

Based on the critical 3D geometric and semantic information of IFC data, it is possible to derive the required navigation models [26]. Generally indoor spaces (e.g., *IfcSpace* instances) are connected by portals (e.g., doors/doorways), and *IfcStair* and *IfcRamp* provide the information for vertical transitions. Other classes of *IfcBeam*, *IfcColumn*, *IfcRailing* and *IfcFurniture* can be regarded as obstacles.

There are two forms of navigation model, i.e., vector (explicit network) and discrete models (implicit network). For vector networks, a common means of processing 3D geometry is to skip its height properties on each floor [27]. Based on these simplified vector floor plans, navigation networks [24,28–30] can be generated by following Poincaré Duality [31]. Each 3D space is mapped to a node, and the connectivity between the spaces is presented by a link [32–34]. In contrast, some researchers [13,17,35] discretize indoor environments by overlaying grids on building models to represent a higher freedom of movement. A vital factor for navigation network generation is the spatial subdivision of building [33,36,37]. A group of studies [12,22,38,39] extracts spatial geometry from IFC files into 2D plans, and add navigation nodes according to the subdivision. These studies indicate that the reported navigation applications primarily adopt 2D floor plans, although the 3D features of BIM are given as a benefit for navigation.

#### 4.2.1. Different navigation networks

Navigation networks depict the connections and accessibility of spaces and they are widely applied for indoor environments. Chen et al.

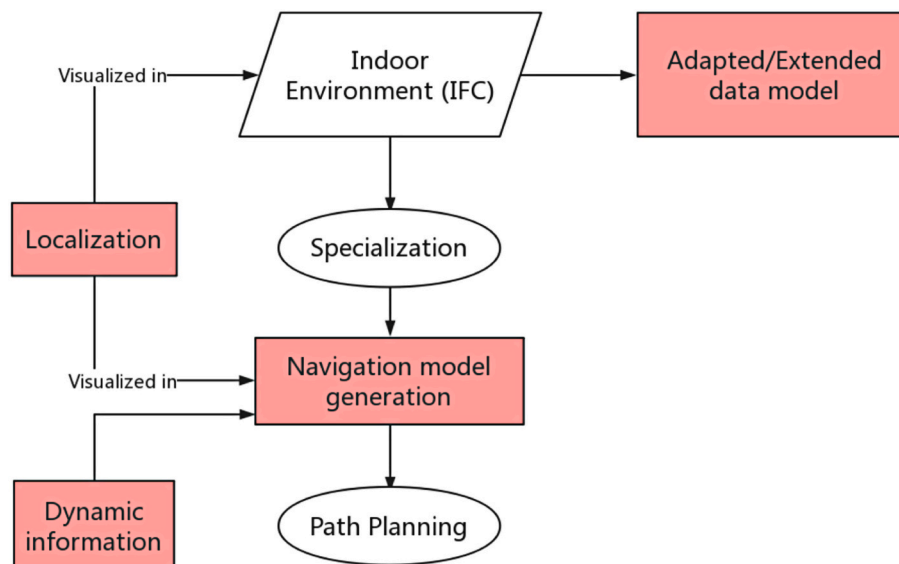

Fig. 4. The four application fields (rectangle boxes) of IFC for indoor navigation.

[24] extract a geometry network model (GNM) in multiple 2D layers. Boguslawski et al. [40] select the rooms in floors based on the *IfcSpace* instances [33], and they preserve both the boundary representation and the connectivity of spaces. A study [34] uses the functional space of building elements to specify the accessibility and provide the user-tailored network. Generally, these networks keep the topological and semantic information of the related spaces. Besides the space-based approach using Poincaré Duality, a navigation network can also be created with visibility graph (VG) [41] or medial axis transform (MAT) [32,42–44] (see Fig. 5). Specially, Tang et al. [29] extract the 2D floor plan from IFC data and generate the network of straight medial axis transformation (S-MAT) [45]. Considering people movement patterns, Lee et al. [46] generate a distance-weighted network based on BIM for indoor circulation. In the above cases, BIM provides the geometry of building components and their topological relationships for the network derivation. The frequently-used classes include *IfcSpace*, *IfcDoor* and *IfcRelSpaceBoundary*. In general, there are two basic ways to obtain navigation networks from IFC. One is to elicit the network using the topological relationships of IFC [47,48], and the other one is to derive it from the geometry and semantics [13].

#### 4.2.2. Network derivation with IFC relationships

The IFC schema defines a number of topological relationships between spaces and objects [49], which facilitates the derivation of navigation networks. For instance, a study [50] models a network with the topological operations of ‘decompose’, ‘union’, ‘intersect’, and ‘subtract’.

*IfcRelSpaceBoundary* can facilitate the extraction of space topology [13,51]. By using its attributes *RelatingSpace* and *RelatedBuildingElement*, the relationship between two spaces/objects can be determined. Fig. 6 presents an example of topological network based on the *IfcSpace* instances and their connectivity.

Some approaches are proposed to retrieve components and their relationships in IFC [52–54]. Such methods rely on a directed graph to provide the relation descriptions (see Fig. 7). Queries are also extended to the relationships of indoor facilities [50,55].

Other research about the queries of graph-based BIM information also explicitly organize relationships in graph structures [8,48]. They provide the means to find the adjacent and access relations of spaces. The adjacency is confirmed when two *IfcSpace* entities refer to the same *IfcWall* via *IfcRelSpaceBoundary*. In addition, *IfcRelFillsElement* and *IfcRelVoidsElement* are used in conjunction to recognize the link between a door to a wall, and further to find the connected rooms of the door (see Fig. 8). In contrast, the detection of space connection shown in Fig. 3 is more direct.

#### 4.2.3. Network derivation with IFC geometry and semantics

These studies do not emphasize (or even skip) the topological

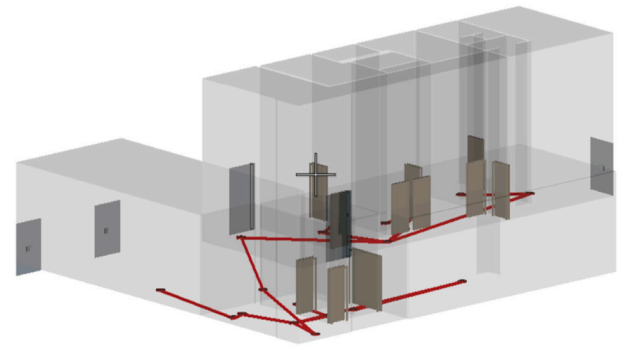

Fig. 6. Topological network derived from *IfcSpace* instances.

relationships in IFC data. A pure geometric method has been used to obtain the networks in the 2D partitioned polygons derived from BIM [22]. They only provide the MAT method for 2D rectangle corridors, but no evidences show it can be extended for open spaces.

The clean geometry of *IfcSpace* instances is important for navigation network generation. A study [56] validates the incorrect geometric and topological information of *IfcSpace* objects. In addition, a relevant study [57] isolates the 3D free space from the rest of the components of IFC models, which supports the network directly generated from these free spaces according to [33].

Boysen et al. [58] avoid space topology as well since they consider it is only implicit or even incomplete. These researchers mainly consider two issues to construct a navigation model: 1) distance; and 2) space model created from raw data of IFC. The connection of indoor entities are detected in a geometric manner: 1) represent the portals as a short line, and 2) detect the intersections with 2D room polygons.

There is a small group of studies [17,59] which create navigation-related models based on the grids of building (see Fig. 9). Lin et al. [17] extract both the geometric and semantic information from IFC files, and then discretize them into a planar grid model. In this study, obstacles are *IfcDoor*, *IfcColumn*, *IfcFurnishingElement* and *IfcDistributionElement*. Their geometry is represented with the related bounding box.

These discrete models can be further subdivided into two sub-groups: regular or non-regular (e.g., Delaunay triangulations, see Fig. 10). A study [15] presents an example of non-regular discretization, and the researchers generate a 2.5D navigation network. Lin et al. [14] use *IfcSlab* to identify indoor spaces and generate networks based on the Triangulated Irregular Network (TIN). Similarly, Xu et al. [60] use TIN to derive evacuation networks from IFC for crowd evacuation.

#### 4.2.4. Automation of navigation network generation

Previously geometric networks and the required attributes were

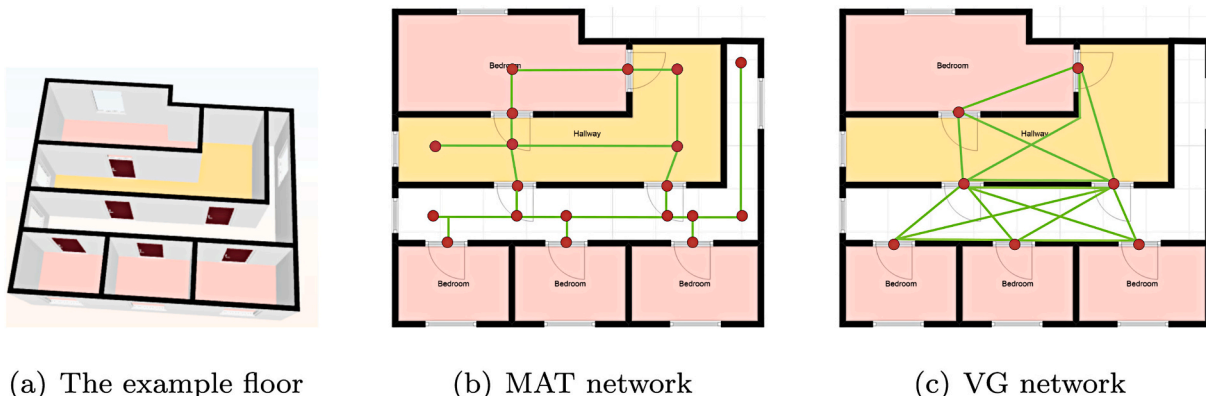

Fig. 5. A floor and its related MAT and VG navigation networks.

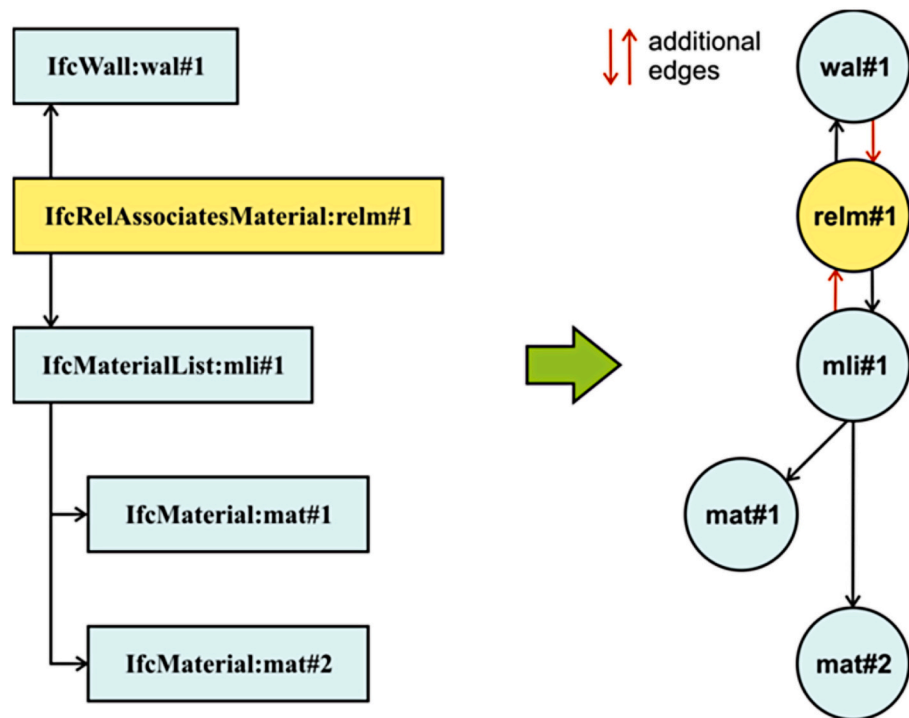

Fig. 7. Transformation from IFC objects to a graph model of building elements ([54]).

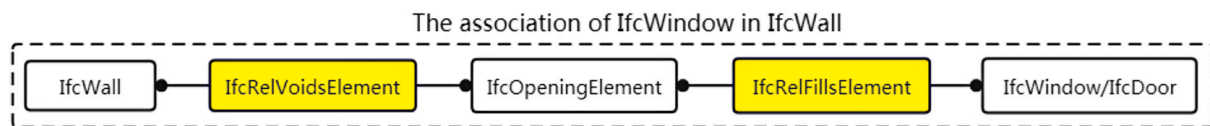

Fig. 8. The relationship between *IfcWall* and *IfcDoor/IfcWindow*.

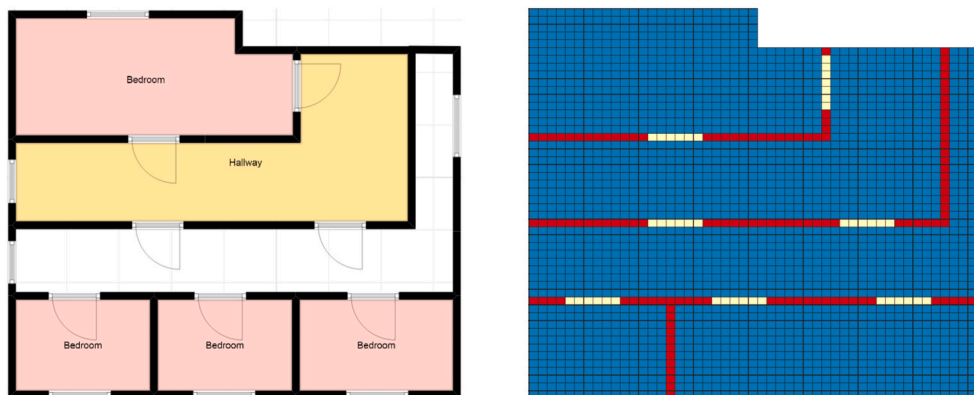

Fig. 9. A floor is discretized into grid cells.

extracted manually from IFC data [15,58,61]. In some studies [18,62,63], even 2D MAT networks are generated manually. Towards automatic generation, navigation networks are usually constructed based on the 2D floor plans [13,27,52,64,65] or the 3D spaces [33,34] derived from IFC files.

Commonly vertical connections have to be manually created [15,16]. It is difficult to automatically extract vertical connections from IFC. Lin et al. [14] identify the named spaces and select adequate nodes for the navigation network. Specifically, access points on stairs are manually added (see Fig. 11). Instead, Hamieh et al. [19] develop a geometric method that uses bounding boxes to detect these connections

by overlapping.

A feasible way for network automation is to conduct the mapping between two data models. An early study named multi-layered space-event model (MLSM) [66] conceptually discusses an approach which can create different networks from BIM for various users. Some other studies [3,67] conceptually define semantic mapping procedures from IFC to CityGML (an OGC standard for 3D modeling) [68], and they mainly simplify IFC elements to get a B-Rep geometric model [69].

#### 4.2.5. Path planning

Path planning greatly relies on indoor navigation networks. The



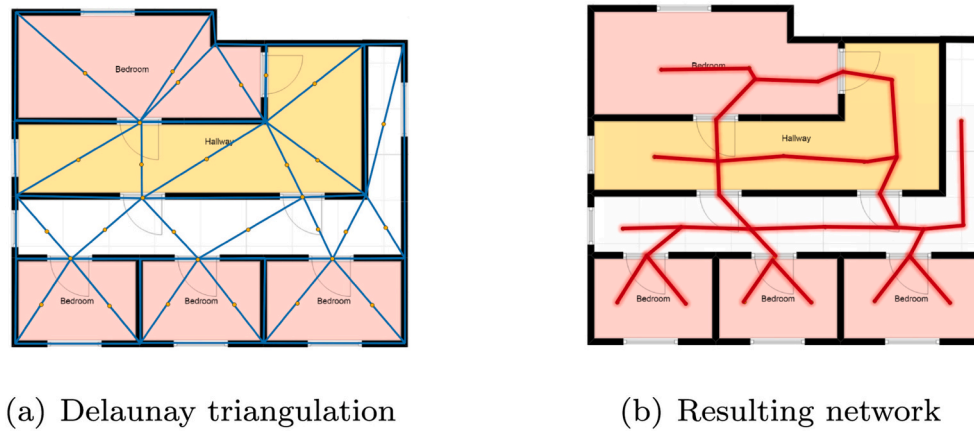

Fig. 10. A navigation network derived from Delaunay triangulation.

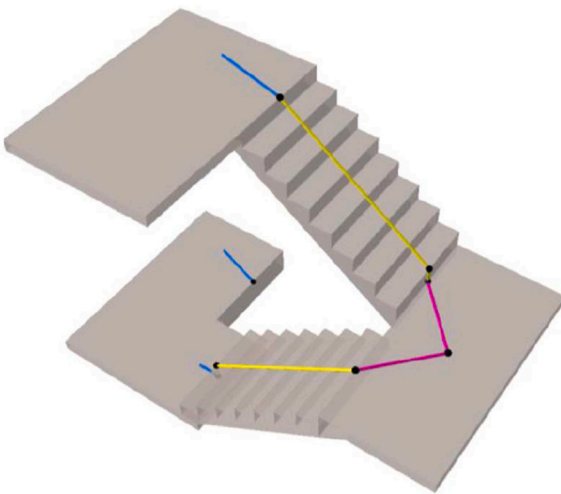

Fig. 11. The vertical connections are manually created ([14]).

attributes of nodes and edges represent the cost for path planning [70]. For instance, we present a path to avoid the obstacles in 2.5D floor plans (see Fig. 12).

Hamieh et al. [19] summarize the process of path-finding with IFC data. First, the navigation network is extracted; second, static paths are determined by routing algorithms; third, accessible paths can be identified according to the agent type, restricted areas and real-time restrictions. A related study [47] presents how to search accessible routes with IFC data for motion-impaired people in public buildings.

In the context of human wayfinding, Arendholz et al. [20] generate indoor route descriptions from IFC models. The landmarks are also

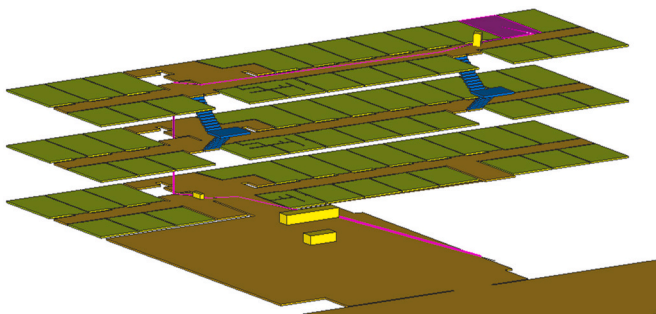

Fig. 12. An obstacle-avoiding path.

abstracted as nodes. Here IFC is used to ascertain the salient landmarks for route descriptions.

Another group of related research [64,71] derives the networks from IFC data for building design. These studies implicitly contribute to indoor path-finding since important path features are provided (e.g., turns).

#### 4.3. IFC-based data models on navigation

Researchers have tried to extend the IFC schema for different applications in a wider context of navigation. Some researchers [72,73] have reviewed different formats used in BIM and points out the IFC schema may allow redundant data. In an early phase, Shayeganfar et al. [74] have indicated specific applications on building always defines their own semantics. Thus, it is necessary to propose a navigation ontology on the basis of IFC since it can be reused. But this study did not provide more details about the ontology.

A model named Ubiquitous Space Information Model (USIM) is designed on top of the IFC schema [75]. The researchers provide an abstraction of the IFC schema for GIS applications. *USIMBuildingStory* relates to *IfcBuildingStorey* (see Fig. 13); *USIMBuilding* relates to *IfcBuilding* and inherits its attributes; and the class *USIMPolygon* corresponds to the boundaries defined in IFC. In addition, it aims to describe real-time information about sensors, events and actions. But this simple data model does not give more details about sensor attributes and the deployment ways [75].

Meanwhile, the relationships between indoor spaces and objects can be refined and easily retrieved with GIS platforms. Isikdag et al. [7] investigate the requirements for indoor navigation and propose a new GIS data model regarding BIM. The researchers transfer a BIM into the ArcGIS environment, preserving a smaller set of geometric and semantic information in the model. They implemented a part of the designed classes such as *WallPart*, *SlabPart*, *BeamPart*, *ColumnPart*, *DoorPart* and *WindowPart* (see Fig. 14). The data model breaks the solid geometry into B-Rep representation, and thus new subclasses (those with the suffix ‘-part’) are devised to assign the surface geometry and specific attributes for motions (e.g., emergency exits for *DoorPart*).

Special modeling efforts are devoted for evacuation scenarios where pedestrians require urgent path planning in limited time. Some researchers [76] argue that the IFC model is too complex for emergency response and management, and they design the Indoor Emergency Spatial Model (IESM) to meet the requirements of emergency-related information, including safe gathering locations, staircases/elevators, material types and dynamic information (e.g., *Smoke Detectors*) (see Fig. 15). As a result, the IESM combines the navigation network, building elements, fire reduction utilities, emergency utilities and sensors [76].



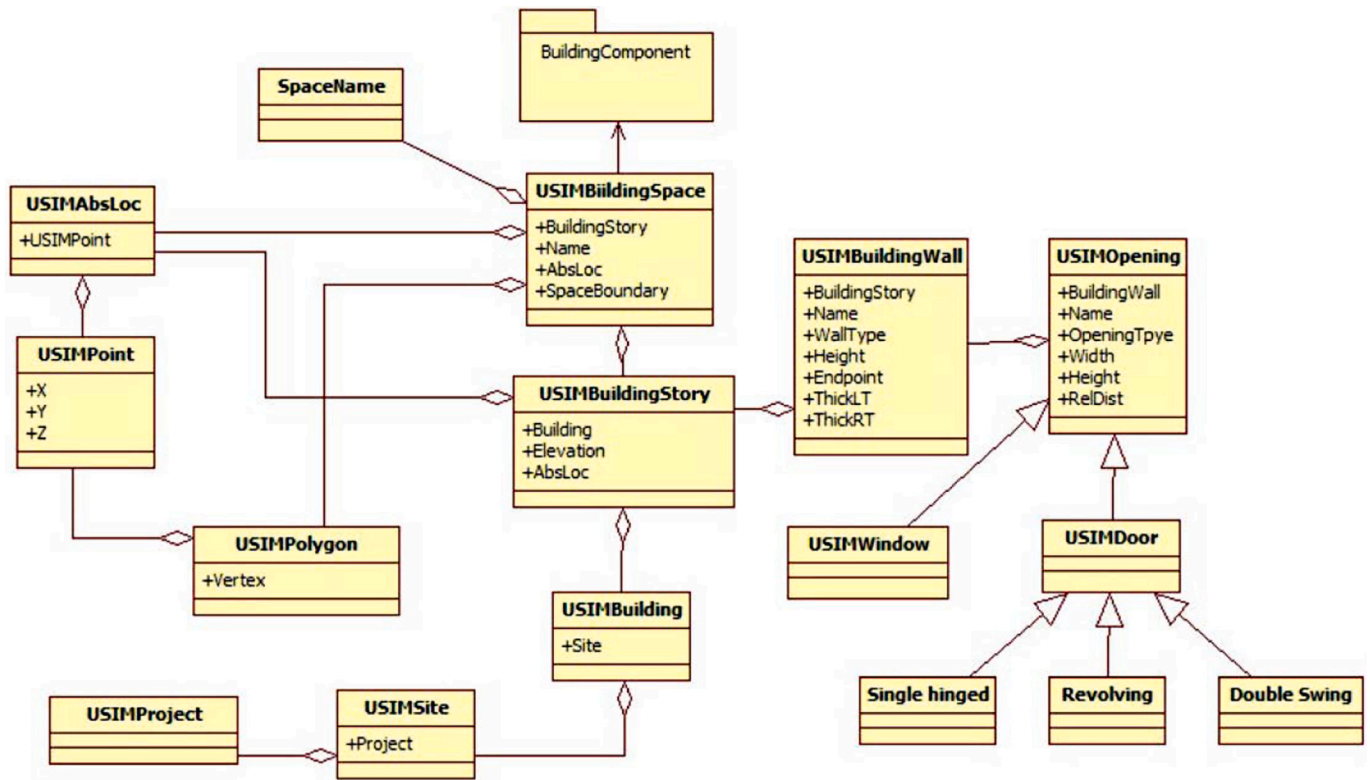

Fig. 13. The Ubiquitous Space Information Model ([75]).

Sensor information is also considered in other cases. Motamedi et al. [77] aim to formally define the RFID tags with their properties by extending the IFC schema. A new class named *IfcRFIDSystem* is defined as a subclass of the *IfcFlowTerminal*, and a new type named *IfcRFIDSystemType* is used to define passive/active tags (transponders) and passive/active readers (transceivers). In this way, the RFID tags can be searched in BIM data and used for localization-oriented applications.

A BIM-based pathfinding method [78] is proposed with its own data model. This model re-organized the geometry of building elements/objects including obstacles, hazards and landmarks. However, the IFC data model actually contains the classes for sensors, constraints and agent information (see Fig. 2). Thus, this work is just a kind of simplification of the IFC classes.

Except the navigation network, the access control issue has been modeled as well. Some related studies [79–81] discuss the navigation in access control scenarios and the researchers devise an authorization framework using IFC as its core spatial data model. Spaces and portals are extracted from IFC data and the access control constraints are attached to nodes and edges. The related attributes of the edges and nodes involve the distances and the security clearance/size/type of a portal. The model can reflect flexible access control processes using classes *IfcProcess*, *IfcControl*, *IfcResource*, *IfcActor*, *IfcGroup*, etc.

The above data models for various applications are arbitrarily different. They add specific definitions and formats for data in a given context. BIM is also an evolving standard which increasingly contains new classes for facility management purposes. Thus, we can argue that most classes and attributes can be transformed from the IFC schema.

#### 4.4. IFC for dynamic environments

Indoor navigation can also be influenced by different dynamic factors, such as crowds, smoke and fire in emergencies. Fig. 16 presents a case that smoke diffuses along with fire and the safe navigable spaces shrink. Here dynamic environments refer to the spaces with real-time variations of these factors. These dynamic factors can be computed,

simulated and visualized in IFC-Based BIM. Related studies mostly come from the context of emergency response, which needs to provide pedestrians with feasible routes. Thus, we reviewed the papers which involve indoor emergencies and BIM data. In general, the current applications of BIM and simulation modules are bound in a ‘low coupling’ style, *i.e.*, BIM is regarded as data input only.

The semantics and 3D geometry of IFC data are adopted as the base for fire simulation. Shi and Liu [82] simulate emergency scenarios in the platform integrating BIM, 3D GIS and a fire simulation model. In another pilot study for fire simulation, Dimyadi et al. [35] transfer geometrical information and fire-related information from an IFC model to the fire simulation tool. The key element is the boundary of spaces and the portals (doors/windows). As an early research, this work is inevitably bounded to some limitations. The key class *IfcSpace* was not adopted though 3D spaces are required by this simulation tool.

Real-time information can be collected *via* sensors and be added to the BIM. Fosu et al. [83] identify the requirement of real-time information for indoor path-finding. By integrating sensors with IFC data, path-finding methods can be designed to deal with dynamic data. Wang et al. [59] propose a conceptual framework which can import real-time information for evacuation with BIM on grid models. This method provides a bi-directional interaction between indoor dynamics and evacuation route planning. Location tags and voice messages can also be deployed to sense user locations. Some studies [21,84] incorporate real-time information for visual-impaired people to navigate in unfamiliar buildings.

BIM is also used to update the hazardous information. Park et al. [85] apply sensors to construction sites for safety monitoring, and propose a framework as a cloud-based application. In this case, BIM is used as a platform for automated hazard identification, registration, and visualization. But the hazards still have to be manually recognized by field inspection. Another study [86] based on BIM and wireless sensors is designed to reduce safety hazards in confined spaces. This technique can be used to monitor oxygen and temperature levels in a confined space. A site supervisor can retrieve sensor data stored in database server on BIM

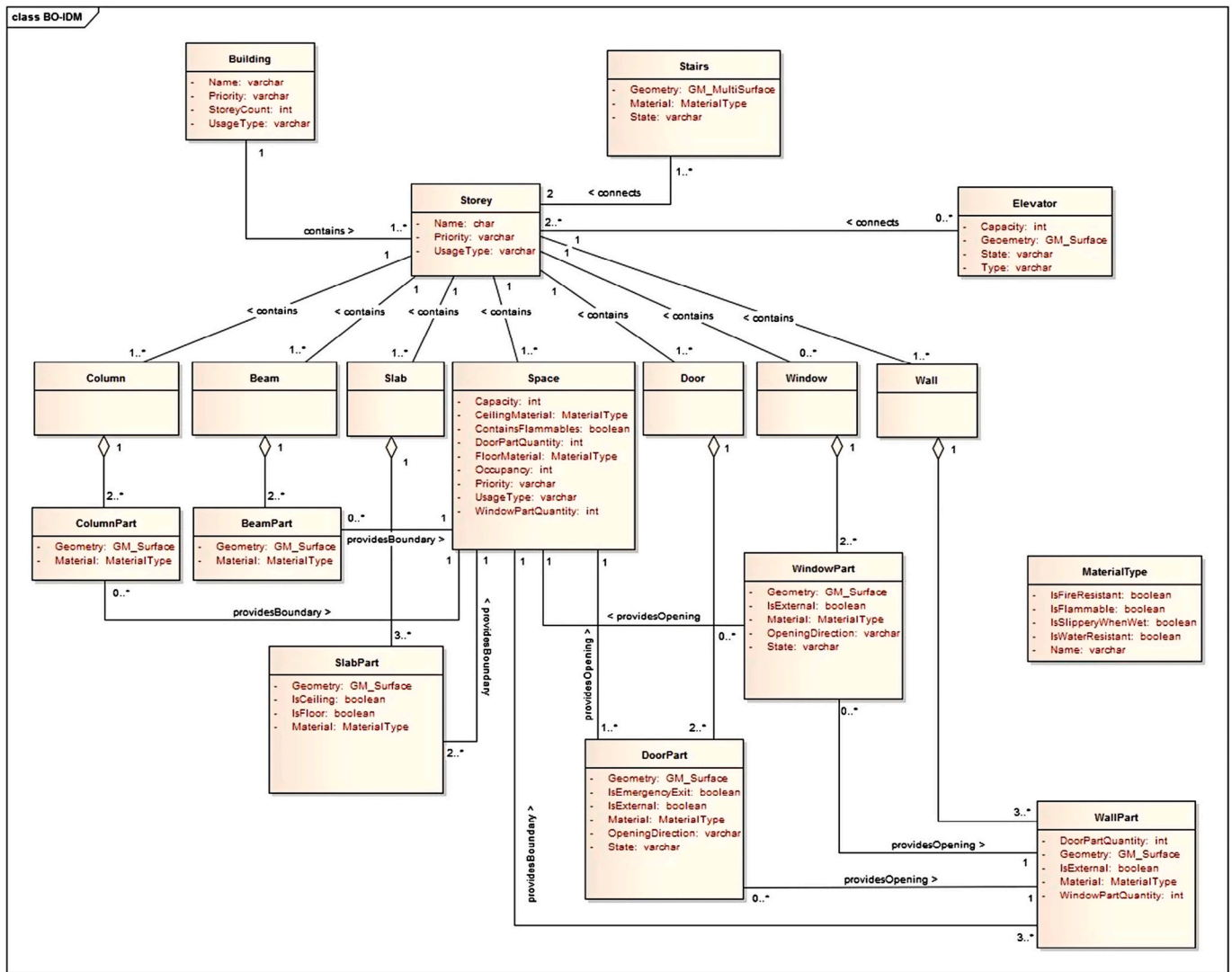

Fig. 14. The BIM Oriented Indoor Data Model, BO-IDM ([7]).

software.

A typical application for indoor dynamics is emergency response and evacuation planning. Commonly the dynamics are simulated by mathematical models; while the evacuation computation is often conducted by path-finding algorithms. Wang et al. [87] provide a whole picture of the BIM use for evacuation simulation. BIM information are adopted to measure the maximum escape range and to search the escape route to each exit. The required egress time can be computed according to evacuation regulations. Another regulation study [88] for compliant evacuation specifies escape routes, the types of evacuees and the capacity of these routes. These researchers generate the simulation input by using IFC data for a network-based risk evacuation model.

IFC can extend evacuation-related properties via property set (Pset). Choi et al. [89] check evacuation regulations on IFC which require different node types for evacuation routes. The IFC data are investigated according to a group of designed regulations (e.g., safety zones, firewalls, escape stairs and exit routes). These properties of the building and its subspaces can be retrieved from Pset (see Fig. 17). Important properties include 'FireExit' in *IfcDoor*, *IfcStair*, *IfcTransportElement* and *IfcSpace*, and 'Combustible' for *IfcWall*.

For emergencies, BIM is also organized as the query database and used to support route optimization. Cheng et al. [90] develop a BIM-based application to integrate fire and rescue information. The main BIM modules refer to fire-fighting equipment, bluetooth sensors to

detect danger, and route planning for evacuation and rescue groups. In addition, Yenumula et al. [91] propose a conceptual design for a BIM-based signage system for evacuation. A facility manager can remotely control and activate the light of the selected exits where the optimal path is. In the designed scenarios, the BIM data mainly serve the following information: 1) fire sensor locations (e.g., *IfcSensor*); 2) spatial information for network; and 3) exit (sign) locations.

#### 4.5. IFC for indoor localization

In the realm of indoor navigation, studies on positioning/localization and pathfinding are closely related. Li et al. [9] summarized the specific uses of BIM for localization as: 1) support the computation of the configuration plan of positioning beacons; 2) support extracting room/space attributes and applying semantic/geometric constraints to indoor locations; and 3) visualize the estimates of indoor locations. In a radio frequency identification (RFID) localization system based on BIM and cloud computation [92], BIM facilitates the automatic layout planning of RFID antenna, and the visualization serves real-time monitoring [92,93] in the building. For another type of indoor localization technique based on the ultra-wide band (UWB) wireless network, Tomasi et al. [94] explore the influence of deployment planning on the interoperability of BIM and Wireless Sensor Network (WSN) systems. In this case, BIM and positioning sensors are used together to predict the

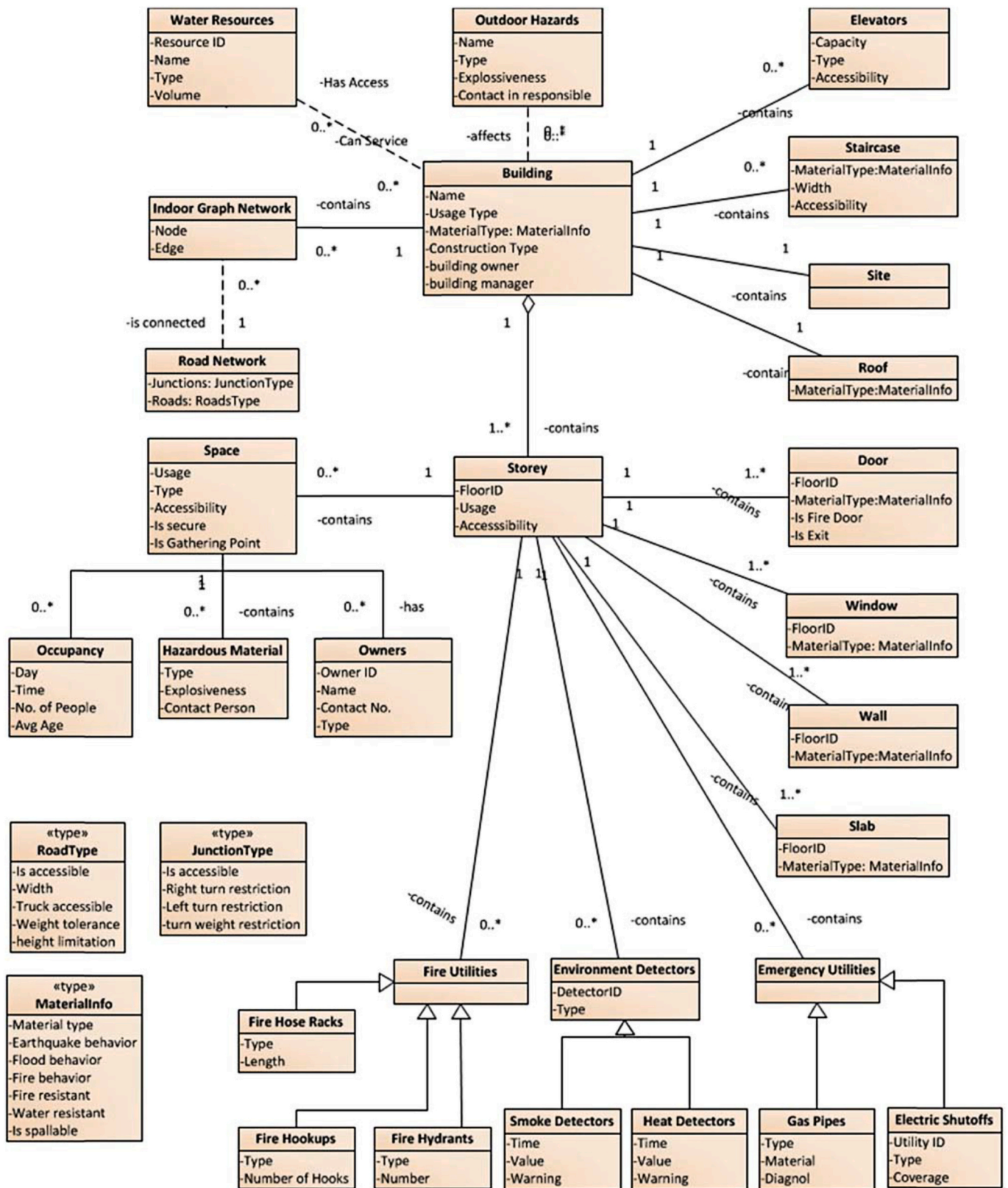

Fig. 15. The data model of IESM ([76]).

-ranging behavior of the WSN. The placement of facilities can be represented by the minimal set of UWB nodes, when the physical parameters of interest are properly obtained. In addition, construction processes monitoring can be supplemented with indoor positioning. As a spatial framework of the sensing areas, indoor locations can be easily

pinpointed in BIM with their (local) coordinates [28,95].

Indoor tracking indicates the continuous localization of agents and it often involves the support from IFC models. Because IFC-Based BIM can provide accurate 3D scenarios for location matching, the semantic and geometric constraints of IFC data are employed to increase the accuracy



### Dynamic Subdivision

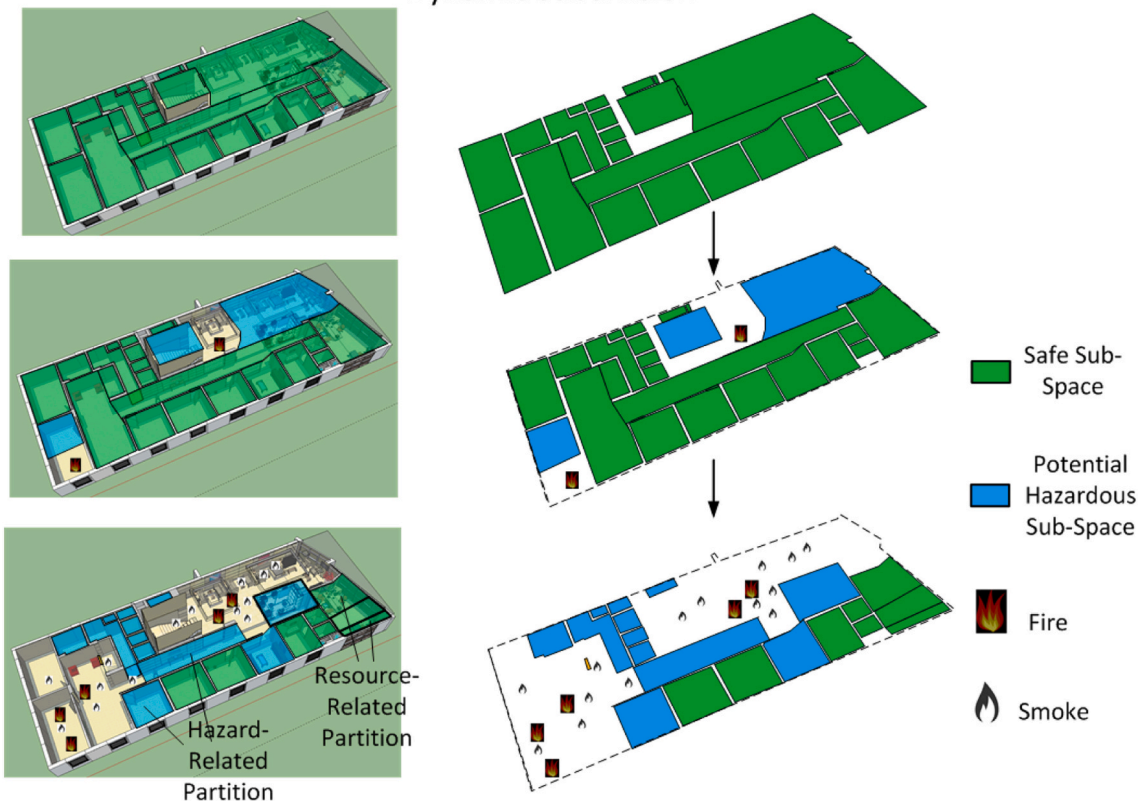

Fig. 16. Extension of fire and smoke in emergencies [36].

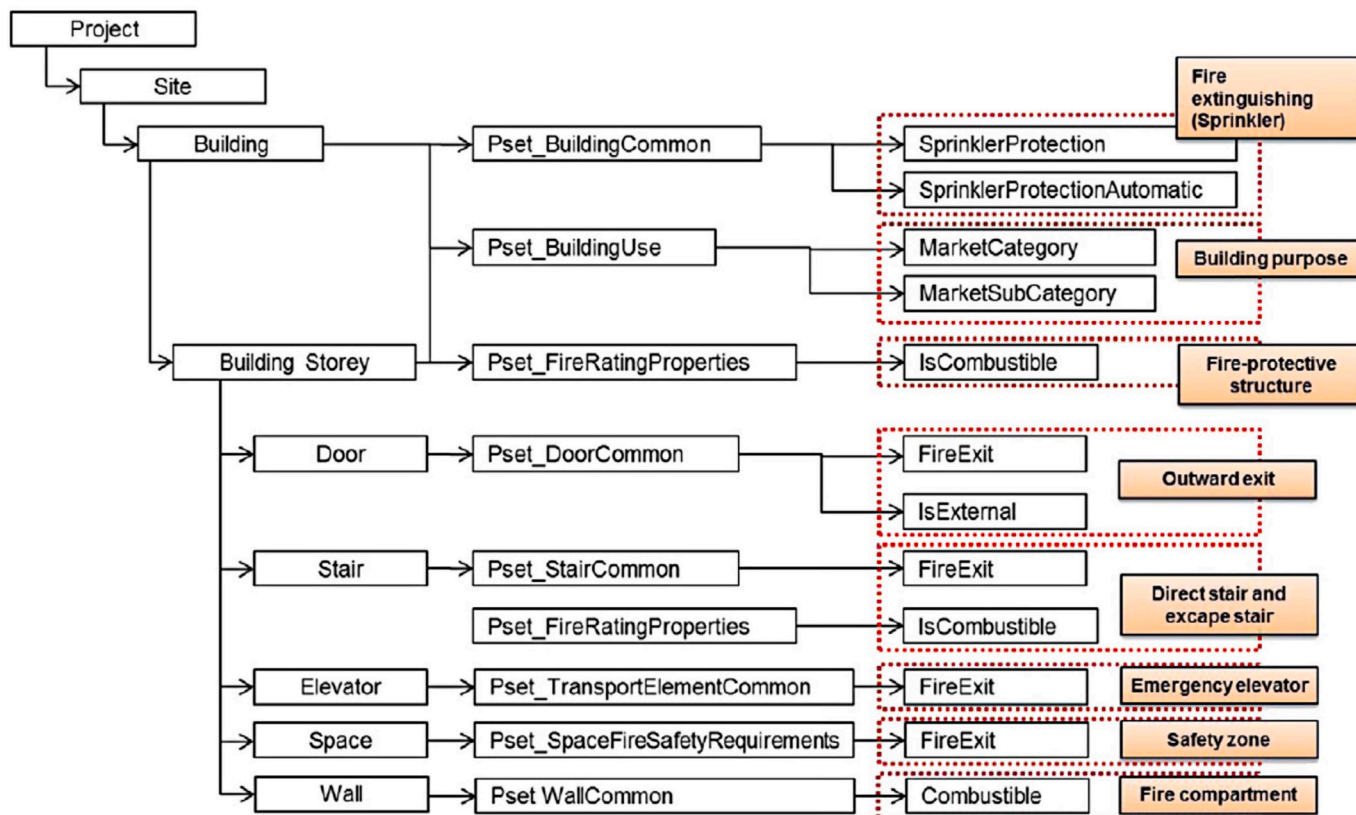

Fig. 17. IFC properties for evacuation regulations ([89]).

of location estimates [6,10]. For example, a study [96] presents how the geometry and object information are extracted from BIM into XML documents for mobile applications. This study investigates 2D location tracking in building where the geometric restrictions (e.g., walls) are applied. To combine the data from various sensors, Taneja et al. [44] suggest to introduce BIM into IMU-based positioning technologies to curb the drift error of motion sensors. Any plausible move crossing the physical boundaries are removed. The adopted space semantics exclude impossible locations and thus improve positioning accuracy as well. Similarly, another tracking system integrates Bluetooth Low Energy (BLE) with BIM, and the BIM was exploited to extract the 2D maps on movement constraints [11,96]. Here BIM is also used to enable the visualization of the building on a mobile device.

Except geometric/spatial restrictions, topological restriction is also adopted to estimate the true locations of landmarks [6]. Considering these constraints, Taneja et al. [13] aim for the automation of navigation models for the map-matching of indoor positioning data. The researchers summarize three types of model for map-matching, i.e., the boundary model (2D plans), the medial axis network (center-lines), and the grid model. Localization results can be mapped to the medial axis network or the grid model to increase the accuracy.

With these constraints represented in IFC data, a more accurate location can also help a user to manage indoor facilities. For example, by using an augmented reality (AR) and a Wi-Fi-based positioning method, Chen and Chang [97] identify and retrieve building elements via measured indoor locations. In this context, the BIM is used as a benchmark to locate building components corresponding to a user's location.

Besides, an image recognition technique is applied to detect indoor locations in IFC models [98]. Locations are automatically collected from the IFC data, and the maps derived from IFC are used to bound the related locations. Images are aligned with the coordinates of the IFC data. A mobile camera is used to recognize the frames, and thus the location of the mobile device is inferred.

## 5. Discussions and challenges

### 5.1. Geometric representations for indoor navigation

To generate navigation models, the researchers often extract the surfaces out of the 3D geometry (e.g., B-Rep). Because of the different algorithms, the created 2.5D navigation models have slight variations and they may influence navigation paths. In addition, distinct space subdivisions have impact on the navigation models as well. For instance, Tessellation (e.g., Delaunay triangulation) methods generate the irregular shapes (Fig. 10), while the original partition (following the physical boundaries) can support the MAT networks in more regular shapes (Fig. 5b). Accordingly, paths on these networks would be curved or straight lines/line strings in various lengths. In general, navigation models being an abstracted representation cannot yield the unique standard network, and thus the shortest-distance path will vary. Instead, a fine grid model based on the floor surfaces can provide a unique shortest-distance path, which can be closer to the reality.

At present, the common navigation models mostly rely on 2D/2.5D surfaces. Even if the navigation agent is not explicitly stated, the implicit assumption of locomotion mode is walking or driving. Thus, the agent can move on floor surfaces (horizontally) and stairs/elevators (vertically). In such cases, a complete 3D model may not be necessary. But the 3D representations become important when the agent's height is critical (e.g., to transport equipment) or a flying agent (drone) needs to navigate in the building.

Recently the research of true 3D representations of IFC is growing. As the frequently used class in IFC, *IfcSpace* can be represented with multiple 3D representations such as SweepSolid, CSG and B-Rep. Many commercial BIM packages (e.g., Revit) provide the conversions between SweepSolid/CSG and B-Rep shapes, which is important for the integration of IFC with 3D GIS models such as CityGML [67,68].

In genuine 3D environments, the 3D features of IFC data are not fully considered. The heights of ceilings could be considered for some specific applications. For example, a drone can flexibly adjust its route and flight height in the 3D space. The geometric representation of PointCloud and the related voxel model can be a promising option for drones. The complete voxelization can facilitate accurate indoor routing [99]. A voxel model can be generated with the 3D geometry of indoor spaces/elements in a specified granularity (Fig. 18a), and then the navigation network derived from these voxels can support real 3D routing. In this case, the current 2.5D navigation networks (i.e., with the user height on floors) [12,16,29,38,40] could be extended to the genuine 3D networks using different heights of agents (e.g., drones).

Except the derivation of 2.5D navigation networks, the B-Rep representation is also useful for identifying wall surfaces (i.e., vertical surfaces). Walls are the most important partition form of spaces (represented by *IfcWall* and *IfcWallStandardCase*). But only the tangible wall surfaces can be perceived by humans. Fig. 18b presents the inner boundary of walls. These boundaries are employed to detect the navigable regions.

In general, other 3D geometry such as SweepSolid/CSG have not shown the obvious values for the generation of pedestrian navigation models. These representations shape an object (e.g., rooms) in the 3D space, and thus their volume information can be considered. Similar to the S-MAT networks, the medial axis networks in the 3D space can be derived. The heights of the navigation network indicate those of the reference point of the agent. Another possible application of the SweepSolid/CSG representations could be the fast detection of an agent's location. For example, the volume is used to determine whether a location estimate is inside the space. In addition, for some geometrically complex objects, the *BoundingBox* geometry can be adopted so that the exquisite details can be avoided for navigation computation (Fig. 18c). This measure ensures the computation of obstacle-avoiding paths while it can also save the computational resource [17,33]. For example, Lin et al. [17] adopts the *BoundingBox* representation for the instances of *IfcColumn* and *IfcFurnishingElement*.

### 5.2. Suggestions on IFC uses

From the perspective of GIS, the IFC model is considered a data container for indoor navigation, especially the geometry and spatial semantics of buildings. We list the supporting characteristics of IFC for pedestrian indoor navigation as follows: 1) many relevant classes are scattered across the hierarchy of the IFC schema, which hampers the effort of navigation model generation; 2) there are various generation methods of navigation models from IFC for different applications; 3) on top of IFC, specific navigation-oriented data models are developed to ease the navigation model generation, to support urgent pathfinding in evacuation scenarios, and to consider sensors and access control; 4) the visualization of real-time information on IFC data can provide users with an overview about indoor dynamics and hazards; 5) the location estimates of indoor localization can be visualized in IFC data and corrected by the geometric/semantic constraints.

The limitations of IFC for indoor navigation are obvious as well: 1) no supports for network structure (nodes and edges); 2) no explicit storage for the connectivity relationships of *IfcSpace* instances; 3) implicitly links between some semantics in separate IFC hierarchies need to be elucidated for navigation purposes; and 4) potential geometric errors from the model creation process. These limitations hinder the automatic generation from IFC-Based BIM to navigation models, which is the primary challenge of IFC for indoor navigation. Other challenges include: 1) to readily employ navigation-oriented IFC data in GIS environments; 2) to facilitate the query of dynamic information with IFC data; and 3) to pinpoint the IFC classes which can further support indoor localization applications.

The majority of these reviewed studies concentrate on the generation methods of navigation models (Section 4). So far there are no complete



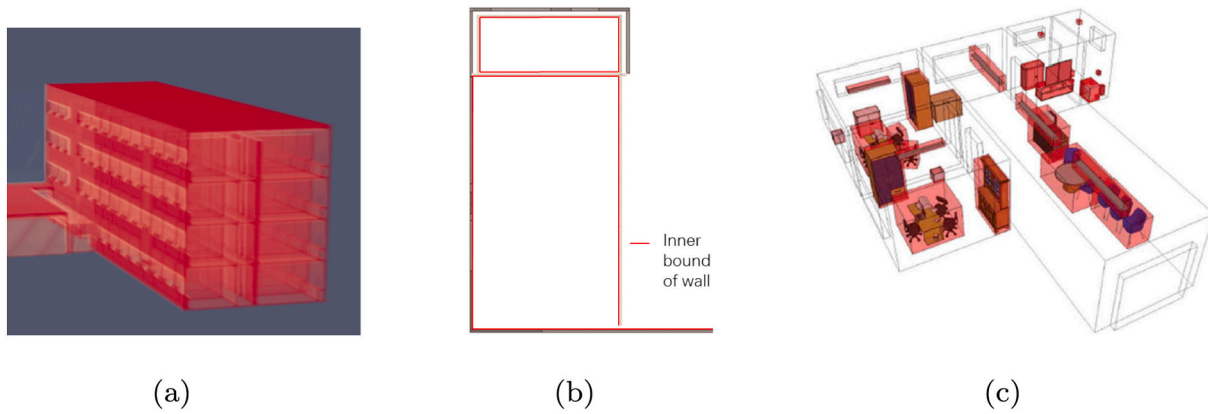

Fig. 18. Examples of different geometric representations. (a) An example of a voxel model; (b) an example of the inner boundary of walls in the bird's-eye view; (c) the bounding boxes of indoor objects ([33]).

automation solutions, and thus various types of navigation model are adopted. There is no unique optimal navigation network for all kinds of building and application. Nevertheless, we can delineate these classes and objectified relationships which can support the possible automation.

Specifically, the most important IFC class is *IfcSpace* because it models the navigable spaces where agents can be located and navigated. Commercial software (e.g., Autodesk Revit) provide multiple means to create *IfcSpace* instances automatically on the basis of bounding construction elements. However, *IfcSpace* instances are not always created in the design process and many IFC files may not contain them.

To facilitate the generation of indoor navigation models, we elicit the minimum set of classes and their relations on different levels of spaces and building elements (see Fig. 19). These classes can meet the

fundamental requirement of navigation model generation. In general, the connections of horizontal spaces are identified with *IfcWall*. It is the pivot intermediate to find out the portals (*IfcDoor*) to a space (*IfcSpace*) in a floor (*IfcBuildingStorey*). According to the *IfcRelAggregates* from *IfcSpace* to *IfcBuildingStorey*, the connectivity graph/network of the rooms in the floor can be derived.

Moreover, we can confirm the connections between the vertical and horizontal parts of building using *IfcStairFlight* and *IfcSlab*. As an *IfcSlab* instance is contained in a floor, the connection between the related *IfcStair* instance and the floor is determined by this *IfcSlab* instance. Other vertical parts (i.e., elevator or escalator) can be identified by *Pset\_TransportElementCommon* and *Pset\_TransportElementElevator*.

One tricky issue of navigation network automation is to transform

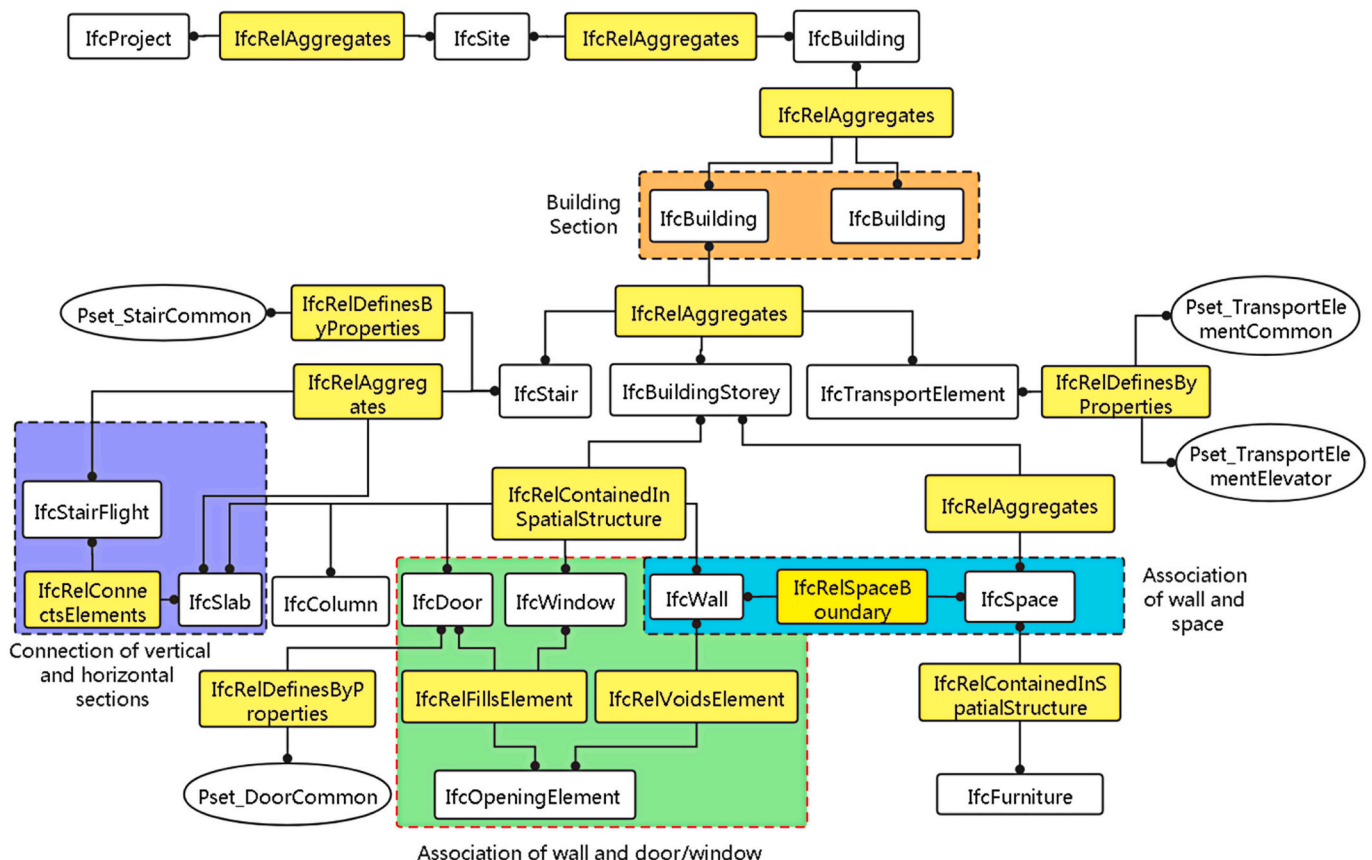

Fig. 19. The suggested minimum set of IFC classes to derive indoor navigation models.

complicated 3D shapes. A solution is to consider only the accessible surfaces (e.g., floor surfaces) of 3D solid geometry in IFC data. The floor surfaces of horizontal spaces can be automatically extracted, but the shapes representing vertical passages are always manually created [14,15]. These vertical passages such as stairs are represented by a composite of solids (steps), which impedes the automation of walkable surface generation. There are two types of method can be adopted to facilitate such an automation. The first way is the voxelization of the whole building (see Fig. 18a). The second one is to develop an automatic extraction method of the boundary for vertical passages. For example, Fig. 20 presents the transformation from a stair consisting of solids to its counterpart represented by a 3D surface.

In order to highlight the essential parts regarding dynamic information, we aim to outline these related IFC classes in a logic way. According to a previous conceptual framework of space-event for indoor navigation [36], there are six general notions: 'space', 'partition', 'agent', 'activity', 'resource' and 'modifier'. Different spaces are derived from a certain partition. In these spaces, an agent (e.g., pedestrians or drones) can conduct different activities such as walking to a place and picking up objects. During this activity, the agent may use some resource, such as operating a fire hydrant in emergencies. Modifier instances refer to indoor changes and different events (e.g., furniture displacement, temporary closing and hazards), which triggers different constraints on space access rights of the agent. These notions are designed to structure all kinds of indoor information, and they lay the foundation for all the computations of indoor navigation.

We identified the counterparts of those six notions in IFC (see Fig. 21). Indoor 'spaces' are represented by *IfcSpace* instances in IFC; 'agents' can be represented by the instances of *IfcActor*; 'activity' instances associate to the subclasses of *IfcProcess*, i.e., *IfcTask* and *IfcProcedure*. As an activity may last for a certain period of time, an *IfcProcedure* instance can present the sequence of activities; 'partition' associates to the objectified relationship *IfcRelDecomposes*; 'resource' instances refer to the *IfcResource* class (materials, facilities or equipment); 'modifier' instances are referred as *IfcConstraint* and they also relate to *IfcSensor* regarding real-time sensor data. In this sense, *IfcConstraint* can restrict the motions and the access types of spaces for different agents. 'Modifier' can also relate to *IfcEvent* since the changes can be caused by events. 'Modifier' also associates to *IfcZone* instances since it can influence on different groups of spaces.

For indoor tracking, the characteristics of the involved sensors include the quantitative data of sensor behavior [96]. Some Psets regarding *IfcSensor* need to be considered, such as *Pset\_SensorTypeFireSensor*, *Pset\_SensorTypeGasSensor* and *Pset\_SensorTypeSmokeSensor* (see Fig. 21). These properties in the Psets can reflect the status of emergencies in fire, gas leak, and smoke concentration, respectively.

In addition, most of the derived navigation networks rely on the structural subdivision provided in IFC data. But functional areas may need to be specified for emergencies (e.g., safety zones). As IFC-Based BIM is also an ideal data source for simulations, dynamic factors such as fire/smoke can be simulated with IFC data [100]. The material property of the IFC classes can be applied to the computation of fire diffusion. In these simulations, the focus is on the influenced zones and

their degrees of impact. Consequently, the accessible spaces can be confirmed, which shall be recorded with *IfcSpatialZone* instances.

For indoor localization, the space boundary in BIM is a straightforward and useful constraint to improve the accuracy of location estimates. Some previous studies [44,86] of indoor localization have adopted grid models to infer user locations. The data type of grid has been supported in IFC, thus they can be leveraged to identify the locations of pedestrian (see Fig. 22). But the class *IfcGrid* is just an auxiliary class to locate elements and it merely represents the geometric shapes with lines/curves. New Psets need to be defined for *IfcGrid* if more attributes need to be attached to its instances. In other words, this class has no specific attributes for semantic information (e.g., the membership of spaces). Except the geometric constraints, other agent semantics can also contribute to confining indoor localization errors. For example, a visitor is not supposed to directly access the accounting office of a company in a building.

### 5.3. New research directions

We summarized the main uses of BIM for indoor navigation in Table 2. The largest category is the generation of navigation models, and most of the studies present the navigation network; the other navigation models refer to discrete models (e.g., grids). The other four directions involve a similar number of studies, i.e., localization, dynamic environment, data modeling and visualization.

To further facilitate the application of IFC data to indoor navigation, we also propose the following directions to be investigated.

1. To further investigate the vertical dimension of the 3D geometry in IFC.
2. To facilitate the transformation from IFC to the standard models of indoor navigation.
3. To manage real-time data with IFC to reflect indoor changes.

#### 5.3.1. 3D geometry

The first new research direction, investigation of the vertical dimension, is motivated by the influences of genuine 3D models on navigation choices. 3D geometry of IFC data can be adopted for the navigation of drones. In general, most methods [24,29,30] regarding navigation network for pedestrians derive the horizontal paths in floors using the simplified geometry from IFC (e.g., surfaces). However, as drones can fly in different heights, the 3D geometry is required for the drones to calculate safe and accurate routes. A previous study has shown the safe route planning which provides 3D optimal paths for drones to avoid obstacles by flying above or under them [102]. This work is developed on the basis of the voxel model of building. Generating navigation networks are not appropriate for such cases since a single network cannot reflect all these heights. Therefore, other 3D IFC geometry can be applied, such as *PointCloud* and *Surface3D*. *PointCloud* in regular arrays can correspond to voxels, and drone locations and paths can be identified in these voxels. Also, the 3D space can be sliced into different layers represented by *Surface3D*. Drones can change routes between different layers with different heights. Meanwhile, indoor obstacles can be identified on these 3D structures for obstacle-avoiding path-finding.

Even just for human users, the vertical dimension of 3D models certainly needs to be considered for the more accurate description of navigable spaces. Currently path-finding in the reported studies are mostly for pedestrians who can walk on floor surfaces, and thus their paths are planned with 2D or 2.5D geometric models. However, these previous work seldom consider the influence of pedestrian dimensions on path selection. The 3D model of IFC can provide more accurate descriptions of accessible spaces for a given user, and thus accurate navigable paths can be derived from them. These descriptions can also be utilized for path planning in emergencies. For example, Fig. 23 presents

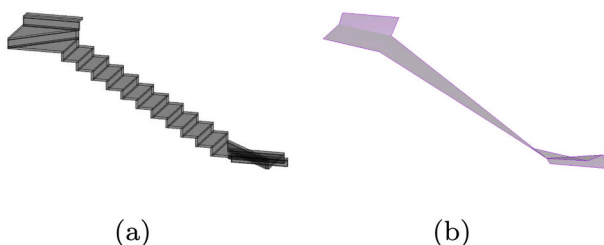

Fig. 20. Boundary creation from an *IfcStair* instance. (a) A stair as a composite solid; and (b) the stair as a 3D polygon.

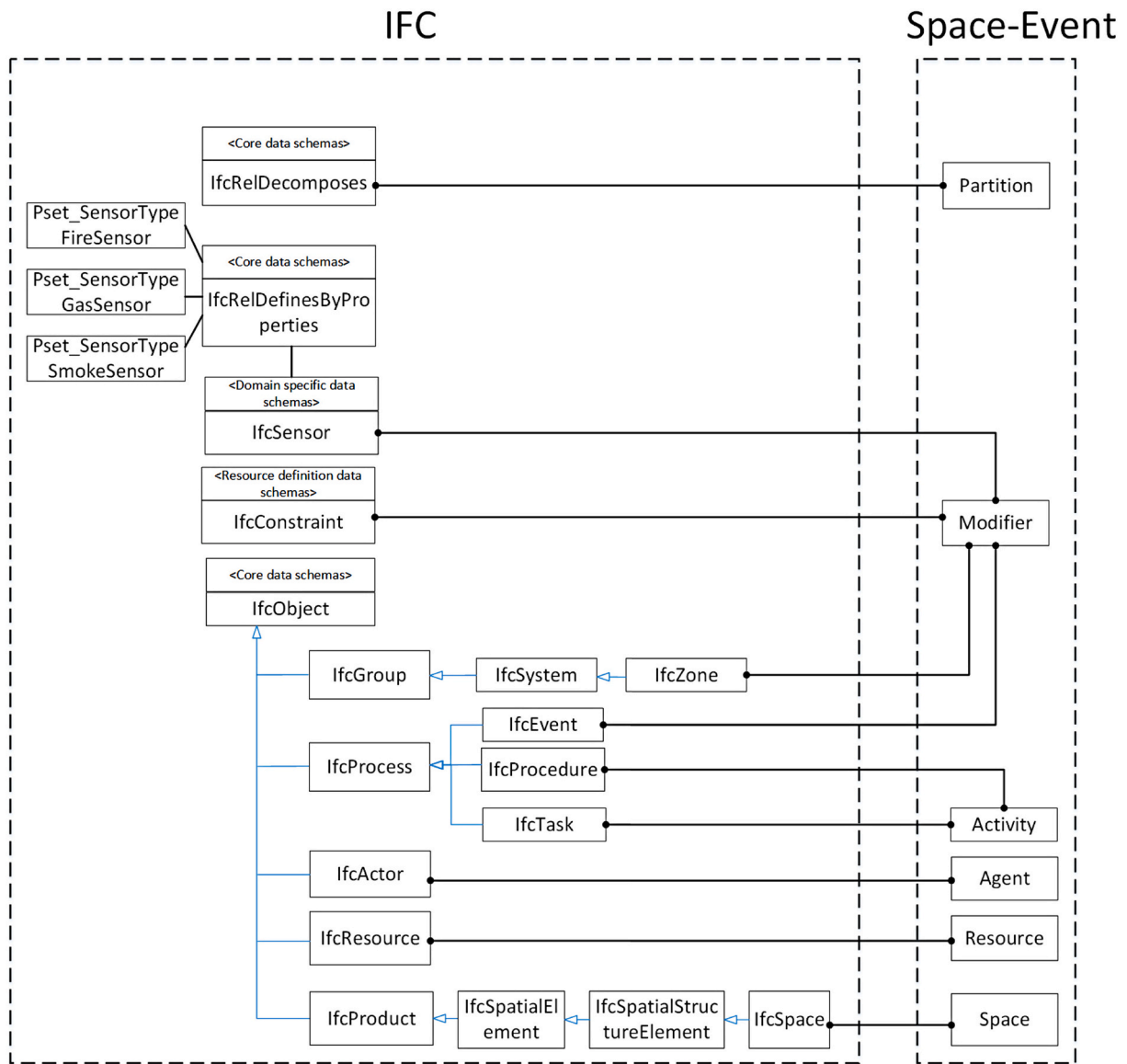

Fig. 21. The relations between the IFC classes and the conceptual framework of space-event.

two object spaces of the same desk for two distinct agents. The pedestrian can go above or under the desk, while the wheelchair user can avoid this desk only. In general, customized paths based on different navigable spaces require the support of the accurate 3D models of IFC.

Moreover, 3D model demonstrates its values in the computation of cognitive salient indoor spaces or signage. In [20], the researchers summarize the features of indoor landmarks to support human way-finding, that is, visual salient (e.g., color and texture pattern), cognitive salient (e.g., name) and structural salient (e.g., high accessibility). But these cognitive notions are not supported by building models. These 3D indoor landmarks with their semantics have to be interpreted and then can be accessed in the IFC model. Users with distinct heights may perceive different visual regions. Thus, the people-object interaction process can be simulated with the 3D models of IFC. In this case, new customized paths regarding 3D objects could be further investigated by parameterizing salience levels. For instance, a route is suggested for a pedestrian since it includes the most salient objects to be easily located.

### 5.3.2. Transformation of standardized models

It is promising to design and implement adapters between IFC and the standard data models of indoor navigation. The rich spatial

semantics of IFC-based BIM are significant for path-finding. Take IndoorGML [103] for example, a corridor tagged as 'IfcSpace' is also a 'GenericSpace'/'ConnectionSpace' instance in the ontology of IndoorGML; and an 'IfcDoor' instance can be regarded as 'TransitionSpace' in IndoorGML. IndoorGML mainly describes indoor navigation networks and spaces, and these space classes of IndoorGML are relevant to the nodes/edges of navigation networks. With such adapters, IFC data can be readily linked to navigation networks. As mentioned before, network primitives (nodes and edges) can be extracted from IFC data in a relative complicated manner. In contrast, it is relatively easy to conduct the automation of navigation network with IndoorGML data.

On the basis of the relationship classes in the IFC model, navigation networks can be readily derived from the topology and semantics in IFC [47,48]. This type of networks are similar to Node-Relation Graph (NRG) [32] within GIS data. Given an IFC model, the adjacency and connectivity can be decided by the instances of IfcSpace and those of its related relationship classes. In this sense, the transformation of navigation network is determined between the two data schemas of IFC and IndoorGML.

However, navigation networks are not unique and user-dependent networks can be generated on the same dataset. Both IndoorGML and

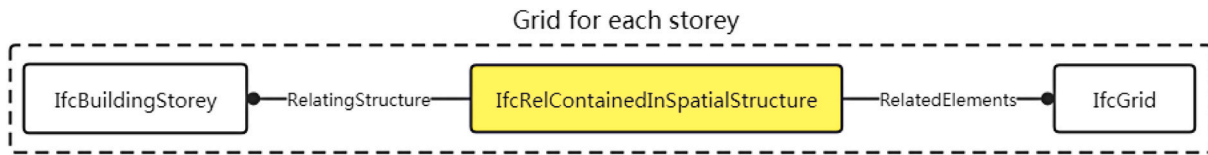

(a) The relationship between *IfcStorey* and *IfcGrid*

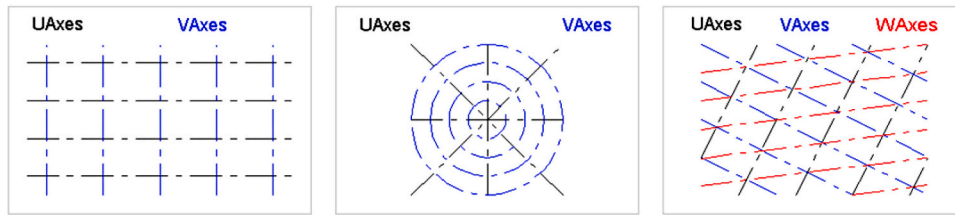

(b) Three types of *IfcGrid*

Fig. 22. The class *IfcGrid* is used to represent a floor (from [1]).

**Table 2**  
Statistics of the directions in the literature.

Topics	Subtopics	References
Navigation model generation	Network model & Path-finding	[14,27,29,38,52,64,65,67,79] [8,12,13,16,18,19,24,28,30,37,40,46,62,63,71]
	Discrete model & Path-finding	[14,15,17,22,35,56,58–60]
Localization	Deployment for localization	[9,28,77,92,98,101]
	Correction for localization	[6,10,11,13,21,44]
Dynamic environment	Spatial database for simulation	[22,35,59,82,85,87,90,91,100]
	Routing for Evacuation	[22,60,61,89]
Data modeling		[3,49,53,54,66,74,84] [7,56,57,70]
Visualization	Building interiors & indoor locations	[6,9,25,50,59,86,93–95,97]

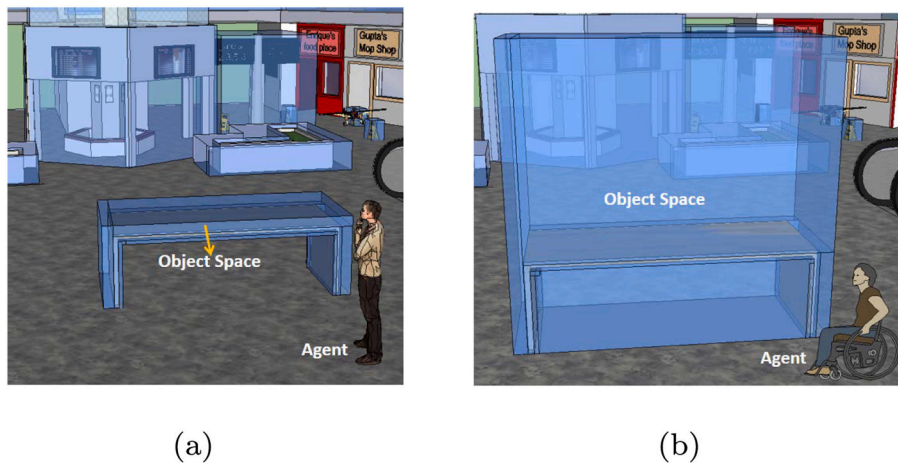

Fig. 23. Object spaces for different agents. (a) The desk with a small buffer space to a pedestrian; and (b) a large buffer to a wheelchair user.

some domain models [76,80] refer to navigation networks, but the gap between these models and IFC is how to define the navigation network. Geometric networks, such as the MAT network [13], include extra nodes and edges created by the generation algorithm but they are not originally from IFC. More specifically, the researchers first access spatial data by parsing IFC objects from the EXPRESS file to Java objects, and then apply the algorithm of network generation to obtain the MAT network. Similar methods [27,39,52,64] rely on 2D floor plans extracted from IFC

models and create slightly different geometric networks. In addition, [13,17] adopt a planar grid model to sustain the semantics of IFC objects for pathfinding. In this case, the network of grid cells is the actual network and it is not explicitly stored in the IFC model. Transformation between the IFC model and IndoorGML data is not only about the format changes or schema mapping, but also with respect to the generation of navigation network. Basically these different forms of navigation network are derived with the semantics and geometry of free spaces,



doors and walls in IFC files (see Fig. 19). For these networks, they have to be derived case-by-case and then they could be converted to IndoorGML.

Our suggestion on this topic is to investigate more prompt approaches which can facilitate the generation of geometric networks based on IFC data. In fact, automation of network generation relies on indoor space decomposition. Different sets of subspaces can be subdivided from *IfcSpace* instances to cater for different agents or perception rules (e.g., visibility). IndoorGML can manage varied networks by inserting or deleting the nodes and edges with semantic descriptions. Intermediate operators/software modules shall be specifically designed for space decomposition and network generation. It needs to accept a set of parameters and result in an expected network. For example, the operator/module can generate a navigation network with the input of subspace boundaries, or it can generate a grid network according to a given resolution. By preserving the semantics of IFC elements and the derived network, one can transform the network elements into IndoorGML files. This measure can facilitate the exchange of indoor navigation networks.

### 5.3.3. Indoor changes

The third research direction is about the management of indoor changes, since the dynamics of buildings have potential influences on navigational activities. In general, the contribution of IFC models for dynamic analysis is reflected by its fine granularity of data. Since IFC4 introduces the *domain layer* (see Section 3), real-time data can be monitored with the sensors represented by *IfcSensor*. A spectrum of analyses can be benefited from the accurate dynamic (sometimes hazardous) data collected by different sensors. In previous studies dynamic information are visualized for safety monitoring in terms of emergency utilities and sensors [76,85]. Meanwhile, the semantics and 3D geometry of IFC data are adopted as the base for fire simulation [35,82]. User locations can be calculated with BIM [11,92–94,96]. Evacuation simulation and escape route planning are investigated as well [87]. Generally these studies refer to user locations and the simulation of hazards and evacuation.

In the next steps, potential studies can leverage the IFC support for the analyses in normal circumstances as well. Here we focus on user-centric services in the context of indoor navigation. In normal scenarios, continuous pedestrian flows vary over time and they can be monitored and visualized in an IFC-based building. For example, during a construction period, video monitors and positioning devices can identify the number of pedestrians and their movements (e.g., how many people indoors, and where are they?). Specific data models can be developed on top of IFC, and they can incorporate sensor data with the trigger conditions of corresponding events (e.g. regional congestion).

Meanwhile, data management has to be employed to store and update real-time sensor data, the IFC spatial semantics (e.g., in which rooms) and the relationships of IFC entities (e.g., the area of influence). The above studies mentioned the *ad-hoc* cases for specific scenarios, while we look forward to more generic applications of dynamic data. Considering dynamic data increase in time dimension, a static IFC file may not meet the requirement of real-time analysis. Therefore, one can develop a precise mapping between the IFC models and a spatio-temporal database. In this way, dynamic data can be continuously maintained and applied to analysis. Based on different vendor software, a generic module can be developed to stream and receive the real-time data of different kinds of indoor sensors.

As IFC data are intrinsically suitable for visualization and simulation, they shall be further investigated in serious gaming. Specifically, safety training software can incorporate the IFC models and simulate evacuation planning in construction sites considering possible accidents (e.g., falling of building components). Compared to the work reported in [87], this simulation shall further incorporate the influence of accidents and real-time user locations to discuss potential events along with time. This simulation aims to find the maximum probability to avoid injury.

## 6. Conclusions

The conducted literature review of 87 publications presented the state-of-the-art implementation and research of IFC-based BIM with focus on indoor navigation. The literature presents a variety of theoretical methodologies, technologies and applications on navigation model generation, domain models on top of IFC, IFC for dynamic environments and indoor localization. The most active research direction is to generate the navigation models from IFC data (almost one-third of all the related papers), and most of these models are represented by network. IFC data are also averagely considered in other four aspects: indoor localization, data modeling, dynamic environments and visualization. Our survey identifies several features of IFC data in terms of indoor navigation. First, the semantics and geometry of IFC data are often adopted to derive 2.5D navigation networks; second, some researchers focus on data modeling on top of the IFC schema to ease the interoperability of IFC for specific applications; third, these studies regarding dynamic environments either take IFC data as the context knowledge for hazard simulations, or calculate evacuation routes for pedestrians in the IFC building; fourth, the indoor localization research employs IFC data mainly to correct localization results with the spatial/semantic constraints; at last, IFC data are ideally for the visualization of map/location information due to the complete 3D geometry and the rich semantics of building.

However, there is still lack of evidence on the completeness of automation of IFC-based BIM for indoor navigation. But to our knowledge, no available methodology was adequate to handle various buildings in a standardized way. The main challenges for further research are the automatic generation of navigation models, and the automatic transformation of 3D complicated shapes and relationships from IFC data. Moreover, it is necessary to make a complete use of IFC semantics, and to adopt 3D models to locate other agents (e.g., drones) and conduct path-finding regarding the vertical dimension. Furthermore, navigation-oriented data models should be designed with consideration of dynamic information. For the path planning in emergencies with IFC data, different spatial subdivision results need to be taken into account. When crowds or hazards develop over time, the navigable or safety region could shrink. In this case, real-time data shall be managed and updated with IFC spatial semantics and relationships for influence analysis.

In the future, we expect the above unmet needs on IFC-based BIM can be achieved. It is crucial to bridge IFC data and applied functionalities for further development. Fast developments of IFC and the recent release of indoor navigation-related standards such as IndoorGML [103] are promising for the future automation of navigation models.

### Declaration of Competing Interest

The authors declare no conflict of interest.

### Acknowledgments

This research is supported by ZFS (ZFS19001D-ZTYJ03, Y9E0151M26). We also acknowledge the funding support provided by China Postdoctoral Science Foundation (grant number 2019M651581), National Natural Science Foundation of China (41874030), The Scientific and Technological Innovation Plan from Shanghai Science and Technology Committee (18511101801), The National Key Research and Development Program of China (2016YFB0501802), and The Fundamental Research Funds for the Central Universities.

### References

- [1] BuildingSMART International Limited, Industry Foundation Classes Version 4.1.0.0. [http://standards.buildingsmart.org/IFC/RELEASE/IFC4\\_1/FINAL/HTML/](http://standards.buildingsmart.org/IFC/RELEASE/IFC4_1/FINAL/HTML/), 2020.
- [2] C. Nagel, A. Stadler, T. Kolbe, Conceptual requirements for the automatic reconstruction of building information models from uninterpreted 3D models,



- Proceedings of the International Archives of Photogrammetry, Remote Sens. Spatial Inform. Sci. (2009) 46–53.
- [3] U. Isikdag, S. Zlatanova, Towards Defining a Framework for Automatic Generation of Buildings in CityGML Using Building Information Models, Springer, Berlin Heidelberg, 2009.
- [4] M. Gunduz, U. Isikdag, M. Basaraner, A review of recent research in indoor modelling & mapping, *Int. Arch. Photogramm. Remote Sens. S XLI-B4* (2016) 289–294.
- [5] K. Li, S. Zlatanova, J. Torres-Sospedra, A. Perez-Navarro, C. Laoudias, A. Moreira, Survey on indoor map standards and formats, in: 2019 International Conference on Indoor Positioning and Indoor Navigation (IPIN), Pisa, Italy, 2019, pp. 1–8.
- [6] A. Costin, J. Teizer, Utilizing bim for real-time visualization and indoor localization of resources, in: 2014 International Conference on Computing in Civil and Building Engineering, 2014, pp. 649–656, <https://doi.org/10.1061/9780784413616.081>.
- [7] U. Isikdag, S. Zlatanova, J. Underwood, A bim-oriented model for supporting indoor navigation requirements, *Comput. Environ. Urban. Syst.* 41 (3) (2013) 112–123.
- [8] C. Schultz, M. Bhatt, A multi-modal data access framework for spatial assistance systems: use-cases with the building information model (BIM/IFC), in: Proceedings of the 2nd ACM SIGSPATIAL International Workshop on Indoor Spatial Awareness, ACM, 2010, pp. 39–46.
- [9] N. Li, B. Becerik-Gerber, B. Krishnamachari, L. Soibelman, A bim centered indoor localization algorithm to support building fire emergency response operations, *Autom. Constr.* 42 (2) (2014) 78–89.
- [10] A.M. Costin, J. Teizer, Fusing passive RFID and BIM for increased accuracy in indoor localization, *Visualization Eng.* 3 (1) (2015) 17.
- [11] J. Park, Y.K. Cho, C.R. Ahn, A wireless tracking system integrated with BIM for indoor construction applications, in: Construction Research Congress 2016, 2016, pp. 2660–2668.
- [12] M. Boysen, C.D. Haas, H. Lu, X. Xie, A journey from IFC files to indoor navigation, in: International Symposium on Web and Wireless Geographical Information Systems, 2014, pp. 148–165.
- [13] S. Taneja, B. Akinci, J.H. Garrett, L. Soibelman, Algorithms for automated generation of navigation models from building information models to support indoor map-matching, *Autom. Constr.* 61 (2016) 24–41.
- [14] W. Lin, P. Lin, H. Tserng, Automating the generation of indoor space topology for 3D route planning using bim and 3D-GIS techniques, in: ISARC. Proceedings of the International Symposium on Automation and Robotics in Construction vol. 34, Vilnius Gediminas Technical University, Department of Construction Economics & Property, 2017, pp. 1–8.
- [15] W.Y. Lin, P.H. Lin, Intelligent generation of indoor topology (i-GIT) for human indoor pathfinding based on IFC models and 3D GIS technology, *Autom. Constr.* 94 (2018) 340–359.
- [16] T.-A. Teo, K.-H. Cho, BIM-oriented indoor network model for indoor and outdoor combined route planning, *Adv. Eng. Inform.* 30 (3) (2016) 268–282.
- [17] Y.-H. Lin, Y.-S. Liu, G. Gao, X.-G. Han, C.-Y. Lai, M. Gu, The IFC-based path planning for 3D indoor spaces, *Adv. Eng. Inform.* 27 (2) (2013) 189–205.
- [18] A.Y. Chen, J.C. Chu, Tdvrp and bim integrated approach for in-building emergency rescue routing, *J. Comput. Civ. Eng.* 30 (5) (2016), C4015003.
- [19] A. Hamieh, D. Deneux, C. Tahon, Bimov: bim-based indoor path planning, in: B. Eynard, V. Nigrelli, S.M. Oliveri, G. Peris-Fajarnes, S. Rizzuti (Eds.), *Advances on Mechanics, Design Engineering and Manufacturing: Proceedings of the International Joint Conference on Mechanics, Design Engineering & Advanced Manufacturing (JCM 2016)*, 14–16 September, 2016, Catania, Italy, Springer International Publishing, Cham, 2017, pp. 889–899, [https://doi.org/10.1007/978-3-319-45781-9\\_89](https://doi.org/10.1007/978-3-319-45781-9_89).
- [20] K. Arendholz, T. Becker, Requirements on building models enabling the guidance in a navigation scenario using cognitive concepts, in: M. Breunig, M. Al-Doori, E. Butwilowski, P.V. Kuper, J. Benner, K.H. Haefele (Eds.), *3D Geoinformation Science: The Selected Papers of the 3D GeoInfo 2014*, Springer International Publishing, Cham, 2015, pp. 157–173, [https://doi.org/10.1007/978-3-319-12181-9\\_10](https://doi.org/10.1007/978-3-319-12181-9_10).
- [21] C. Jayakody, N. Abhayasinghe, I. Murray, AccessBIM model of environmental characteristics for vision impaired indoor navigation and way finding, in: *International Conference on Indoor Positioning and Indoor Navigation* vol. 13, 2012.
- [22] L. Zhang, Y. Wang, H. Shi, L. Zhang, Modeling and analyzing 3D complex building interiors for effective evacuation simulations, *Fire Saf. J.* 53 (53) (2012) 1–12.
- [23] A. Borrmann, J. Beetz, C. Koch, T. Liebich, S. Muhic, Industry foundation classes: a standardized data model for the vendor-neutral exchange of digital building models, in: *Building Information Modeling*, Springer, 2018, pp. 81–126.
- [24] L.-C. Chen, C.-H. Wu, T.-S. Shen, C.-C. Chou, The application of geometric network models and building information models in geospatial environments for fire-fighting simulations, *Comput. Environ. Urban. Syst.* 45 (2014) 1–12.
- [25] J. Ryu, J. Jaehong, L. Seunghyeon, C. Seunghyeon, A study on development of the ifc-based indoor spatial information for data visualisation, in: Proceedings of the 21st International Conference of the Association for Computer-Aided Architectural Design Research in Asia, 2016, pp. 497–506.
- [26] D. Li, D. Lee, A lattice-based semantic location model for indoor navigation, in: 2008 the 9th International Conference on Mobile Data Management, 2008, pp. 17–24, <https://doi.org/10.1109/MDM.2008.11>.
- [27] J. Lertlakkhanakul, Y. Li, J. Choi, S. Bu, Gongpath: development of bim based indoor pedestrian navigation system, in: 2009 Fifth International Joint Conference on INC, IMS and IDC, IEEE, 2009, pp. 382–388.
- [28] U. Rueppel, K.M. Stuebbe, Bim-based indoor-emergency-navigation-system for complex buildings, *Tsinghua Sci. Technol.* 13 (2008) 362–367.
- [29] S. Tang, Q. Zhu, W. Wang, Y. Zhang, Automatic topology derivation from IFC building model for in-door intelligent navigation, *The International Archives of Photogrammetry, Remote Sens. Spatial Inform. Sci.* 40 (4) (2015) 7.
- [30] G. Suter, Modeling multi-level spaces with network-based space layouts: a case study, in: Proceedings of European Group for Intelligent Computing in Engineering - 21st International Workshop: Intelligent Computing in Engineering 2014, 2014, pp. 394–403.
- [31] J. Lee, M. Kwan, A combinatorial data model for representing topological relations among 3d geographical features in micro-spatial environments, *Int. J. Geogr. Inf. Sci.* 19 (10, 2005) 1039–1056.
- [32] J. Lee, A spatial access-oriented implementation of a 3-D GIS topological data model for urban entities, *Geoinformatica* 8 (3) (2004) 237–264.
- [33] A.A. Diakitè, S. Zlatanova, Spatial subdivision of complex indoor environments for 3D indoor navigation, *Int. J. Geogr. Inf. Sci.* 32 (2) (2018) 213–235.
- [34] A. Alattas, S. Zlatanova, P. Van Oosterom, E. Chatziniolaou, C. Lemmen, K. Li, Supporting indoor navigation using access rights to spaces based on combined use of IndoorGML and LADM models, *ISPRS Int. J. Geo Inf.* 6 (12, 2017) 384.
- [35] J.A. Dimyadi, M. Spearpoint, R. Amor, Generating fire dynamics simulator geometrical input using an IFC-based building information model, *Electron. J. Inf. Technol. Constr.* 12 (2007) 443–457.
- [36] S. Zlatanova, L. Liu, G. Sithole, A conceptual framework of space subdivision for indoor navigation, in: Proceedings of the Fifth ACM SIGSPATIAL International Workshop on Indoor Spatial Awareness, ISA '13, ACM, New York, NY, USA, 2013, pp. 37–41, <https://doi.org/10.1145/2533810.2533819>.
- [37] A. Khan, T. Kolbe, Subspacing based on connected spaces and opening for different types locomotion using geometric and graph based representation in multilayered space-event model (mlsem), in: *ISPRS Annals of Photogrammetry, Remote Sensing and Spatial Information Sciences* vol. II-2/W1, 2013, pp. 173–185.
- [38] Y. Li, Z. He, 3D indoor navigation: a framework of combining BIM with 3D GIS, in: Proceedings of 44th The International Society of City and Regional Planners (ISOCARP) Congress 2008, 2008, pp. 1–10.
- [39] Y. Li, Building information model for 3D indoor navigation in emergency response, in: *Advances in Civil Engineering and Architecture Innovation*, Vol. 368 of *Advanced Materials Research*, Trans Tech Publications, 2012, pp. 3837–3840.
- [40] P. Boguslawski, L. Mahdjoubi, V. Zverovich, F. Fadli, Automated construction of variable density navigable networks in a 3D indoor environment for emergency response, *Autom. Constr.* 72 (2016) 115–128.
- [41] M.H. Overmars, E. Welzl, New methods for computing visibility graphs, in: Proceedings of the Fourth Annual Symposium on Computational Geometry, SCG '88, ACM, New York, NY, USA, 1988, pp. 164–171, <https://doi.org/10.1145/73393.73410>.
- [42] M. Meijers, S. Zlatanova, N. Pfeifer, 3D geo-information indoors: structuring for evaluation, in: Proceedings of Next Generation 3D City Models, 2005, pp. 11–16.
- [43] J. Choi, J. Lee, 3D geo-network for agent-based building evacuation simulation, in: *3D Geo-Information Sciences*, Springer, 2009, pp. 283–299.
- [44] S. Taneja, A. Akcamete, B. Akinci, J.H.G. Jr, L. Soibelman, W.E. East, Analysis of three indoor localization technologies for supporting operations and maintenance field tasks, *J. Comput. Civ. Eng.* 26 (6) (2012) 708–719.
- [45] D. Eppstein, J. Erickson, Raising roofs, crashing cycles, and playing pool: applications of a data structure for finding pairwise interactions, *Discrete Comput. Geom.* 22 (4) (1999) 569–592.
- [46] J.-K. Lee, C.M. Eastman, J. Lee, M. Kannala, Y.-S. Jeong, Computing walking distances within buildings using the universal circulation network, *Environ. Plan. B Plan. Design* 37 (4) (2010) 628–645.
- [47] B. Strug, G. Ślusarczyk, Reasoning about accessibility for disabled using building graph models based on BIM/IFC, *Visualization Eng.* 5 (1) (2017) 10, <https://doi.org/10.1186/s40327-017-0048-z>.
- [48] L. Christoph, W. Markus, L. Marcus, P. Frank, A. Dengel, Graph-based retrieval of building information models for supporting the early design stages, *Adv. Eng. Inform.* 27 (4) (2013) 413–426.
- [49] A. Khalili, D.K.H. Chua, IFC-Based graph data model for topological queries on building elements, *J. Comput. Civ. Eng.* 29 (3) (2015), 04014046–1–04014046–14.
- [50] G. Suter, F. Petrushevski, M. Šipetić, Operations on network-based space layouts for modeling multiple space views of buildings, *Adv. Eng. Inform.* 28 (4) (2014) 395–411.
- [51] G. Boyes, C. Thomson, C. Ellul, Integrating bim and gis: exploring the use of ifc space objects and boundaries, in: Proceedings of GISRUK 2015, 2015, pp. 98–106.
- [52] C. Schultz, M. Bhatt, Toward accessing spatial structure from building information models, in: UDMS 2011: 28th Urban Data Management Symposium, Delft, The Netherlands, September 28–30, 2011, Urban Data Management Society; OTB Research Institute for the Built Environment; Delft University of Technology, 2011, pp. 25–30.
- [53] E. Tauscher, M. Wunsch, K. Smarsly, Towards generic bim queries based on the ifc object model and graph theory, in: Proceedings of the 20th International Conference on the Applications of Computer Science and Mathematics in Architecture and Civil Engineering (IKM), 2015.
- [54] E. Tauscher, K. Smarsly, Generic bim queries based on the ifc object model using graph theory, in: The International Conference on Computing in Civil and Building Engineering, 2016, pp. 905–912.
- [55] K. Al Sayed, M. Bew, A. Penn, D. Palmer, T. Broyd, Modelling dependency networks to inform data structures in BIM and smart cities, in: SSS 2015-10th

- International Space Syntax Symposium vol. 10, Space Syntax Laboratory, The Bartlett School of Architecture, University College London, 2015, p. 90.
- [56] A.A. Diakit , S. Zlatanova, Valid space description in BIM for 3D indoor navigation, *Int. J. 3-D Inform. Model.* 5 (3) (2016) 1–17.
- [57] A.A. Diakit , S. Zlatanova, Extraction of the 3D free space from building models for indoor navigation, *ISPRS Annals. Photogramm. Remote Sens. Spatial Inform. Sci.* IV-2/W1 (2016) 241–248.
- [58] M. Boysen, C.D. Haas, L. Hua, X. Xie, A. Pilvinyte, Constructing indoor navigation systems from digital building information, in: 2014 IEEE 30th International Conference on Data Engineering, 2014, pp. 1194–1197, <https://doi.org/10.1109/ICDE.2014.6816739>.
- [59] B. Wang, H. Li, Y. Rezgui, A. Bradley, H.N. Ong, Bim based virtual environment for fire emergency evacuation, *Sci. World J.* 14 (2014) 1–22.
- [60] M. Xu, I. Hijazi, A. Mebarki, R.E. Meouche, M. Abune'Meh, Indoor guided evacuation: tin for graph generation and crowd evacuation, *Geom. Nat. Hazards Risk* 7 (2016) 1–10.
- [61] H. Tashakkori, A. Rajabifard, M. Kalantari, Facilitating the 3D indoor search and rescue problem: an overview of the problem and an ant colony solution approach, *ISPRS Annals of the Photogrammetry, Remote Sens. Spatial Inform. Sci.* 4 (2016) 233.
- [62] B. Wu, S. Zhang, Integration of gis and bim for indoor geovisual analytics, in: L. Halounova, S. Li, V. Saf r, M. Tomkov , P. Rapant, K. Br zdi l, A. Stein (Eds.), XXIII ISPRS Congress, Commission II, 2016, pp. 455–458.
- [63] S. Taneja, B. Akinci, J. Garrett, L. Soibelman, B. East, Transforming ifc-based building layout information into a geometric topology network for indoor navigation assistance, in: Proceedings of International Workshop on Computing in Civil Engineering 2011, 2011, pp. 315–322, [https://doi.org/10.1061/41182\(416\)39](https://doi.org/10.1061/41182(416)39).
- [64] H. Lee, J. Kim, M. Shin, I. Kim, J.-K. Lee, A demonstration of BIM-enabled quantitative circulation analysis using bera language, in: ISARC. Proceedings of the International Symposium on Automation and Robotics in Construction vol. 31, Vilnius Gediminas Technical University, Department of Construction Economics & Property, 2014, p. 1.
- [65] A.Y. Chen, T. Huang, Toward BIM-enabled decision making for in-building response missions, *IEEE Trans. Intell. Transp. Syst.* 16 (5) (2015) 2765–2773.
- [66] A. Donaubaer, F. Straub, N. Panchaud, C. Vessaz, A 3D indoor routing service with 2d visualization based on the multi-layered space-event model, in: Progress in Location-Based Services, Springer, 2013, pp. 453–469.
- [67] A. Khan, A. Donaubaer, T.H. Kolbe, A multi-step transformation process for automatically generating indoor routing graphs from semantic 3D building models, in: Proceedings of the 9th 3D Geoinfo Conference 2014, 2014, pp. 123–141.
- [68] G. Gr ger, T. Kolbe, C. Nagel, K. H fele, OGC City Geography Markup Language (CityGML) Encoding Standard. <https://www.ogc.org/standards/citygml>, 2012 (accessed: March, 2020).
- [69] A. Geiger, J. Benner, K.H. Haeefe, Generalization of 3D IFC building models, in: M. Breunig, M. Al-Doori, E. Butwilowski, P.V. Kuper, J. Benner, K.H. Haeefe (Eds.), 3D Geoinformation Science: The Selected Papers of the 3D Geoinfo 2014, Springer International Publishing, Cham, 2015, pp. 19–35, [https://doi.org/10.1007/978-3-319-12181-9\\_2](https://doi.org/10.1007/978-3-319-12181-9_2).
- [70] I. Hijazi, M. Ehlers, S. Zlatanova, BIM for geo-analysis (BIM4GEOA): set up of 3D information system with open source software and open specification (OS), in: 5th International 3D Geoinfo Conference, Berlin, November 3–2, 2010 vol. 38-4/W15, International archives of photogrammetry, remote sensing and spatial information sciences, ISPRS, 2010, pp. 45–49.
- [71] J.K. Lee, M.J. Kim, BIM-enabled conceptual modelling and representation of building circulation, *Int. J. Adv. Robot. Syst.* 11 (8) (2014) 127.
- [72] T. Cerovsek, A review and outlook for a 'Building Information Model' (BIM): a multi-standpoint framework for technological development, *Adv. Eng. Inform.* 25 (2) (2011) 224–244.
- [73] R. Volk, J. Stengel, F. Schultmann, Building Information Modeling (BIM) for existing buildings Literature review and future needs, *Autom. Constr.* 38 (2014) 109–127.
- [74] F. Shayeganfar, A. Anjomshoaa, A.M. Tjoo, A smart indoor navigation solution based on building information model and google android, in: International Conference on Computers for Handicapped Persons, Springer, 2008, pp. 1050–1056.
- [75] J.W. Choi, S.A. Kim, J. Lertlakhanakul, J.H. Yeom, Developing ubiquitous space information model for indoor gis service in ubicomp environment, in: 2008 Fourth International Conference on Networked Computing and Advanced Information Management vol. 2, 2008, pp. 381–388, <https://doi.org/10.1109/NCM.2008.97>.
- [76] T. Hosna, R. Abbas, K. Mohsen, A new 3D indoor/outdoor spatial model for indoor emergency response facilitation, *Build. Environ.* 89 (2015) 170–182.
- [77] A. Motamedi, M.M. Soltani, S. Setayeshgar, A. Hammad, Extending IFC to incorporate information of RFID tags attached to building elements, *Adv. Eng. Inform.* 30 (1) (2016) 39–53, <https://doi.org/10.1016/j.aei.2015.11.004>.
- [78] R. Ivanov, An algorithm for on-the-fly K shortest paths finding in multi-storey buildings using a hierarchical topology model, *Int. J. Geogr. Inf. Sci.* 32 (12, 2018) 2362–2385, <https://doi.org/10.1080/13658816.2018.1510126>.
- [79] N. Skandhakumar, Integrated Access Control for Smart Buildings Using Building Information Models, Ph.D. Thesis, Queensland University of Technology, 2014.
- [80] N. Skandhakumar, F. Salim, J. Reid, R. Drogemuller, E. Dawson, Graph theory based representation of building information models for access control applications, *Autom. Constr.* 68 (2016) 44–51.
- [81] N. Skandhakumar, J. Reid, F. Salim, E. Dawson, A policy model for access control using building information models, *Int. J. Crit. Infrastruct. Prot.* 23 (2018) 1–10.
- [82] J. Shi, P. Liu, An agent-based evacuation model to support fire safety design based on an integrated 3D GIS and BIM platform, in: International Conference on Computing in Civil and Building Engineering, 2014, pp. 1893–1900.
- [83] R. Fosu, K. Suprabhas, Z. Rathore, C. Cory, Integration of Building Information Modeling (BIM) and Geographic Information Systems (GIS)—a literature review and future needs, in: Proceedings of the 32nd CIB W78 Conference - Applications of IT in the Architecture, Engineering and Construction Industry, Eindhoven, The Netherlands, 2015, pp. 196–204.
- [84] R. Ivanov, An approach for developing indoor navigation systems for visually impaired people using building information modeling, *J. Ambient Intelligence Smart Environ.* 9 (4) (2017) 449–467.
- [85] J. Park, K. Kim, Y.K. Cho, Framework of automated construction-safety monitoring using cloud-enabled BIM and BLE mobile tracking sensors, *J. Constr. Eng. Manag.* 143 (2) (2016), 05016019.
- [86] Z. Riaz, M. Arslan, A.K. Kiani, S. Azhar, CoSMoS: a BIM and wireless sensor based integrated solution for worker safety in confined spaces, *Autom. Constr.* 45 (2014) 96–106.
- [87] S.-H. Wang, W.-C. Wang, K.-C. Wang, S.-Y. Shih, Applying building information modeling to support fire safety management, *Autom. Constr.* 59 (2015) 158–167.
- [88] J. Dimyadi, R. Amor, M. Spearpoint, Using BIM to support simulation of compliant building evacuation, in: 11th European Conference on Product and Process Modelling (ECPMM), CRC Press, 2016.
- [89] J. Choi, J. Choi, I. Kim, Development of BIM-based evacuation regulation checking system for high-rise and complex buildings, *Autom. Constr.* 46 (2014) 38–49.
- [90] M.-Y. Cheng, K.-C. Chiu, Y.-M. Hsieh, L.-T. Yang, J.-S. Chou, Development of BIM-based real-time evacuation and rescue system for complex buildings, in: ISARC. Proceedings of the International Symposium on Automation and Robotics in Construction vol. 33, Vilnius Gediminas Technical University, Department of Construction Economics & Property, 2016, p. 1.
- [91] K. Yenmulu, C. Kolmer, J. Pan, X. Su, BIM-controlled signage system for building evacuation, *Procedia Eng.* 118 (2015) 284–289.
- [92] Y. Fang, Y.K. Cho, S. Zhang, E. Perez, Case study of BIM and cloud-enabled real-time RFID indoor localization for construction management applications, *J. Constr. Eng. Manag.* 142 (7) (2016), 05016003.
- [93] M. Arslan, Z. Riaz, A.K. Kiani, S. Azhar, Real-time environmental monitoring, visualization and notification system for construction H&S management, *J. Inform. Technol. Const.* 19 (4) (2014) 72–91.
- [94] R. Tomasi, F. Sottile, C. Pastrone, M.M. Mozumdar, A. Osello, L. Lavagno, Leveraging BIM interoperability for UWB-based WSN planning, *IEEE Sensors J.* 15 (10, 2015) 5988–5996.
- [95] J. Park, Y.K. Cho, D. Martinez, A BIM and UWB integrated mobile robot navigation system for indoor position tracking applications, *KICEM J Const. Eng. Project Manag.* 6 (2016) 30–39, <https://doi.org/10.6106/JCEPM.2016.6.2.030>.
- [96] J. Park, J. Chen, Y.K. Cho, Self-corrective knowledge-based hybrid tracking system using BIM and multimodal sensors, *Adv. Eng. Inform.* 32 (2017) 126–138.
- [97] H.M. Chen, T.Y. Chang, Integration of augmented reality and indoor positioning technologies for on-site viewing of BIM information, in: ISARC. Proceedings of the 31st International Symposium on Automation and Robotics in Construction and Mining, 2014, pp. 616–623.
- [98] M.H. Tsai, Y.C. Hus, C.M. Chiu, S.H. Chuang, BIM-Image-Based indoor localization prototype, in: ISARC. Proceedings of the International Symposium on Automation and Robotics in Construction vol. 29, Vilnius Gediminas Technical University, Department of Construction Economics & Property, 2012, p. 1.
- [99] F.W. Fichtner, A.A. Diakit , S. Zlatanova, R. Vo te, Semantic enrichment of otree structured point clouds for multi-story 3D pathfinding, *Trans. GIS* 22 (1) (2018) 233–248, <https://doi.org/10.1111/tgis.12308>.
- [100] U. R ppel, K. Schatz, Designing a BIM-based serious game for fire safety evacuation simulations, *Adv. Eng. Inform.* 25 (4) (2011) 600–611.
- [101] A. Anjomshoaa, F. Shayeganfar, A.M. Tjoo, Exploitation of semantic building model in indoor navigation systems, in: EGU General Assembly Conference 2009 vol. 11, 2009, p. 13476.
- [102] F. Li, S. Zlatanova, M. Koopman, X. Bai, A. Diakit , Universal path planning for an indoor drone, *Autom. Constr.* 95 (2018) 275–283.
- [103] J. Lee, K. Li, S. Zlatanova, T. Kolbe, C. Nagel, T. Becker, IndoorGML. <https://www.ogc.org/standards/indoorgml>, 2014 (accessed: March, 2020).