



INTERVAM

-I-

Graduation Studio - Heritage & Architecture - Re-Housing
Analysis Group Intervam - Rick Hoofd - Xiaoyu Chen - Chi Teng - Heejin Chung

Image: Utrecht Archive

Preface

This research report is a result of the first stage PI of our Graduation studio Re-Housing, which is under Chair of Heritage & Architecture at the Faculty of Architecture of Delft University of Technology.

The theme of the studio is about transformation of existing post war housing stock built with non-traditional-building-methods. VAM-system building is our group's main focus. We took one of the Vam projects, which is located at the Camera Obscuradreef in Overvecht, Utrecht, into further study. When we paid our first visit to the site, the housing corporation Mitro that owns the building stock is doing a pilot experiment with 8 apartments, aiming to evaluate the energy zero renovation plan.

Basically there are three sections: cultural value assessment, quality of living and technical study, which are parallel under research through the entire PI.

The framework of the architectural, cultural and technical analysis is based on 6's system of Steward Brand: site, structure, skin, service, space plan, stuff + 1's of "story".

Cultural value evaluation was assimilated into a matrix which is scaled on the y-axis according to the 7 S; and different heritage values designated on the x-axis: age, historical, artistic, commemorative, use, newness, conflict value of Alois Riegl's theory. Technical analysis was integrated in one axonometric drawing. In the meanwhile, the perception of quality of living was well developed during the course. Cases of transformation approaches were studied as well.

For the research, both primary and secondary sources were consulted, including relevant

literature, archives, newspaper, magazines, websites, site visits and interviews of the residents.

The research attempts to provide readers and ourselves the knowledge of VAM system, the history of urban planning and modern architectural movement and the comprehension of values, limitations and possibilities of the VAM project. The result is expected to solidify as a foundation for the individual design in the following process.

Last but not least, we would like to express our sincere gratitude towards the instructions and guidance from Ms. Lidwine Spoormans (architecture tutor), Mr. Bas Gremmen (building technology tutor), Mr. Nicholas Clarke (cultural value tutor) and Ms. Anne Lacaton (visiting professor of the office Lacaton & Vassal, Paris), who are all dedicated to the cooperative efforts in the graduation studio.

Introduction

This report is intended to analyse the building system Intervam which is a non-traditional-building-method developed in the housing shortage period after WOII. The research will focus on the specific area of Overvecht in Utrecht.

The first part of the report is the analysis of the building system. This section is divided into seven chapters. The first six chapters are based on the concept of 'S' system presented by Steward Brand in his book "How Buildings Learn". He introduced "shearing layers of change" with a brilliant diagram (Figure 1) which illustrates how the different building components change at a different pace. Because of their exposure and response to various environmental influences, some will last longer than others. The shear layers Brand identifies are: Site, Structure, Skin, Services, Space Plan and Stuff. In addition to the Brand's 'S' system, there is another layer, the Story, to cover the intangible qualities lying behind the project.

To be more specific on each chapter, the first is explained about the Site. This chapter contains the history of urban construction and urban planning strategies of Overvecht which were based on the modern principle of light, air and space.

The next chapter is about the Structure of the building system. Starting with the emergence of the Intervam system in the post-war situation, the manufacturing process and assembly of the prefabricated elements is addressed after that.

The Skin shows the distinctive character of the Intervam system. This chapter states about the main characteristics of the building facade in terms of technical and aesthetic aspects. The change of facade in the course of the building life-cycle is discussed as well.

The next chapter is the Service, which is closely related to the comfort of the living space. The change of building technology and specific agenda of the times have affected the subject to improve our living environment over time and it will

continue in the future.

The fifth chapter focus on the use of Space and Stuff which are mostly influenced by time and its user. The use of space in the living area is analyzed carefully by observation, comparison and interpretation to gain deeper understanding of the subject and illustrated in the detailed three dimensional drawings.

More information that we gained from the residents is displayed in the Story chapter. The change of demographics in Overvecht is analyzed with statistic maps.

All the chapters are concluded by the significant values that we found in this research. The possibilities and limitations to be considered for the future design is also described in the last page of the chapter.

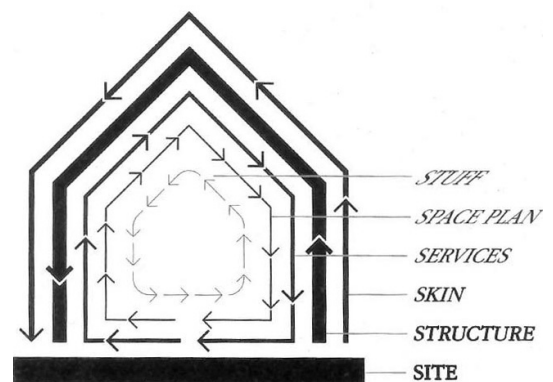

Figure 1: The 'S'-system of Steward Brand (Steward Brand, 1994)

The cultural value statement is discussed in the last chapter of this section. The values were identified by Alois Riegler and social value is added for this specific case of Overvecht. In the matrix, which is attached to the appendix, the values and the 'S' systems are arranged in rows and columns to assess the significance and priority that embodied in the seven building layers. The cultural value statement is to summarize and conclude with essential values what we explored in the matrix. This will motivate and guide our decisions during the design process. The axonometric is also included in the appendix. This is a comprehensive drawing that contains overall aspects of the building system.

The second part of the report is about the transformation approaches. The book "Plus" by Druot, Lacaton & Vassal, which shows specific transformation approach of existing housing blocks, is used as a starting point to relate them to our own design context. We choose the Park Hill project in Sheffield, UK as a counterpart to examine the reasoning behind each design method under different circumstances.

To conclude this report each student describes the quality of living in the last part, the Individual Approach. The quality of living is our personal statement which gives direction to the next phase of designing.

Time line

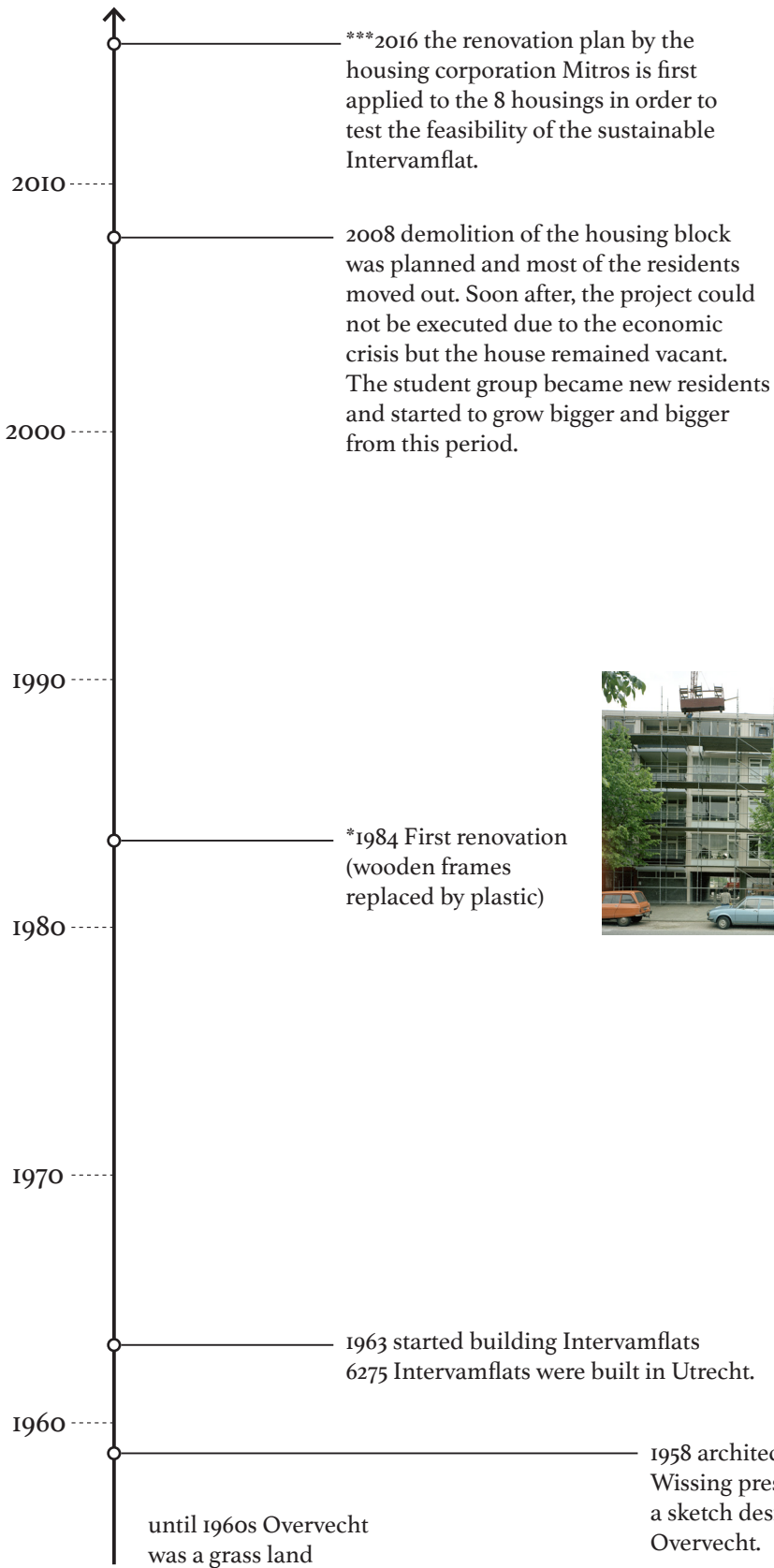

flatmettoekomst Keep It Simple Share Elsevier P&C

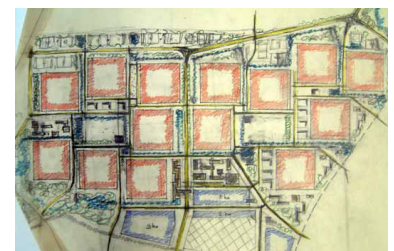

**24 April 1958
sketch plan of Overvecht



*2013 paintings on the wall by artist Jan is de Man and children in the neighborhood.



*after 2008 the open passage on the Taagdreef was closed by the request of the residents and filled with community programs.



*1984 wooden window frames of the facade (before the renovation)



*1984 plastic window frames of the facade (after the renovation)



*1965-69 two-storey residential-commercial housing block



*1983 two-storey residential-commercial housing block



*1965- 1970 public outdoor space between housing blocks

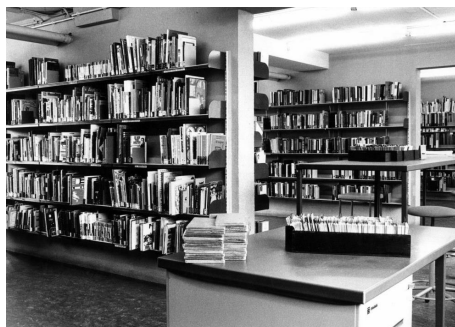

*1973-1978 public library in Vader Rijndreef 84



*1983 art sculpture by David van de Kop

Source: *Utrecht Archive
 ** NAI
 *** Mitros. (n.d.).

Table of Contents

Preface	3
Introduction	4
Time Line	6
I. Analysis of the system	
I-1 Site	
History of Overvecht	12
Urban planning	16
Site plan	22
Site analysis	24
Conclusion	27
I-2 Structure	
VAM system	30
I-3 Skin	
Skin	38
Concrete frame	40
Infills	42
Renovations on Skin	44
Construction Details	48
Conclusion	50
I-4 Service	54
I-5 Space plan & Stuff	
Introduction / Typology	60
Circulation	62
Use of Space & Stuff	64
Conclusion	84
I-6 Story	
Demographics	88
Interviews	90
I-7 Cultural Value Statement	96

2. Transformational approach

PLUS approach	100
Park Hill approach	102
SWOT analysis	108

3. Individual approach

Quality of living	III
-------------------	-----

4. Bibliography

123

5. Appendix

127

I. Analysis of the system

I-I. SITE

History of Overvecht

The post-war housing shortage



Figure 1.1.1 overview of the Intervamflats from Taagdreef in 1978
(Photo: the Utrecht Archive)

After the Second World War, the housing shortage in the Netherlands was estimated at 300,000 (Thijssen, 1990). The shortage resulted from several reasons. Before the war, not many houses were built for a period of ten years due to the economic crisis. During the war, few houses were built but a lot of houses were lost by the bombing. After the war, the demand for houses was big. The population increased rapidly because of the post-war birth explosion and people who repatriated from Indonesia (Battum, 2002). More houses were needed than Dutch developers were capable of building. There was also a shortage of traditional building materials and skilled workers. Furthermore, the Netherlands lacked the finances to build the full number of homes required. For these reasons non-traditional building methods were further investigated. Some parts of the production moved to the factory in order to guarantee manufacturing conditions. In most cases concrete was used to replace the lacking traditional building materials.

The development of non-traditional building methods started in 1920, but it was applied on a bigger scale after the Second World War. In 1944 the foundation 'Stichting Ratiobouw' (roughly translatable as the 'Rational Building Foundation') was established. This foundation stimulated the development of construction systems. People who had an idea about a building system and wanted to develop it could apply to the commission (Priemus & Van Elk, 1971).

To ensure that new housing was fairly spread across the country and to avoid wastage in building capacity the government involved in every level of construction. Each year the municipalities were told how many homes they were allowed to build. When a local council demolished inner-city slums or worked with efficient construction systems they were rewarded with a quota (Renée Kool and Neeltje ten Westenend, 2011).

Urban construction

Between 1945 and 1970 ten new neighborhoods were developed in Utrecht, of which Overvecht was the largest and the most quickly realised. In 1954 the municipality borders were extended from the overall area of 2300 to 5200 hectares. The city was able to build large-scale estates such as Tolsteeg-Hoograven, Kanaleneiland and Overvecht. The master plan from 1954 showed how the city intended to grow from 243,000 to 307,000 residents with the construction of 37,000 new homes (Kijken naar Overvecht, 2011).

Pre-war building methods were inadequate to meet the quantities of homes required in the post-war period. However, the war effort had focused attention on inexpensive and quick building methods and studied into prefabrication and standardisation. Around 1960 the construction industry became truly industrialised and also the scale quickly grew. Cranes, large pre-fabricated elements and a variety of construction system were used to build mass housings. These rationalised and industrial construction methods meant that entire neighborhoods could be built with great speed.

After 1954 Overvecht was the largest estate in Utrecht where ideal city could be realised in the purest form. It was designed as a fully fledged neighbourhood with a mix of housing and amenities (schools, shopping centres, hospital), work (offices, industry) and recreation (swimming pool, sports facilities, parks and cemetery). The neighbourhood concept was a typical product at the time to avoid social alienation and congested life in the city. The idea was to build recognizable neighbourhoods that could work as a close-knit communities. Each neighbourhood is defined by the surrounding green area which could work as a buffer zone. The important character of this ideal city was to connect the dwelling with different level of urban scales such as the neighbourhood (*buurt*), town (*wijk*), district (*stadsdeel*) and finally the entire city (*stad*).

map source : mappinghistory.nl



Figure 1.1.2 urban map in 1945.

Before the urban development Overvecht was a grassland.



Figure 1.1.3 urban map in 1970

Mass housings were built at a rapid pace

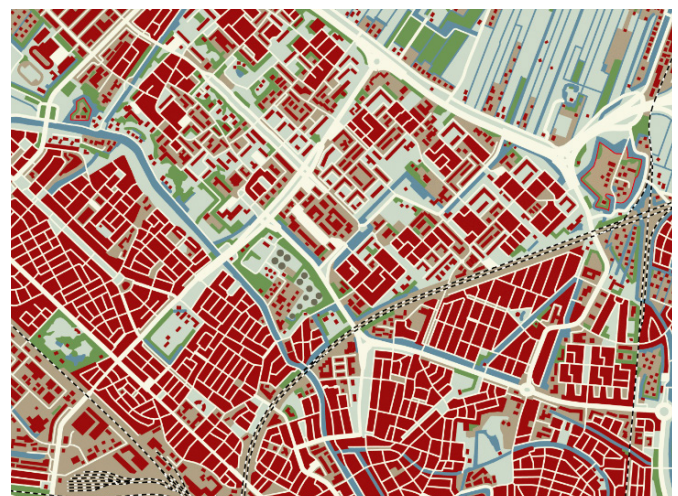

Figure 1.1.4 urban map in 2016

the greenery was began to be filled with buildings to densify the area since 1980s under the name of 'stadsverdichting'

The new concept of the city



Figure 1.1.5 Catholic version of “Wijkgedachte”
 (image link: <http://www.bestaandewoningbouw.nl/begrip-van-het-verleden-biedt-kansen-voor-de-toekomst/>)

The “Wijkgedachte” is an urban theory that was used to design the cities during the reconstruction period after the Second World War. Architects, urban planners, sociologist and policy makers engaged in the discussion and studied for the new society. The study was based on the vision to seek for a panacea against the superficiality and alienation of the big city. They also wanted to create the society in which the religion, social status, and stage of life was no longer the determinant to form a boundary. The new city would be the place where diverse people can live together by establishing the community.

The Overvecht area has been realized in 1960s based on the idea of “Wijkgedachte” and it was the typical product of its time. The idea was to build cities consist of recognizable neighborhoods that would function as a community. The neighborhood therefore consisted of housing types for all ages: young families, the single, the elderly couple. The facilities were classified by the frequency of use and divided into certain distances. For example, each neighborhood is partly self-sufficient by the

existence of bakery, grocery store and community center at the neighbourhood scale. The rest of the larger-scale facilities such as hospital, theater or university are available at the city level. The principle of ‘stempel’ was used here as well. There was a combination of high-, medium-, and low-rise buildings with different kinds of public spaces located inbetween the housings. The children were playing on the playground close to the houses and people were strolling along the park. The large central square was mostly having a paddling pool.

This new concept which emerged during the time of post-war period now creating challenges for the future. It was designed to build a ‘perfect society’ to improve the living condition. It appeared that a single neighbourhood is not capable to provide a wider range of welfare that is required for the citizens. However, as the society overflowing with individualism, a sense of community is drawing attention. It is important to bring back the inherent value of the “Wijkgedachte” and think about how to add the new quality of today’s society.

The original master plan

In the 1950s it was thought that Overvecht would not be realized until the distant future. The city council believed that the Hoograven and Kanaleneiland estates would provide sufficient numbers of housings for many years to come. But the increased scale of construction and the economic growth fostered the building sites to be filled up much more quickly than expected and thus the requirement in Overvecht became urgent already in 1958. At that moment the city council did not have sufficient manpower to begin construction of the new estate. Because Utrecht did not, however, want to give up the right to build large numbers of new homes, the municipality commissioned the design of the estate to an external urban planning office: Bureau Wissing in Barendrecht (Kijken naar Overvecht, 2011).

In 1958, architect Wim Wissing presented the design of Overvecht, with a detailed design of Overvecht-Zuid. He divided Overvecht into fifteen small neighbourhoods. Each neighbourhood would contain approximately 800 homes, divided between terraced housing (rijtjeshuizen) and medium-rise blocks with a maximum of six storeys. Between the neighborhood there were green zones named 'recreational strips'. These offered a connection for pedestrians and cyclists to the parks and schools. He also established green zones at the edges, to act as a buffer between the estate and the surrounding environment. (Kijken naar Overvecht, 2011) However, the original urban planning was not fully implemented. The seven neighborhoods of Overvecht-Zuid with the green frames and the shopping center on the edge of Overvecht were realized, but the structure of the neighborhood was changed and mostly decided by the municipality.

The original urban planning was not implemented because the municipality had to meet the demand of housings as quickly as possible. The city began clearing the land for the seven neighbourhoods of Overvecht-Zuid even before Wissing's design was approved. In 1962, the first housings were finished in Overvecht-Zuid. By 1966 4200 out of

7000 housings were completed and the remainder was under construction. During the construction of Overvecht, there were two significant changes compared to the original master plan. First, the minimum height of the building in the neighbourhood was increased from six to ten storeys. This was due to the pressure from the building contractors, to ease the housing shortage. The second change was that more single-family homes were built than originally intended. This was due to the fact that, in the early 1960s, the municipality had negotiated with central government to build a large number of heavily subsidised houses, so-called 'keuzeplanwoningen'. These changes created great contrasts of the skyline in this area.

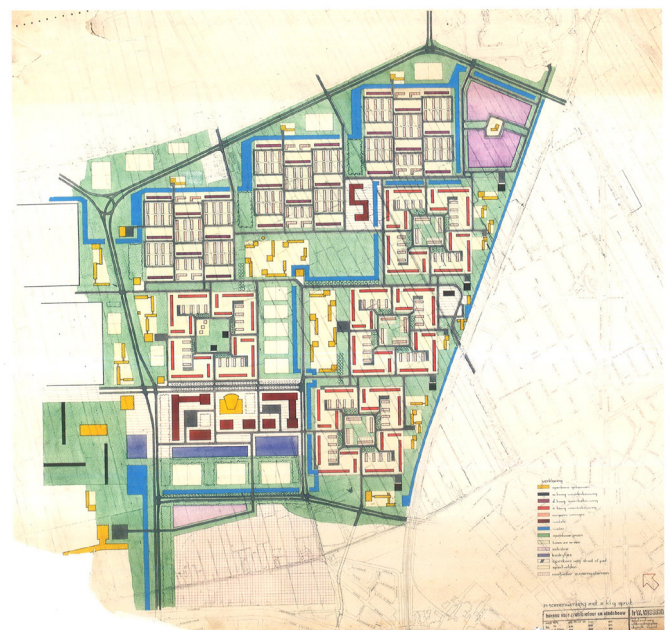

Figure 1.1.6 Expansion plan of Overvecht-Zuid in 1958 by Wissing & Spruit (image: NAI archive)

Urban Planning

Overvecht-Zuid

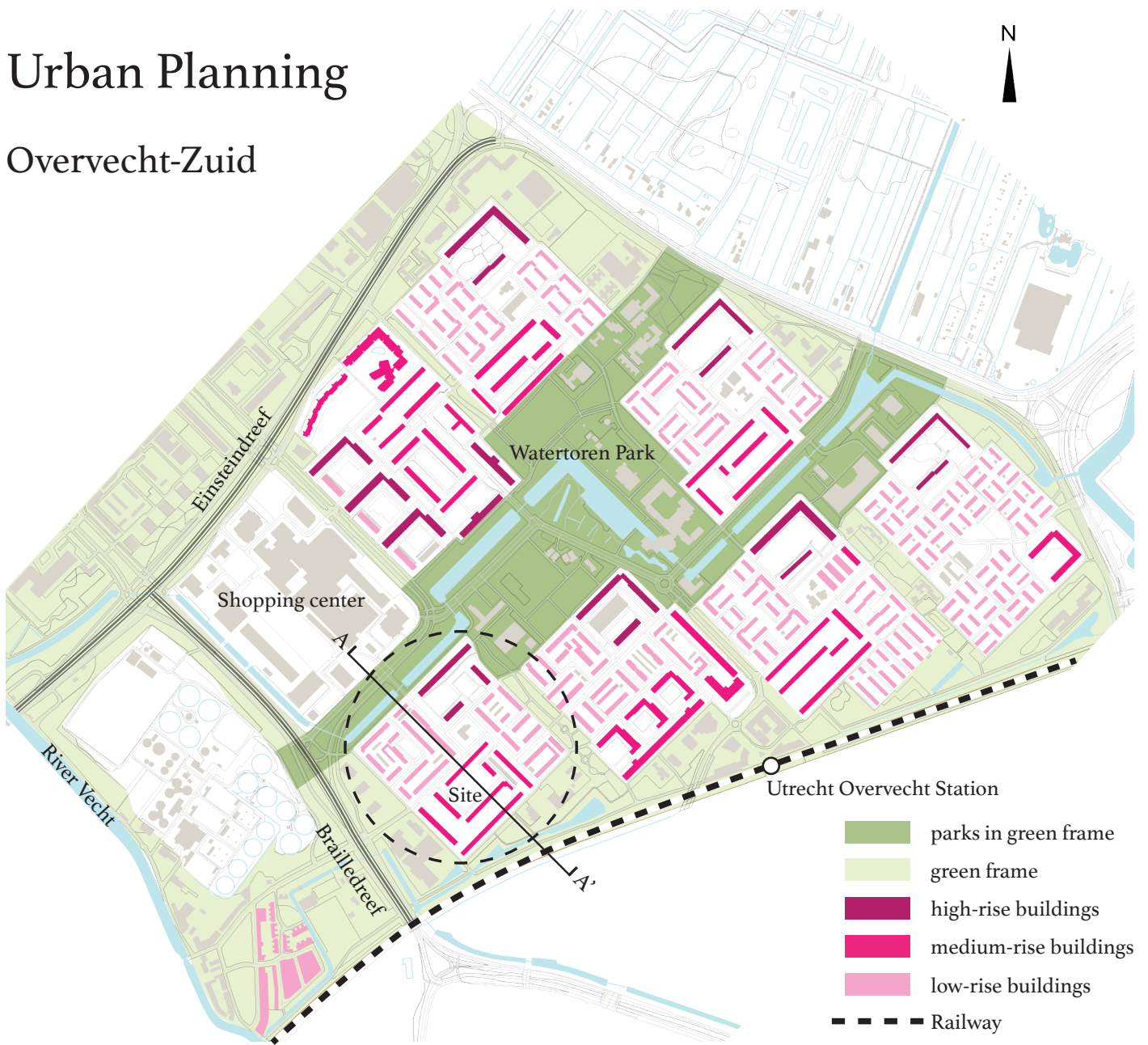

Figure 1.1.7 urban planning map

Overvecht is one of the ten districts of Utrecht located on the northern outskirts of the city. It is the largest expansion area Utrecht with 33,732 inhabitants (2015, source: www.utrecht.nl). The area is characterised by spacious greenery with stacked high-rise flats built in post-war period. Majority of the buildings (approximately 80%) is social housing. Each neighbourhood is clearly defined by the surrounding green frame. It was designed as a modern garden city with the principle of open planning. The structure of the neighbourhood consists of strips of buildings. In most cases, the buildings have more than one front side because they are facing the main street on one side and communal outdoor space on the other side.

The designated site is located in one of the seven neighbourhoods in Overvecht-Zuid. The boundary of Overvecht-Zuid is marked by Brailledreef, Einsteinendreef, the municipal boundary with Maartensdijk, and railway connects Utrecht - Hilversum - Amersfoort. The seven neighbourhoods are situated around the Watertoren Park. Each neighbourhood has the same structure which is repeated as “stamps (*stempel*)” but the configuration of the buildings varies by stamp. Almost all of the buildings and streets are planned in the strict orthogonal grid orientated toward the same direction. The buildings show a distinction between low-, medium-, and high-rise. The main facilities in the area include a large shopping center and Overvecht station.

Each stamp has the following areas:

- The corner stone (*De hoeksteen*)

The corner stone, which is located in the northern corner, is the highest part of the neighbourhood. The high-rise apartments are standing here with the central courtyard.

- The fields (*De velden*)

The fields are small neighbourhoods composed of cohesive housing complex with medium- or low-rise houses.

- The square (*Het plein*)

At the center, the square is enclosed by the fields and corner stone. The square is generally reserved for special functions such as a community center.

- The wing (*De molenwiek*)

The wing consists of the streets that run between the different areas. The streets together have the shape of the blades of a windmill and function as the entrance to the neighbourhood.

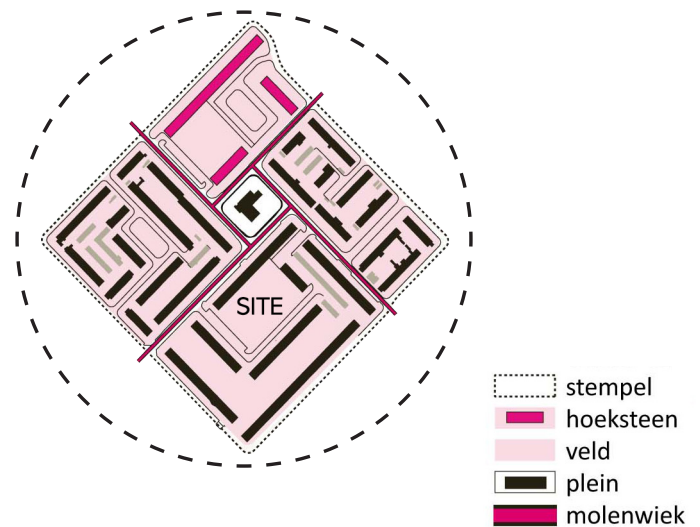

Figure 1.1.8 structure of the neighborhood

(image link: http://ro-online.robeheer.nl/0344/8F29C843-19C2-41E8-AB55-A18699DF96DD/t_NL.IMRO.0344.BPOVERVECHTNSR-0601_3.2.html)



Figure 1.1.9 buurtcentrum in 1987
(photo: the Utrecht Archive)

The community center (*buurtcentrum*) located at the square (*Het plein*) of the neighbourhood. This place provide space to residents for diverse social activities such as fitness class, social event, childcare etc.



Figure 1.1.10 View of Overvecht-Zuid
(photo by domtoren, link: <http://www.skyscrapercity.com/>)

The high-rise building at the corner can be recognized easily from the street. It seemed like a punctuation of each neighbourhood. The scenery of the district is characterised by the overlapping layers of repetitive housing blocks.

Street Profile

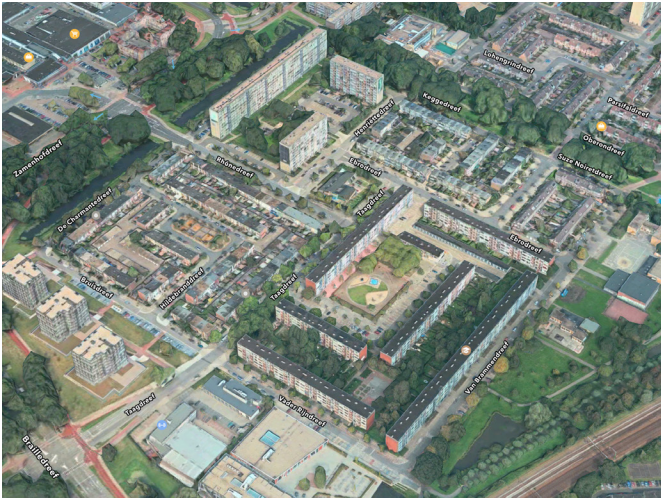

Figure 1.1.11 three dimensional map showing the configuration and clear distinction of the building height

In 1969 the distribution of housings in Overvecht-Zuid was as follows (Dienst Stadsontwikkeling afd. S.E.S.O., Uitbreidingsplan Overvecht in cijfers en tijd, 1969) :

High-rise (55%)

High-rise residential building in Overvecht are mostly disc-shaped building with portiekflats of ten storey high. The characteristic of these buildings is that they are able to form a space which could serve as a courtyard.

Medium-rise (24%)

Medium-rise buildings generally consist of five layers. It could play a role as a connection between high-rise and low-rise buildings. The ground floor is a combination of entrance hall, housing, storage and garages. The houses on the ground floor normally has a garden on the back side and the front side which is adjacent to the public street.

Low-rise (21%)

Overvecht has a large amount of low-rise housings. Normally, they are single-family houses with front and back yard. Originally, the low-rise buildings have a collective image. But over time, the residents made adjustment for their houses to have individual appearance.

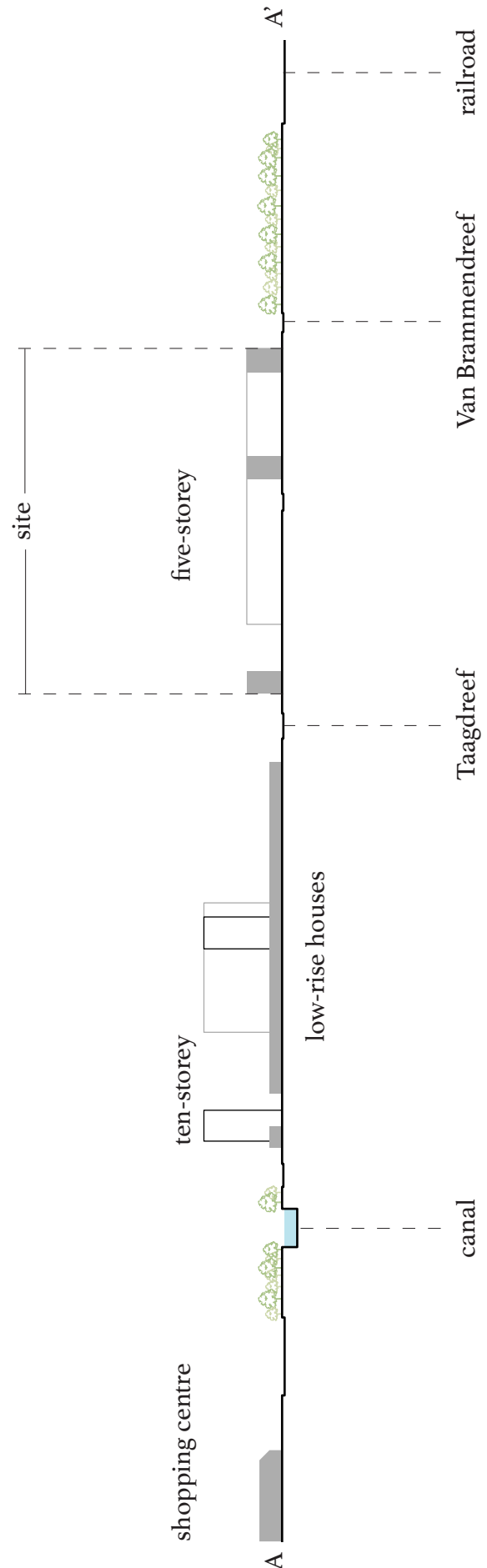



Figure 1.1.12 courtyard in high-rise housings

The high-rise housing blocks are located around the courtyard. The courtyard is more open to the public street compared to the courtyard in medium-rise housing blocks. The access from the housings to the courtyard is difficult in the higher level.

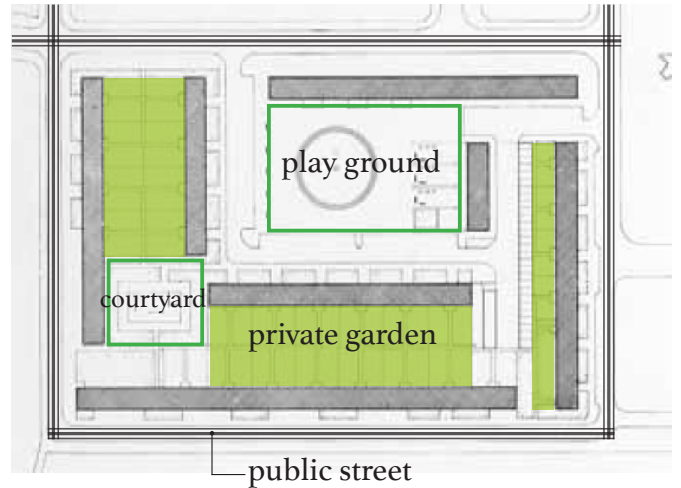

Figure 1.1.13 outdoor space in medium-rise housings

The medium-rise housings are facing the public street on the front side and the private garden on the back side. The housings on the ground floor can use to the garden. The parking space, courtyard, and private garden is carefully designed in the housing block. Those communal spaces can contribute to the social cohesion for the community.

change in appearance of low-rise housings



Figure 1.1.14 street view of Ebrodreef in 1978 (photo: the Utrecht Archive)

The low-rise housings share the same image when it was first built in 1960s. A large amount of low-rise housings were built with standard design so-called 'keuzeplanwoningen'.



Figure 1.1.15 street view of Ebrodreef in 2015

The colour and material of the building facade have been changed over time. Some of the balconies are extended to have more interior space. The fence between the pedestrian and front yard also have different appearance by each housing.

The phase of construction

In 1962, the five-storey Intervam flat was built on a large scale in Kanaleneiland of Utrecht. The urban planning of the Kanaleneiland is strongly influenced by the building system. Every Intervam housing block was standing in a row facing the main street. This was due to the construction method which requires 38.5m to be kept free on site during assembly process. The building materials were transported from the factory and put together on site by the crane. This is why the wide road was needed next to the construction site.

The similar Intervam flat was also realized in Overvecht. The same floor plan was applied to some of the medium-rise buildings in Overvecht-Zuid but on the different site plan. In 1962 the first five-storey Intervam flat was built in Donaudreef. The complex consists of six buildings with 336 homes. However the buildings were demolished in 2011. The new building constructed with 70 percent of private housing and 30 percent of social housing (Jongeren, sloop en sociale stijging, 2011). This illustrates that the building program should contribute to the social mixing in Overvecht. The proportion of owner-occupied homes will therefore continue to rise.

In 1964 the other five-storey Intervam flat was built in Camera Obscuradreef (Figure 1.1.18). After a year the single-family houses were built next to this Intervam flat. In other neighbourhood the single-family houses, especially the keuzeplanwoningen, were built earlier than medium-rise buildings. This is because the government gave extra subsidy which was 40% more than the average to this housing type (to cultuurhistorisch onderzoek en ruimtelijke analyse Utrecht NaOorlogseWijken, 2006). The medium-rise Intervam flats were the first dwellings that was built in this neighborhood. For this reason, it can be assumed that Intervam flat could be built first allowing remaining space for the following construction (Figure 1.1.18).



Figure 1.1.16 Medium-rise Intervam flat in Kanaleneiland



Figure 1.1.17 Demolition of the Intervam flat in Donaudreef. (Photo link: <http://mapio.net/s/42073773/>)

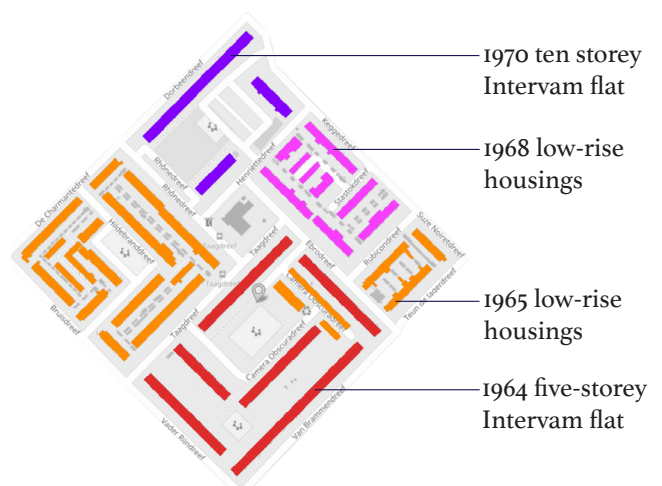

Figure 1.1.18 construction phase

Along with the ground-level terraced houses (*rijtjeswoningen*), just as many stacked housings were constructed in portiekflat which was the most common housing until 1965. Soon after, the natural gas was widely introduced in the heating system after the gas was discovered in Slochteren. The housing can be higher than five-storey, because the coal was no longer needed to be carried upwards (Kansen voor de naoorlogse portiekflat, 2015). From this period, other Intervam flats were all built in ten-storey buildings. The ten-storey Intervam building could be found in Overvecht-Noord and they were built after 1967 as well. The Intervam building system might be inefficient to be built as medium-rise building because it required a lot of space during the construction. The housing blocks in Camera Obscuradreef are only one that is still remained as a five-storey Intervam flat in Overvecht-Zuid.



Figure 1.1.19 Intervam flats in Overvecht-Zuid

The large scale urban development was imported from Kanaleiland, where the urban construction started in the years prior to the construction of Overvecht. The high-rise portiekflats were possible from the previous experience. When contractor Intervam introduced the building system, they worked with municipality to develop the floor plan for ten-storey building. The lift was added to the stairwell and three housings were included in every level of one portiek. The city of Utrecht benefited from the building system, because the priority was to achieve large house numbers with maximum rationalization of the construction process.

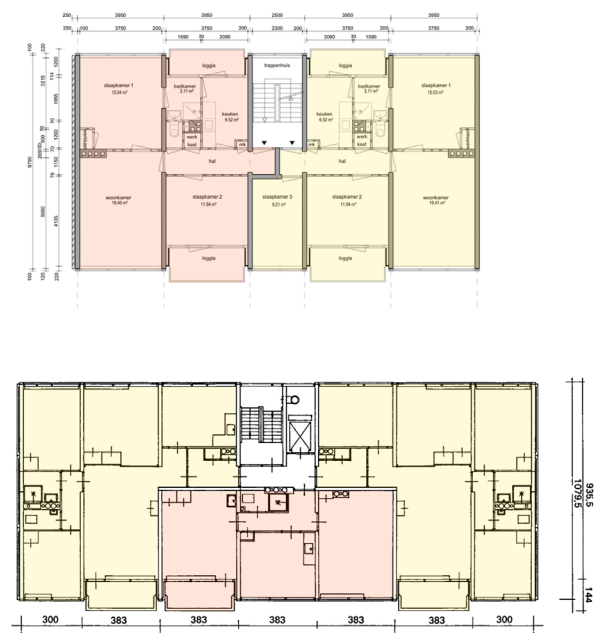

Figure 1.1.20 Intervam floor plan :
five-storey floor plan (above)
ten-storey floor plan (below)

Site Plan

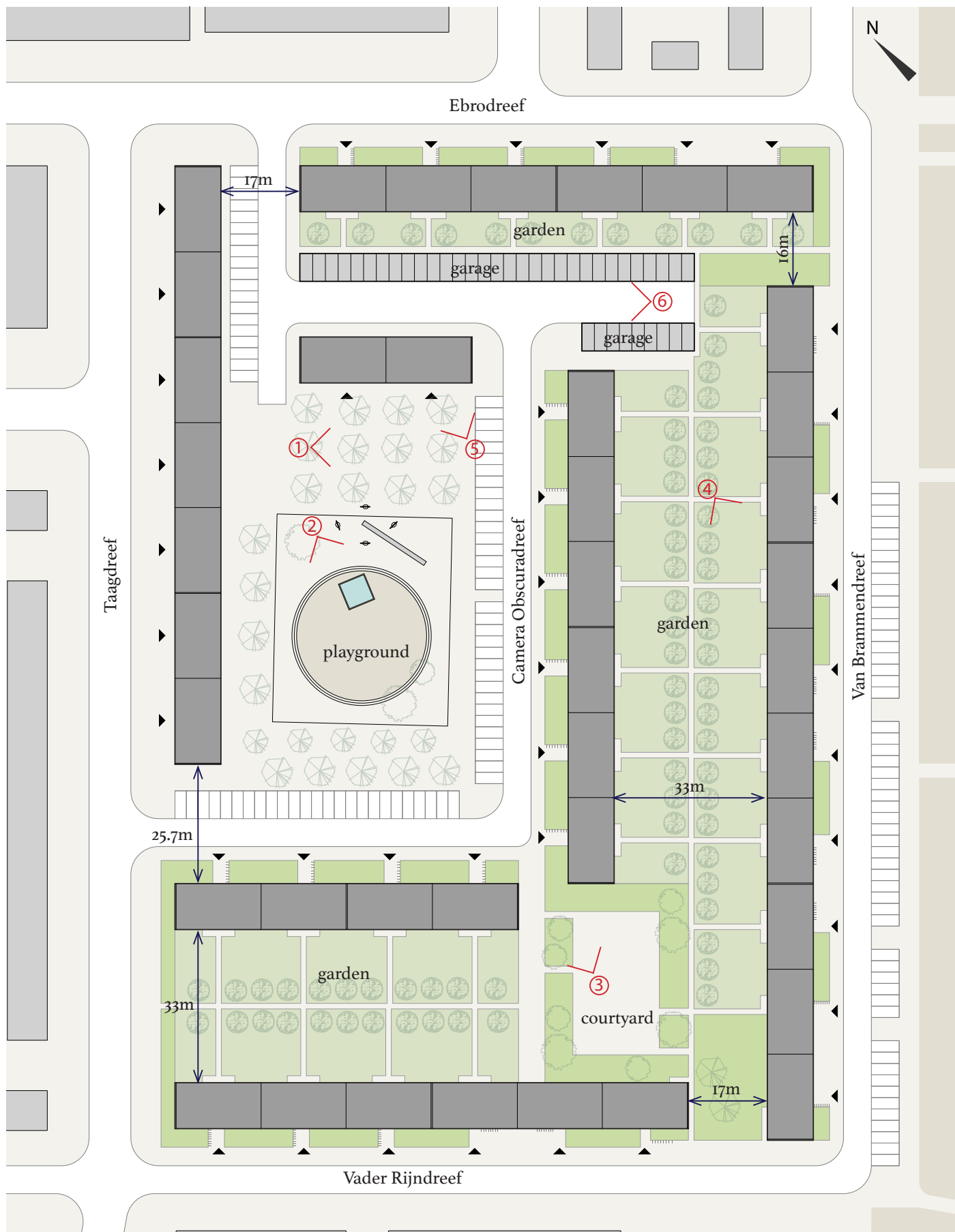

Figure 1.1.21 site plan

The project area is consist of six medium-rise housing blocks on the Taag- and Ebrodreef. The type of housing blocks is a portiekflat with five-storey. The total amount of households is 312. The outdoor area can by define by three different milieus, namely a square (Camera Obscuradreef), an inner area and the outer shell. At the square there are playground, parking space, and two-storey residential-commercial block. The design of the square was not part of the planning. The playground equipment, a sunken lawn, some benches, trees and a parking lane were included during the construction (10 cultuurhistorisch onderzoek en ruimtelijke analyse Utrecht NaOorlogse Wijken: Overvecht, 2006). Today the playground is enclosed by the fences. The ground floor of the two-storey block was designed for shops and the first floor was usually occupied by shop

owners. Right behind the shops there are ground-level garages. The inner areas is largely divided into private gardens and public courtyard. The different world of 'secret garden' is hidden behind the portiekflat. The private garden is connected to the apartments on the ground floor and first floor. The inner courtyard at the corner is a communal outdoor space with a plant box. The outer shell of the housing blocks is public green area facing the main street. Originally there were several public facilities on the ground floor along the street such as the church in Ebrodreef and public library in Vader Rijndreef. Now the public facilities today do not seem to function optimally, and the question arises whether they could have a relationship with the outdoor area of nowadays. Most shops have been closed their doors, partly because of the competition with the large supermarket near the neighbourhood.



1. Full of greenery in the courtyard provide pleasant atmosphere. The public furniture such as benches and streetlamps could encourage the use of space.



2. Mostly the playground is empty because there are less families left. The residents decided to build fence around the playground for the maintenance reason after 2008.



3. Inner courtyard is located at the corner. The paintings on the wall was done by artist Jan is de Man. He collaborated with the children living in the neighbourhood.



4. The private garden is surrounded by high hedges and shows unexpected quality but the poor maintenance still remained for the task needs to be addressed.



5. The two-storey residential-commercial complex was originally designed to provide basic necessities nearby. Now, there are Mitros office and Turkish bakery on the ground floor.



6. The single-storey garages are standing in a row. People can rent the space for 100 euro per month. The area seems disconnected from the surrounding environment.

Site Analysis

Openness and transparency of public space

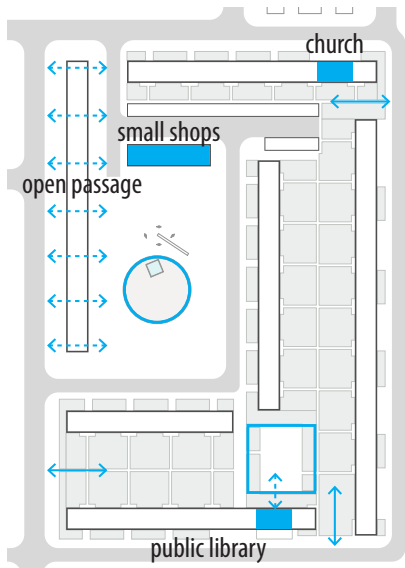

Figure 1.1.22 past

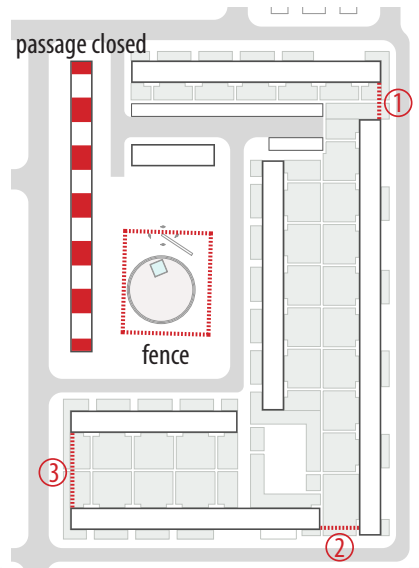

Figure 1.1.23 present

In the past, there was open passage on the ground floor next to the Taagdreef. The playground in the center of the housing block was more open to the public. The two-storey residential-commercial complex was facing the public courtyard. There would be more chance for residents living nearby to use the small shops in this two-storey building. Several spaces on the ground floor facing the main street also filled with public functions such as library and church. The site was designed in accordance with the modern principle of openness, so the housing blocks were more open and transparent toward the surrounding environment



1. The green bushes are kept in low height. The narrow street connecting the public street and housing block is not completely closed.



2. The fence is built along the edge and it is covered by the green bushes. The gate on the fence is mostly closed.



3. Present: The width of the edge is 33m. The tall trees and green bushes are blocking the sight. The fence around edge is mostly closed.



3. Past: The boundary between public street and private garden was not clearly defined. The housing blocks are more open to public space. (Photo: Utrecht Archive)

In 2008, the housing blocks were planned to be demolished. Most of the residents had to move out from their houses. Due to the economic crisis in the same year the construction plan could not be implemented. The site was remained empty and abandoned for a while. The open passage on the ground floor became a place for homeless people and the playground was occupied by the drunken people. The remaining residents required Mitros to deal with the insecure problems. Finally, the open passage was closed and offered as a space with community program for free. The playground and boundary of the site closed by the fence as well. However, the security problems have not been solved successfully. 50% of the residents feel unsafe in the neighborhood. This is the highest among all Utrecht areas and has increased since 2011 (WijkWijzer 2016). The residents who lived here for a long time remembered that the safety condition was better before the families moved out.

The relationship between housings and communal spaces

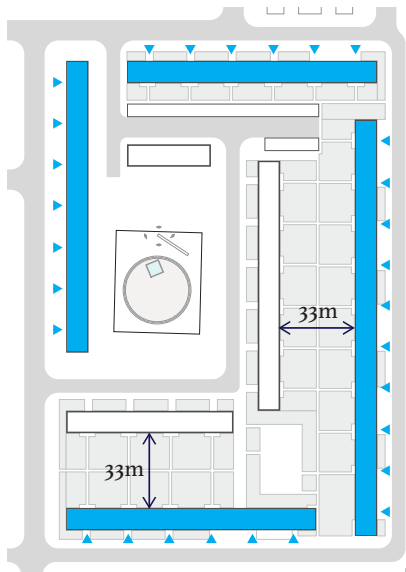

Figure 1.1.24 outer layer of housings

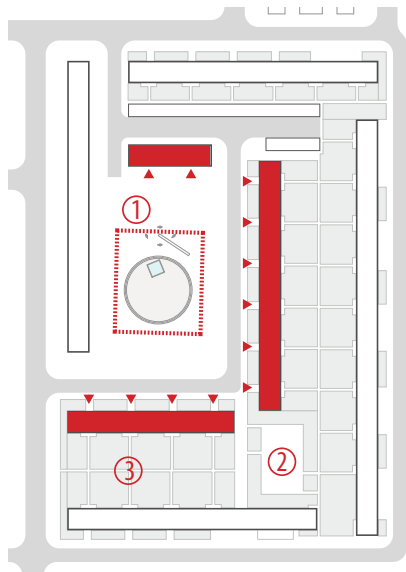

Figure 1.1.25 inner layer of housings

The dwellings share the common principle of housing plan but they are not functioning well as a whole community. The housing blocks are rather standing independent than closely connected to each other. The outdoor communal space was carefully designed for social cohesion at the beginning but those spaces often left abandoned as well.

There are two layers of housing blocks in the site. The outer layer of four housing blocks are facing the public street and the inner layer of three housing blocks are facing the courtyard. The private garden(3 in Figure 1.1.25) and the small courtyard(2 in figure 1.1.25) located inbetween these two layers are not fully used and well-maintained by the residents. This is because those spaces are not connected to the main entrance of the housing blocks or the living area of the individual housing. The far distance between the housing blocks might also cause the difficulties for residents to get to know each other.

The social service organization, for instance Stichting Siguro, Stichting Present and also some religious groups, wanted to make the outdoor space more nice and livable. They, together with the residents, put planting boxes and wall painting in the small square to give energetic atmosphere but those efforts were not the fundamental solution for the problem. The more important thing is to reconsider about the spatial relationship between housings and communal spaces. It is important to reinforce the interaction between the residents and voluntarily induce them to take care of their living environment.



1. The fence was built around the playground after 2008. Most of the time the space turns out to be empty and hollowed.



2. The vegetable garden was placed in the small square by the volunteers of church group in 2014 but it became ruined and useless.



3. View of the backyard in November 2014. The green bushes are well-managed at the time. (Photo taken by Leo)



3. Two years later in September 2016 the bushes were grown but the residents did not put much effort to maintain the garden.

Light, Air and Space

The site plan is designed by the modern principle of light, air and space. CIAM had demonstrated the fundamental importance of favorable solar orientation in low-cost apartments. Cornelis van Eesteren who was the chairman of CIAM and worked for Town Planning department in Amsterdam also argued that the best position for sunlight for a particular housing type should determine the direction of the whole apartment series.

The distance between the housing block would be decided carefully to fulfill this requirement. In this Intervam case, all the housing blocks can bring the daylight in the interior space during the daytime both in winter and summer. However, the rigid geometries of urban planning would raise a question for neighbourhood approach that demand more association and organic connection between housing blocks.

Shadow study - winter

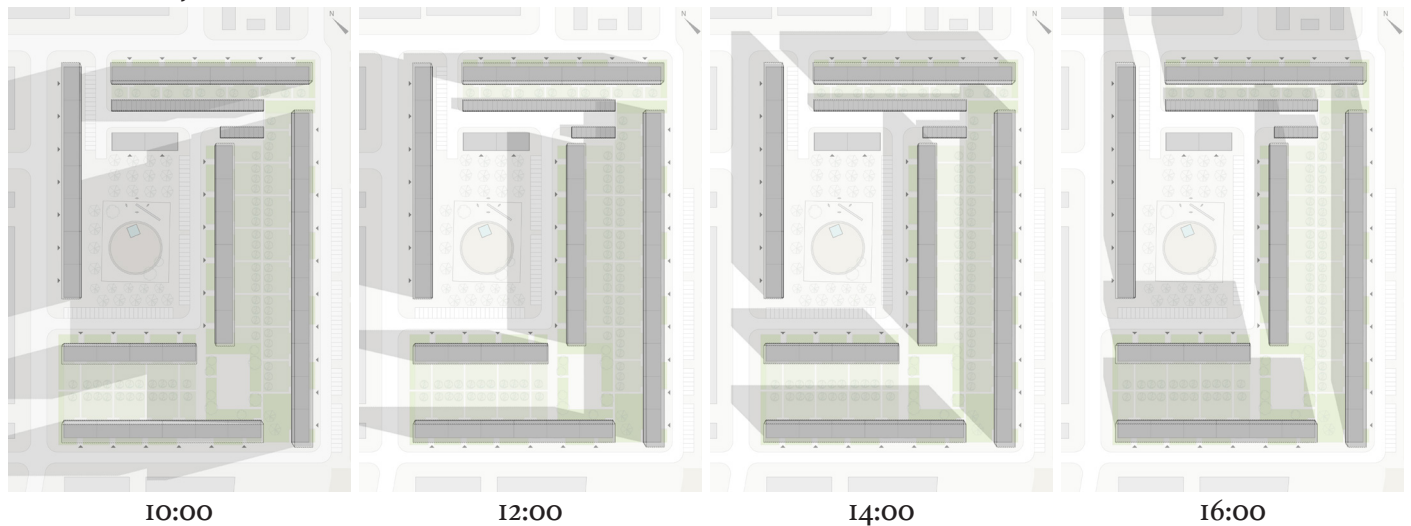

Shadow study - summer

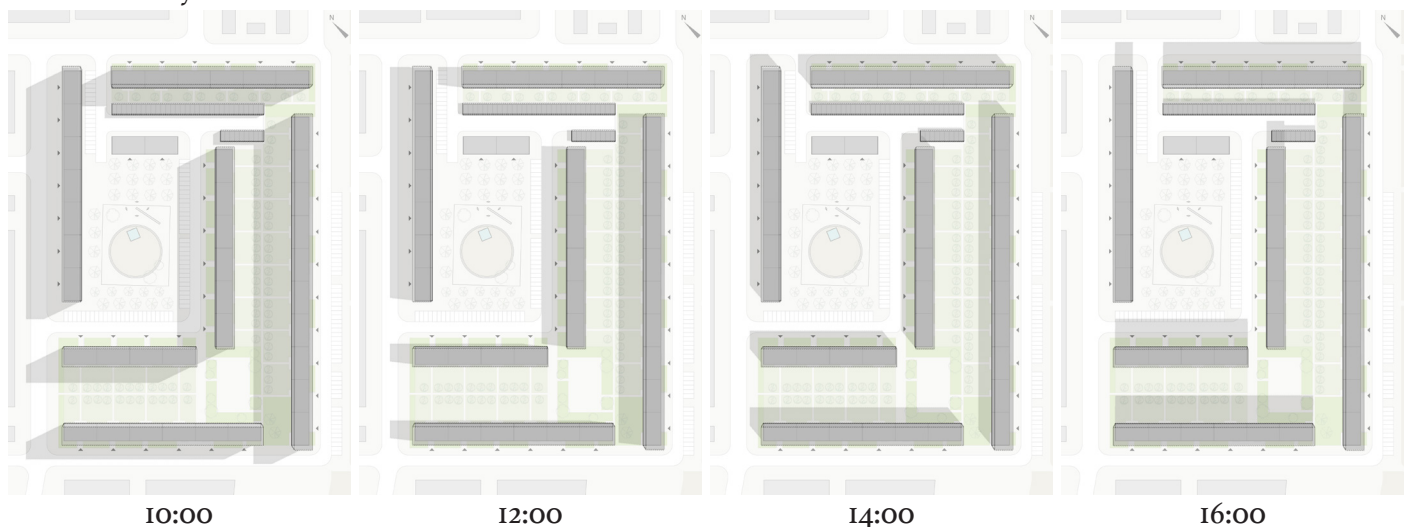

Conclusion

Value

- Overvecht area is a typical product of the post-war period. A desire to build the ideal city where different group of people could live together was reflected on the urban planning. A sense of community deeply rooted in the original design will shed new light on today's society.

Possibilities

- A full of greenery and different kinds of outdoor spaces between the housing blocks can contribute social cohesion to the neighbourhood and encourage people to live healthy life.

- A mix of different housing types, low-, medium- and high-rise buildings can be offered to all kinds of residents such as large family, elderly and students. The plinths on the medium-rise housings can be adapted to suit for different functions. Community programs, commercial shops or any other functions can be introduced in this space.

Limitations

- 50% of residents think Overvecht is unfavorable place for living. Residents do feel unsafe in the neighborhood, which is the highest among other Utrecht areas and has increased since 2011. Also, youth nuisance showed an increase; 41% frequently experienced youth nuisance (WijkWijzer 2016, Gemeente Utrecht).

- The housing blocks contain different levels of outdoor spaces but the use of space is limited by its spatial structure. To foster proper use and maintenance of the communal space, the relationship between living area and outdoor space should be reinforced.

I. Analysis of the system

I-2. STRUCTURE

VAM System

Non-traditional-building-methods

The development of non-traditional-building-methods started in 1920 but was applied on a bigger scale after WOII. In 1944 the foundation 'Stichting Ratiobouw' was established. This foundation stimulated the development of construction systems. Everybody who had an idea about a building system and wanted to develop it, could apply to this commission after the war. If the system was approved two to ten pilot houses could be built. When the result was satisfying 50-100 more were built. When a construction company would build with this system 10% of the building cost would be subsidised by the government but in the end this procedure took a bit long. The government introduced the English system-Airey to set an example in 1947. In the end of 1947, 21 systems were recommended, 19 of them were recommended for mass production. The period between 1946-1951 can be seen as the main development period of the non-traditional-building-methods. In the period of 1952-1954 the subsidies stopped due to political issues. In 1954 subsidies were provided if a reduction of 40% on craftsmanship could be established. In the period after 1956 several multi-year contracts were signed which brought more security to the construction companies. Six of the systems were frequently built. The contracts were abandoned in 1960 which made it hard for new systems to start. In this year prefabrication system 'Larsen & Nielsen' founded a factory in Maassluis. Iboco was made here, a system that will develop into the VAM system.

VAM system

The VAM system is a prefabrication building method conducted mostly by Intervam N.V. but some are built as well by Brabant-O. 14,000 'portiekwoningen' have been built with this system, 6,500 of them were built in Utrecht. The system consists of heavy mounting elements which were prefabricated in the factory. The factories were located in Valkenburg (Z.H.) Hoogkerk and Utrecht (figure 1.2.1). The factory in Utrecht is the largest one where all the walls, floors and 'galerijplaten'

were made (figure 1.2.2). The other two made more specialized elements such as stairs, parapets and eaves. The elements are merged together on the construction site, which have four or ten storeys (figure 1.2.3). The three factories together have a production capacity of six houses a day. The transport of the elements to the construction site was done with trucks (figure 1.2.4 and 1.2.5). By placing the elements directly from the truck, there was no unnecessary transportation on site. For one house four trucks were needed. For assembly a crane was needed called 'looppadkranen'. When two cranes were used on site, 4 to 5 homes could be built each day. Ten people (half of them unskilled) were needed to put a building together. The fast construction time and reduced working capacity are characteristic of the non-traditional-building-methods. By using the VAM system a saving of 53% on man hours on the construction site can be obtained. The total number of man-hours for one property (including factory production and on-site construction) is 1000, in comparison the average was 1600 hours (Van Nuenen, 2013).

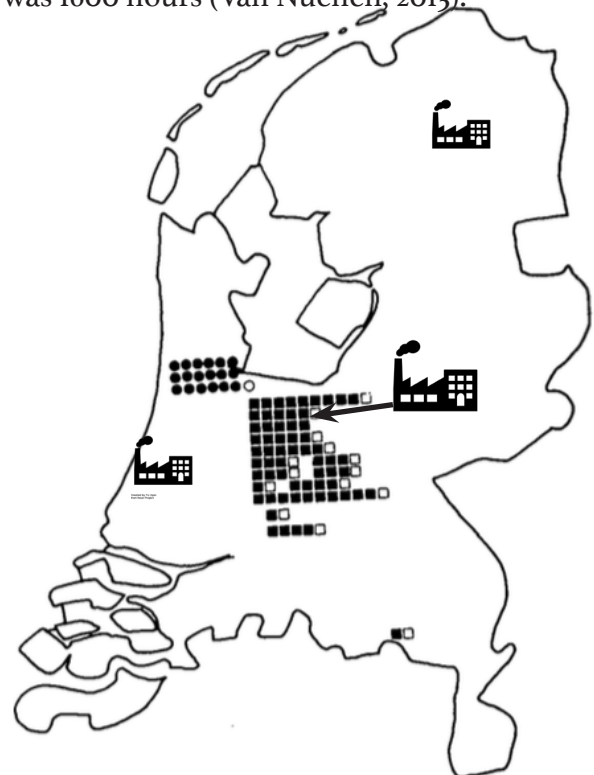

Figure 1.2.1: Factories and production. (Priemus & Van Elk, 1971).

General information

- Prefab (zware montagebouw) heavy mounting elements
- Built 1962-'70s
- Mostly built around Utrecht
- Portiekflat
- 3 Factories

Main production in factory Utrecht

Specialised products stairs, roof edges etc. in: Valkenburg Z.H. and Hoogkerk

- 4 or 10 stories high
- Total built 14.000 (Utrecht 6.500)
- Factories made 6 houses a day
- Transportation on truck (1 house 4 trucks)
- Montage direct from trucks
- Elements equal to the depth of the room, with a maximum of 5,5 meters

- Cranes needed to place elements (2 cranes 4/5 houses a day)
- 10 people (5 without education)
- Average 40 elements for 1 house (40 m³ concrete)
- 1000 Man-hours for one property (factory and on-site)

Guiding rules for size construction site:

On one of the long side of the facade 38,5 meter has to be kept free for the construction site:

- 7 m crane
- 6 m storage large wall elements
- 3,5 m conveying (trucks)
- 8 m storage floor elements
- 10 m storage small elements
- 4 m storage window frames etc.
- Total: 38,5 meters

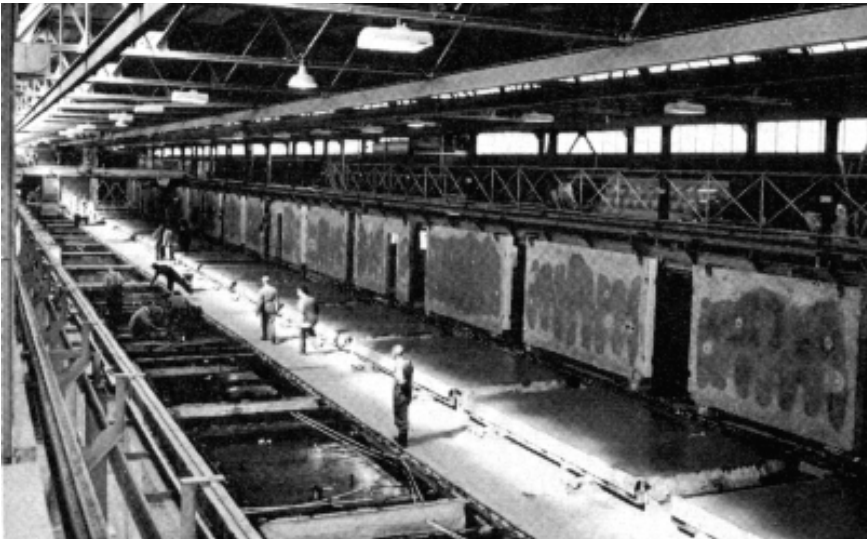

Figure 1.2.2: Factory production.



Figure 1.2.3: Assembly on site



Figure 1.2.4: Construction site.



Figure 1.2.5: Construction site.

Figure 1.2. 2-5: (Priemus & Van Elk, 1971)

Assembly

The assembly took place on a construction site approximately according the guiding rules as described on the previous page. The assembly took place as followed.

Ground floor

First the prefabricated frost edge is placed on the ground. The prefabricated frost edge is used to prevent unnecessary form work for in-situ concrete system. On top of that, in-situ concrete slab is applied on the ground floor (figure 1.2.9). The walls located on both sides of the stairwell, the landing on ground floor level and the first floor of the stairwell are built in-situ concrete as well (figure 1.2.6). On top of the ground floor a keyway (kimband) was place to set the height of the prefabricated walls. After the load-bearing walls were placed the non-bearing light-weight concrete walls were assembled on the floor (figure 1.2.7). Next to that, the strip was placed on top of the load-bearing wall to distribute the compression load from the prefab floor which was layered on top.

First floor and above

The load bearing walls were placed on the prefabricated slab. To place the walls in the right position two tubular positioning pins were used (figure 1.2.8). The load bearing walls contain gaines. From these gaines the cavity between wall and floor were poured with cement to combine them together. After that the non-bearing light-weight concrete walls were placed on the slab as aforementioned on the ground floor. Before placing the next slab other materials such as wooden walls and door frames were laid on the floor. This saved a lot of excessive works of lugging construction materials. The prefabricated concrete elements were used on the roof as well. To create a sloping surface, cement and insulated channel plates were used. In the end the insulated channel plates which were based on closed air ducts were replaced by glass foam due to the poor insulation performance. Floating screed or screed was applied on the floor.

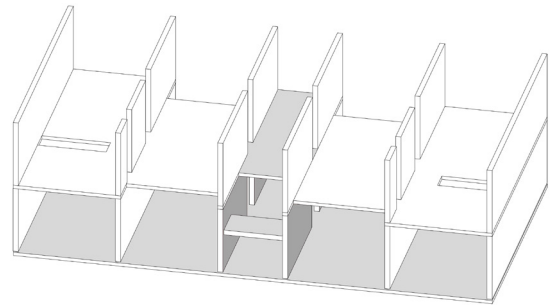

Figure 1.2.6: In-situ concrete

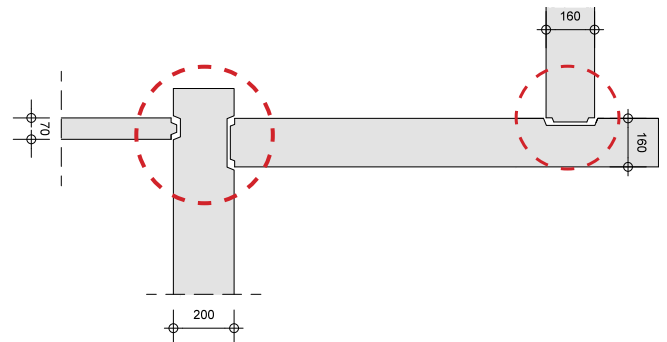

Figure 1.2.7: Connection with grooves reinforced with steel pins which connect with the wall and floor. Information: (Priemus & Van Elk, 1971)

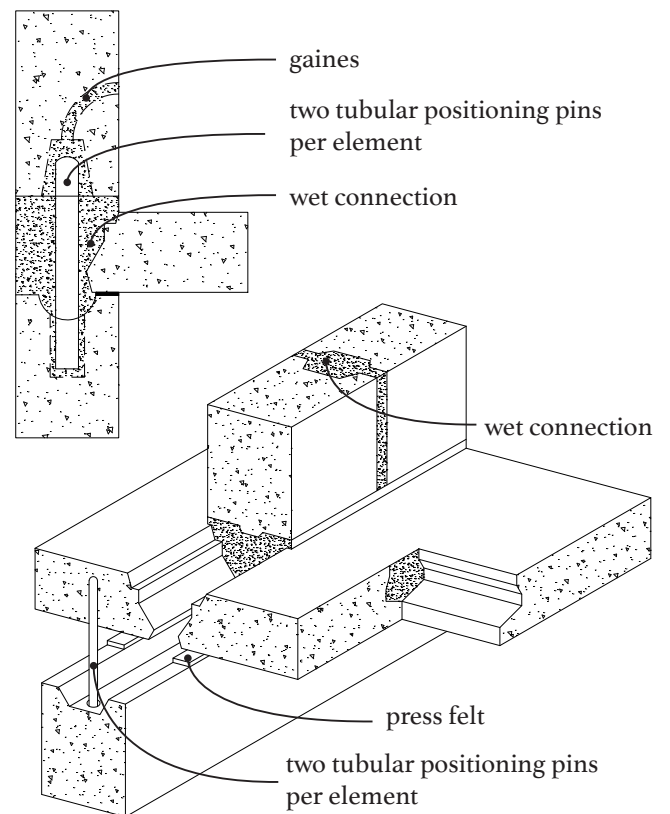

Figure 1.2.8: Construction details

Camera Obscuradreef built in 1964:

- Foundation: On steel with prefabricated frost edges
- Ground floor, walls on the ground floor of the staircase and 1st floor staircase: In-situ concrete
- From ground floor: Prefabricated concrete
- Stability: Wet connection between load-bearing walls and floors. In combination with perpendicular pre-stressed walls which continue for four stories, with mutual overlaps.

Material list:

1. Exterior wall: Concrete 20cm and brick R-value: 0,60
2. Parapet: Sandwich panel with 3cm polystyrene
3. Restoration: Glassal panel R-value: 1,25
4. Floor: Concrete 14cm
5. Roof: Concrete 14cm and screed R-value: 0,80 - 1,00 - 1,50
6. Interior wall: Lightweight concrete 7 or 9cm
7. House separating wall: Concrete 20cm

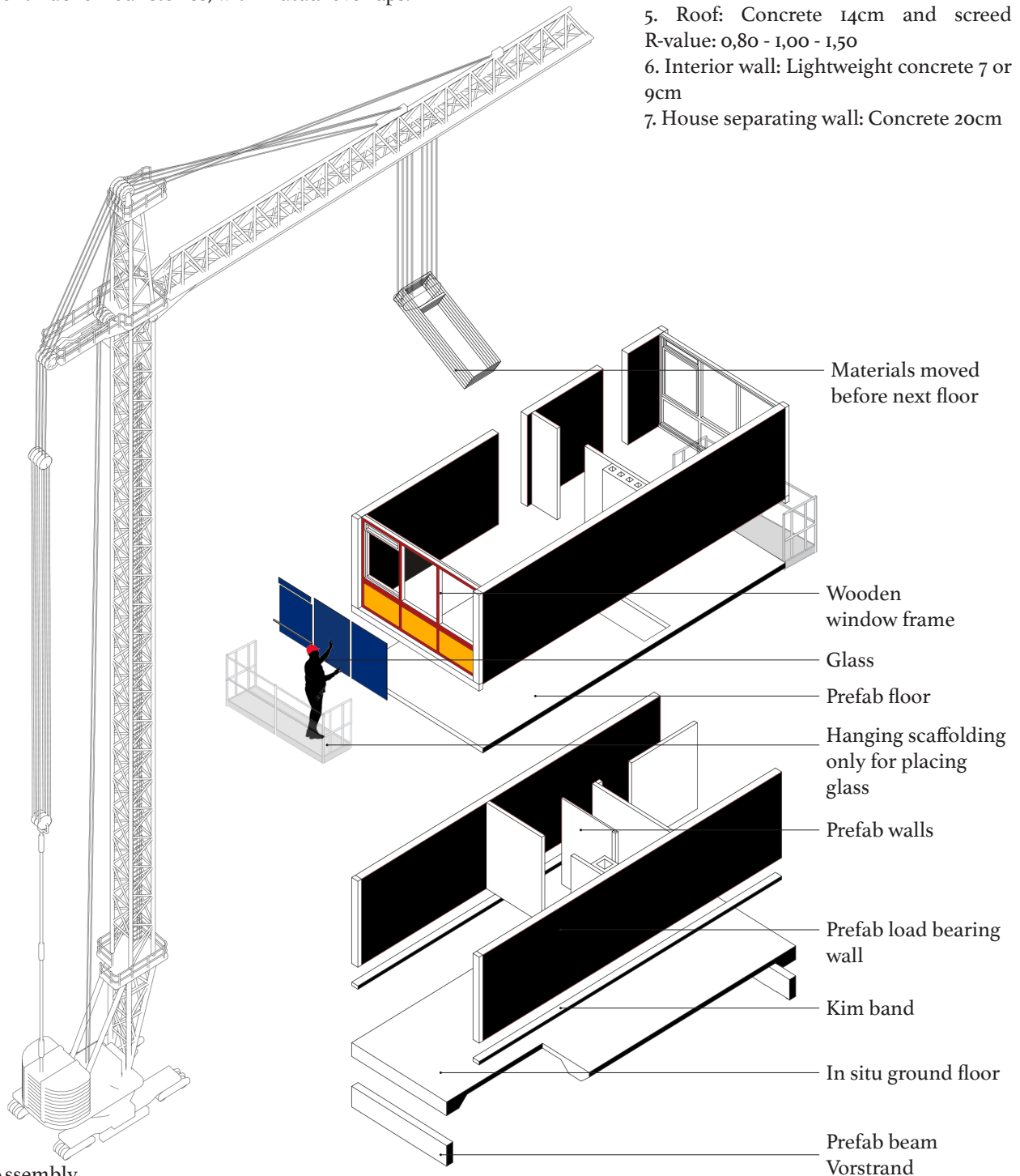

Figure 1.2.9: Assembly

Stability

The stability is gained by the wet connection between the prefabricated load bearing walls and floors. Some of the light-weight concrete walls standing orthogonal to the load-bearing walls also contribute to the stability. These pre-stressed walls are stacked vertically in four layers by overlapping each other (figure 1.2.10).

Facade elements

The concrete grid elements and window frames are manufactured in the factory before transported to the construction site. Only the glass had to be placed in the pre-made wooden frames (figure 1.2.7). This could be done right after the frame was placed by using suspended scaffolding. In other construction process, scaffolding was not used unless the end wall was designed in brick.

Finish

After the assembly of the facade the building was almost finished. The prefabricated ceiling and walls were produced almost in a flat surface so, after small unevenness was eliminated, that they could be applied with the selected finish such as paint, wall paper, or plaster. (Van Nuenen, 2013).

The whole drawing of the assembly and the prefabricated elements can be found in the appendix. As well the original floor plans.

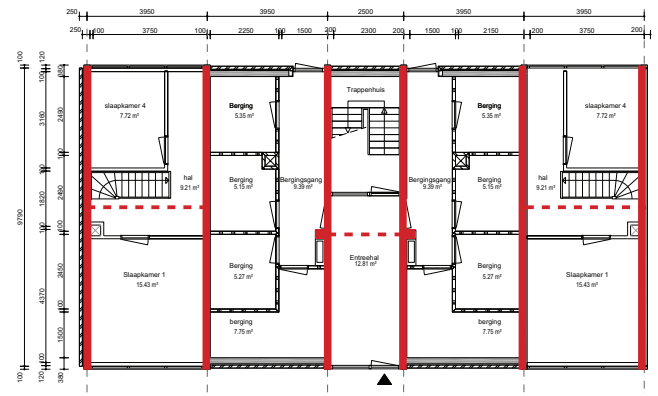

Ground floor

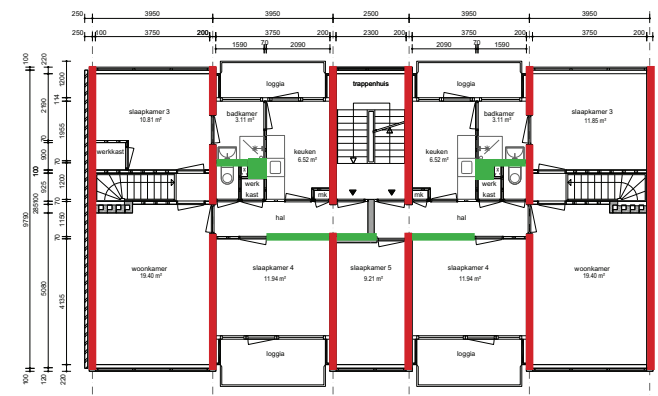

1st floor



2nd floor and above

— Load bearing walls

— Stability walls*

- - - Beams

Figure 1.2.10: Load bearing structure and stability

* stability based on own interpretation

Possibilities and limitations

The structure of the VAM system has lots of possibilities but as well some limitations. These are discussed below.

The load bearing structure is still in a good condition but has big influence on the flexibility of the floor plan when redesigning. The walls are fixed with a certain distance and the space in between has a maximum of 3950mm. This gives proper dimensions of each room but this limits as well the flexibility of the floor plan. When parts of the load bearing walls are removed, constructive measures should be probably taken. The walls in between the bays can be removed with exception of the stability walls. If these are removed other stability measures should be introduced. The structure is limiting the possibility of combining apartments together. Because the apartments are separated by load bearing walls which are interlocking with the floor slabs. Small interventions of introducing stairs and doors in the structure are possible in consultation with a structural engineer. Sound can be as well a problem of the structure, the wall between apartments is 20 cm. The standard for massive house separating walls is nowadays 30 cm (SBRCURnet, z.j.).

Opportunities of the structure

- Good condition to reuse
- Flexibility within the bay
- Possible opportunity to make small openings in the structure
- Proper dimensions of each room by the dimensions of the load bearing walls
- According to Dr. ir. L.M Oorschot possibility to put 2 levels on top.

Limitations of the structure

- Flexibility of the floor plan in combining apartments and rooms
- Thermal bridges
- Sound

1. Analysis of the system

I-3. SKIN

Skin

The skin of Intervam flat is instantly recognizable. The concrete grid is one of its strongest characteristics and is well preserved in most of the Intervam flats. Compared to the retained frame, other elements filled in it, for example, window frames and handrails, are more flexible. These infill various from building to building, and can be easily replaced in renovation. The elements are following a

specific rhythm, which is another feature of Intervam flats. This chapter introduces skin of Intervam flats on both technical and aesthetic aspects. Skin elements of Intervam flats exemplified by Camera Obscuradreef, including the permanent concrete grid and flexible infill, is researched. Moreover, exploration on renovation of Intervam flats in Camera Obscuradreef is also explained in the chapter.



Figure 1. 3.1 Front elevation (before renovation) 1:300



Figure 1. 3.2 Rear elevation (before renovation) 1:300



Concrete Frame

General Information

The strong concrete grid reflects the structural module of the building system. The prefabricated concrete elements are attached in front of the load-bearing walls to protect the structure and emphasize the grid. The horizontal element of the concrete grid is ornamented with corrugated surface.

There is a reduction on the skin: only the concrete elements, which has been reduced to its minimum size to fulfill its function as protectors are rigid. The resulting large openings in the grid provide possibility for flexibility of its infill. The possibility is discussed in the following section "Infill".



Figure 1.3.3
Overview of Concrete Frame in one portiek

Visual Strength

The special concrete structure system of VAM is expressed on the facade by the concrete frame, becoming a strong characteristic of Intervam flats and makes them recognizable. Nevertheless the intelligent frame is weakened by its infill (figure 1.3.4).



Figure 1.3.4. Comparison between a skin with the grid only and with both grid and infill

Construction

In order to protect the concrete structure, prefabricated cladding elements are attached to the structure, including the vertical concrete fragment (figure 1.3.5), horizontal elements for balcony and the corrugated horizontal elements. No literature has been found to explain the original purpose of design for these prefabricated elements, but we assume that the corrugated horizontal elements are designed for rainwater drainage, and decoration.



Figure 1.3.5 . Prefabricated fragments attached to structure

Lack of Maintenance

The painting on claddings of Camera Obscuradreef contributes to maintenance of the fragments, nevertheless the painting applied to it has felled off (figure 1.3.6.). Aesthetically the concrete frame is weakened because of the worn-out facade.



Figure 1.3.6 . Cladding with poor maintenance

Infill

General Information

Aesthetically, the repetition and symmetry are two main characteristics of Intervam flats. The order and regular rhythm follows the aesthetic of rationalism, which was popular during post-war construction period.

Structurally the elements are prefabricated in the factory and installed into the concrete frame. The method contributes to efficiency of construction, which fulfill the requirement for large amount of dwellings. However due to fast construction and lack of knowledge in 1960s, problems of thermal bridge and lack of insulation was gradually revealed. More research about solution will be discussed in next section.

Diversity

Resulting from the large openings of concrete frame, the design of the infill can be varied in different Intervam flats. This means despite of rigid concrete frame on the skin, various design of infill could be chosen within the given grid. As illustrated in figure 1.3.8.-Figure. 1.3.10, fragments vary from project to project, but the rhythm of fragments follows the same rule of repetition.



Figure 1.3.8.
Skin of Intervam flats in Dorbeendreef, Utrecht

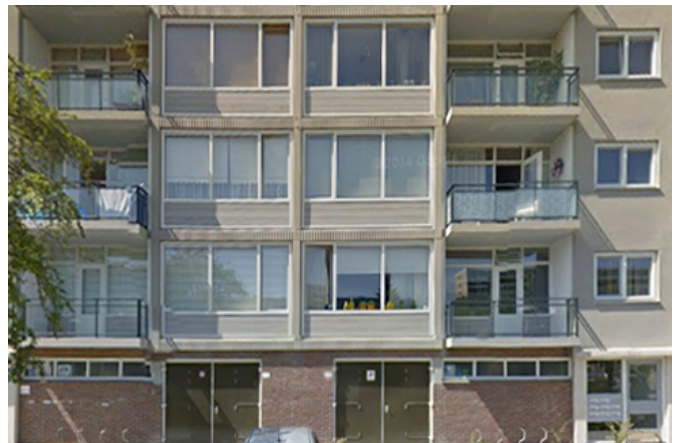

Figure 1.3.9.
Skin of Intervam flats in Stanleylaan, Utrecht



Figure 1.3.7. Concrete frame in Camera Obscuradreef filled with different elements

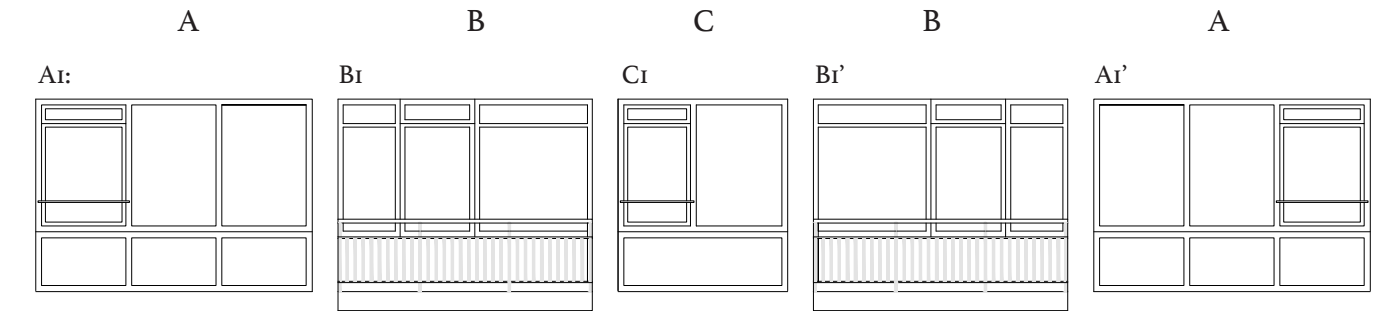

Figure 1.3.10.
Skin of Intervam flats in Altasdreef, Utrecht

Infill of Camera Obscuradreef

One portiek is consist of 5 bays and it has been copied many times next to each other. The appearance of front and rear facade is almost

same except for the one bay in the middle. The skin could be flexible according to the different functions of the ground floor.



Front facade fragments

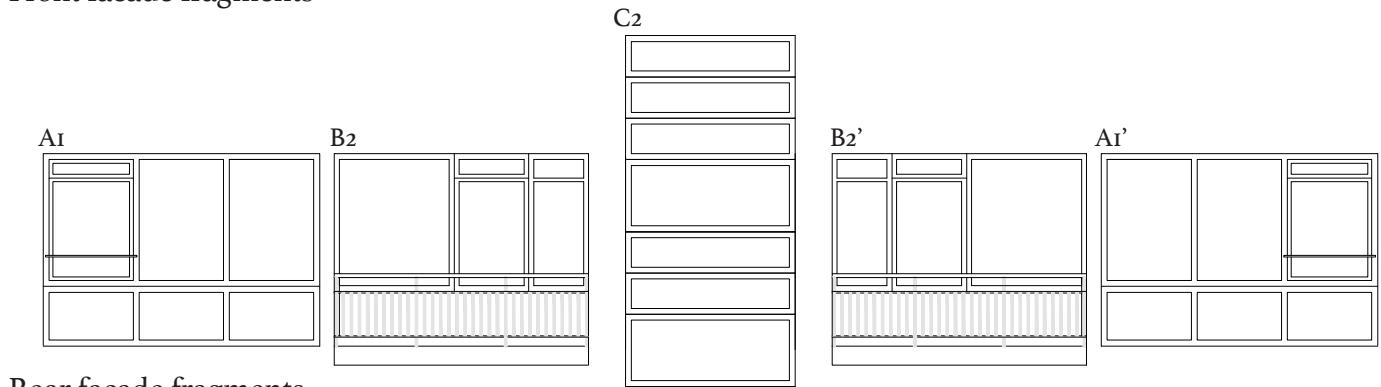

Rear facade fragments

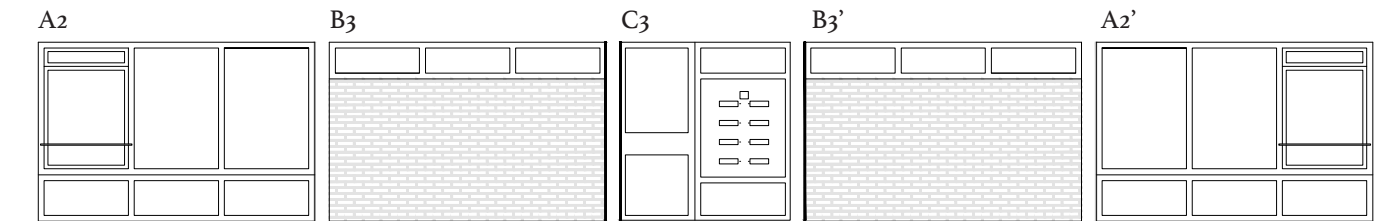

Front facade fragments ground floor

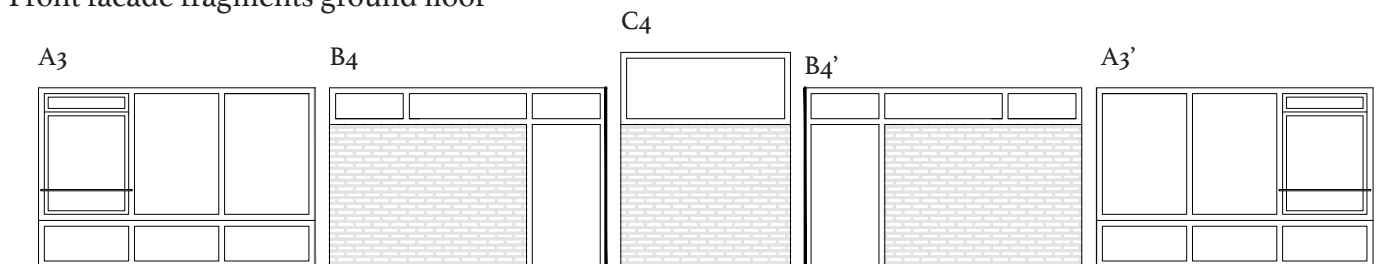

Rear facade fragments of ground floor

Figure 1.3.12 fragments infilled into concrete grid

Number of each fragments in one portiek

A1: 8	B1: 4	C1: 4	B1': 4	A1': 8
A2: 1	B2: 4	C2: 4	B2': 4	A2': 1
A3: 1	B3: 1	C3: 1	B3': 1	A3': 1
	B4: 1	C4: 1	B4': 1	

Renovations on Skin

General Information

After the completion of Intervam flats at Camera Obscuradreef in 1965, they have been renovated for several times. The biggest renovation was in 1984, and after renovation in 2009 the passages were closed. Currently, a renovation by Mitros is being tested on site. The institution proposed the renovation for zero-energy Intervam flat.

The concrete grid is kept during renovations, though it has been painted several times. Infilled fragments, including windows, handrails and parapet was replaced. Most of renovations were launched for energy efficiency and security reasons. The building was also painted several times, probably for achieving a refreshed appearance. More detailed information about renovation is provided in this section.

Timeline

- 1965: After Completion

End wall: Red brick

Roof edge: Prefab concrete (not painted)

Front and rear facade: Concrete grid (not painted)

Frames: Wooden window frames (colour probably white). (see figure 1.3.14.)

Parapet: Coloured glass (colour probably white and at the stairs red and green/blue)

Storages: Brick and wooden window frames

Balconies: Concrete (not painted) (see figure 1.3.19)

- 1984: Renovation

End wall: Not changed

Roof edge: Concrete painted light brown

Front and rear facade: Concrete grid painted light brown (see figure 1.3. 22)

Frames: Wooden window frames replaced by plastic window frames (white) with double glassing, except the frames at the balconies, the storages and the entrance.(see Figure 1.3.16.)

Parapet: Glasal panels in three different colours:

Bay A and B leleur 511

Bay C bedroom leleur 689 and stairs leleur 728

Storages: Not changed

Balconies: Painted gray (see Figure 1.3.22.)

Sound insulation: suskasten (silencers) are placed at Van Brammendreef and Vader Rijndreef.

Safety: Fall protection at windows installed. Maybe asbestos panels placed in parapets, chimneys and kitchen for fire safety(see Figure 1.3.15.)

- Through time

Balconies: Concrete colour then white, then gray and now are red(see Figure 1.3.23.)

Concrete grid: Concrete colour than vertical grid painted white. In the renovation of 1984 light brown and are now white.(see Figure 1.3.23.)

Mailbox: moved from hall to the outside window frame(see Figure 1.3.17.)

- 2009: Renovation

Passage: closed with wooden frames colour white. (see Figure 1.3.17)

- 2016: renovation for Energy zero portiek

Window frames: Aluminum with triple glassing(see Figure 1.3.18)

Parapet: Sandwich panels with high RC value

Safety

1965-1984 After Completion



* Figure 1.3.13. 1984: Before renovation Mailbox was in the entrance hall; The passages were opened.

1984: After renovation



*Figure 1.3.15. 1984 After Renovation: Fall protection was added.

Current situation and future expectation



Figure 1.3.17. 2009: The closed passage; N.D.: The moved mail box



*Figure 1.3.14. 1984: Timber window frame with Single glazing



*Figure 1.3.16. 1984: Being renovated with plastic window frames



Figure 1.3.18. Future: Mitros has launched the renovation for zero-energy flat. (<http://www.onb.nl/wp-content/uploads/flat-met-toekomst-4-700x500.jpg>)

Painting



*Figure 1.3.19. 1965: frame was in one colour, probably not painted



*Figure 1.3.20. 1973-78: Vertical grid painted white; Horizontal grid painted brown; Window frames and parapet white.



*Figure 1.3.21. 1984 before renovation: Staircase red and green/blue



*Figure 1.3.22. 1984 After Renovation: Grid: light brown, Balconies: gray; Parapets were in different colors.



Figure 1.3.23. 2016 Current situation: Balconies and doors: red, Grid: white, Staircases: yellow; Parapets were in different colors.

Materials

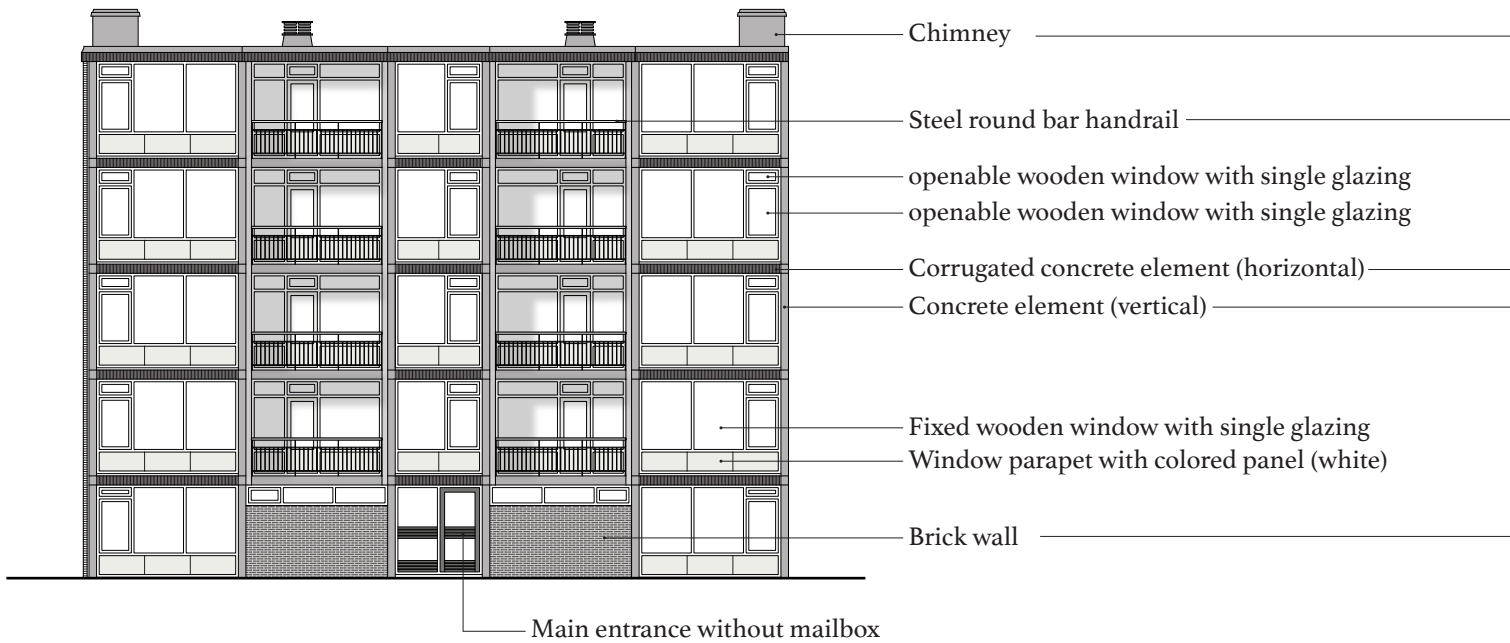

Figure 1.3.24. Front elevation (before renovation) 1:200

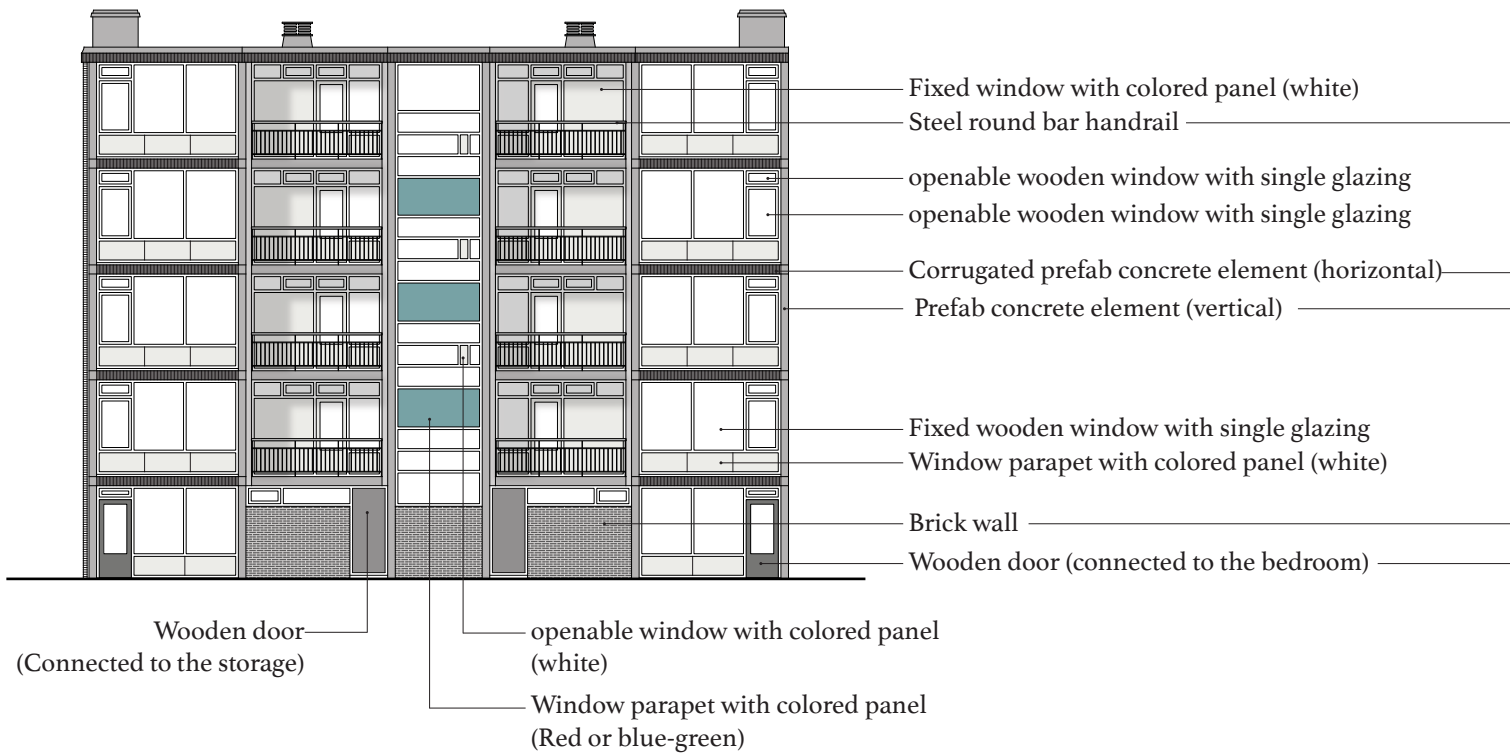

Figure 1.3.25. Rear elevation (before renovation) 1:200



Figure 1.3.26. Front elevation (After renovation) 1:200

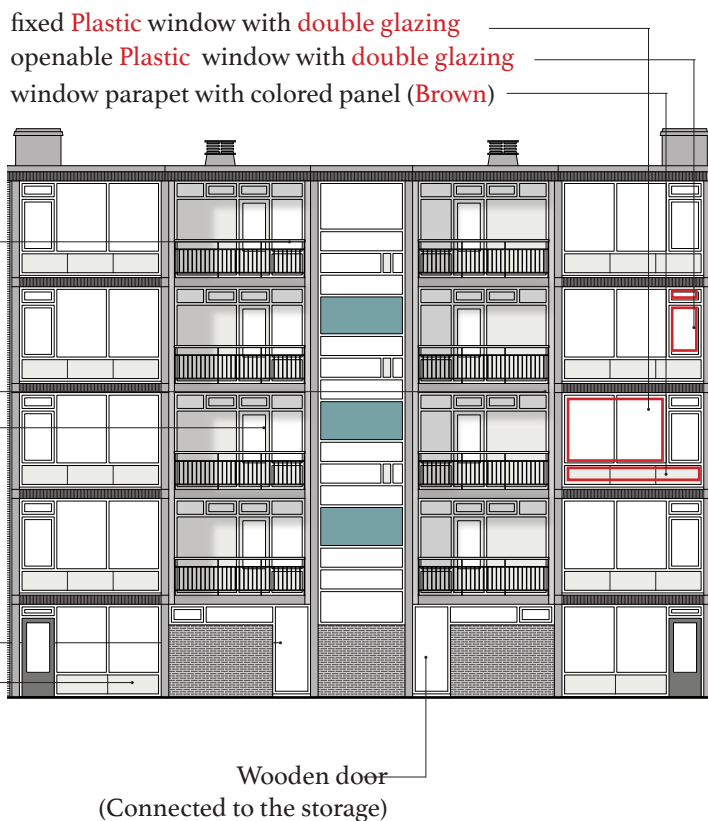

Figure 1.3.27. Rear elevation (After renovation) 1:200

Aim renovation: With the renovation of 1984 the facade got a new appearance. The concrete got painted, windows were replaced by plastic window frames and double glazing, silencers and asbestos were placed as technical improvements. Possible reasons for this renovation can be: reduce maintenance, lifespan, save energy, fire safety, upgrade comfort in the rooms and create a modern appearance.

Result renovation: Painting the concrete made the building more dependent on maintenance but this could be saved on the maintenance of the window frames. Because the concrete was painted and had to be repainted within a couple of years. The appearance could easily be changed during the maintenance. With the improvement of double glazing less energy was needed to heat the living room and the master bedroom. The silencers at the Van Brammendreef and Vader Rijndreef, which were installed in each window fragment (see Figure 1.3.28), made it possible to ventilate without having much noise pollution, which led to increased comfort. By placing fall protection at the windows the building met the building regulations of the time. Asbestos panels were fireproof and therefore installed but several years later it turned out that asbestos is harmful to health when the product is processed. With the renovation the building gained a new appearance that improved the service life of the building.

Future: To bring the building back to the future Mitros is starting a test with the Energy zero portiek where the plastic window frames will be replaced by Aluminum frames with triple glazing to save energy. The parapets are also renewed and the installations will be made to achieve energy zero standards. In 2017 the renovation will be tested for 1 year. If the results meet the requirements it will be applied on 40 houses.

Through time interventions has taken place for safety reasons. The passage has been closed and the mailbox has been moved from the hall to the outside window. The nuisance in those places has become less but problems shifted to other places.

Construction Details

General Detail: skin of Intervam system

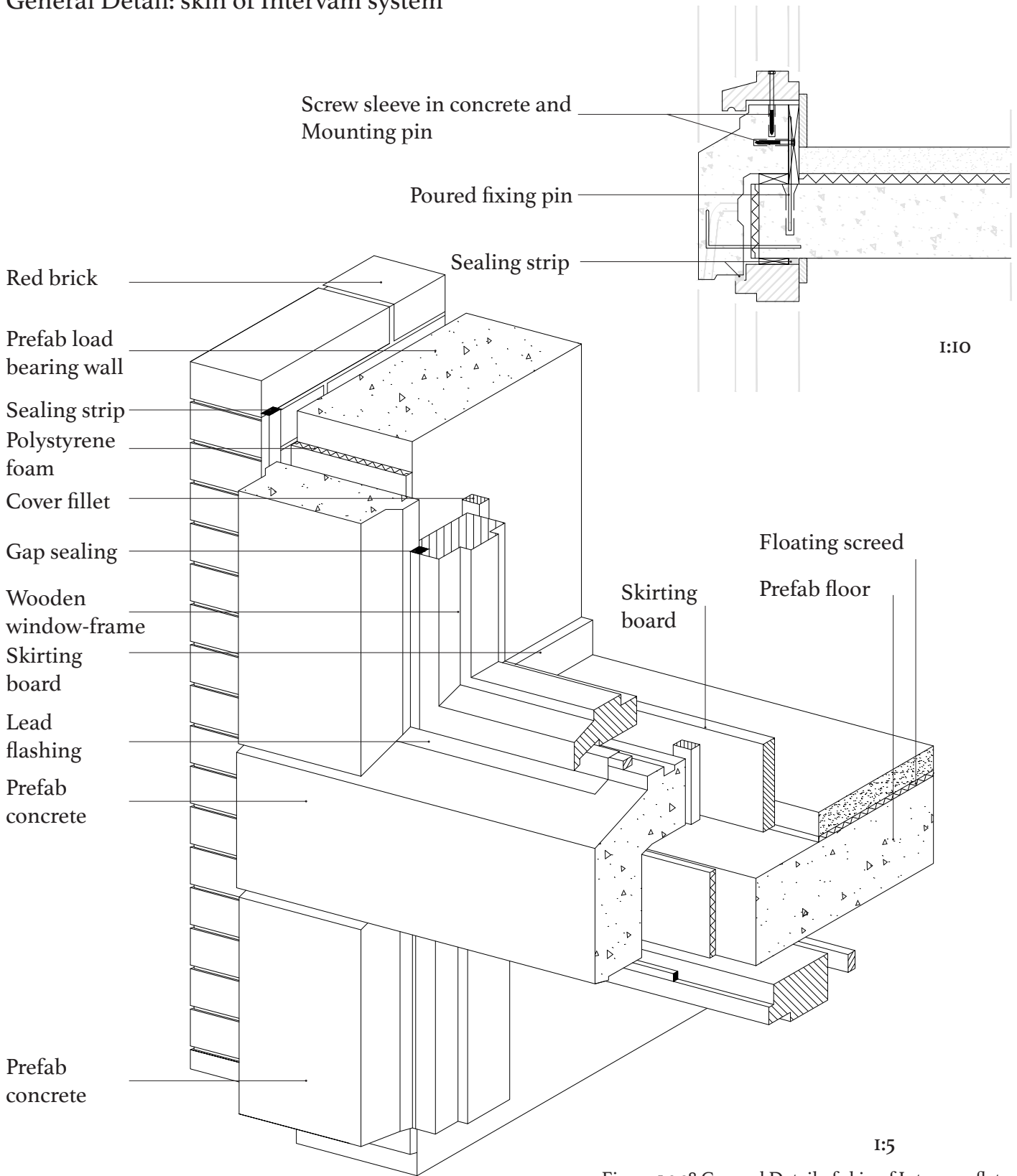

Figure 1.3.28 General Detail of skin of Intervam flat Factories and production. (Priemus & Van Elk, 1971).

Renovated Details in Camera Obscuradreef

Vertical section detail

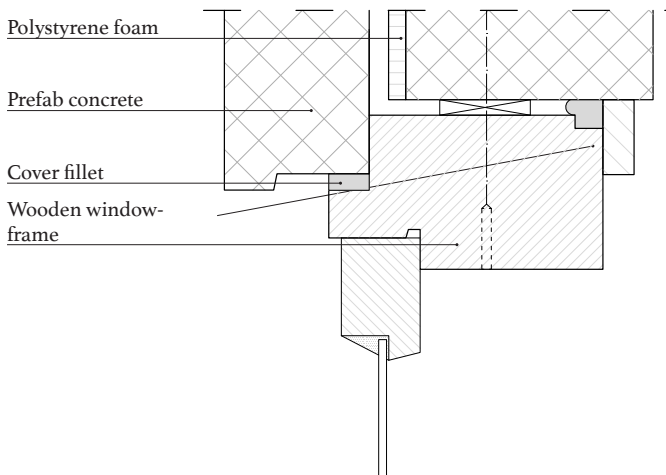

Figure 1.3.29 wooden window frame (before renovation)

Horizontal section detail

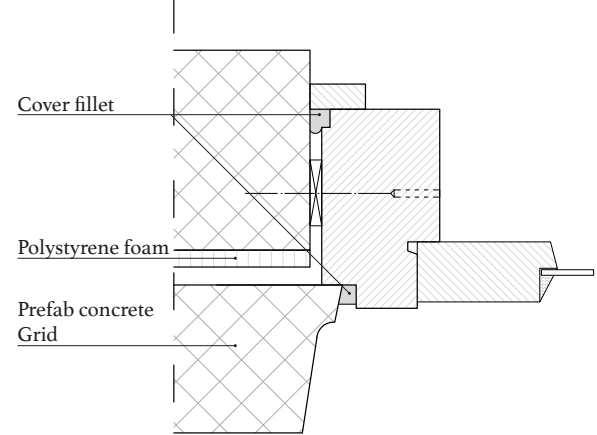

Figure 1.3.30 wooden window frame (before renovation)

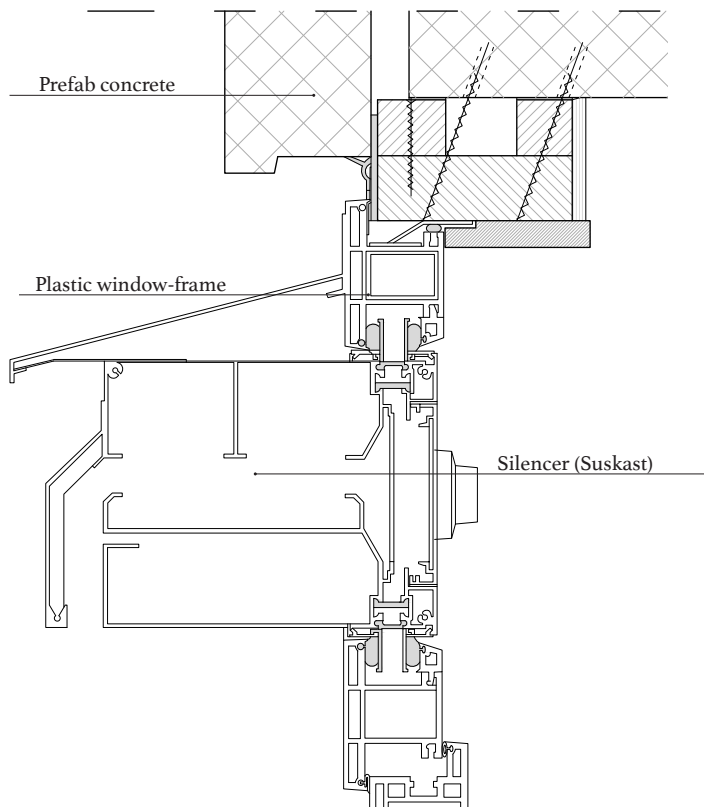

Figure 1.3.31 plastic window frame (after renovation)

Aim renovation: With the renovation of 1984 the wooden window frames has been replaced for plastic frames with double glazing with exception of the frames at the balconies, the storages and the entrance. Possible reasons for this renovation can be: reduce maintenance, lifespan, save energy, upgrade comfort in the rooms and create a modern appearance.

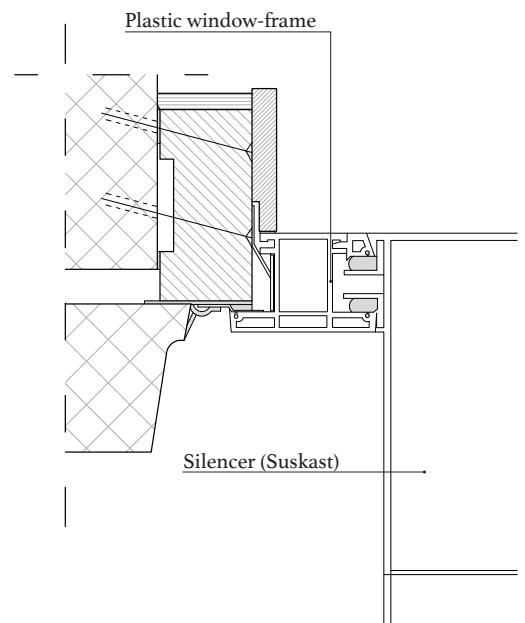

Figure 1.3.32 plastic window frame (after renovation)

Result renovation: The plastic window frames are now 32 years old and have proven to have a long lifespan without a lot of maintenance. Back in the day it was state of the art. Now these older plastic frames are out of fashion. With the arrival of double glazing the energy and thereby the comfort improved. Nevertheless, the plastic window frame brings problem of lack of ventilation, which will be discussed in chapter "service".

Conclusion

Value

The concrete grid on the skin is one of the most significant characteristic of the VAM flats. Aesthetically, the skin expresses the special structural system of VAM. Functionally, the load-bearing structure is protected by the cladding. Moreover, the large openings of the grid enable diversity of filled fragments, creating possibilities for various approach of facade of VAM flats.

Limitations

In general, the whole skin is poorly insulated, and its aesthetic value is weakened by maintenance problems. The concrete grid on the skin is one significant characteristic of Intervam flat, nevertheless lack of maintenance is causing problems. The painting falls off, resulting in feeling of disrepair of the building.

Visual strength is weakened by not only poor maintenance of the grid itself but also condition of fragments filled into the frame. Moreover, in the technical aspect, these fragments are causing thermal bridges, affecting thermal comfort and energy efficiency of the flats. The plastic window frame installed in 1984 tried to solve the problem, but a new difficulty on lack of ventilation caused by the sealed window frame was introduced, which will be discussed in detail in chapter “service“.

Possibilities

Nevertheless, there is opportunity to improve the skin. The concrete grid is still in a good quality, of which could be made full use. However, it should be maintained in time. A method to stress the concrete frame should be carefully considered.

Technically, the skin system should contribute more to a better thermal performance of the building. New insulation should be added, while thermal bridges should be filled.

I. Analysis of the system

I-4. SERVICE

Service

Services are important for a building and take, for a big part, care for the comfort. The demand for comfort is increasing. When people arrive at home they expect a nice indoor climate which is stable, well ventilated without cold symptoms and that hot water is instant available. The demands for comfort changed over time, which caused changes in the systems.

Heating system

In 1959 gas was discovered in Groningen. From this moment an energy transition took place. A gas network was built in the Netherlands and coal stoves were replaced by gas heaters. Hot water was supplied by gas boilers (CBS, 2016). On the drawings of Camera Obscuradreef from 1962 'kolenkisten' coal boxes were still drawn on the balconies connected to the kitchen. It is unknown if those were changed to gas heaters in the period between 1962 and 1964 when they were built. If this was the case the gas heater was installed in the living room at the chimney. The gas boiler for hot water was placed above the sink in the kitchen. Over time most gas heaters and gas boilers are replaced by a 'cv ketel' and radiators. Since the residents has

to purchase their own 'cv ketel' and radiators, this has not happened in each apartment. It is possible that there is still a gas boiler or gas heater present in the apartments. In the apartments we visited, the heating and hot water supply was placed in different ways:

Student house 1:

Heating: Gas heater in living room 'gaskachel' (figure. 1.2.1)

Other rooms: Electrical but only one can use it at the time otherwise the fuse will turn off.

Hot water: gas boiler 'gesloten geiser' (figure. 1.2.2)

Student house 2:

Heating + water: Gas boiler in kitchen 'CV ketel' (figure. 1.2.3)

Other rooms: Radiators (figure. 1.2.4)

Hot water: Gas boiler in kitchen 'CV ketel' (figure. 1.2.3)

Student house 3:

Heating + water: Gas boiler in storage 'CV ketel' (figure. 1.2.3)

Other rooms: Radiators (figure. 1.2.4)

Student house 4:

Heating: Gas heater in living room 'gaskachel' (figure 1.2.6)

Other rooms: Electrical but only one can use it at the time otherwise the fuse will turn of.

Hot water: Electric boiler 'elektrische boiler' (figure 1.2.5)

Family:

Heating: Gas heater in living room 'moederhaard' (figure 1.2.8)

Other rooms: Radiators (figure. 1.2.4)

Hot water: Gas boiler 'open geiser' (figure 1.2.7)



Fig. 1.2.1: Student 1: Gas heater



Fig. 1.2.2: Student 1: Gas boiler



Fig. 1.2.5: Student 4: Electric boiler



Fig. 1.2.6: Student 4: Gas+electric



Fig. 1.2.3: Student 2: CV ketel
Student 3: placed in storage



Fig. 1.2.4: Student 2, 3 and
family: Radiator



Fig. 1.2.7: Family: Gasboiler
(open geiser)



Fig. 1.2.8: Family: Gas heater
(moederhaard)

Comfort:

In 1999 a report was made at the request of residents to measure the building physics. Lot of houses had problems with low temperatures, moisture and mold. Some residents purchase their own 'cv ketel' and radiators. Others had only a gas heater in the living room. In two houses with 'cv ketel', which were monitored, the average temperature was 15 degrees at the door of the room at the balcony, 14 degrees in the hall and 11,8 degrees in the small room at the wisselbeuk. The floor was cold as well and mold was growing on the walls. In the other house the temperatures where even lower. 9,2 degrees in the hall, 11,7 in the kitchen and 7,4 in the room at the balcony. In both houses the moisture and mold is due to the low temperatures and the lack of ventilation options. Open windows has no preference in the winter and the ventilation grill were dirty. Recommendations were: check the capacity of the CV system, ventilation grill should be cleaned and change single to double glazing (Langeveld et al., 1999). If any action has been taken after this report unknown. The interview with the residents shows that the comforts of the homes are now better than outlined in the report. But it should be mentioned that the interview took place in October just after the summer.

Student house 1: Can be cold in the winter in the unheated spaces.

Student house 2: Temperature inside is most of the time good but in the summer it can be hot.

Student house 3: Radiators in the bedrooms are usually off and in the living room on. The interior climate is comfortable but in summer it can be hot

Student house 4: Can be cold in the winter in the unheated spaces.

Family: temperature in the house is alright but use a lot of energy

Aim renovation (individual done by residents):

People with only a gas heater in the living room had only one space in the winter to warm up. Other rooms like the bedrooms and kitchen didn't have heating which caused that these spaces were only used for the functional purpose. When people decided to purchase central heating this could change radically.

Result renovation:

Because the renovation was not centrally controlled there is a variety of systems. In the visited apartments different systems were available. Some residents built the installation on their own which can lead to dangerous situations. It happens that a discharge channel is placed next to a moving element such as a bathroom window, which can be opened for ventilation but when opened it picks up the exhaust air of the system. The positive effect of the renovation is that all the spaces are heated and can be used in different ways. Before, the living room was the only heated place and therefore most activities took place in this room, which lead to more social interaction. This could also lead to problems for the large families lived in one apartment. By heating the whole apartment more comfort and privacy could be achieved but maybe as well less social interaction was created.

Future:

Mitros has started a pilot project with one portiek. The 8 apartments, which are located in the portiek, will be renovated to zero energy housing (nul-op-de-meter woningen). In this project, no fossil fuel will be used to heat the dwelling (Straver, 2016). These homes are inhabited for a period and the results will be analyzed. If the results are according to the concept of 'zero-to-the-meter' another 40 properties will be renovate according to the same principal as can be seen in figure 1.2.9 (Mitros, n.d.).

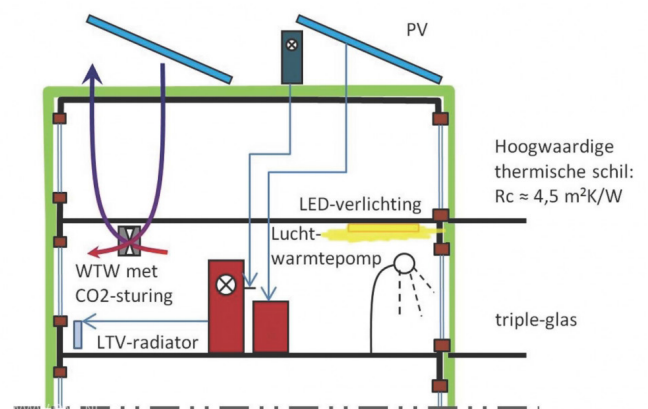

Figure 1.2.9: Energy zero system, Mitros. (n.d.).

Ventilation system

The ventilation is natural supply, natural outlet. The air supply is through gaps by the windows and doors and open windows and the extraction takes place through the shaft behind the kitchen. The ventilation grill are installed at the kitchen, bathroom and toilet.

General service system

The gas line, electricity and water line is introduced from below the street into the storage to the fuse box. From the fuse box they are divided into the dwelling. Pipes for the electricity and water are cast in the prefab concrete. The rainwater is drained by the drainpipe at the balcony and the sewage water is drained by a pipe in the shaft behind the kitchen see figure I.2.10.

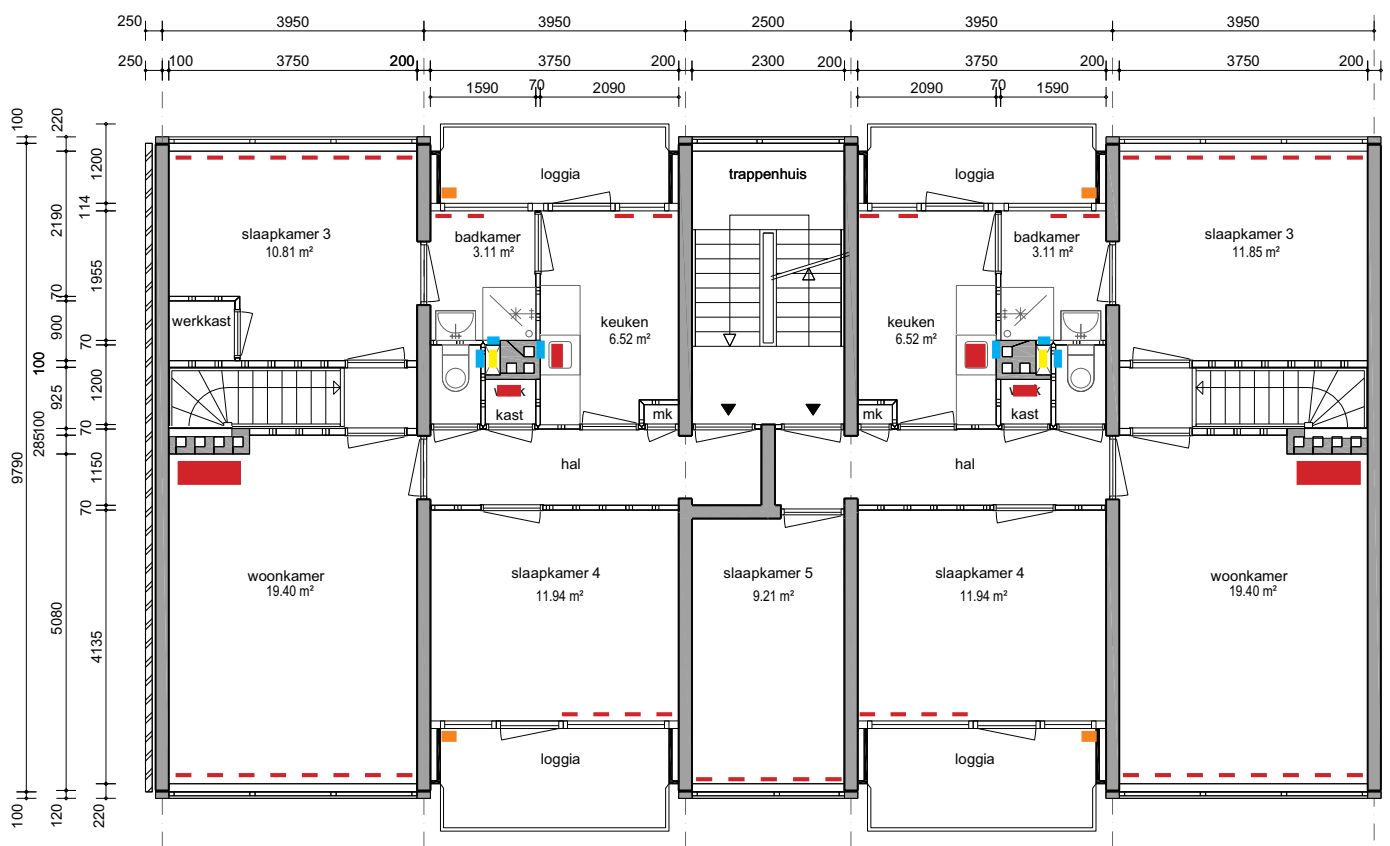

Figure I.2.10: Services

- Ventilation grill
- Possible position heat source
- - - Possible position radiator if they are installed
- Rainwater
- Sewage

Possibilities and limitations

When the buildings at the Camera Obscuradreef were built an energy transition was going on. Coals were replaced by gas in this transition, which brought more comfort to the dwellings because people didn't have to carry the coals to the living room any more. Probably in the beginning a gas heater was installed in the living room. This was the only heater. Due time residents change their systems what led to a variety in heating systems in the apartments. This can be seen in the heating part. In the '80 the government subsidizes energy saving projects also called 'Nationale kierenjacht'. Residents and corporations insulated their buildings. This resulted that small gaps were discovered because the cold was coming true. These gaps were closed, which caused poor ventilation. In the renovation of '84 at the Camera Obscuradreef plastic window frames were installed. In the report of Langeveld et al., 1999 can be read that moisture and mold occurred in many households. If any action has been taken after this report unknown. But the interview with the residents shows that the comforts of the homes are now better than outlined in the report.

Mitros is now working on a pilot project where the gas, which was introduced in the transition of the '60, is banned. In this project no fossil fuel will be used to heat the dwelling (Straver, 2016). It looks

Opportunities for the services

- Creating better comfort
- Low energy bill
- Sustainable (Get rid of fossil fuels)
- Reduce energy consumption
- Generate energy
- Low maintenance costs

like the Netherlands finds itself on the moment on the beginning of a new energy transition. According to the CBS there is only for 17 years of gas left in the gas fields of Groningen (CBS, 2016). Most renovations are now in particular focused on insulation, airtight construction and energy efficient systems. This can lead to problems in the existing housing stock. When a thick insulation layer is mounted to the façade, the aesthetic qualities will be lost. But if no insulation will be used the now existing thermal bridge will continue to exist, which results in energy losses. Other problems are that in the existing floor plan no space for installations is reserved. When the building is going to be insulated inside produced noises will be worse if no measures are taken. If the residents want to stay in the apartment during the renovation big changes on the systems cannot be made. Floor heating is for example almost impossible when the tenants stay. With a renovation the sustainability, aesthetics, comfort, energy bill, energy consumption and maintenance cost can be improved. But renovations are always a guess how they will work in the future. It can be that the use value or the comfort is not increased as much as expected or that a new system will be introduced on the market, which change the value of the system. Energy prices can also have big influence on the investment.

Limitations of/for the services

- Space for installations and tubes
- Thermal bridges
- Sound (noise)
- Existing aesthetic qualities
- Residents who stay in the apartment
- Uncertain future (economic, use and comfort)

I. Analysis of the system

I-5. SPACE PLAN & STUFF

Space Plan and Stuff

This chapter deals with space plan and stuff.

SPACE PLAN -The interior layout-where walls, ceilings, floors, and doors go. Turbulent commercial space can change every 3 years or so; exceptionally quiet homes might wait 30 years.

STUFF -Chairs, desks, phones, pictures; kitchen appliances, lamps, hair brushes; all the things that twitch around daily to monthly. Furniture is called mobilia in Italian for good reason. (Steward Brand, 1994)

The space plan is the stage of the human comedy and the stuff just keeps moving. (Steward Brand, 1994) Comparing with site, structure, skin and service, these two layerings of the building are more easily to be influenced in terms of time and their users.

The unit of analysis firstly shows the typology and circulation of space to give readers a general impression of it. Then the main focus would turn to the inhabitants' use of space plan and stuff through time. By observation, comparison and interpretation, we tried to gain deeper understanding of how inhabitants were engaged with space plan and stuff.

Typology

This is a portiekflat which was created to meet the urgent needs of postwar housing shortage in 1960s'.

Eight apartments share one main entrance and one staircase in one portiek. There are basically four types of dwellings with surface area ranging from 58 m² to 100.7 m². (see figure 1.5.1) The variation lies in the number of bedrooms. For post war mass housing, the floor plan was intended to design as many bedrooms as possible in order to accommodate more people at that time. Even the living room could have the possibility to function as bedroom as well. Following the principal of "Light, Air and Space", bedrooms and living room were designed spacious and with a lot of light coming in.

The the kitchen, balconies, bathroom, toilet and living room are standard and with the same surface area in each dwelling. Every room is independent and connected to the inner corridor. The arrangement of space plan turned out to function efficiently.

- type A (4 bedrooms)
- type B (5 bedrooms)
- type C (2 bedrooms)
- type D (3 bedrooms)

	type A	type B	type C	type D
living room	19.40 m ²	19.40 m ²	19.40 m ²	19.40 m ²
bedroom	45.90 m ²	55.11 m ²	22.25 m ²	31.96 m ²
kitchen	6.52 m ²	6.52 m ²	6.52 m ²	6.52 m ²
bathroom	3.11 m ²	3.11 m ²	3.11 m ²	3.11 m ²
etc	15.93 m ²	15.93 m ²	6.72 m ²	6.72 m ²
total	90.86 m ²	100.70 m ²	58.00 m ²	67.21 m ²

Figure 1.5.1 Typology of dwellings in the Intervam buildidngs, Camera Obscuradreef, Overvecht, Utrecht



2nd - 4th floor plan



1st floor plan



Ground floor plan

Figure 1.5.2 Floor plan of dwellings in the Intervam buildings, Camera Obscuradreef, Overvecht, Utrecht

Circulation

Circulation of one portiekflat

The stairwell and the entrances of each portiekflat are shared by 8 apartments. The stairwell will carry low traffic when it goes higher. One main entrance connects the entrance hall, stairwell and storages on ground floor. Two back entrances, which are more private, are used as access from gardens to storages.

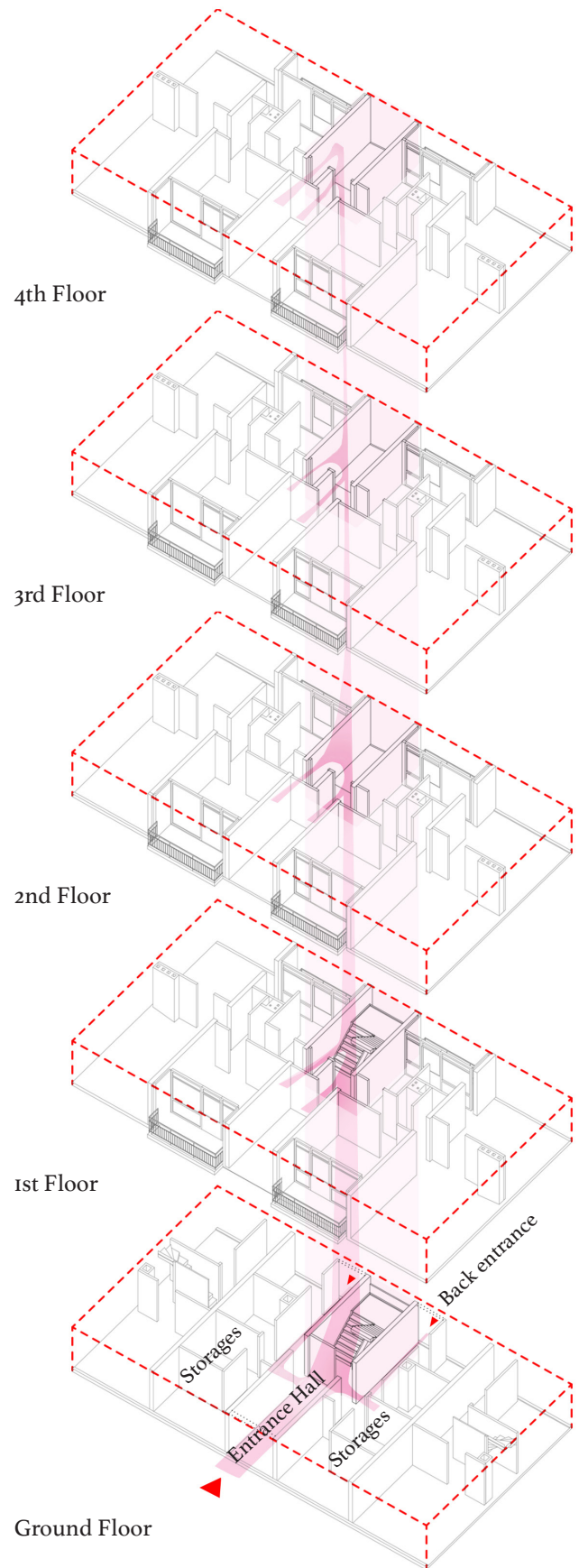

Figure 1.5.3 Circulation of Intervam Portiek

Interior Circulation

Exemplified by apartment type A and type C

For all types of apartments, the hallway directly connects bedrooms, living rooms, kitchen and toilet. The bathroom need to be accessed from kitchen or one of the bedrooms, which might cause some inconvenience.

For apartment type A and type B, there are two more bedrooms on ground floor, which should be accessed from first floor. The two rooms are connected with the upper floor by a narrow staircase. The two bedrooms could be independent from the living area on the first floor because it can have its own access on the ground floor.

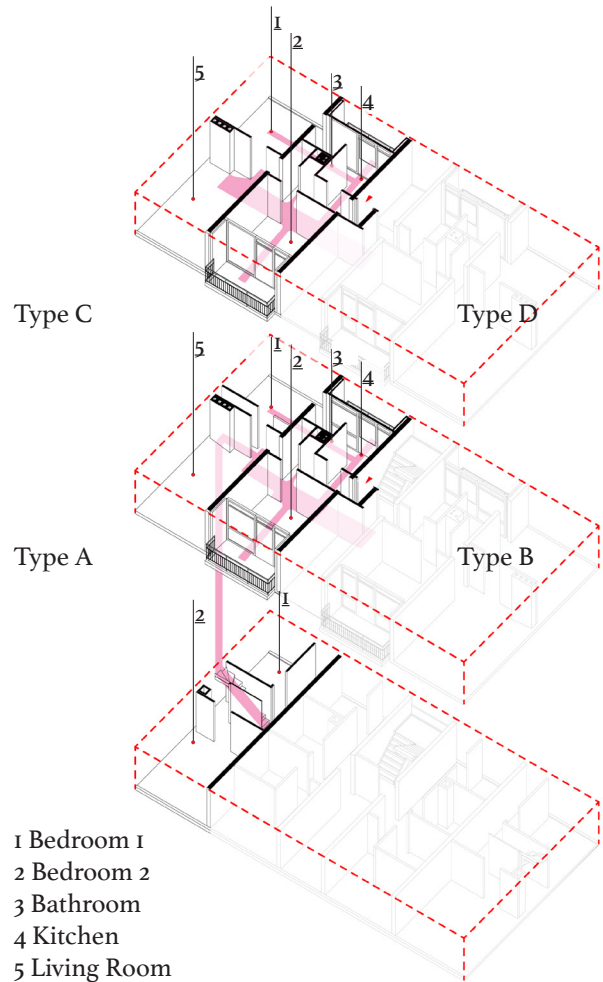

Diagram 1.5.4 Circulation of Intervam apartment, type A and C

Exterior Circulation

Exemplified by apartment type B and type D

For all types of apartments, the two balconies are attached to the bedroom and the kitchen respectively.

Apartment type A and B can enjoy their private gardens on ground floor. The garden can be accessed from the walkway on ground floor. Moreover, external stairs attached to the balcony on the kitchen connect the garden.

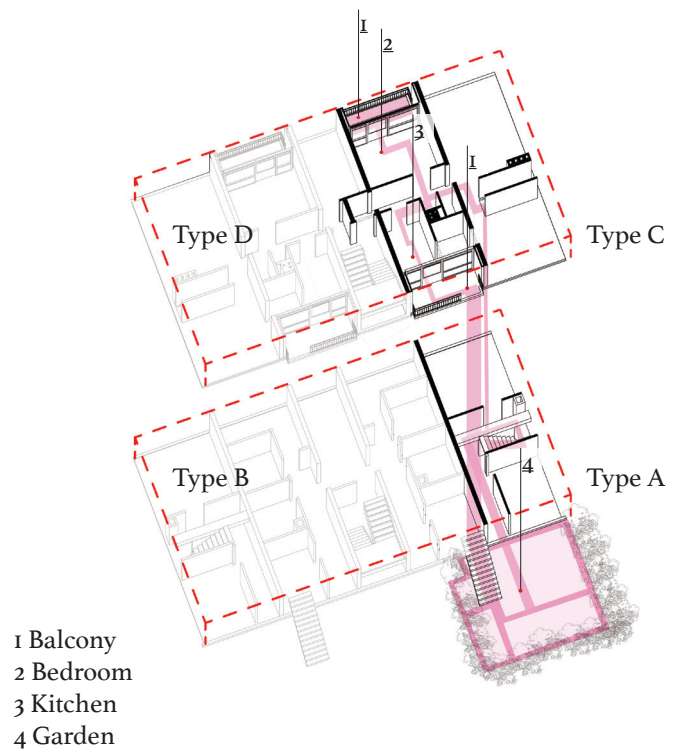

Figure 1.5.5 Circulation of Intervam apartment, type B and D

Use of Space & Stuff

Entrance of the portiekflat

History design and use

The entrance of the portiekflat was designed to serve for 8 households. Before 1984, the space of entrance was bright and translucent with glass interface in its front. The mail box was arranged inside (see figure 1.5.10). Stranger and thief might get the chance to go inside and increase the potential insecurity.

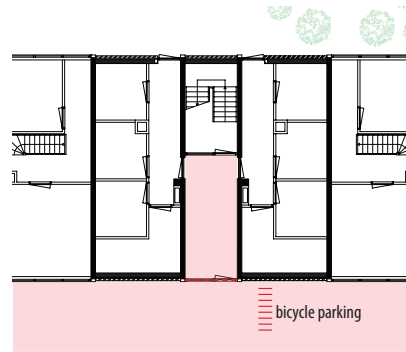

Current Situation



Harsh Border

Figure 1.5.6 The entrance door forms a harsh boundary which causes the immediate transition between indoor and outdoor space.

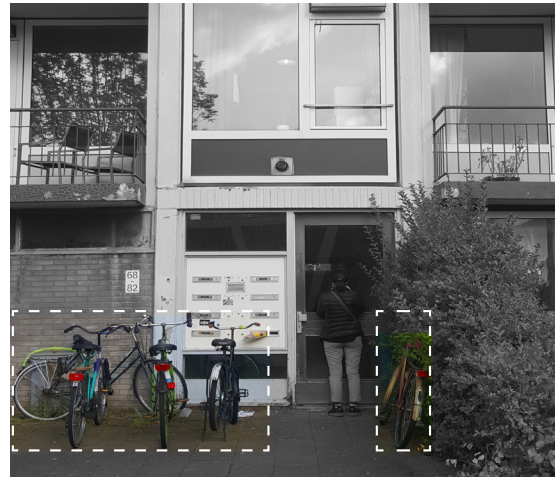

Random Bicycle Parking

Figure 1.5.7 Some residents park their bicycles casually for convenience even though there is vacancy of parking spots in front of the entrance.



Parking inside

Figure 1.5.8 The size of the hall at the entrance is relatively small and some of them are used to parking the bicycles for security reasons, which makes them narrower.



Space in Front

Figure 1.5.9 There is a large space in front of the entrance hall but it is not used for any specific purpose other than bicycle parking.

Conflict, Quality and Possibility

Conflict

Transparency|Convenience| Space VS Security:
 In order to increase security for the apartment, the mail box was replaced from the interior to the exterior facade. The results turned out to lose the original transparency and openness, form a harsh border and cause inconvenient use in rainy days. Moreover, some residents park their bicycles inside and narrow the space for safety reasons as well.

Quality

One entrance is shared by eight apartments.

Possibility

The blank space in front of the entrance has the possibility to be used as an extension or an extra space to create a more inviting and welcoming entrance.

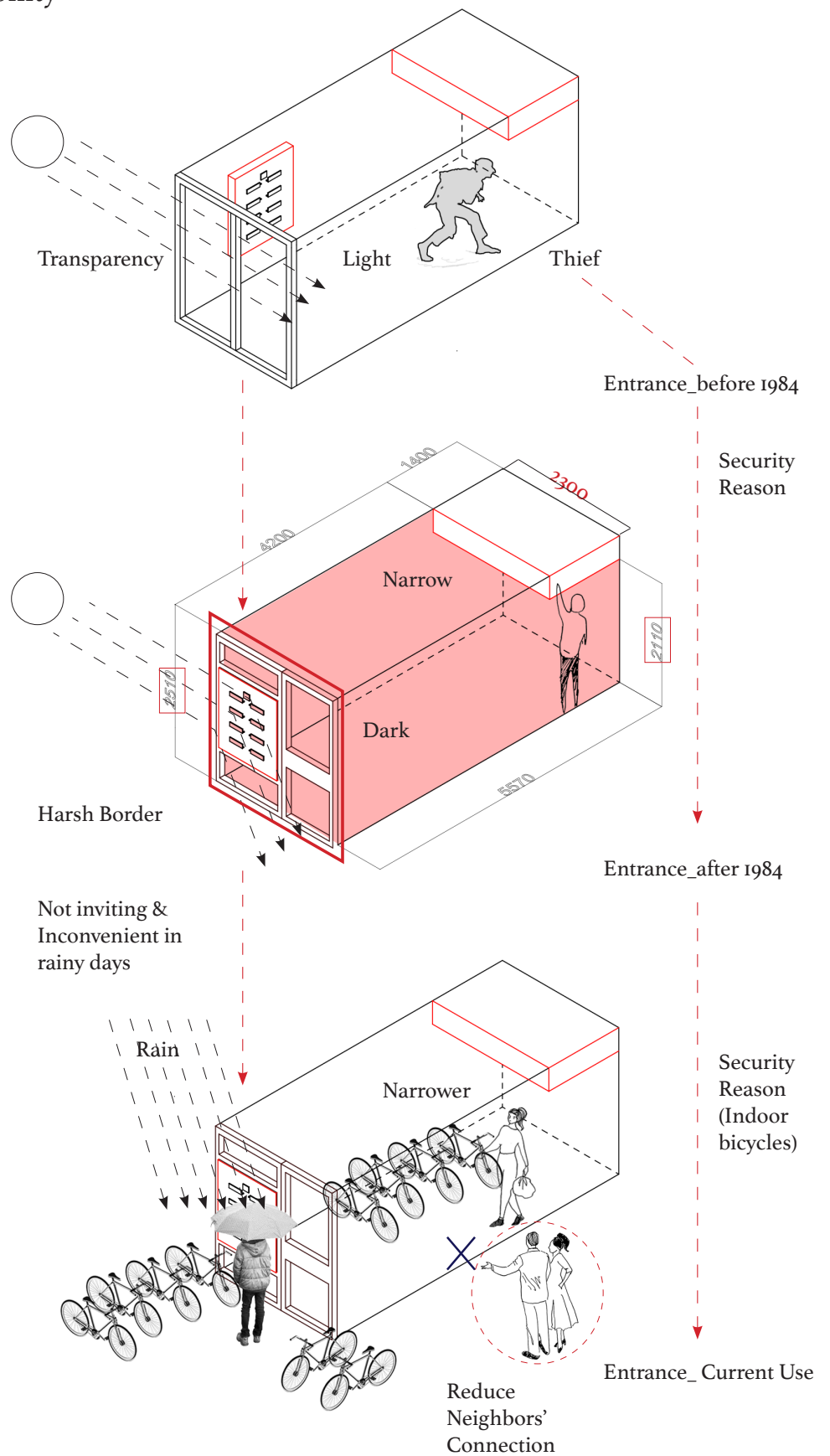

Figure 1.5.10 Entrance of the Intervam buildings, Camera Obscuradreef

Stairwell

History Design and Use

The stairwell, located at middle bay of the portiek, was designed to be shared by 8 households. For people living in 2-4 floor, it is the only route to escape in case of emergency. With the dimension of 2.3m by 4.2, it is neither big or small and provided a chance for the 8 families to get to know each other. It was intended merely to be functional for circulation. But the residents began to decorate it and add expressions for it during time.



Current Situation



View of Nature

Figure 1.5.11 Residents get a nice view of nature through a large window at landing of the stairwell.



Plant at Landing

Figure 1.5.12 Some of the residents decorated their stairwell with plants as an inviting and welcoming gesture.



Painting on the Wall

Figure 1.5.13 Some residents decorated their stairs with art pieces to change the repetitive and dull space in the standard staircase.



Extra Use

Figure 1.5.14 The residents on the top floor use the landing space for individual purpose, for instance storage.

Conflict, Quality and Possibility

Quality 1 and Possibility

By decorating with plants and other stuffs, the stairwell is beyond functional and transmits a sense of living. It is also possible to eradicate anomony and showcase a richful life.

Quality 2

With large window frame, the stairwell is full of light and views.

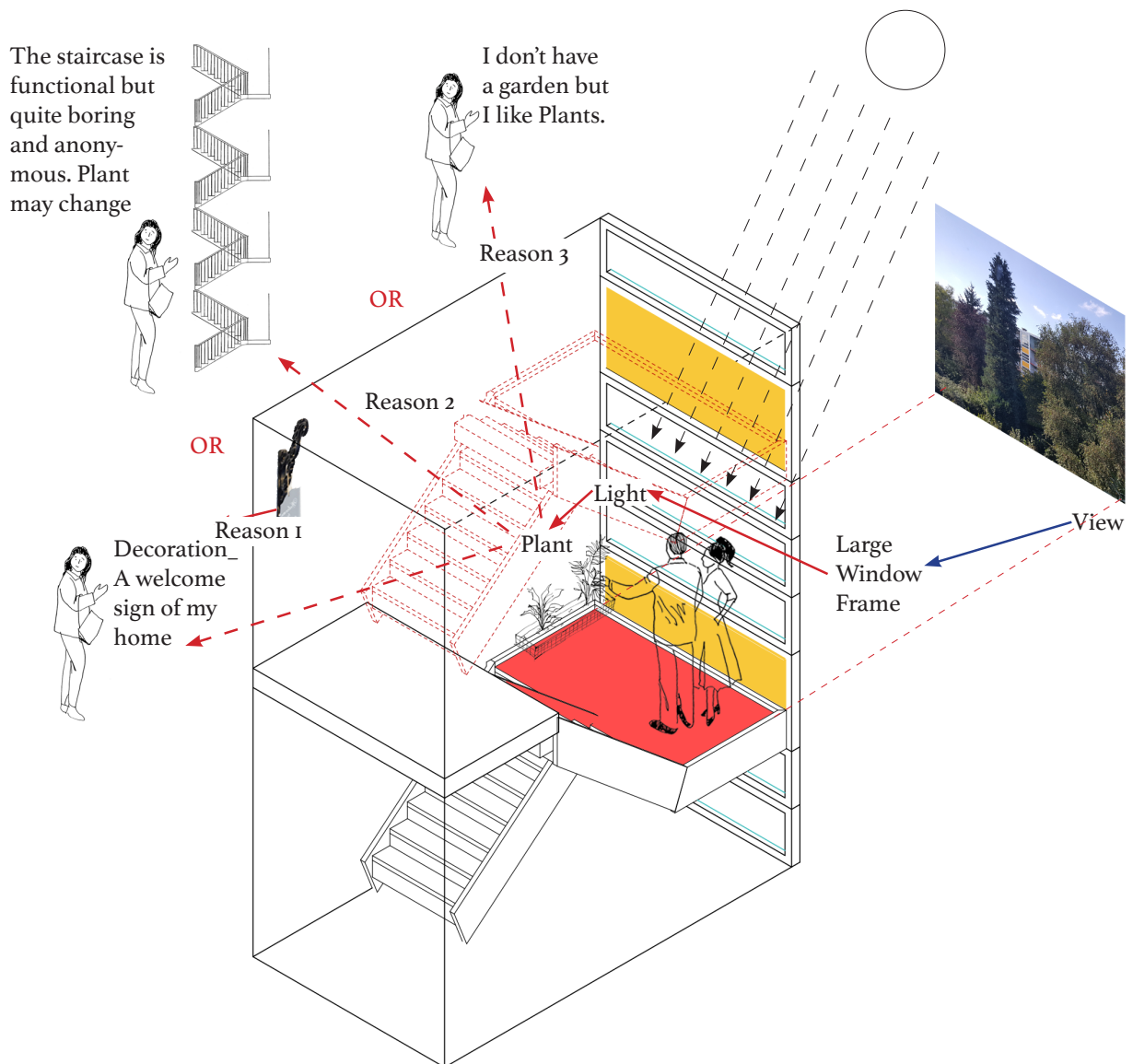
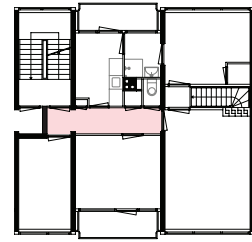

Figure 1.5.15 Stairwell of the Intervam buildings, Camera Obscuradreef

Hallway

History Design and Use

In order to accommodate more people, the majority of floor area was designed as bedrooms. By using one corridor, all the functional spaces are connected. With the width of 1.14m, the hallway was mainly intended to be functional and efficient.



Current Situation



dark

Darkness

Figure 1.5.16 The hallway is with dim light when doors on both sides are closed. Sometimes, tenants have to turn on the light even during daytime.



stuffs

narrow

Narrow Space with Stuffs

Figure 1.5.17 Some tenants use it to put coats and shoes when they enter the house or use it as a temporary storage of stuffs, which might cause the hallway even narrower.

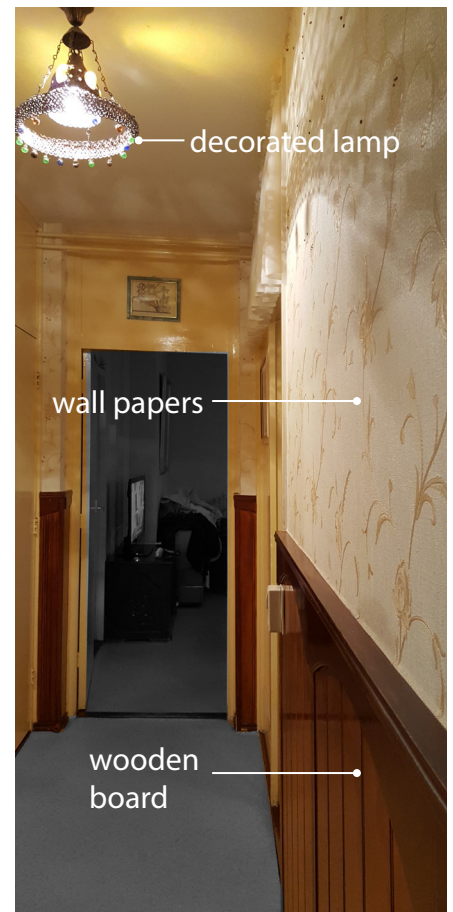

decorated lamp

wall papers

wooden board

Decoration

Figure 1.5.18 Some tenants from family group keep the hallway clean and decorate it for their own taste.

Conflict, Quality and Possibility

Conflict

Stuff VS Space:

Due to lack of space for storage, the stuff put in the hallway make it narrower.

Privacy VS Light:

Due to privacy reason, the door of bedroom is often closed which blocks the light. Thus, it is usually dim in the hallway.

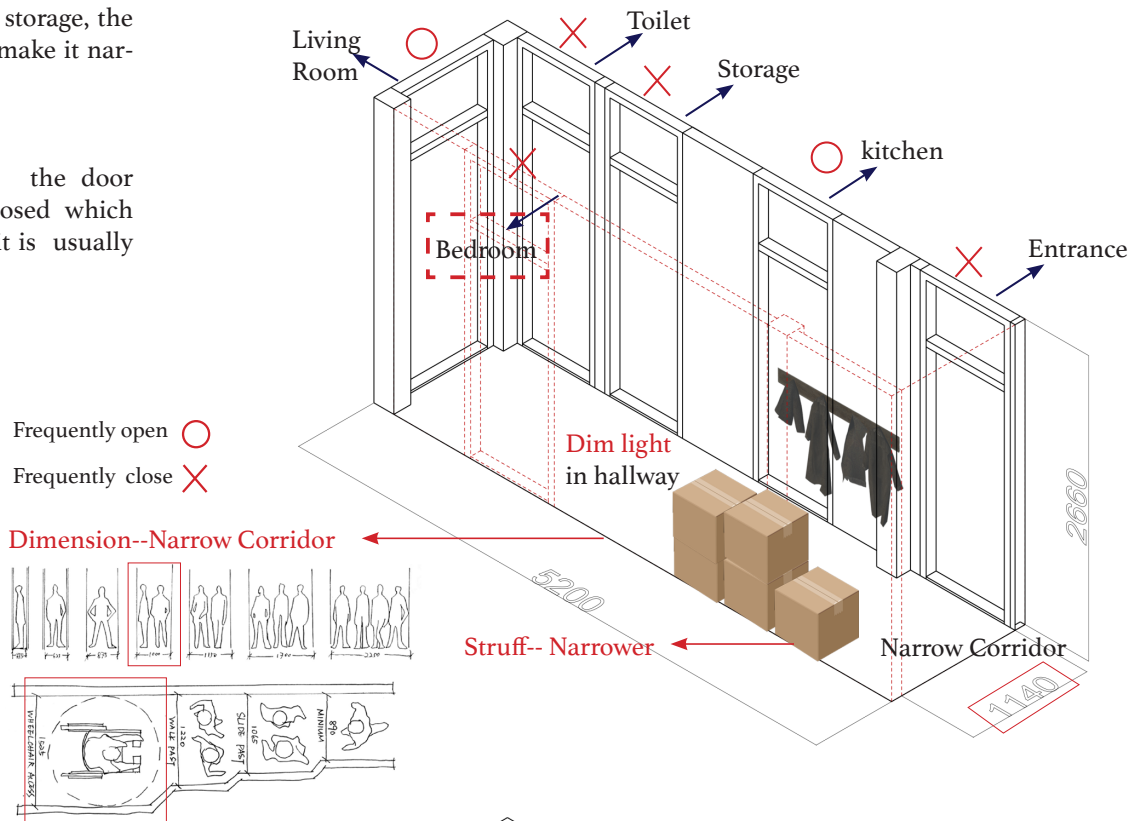

The size of a hallway only meets the minimum requirement and is not possible for wheelchair across

Quality

Beyond functional: Using decoration and materials to create a welcoming atmosphere of home.

Possibility

In a sense, the corridor serves for people's flow in an efficient way. But what if the corridor disappears by switching the living room and bedroom and removing bedroom's wall next to the corridor? A bonus space might be gained from the corridor.

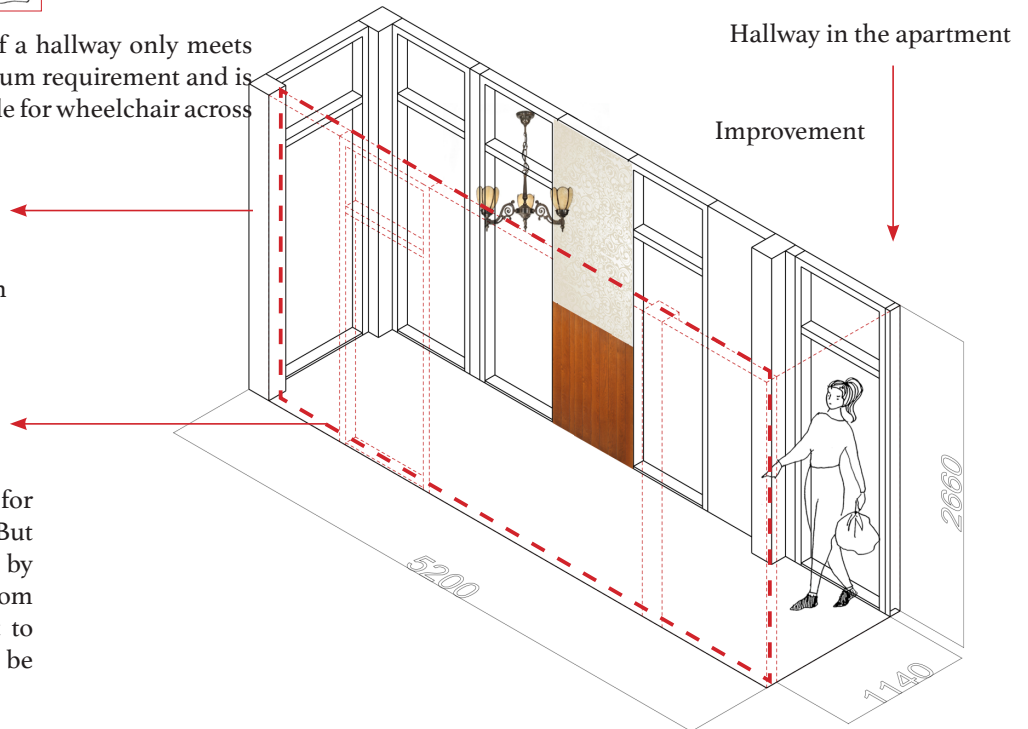

Figure 1.5.19 Hallway of the Apartment in Intervam buildings, Camera Obscuradreef

Living Room

History Design and Use

The living room was designed under the manifesto of Light, Air and Space which demonstrated the optimism and enthusiasm to pursue a better life in post-war mass housing construction. Large windows were applied to let plenty of light and views penetrate inside. Before the discovery of gas, heating was only provided in living room, in which family members often spent time together. Later, such intimacy kind of being affected since every room got heated in winter.

Current Situation

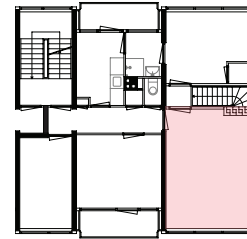

Figure 1.5.20 Student 1: Living room
Lounge area, dining, daylight, daily use, student association



Figure 1.5.21 Student 2: Living room
Lounge area, dining, daylight, daily use



Figure 1.5.22 Student 3: Living room
Lounge area, dining, daylight, daily use, student association

Conflict, Quality and Possibility

Conflict

Space VS Stuff; Intended Function VS Multi-functions
 The floor plan was to design as many bedrooms as possible in post-war mass housing. The surface area of other functional space was reduced, let alone the storage space. In this circumstance, it made the living room become a passively flexible and multi-functional space in the apartment. Stuff began to occupy the space of living room. A living room becomes a literally “living “ room containing more than it was intended to be.

Quality

Modern idea of light, air and space was put into practice in the building and the living room has been keeping the quality for people’s life till now.

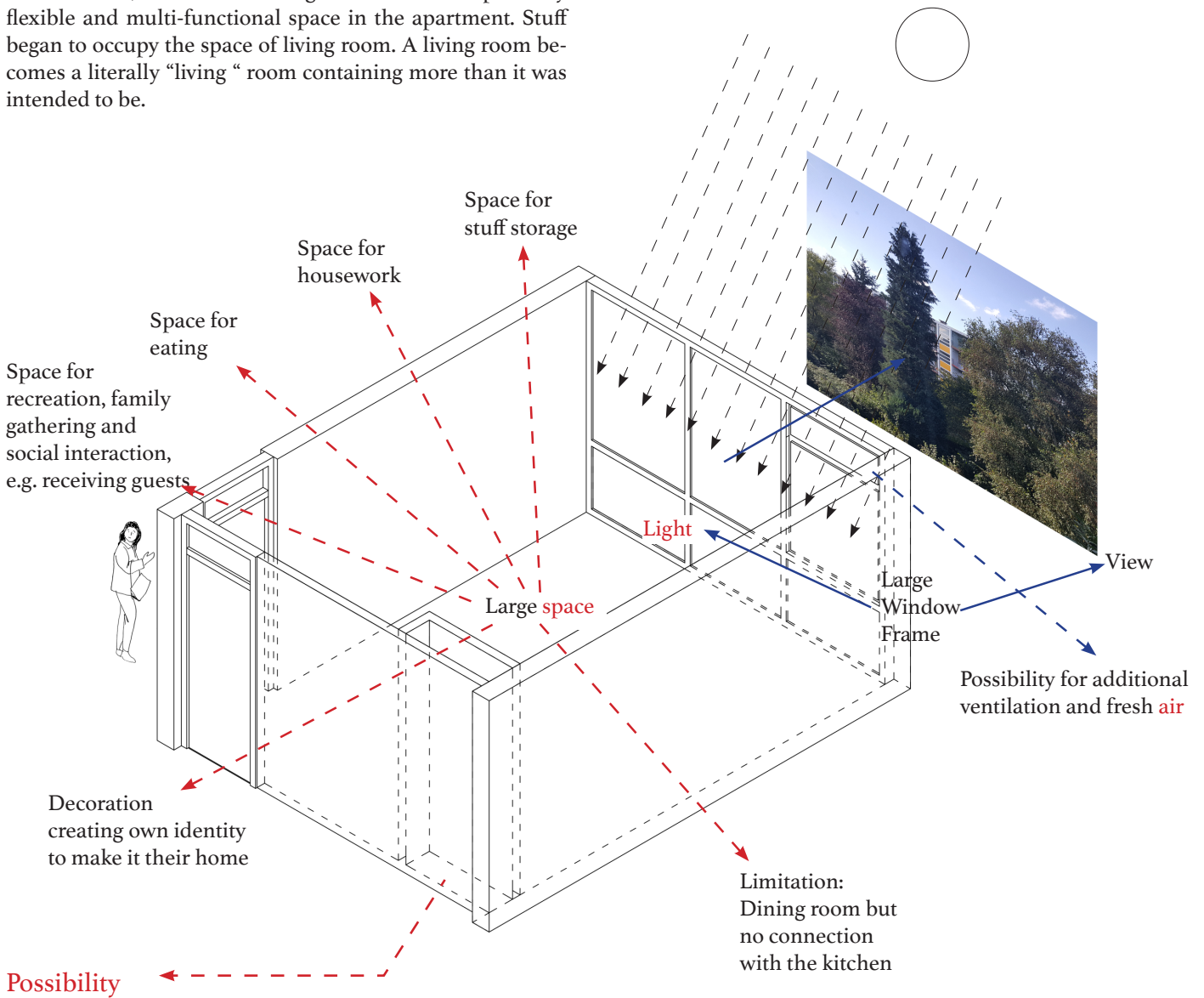

The chimney was intended to ventilate the waste gas of burning coal and later was used for gas heater in some apartments. The shifting of energy also accompanies the changing of lifestyles. The chimney might have potentials to contribute to the comfort of the interior environment and life but needs to be further explored.

Figure 1.5.23 Living Room of the Apartment in Intervam buildings, Camera Obscuradreef

Kitchen

History Design and Use

The kitchen is quite small with the surface area of only 6.52 m². But it was a luxury to have a separated kitchen in an ordinary household at previous time. In this condition, it might be mainly intended to be used by housewife. And kitchen was usually designed with a balcony which functioned as an extension of kitchen for doing houseworks.

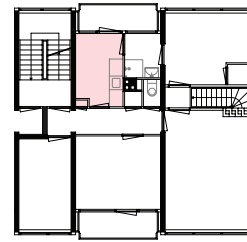

Current Situation



Figure 1.5.24 Basic social housing kitchen



Figure 1.5.25 Community kitchen



Figure 1.5.26 Community kitchen



Figure 1.5.27 Student 2 kitchen



Figure 1.5.28 Student 3 kitchen



Figure 1.5.29 Family kitchen

Conflict, Quality and Possibility

Conflict

Space VS Changing of Lifestyles| Stuff | Circulation

The kitchen was mainly designed for housewife previously. It is functional but quite small which can not meet some changing lifestyles nowadays. For instance, it is uncomfortable for the whole family to share cooking time together. And it lacks storage space for stuff, let alone some modern kitchen appliances with bigger size. The small space would also be disturbed sometimes by residents accessing to bathroom or balcony (garden).

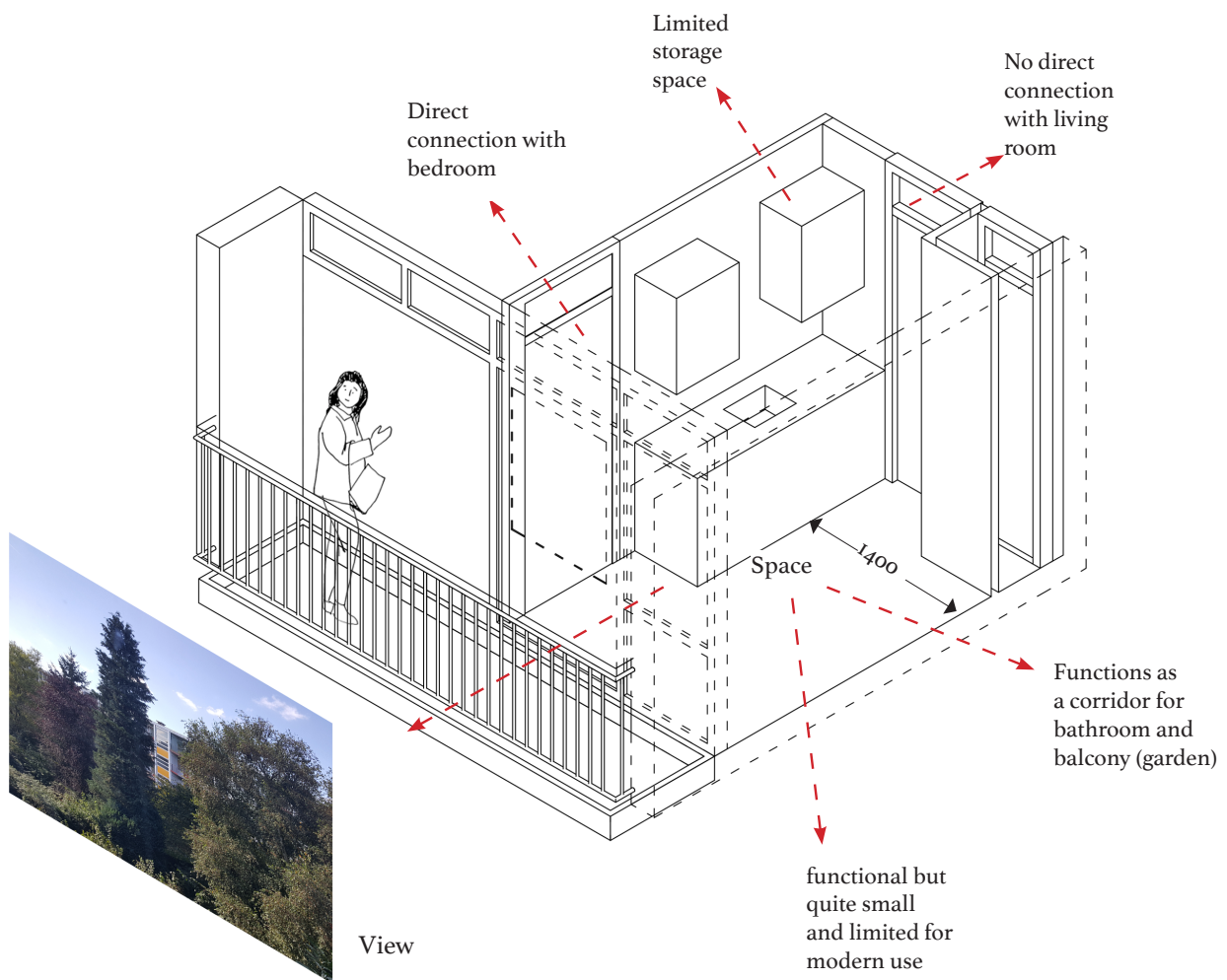

Quality

Direct connection with balcony and outside is a quality of kitchen which provides good light, air, view, outside space and other possibilities for kitchen life. In an apartment without mechanical ventilation, it may also help to ventilate the smells and steams from cooking in the kitchen.

Figure 1.5.30 Kitchen of the Apartment in Intervam buildings, Camera Obscuradreef

Bathroom and Toilet

History Design and Use

Apart from kitchen, it was also a luxury to have a bathroom at that time. The bathroom and toilet were in standard design no matter how big the family is. And the route to bathroom should go through kitchen or bedroom which sometimes causes inconvenience . In a sense, the industrial building with standard and mass production lacked the consideration of human needs and routines.

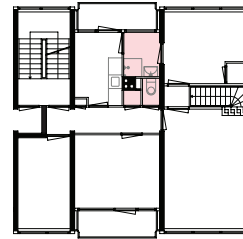

Current Situation



Figure 1.5.31 Basic bathroom



Figure 1.5.32 Basic bathroom



Figure 1.5.33 Seperate toilet



Figure 1.5.34 Washing machine in the closet

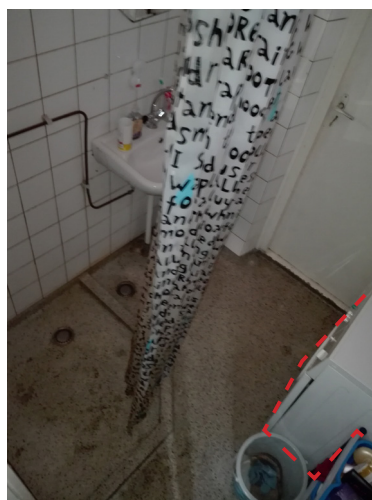

Figure 1.5.35 Student bathroom with washing machine



Figure 1.5.36 Student bathroom

Conflict, Quality and Possibility

Conflict

Use VS Inconvenient Circulation | Space

There is one private entrance from master's bedroom and one more public entrance from the kitchen. Entering from narrow kitchen may cause inconvenience when the kitchen is in used.

Due to the small size of bathroom (3.11 m²), it can be inconvenient when it is shared with a big family. The original aim of the design could be to ensure access to bathroom for the whole family while leaving as much floor area for bedrooms as possible.

Quality

The bathroom, kitchen and toilet are grouped together for a more efficient solution for ventilation and sewage water.

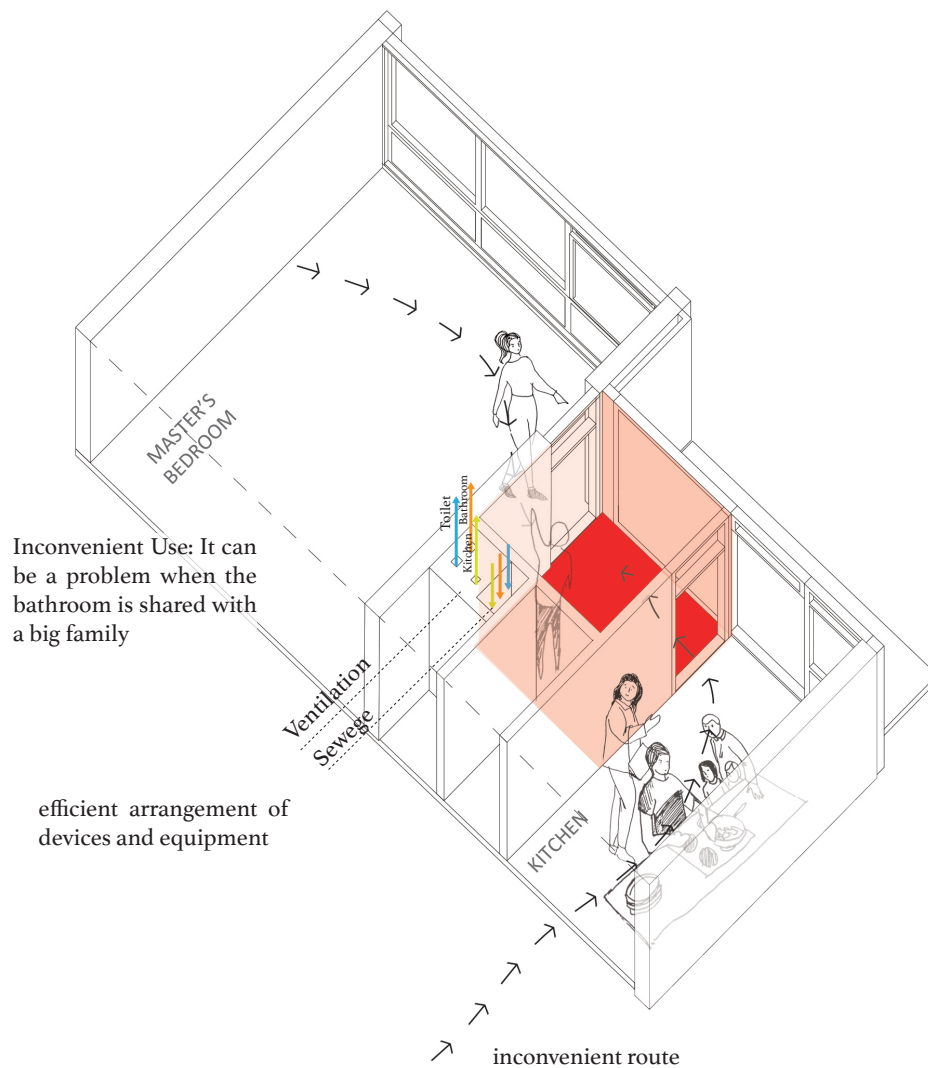
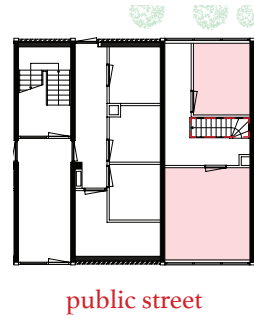

Figure 1.5.37 Bathroom and Toilet of the Apartment in Intervam buildings, Camera Obscuradreef

Bedroom

History Design and Use

In order to meet the housing demand in 1960s', the majority of space was designed as bedrooms to hold more people. Each bedroom, with large window and span, is positioned on both sides of the building, which practiced the modern movement of light, air and space.



Bedroom on the ground floor



Bedroom on other floors

Current Situation

Bedroom on the ground floor

The bedroom on the ground floor which is facing the public street could cause the problem of privacy and safety. People often close the curtain to prevent other people from looking inside their private room.

The old wooden stair could occur the noise problem and the corridor is narrow and always dark during the whole day.

Bedroom on other floors

The bedroom on the middle is smaller than other rooms due to the rigid concrete module. Some of the residents are using the room as a storage.

In some cases, the bedroom located opposite the kitchen is transformed into dining room. The flexible use of space is needed to satisfy the residents of different cultural background.

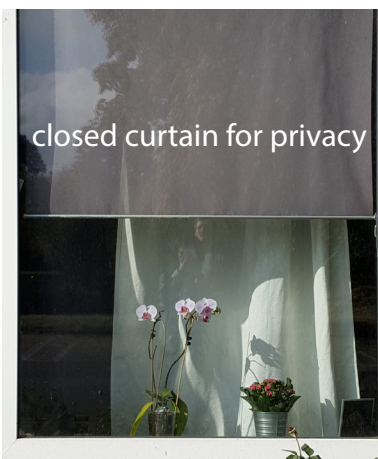

Figure 1.5.38 lightness vs privacy



Figure 1.5.39 noise disturbance



Figure 1.5.40 small bedroom used as a storage

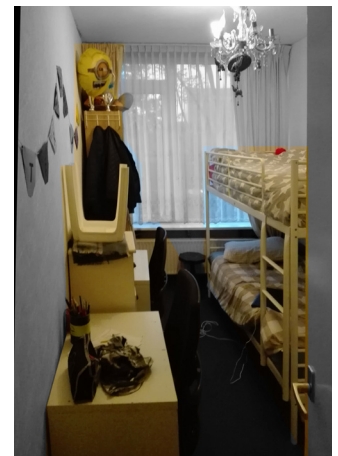
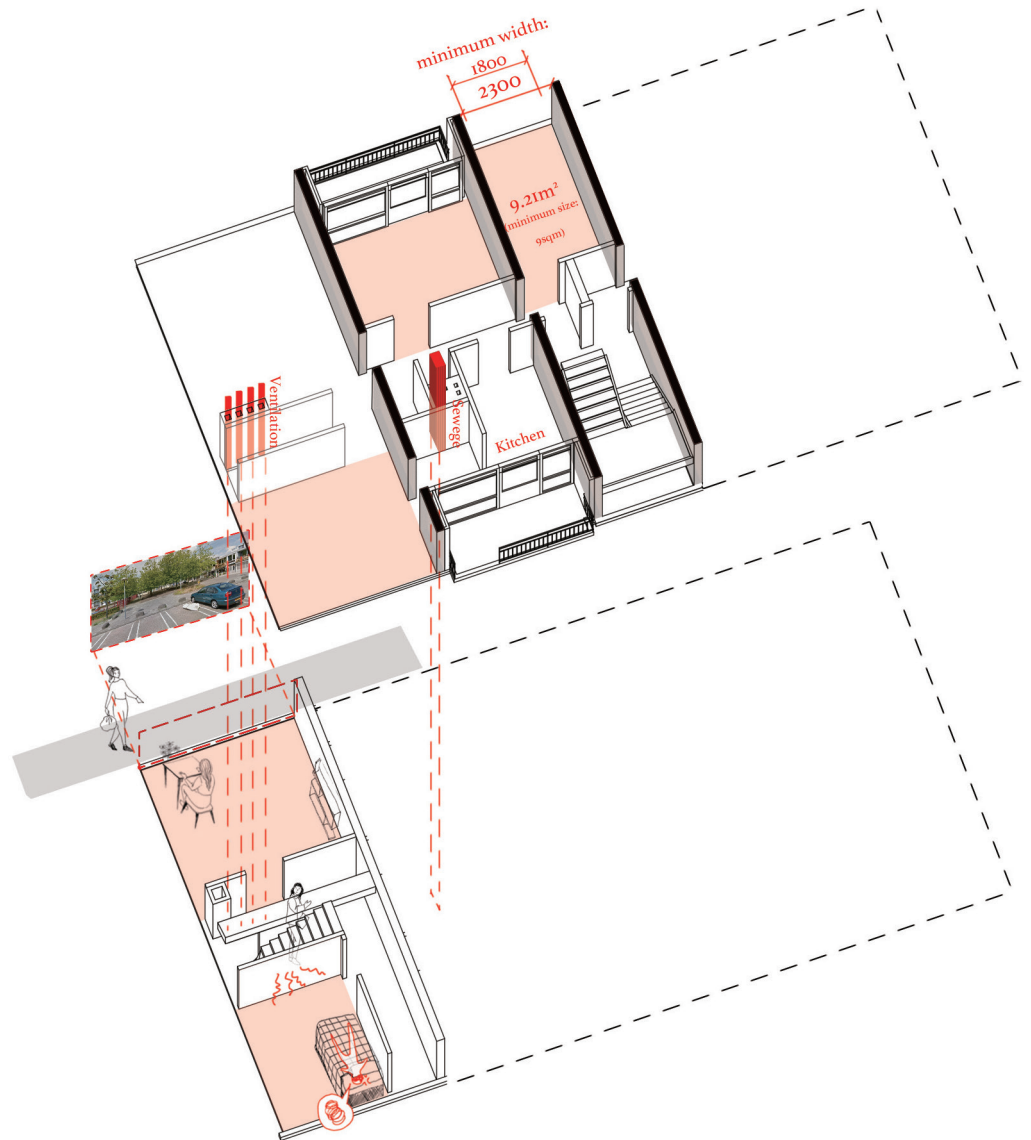

Figure 1.5.41 small bedroom used as a bedroom for kids

Conflict, Quality and Possibility

Conflict and Possibility

Space VS Structure
The small bedroom was limited by the rigid concrete module. However it can be a good space for storage, cloak room or guest bedroom.



Conflict and Possibility

Position of Bedroom VS Privacy
The privacy problem can be solved by using the space as a living room instead of bedroom. However, it was disconnected with the kitchen on the upper floor, which may bring some inconvenience. Moreover, the function of ground floor is limited, since there is no ventilation shaft and water pipes.

Figure 1.5.42 Bedrooms of the Apartment in Intervam buildings, Camera Obscuradreef

Balcony

History Design and Use

There are two balconies in each household. The balcony was designed next to kitchen and bathroom(which was used for laundry as well), since it was a comfortable working place for housewives. The one connected to the bedroom was intended for spending leisure time or for children to play.

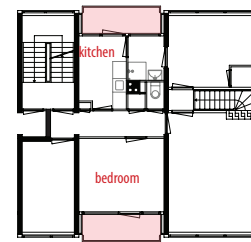

Current Situation

Balcony Connected with Kitchen:

Nowadays it is mainly used as storage or for housework due to the lack of storage space for stuff which was not well considered in the floor plan.



Figure 1.5.43 Balcony as storage



Figure 1.5.44 Balcony as storage

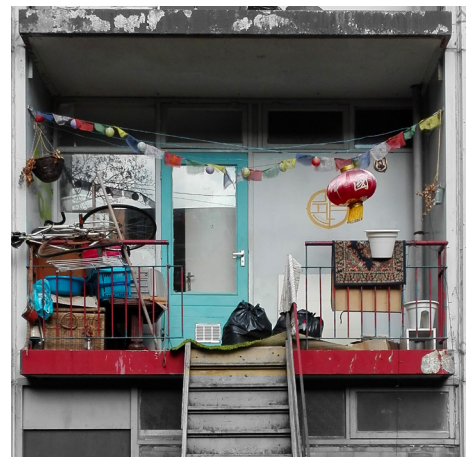

Figure 1.5.45 Balcony as storage



Figure 1.5.46 Balcony for housework



Figure 1.5.47 Balcony for housework



Figure 1.5.48 Balcony for housework

Balcony Connected with Bedroom

The balcony on this side is used to relax or do the gardening in current situation. By decoration, the balconies take on different looks and deliver a scent of living.



Figure 1.5.49 surrounding view from the balcony



Figure 1.5.50 appearance from outside



Figure 1.5.51 Balcony for leisure



Figure 1.5.52 Balcony for leisure



Figure 1.5.53 Balcony for leisure



Figure 1.5.54 Balcony for gardening

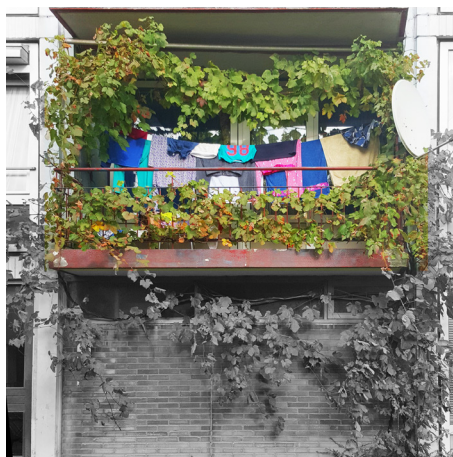

Figure 1.5.55 Balcony for gardening



Figure 1.5.56 Balcony for gardening

Conflict, Quality and Possibility

Quality and Conflict

Two balconies with views of surroundings and neighbourhood are a quality for the apartment. But both of them are not connected with living room. The one attached with bedroom is relatively private and may limit the use for other residents in the dwelling. For student group, this balcony serves to be a totally private use.

Possibility

By exchanging the positions of living room and bedroom, the balcony will be connected with the most communal and public space in the apartment. In this case, the balcony can be shared by the whole members freely and frequently.

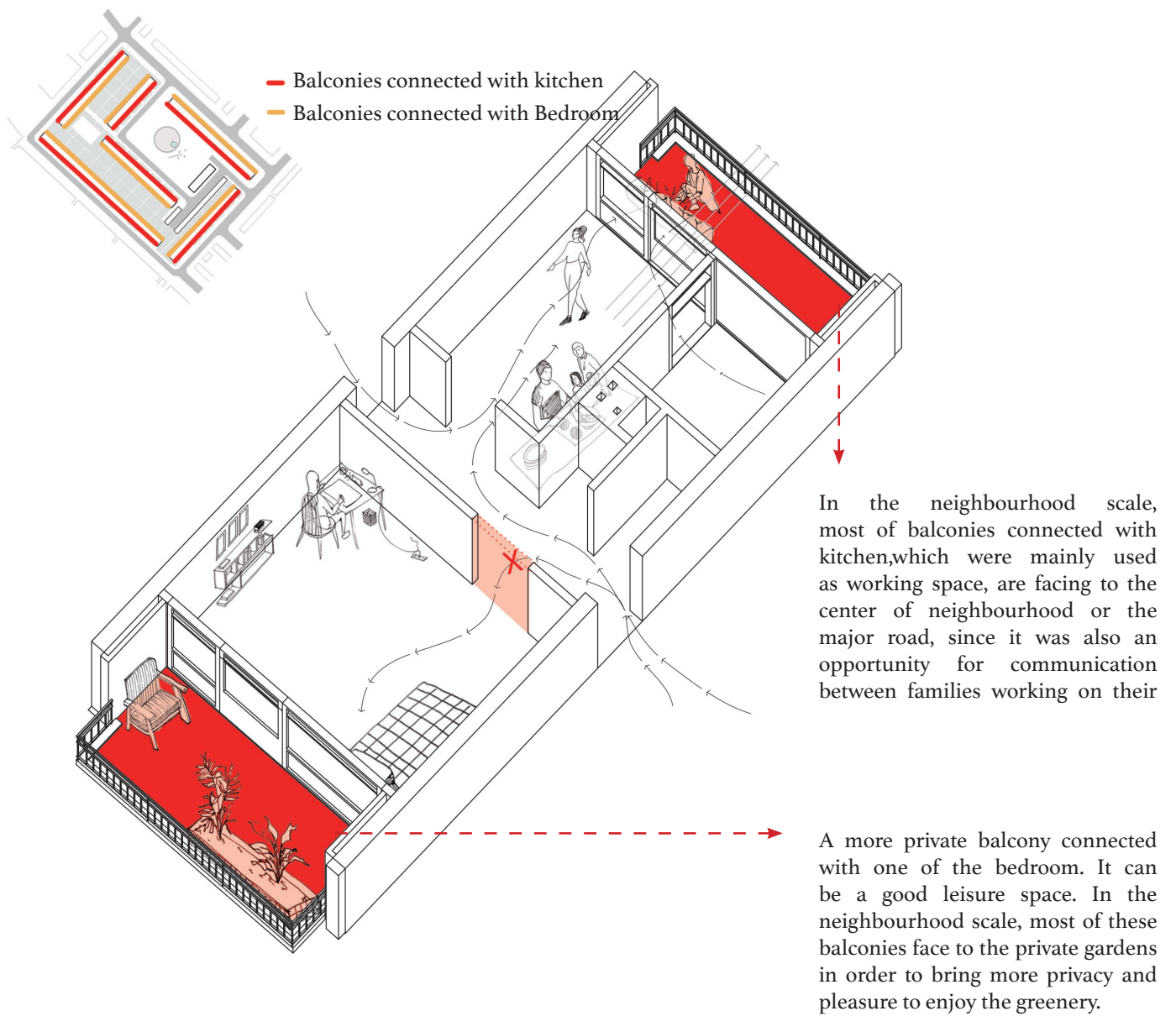

Figure 1.5.77 Balconies of the Apartment in Intervam buildings, Camera Obscura reef

The use of garden

History Design and Use

The idea of “Light Air Space“ was also implemented in gardens. The generous space in between two buildings was mainly designed as private garden, which reflects the essence of postwar optimism with constructions of garden cities. In previous time, the hedges were well maintained to a certain height in order to keep the open green structure and the smooth transition from public space to private gardens. One downside is the accessibility to the garden. In some cases, people have to go up to first floor and use stair to go down again to access the garden. Moreover, it is not connected to the communal space of the apartment such as living room or dining room.

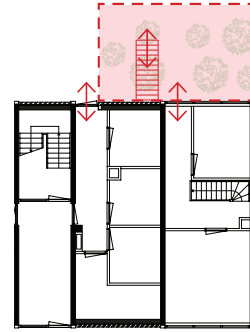

Figure 1.5.58 view of gardens in 1960s



Figure 1.5.59 current view of gardens

Current Situation

Through time, trees and shrubs are thriving. The height of hedge breaks the view of the original open green structure (Figure 1.5.58/1.5.59). Due to different group of tenants, gardens are under different circumstances. For student group (the majority tenants), most of the gardens are not well maintained and some of them are even deserted because they view themselves just as temporary tenants. It is not worth for them to put much effort on it since they will move out after all. However, for family group, every household uses it in their own way and gives the garden its own identity. But it's still difficult to maintain since it's rather big.



Figure 1.5.60 garden in use with shed (family group)



Figure 1.5.61 abandoned garden (student group)



Figure 1.5.62 abandoned garden (student group)



Figure 1.5.63 lack of maintenance (student group)

Another Quality: Though lacking maintenance, the trees, hedges and grass in the current state give the garden a more natural expression and poetic atmosphere in a sense. Borders are strengthened by green structure, while fantastic space is also formed as a footprint of nature and time.



Figure 1.5.64 the door of garden



Figure 1.5.65 silent garden

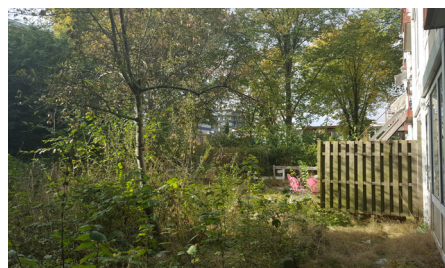

Figure 1.5.66 a tree in garden

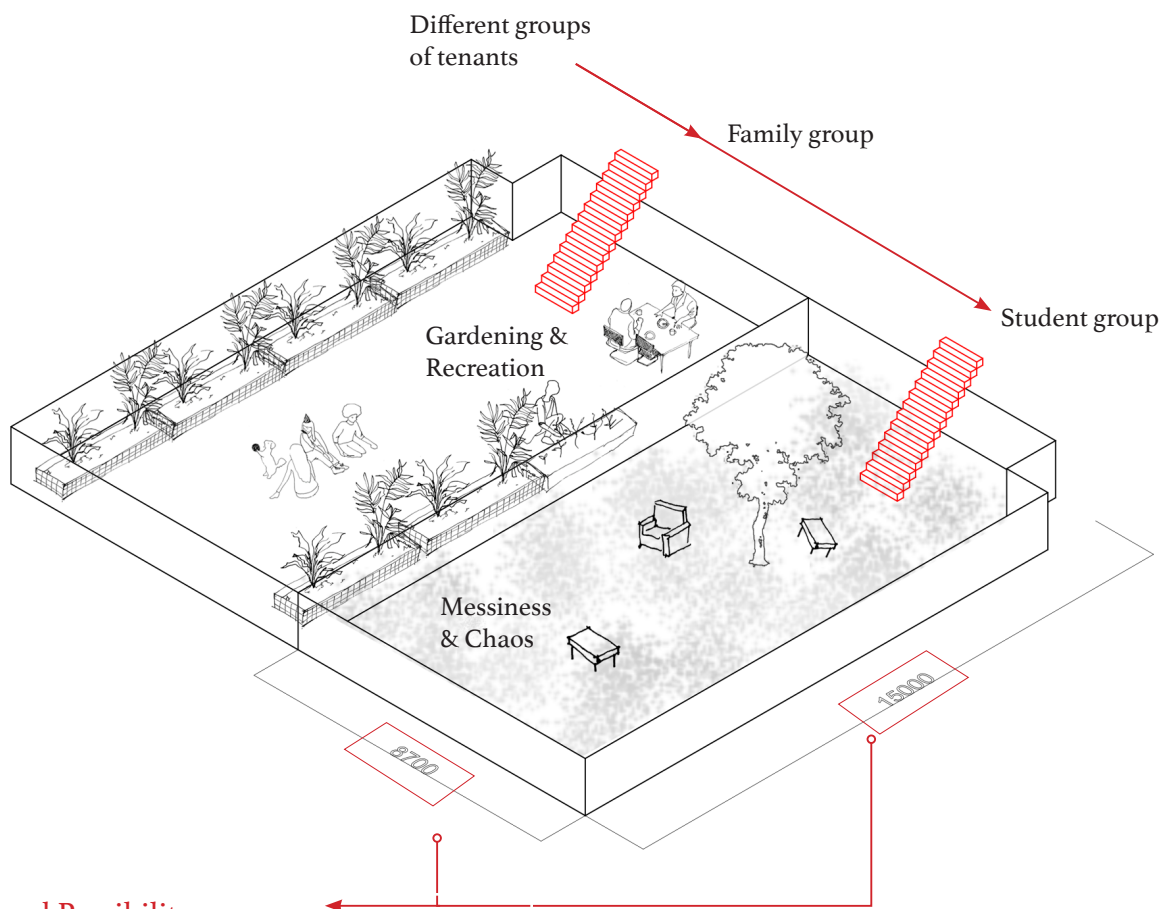

Figure 1.5.67 green passage between gardens

Conflict, Quality and Possibility

Quality

The gardens , with the dimension of 15m by 8.7m are very spacious and also are in private use. Trees and hedges help to create a natural and quite atmosphere in the gardens.



Conflict and Possibility

Space VS Maintenance

The scale of garden may cause difficulty in maintenance even for family group. One possibility is to reduce the size for less maintenance and add the extra space for public services and uses. while it might destroy the existing qualities of a spacious, private garden which exhibits the work of nature and time.

Figure 1.5.68 Garden of the Apartment in Intervam buildings, Camera Obscuradreef

Conclusion

Quality_Light Air Space

The space plan of the Intervam buildings reflected the ideals of Light, Air and Space of the modern movement. Large windows were applied on the skin. Living room, bedroom, balcony and stairwell are full of light and views. The generous outdoor space between two buildings guaranteed light, air and space. Spacious garden represented positive life of postwar garden city. Those qualities have been examined through time and still should be cherished and preserved for the future.

Conflict_Changing Needs

The standardization of the industrial buildings catered for the urgent housing scarcity. With time flying, however, the intended use can not fit the current changing needs very well.

The arrangement of the floor plan is characterized by a corridor connecting the majority of space and every room separated by inner wall. The position of bathroom is a downside of the layout which results in inconvenient use of residents. It is a pity that both of the two balconies are not connected with living room. The location of the balcony next to bedroom turns out to be more private, thereby undermining its communal use. The service space such as kitchen, bathroom, toilet was designed with the same standard neglecting the size of different households. The surface area of them were also reduced to leave space for bedrooms. In addition with lacking consideration of adequate storage space, residents' stuffs are fighting for their territory in the space. Some modern household appliances are also struggling to find their place.

Though the space plan meets the minimum requirement and is still functioning, it largely limits the flexible and free use for a modern life. Thus, conflict between space plan and changing needs should be carefully taken into consideration for the revitalization of the Intervam buildings.

Possibility_Modern Life

Exchanging the positions of living room and bedroom and removing the separating interface between the bedroom and corridor could be an approach to create a new corridor-free floor plan. In this circumstance, living room will directly connect with kitchen and one of the balconies, which might breed more convenient and free use.

For apartments occupying both the ground floor and the first floor, one possibility is to access the house from the garden and bring living room and kitchen to the ground floor. In this way, the circulation will be more reasonable and the use of garden will be increased. Besides, communal and private zones will be clearly defined in two layers and not interrupt each other.

To reduce maintenance of garden, the surface area can be lessened in a proper scale and be transferred to communal use in the neighborhood.

Decoration from the residents could be an avenue to showcase their own identities and to wipe out the anonymity resulting from the standardized construction and production.

I. Analysis of the system

I-6. STORY

Demographics

Change of residence

Constructing for satisfying requirement on large amount of housings caused by baby-boom after WWII, the community were occupied by families after its completion in 1960s. The community was well maintained and made full use. Over the years, like as in many other post-war housing estates, the demographics has been changed in Overvecht. In 1980s many Overvechters went to find family houses with garden in Maarssenbroek and Lunetten. The new residents were mostly foreigners. The income of the family changed dramatically. Originally, most residents were middle-income neighborhoods, now there are mainly residents from the lower income groups living in Overvecht (see figure 1.6.2.).

Overvecht has become a district with a great mix of cultures, now approximately 50% of the population are immigrants(see figure 1.6.1.). Most of them are from Morocco, Turkey and to a lesser extent of those from Surinam and Antilles. Some of them speaks their own language only, and have difficulties in integrating with the community. In recent years there has been more attention to the problems in the neighborhoods. Overvecht, along with forty other neighborhoods in the Netherlands, designated as “focus area” to improve the quality of life (Municipality, 2016).

Now there are temporary rooms for students in Camera Obscuradreef, Van Brammendreef, Vader Rijndreef, Ebrodreef and Taagdreef. These areas were planned to be demolished in 2008 but the project was canceled due to the economic crisis. However, after the residents were moved out from the flat, those empty houses were now transformed into one of the largest student enclaves in Utrecht. The community is becoming a young neighborhood. As illustrated in figure 1.6.3. , Compared with other neighborhood in Overvecht, senior citizens over 65 years old are in the minority in Camera Obscuradreef. It is a perfect place for students in terms of location and low rent.

The size of households has been changed as well. Originally, the community was occupied by families with children. Nevertheless, According to figure 1.6.5. and figure 1.6.6. , households of small size are now common in the whole Overvecht area, especially in Camera Obscuradreef. As expressed in figure. , only 20-30 percent households in Camera Obscuradreef have children. The proportion is also low in the most part of Overvecht area. Requirement of current tenants cannot be fulfilled by the original floor plans and neighborhood planning, which were designed for large families.

To conclude, The area has been changed a lot over time. The demolition plan of Intervam flats in 2008 fostered many residents to leave. Now many of the empty dwellings have been filled with temporary residents and only few families are left. Temporary tenants and mixture of residents groups lead to lack of communication between occupants. Temporary tenants pay less effort on maintenance of the community, bringing more problems. The playground at the center of the housing blocks is hardly used anymore and the maintenance of the gardens is no longer executed. Even the heating system of each household are different which is difficult to manage and control the whole block.

Mitros did for a long time the minimal maintenance because the building was nominated for demolition. While making plans, the maintenance was not carried out which put the district in decline. Mitros is planning to renovate and put their target group, back in the location. This is social housing, which can be a mix of all layers of the society. Incomes indicate the border. Since July 1, 2015 housing corporations must annually allocate at least 80% of their vacant social rental housing to households with an income up to € 35,739 (price level 2016). 10% goes straight to households with an income between € 35,739 and € 39,874 (price level 2016) and 10% goes straight to the higher incomes (Rijksoverheid, N.D.). A variety of people can live here. Places in the plinth of the building can contribute to reinforce social cohesion. The Intervam buildings at Camera Obscuradreef can go for their third life.

Demographics: current situation

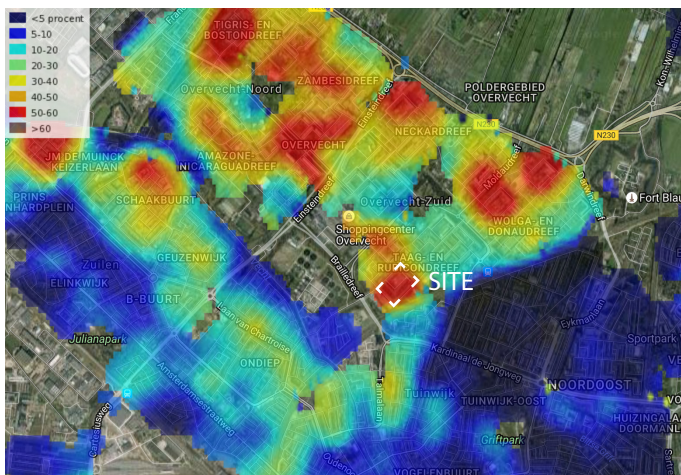

*Figure 1.6.1. Percentage of Non western immigrants

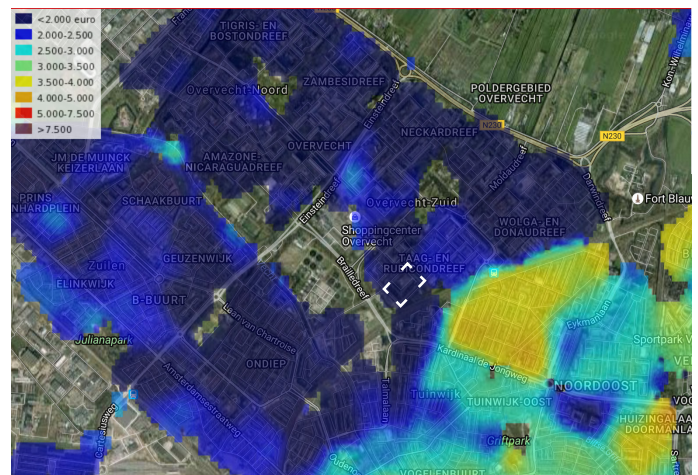

*Figure 1.6.2 Fiscal monthly income per person

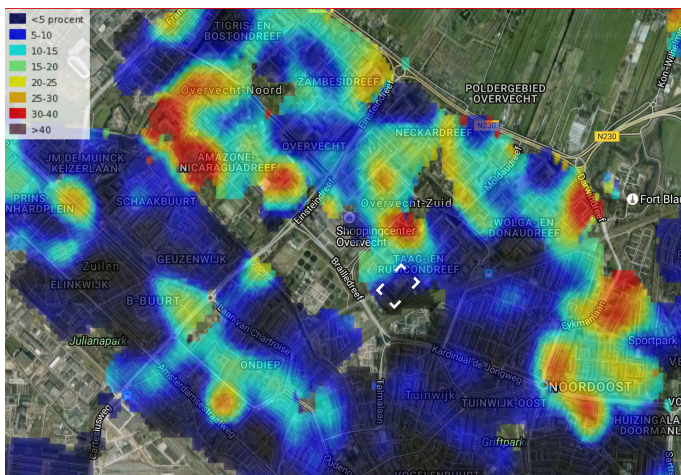

*Figure 1.6.3. Percentage of people over 65 years of age

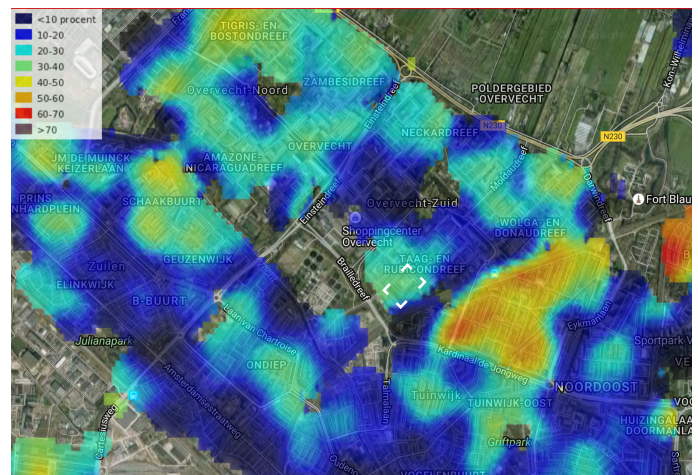

*Figure 1.6.4. Percentage of households with children

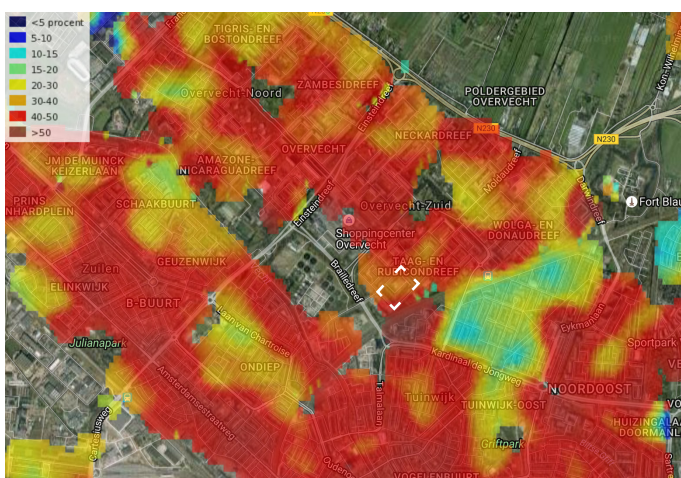

*Figure 1.6.5. Percentage one person households

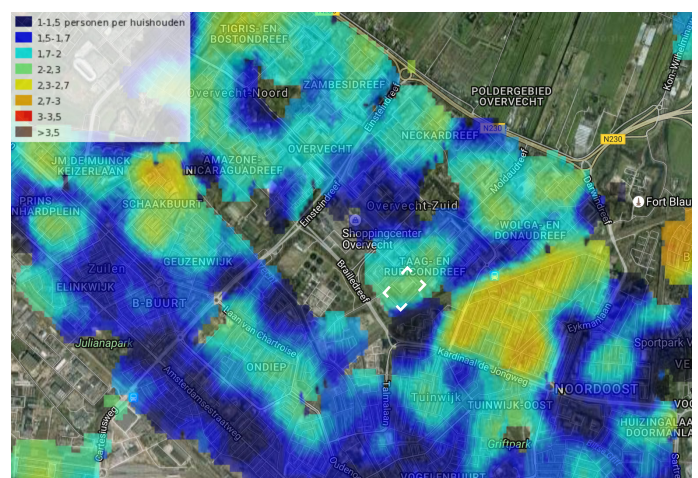

*Figure 1.6.6. Average household size

*Source: <http://maps.nrc.nl/CBS.html?#>

Interviews

Different groups of tenants are interviewed, and their apartments have been visited. Different lifestyles are revealed, and various requirements on their quality of living are expressed.



The rent is low ±€220 and everything is included. It can be cold in the winter and hot in the summer but the location is great! It's a shame that we can not stay here

Students: Text applies to students we have spoken

Interview with students

- Rent amount: euro 220-250 incl. For the energy bill the students who came in later pay more.
- Insulation: bad performance. Hot in summer and also can be cold in the winter.
- Regarding garden: not well maintained because they live there for a short period and the apartments have balconies.
- Best place to sit: balcony and living room. From the interviews the lower balconies are used less than the higher balconies. Orientation of the balcony is important as well. (Sun in the evening).
- Lives from 2008 or later in the neighborhood.
- Shares apartment with 2-4 students.
- Most of the time not at home (study, work, social activities etc.)
- About noise: neighbors can be heard and the stairs from living room to bedroom is noisy. Neighbor noise is not perceived as annoying.
- Safety (happened to one interviewee): Didn't feel safe for a while because of stealing beer boxes from the balcony barbed wire used on the fence but then a metal piece was thrown through the window. After a while he felt safe again. (He guesses the thieves are the youths from the area)

A photograph of a man and a woman talking in a living room. A speech bubble is overlaid on the image, containing text about a Christian community and helping others. The room has a wooden wardrobe, a blue stool, and a colorful abstract painting.

I live in a Christian community and like to help other people. I also run the 'give a way store' and give lessons at the community center. We would like to buy the whole block so more people can live with us.

Interview with family

Interviewee 1 : a woman of Christian community

Interviewee 2 : the man of the bicycle repair.

- The woman has lived in the neighborhood for 7 years the man for 30 years
- Woman lives with family 4 people and Christian community change by the time
- Man lives with his woman and children. Varies who stays to sleep. When visited total 4
- Tenants composition neighborhood: Most of the original tenants has moved out, now max. 20 families stay. The new tenants including students, young couples and refugees.
- Future tenants: social housing original tenants might come back.

Neighborhood Relationships

- The Christian community holds activities to help each other, including language lessons for refugees (some of them don't speak English nor Dutch) and lessons for children.
- Some residents volunteer to maintain the living condition of neighborhood, refugees also join.
- There is strong connection within the Christian community.
- Families are not really in touch with students but there is strong connection among families.

We can rent this for free if we contribute to the neighborhood and serve free of charge. The boys on the square which hang around doesn't show respect and cause many problems.

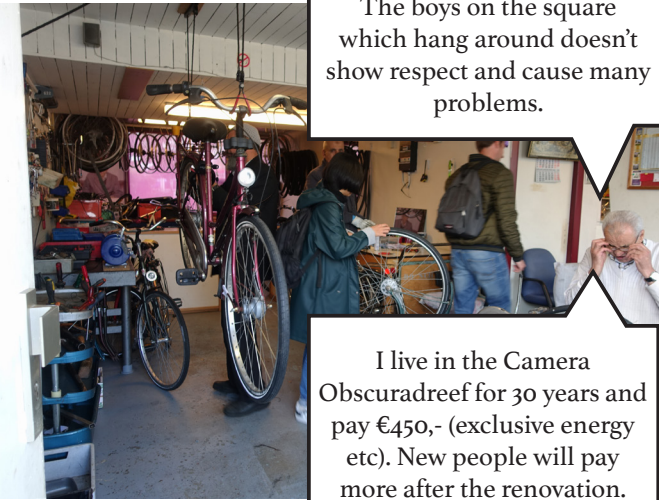

I live in the Camera Obscuradreef for 30 years and pay €450,- (exclusive energy etc). New people will pay more after the renovation.

We are Stichting Seguro and want to provide a shelter and better life circumstances for people without documents.



- Complicated relationship between Christian and Muslim groups but as well between Muslims. Rumors, gossips and few contacts. Turkish or Moroccan who do not wear headaddress feel watched
- In the passages people with a idea for the neighborhood can put their idea in practice, like the bike repair and free shops. Mitros rent these rooms for free without running water or toilet.

Problems about the community

- The connection between groups (high-income and low-income, well-educated and undereducated, etc) is a big problem. (Groups don't mix)
- There is no official neighborhood committee, the guy in the bicycle shop takes care of the neighborhood unofficially. He knows almost everyone and is important to the neighborhood. A committee might help, and strategy in the long term will be helpful. However, budget for social work is reduced, and lots of projects has stopped.

Security

- The interviewees personally feels safe of living in the neighborhood. One burglar climbed over the balcony of the woman one year ago.
- Some residents feels insecure since they live in a immigrant community. They are afraid of leaving children playing outside.

- Young people and drunkards hang around in the neighborhood.
- Fence built around the playground because of demolition and young people hanging around and may mess the playground with beers and glasses.
- Passages closed because of young people hanging and nuisance

Christian community lives in the two-stories building block and rent a piece of the ground floor and has the whole 1st floor.

On the ground floor there is a shared living room and kitchen. There are 4 apartments on 1st floor, accommodating two families, one male group and one female group.

Best place: communal living room and the balcony. She wants her own garden.

The woman personally has no need for extra space. She

Want to buy block so she can help more people

Expectation for Camera Obscuradreef

- Small spots to meet
- Share different cultures (America/Iraq/Iran...)
- Share life, learn from refugee how to live under such condition and be thankful for life
- More projects for children
- Shared gardens

Conclusion

Values

Tenants with different background provide possibilities for a diversity of culture in the neighborhood. Current social works carried out on site, though still insufficient is bringing residents together.

Limitations

According to the interview of residents and literature, the neighborhood is facing to problems caused by changed tenants groups. Most of the tenants are temporary tenants, and a majority of the are students and young commuters. The unsettling tenancy results in lack of maintenance of not only their own but also the whole neighborhood. Other tenants in the neighborhood are immigrations from different countries. It is difficult for them to assimilate into the community. There is a smaller size of households compared with 1960s and 1970s. Their lifestyle are also differs from residents 1960s. The current floor plans, neighborhood design and other technical issues do not fit the new lifestyle of new households.

Possibilities

Nevertheless, the neighborhood has a potential to be an active and energetic neighborhood with multi-cultural background. In order to achieve the aim, proper spaces for communication between tenants should be provided. Consideration on the changed tenants group and changed lifestyle is required.

1. Analysis of the system

1-7. Cultural Value Statement

Cultural Value

The urban planning strategy in Overvecht is based on the idea of “Wijkgedachte”. The functions were classified by the frequency of use and divided into different distances. The idea was mainly to build the stable and healthy neighborhoods that create social communities and avoid the congested city life. Over time, the idea of wijkgedachte put into question when the society became more heterogeneous and individualized. However, we think the **historical value** of “Wijkgedachte” still exist in the site and it is important to bring this quality to the future. This urban planning idea is deeply rooted in the whole Overvecht area. It has been influenced the design of the housing blocks, so it is important to start with the historic value that we found in this area. The Intervam system in Overvecht built in the post-war period to provide appropriate dwellings for people. It reflects the rational way of thinking in those days. It was based upon the use of new construction method and new building materials. The housing block was designed according to the modern principles of light, air and space to fulfill the basic quality required for everyday living. The notion of openness and transparency also applied to the design from urban scale to floor plan. It was based on the desire to build a community where different group of people can harmonize with each other. The **use value** of Intervam system strengthen the feasibility of existing quality. First of all, the structure of Intervam system is remained in a good state which makes it possible for the sustainable and economic use. The repetition of the facade and the concrete grid also represents the inherent character of the Intervam buildings. The aesthetic value lies in the building facade can reinforce the reason behind the continuous use of existing building and keep the inherent value what we have at hand. The use value is related to the physical quality of space. The greenery and communal outdoor space between the housing blocks help residents to interact each other. With the assessment of use value architects can provide the space for the social activities. We found that there are a lot of **social values** exist in this area. Mixed use of ground floor was considered from

the beginning to have different kinds of functions that residents would need for their living. We found that those spaces are now used for various social activities such as donation shops, bicycle repair store and art studio. The residents from multicultural background could be act as a possibility to form diverse social activities in this area. It is, however, difficult for architects to expect people’s behavior and envision the image of society that he or she want to create. We have already learned from the past that architecture is not a panacea for all the societal problems. What we can do is to carefully evaluate the cultural values that we have found and put our efforts to elaborate them on our own design.

The mix-use of ground floor:
Followed the concept of Wijkgedachte:
achieving social cohesion and brings
residents together

Demographic: Mixed cultural background
Immigrants

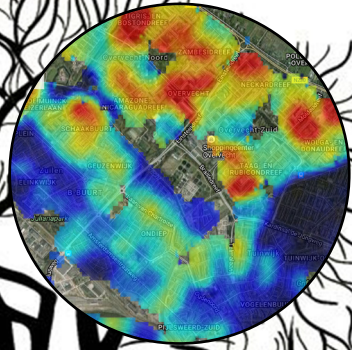
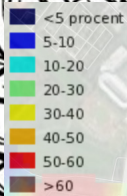

Transparency of the
neighbourhood



Social Value

Use Value

- Concrete Structure
- Light, Air & Space
- Mix Use of Ground Floor



Intervam

Wijkgedachter

Historical Value

2. Transformational Approach

PLUS Approach

Analysis on PLUS

-Added Extra Space-

Benefits:

Having a flexible space to give freedom to the users;
Affordable price;
Apartment goes beyond the function and conveys pleasure like in a single house.

Limitations:

Enlargement of space is not always applicable to different types of families;
Generosity of the space depends on the surrounding environment;
The central living area could be dark due to the extension.
The lifespan of the material.

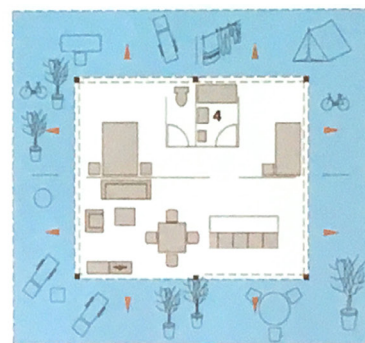
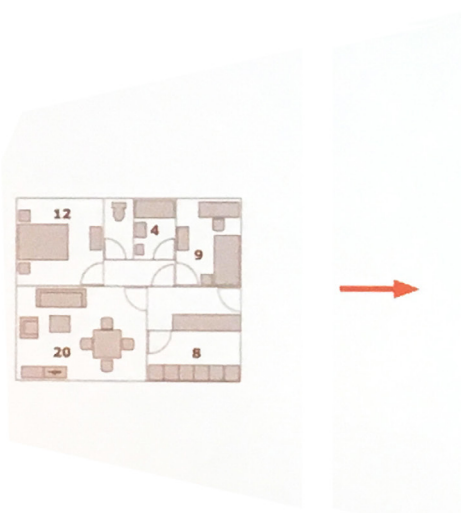
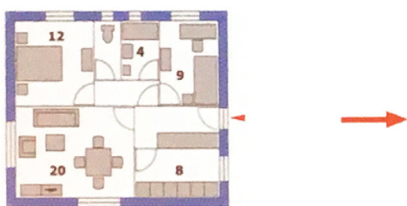

Extra Spaces for flexible uses;



Facility of moving by inside or by outside as a house on the same level.

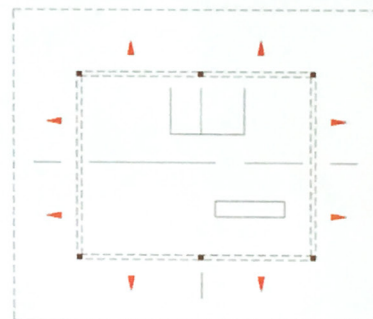

All rooms have large doors opening to outside;

Figure 2.1.3 Floor Plan: Before
2 Bedrooms Dwellings, 60/65 sqm,
Insulated Facade

Figure 2.1.4. Floor Plan: After
Habitation 130 sqm.

Analysis on PLUS -Facade-

Characteristic:

One of the main characteristics of PLUS approach is the added new facade resulting from the added space. Original facade is replaced by a more open and transparent new skin.

Benefits:

During renovation tenants do not have to move out.

Limitations:

The change of existing appearance. The original façade cannot be restored.

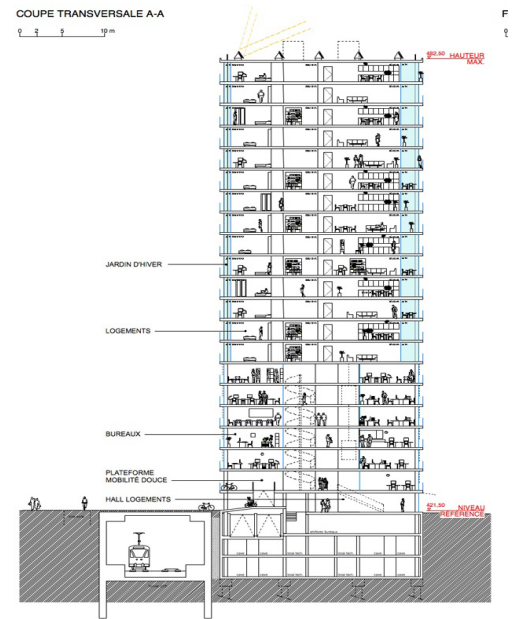

Figure 2.1.1. Section of one project renovated in plus approach.



Figure 2.1.2 Elevation of one project renovated in plus approach.
Left: original condition; Right: Renovated

Park Hill Approach

Renovation on Park Hill Phase I -Background

Location:
Sheffield, United Kingdom

Project Team:
Studio Egret West | Grant Associates

Civic Engineering:
Simon Fenton Partnership | Ashmount Consulting
Engineers Ltd

Number of apartments: 874

Architects Hawkins\Brown and urban designers Studio Egret West were commissioned by property developer Urban Splash to take on the renovation of the notorious social housing estate, which is one of the most famous examples of the “streets in the sky” typology that typified many post-war UK developments in the 1960s and 70s. (Frearson, 2013)

Influenced by projects such as Le Corbusier’s Unité d’Habitation, architects at that time thought large housing blocks with communal open-air walkways would foster communities, but they instead became associated with antisocial behaviour, vandalism and crime. Park Hill became a sink estate before falling into disrepair - a blot on the landscape, a rotting concrete corpse. (Frearson, 2014)

The renovation includes renovated facade, redesigned floor plan and the open-air walkways. Energy efficiency was also achieved in the renovated project.

In January 2013 the first new residents and commercial tenants moved in, and with this defining moment the building started a new phase in its life. (Townsend, 2013)



Figure 2.2.1 Before
(Hopkinson et al., 2011)

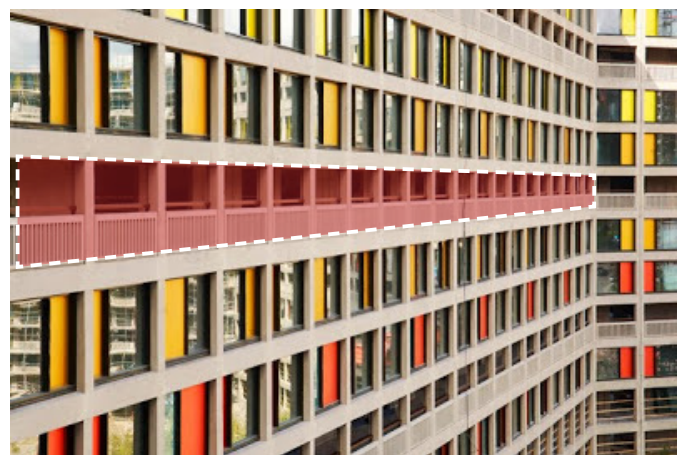

Figure 2.2.2 After
(Hopkinson et al., 2011)

Renovation on Park Hill Phase I

-Facade-

Architects tend to **preserve and strengthen the existing facade by renovation.**

The architect found Park Hill to be a remarkably intelligent structure full of complexity, potential and great character. However, it was believed that the grid was weakened in the original facade. The frame was kept and strengthened by applying coloured panels and enlarged windows.

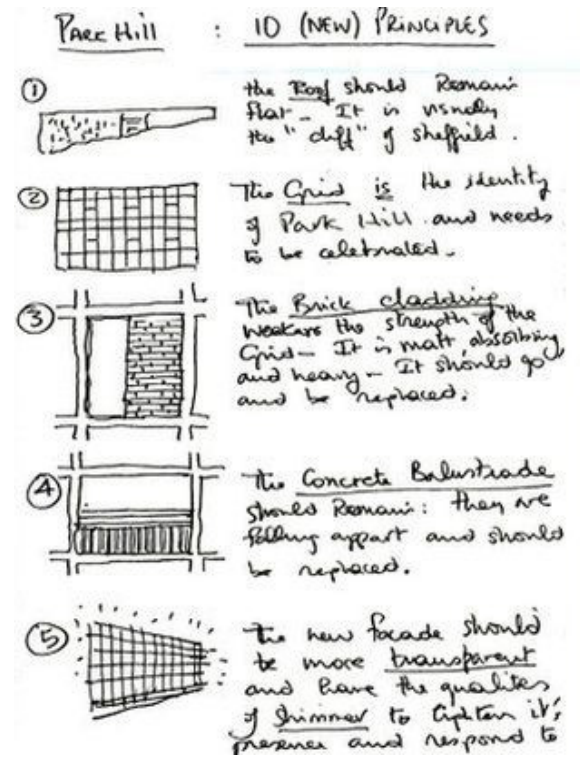

Figure 2.2.3. Architect's sketch on facade renovation (Hawkins/Brown Architects, 2011)



Before

During Construction

After

Figure 2.2.4. Facade at three stages (Hopkinson et al., 2011)

Renovation Approach

Renovation on Park Hill Phase I

-Space Plan-

Before:

There were nurseries and bakeries in the complex. The external walkway, or “streets in the sky”, was wide enough for a milk float and the bakery van to make doorstep deliveries and for community life. (Frearson, 2014)

After:

The redeveloped flats are bigger - about a metre has been taken from the external walkways and added in to the homes. Although milk floats may struggle to drive along them now, they still offer a generous amount of space. By reducing the width of the “streets”, the architects were able to extend the size of the apartments, creating new street-facing windows and much-needed additional storage. (Frearson, 2014)



Original Floor Plan
Upper Level

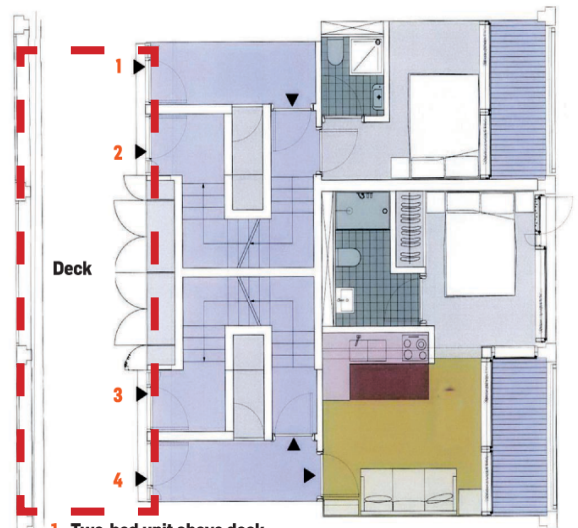

- 1 Two-bed unit above deck
- 2 One-bed unit below deck
- 3 Two-bed unit below deck
- 4 One-bed studio at deck + one-bed unit above deck

Original Floor Plan
Mid Level



Original Floor Plan
Lower Level

Figure 2.2.5.
Original Floor plans(Parnell, 2011)

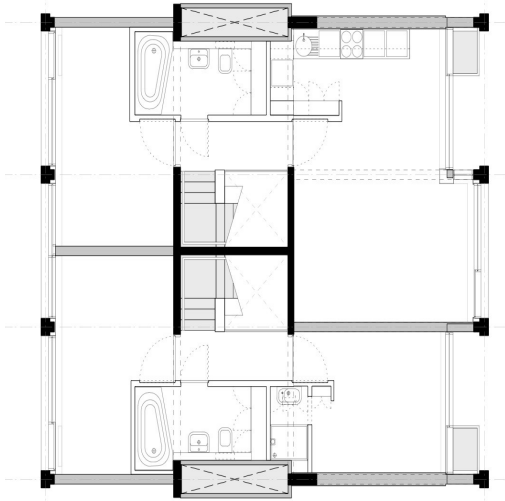

Modified Floor Plan
Upper Level



Figure 2.2.7. Renovated interior space and the preserved concrete beam (Hopkinson et al., 2011)

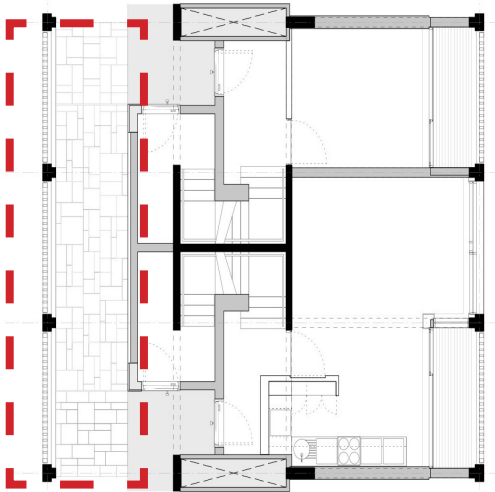

Modified Floor Plan
Mid Level



Figure 2.2.8. Renovated interior space and the preserved concrete beam (Hopkinson et al., 2011)

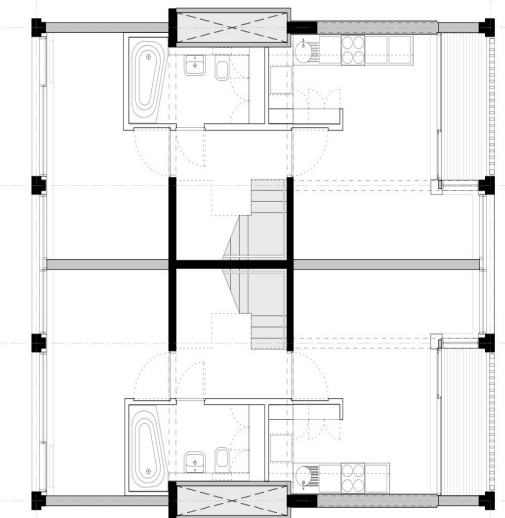

Modified Floor Plan
Lower Level



Figure 2.2.9. Renovated interior space and the preserved concrete beam (Hopkinson et al., 2011)

Figure 2.2.6. Renovated floor plans
(Hawkings/Brown Architects, 2011)

Renovation on Park Hill Phase I -Space Plan-

The ambition behind the extra space gained from the walkway and the resulting narrower street is to **bring the original vision of the community spirit back**.

1960s

To foster **a sense of community spirit**, families housed in Park Hill were put next to their original neighbours. The street was a **nice place for communication within the complex**. (Frearson, 2014)



Figure 2.2.10. Original walkway: a communication space (Municipal Dreams in Housing, Sheffield, 2015)

1980s

The collapse of the steel industry – Sheffield’s biggest income provider and employer – in the 1980s leads to **collapse of the community spirit**. The labyrinth of passages and decks became the perfect place for anti-social behaviour, vandalism and crime. Park Hill become a no-go area.

The same streets offered quick getaways for thieves. Poorly lit walkways **made people feel unsafe and the site became dilapidated** - graffiti and broken windows blotted the greying landscape.



Figure 2.2.11. Safety problem (Nick and Trevor , 2015)

2000s

Architects wanted to **bring the spirit back by redesigning the “street on the sky”**:

“It is defined by its heroic ambition and bravery tempered with great humility and dignity. We wanted to capture more permanently that original moment of vision, optimism and hope for the future that seemed to have been lost.”

---David Bickle, Hawkins\Brown (2014)

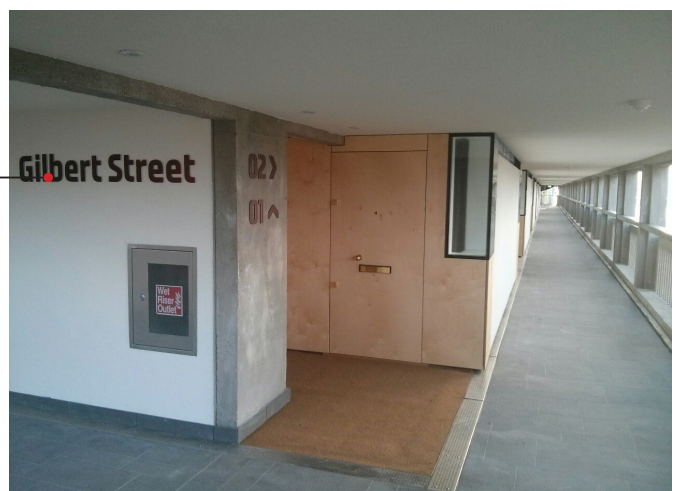

Figure 2.2.12. The Reopened street after renovation. (My Parkhill, 2015)

Renovation on Park Hill Phase I

-Space Plan-

Create the mix of social housing and private apartment, alongside office, shops, restaurants and bars
 VS Only 1/3 of total housing are remained as social housing. (Frearson, 2013)

The ground floors that face West have been converted from residential into commercial units.
 Due to the way the building works there are a variety of options for workspace or retail space - single storey, duplex or triplex. Sizes range from 500 sq ft to 30,000 sq ft. (Urban Splash, 2013)



Figure 2.2.13. Ground Floor used as commercial units.

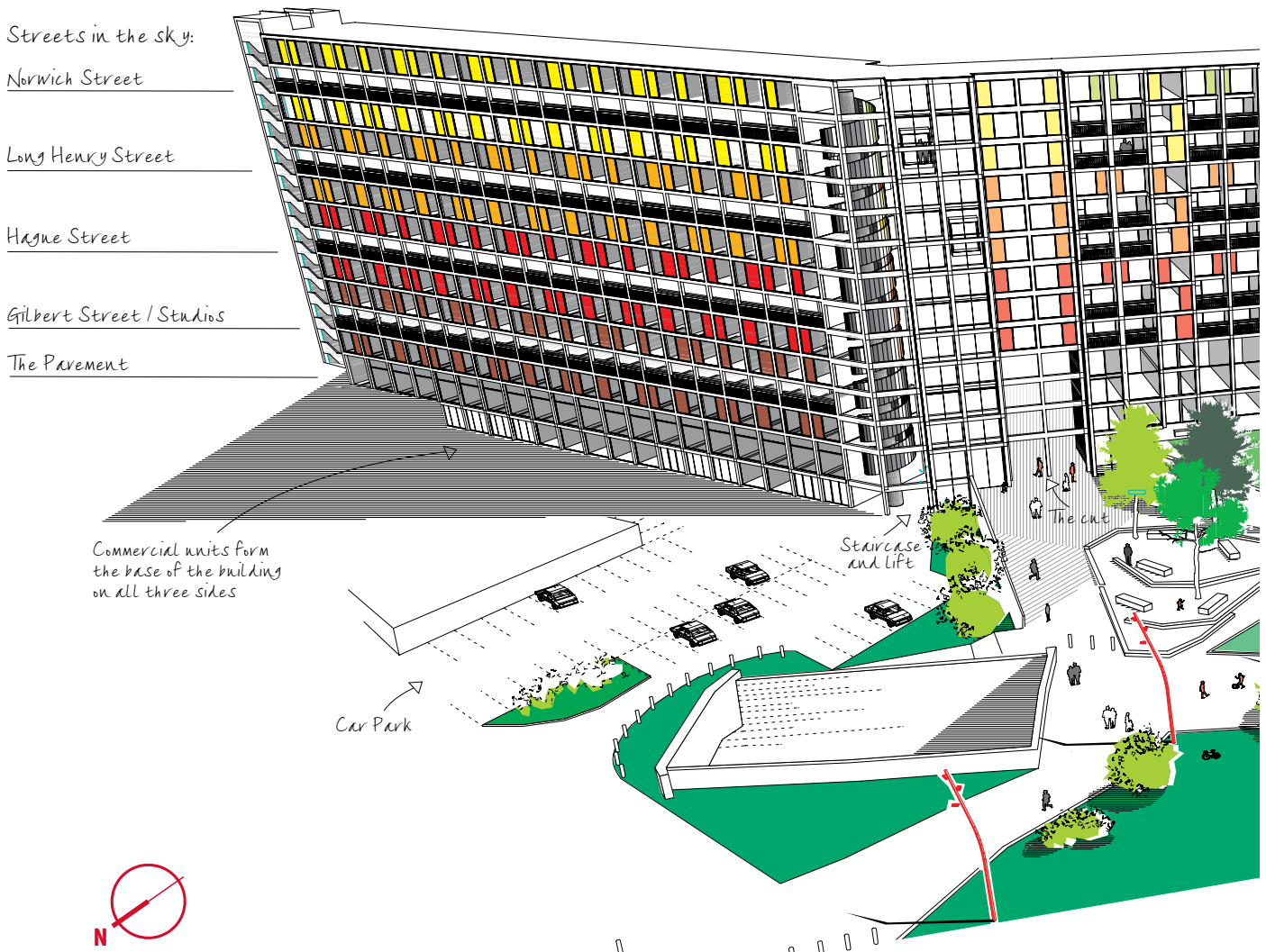

Figure 2.2.14. Function of the Ground Floor (Urban Splash, 2013)

SWOT analysis

	PLUS approach	Park Hill approach
Strength	<ul style="list-style-type: none"> - Having a flexible, extra space to give freedom to the users with affordable price. - During the renovation, tenants do not have to move out and stay in their homes. - The renovation cost 1/6 budget of demolishing and rebuild 	<p>The architect found Park Hill to be a remarkably intelligent structure full of complexity, potential and great character. They transformed the building into new brand by reinforcing the existing quality.</p>
Weakness	<ul style="list-style-type: none"> - Enlargement of the space is not always applicable to different types of families. People might want to have a cosy or compact space of living. - Additional space cause the complete change of building facade. In this case the value of the facade should be assessed 	<p>One third of the total social housings will be remained. Most of the tenants should move out during the renovation or they might have to wait a long list to find affordable place for living.</p>
Opportunity	<ul style="list-style-type: none"> - Low cost apartment or social housings goes beyond the functional use of space and conveys pleasure like as a villa. - Neutral, pragmatic approach which has the potential to be widely applied to increase the quality of living. 	<ul style="list-style-type: none"> - The value of the original facade and the intention of “streets in the sky” were highly appreciated. The streets are expected to bring new quality to the building and encourage interaction with neighborhoods. - The development not only transformed the dilapidated site into fancy place but also revitalise the area with a mix of different social groups.
Threats	<ul style="list-style-type: none"> - The generosity and openness of the space would be influenced by the surrounding environment. - The central living area could be dark due to the extension. - By using cheap materials to meet the financial requirement, the life span of the material would be short. 	<p>The concern for social cohesion in mass housing is a difficult task for architects. In this case, architects decided to reduce the width of the communal street but this rather passive approach cannot ensure the increase of interaction.</p> <p>A mix of social group under the name of ‘class cleansing’ put more people in the social housing waiting list.</p>

Conclusion

The PLUS approach created the additional space from the outside of the building and thus it adapted into a new typology with different exterior material. The extra space provide a lot of freedom to the users in terms of the flexible use of space and also facilitate the circulation with surrounding spaces. This approach has a great benefit because the interior space will be remained intact, so the residents can continue to stay in their houses during the renovation. The use value of the building is the most important factor and people who actually live in this building will be taken care of during the design process.

The Park Hill approach is focused on the historical value of the existing building. Its almost-certain demolition was avoided when English Heritage controversially placed a Grade II listing on the entire estate in 1998. The architect wanted to realize the vision that lay behind the original design and tried to keep the intention from the past. The concrete grid was highly appreciated to strengthen the existing quality. Even the concrete structure that was not intended to be reveal was exposed to the renovated interior space. The “streets in the sky” is expected to introduce the communal spirit once again in this mass housing estate.

The PLUS approach and Park Hill approach have chosen a different way of design with the existing building. Two approaches cannot be compared directly in parallel. The different backgrounds and circumstances of the projects resulted in the opposing design methods. We should keep in mind the benefits and limitation of those approaches in our own design process.

Illustration list:

- 1) Lacaton, A. Reuse, Not Demolish. 2016.
- 2) Hawkings/Brown Architects. Plan. [Online] <http://www.archdaily.com/174968/park-hill-hawkins-brown-with-studio-egret-west> [October, 2016]
- 3) Hawkings/Brown Architects. What guided the architects of the Park Hill renovation. [Online] <http://www.bbc.com/news/magazine-24054185> [October, 2016]
- 4) Hanson, R., Collie, K. and Hopkinson, D. Park Hill past and present [Online] <http://www.bbc.com/news/magazine-24054185> [October, 2016]
- 5) Howpkinson, D., Bennett, P., Collie, K. [Online] <http://www.archdaily.com/174968/park-hill-hawkins-brown-with-studio-egret-west> [October, 2016]
- 6) Municipal Dreams in Housing. The Park Hill Estate, Sheffield: ‘Streets in the sky’. [Online] <https://municipaldreams.wordpress.com/2013/04/16/the-park-hill-estate-sheffield-streets-in-the-sky/> [October, 2016]
- 7) My ParkHill. [Online] <http://myparkhill.tumblr.com/> [October, 2016]
- 8) Nick and Trevor. [Online] <http://myparkhill.tumblr.com/> [October, 2016]
- 9) Parnell, S. Modified and original floorplans. [Online] <http://www.bdonline.co.uk/park-hill-estate-sheffield-by-hawkins-brown-with-studio-egret-west/5024432.article>[October, 2016]
- 10)Urban Splash. Park Hill Explained. [Online] http://www.urbansplash.co.uk/documents/brochure/park_webbrochure_august12.pdf [October, 2016]

3. Individual Approach

Quality of Living

Traditionally the most basic requirement for house was to provide a shelter to protect ourselves from adverse conditions. This was meant to isolate human being from nature and to become independent of each other. Here, I would like to add a new meaning - the house as a mediator - to actively

engage with the surrounding environment rather than build a protection against it. Our everyday life will be able to intensify the relationship with natural environment, local community and also the passing of time.

House as a shelter

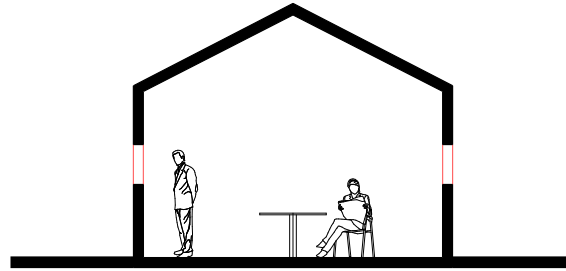

House as a mediator

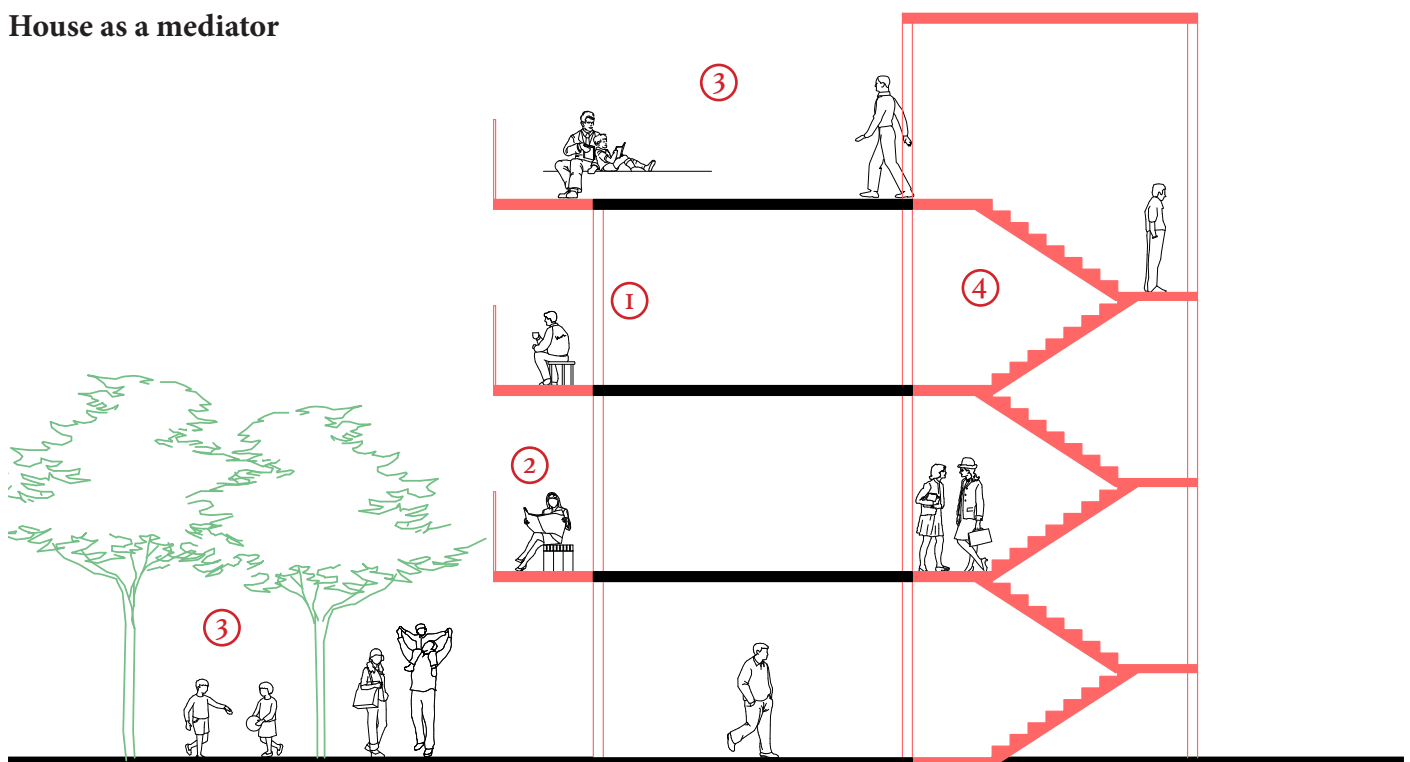

1. The Window

The living space should be equipped with a window that is large enough to let in a sufficient amount of daylight and fresh air. It also provides visual connection to enjoy the ever changing environment.



2. The Balcony

The outdoor space that is connected to the living area could give more diversity in our life. With the proper size of a balcony, people could use the space for different purposes such as to relax, communicate or do housework.



3. Communal Outdoor Space

The quality of living depends on the people who try to make the better place in the neighbourhood. The more chance for people to voluntarily participate in a community the more people could satisfied with their town and their own houses.

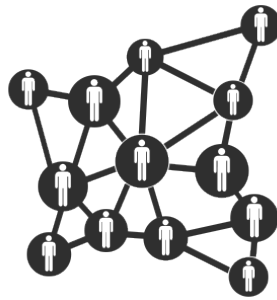

4. The Circulation

The corridor, staircase and entrance are in-between spaces to link our private living space to outside world. These spaces not only serve as functional elements but also could create a wide range of diverse activities.

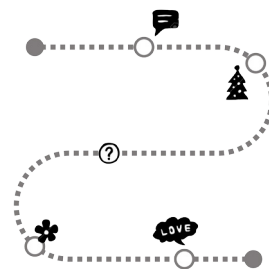

5. The Story

The living space that possesses many stories from the past could also have a lot of potential. People could relate themselves to similar sceneries and share their feelings so that people connect themselves to the past and pass those memory to the future generations. They also feel attractive to the place where they could find many different stories. Time can only give the meaning to the place.



From my point of view, quality of living is the quality of relationship between me and people around me. There is a requirement on the balance between privacy and communication. In a dwelling, this quality, can be achieved by proper relationship between each space.

Personal Experience: My two dormitories and my three roommates.

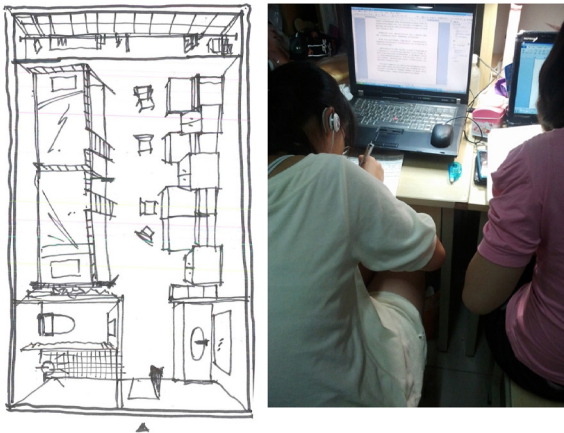

2011-2013, Suzhou, China

The first dormitory was shared by four of us, including bathroom, toilet and a small balcony. Because of frequent communication we soon developed strong relationship between each other, though sometimes there can also be conflict between us.

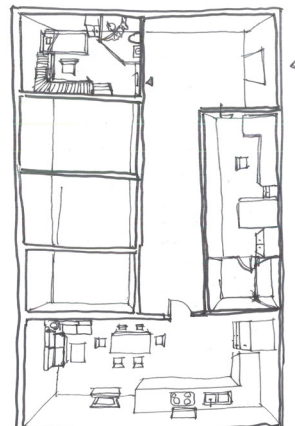

2013-2015, Liverpool, UK

In the second dormitory everyone has a private bedroom and a shared living room. The doors and walkway that separated our rooms actually brought closer relationship between us. Instead of living room, the corridor become the mostly used space when we want to talk to each other.



Camera Obscuradreef: the Intervam flat

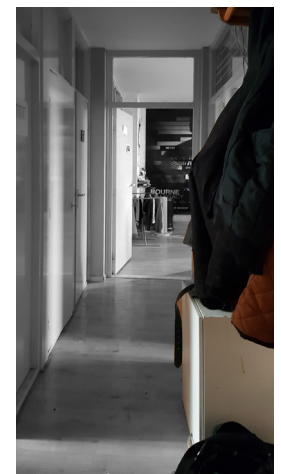
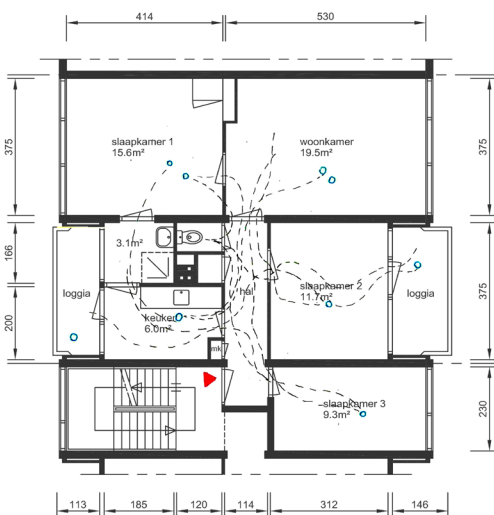

In the Camera Obscuradreef, hallway is the most busy space in the apartment. It connecting every room efficiently, and has a potential for becoming a nice space for communication. However, the narrow and dark space blocks the possibility.

The door and dimension of hallways can be two main aspects to bring the quality.

MINIMUM- Size of the Door and Size of Corridor

-Minimum requirement of size of a corridor

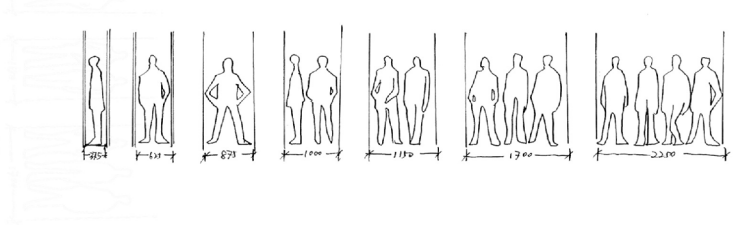
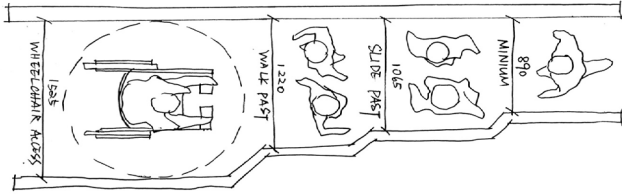

-What is the minimum requirement of dimension of a corridor with doors?

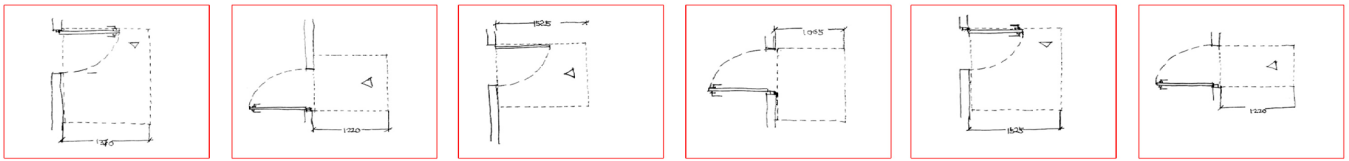

Hinge Approach, Enter from Pull Side

Hinge Approach, Enter from Push Side

Front Approach, Enter from Pull Side

Front Approach, Enter from Push Side

Hinge Approach, Enter from Pull Side

Front Approach, Enter from Push Side

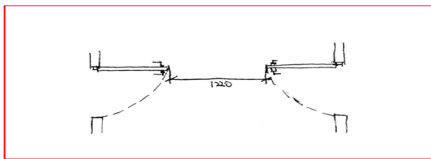

Both Pull Side

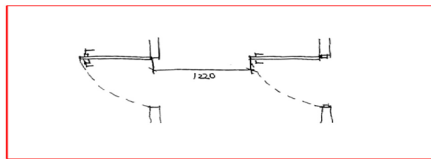

One Push Side, One Pull Side

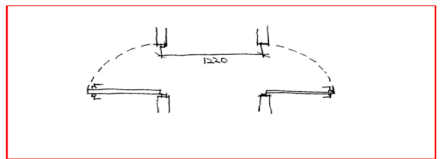

Both Push Side

-Different types of doors in a corridor that meets its minimum requirement of its dimension

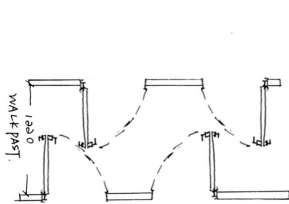

Push Side + Pull Side

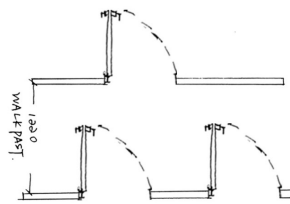

Push Side + Pull Side

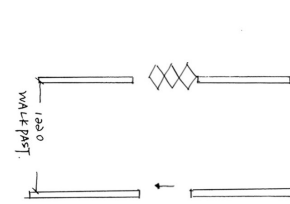

With folding doors & sliding doors: openings face to each other

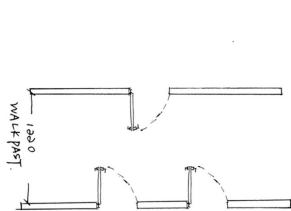

All Pull Side

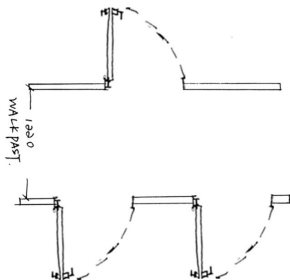

All Push Side

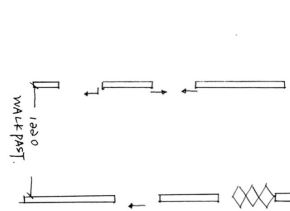

With folding doors & sliding doors: Openings interlock with each other

MAXIMUM: What else can be achieved if the dimension of the corridor are **maximized** ?

-In an apartment:

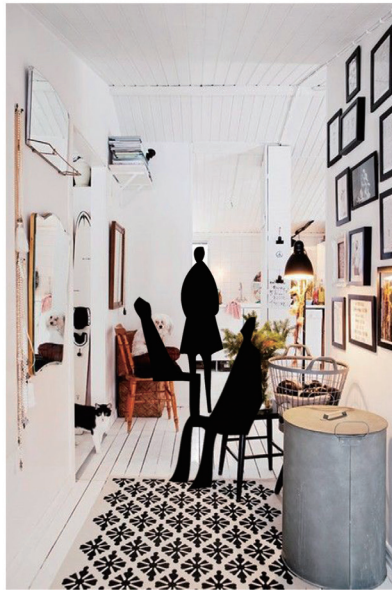
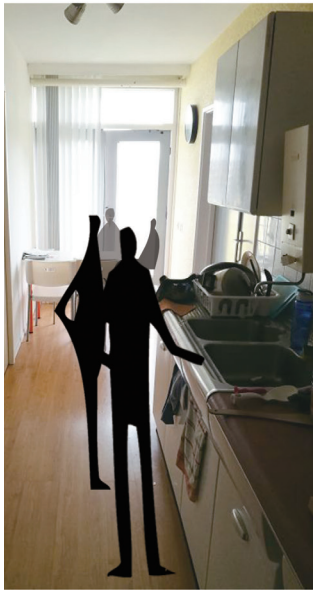

Communication in a walkway works as:
Kitchen, dining room, living room, storage, exhibition...

-In other spaces I have visited:



Manchester School of Architecture,
Manchester, UK.
by Feilden Clegg Bradley
Studios
Used as a computer room



Tea Room of Ludlow Castle,
Ludlow, UK
Used as a Dining Area

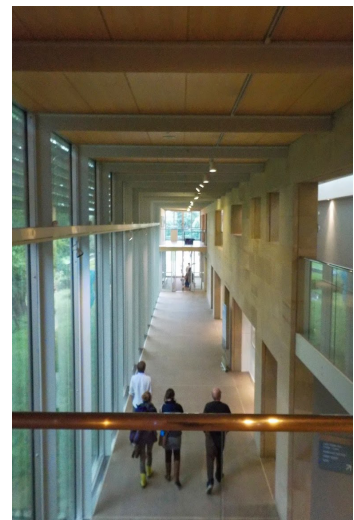

Visitor Center,
Yorkshire Sculpture Park
Wakefield, UK
by Feilden Fowles
With nice views towards
outside;
Organizing openings

The architecture of the house should not belong to the world of geometrical spaces, but to the domain of values.

--Sander Hölsgens

Statement

Inhabitant is the essence of both house and household. Instead of adapting inhabitants' lifestyles to their standardized apartment, it's better to take the inhabitants and their lifestyles as starting points to develop apartments adapted to their **situations**, their **uses** and their **evolutions**.

I. Situations



A-- Outside Space
Correspondence with environment



B-- Associative Spaces
Intimacy with family



C-- Personal / Private Space
Time spent with their own

3. Fluid Use via Flow of Space & Order of Stuff

Flow of Space

Case 1 Linear /Static

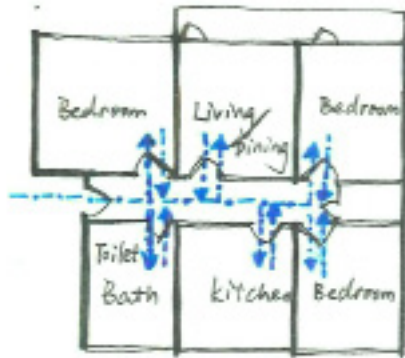

Storage Space

Messy stuff

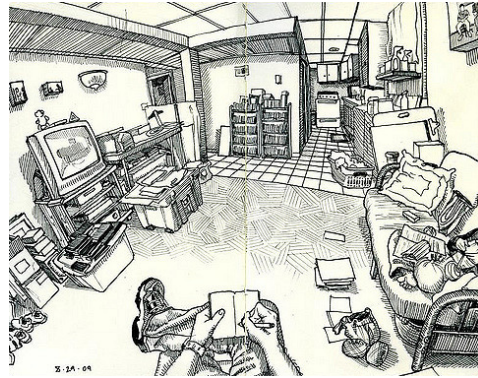

Case 2 Circular/Dynamic

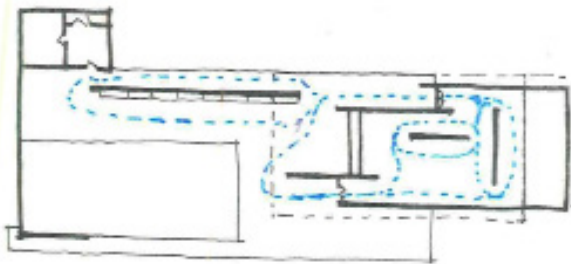

Order of stuff



Case 3 Circular/Dynamic

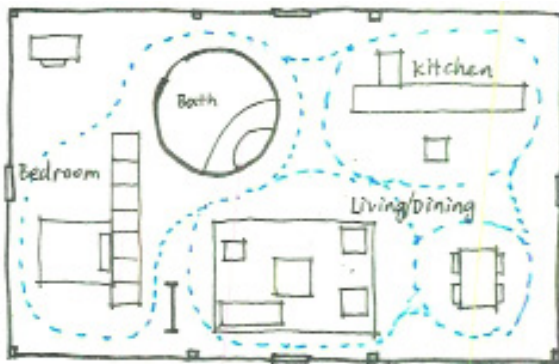

Storage space should also be taken into consideration in design for increasing the freedom of inhabitants' use and movement

4. Growing House via Extra Space

Evolution of Space

2 inhabitants



3 inhabitants

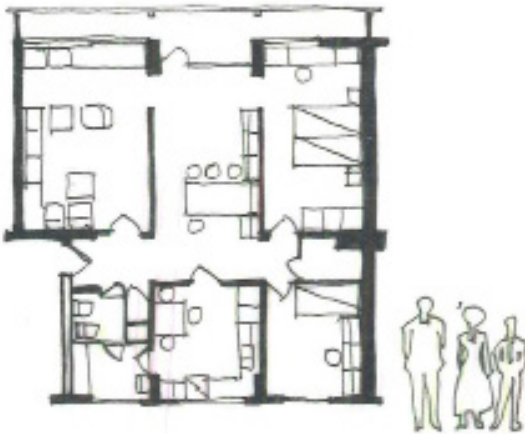

4 inhabitants



5. BS/HS Ratio

BS: Bedroom Surface
HS: Habitable Surface

1 Bedroom
BS/HS=1/6

Super Luxury

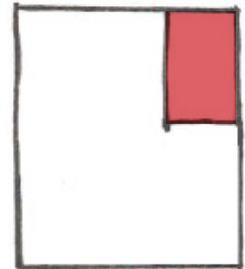

2 Bedrooms
BS/HS=1/3

Luxury

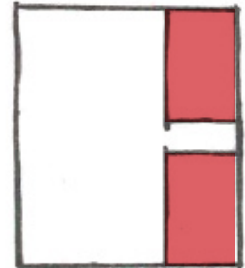

3 Bedrooms
BS/HS=1/2

Certain Quality

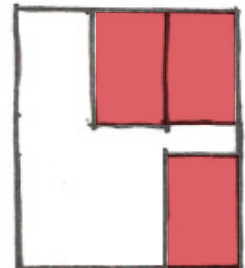

4 Bedrooms
BS/HS=2/3

Low Quality

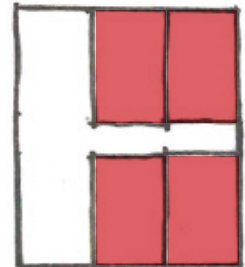

Low ratio of BS/HS indicates a certain degree of flexibility and extra capacity for adaptability

The customizable house

4415272 Rick Hoofd

Statement quality of living:

A place where you can create your own identity, relax, charge yourself and receive guests.

In short, a place where you can be proud of.

In architecture:

The quality of living shouldn't be fixed in architecture but the architecture should make it possible for residents to create quality. Quality is for everybody different and therefore it cannot be determined by one person or architect. All what we can do is give people the space to create quality. To give them the freedom of use of space*, an affordable rent and (adjustable) comfortableness**.

* No minimum spaces but generous spaces

** Comfortableness = stable temperature, noise, safety, daylight, view, interaction, air and privacy

Spaces

Houses are occupied by several type and quantity of people. Each person would thus have his own space where he or she can withdraw such as a bedroom. People also should have a place to meet, relax and receive guests. This could be the living room. Some people prefer an open kitchen in the living room but other rather want a kitchen in a separate room. This possibility should be given in the floor plan. The kitchen should have enough space to cook but also to eat. Ideal would the kitchen and living room has access to an outdoor area in order to widely use this outdoor space. An extra space which function is determined by the inhabitants is recommended to create more freedom in the use of space.

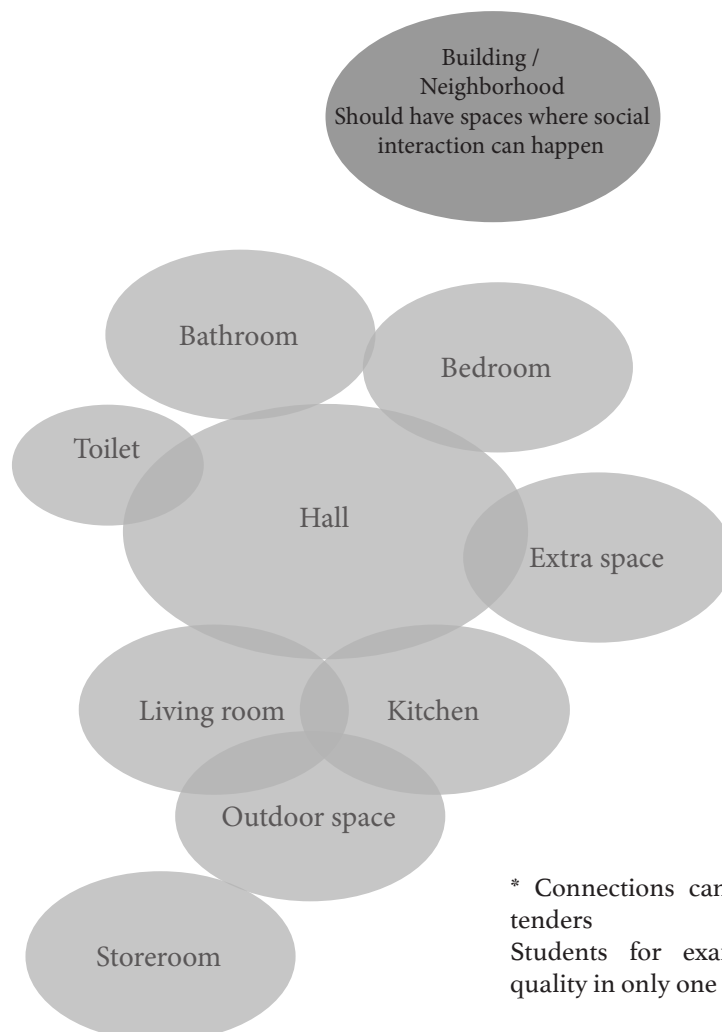

* Connections can vary with the
tenders
Students for example can find
quality in only one room or studio

Quality's every dwelling should have

1. Connection with the world

The dwelling should have a connection with the outside world. This can be achieved with a large window or outdoor space. This outdoor space should be connected with the living room or/and kitchen in order to be widely used. Community spaces are important outside the dwelling to make live happen.



2. Freedom use of space

To use the dwelling, as people want the spaces shouldn't be fixed. Spaces should be flexible in use so people can decide on their own how to decorate and use it. The room should be a blank sheet and spacious as possible so people really can create their own space. For each resident an own private place should be available. In the picture this could be the tent for example.

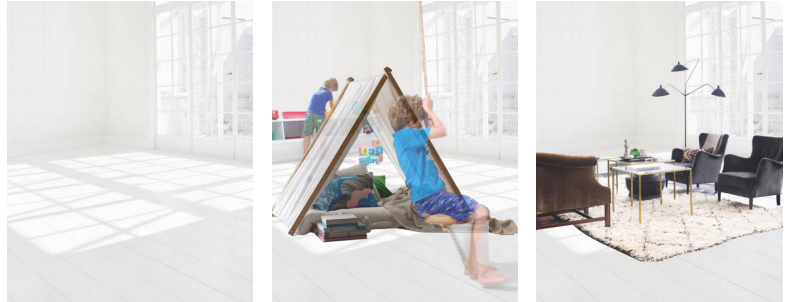

3. Adjustable comfortableness

The dwelling should be adjustable in comfortableness. People than have the freedom in use. For the comfortableness temperature, noise, safety, daylight, view, interaction, air and privacy should be adjustable.



Studio 



One room apartment 



Two room apartment 

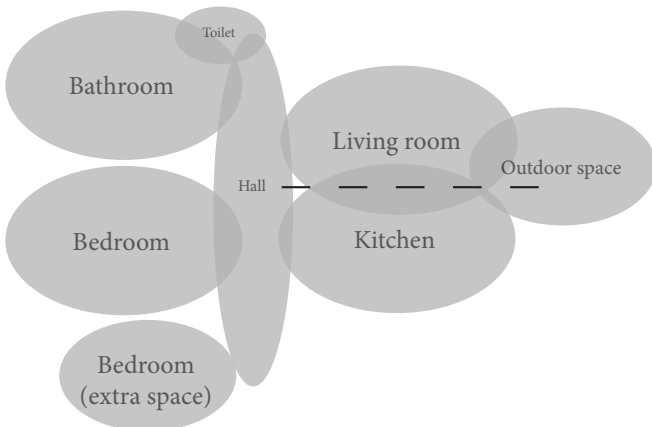

Three/four-room apartment 

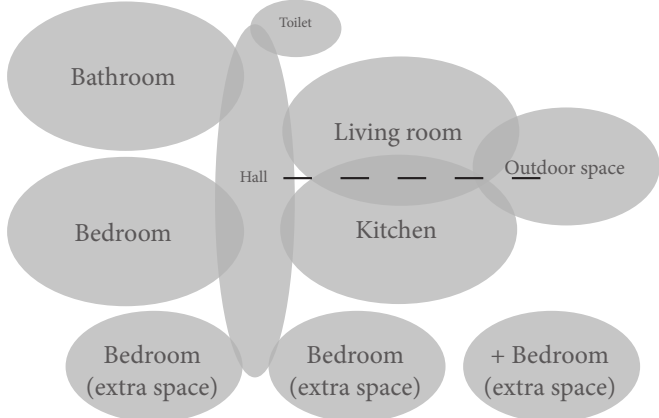

4. Bibliography

Thijssen, C. C. F. (1990). *Technische kwaliteit van etagewoningen: D.I.B.* Delft: Delftse Universitaire Pers.

Battum, M. T. (2002). *Enige (on)mogelijkheden van portieketagewoningen bij herstructurering van vroeg naoorlogse wijken*. TU Delft faculteit Bouwkunde afdeling Volkshuisvesting en Stadsvernieuwing.

Priemus, H., & Van Elk, R. S. F. J. (1971). *Niet-traditionele woningbouwmethoden in Nederland (2nd ed.)*. Alphen a.d. Rijn: Samsom

Brand, S. (1994). *How buildings learn: What happens after they're built*. New York, NY: Viking.

Renée Kool and Neeltje ten Westenend. (2011). *Kijken naar Overvecht: De naoorlogse woonwijk anders in beeld gebracht = Looking at Overvecht: other ways of picturing the post-war housing estate*. S.l.: s.n..

Paul Meurs and Marinke Steenhuis. (2006). *10 cultuurhistorisch onderzoek en ruimtelijke analyse Utrecht Na Oorlogse Wijken: Overvecht*. Gemeente Utrecht afdeling Stedenbouw en Monumente van de Dienst Stadsontwikkeling

Garritzmann Architecten and hp architecten. (2015). *Kansen voor de naoorlogse portiekflat: Het specifieke van de middenniveau renovatie*.

CBS. (2016, September 16). *Aardgas voor bijna 80 procent op*. Retrieved from <https://www.cbs.nl/nl-nl/nieuws/2016/37/aardgas-voor-bijna-80-procent-op>

Langeveld, C., Penninkhof, J., Oti, E., Keyzer, N. de, & Woestenenk, G. (1999). *vocht- en koude overlast in woningen op de Camera Obscuradreef en de Taaqdreef*. Utrecht, Nederland: Utrechtse wetenschapswinkels.

SBRCURnet. (z.j.). *Akoestische details voor de woningbouw*. Geraadpleegd van <http://www.sbrcurnet.nl/producten/kennisarchief/bouwbesluit-geluidsisolatie-en-woningbouwpraktijk/1-akoestische-details-voor-de-woningbouw>

Van Nunen, H. (2013). *DOCUMENTATIE SYSTEEMWONINGEN '50 -'75*. Retrieved from https://blackboard.tudelft.nl/bbcswebdav/pid-2873414-dt-content-rid-9553909_2/courses/38610-161701/Bouwhulpgroep2012.pdf

Freason, A. (2013). *Park Hill Phase 1 by Hawkins\ Brown and Studio Egret West*. Retrieved from <http://www.dezeen.com/2013/07/22/park-hill-phase-1-by-hawkinsbrown-and-studio-egret-west/>

Freason, A. (2014). *Brutalist buildings: Park Hill, Sheffield by Jack Lynn and Ivor Smith*. Retrieved from <http://www.dezeen.com/2014/09/10/brutalist-buildings-park-hill-jack-lynn-ivor-smith/>

Townsend, L. (2013). *Stirling Prize: Park Hill Phase 1*. *BBC News Magazine*. Retrieved from <http://www.bbc.com/news/magazine-24054185>.

Urban Splash. (2013). *Park Hill Sheffield*. Retrieved from http://www.urbansplash.co.uk/documents/brochure/park_webbrochure_august12.pdf

ONDERZOEK EN CIJFERS Overvecht. Municipality of Utrecht. [Online] <https://www.utrecht.nl/bestuur-en-organisatie/publicaties/onderzoek-en-cijfers/cijfers-en-feiten-zoeken/overvecht/> [September, 2016]

5. Appendix

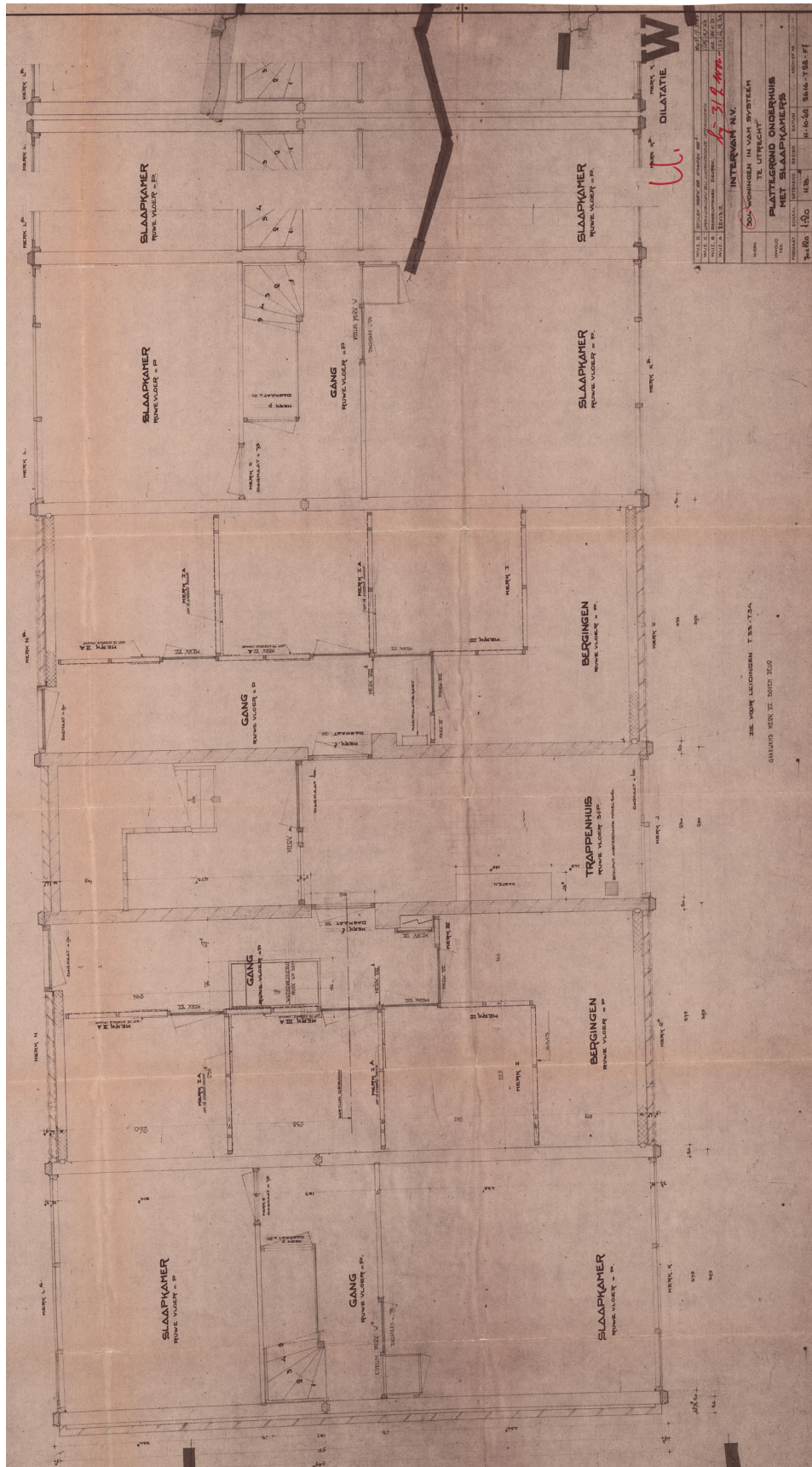

Original drawing ground floor with bedrooms

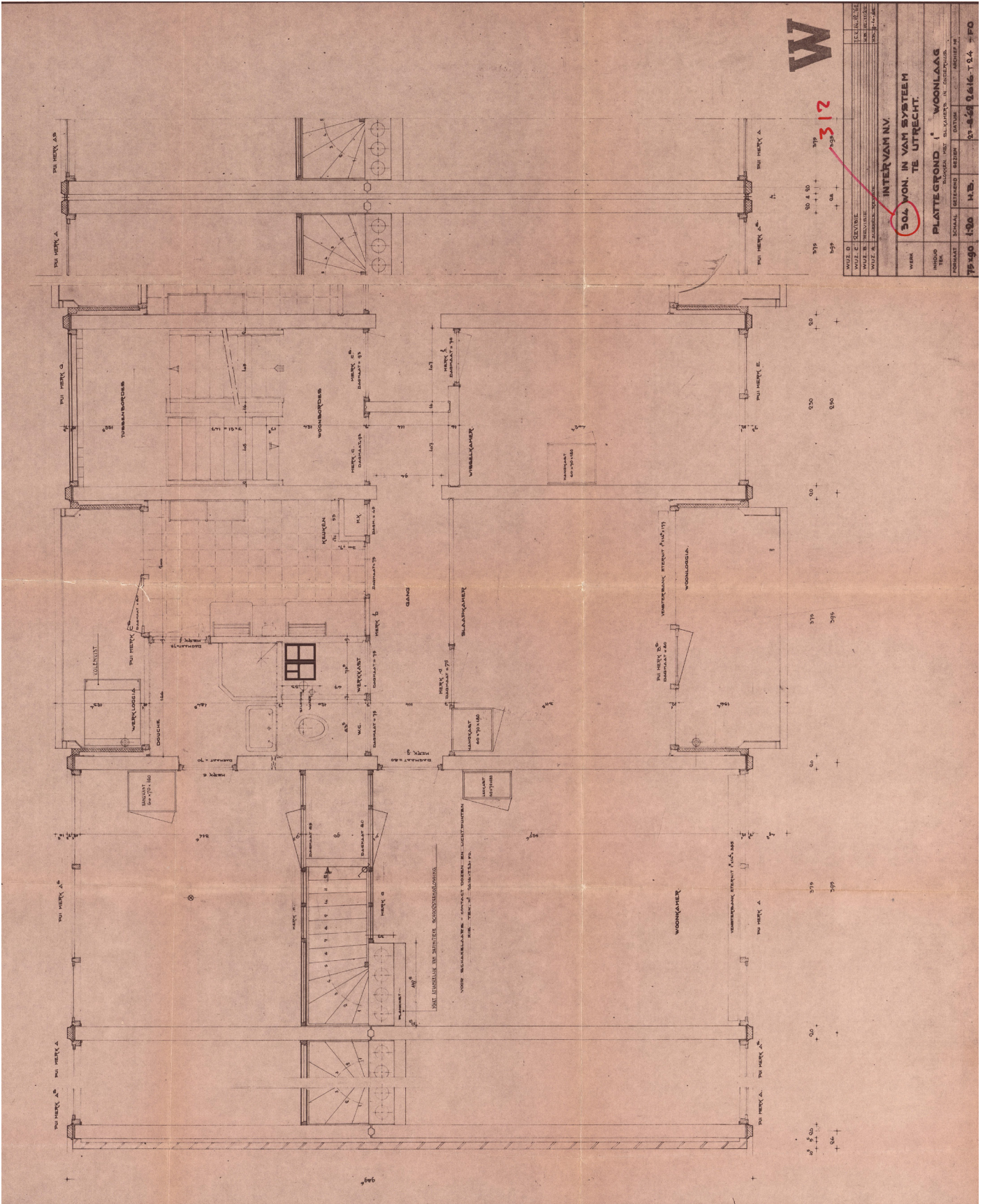

Original drawing 1st floor with bedrooms in the ground floor

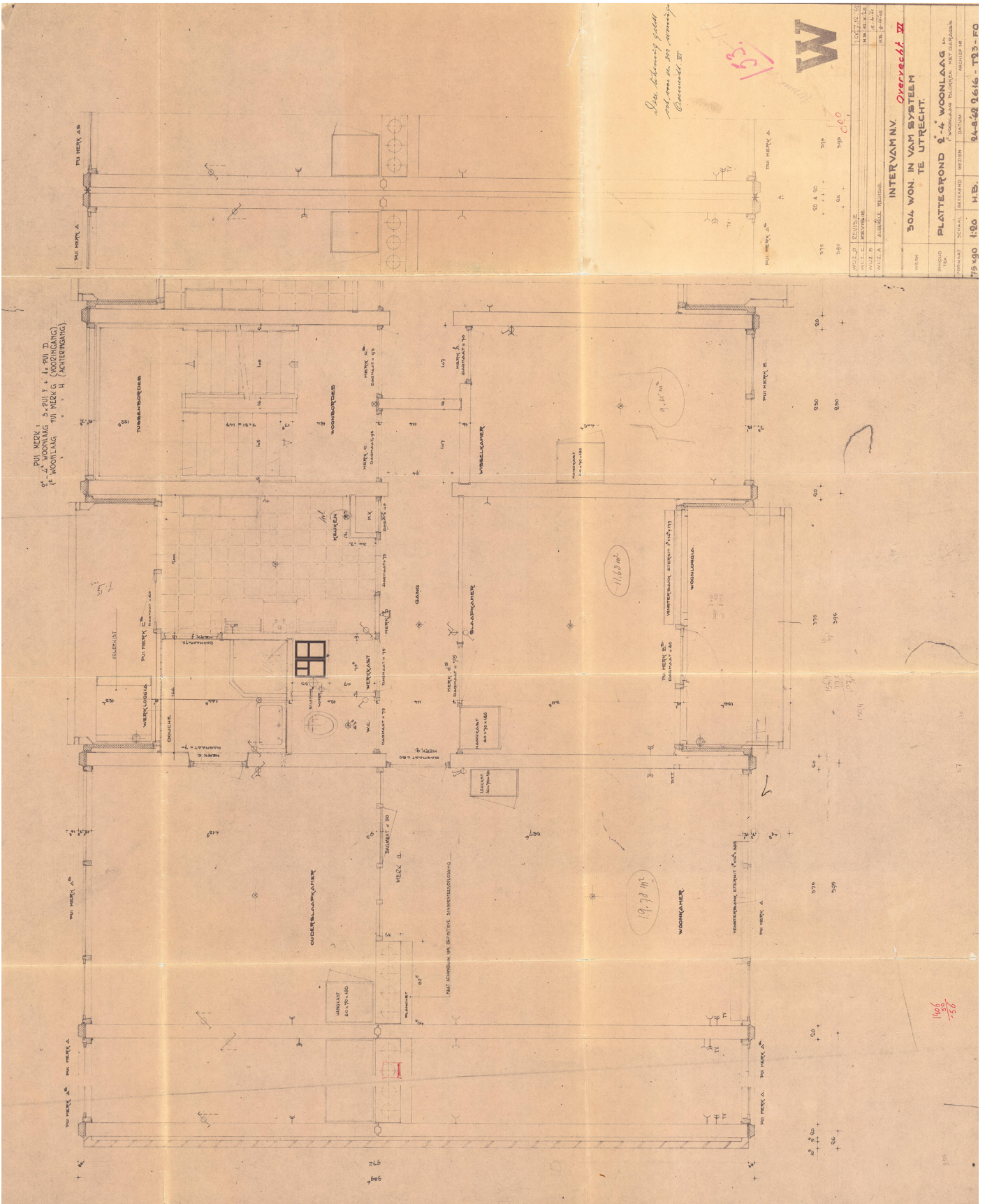

Original drawing 2nd- 4th floor