

ADMINISTRAÇÃO - GERAL DO PORTO DE LISBOA

Hydro-morphological study Tagus Estuary

Part 2
Estuarine circulation model

Volume 2.2
Figures

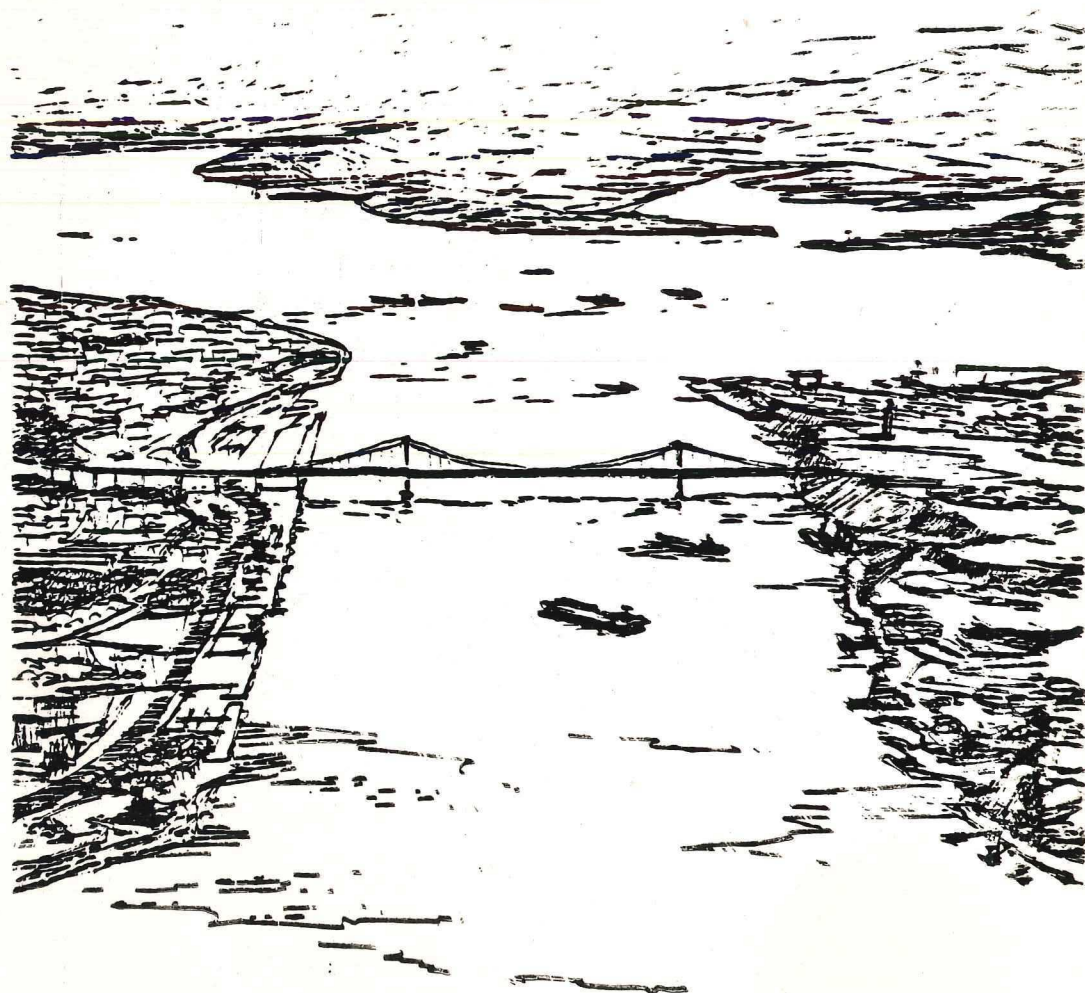

June 1982 / P473

PORT AND WATERWAY ENGINEERS

ADMINISTRAÇÃO - GERAL DO PORTO DE LISBOA

Hydro-morphological study Tagus Estuary

Part 2
Estuarine circulation model

Volume 2.2
Figures

June 1982 / P473

PORT AND WATERWAY ENGINEERS

hydronamic^{by}

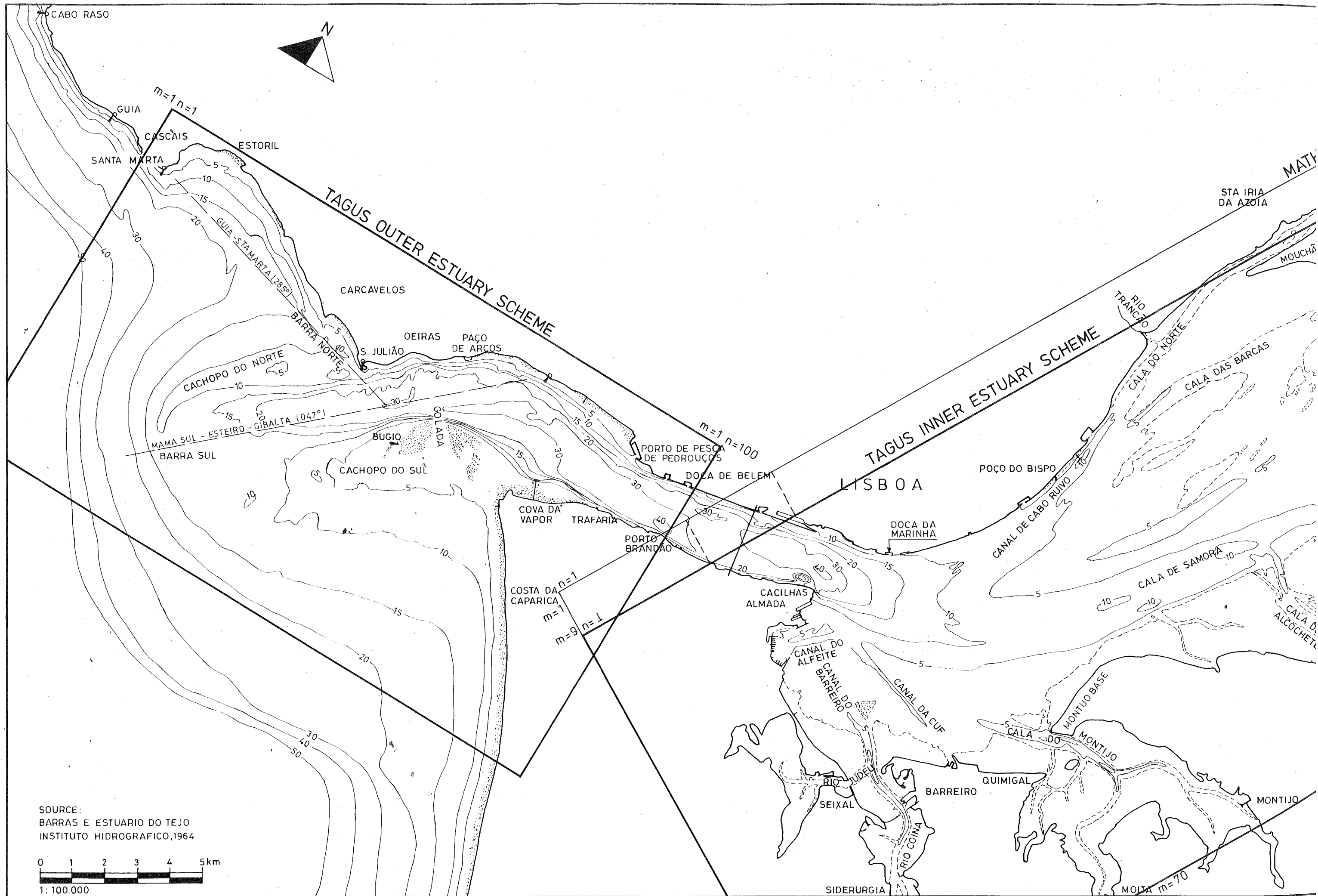

SOURCE:
BARRAS E ESTUARIO DO TEJO
INSTITUTO HIDROGRAFICO, 1964

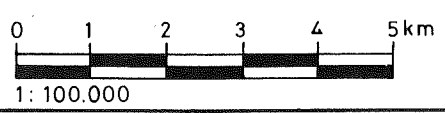

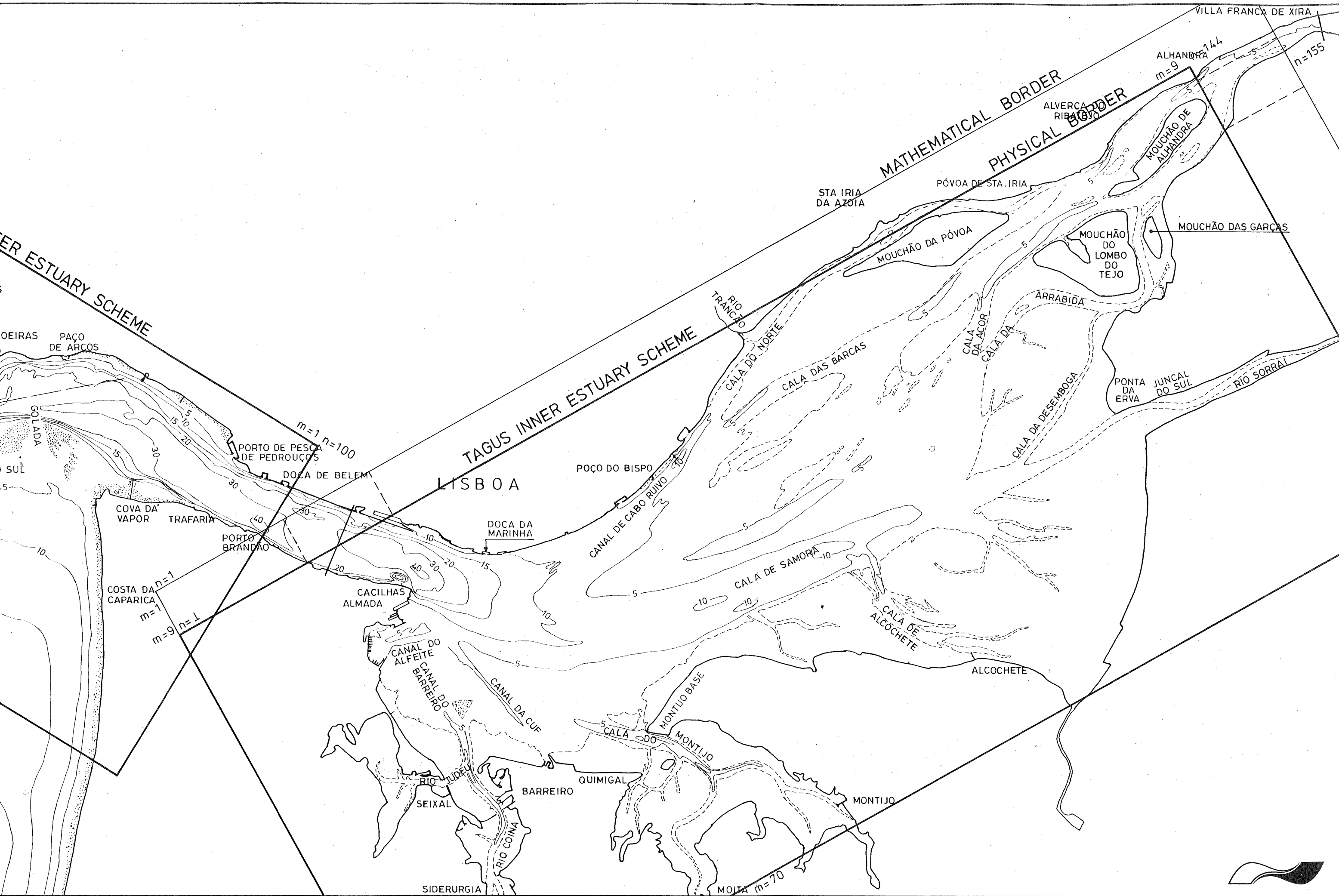

SCHMATIZATION OF TAGUS ESTUARY.

FIGURE 1.3.1.

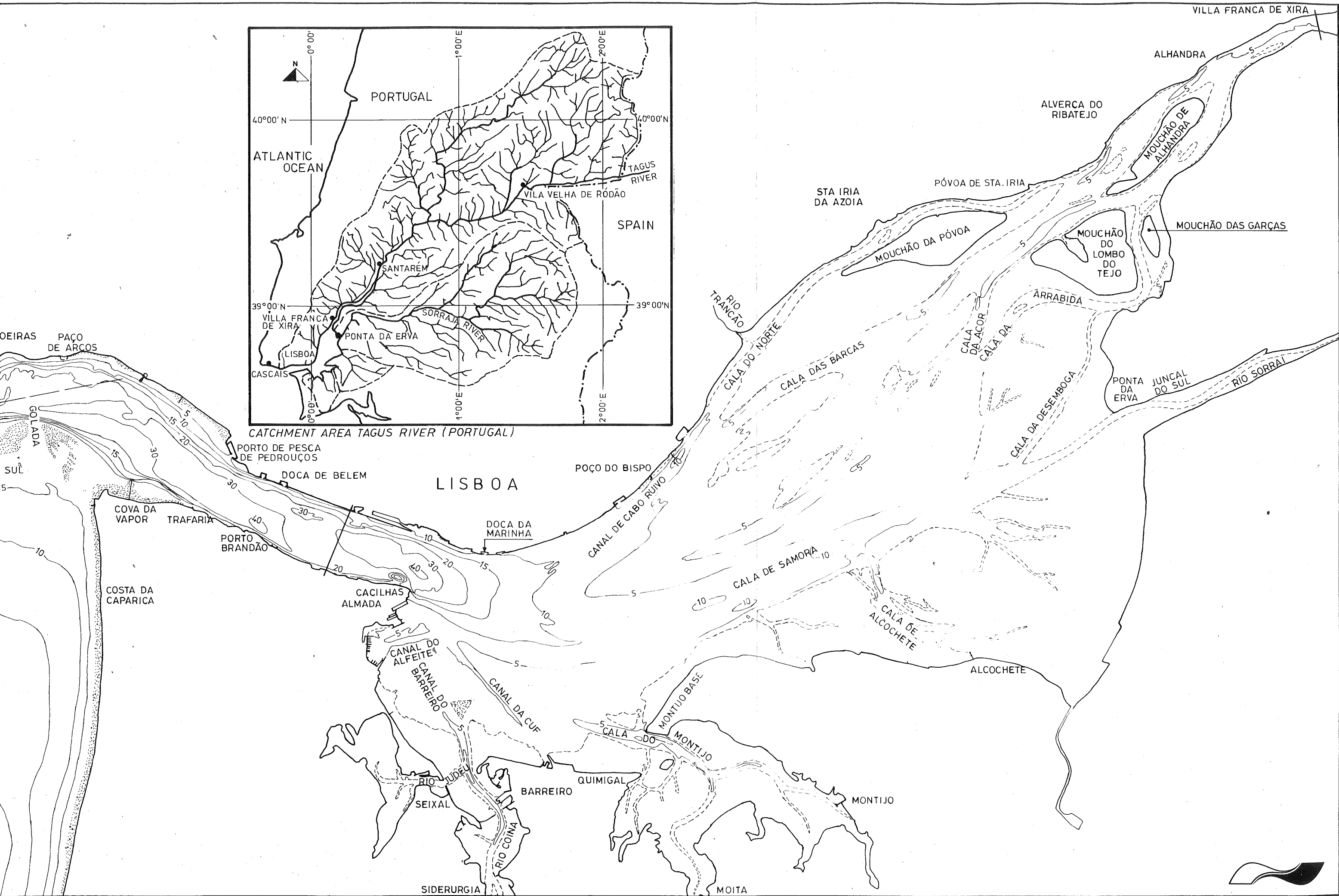

GENERAL MAP TAGUS ESTUARY

FIGURE 2.1.1.

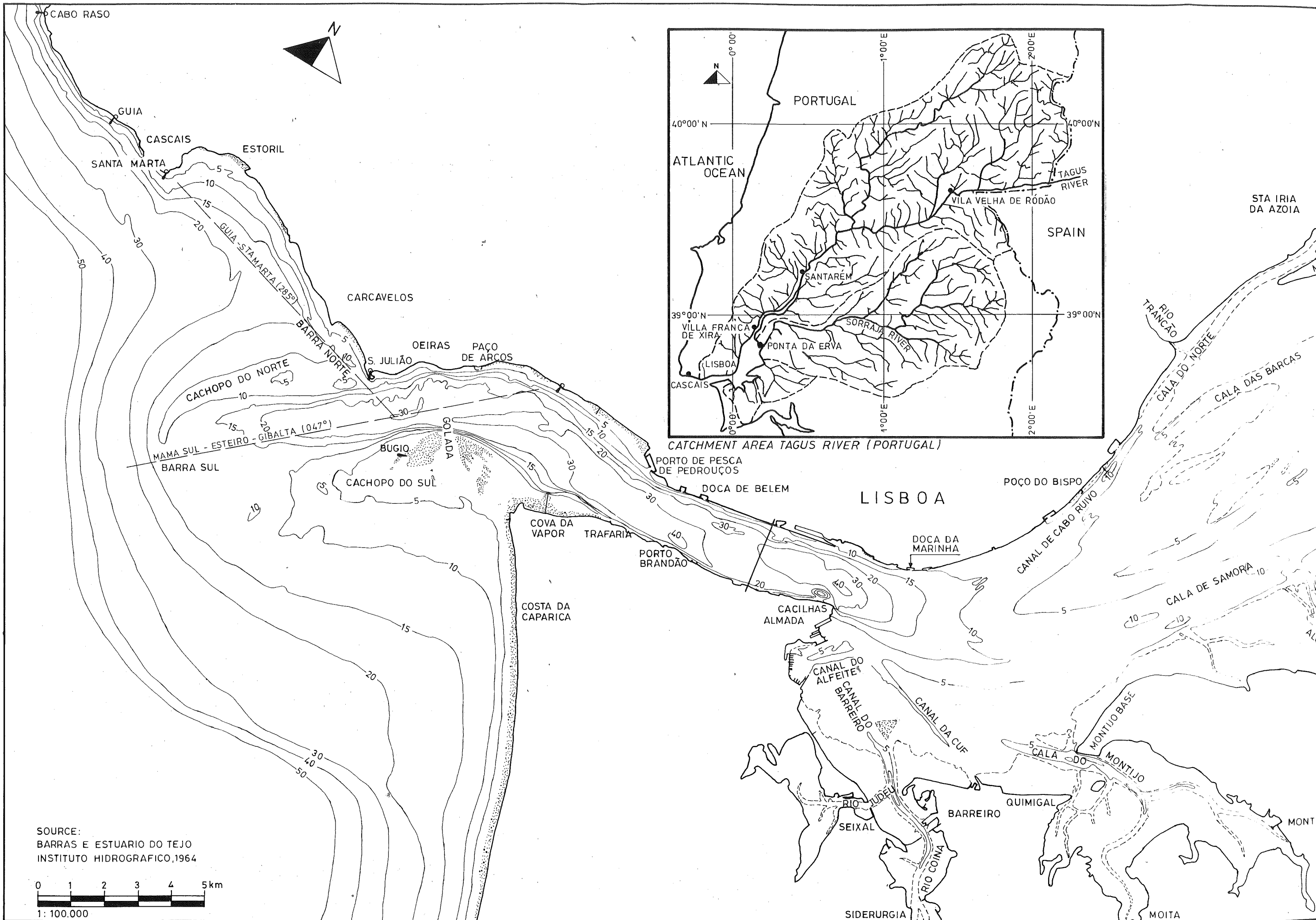

SOURCE:
BARRAS E ESTUARIO DO TEJO
INSTITUTO HIDROGRAFICO, 1964

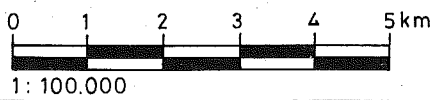

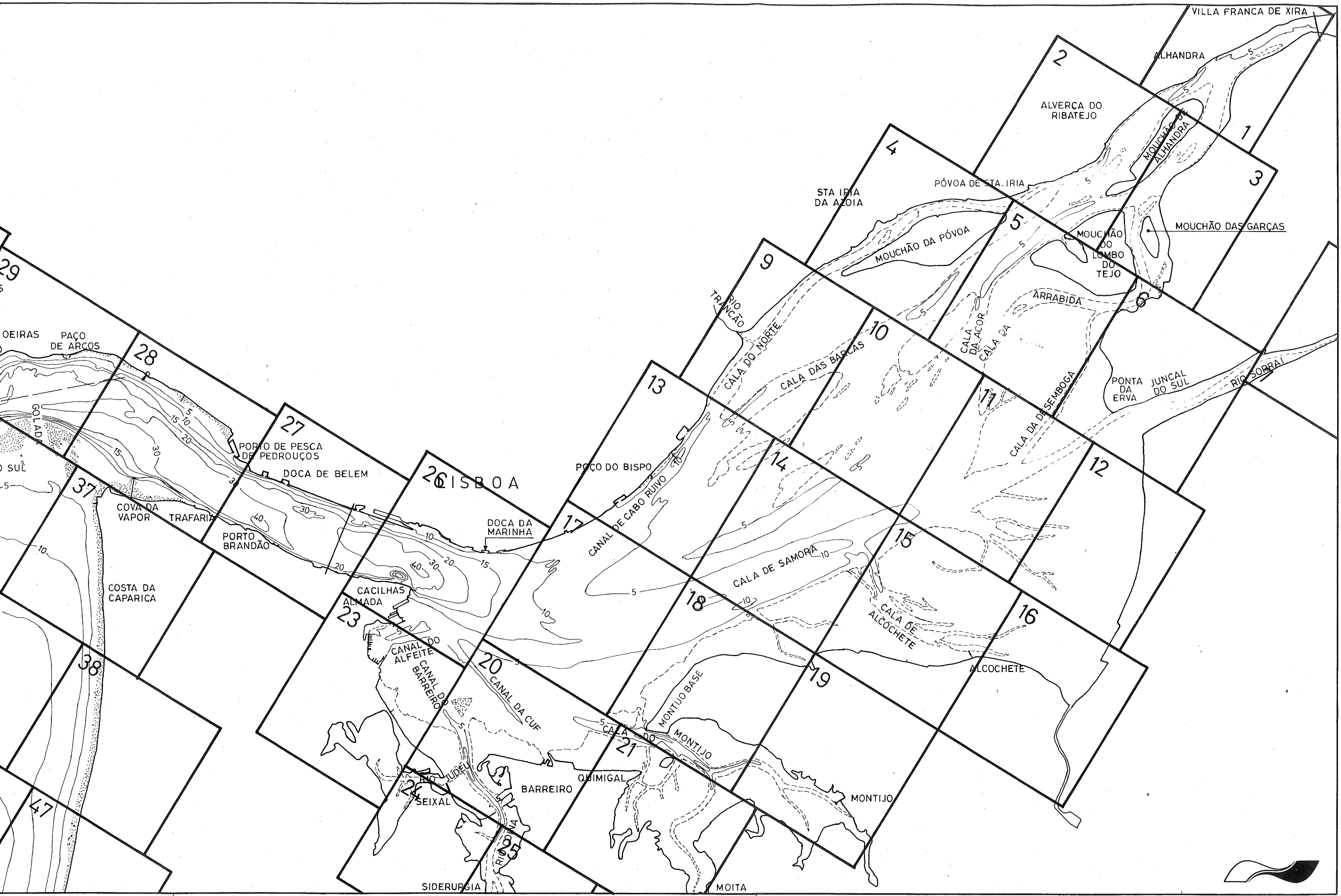

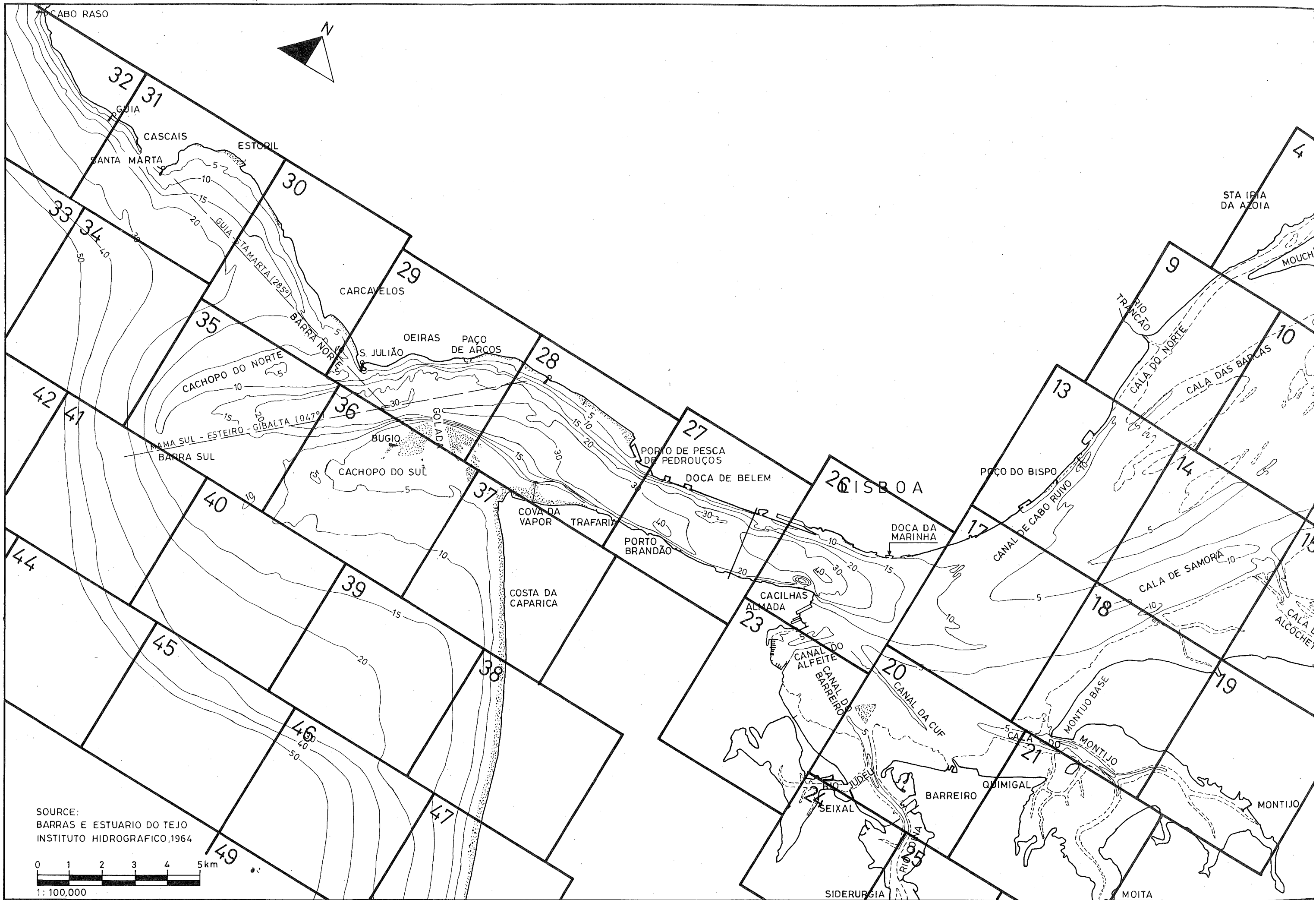

SOURCE:
BARRAS E ESTUARIO DO TEJO
INSTITUTO HIDROGRAFICO, 1964

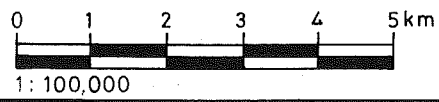

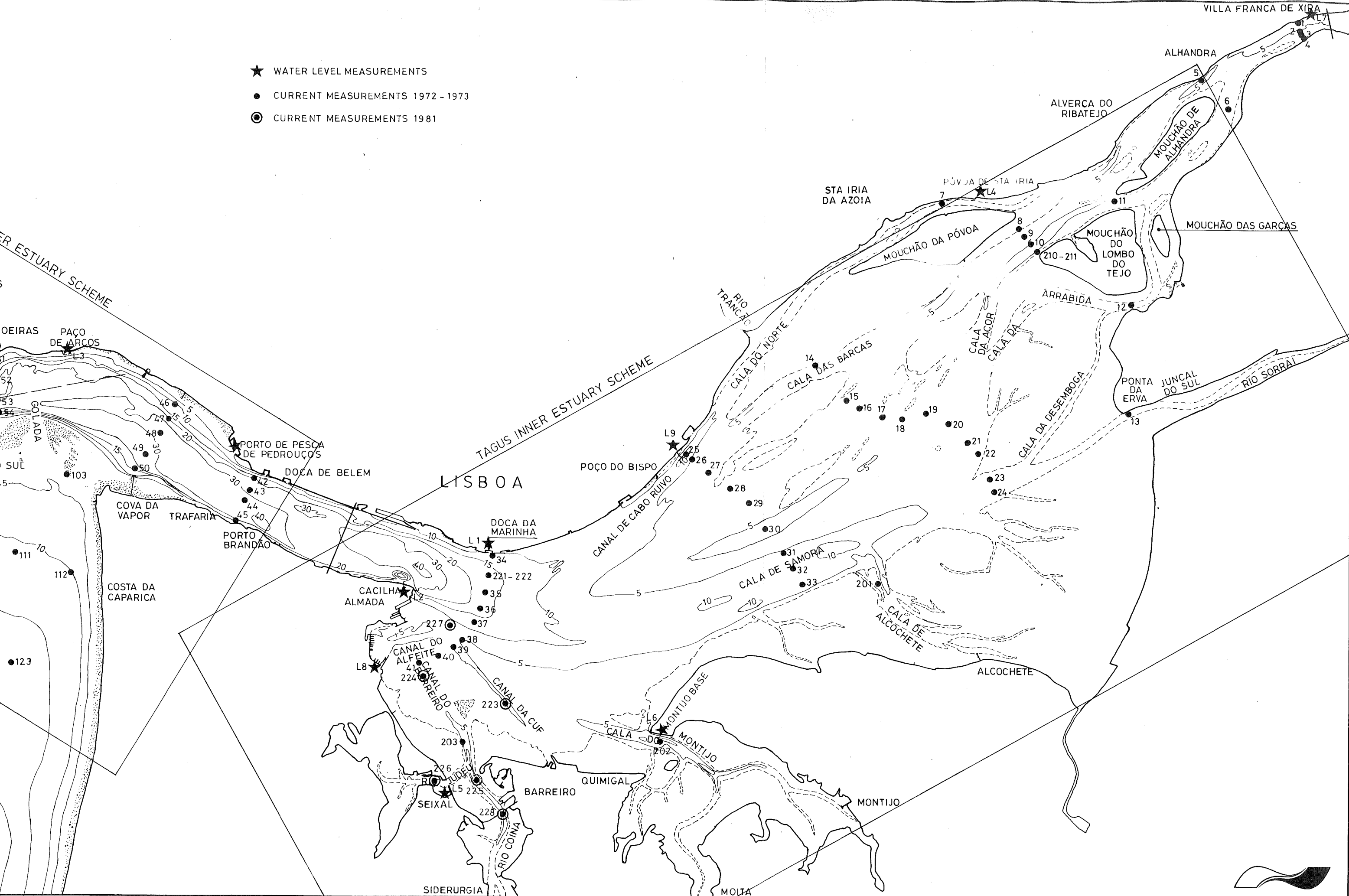

KEYPLAN STATION NUMBERS.

FIGURE 2.2.2.

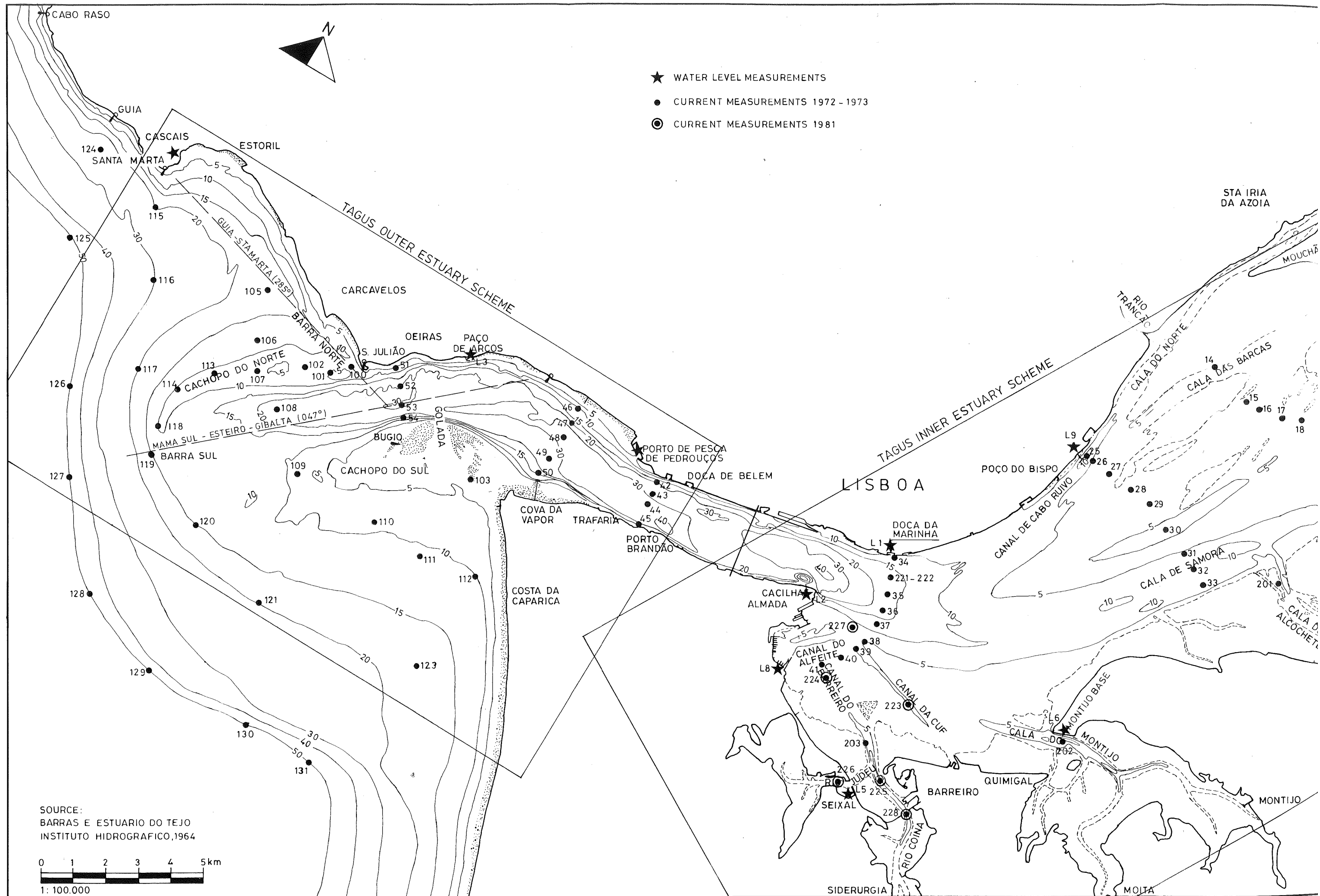

- ★ WATER LEVEL MEASUREMENTS
- CURRENT MEASUREMENTS 1972 - 1973
- ◎ CURRENT MEASUREMENTS 1981

SOURCE:
BARRAS E ESTUARIO DO TEJO
INSTITUTO HIDROGRAFICO, 1964

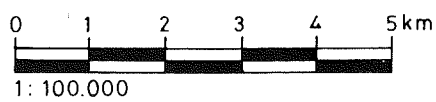

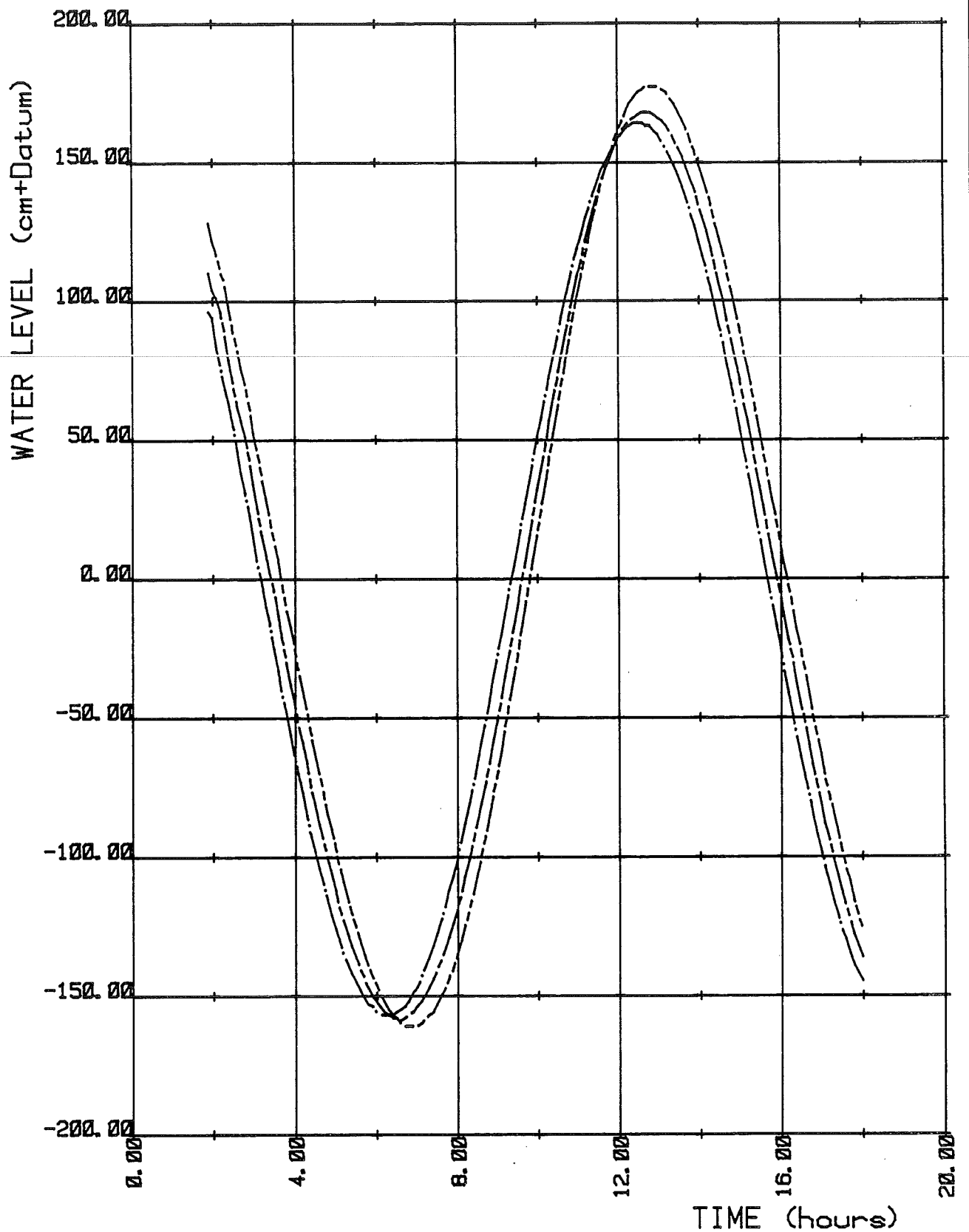

Computed water level curves

-----	N= 91 M= 10	station 42
- . - . - .	N= 56 M= 13	station 51
—————	N= 7 M= 5	station 115



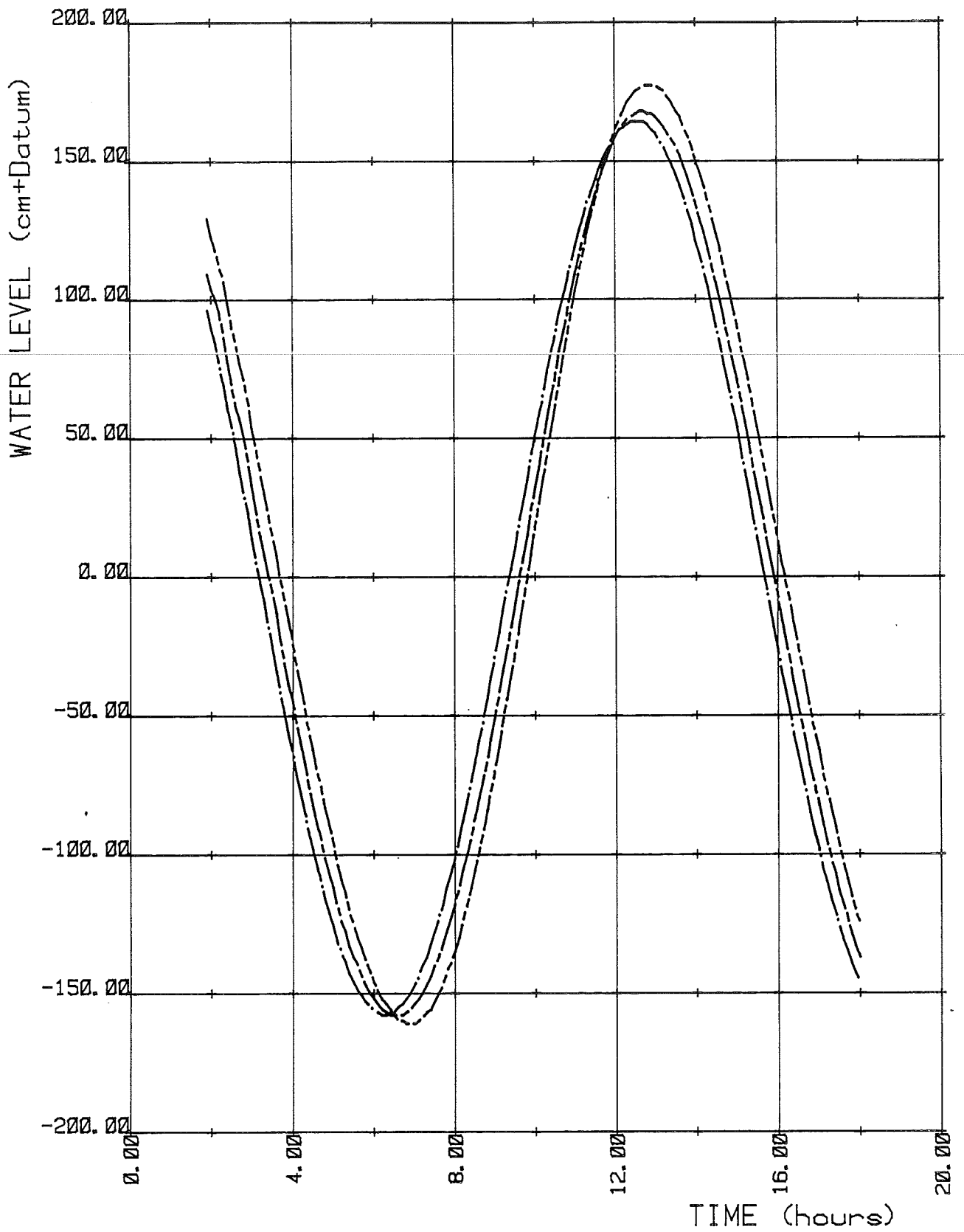

Computed water level curves

- N= 91 M= 12 station 43
- .-.-.-.- N= 56 M= 16 station 52
- . - . - . N= 12 M= 25 station 116



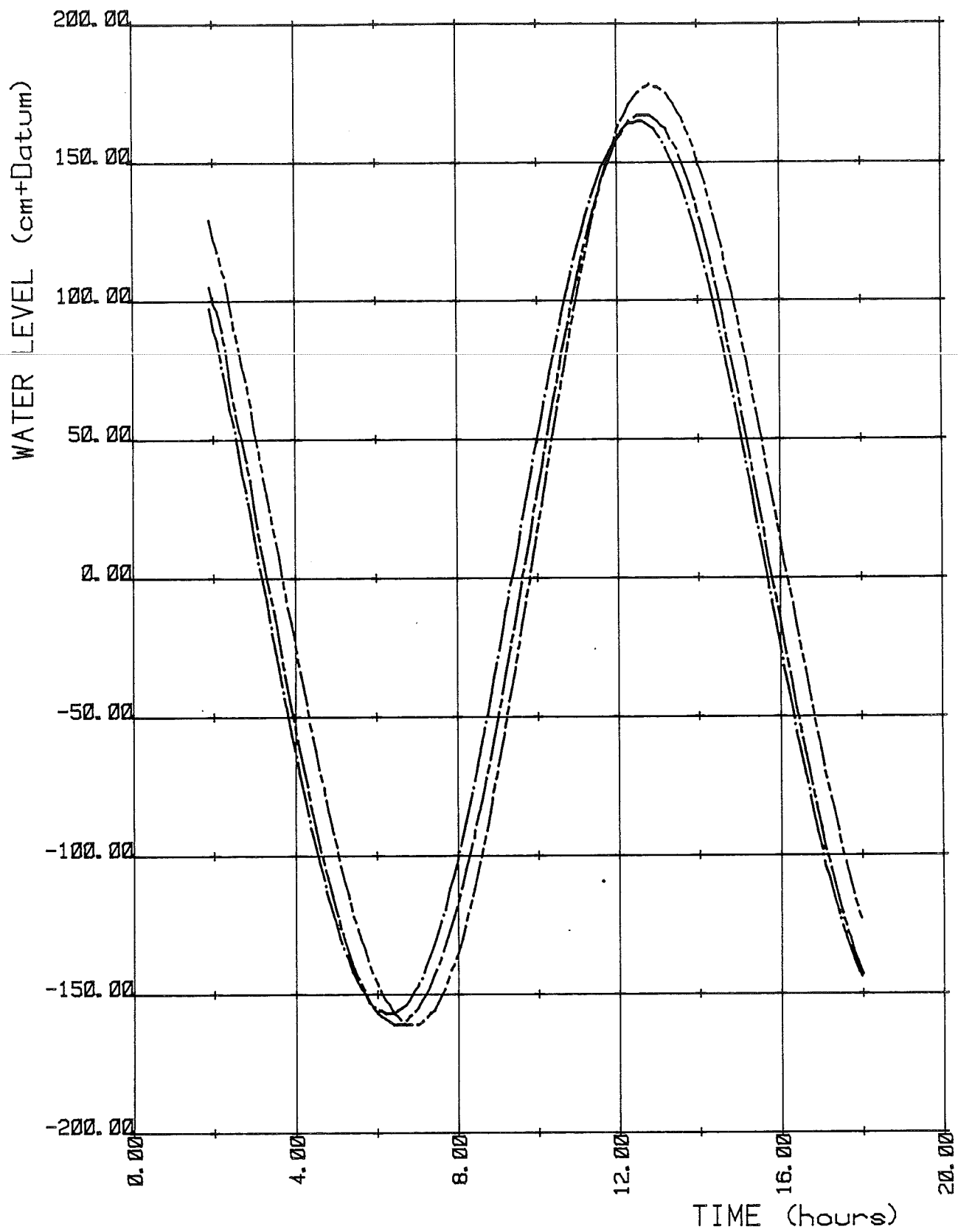

Computed water level curves

- N= 91 M= 14 station 44
- .-.-.-.- N= 57 M= 20 station 53
- _____ N= 17 M= 37 station 117



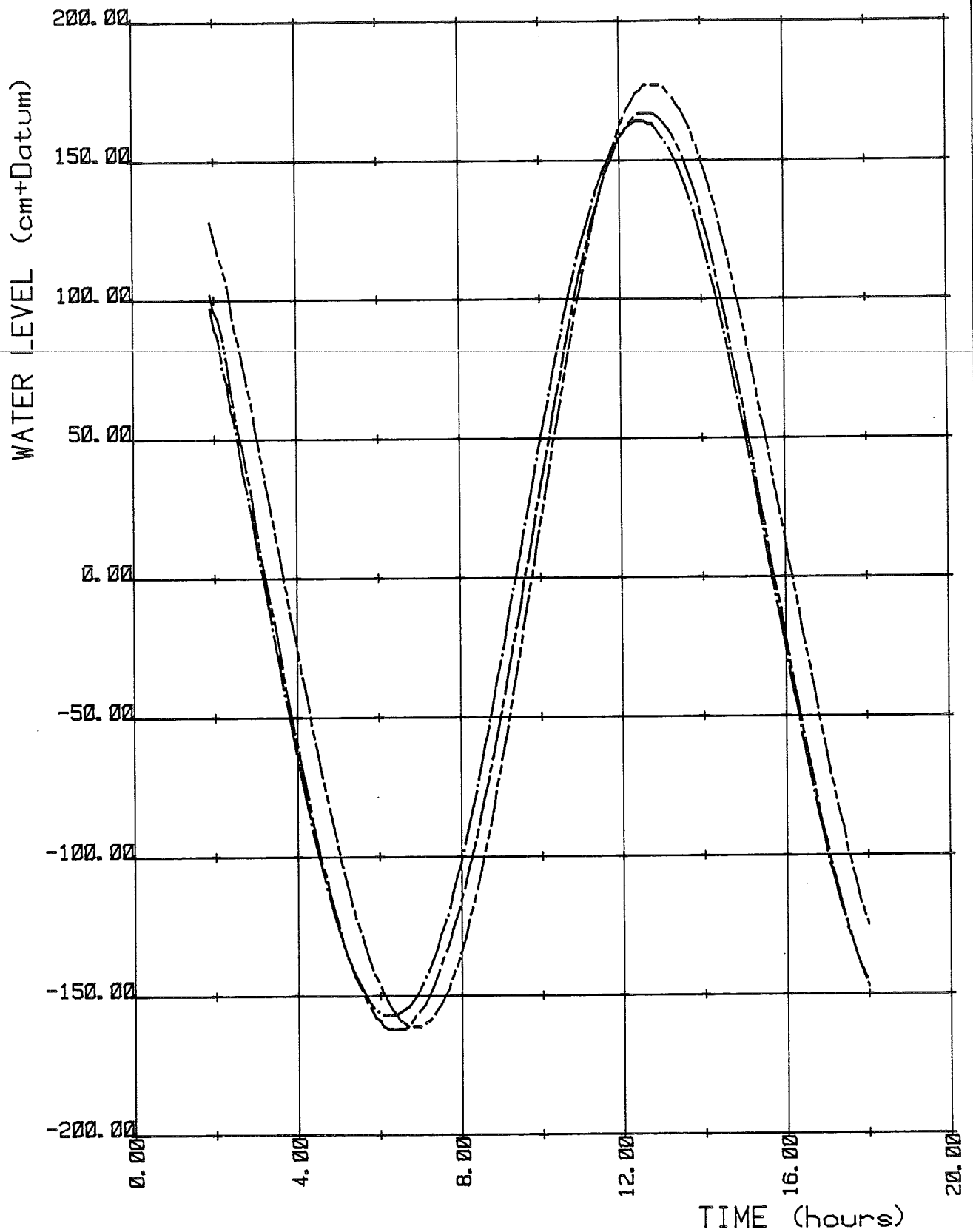

Computed water level curves

-----	N= 91 M= 17	station 45
-.-.-.-.-	N= 57 M= 22	station 54
—————	N= 25 M= 43	station 118



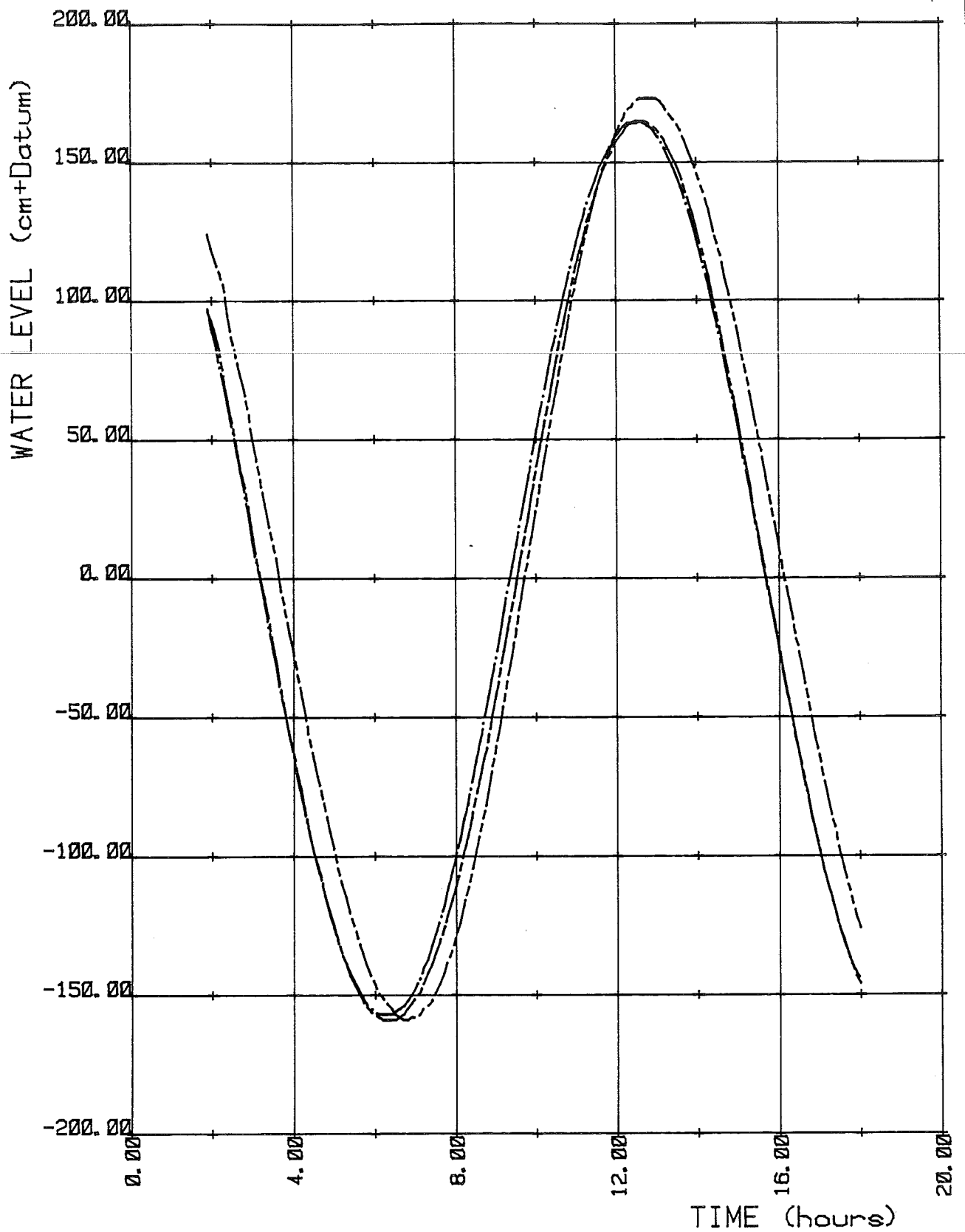

Computed water level curves

- N= 79 M= 7 station 46
- . - . - . N= 45 M= 21 station 100
- N= 7 M= 41 station 126



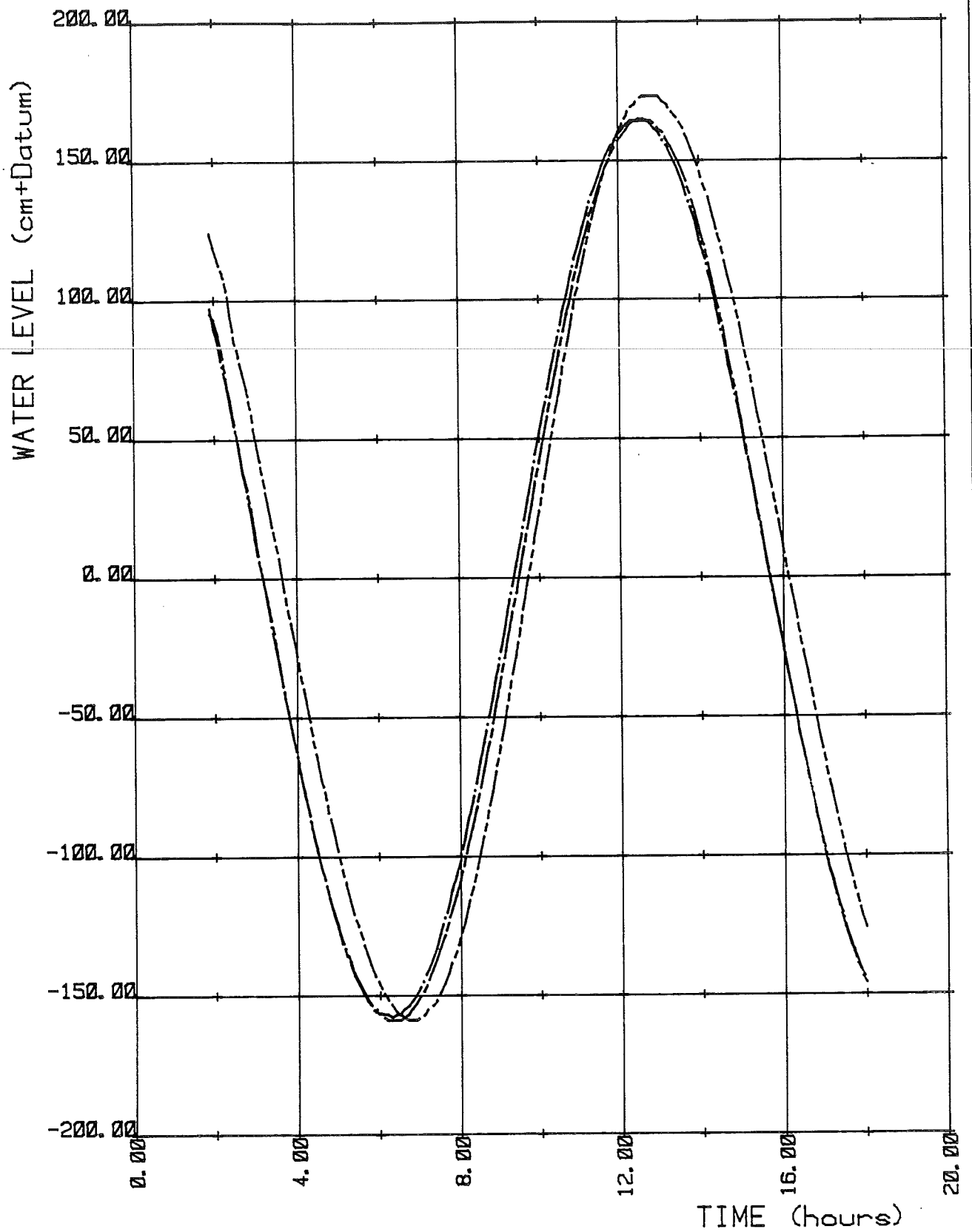

Computed water level curves

-----	N= 79 M= 9	station 47
-.-.-.-.-	N= 43 M= 22	station 101
—————	N= 17 M= 58	station 127



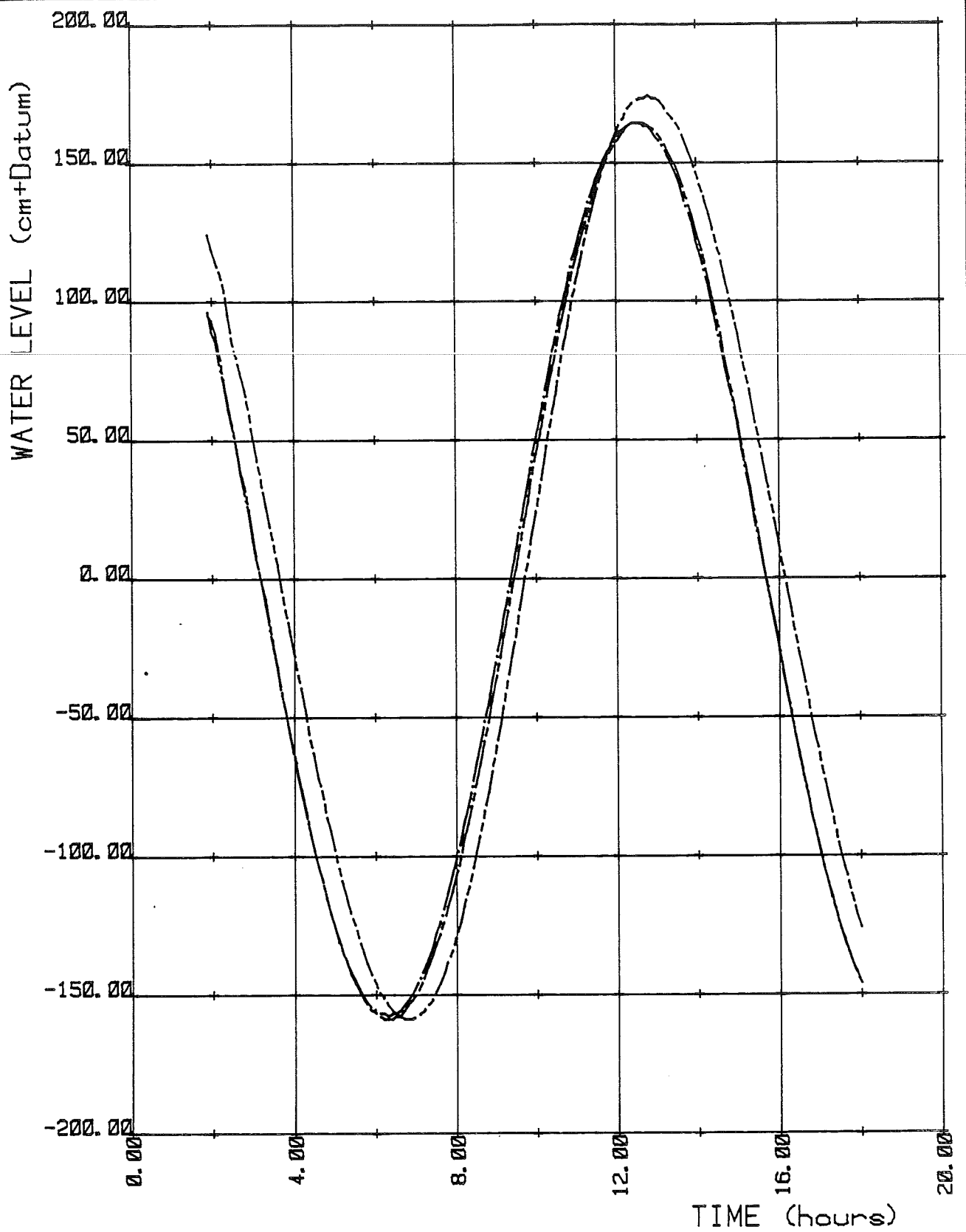

Computed water level curves

- N= 79 M= 12 station 48
- .-.-.- N= 39 M= 24 station 102
- · — · — N= 25 M= 47 station 119



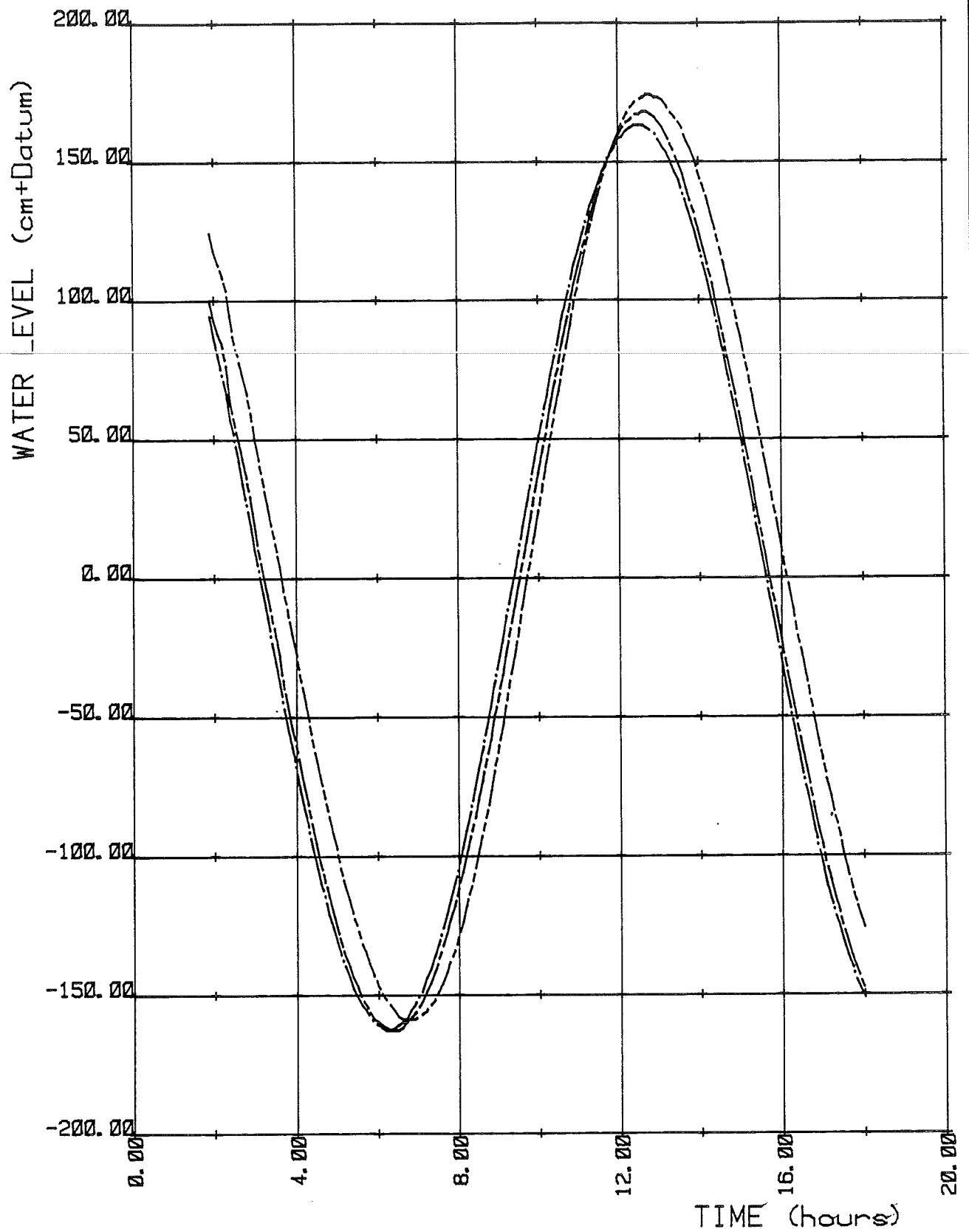

Computed water level curves

- N= 79 M= 16 station 49
- . - . - . N= 70 M= 25 station 103
- N= 80 M= 57 station 123



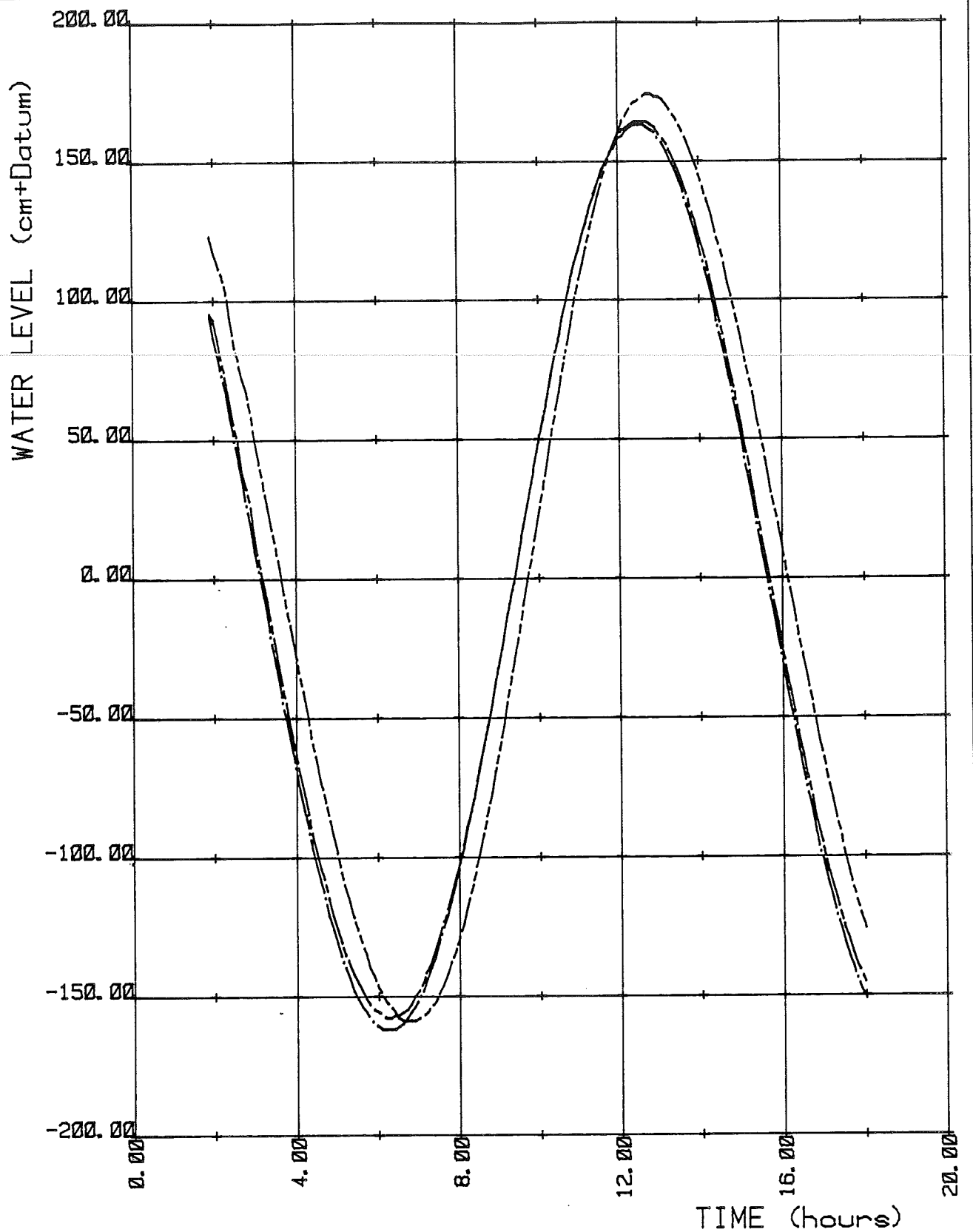

Computed water level curves

- N= 79 M= 18 station 50
- .-.-.- N= 29 M= 16 station 105
- _____ N= 51 M= 58 station 121



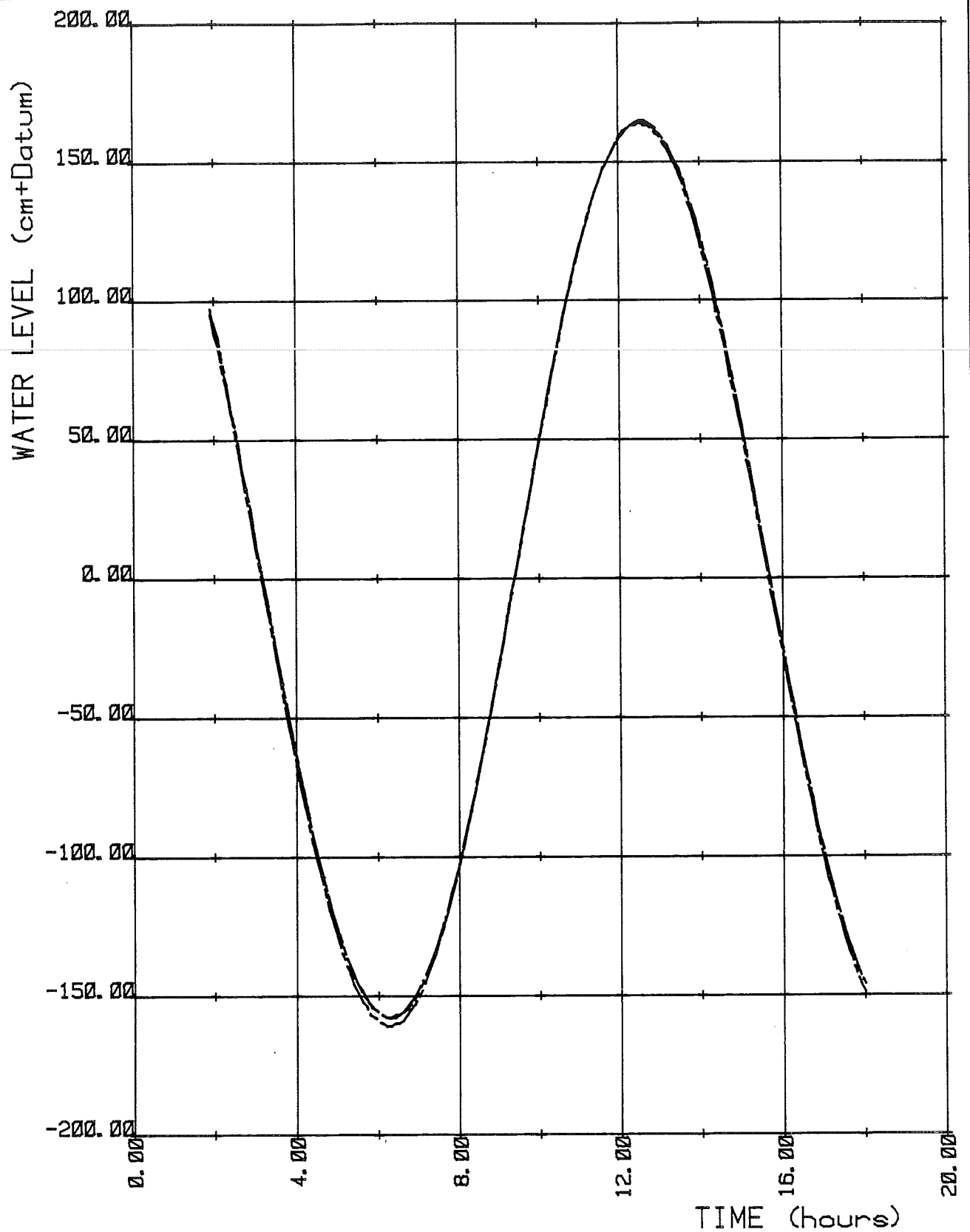

Computed water level curves

-----	N= 31 M= 24	station 106
- - - - -	N= 37 M= 53	station 120
- . - . - .	N= 25 M= 35	station 114



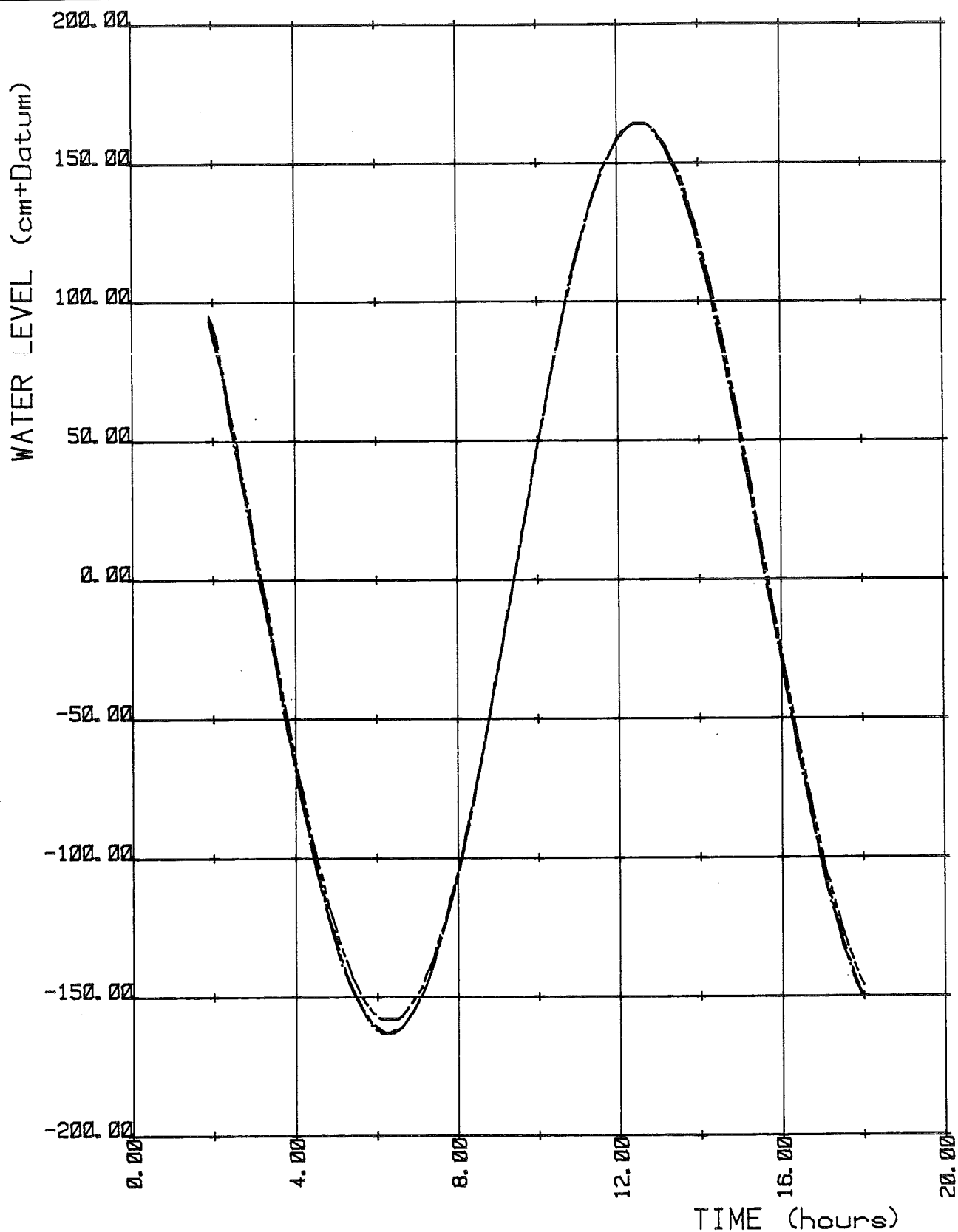

Computed water level curves

-----	N= 33 M= 27	station 107
-----	N= 47 M= 38	station 109
-----	N= 68 M= 40	station 111



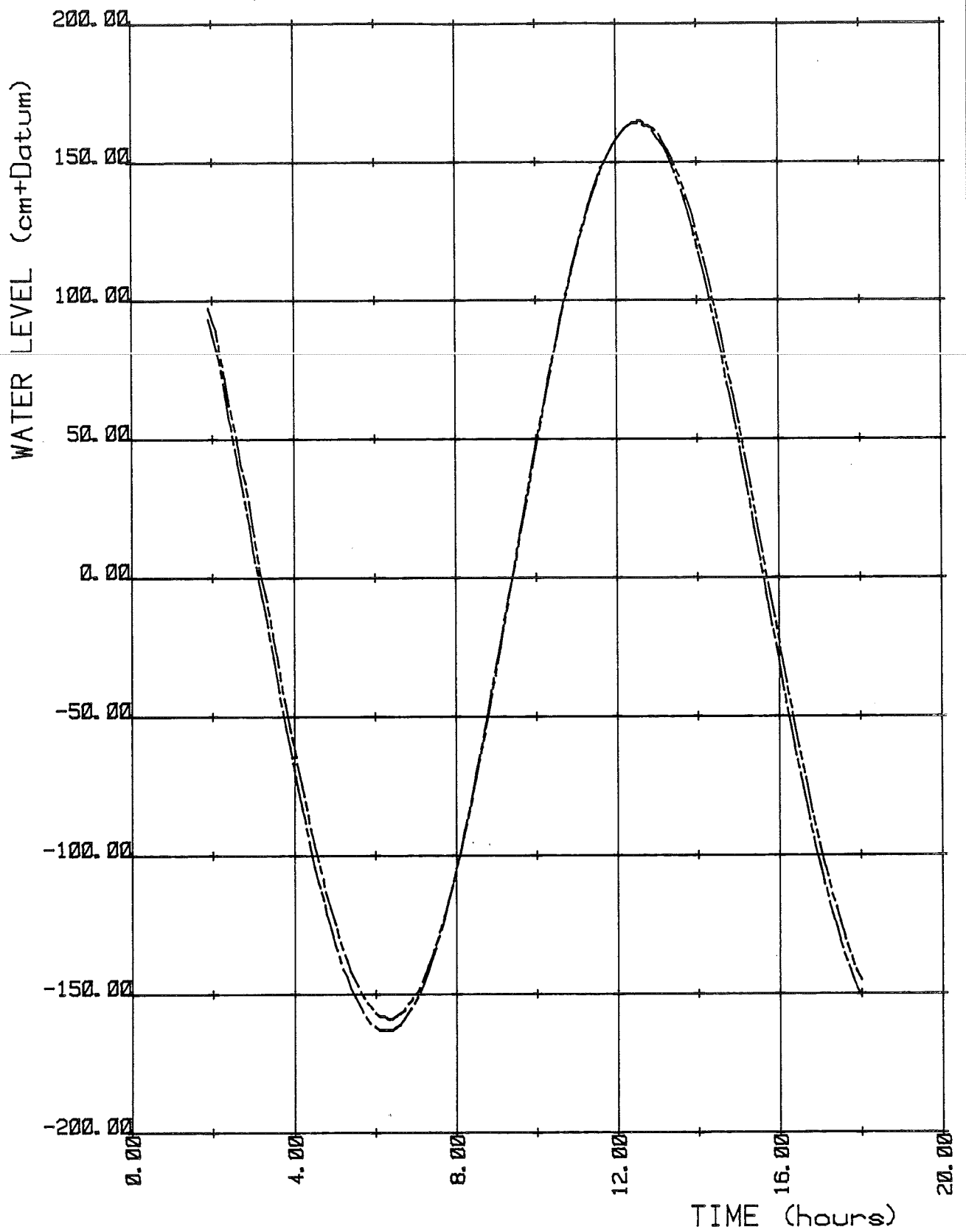

Computed water level curves

- N= 38 M= 32 station 108
- N= 59 M= 40 station 110



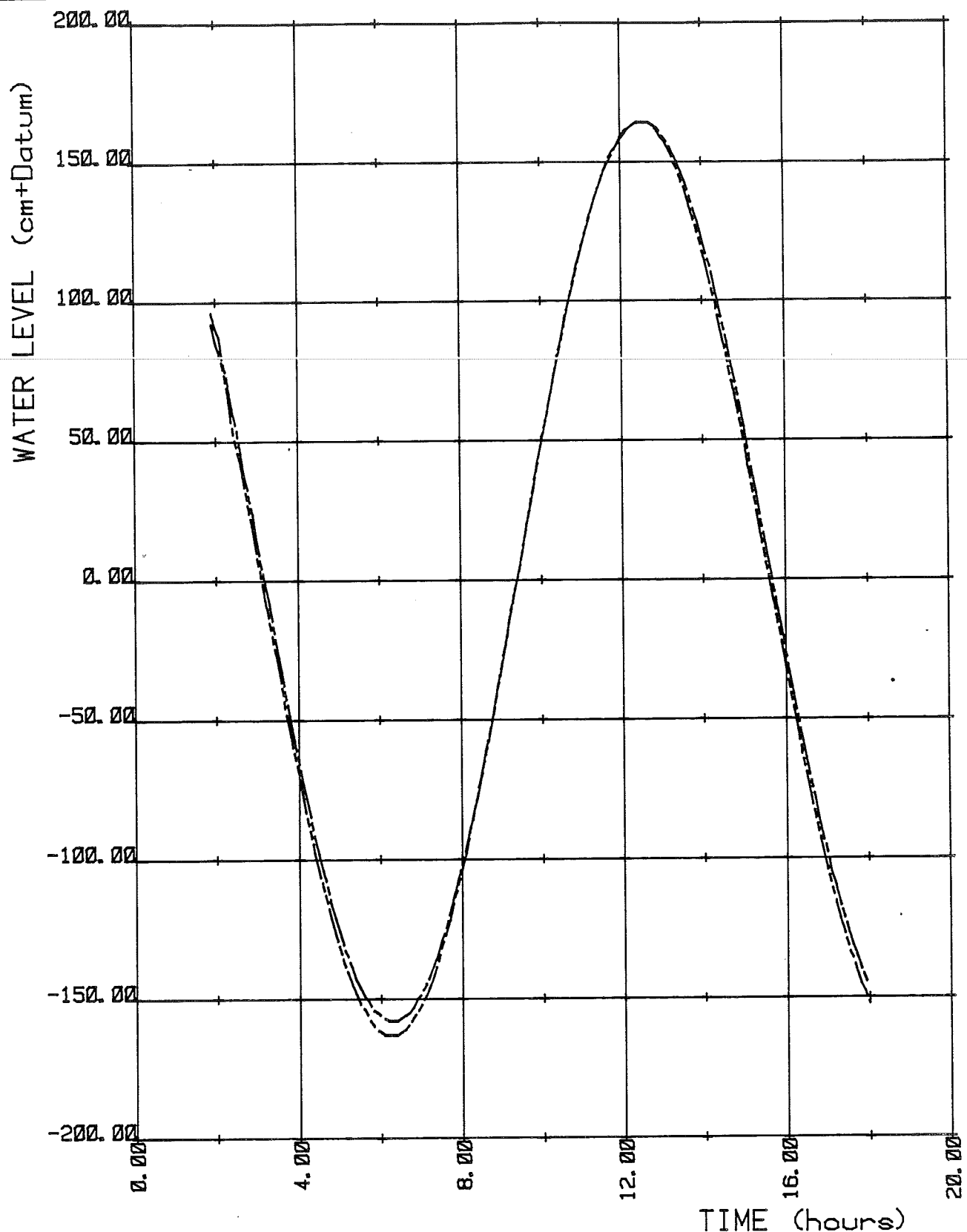

Computed water level curves

----- N= 78 M= 37 station 112
 - - - - - N= 28 M= 31 station 113



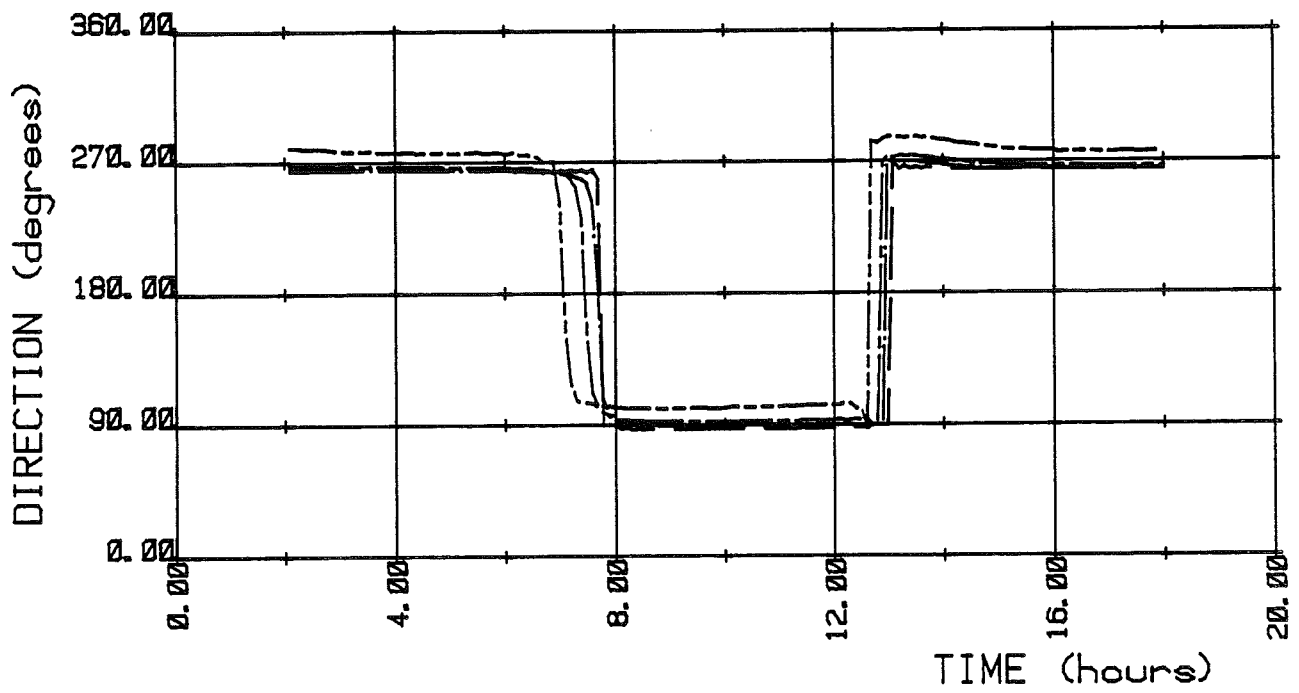
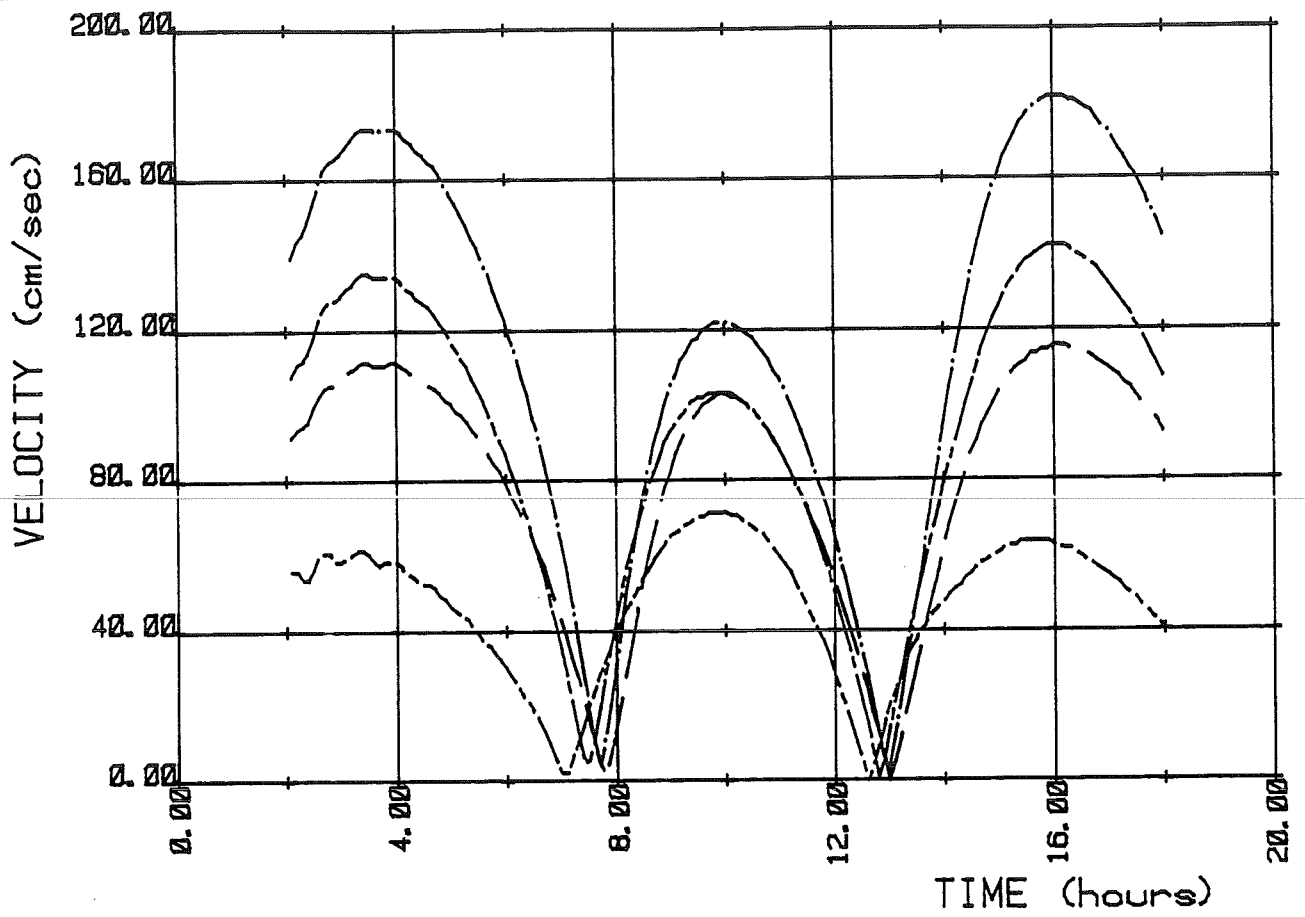

Computed velocity curves

.....	N= 91 M= 10	station 42
- . - . - .	N= 91 M= 12	station 43
—————	N= 91 M= 14	station 44
—— ———	N= 91 M= 17	station 45



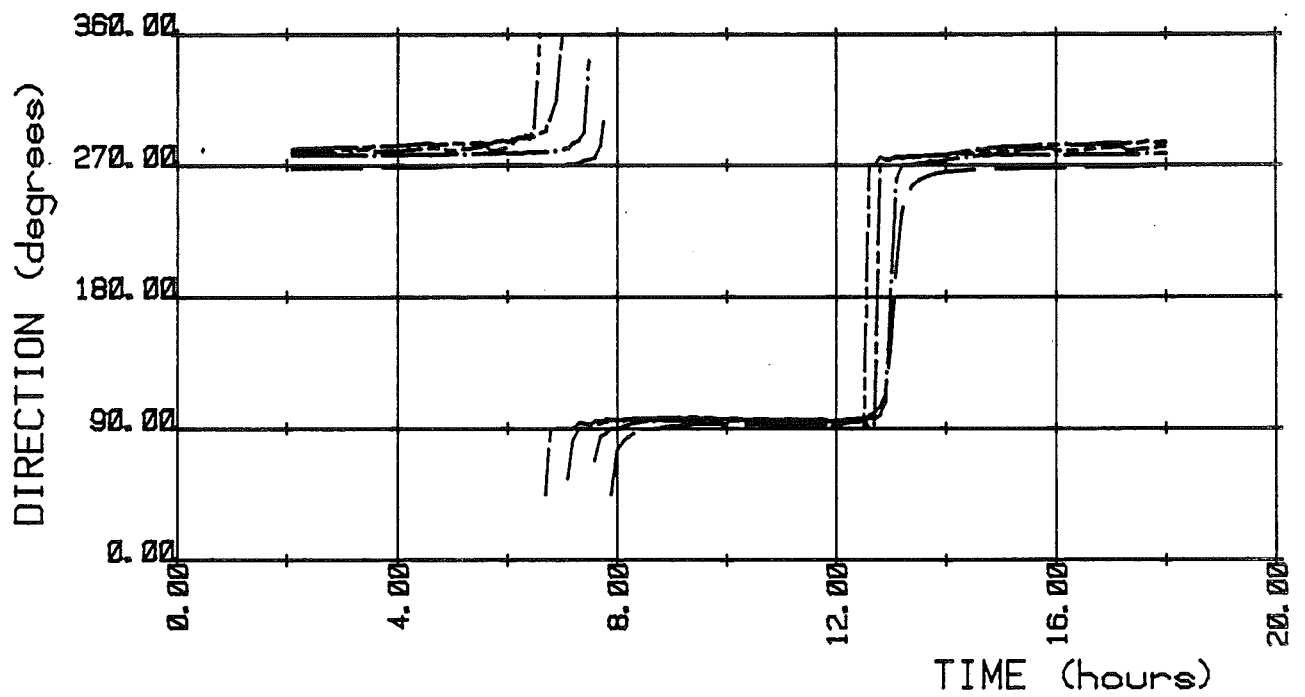
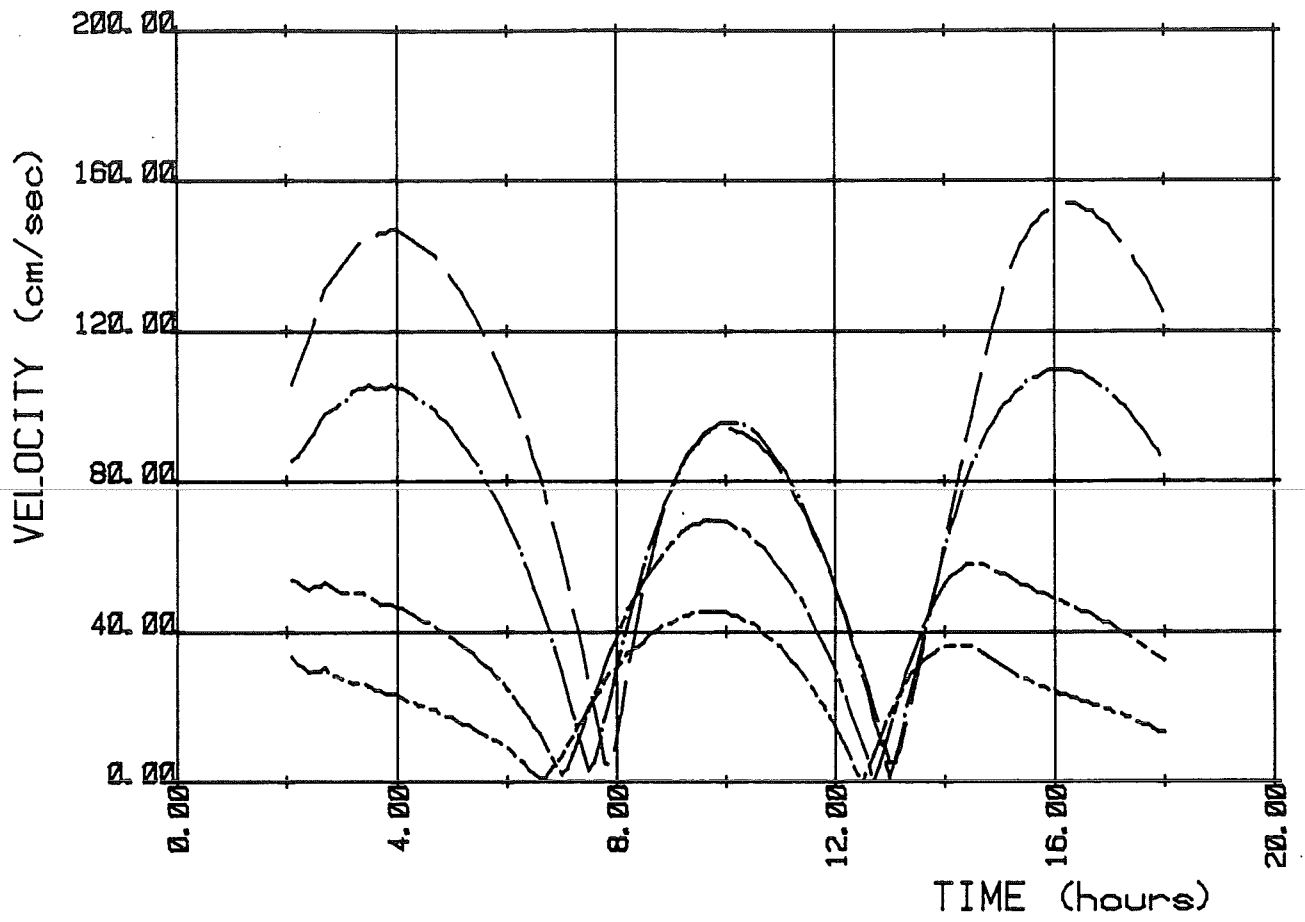

Computed velocity curves

- | | | |
|-------|-------------|------------|
| ----- | N= 79 M= 7 | station 46 |
| ----- | N= 79 M= 9 | station 47 |
| ----- | N= 79 M= 12 | station 48 |
| ----- | N= 79 M= 16 | station 49 |



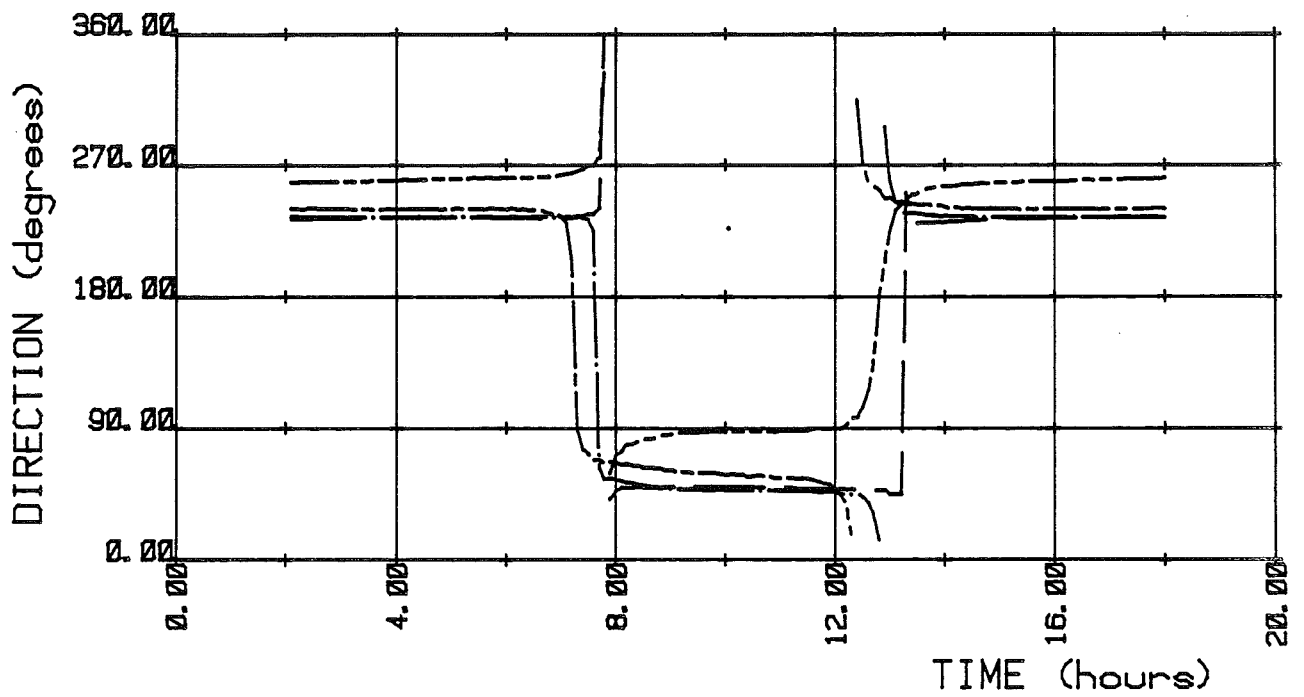
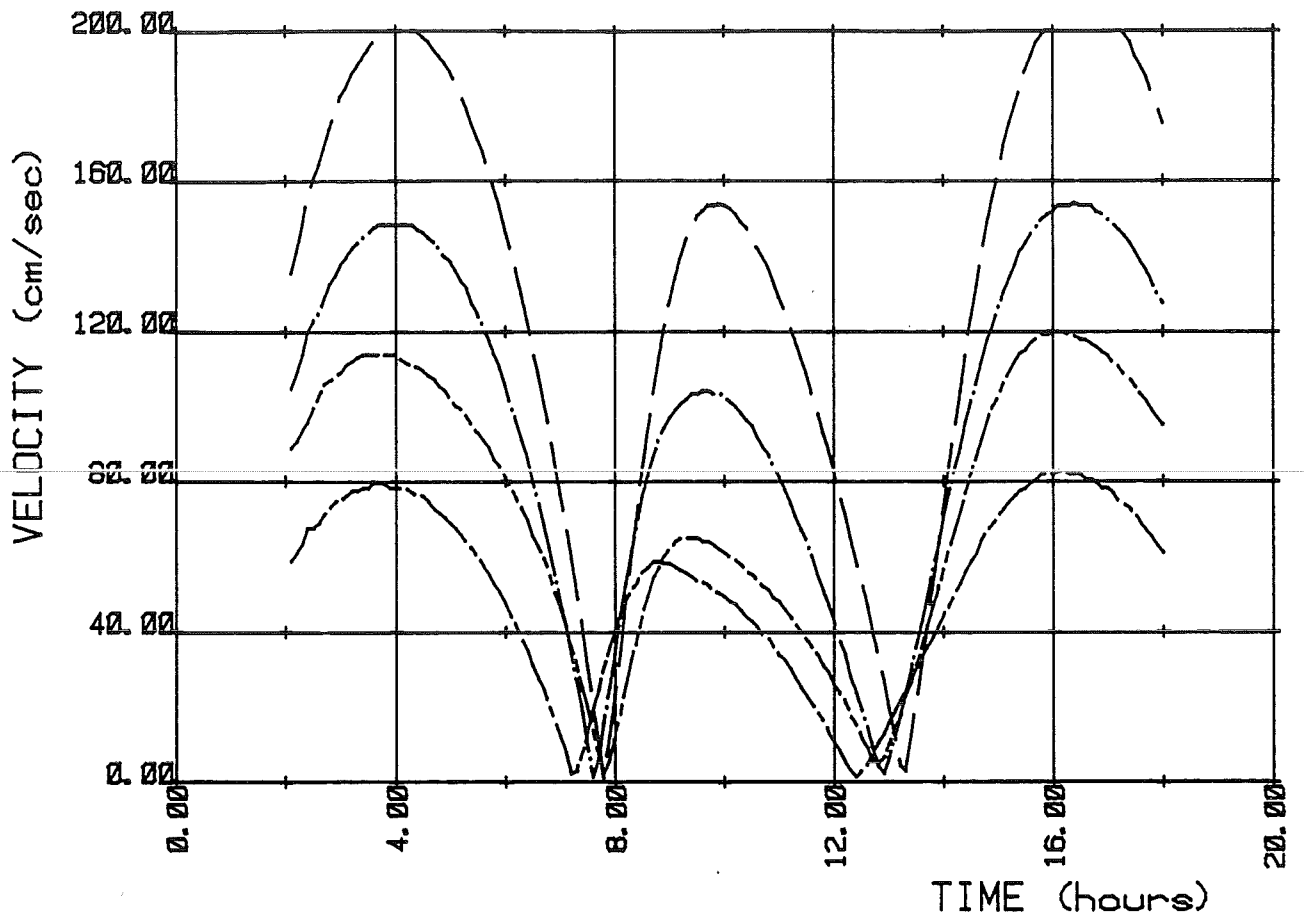

Computed velocity curves

-----	N= 79 M= 18	station 50
- - - - -	N= 56 M= 13	station 51
- . - . - .	N= 56 M= 16	station 52
- - - - -	N= 57 M= 20	station 53



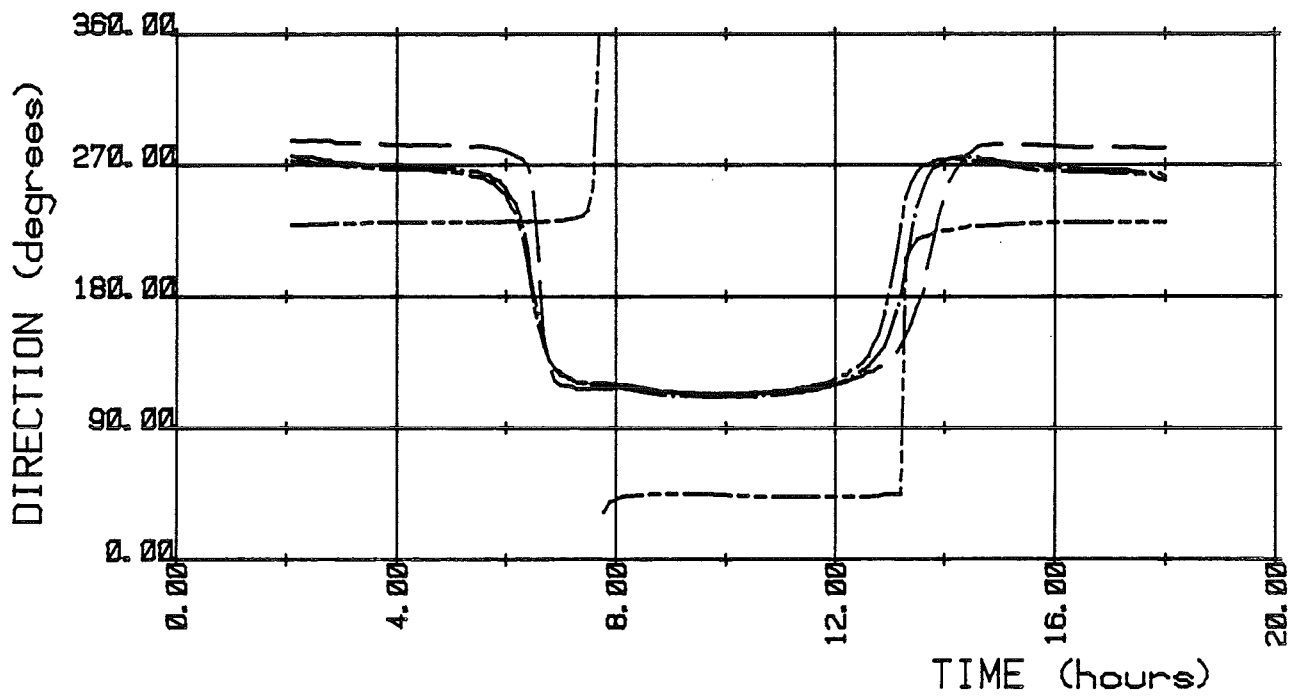
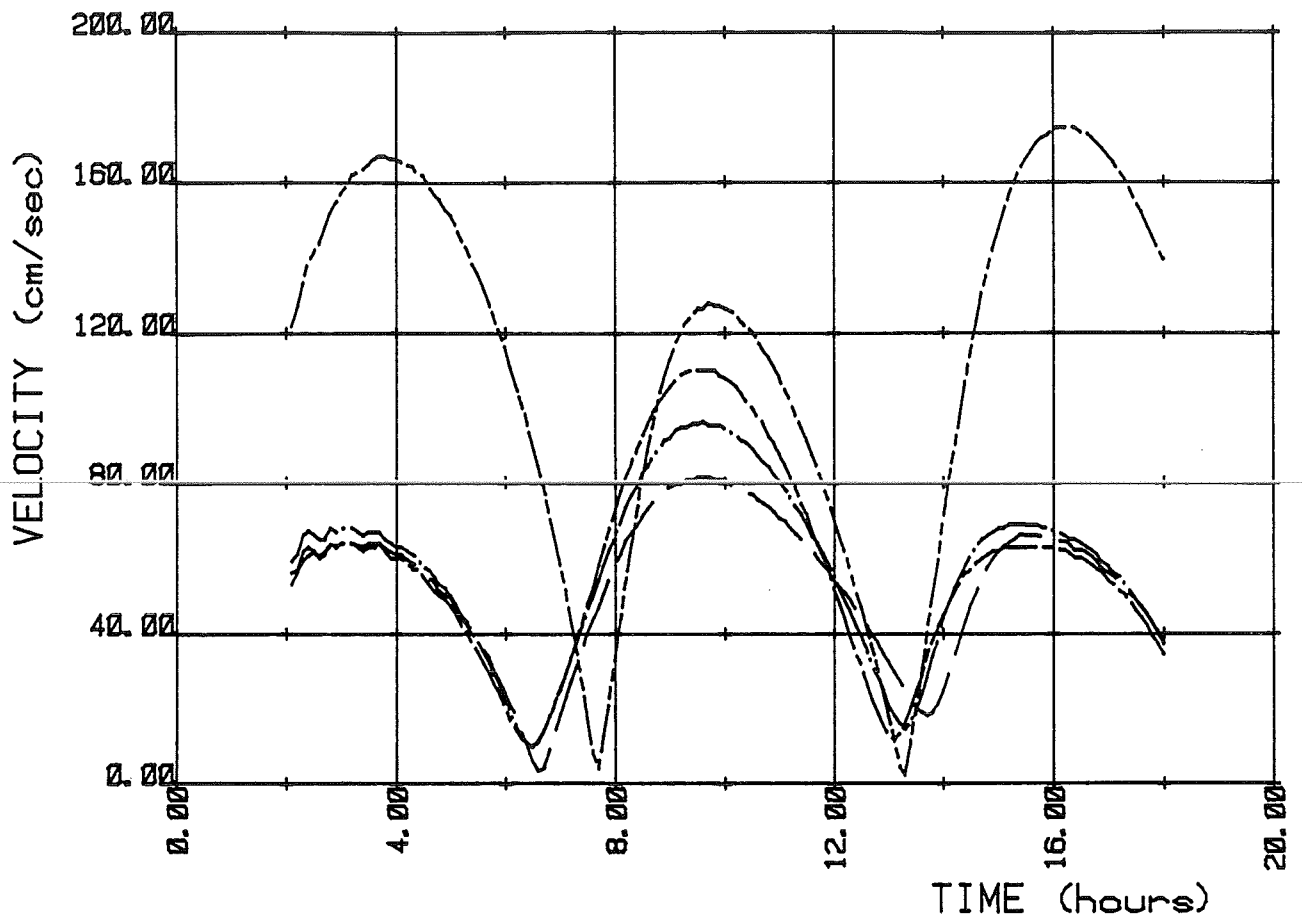

Computed velocity curves

-----	N= 57 M= 22	station 54
-.-.-.-.	N= 45 M= 21	station 100
_____	N= 43 M= 22	station 101
-----	N= 39 M= 24	station 102



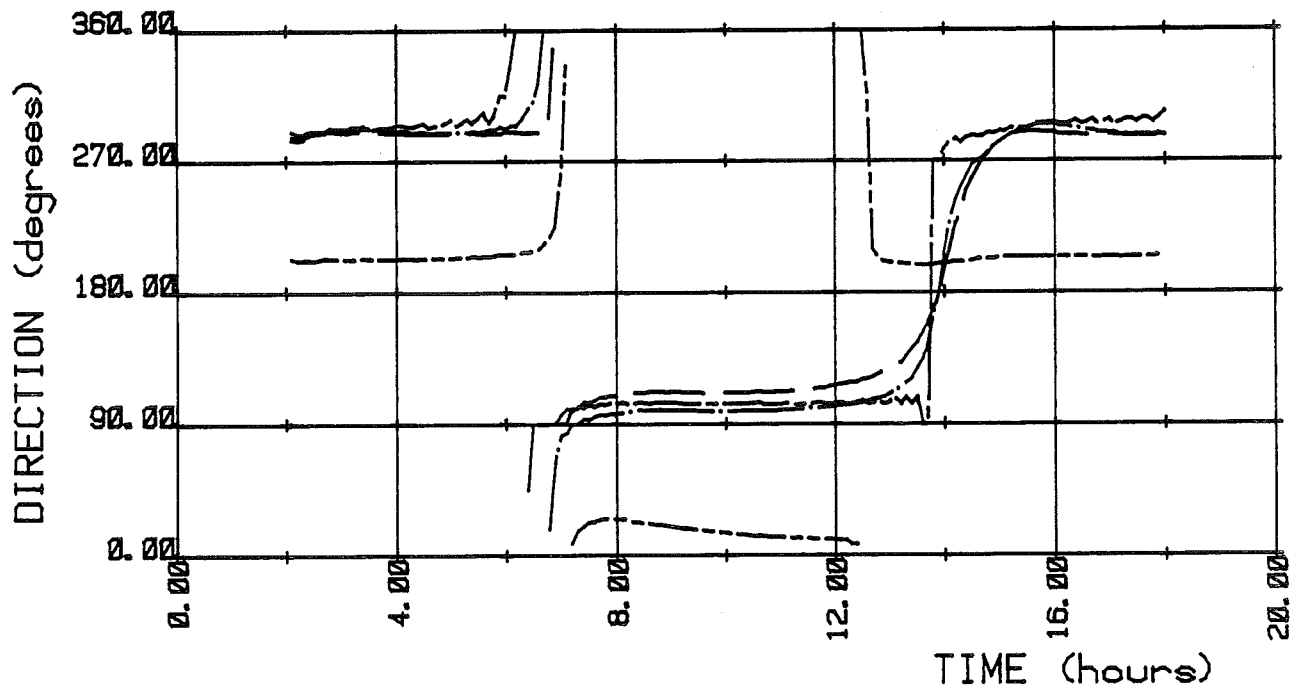
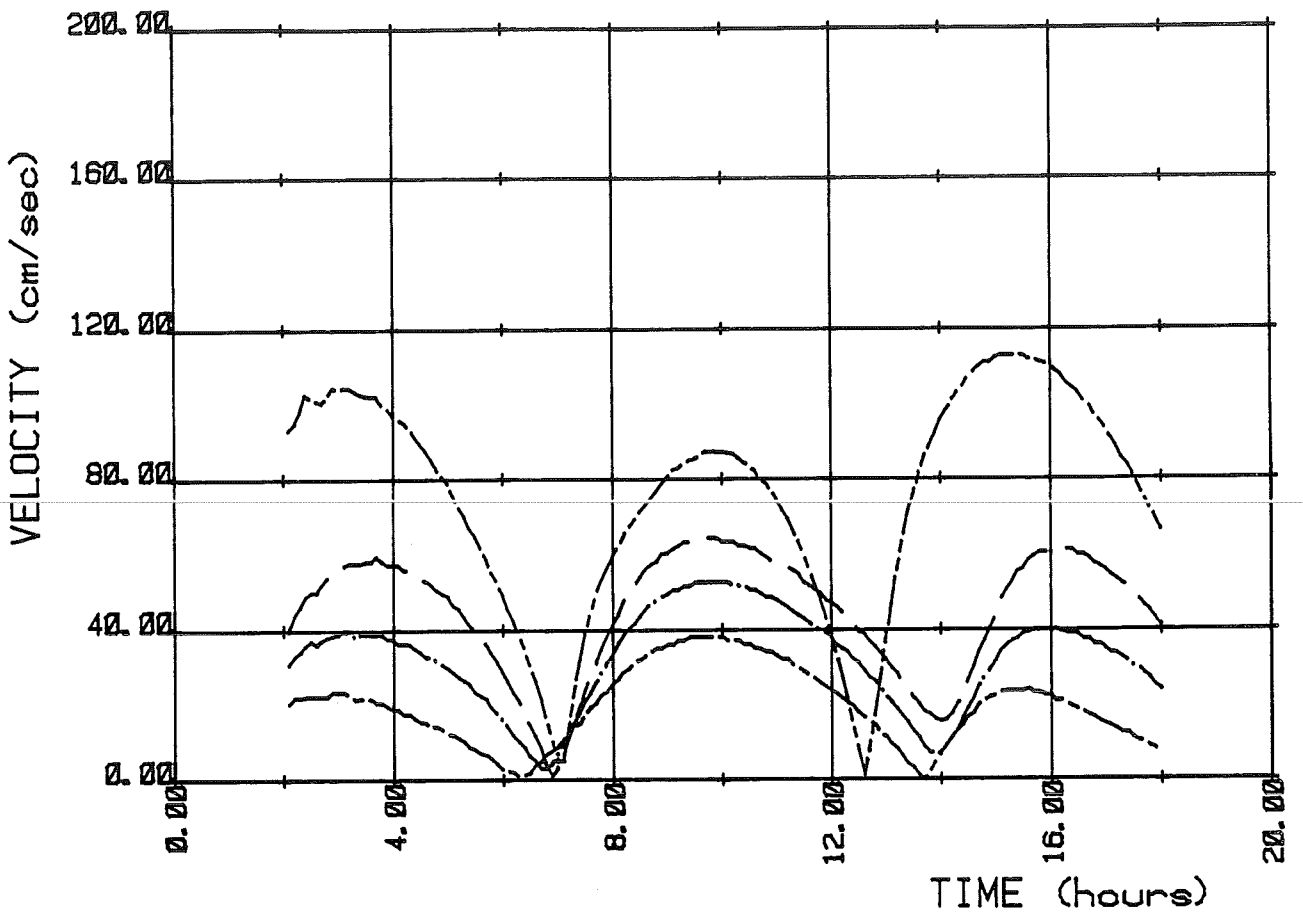

Computed velocity curves

-----	N= 70 M= 25	station 103
- . - . - .	N= 29 M= 16	station 105
—————	N= 31 M= 24	station 106
— — — —	N= 33 M= 27	station 107



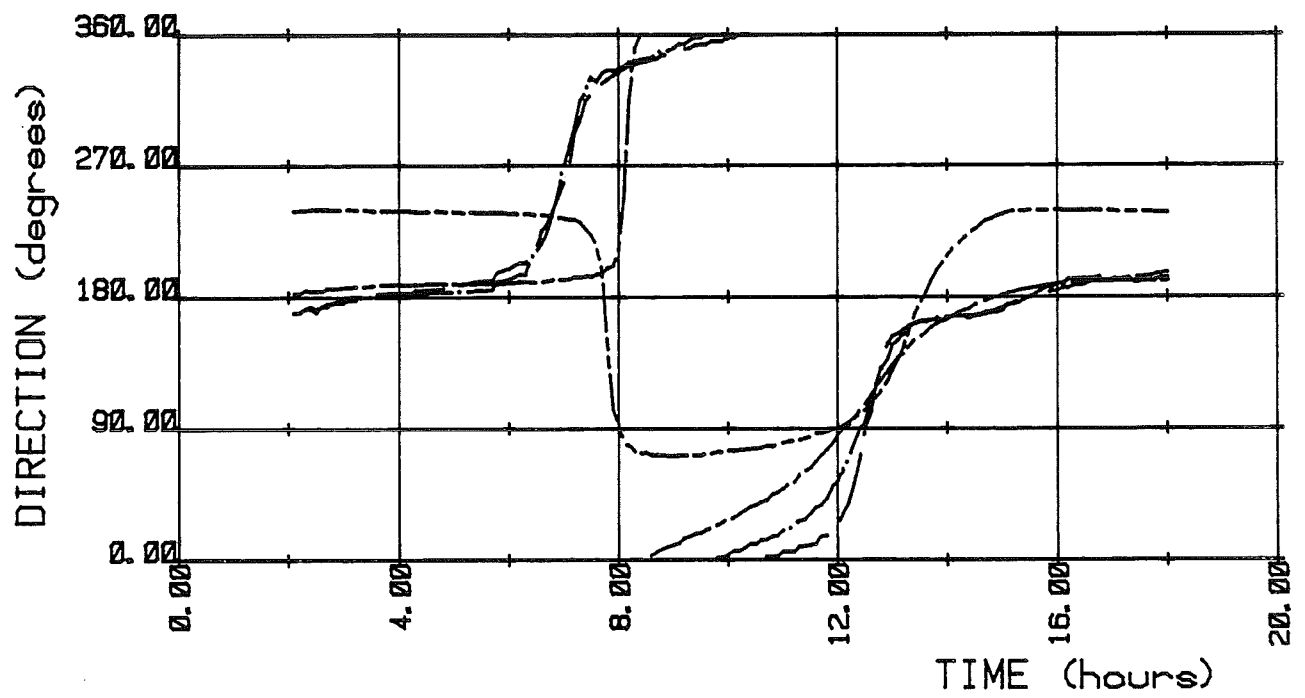
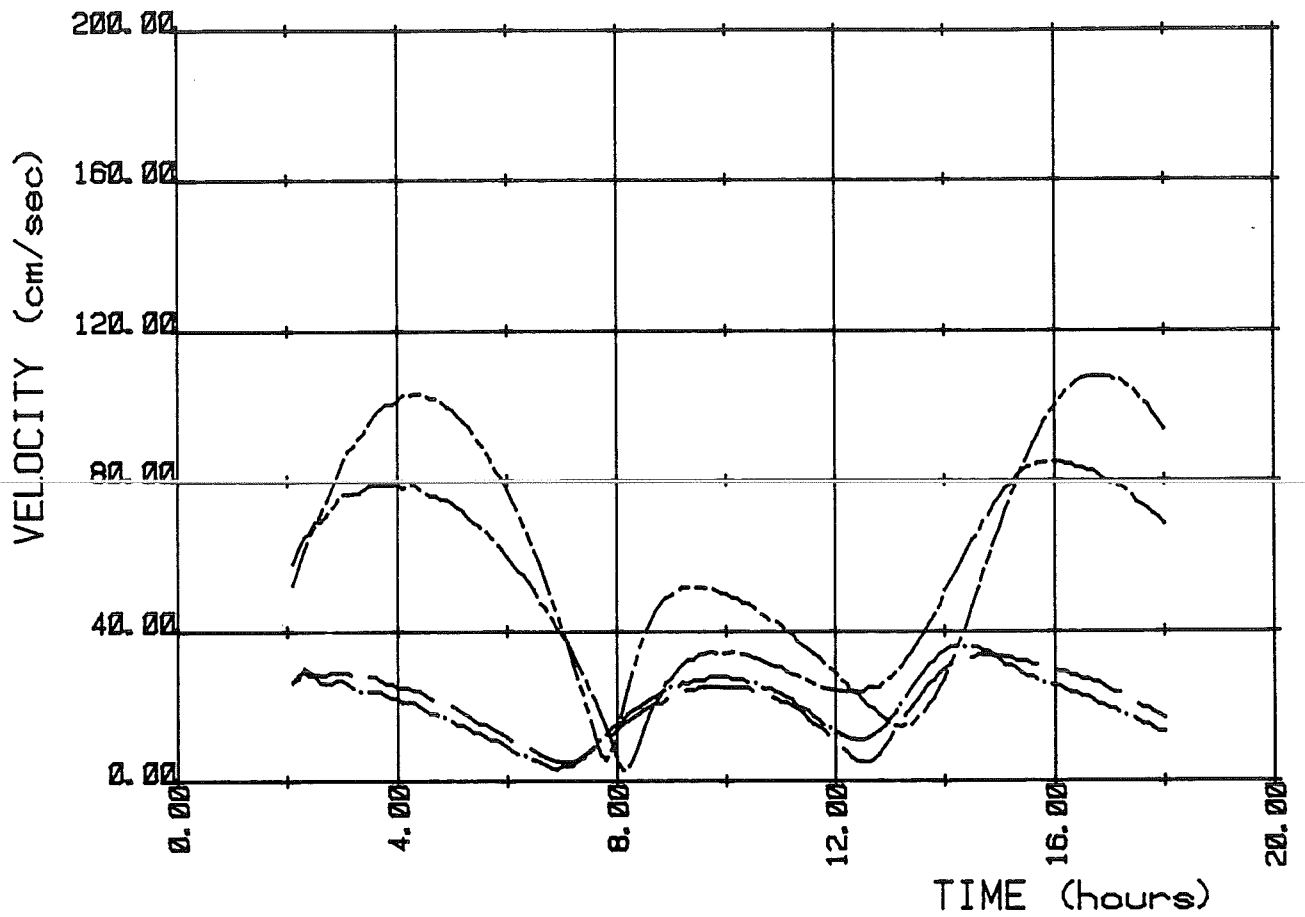

Computed velocity curves

- N= 38 M= 32 station 108
- N= 47 M= 38 station 109
- . - . - . N= 59 M= 40 station 110
- - - - - N= 68 M= 40 station 111



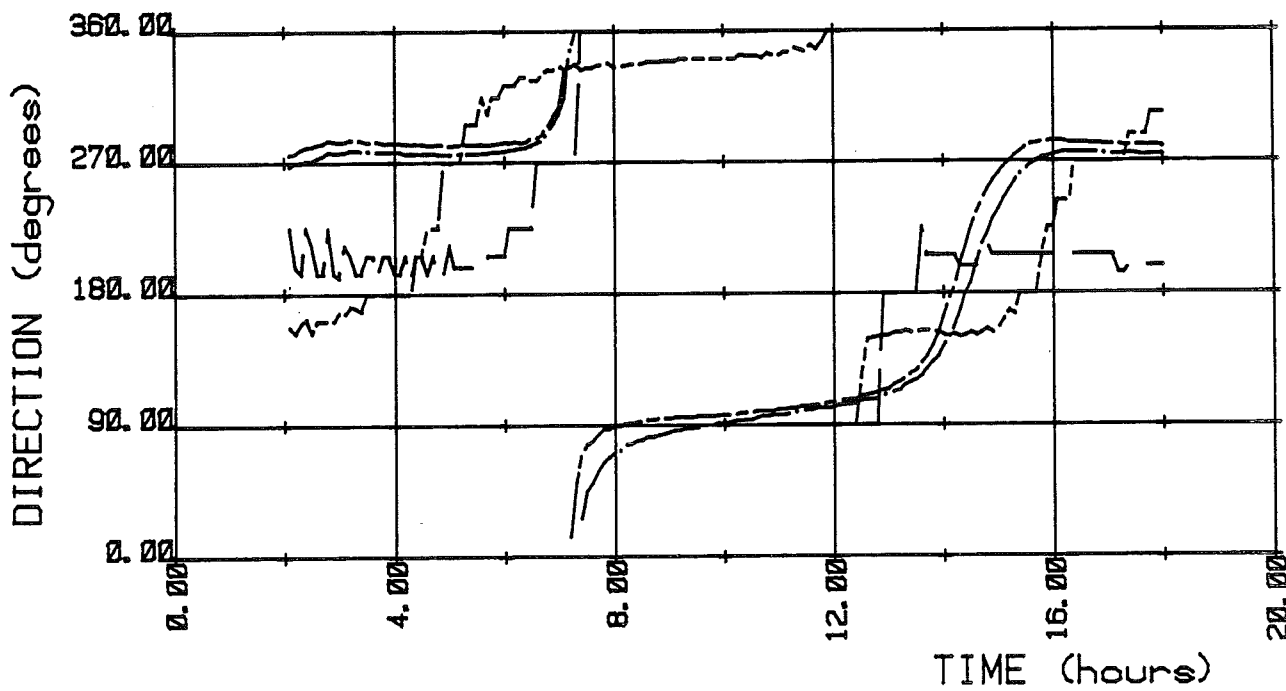
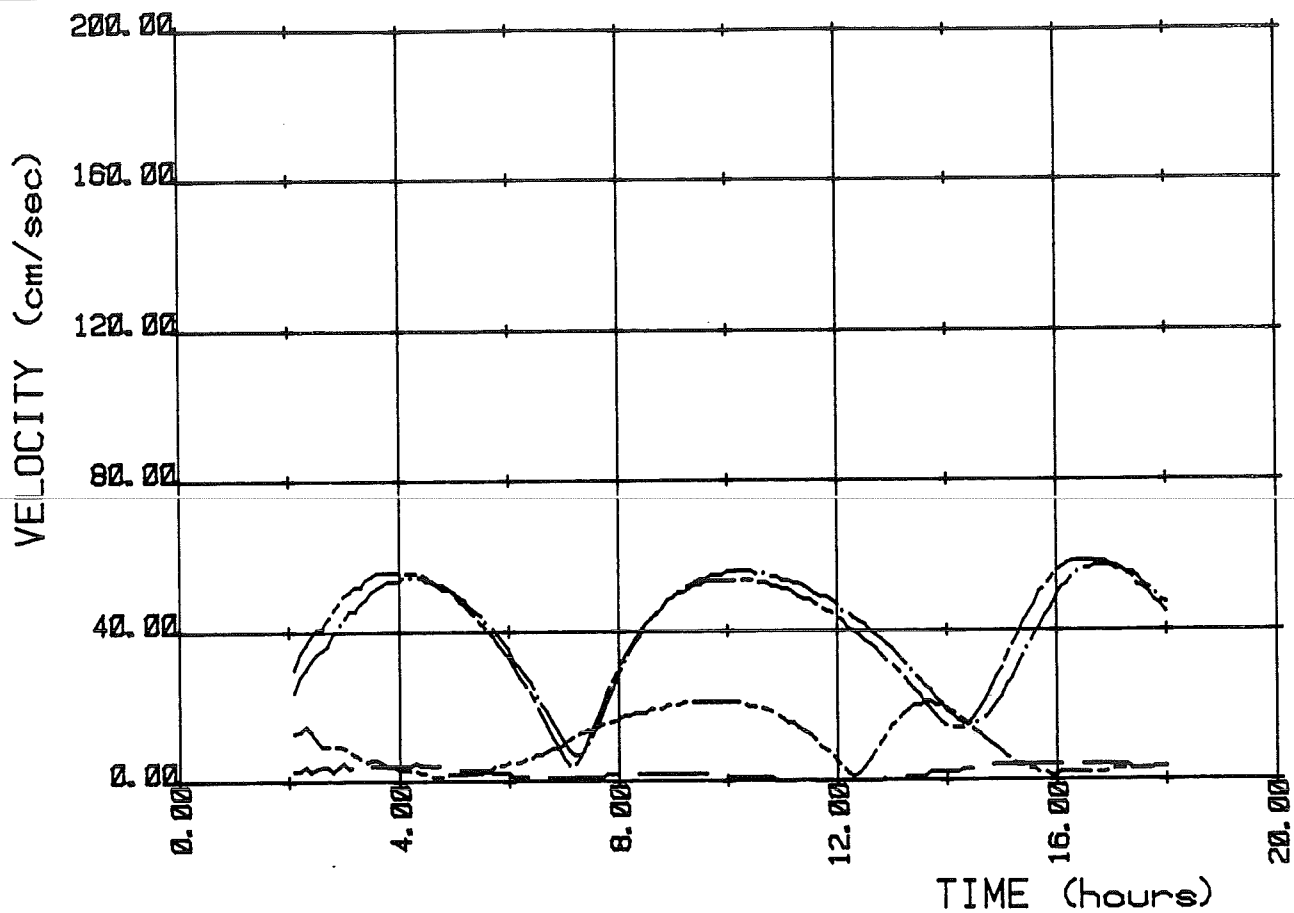

Computed velocity curves

-----	N= 78 M= 37	station 112
-----	N= 28 M= 31	station 113
-----	N= 25 M= 35	station 114
-----	N= 7 M= 5	station 115



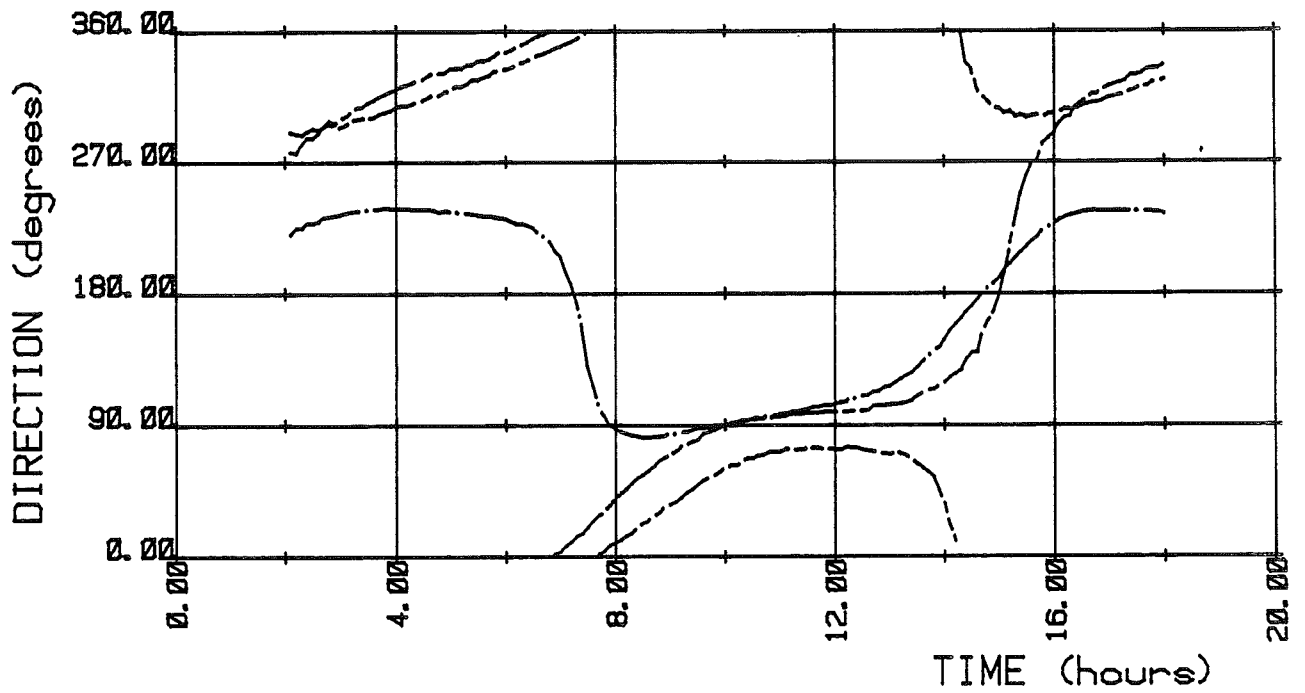
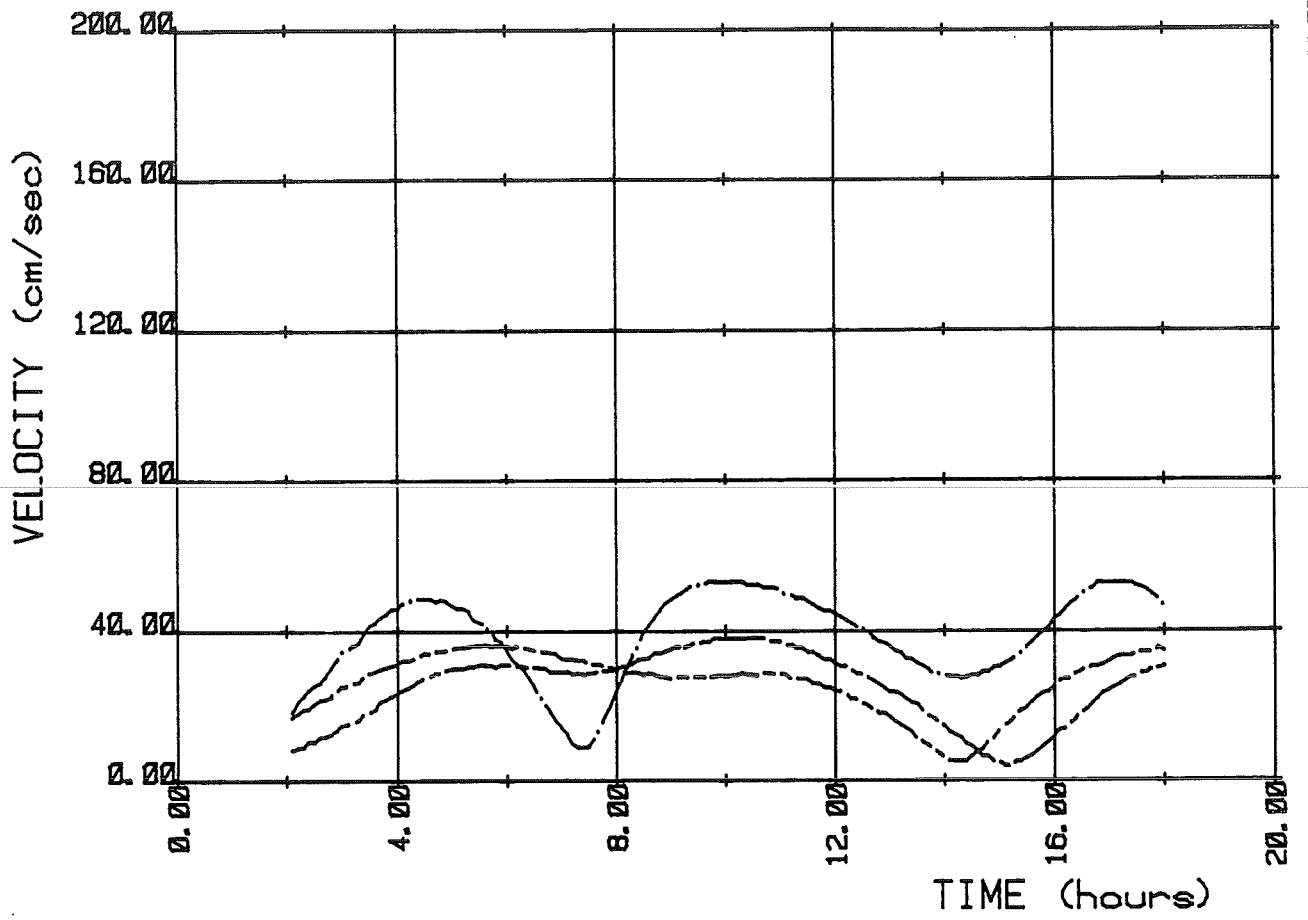

Computed velocity curves

-----	N= 12 M= 25	station 116
-.-.-.-	N= 17 M= 37	station 117
————	N= 25 M= 43	station 118



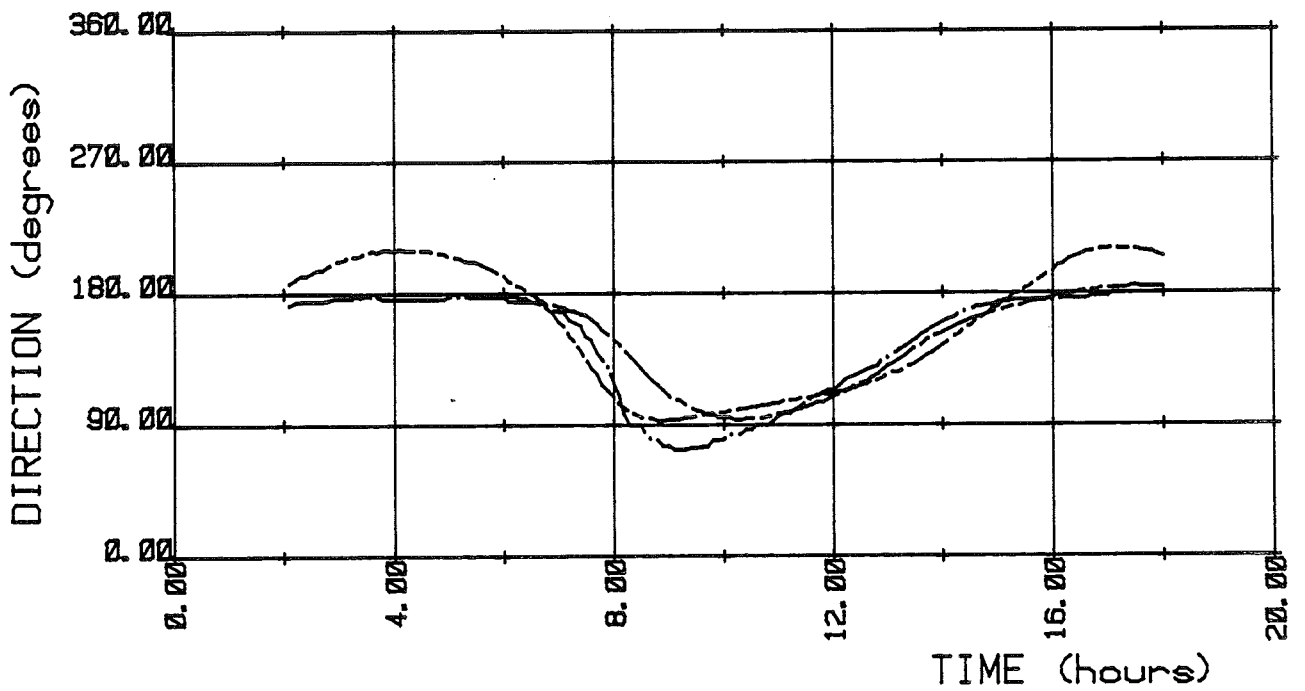
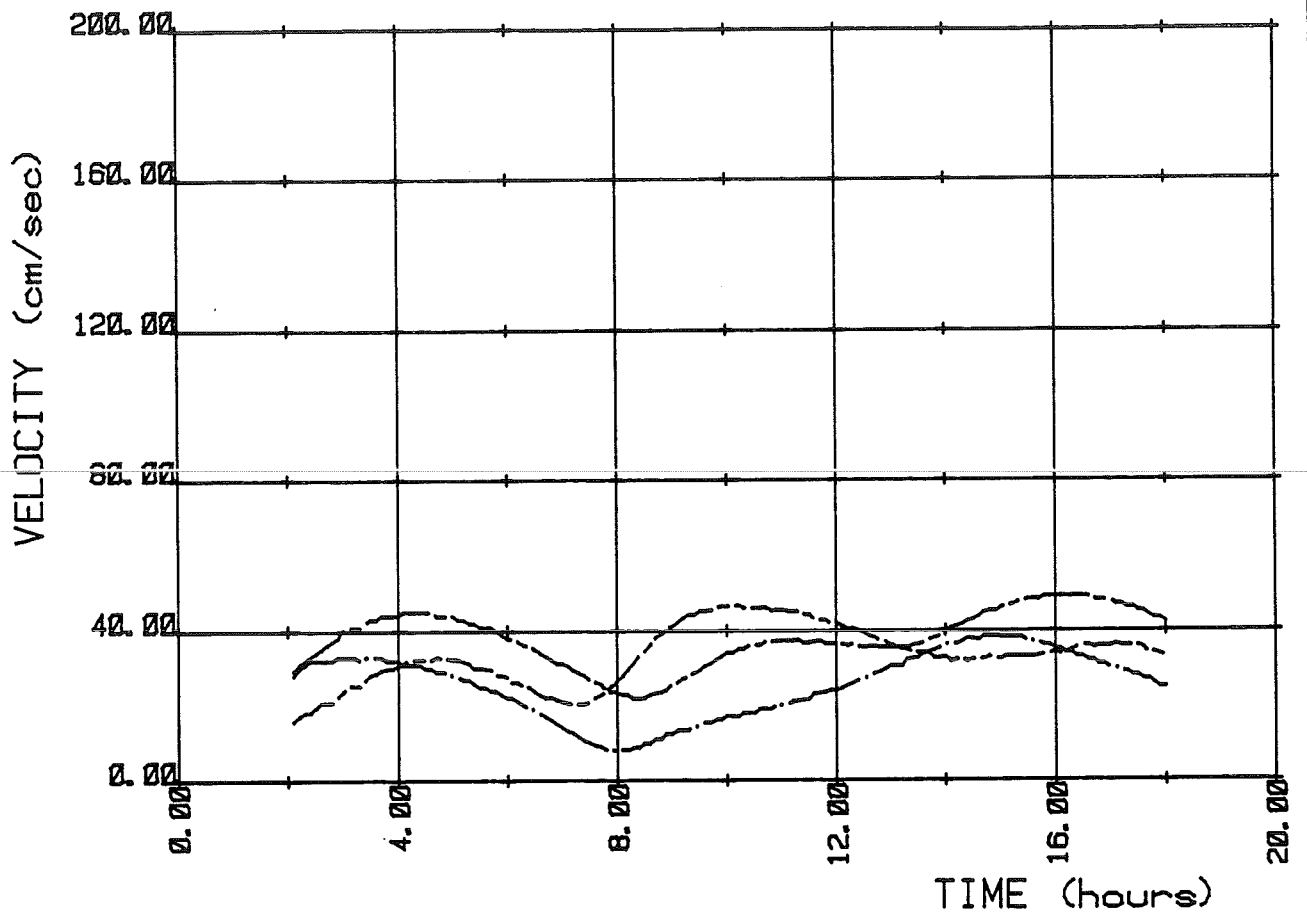

Computed velocity curves

-----	N= 25 M= 47	station 119
- . - . - . - .	N= 37 M= 53	station 120
—————	N= 51 M= 58	station 121



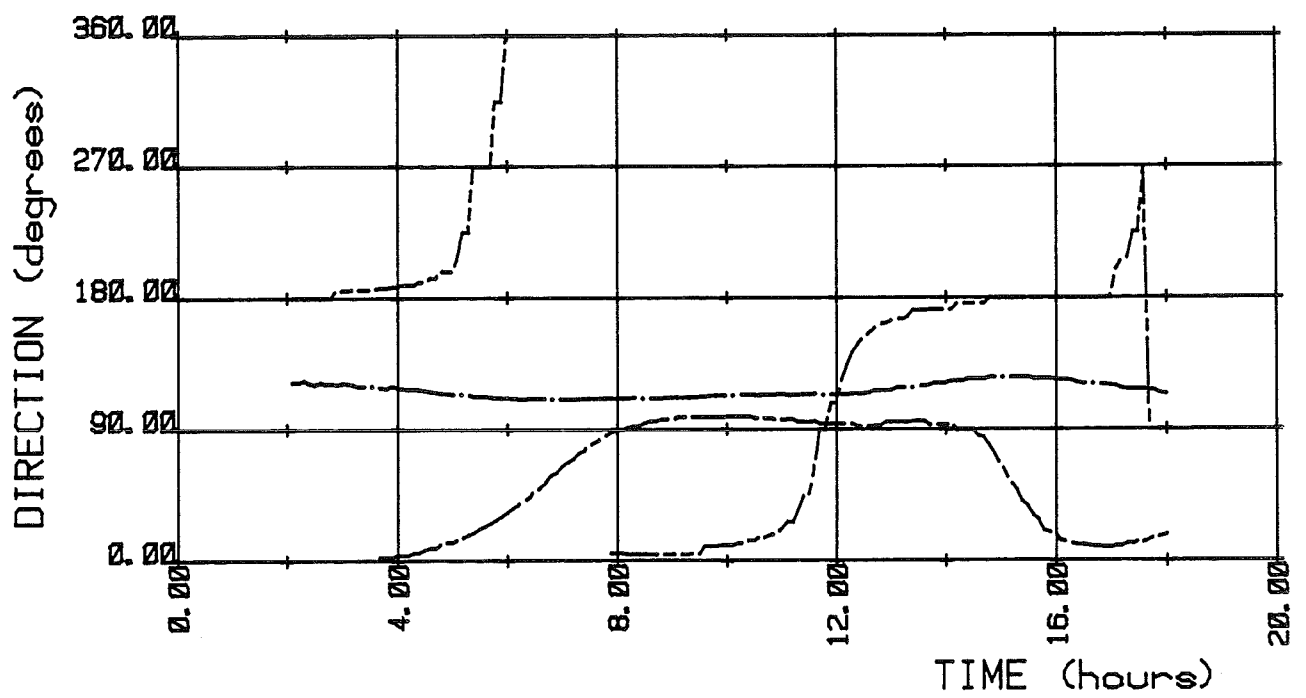
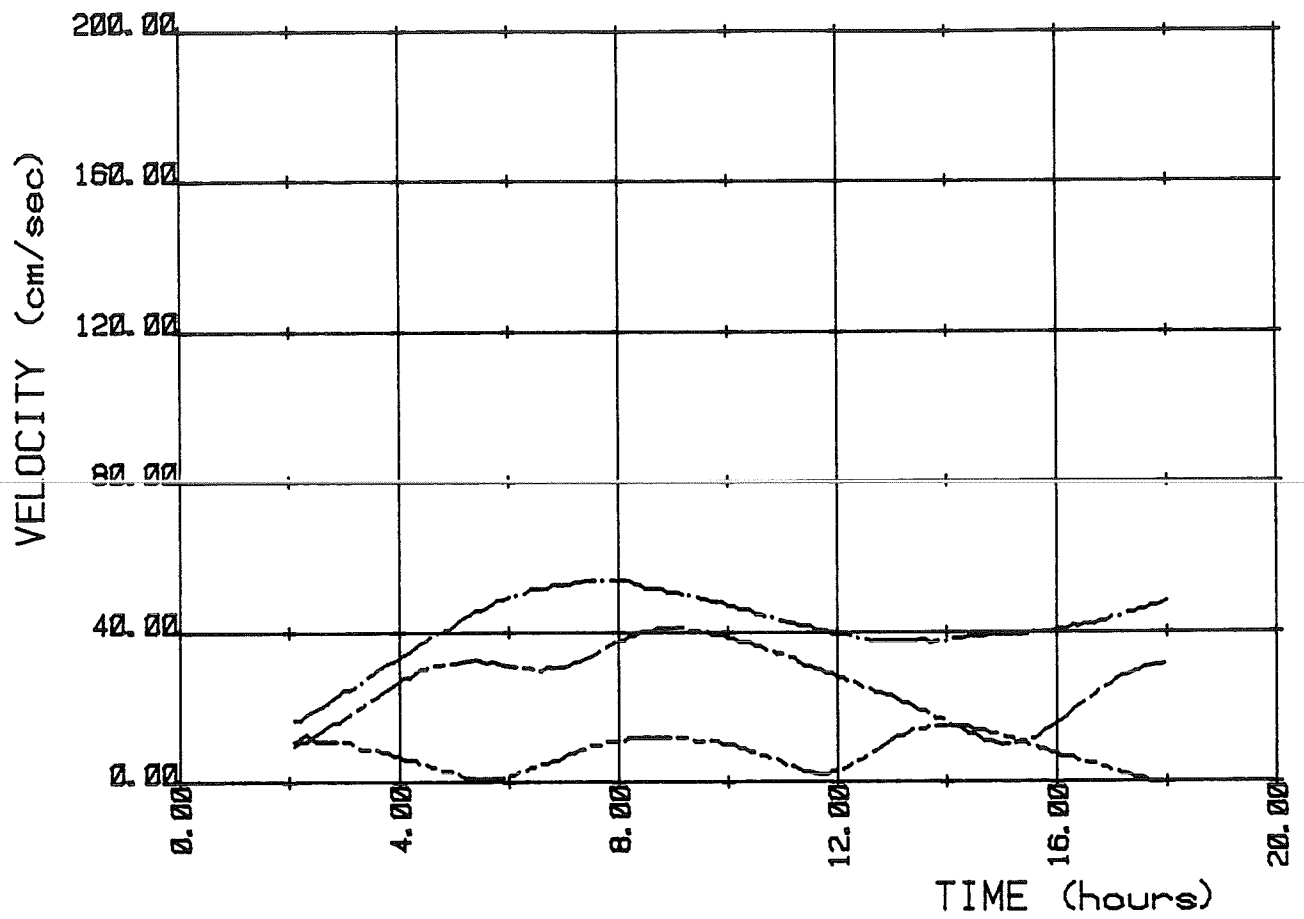

Computed velocity curves

- N= 80 M= 57 station 123
- N= 7 M= 41 station 126
- N= 17 M= 58 station 127



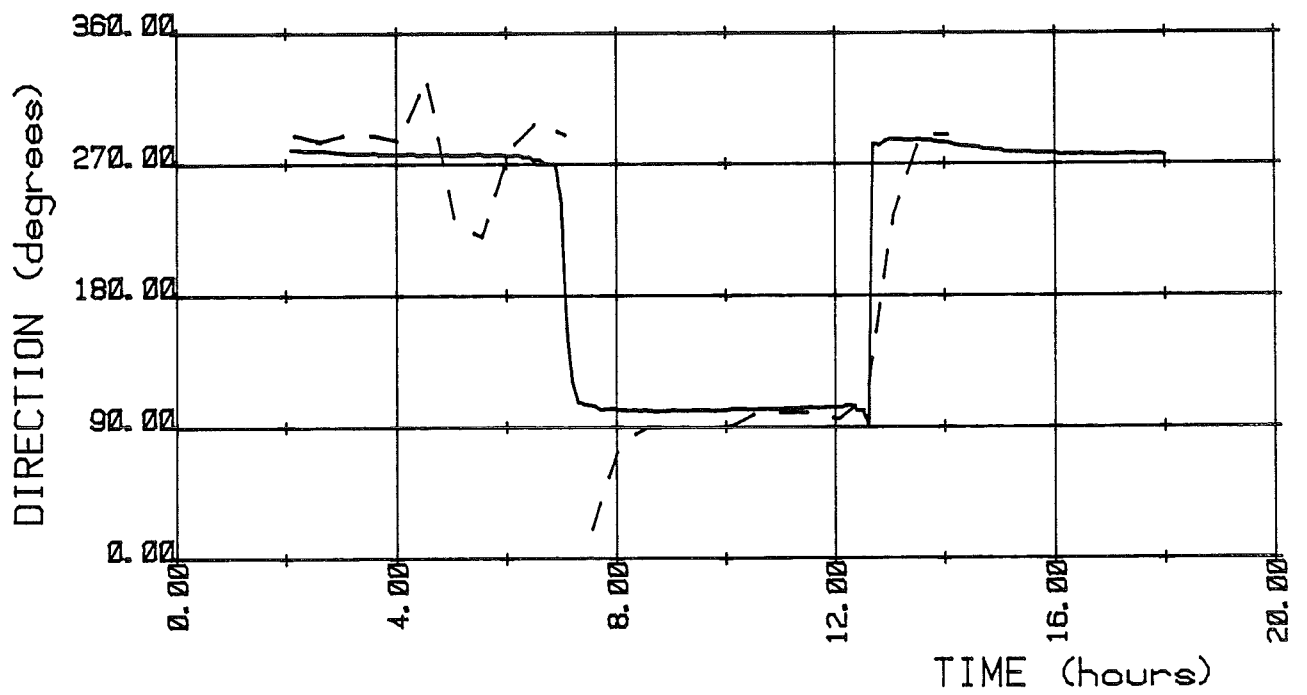
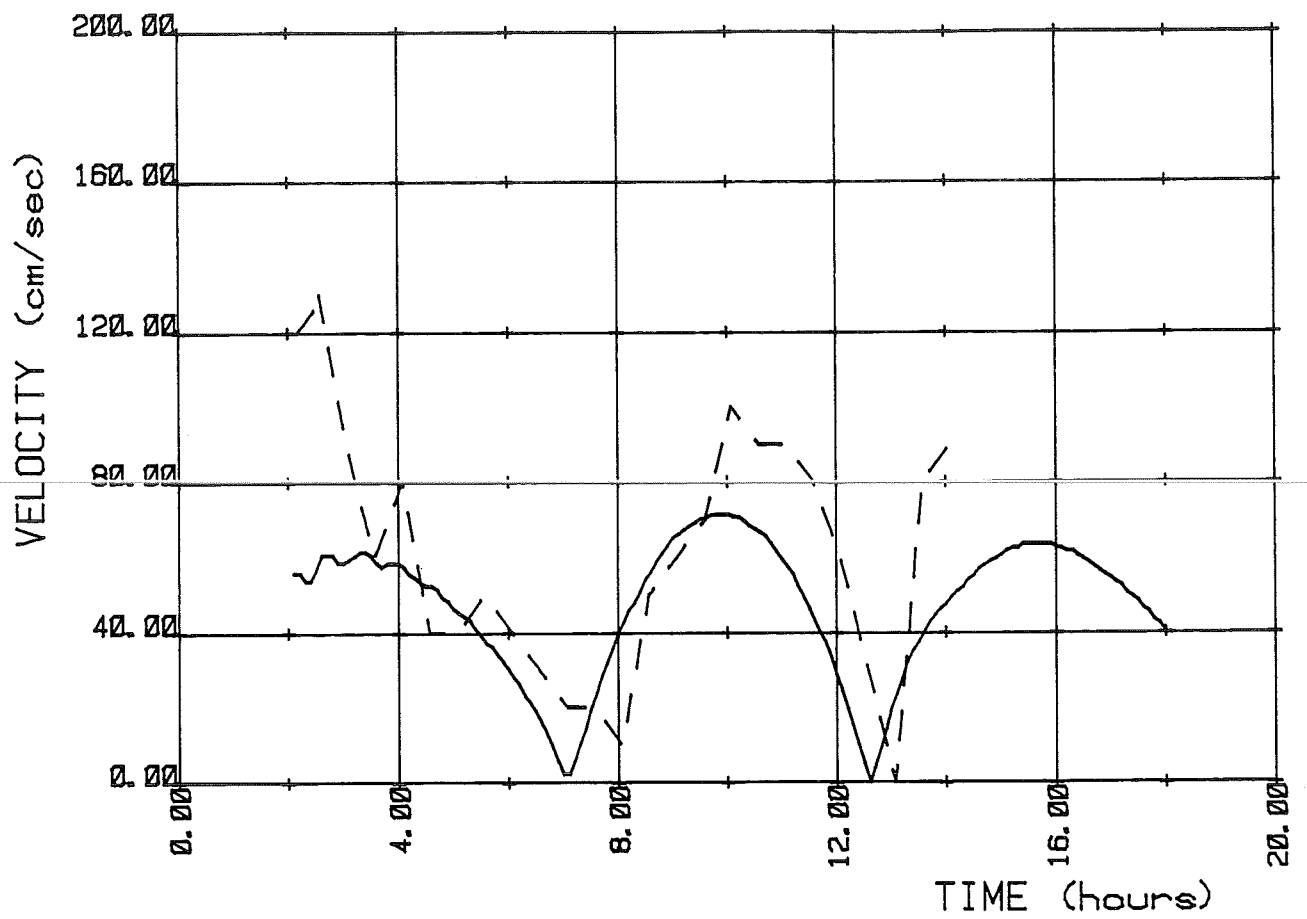

Velocity curve at station: 42

————— computed at $N=91$ $M=10$

- - - - - measured July 12th 1972



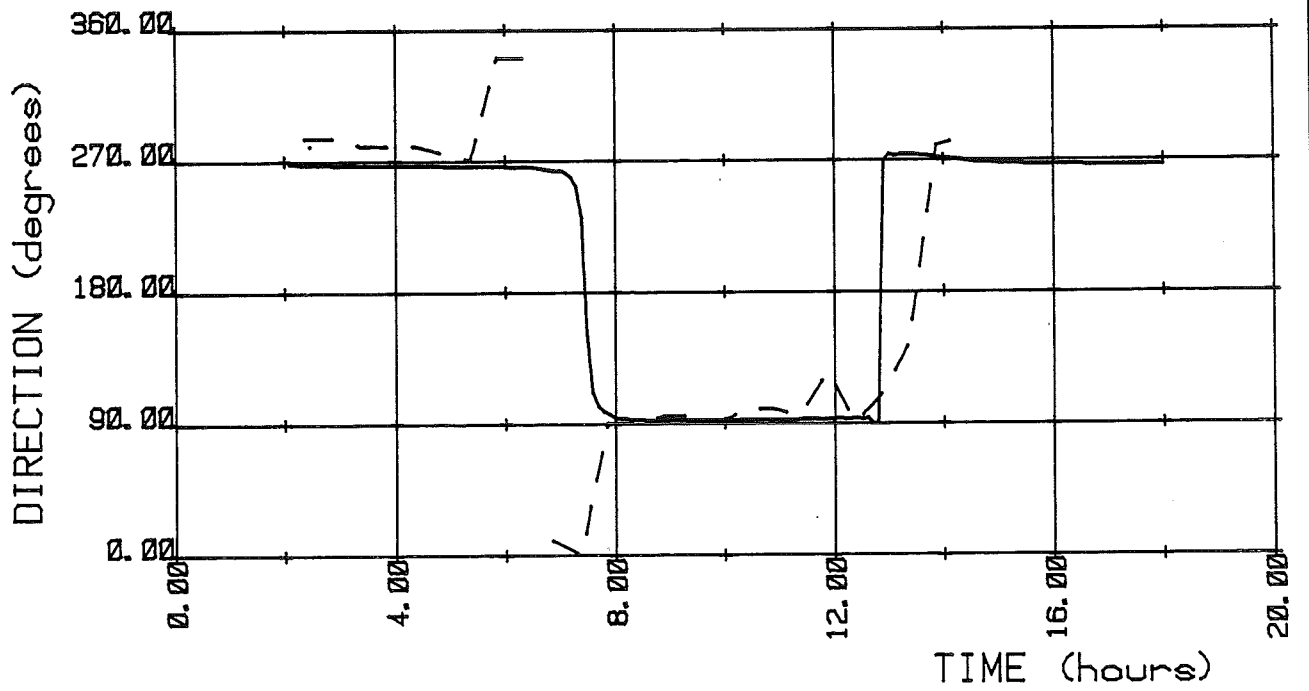
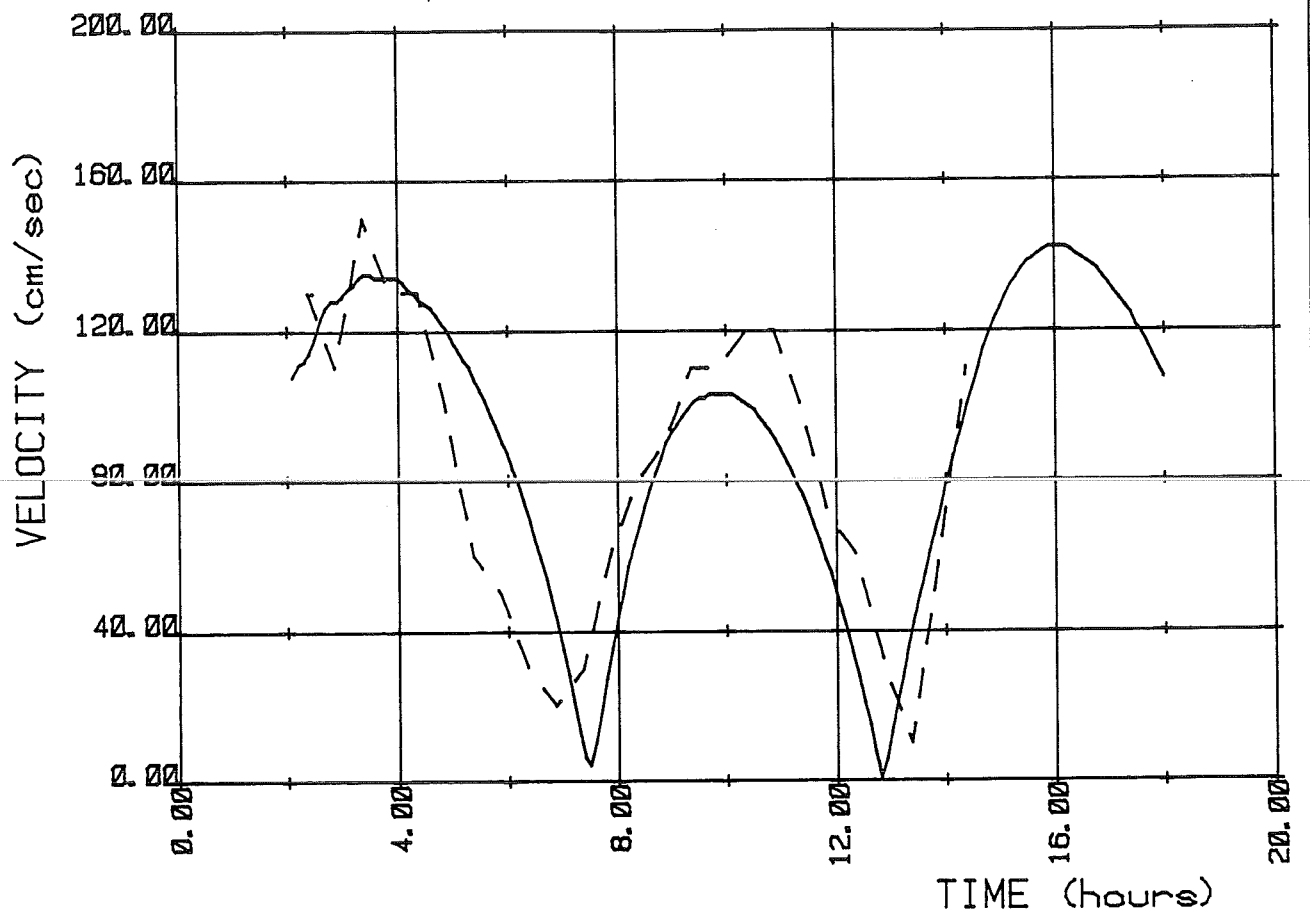

Velocity curve at station: 43

————— computed at $N=91$ $M=12$

- - - - - measured July 13th 1972



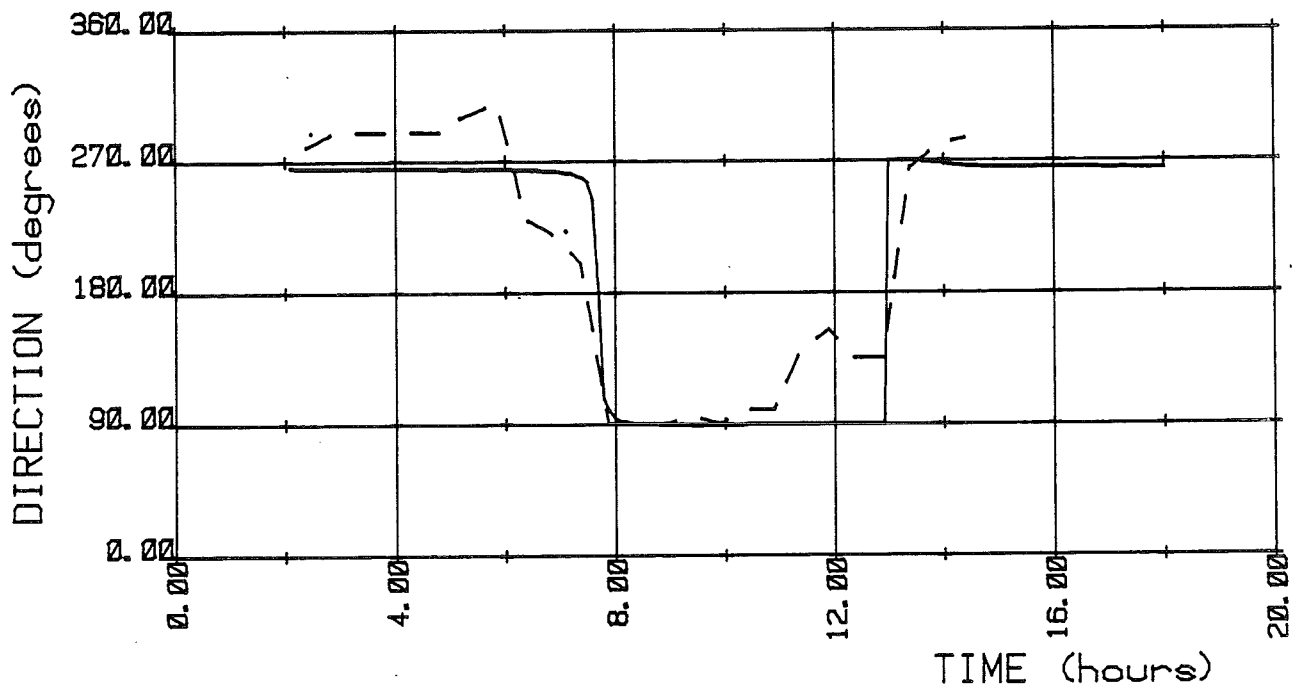
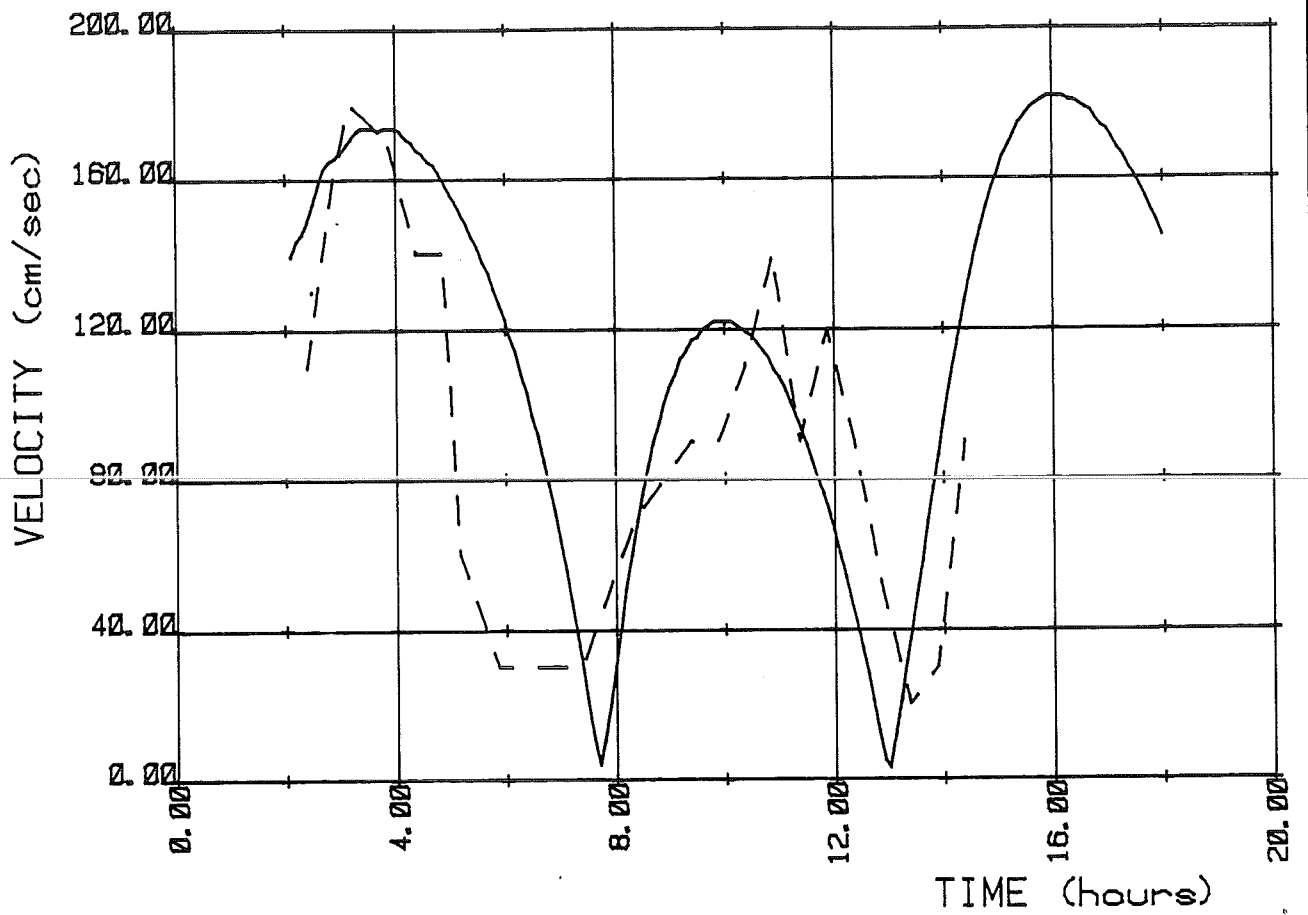

Velocity curve at station: 44
 ————— computed at N= 91 M= 14
 - - - - - measured July 13th 1972



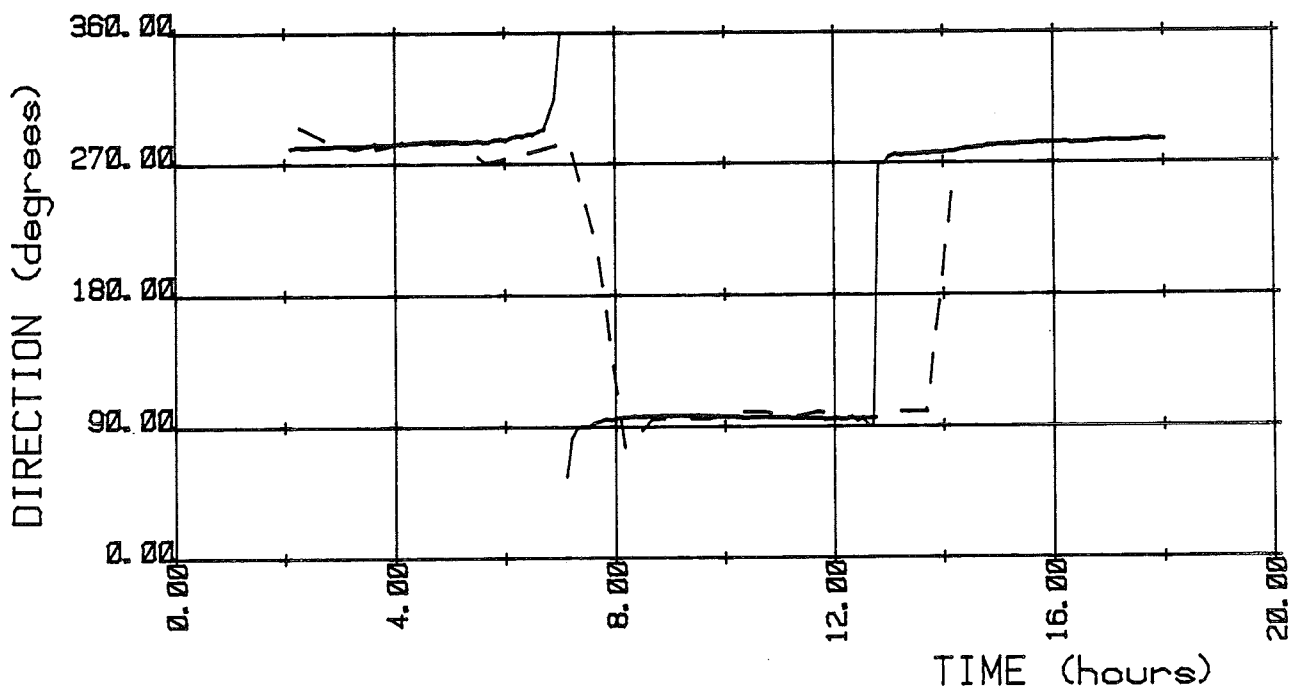
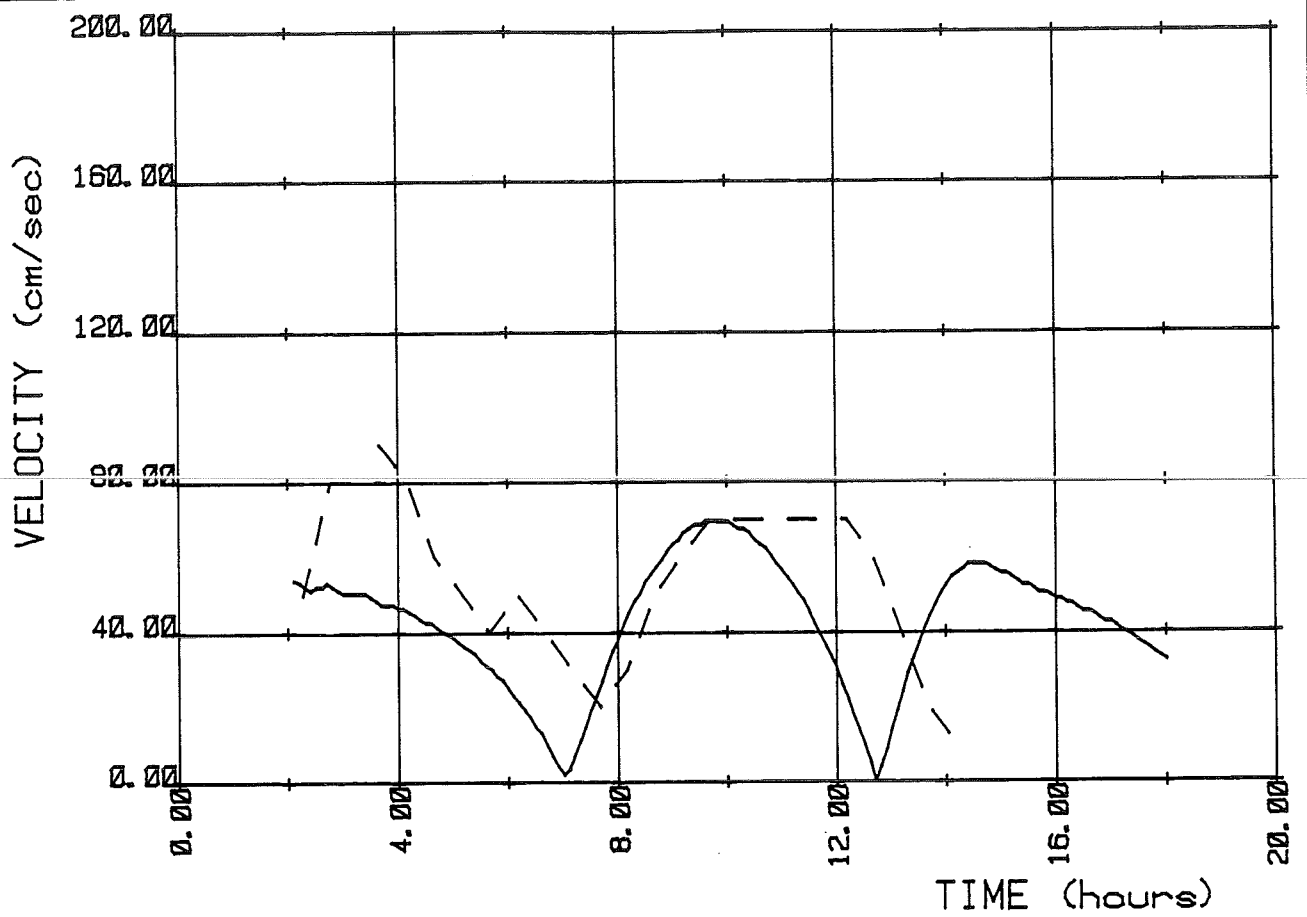

Velocity curve at station: 47
 ————— computed at N= 79 M= 9
 - - - - - measured May 13th 1972



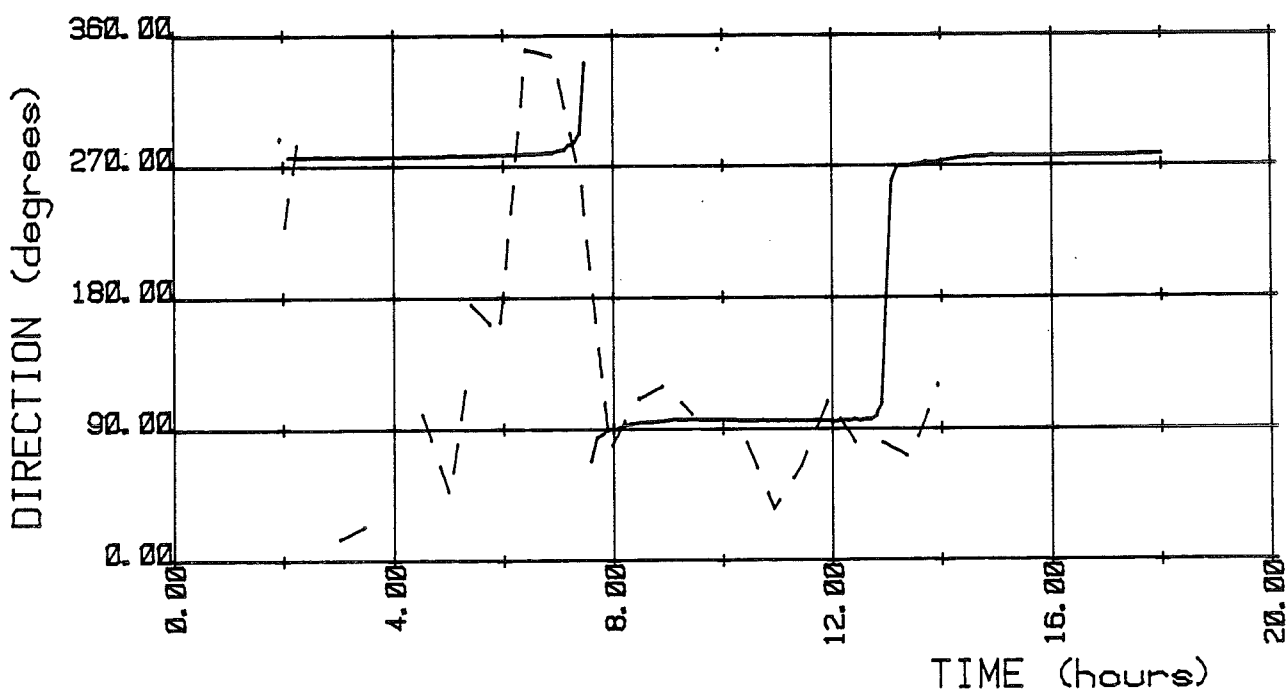
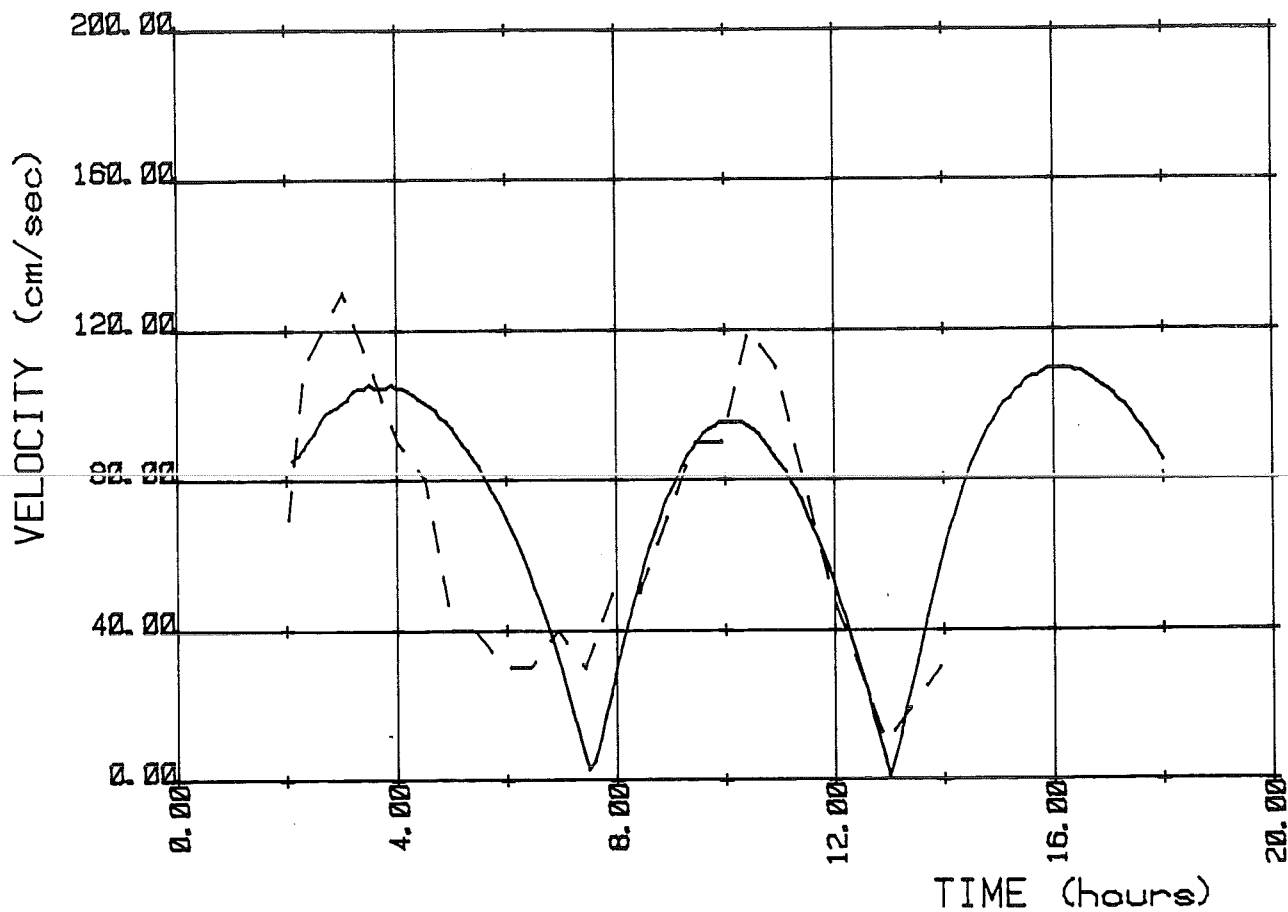

Velocity curve at station: 48
 ————— computed at N= 79 M= 12
 - - - - - measured May 12th 1972



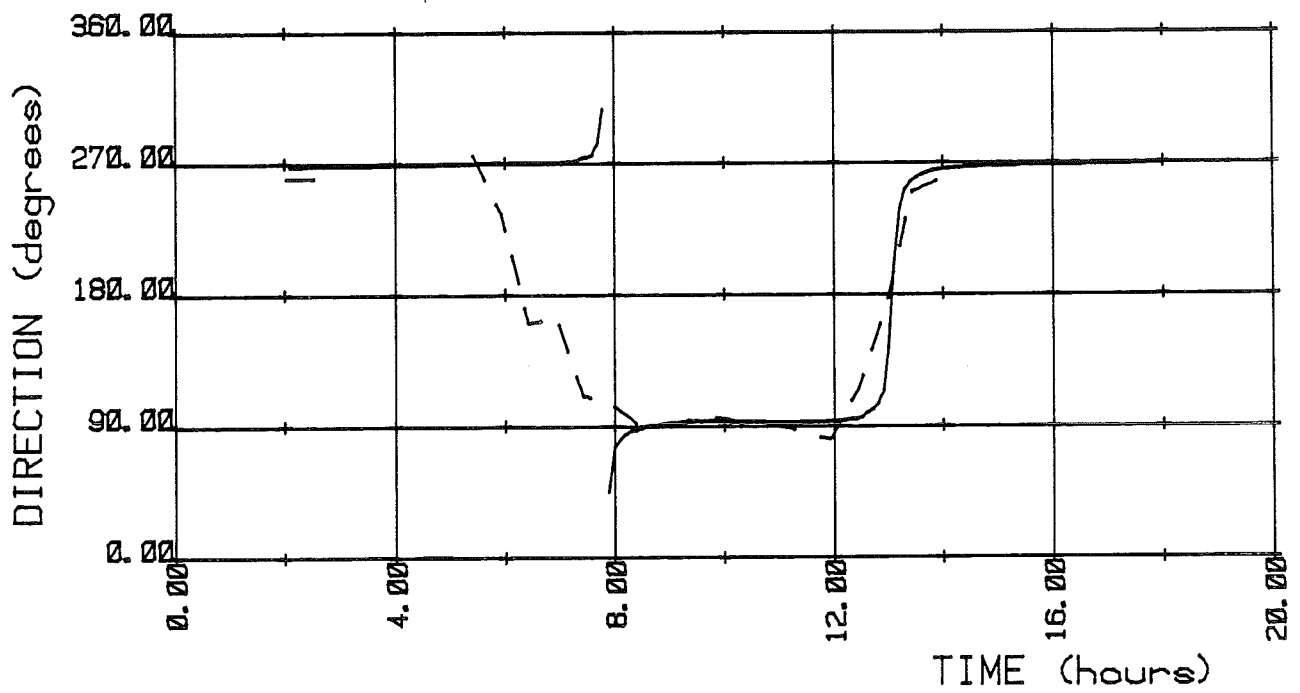
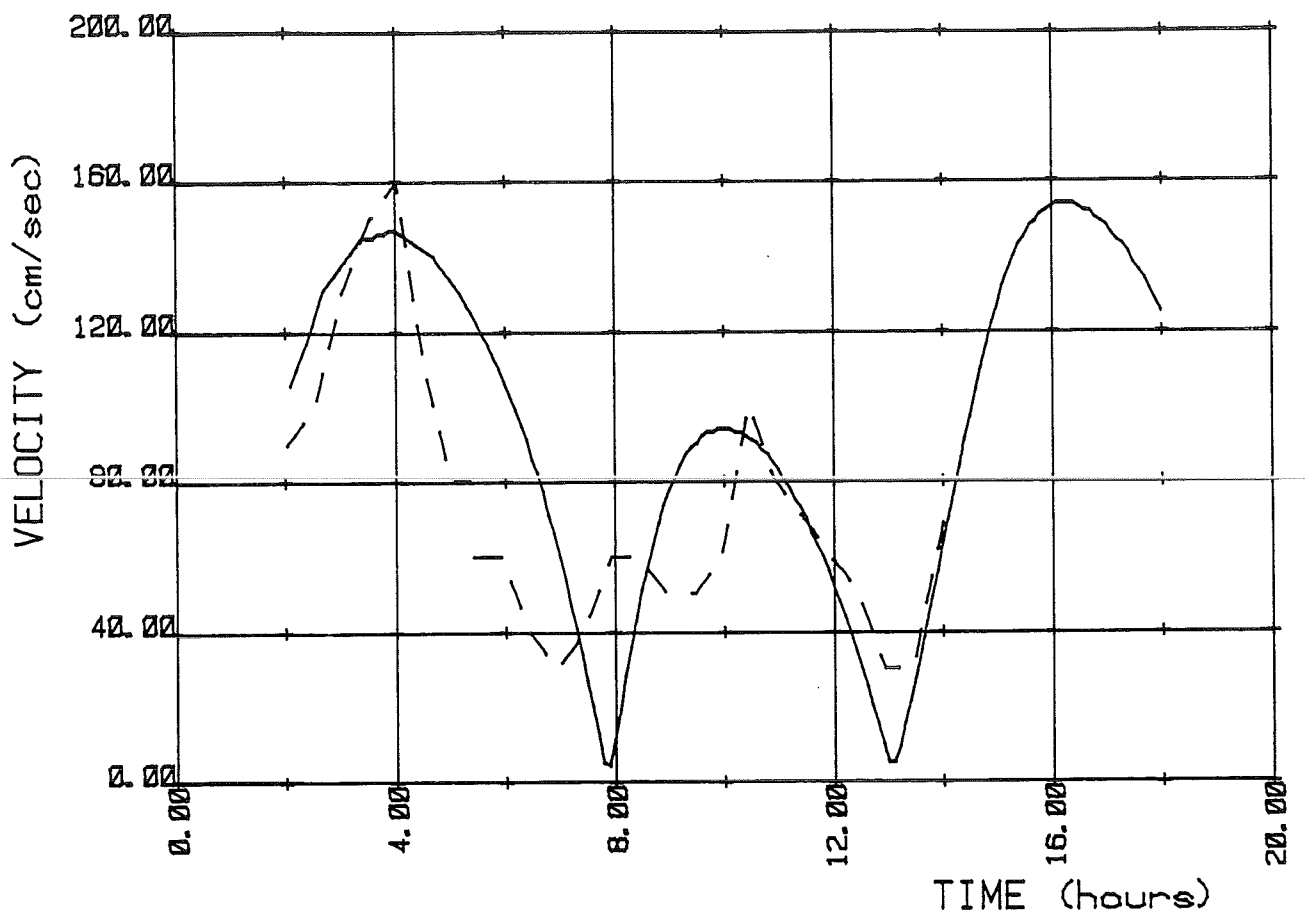

Velocity curve at station: 49
 ————— computed at N= 79 M= 16
 - - - - - measured May 12th 1972



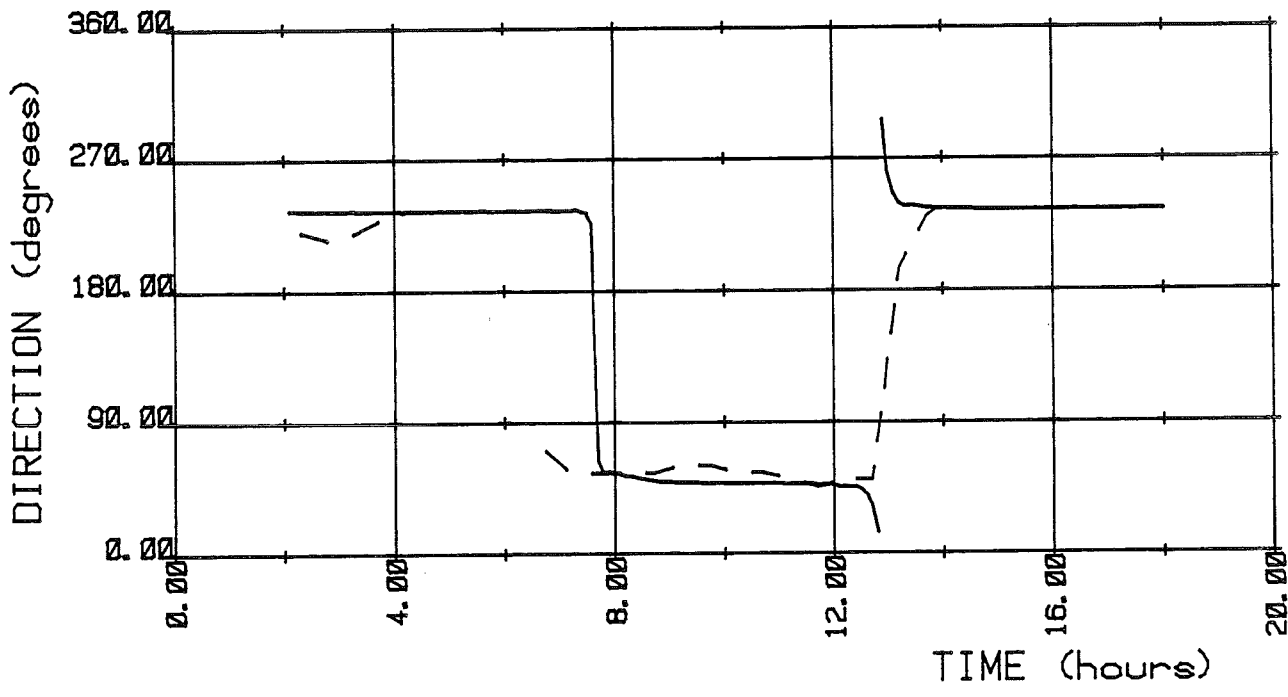
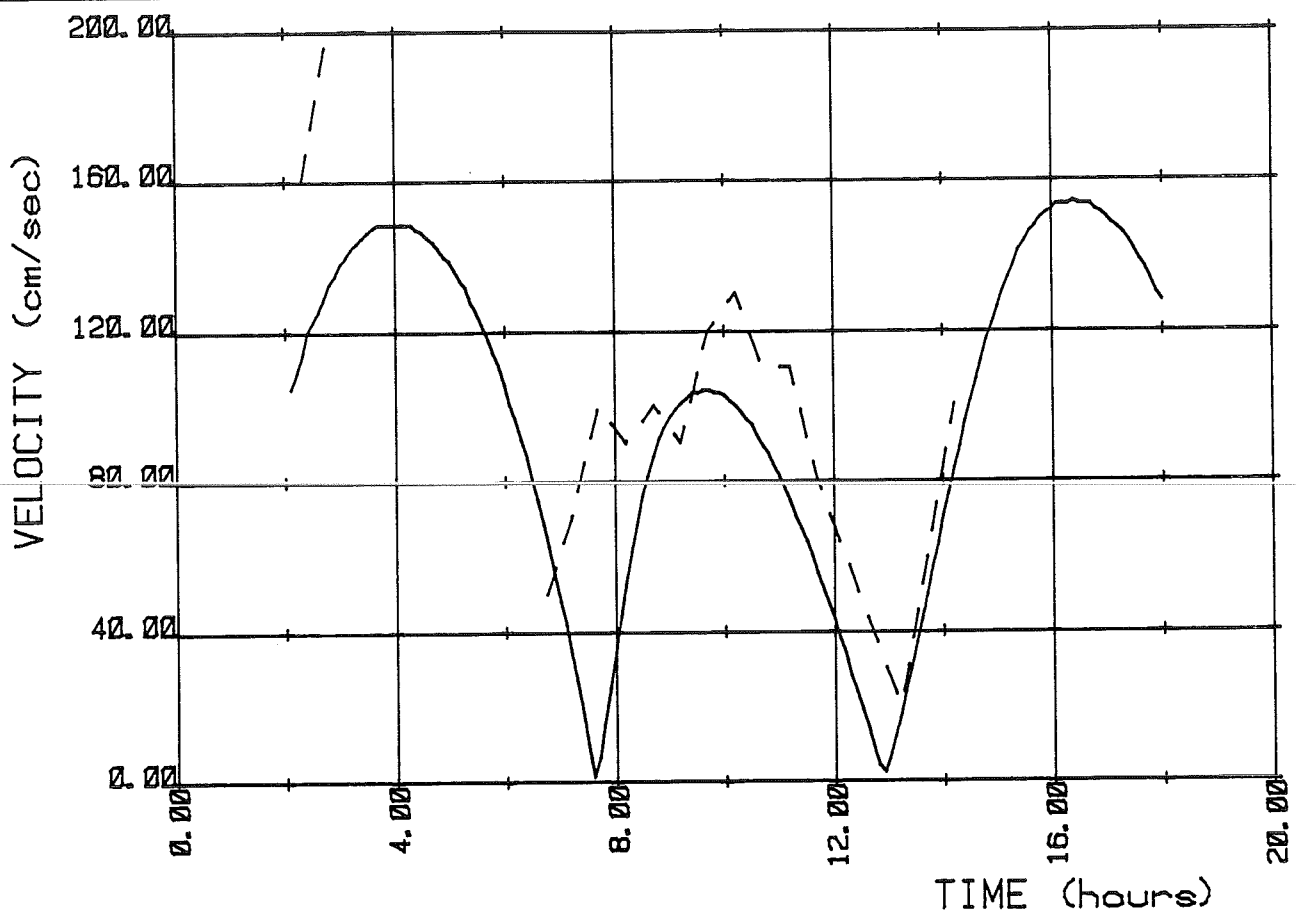

Velocity curve at station: 52

————— computed at $N=56$ $M=16$

- - - - - measured May 11th 1972



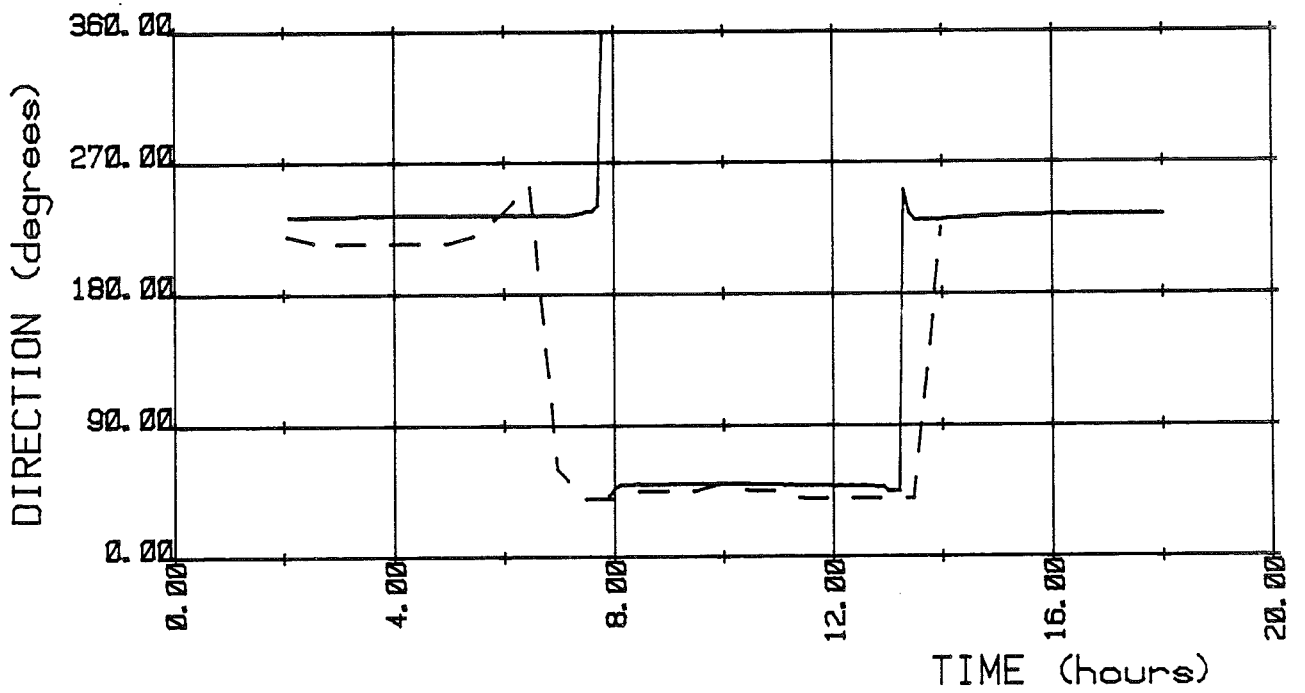
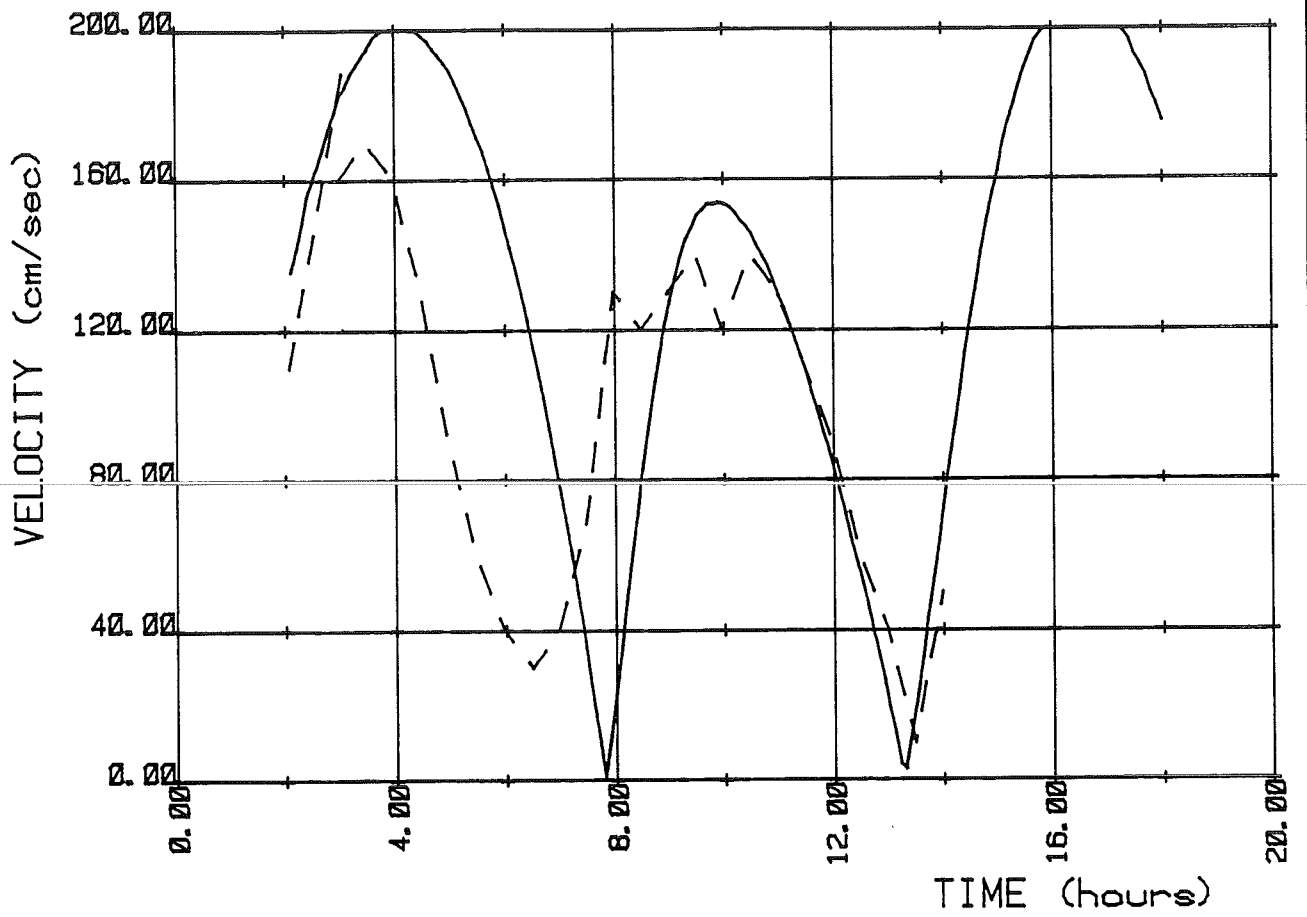

Velocity curve at station: 53

————— computed at $N= 57$ $M= 20$
 - - - - - measured July 27th 1972



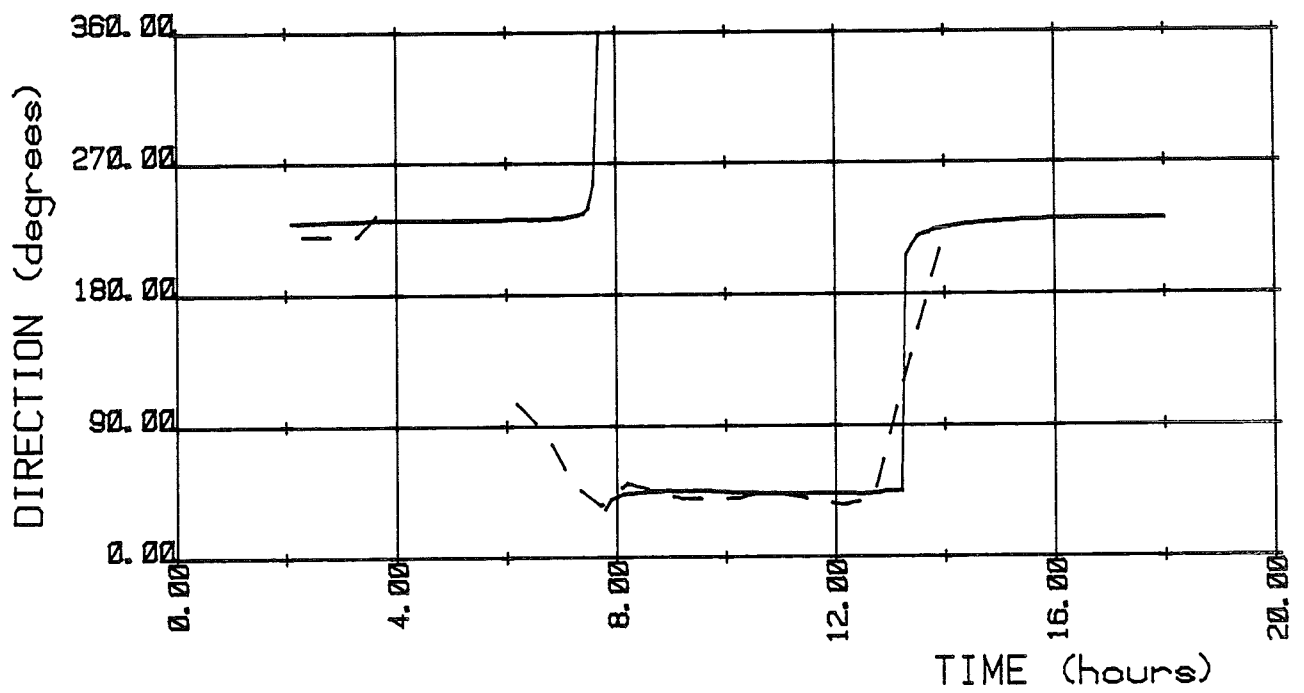
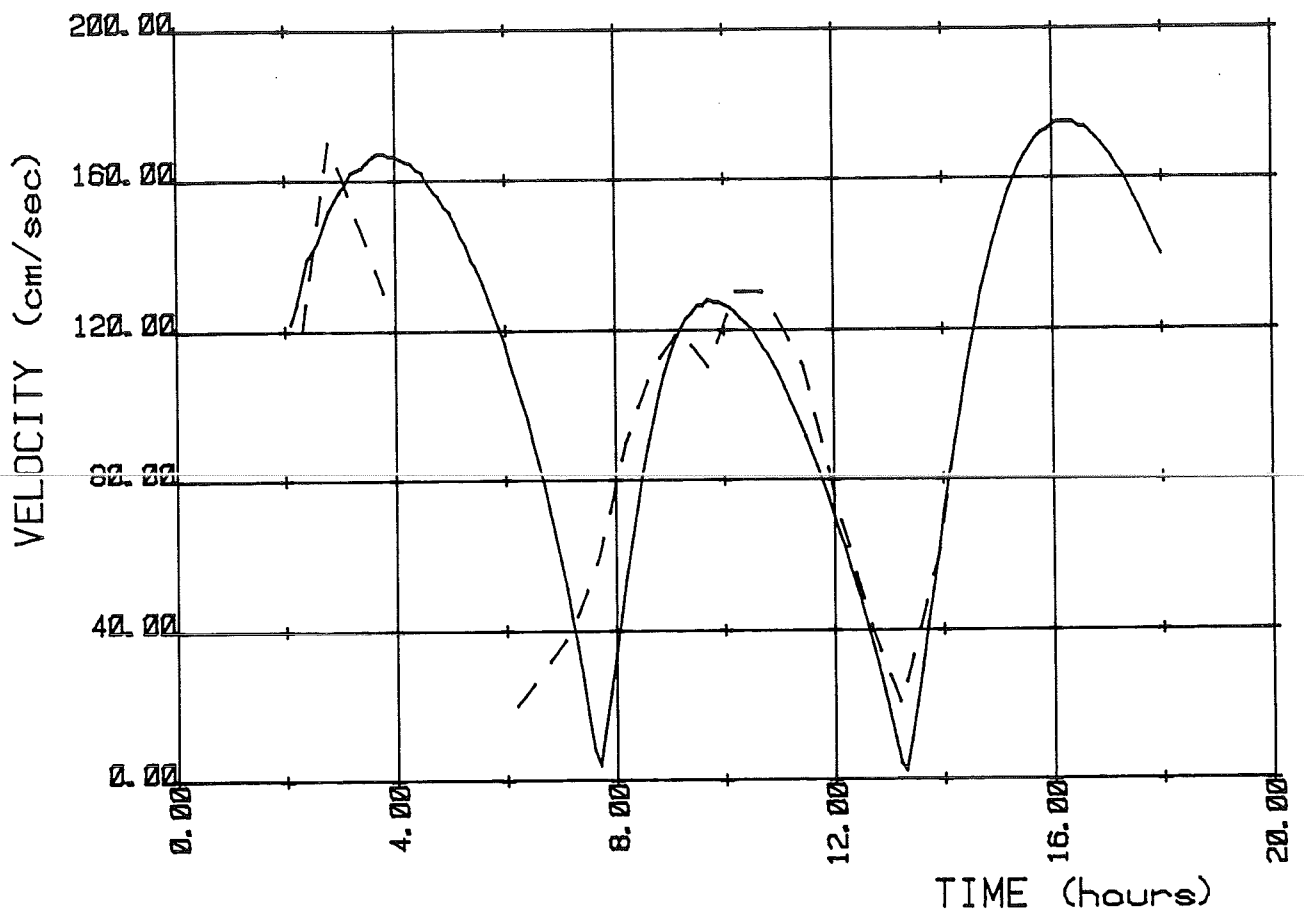

Velocity curve at station: 54

————— computed at N= 57 M= 22

- - - - - measured May 11th 1972



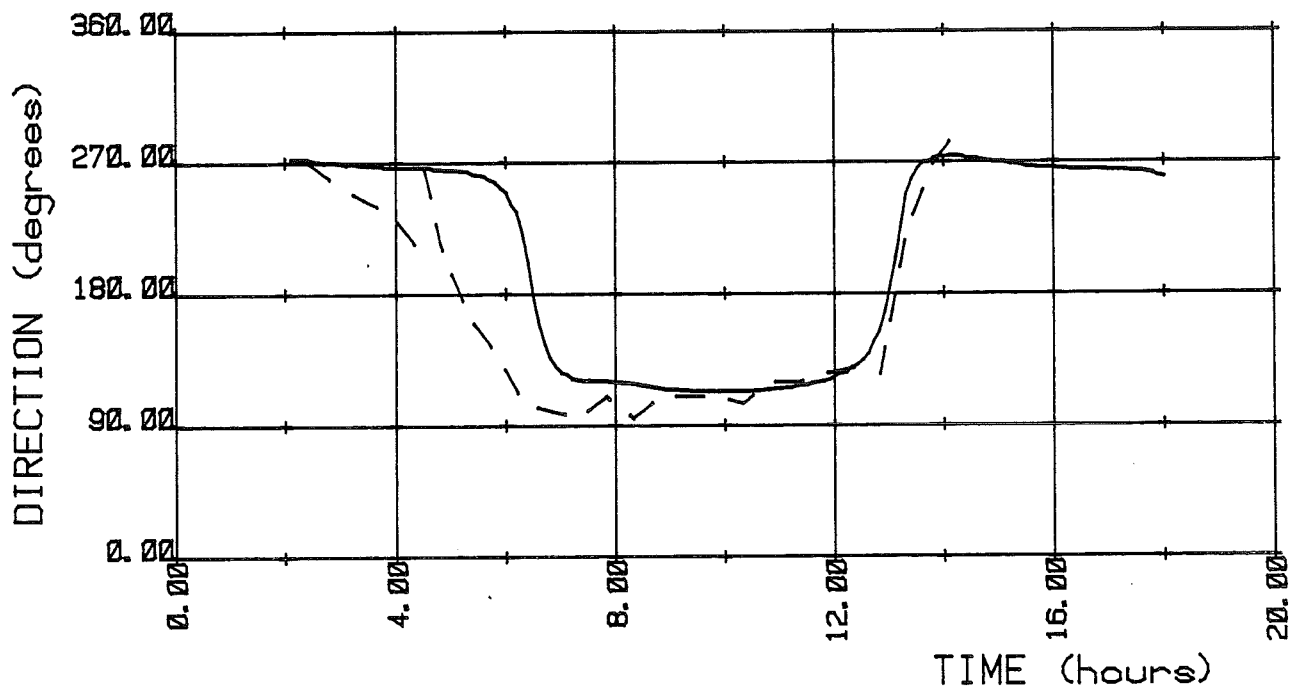
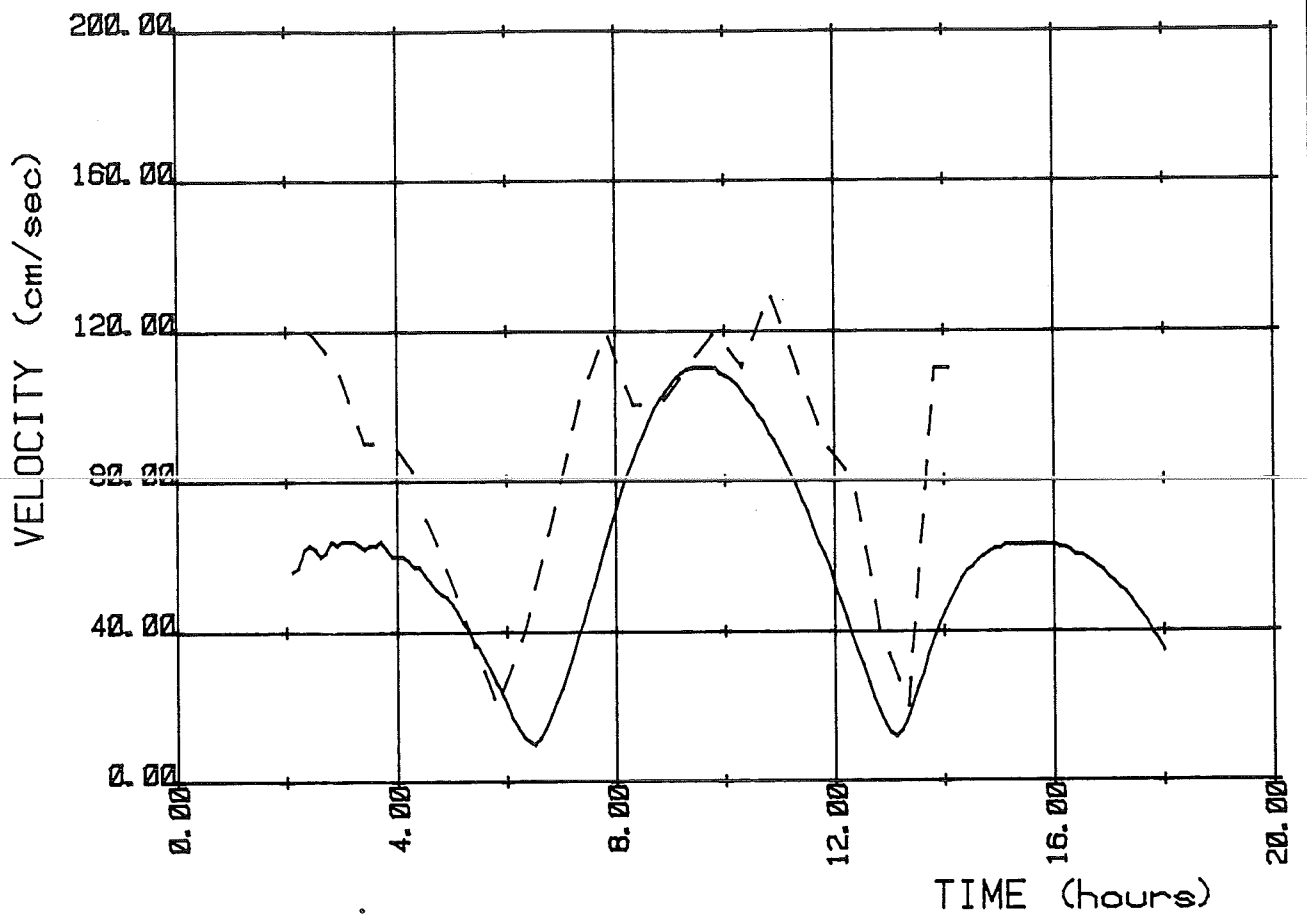

Velocity curve at station: 100

————— computed at $N=45$ $M=21$

- - - - - measured June 30th 1973



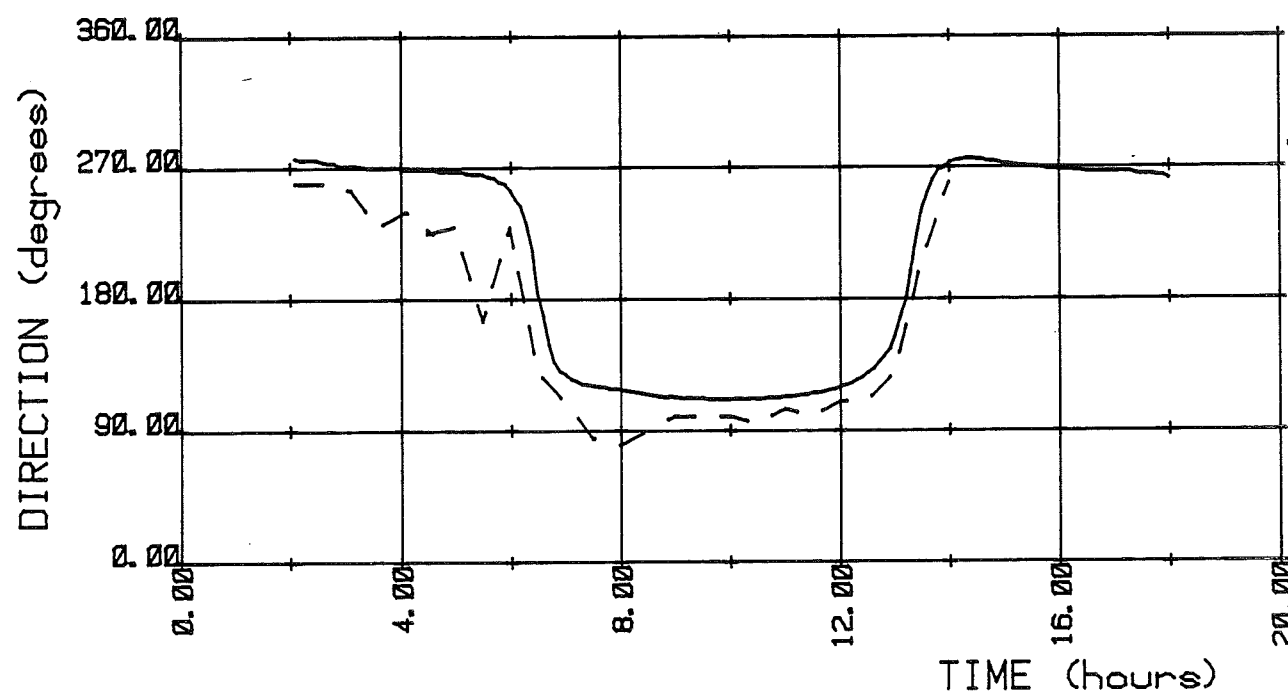
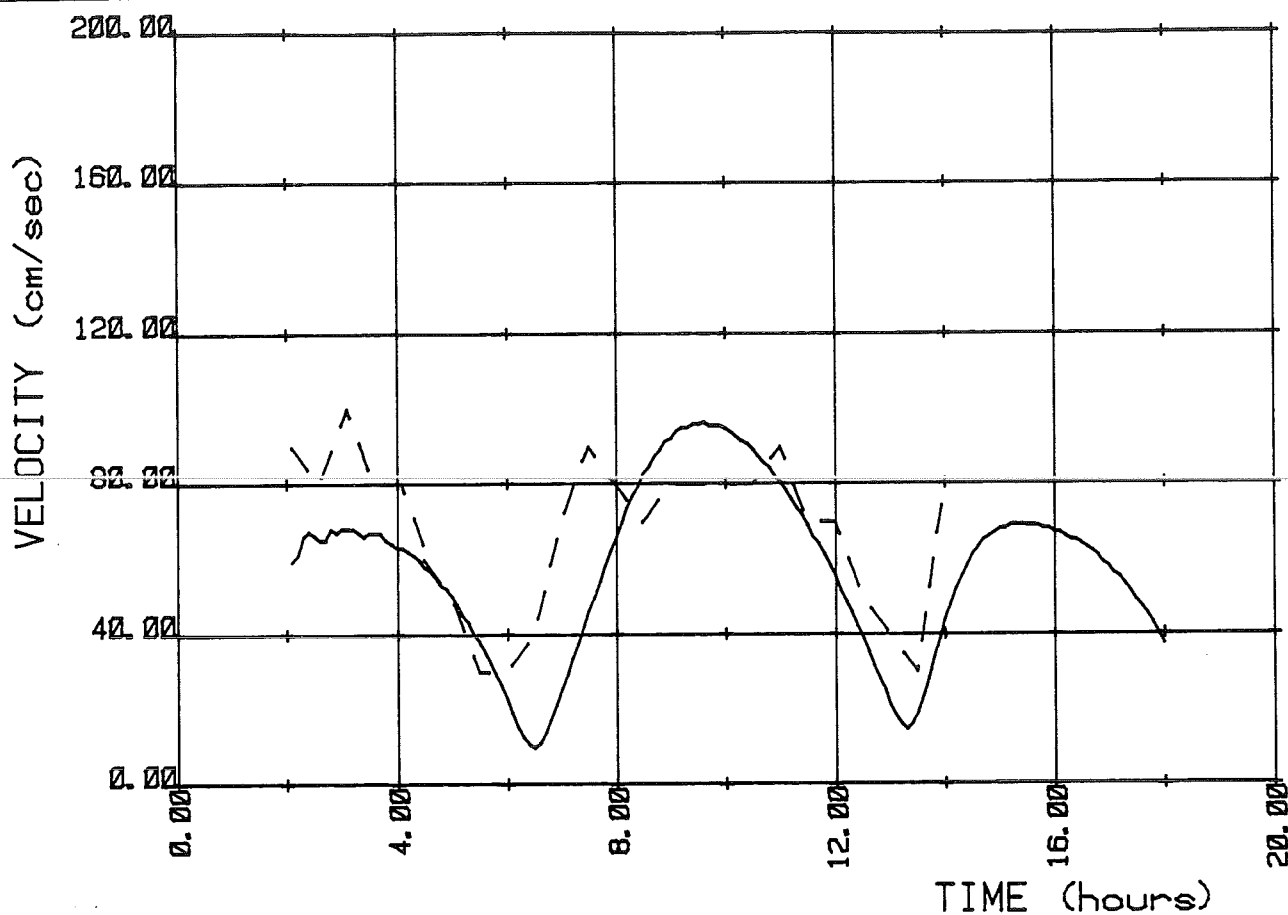

Velocity curve at station: 101
 ————— computed at N= 43 M= 22
 - - - - - measured June 6th 1973



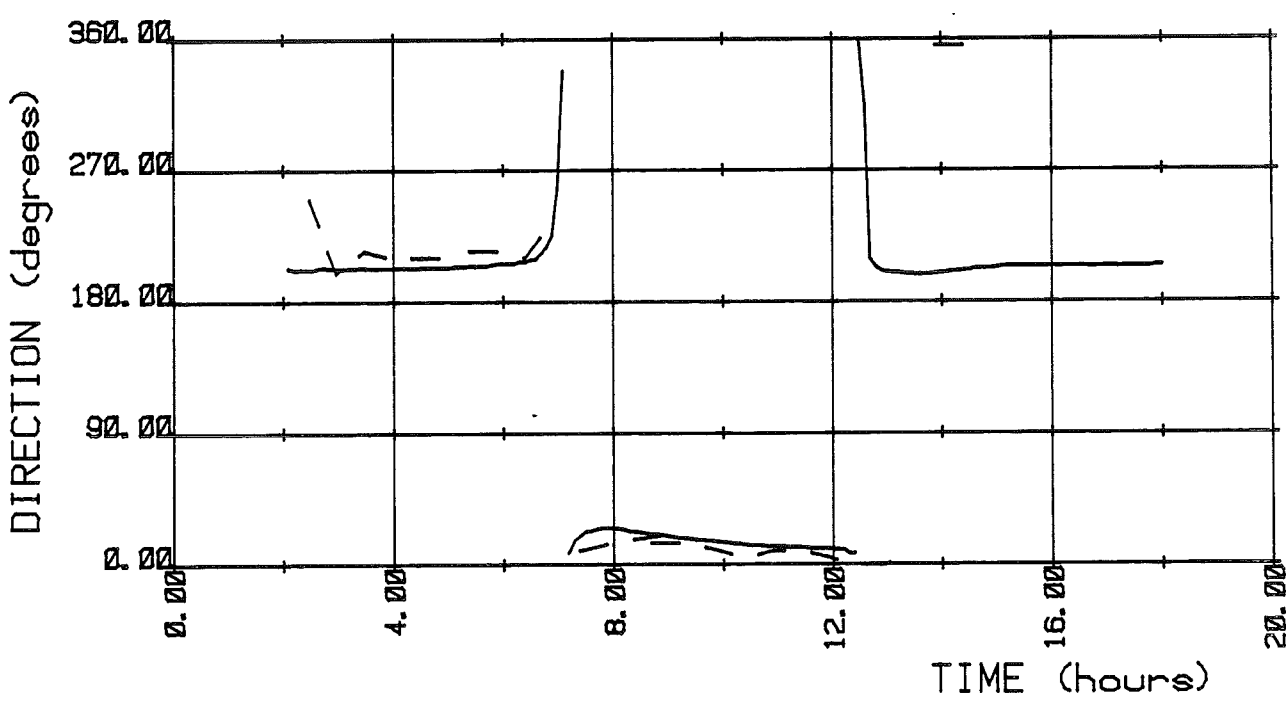
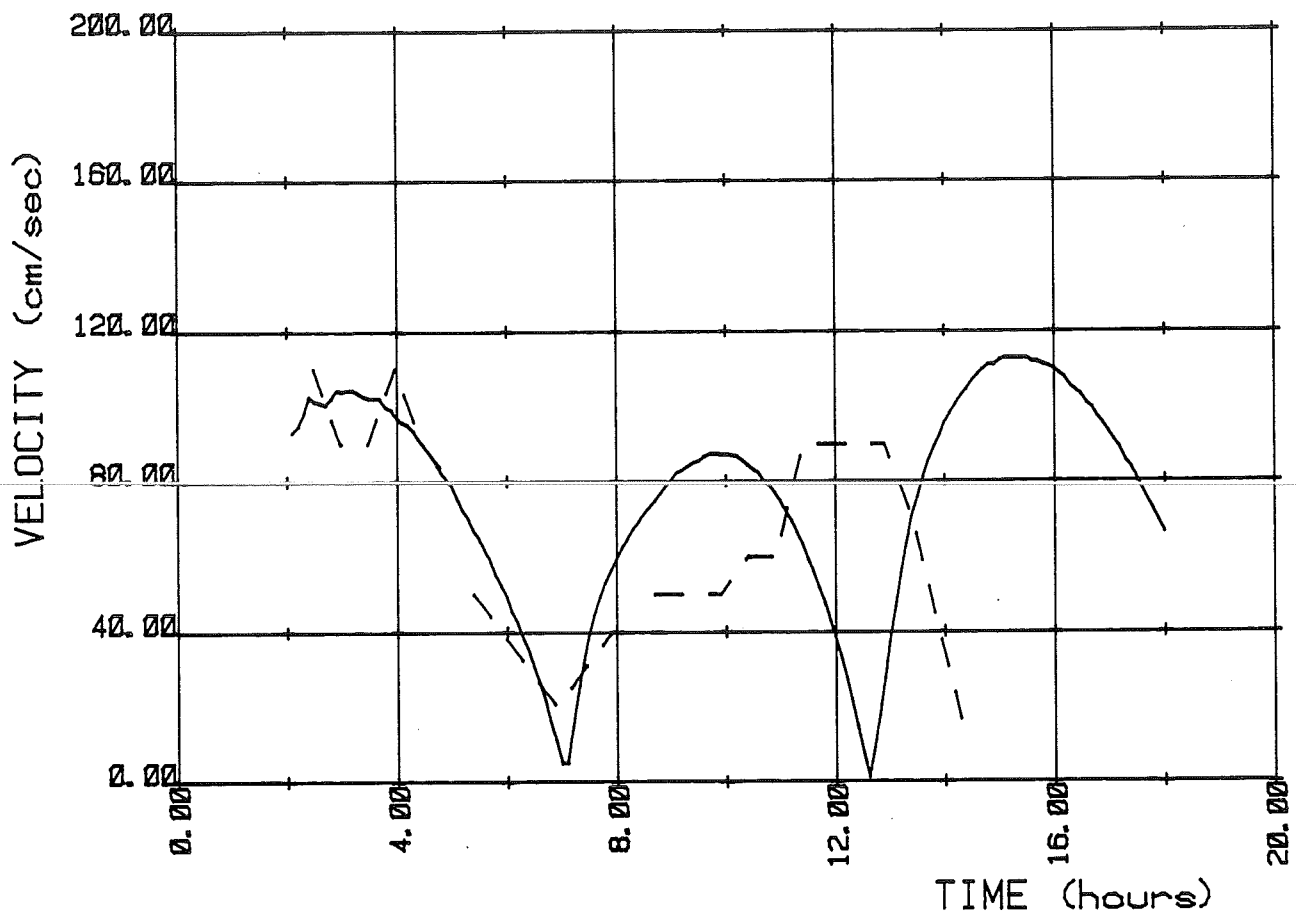

Velocity curve at station: 103
 ————— computed at $N = 70$ $M = 25$
 - - - - - measured July 12th 1973



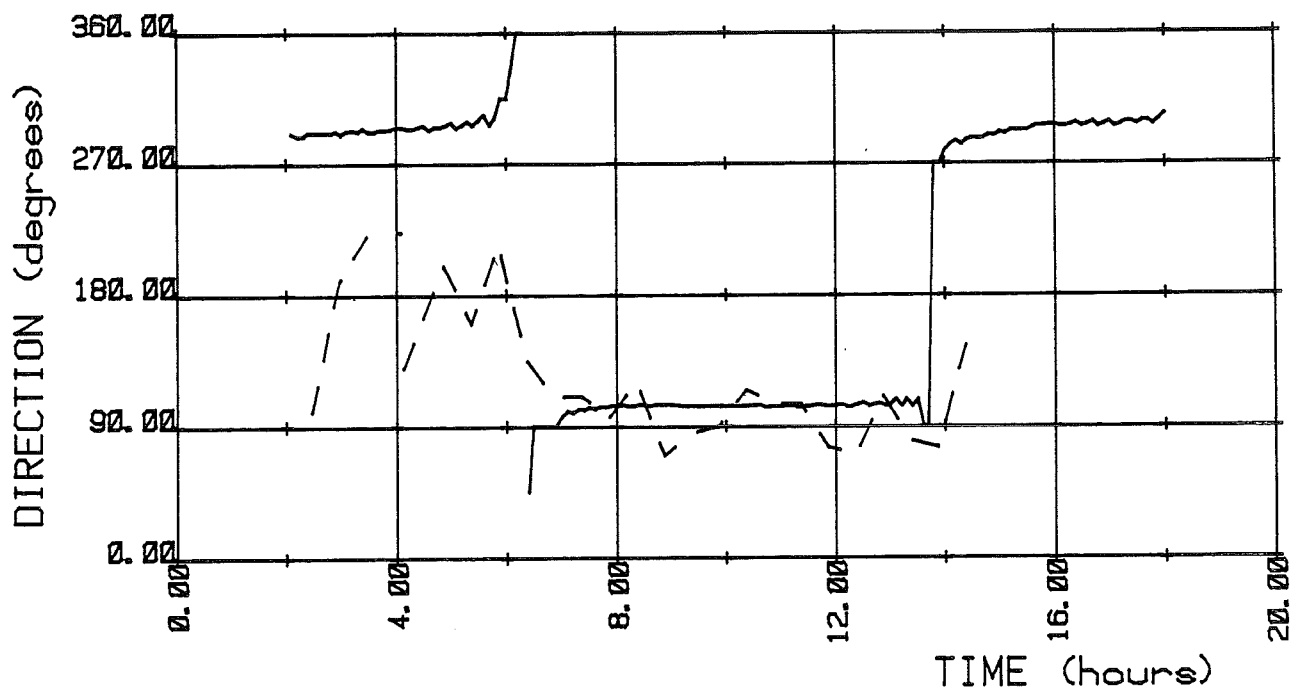
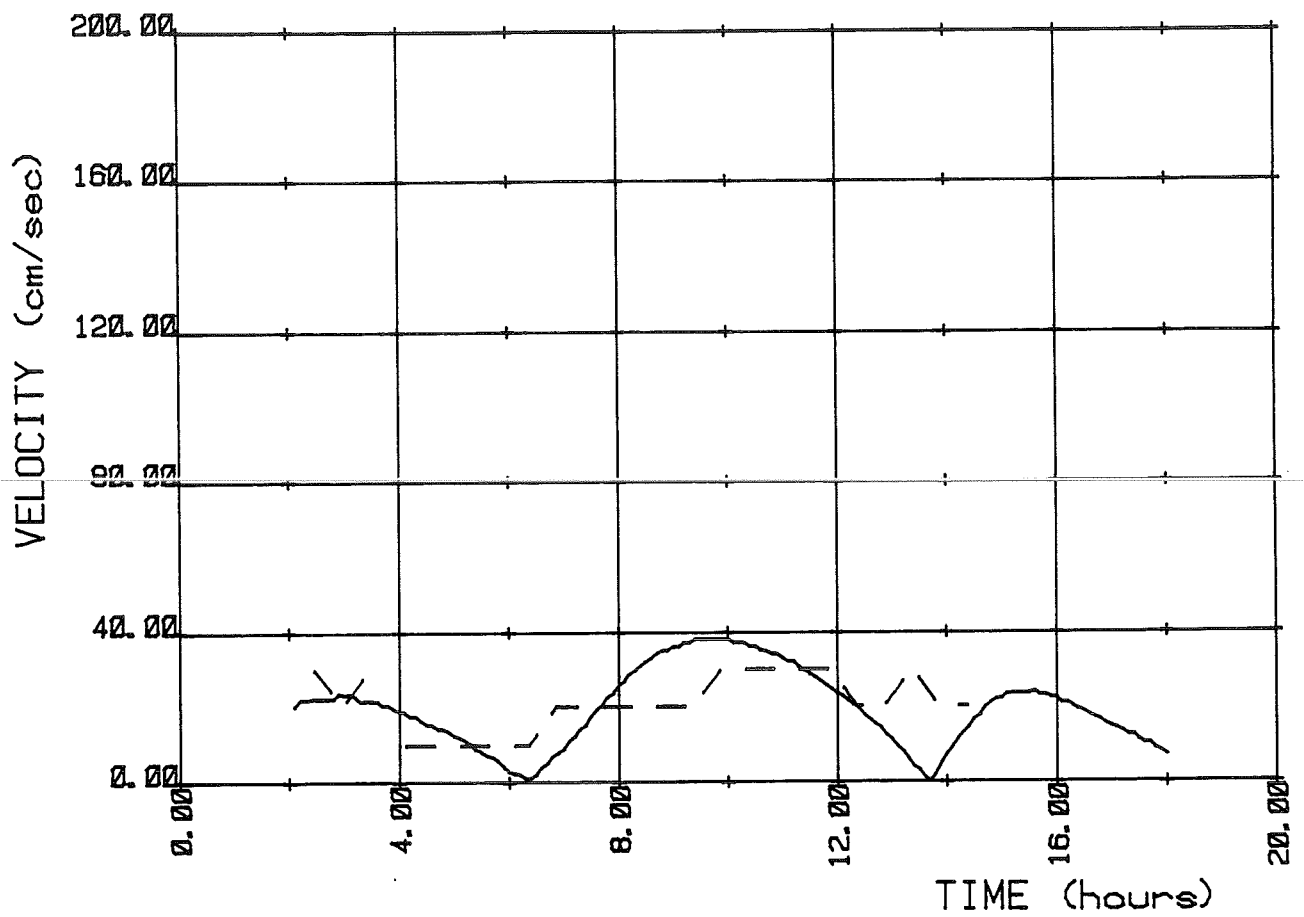

Velocity curve at station: 105
 ————— computed at N= 29 M= 16
 - - - - - measured June 2nd 1973



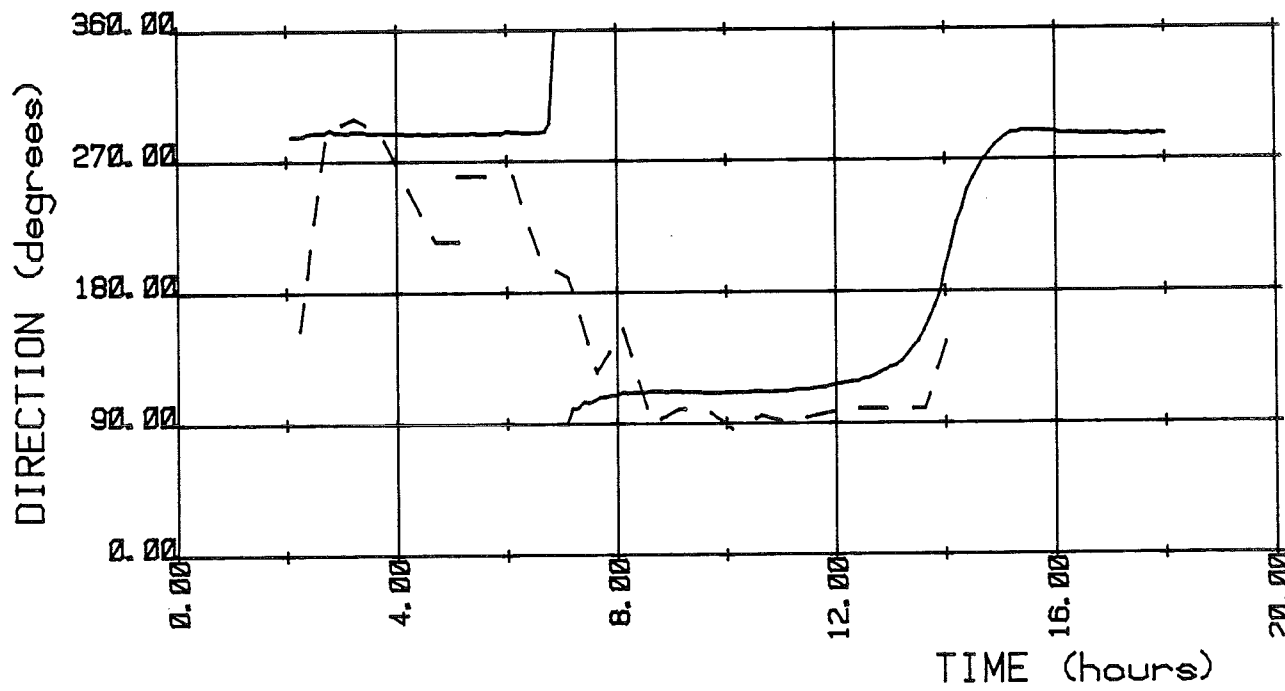
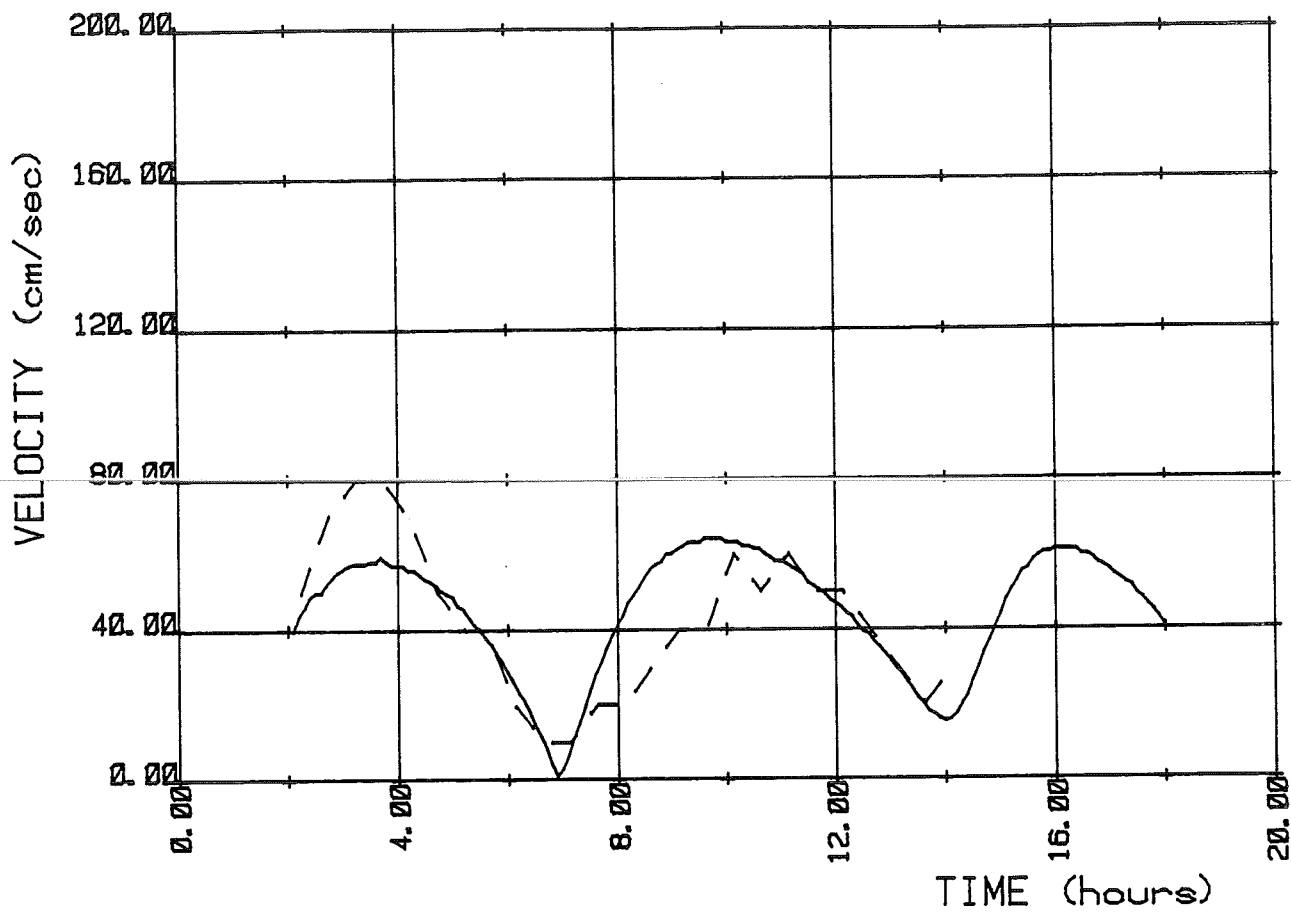

Velocity curve at station: 107

————— computed at N= 33 M= 27

- - - - - measured June 29th 1973



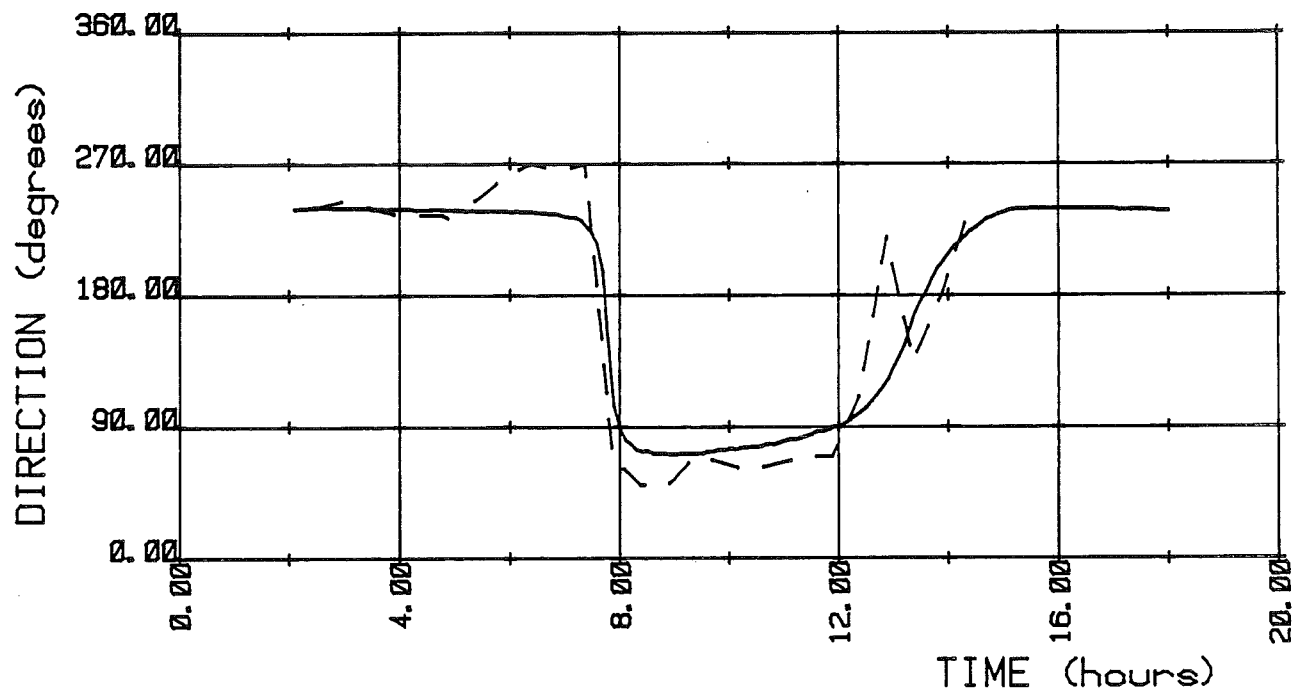
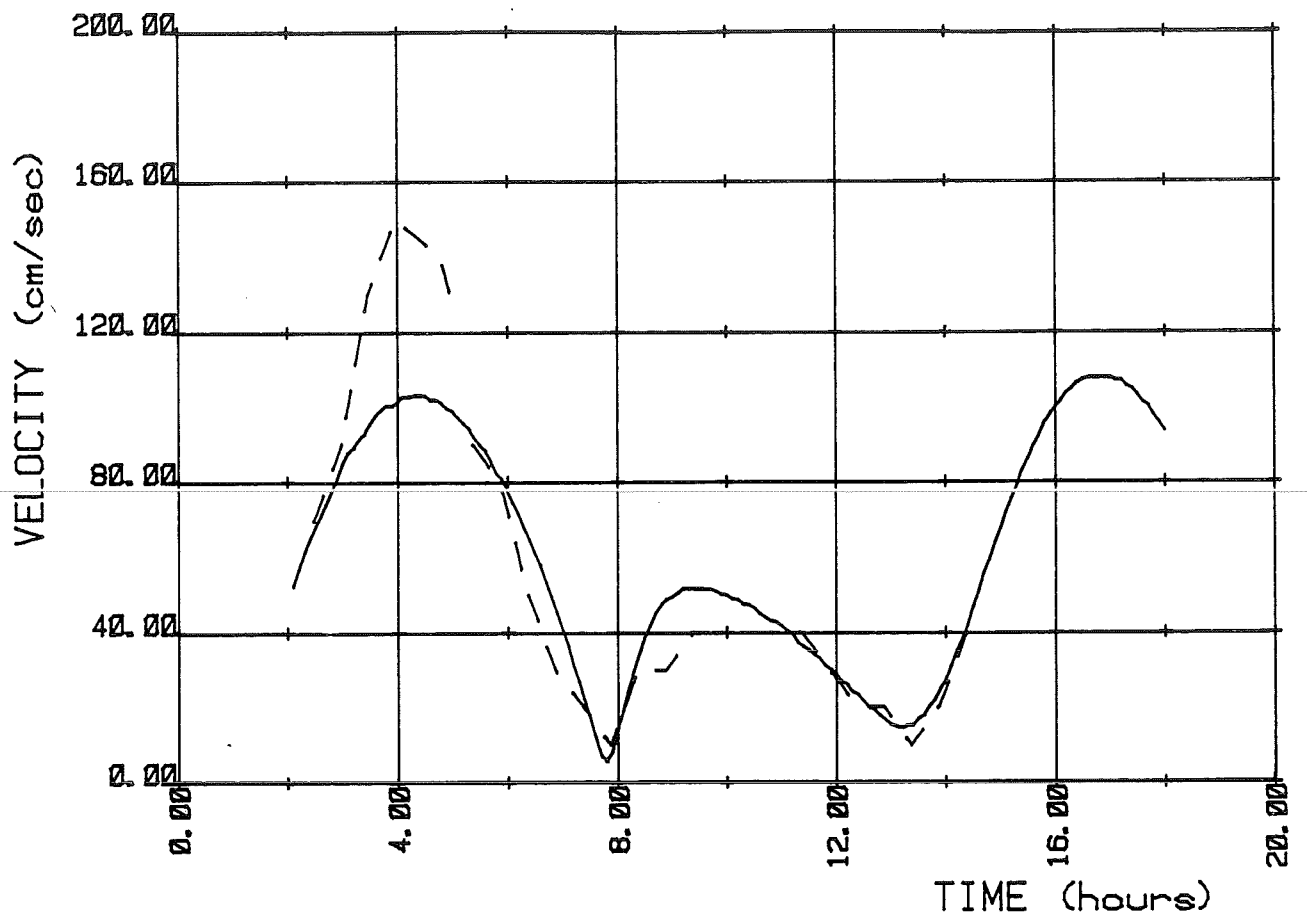

Velocity curve at station: 108
 ————— computed at N= 38 M= 32
 - - - - - measured July 31st 1973



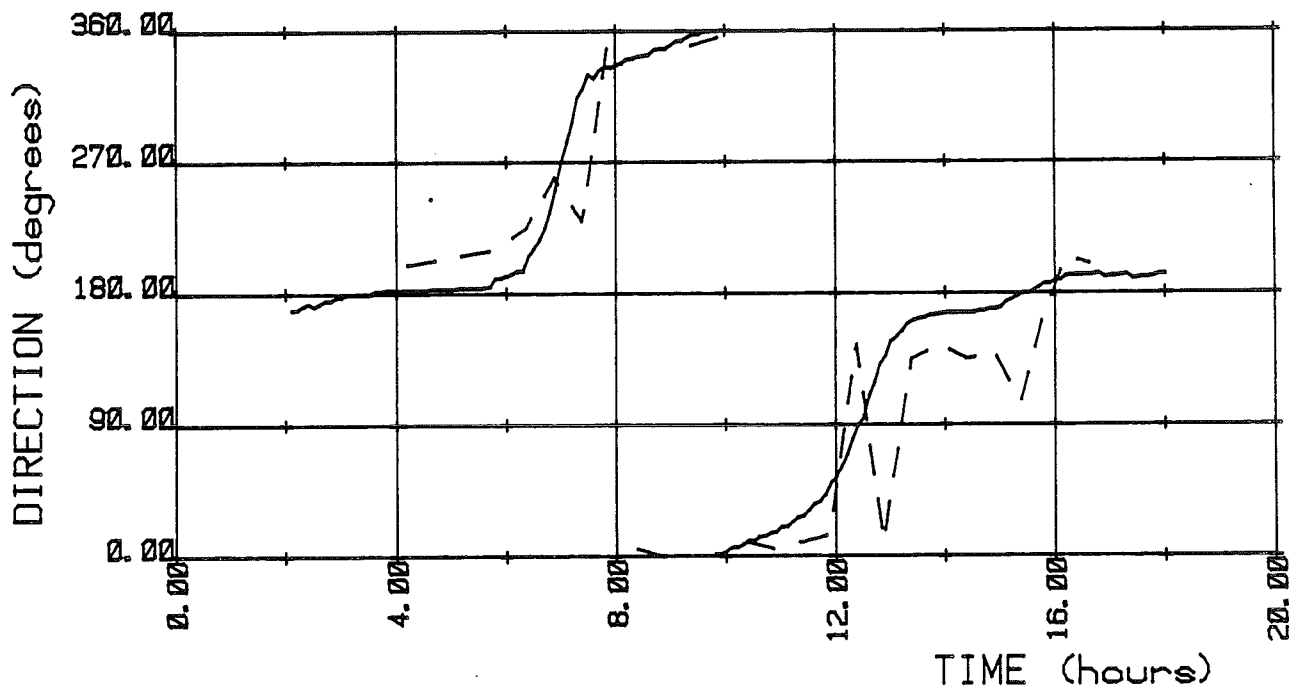
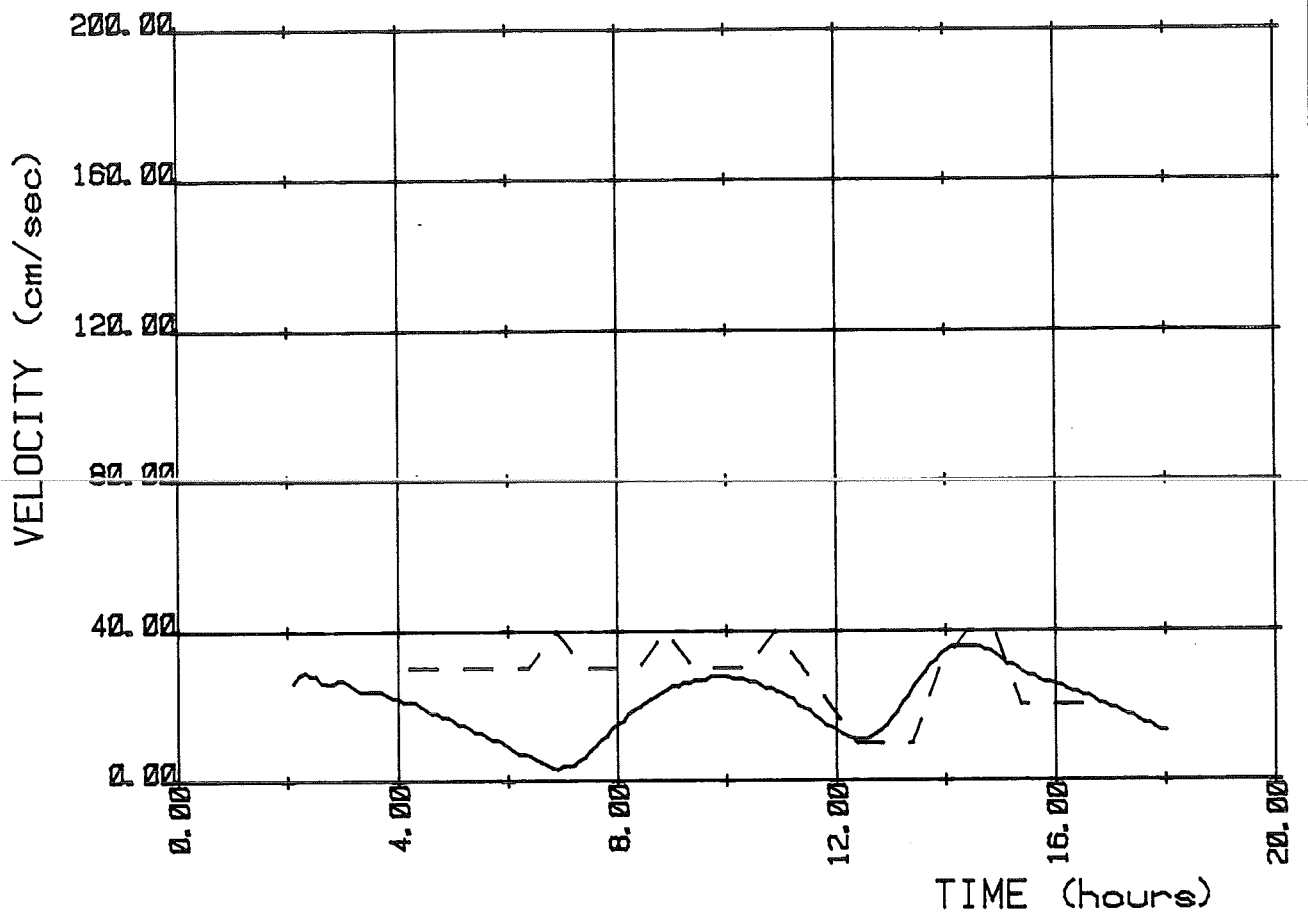

Velocity curve at station: 110
 ————— computed at N= 59 M= 40
 - - - - - measured July 30th 1973



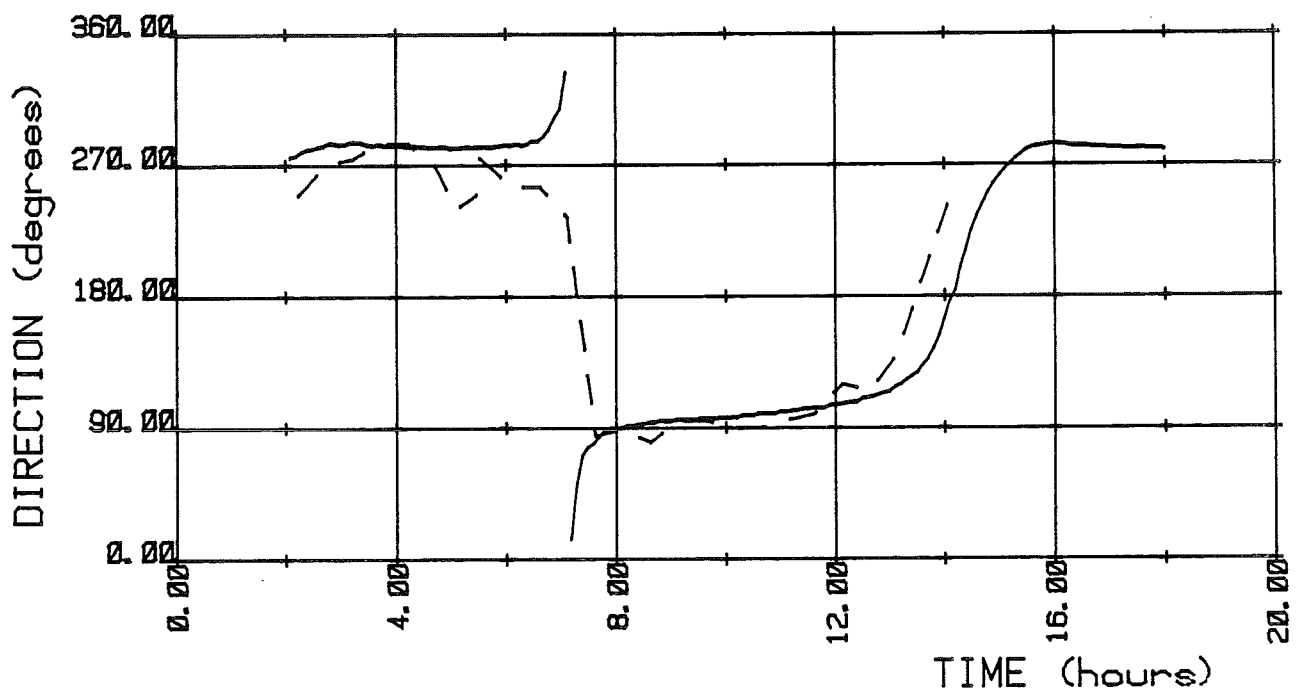
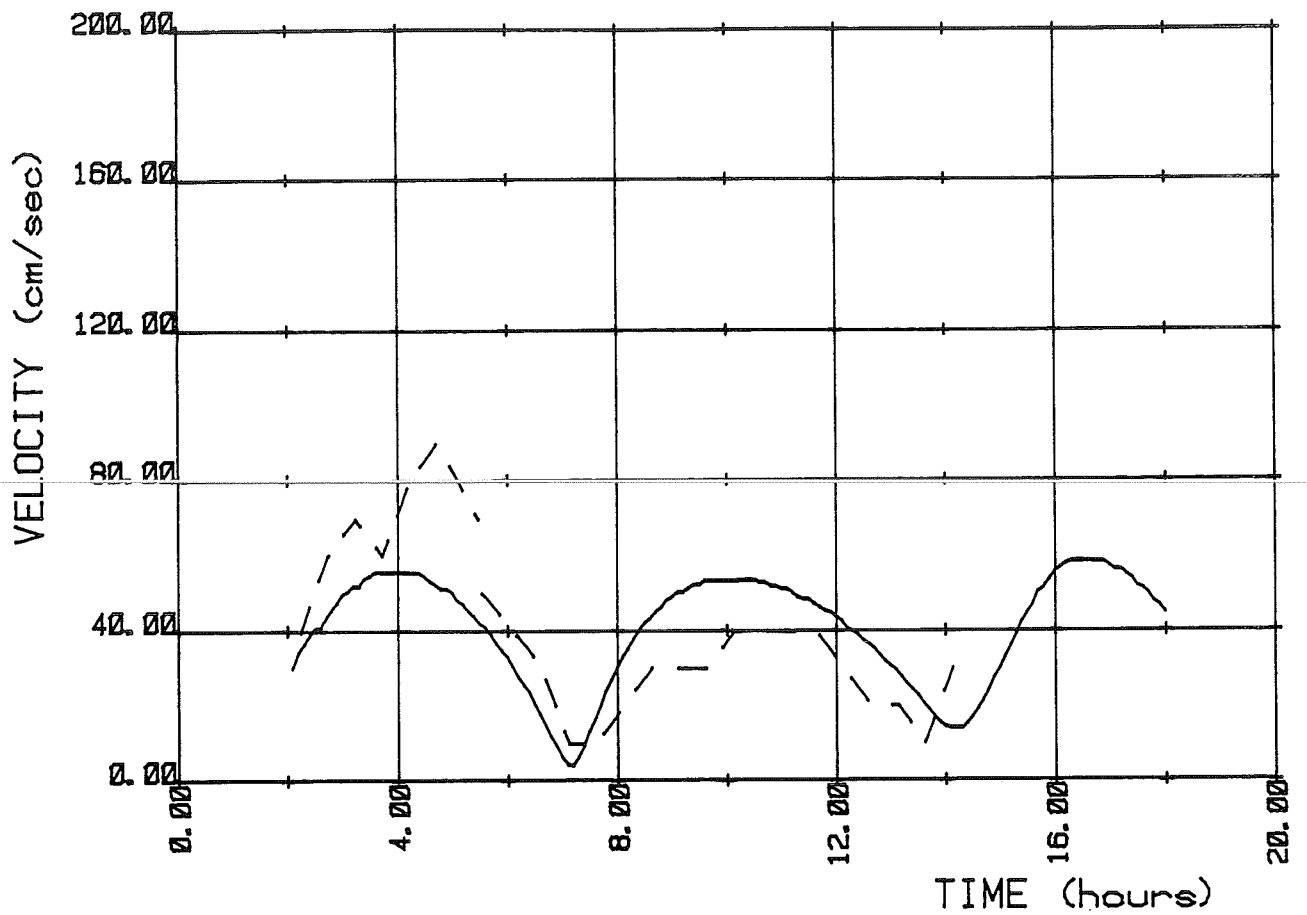

Velocity curve at station: 113

————— computed at N= 28 M= 31
 - - - - - measured June 29th 1973



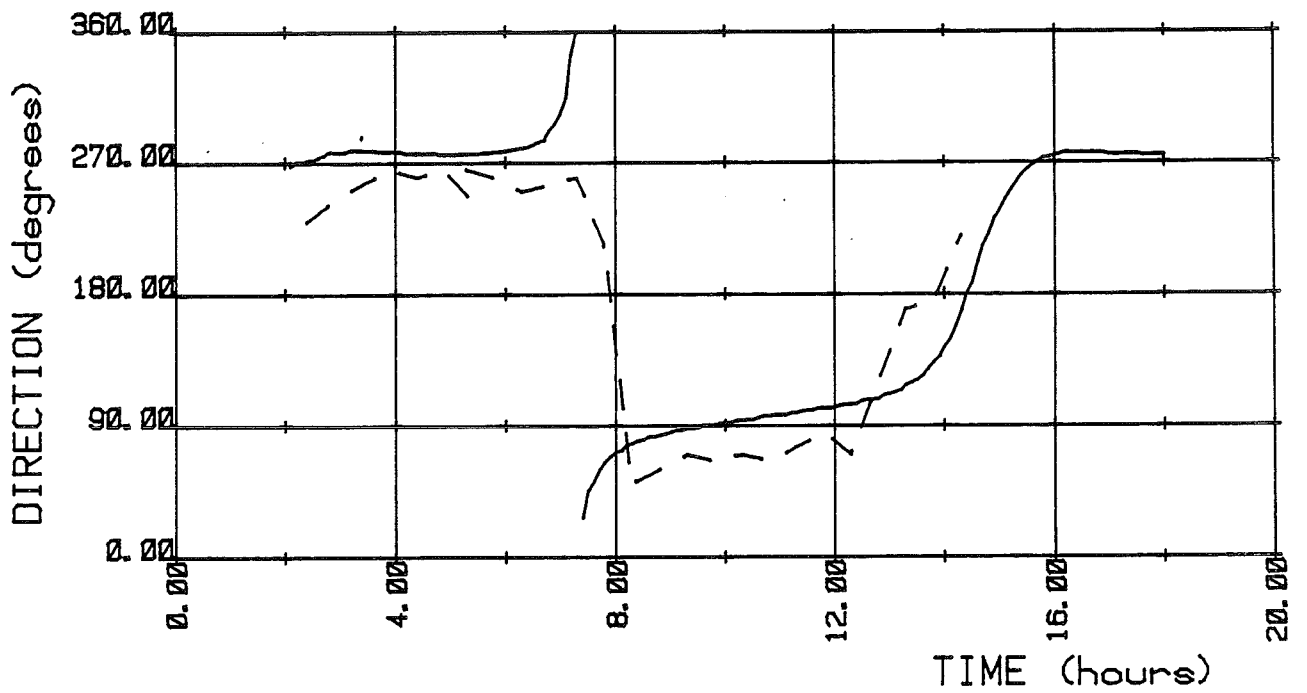
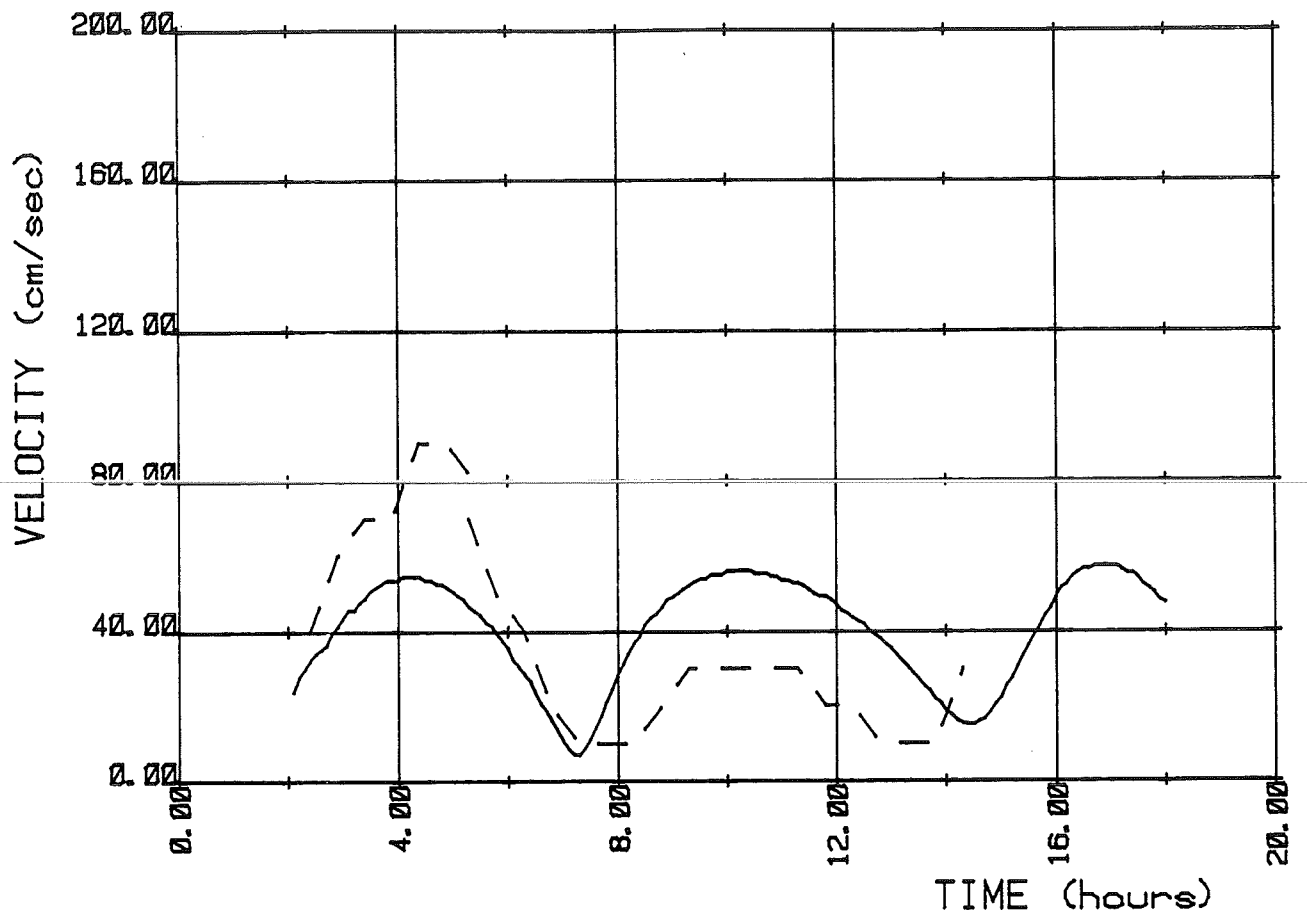

Velocity curve at station: 114
 ————— computed at N= 25 M= 35
 - - - - - measured June 29th 1973



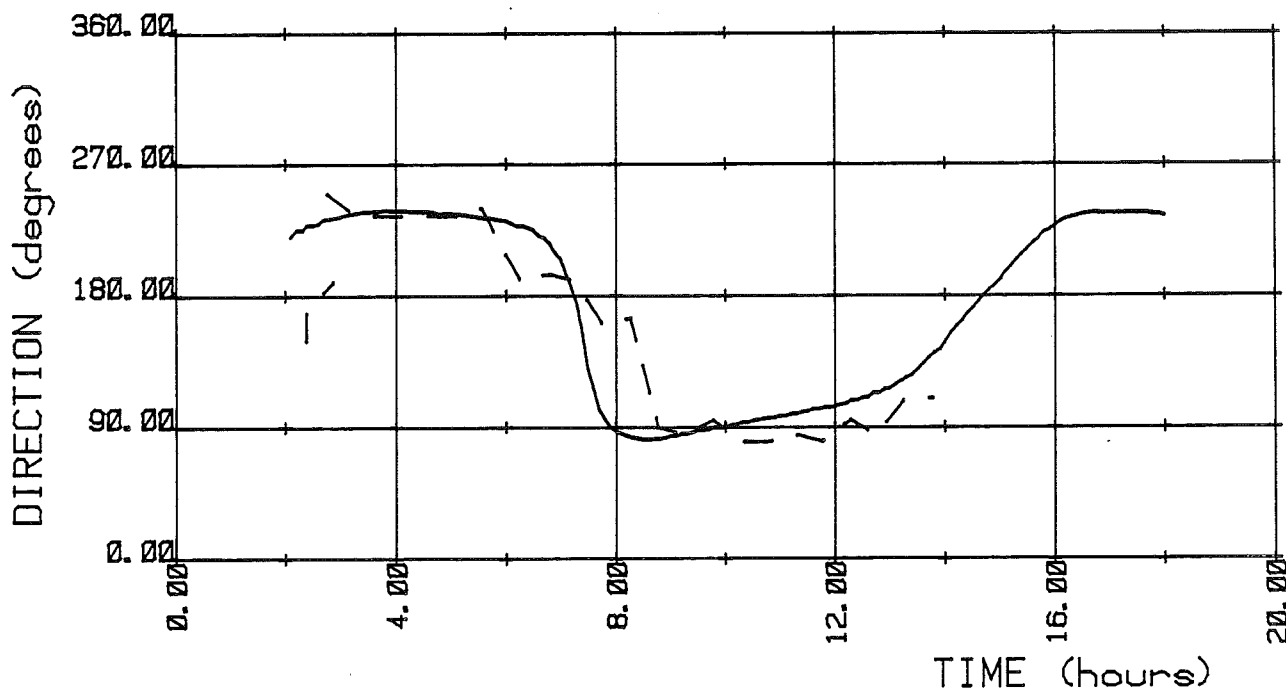
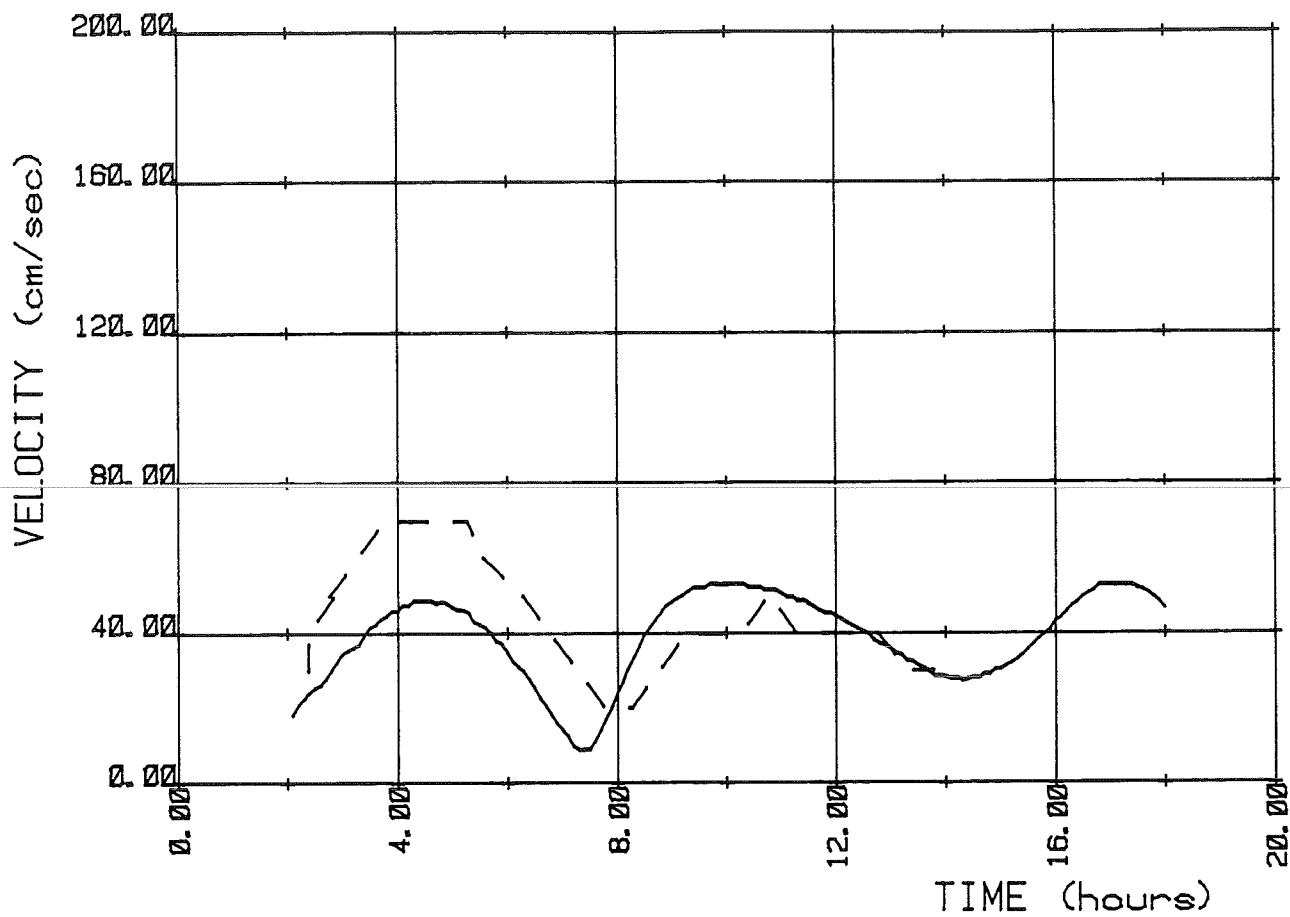

Velocity curve at station: 118
 ————— computed at N= 25 M= 43
 - - - - - measured July 2nd 1973



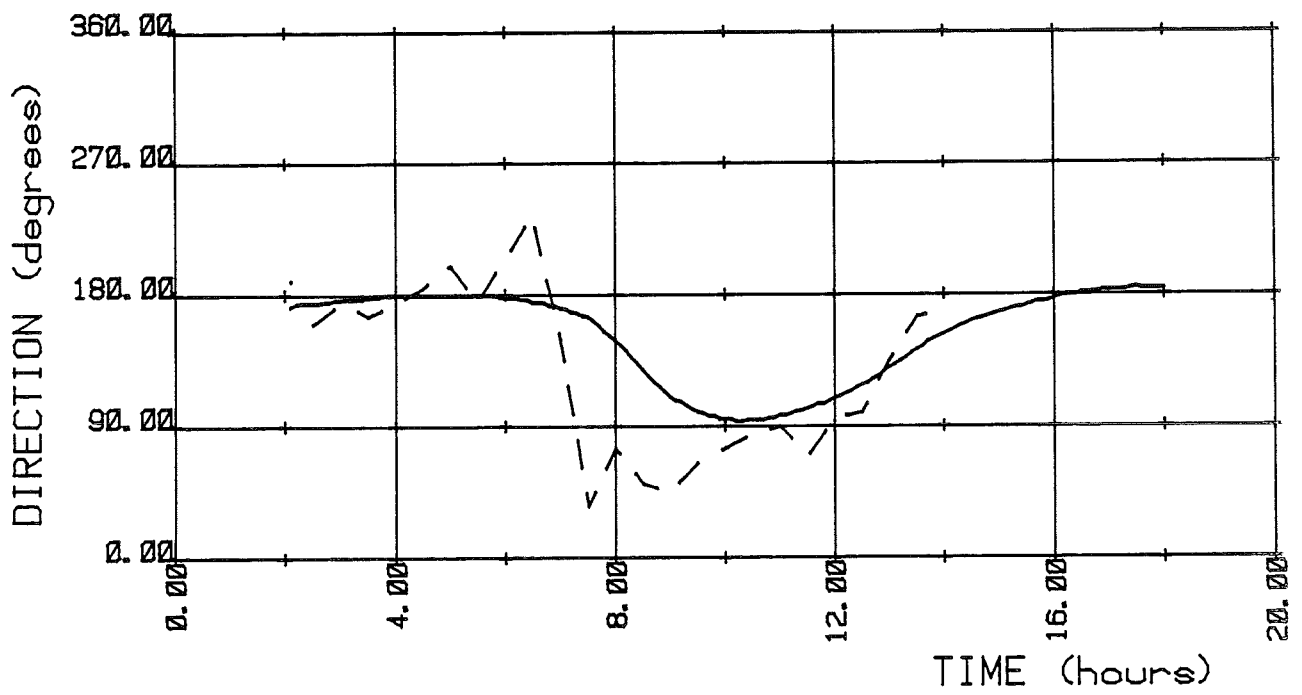
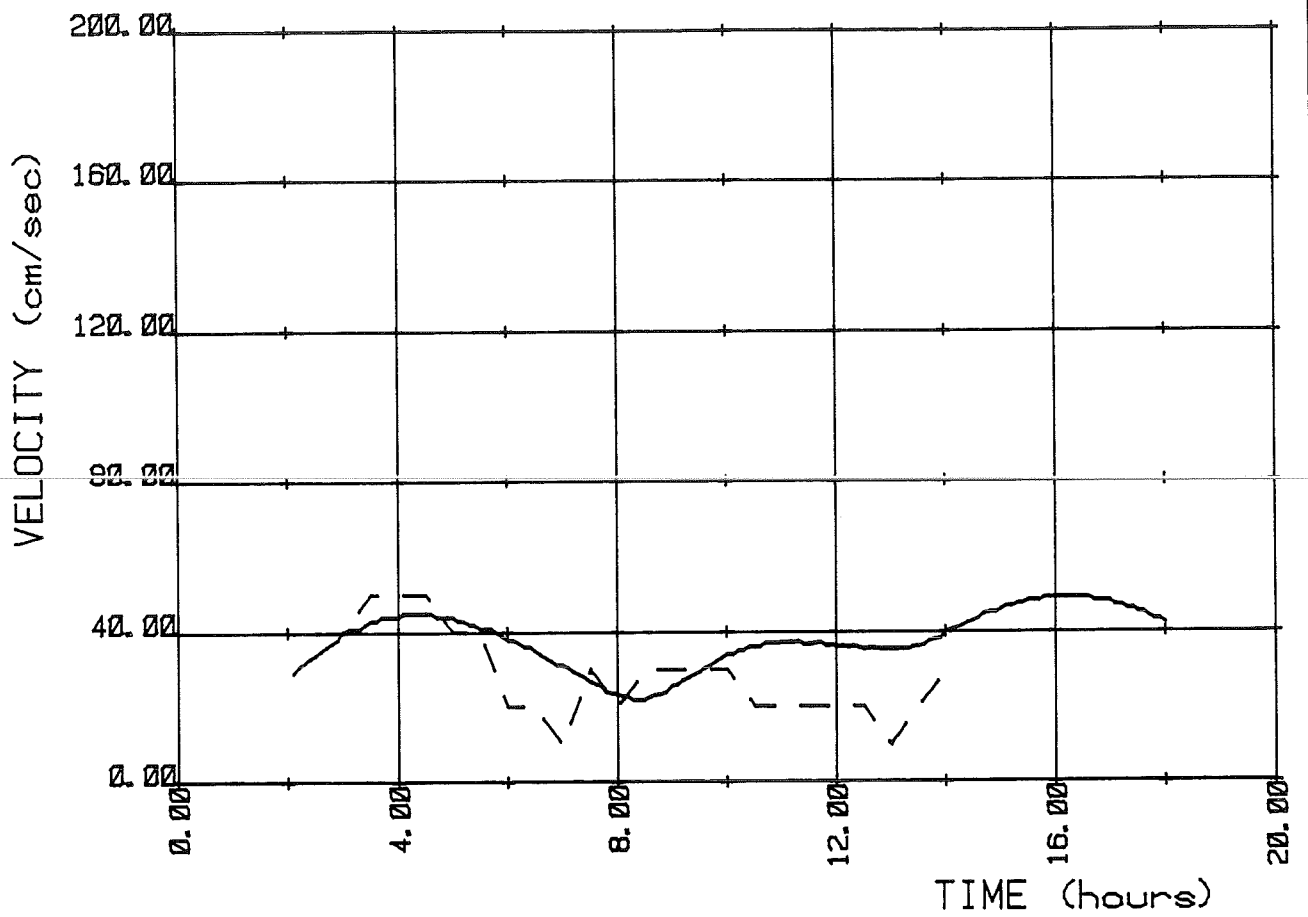

Velocity curve at station: 120
 ————— computed at N= 37 M= 53
 - - - - - measured July 3rd 1973



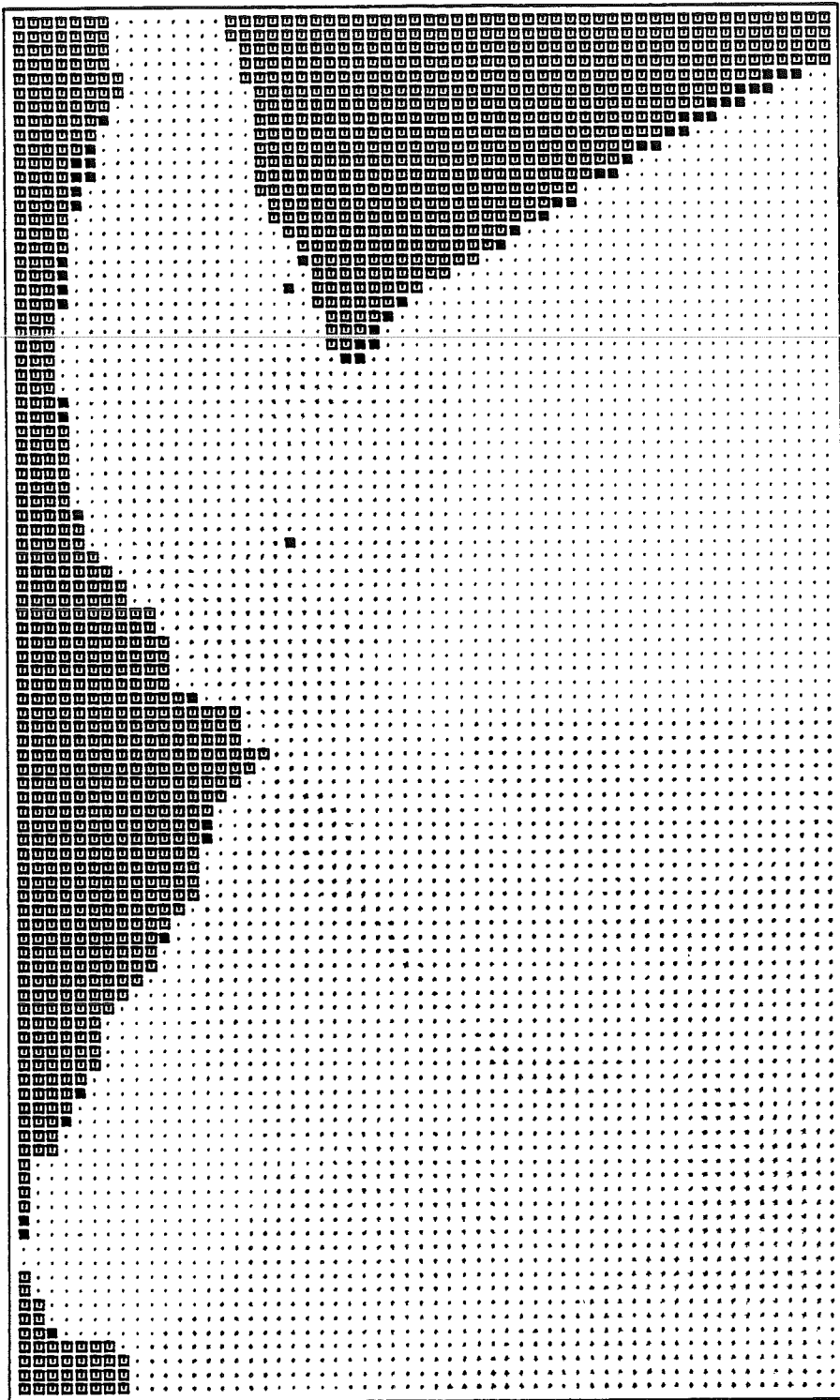

scale 1 : 100000

Computed flowfield; 9 hours after HW
at Cascais

- velocity = 1.20 m/s
- velocity = .60 m/s
- land node
- dry shoal node

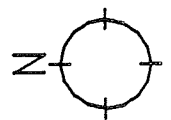

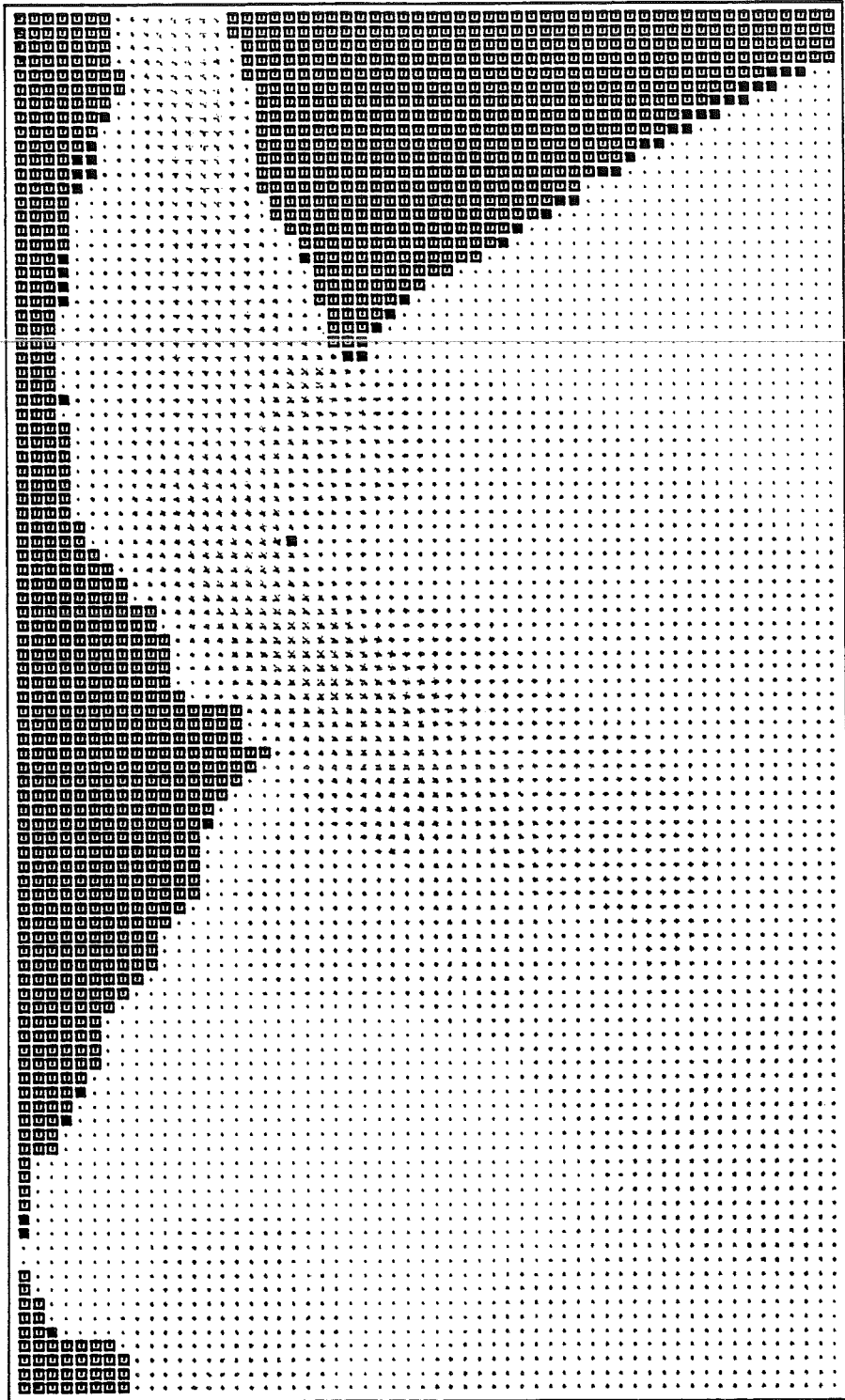

scale 1 : 100000

Computed flowfield; 15 hours after HW
at Cascais

- velocity = 1.20 m/s
- velocity = .60 m/s
- land node
- dry shoal node

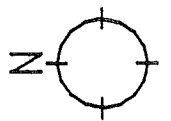

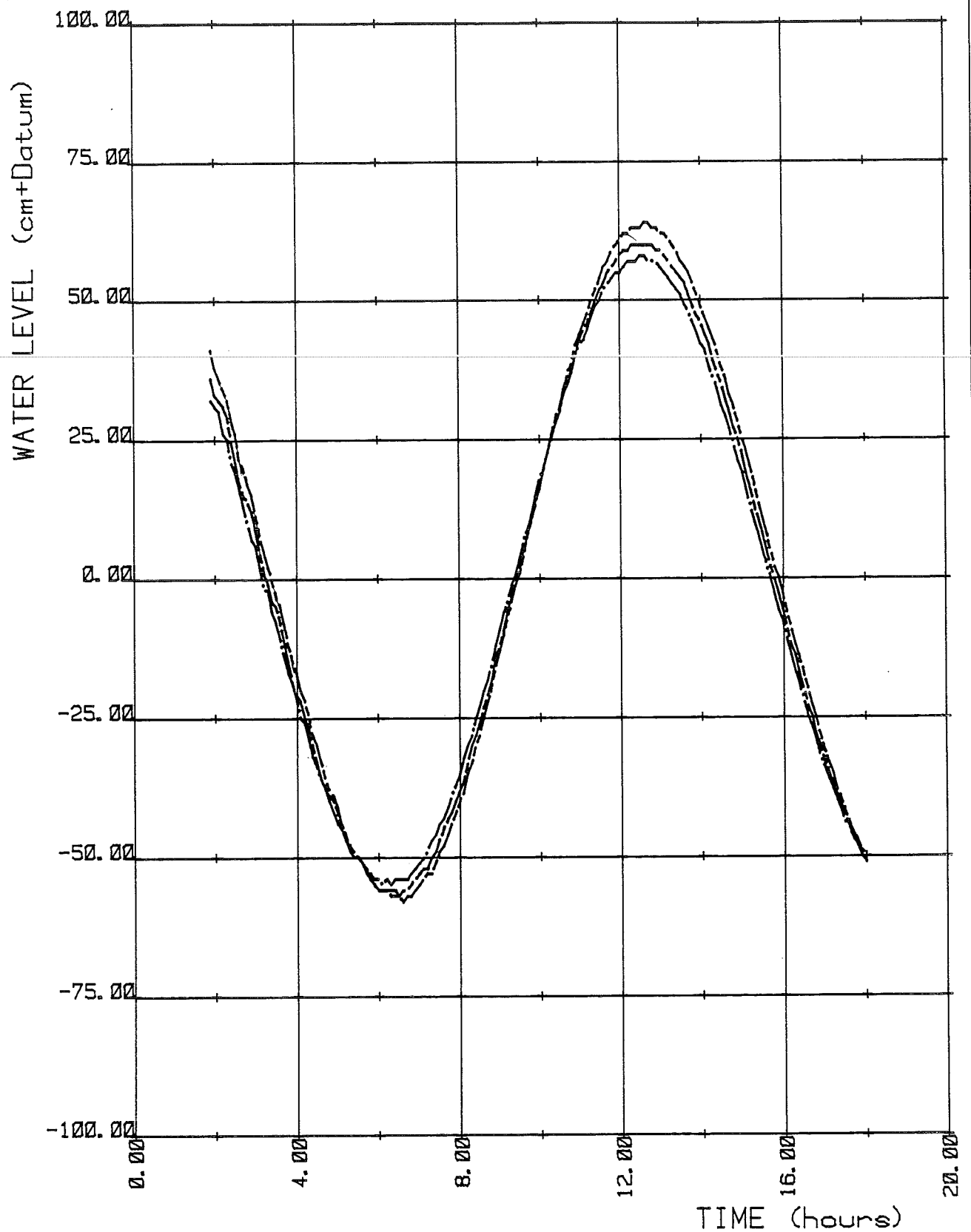

Computed water level curves

- N= 91 M= 10 station 42
- N= 56 M= 13 station 51
- N= 7 M= 5 station 115



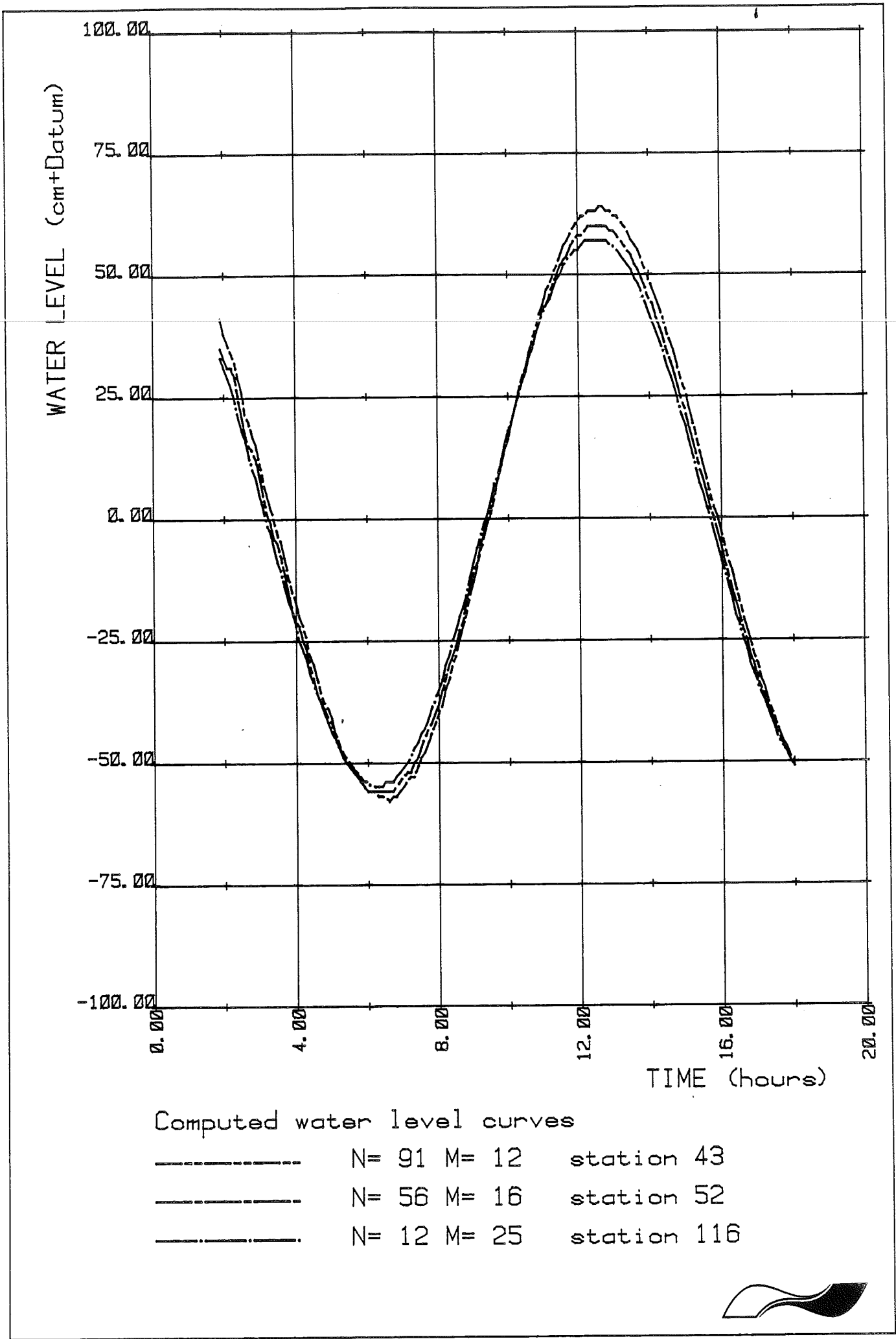

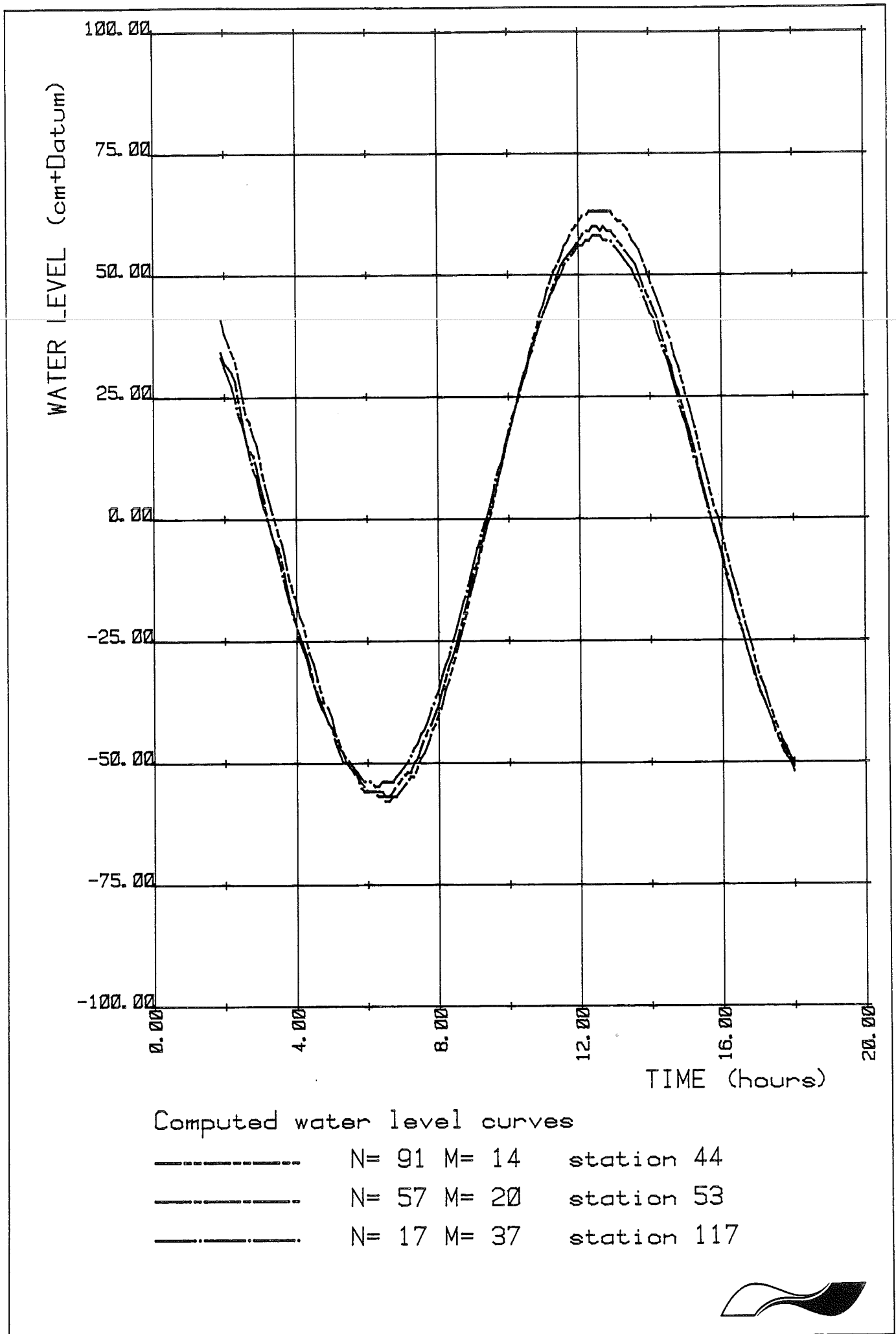

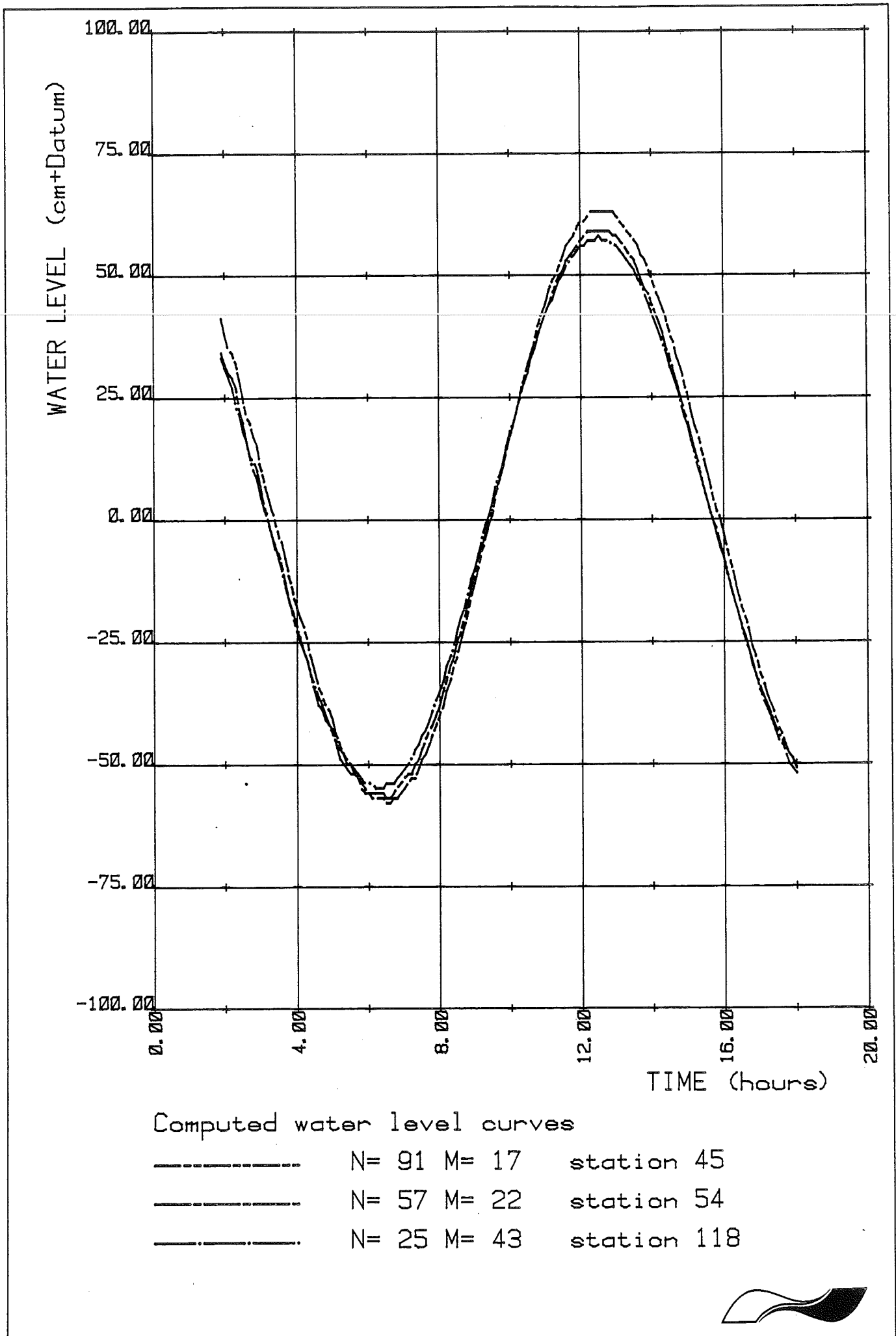

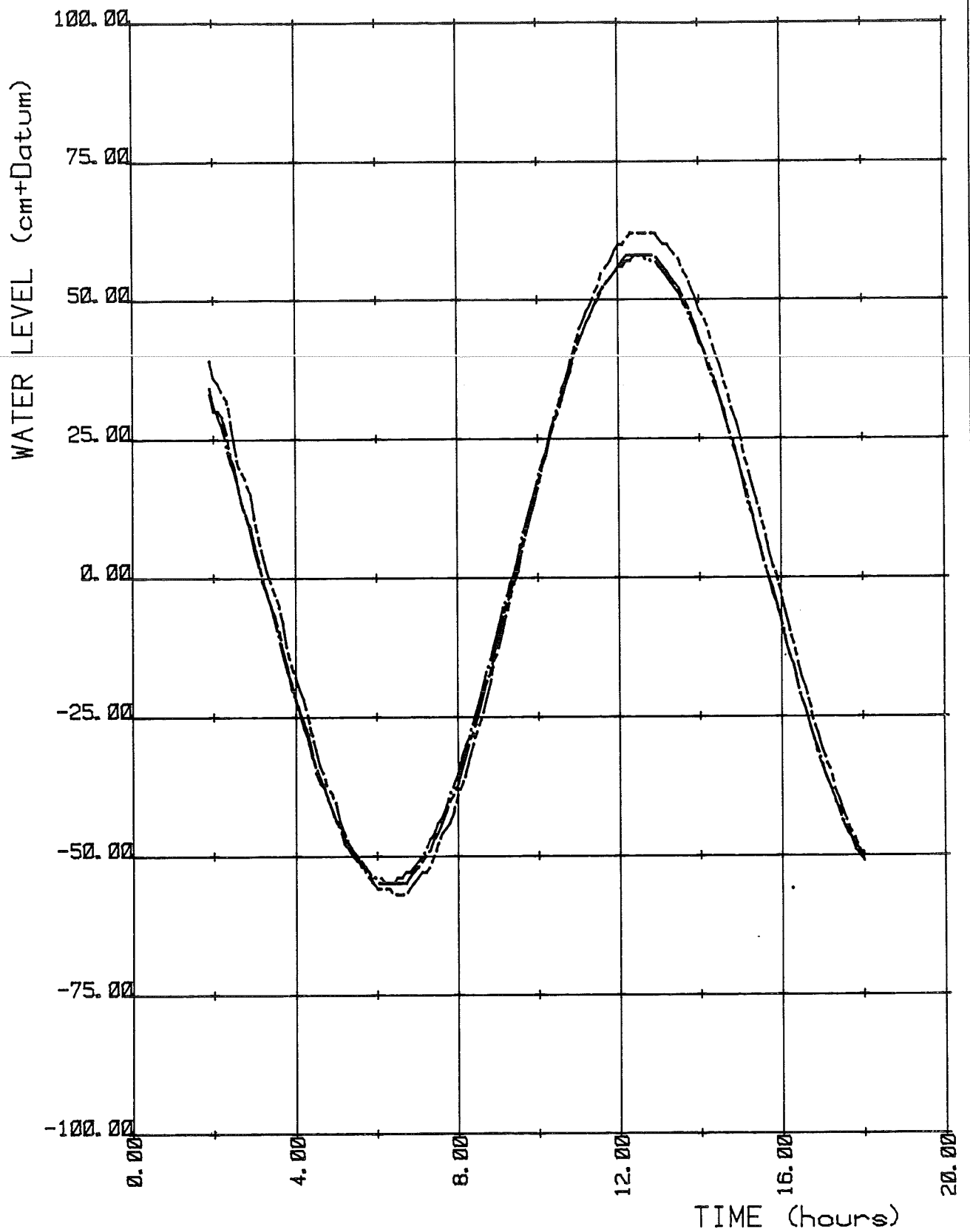

Computed water level curves

- N= 79 M= 7 station 46
- .-.-.- N= 45 M= 21 station 100
- _____ N= 7 M= 41 station 126



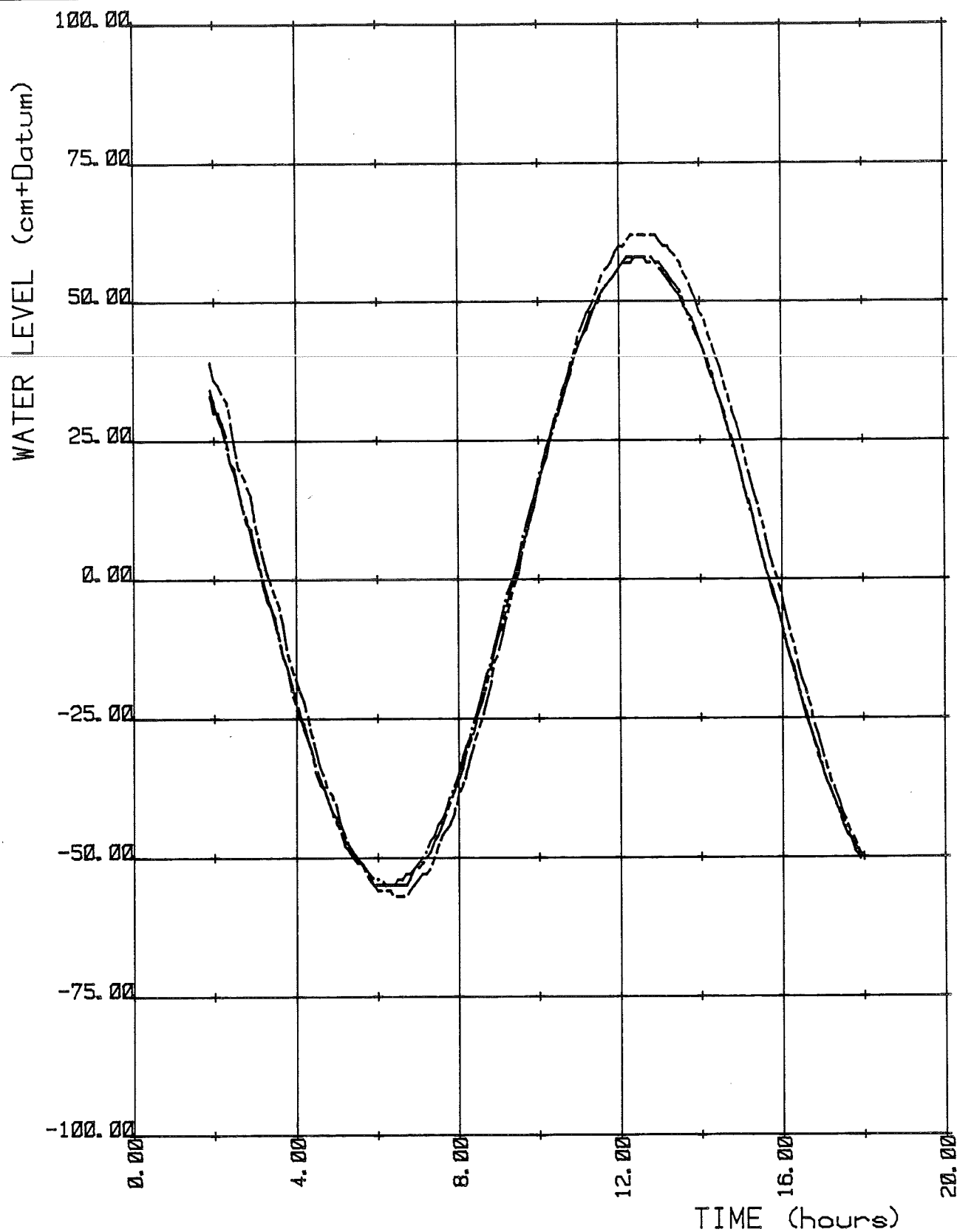

Computed water level curves

- N= 79 M= 9 station 47
- - - - - N= 43 M= 22 station 101
- . - . - . N= 17 M= 58 station 127



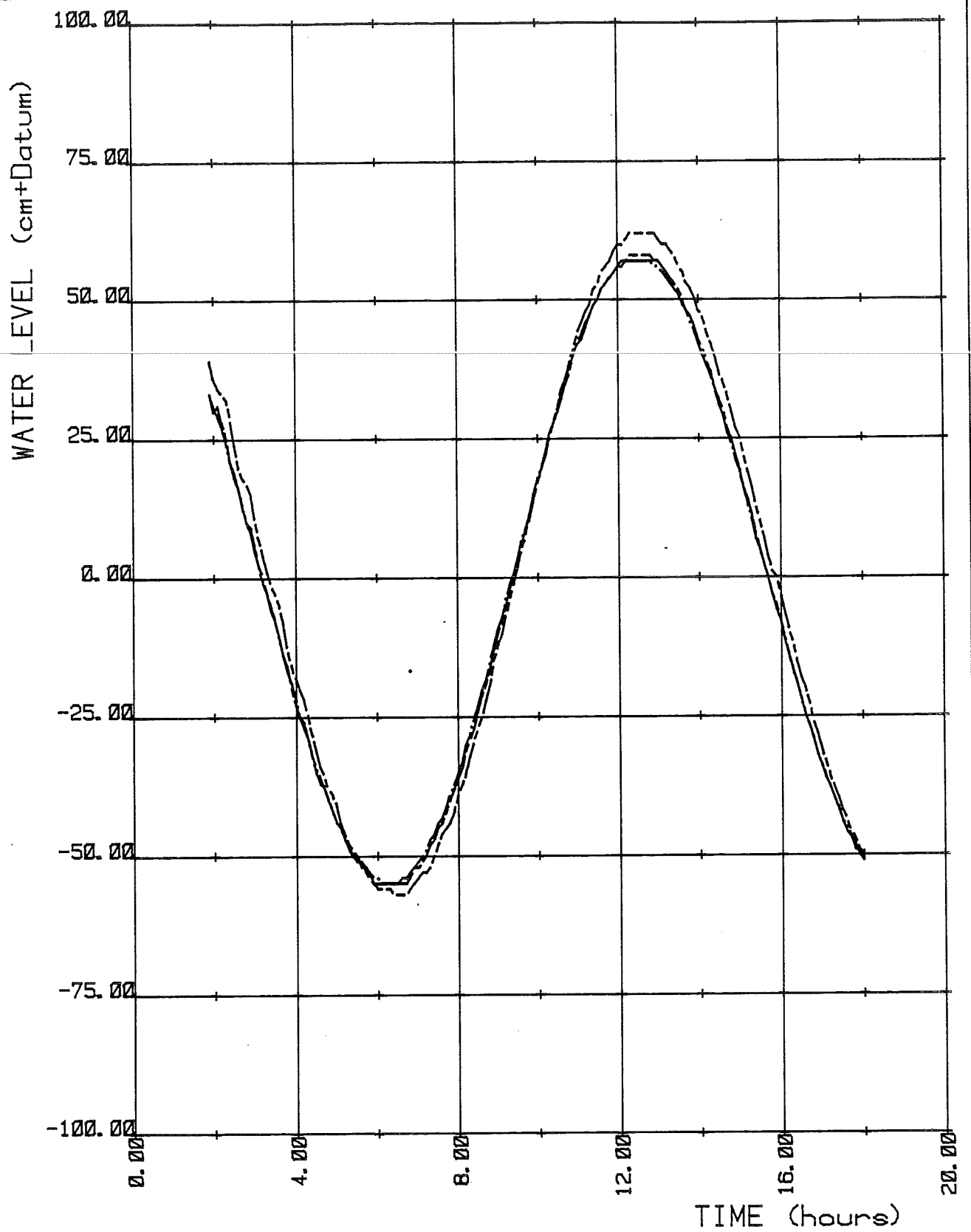

Computed water level curves

- N= 79 M= 12 station 48
- _____ N= 39 M= 24 station 102
- .-.-.-.- N= 25 M= 47 station 119



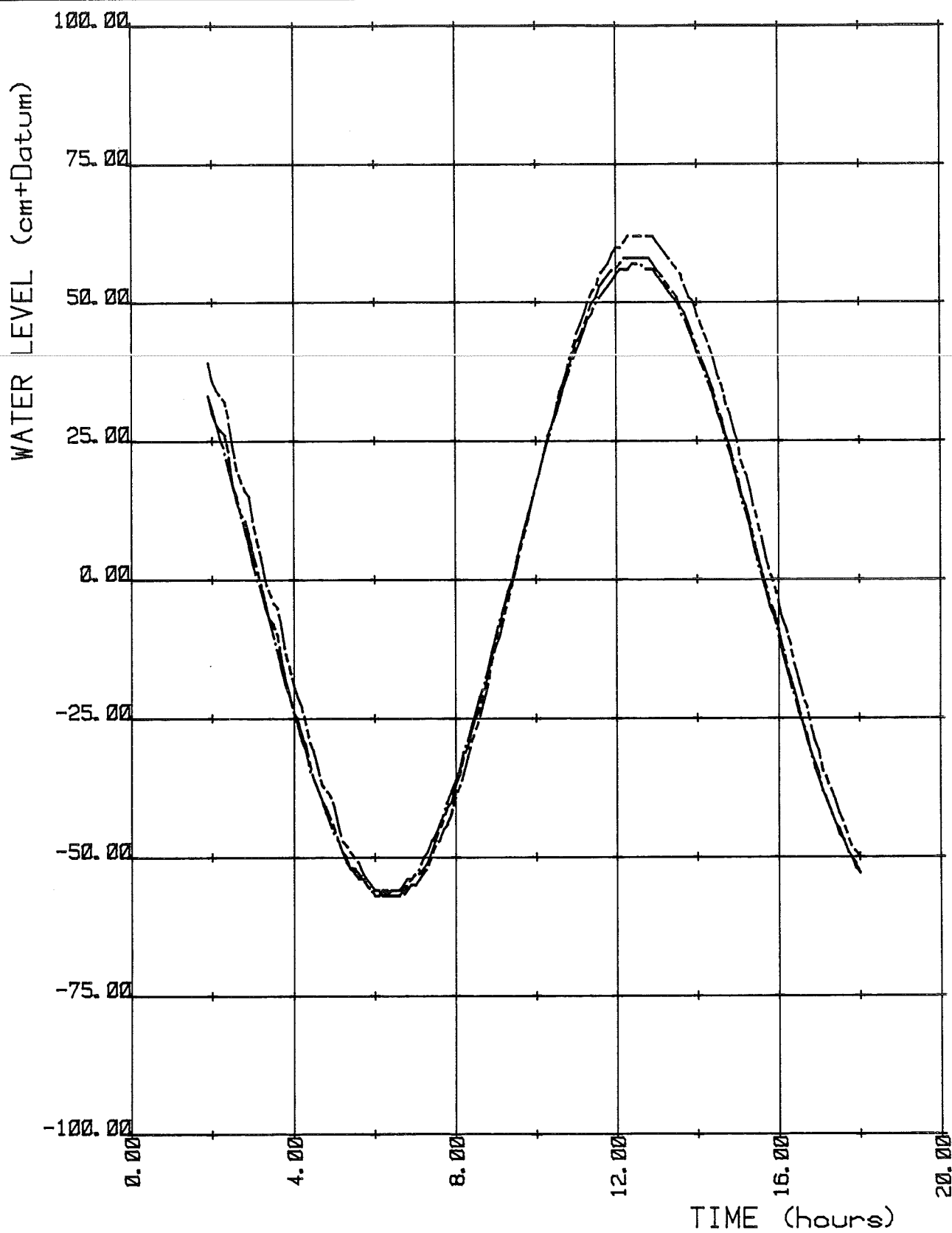

Computed water level curves

- N= 79 M= 16 station 49
- N= 70 M= 25 station 103
- N= 80 M= 57 station 123



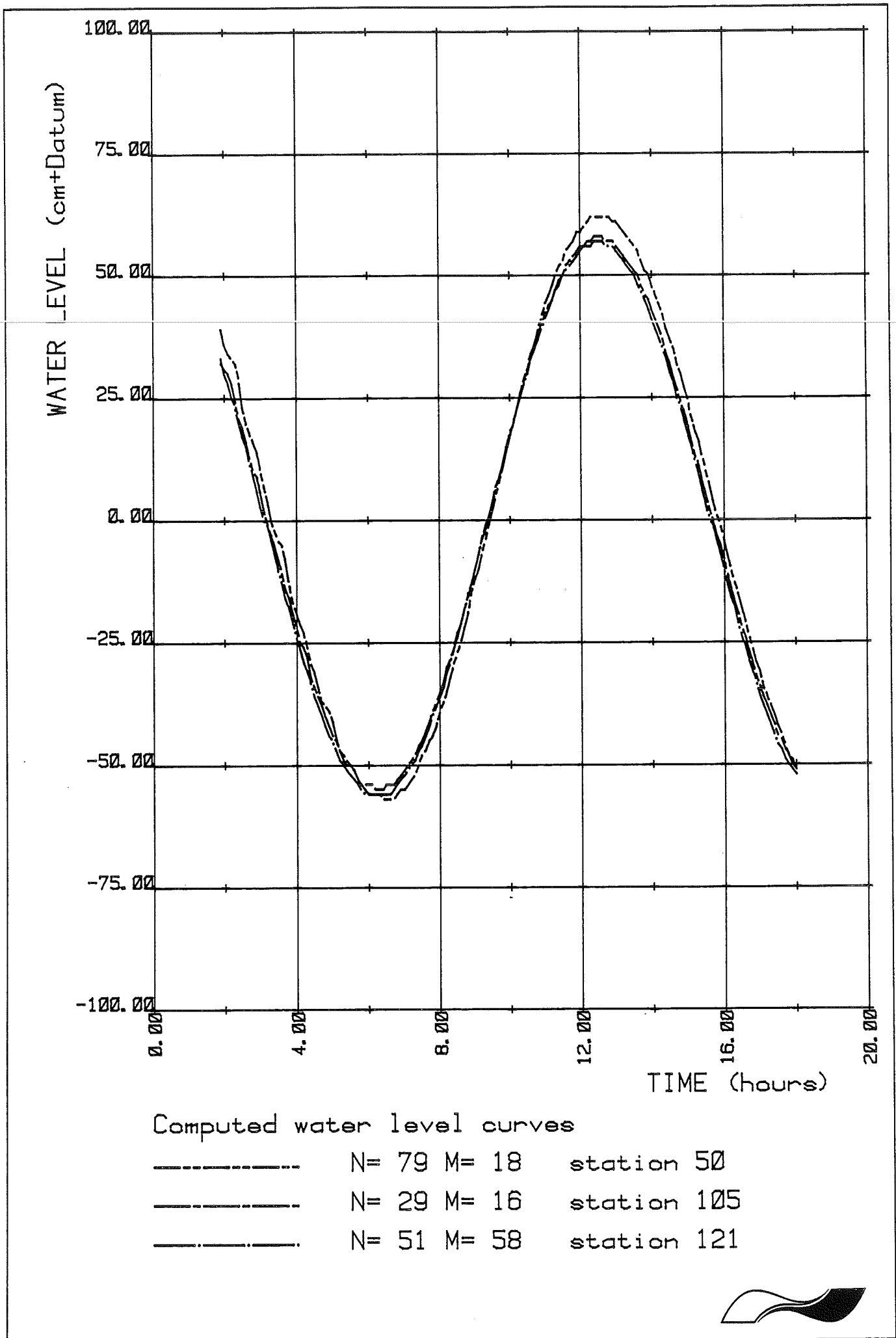

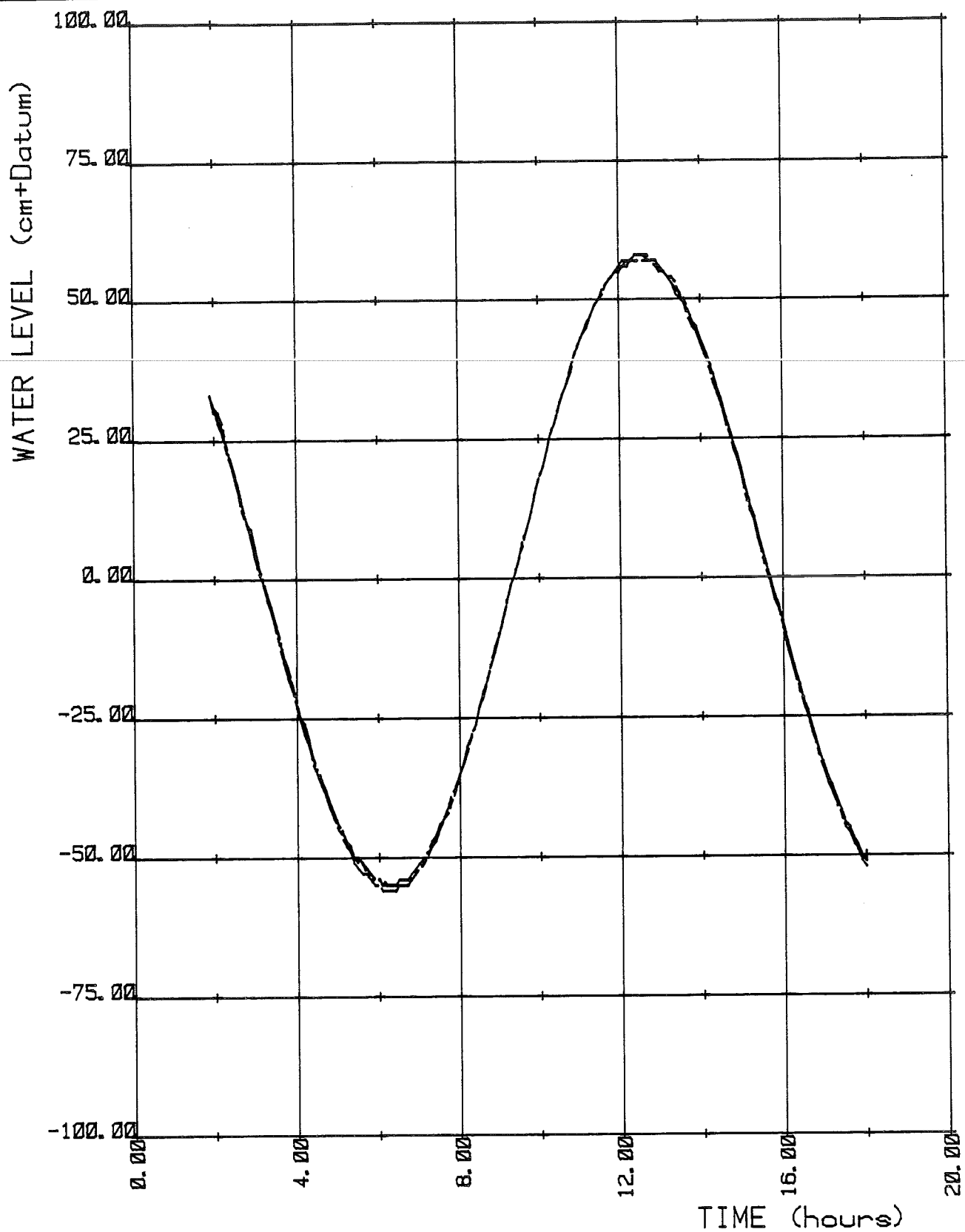

Computed water level curves

- N= 31 M= 24 station 106
- - - - - N= 37 M= 53 station 120
- . - . - . N= 25 M= 35 station 114



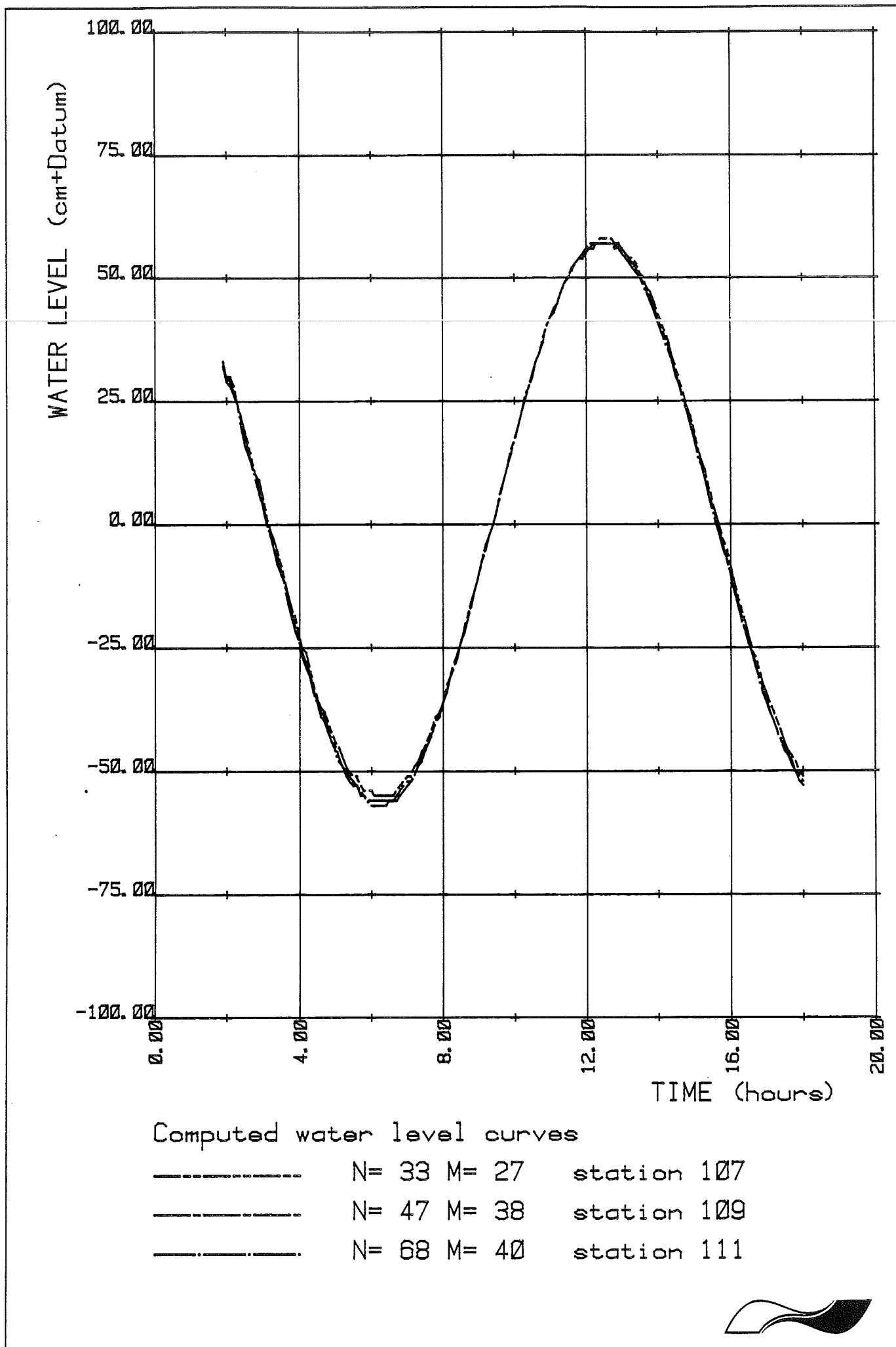

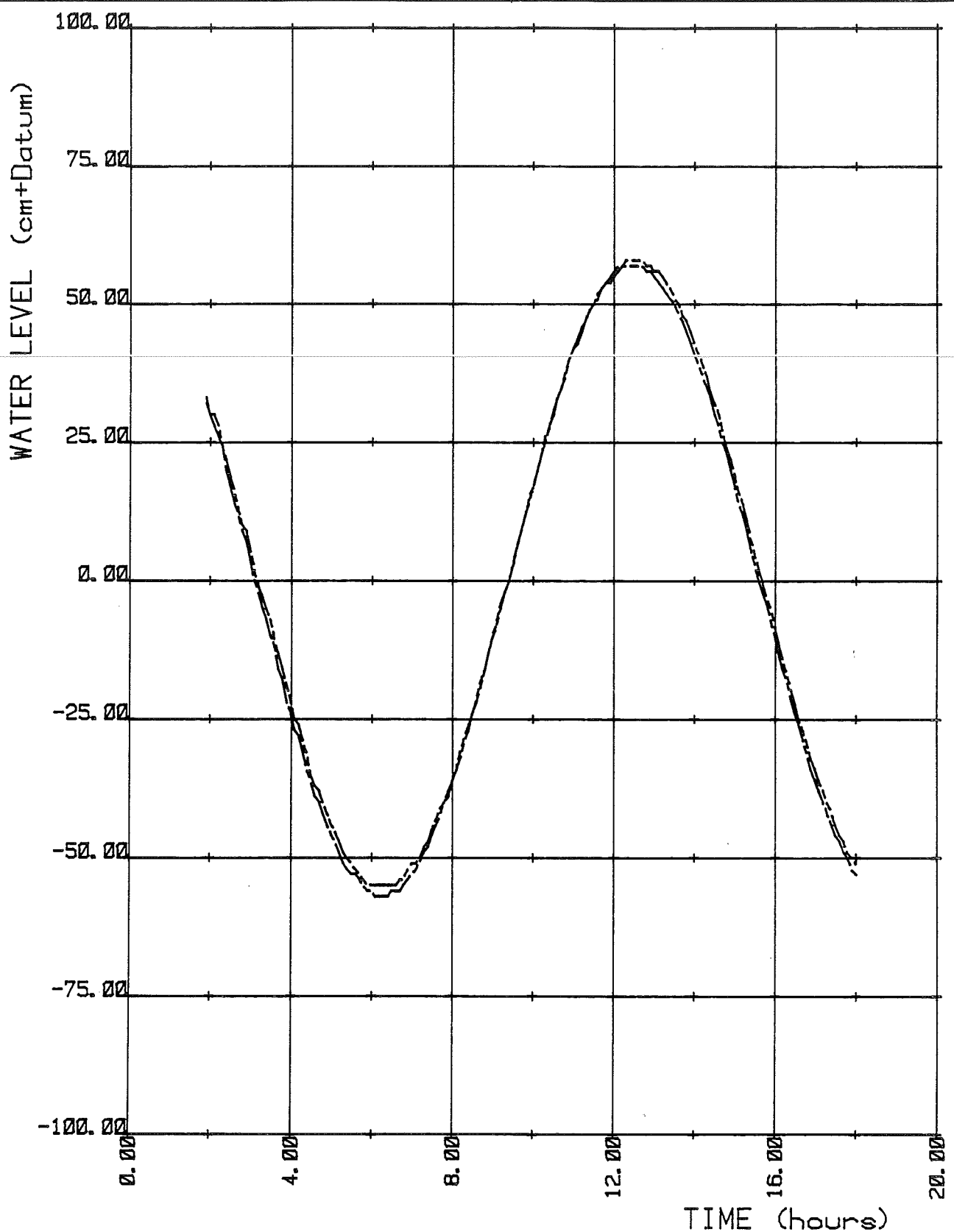

Computed water level curves

- N= 38 M= 32 station 108
- N= 59 M= 40 station 110



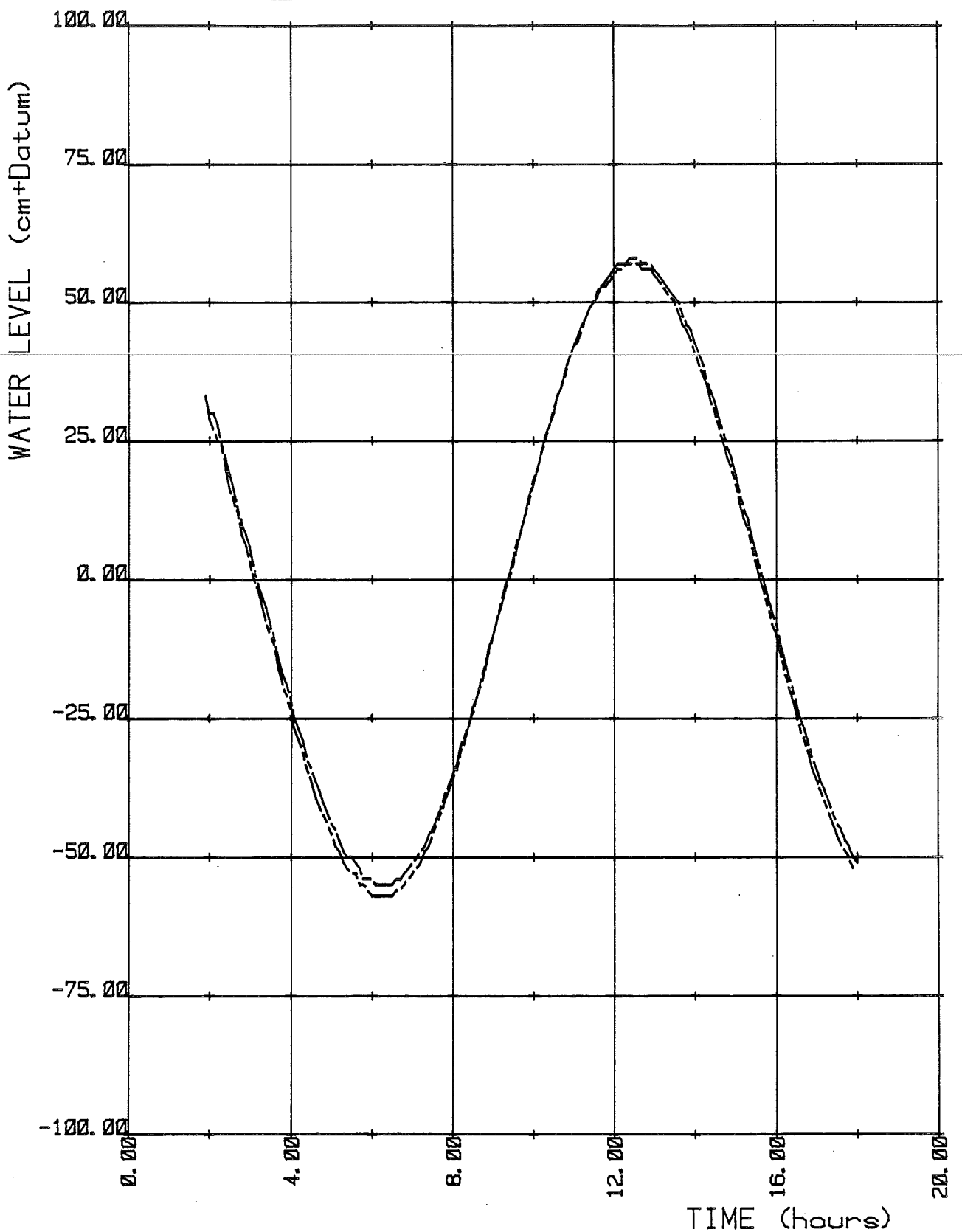

Computed water level curves

- N= 78 M= 37 station 112
- N= 28 M= 31 station 113



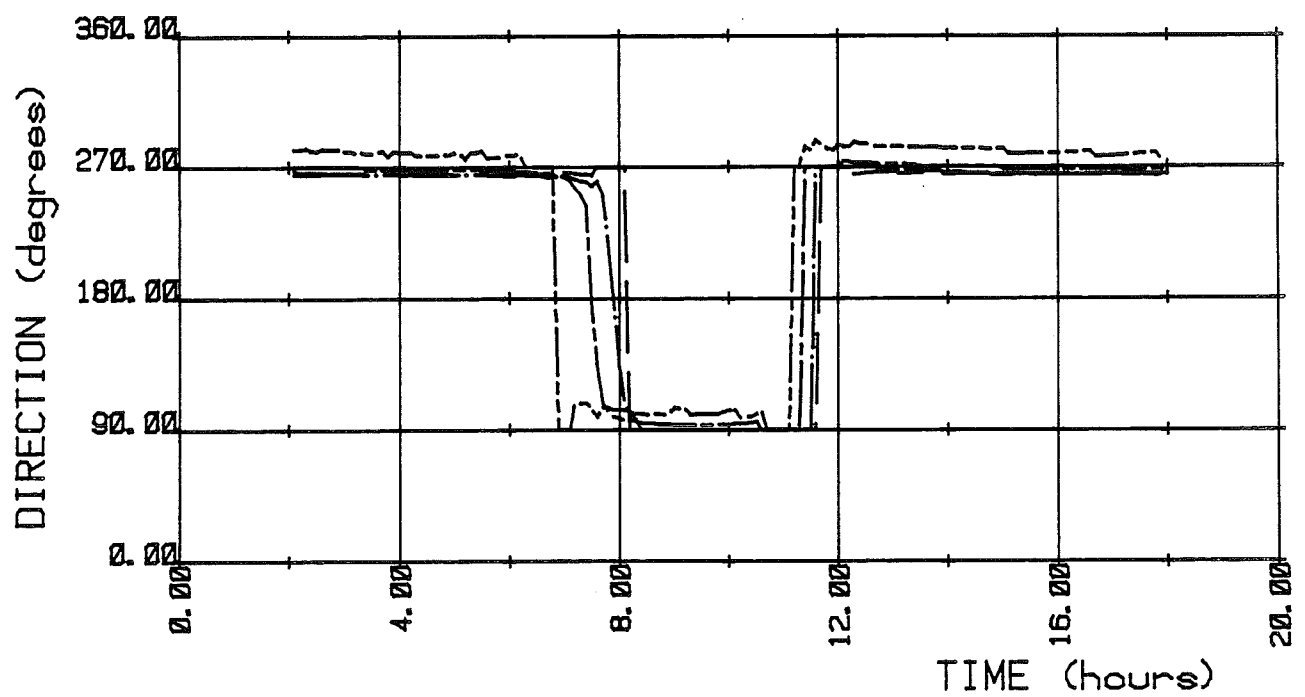
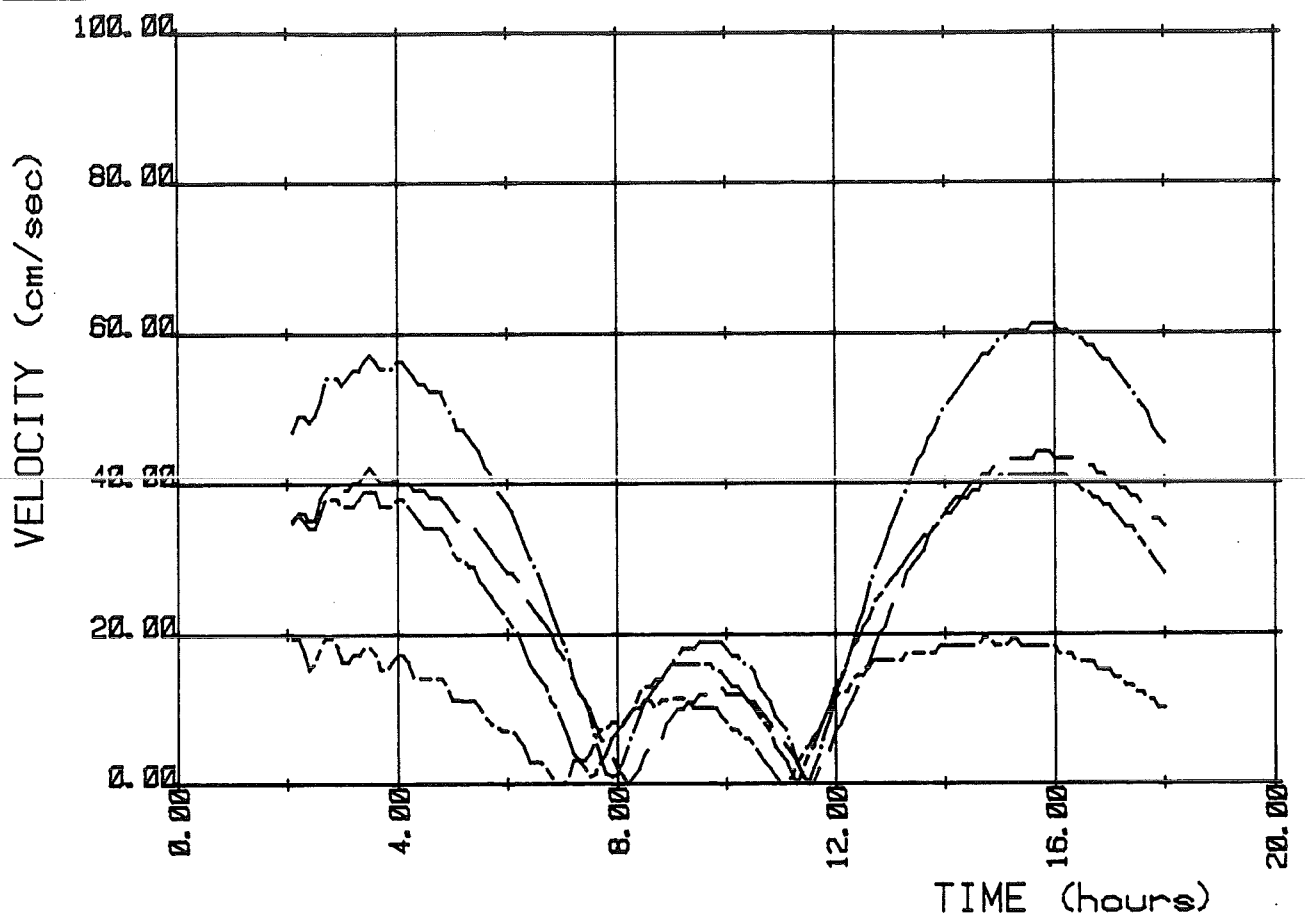

Computed velocity curves

-----	N= 91 M= 10	station 42
-----	N= 91 M= 12	station 43
-----	N= 91 M= 14	station 44
-----	N= 91 M= 17	station 45



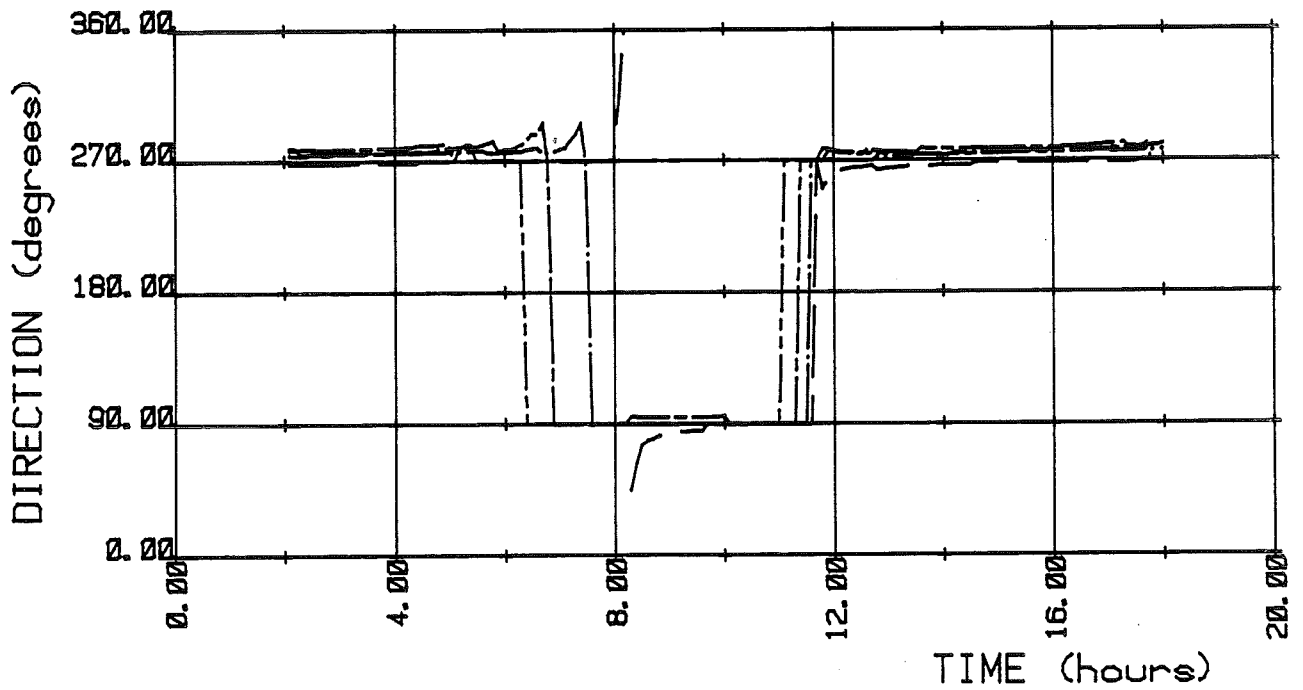
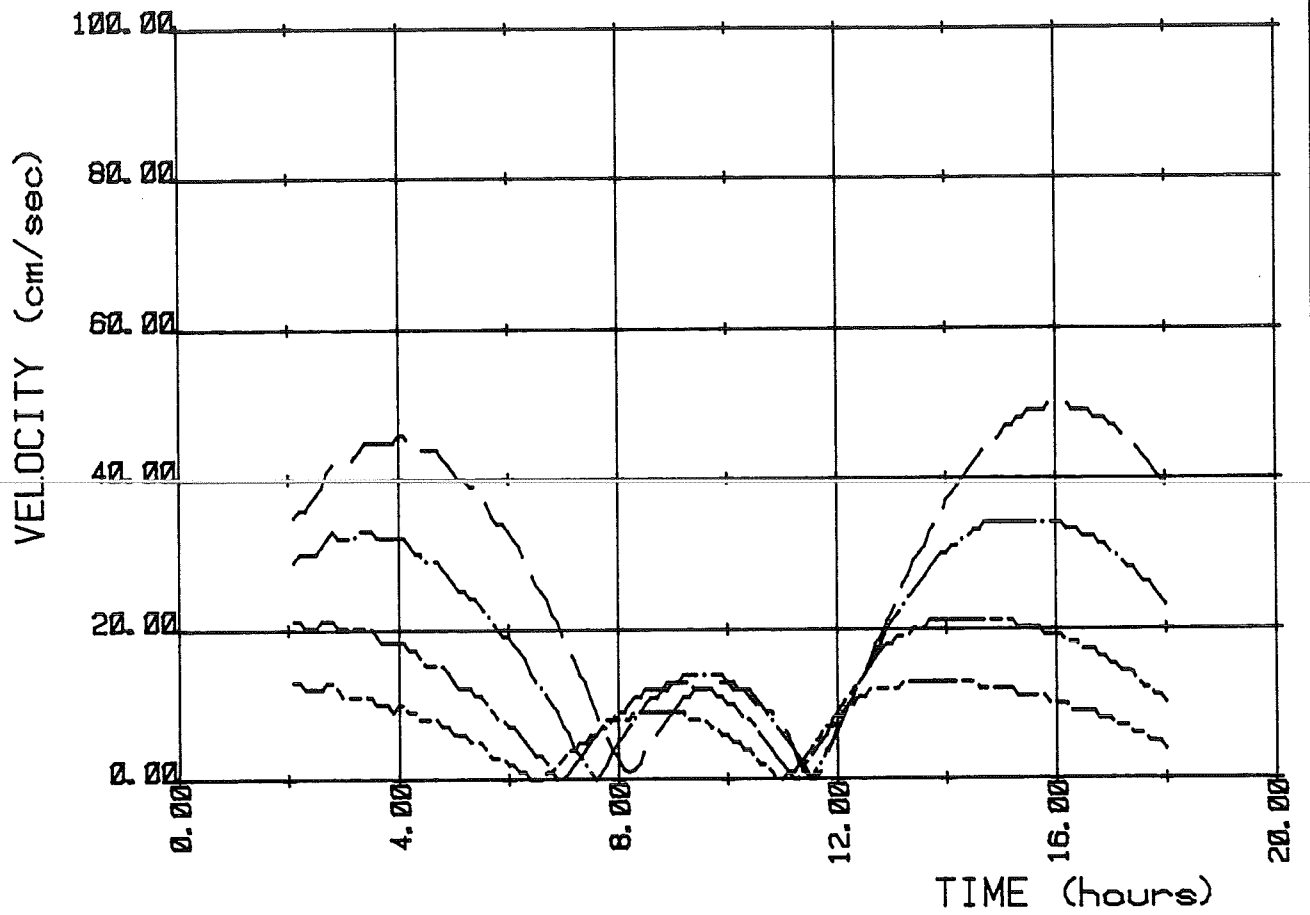

Computed velocity curves

- N= 79 M= 7 station 46
- N= 79 M= 9 station 47
- . - . - . N= 79 M= 12 station 48
- - - - - N= 79 M= 16 station 49



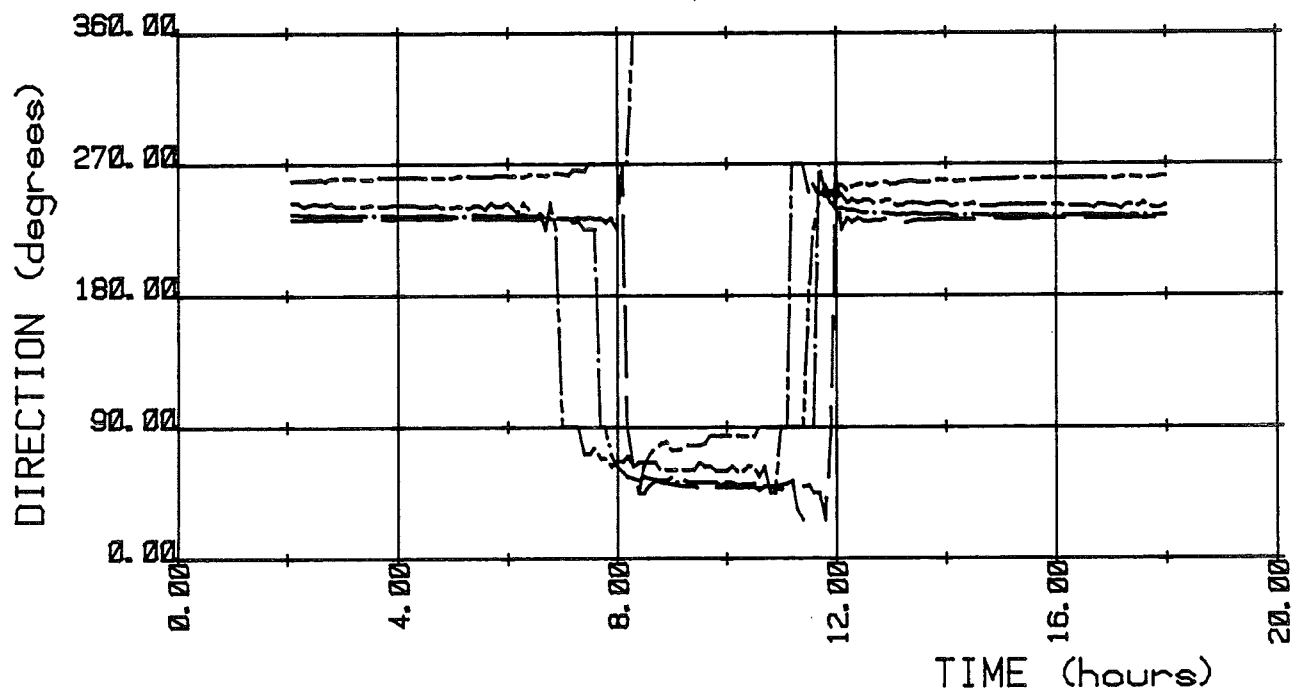
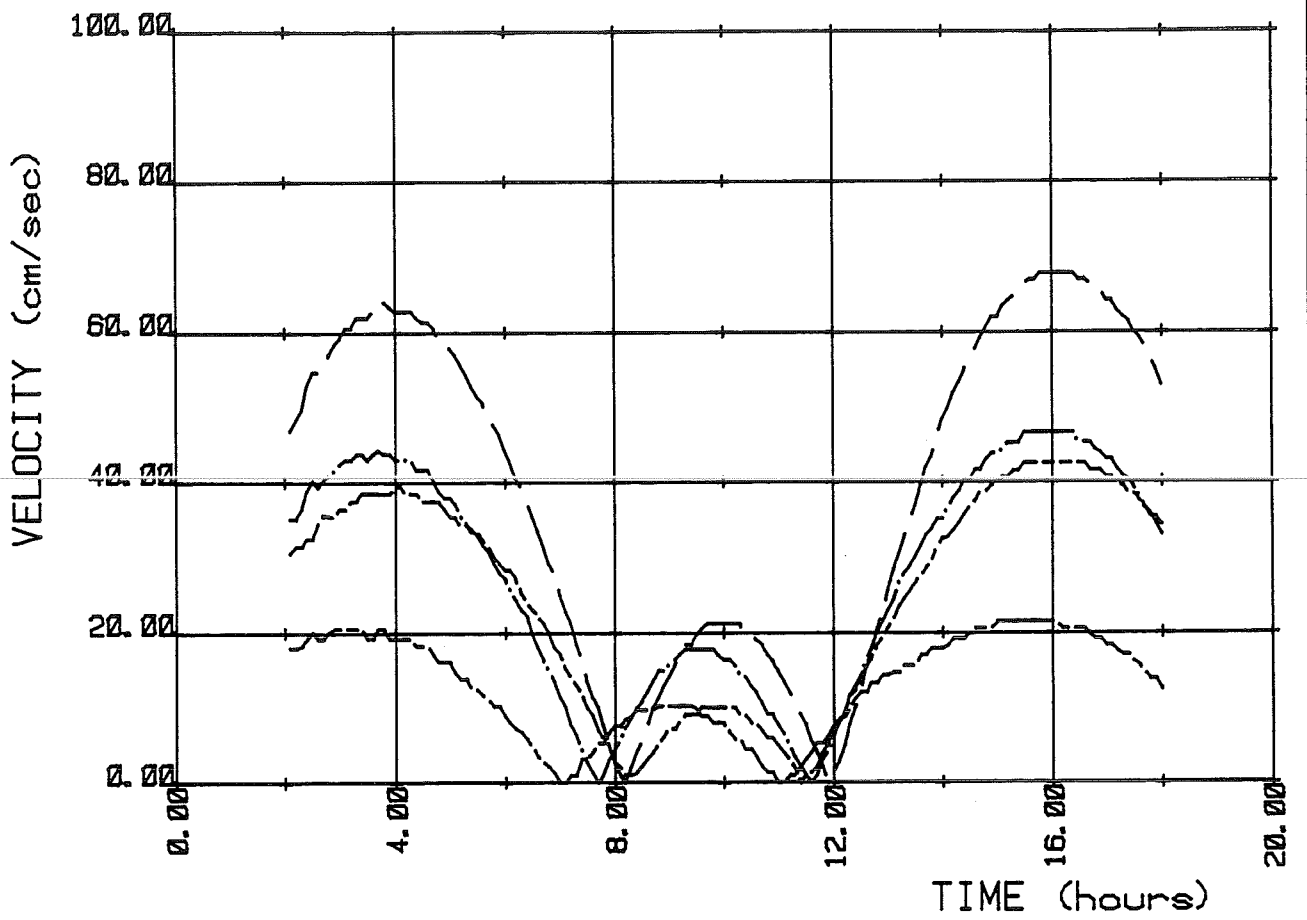

Computed velocity curves

-----	N= 79 M= 18	station 50
- - - - -	N= 56 M= 13	station 51
- . - . - .	N= 56 M= 16	station 52
- - - - -	N= 57 M= 20	station 53



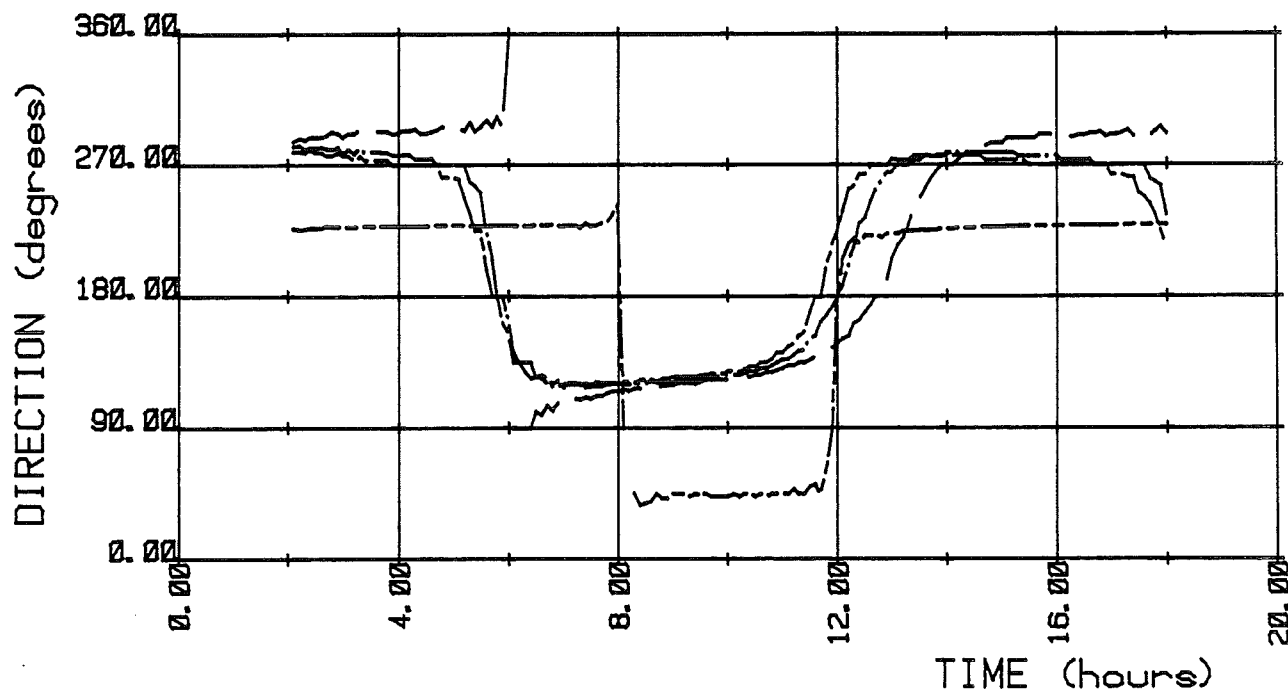
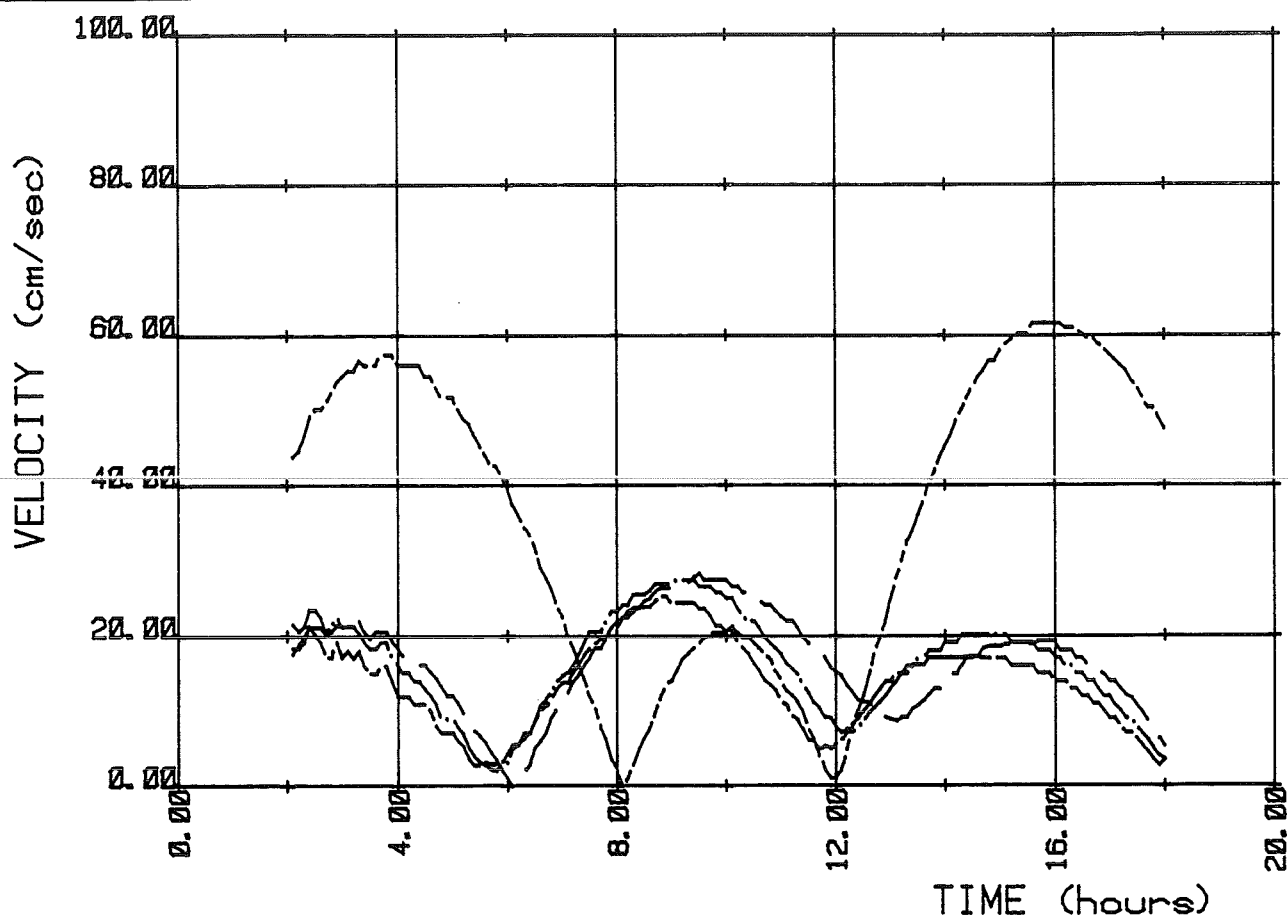

Computed velocity curves

-----	N= 57 M= 22	station 54
-----	N= 45 M= 21	station 100
-----	N= 43 M= 22	station 101
-----	N= 39 M= 24	station 102



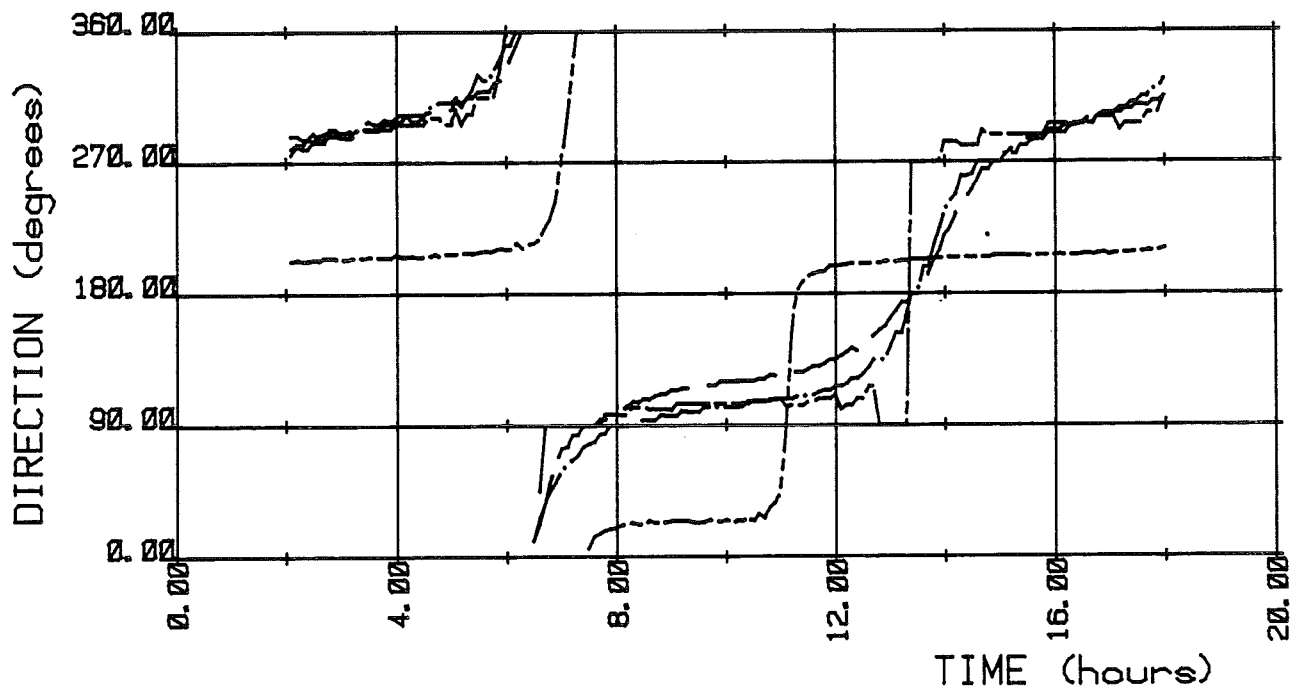
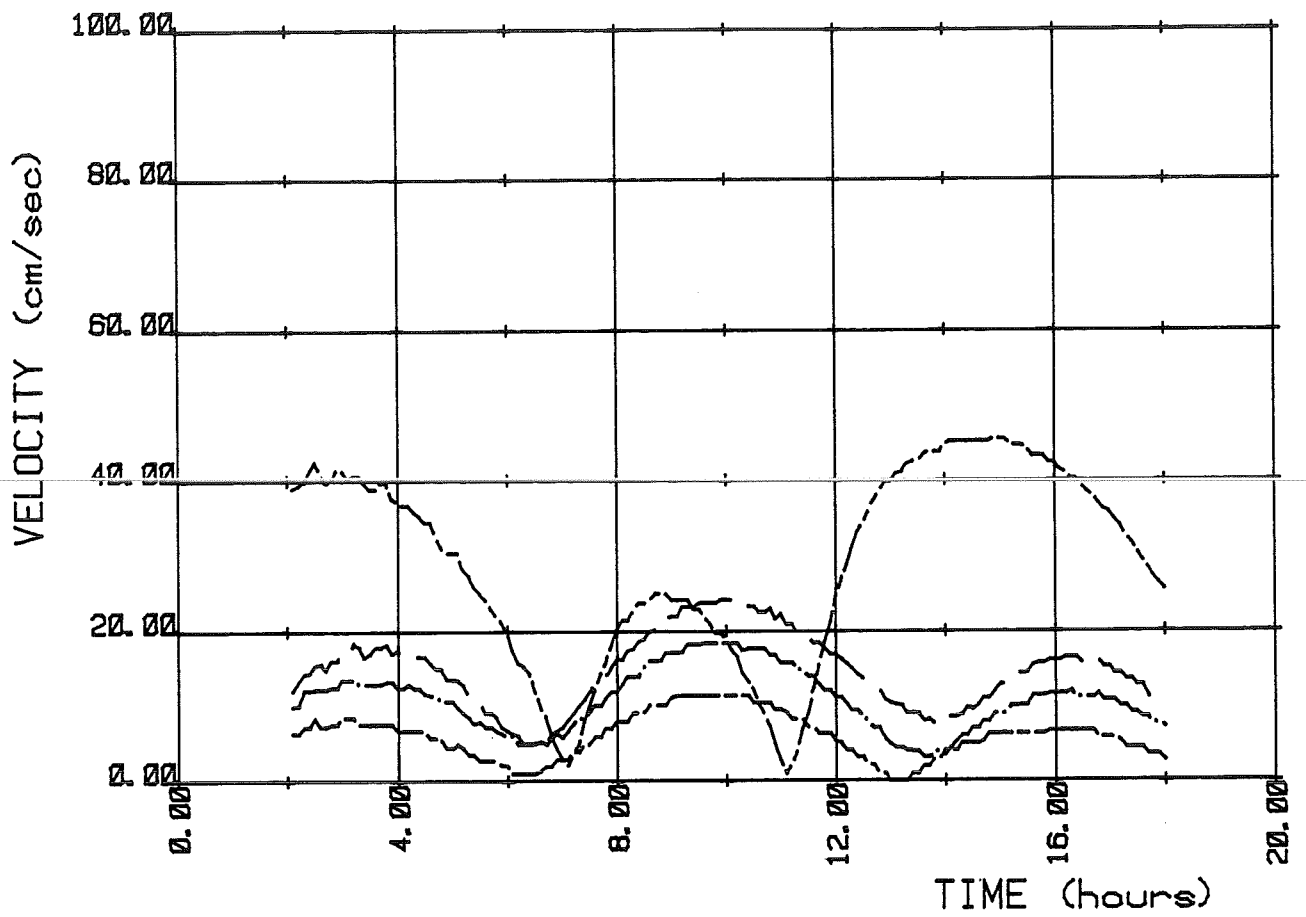

Computed velocity curves

-----	N= 70 M= 25	station 103
- - - - -	N= 29 M= 16	station 105
— · — · —	N= 31 M= 24	station 106
- - - - -	N= 33 M= 27	station 107



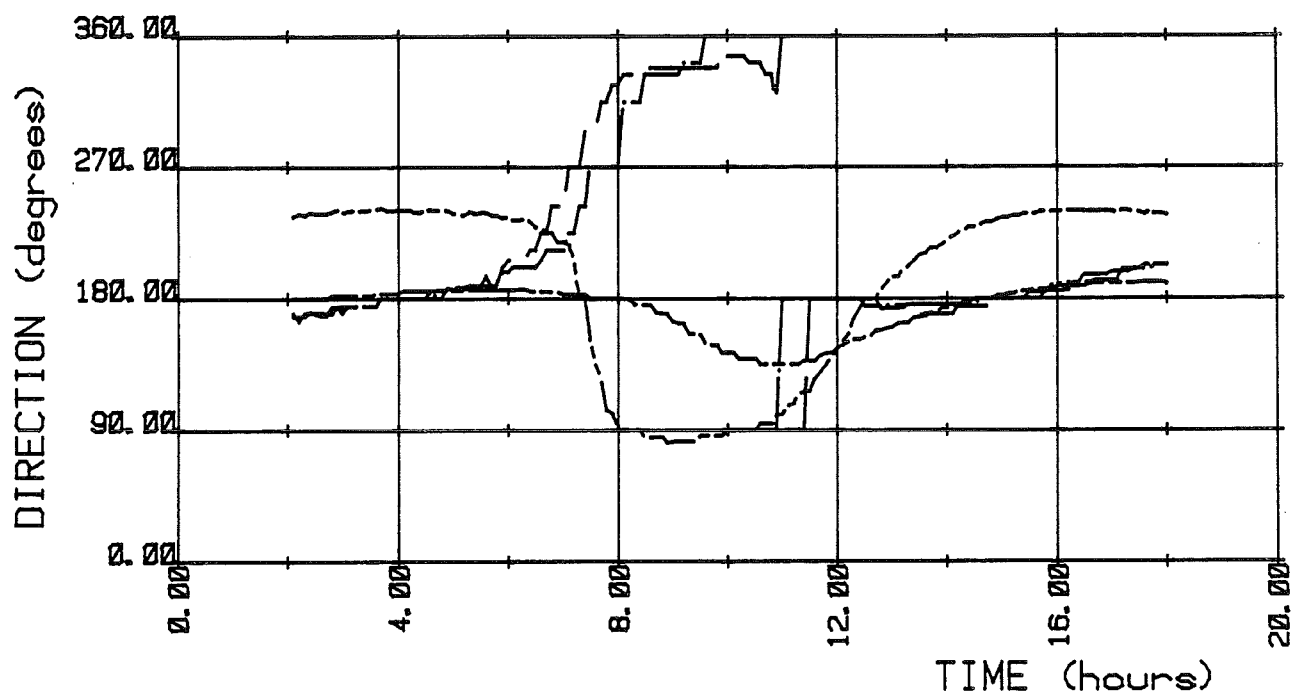
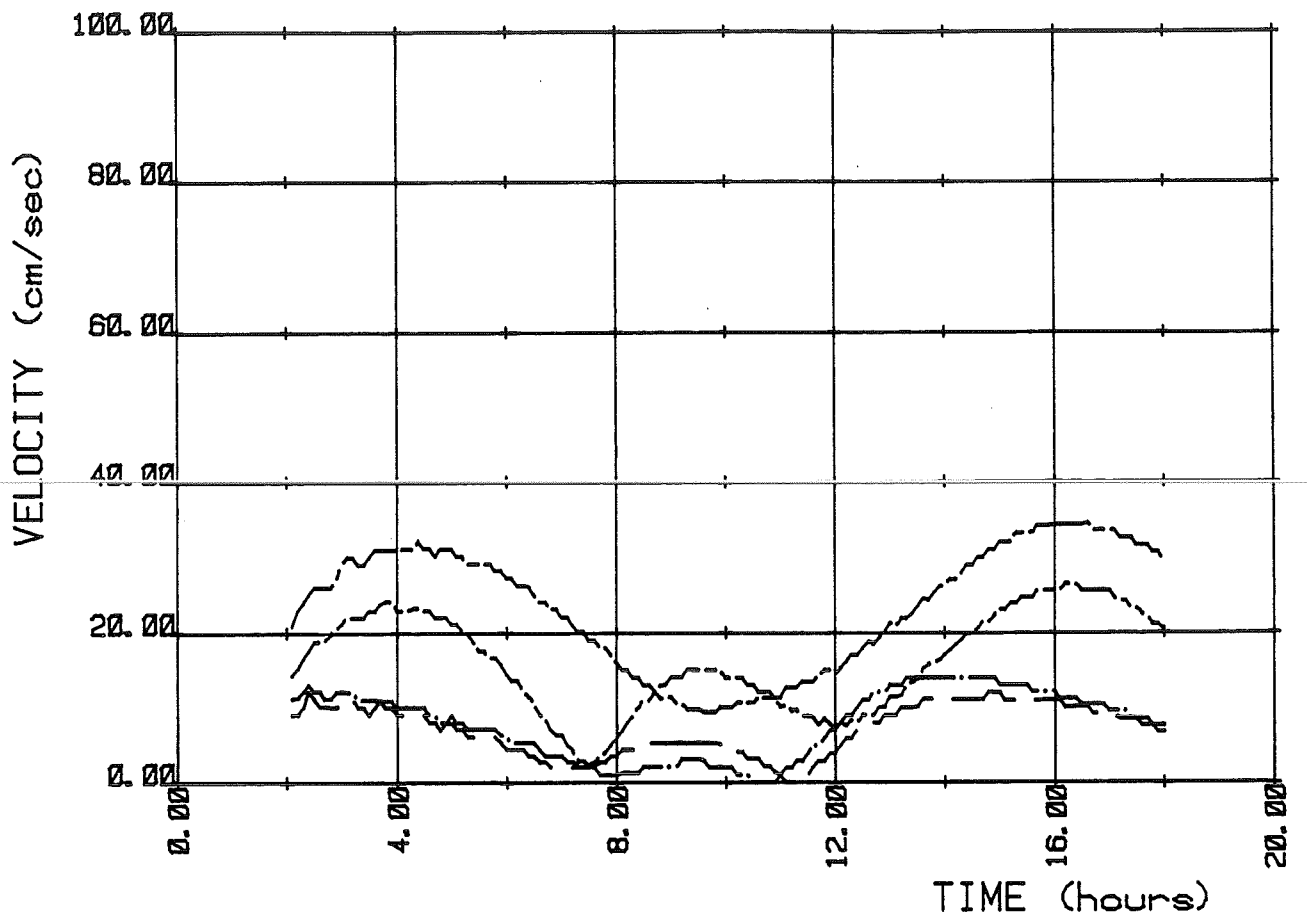

Computed velocity curves

-----	N= 38 M= 32	station 108
- - - - -	N= 47 M= 38	station 109
— · — · —	N= 59 M= 40	station 110
- - - - -	N= 68 M= 40	station 111



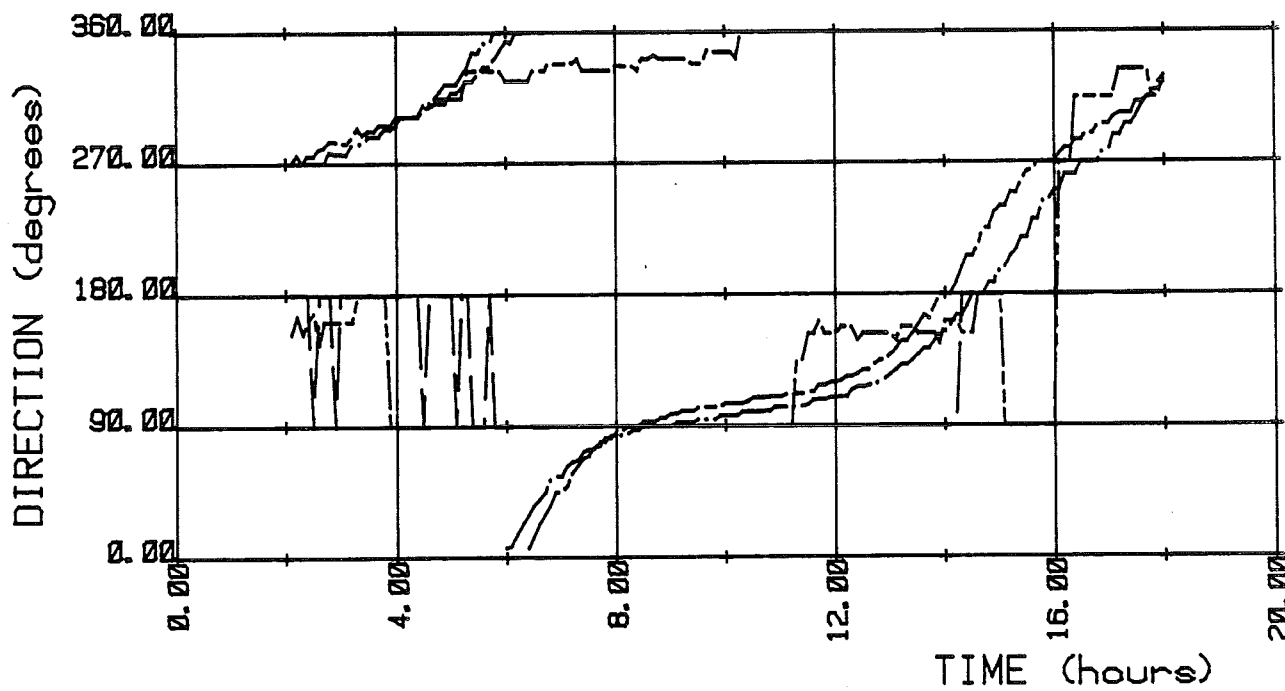
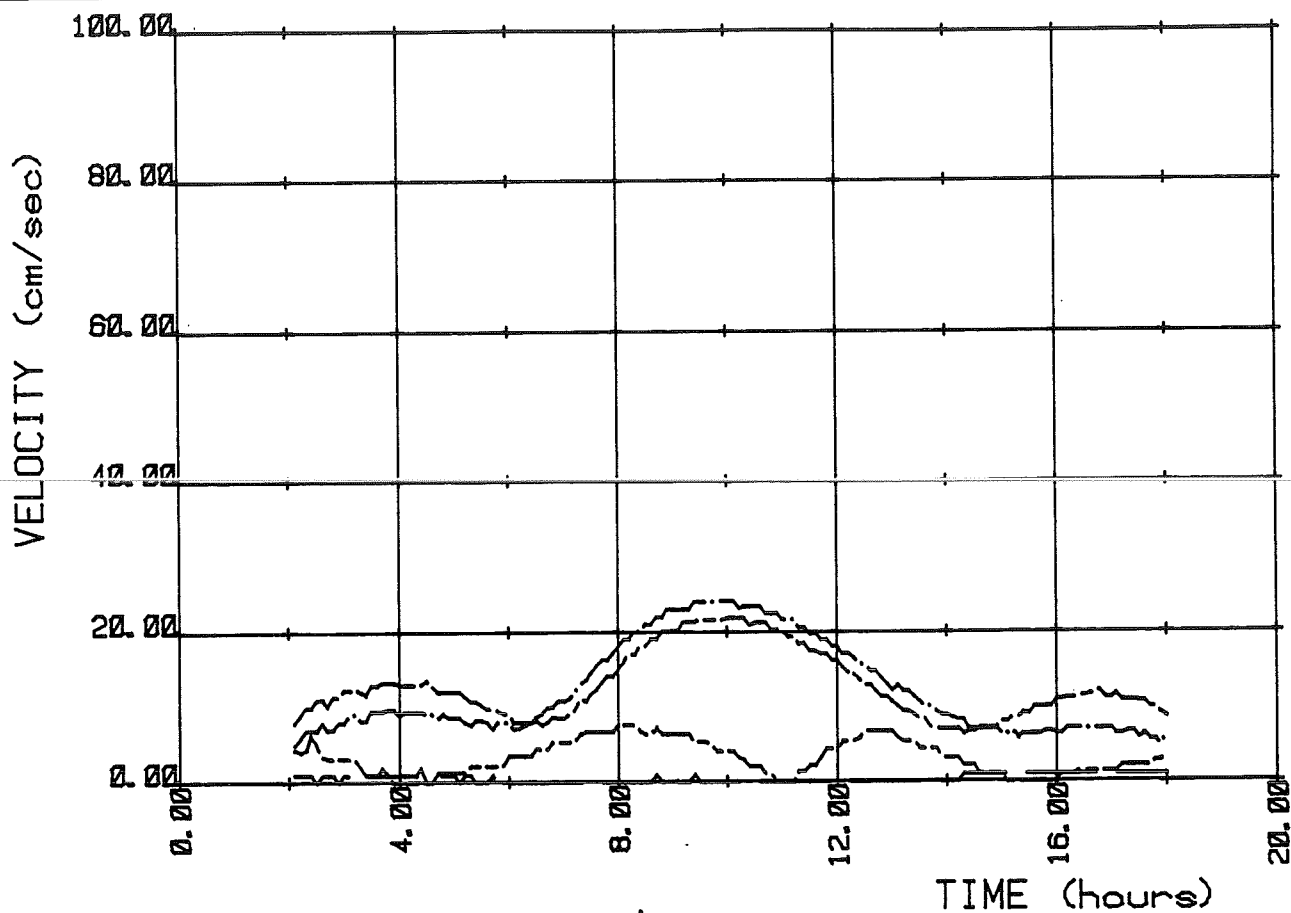

Computed velocity curves

.....	N= 78 M= 37	station 112
-----	N= 28 M= 31	station 113
- . - . - .	N= 25 M= 35	station 114
-----	N= 7 M= 5	station 115



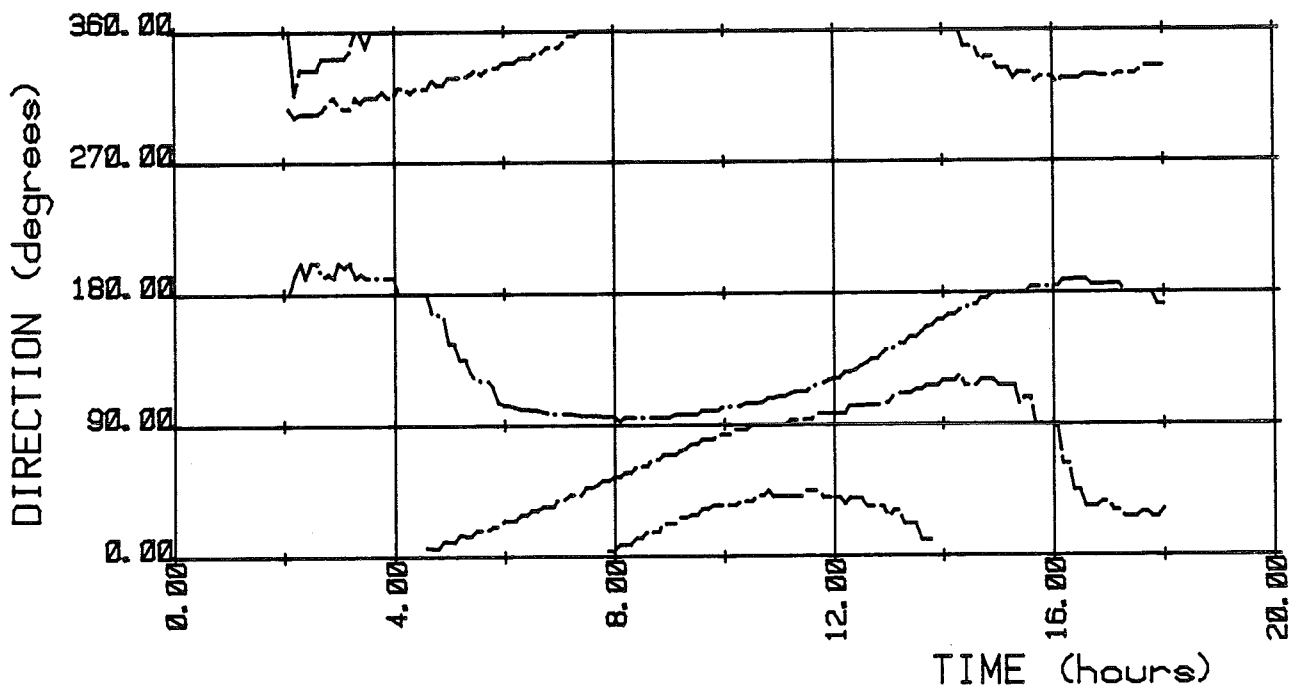
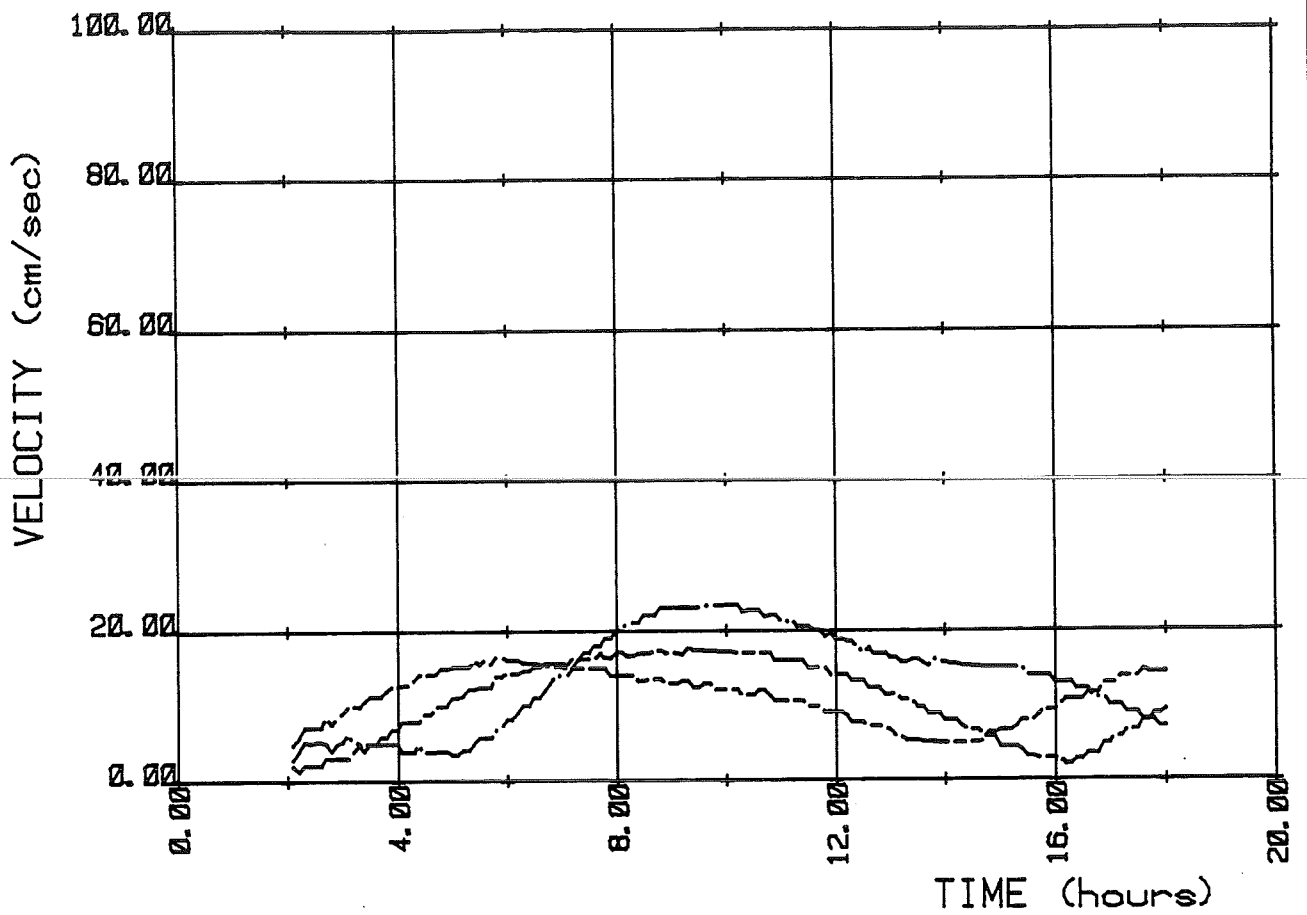

Computed velocity curves

.....	N= 12 M= 25	station 116
-----	N= 17 M= 37	station 117
- . - . - .	N= 25 M= 43	station 118



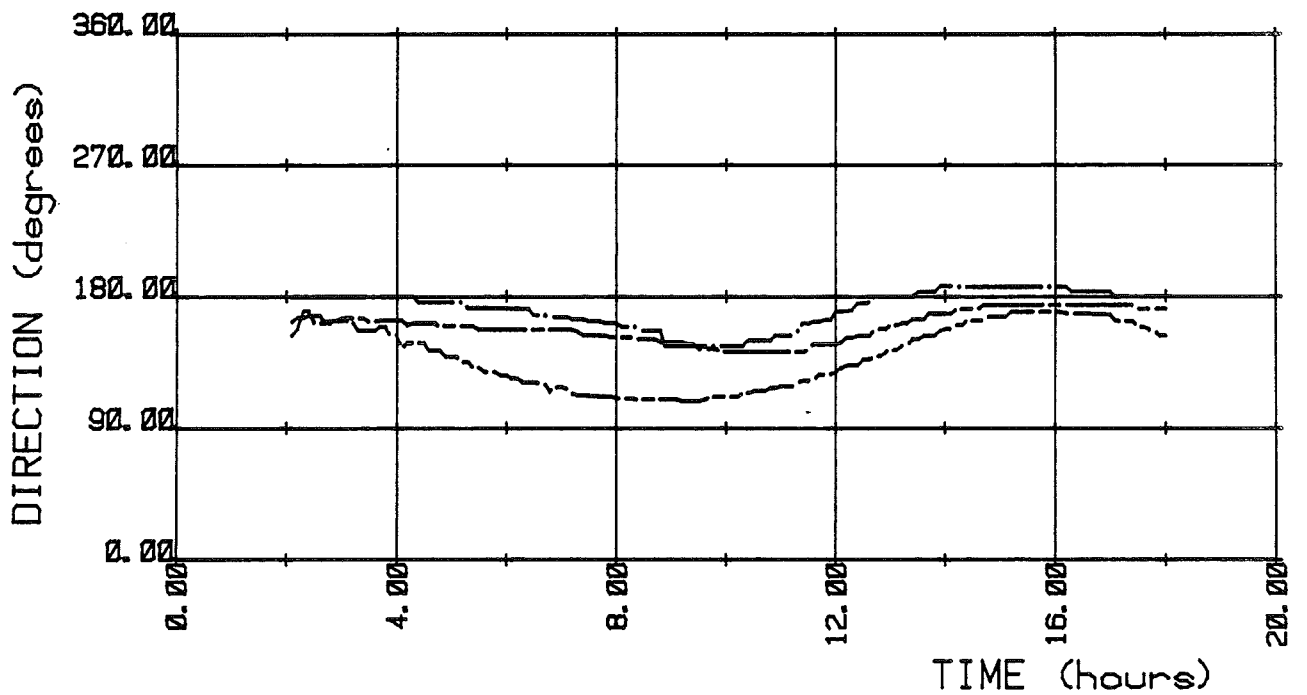
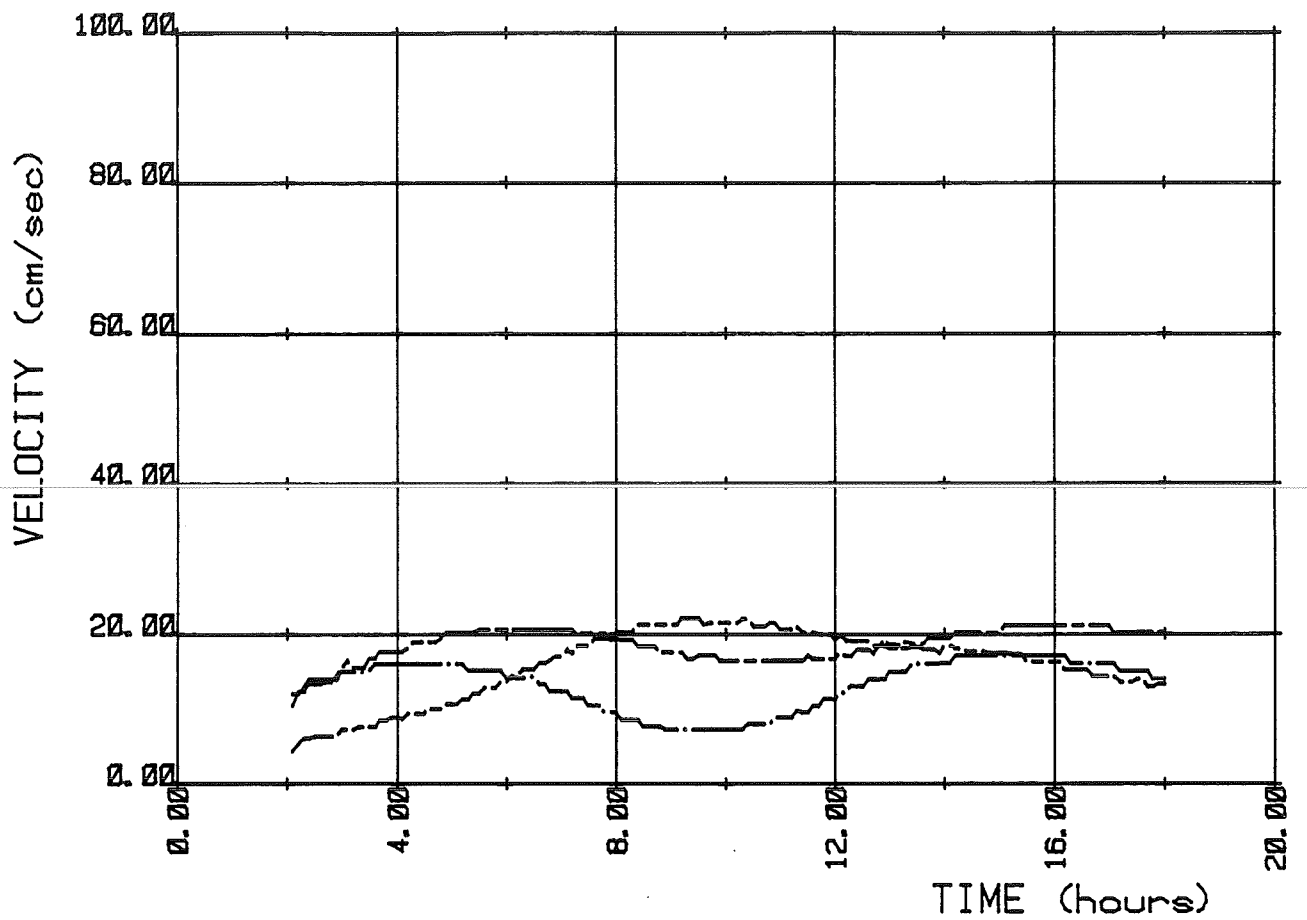

Computed velocity curves

-----	N= 25 M= 47	station 119
—————	N= 37 M= 53	station 120
- · - · - · -	N= 51 M= 58	station 121



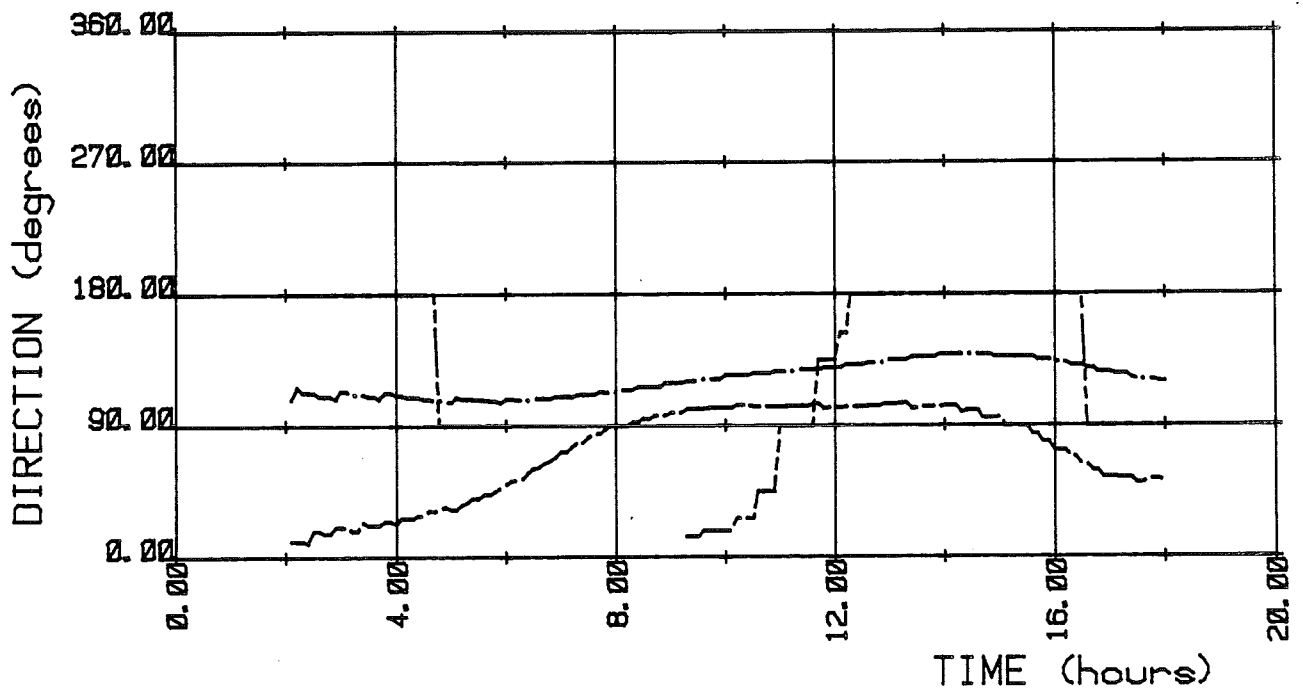
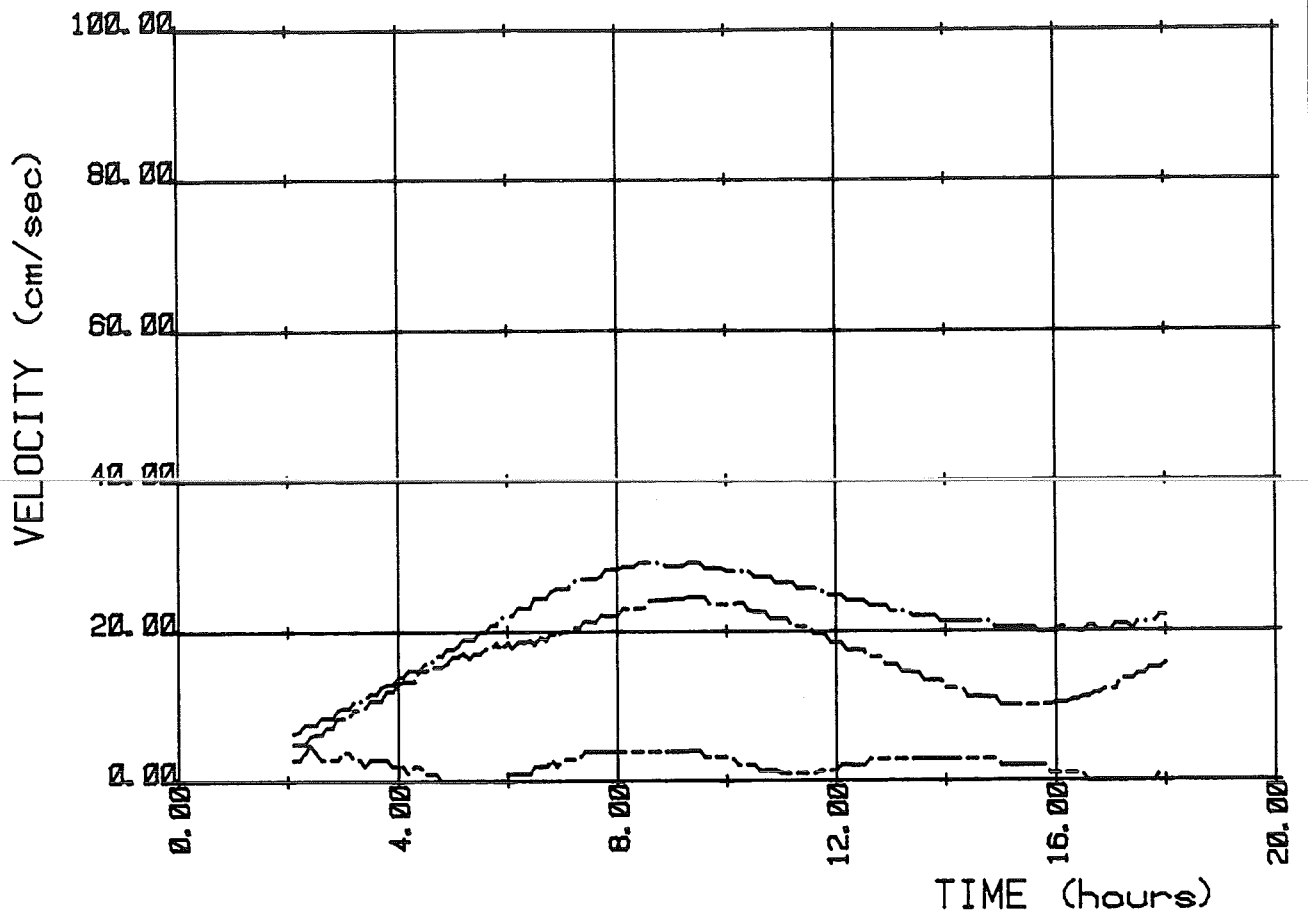

Computed velocity curves

- N= 80 M= 57 station 123
- N= 7 M= 41 station 126
- .-.-.- N= 17 M= 58 station 127



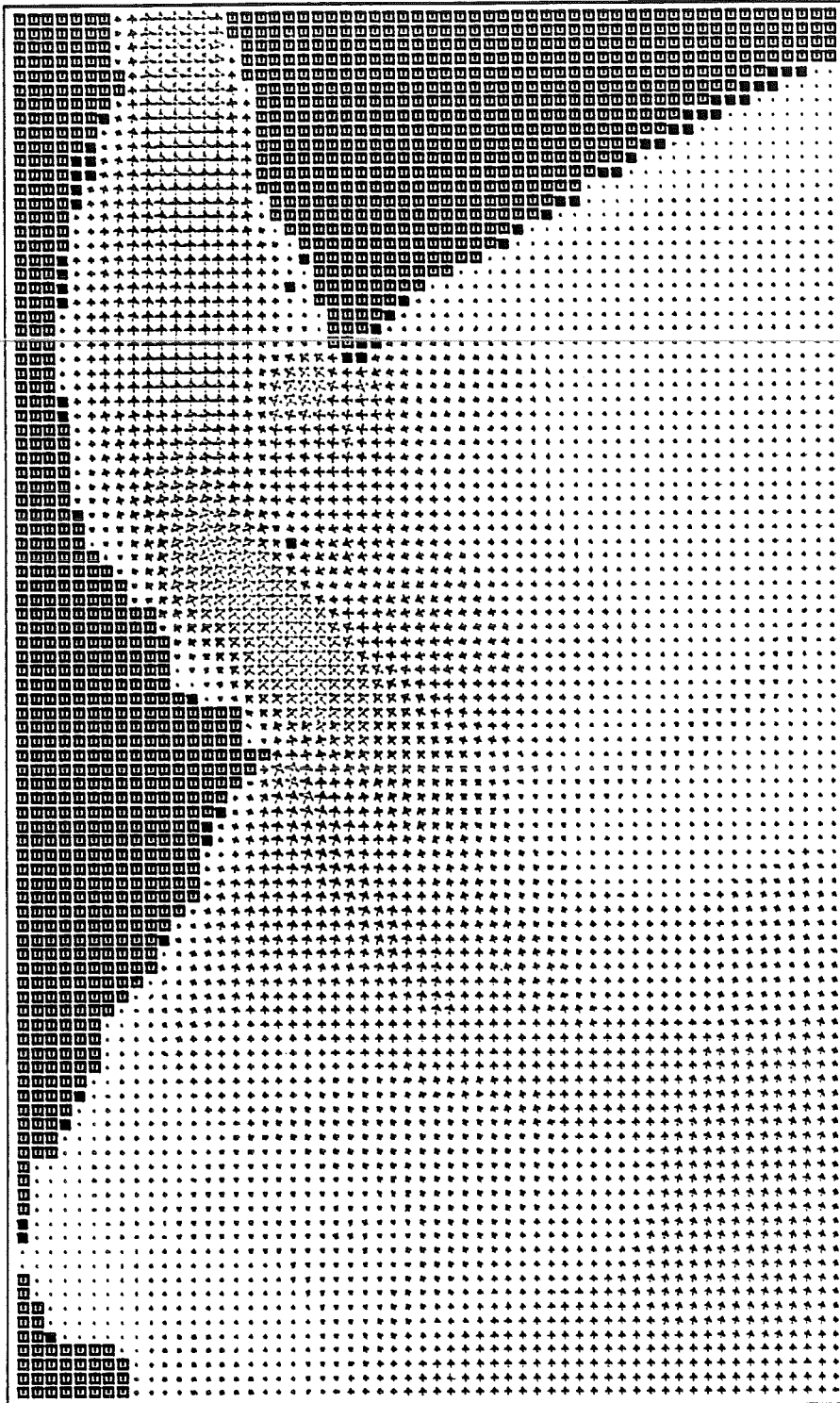

scale 1 : 100000

Computed flowfield: 9 hours after HW
at Cascais

- ÷ velocity = 1.20 m/s
- + velocity = .60 m/s
- land node
- dry shoal node

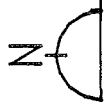

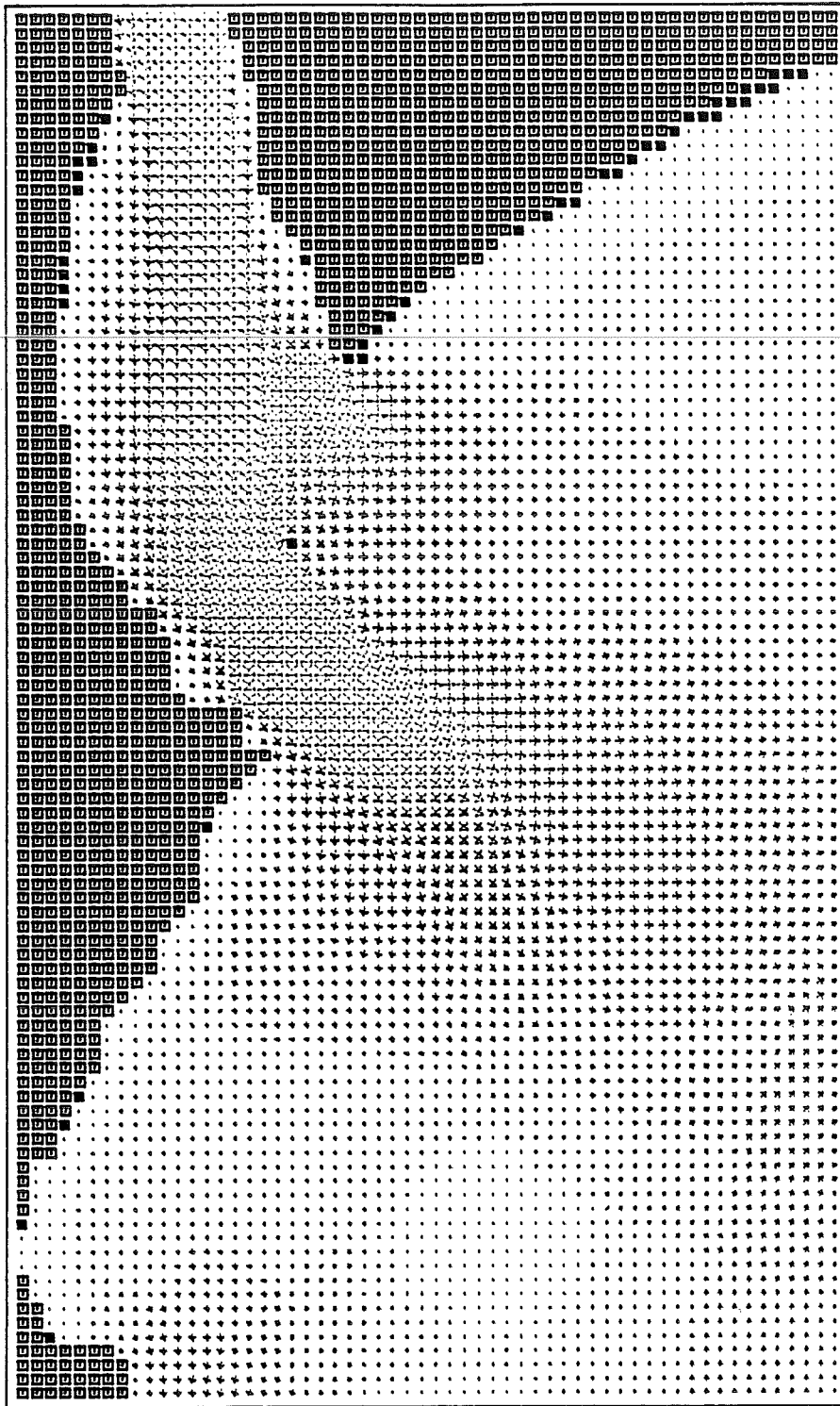

scale 1 : 100000

Computed flowfield; 15 hours after HW
at Cascais

- ⊕ velocity = 1.20 m/s
- ⊕ velocity = .60 m/s
- land node
- dry shoal node

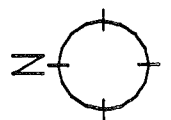

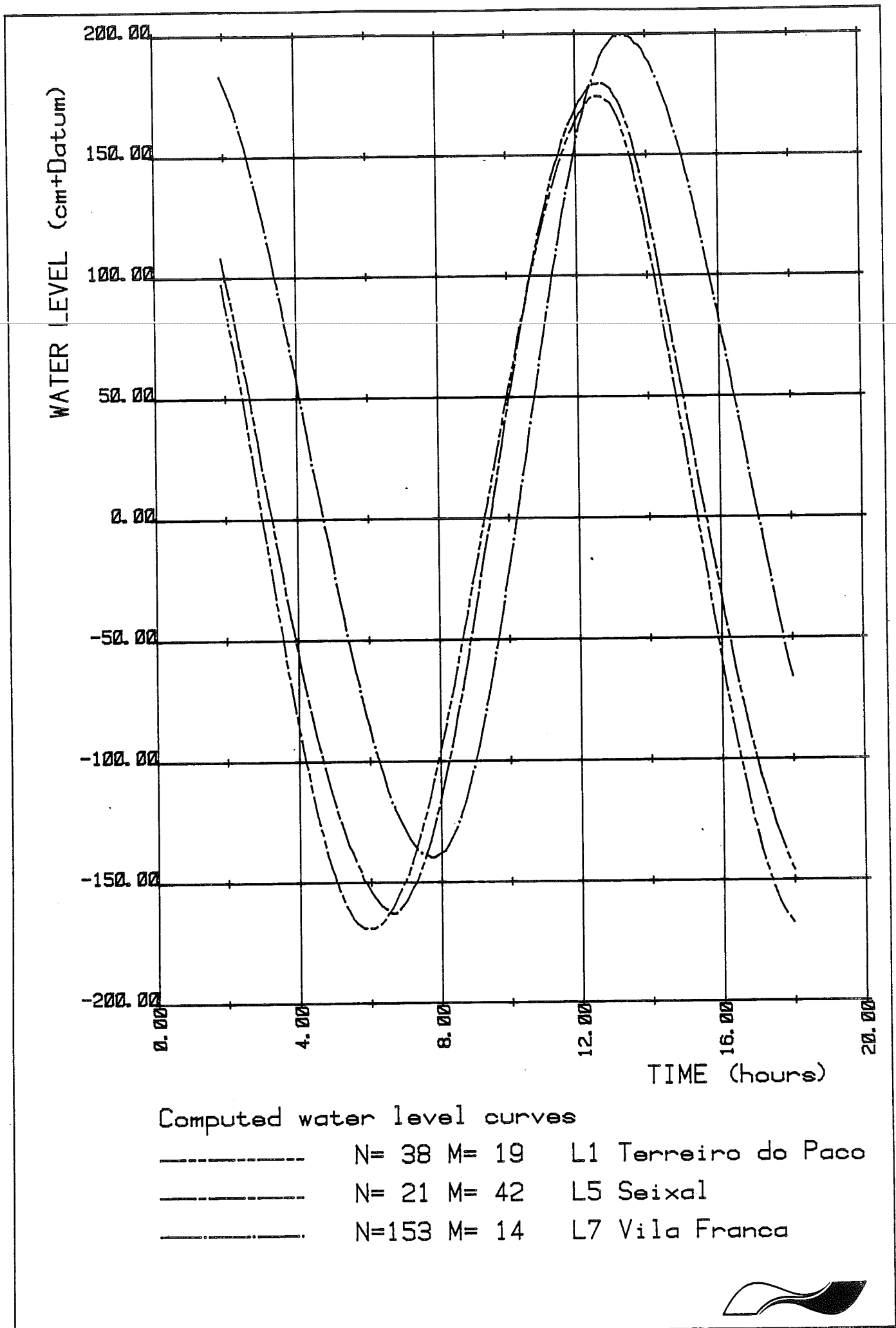

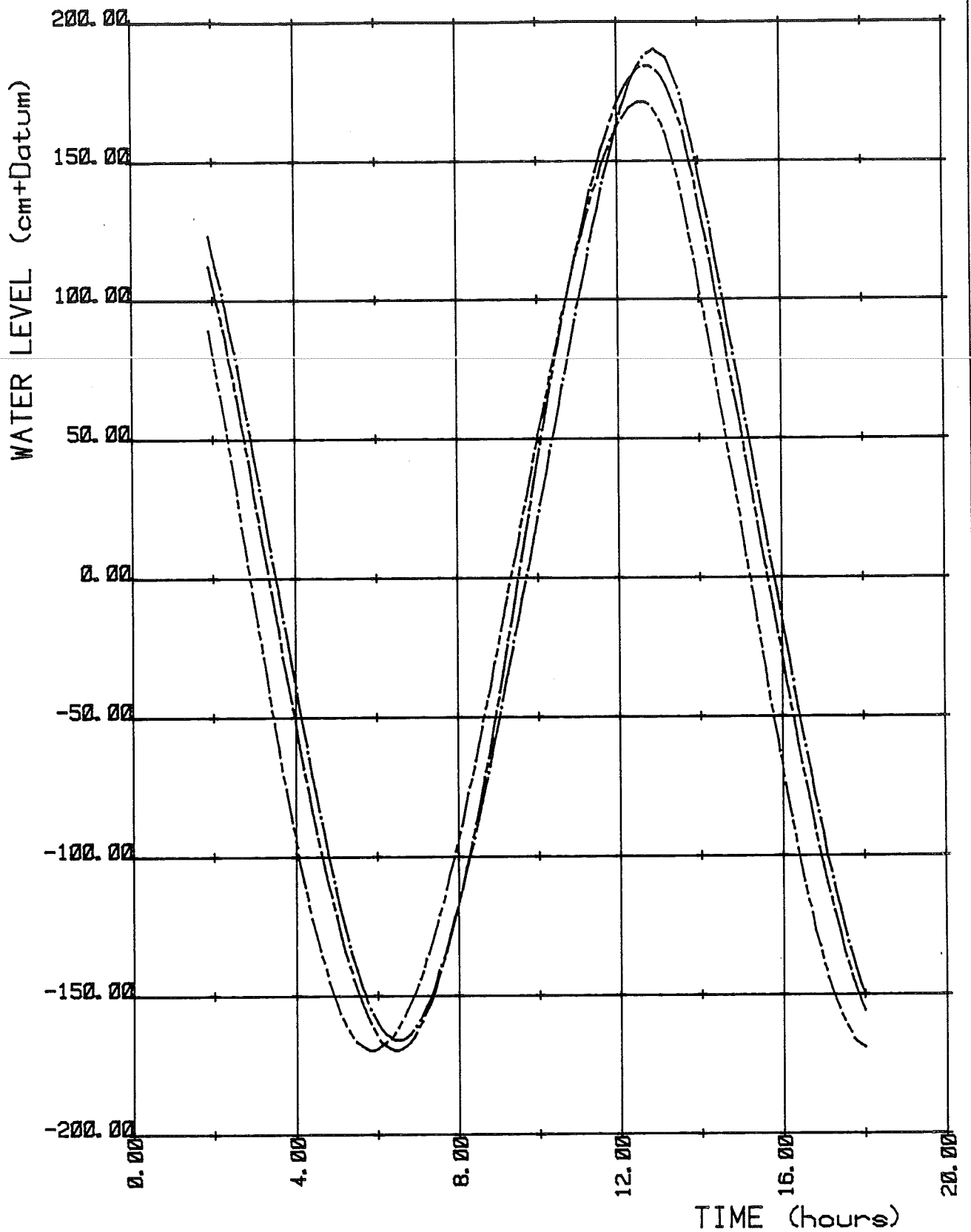

Computed water level curves

- N= 28 M= 18 L2 Cacilhas
- N= 46 M= 48 L6 Montijo Base
- N= 64 M= 20 L9 Cabo Ruivo



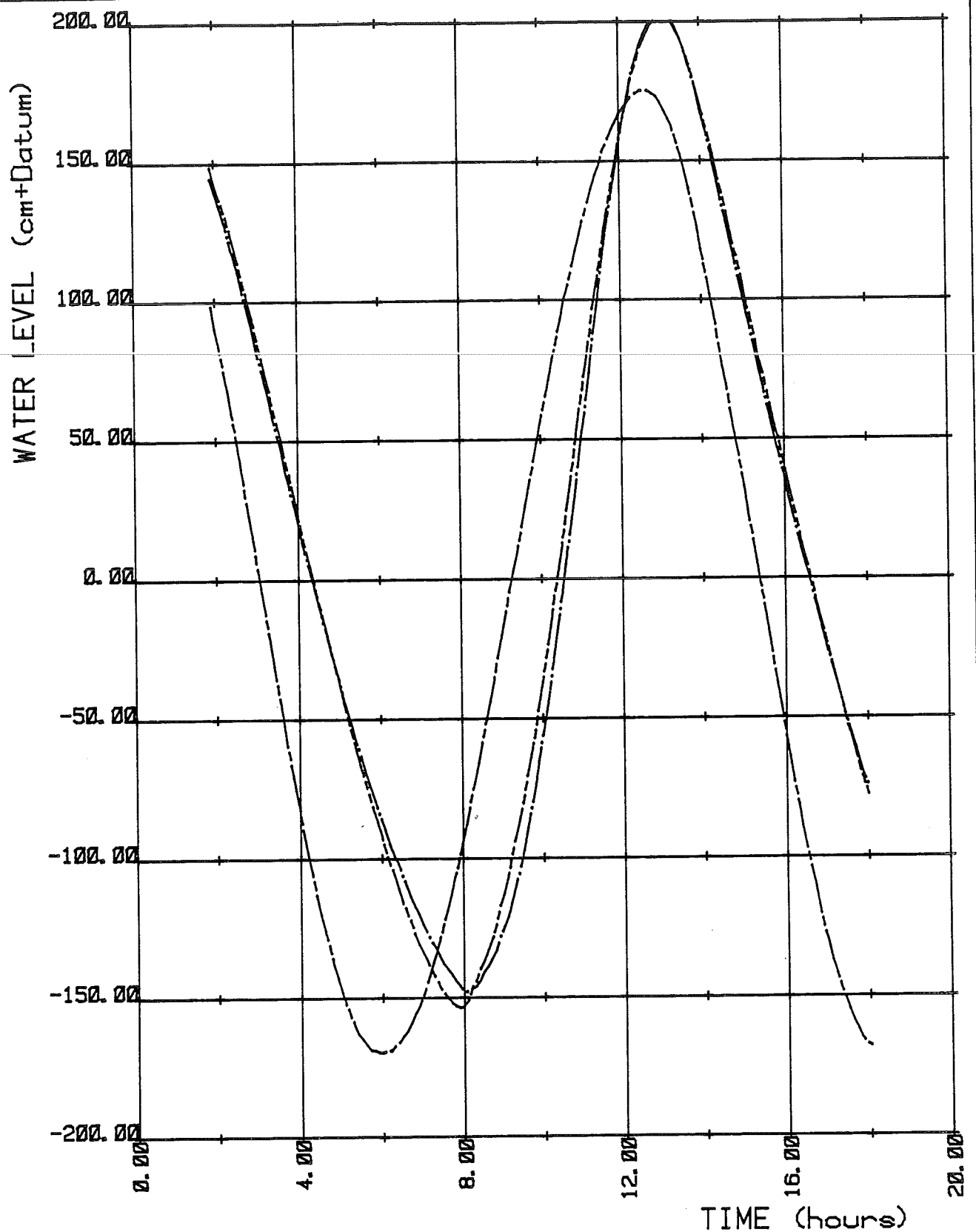

Computed water level curves

- N=112 M= 11 L4 Povoa
- N= 21 M= 25 L8 Alfeite
- N=116 M= 43 station 13



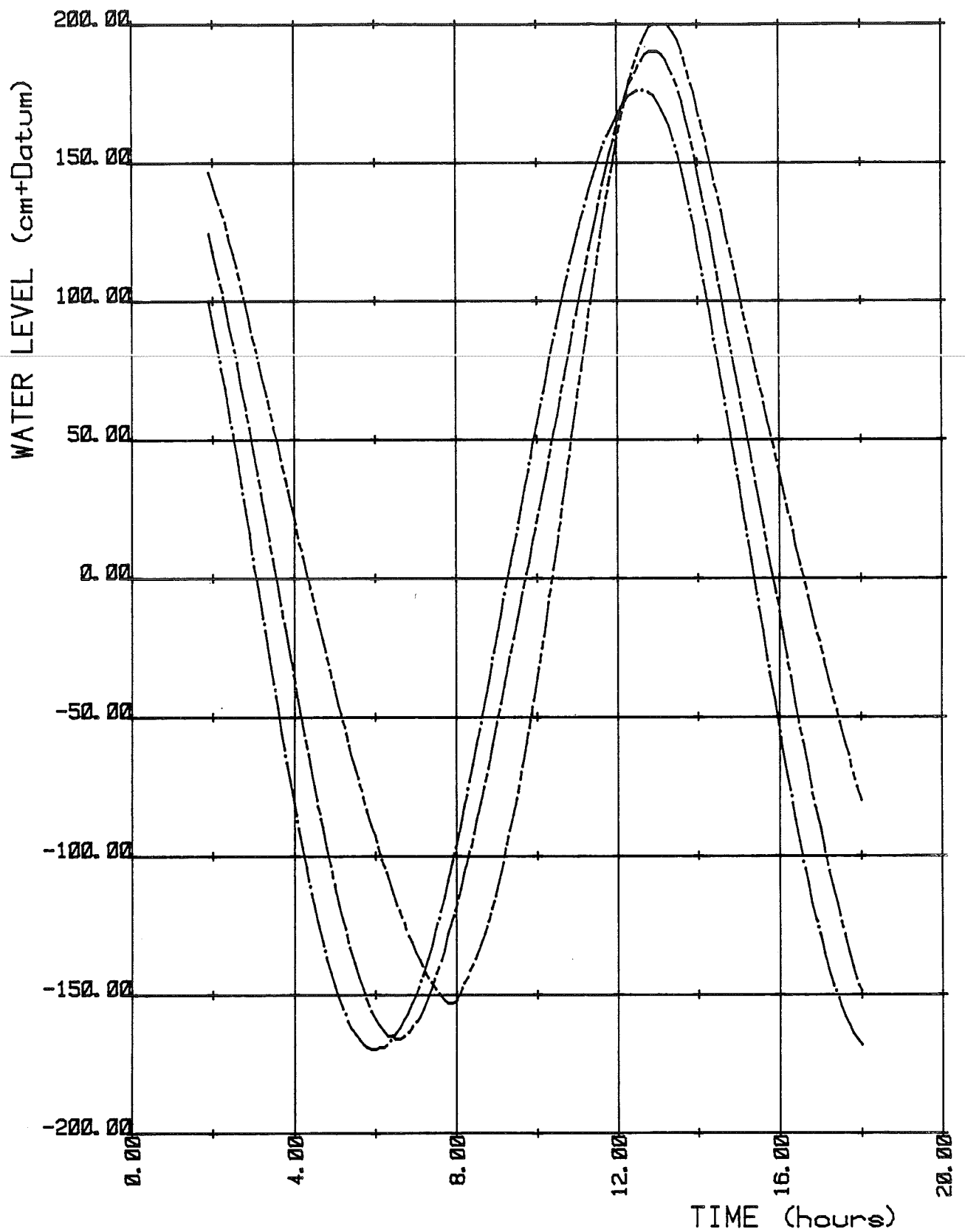

Computed water level curves

-----	N=108 M= 10	station 7
—————	N= 66 M= 21	station 26
-.-.-.-.-	N= 26 M= 27	station 41



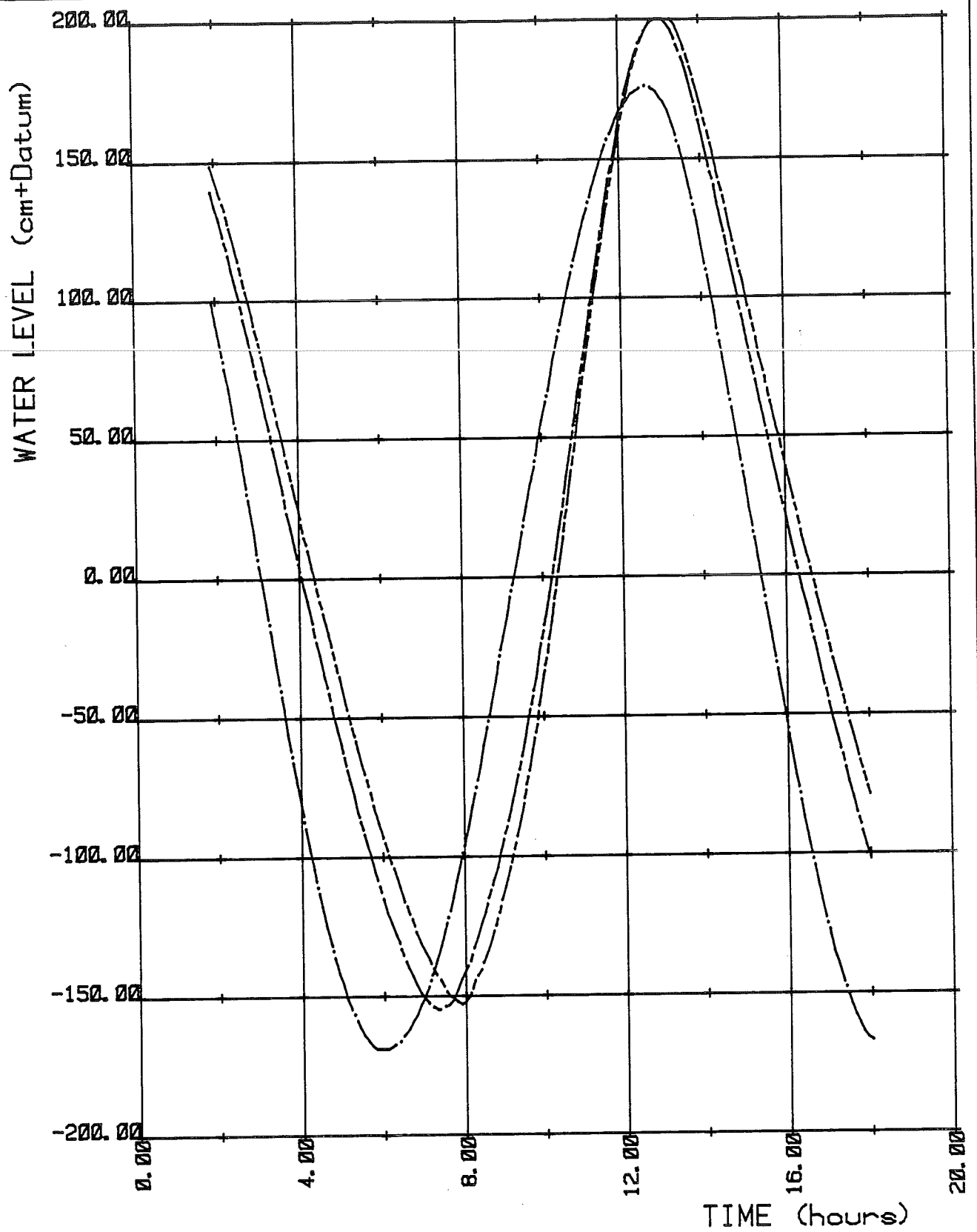

Computed water level curves

- N=116 M= 17 station 8
- .-.-.-.- N= 97 M= 43 station 24
- _____ N= 35 M= 25 station 36



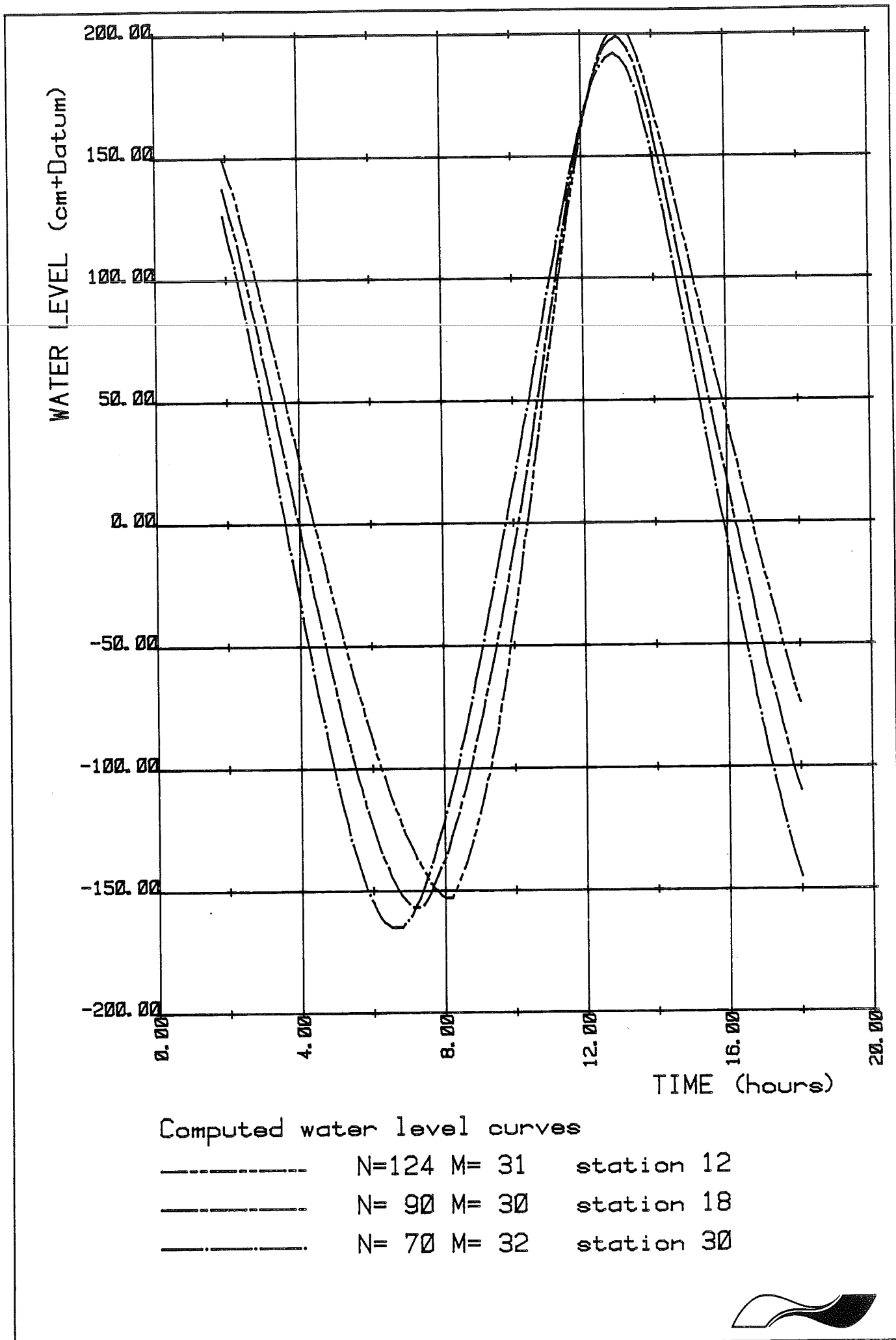

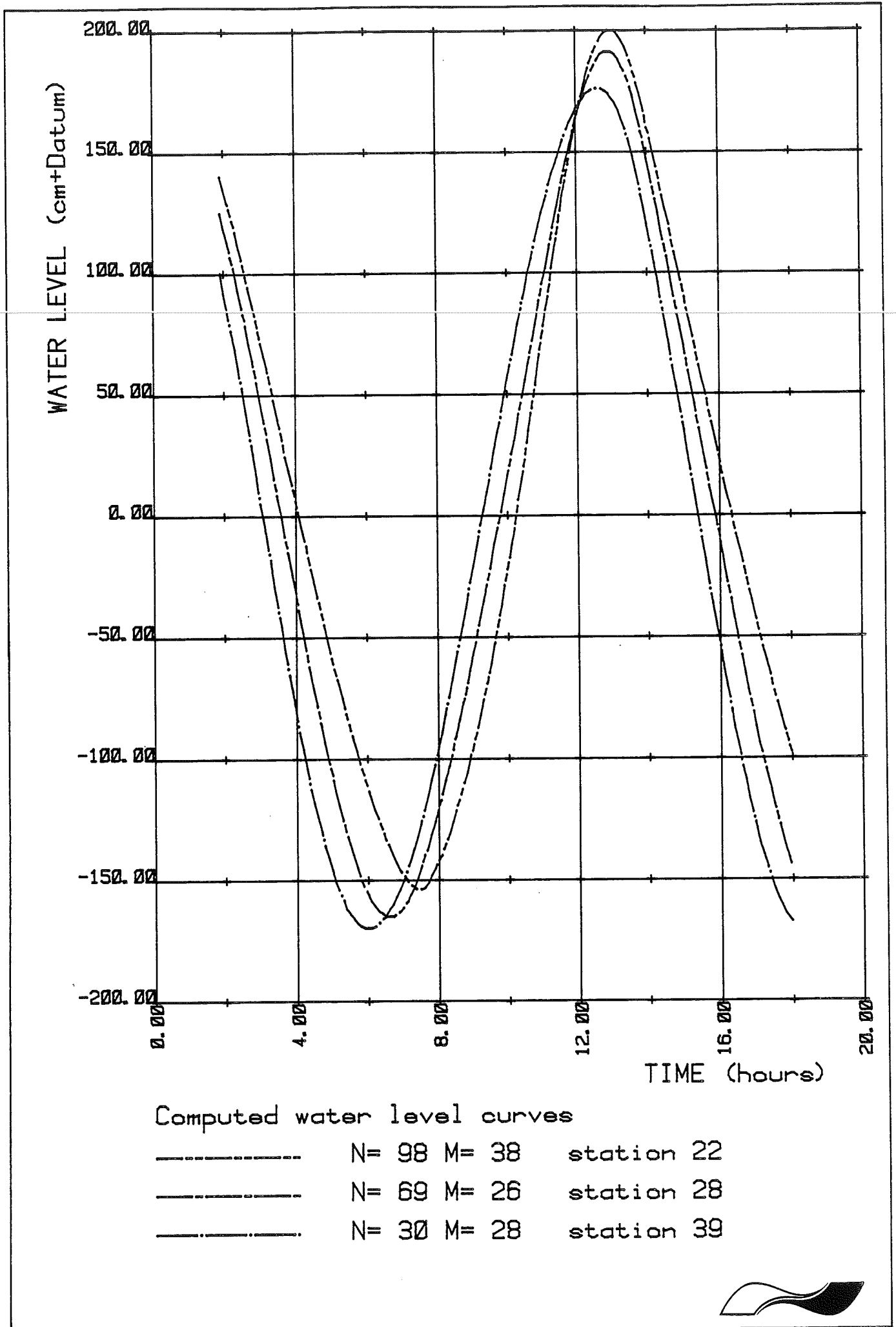

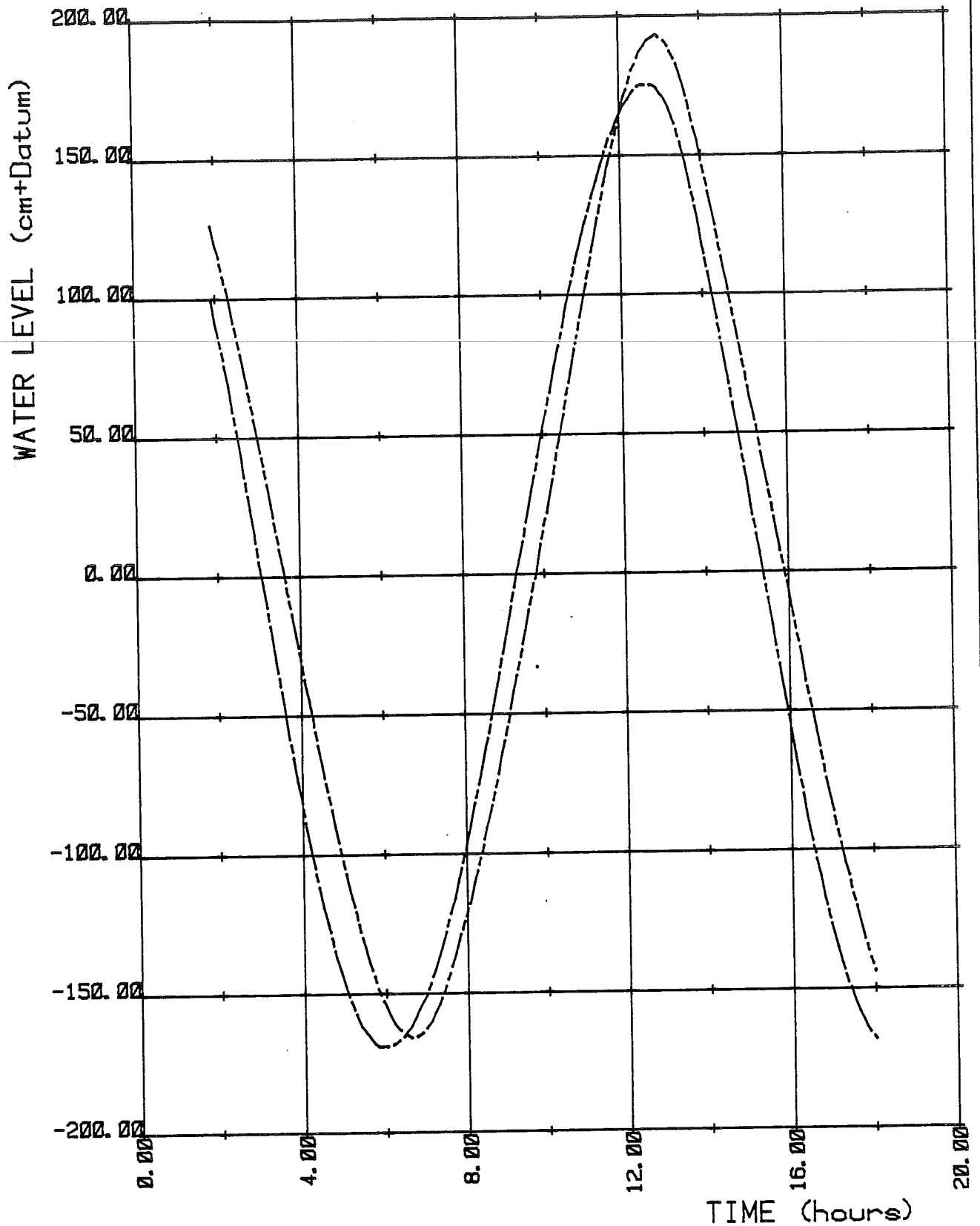

Computed water level curves

----- N= 71 M= 38 station 32
 - . - . - . N= 38 M= 22 station 221-222



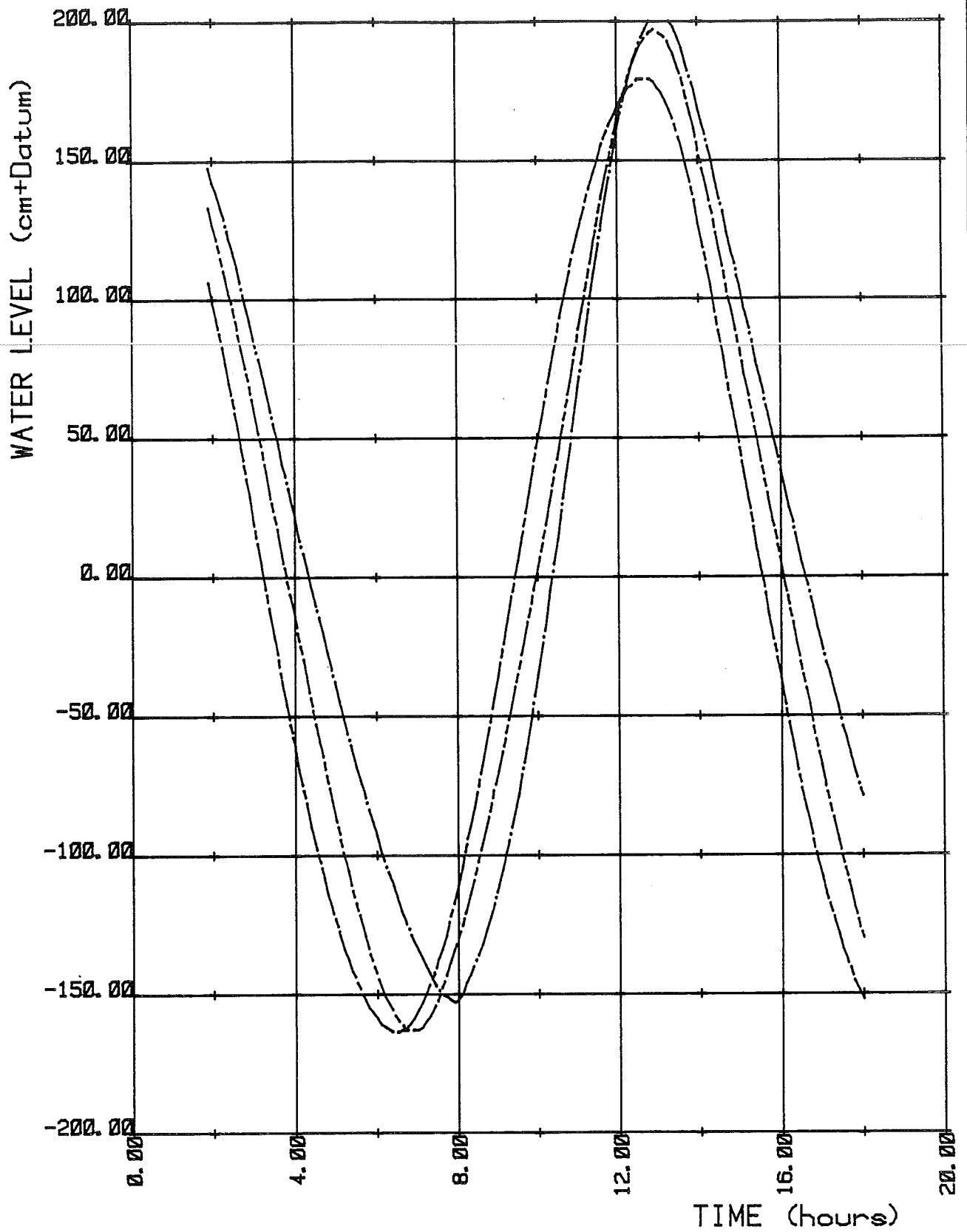

Computed water level curves

- N= 80 M= 45 station 201
- .-.-.-.- N= 25 M= 40 station 203
- N=116 M= 19 station 210-211



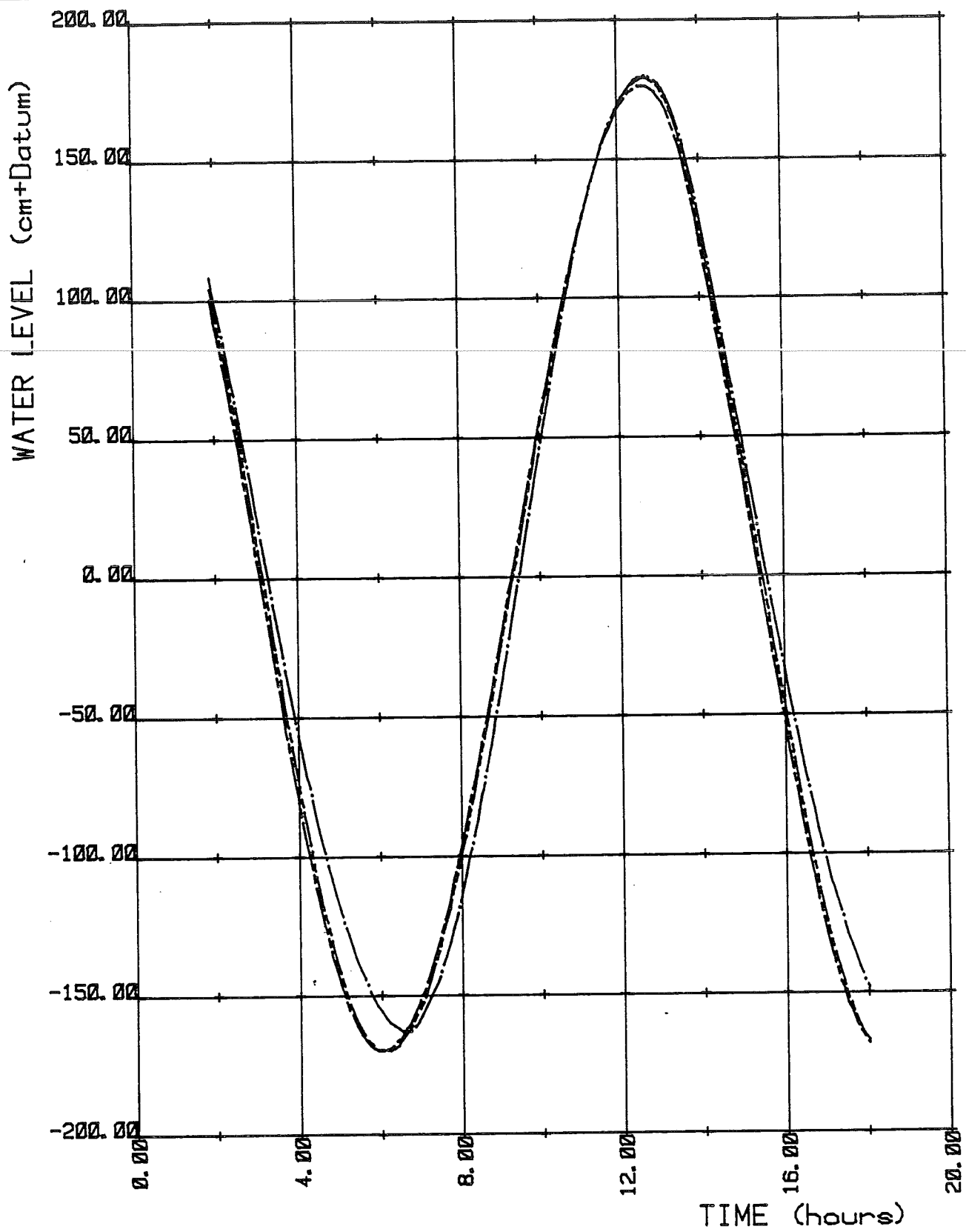

Computed water level curves

----- N= 32 M= 35 station 223

----- N= 25 M= 28 station 224

----- N= 24 M= 43 station 225



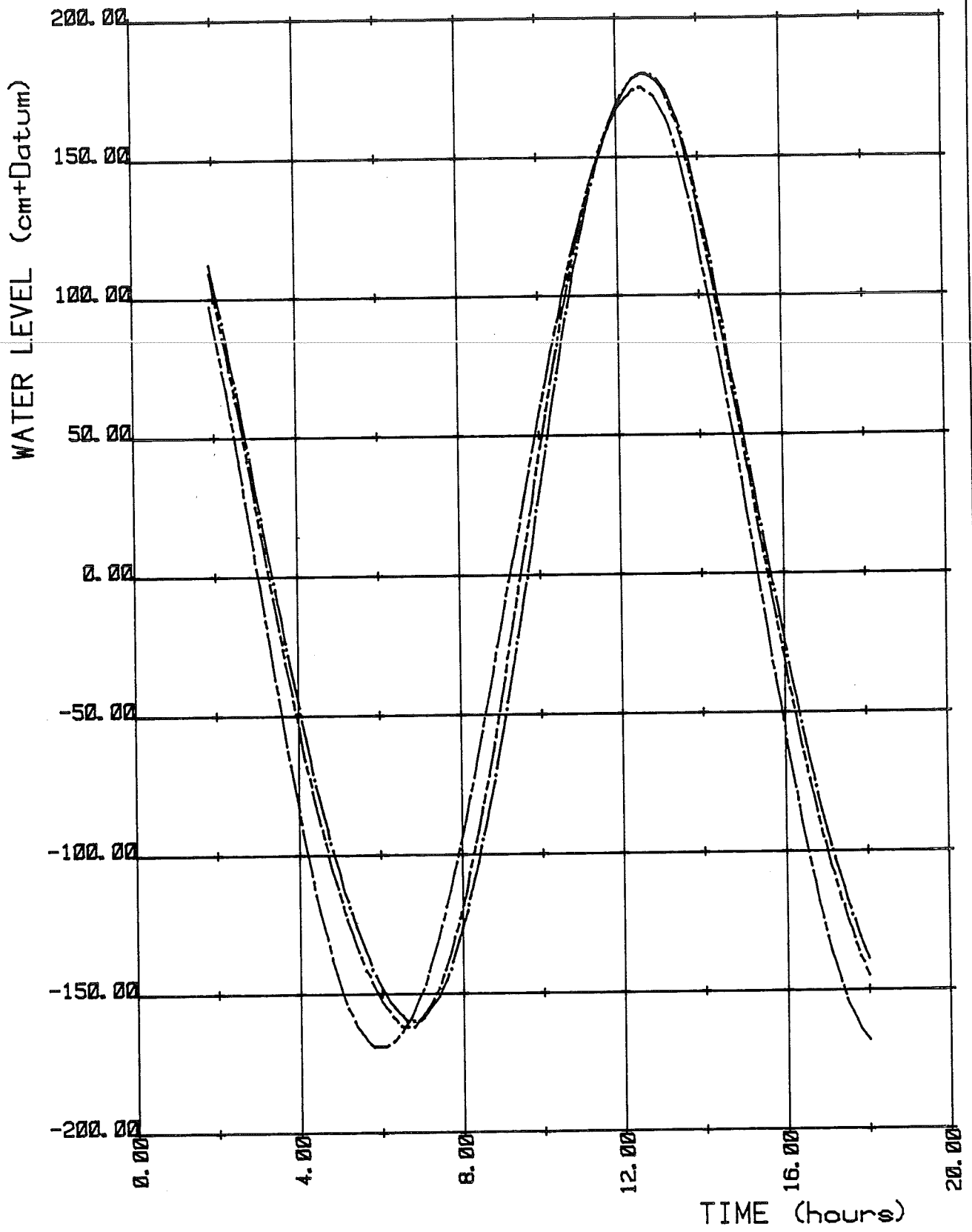

Computed water level curves

- N= 20 M= 41 station 226
- N= 30 M= 24 station 227
- · - · - · N= 25 M= 48 station 228



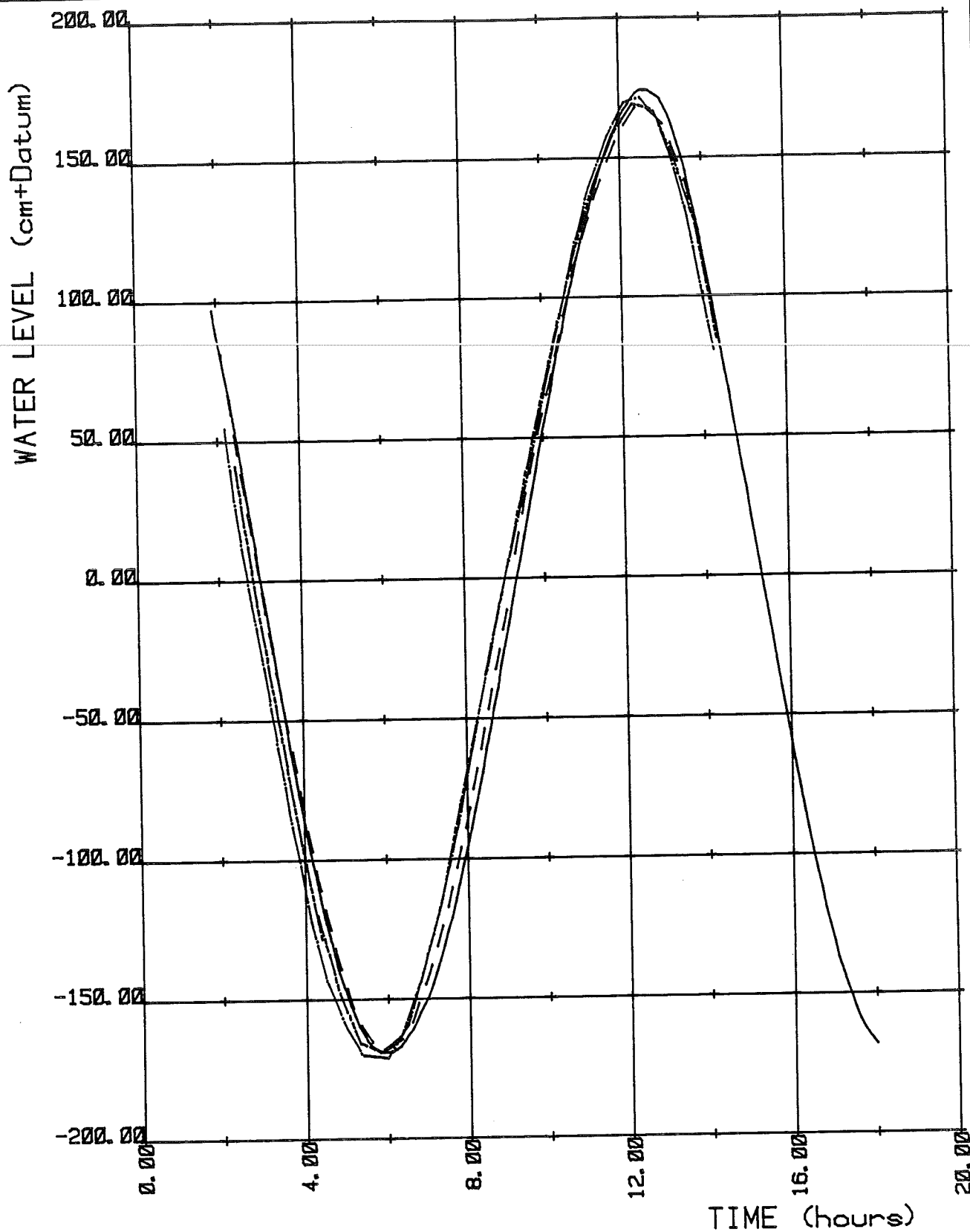

Water level at station: L1 Terreiro do Paço

_____ computed at $N=38$ $M=19$
 - - - - - measured March 18th 1973
 - . - . - . measured March 19th 1973
 - - - - - measured July 2nd 1981



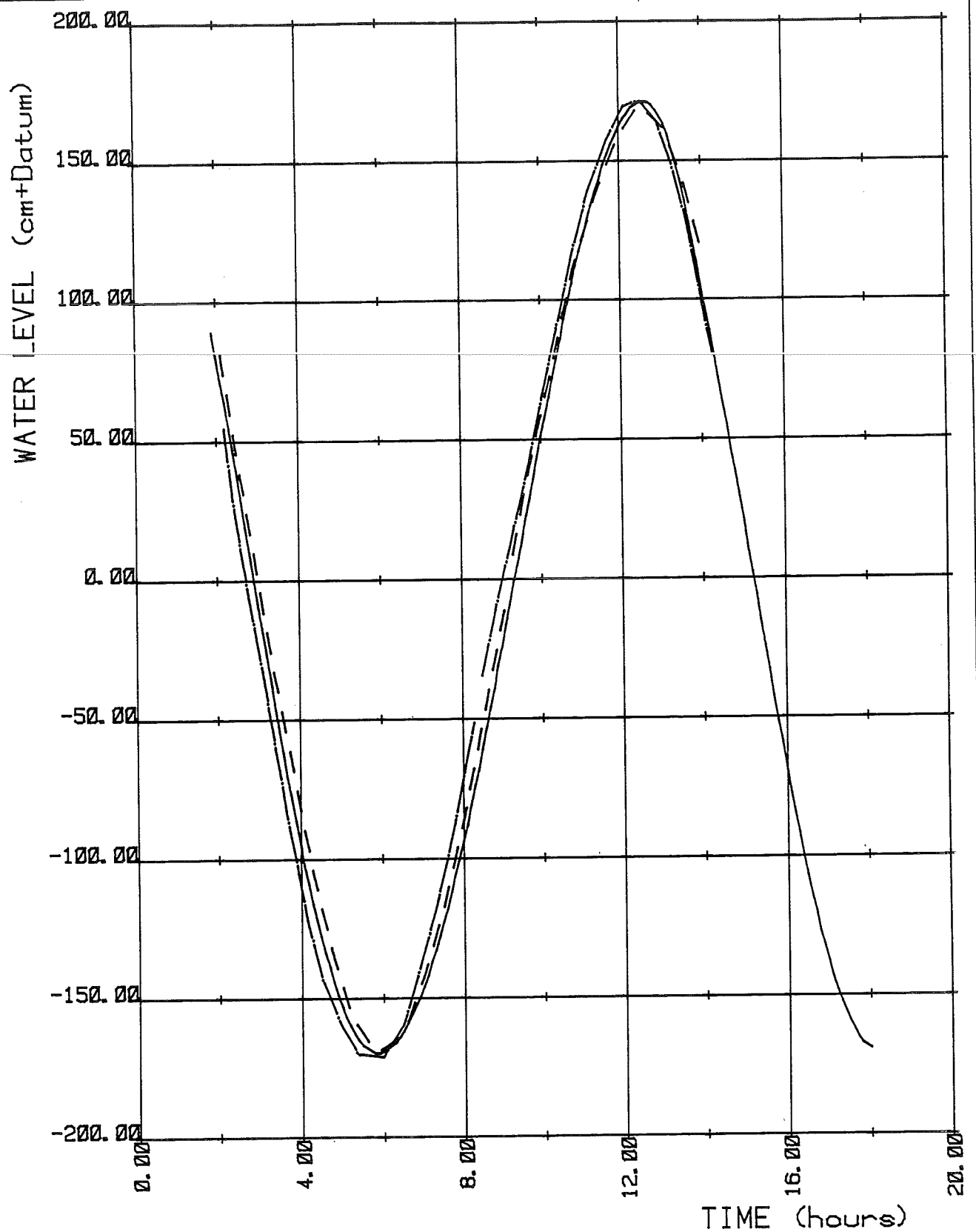

Water level at station: L2 Cacilhas

————— computed at N= 28 M= 18

- - - - - measured March 18th 1973

- . - . - . measured March 19th 1973



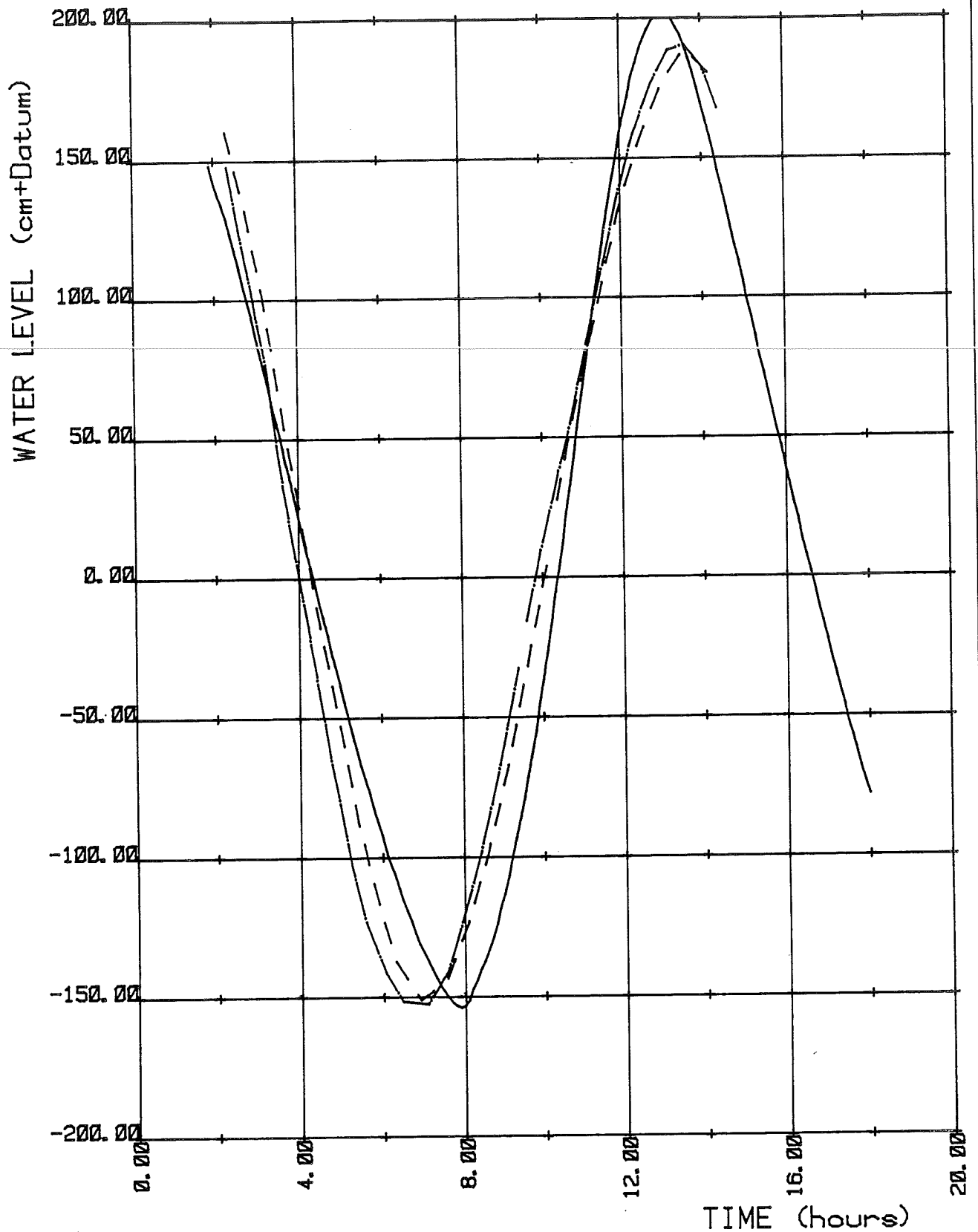

Water level at station: L4 Povoa

_____ computed at N=112 M= 11
 - - - - - measured March 18th 1973
 - . - . - . measured March 19th 1973



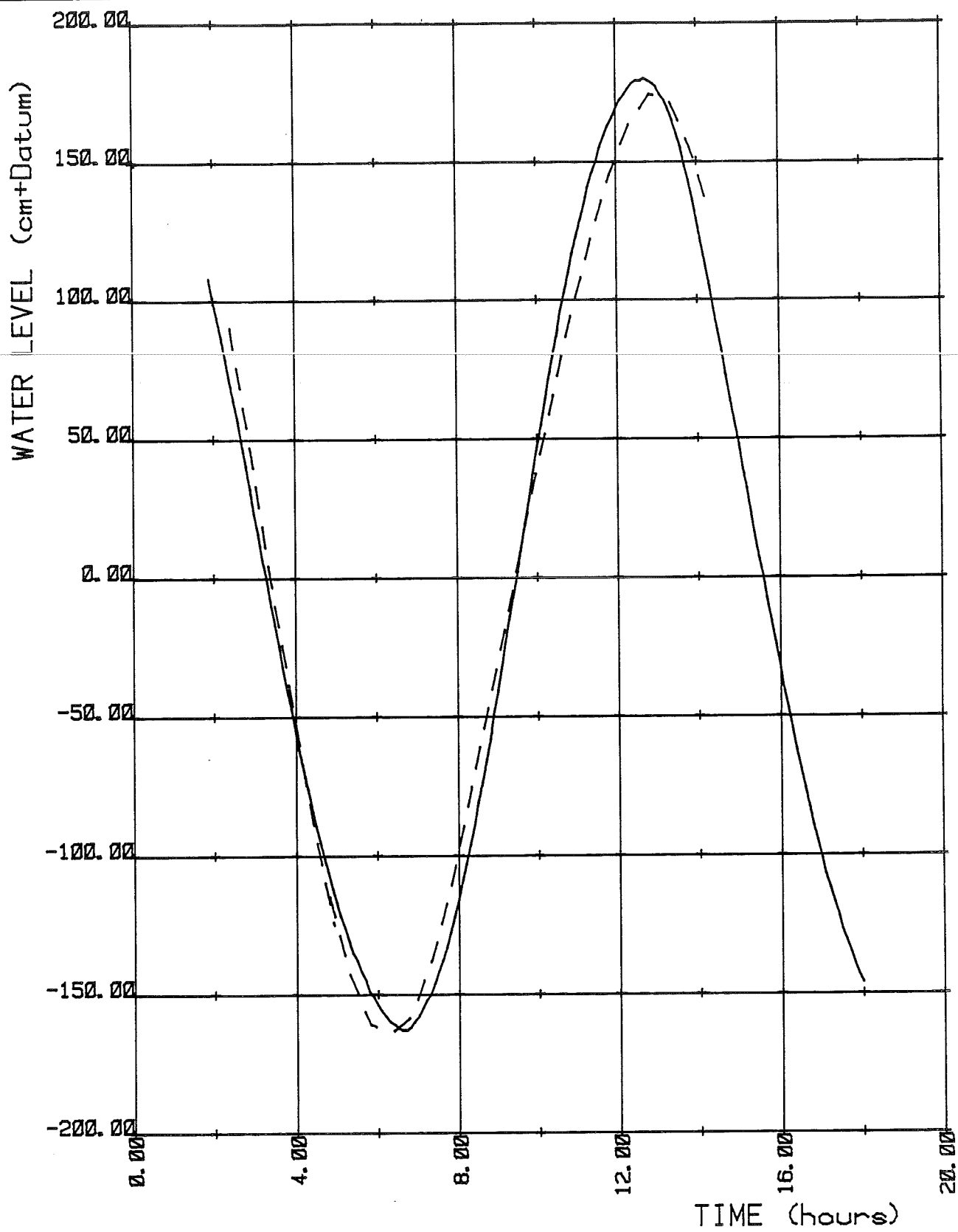

Water level at station: L5 Seixal
 ————— computed at N= 21 M= 42
 - - - - - measured July 2nd 1981



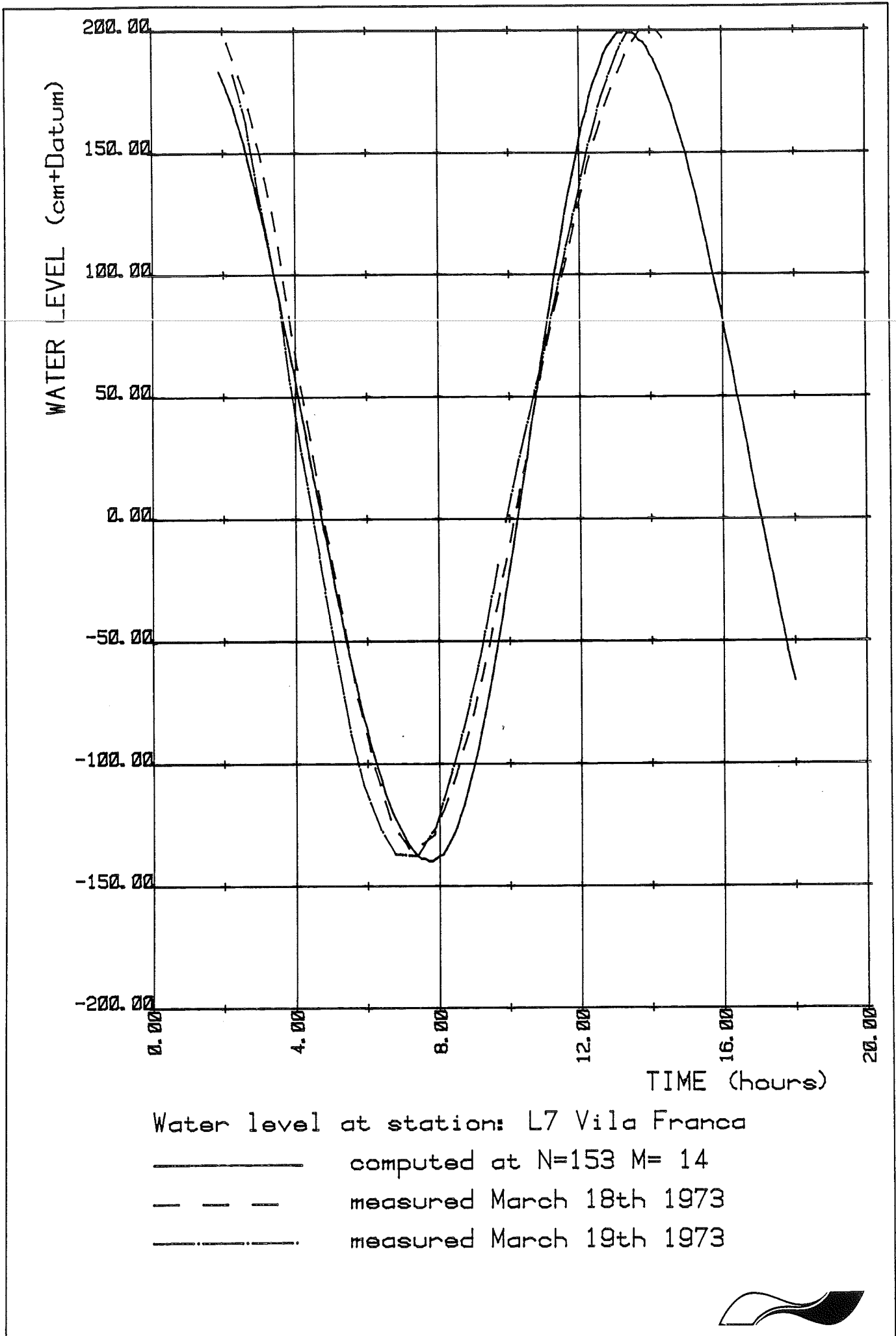

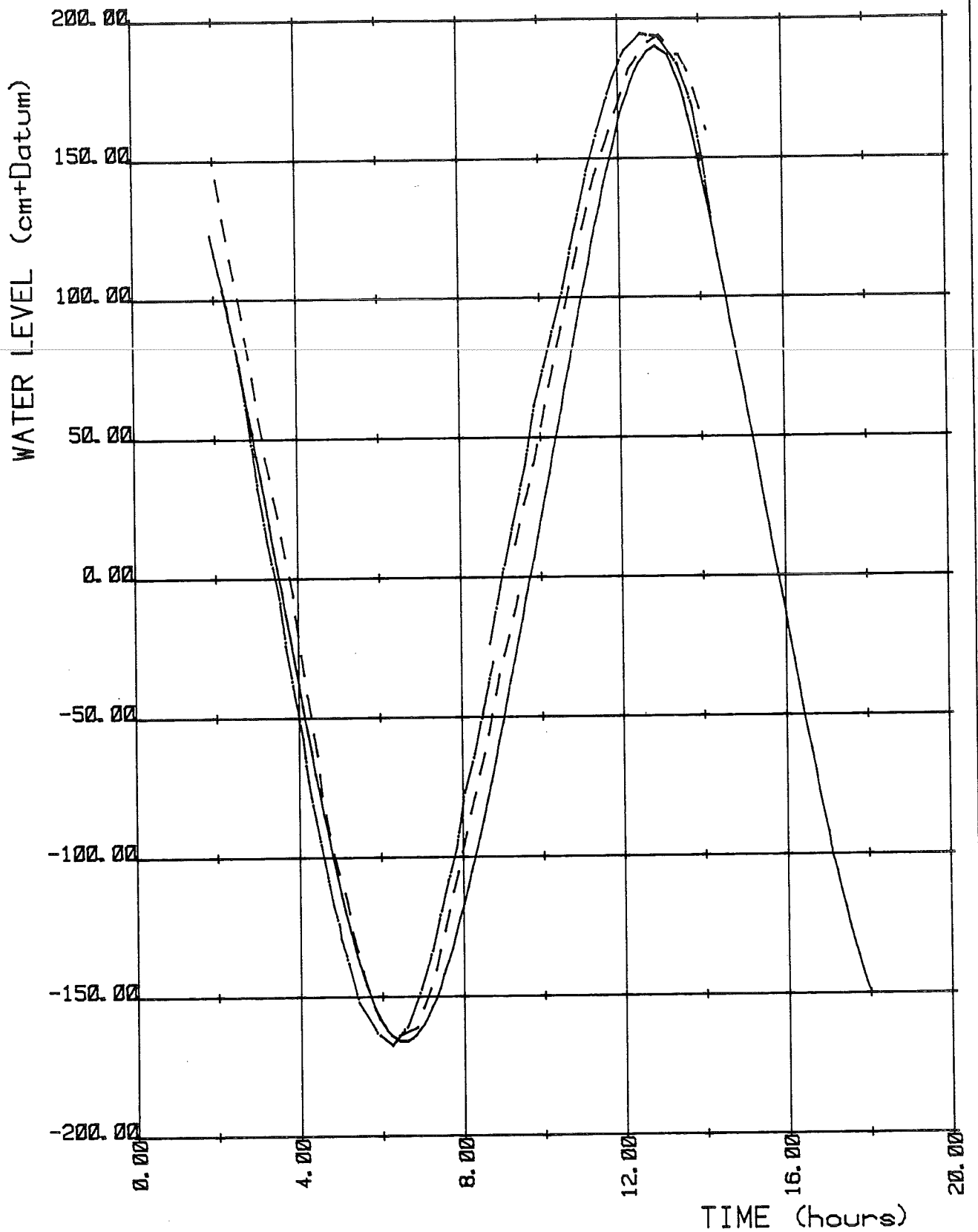

Water level at station: L9 Cabo Ruivo

————— computed at $N = 64$ $M = 20$

- - - - - measured March 18th 1973

- · - · - · measured March 19th 1973



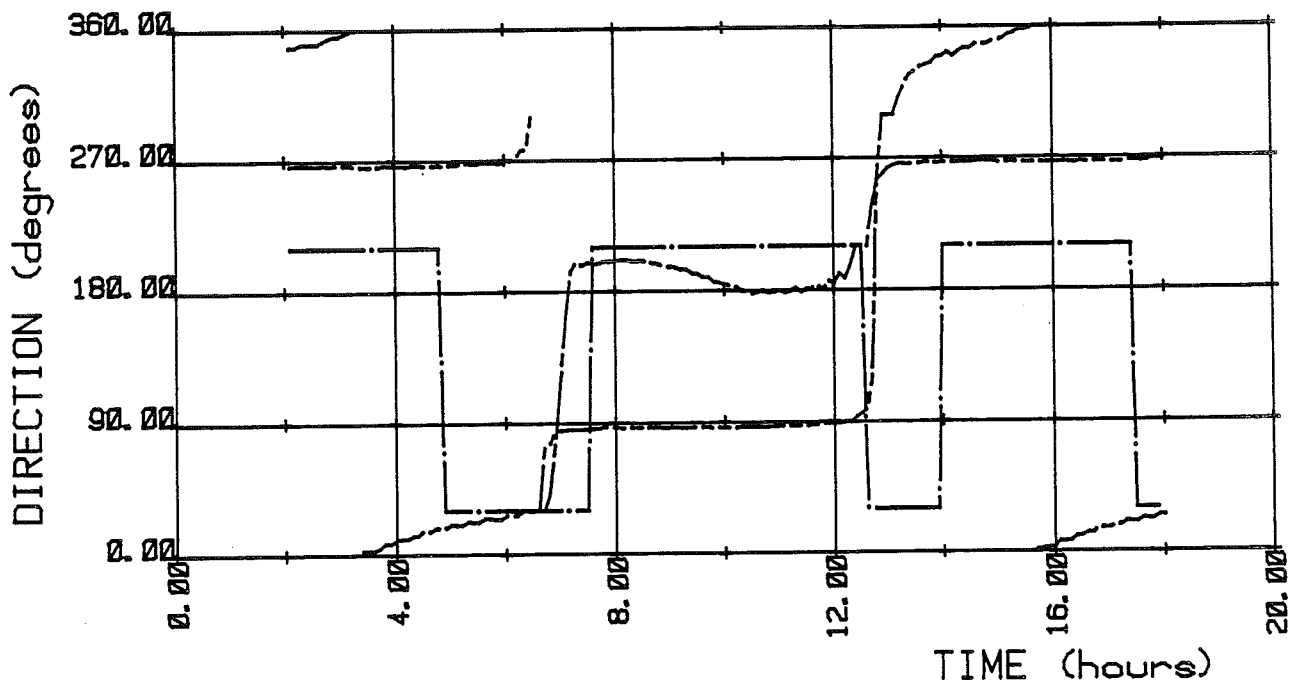
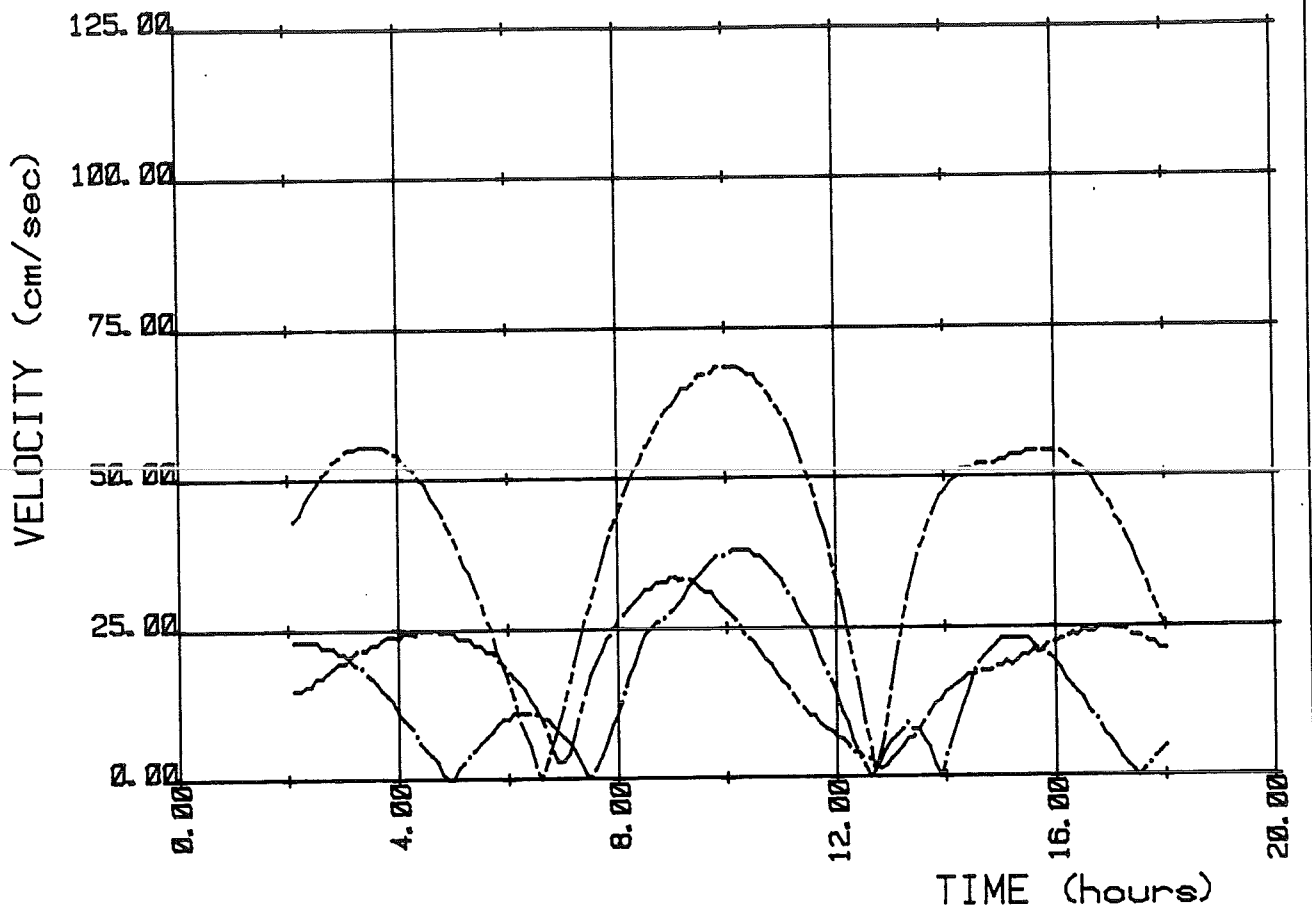

Computed velocity curves

-----	N= 38 M= 19	L1 Terreiro do Paco
- . - . - .	N= 21 M= 42	L5 Seixal
—————	N=153 M= 14	L7 Vila Franca



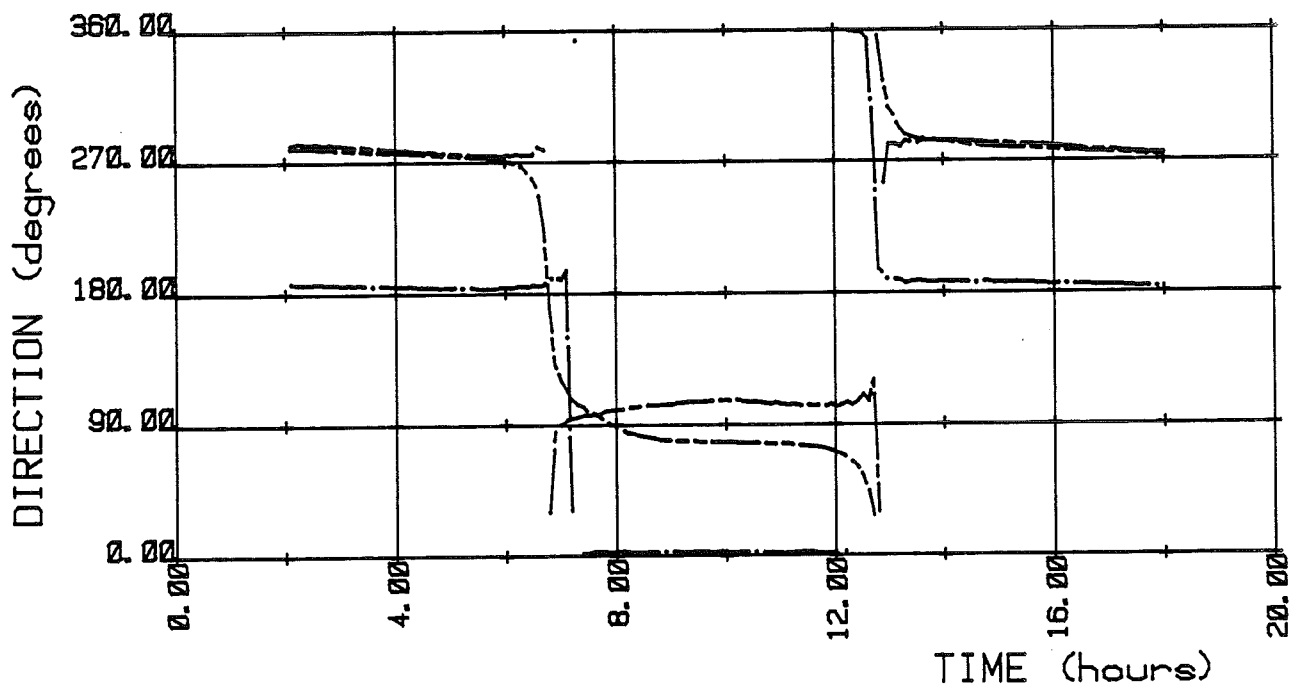
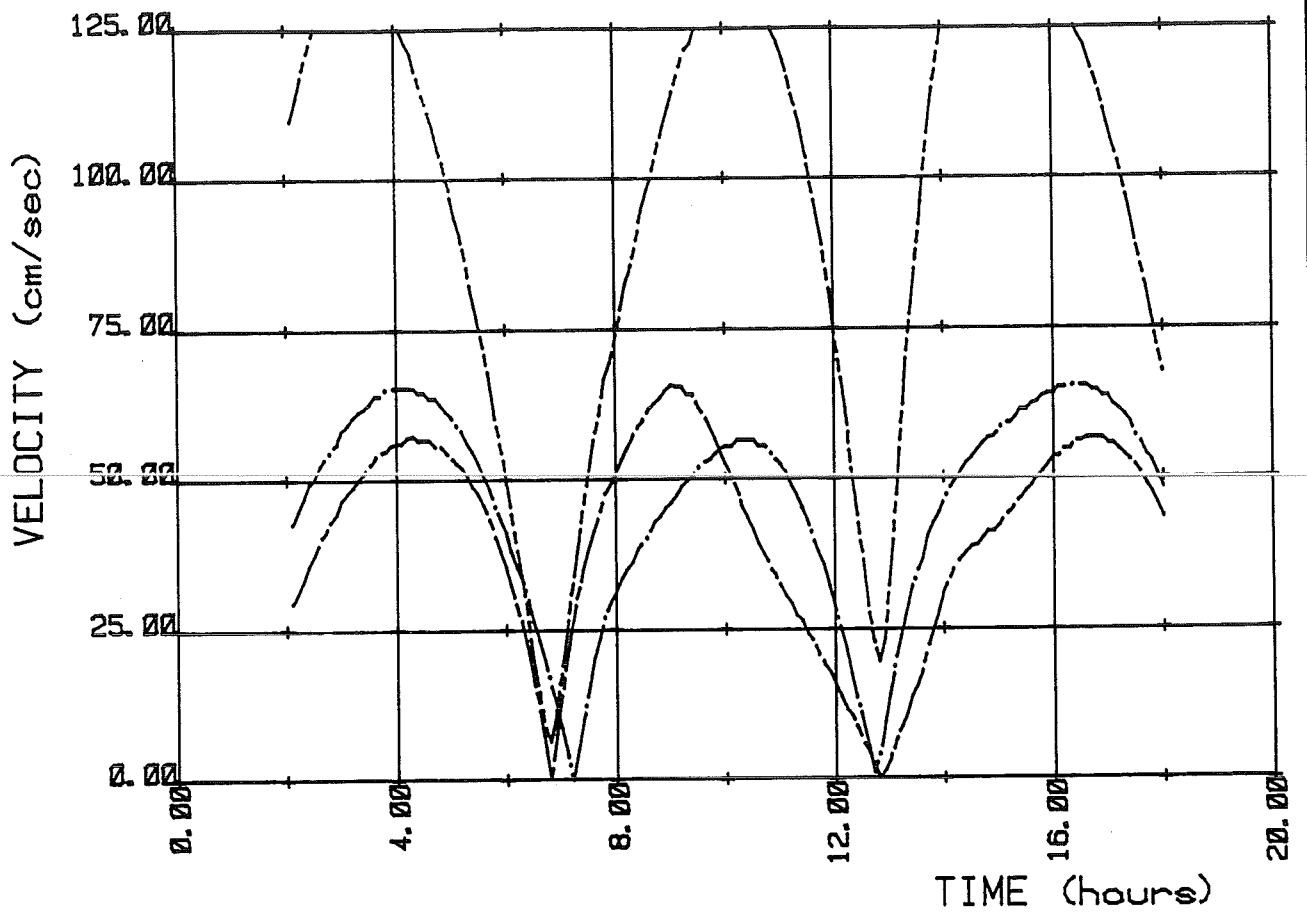

Computed velocity curves

-----	N= 28 M= 18	L2 Cacilhas
-----	N= 46 M= 48	L6 Montijo Base
-----	N= 64 M= 20	L9 Cabo Ruivo



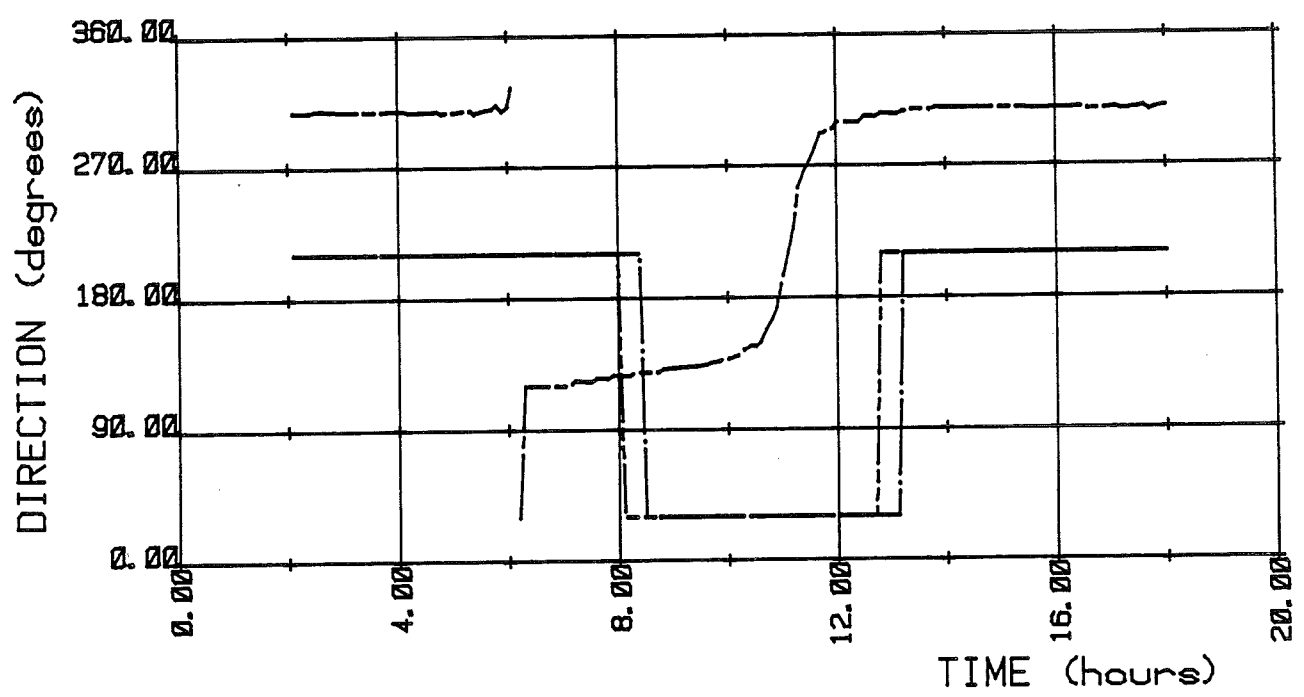
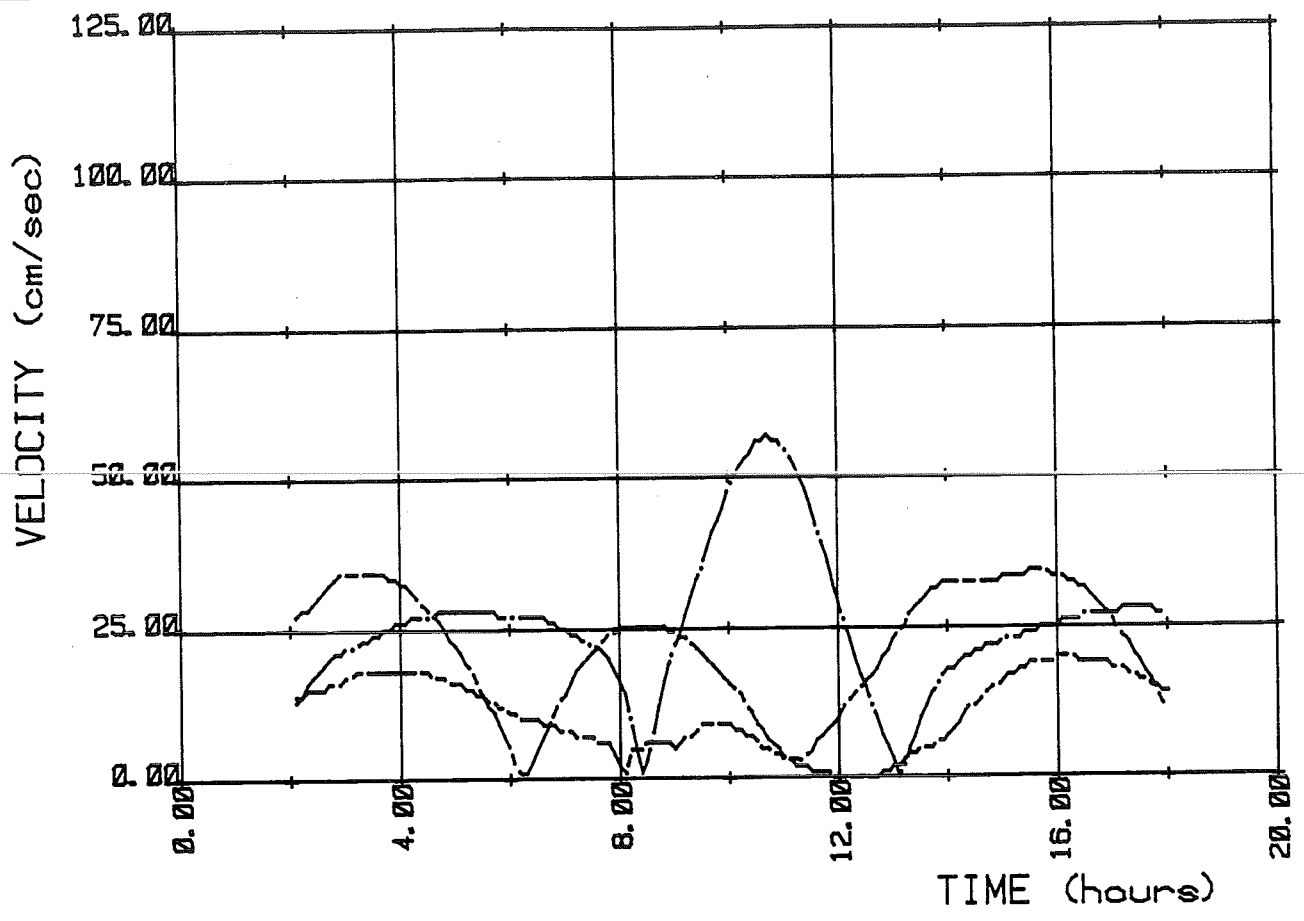

Computed velocity curves

-----	N=112 M= 11	L4 Povoa
-----	N= 21 M= 25	L8 Alfeite
-----	N=116 M= 43	station 13



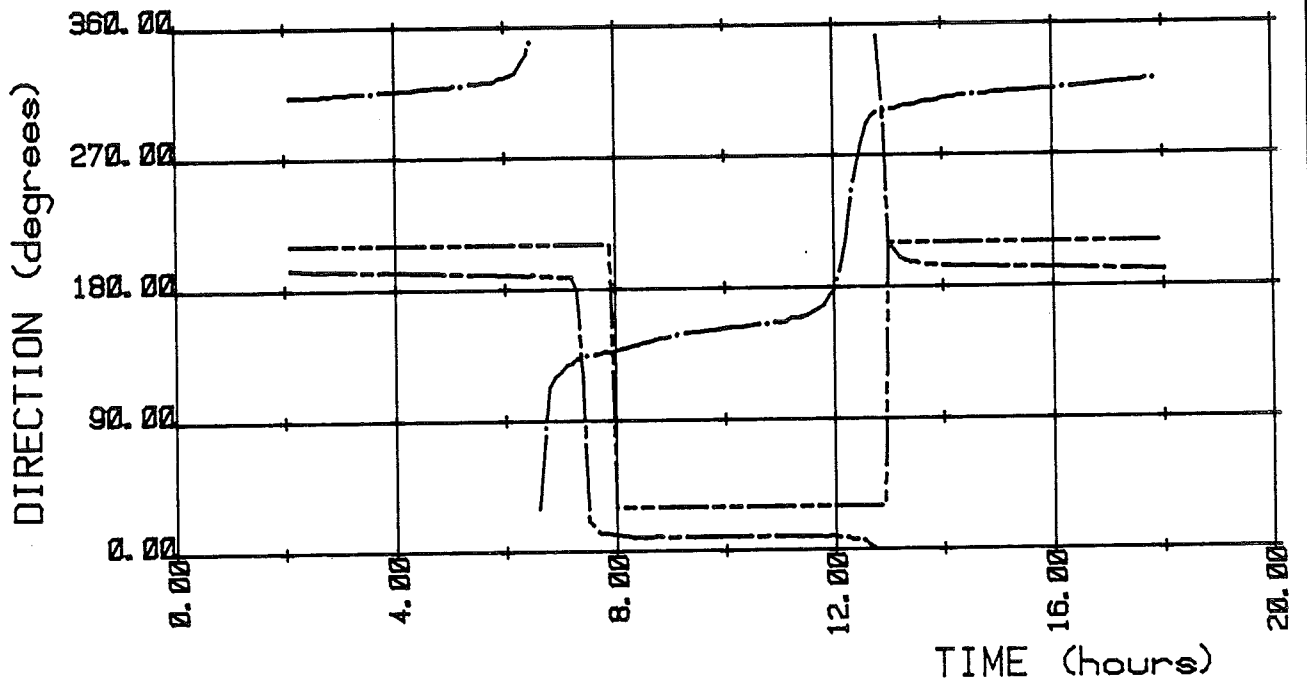
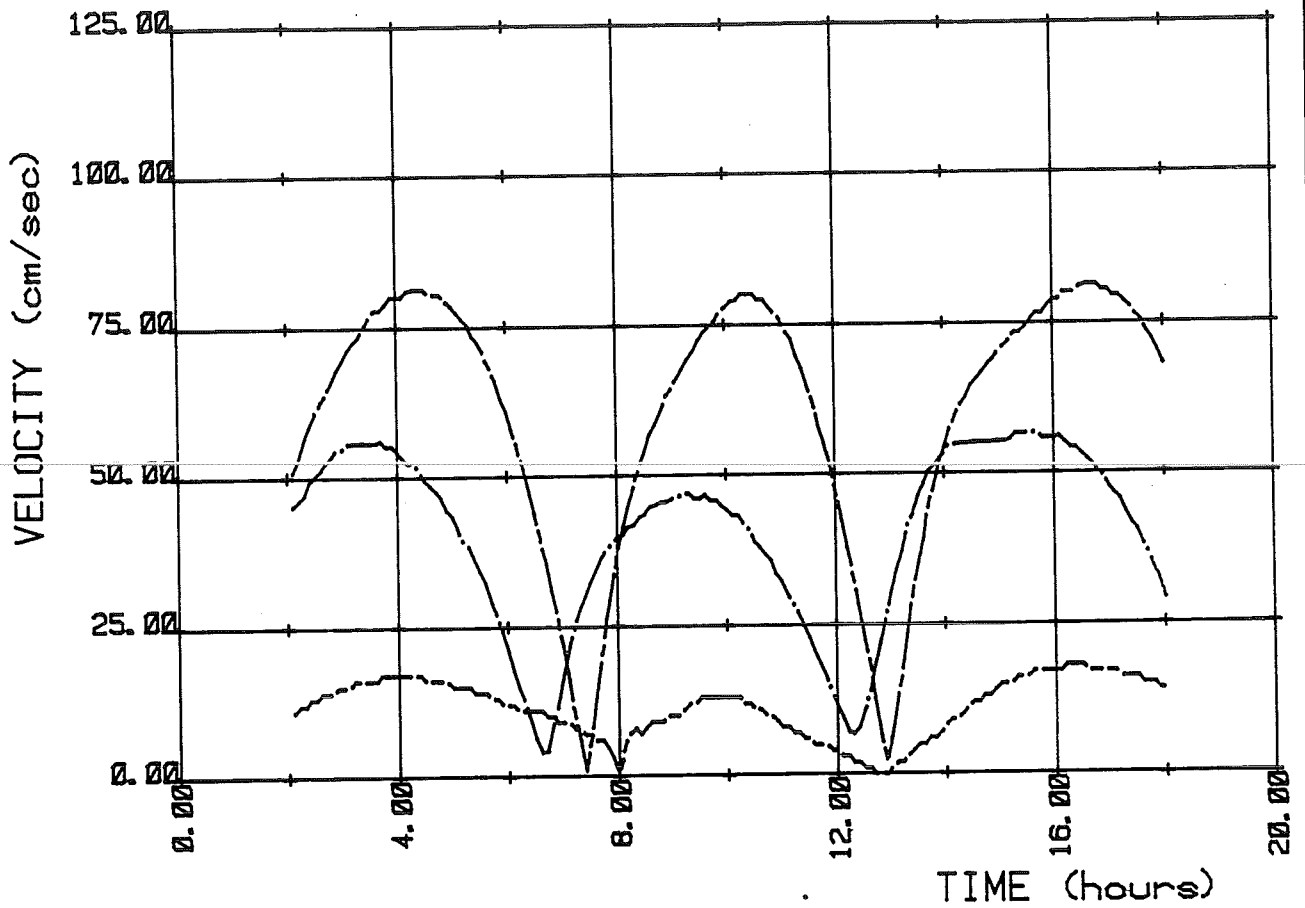

Computed velocity curves

-----	N=108 M= 10	station 7
- . - . - .	N= 66 M= 21	station 26
—————	N= 26 M= 27	station 41



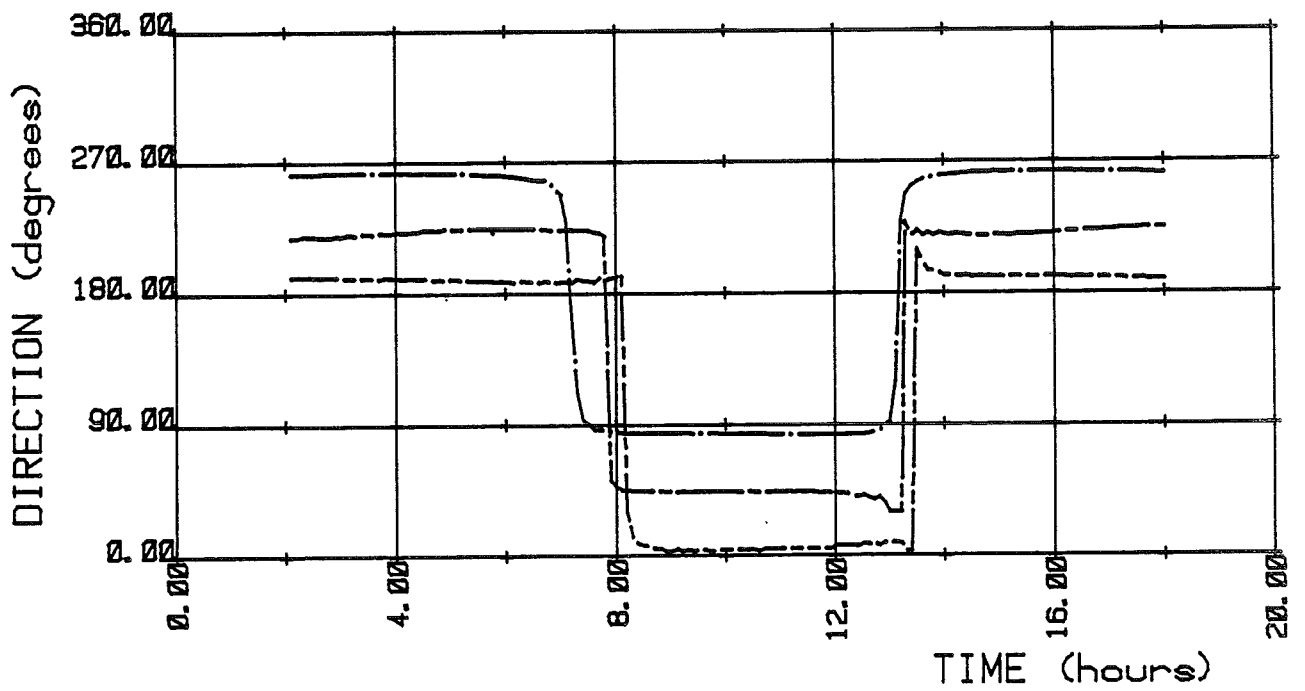
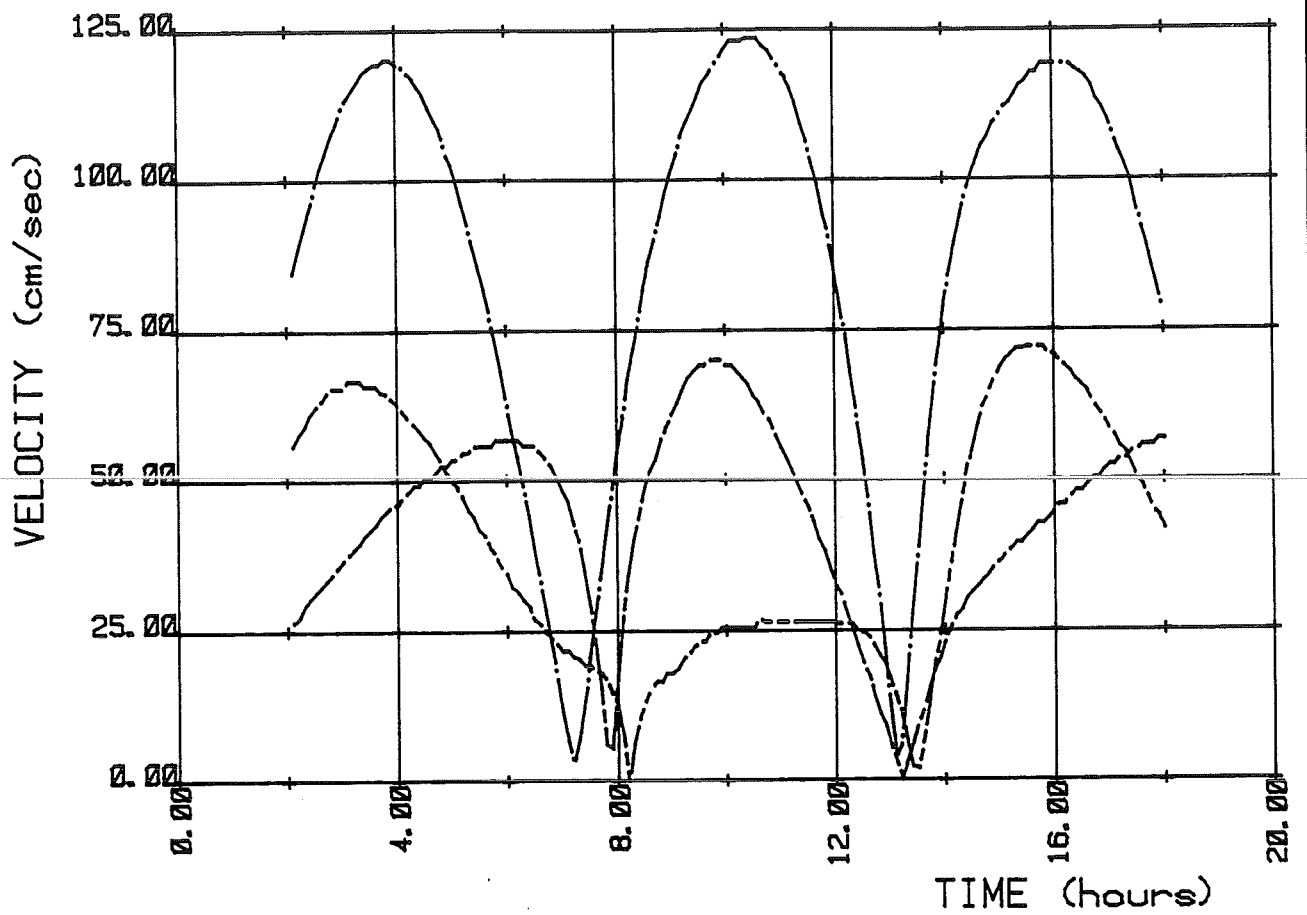

Computed velocity curves

.....	N=116 M= 17	station 8
- - - - -	N= 97 M= 43	station 24
- . - . - .	N= 35 M= 25	station 36



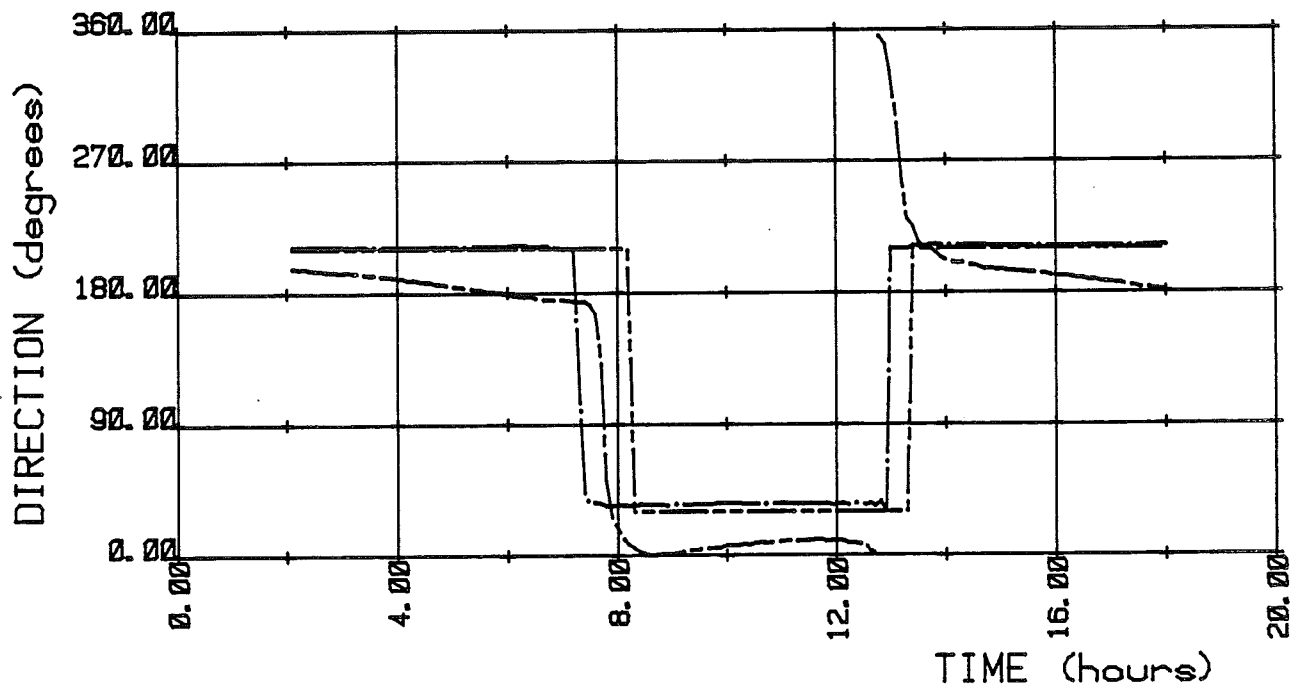
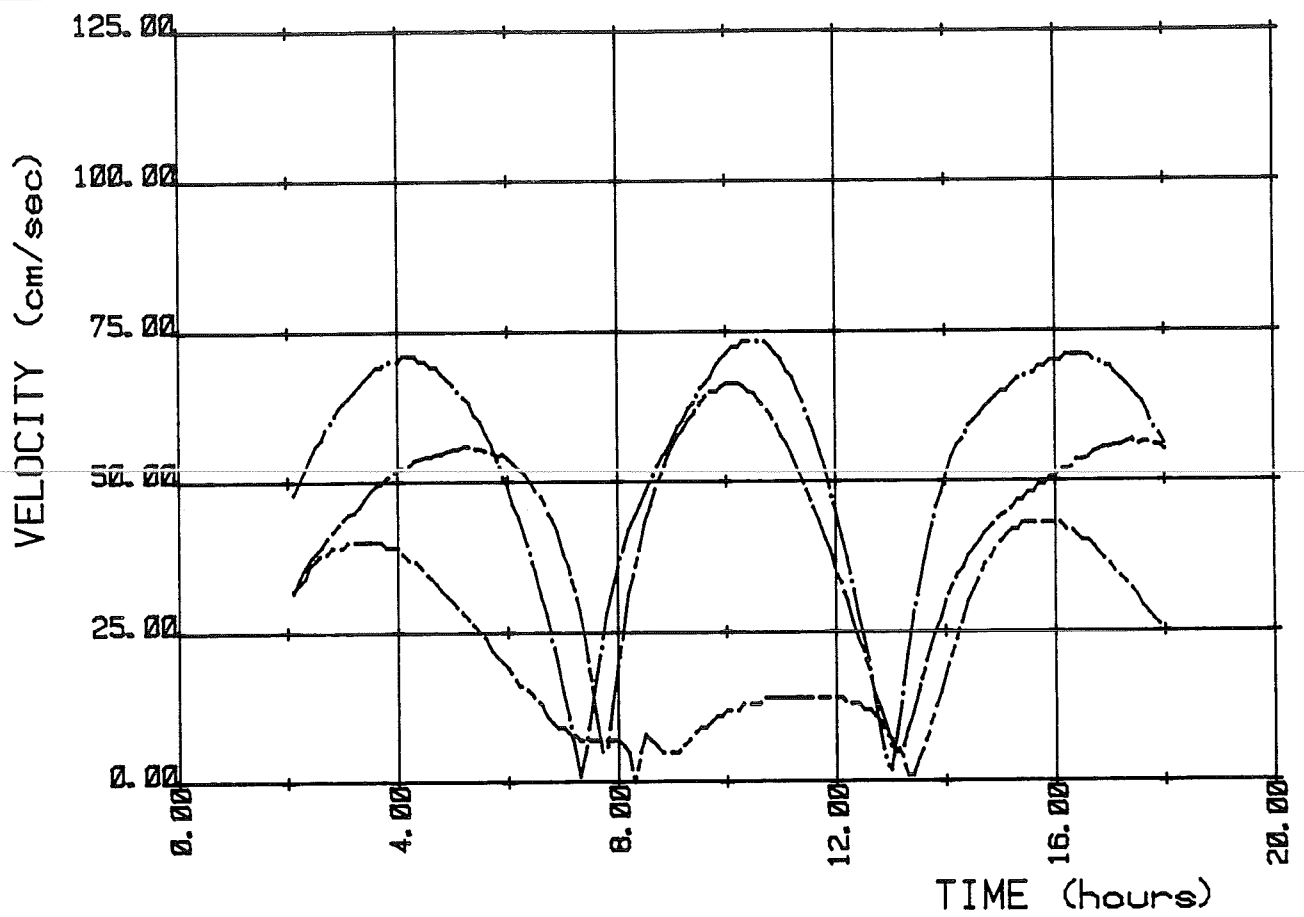

Computed velocity curves

— · — · — · — ·	N=124 M= 31	station 12
- - - - -	N= 90 M= 30	station 18
—————	N= 70 M= 32	station 30



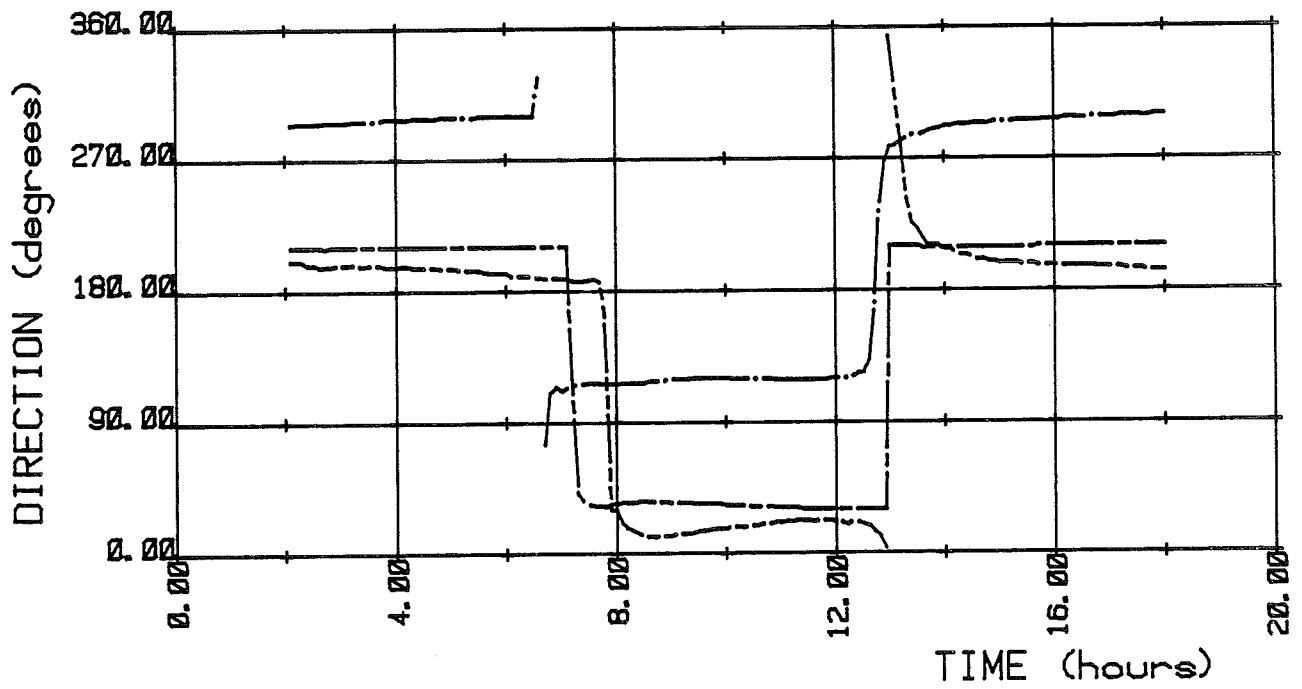
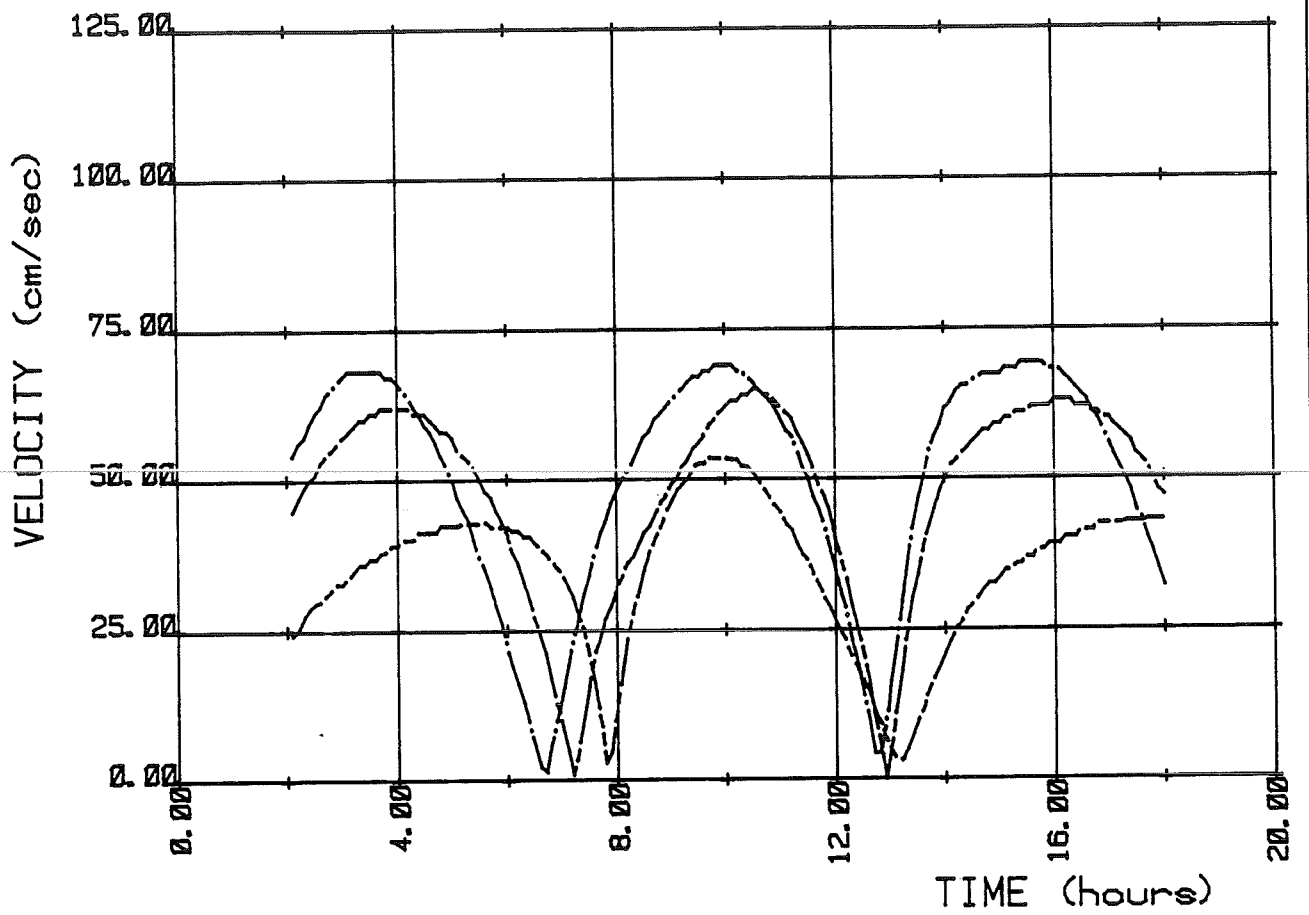

Computed velocity curves

-----	N= 98 M= 38	station 22
- . - . - .	N= 69 M= 26	station 28
—————	N= 30 M= 28	station 39



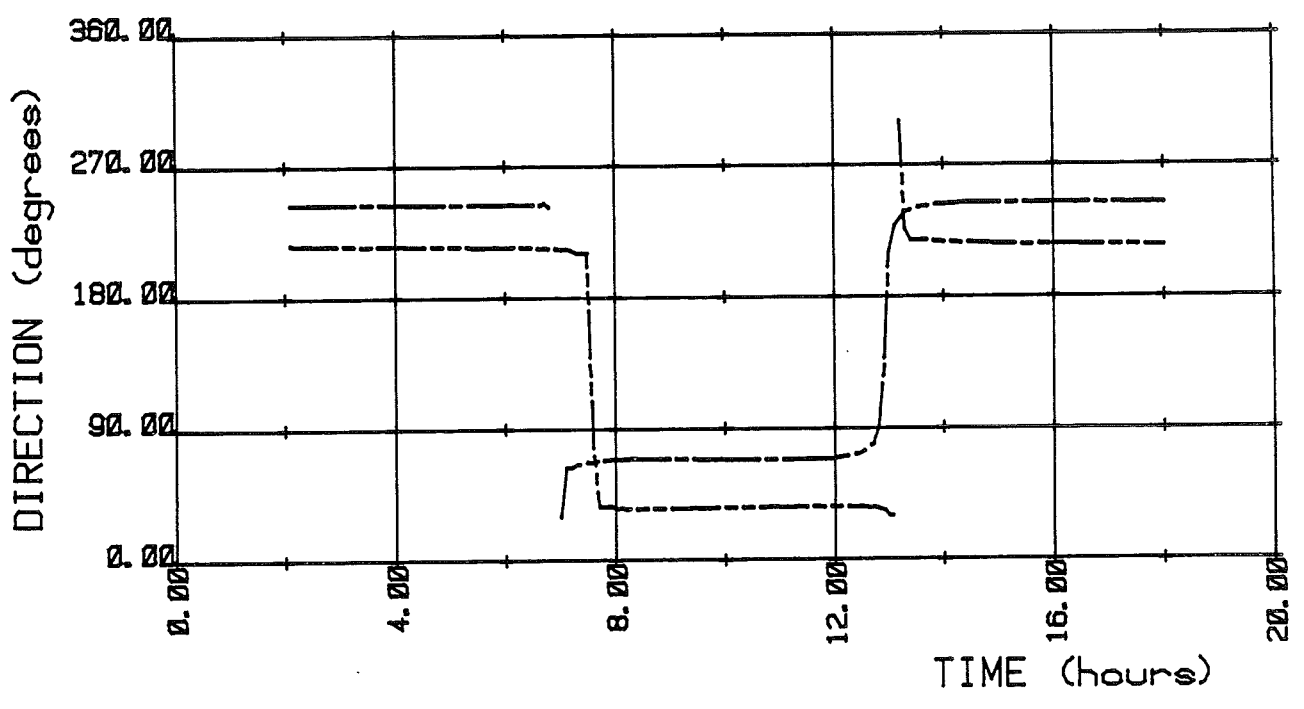
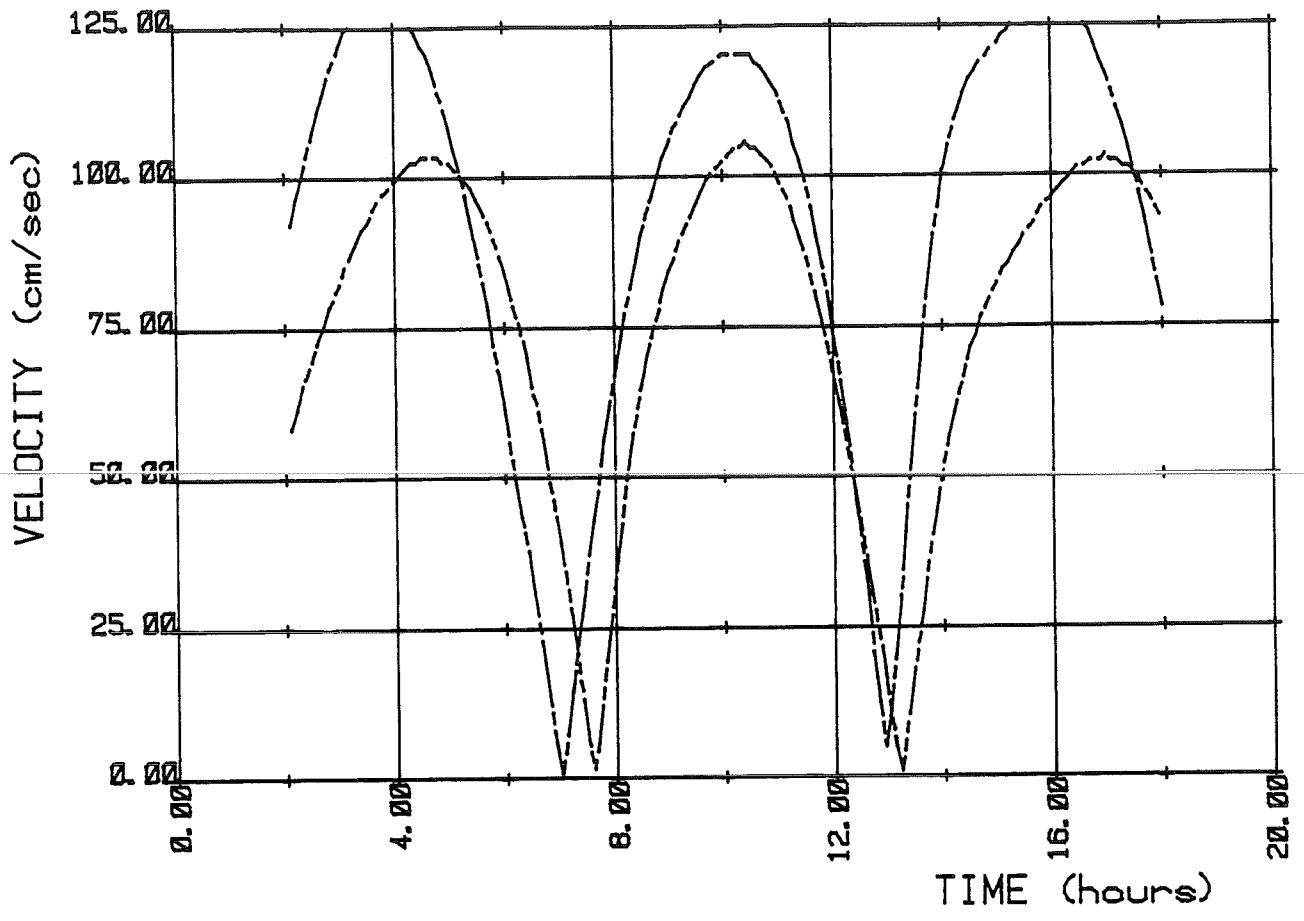

Computed velocity curves

----- N = 71 M = 38 station 32

----- N = 38 M = 22 station 221-222



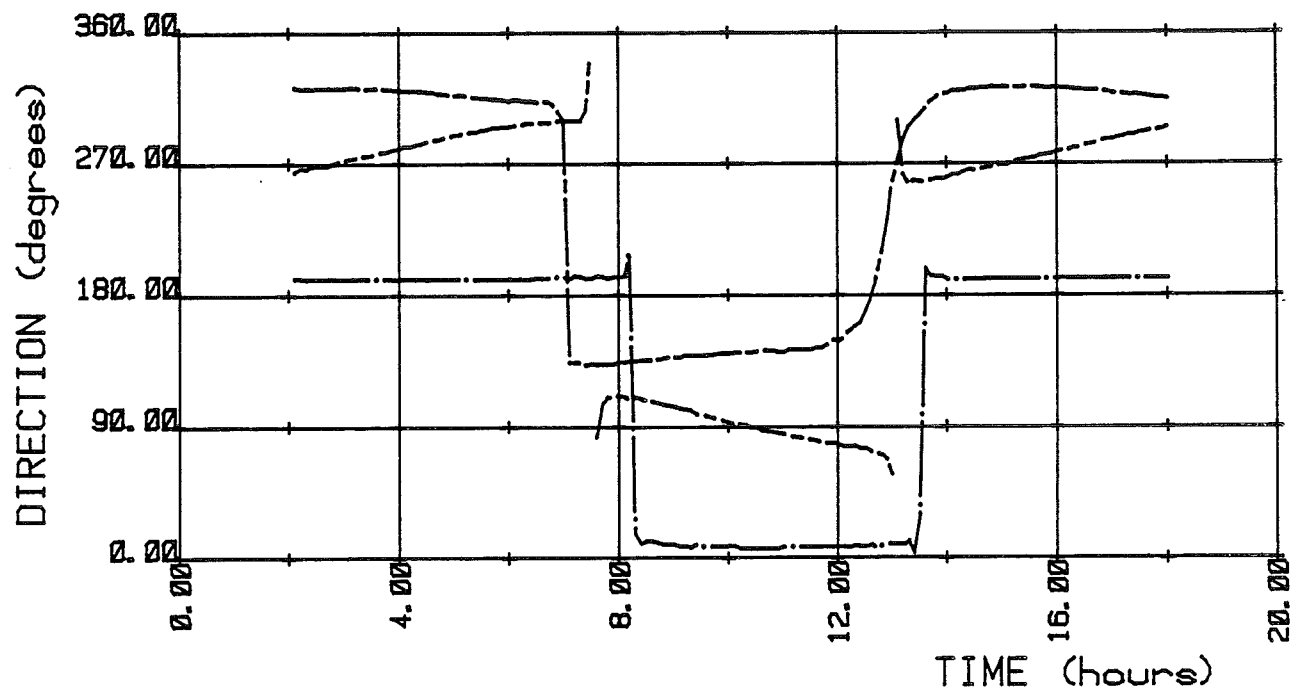
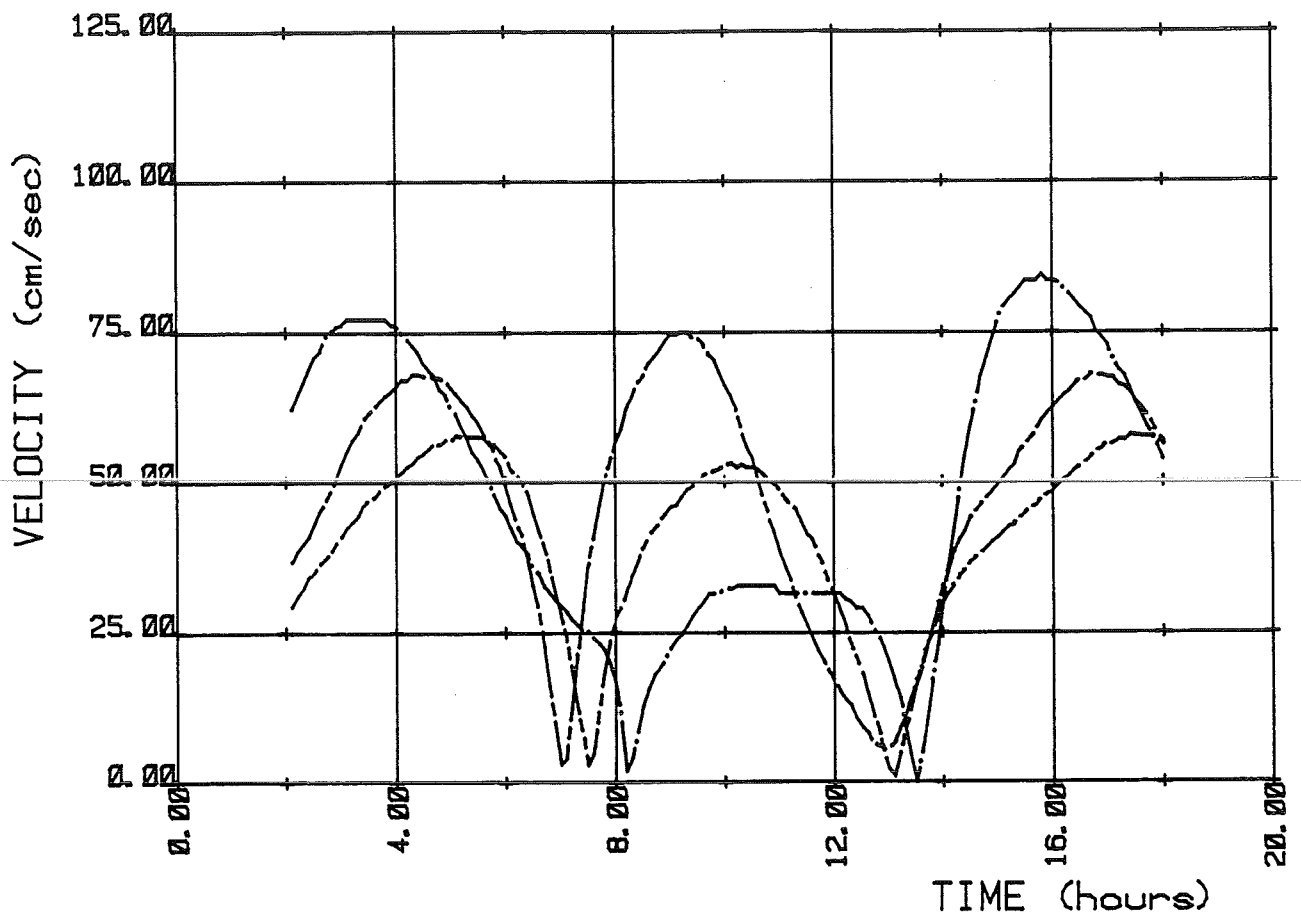

Computed velocity curves

- N= 80 M= 45 station 201
- N= 25 M= 40 station 203
- .-.-.- N=116 M= 19 station 210-211



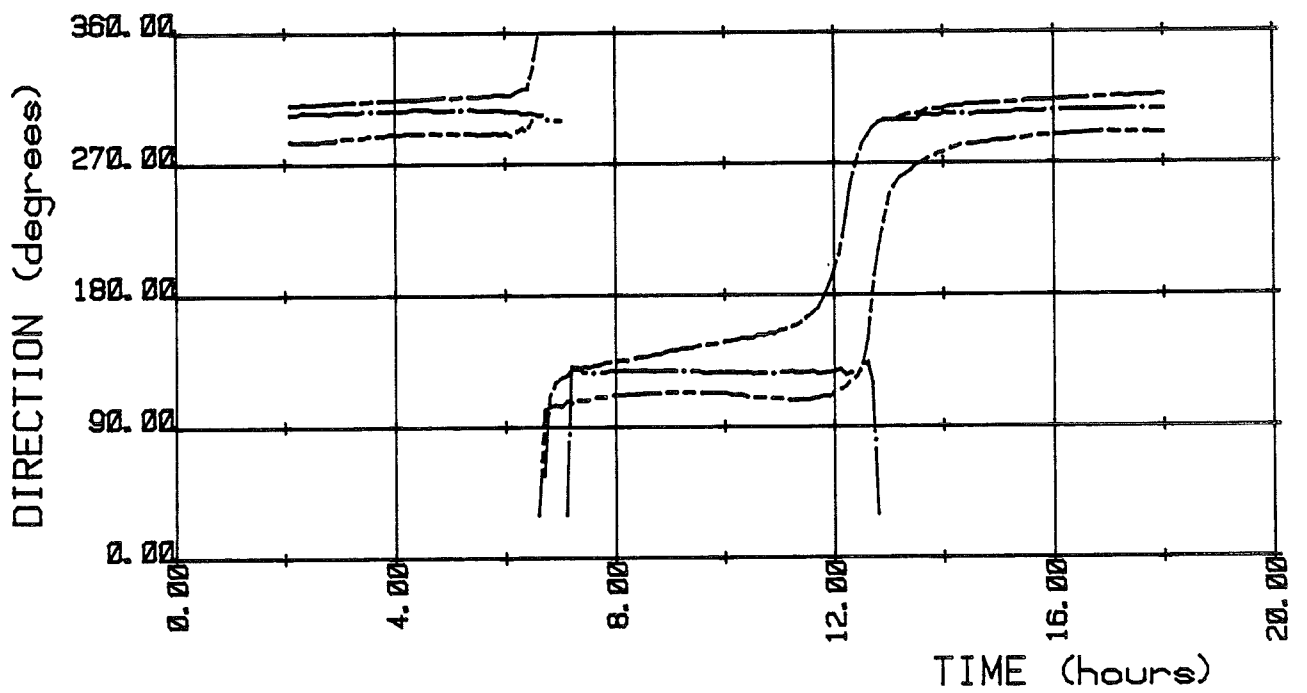
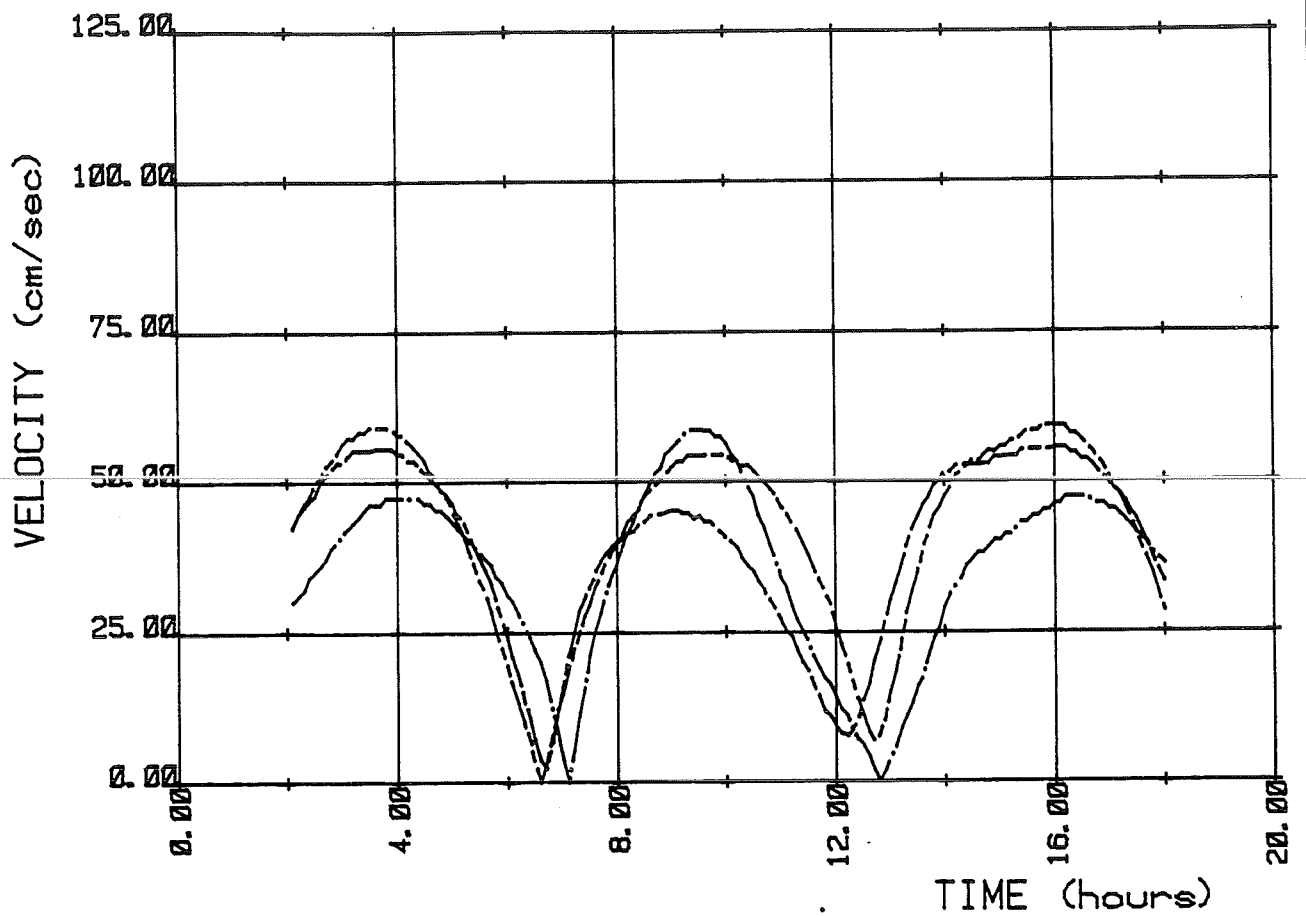

Computed velocity curves

-----	N= 32 M= 35	station 223
- - - - -	N= 25 M= 28	station 224
— · — · —	N= 24 M= 43	station 225



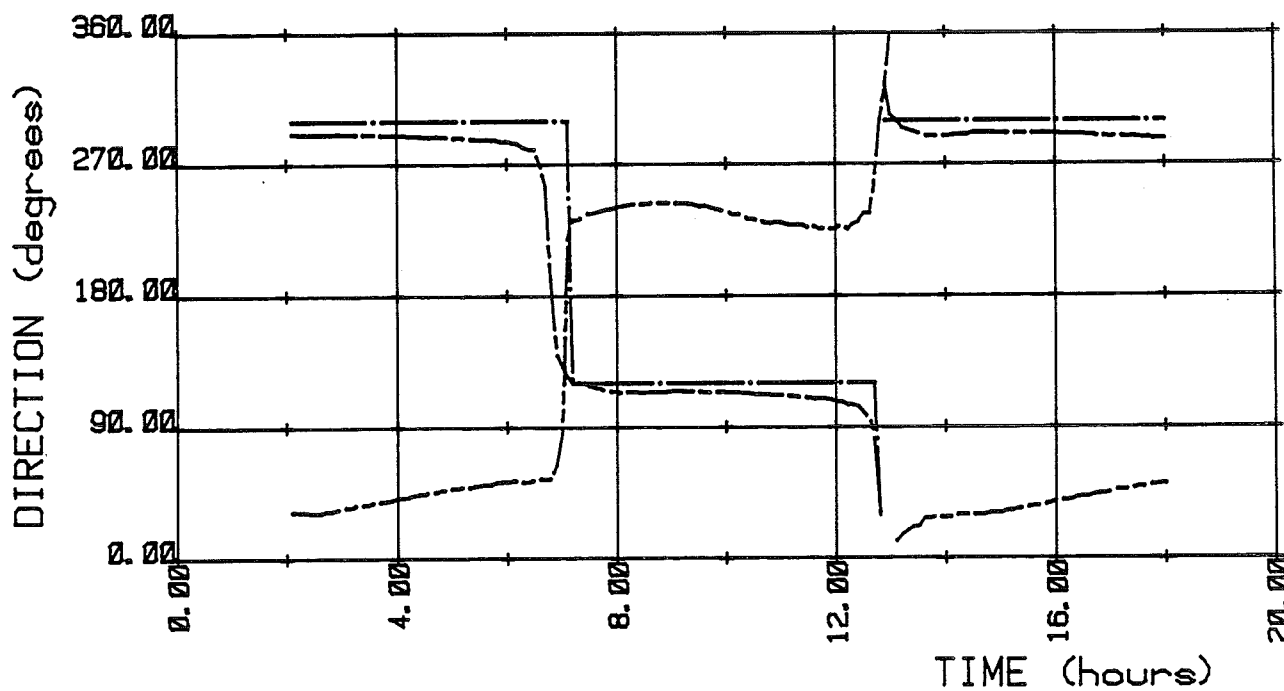
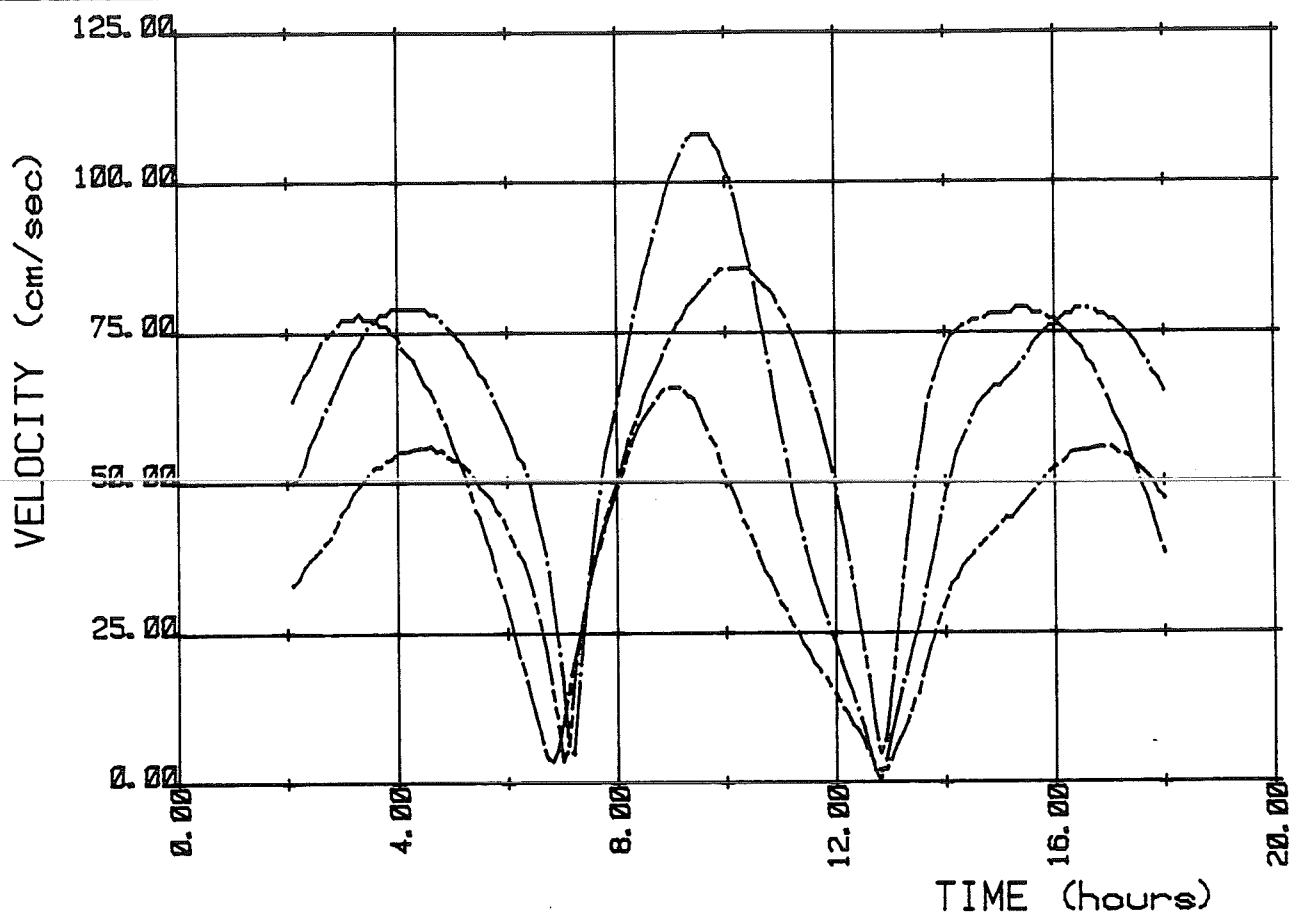

Computed velocity curves

-----	N= 20 M= 41	station 226
-.-.-.-.	N= 30 M= 24	station 227
_____	N= 25 M= 48	station 228



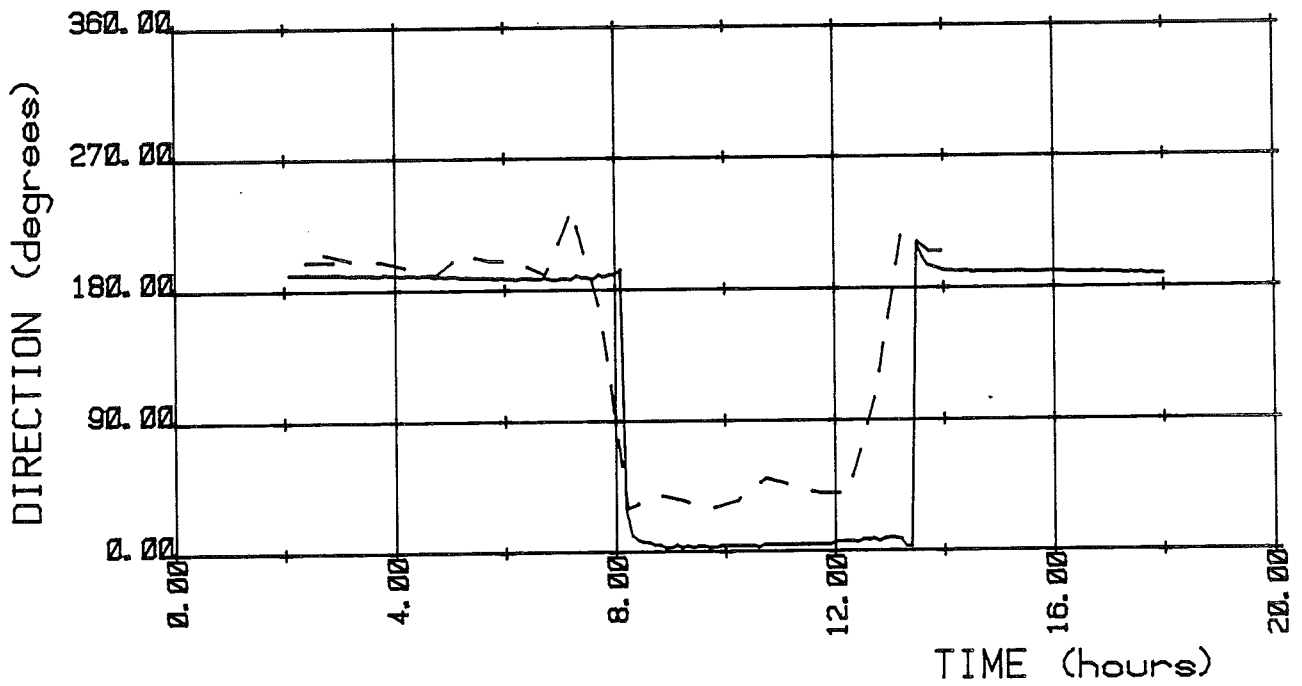
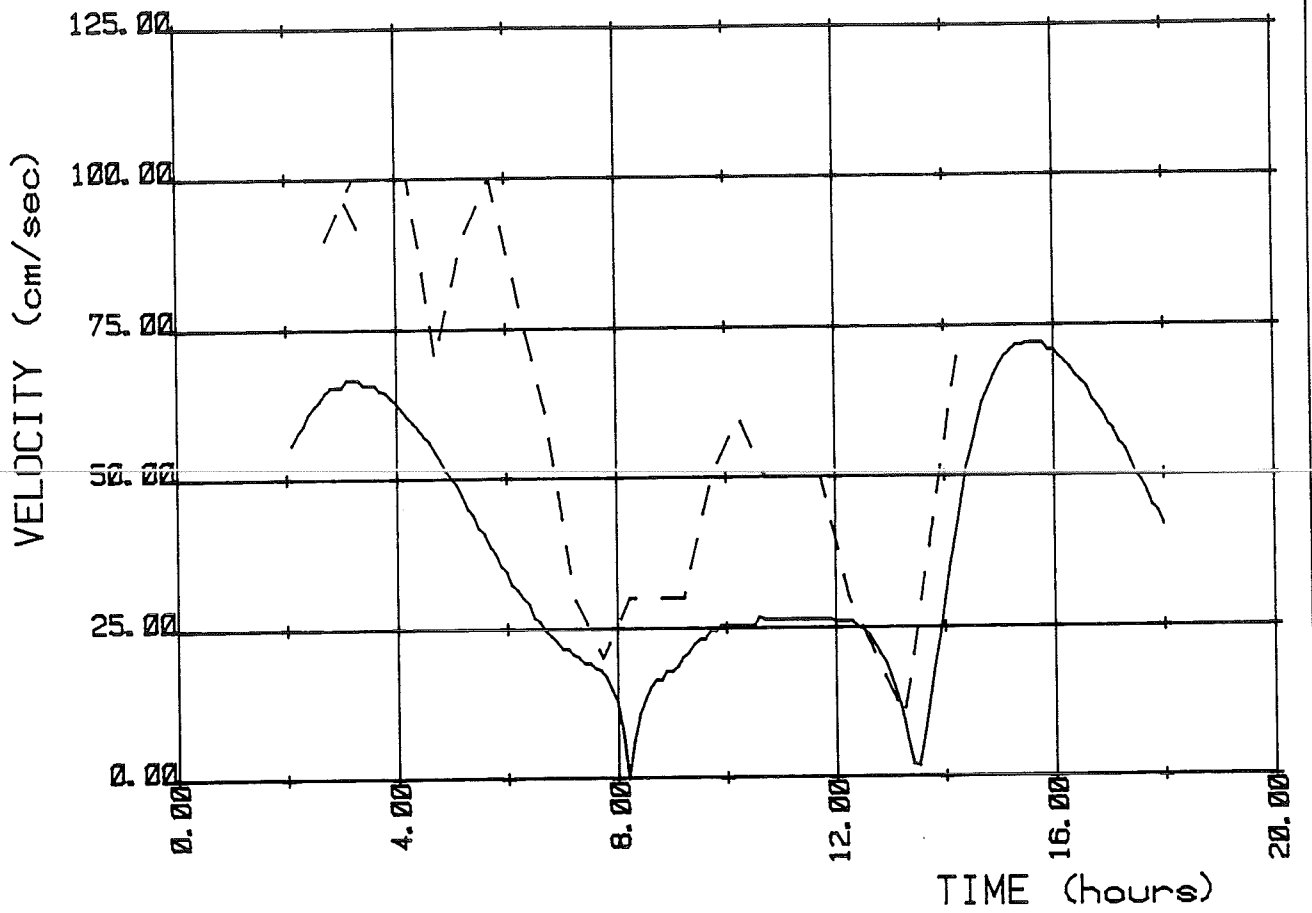

Velocity curve at station: 8

————— computed at N=116 M= 17
 - - - - - measured March 31st 1972



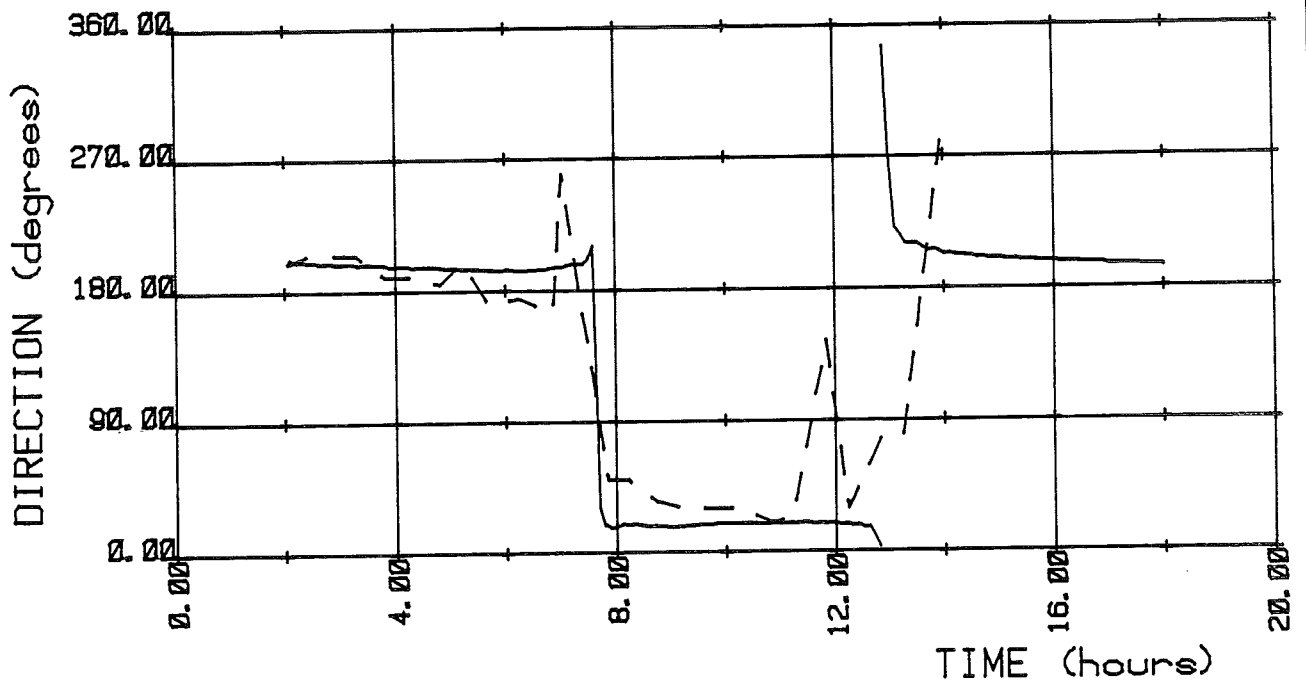
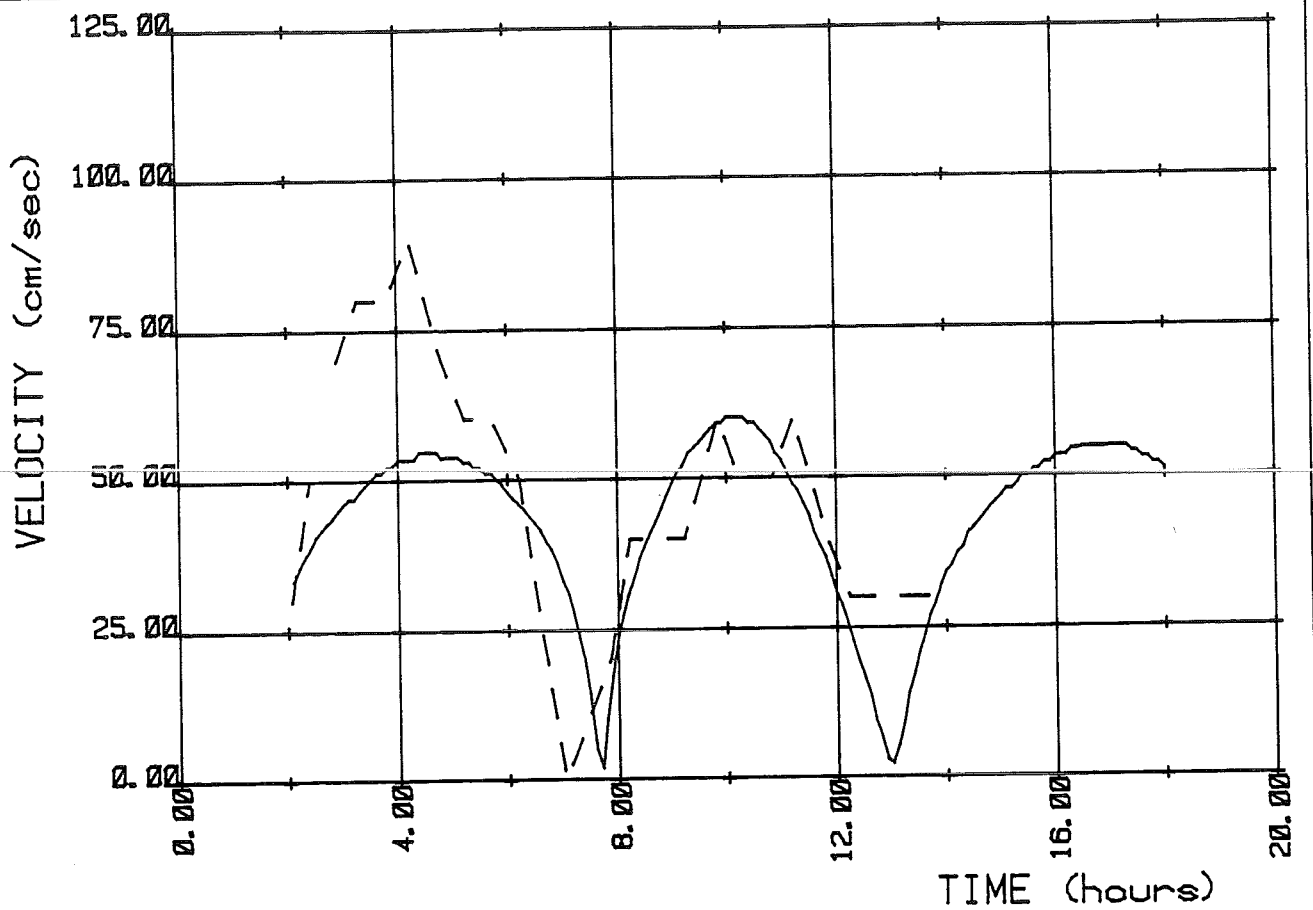

Velocity curve at station: 15

————— computed at $N = 86$ $M = 25$
 - - - - - measured April 17th 1972



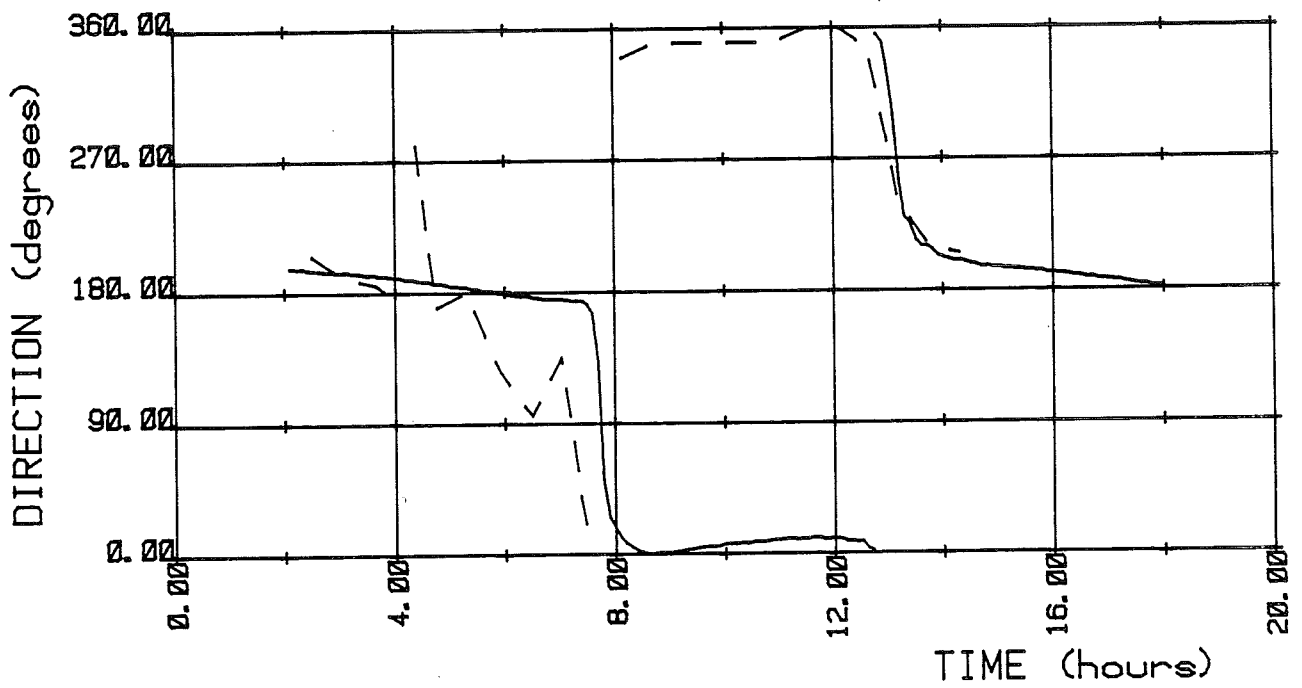
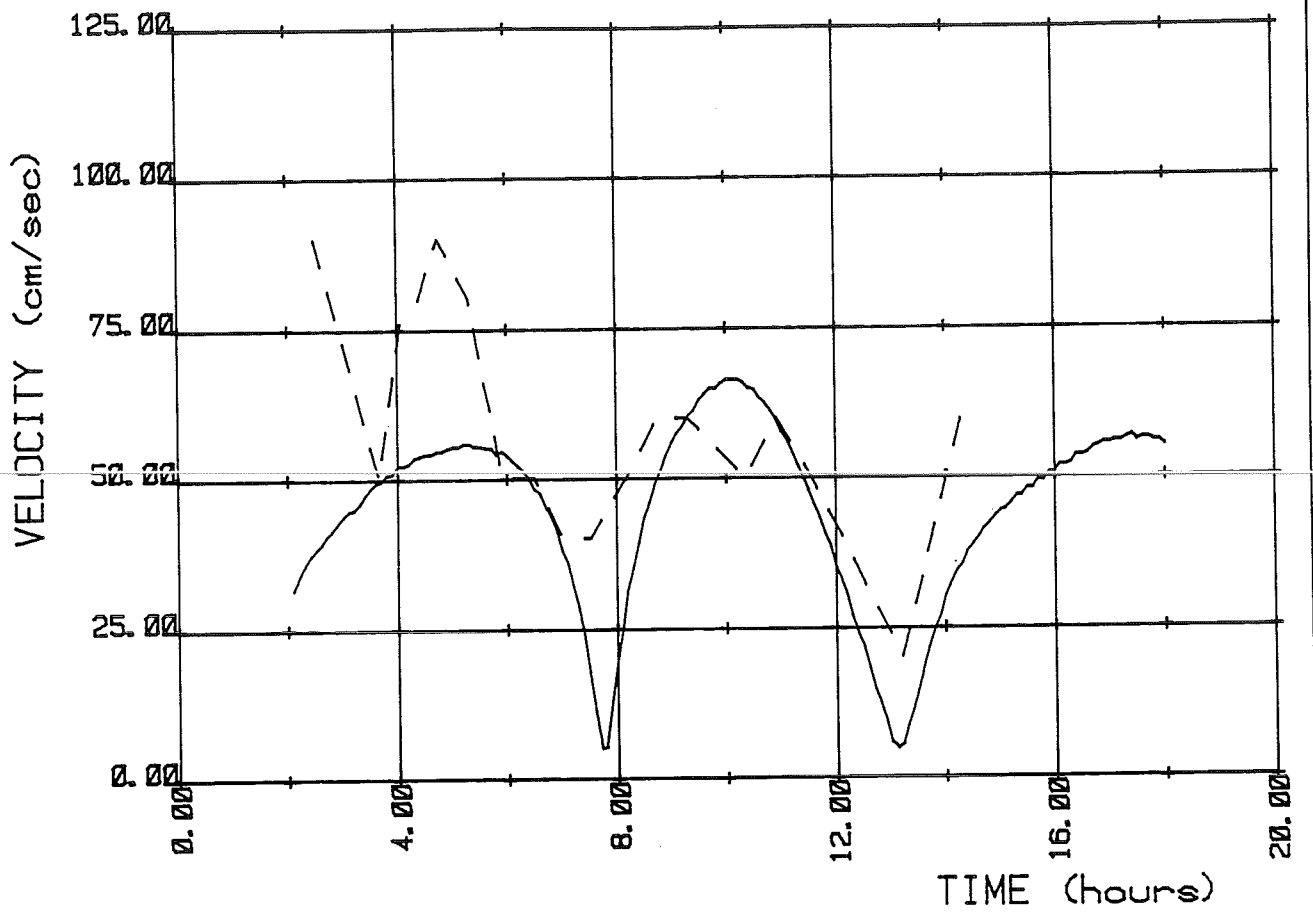

Velocity curve at station: 18

————— computed at $N=90$ $M=30$
 - - - - - measured April 15th 1972



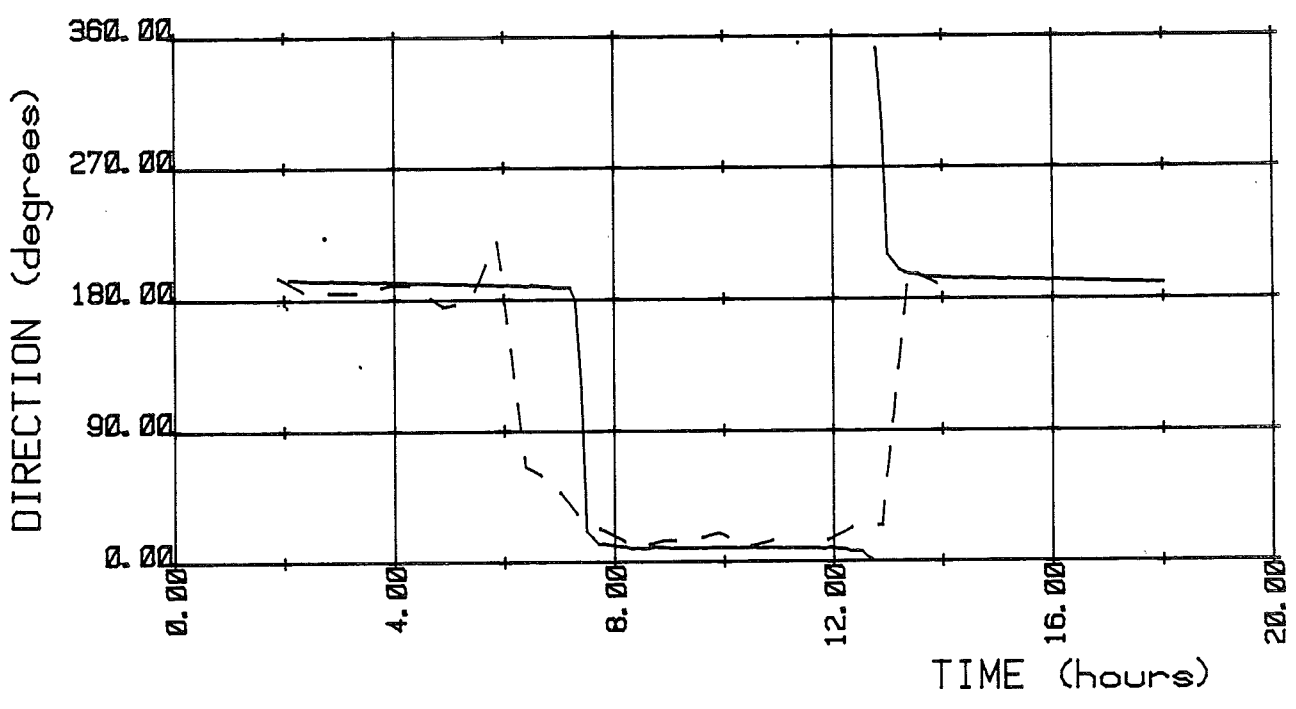
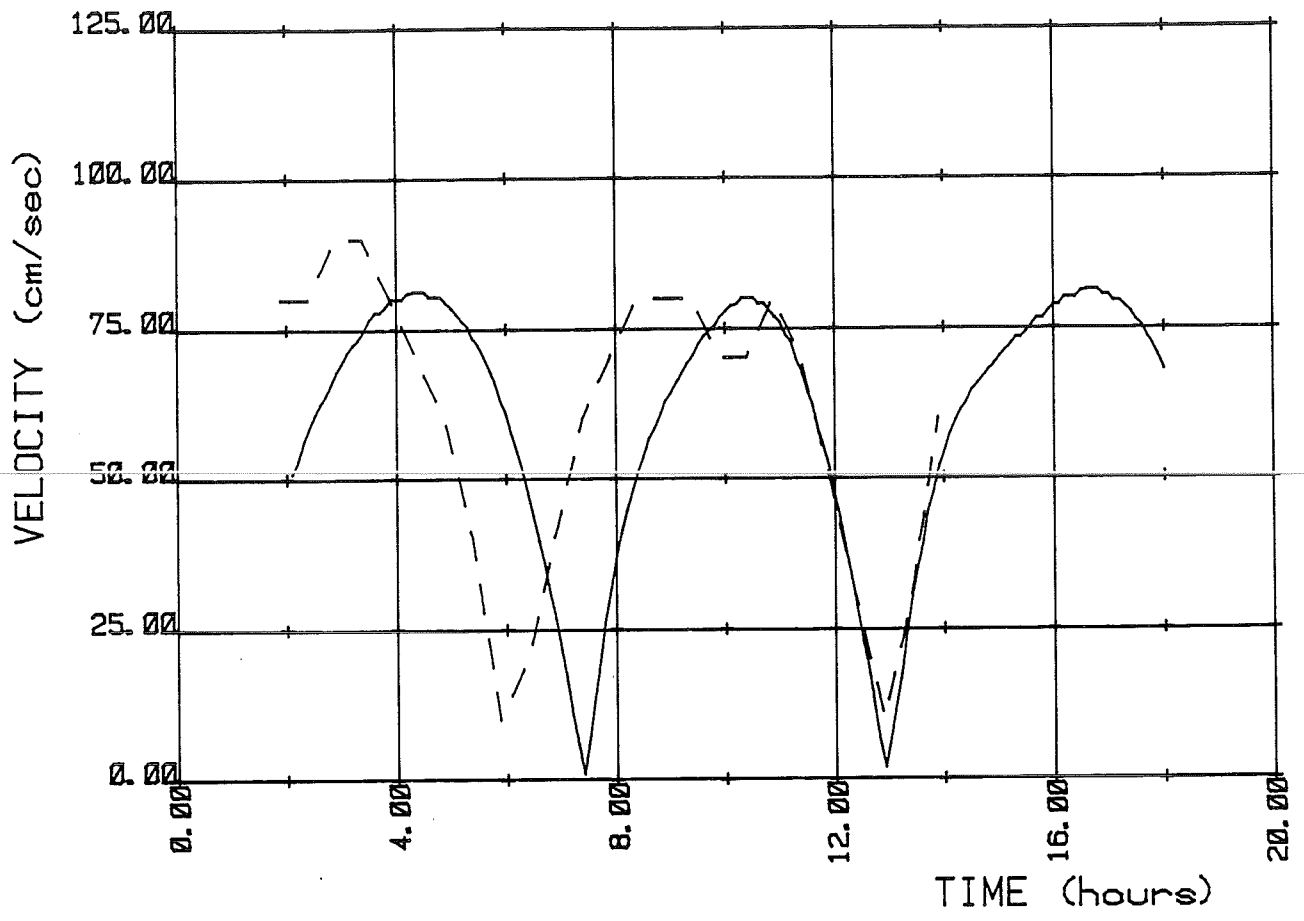

Velocity curve at station: 26
 ————— computed at N= 66 M= 21
 - - - - - measured June 13th 1972



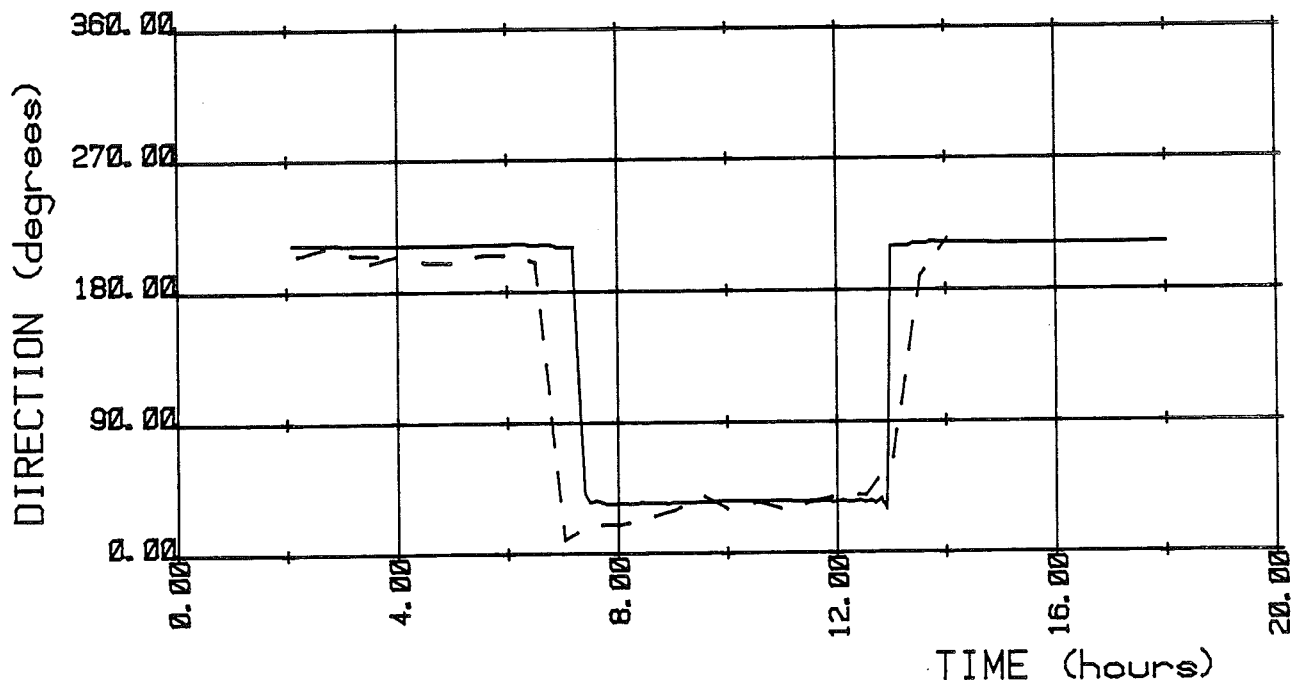
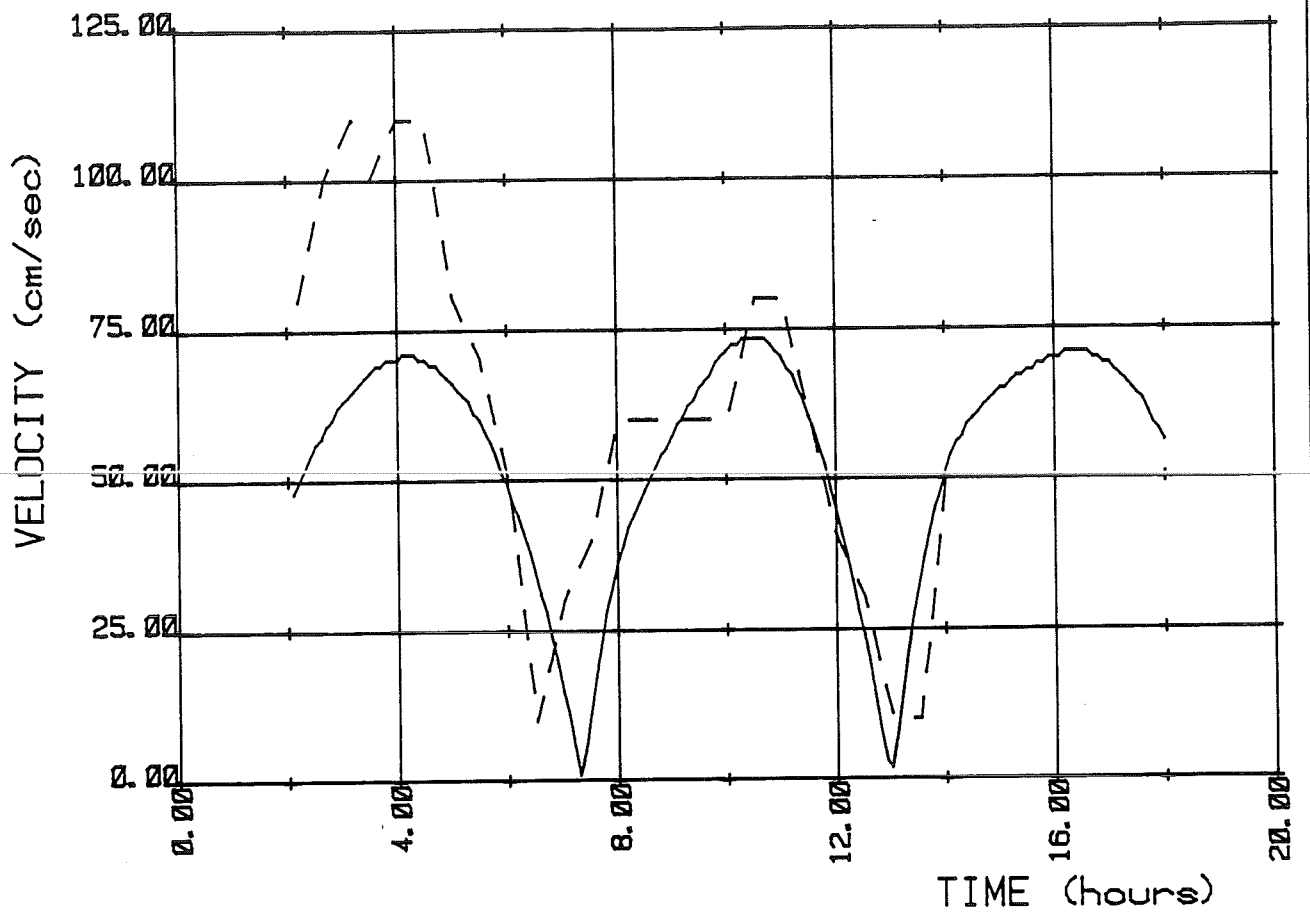

Velocity curve at station: 30

————— computed at $N=70$ $M=32$
 - - - - - measured June 12th 1972



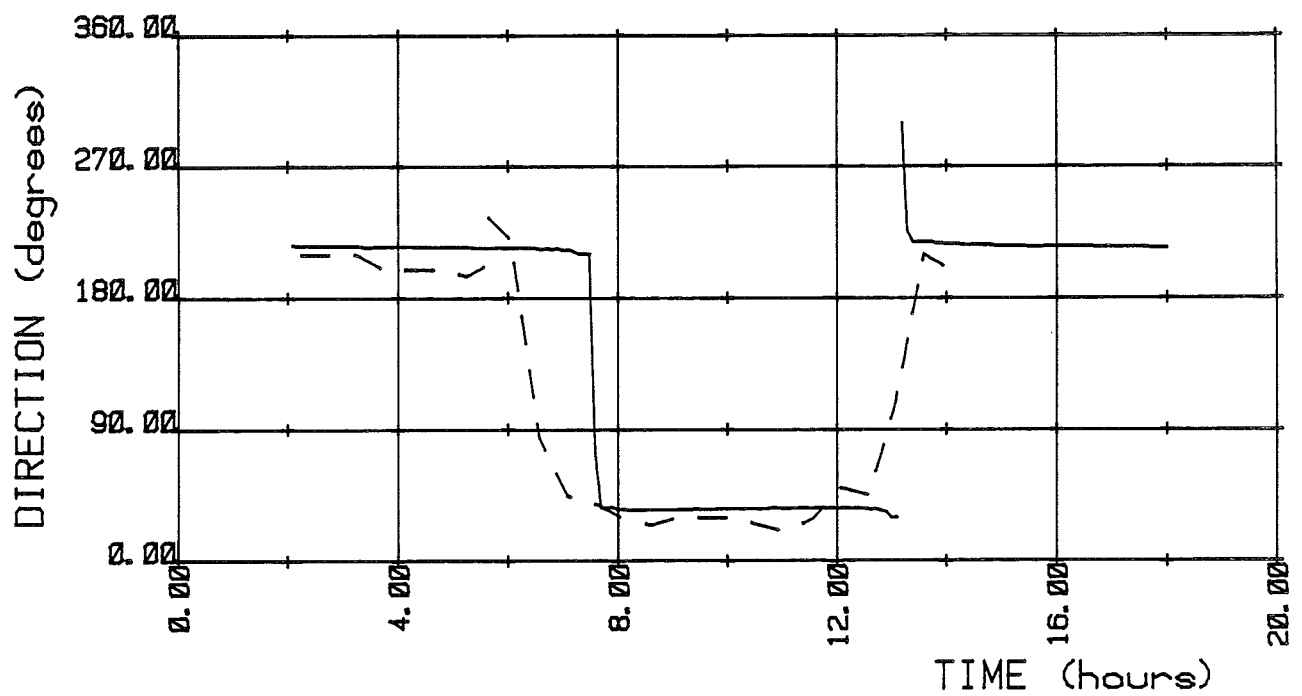
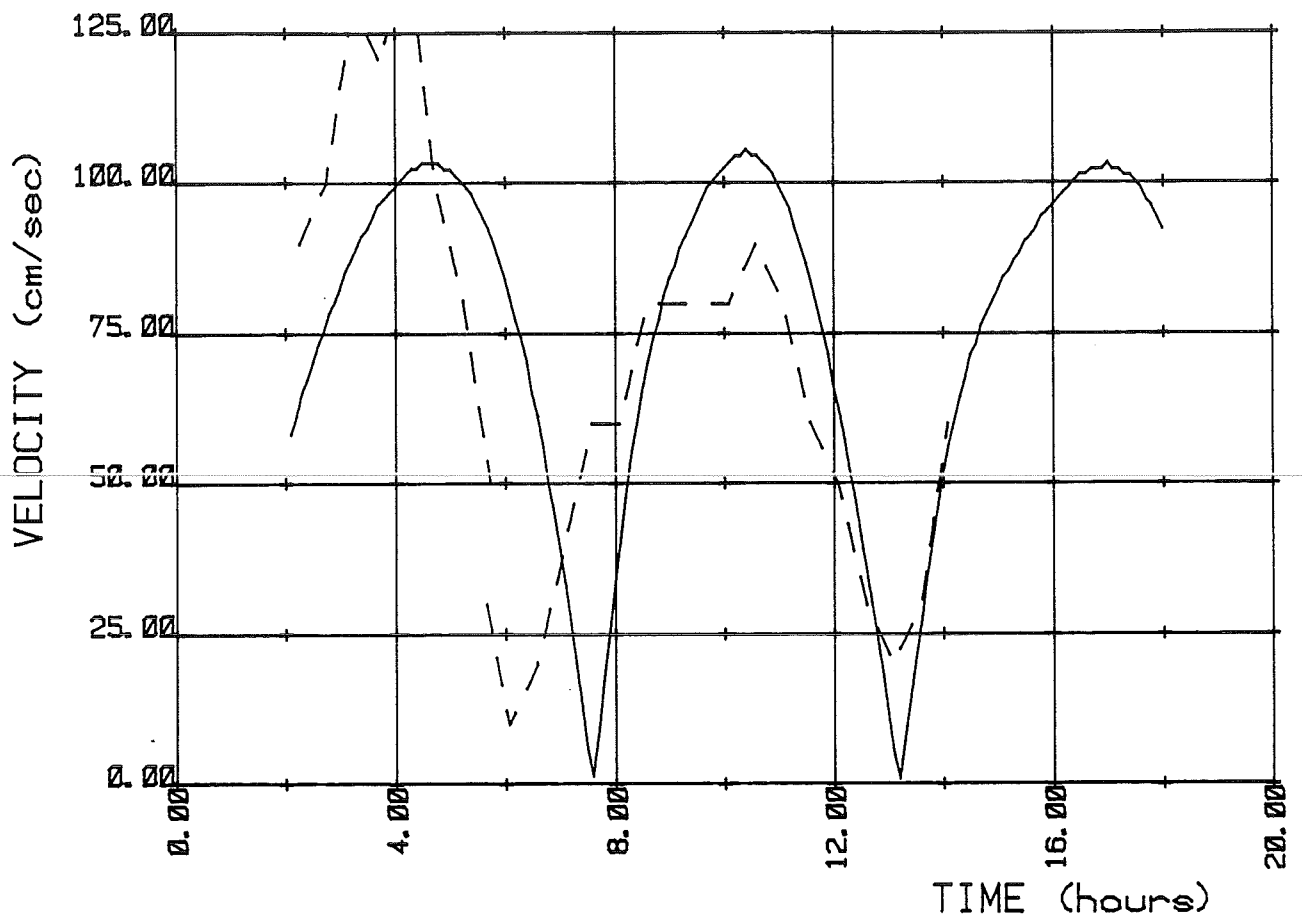

Velocity curve at station: 32

————— computed at $N= 71$ $M= 38$

- - - - - measured June 9th 1972



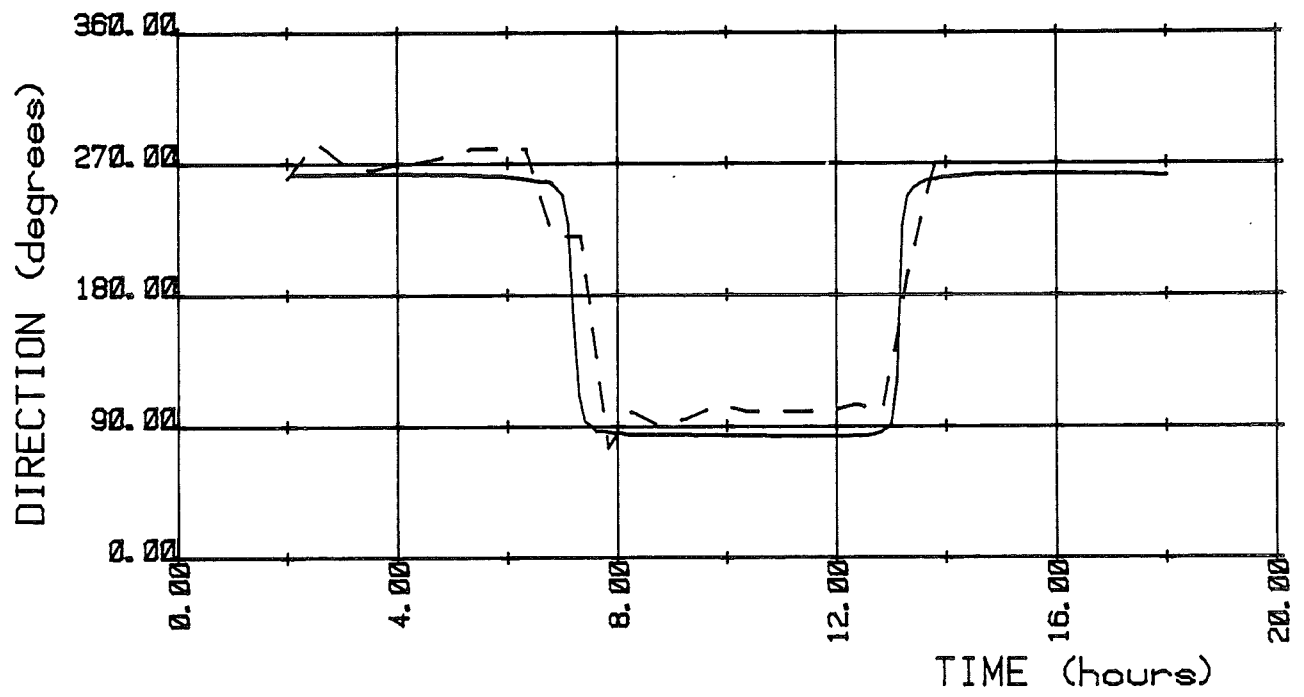
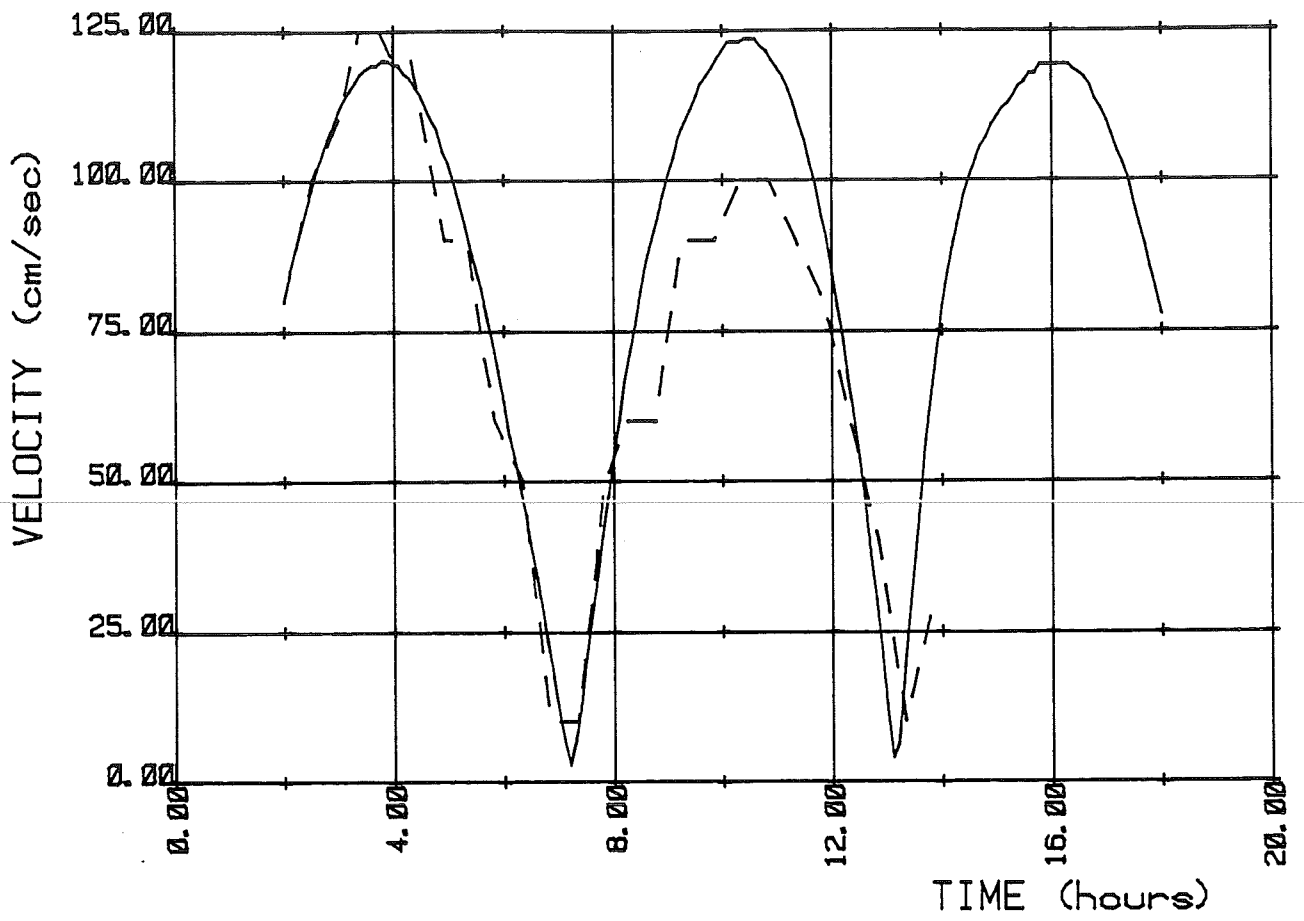

Velocity curve at station: 36
 ————— computed at N= 35 M= 25
 - - - - - measured October 12th 1973



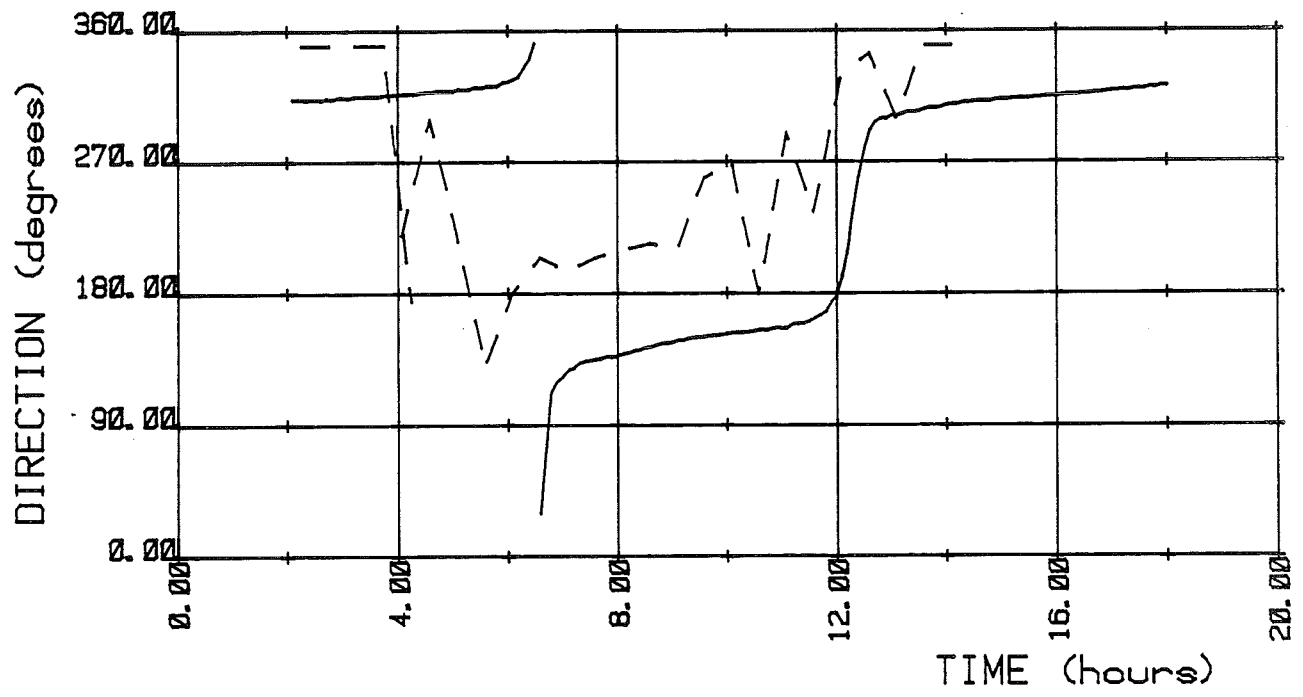
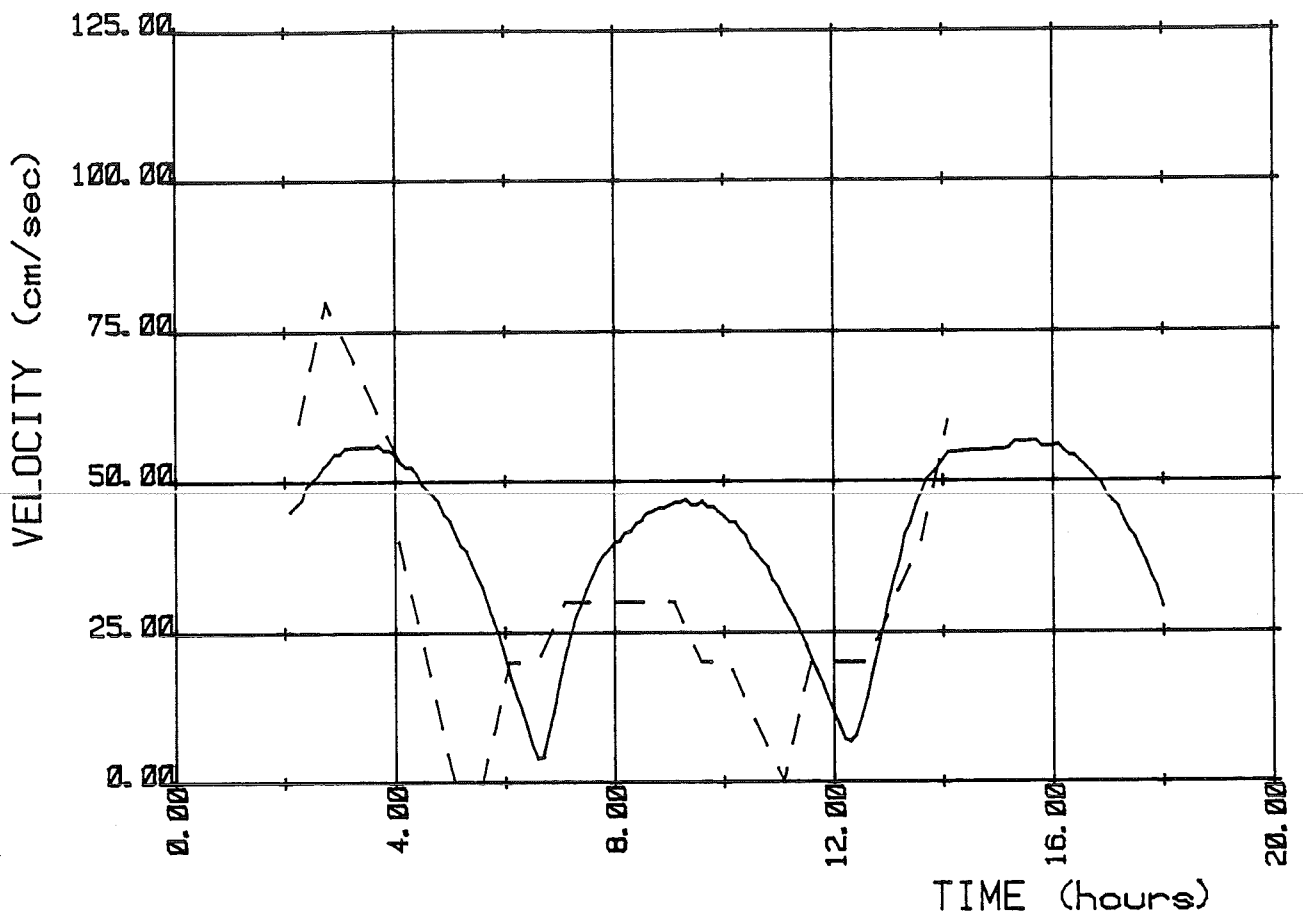

Velocity curve at station: 41
 ————— computed at N= 26 M= 27
 - - - - - measured July 10th 1972



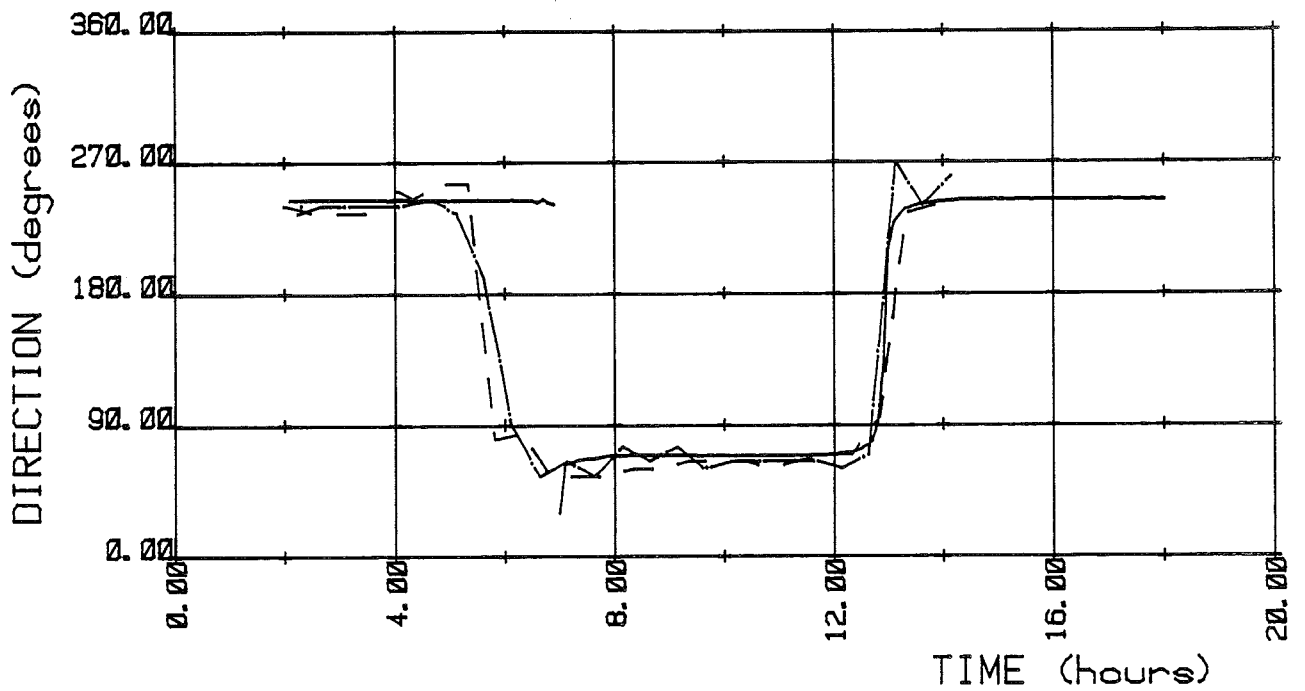
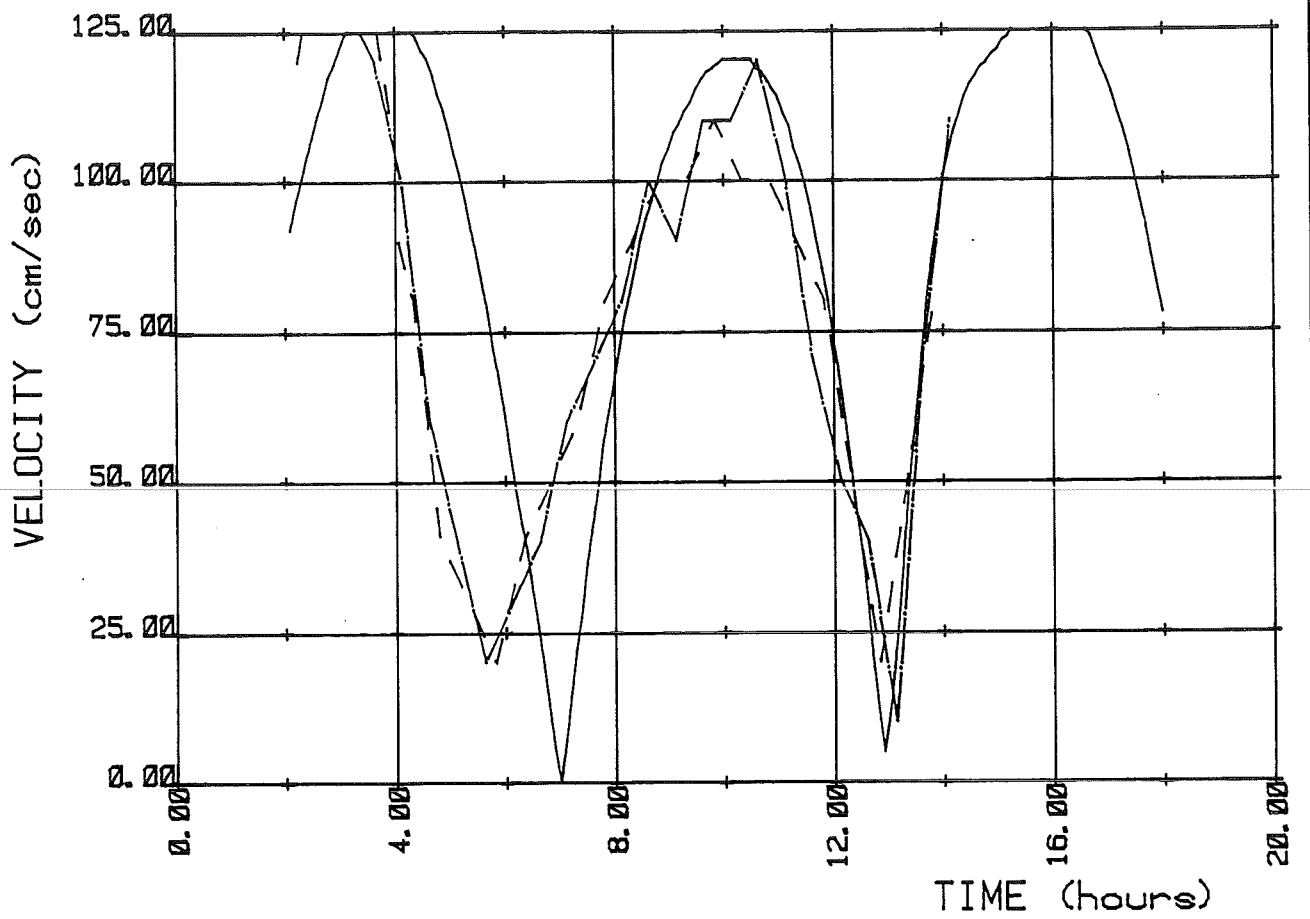

Velocity curve at station: 221-222

- computed at $N = 38$ $M = 22$
- - - - - measured July 7th 1972
- · - · - · measured July 12th 1972



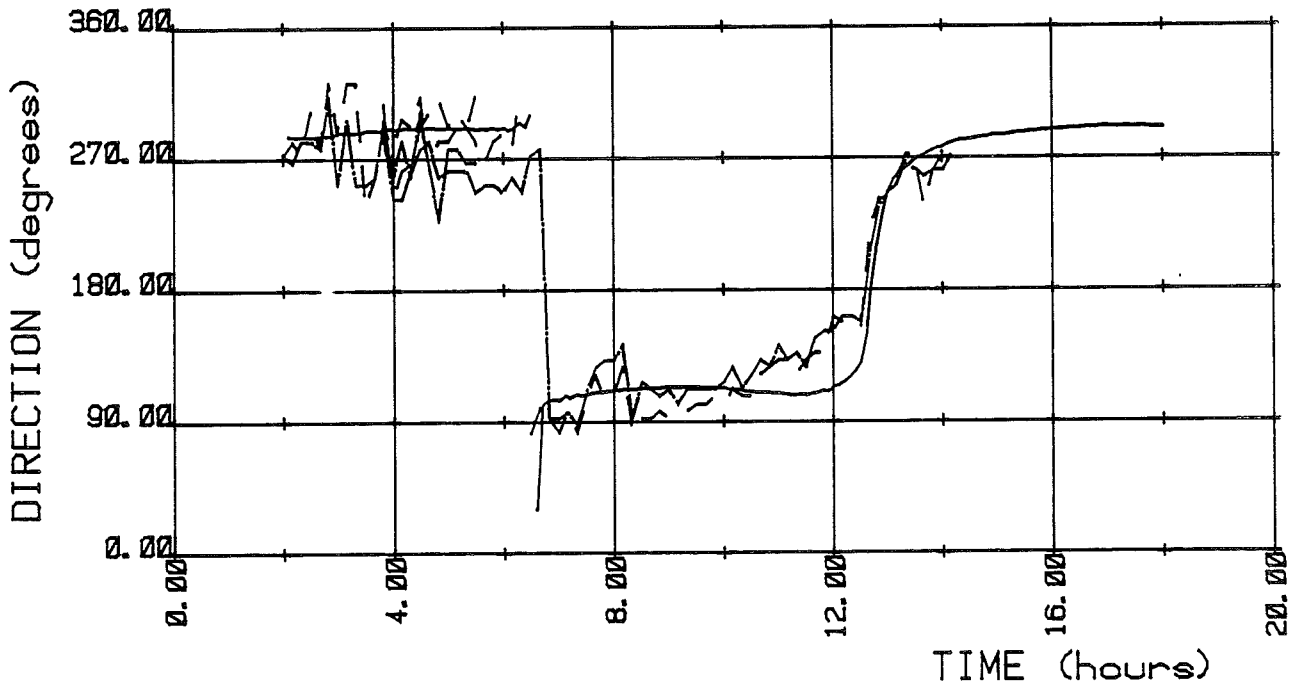
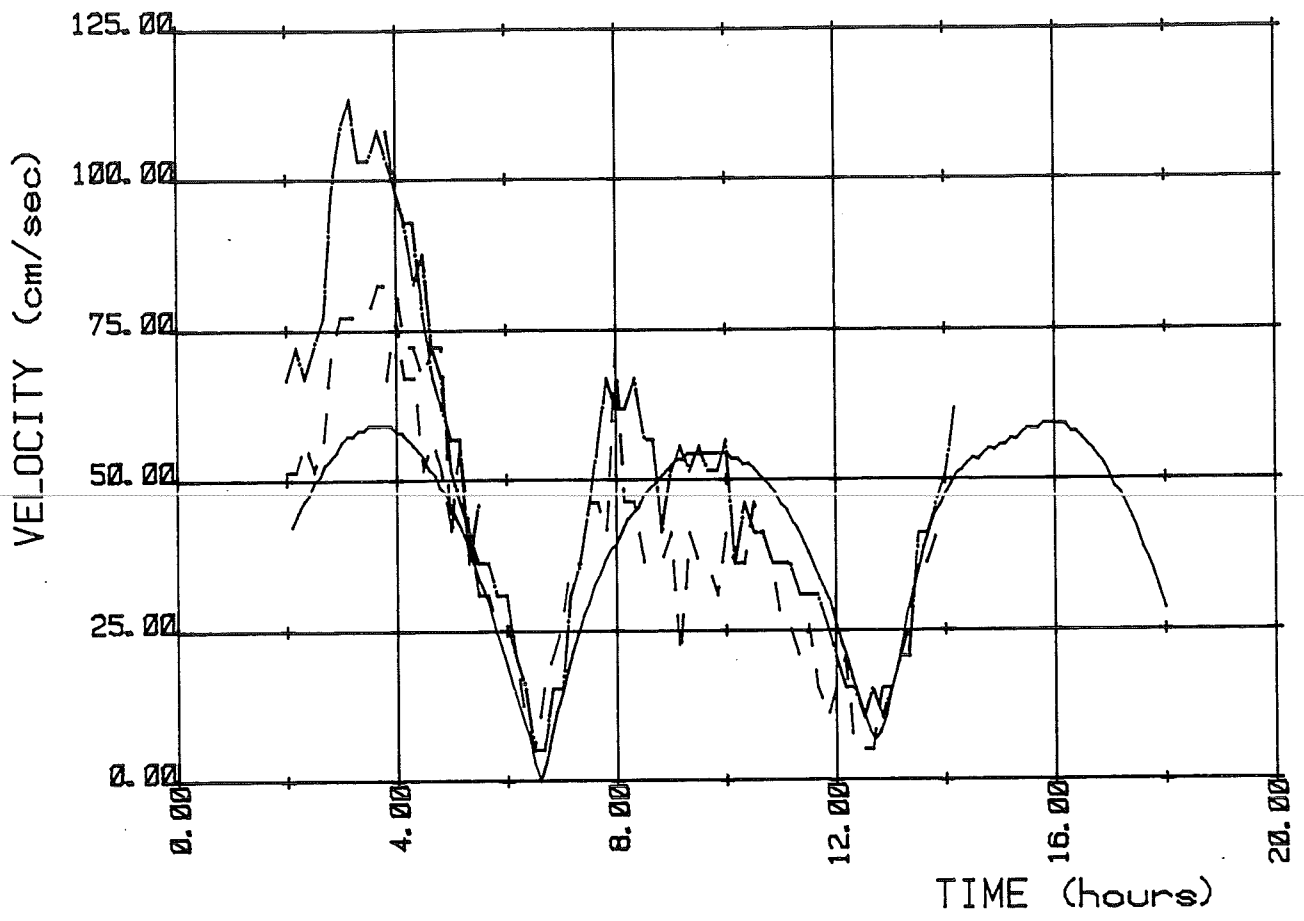

Velocity curve at station: 223

_____ computed at N= 32 M= 35
 - - - - - measured 1m+floor April 6th 1981
 - . - . - . measured 2m-surface April 6th 1981



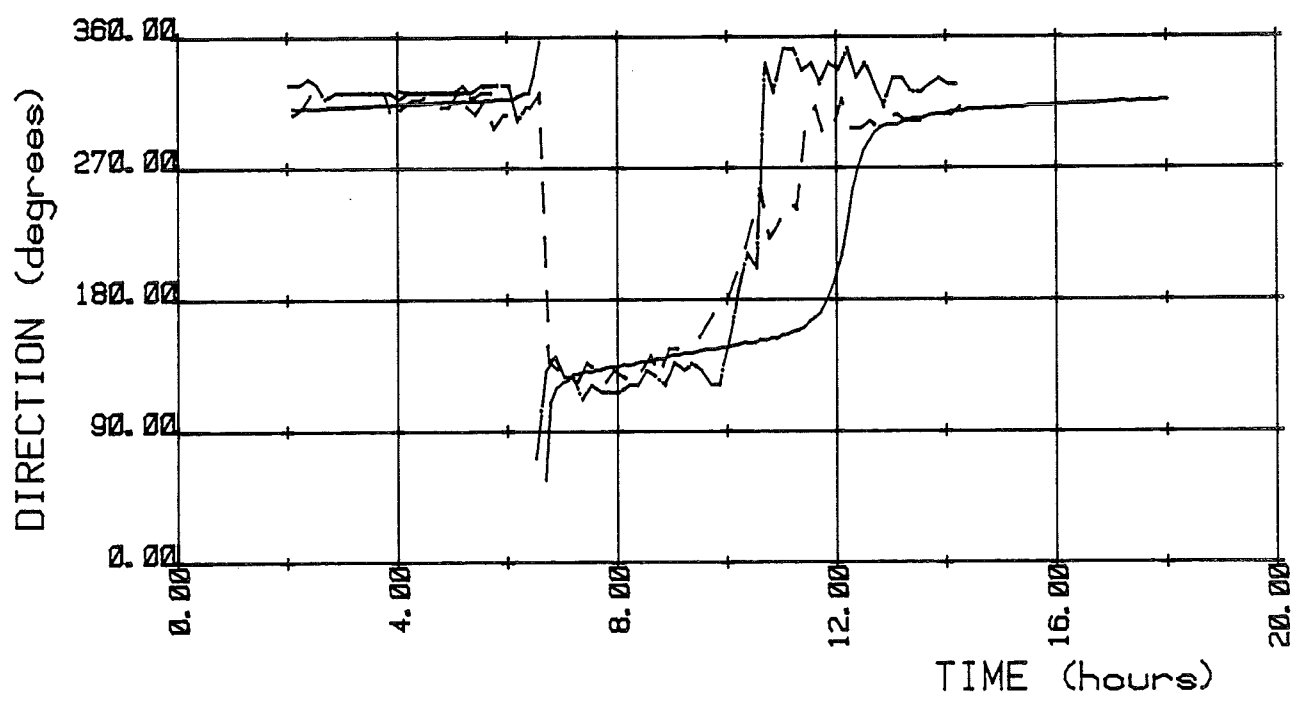
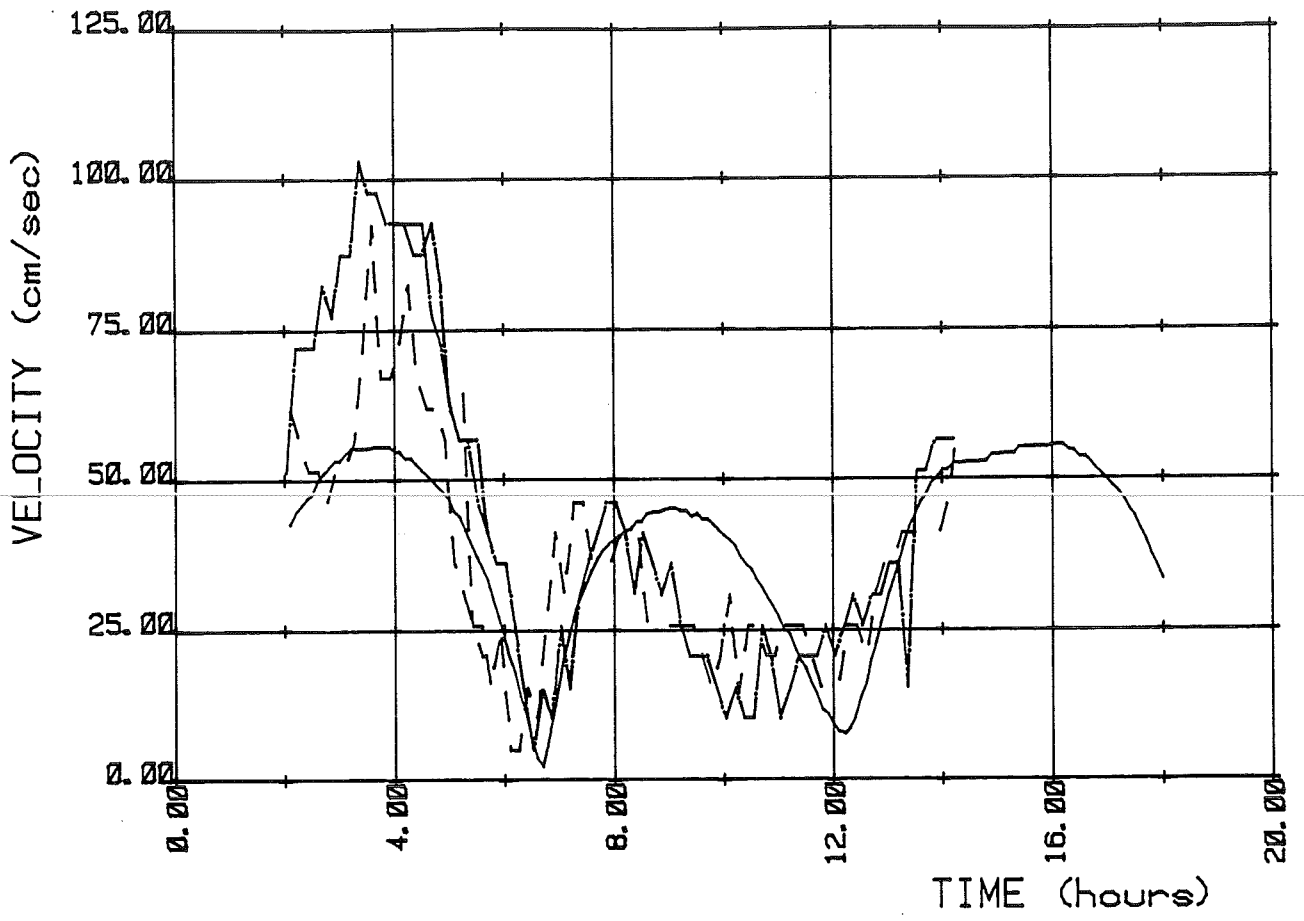

Velocity curve at station: 224

- computed at N= 25 M= 28
- - - - - measured 1m+floor April 6th 1981
- · - · - · measured 2m-surface April 6th 1981



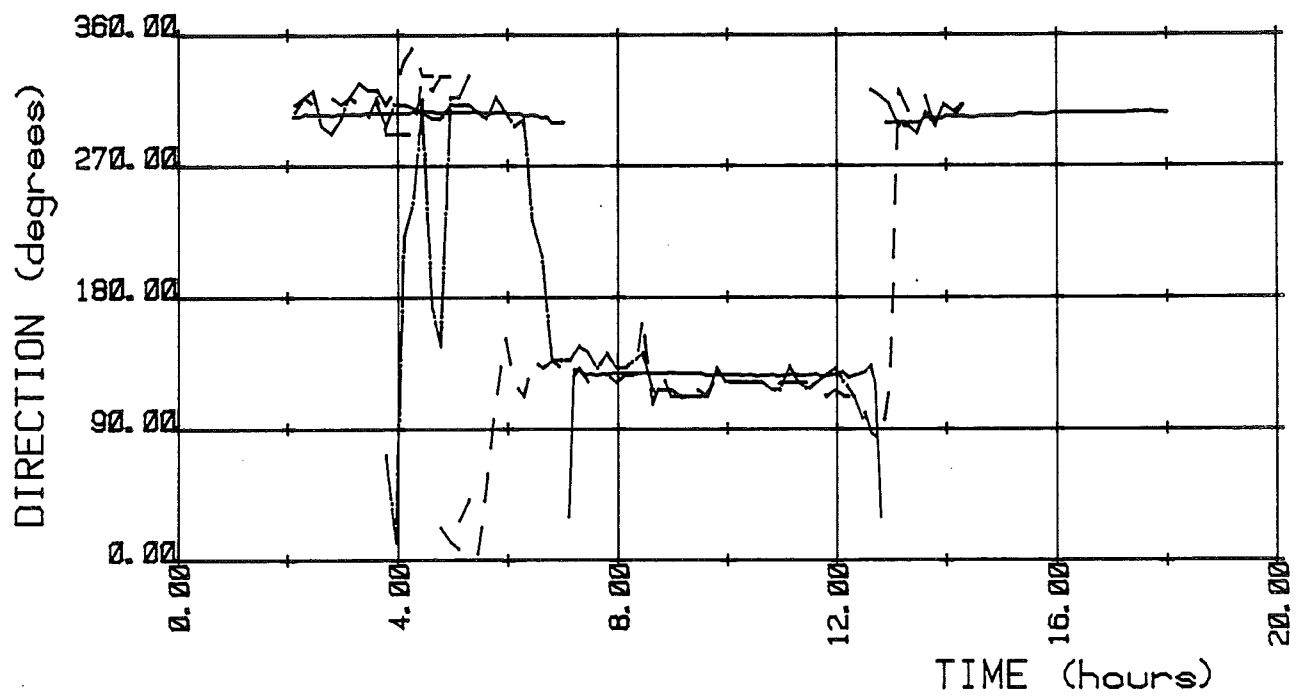
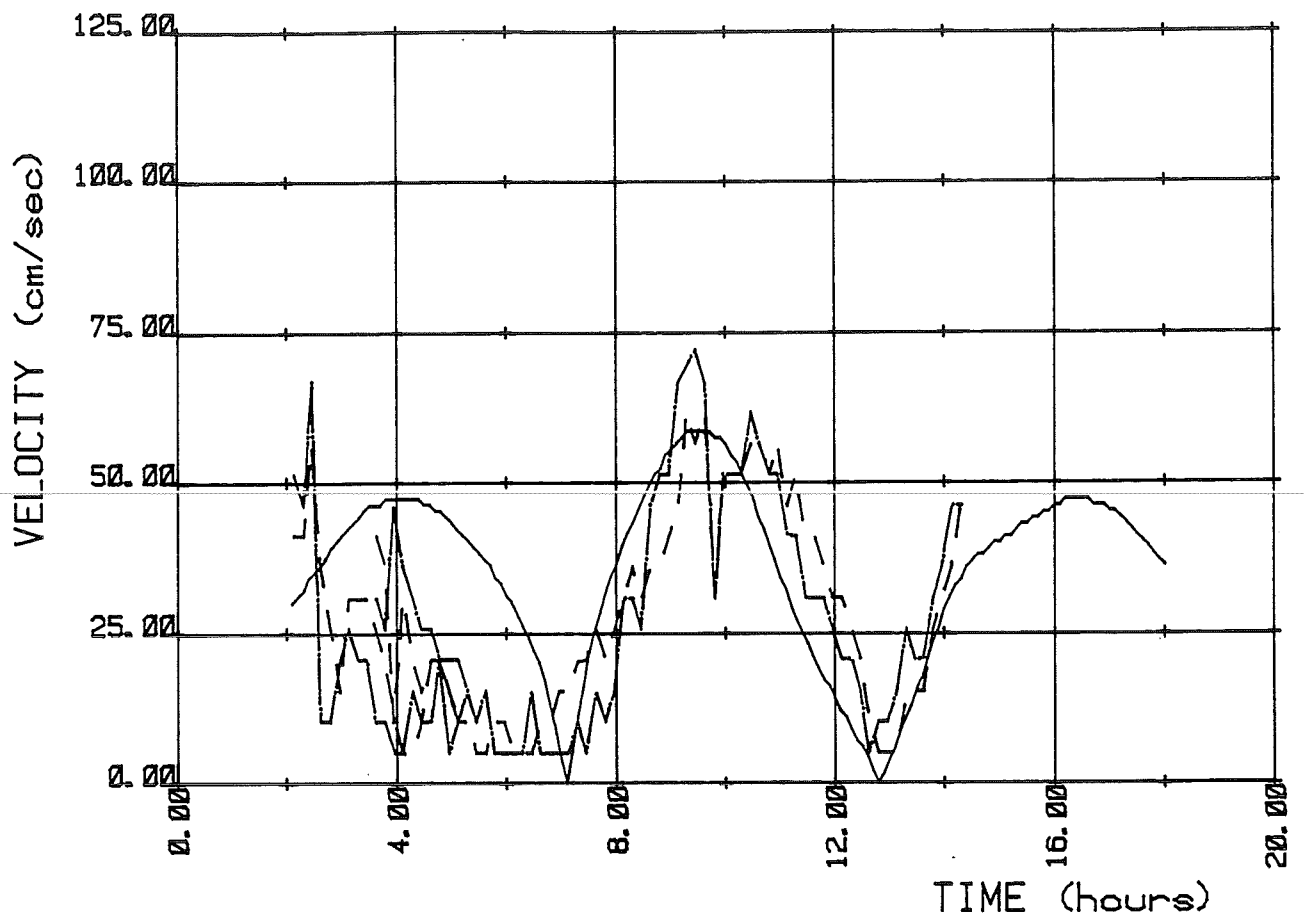

Velocity curve at station: 225

- computed at $N=24$ $M=43$
- - - - - measured 1m+floor April 6th 1981
- · - · - · - measured 2m-surface April 6th 1981



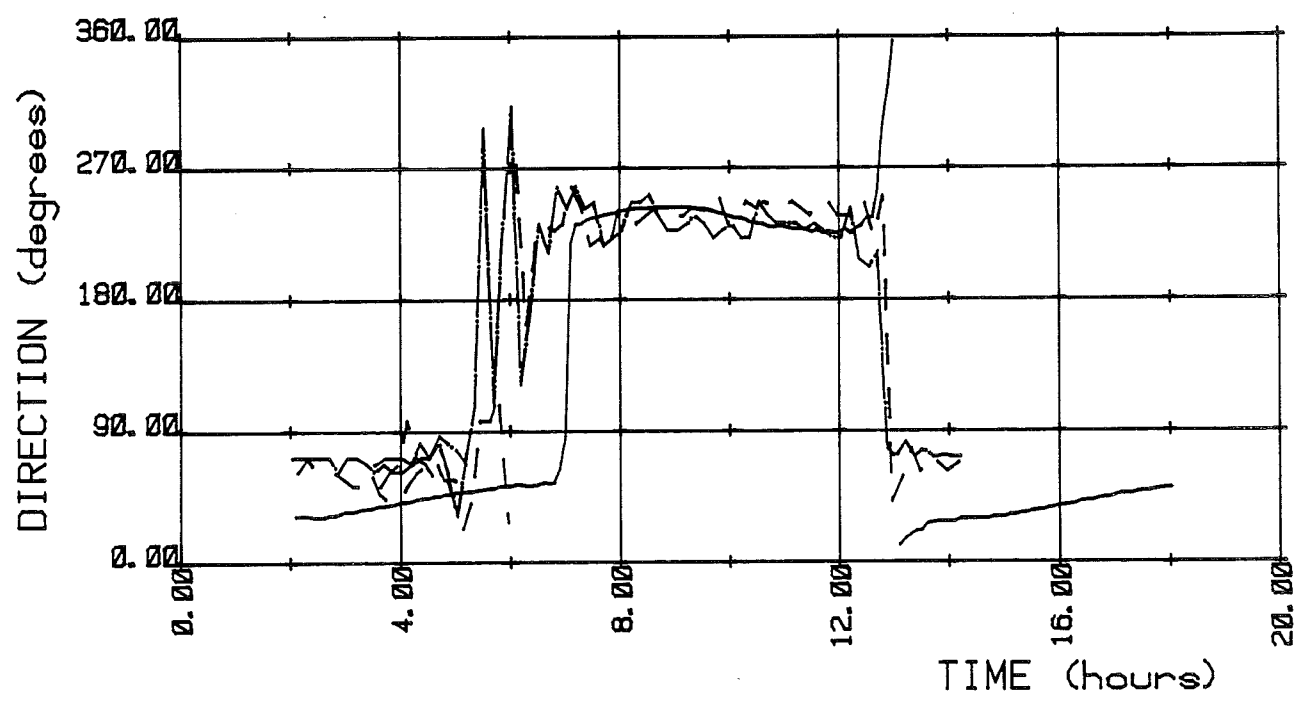
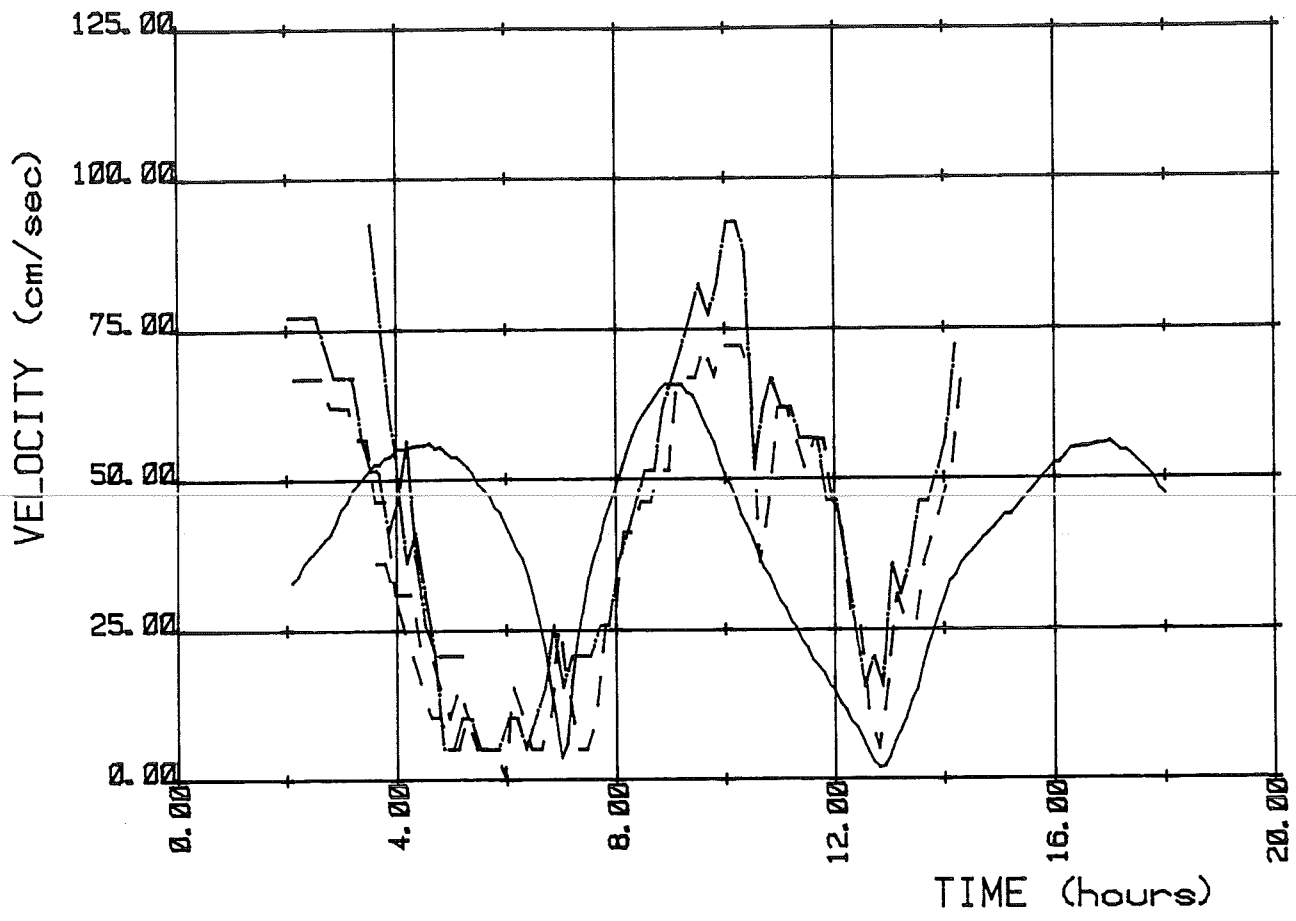

Velocity curve at station: 226

————— computed at $N=20$ $M=41$

- - - - - measured 1m+floor April 6th 1981

- · - · - · measured 2m-surface April 6th 1981



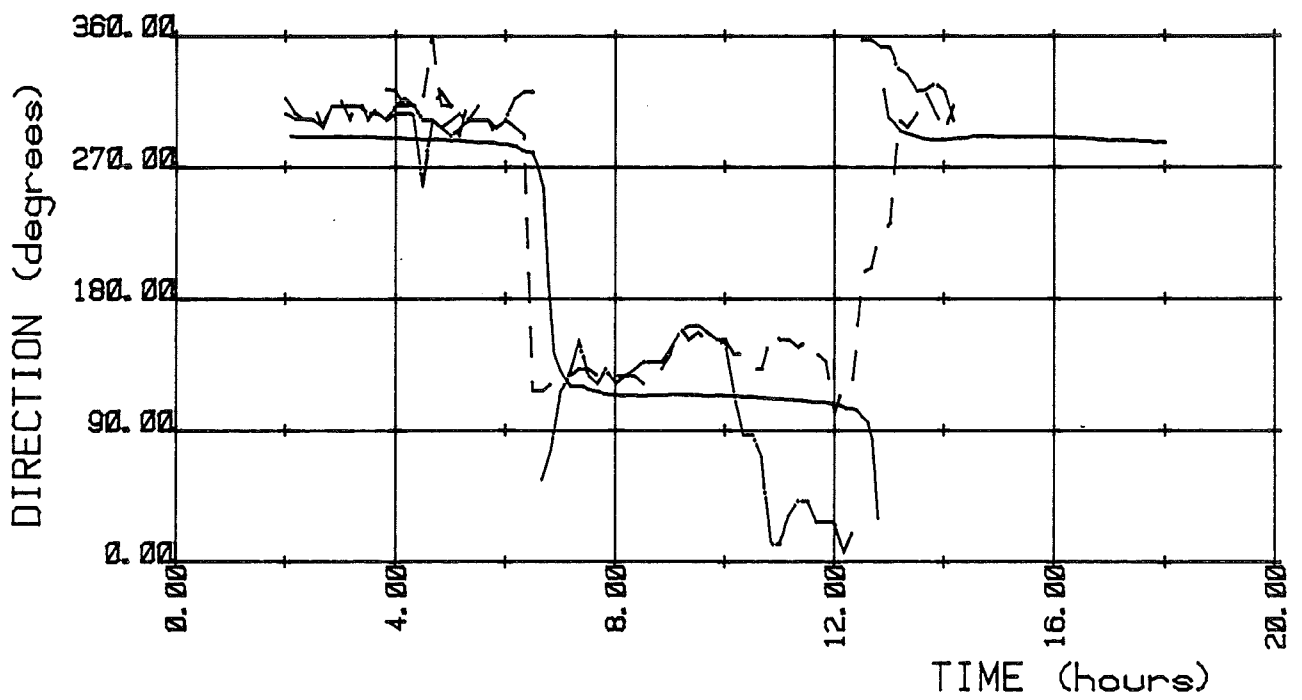
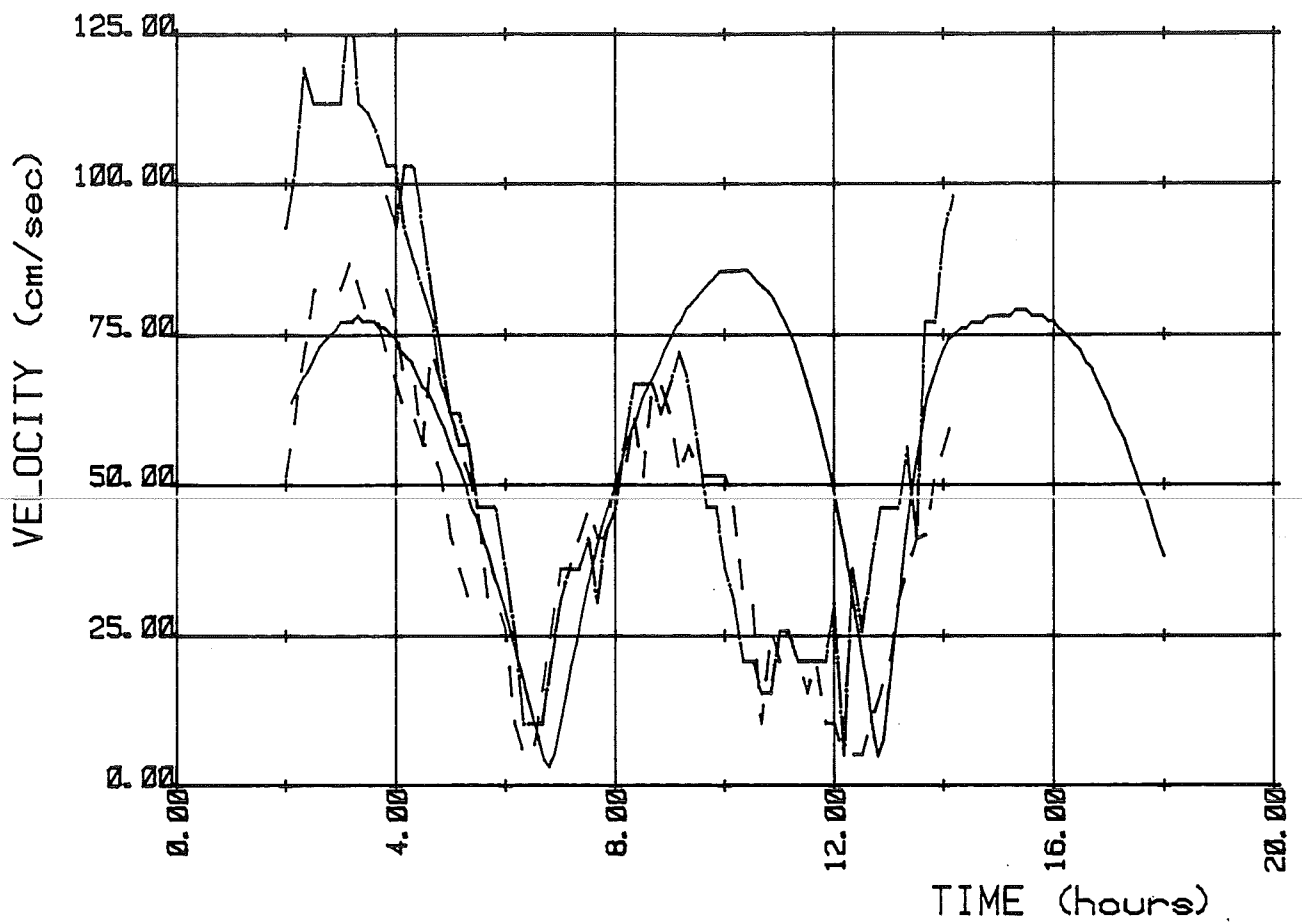

Velocity curve at station: 227

- computed at $N = 30$ $M = 24$
- - - - - measured 1m+floor April 6th 1981
- · - · - · measured 2m-surface April 6th 1981



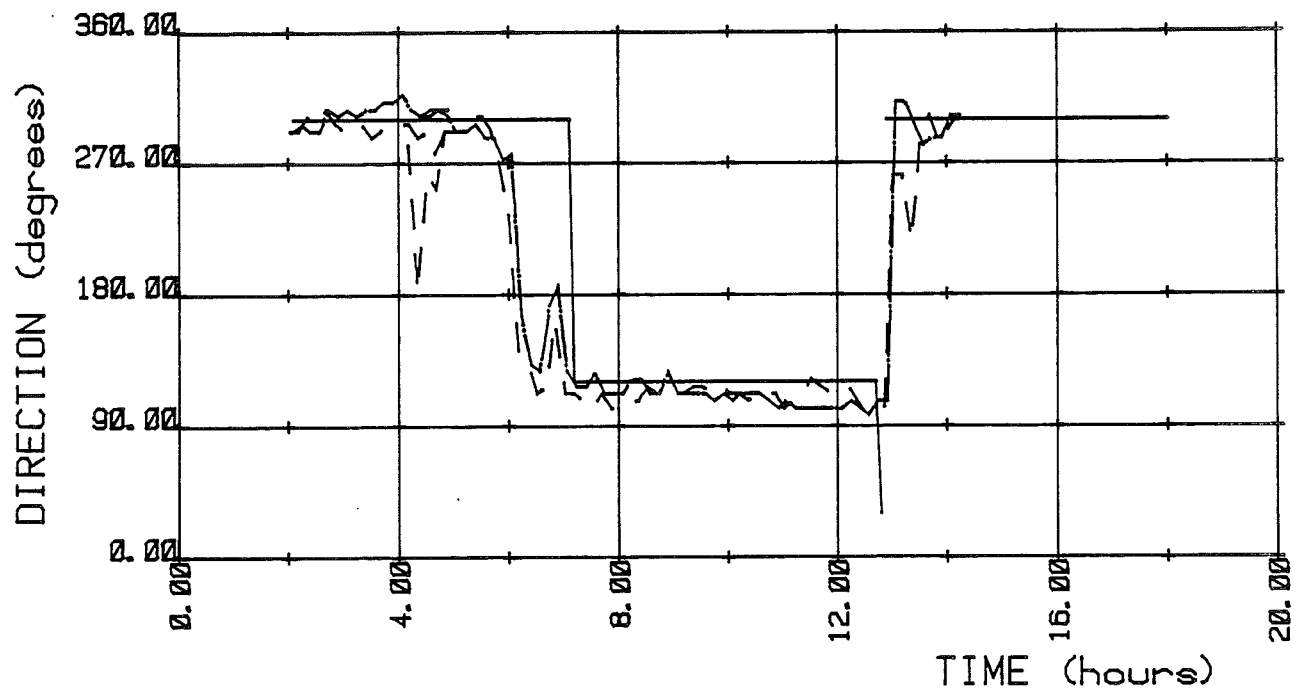
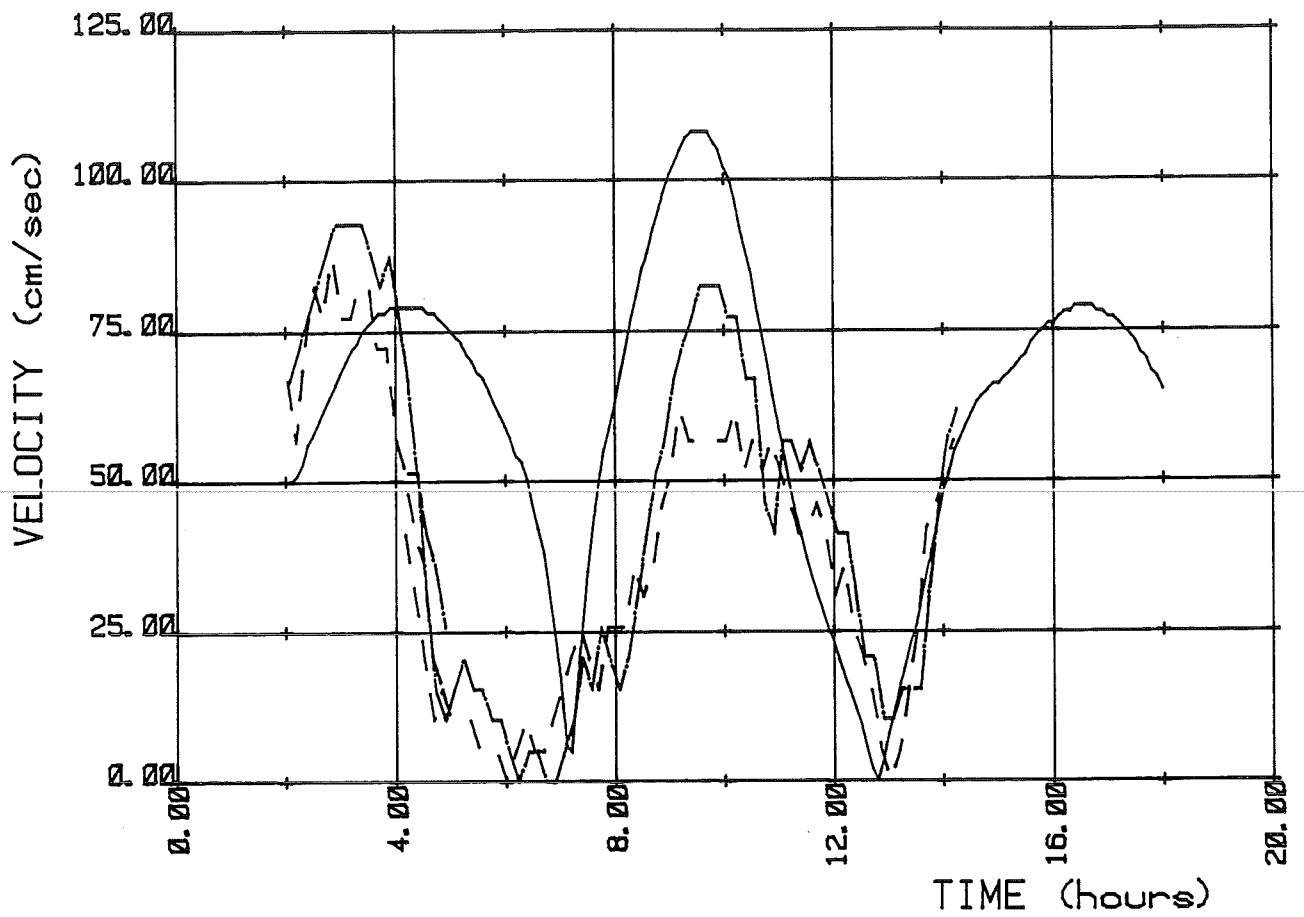

Velocity curve at station: 228

- computed at N= 25 M= 48
- - - - - measured 1m+floor July 2nd 1981
- · - · - · - measured 2m-surface July 2nd 1981



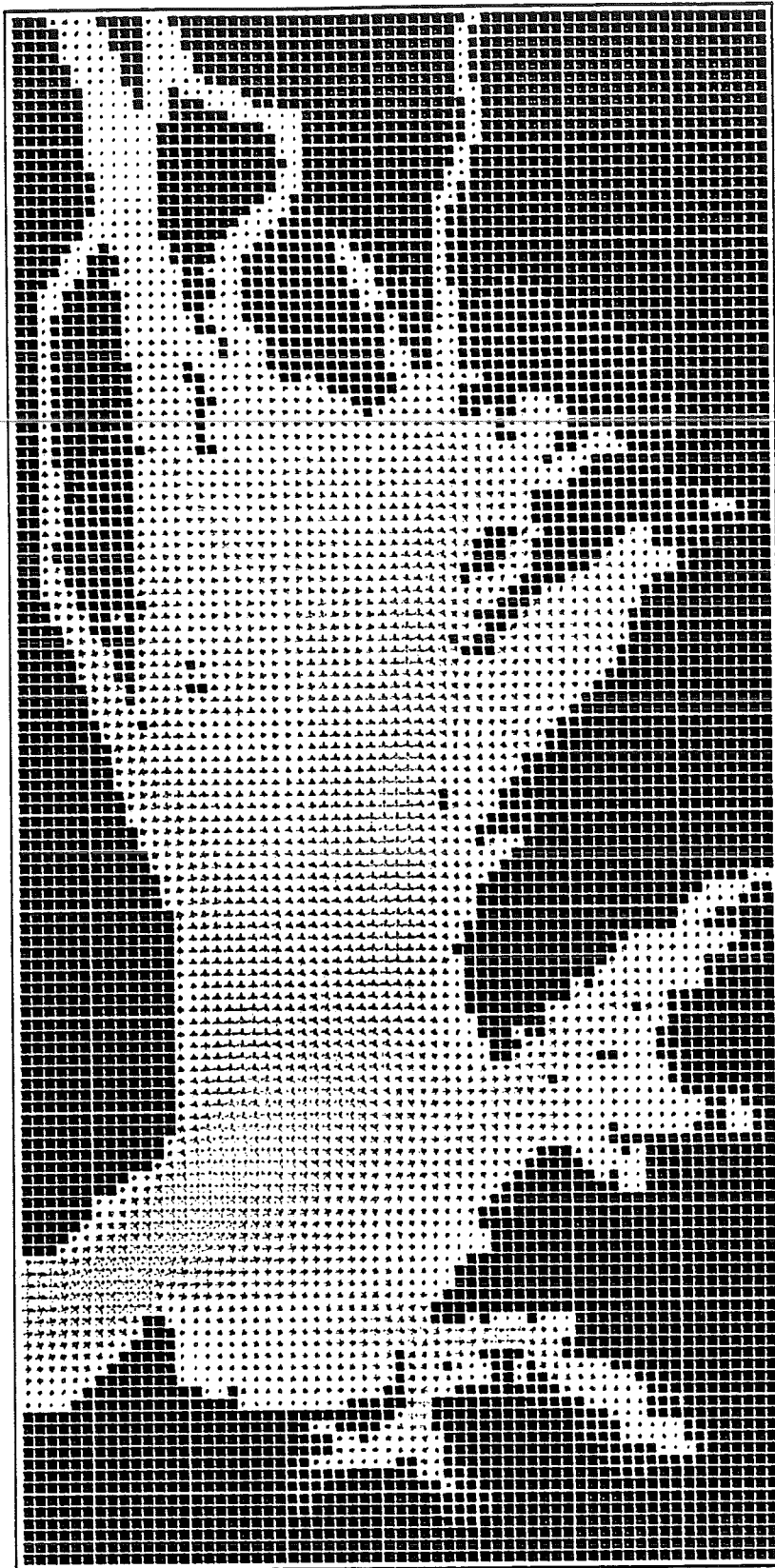

scale 1 : 150000

Computed flowfield: 9 hours after HW
at Lisbon

- velocity = 1.20 m/s
- velocity = .60 m/s
- land node
- dry shoal node



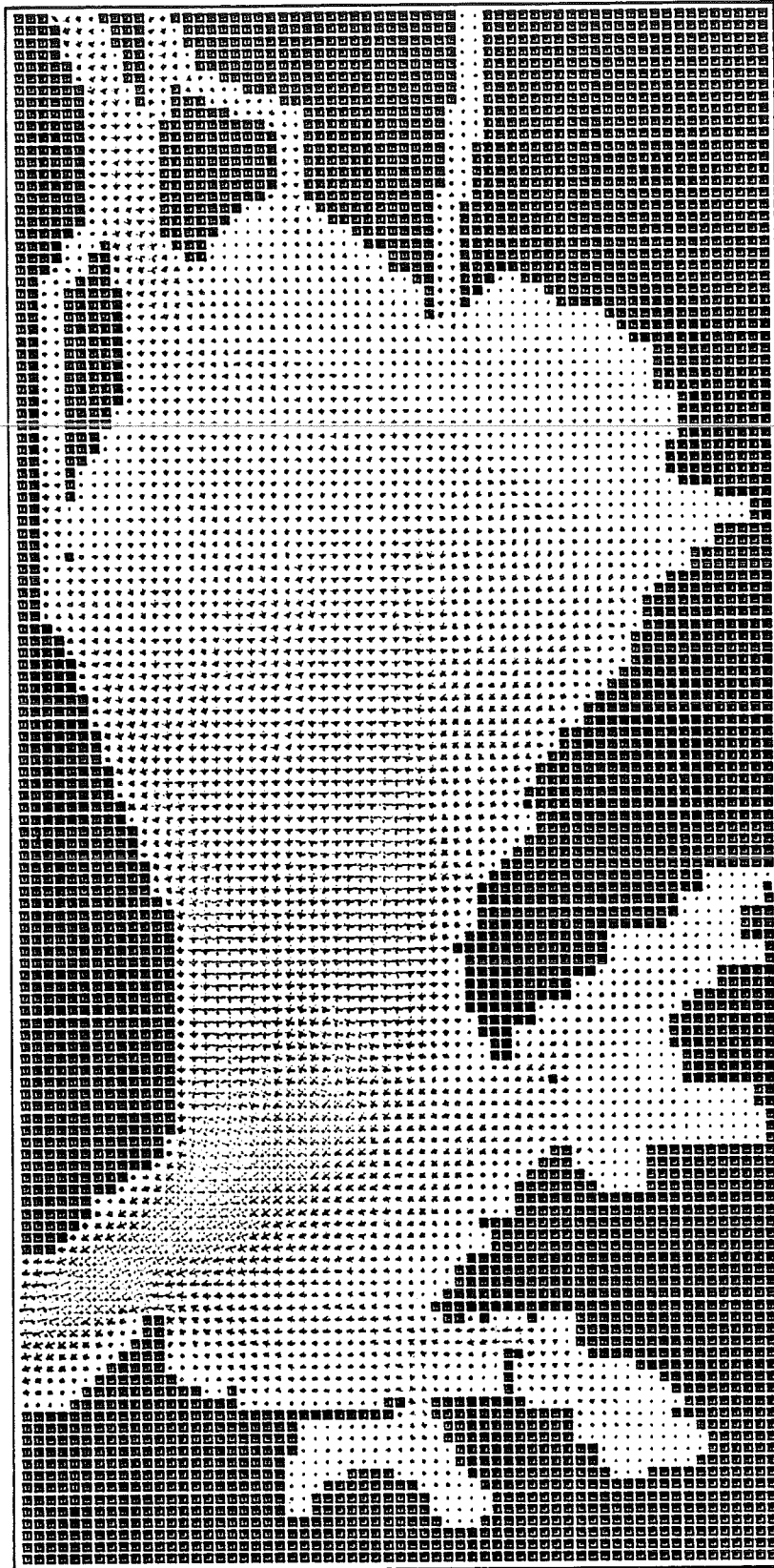

scale 1 : 150000

Computed flowfield; 15 hours after HW
at Lisbon

- velocity = 1.20 m/s
- velocity = .60 m/s
- land node
- dry shoal node

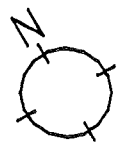

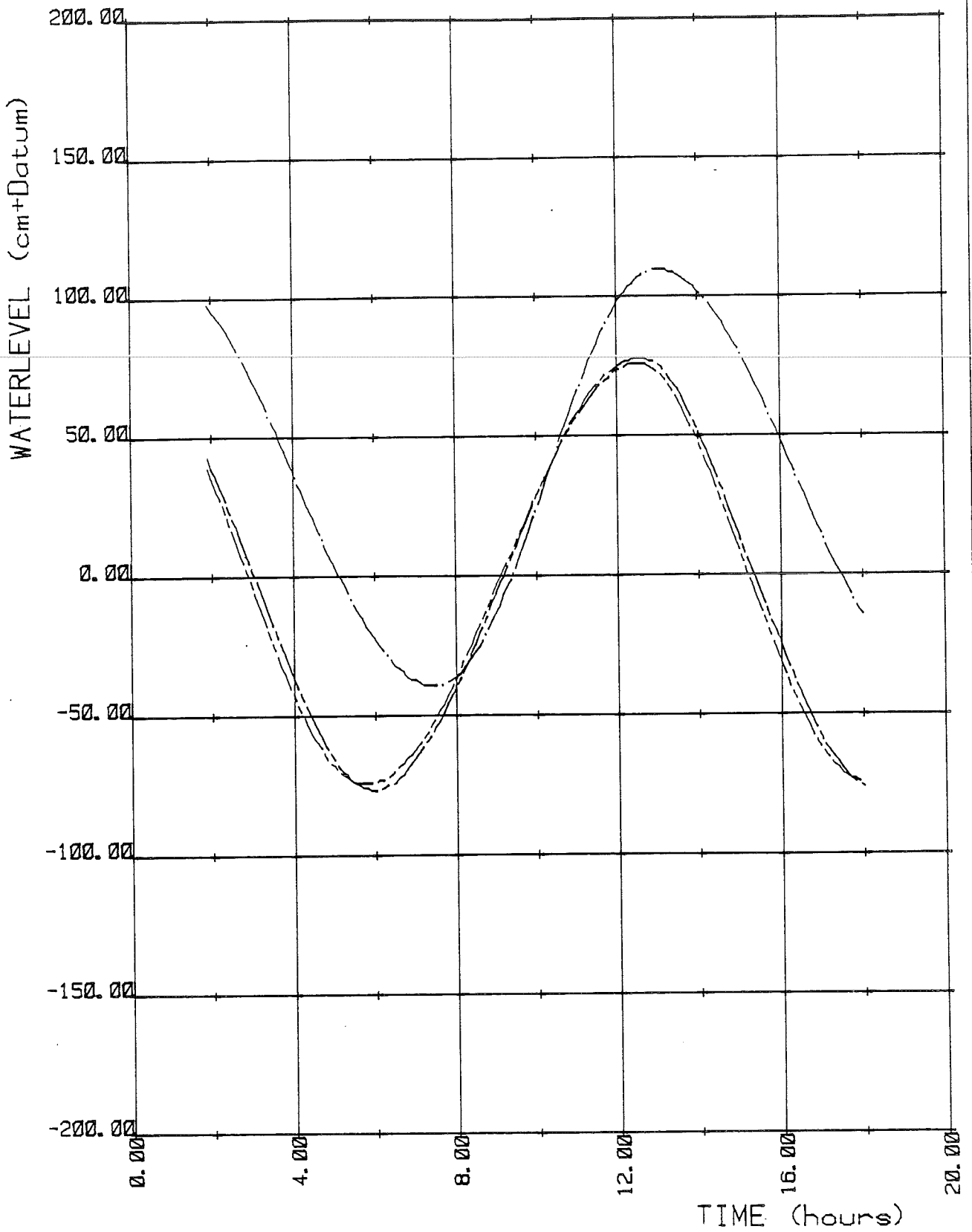

Computed waterlevel curves

- N= 38 M= 19 L1 Terreiro do Paco
- N= 21 M= 42 L5 Seixal
- N=153 M= 14 L7 Vila Franca



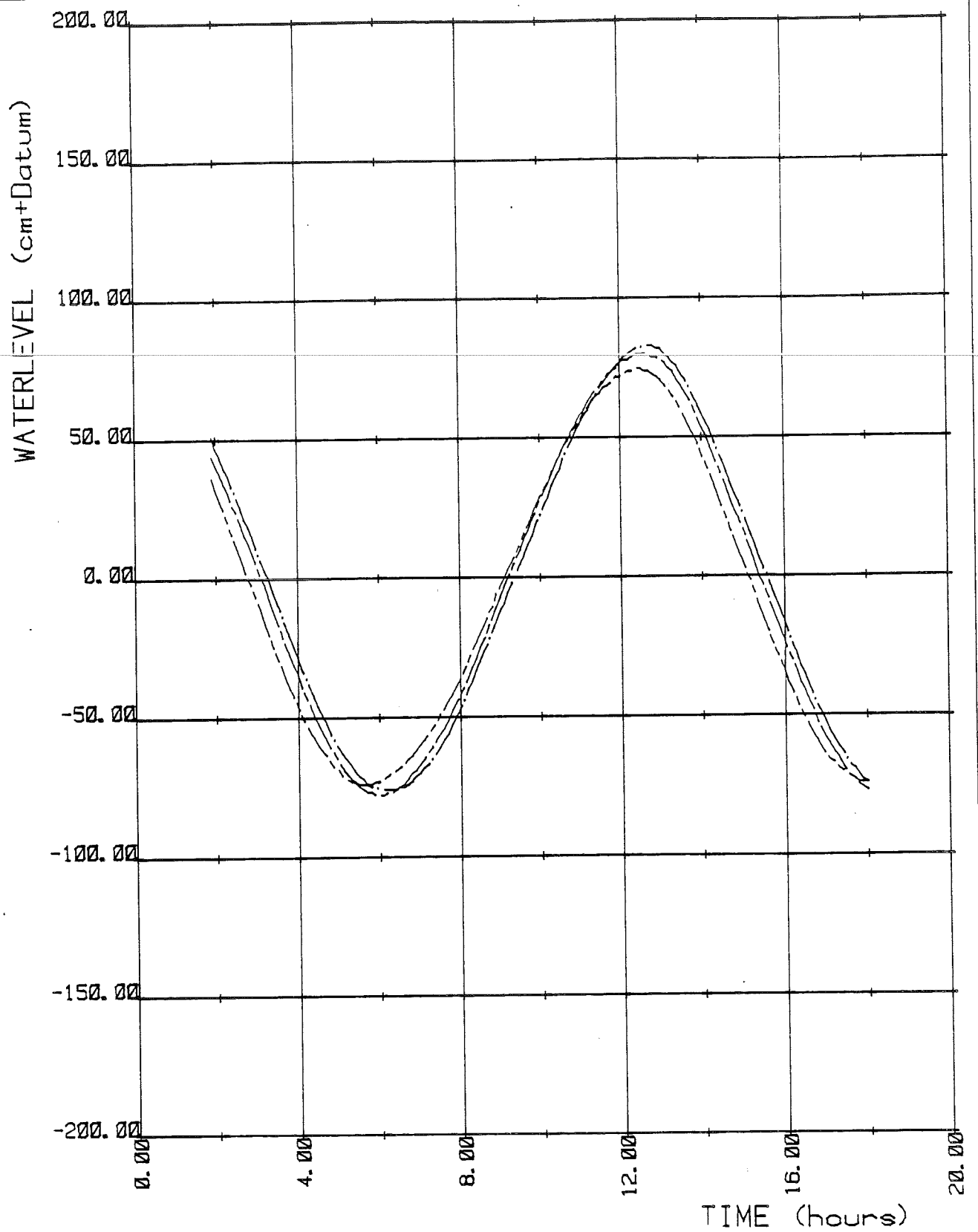

Computed waterlevel curves

- N= 28 M= 18 L2 Cacilhas
- . - . - . N= 46 M= 48 L6 Montijo Base
- _____ N= 64 M= 20 L9 Cabo Ruivo



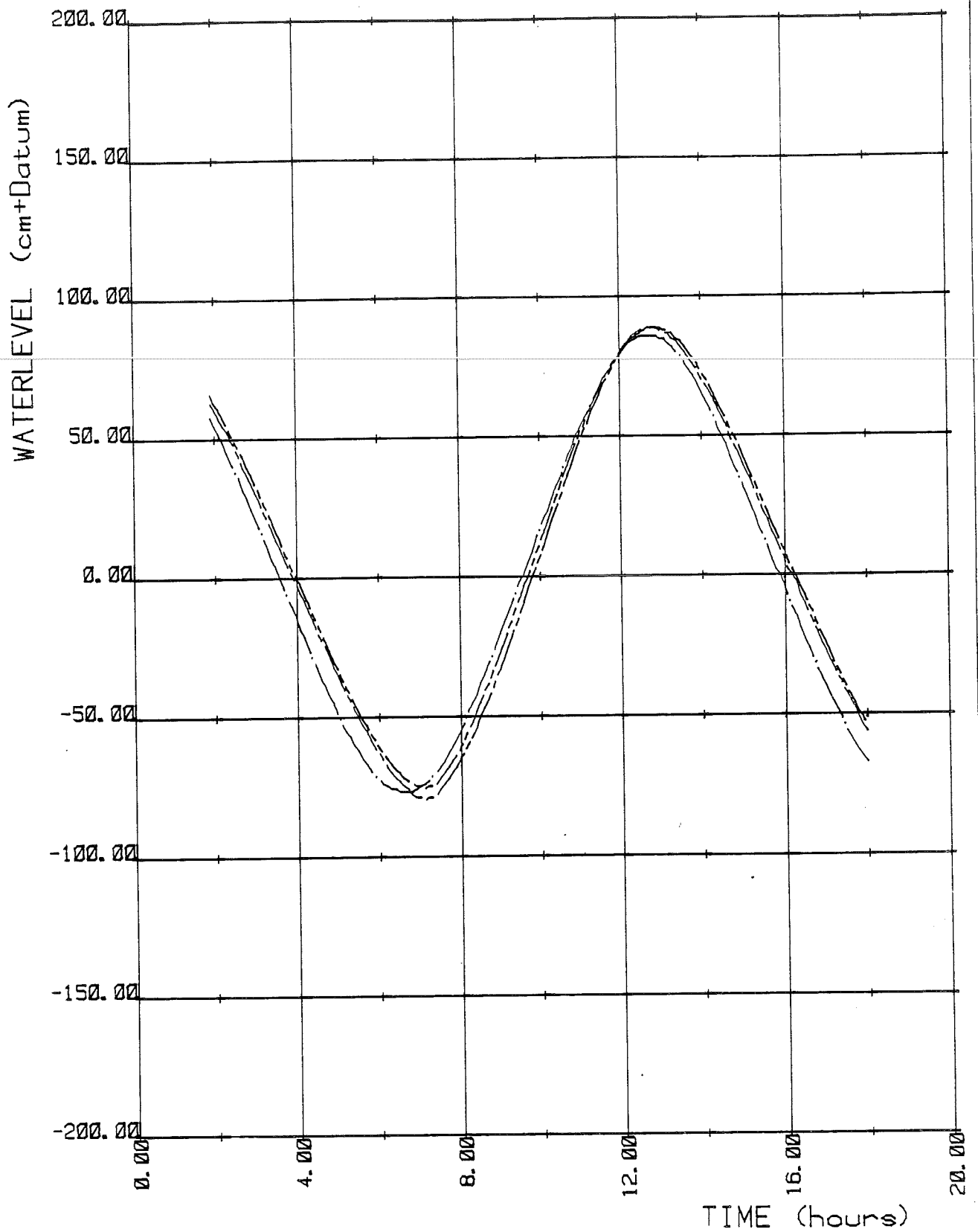

Computed waterlevel curves

- N=108 M= 10 station 7
- N=116 M= 43 station 13
- N= 86 M= 25 station 15



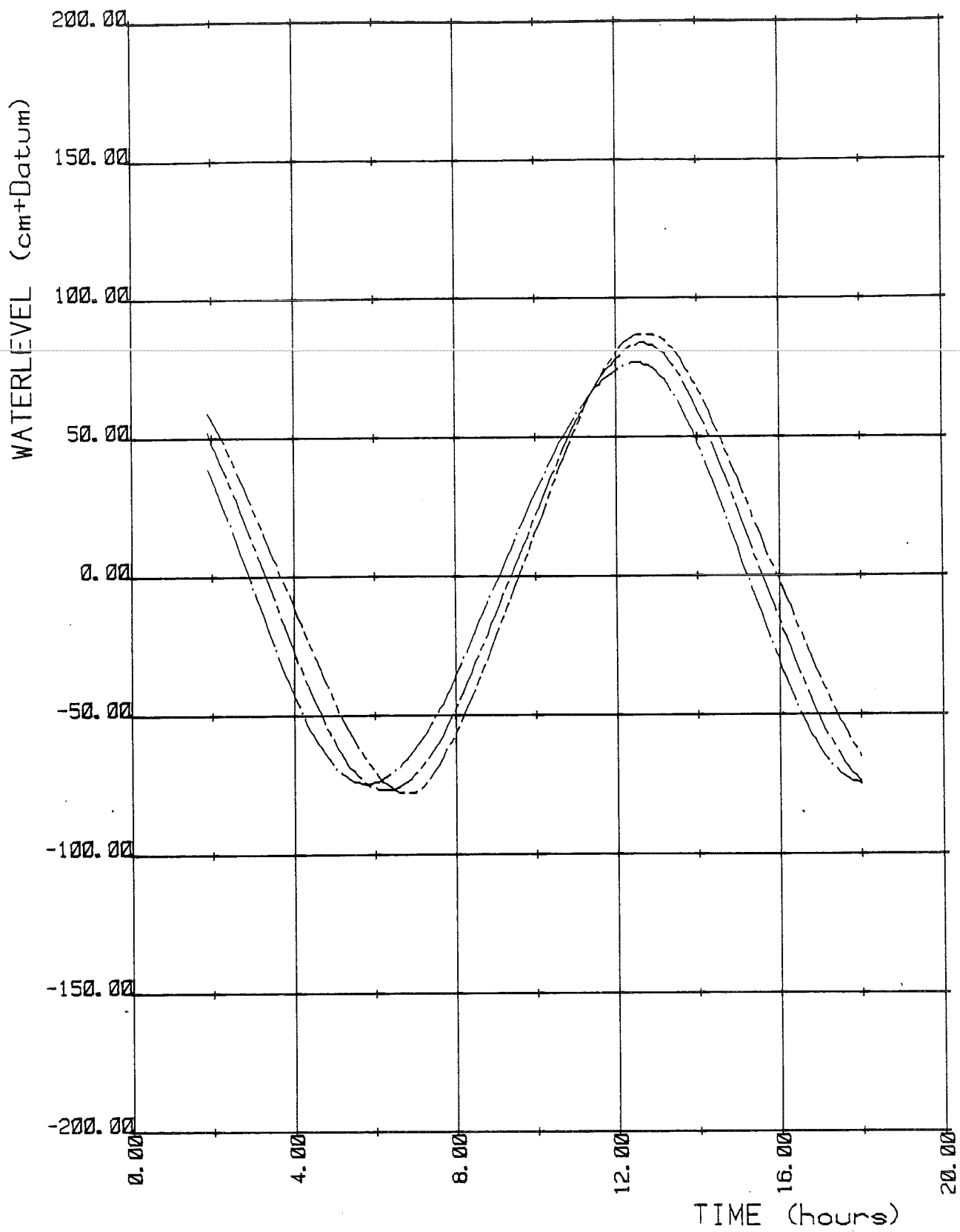

Computed waterlevel curves

- N= 98 M= 38 station 22
- . - . - . N= 70 M= 32 station 30
- _____ N= 35 M= 25 station 36



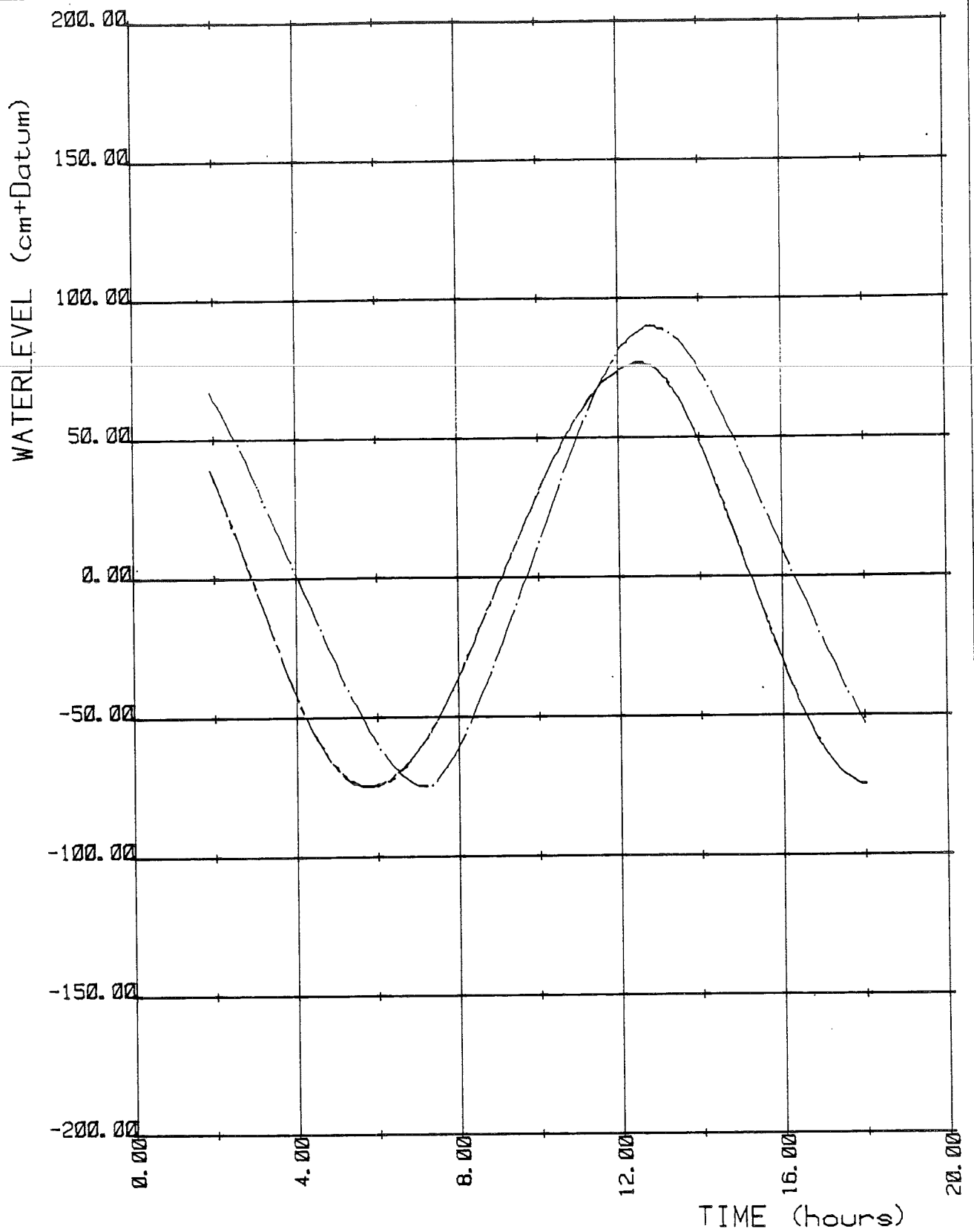

Computed waterlevel curves

- N= 30 M= 28 station 39
- N= 26 M= 27 station 41
- N=112 M= 11 L4 Povoa



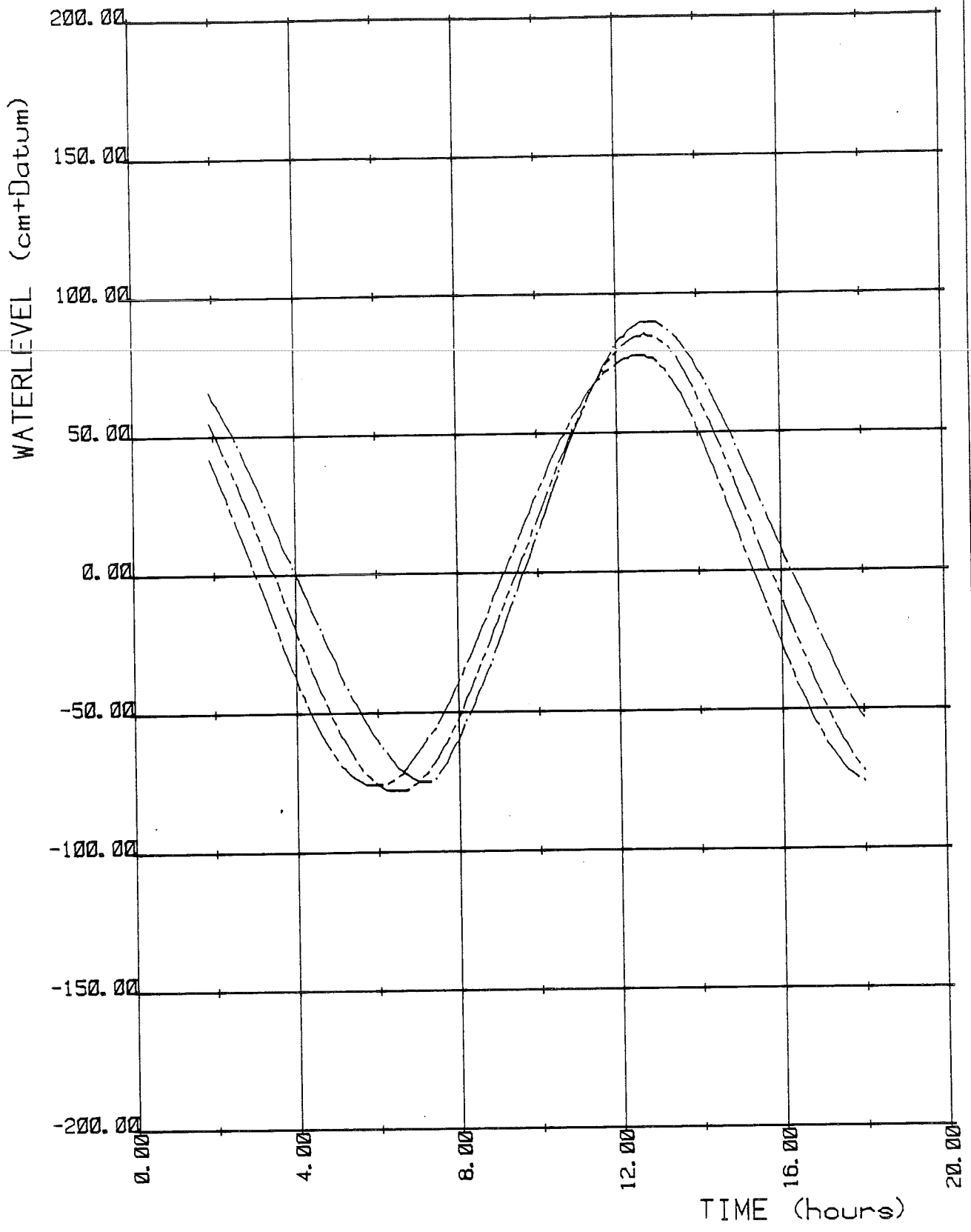

Computed waterlevel curves

- N= 80 M= 45 station 201 A
- _____ N= 25 M= 40 station 203 C
- . - . - . N=116 M= 19 station 210-211 M



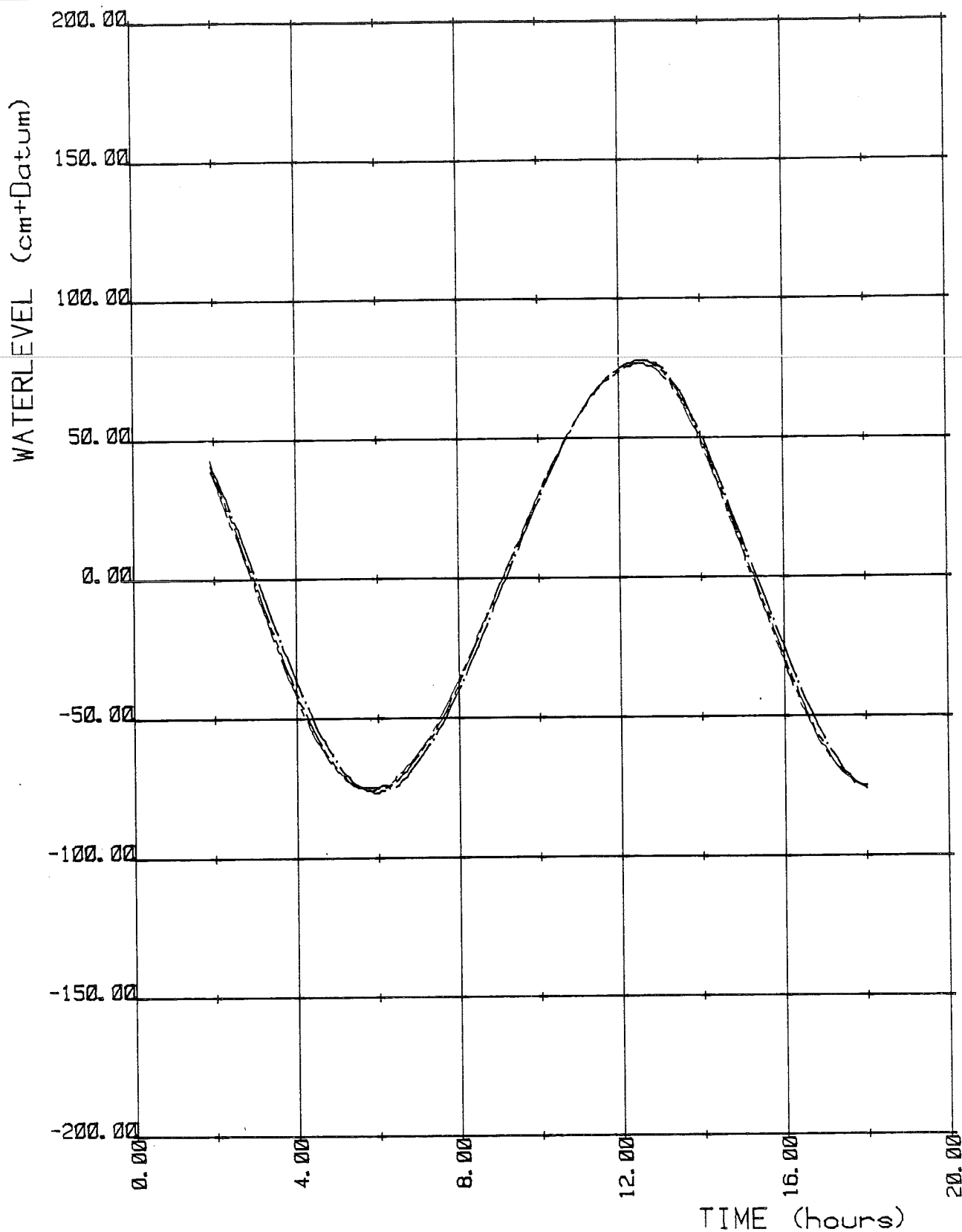

Computed waterlevel curves

- N= 32 M= 35 station 223
- N= 25 M= 28 station 224
- N= 24 M= 43 station 225



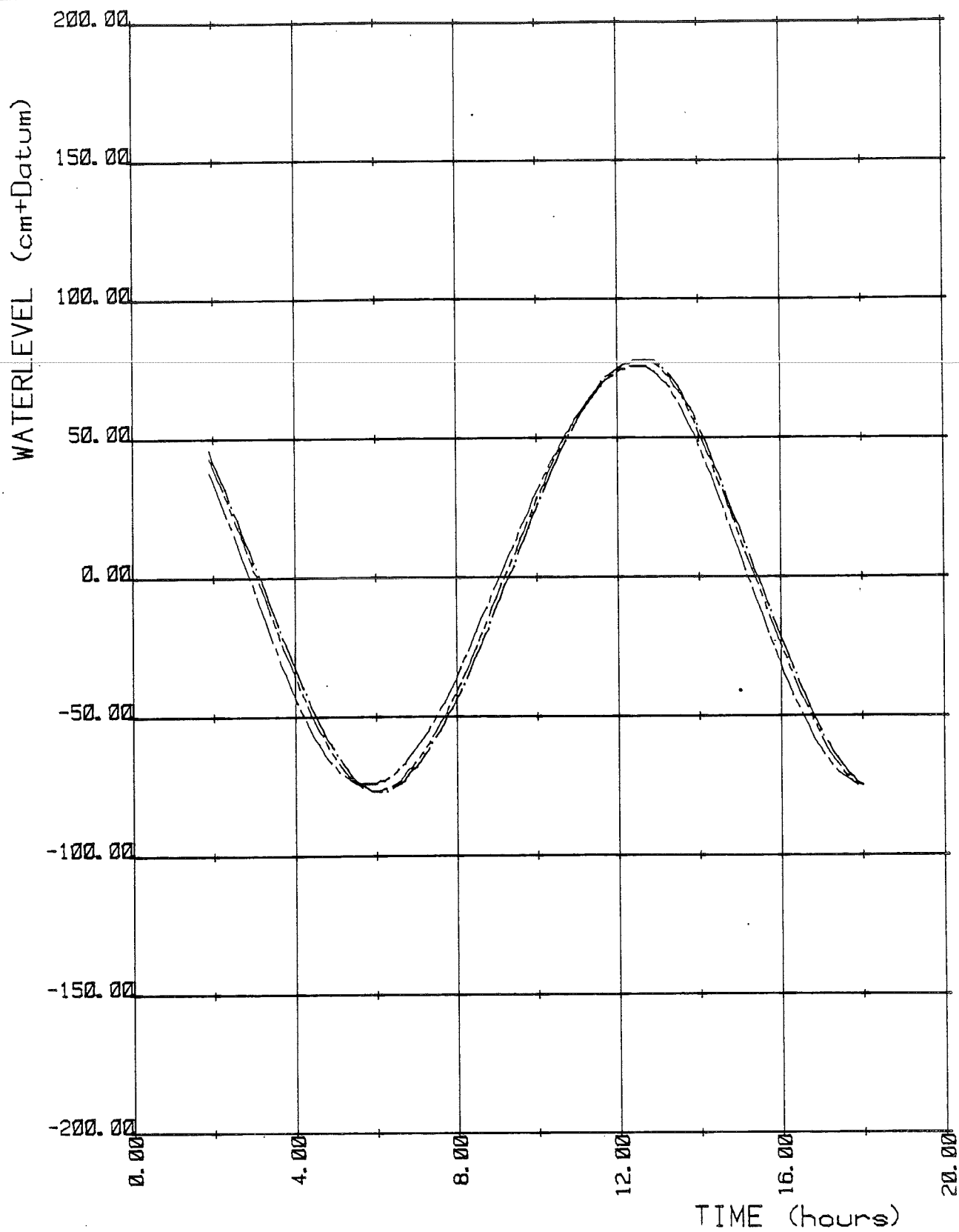

Computed waterlevel curves

----- N= 20 M= 41 station 226
 - · - · - · N= 30 M= 24 station 227
 ————— N= 25 M= 48 station 228



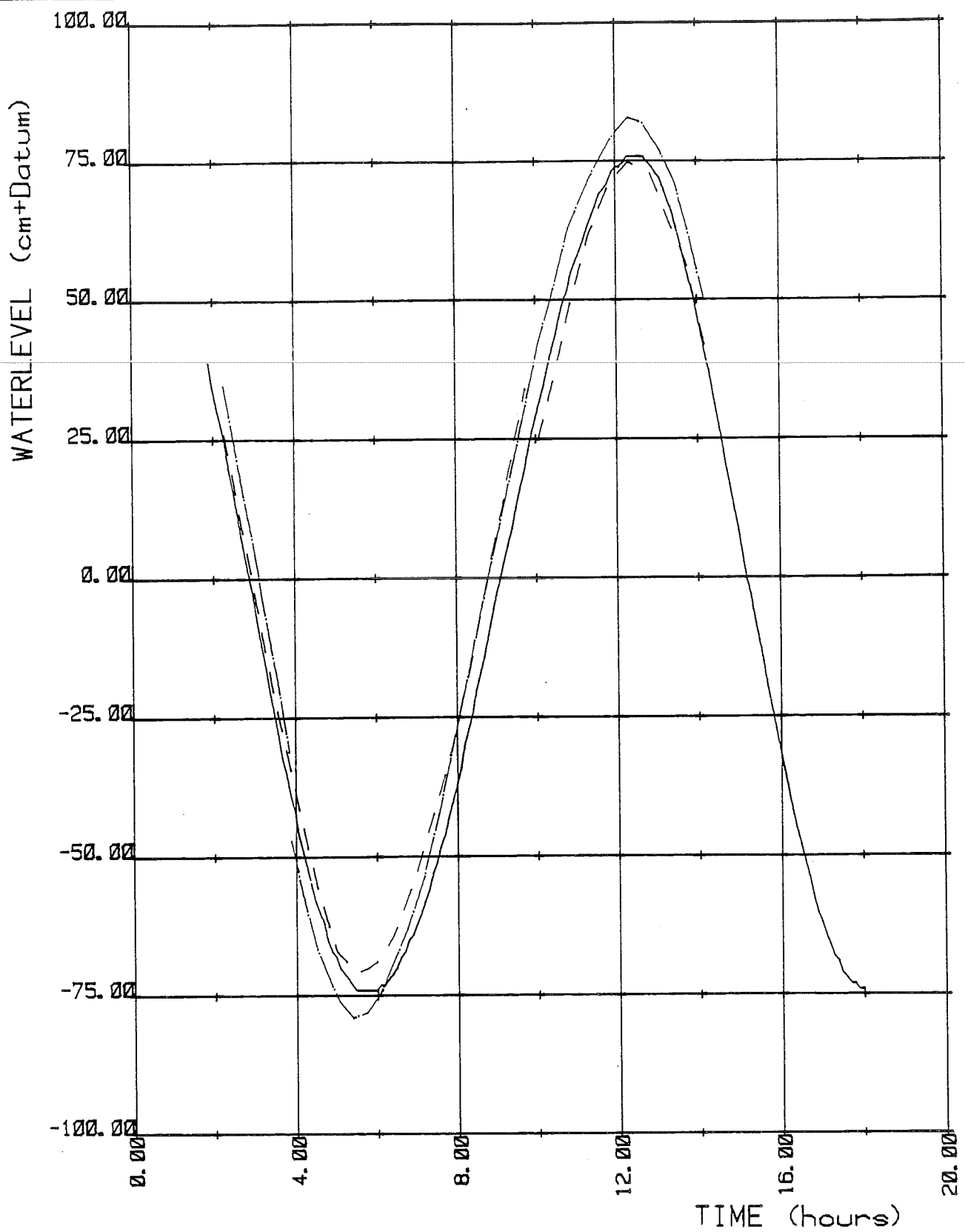

Waterlevel at station: L2 Terreiro do Paco

_____ computed at N= 38 M= 19
 - - - - - measured March 13th 1973
 - · - · - · measured March 25th 1973



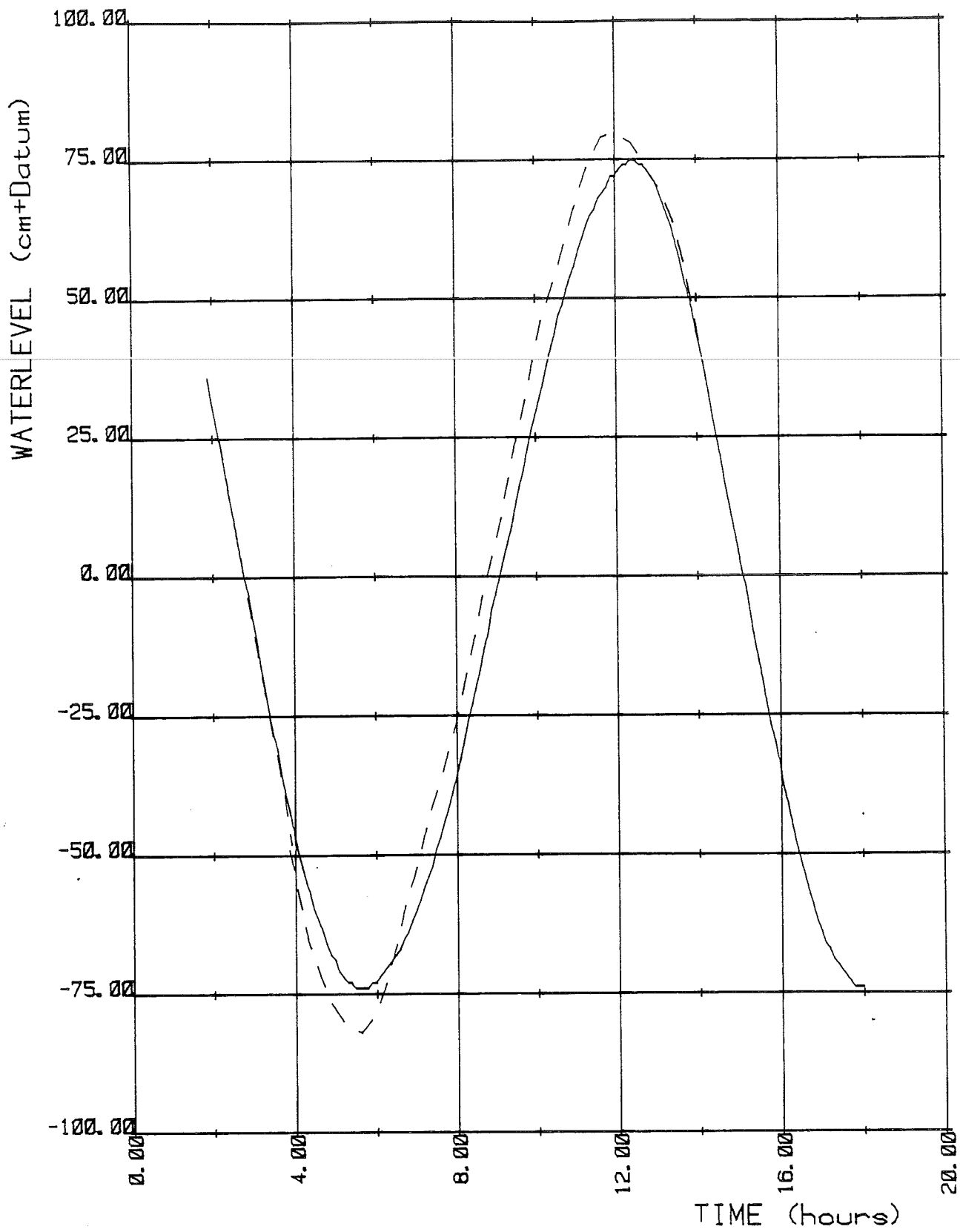

Waterlevel at station: L2 Cacilhas
 ————— computed at N= 28 M= 18
 - - - - - measured March 25th 1973



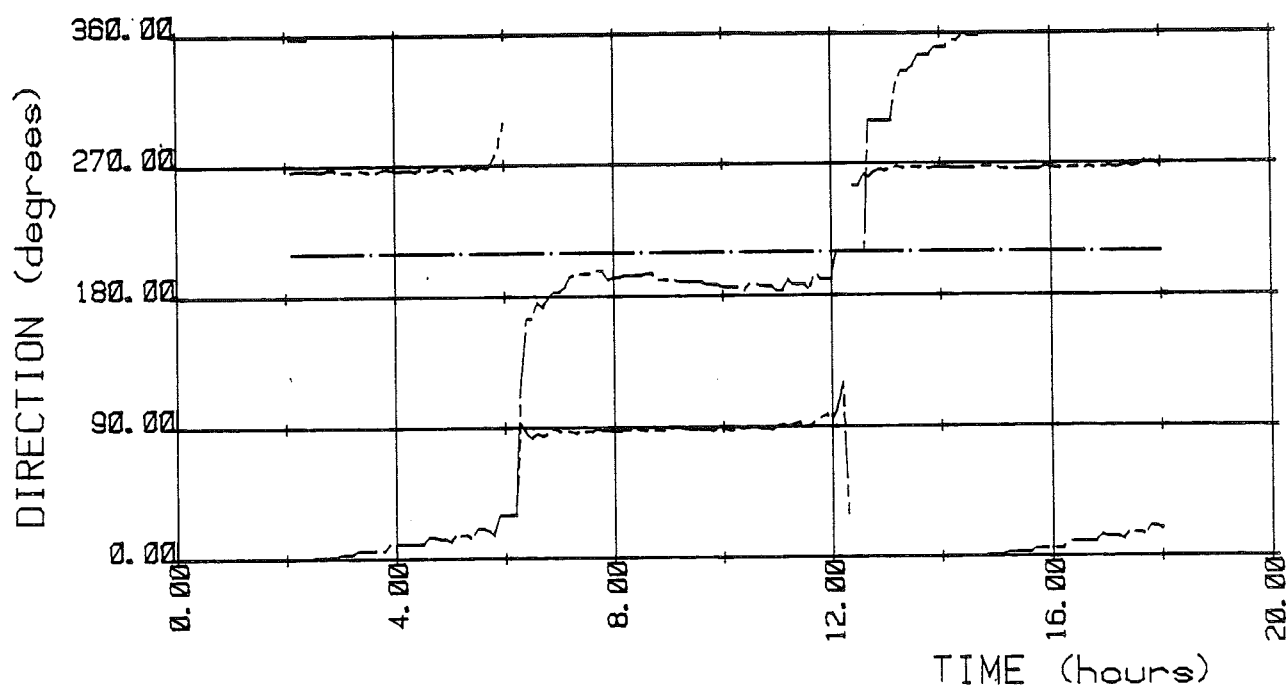
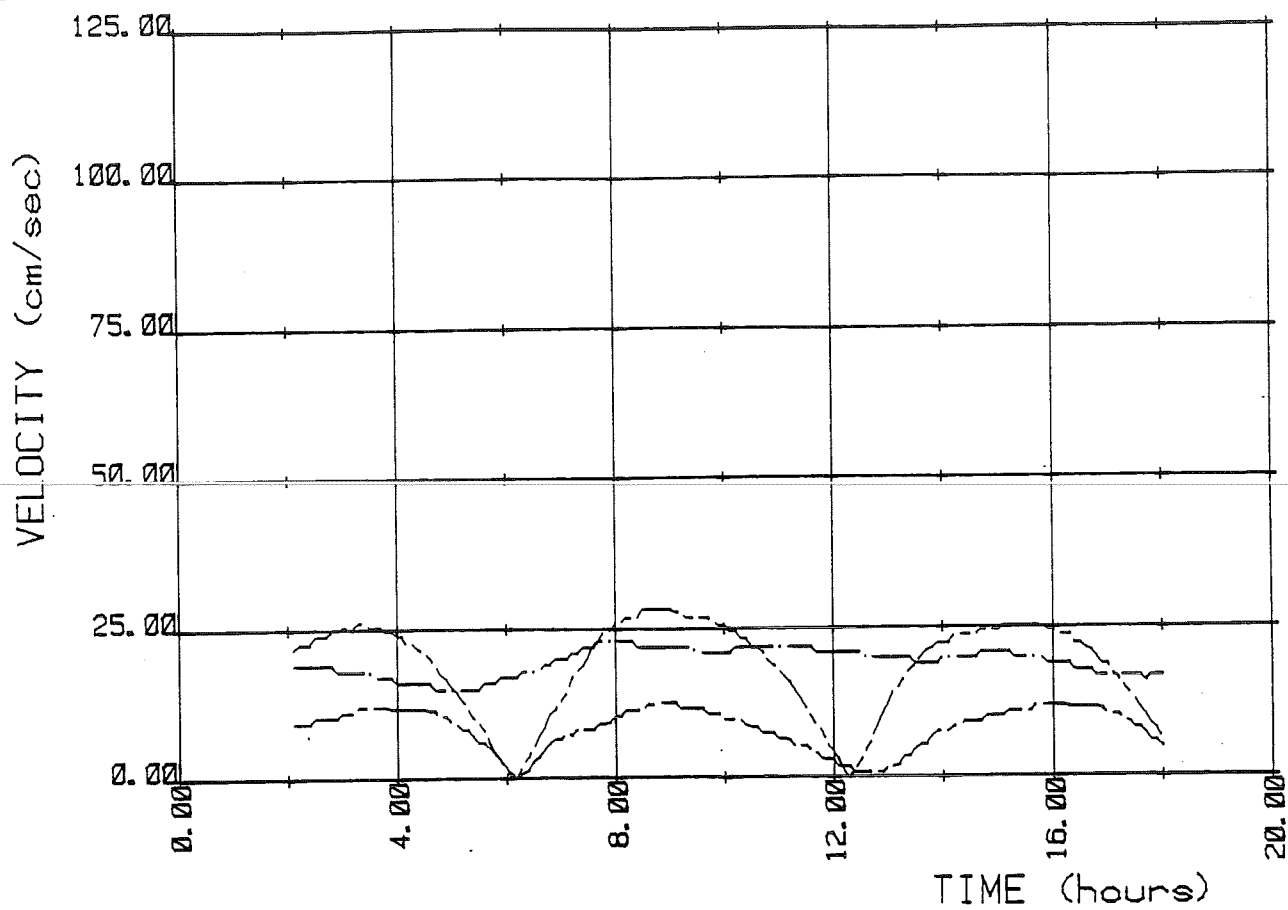

Computed velocity curves

- N= 38 M= 19 L1 Terreiro do Paco
- N= 21 M= 42 L5 Seixal
- N=153 M= 14 L7 Vila Franca



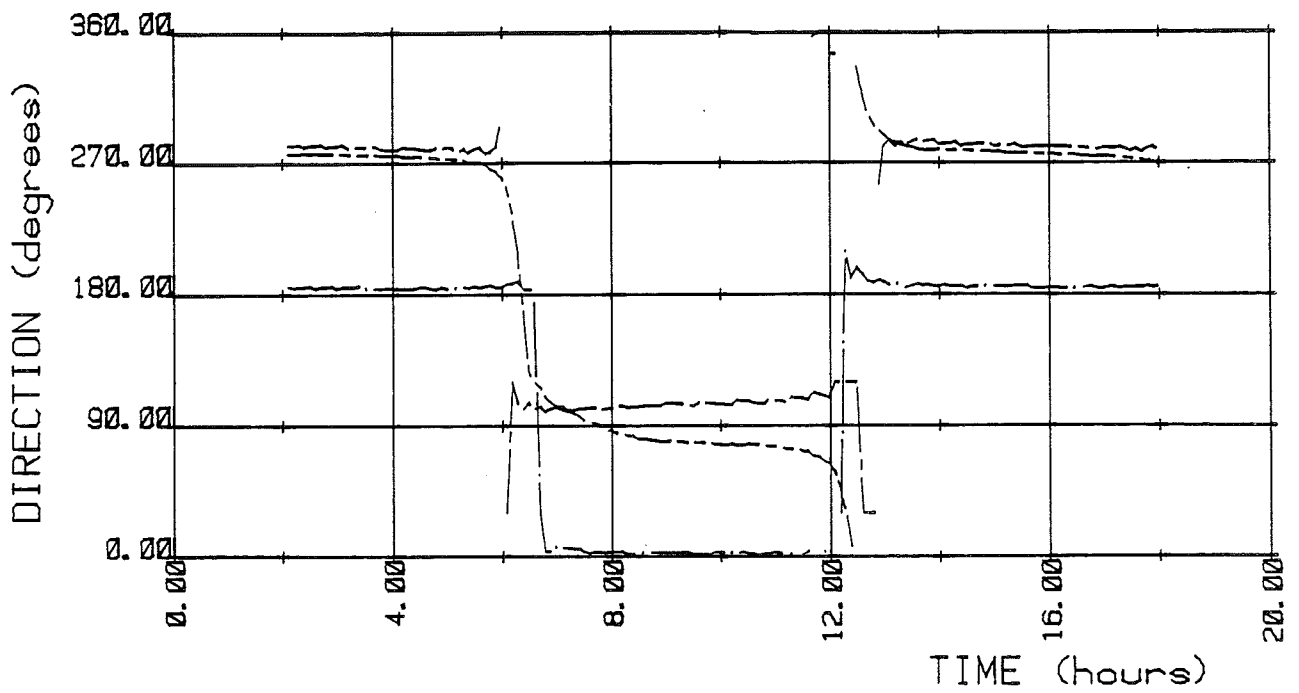
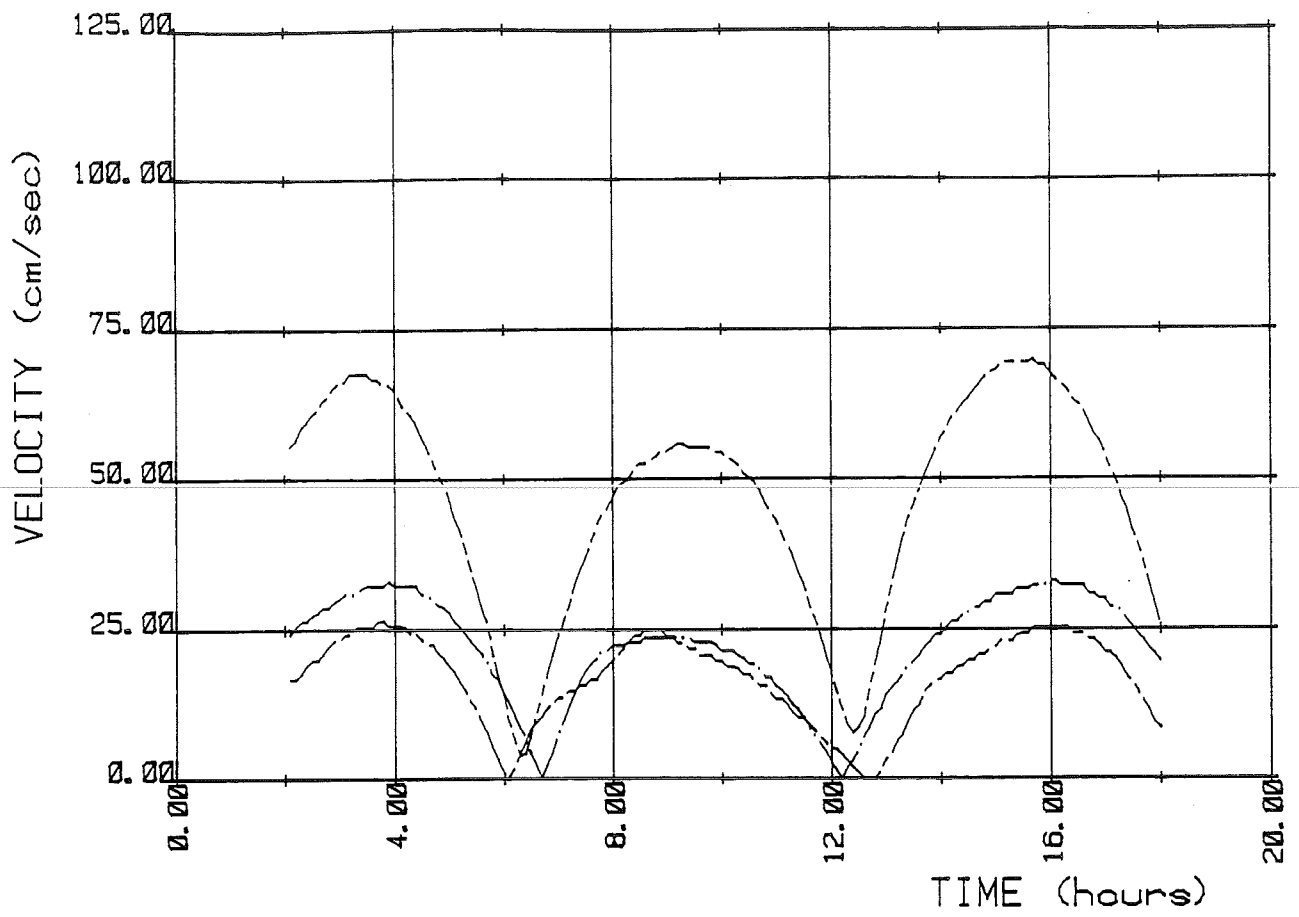

Computed velocity curves

-----	N= 28 M= 18	L2 Cacilhas
-----	N= 46 M= 48	L6 Montjio Base
-----	N= 64 M= 20	L9 Cabo Ruivo



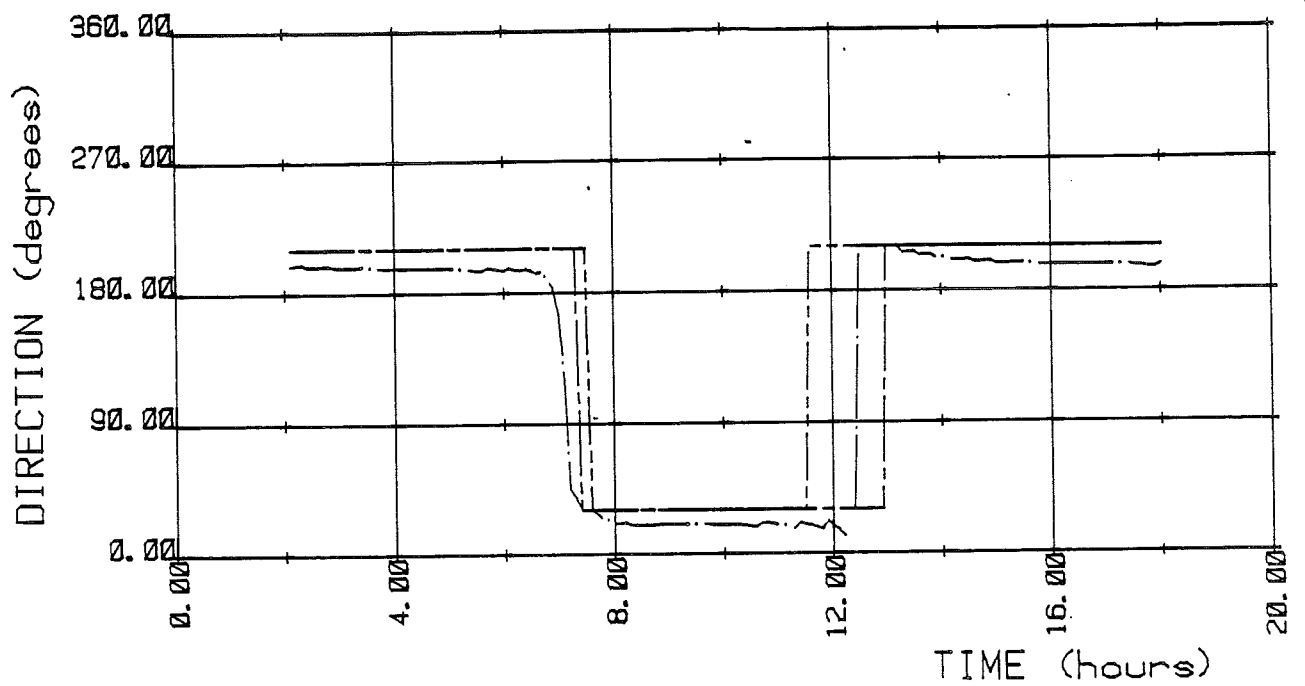
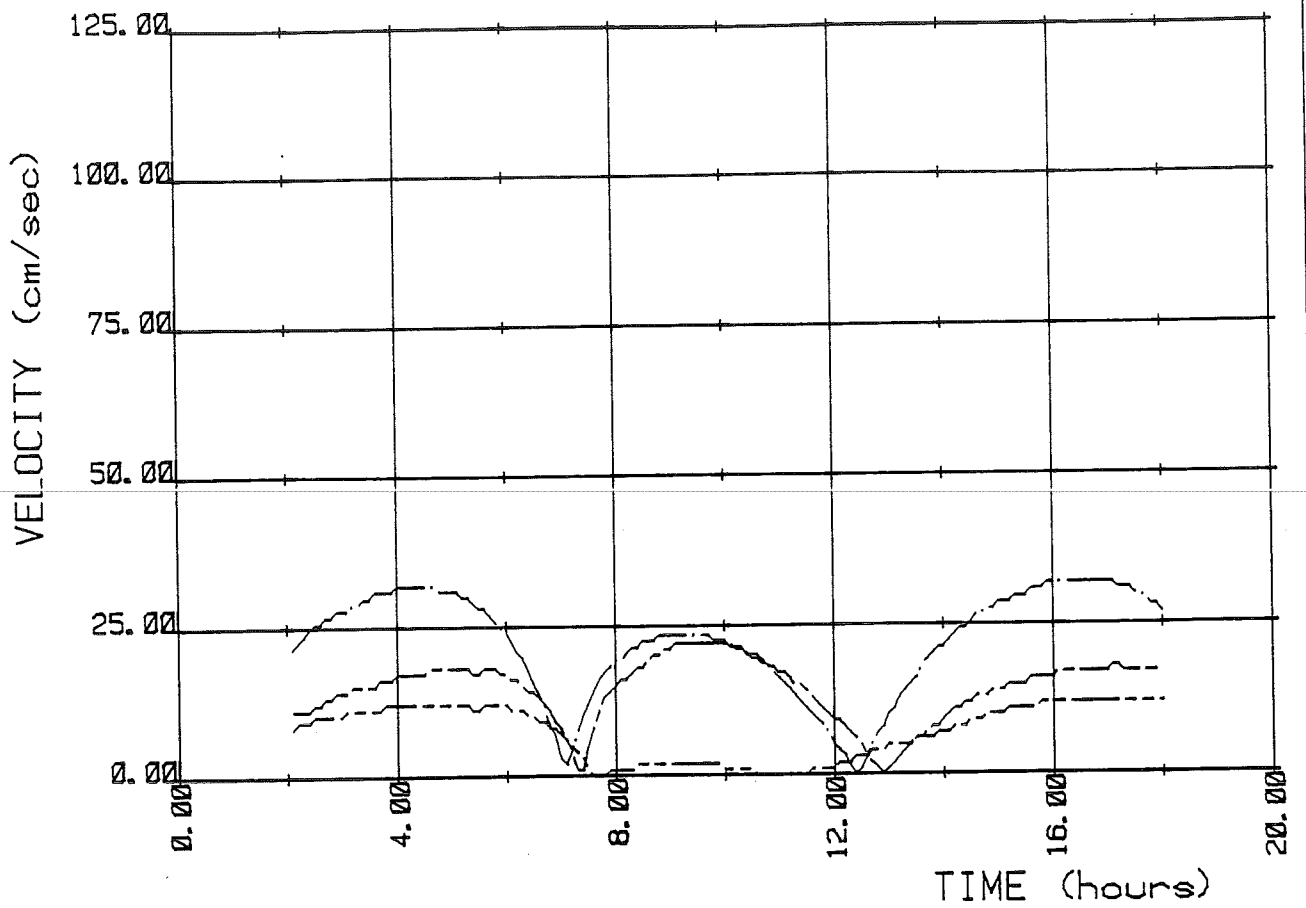

Computed velocity curves

-----	N=108 M= 10	station 7
- . - . - .	N=116 M= 43	station 13
_____	N= 86 M= 25	station 15



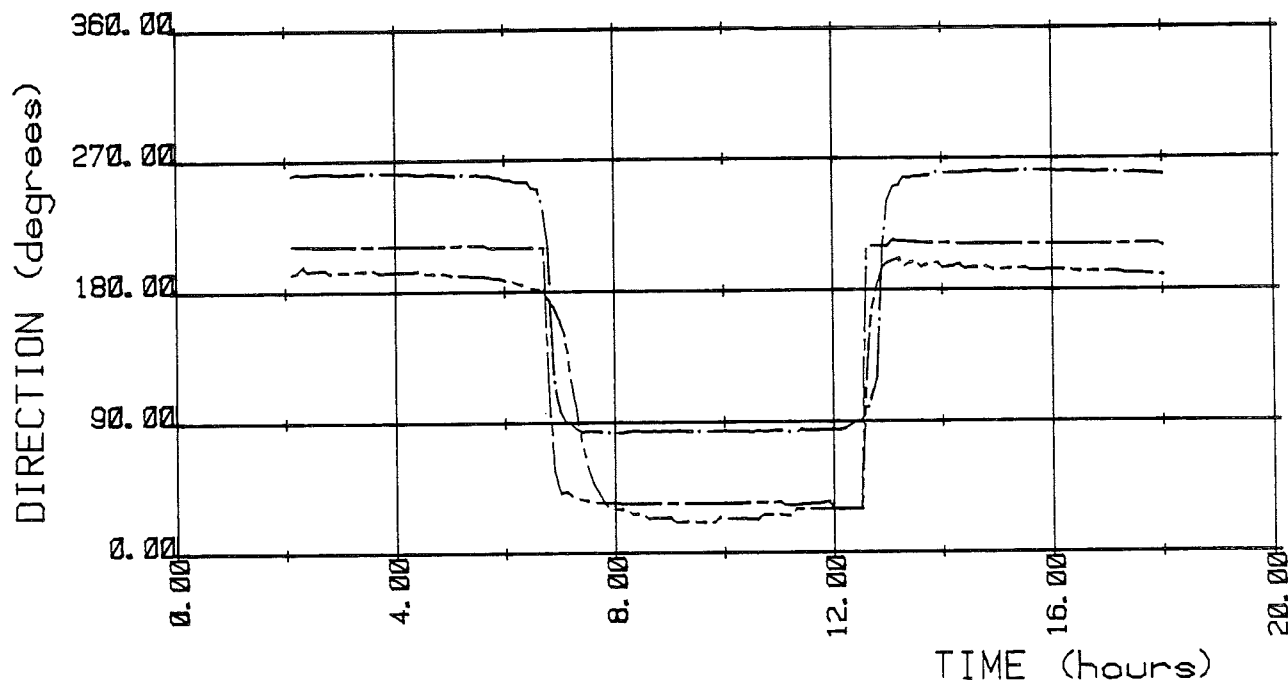
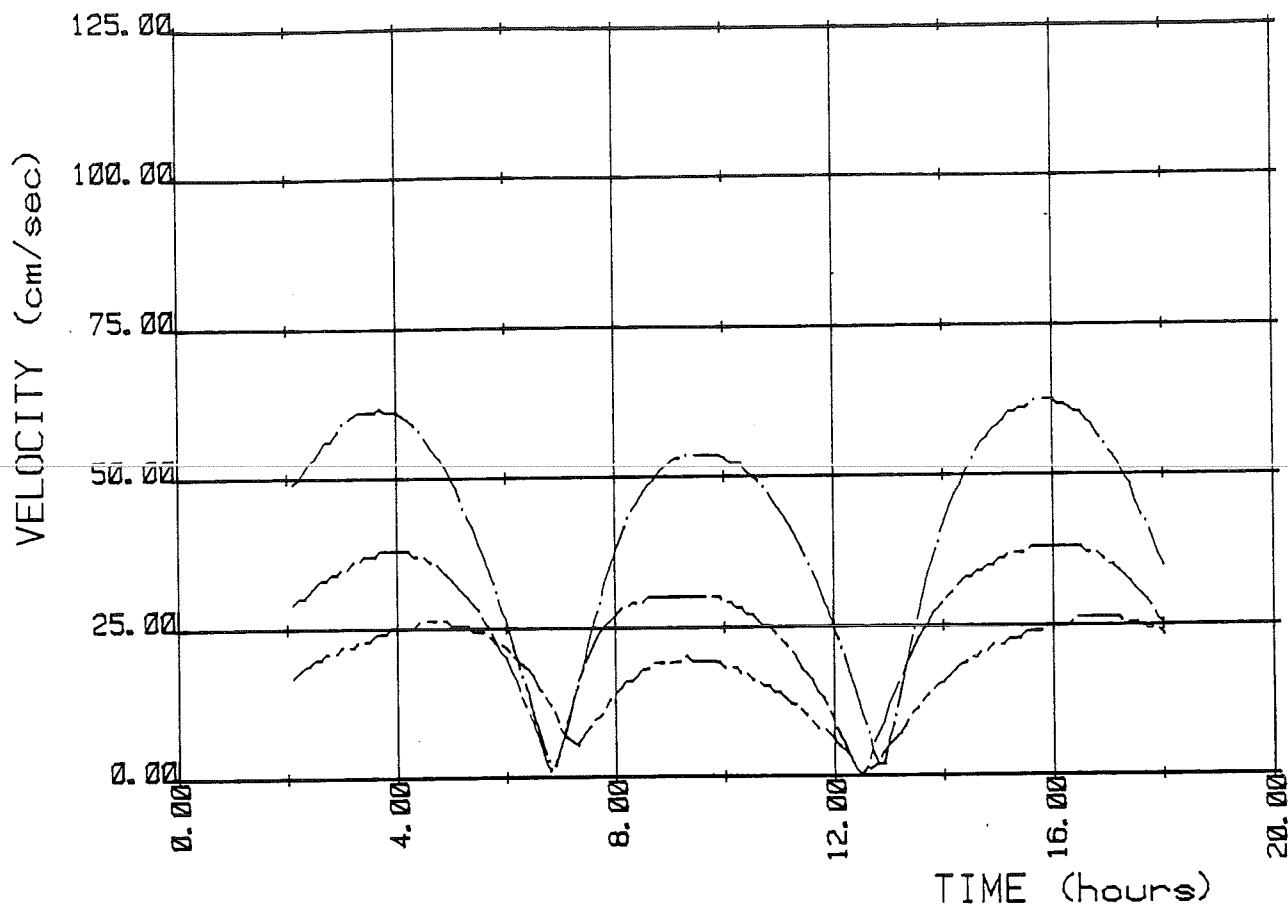

Computed velocity curves

-----	N= 98 M= 38	station 22
-----	N= 70 M= 32	station 30
-----	N= 35 M= 25	station 36



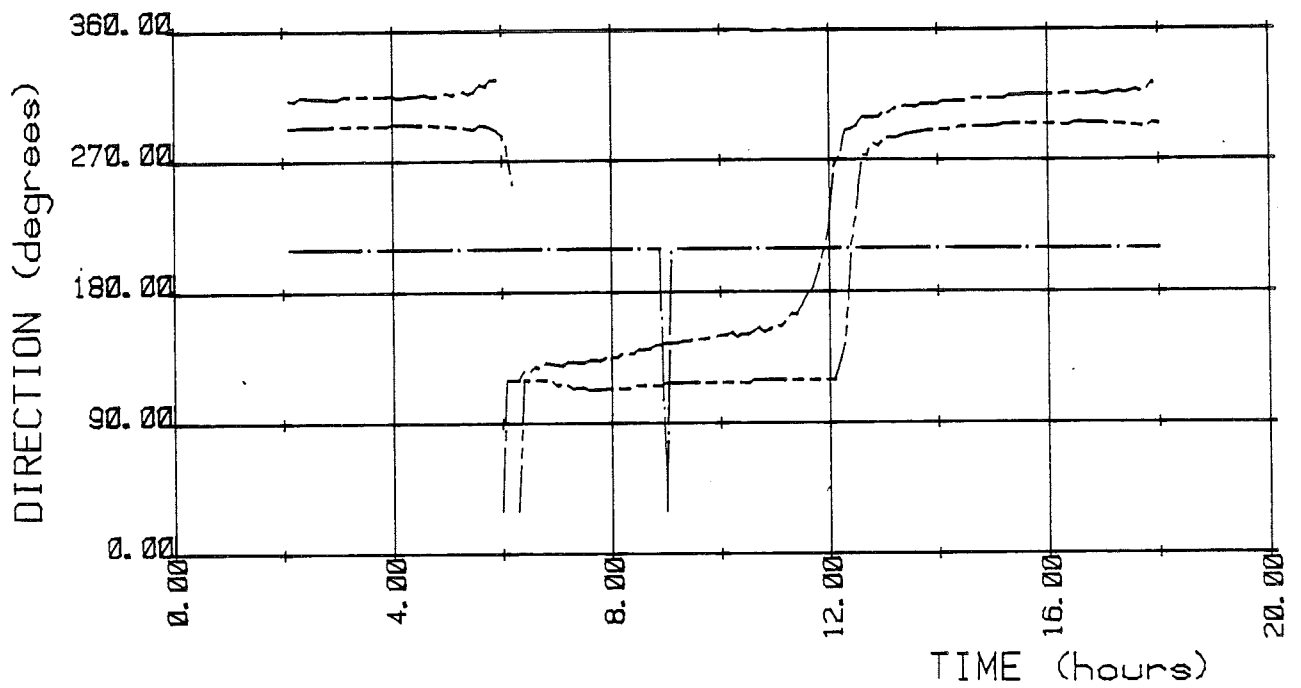
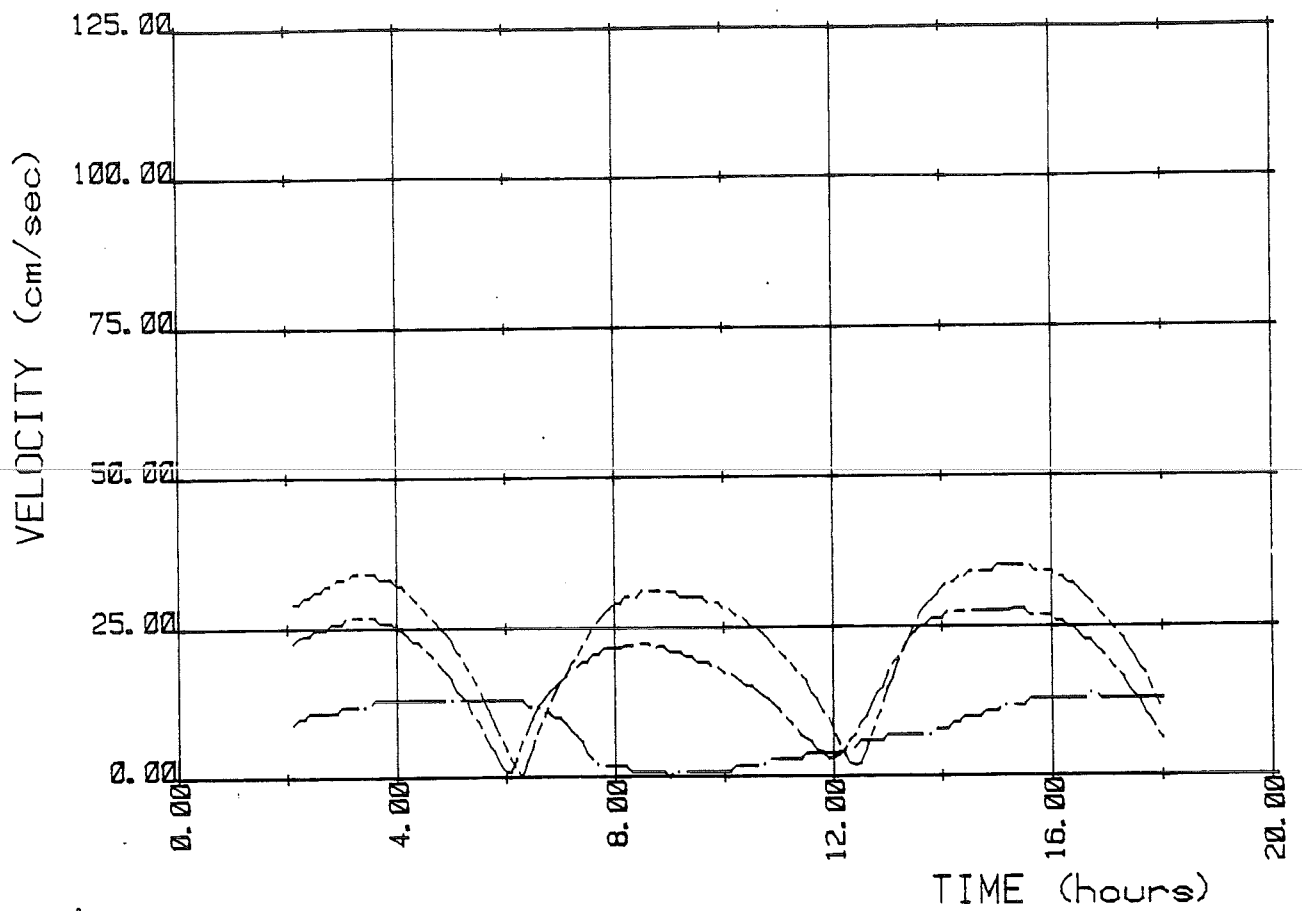

Computed velocity curves

- N= 30 M= 28 station 39
- N= 26 M= 27 station 41
- N=112 M= 11 L4 Povoa



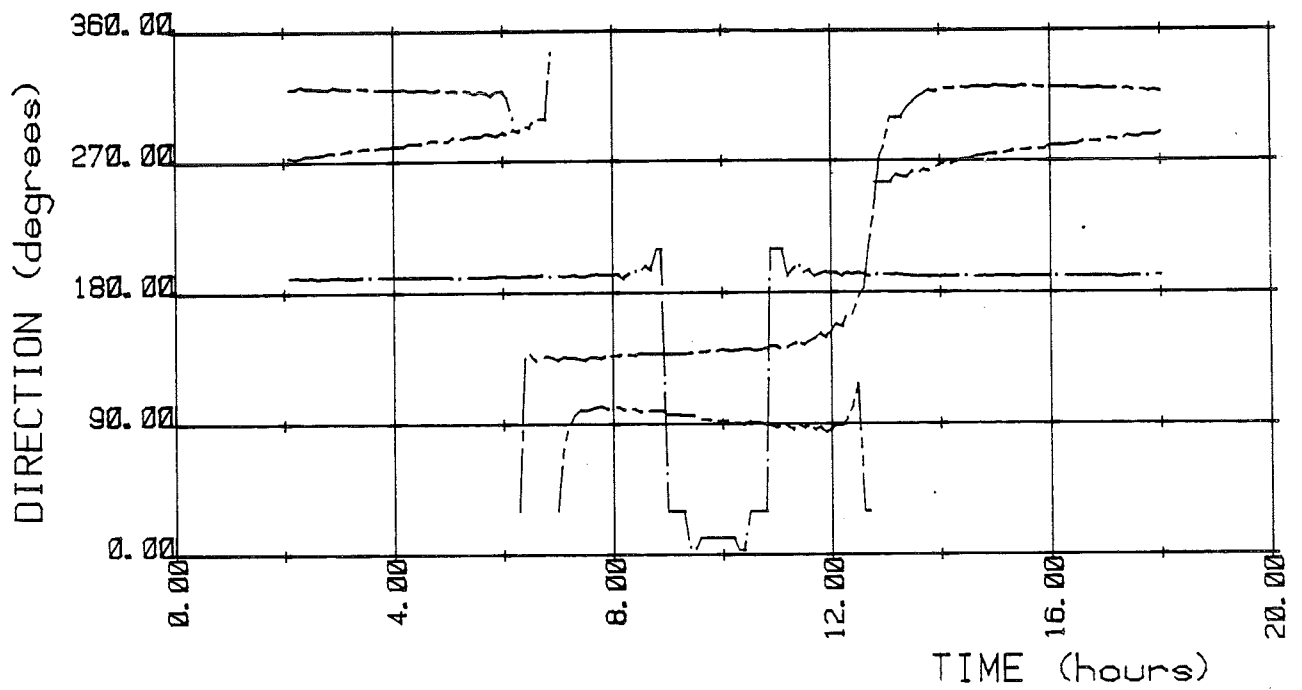
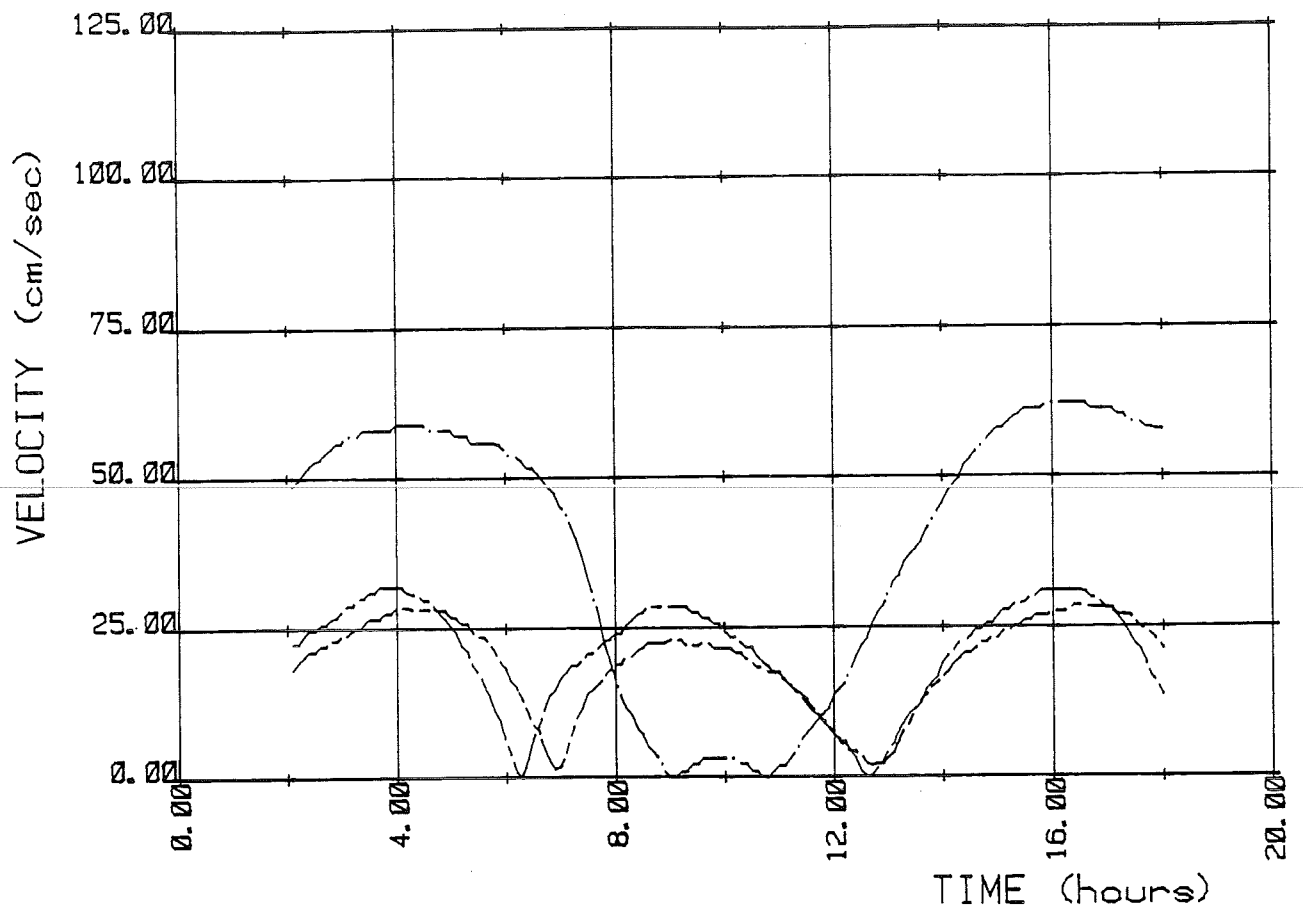

Computed velocity curves

-----	N= 80 M= 45	station 201 A
-----	N= 25 M= 40	station 203 C
- . - . - .	N=116 M= 19	station 210-211 M



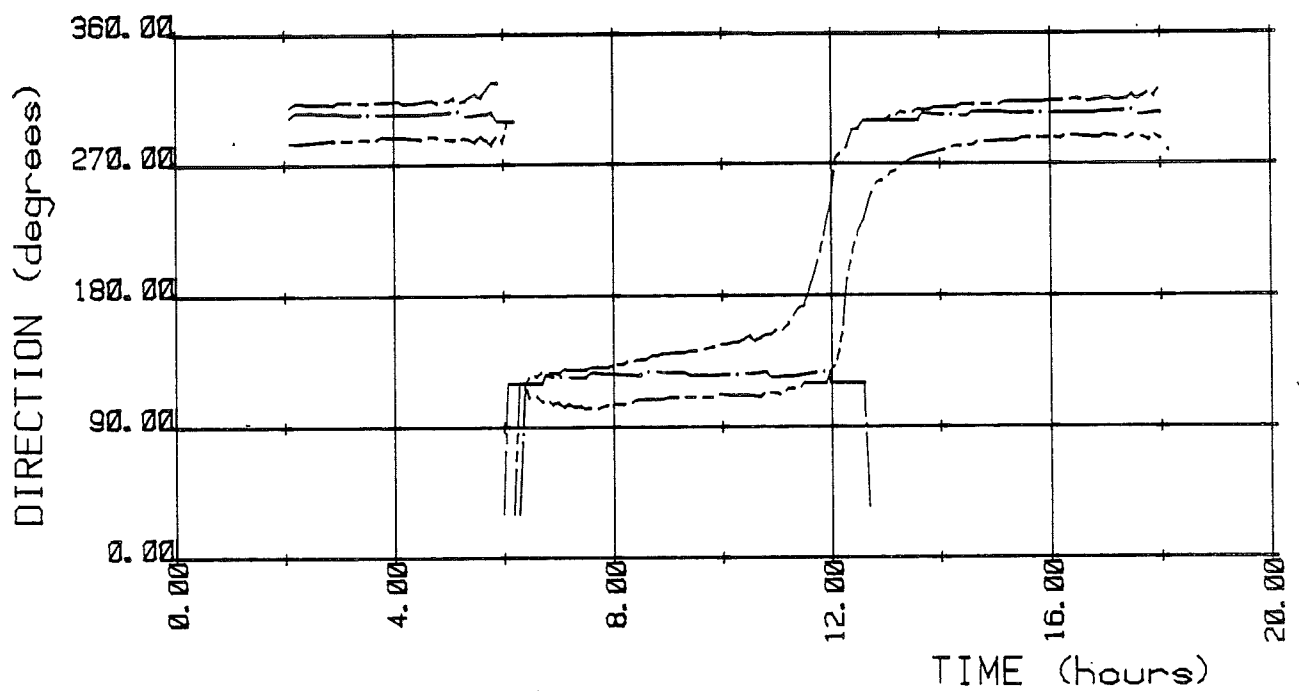
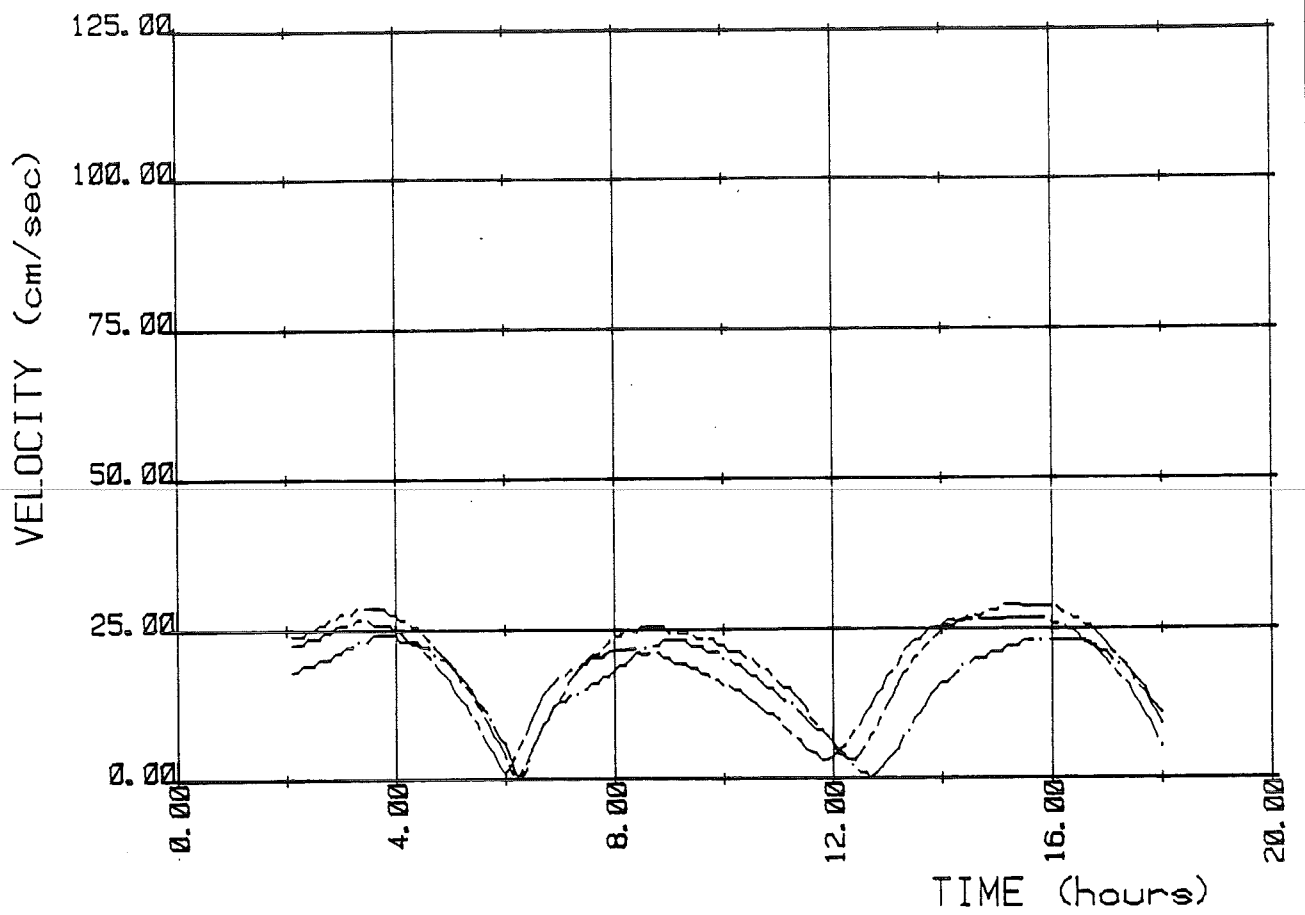

Computed velocity curves

-----	N= 32 M= 35	station 223
-----	N= 25 M= 28	station 224
-----	N= 24 M= 43	station 225



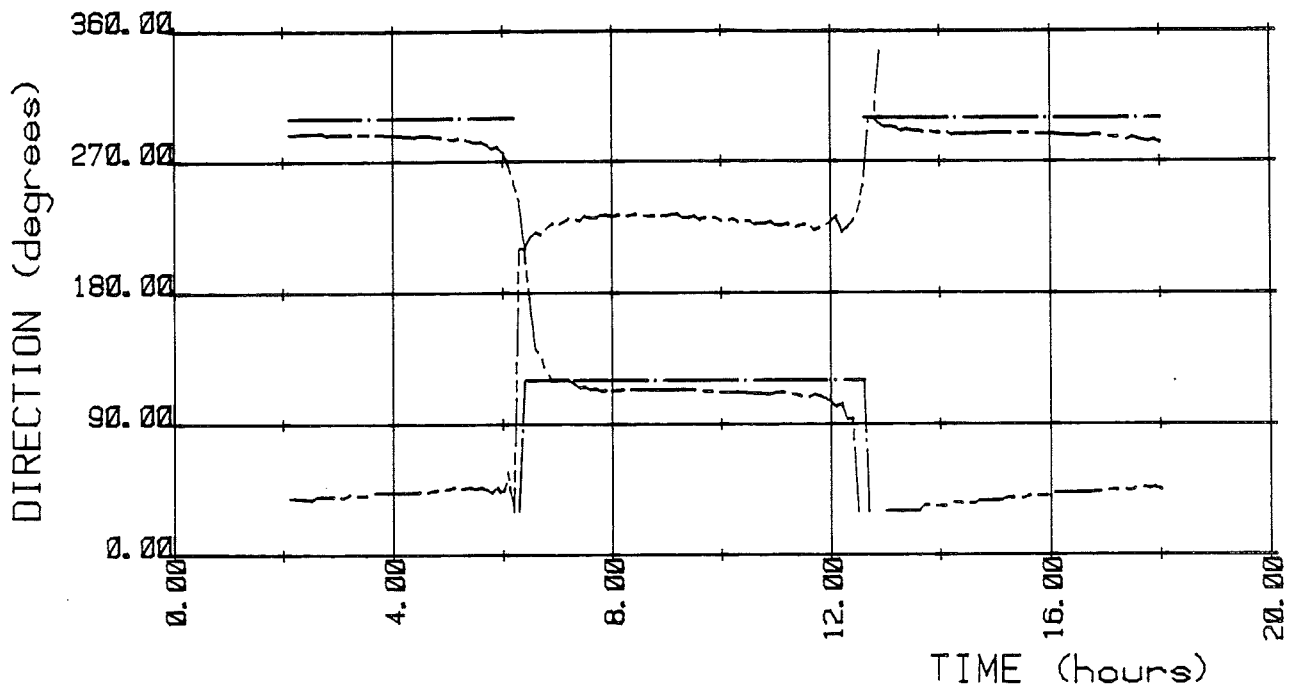
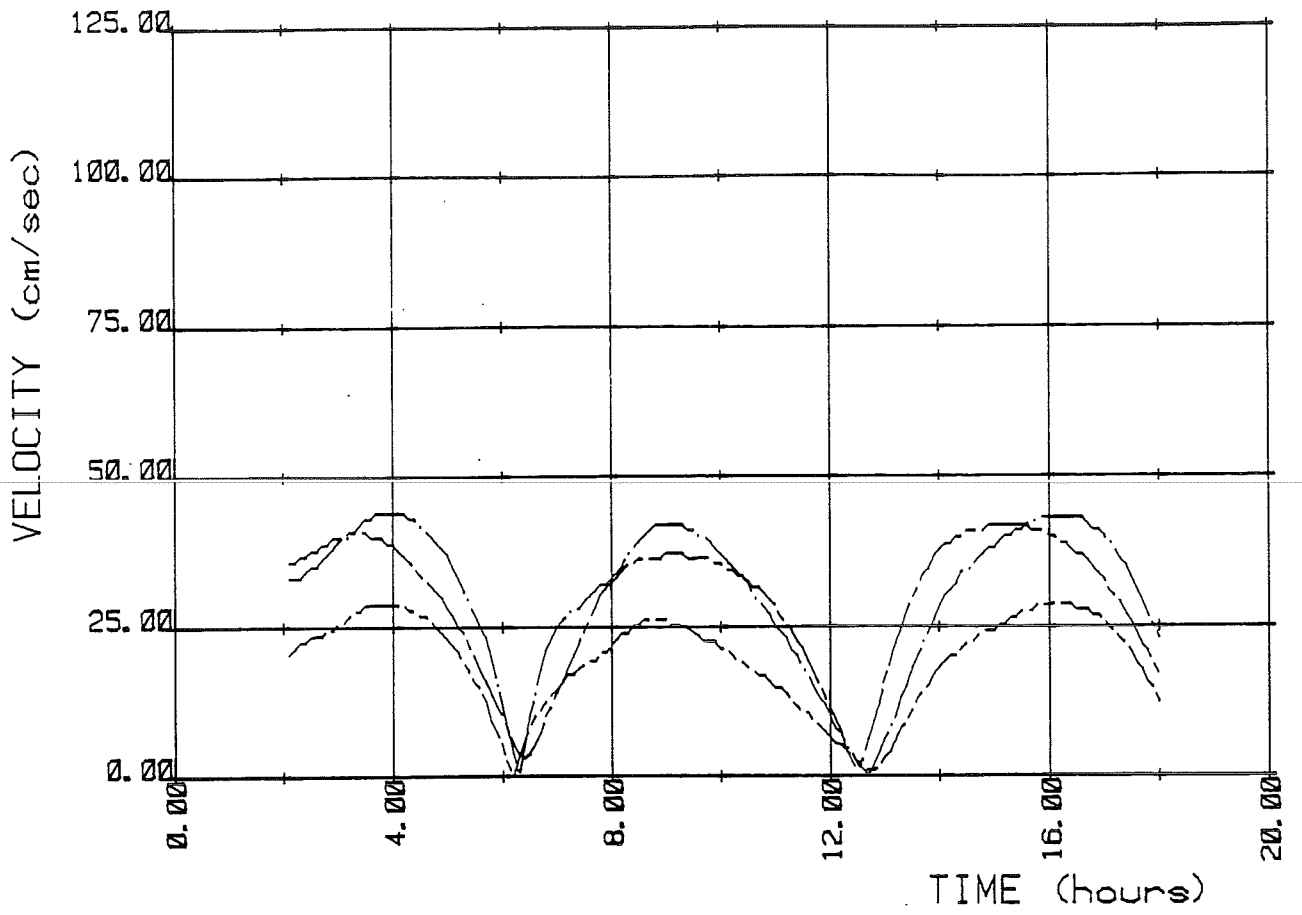

Computed velocity curves

-----	N= 20 M= 41	station 226
-----	N= 30 M= 24	station 227
-----	N= 25 M= 48	station 228



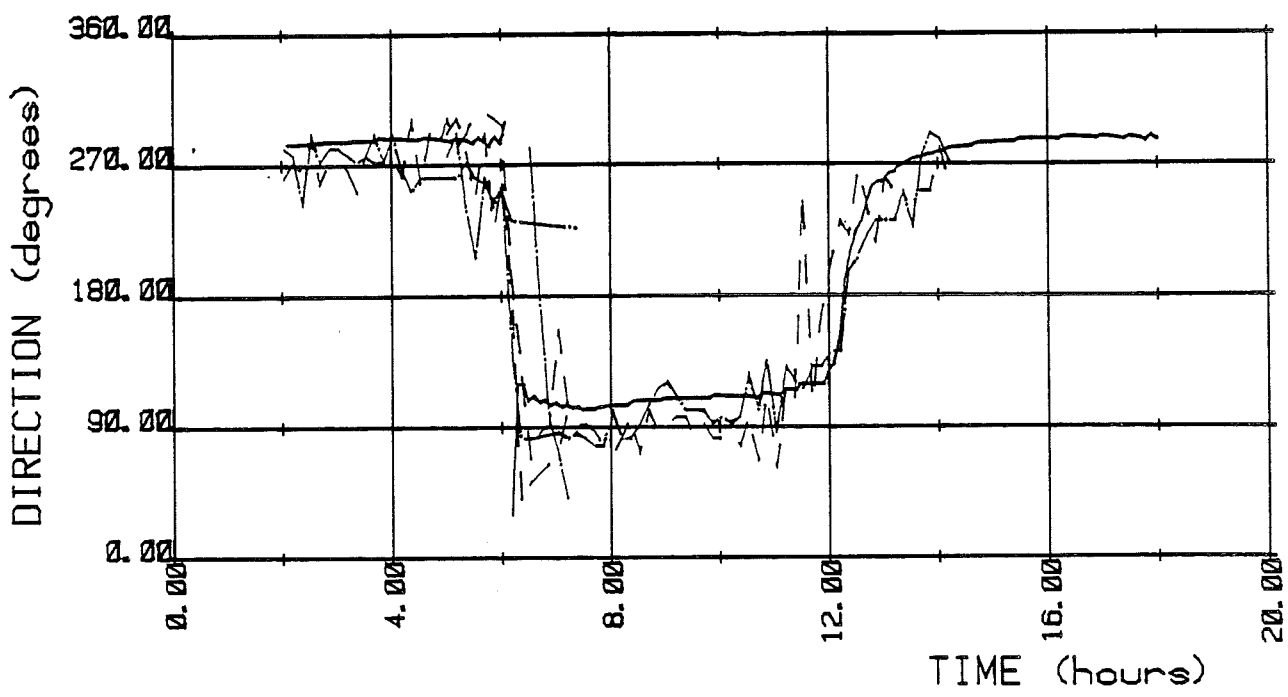
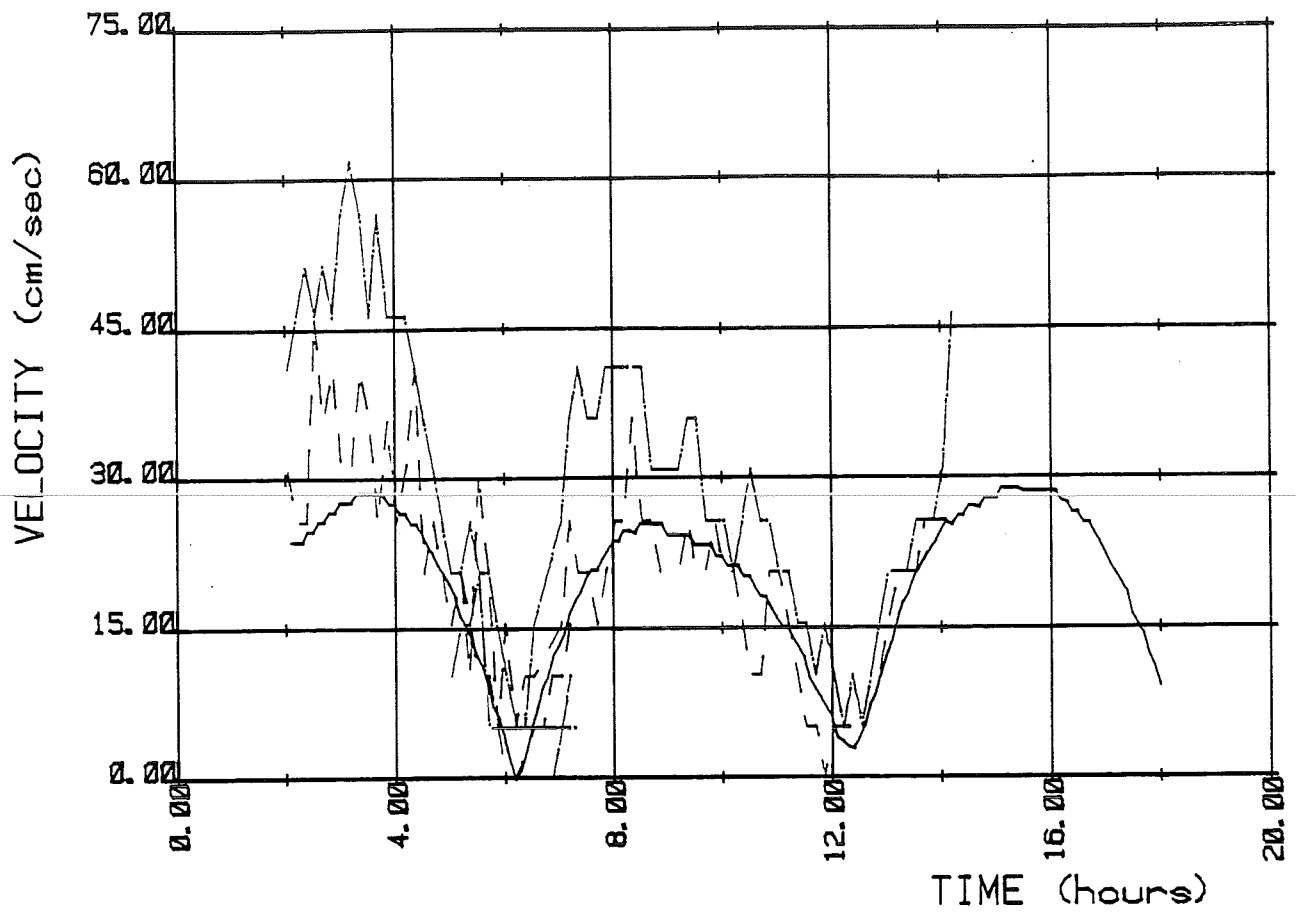

Velocity curve at station: 223

————— computed at N= 32 M= 35

- - - - - measured 1m+floor April 13th 1981

- · - · - · measured 2m-surf. April 13th 1981



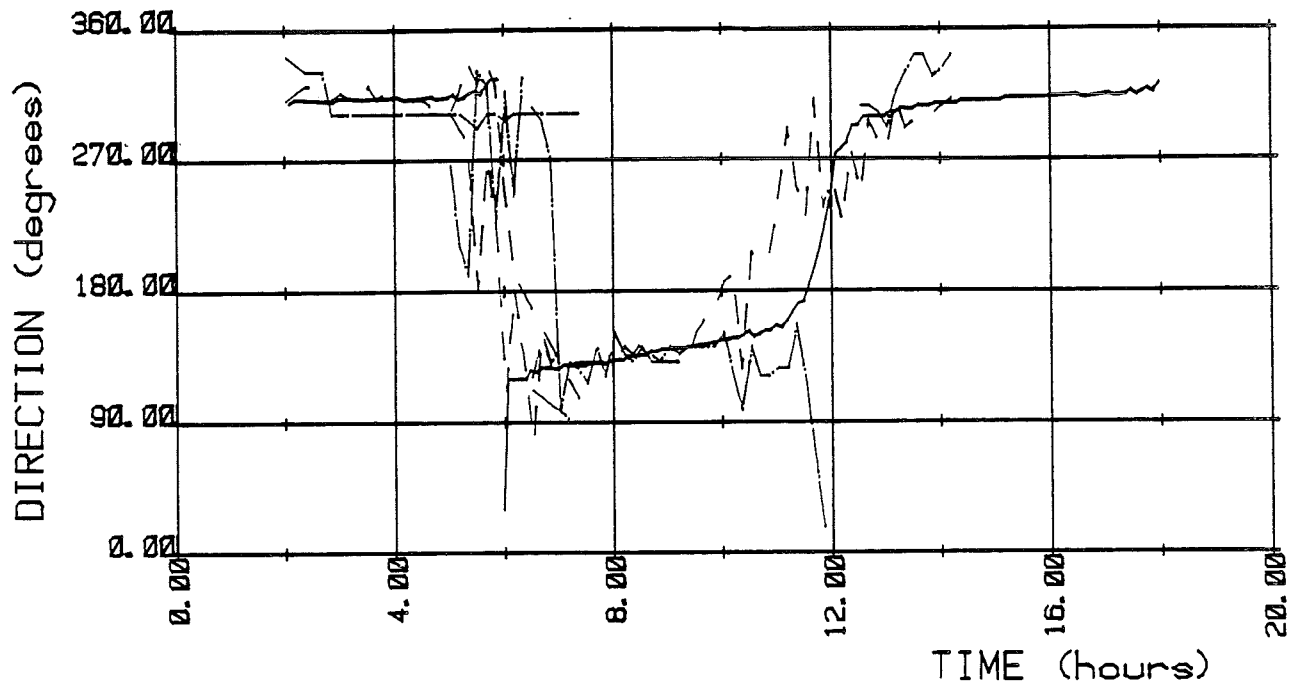
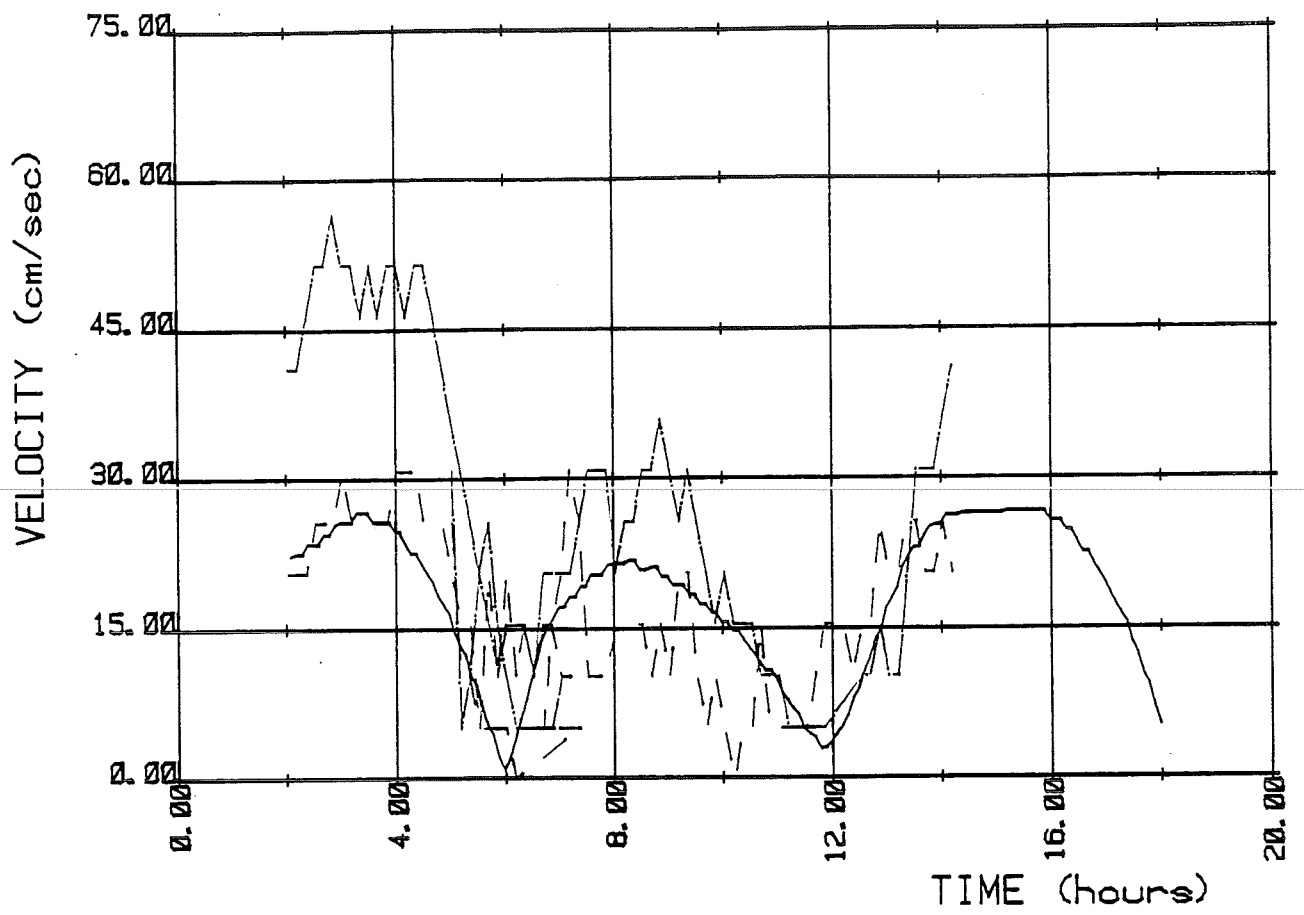

Velocity curve at station: 224

- computed at $N=25$ $M=28$
- - - - - measured 1m+floor April 13th 1981
- · - · - · measured 2m-surf. April 13th 1981



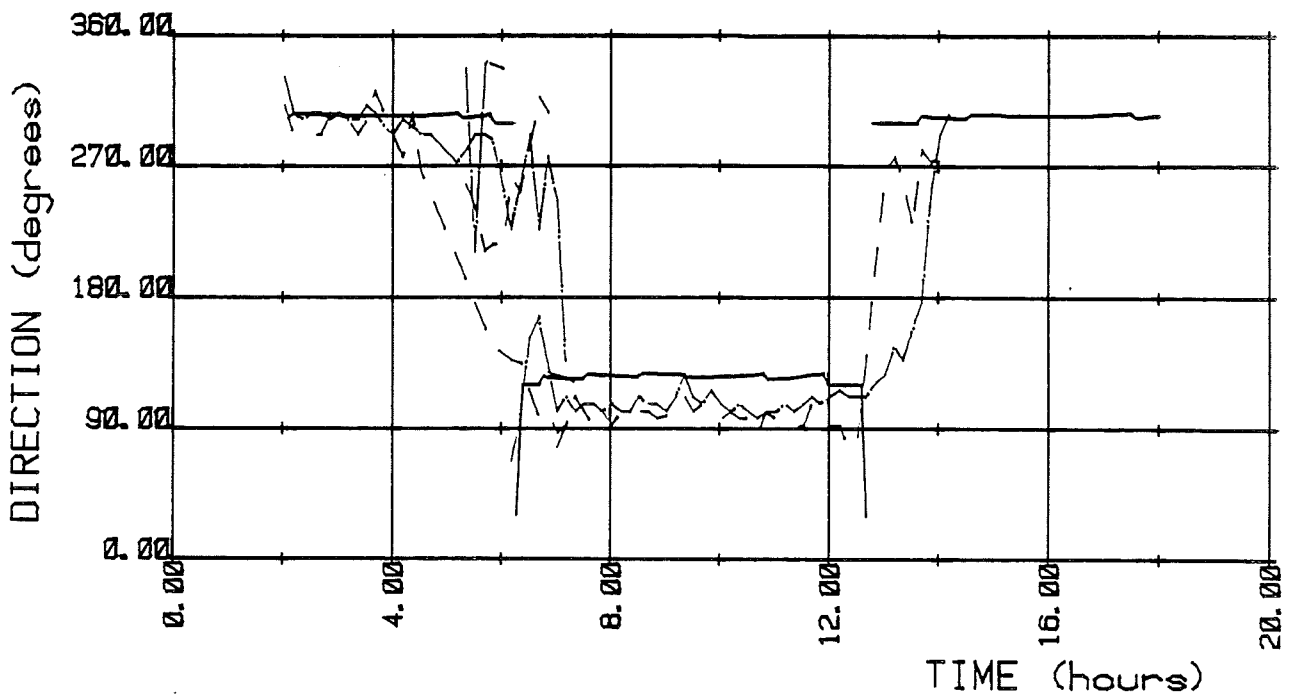
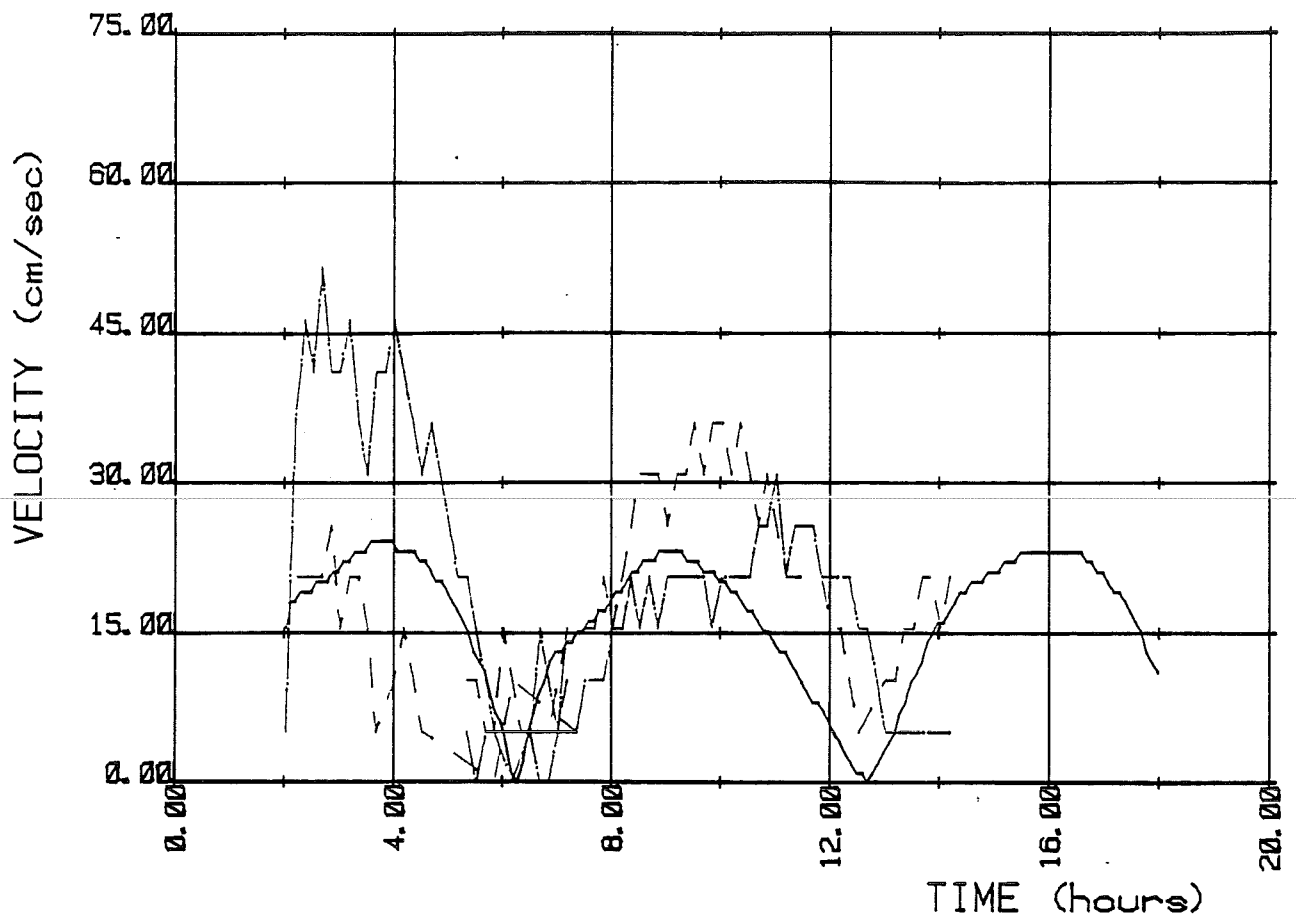

Velocity curve at station: 225

_____ computed at $N=24$ $M=43$
 - - - - - measured 1m+floor April 13th 1981
 - · - · - · measured 2m-surf. April 13th 1981



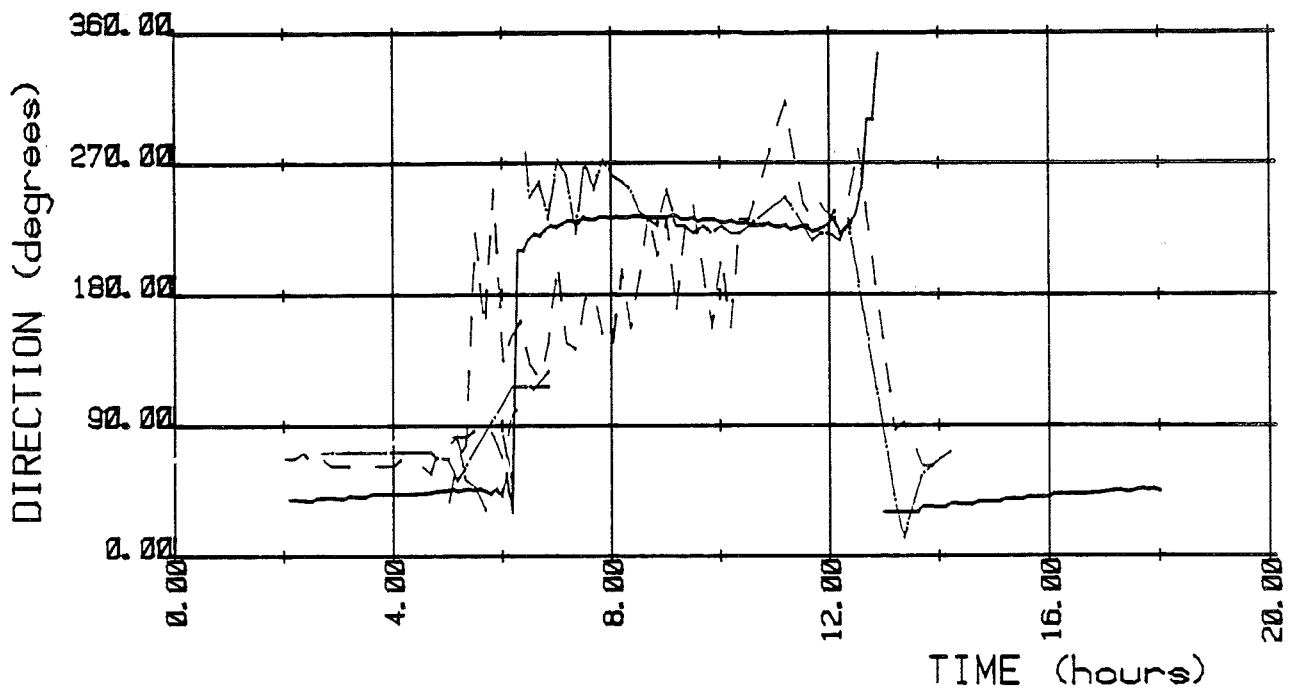
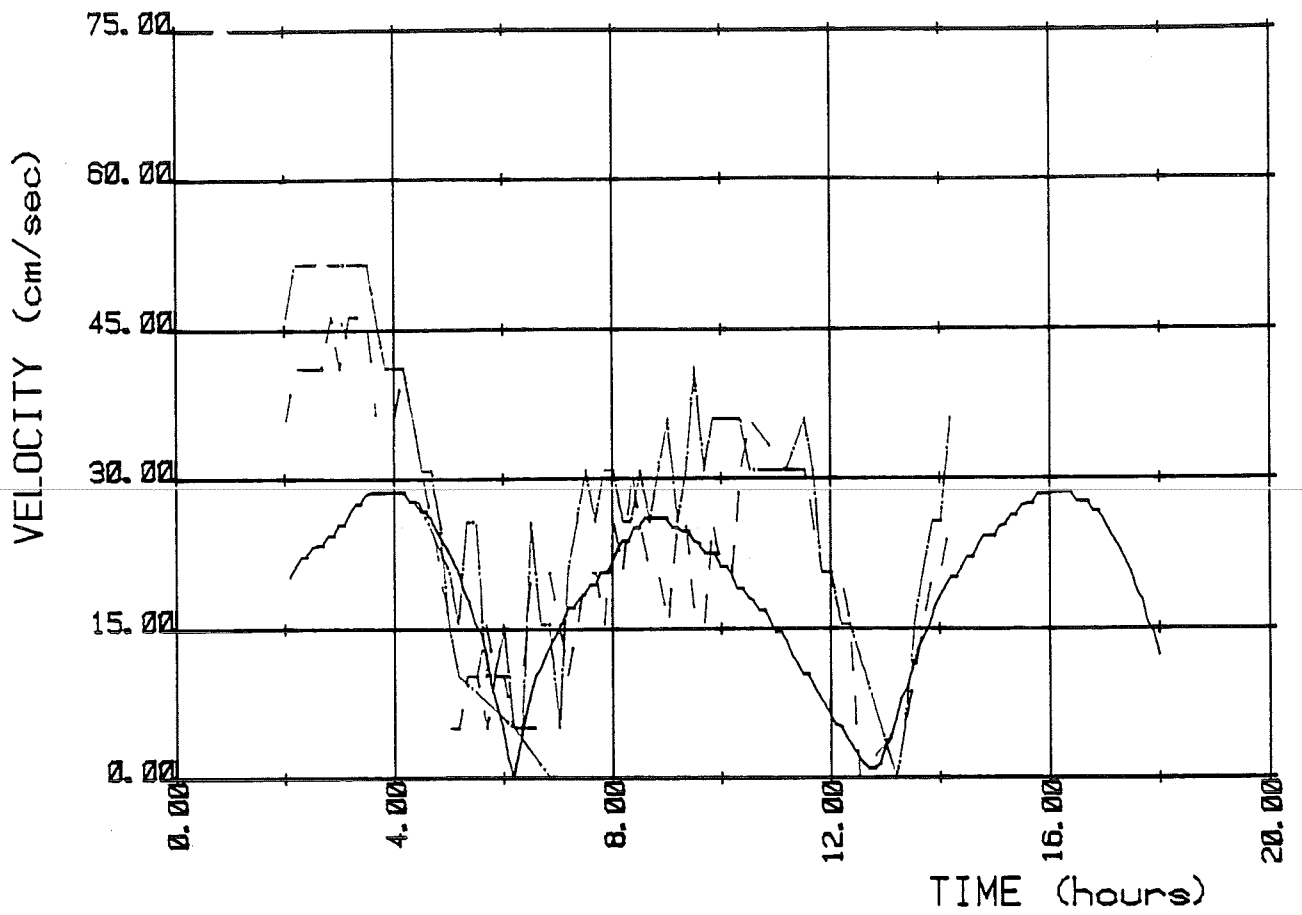

Velocity curve at station: 226

- computed at $N=20$ $M=41$
- - - - - measured 1m+floor April 13th 1981
- · - · - · measured 2m-surf. April 13th 1981



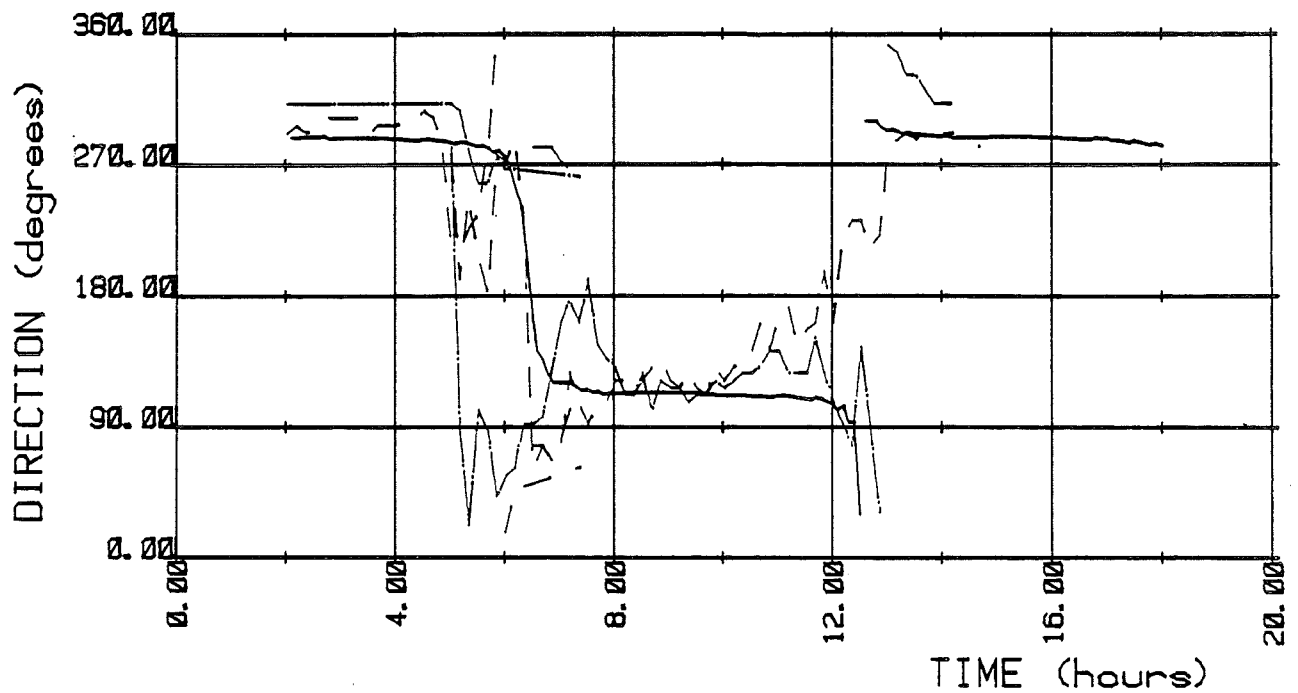
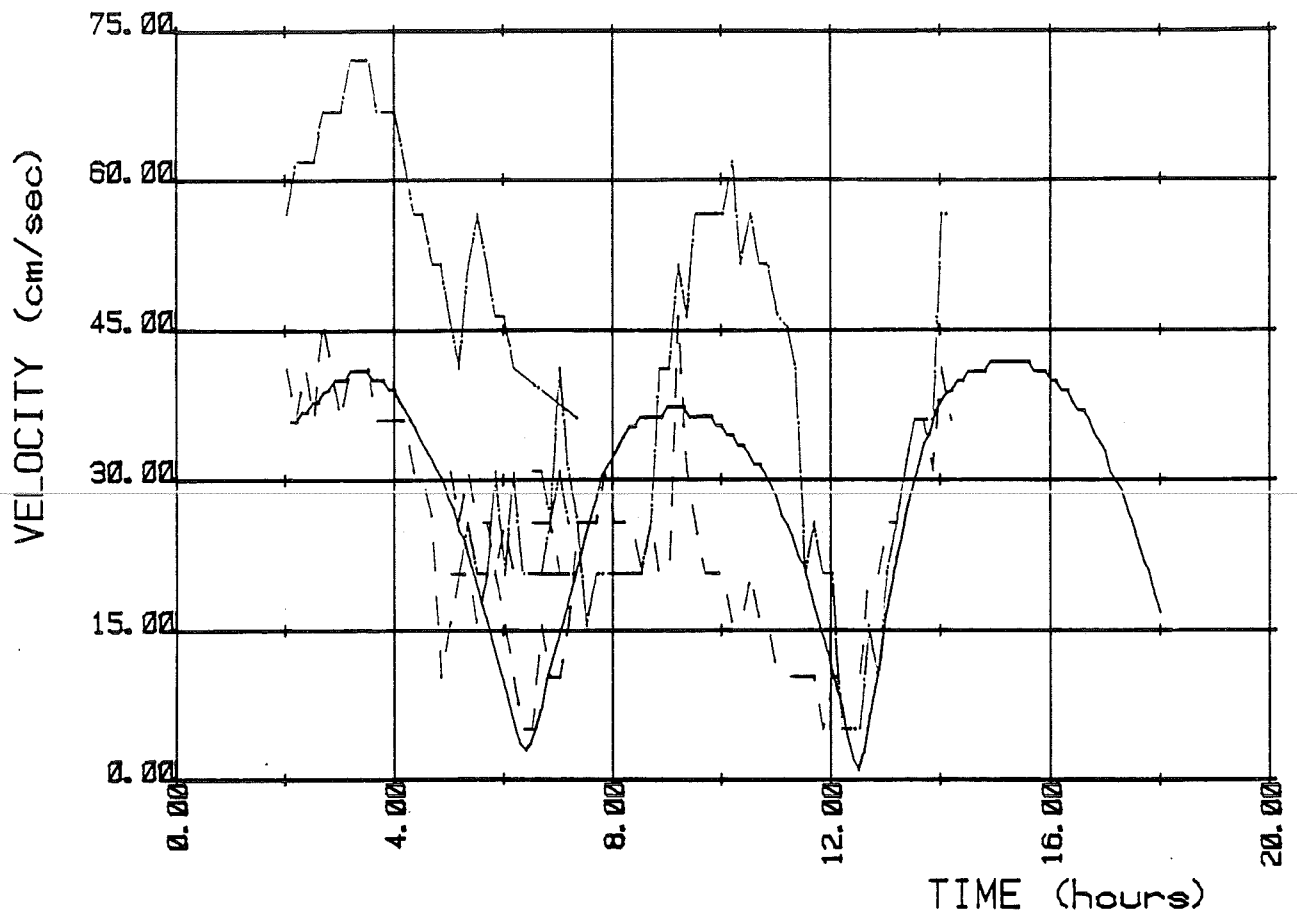

Velocity curve at station: 227

- computed at $N=30$ $M=24$
- - - - - measured 1m+floor April 13th 1981
- · - · - · measured 2m-surf. April 13th 1981





scale 1 : 150000

Computed flowfield; 9 hours after HW
at Lisbon

- velocity = 1.20 m/s
- velocity = .60 m/s
- land node
- dry shoal node



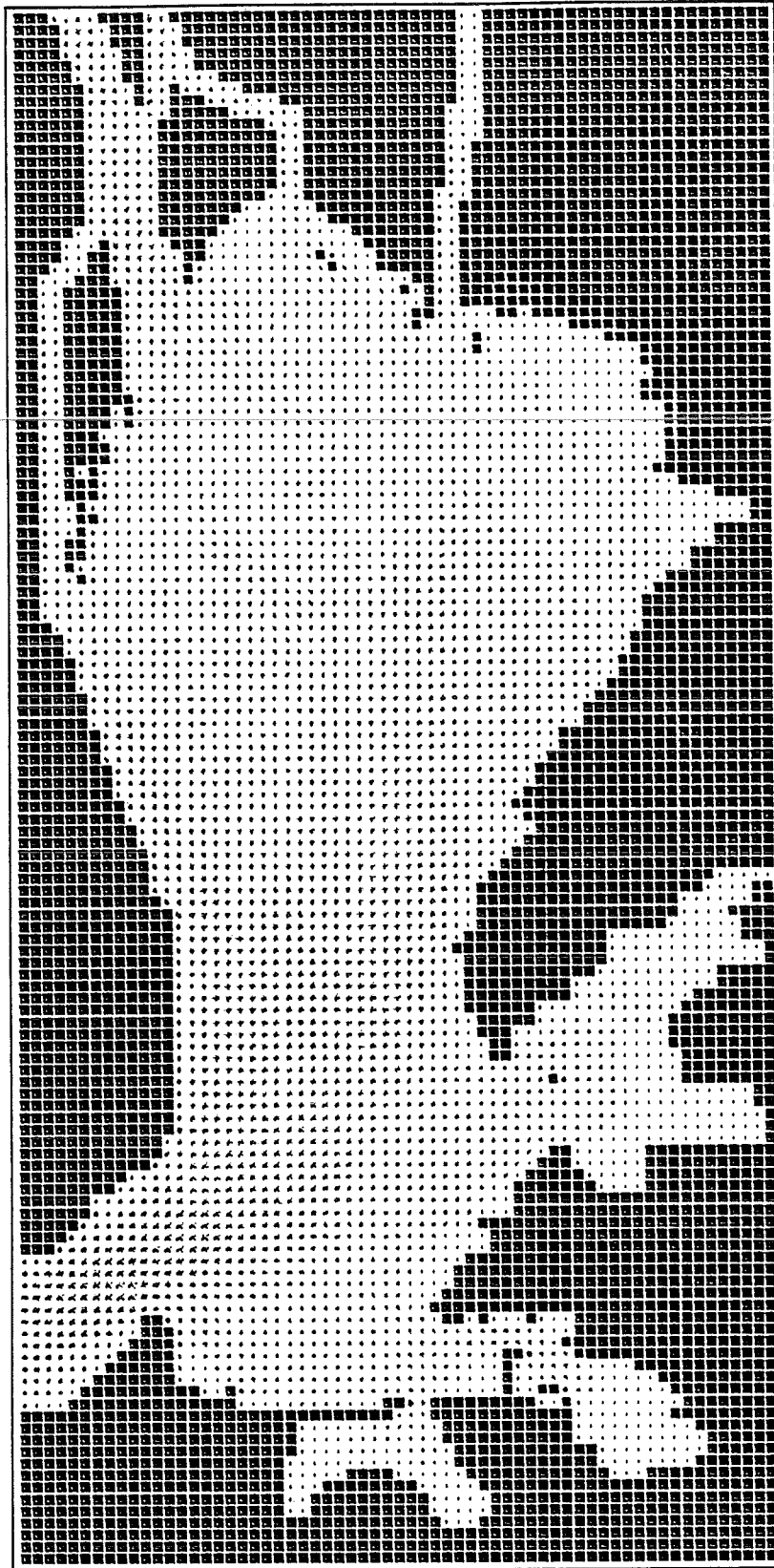

scale 1 : 150000

Computed flowfield; 15 hours after HW
at Lisbon

- velocity = 1.20 m/s
- velocity = .60 m/s
- land node
- dry shoal node





Hydro - Morphological Study		Tagus Estuary	
A.G.P.L.	TAGUS INNER ESTUARY	date	
	Mean Neap Tide	drawn by	
 aliedrecht holland	Present situation	appr. by	
	12 hours after H.W. Lisbon	scale	1: 50 000
		drawing nr.	P473 - 5.7



Hydro - Morphological Study		Tagus Estuary 8	
A.G.P.L.	TAGUS INNER ESTUARY	date	p473
	Mean Neap Tide	drawn by	
 hydronamic sliedrecht holland	Present situation	contr. by	
	15 hours after H.W. Lisbon	appr. by	
		scale	1:50 000
		drawing nr.	P473 - 5.8