

Spatial decision support systems for hospital layout design

A review

Jia, Zhuoran; Nourian, Pirouz; Luscuere, Peter; Wagenaar, Cor

DOI

[10.1016/j.jobe.2023.106042](https://doi.org/10.1016/j.jobe.2023.106042)

Publication date

2023

Document Version

Final published version

Published in

Journal of Building Engineering

Citation (APA)

Jia, Z., Nourian, P., Luscuere, P., & Wagenaar, C. (2023). Spatial decision support systems for hospital layout design: A review. *Journal of Building Engineering*, 67, Article 106042. <https://doi.org/10.1016/j.jobe.2023.106042>

Important note

To cite this publication, please use the final published version (if applicable). Please check the document version above.

Copyright

Other than for strictly personal use, it is not permitted to download, forward or distribute the text or part of it, without the consent of the author(s) and/or copyright holder(s), unless the work is under an open content license such as Creative Commons.

Takedown policy

Please contact us and provide details if you believe this document breaches copyrights. We will remove access to the work immediately and investigate your claim.

Contents lists available at [ScienceDirect](https://www.sciencedirect.com)

Journal of Building Engineering

journal homepage: www.elsevier.com/locate/job

Spatial decision support systems for hospital layout design: A review

Zhuoran Jia^{a,*}, Pirouz Nourian^a, Peter Luscuere^a, Cor Wagenaar^{a,b}

^a Faculty of Architecture and the Built Environment, Delft University of Technology, Delft, the Netherlands

^b History of Architecture and Urbanism – Faculty Board, Faculty of Arts, University of Groningen, Groningen, the Netherlands

ARTICLE INFO

Keywords:

Hospital layout design
Agent-based modelling
Discrete event simulations
Markov chain random walk simulations
Space syntax analysis
Decision support systems

ABSTRACT

This study presents a systematic review of the literature on decision support for designing hospital layouts using spatial network analysis and/or simulation modelling. The review includes 102 articles, which are classified into five different categories concerning their layout-related challenges. Specifically, the categories include overcrowding, patient waiting times, visibility & staff interaction, wayfinding & walkability, and other issues such as hospital-acquired infections. The main finding is the cross-referenced table of different performance issues related to the hospital layout to different assessment methods, indicators, and quality criteria. The review suggests prospects for associating hospital design problems/challenges with spatial layout, as well as a framework for developing methods for layout representation, aggregation and relativization borrowing from the fields of transport planning and operations research. The main focus of this study lies in the spatial layout. Viewing the spatial complexity of a hospital as an indoor spatial environment is at least as complex as an urban environment, thus justifying a geographical approach; hence we expand the scope of the literature review to papers that may not directly address hospital design but have relations to spatial decision support systems.

1. Introduction

Hospitals have multiple functions including clinical, nursing, administration, services, etc. These functions have various kinds of aspects such as crowdedness, wayfinding, the efficiency of service, etc. Studies have shown that these aspects are determined by the layout of the hospital. According to the literature, over 67% of employees are unable to perform their jobs efficiently due to inappropriate layouts of the working environment [1]. Moreover in hospitals, nurses were found to spend more time walking than their caregiving activities because of the problems related to hospital layouts [2]. One study found that 28.9% of nurses' time was wasted on walking [3]. In another study, Peponis et al. [4] found that the extra expenditure caused by difficulty in wayfinding is \$ 220,000 per year in 1990 in the USA, the reason is that staff are interrupted by patients for giving them directions.

The reasons why the layout of a hospital has a great impact on various aspects of functions are twofold. Firstly, from a functional point of view, hospitals are complex as a 'healing factory' in which services are produced. The patient enters the hospital with a condition, a series of services are produced around the patient, and the patient leaves the hospital (ideally) healed. Secondly, from a formal/configurational point of view, hospitals are complex as small indoor cities, where corridors in hospitals can be compared to streets in a city, and different spatial units that serve different functions in hospitals can be compared to land uses in a city. Hospitals are complex from both points of view, and when we combine these two perspectives, it indicates that the layout of a hospital affects

* Corresponding author. Julianalaan 134, 2628 BL, Delft.
E-mail address: Z.Jia@tudelft.nl (Z. Jia).

<https://doi.org/10.1016/j.job.2023.106042>

Received 17 October 2022; Received in revised form 5 December 2022; Accepted 1 February 2023

Available online 4 February 2023

2352-7102/© 2023 The Authors. Published by Elsevier Ltd. This is an open access article under the CC BY license (<http://creativecommons.org/licenses/by/4.0/>).

the visibility and walkability of two types of users in the hospital, namely, the people being served and the people serving others. Spatial Network Analysis is a popular method for assessing the visibility and accessibility of a layout design, and Simulation Modelling can provide quantitative measurements related to aspects of hospital functions such as the number of patients and distance, etc. This paper aims to review studies applying Spatial Network Analysis and Simulation Modelling for decision support in hospital layout design.

The importance of layout problems in hospitals can be understood by investigating inefficiencies as mentioned above, however, there are also critical issues related to the main function of a hospital such as increased chances of transmission of Hospital Acquired Infections (e.g. for airborne diseases such as COVID-19) with overcrowding ([5–9]) or long patient waiting time issues that pertain to layout problems ([10–13]).

The contribution and novelty of this paper are the following:

- We propose a comprehensive engineering approach for the formulation of problems related to human movements in hospitals, spatial representation of hospital layouts, and quantification of issues such as over crowdedness. This approach borrows from Operations Research and builds on analogies between hospital layout design with Transport Planning, particularly utilizing the 4-Step Transport Modelling approach, with an explicit link made to Spatial Network Analysis.
- We demonstrate gaps in the literature for adequately quantifying several performance issues of hospitals that can be traced back to their layouts and argue for the use of simulation modelling such as ABM and DES for ex-ante assessment of hospital layouts and propose the outline of envisaged Hospital Design Support Systems (HDSS) as information systems featuring such assessment models in conjunction with Multi-Criteria Decision Analysis (MCDA) tools.
- We articulate the main components and procedural steps for making such ex-ante assessment models to operate on Building Information Models (BIM) of hospitals, namely, a spatial network representation of hospital layouts, alternative simulation modelling methods, spatial aggregation methods, and relativization methods based on standardized functional units.

1.1. Objectives of the review

The main focus of this review lies in the spatial layout of hospitals. A clear-cut data model or mathematical representation of a layout configuration is necessary for any kind of assessment. Spatial layout is relevant to identifying feasible locations and dimensions for a group of interrelated elements that satisfy design goals and maximize design performance according to certain preferences [14]. For a detailed definition of the layout, please see section 4. This study aims to review publications that apply the assessment approach of Spatial Network Analysis (SNA) and Simulation Modelling such as Agent-Based Modelling (ABM), Discrete-Event Simulation (DES) and Random Walk Simulation (RWS) for assessing hospital layouts.

1.2. Questions of the review

The following thematic questions have formed the rationale of the review and underpinned the search methods and search criteria:

- **What would be the desired/required features of a hospital design support system (a spatial decision support system for informing the design of a hospital)?**

The kind of aspects of the function include crowdedness, wayfinding, the efficiency of the service, etc., we have a strong intuition that these aspects are determined by the layout of the building, not the materiality/systems inside the building.

- **What are the effects of the layout of a hospital on its functionality?**

As mentioned in section 1, Hospitals are complex as a ‘healing machine’ from a functional point of view and as small indoor cities from a formal point of view. The layout of a hospital has a great impact on the visibility and walkability of the users in the hospital. Hence, We are looking at the walkable space as a 2-manifold space and the visible space as a 3-manifold space.

- **How is Spatial Network Analysis applied in the field of Hospital Layout Design?**

We are missing two things in Spatial Network Analysis, even though it is intuitive and useful, Spatial Network Analysis cannot give us quantities of a physical dimension (e.g., the number of people, distance, etc.). The other issue is that time is usually not in the picture of Spatial Analysis, and yet time is very important in the way a hospital functions. Hence another concept of Simulation Modelling needs to be considered.

- **How is Simulation Modelling (e.g., Agent-Based Modelling, Discrete-Event Simulation, Random Walk Simulation, Transport Models, etc.) applied in the field of Hospital Layout Design?**

1.3. Previous reviews

Some other reviews share similar topics to this review. However, they do not include studies in recent years and/or their focuses are on other factors such as management policies instead of spatial layout.

In a recent study, Halawa et al. [15] presented a review of hospital designs that apply methodologies from Operation Research and healthcare engineering to enhance design performance. The methodologies include mathematical models, simulation modelling, statistical analysis, Space Syntax Analysis (SSA), Heuristics, Lean six sigma, reviews, machine learning, fuzzy logic, Markov chain as well as observation and surveys. This review illustrates the application of Operation Research methods in healthcare facility design and its potential for further investigation. However, it does not include a cross-reference between hospital design challenges and those

methodologies. Rashid [16] reviewed studies on nursing unit layout design using simulation modelling and Spatial Network Analysis (SNA) until 2014. The author only focused on one type of spatial unit of the hospital, namely the nursing unit, and did not include studies on other spatial units. Other reviews have focused only on either the methods of SNA or methods of simulation modelling. Concerning the spatial network analysis, Haq and Luo [17] explained a methodology of SNA, namely Space Syntax Analysis (SSA), and overviewed its application in healthcare facility design until 2011. Sadek and Shepley [18] reviewed basic and newly developed SSA tools used in the field of healthcare design until 2014. Reviews on simulation modelling in healthcare research mainly focus on operation and management perspectives instead of spatial layout perspectives. For example, In an early study in 1988, Smith-Daniels et al. [19] reviewed literature applying methods such as simulation, queueing theory, Markov chains and heuristics for management decision support such as facility sizing and patient admission scheduling. Jun et al. [20] surveyed literature applying discrete event simulation in hospitals, outpatient clinics and emergency departments until 1997. Fone et al. [21] reviewed studies applying simulation modelling in population health and health care delivery. Sobolev et al. [22] overviewed studies using simulation modelling in surgical care until 2007. Brailsford et al. [23] reviewed studies applying simulation and modelling in healthcare until 2007. In a recent study, Al-Kaf [24] reviewed studies applying Discrete-Event Simulation (DES) for improving resource utilization and patient experience in outpatient clinics.

1.4. Paper structure

The computational assessment of layouts requires specific data structures and algorithms. The data structures, as explained further must be compatible or related to BIM and GIS structures due to the scale and complexity of hospitals. The algorithms required for the assessment of hospitals must be capable of analysing their network models and also running simulations on top of such network-space models. Thus, the paper has sections dedicated to discussing the specifics of such algorithms and their application for layout assessment in hospital design. The paper is structured as follows: Section 1, an introduction including the focus of this review and relevant previous reviews. Section 2, the methodology used in this review. Section 3, brief introductions of the terminologies pertained to this study. Section 4, defines what is layout configuration. Section 5, a brief introduction to Spatial Network Analysis (SNA). Section 6, the introduction of three different methods of Simulation Modelling including Agent-Based Modelling (ABM), Discrete-Event Simulation (DES), and Random Walk Simulation (RWS). Section 7, introductions of methods of fair comparison and decision support. Section 8, review taxonomies that categorize the reviewed papers into five groups. Section 9, review results and Section 10, conclusion.

2. Research methodology

This review follows PRISMA (Preferred Reporting Items for Systematic Reviews and Meta-Analysis) guidelines. It considers conference papers, peer-reviewed articles and PhD thesis published between 1965 and 2022. The databases used in this review include Scopus and Google Scholar. The keywords used for literature searching include “hospital design”, “healthcare facility design”, “healthcare architecture”, “healthcare design”, “hospital setting”, “outpatient clinic” and “inpatient ward” in combination with “spatial network”, “space syntax”, “spatial analysis”, “layout analysis”, “decision support system”, “random walk”, “Markov chain”, “Markov model”, “queueing theory”, “simulation model”, “agent-based”, “discrete event simulation”, “simulation model”, “multi-agent”, and “pre-occupancy”. A search filter was used for identifying literatures that contain these keywords in the title, abstract and keywords of the paper and were written in English. Fig. 1 illustrates the search strategy and the number of identified literatures. The total number of identified studies includes 315 from Scopus and 109 from Google scholar. After duplicate removal, the results are 421 unique literatures. A detailed title and abstracted review according to specific inclusion criteria left 71 studies. The inclusion criteria are as follows:

- **Inclusion criteria 1:** publications explicitly mentioned what design challenges they attempted to address or what useful facts they discovered
- **Inclusion criteria 2:** studies that are explainable and reproducible, i.e., a clear description of the methodology in terms of mathematical formulation and/or pseudocode

After a full-text review according to inclusion criteria, there were 51 publications left. Reference chasing from the included literatures was then conducted to find more related studies. Lastly, there were 102 studies included in this review.

3. Terminology

This section introduces the relevant terminologies of this study. The terminologies include hospital types, hospital building types, Geographical Information Systems (GIS), Building Information Modelling (BIM), Operations Research (OR) and its interrelated disciplines such as Industrial Engineering (IE), Multiple-Criteria Decision Analysis (MCDA), Facility Layout Planning (FLP) and Human Factors and Ergonomics (HFE), Graph Theory and Network Analysis. Specifically, the interrelationships between these terminologies are shown in Fig. 2 and this section is structured as follows:

- Hospitals are indoor cities/villages, the scale is big, much bigger than many buildings (Section 3.1).
- This makes them hard to navigate, hard to manage logistics, etc. (section 3.2)
- This means that analysing their spatial model's integration of BIM and GIS (building scale and geographical scale) is most likely to be necessary (sections 3.3 & 3.4).

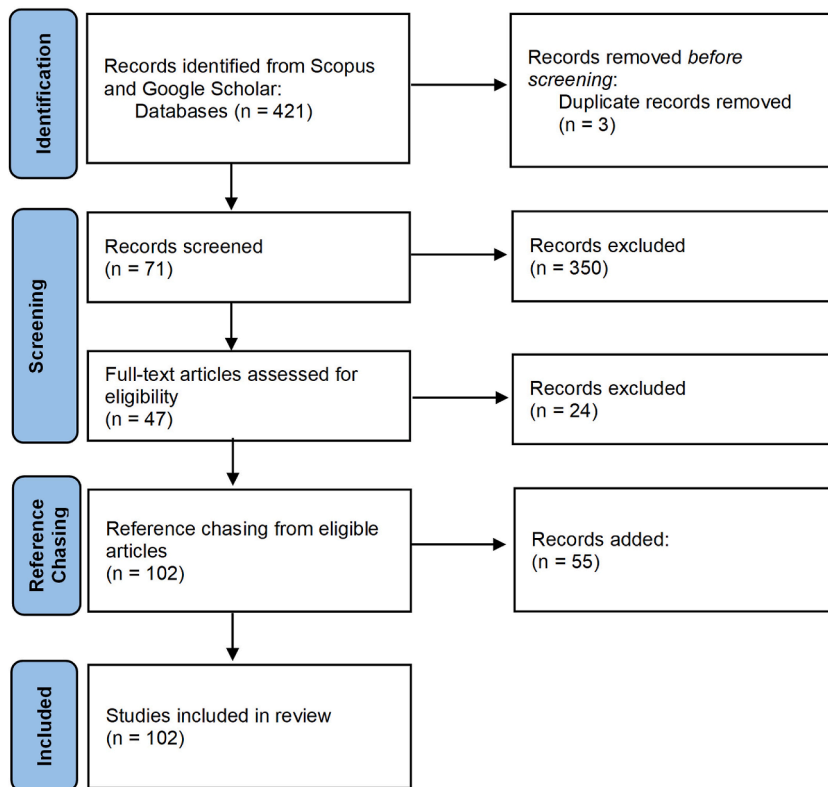

Fig. 1. Search strategy diagram based on PRISMA (a 2-column fitting image), image source [25].

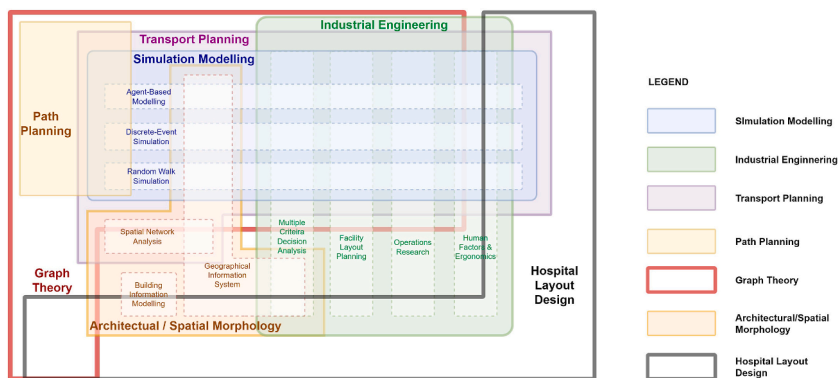

Fig. 2. An Euler diagram illustrating the intersections/overlaps between the fields that pertain to hospital layout design and assessment (a 2-column fitting image), image source: author.

- The importance of the layout of a hospital is related to “facilities layout planning (FLP)” and facility management in terms of the efficiency and effectiveness (efficacy) of “operations”, as in Operations Research (including IE, MCDA, FLP, HFE including cognitive comfort and physical comfort for both staff and visitors) (section 3.5).
- Why graphs/networks? Navigation and studying operations involving human movement in a complex (non-Euclidean) environment make the use of graphs/networks inevitable. Network models (or hyper-graph/Mesh models) are necessary for modelling walkable 2D manifolds (section 3.6).
- Transport patterns inside a hospital can be complex and they need to be planned properly. (section 3.7).
- Path Planning & Indoor Navigation for such complex buildings bring about additional challenges in terms of spatial analysis of ergonomics, e.g., concerning how intuitive it is to find a path (section 3.8).
- What is a layout? A layout representation of a hospital is necessary for any kind of assessment, e.g., Spatial Network Analysis (SNA) and simulation modelling (section 4).

3.1. Hospital types

Based on their functionalities, Hospitals can be differentiated into different types such as general hospitals, children's hospitals, university hospitals, specialized hospitals, community health centres, and rehabilitation and support clinics [26]. Hospitals can also be categorized based on ownership, such as private hospitals and public hospitals (including state hospitals, city hospitals, district hospitals, and village hospitals). These types of hospitals are all common in China, and there is another special type of hospital in China, which is the Traditional Chinese Medicine (TCM) hospital [27, p. 13]. Most hospitals have large scales, their scales are so large that one can compare them to small cities. The large scale makes the hospital hard to navigate and manage the logistics, etc.

3.2. Hospital building types

The current hospital building types can be classified into two main groups – high-rise hospitals and low-rise hospitals (see Fig. 3). High-rise hospitals are suitable for limited site areas, where all the major departments and functions could be compacted into one single large building complex. The variations of high-rise hospital types include Monoblock, Breittfuss Model (also known as the “Wide Foot Model”) and Hull model [27]. In comparison, the low-rise hospital has a higher requirement on the size of the site, and it is more flexible and easier to expand due to a clear division of different functions (e.g., inpatient and outpatient) into different building wings so that the construction of one function will not influence the operation of another. The popular variations of low-rise hospital types include village form, Titanic form, pavilion, block forms, courtyards, etc. [27]. Fig. 3 shows the two types of hospitals and their variations.

The scales of both types of hospitals are large, which makes them difficult to navigate. Hence, it is appropriate to introduce Geographical Information Analysis (GIS) and Building Information Modelling (BIM) as means of analysing the spatial models of hospitals.

3.3. Geographical Information Systems

A Geographical Information System (GIS) mainly consists of a geospatial database management system that is used for systematically storing and retrieving geospatial data, a data processing workbench that can manipulate data for higher-level analysis and decision support, and a data visualization system that can communicate to users by presenting the result of data analysis [29, pp. 1–5]. The information stored in the geospatial database management system is threefold, namely, geometric information such as room sizes and shapes, topological information such as connectivity and adjacency, and semantic information such as pedestrian density and room functions etc., [30, pp. 11–15]. Hospitals can be considered as an analogy of a small city, it is reasonable to use a geographical

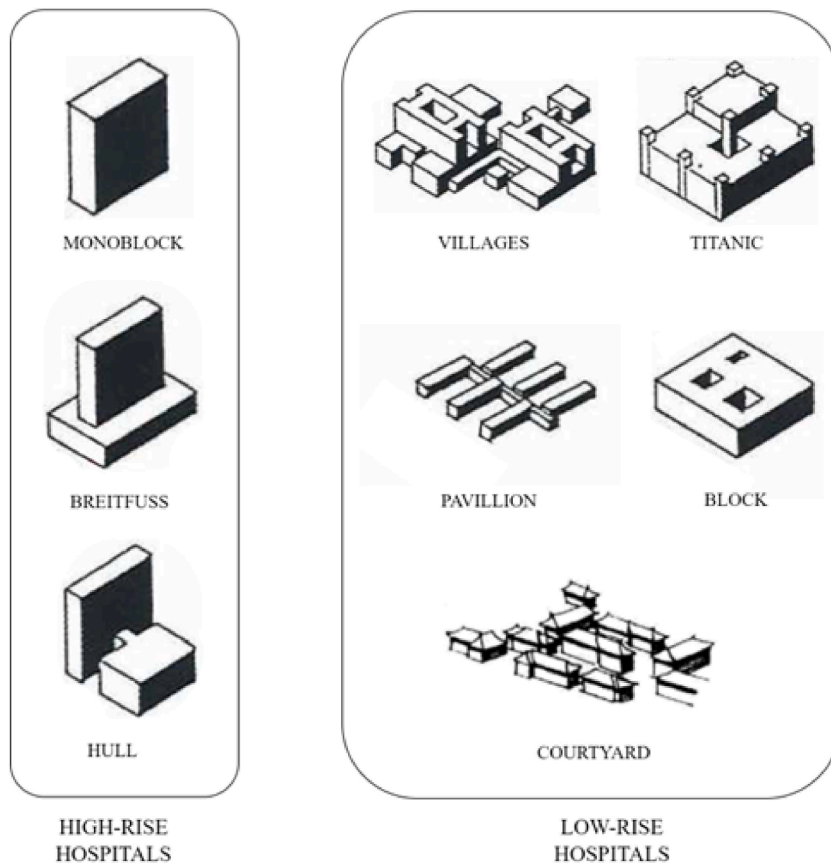

Fig. 3. High-rise hospital type and low-rise hospital type and their variations (a 1.5-column fitting image), image source: [28, p. 14], [27, p. 125].

approach (i.e., the GIS approach) to analyse hospitals. Our research is mainly concerned with the spatial database management system part of GIS. For example, we propose a spatial database management system where a hospital's geometric information, topological information and semantic information can be stored and retrieved.

3.4. Building Information Modelling

Building Information Modelling (BIM) consists of a 3D model, a database that contains all the relevant data, and the interoperable software used for building the 3D model [31, pp. 201–204]. Architects can use BIM software to design buildings and build their virtual models in 3D [31, pp. 201–204]. The information contained in BIM's database includes geometric information, topological information, attributes information, and geographical information. Our research uses BIM models of hospitals as input and extracts the relevant data (mainly geometrical and topological data) from it and stores the data in the spatial database management system mentioned in section 3.3 for further analysis.

3.5. Operations Research

The spatial decisions made when designing a hospital layout are related to objectives of higher efficiency and effectiveness of “operations”, as in Operations Research (OR). OR is a discipline that can support decision-making by developing and applying advanced analytical methods [32]. When dealing with complicated decision-making problems, OR approaches can find an optimal solution (or optimal solutions) by employing methods and techniques such as mathematical modelling, mathematical optimization, simulation, queuing theory, Markov Decision Process, statistical analysis, decision analysis, etc. The optimal solution identified by a OR process is often a maximised result (e.g., maximised performance or interest) or a minimised result (e.g., minimised cost or distance) [32].

In this study, four interrelated disciplines of OR are discussed, this includes Industrial Engineering (IE), Multiple-Criteria Decision Analysis (MCDA), Facilities Layout Planning (FLP), and Human Factors and Ergonomics (HFE).

- **Industrial Engineering.** Industrial Engineering (IE) and OR are two interrelated fields. According to IISE [33], IE is “concerned with the design, improvement and installation of integrated systems of people, materials, information, equipment and energy. It draws upon specialized knowledge and skill in the mathematical, physical, and social sciences together with the principles and methods of engineering analysis and design, to specify, predict, and evaluate the results to be obtained from such systems.” IE approaches such as Lean Thinking and Six Sigma concepts have been applied in healthcare to reduce patient waiting time and reduce overcrowding [34].
- **Multiple-Criteria Decision Analysis.** Multiple-Criteria Decision Analysis (MCDA) is a term that describes a group of approaches that can explicitly evaluate multiple criteria in conflict with each other in helping decision-makers achieve satisfactory non-dominated decisions [35, p. 2]. For example, when designing a hospital, one of the design aims is to maximize visibility for nurses to monitor the patients, on the other hand, it is also aimed to reduce visibility for patients' privacy. These two design objectives conflict with one another, and decision-makers must make trade-offs among these conflicting objectives. Fig. 4 is an example illustrating how to compare design solutions in terms of two conflicting criteria and identify near-optimal solutions. In the figure, there are 20 dots representing 20 design solutions, each dot has a coordinate representing the design solution's scores in terms of visibility and privacy. We define that *design solution a* dominates *design solution b* if both criteria of *a*'s are higher than *b*'s [36]. The near-optimal design solutions are then the ones that are dominated by none (i.e., non-dominated solutions), which forms a Pareto front as shown in Fig. 4.
- **Facility Layout Planning.** Facility layout planning (FLP) is one of the most important problems in the field of OR and IE [37]. FLP is defined as locating different facilities in a plant area, to achieve the most efficient layout according to certain criteria or

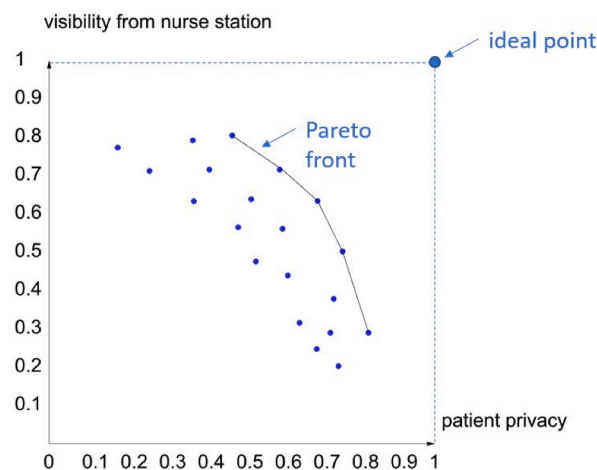

Fig. 4. Identifying near-optimal design solutions with the Pareto front (please note that the Pareto front is only a hypothetical example made for illustration purposes) (a 1.5-column fitting image), image source: author.

objectives while taking into account different constraints such as size and form, etc. [38]. The most common and significant objective related to the efficiency of a layout is the minimization of material handling cost because such cost is proportional to the distance which depends on the layout [39, p. 85], [40]. A hospital-related example of FLP is placing eight different departments/functional areas into eight different locations within a hospital building, to minimize the patient and staff walking distance (see Fig. 5).

- **Human Factors and Ergonomics.** According to International Ergonomics Association [41], Human Factors and Ergonomics (HFE) is defined as “the scientific discipline concerned with the understanding of interactions among humans and other elements of a system, and the profession that applies theory, principles, data, and methods to design to optimize human well-being and overall system performance.” The study of HFE can be divided into two main categories: physiological ergonomics which studies the physical aspects of human activities (e.g., lifting, seeing or hearing, etc.) and cognitive ergonomics which studies the mental aspects of human activities (e.g., perception, reasoning, memory and stress etc.) [39, p. 255], [41]. Another dimension for separating different aspects of HFE is the various interfaces that humans interact with, for example, human interface with the work environment/machines/organizational structure etc. [39, pp. 259–264]. This study focuses on cognitive ergonomics and the interface with the work environment. For example, the layout design of a hospital influence the patient's perception of the hospital environment and thus influence the performance of wayfinding.

3.6. Graph Theory & network analysis

Graph Theory is a term used in the field of mathematics, it is also known as Network Analysis in the fields of engineering and applied science, these terms can be used interchangeably [42, p. 4]. The terms *graph*, *weighted graph*, *directed graph*, *dual graph* and *coloured graph* are introduced respectively in the following:

- **Graph/network:** A graph/network G is composed of two sets of objects, namely, the set of nodes/vertices $V = \{v_1, v_2, v_3, \dots\}$ and the set of links/edges $E = \{e_1, e_2, e_3, \dots\}$ [42, pp. 203–205].

The spatial configuration of a hospital can be represented by a graph. Specifically, nodes can represent rooms/corridors in a hospital, and if two rooms/corridors are directly connected, a link can represent the connection between these rooms/corridors. Fig. 6(a) shows a small portion of the Panyu Central Hospital in Guangzhou China, it includes eight rooms and one corridor. Fig. 6(b) is a graph representation drawn from Fig. 6(a) and shows the connection relationships between rooms or rooms and corridors. For example, rooms v_1 and v_2 are directly connected while rooms v_1 and v_6 are not directly connected (connected through room v_2). The degree of a vertex is defined as the number of edges incident to it (e.g., the degree of v_1 is 4 and the degree of v_2 is 2) [42, pp. 203–205].

- **Weighted graph:** A weighted graph/network means that the edges and/or the vertices are attached with weights [42, pp. 203–205]. In a network representation of hospital spatial configuration, the links can be assigned with weights representing travel distance or travel time, etc. For example, in Fig. 7(a), each edge is assigned with a weight concerned with distance. A path in a graph/network from v_i to v_j is denoted as $p(i, j)$ [42, pp. 203–205]. For example, in Fig. 7(a), path $p(1, 6)$ is a sequence of vertices and edges $\{v_1, e_1, v_2, e_5, v_6\}$.

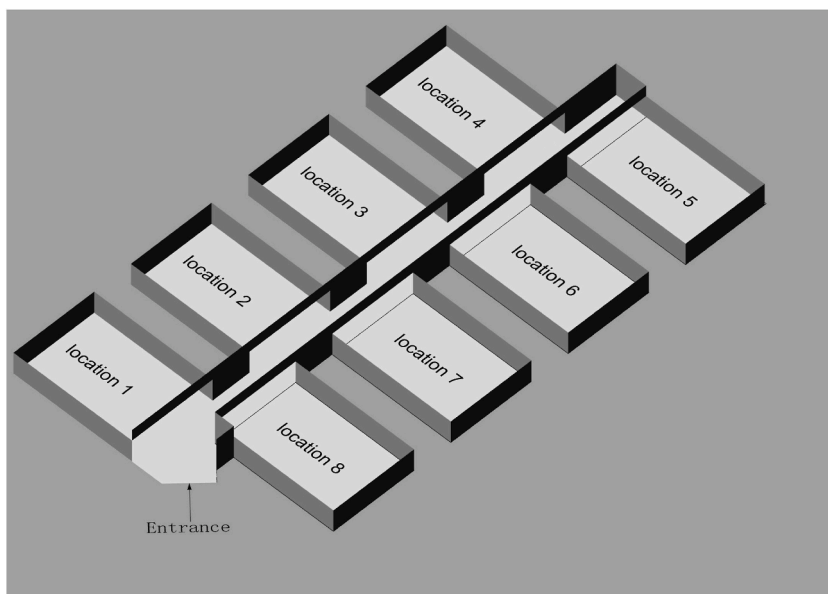

Fig. 5. An example of FLP: placing eight departments (e.g., radiology, consulting room, pharmacy, clinical laboratory, ENT, surgery, ophthalmology, dental) into eight locations with the aim of minimizing patient walking distance (a 1.5-column fitting image), image source: author.

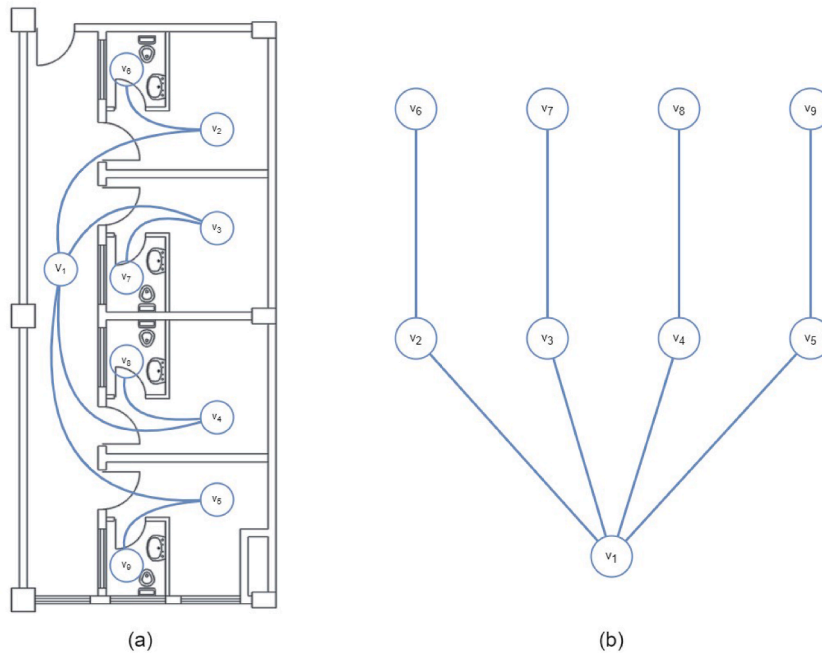

Fig. 6. A small portion of the ground floor plan of Panyu Central Hospital (a) and a graph representation showing adjacent relationships among rooms/corridors (b) (a 2-column fitting image), image source: author.

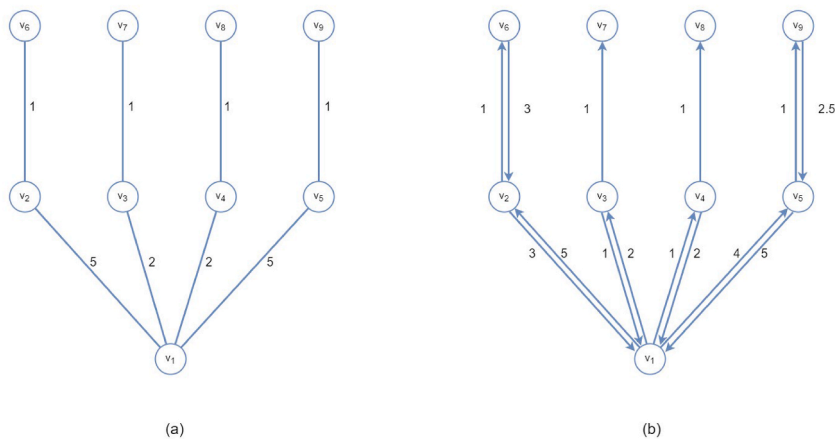

Fig. 7. An example of a weighted graph/network (a 2-column fitting image), image source: author.

- **Directed graph:** The graphs shown in Figs. 6 and 7(a) are undirected graphs, which means that the edges in this graph do not have directions. By contrast, the graph in Fig. 7(b) is a directed graph, each edge in this graph has one or two directions, and the two directions of one edge can have different weights [43, p. 3]. The shortest path in a weighted graph/network is the path between two nodes such that the sum of the weights of its elemental edges is minimal when weights represent travel distance [43, p. 278]. For example, in Fig. 8, the shortest path between v_1 and v_4 is the path highlighted in red.
- **Dual graph:** Another important concept of Graph theory is **Dual Graph**. In a 2D space, the dual graph of its primal graph G is a graph that has a vertex for each face of G and an edge between vertices for each pair of adjacent faces (see Table 1) [44], a face in a graph is defined as a region surrounded by a group of vertices and edges [45]. An example of a dual graph can be seen in Fig. 9, where the blue graph is the dual of the black graph and vice versa.

3.7. Transport Planning

Transport planning is concerned with evaluating, assessing, designing and planning transport facilities such as streets, highways, public transport lines, etc. to move people and goods to destinations efficiently and cost-effectively [47]. Since hospitals have similar transport systems to cities (public main corridors and access-limited corridors in a hospital can be compared to major and minor roads

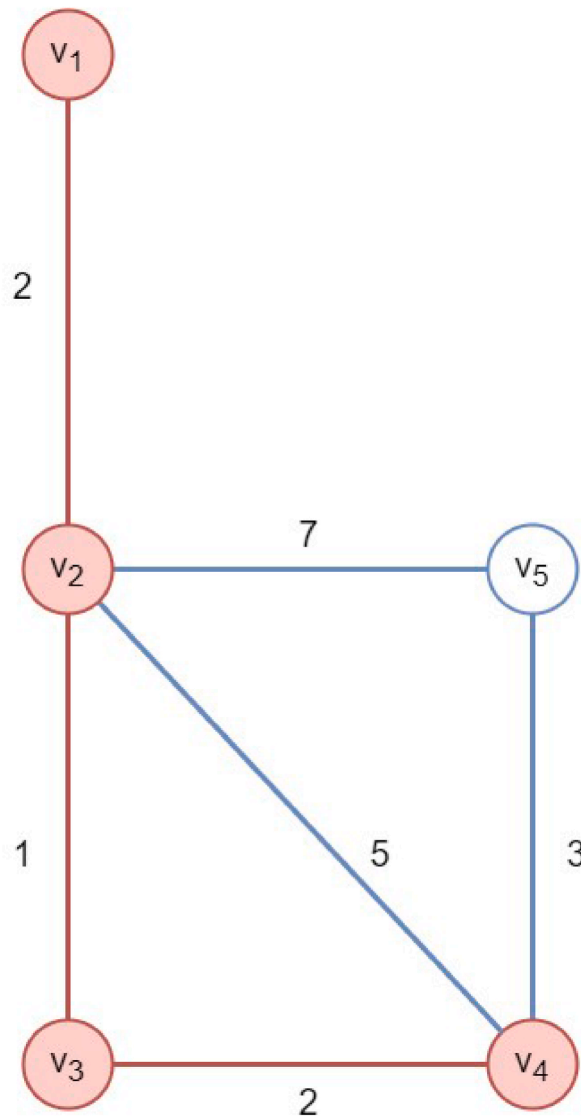

Fig. 8. Shortest path highlighted in red (a single-column fitting image), image source: author.

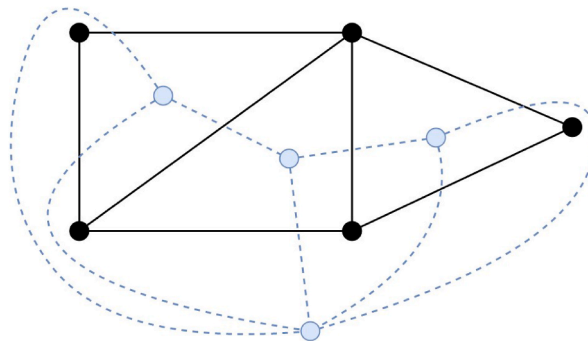

Fig. 9. The blue graph is the dual graph of the black graph and vice versa (a 1.5-column fitting image), image source [46].

in a city), the knowledge from the area of transport planning can be used for designing and evaluating the pedestrian flows and logistics in hospitals.

The transport planning process has four steps (i.e., Four-Step Travel Model) In the following, we can see the meaning of these four steps in the context of a contrived illustrative example. Please note that the numbers and everything else about this example are hypo-

Table 1
Duality of features in 2D space [44].

PRIMAL	DUAL
Vertex (node)	Face
Edge (link)	Edge
Face (e.g., a triangle or a polygon)	Vertex

thetical and fictitious. However contrived, the consistency between the first two steps of this modelling approach has been shown in correspondence between the row-sums and column-sums of Table 3 being equal to the values in Table 2, respectively for generated and attracted trips, both of which add up to the same number:

- Trip generation: this step predicts the number of people starting from and arriving at each zone in the studied area [48]. For example, the trip generation step in a hospital design project can be about predicting the number of pedestrians travelling from and arriving at each spatial unit that serves a particular function. Five spatial units with five general and representative functions (i.e., reception hall, orthopaedics, radiology department, pharmacy, clinical laboratory) are chosen in this example. The period of pedestrians counted is one day. Table 2 illustrates the trip generation of the contrived example.
- Trip distribution: this step predicts the number of people from each origin to each destination by producing an origin-destination matrix/table [48]. For example, in the case of the hospital design, this step predicts the distribution of the total number of people going from each origin to each destination (see Table 3).
- Mode choice: this step predicts which pedestrian will use which travel mode [48]. For example, in the case of the virtual hospital, the total number of pedestrians travelling from the entrance to the consulting room (row 2, column 3 in Table 3) is 2000, among which 1000 pedestrians could be patients travelling by walking, 500 pedestrians could be patients travelling while lying on the bed and being pushed by the nurse, the other 500 pedestrians could be nurse travelling with/without a medical trolley. The distribution of the travel mode of each cell in Table 3 will be predicted, and each travel mode will be assigned with a modal share matrix, i.e., modal share matrix for walking, modal share matrix for lying on bed and being pushed, modal share matrix for walking with a trolley.
- Route assignment: the last step selects the paths between all origins and destinations and hence the total amount of pedestrians on each path will be known [48]. In this research, path selection will be based on the shortest path (path with the shortest travel time).

In this research, the predicted number of pedestrians departing from and arriving at each spatial unit in the trip generation step will contribute to the attributes/colours of the nodes in the coloured graph when constructing a coloured graph (see section 4).

3.8. Robot Motion Planning, Path Planning & Indoor Navigation

Once the information for transportation in hospitals is estimated by Transport Planning, the dynamics of the hospital transport can be simulated using methods of Simulation Modelling. However, before Simulation Modelling, essential preparations are needed, i.e., partitioning the navigable surface of the architectural model and transforming it into a graph, which is achieved through techniques from the fields of Robot Motion Planning (a.k.a., Path Planning or Indoor Navigation). Robot Motion Planning is defined as finding a safe path from an origin to a destination by detecting and avoiding obstacles [49]. The classical approaches of Robot Motion Planning

Table 2
An example of trip generation in a virtual hospital project (please note that this is a hypothetical example made for illustration purposes), source: author.

Spatial units	Production	Attraction
	No. of pedestrians in 1 day	No. of pedestrians in 1 day
Reception hall	5000	2800
Orthopaedics	3000	2600
Radiology	1000	1950
Pharmacy	2000	1750
Clinical Laboratory	500	2400

Table 3
An example of trip distribution in a virtual hospital project (please note that this is a hypothetical example made for illustration purposes), source: author.

O-D	Entrance/exit	Consult room	Radiology	Pharmacy	Clinical Laboratory	Σ O
Reception hall	N/A	2000	1000	1000	1000	5000
Orthopaedics	1000	N/A	500	500	1000	3000
Radiology	500	200	N/A	200	100	1000
Pharmacy	1000	300	400	N/A	300	2000
Clinical Laboratory	300	100	50	50	N/A	500
Σ D	2800	2600	1950	1750	2400	11,500

Table 4
Problems & Challenges with hospital layout design and how to measure them.

Challenges	Indicators (disaggregate indications of how to measure)	Approaches	Quality criteria (aggregate indications of how to measure)
Overcrowding [27,185]	Number of patients in public spaces (e.g., waiting areas, corridors, etc.) of different functional areas/departments [10,68,76–79,81–83,186]	ABM + aggregation [75–78] DES + aggregation [80–84] RWS + aggregation [168]	The average people density over time in the public spaces (e.g., waiting area, corridor, etc.) of each functional area/department & Their weighted average [10,68,79,186]
long patient's waiting time and/or long patient length of stay and/or low patient throughput [10, 11]	Each patient's time spent on waiting for different procedures (e.g., diagnosis, clinical check-up, ultrasound test, etc.) [11,69, 88,131,188–193]	ABM + aggregation [10,68,76,77,88,89] DES + aggregation [79,188], [11,69,189, 190], [11–13,73,74,81,82,85,87,90–99, 101,102,104–113,115,115,117,119,119, 123,124,126,127,129], [130–134,192–194] RWS + aggregation [135–138,186,191] SNA + aggregation [139]	Average agent waiting time for each procedure (e.g., diagnosis, clinical check-up, ultrasound test, etc.) & A typical agent's average total waiting time (e.g., outpatient) [11,69,89,122,124,127,129–134, 188–193]
Low visibility [139–141, 143] and Less staff interaction [145,195]	Degree and closeness centrality value of the spatial units [139, 147,148]; Degree and closeness centrality value of the spatial units [145,146]	ABM + aggregation [176] SNA + aggregation [139–150,152–156]	the visual outputs depicting the distribution of centrality values in the area [139,144]; The intelligibility (i.e., a correlation coefficient between degree and closeness centrality values) of the whole layout [150]; average closeness centrality of different spaces [152]
Difficulty in wayfinding [27]	Each spatial unit's centrality value . i.e., How many spatial units one is connected to and how close are these connections [4,157–161,165]; Each agent's travel path [10]	ABM + aggregation [10,165,165,166] SNA + aggregation [4,7,157–165]	The intelligibility (i.e., a correlation coefficient between degree and closeness centrality values) of the whole layout and/or the visual outputs depicting the distribution of centrality values in the area [4,157–161,165]
long patient/nurse travelling distance between processes [27]	Each patient/nurse's time spent on travel [54] or each patient/nurse's travel distance [70,169]	ABM + aggregation [167,169] DES + aggregation [171,172] SNA + aggregation [54,70]	A typical agent's average travel time [54] or travel distance [70,169]
Patient Interruption on staff [174]	Each spatial unit's closeness centrality value . [173,174]; the number of staff-patient interactions and location of each interaction [10]	SNA + aggregation [10,173–175]	Aggregate location with higher closeness centrality values [174]; Aggregate location of staff-patient interactions [10]
Hospital-acquired infection [183]	location of each actor and the location of each interaction between actors [9]	ABM + aggregation [5,8,9,177–182] RWS + aggregation [183,184]	Aggregate propagation areas due to the actor's interaction with the environment and other actors [9]

can be divided into two categories, namely, Cell Decomposition Approach and Roadmap Approach [50]. Each category contains multiple algorithms. This study introduces three popular algorithms and compares them as follows:

- The Roadmap Approach produces a navigation network model by drawing straight lines connecting all points to all other visible points [51]. This research mainly focuses on Cell Decomposition Approach because it is more relevant as introduced in the following.
- The Cell Decomposition Approach discretizes the navigable surface of an architectural (BIM) model into regular/irregular grid cells and constructs a graph/network model based on the cells according to the theory of Dual Graph [52].

A popular algorithm of the Cell Decomposition Approach is Voxelization, which discretizes the surface into regular grid cells (see Fig. 10). Then the dual graph of the grid cells will be drawn to obtain the graph/network model for navigation. In the 2D grid cells, its dual graph is constructed by drawing a vertex in each cell and an edge between vertices for each pair of adjacent cells (illustrated in Fig. 10).

Another popular algorithm of the Cell Decomposition Approach is Constrained Delaunay Triangulation, which discretizes the surface into irregular triangular cells, and then the dual graph of the triangular cells will be drawn to obtain the graph/network model for navigation (see Fig. 11). In the 2D triangular cells, its dual graph is constructed by drawing a vertex in each triangle and an edge between vertices for each pair of adjacent triangles (illustrated in Fig. 11).

The visibility algorithm of the Roadmap Approach can produce a navigation network model and identify the shortest path more quickly, but the network model it creates is more abstract than others. Hence, the representation can be far away from reality [50,52]. By contrast, the voxelization algorithm of the Cell Decomposition Approach can produce a very fine-grained network model by having small grids (e.g., 1 m, 0.1 m, etc.) and the representation is very close to reality; however, the excessive amount of vertices and edges also cause problems for computation and calculation [50]. The Constrained Delaunay Triangulation algorithm's performance is between the other two, the network model it produces can represent reality to a certain degree, and it does not have as many cells as Voxelization's network model thus it does not cause problems for computation and calculation.

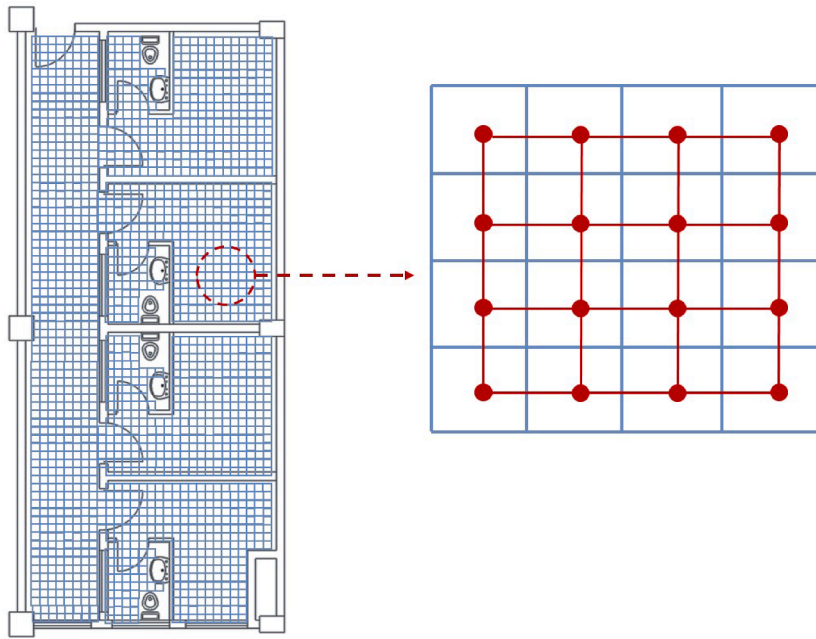

Fig. 10. Voxelization of part of Panyu Central Hospital (left) and the navigation model from it (right) (a 2-column fitting image), image source: author.

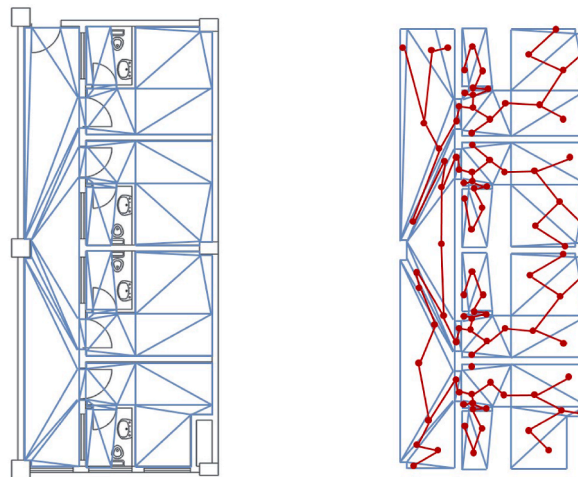

Fig. 11. Constrained Delaunay Triangulation of part of Panyu Central Hospital (left) and the navigation model from it (right) (a 2-column fitting image), image source: author.

4. Definition of layout configuration

A layout configuration is composed of two types of graphs, namely, a black & white graph and a coloured graph. A black & white graph is the navigation network model gained by drawing the dual graph of the discretized navigable surface. A coloured model is gained by assigning different colours to the vertices of the navigation network model, where different colours represent different attributes of the node (e.g., the node's function, the number of pedestrians departing from the node, and the number of pedestrians arriving at the node, etc.) [53]. In a coloured graph, a colour can be assigned to multiple nodes, illustrating that these nodes share the same attributes (e.g., function) and constitute the same zoning in a graph, the graph is then divided into different zones (see Fig. 12 (b)), where different zones have different colours representing different attributes, such as functions, number of departing pedestrians or arriving pedestrians, etc. The coloured graph and the navigation network model (i.e., black & white graph) together constitute a layout configuration, where the black & white graph is used for Spatial Network Analysis (i.e., each node's centrality value is to be computed) and the coloured graph is used for simulating modelling (i.e., a different group of nodes have different attributes concerned with the trip generation and trip distribution, etc.)

Fig. 12 illustrates a layout configuration composed of a black & white graph and a coloured graph. In this example, different colours in the coloured graph represent the attribute of different functions, i.e., the blue node represents corridor space, the grey

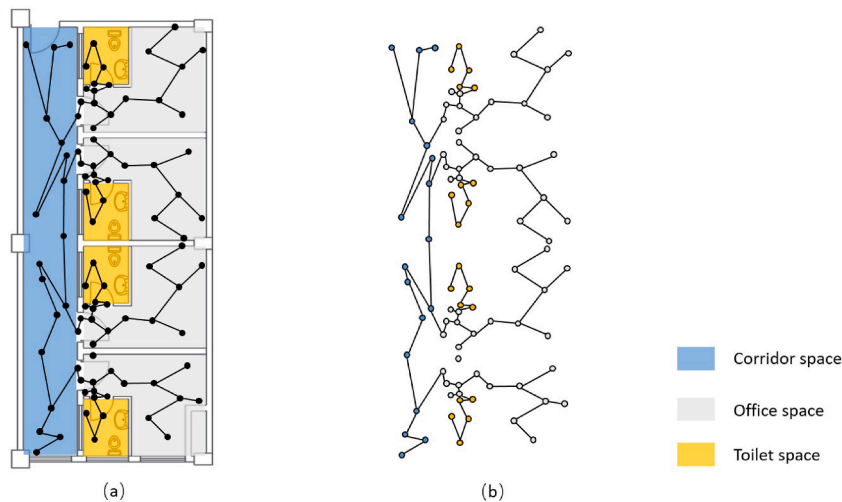

Fig. 12. An example of a layout configuration composed of a black and white graph (a) and a coloured graph (b) (a 2-column fitting image), image source: author.

node represents office space, and the grey node represents toilet space. A colour is assigned to multiple nodes so that the graph is divided into different zones, where each zone represents a unique function.

Multiple studies illustrated explicit representations of configurations in hospitals. For example, Cemre et al. [54] constructed a coloured network model of a hospital. Haq constructed graphs based on a hospital floor plan in various studies [17,55].

5. Spatial network analysis

Spatial Networks Analysis (SNA) lies in the field of Graph Theory and is inspired by the study of Social Network Analysis [44, p. 64]. Spatial Networks are graphs whose vertices/edges are spatial elements (such as rooms, corridors, streets, etc.), i.e., the vertices in a spatial network are embedded in a space provided with a metric (e.g., distance) [56]. Fig. 6(b) is an example of a spatial network, where vertices represent rooms and edges represent direct connections between rooms. SNA adopted the concept of Centrality metrics from Social Network Analysis, which measures the influences of the vertices in a graph [57]. Four common centrality measures are discussed in this study:

- **Degree Centrality:** It measures how many other nodes a node is directly connected to (the degree of a node) [37, p. 47].
- **Closeness Centrality:** It measures how close a node is to every other node in the network [37, p. 47].
- **Betweenness Centrality:** It measures the frequency of a node serving as a bridge along the shortest path between two other nodes in a network [37, p. 48].
- **Eigenvector Centrality:** It measures the influence of both a node and its neighbours in a network, if the node is connected to other nodes with high quality, then its Eigenvector Centrality will also be high [37, p. 48].

Based on the theory of SNA, one can calculate the centrality values mentioned above, to evaluate the layout design of complex buildings such as hospitals and predict their “potential performances”.

A famous methodology of SNA, namely Space Syntax Analysis (SSA), is developed by Bill Hillier et al. to study spatial configurations by assessing how accessible and visible a spatial unit is concerning all other spatial units in a layout [55]. In SSA theory, the layout configuration of the building can be represented by a graph/network model, where each spatial unit can be represented by a node and the connection between any two spatial units can be represented by an edge. The degree centrality (termed as ‘connectivity’ in SSA) and closeness centrality (termed as ‘integration’ in SSA) of each node of the network model can be calculated to analyse the accessibility of each spatial unit with all other spatial units. The centrality value of each spatial unit is a desegregate result. An aggregated result showing the score of the entire layout is needed for ease of comparison between different layouts. Hence, the concept of ‘intelligibility’ (i.e., a correlation coefficient between degree centrality and closeness centrality) is introduced [55]. These values show how easily a layout design can be understood [55]. The methodology of SSA and its concepts of connectivity (degree centrality), integration (closeness centrality) and intelligibility are suitable for analysing the performance of complex architectures such as hospitals in terms of accessibility and wayfinding.

6. Simulation modelling

The Transport Planning and Four-Step Travel Model predicts the static transportation systems inside a hospital, in this research, it will serve as a base for the dynamic simulation (Simulation Modelling) of hospital transportation. Methods of Simulation Modelling will be applied to achieve the goal of evaluating the hospital layout design at the layout design stage by simulating the dynamics of the hospital and making an assessment based on the simulation results.

To understand simulation modelling, the concepts of *system* and *model* need to be explained. A *system* is defined as a set of related components (e.g., individuals, elements, spaces, etc.) interacting with each other to achieve a certain objective [39, p. 33]. A *model* is a representation of a system [58, p. 13]. Specifically, system models are developed to design, assess, explain, verify and validate a system [59]. Any activity of imagining or speculating how a social dynamic would develop is running a model (e.g., imagining how the hospital-acquired infection would spread inside a hospital) [60]. However, this is an implicit model, our study focuses on explicit models in which assumptions are described elaborately for simulation and thus making informed predictions [60]. One should notice that modelling is not equal to prediction, it has many functions other than prediction. According to Epstein [60], the explicit model's functions include "explain", "guide data collection", "illuminate core dynamics", "demonstrate trade-offs/suggest efficiencies", and "reveal the simple (complex) to be complex (simple)" among others.

System models can be categorized into deterministic models and stochastic models, between which a distinction must be made. When we try to model a system, the values of parameters/variables (e.g., each patient's time spent in the doctor's consulting room) need to be appraised [39, p. 305]. These parameters/variables can change over time, i.e., they are random variables or their changes are predictable [39, p. 305]. Deterministic simulation ignores the randomness of the variables and assumes that the variable is constant (e.g., when simulating the situation in a hospital, the deterministic simulation assumes that each patient's time spent in the consulting room is always 15 min) [39, p. 305]. By contrast, stochastic simulation recognizes the randomness of the variables (e.g., each patient's time spent in the consulting room is a random variable with a mean of 15 min) [39, pp. 305–308].

A system model can also be static or dynamic [61, p. 2]. A static system model represents a system at a certain point in time, while a dynamic system model shows how a system's state variables change with time (e.g., a patient's walking distance in a hospital can increase with time) [62]. A dynamic system model can be further divided into continuous or discrete system models [61, p. 2]. In a continuous system model, the state variables of the system change continuously over time (e.g., the position of the earth relative to the sun) [63]. Conversely, in a discrete system model, the state variables of the system only change at discrete points in time [63]. For example, patients arrive at the hospital at 8:01, 8:15, 9:20, etc.

Fig. 13 illustrates the categories of the system model. Three types of system models (i.e., Agent-Based Modelling, Discrete-Event Simulation and Radom Walk Simulation) are introduced in the following. These three types of models are classified as stochastic, dynamic, and discrete system models [61,64].

• Agent-Based Modelling

An agent-based model is defined as a computer program composed of *autonomous, heterogeneous, and active* agents, and the interactions between agents and between agents and the environment [65, p. 68]. Agents are small computer programs and can represent any type of entity [65, p. 68], [66, p. 88], in the case of a hospital agent-based model, agents can be people (i.e., patients, visitors, nurses, doctors, etc.). The agent environment is the space where agents interact [66, p. 90], it can be a graph/network as introduced in section 2.6 [65, p. 68]. The italic words in the definition are the characteristics of agents, which are introduced in the following:

- **Autonomy:** agents are autonomous entities and their behaviours are not directed by central controllers, they are able to make independent decisions [66, p. 87].
- **Heterogeneity:** agents can have different attributes such as roles, ages, jobs, etc. [66, p. 87]. For example, in an agent-based model of a hospital, agents can include different roles such as patients, nurses, doctors and visitors.
- **Active:** patients are active entities in terms of:

Goal-directed: agents can be assigned to different goals [66F, p. 87]. For example, in the agent-based model of a hospital, patient-agent can be assigned goals of finding their doctors, getting healed and being discharged.

Perceptive: agents can be enabled of perceiving their surroundings, other agents as well as the whole structure of the environment (i.e., a mental map) so that agents know the locations of obstacles and their destinations [66, p. 87].

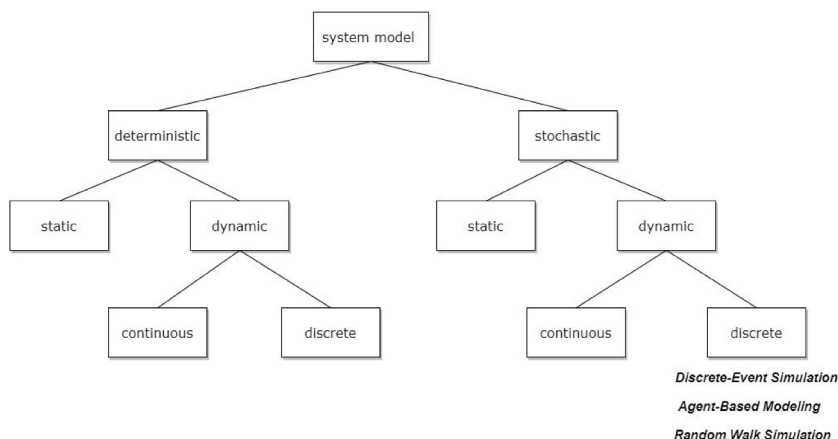

Fig. 13. System model categories (a 2-column fitting image), image source: [61, p. 2] [64].

Bounded Rationality: agents have a finite ability to make adaptive and inductive decisions to achieve their goals [66, p. 87].

- **Interactive:** agents can interact with other agents and/or the environment [66, p. 87].

Mobility: agents can move in the environment [66, p. 87]. For example, in the hospital agent-based model, agents are able to move in order to achieve their goals such as wayfinding.

Adaptation/Learning: agents can be adaptive, they can be enabled to change their state according to previous states, to memorize/learn [66, p. 87]. For example, patient-agent can be enabled to memorize their path during wayfinding so that they will not repeat the wrong path.

Agent-based modelling (ABM) can be applied for hospital design/evaluation with the aim of simulating the flow in the hospital space or examining the crowd congestion in public corridors or waiting areas, to name but a few.

• Discrete-Event Simulation

A Discrete-Event Simulation (DES) is the model of a system where events occur at different instants in time, which leads to changes in the system state [67, p. 894]. A DES model is composed of:

- **Discrete-event:** the state variables of a DES model do not change continuously, they only change at discrete time instances due to events occurring at different time instances [61, pp. 2–3]. For example, the number of patients in a hospital only changes if a new patient comes in or a current patient is discharged.
- **Clock:** a clock tracks the simulation time, the DES model is dynamic because time is a significant variable, i.e., the state variables of the system are different at different points in time [61, pp. 2–3]. For example, the number of patients in a hospital can vary at different points in time.
- **Random number generators:** a DES contains randomized variables (e.g., patient inter-arrival rate can be randomised) [61, pp. 2–3].
- **Statistics:** it tracks the system's statistics [61, pp. 131–135], e.g., patient mean waiting time, the total number of people inside the hospital, etc.
- **Ending Condition:** the simulation will end when the ending condition is met, e.g., the simulation is set to end at a certain simulation time [61].

This research aims to use the DES to simulate and predict the pedestrian density, pedestrian travel time and patient waiting time in a hospital project at the design stage.

• Markov chains/Random Walk Simulation

A Markov chain is a stochastic system model whose state transitions from one to another, the system changes its current state to the next state at each point in time, and it is changed based on a transition probability [39, p. 342]. A Markov chain has three attributes: the number of possible states is finite [39, p. 342]; the probability of transitioning from one state to another is only dependent on the current state, not on any earlier history (it is memoryless) [39, p. 342]; the transition probability from one state to another is constant [39, p. 342].

Fig. 14 is an example of a Markov Chain model illustrating the dynamics and the randomness in a hospital. As shown in Fig. 14, a directed weighted graph has four nodes representing four spatial units of pharmacy, radiology, consulting room and clinical laboratory in a hospital. Each node is assigned with several edges which have different weights. The weight assigned with the edge indicated the transition probability. For example, the node 0 has an edge directed to node 2 with a weight of 0.7, an edge to node 1 with a weight of 0.2, and an edge to node 3 with a weight of 0.1, which means at the next point in time of this system, there is a 70%

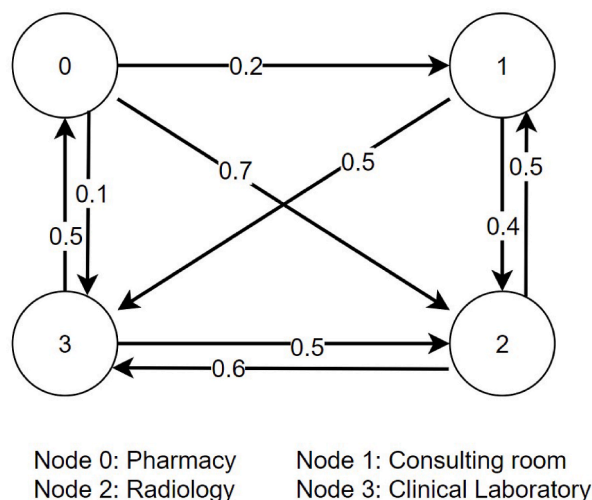

Fig. 14. An example of a Markov Chain/RWS model (a 1.5-column fitting image), image source: author.

probability of the patient in the pharmacy (node 0) will go to radiology (node 2), a 20% probability that he/she will go to the consulting room (node 1), and a 10% probability that he/she will go to the clinical laboratory (node 3). This example illustrates the situation of first-time visitors not knowing where the destination is and might go to a set of wrong places before finally arriving at the destination.

Markov Chain/Random Walk Simulations (RWS) are to be used in this research to simulate patients' and visitors' wayfinding behaviours, they might get lost and go to several wrong places before arriving at their destination. Hence, more time will be spent on wayfinding. In this research, extra walking time (i.e., total walking time minus shortest path walking time) will be computed to measure and evaluate the hospital's performance in wayfinding.

7. From analysis to evaluation to decision-support

Analytical exploratory models such as those of Space Syntax Analysis (SSA) and generative [simulation] models such as Discrete-Event Simulation (DES) produce results that are spatially disaggregate. However, a decision-maker concerned with making better decisions about the whole building would be required to take at least four important steps to be able to use such information (see also Fig. 15):

- **Spatial Aggregation and Temporal Aggregation:** the simulation results are disaggregated, e.g., it might contain the number of pedestrians in each spatial unit in the hospital, or each pedestrian's time spent walking and waiting. These disaggregated results need to be aggregated for ease of comparison. Table 4 illustrates studies that applied spatial and temporal aggregations. In Table 4, problems related to hospital layout designs are presented in the first column which is named 'challenges', the disaggregated form of measurements of these problems are presented in the second column (named 'indicators'), and the aggregated measurements are shown in the last column which is named 'quality criteria'. For example, Schaumann et al. [10,68] conducted aggregations of patients' walking paths, nurses' walking paths, people density and location of staff-patient interactions in a hospital in multiple studies. Pan et al. [69] aggregated patient waiting times in a hospital by calculating their mean value. Cubukcuoglu et al. [11] also obtained the aggregation of patient waiting times by averaging the results. Nanda [70] achieved the aggregation of nurses' walking distances in a medical-surgical unit of a hospital by calculating its mean value.
- **Relativization:** the aggregate results need to be further relativized/normalized. For instance, it is unfair to compare the average pedestrian walking distance in a large hospital with a relatively small hospital, because the walking distance in a large hospital will be naturally longer. Hence, the aggregated results need to be relativized for accurate comparison.
- **Functional Unit Equalization:** the functional unit is defined as 'a reference unit of study normally used for comparative purpose' [71]. It is a necessary parameter in a comparative assessment [71]. For example, when comparing two hospitals' performances in terms of reducing overcrowding, a fair comparison can be 'people density per hundred squared metres of the waiting area in the Emergency Department over one week'; this is in contrast to the comparison of 'people density in hospital', where area, spatial unit, department, and time are excluded for comparison. Only when all the factors are considered can the better design be identified.
- **Multiple-Criteria Decision Analysis (MCDA):** As introduced in section 3.5, once the simulation results are aggregated and relativized, the method of MCDA can be used for comparing different design solutions' performances in terms of overcrowding, pedestrian walking time, pedestrian extra walking time and patient waiting time at the same time and identify the non-dominated design solutions. Previous studies have applied the technique of MCDA in the field of hospital layout design. For example, Parsia and Sorooshian [72] developed an algorithm based on the MCDA methods for reducing nosocomial infections in the hospital. Denton and Rahman [73] developed a simulation model which can trade off multiple criteria and aid the decision-making related to outpatient surgery scheduling.

8. Review taxonomy

This section presents the five categories of the reviewed studies. The categories include overcrowding, patient waiting times, visibility and staff interaction, wayfinding and walkability, and other issues (i.e., patient/visitor interruption on staff and hospital-acquired infections). Specifically, the section is structured as follows:

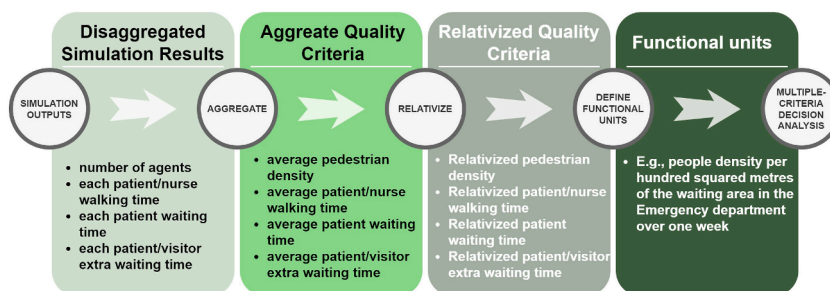

Fig. 15. The necessary steps between analysis, evaluation and decision support (a 2-column fitting image), image source: author.

- Inappropriate layout designs can lead to overcrowding and Simulation Modelling can be used to assess the overcrowding potential.
- Overcrowding relates to another problem of long patient waiting times, which can be evaluated by simulating patient flows using ABM or DES.
- Another layout-related issue that causes multiple sub-problems in hospitals is visibility, e.g., low visibilities hinder staff interactions. SNA can be utilized for assessing visibility
- Low visibility is also related to patient/visitor's difficulty in wayfinding, and difficulty in wayfinding is one of the reasons causing long patient/nurse walking distance, which can be measured using SNA or Simulation Modelling
- Other layout-related problems include patient/visitor interruption on staff and hospital-acquired infections.

8.1. Overcrowding

It is not easy to put a number into this intuitive notion of over crowdedness in hospitals because we do not have a very clear notion of two types of spaces (i.e., spaces to go to such as examination rooms and spaces to go through such as corridors), however, there have been attempts to measure, predict and curb/mitigate overcrowding in hospital design. For example, Schaumann et al. [68] reduced corridor overcrowding and patient interruption on staff in an internal medicine ward using the ABM approach, and the mean patient and visitor density was reduced from 0.16 patient/m² to 0.09 patient/m² after improving the layout of the ward (i.e., introducing a dayroom in the ward). In another study [10], the authors applied the ABM method for comparing two layout design alternatives for an ophthalmology outpatient clinic in terms of people density and achieved a graphical result of aggregate people density. Tang and Chen [8] reduced the overcrowding in the corridors of a hospital by improving the hospital layout design and gained quantitative measurements of the improvement by applying the ABM method. The ABM result shows that the overall patient density in the corridor has decreased from 0.719 patients/m² to 0.431 patients/m² [8]. Iskander and Carter [74] proposed a DES model to evaluate the overcrowding in a hospital care unit. The authors discovered that at least 160% more waiting spaces are needed to resolve the overcrowding in the care unit [74]. Jones and Evans [75] utilized the ABM method for reducing overcrowding in the emergency department of a hospital. Taboada et al. [76] used the ABM approach to assess the patient length of stay and overcrowding potential in a hospital emergency department. In this study, the overcrowding issue in the emergency department was mitigated by the derivation of non-urgent patients to other departments. As a result, the patient's throughput has increased by 20%–100%, and the patient's length of stay has decreased by 5%–14% [76]. In another two studies [77,78], the authors developed an Agent-Based Model for reducing overcrowding and patient waiting times in the emergency department of a hospital. Overcrowding in the emergency department was reduced by increasing the number of staff. As a result of reduced overcrowding, the number of treated patients has increased by 100% and the average time of stay was reduced by 51% [78]. Valipoor et al. [79] utilized the DES method for reducing overcrowding in the emergency department of a hospital. In this study, overcrowding was reduced by providing care service in the hallway and introducing a dedicated triage space to improve patient flow. The resulting statistics show a significant reduction in patient length of stay (10%–16% reduction) and patient times spent in the exam room (10% reduction) [79]. In another study, Hancock and Walter [80] used the DES method to model the patient flow for assessing overcrowding potential in outpatient and inpatient departments. Badri and Hollingsworth [81] implemented a DES model intending to assess the number of patients, overcrowding potential and patient waiting time in the emergency department. The author decreased overcrowding in the emergency of a hospital by not serving patients with less urgent conditions. Statistically, the patient mean length of stay was decreased by 8% [81]. Lopez-Valcarcel and Perez [82] utilized the DES method for assessing crowdedness and patient waiting times in the emergency department. Viana et al. [83] applied both approaches of DES and ABM for assessing the number of patients and patient length of stay in the obstetrics department of a hospital. In their experiment, the number of patients and patient length of stay increased by 18% and 200% respectively, by increasing the arrival rate of patients by 25% [83]. Lin et al. [84] utilized the DES method for reducing overcrowding in waiting areas and reducing patient waiting times in outpatient clinics. By improving resource allocation and optimizing patient appointment scheduling, the congestion in waiting area was decreased by 46%–52% [84]. Draeger [85] built a DES model for emergency department for evaluating overcrowding and patient waiting times. By improving the nurse scheduling policy, the crowdedness in the emergency department was down by 19%–23%, and the average patient waiting time was reduced by 51%–57% [85]. Vasilakis et al. [86] used the DES approach to identify the number of patients waiting for appointments and patient waiting time in surgical care. By altering the method of scheduling patient appointments, the number of patients was reduced by 30% [86].

8.2. Patients waiting times

Cubukcuoglu et al. [11] implemented a DES model and found the interrelationship between hospital layout and patient waiting time. By enlarging the area of the outpatient department of a hospital and adding one extra doctor, the patient waiting time was reduced by 86 min. McGuire [12] built a DES model for reducing patients' length of stay in emergency departments. The study showed that if the layout of the emergency department was changed by adding a holding area, each patient's waiting time would be reduced by 22 min [12]. Baril et al. [13] modelled outpatient flows in an orthopaedic clinic using the DES method for reducing patient waiting times. The authors discovered that patient length of stay can be reduced by up to 67% by improving the layout of the outpatient department (i.e., changing the number of consulting rooms) and improving the patient appointment scheduling policy [13]. Morrice et al. [87] utilized the DES approach for improving patient throughput and reducing patient waiting times in hospitals. The authors found that changing the layout of the care unit by adding an extra room does not affect patient waiting times, however, increasing the patient schedule time slot from 12 min to 15 min would decrease the patient waiting time by 50% [87].

Rahmat et al. [88] implemented an Agent-Based Model for reducing patient waiting times in the emergency department. By improving the triage policy, average patient waiting times in the emergency department were decreased by 17%–32% [88]. Viana et al.

[89] combined the methods of ABM and DES and developed a tool for reducing patient waiting times and patient lengths of stay in post-term pregnancy outpatient clinics, the patient waiting time for staff and equipment was reduced by 51.12% and 73.06% respectively. In an early study, Fetter and Thompson [90] applied the DES method for assessing patient waiting time in the maternity suite, outpatient clinic, and surgical pavilion. The authors found that by forcing every patient to arrive on time, each patient's waiting time would be saved by 8 min, which leads to a total saving of 280 h in a period of 50 days [90]. Smith and Warner [91] used the DES approach for reducing the patient length of stay in hospitals, by changing the patient's arrival rate, and patient waiting time decreased by 40%–50%. Kho and Johnson [92] used the DES approach for assessing patient waiting time in a radiology department. Kachhal et al. [93] applied the DES approach for evaluating patient waiting times in ear, nose and throat clinics. The patient average waiting time has decreased by 44.7% by improving patient appointment scheduling policy [93]. Bailey [94] implemented a DES model for evaluating patient waiting times in the outpatient department. By improving the department's patient appointment scheduling policy, patients' average waiting time was decreased by approximately 42% [94]. Smith et al. [95] built a DES model for improving patient throughput and reducing patient waiting time in the outpatient clinic, the mean patient waiting time was decreased by 17%–33% by improving the patient appointment scheduling policy. Fitzpatrick et al. [96] applied the DES method for assessing patient throughput, and patient waiting times in a hospital operating room. The average patient waiting times were reduced by 11% by improving the patient appointment scheduling procedure [96]. Klassen and Rohleder [97] utilized DES for reducing patient waiting times in the outpatient department. The authors found that by changing patient appointment scheduling rules, more than 19% of patient waiting times can be saved [97]. Hancock and Walter [80] used the DES method for increasing patients' throughput in the inpatient department. Walter [98] used the DES method for assessing patient waiting time and doctor waiting times for patients' arrival in the radiology departments. Garcia et al. [99] modelled the patient flow in the emergency department of a hospital using DES for reducing patient waiting times. By introducing a fast track lane dedicated to non-urgent patients, their waiting times were reduced by almost 25% without increasing the waiting times for urgent patients [99]. Kirtland et al. [100] built a DES model for increasing patient throughput and reducing patient waiting times in emergency departments. Enhancing the utilization of medical resources leads to a reduction of 24% in patient waiting times [100]. Blake et al. [101] utilized the DES method for investigating patient waiting times in emergency rooms. The authors found that by implementing a fast track for non-urgent patients, a 10% decrease in patient mean waiting time could be realized [101]. Edwards et al. [102] modelled patient flows in outpatient clinics using DES for reducing patient waiting times. By improving the patient appointment scheduling system, the average patient waiting times was decreased by 27% [102]. Alessandra and Grazman [103] utilized the DES method for improving patient throughput and reducing patient waiting times in hospital clinics. By improving the staff scheduling policy, the patient waiting time was reduced by 37% [103]. Mukherjee [104] applied the DES approach for reducing patient waiting time and improving patient throughput in a hospital pharmacy. By improving the staff scheduling policy in the pharmacy, the patient waiting time could be reduced by 8% [104]. Evans et al. [105] utilized the DES method for reducing patients' length of stay in an emergency room. Patient length of stay was decreased by 4% by improving the staff scheduling policy [105]. Mahachek and Knabe [106] utilized DES for evaluating patient waiting times in obstetrical and gynaecology clinics of a hospital. Liyanage and Gale [107] utilized the DES approach for reducing patient waiting times in the emergency department. O'Kane [108] implemented a DES model for assessing the number of patients, and patient waiting time in the radiology department. Klafehn [109] modelled the patient flow in the radiology department using DES to assess the patient waiting time and patient length of stay. The author found that by adding one more radiologist, the patient mean waiting time would be reduced by 25% [109]. Vemuri [110] utilized the DES method to evaluate patient waiting times in an outpatient pharmacy. The patient mean waiting time could be decreased by 49% if an additional technician is added to the pharmacy [110]. Ishimoto et al. [111] applied the DES approach for assessing patient waiting time in a hospital pharmacy. By adding another pharmacist in the pharmacy, approximately 50% of patient waiting times can be saved [111]. Hashimoto and Bell [112] studied patient flows in outpatient clinics using DES to reduce patient length of stay. The average patient length of stay was reduced from 75.4 min to 57.1 min by optimizing staffing levels [112]. Lim et al. [113] implemented a DES model to represent patient flow in emergency departments with the aim of assessing patient waiting times and lengths of stay. Patient waiting times were down by 1%–4% and patient length of stay was down by 61%–136% by improving the staff interactions [113]. Denton et al. [73] applied DES to model outpatient surgery scheduling in a hospital for assessing patient waiting time. The authors achieved a 50% improvement in patient waiting times by optimizing the patient appointment scheduling policy [73]. Kuzdrall et al. [114] built a DES model for assessing patient waiting time in a hospital surgical suite, the results show that by improving the patient appointment scheduling policy, 30% of the patient mean waiting time can be saved. Lim et al. [115] used the DES method to model patient flows in the hospital and assessed patient length of stay and patient waiting times. The patient waiting times was reduced by 28% by improving the patient appointment scheduling policy [115]. Marcon et al. [116] used the DES model to evaluate the patient waiting time and throughput in the Post-anesthesia Care Unit. Stahl et al. [117] built a DES model for assessing patient throughput and patient waiting time in the surgical and anaesthesia care units, 4% of the patient waiting times can be reduced by applying different staff scheduling policies. Testi et al. [118] developed a DES approach for reducing patient waiting time and improving patient throughput in operating rooms. According to their results, patient waiting times could be reduced by 23/24% if a different patient appointment scheduling policy was utilized [118]. VanBerkeel and Blake [119] used DES for reducing patient waiting times in the General Surgery Department of a hospital, the patient throughput has increased by 3.4% by adding four extra beds in the general surgery department. Marmor et al. [120] modelled patient flow in the emergency departments using DES for assessing the patient's length of stay and waiting times. Zhang et al. [121] developed a DES model for reducing patient waiting times in a hospital. The patient waiting time can be decreased by 29% by applying different patient appointment scheduling policies [121]. Pan et al. [69] modelled patient and information flow in specialist outpatient clinics using DES for reducing patients' length of stay. The simulation results show that the average patient waiting time can be reduced by 59% by enhancing the patient appointment scheduling policy [69]. Min and Yih [122] applied the DES approach for assessing patient waiting times in an outpatient

clinic. By improving the patient registration and queuing policy, each patient's waiting time can be reduced by up to 4 min [122]. Ramirez Valdivia and Crowe [123] implemented a DES model for reducing patient waiting times in hospitals. The authors conducted patient interviews and surveys and concluded that patient waiting times in the outpatient department should be less than 30 min, they achieved the goal by improving the patient administration policies [123]. Bowers et al. [124] applied the DES method for reducing patient waiting times and improving patient throughput in the emergency department of a hospital, the patient length of stay has decreased by 10% by increasing bed capacity. Chu et al. [125] utilized simulation modelling for assessing patient waiting times for lifts and the number of patients waiting for lifts in two hospitals. The average patient waiting times for lifts can be reduced by up to 26% by applying lift zoning policy (i.e., different lifts are designated with different floors) [125]. Niu et al. [126] applied the DES method for reducing patient waiting times and improving patient throughput in the operating room. According to their study, 17% of patient waiting time can be saved by optimizing the resource utilization [126]. Su and Shih [127] proposed a DES model for reducing patient waiting times in outpatient clinics. By improving the patient appointment scheduling policy, patient waiting times can be reduced by up to 59% [127]. Zonderland et al. [128] implemented a queuing model for reducing patient waiting times and patient length of stay in an university hospital. By changing the patient appointment scheduling policy, the patient throughput over one year has increased by 16% [128]. Ortiz et al. [129] proposed a DES model for reducing patient waiting times in the outpatient department of a hospital. Patient waiting times can be saved up to 13% by improving staff scheduling policy [129]. Norouzzadeh et al. [130] developed a DES model for decreasing patient waiting times by almost 20% in the outpatient clinic. Edward et al. [131] built a DES model for reducing patient waiting times in the preoperative assessment clinic of a hospital. By optimizing the patient appointment scheduling system, 95% of the patients waiting times were reduced to less than 10 min [131]. Berg et al. [132] used DES approach for reducing patient waiting times in a multidisciplinary outpatient clinic. The authors found that patient waiting time could be reduced by up to 17% by implementing different resource assignment strategies [132]. Demirli et al. [133] applied DES method to decrease patient waiting times in an outpatient clinic. Patient waiting times were decreased by 86% by enhancing the cooperation between doctors and nurses [133]. Patel et al. [134] developed a DES model for assessing patient waiting times in outpatient clinics. Patient waiting times could be reduced by up to 23% by applying different resource allocation policies [134].

Creemers et al. [135] developed a Markov process model for reducing patient waiting times in hospitals. The patient waiting time can be reduced by up to 80% by applying different resource allocation policies [135]. Liao et al. [136] modelled patient arrival schedules in a hospital using the Markov chain for reducing patient waiting times. Pegden et al. [137] developed a Markov process model to evaluate patient arrival scheduling in hospitals and reduce patient waiting times. Akkerman and Knip [138] implemented a Markov process model for reducing patient waiting time in hospital wards.

8.3. Visibility & staff interaction

Schaumann et al. [68] reduced patient interruption on staff in an internal medicine ward by improving the layout of the ward (i.e., adding an extra day room). The result of the Agent-Based Simulation shows that visitor interruption was reduced by 35% [68]. Lu et al. [139] applied SSA to find the correlation between the visibility and density of people and their interactions in an intensive care unit (ICU). The authors found that the layout influences the visibility in the ICU and hence influences the people density in the ICU, i.e., there is more staff in the places with higher visibility (correlation coefficient $r = 0.786$) [139]. Hadi and Zimring [140] applied SSA for improving visibility in intensive care units. The authors discovered that ICU with a less discretised layout and wider corridors will improve visibility [140]. Ossmann [141] applied SSA to find the impact of visibility on mortality rates in ICUs. By analysing the layout of the ICU rooms in terms of visibility, patients' odds of death are 42% lower in the rooms with high visibility than in the rooms with low visibility [141]. Alalouch and Aspinall [142] used the SSA method to find the correlation between visibility and privacy in hospital wards. According to their results, the ward layouts with high visibility are less preferred by the patients, in another word, there is a strong negative relationship ($r = -0.957$) between the visibility of the ward and the level of preference for the ward in terms of privacy [142]. Lu et al. [143] identified the relationship between patient mortality and room visibility using SSA. Their study shows that visibility accounts for 35% of the variance in ICU mortality [143]. Kim and Lee [144] used SSA to evaluate users' movement patterns and visibility in hospitals. Three different types of hospital ward layouts were evaluated, and the visibility difference can be up to 32% between different layouts [144]. Trzpuć et al. [145] applied SSA to assess how the layout design can influence nurse interactions in medical-surgical nursing units. Gharaveis et al. [146] used SSA for evaluating the correlation between visibility and staff communication in the emergency department. The authors found that a change in the layout design of the emergency department can lead to a 52% improvement in visibility and a 45% improvement in staff communications [146]. In a similar study, the authors used SSA to evaluate the influence of visibility on teamwork, collaborative communication and security issues in the emergency department [147]. Similarly, O'Hara et al. [148] used SSA to find the correlation between visibility and team interactions and observation of patients. Xuan et al. [149] used SSA to evaluate the influence of visibility and accessibility on nurse communication, perception of privacy, and efficiency in a nursing unit. Pachilova and Sailer [150] used SSA to investigate the influence of an inpatient ward's spatial configuration on staff communication and care quality. Three different hospital ward layouts were analysed, and the difference in visibilities can be up to 32%, which leads to a difference of 4% in staff interaction [150]. Cai and Zimring [151] used SSA to examine the nurses' interaction patterns in hospitals. By improving the layout design of the ICU, the overall visibility in the ICU was increased by 3%, and consequently, the nurse's communication rate was raised by 7% [151]. Rashid et al. [152] used SSA to find the correlation between staff communication patterns and visibility and accessibility in ICUs. The results show a positive correlation (correlation coefficient $r = 0.387$) between visibility and staff interaction, which indicates that staff interaction tends to happen in places with higher visibility [152]. Similarly, in other studies, the authors used SSA to compare two hospital layout designs and evaluated the association between visibility and staff interaction [153,154]. In Ref. [153], Rashid et al. discovered that different types of ICU layouts could lead to a 13% difference in visibility. In Ref. [154], the authors found that by improving the layout design of the ICU,

the visibility can be improved by 4%–5%. Lim et al. [155] applied SSA to find the impact of visibility on staff interaction and team collaboration. Cai and Spreckelmeyer [156] applied SSA for improving visibility in a hospital's nurse working area. By improving the layout design of the nursing unit, the visibility was increased by approximately 10% [156].

8.4. Wayfinding & walkability

Kim and Lee [144] used SSA to evaluate users' movement patterns and visibility in different hospital wards layouts and found that the deep-plan layout can be 22% more navigable than the courtyard-plan layout [144]. Haq [157] applied the method of SSA for assessing visitors' environmental cognition and wayfinding behaviour in a hospital. The author found that the accessibility analysis of the layout can predict 56% of the variation in wayfinding difficulty [157]. Lu and Bozovic-Stamenovic [158] utilized SSA for evaluating patients' wayfinding behaviour in three hospitals. Haq et al. [159,160] applied the SSA theory for evaluating patient/visitors' wayfinding behaviour in different hospitals. Tzeng and Huang [161] reduced patients' difficulty in wayfinding in the outpatient department of a hospital using SSA. Pouyan et al. [162] used SSA for assessing first-time users' wayfinding behaviours in a hospital. Laccana [163] utilized SSA for assessing patient wayfinding behaviour in hospitals. Zwart and Voordt [164] applied SSA for evaluating the difficulty of wayfinding for patients and visitors in a hospital ward. Zamani [165] combined the methods of ABM and SSA for evaluating the visibility and difficulty of wayfinding in hospitals. Gath-Morad et al. [166] implemented an Agent-Based Model for assessing users' wayfinding performance in complex buildings such as hospitals.

Schaumann et al. [68] reduced staff walking distance in an internal medicine ward by improving the ward layout design (i.e., adding an extra day room). The result of the Agent-Based Simulation shows that staff mean walking distance was decreased by 5% [68]. In another study [167], the authors developed an Agent-Based model for evaluating nurse walking distance, patient waiting times and visitor disruption on staff in a general hospital. In Ref. [10], Schaumann et al. applied the ABM method for comparing two layout design alternatives for an ophthalmology outpatient clinic in terms of people walking distance. The simulation results show that one design alternative outperforms another by 20% and 6% in patient walking distance and nurse walking distance respectively [10]. Vahdatzad [168] reduced the patient walking distance in a hospital by optimizing the hospital layout (i.e., locating the waiting area in the centre of the layout and locating service areas closer to the entrance and elevator). With the application of the DES method for measuring the performances, the mean patient walking distance was reduced by approximately 33% and the average patient length of stay was decreased by 6% [168]. Nanda et al. [70] applied SSA for assessing staff travelling distance in a surgical unit of a hospital. Lee et al. [169] implemented an Agent-Based model for reducing nurse walking distance in hospital nursing units. Cai and Jia [170] applied the DES method for reducing surgeon walking distance in a surgical suite. Vahdat et al. [171] implemented a DES model for reducing patient walking distance and patient length of stay in the outpatient clinic of a hospital. O'Hara [172] proposed a DES model for assessing nurse walking distance in the Intensive Care Unit of a hospital.

8.5. Other issues

Other categories include the following:

- **Patients/visitors interruptions on staff**

In [10], Schaumann et al. applied the ABM method for comparing two layout design alternatives for an ophthalmology outpatient clinic in terms of patient interruptions on staff. The simulation results show that there is a 22% difference between the two designs' performances in reducing patients' interruptions on staff [10]. Hendrich et al. [173] used SSA to evaluate the influence of the nursing unit's layout on nurse movement patterns and time spent on staff-patient interactions. Sagha Zadeh [174] developed a design tool using SSA for reducing staff fatigue and interruptions in acute care units. Setola et al. [175] utilized SSA for assessing the frequencies and locations of patient-staff interaction in public spaces in the hospital. Huynh et al. [176] developed an Agent-Based Model for assessing the nurse's time spent on interpretation in a hospital. By redesigning the medical administration process, the time nurses spent on interruptions was reduced 100% [176].

- **Hospital-Acquired Infections**

Wang et al. [5] developed an ABM model for testing the impact of a clinic layout design on the infection risk of COVID-19. Their findings suggest that overcrowded areas (e.g., waiting areas) have a higher infection risk (the cumulative exposure dose in the waiting areas constitutes 66.5% of the total) [5]. Tahir et al. [6] applied both methods of SNA and ABM to find the correlations between hospital layouts and the risk of hospital-acquired infections (HAIs). The authors discovered a strong positive correlation (correlation coefficient $r = 0.8$) between department prevalence and the degree centrality of the department (i.e., the higher prevalence was found in the departments with higher centrality values). Mustafa and Ahmed [7] used SSA for assessing the effects of different types of outpatient layouts on limiting the spread of COVID-19. The authors found that the integration value in a decentralized layout is 23% lower than the integration value in a centralized layout, which means that a decentralized layout has fewer overcrowded areas and thus more advantage in providing social distancing [7]. Tang and Chen [8] improved a hospital layout design for reducing the risk of the spread of COVID-19. The Agent-Based simulation results show that the overall patient density in the corridor has decreased from 0.719 patients/m² to 0.431 patients/m² after improvement, which enhances the control of the spread of COVID-19 because reduced congestion in the hospital helps to keep social distancing [8]. Esposito et al. [9] simulated the HAIs propagation dynamics in the hospital using the ABM method with the aim of reducing HAIs. Schaumann et al. [177] developed an Agent-Based Model for simulating and investigating HAIs in the hospital. Hotchkiss et al. [178] simulated the spread of the pathogen in an ICU using ABM with the aim of reducing HAIs. Ong et al. [179] developed an Agent-Based Model for investigating HAIs in the hospital. Meng et al. [180] applied the ABM approach for reducing HAIs in a hospital ward. Ferrer et al. [181] proposed an Agent-Based Model to simulate pathogen

transmission in ICU with the aim of controlling HAIs. Milazzo et al. [182] utilized the ABM approach for reducing HAIs in a hospital ward.

Pelupessy et al. [183] developed a Markov chain model to simulate the transmission dynamics in a hospital and aimed at controlling HAIs. Lopez-Garcia and Kypraios [184] developed a Markov chain model for analysing the spread of nosocomial infections in hospitals.

9. Review results

The hospital design challenges, the approaches for assessing these challenges and the corresponding indicators and quality criteria were summarized in Table 4. It is to be noticed that indicators are the disaggregate results from assessment approaches of SNA or Simulation Modelling. The quality criteria are an aggregate form of indicators (i.e., average, maximum or minimum values, etc.). Both indicators and quality criteria indicate how to measure the challenges. Among the total 102 reviewed papers, they all investigated one or several of the seven challenges of overcrowding, long patient waiting time, patient/visitors' difficulties in wayfinding, low visibility and less staff interaction, hospital-acquired infections, long patient/nurse travelling distance and patients' interruptions on staffs. Although these issues are related to layout, many of the reviewed studies do not associate them with the layout. Only 34% of them (35 out of 102 papers) studied the effects of layout on hospitals, and most of them applied SSA ([7,139–153,155–165,175]), others used ABM approach ([5,8–10,68,177]). One study combined SSA with ABM [165]. There is a clear research gap indicating that although these studies associate the hospital problems and challenges with layout, they did not mention the representation of layout, or they do not mention what is a layout representation or how to model the layout. However, a layout representation is necessary and critical for evaluation (for the definition of layout representation, see section 4).

From the review results, the following can be summarised:

- Although all reviewed publications investigated hospital problems and challenges that are related to layout, few of them associated the problems/challenges with the layout. Especially, studies that apply simulation modelling approaches rarely associated the problems with hospital layout. This suggests a potential research direction of utilizing Simulation Modelling to study the impact of layouts on hospitals.
- As for the few studies that investigated the effects of layout on hospitals, they did not mention the representation of the layout. However, a clear representation of the layout is needed for assessments. Hence, another potential research direction is to develop methods of modelling and representing the layout.
- None of the reviewed publications introduced the method for relativizing/normalizing the quality criteria for a fair comparison between different hospitals. As mentioned in section 7, it is inappropriate and inaccurate to directly compare the quality criteria of a small hospital with a large hospital. Hence, methods for relativization or normalization are necessary.
- None of the reviewed studies introduced the method for defining functional units for a fair comparison. As discussed in section 7, the functional unit quantifies the performance of the system and serves as a reference unit. It is necessary to have a functional unit for comparing two different hospitals' quality criteria. Hence, methods for defining functional units for comparative assessments of different hospitals are needed.
- As illustrated in Fig. 2, some of the disciplines discussed in this review have been separated, though they have the potential to be combined and studied, which points out our future research direction of combining certain disciplines/terminologies for the study of hospital layout design (as shown in Fig. 16).

10. Conclusion and future research

The conclusion of this review paper is summarised below:

1. We have established the importance of adequate hospital layouts/by summarising problems caused by inadequate layouts (see Table 4)

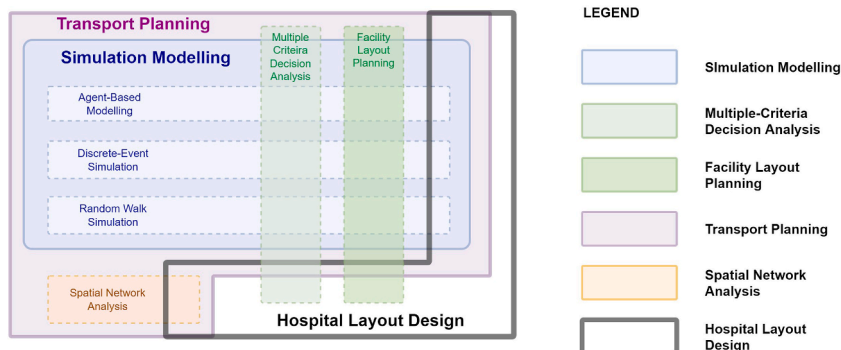

Fig. 16. Disciplines that will be focused on and studied together for our future research (a 2-column fitting image), image source: author.

2. We have summarised the gaps in the literature, especially in the proper mathematical treatment of spatial representation issues and quantification of such problems as overcrowding and risk of cross-contamination (see section 9)
3. We have illustrated the parallels and analogies between hospital layout problems and well-known problems in transport planning, especially in conjunction with land-use planning in cities. In other words, the paper has shown by examples that there is a lack of comprehensive frameworks for the quantification of such issues. The hospital-city analogy and the transport planning approach can lead to the establishment of adequate methodologies capable of properly quantifying these issues for hospital layout assessment.
4. Providing any kind of reliable decision support mechanism is first and foremost about the provision of reliable and transparent assessment mechanisms for predicting the impact of design choices.
5. Therefore, we conclude with some priorities for future research into the quantification and assessment of hospital layouts:
 - a. Devising a mathematical framework for spatial representation and measurements in a clearly defined analogy of a hospital with a city and borrowing the terminology and methodological practices of transport planning and land-use transport interaction models (LUTI).
 - b. Developing a standardized hospital/building layout representation model only containing information relevant for ex-ante assessment of the effects of layout on human movement inside the hospital.
 - c. Developing a standardized hospital layout assessment framework based on well-defined functional units, relativized formulations of quantities of interest, estimation methods driven by standardized simulation procedures, and possibly additional tools for integration/aggregation of multiple criteria in a comprehensive assessment of design choices.

The nature of the proposed Hospital Design Support System should be similar to a Transport Planning Support System because designing a hospital is similar to designing a small town, which is even folded in 3D. From both formal and functional points of view, it is similar to designing a city. However, in a city, roads can be widened, and bridges and tunnels can be built to suit the traffic demand. A city can grow and it is elastic, while a hospital is plastic. Hence, designing a hospital is similar to but more difficult than designing a small city. The analogous of streets of a city (or its Transport Network) will be the corridors in the hospital, and the analogous of the land-uses in a city will be the different spatial units serving different functions in the hospital. This study provides a systematic review of the application of SNA and Simulation Modelling on hospital layout designs. The main focus of this study lies in the spatial layout.

To demonstrate the function of the proposed Hospital Design Support System, four use cases are described by answering the following questions: who would be the user of this system? What questions can this system answer? And at what stage of a project can these questions be answered?

- Use Case 1: The hospital director can use this system to check the crowdedness of a hospital project during the layout design stage.
- Use case 2: The architect can use this system to check how difficult it will be for the first-time visitor to find their way in a hospital project during the layout design stage.
- Use Case 3: The head nurse can use this system to check if their walking distance will be too long in a new hospital project during the layout design stage.
- Use Case 4: The hospital director can use this system to check if the patient waiting time or walking distance will be too long in a new hospital project during the layout design stage.

In short, the proposed Hospital Design Support System is envisaged to be a Multi-Criteria Decision Analysis toolkit for the integral evaluation of design alternatives.

Declaration of competing interest

The authors declare that they have no known competing financial interests or personal relationships that could have appeared to influence the work reported in this paper.

Data availability

Data will be made available on request.

References

- [1] A. Chraibi, S. Kharraja, I. Osman, O. El Beqqali, A mixed integer programming formulation for solving operating theatre layout problem: a multi-goal approach, in: *Proceedings of 2013 International Conference on Industrial Engineering and Systems Management, IEEE - IESM, Oct. 2013 2013*.
- [2] R. Ulrich, X. Quan, A. Joseph, R. Choudhary, C. Zimring, The Role of the Physical Environment in the Hospital of the 21 St Century: A Once-In-A-Lifetime Opportunity, Jan. 2004.
- [3] L.D. Burgio, B.T. Engel, A. Hawkins, K. McCormick, A. Scheve, A descriptive analysis of nursing staff behaviors in a teaching nursing home: differences among NAs, LPNs, and RNs, *Gerontol.* 30 (1) (Feb. 1990) 107–112, <https://doi.org/10.1093/geront/30.1.107>.
- [4] J. Peponis, C. Zimring, Y.K. Choi, Finding the building in wayfinding, *Environ. Behav.* 22 (5) (Sep. 1990) 555–590, <https://doi.org/10.1177/0013916590225001>.
- [5] J. Wang, H. Tang, J. Wang, Z. Zhong, An agent-based study on the airborne transmission risk of infectious disease in a fever clinic during COVID-19 pandemic, *Build. Environ.* 218 (Jun. 2022) 109118, <https://doi.org/10.1016/j.buildenv.2022.109118>.
- [6] H. Tahir, et al., Relevance of intra-hospital patient movements for the spread of healthcare-associated infections within hospitals - a mathematical modeling study, *PLoS Comput. Biol.* 17 (2) (Feb. 2021) e1008600, <https://doi.org/10.1371/journal.pcbi.1008600>.
- [7] F.A. Mustafa, S.S. Ahmed, The role of waiting area typology in limiting the spread of COVID-19: outpatient clinics of Erbil hospitals as a case study, *Indoor*

- Built Environ. (2022), <https://doi.org/10.1177/1420326X221079616>.
- [8] K. Tang, B. Chen, How to develop more resilient hospitals through agent-based modelling, *Proc. Inst. Civ. Eng. Civ. Eng.* 175 (1) (2021) 27–32, <https://doi.org/10.1680/jcien.21.00049>.
- [9] D. Esposito, D. Schaumann, D. Camarda, Y.E. Kalay, Multi-agent modelling and simulation of hospital acquired infection propagation dynamics by contact transmission in hospital wards, in: Y. Demazeau, T. Holvoet, J.M. Corchado, S. Costantini (Eds.), *Advances in Practical Applications of Agents, Multi-Agent Systems, and Trustworthiness*, The PAAMS Collection, 12092, Springer International Publishing, Cham, 2020, pp. 118–133, https://doi.org/10.1007/978-3-030-49778-1_10.
- [10] D. Schaumann, N. Putievsky Pilosof, H. Sopher, J. Yahav, Y.E. Kalay, Simulating multi-agent narratives for pre-occupancy evaluation of architectural designs, *Autom. ConStruct.* 106 (Oct. 2019) 102896, <https://doi.org/10.1016/j.autcon.2019.102896>.
- [11] C. Cubukcuoglu, P. Nourian, I.S. Sariyildiz, M.F. Tasgetiren, A discrete event simulation procedure for validating programs of requirements: the case of hospital space planning, *Software* 12 (Jul. 2020) 100539, <https://doi.org/10.1016/j.softx.2020.100539>.
- [12] F. McGuire, Using simulation to reduce length of stay in emergency departments, in: *Proceedings of the 26th Conference on Winter Simulation*, Dec. 1994, pp. 861–867 San Diego, CA, USA.
- [13] C. Baril, V. Gascon, S. Cartier, Design and analysis of an outpatient orthopaedic clinic performance with discrete event simulation and design of experiments, *Comput. Ind. Eng.* 78 (2014) 285–298, <https://doi.org/10.1016/j.cie.2014.05.006>.
- [14] J. Michalek, R. Choudhary, P. Papalambros, Architectural layout design optimization, *Eng. Optim.* 34 (5) (Jan. 2002) 461–484, <https://doi.org/10.1080/03052150214016>.
- [15] F. Halawa, S.C. Madathil, A. Gittler, M.T. Khasawneh, Advancing evidence-based healthcare facility design: a systematic literature review, *Health Care Manag. Sci.* 23 (3) (Sep. 2020) 453–480, <https://doi.org/10.1007/s10729-020-09506-4>.
- [16] M. Rashid, Research on nursing unit layouts: an integrative review, *Facilities* 33 (9–10) (2015) 631–695, <https://doi.org/10.1108/F-01-2014-0009>.
- [17] S. Haq, Y. Luo, Space syntax in healthcare facilities research: a review, *HERD* 5 (4) (2012) 98–117, <https://doi.org/10.1177/193758671200500409>.
- [18] A.H. Sadek, M.M. Shepley, Space syntax analysis: tools for augmenting the precision of healthcare facility spatial analysis, *HERD Health Environ. Res. Des. J.* 10 (1) (Oct. 2016) 114–129, <https://doi.org/10.1177/1937586715624225>.
- [19] V.L. Smith-Daniels, S.B. Schweikhart, D.E. Smith-Daniels, Capacity management in health care services: review and future research directions, *Decis. Sci. J.* 19 (4) (1988) 889–919, <https://doi.org/10.1111/j.1540-5915.1988.tb00310.x>.
- [20] J. Jun, S. Jacobson, J. Swisher, Application of discrete-event simulation in health care clinics: a survey, *J. Oper. Res. Soc.* 50 (Feb. 1999) 109–123, <https://doi.org/10.1057/palgrave.jors.2600669>.
- [21] D. Fone, et al., Systematic review of the use and value of computer simulation modelling in population health and health care delivery, *J. Public Health* 25 (4) (Dec. 2003) 325–335, <https://doi.org/10.1093/pubmed/fgd075>.
- [22] B.G. Sobolev, V. Sanchez, C. Vasilakis, Systematic review of the use of computer simulation modeling of patient flow in surgical care, *J. Med. Syst.* 35 (1) (Feb. 2011) 1–16, <https://doi.org/10.1007/s10916-009-9336-z>.
- [23] S.C. Brailsford, P.R. Harper, B. Patel, M. Pitt, An analysis of the academic literature on simulation and modelling in health care, *J. Simulat.* 3 (3) (Sep. 2009) 130–140, <https://doi.org/10.1057/jos.2009.10>.
- [24] A. Al-Kaf, et al., A critical review of implementing lean and simulation to improve resource utilization and patient experience in outpatient clinics, *TQM J* (2022), <https://doi.org/10.1108/TQM-11-2021-0337>.
- [25] M.J. Page, et al., The PRISMA 2020 statement: an updated guideline for reporting systematic reviews, *BMJ* (Mar. 2021) n71, <https://doi.org/10.1136/bmj.n71>.
- [26] C. Wagenaar, N. Mens, *Hospitals: a Design Manual*, 1 Online Resource, Walter de Gruyter GmbH, Basel/Berlin/Boston, 2018, p. 272.
- [27] D. Peng, Improving the Performance of Hospitals: an Architectural Analysis of Patient Journeys in China, Delft University of Technology, 2022 [Online]. Available: <https://research.tudelft.nl/en/publications/improving-the-performance-of-hospitals-an-architectural-analysis>.
- [28] Y. Luo, Modern hospital building design, in: 现代医院建筑设计, 第2版, second ed., China Architecture Publishing & Media Co., Ltd. 中国建筑工业出版社., 2010 Accessed: Jan. 17, 2022. [Online]. Available: https://issuu.com/bookcat2/docs/_____dc60ec57057275.
- [29] M. Worboys, M. Duckham, *GIS: a Computing Perspective*, second ed., CRC Press, Boca Raton, 2004.
- [30] P. A. (Peter A.) Burrough, *Principles of Geographical Information Systems for Land Resources Assessment*, Clarendon Press, Oxford, 1986.
- [31] S. Kubba, Handbook of green building design and construction: LEED, BREEAM, and Green Globes, in: 1 Online Resource (Xlii, 1064 Pages) : Illustrations Vols, second ed., Butterworth-Heinemann, Oxford, United Kingdom, 2017.
- [32] INFORMS, What is O.R.? INFORMS. <https://www.informs.org/Explore/What-is-O.R.-Analytics/What-is-O.R.> (Accessed 20 January 2022).
- [33] Industrial and systems engineering BoK, <https://www.iise.org/details.aspx?id=43631>. (Accessed 24 February 2022).
- [34] Industrial engineering into healthcare – a comprehensive review, <https://www.tandfonline.com/doi/epub/10.1080/20479700.2020.1757874?needAccess=true>. (Accessed 23 February 2022).
- [35] V. Belton, T. Stewart, *Multiple Criteria Decision Analysis: an Integrated Approach*, Springer Science & Business Media, 2002.
- [36] M.S. Bittermann, *Intelligent Design Objects (IDO): a Cognitive Approach for Performance-Based Design*, S.I., 2009 [s.n.].
- [37] P. Pérez-Gosende, J. Mula, M. Díaz-Madroño, Facility layout planning. An extended literature review, *Int. J. Prod. Res.* 59 (12) (Jun. 2021) 3777–3816, <https://doi.org/10.1080/00207543.2021.1897176>.
- [38] H. Hosseini-Nasab, S. Fereidouni, S.M.T. Fatemi Ghomi, M.B. Fakhrazad, Classification of facility layout problems: a review study, *Int. J. Adv. Manuf. Technol.* 94 (1) (Jan. 2018) 957–977, <https://doi.org/10.1007/s00170-017-0895-8>.
- [39] W. Turner, J. Mize, K. Case, J. Nazemtz, *Introduction to Industrial and Systems Engineering*, third ed., Pearson, Englewood Cliffs, N.J., 1992.
- [40] S. Emami, A. Nookabadi, Managing a new multi-objective model for the dynamic facility layout problem, *Int. J. Adv. Manuf. Technol.* 68 (Oct) (2013), <https://doi.org/10.1007/s00170-013-4820-5>.
- [41] “What Is Ergonomics? | The International Ergonomics Association is a global federation of human factors/ergonomics societies, registered as a nonprofit organization in Geneva, Switzerland.” <https://iea.cc/what-is-ergonomics/> (accessed Feb. 28, 2022).
- [42] G.Y. Handler, P.B. Mirchandani, *Location on Networks Theory and Algorithms*, M.I.T. Press, Cambridge, Mass, 1979.
- [43] C. Vasudev, *Graph theory with applications*, 1 online resource (xx, 466 pages) : illustrations vols, New Delhi: New Age International (P) Ltd., Publishers Accessed: Jan. 24, 2022. [Online]. Available: <http://site.ebrary.com/id/10323360>, 2006.
- [44] P. Nourian, *Configraphics: Graph Theoretical Methods for Design and Analysis of Spatial Configurations*, 2016, <https://doi.org/10.7480/abe.2016.14>.
- [45] Embedding an outer-planar graph in a point set, <http://cgm.cs.mcgill.ca/~athens/cs507/Projects/2004/Andrew-King/507planar.html>. (Accessed 12 April 2022).
- [46] Introduction to graph theory in the context of dual polytopes, <https://notnoshi.github.io/dual-polytopes/>. (Accessed 6 April 2022).
- [47] J. de D. Ortúzar, L.G. Willumsen, *Modelling Transport*, John Wiley & Sons, 2011.
- [48] L.R. Kadiyali, *Traffic Engineering and Transport Planning*, Khanna Publisher, 2011.
- [49] B.K. Patle, G. Babu L, A. Pandey, D.R.K. Parhi, A. Jagadeesh, A review: on path planning strategies for navigation of mobile robot, *Def. Technol.* 15 (4) (Aug. 2019) 582–606, <https://doi.org/10.1016/j.dt.2019.04.011>.
- [50] J. Park, D.W. Goldberg, T. Hammond, A comparison of network model creation algorithms based on the quality of wayfinding results, *Trans. GIS* 24 (3) (2020) 602–622, <https://doi.org/10.1111/tgis.12632>.
- [51] L. Liu, S. Zlatanova, A ‘door-To-Door’ Path-Finding Approach for Indoor Navigation, May 2011.
- [52] L. Liu, B. Li, S. Zlatanova, P. van Oosterom, Indoor navigation supported by the industry foundation classes (IFC): a survey, *Autom. ConStruct.* 121 (Jan. 2021) 103436, <https://doi.org/10.1016/j.autcon.2020.103436>.
- [53] S. Azadi, P. Nourian, *GoDesign: A Modular Generative Design Framework for Mass-Customization and Optimization in Architectural Design*, 2021.
- [54] C. Cubukcuoglu, P. Nourian, M.F. Tasgetiren, I.S. Sariyildiz, S. Azadi, Hospital layout design renovation as a Quadratic Assignment Problem with geodesic distances, *J. Build. Eng.* 44 (Dec. 2021) 102952, <https://doi.org/10.1016/j.jobee.2021.102952>.

- [55] S. Haq, Where we walk is what we see: foundational concepts and analytical techniques of space syntax, *HERD* 12 (1) (Jan. 2019) 11–25, <https://doi.org/10.1177/1937586718812436>.
- [56] M. Barthélemy, Spatial networks, *Phys. Rep.* 499 (1) (Feb. 2011) 1–101, <https://doi.org/10.1016/j.physrep.2010.11.002>.
- [57] A. Pereira Roders (Ed.), *Mastermind Crash: A Method to Reveal the Impact of Architectural Redesign*, TU Delft Open, 2021.
- [58] W. Delaney, *Dynamic Models and Discrete Event Simulation*, CRC Press, 2020.
- [59] S. Friedenthal, D. Dori, Y. Mordecai, Why model? - SEBoK, accessed Mar. 07, 2022). https://www.sebokwiki.org/wiki/Why_Model%3F.
- [60] J.M. Epstein, Why model? accessed Mar. 04, 2022). <https://www.jasss.org/11/4/12.html>, Oct. 31, 2008.
- [61] L.M. Leemis, S.K. Park, *Discrete-event Simulation: A First Course*, Pearson Prentice Hall, 2006.
- [62] X. Meng, Types of models, <https://www.eg.bucknell.edu/~xmeng/Course/CS6337/Note/master/node8.html>, Oct. 18, 2002. (Accessed 8 March 2022).
- [63] X. Meng, Discrete and Continuous Systems, Oct. 18, 2002 accessed Mar. 08, 2022). <https://www.eg.bucknell.edu/~xmeng/Course/CS6337/Note/master/node6.html>.
- [64] Modeling and Simulation CS ppt download, <https://slideplayer.com/slide/16671161/>. (Accessed 3 May 2022).
- [65] C. Elsenbroich, N. Gilbert, Agent-based modelling, in: C. Elsenbroich, N. Gilbert (Eds.), *Modelling Norms*, Springer Netherlands, Dordrecht, 2014, pp. 65–84, https://doi.org/10.1007/978-94-007-7052-2_4.
- [66] A.T. Crooks, A.J. Heppenstall, Introduction to agent-based modelling, in: A.J. Heppenstall, A.T. Crooks, L.M. See, M. Batty (Eds.), *Agent-Based Models of Geographical Systems*, Springer Netherlands, Dordrecht, 2012, pp. 85–105, https://doi.org/10.1007/978-90-481-8927-4_5.
- [67] F.S. Hillier, G.J. Lieberman, *Introduction to Operations Research*, tenth ed., McGraw-Hill Education, New York, NY, 2015.
- [68] D. Schaumann, P.N. Putievsky, M. Gath-Morad, Y.E. Kalay, Simulating the impact of facility design on operations: a study in an internal medicine ward, *Facilities* 38 (7/8) (Jan. 2020) 501–522, <https://doi.org/10.1108/F-10-2018-0132>.
- [69] C. Pan, D. Zhang, A.W.M. Kon, C.S.L. Wai, W.B. Ang, Patient flow improvement for an ophthalmic specialist outpatient clinic with aid of discrete event simulation and design of experiment, *Health Care Manag. Sci.* 18 (2) (Jun. 2015) 137–155, <https://doi.org/10.1007/s10729-014-9291-1>.
- [70] U. Nanda, S. Pati, A. Nejjati, Field research and parametric analysis in a medical-surgical unit, *Health Environ. Res. Des. J.* 8 (4) (2015) 41–57, <https://doi.org/10.1177/1937586715577370>.
- [71] “Embodied Carbon - the Inventory of Carbon and Energy (ICE) (BG 10/2011), Prof Hammond G, Jones C. - Editors Lowrie F. Tse P, 9780860227038.” https://www.bsria.com/uk/product/dDJAnX/embodied_carbon_the_inventory_of_carbon_and_energy_ice_bg_102011_a15d25e1/ (accessed May 03, 2022).
- [72] Y. Parsia, S. Sorooshian, A decision-making algorithm for rearchitecting of healthcare facilities to minimize nosocomial infections risks, *Int. J. Environ. Res. Publ. Health* 17 (3) (2020), <https://doi.org/10.3390/ijerph17030855>.
- [73] B. Denton, A. Rahman, H. Nelson, A. Bailey, Simulation of a Multiple Operating Room Surgical Suite, 2006, p. 424, <https://doi.org/10.1145/1218112.1218192>.
- [74] W.H. Iskander, D.M. Carter, A simulation model for a same day care facility at a university hospital, in: 1991 Winter Simulation Conference Proceedings, Dec. 1991, pp. 846–853, <https://doi.org/10.1109/WSC.1991.185694>.
- [75] S.S. Jones, R.S. Evans, An agent based simulation tool for scheduling emergency department physicians, *AMIA. Annu. Symp. Proc.* 2008 (2008) 338–342.
- [76] M. Taboada, E. Cabrera, F. Epelde, I. Mi, E. Luque, Using an agent-based simulation for predicting the effects of patients derivation policies in emergency departments, *Procedia Comput. Sci.* 18 (Dec. 2013) 641–650, <https://doi.org/10.1016/j.procs.2013.05.228>.
- [77] E. Cabrera, E. Luque, M. Taboada, F. Epelde, M.L. Iglesias, ABMS optimization for emergency departments, in: Proceedings of the 2012 Winter Simulation Conference (WSC), Dec. 2012, pp. 1–12, <https://doi.org/10.1109/WSC.2012.6465116>.
- [78] M. Taboada, E. Cabrera, M.L. Iglesias, F. Epelde, E. Luque, An agent-based decision support system for hospitals emergency departments, *Procedia Comput. Sci.* 4 (Jan. 2011) 1870–1879, <https://doi.org/10.1016/j.procs.2011.04.203>.
- [79] S. Valipoor, M. Hatami, H. Hakimjavadi, E. Akçali, W.A. Swan, G. De Portu, Data-driven design strategies to address crowding and boarding in an emergency department: a discrete-event simulation study, *HERD Health Environ. Res. Des. J.* 14 (2) (Apr. 2021) 161–177, <https://doi.org/10.1177/1937586720969933>.
- [80] W.M. Hancock, P.F. Walter, The use of computer simulation to develop hospital systems, *Simulat. Digest* 10 (4) (Jul. 1979) 28–32, <https://doi.org/10.1145/1102815.1102819>.
- [81] M. Badri, J. Hollingsworth, A simulation model for scheduling in the emergency room, *Int. J. Oper. Prod. Manag.* 13 (Dec. 1993) 13–24, <https://doi.org/10.1108/01443579310025989>.
- [82] B.G. López-Valcárcel, P. Barber Pérez, Evaluation of alternative functional designs in an emergency department by means of simulation, *Simulation* 63 (1) (Jul. 1994) 20–28, <https://doi.org/10.1177/003754979406300103>.
- [83] J. Viana, K. Rand-Hendriksen, T.B. Simonsen, T. Barra, F. Dahl, Do hybrid simulation models always increase flexibility to handle parametric and structural changes? in: Presented at the Proceedings - Winter Simulation Conference, 2016, pp. 1439–1450 <https://doi.org/10.1109/WSC.2016.7822196>, 0.
- [84] C.K.Y. Lin, T.W.C. Ling, W.K. Yeung, Resource allocation and outpatient Appointment scheduling using simulation optimization, *J. Healthc. Eng.* 2017 (2017), <https://doi.org/10.1155/2017/9034737>.
- [85] M.A. Draeger, An emergency department simulation model used to evaluate alternative nurse staffing and patient population scenarios, in: Proceedings of the 24th Conference on Winter Simulation, Dec. 1992, pp. 1057–1064 <https://doi.org/10.1145/167293.167831>, New York, NY, USA.
- [86] C. Vasilakis, B.G. Sobolev, L. Kuramoto, A.R. Levy, A simulation study of scheduling clinic appointments in surgical care: individual surgeon versus pooled lists, *J. Oper. Res. Soc.* 58 (2) (Feb. 2007) 202–211, <https://doi.org/10.1057/palgrave.jors.2602235>.
- [87] D.J. Morrice, J.F. Bard, K.M. Koenig, Designing and scheduling a multi-disciplinary integrated practice unit for patient-centred care, *Health Syst* 9 (4) (2020) 293–316, <https://doi.org/10.1080/20476965.2019.1569481>.
- [88] M.H. Rahmat, M. Annamalai, S.A. Halim, R. Ahmad, Agent-based modelling and simulation of emergency department re-triage, in: 2013 IEEE Business Engineering and Industrial Applications Colloquium (BEIAC), Apr. 2013, pp. 219–224, <https://doi.org/10.1109/BEIAC.2013.6560119>.
- [89] J. Viana, T.B. Simonsen, H.E. Faraas, N. Schmidt, F.A. Dahl, K. Flo, Capacity and patient flow planning in post-term pregnancy outpatient clinics: a computer simulation modelling study, *BMC Health Serv. Res.* 20 (1) (2020), <https://doi.org/10.1186/s12913-020-4943-y>.
- [90] R.B. Fetter, J.D. Thompson, The simulation of hospital systems, *Oper. Res.* 13 (5) (Oct. 1965) 689–711, <https://doi.org/10.1287/opre.13.5.689>.
- [91] E.A. Smith, H.R. Warner, Simulation of a multiphasic screening procedure for hospital admissions, *Simulation* 17 (2) (Aug. 1971) 57–64, <https://doi.org/10.1177/003754977101700202>.
- [92] J.W. Kho, G.M. Johnson, *Computer Simulation of a Hospital Health-Care Delivery System*, Institute of Electrical and Electronics Engineers (IEEE), 1976.
- [93] S.K. Kachhal, G.-A. Klutke, E.B. Daniels, *Two Simulation Applications to Outpatient Clinics*, Institute of Electrical and Electronics Engineers (IEEE), 1981.
- [94] N.T.J. Bailey, A study of queues and appointment systems in hospital out-patient departments, with special reference to waiting-times, *J. R. Stat. Soc. Ser. B Methodol.* 14 (2) (1952) 185–199, <https://doi.org/10.1111/j.2517-6161.1952.tb00112.x>.
- [95] S.R. Smith, B.J. Schroer, R.E. Shannon, *Scheduling of Patients and Resources for Ambulatory Health Care*, Institute of Electrical and Electronics Engineers (IEEE), 1979.
- [96] K.E. Fitzpatrick, J.R. Baker, D.S. Dave, An application of computer simulation to improve scheduling of hospital operating room facilities in the United States, *Int. J. Comput. Appl. Technol.* 6 (4) (1993) 215–224.
- [97] K.J. Klassen, T.R. Rohleder, Scheduling outpatient appointments in a dynamic environment, *J. Oper. Manag.* 14 (2) (Jun. 1996) 83–101, [https://doi.org/10.1016/0272-6963\(95\)00044-5](https://doi.org/10.1016/0272-6963(95)00044-5).
- [98] S.D. Walter, A comparison of appointment schedules in a hospital radiology department, *Br. J. Prev. Soc. Med.* 27 (3) (Aug. 1973) 160–167, <https://doi.org/10.1136/jech.27.3.160>.
- [99] M.L. García, M.A. Centeno, C. Rivera, N. DeCarío, Reducing time in an emergency room via a fast-track, in: Proceedings of the 27th Conference on Winter Simulation, Dec. 1995, pp. 1048–1053 <https://doi.org/10.1145/224401.224771>, USA.
- [100] A. Kirtland, J. Lockwood, K. Poisker, L. Stamp, P. Wolfe, Simulating an emergency department "is as much fun as, in: Winter Simulation Conference Proceedings, Dec. 1995, pp. 1039–1042 <https://doi.org/10.1109/WSC.1995.478896>, 1995.
- [101] J.T. Blake, M.W. Carter, S. Richardson, An analysis of emergency room wait time issues via computer simulation, *INFOR Inf. Syst. Oper. Res.* 34 (4) (Nov.

- 1996) 263–273, <https://doi.org/10.1080/03155986.1996.11732308>.
- [102] R.H. Edwards, J.E. Clague, J. Barlow, M. Clarke, P.G. Reed, R. Rada, Operations research survey and computer simulation of waiting times in two medical outpatient clinic structures, *Health Care Anal. HCA J. Health Philos. Policy* 2 (2) (May 1994) 164–169, <https://doi.org/10.1007/BF02249741>.
- [103] A.J. Alessandra, T.E. Grazman, Using simulation in hospital planning, *Simulation* 30 (2) (Feb. 1978) 62–67, <https://doi.org/10.1177/003754977803000206>.
- [104] A.K. Mukherjee, A simulation model for management of operations in the pharmacy of a hospital, *Simulation* 56 (2) (Feb. 1991) 91–103, <https://doi.org/10.1177/003754979105600205>.
- [105] G.W. Evans, E. Unger, T.B. Gor, A simulation model for evaluating personnel schedules in a hospital emergency department, in: *Proceedings Winter Simulation Conference*, 1996, pp. 1205–1209.
- [106] A.R. Mahachek, T.L. Knabe, Computer simulation of patient flow in obstetrical/gynecology clinics, *Simulation* 43 (2) (Aug. 1984) 95–101, <https://doi.org/10.1177/003754978404300204>.
- [107] L. Liyanage, M. Gale, Quality improvement for the Campbelltown hospital emergency service, in: 1995 IEEE International Conference on Systems, Man and Cybernetics, 3, Intelligent Systems for the 21st Century, Oct. 1995, pp. 1997–2002 <https://doi.org/10.1109/ICSMC.1995.538071>, 3.
- [108] P. Ciaran O’Kane, A simulation model of a diagnostic radiology department, *Eur. J. Oper. Res.* 6 (1) (Jan. 1981) 38–45, [https://doi.org/10.1016/0377-2217\(81\)90326-X](https://doi.org/10.1016/0377-2217(81)90326-X).
- [109] K.A. Klafehn, Impact points in patient flows through a radiology department provided through simulation, in: *Proceedings of the 19th Conference on Winter Simulation*, Dec. 1987, pp. 914–918 <https://doi.org/10.1145/318371.318715>, New York, NY, USA.
- [110] S. Vemuri, Simulated analysis of patient waiting time in an outpatient pharmacy, *Am. J. Hosp. Pharm.* 41 (6) (Jun. 1984) 1127–1130, <https://doi.org/10.1093/ajhp/41.6.1127>.
- [111] K. Ishimoto, T. Ishimitsu, A. Koshiro, S. Hirose, Computer simulation of optimum personnel assignment in hospital pharmacy using a work-sampling method, *Med. Inform.* 15 (4) (Jan. 1990) 343–354, <https://doi.org/10.3109/14639239009025283>.
- [112] F. Hashimoto, S. Bell, Improving outpatient clinic staffing and scheduling with computer simulation, *J. Gen. Intern. Med.* 11 (3) (Mar. 1996) 182–184, <https://doi.org/10.1007/BF02600274>.
- [113] M.E. Lim, A. Worster, R. Goeree, J.-É. Tarride, Simulating an emergency department: the importance of modeling the interactions between physicians and delegates in a discrete event simulation, *BMC Med. Inf. Decis. Making* 13 (May 2013) 59, <https://doi.org/10.1186/1472-6947-13-59>.
- [114] P.J. Kuzdrall, N.K. Kwak, H.H. Schmitz, Simulating space requirements and scheduling policies in a hospital surgical suite, *Simulation* 36 (5) (May 1981) 163–171, <https://doi.org/10.1177/003754978103600504>.
- [115] T. Lim, D. Uyenoi, I. Vertinsky, Hospital admissions systems: a simulation approach, *Simulat. Game.* 6 (2) (Jun. 1975) 188–201, <https://doi.org/10.1177/104687817500600204>.
- [116] E. Marcon, F. Dexter, Impact of surgical sequencing on post anesthesia care unit staffing, *Health Care Manag. Sci.* 9 (1) (Feb. 2006) 87–98, <https://doi.org/10.1007/s10729-006-6282-x>.
- [117] J.E. Stahl, D. Rattner, R. Wiklund, J. Lester, M. Beinfeld, G.S. Gazelle, Reorganizing the system of care surrounding laparoscopic surgery: a cost-effectiveness analysis using discrete-event simulation, *Med. Decis. Mak. Int. J. Soc. Med. Decis. Mak.* 24 (5) (Oct. 2004) 461–471, <https://doi.org/10.1177/0272989X04268951>.
- [118] A. Testi, E. Tanfani, G. Torre, A three-phase approach for operating theatre schedules, *Health Care Manag. Sci.* 10 (2) (Jun. 2007) 163–172, <https://doi.org/10.1007/s10729-007-9011-1>.
- [119] P.T. VanBerckel, J.T. Blake, A comprehensive simulation for wait time reduction and capacity planning applied in general surgery, *Health Care Manag. Sci.* 10 (4) (Dec. 2007) 373–385, <https://doi.org/10.1007/s10729-007-9035-6>.
- [120] Y. Marmor, B. Golany, I. Shlomo, A. Mandelbaum, Designing patient flow in emergency departments, *IIE Trans. Healthc. Syst. Eng.* 2 (Dec. 2012) 233–247, <https://doi.org/10.1080/19488300.2012.736118>.
- [121] H. Zhang, T.J. Best, A. Chivu, D.O. Meltzer, Simulation-based optimization to improve hospital patient assignment to physicians and clinical units, *Health Care Manag. Sci.* 23 (1) (2020) 117–141, <https://doi.org/10.1007/s10729-019-09483-3>.
- [122] D. Min, Y. Yih, A simulation study of registration queue disciplines in an outpatient clinic: a two-stage patient flow model, *Eur. J. Ind. Eng.* 3 (2) (2009) 127–145, <https://doi.org/10.1504/EJIE.2009.023602>.
- [123] M.T. Ramirez Valdivia, T.J. Crowe, Achieving hospital operating objectives in the light of patient preferences, *Int. J. Health Care Qual. Assur.* 10 (5) (1997) 208–212, <https://doi.org/10.1108/09526869710174249>.
- [124] J. Bowers, Balancing operating theatre and bed capacity in a cardiothoracic centre, *Health Care Manag. Sci.* 16 (3) (Sep. 2013) 236–244, <https://doi.org/10.1007/s10729-013-9221-7>.
- [125] S.C.K. Chu, C.K.Y. Lin, S.S. Lam, Hospital lift system simulator: a performance evaluator-predictor, *Eur. J. Oper. Res.* 146 (1) (2003) 156–180, [https://doi.org/10.1016/S0377-2217\(02\)00203-5](https://doi.org/10.1016/S0377-2217(02)00203-5).
- [126] Q. Niu, Q. Peng, T.Y. Elmekawy, Improvement in the operating room efficiency using Tabu search in simulation, *Bus. Process Manag. J.* 19 (5) (2013) 799–818, <https://doi.org/10.1108/BPMJ-Nov-2011-0081>.
- [127] S. Su, C.-L. Shih, Managing a mixed-registration-type appointment system in outpatient clinics, *Int. J. Med. Inf.* 70 (1) (2003) 31–40, [https://doi.org/10.1016/S1386-5056\(03\)00008-X](https://doi.org/10.1016/S1386-5056(03)00008-X).
- [128] M.E. Zonderland, F. Boer, R.J. Boucherie, A. De Roode, J.W. Van Kleef, Redesign of a university hospital preanesthesia evaluation clinic using a queuing theory approach, *Anesth. Analg.* 109 (5) (2009) 1612–1621, <https://doi.org/10.1213/ANE.0b013e3181b921e7>.
- [129] M.A. Ortiz, S. McClean, C.D. Nugent, A. Castillo, Reducing appointment lead-time in an outpatient department of gynecology and obstetrics through discrete-event simulation: a case study, *Lect. Notes Comput. Sci. Subser. Lect. Notes Artif. Intell. Lect. Notes Bioinforma.* 10069 (2016) 274–285 https://doi.org/10.1007/978-3-319-48746-5_28, LNCS.
- [130] S. Norouzzadeh, N. Riebling, L. Carter, J. Conigliaro, M.E. Doerfler, Simulation modeling to optimize healthcare delivery in an outpatient clinic, in: *Presented at the Proceedings - Winter Simulation Conference*, 2016–February, 2016, pp. 1355–1366, <https://doi.org/10.1109/WSC.2015.7408259>.
- [131] G.M. Edward, et al., Simulation to analyse planning difficulties at the preoperative assessment clinic, *Br. J. Anaesth.* 100 (2) (2008) 195–202, <https://doi.org/10.1093/bja/aem366>.
- [132] B. Berg, G. Longley, J. Dunitz, Use of simulation to evaluate resource assignment policies in a multidisciplinary outpatient clinic, *Proceedings - Winter Simulation Conference* 2018–December (2019) 2646–2655 <https://doi.org/10.1109/WSC.2018.8632307>, presented at the.
- [133] K. Demirli, A. Al Kaf, M.C.E. Simekler, R. Jayaraman, M.J. Khan, E.M. Tuzcu, Using lean techniques and discrete-event simulation for performance improvement in an outpatient clinic, *Int. J. Lean Six Sigma* 12 (6) (2021) 1260–1288, <https://doi.org/10.1108/IJLSS-09-2020-0138>.
- [134] K. Patel, B. Berg, V. Vahdat, Using simulation to evaluate operational trade-offs associated with the use of care teams in specialty care settings, in: *Presented at the Proceedings - Winter Simulation Conference*, 2020–December, 2020, pp. 842–852, <https://doi.org/10.1109/WSC48552.2020.9384042>.
- [135] S. Creemers, J. Beljén, M. Lambrecht, The optimal allocation of server time slots over different classes of patients, *Eur. J. Oper. Res.* 219 (3) (Jun. 2012) 508–521, <https://doi.org/10.1016/j.ejor.2011.10.045>.
- [136] C.-J. Liao, C.D. Pegden, M. Rosenshine, Planning timely arrivals to a stochastic production or service system, *IIE Trans.* 25 (5) (Sep. 1993) 63–73, <https://doi.org/10.1080/07408179308964316>.
- [137] C.D. Pegden, M. Rosenshine, Scheduling arrivals to queues, *Comput. Oper. Res.* 17 (4) (Jan. 1990) 343–348, [https://doi.org/10.1016/0305-0548\(90\)90012-V](https://doi.org/10.1016/0305-0548(90)90012-V).
- [138] R. Akkerman, M. Knip, Reallocation of beds to reduce waiting time for cardiac surgery, *Health Care Manag. Sci.* 7 (2) (May 2004) 119–126, <https://doi.org/10.1023/b:hcms.0000020651.02085.49>.
- [139] Y. Lu, J. Peponis, C. Zimring, Targeted Visibility Analysis in Buildings. Correlating targeted visibility analysis with distribution of people and their interactions within an intensive care unit, in: *Proceedings of the 7th International Space Syntax Symposium*, 2009, pp. 1–10.
- [140] K. Hadi, C. Zimring, Design to improve visibility: impact of corridor width and unit shape, *Health Environ. Res. Des. J.* 9 (4) (2016) 35–49, <https://doi.org/10.1177/1937586715621643>.

- [141] M.M. Ossmann, Exploring Spatial Risk: the Impact of Visibility on ICU Mortality, Apr. 2016 Accessed: Apr. 22, 2022. [Online]. Available: <https://smartech.gatech.edu/handle/1853/58151>.
- [142] C. Alalouch, P. Aspinall, Spatial attributes of hospital multi-bed wards and preferences for privacy, *Facilities* 25 (Jul. 2007) 345–362, <https://doi.org/10.1108/02632770710772450>.
- [143] Y. Lu, M.M. Ossmann, D.E. Leaf, P.H. Factor, Patient visibility and ICU mortality: a conceptual replication, *HERD Health Environ. Res. Des. J.* 7 (2) (Jan. 2014) 92–103, <https://doi.org/10.1177/193758671400700206>.
- [144] Y. Kim, H.W. Lee, Analyzing user costs in a hospital: methodological implication of space syntax to support whole-life target value design, *Lean Constr. J.* 2010 (2010) 55–65.
- [145] S.J. Trzpuć, C.S. Martin, Application of space syntax theory in the study of medical-surgical nursing units in urban hospitals, *HERD* 4 (1) (2010) 34–55, <https://doi.org/10.1177/193758671000400104>.
- [146] A. Gharaveis, D. Pati, D.K. Hamilton, M. Shepley, S. Rodiek, M. Najarian, The correlation between visibility and medical staff collaborative communication in emergency departments, *Health Environ. Res. Des. J.* 13 (4) (2020) 81–97, <https://doi.org/10.1177/1937586720921182>.
- [147] A. Gharaveis, D.K. Hamilton, D. Pati, M. Shepley, The impact of visibility on teamwork, collaborative communication, and security in emergency departments: an exploratory study, *Health Environ. Res. Des. J.* 11 (4) (2018) 37–49, <https://doi.org/10.1177/1937586717735290>.
- [148] S. O'Hara, et al., Macrocognition in the healthcare built environment (mHCBE): a focused ethnographic study of 'neighborhoods' in a pediatric intensive care unit, *Health Environ. Res. Des. J.* 11 (2) (2018) 104–123, <https://doi.org/10.1177/1937586717728484>.
- [149] X. Xuan, X. Chen, Z. Li, Impacts of nursing unit design on visibility and proximity and its influences on communication, privacy, and efficiency, *Health Environ. Res. Des. J.* 13 (2) (2020) 200–217, <https://doi.org/10.1177/1937586719881443>.
- [150] R. Pachlova, K. Sailer, Ward layout, communication and care quality: spatial intelligibility as a key component of hospital design, presented at the 12th International Space Syntax Symposium (2019) SSS 2019.
- [151] H. Cai, C. Zimring, Out of sight, out of reach: correlating spatial metrics of nurse station typology with nurses' communication and co-awareness in an intensive care unit," presented at the, *Proceedings of the 8th International Space Syntax Symposium, Santiago, Chile* 36 (2012) 381–391.
- [152] M. Rashid, D.K. Boyle, M. Crosser, Network of spaces and interaction-related behaviors in adult intensive care units, *Behav. Sci.* 4 (4) (Dec. 2014) <https://doi.org/10.3390/bs4040487>, Art. no. 4.
- [153] M. Rashid, N. Khan, B. Jones, Physical and visual accessibilities in intensive care units: a comparative study of open-plan and racetrack units, *Crit. Care Nurs. Q.* 39 (4) (Dec. 2016) 313–334, <https://doi.org/10.1097/CNQ.0000000000000126>.
- [154] M. Rashid, N. Khan, B. Jones, Perceptual effects of physical and visual accessibilities in intensive care units: a quasi-experimental study, *Crit. Care Nurs. Q.* 41 (2) (2018) 197–214, <https://doi.org/10.1097/CNQ.0000000000000200>.
- [155] L. Lim, M. Kim, C.M. Zimring, Measuring interpersonal visual relationships in healthcare facilities: the agent visibility model and SAVisualPower tool, *HERD* 12 (4) (Oct. 2019) 203–216, <https://doi.org/10.1177/1937586719842357>.
- [156] H. Cai, K. Spreckelmeyer, The continuous learning cycle: a multi-phase post-occupancy evaluation (POE) of decentralized nursing unit design, *Health Environ. Res. Des. J.* 15 (2) (2022) 134–148, <https://doi.org/10.1177/19375867211051657>.
- [157] S. Haq, "CAN SPACE SYNTAX PREDICT ENVIRONMENTAL COGNITION?," *PR O C E E N G S*, p. 14.
- [158] Y. Lu, R. Bozovic-Stamenovic, CULTURALPERSPECTIVEOFWAYFINDING behavior- exploring THESOCIO-SPATIALVARIABLEIN THREECHINESE hospitals CASESTUDIES, *Vo Lume 2* (2009) 14.
- [159] S. Haq, C. Zimring, Just down the road A PieceThe development of topological knowledge of building layouts, *Environ. Behav. - Env. BEHAV* 35 (Jan. 2003) 132–160, <https://doi.org/10.1177/0013916502238868>.
- [160] S. Haq, Investigating the syntax line: configurational properties and cognitive correlates, *Environ. Plann. Plann. Des.* 30 (6) (Dec. 2003) 841–863, <https://doi.org/10.1068/b2960>.
- [161] S.-Y. Tzeng, J.-S. Huang, Spatial forms and signage in wayfinding decision points for hospital outpatient services, *J. Asian Architect. Build Eng.* 8 (2) (Nov. 2009) 453–460, <https://doi.org/10.3130/jaabe.8.453>.
- [162] A.E. Pouyan, A. Ghanbaran, A. Shakibamanesh, Impact of circulation complexity on hospital wayfinding behavior (Case study: milad 1000-bed hospital, Tehran, Iran), *J. Build. Eng.* 44 (Dec. 2021) 102931, <https://doi.org/10.1016/j.job.2021.102931>.
- [163] G. Lacanna, C. Wagenaar, T. Avermaete, V. Swami, Evaluating the psychosocial impact of indoor public spaces in complex healthcare settings, *Health Environ. Res. Des. J.* 12 (3) (2019) 11–30, <https://doi.org/10.1177/1937586718812439>.
- [164] J. van der Zwart, T.J.M. van der Voordt, Pre-occupancy evaluation of patient satisfaction in hospitals, *HERD* 9 (1) (2015) 110–124, <https://doi.org/10.1177/1937586715595506>.
- [165] Z. Zamani, Effects of emergency department physical design elements on security, wayfinding, visibility, privacy, and efficiency and its implications on staff satisfaction and performance, *HERD* 12 (3) (Jul. 2019) 72–88, <https://doi.org/10.1177/1937586718800482>.
- [166] M. Gath-Morad, L.E. Aguilar Melgar, R. Conroy-Dalton, C. Hölischer, Beyond the shortest-path: towards cognitive occupancy modeling in BIM, *Autom. Construct.* 135 (Mar. 2022) 104131, <https://doi.org/10.1016/j.autcon.2022.104131>.
- [167] D. Schaumann, N.P. Pilosof, K. Date, Y.E. Kalay, A study of human behavior simulation in architectural design for healthcare facilities, *Ann. Ist. Super Sanita* 52 (1) (2016) 24–32, <https://doi.org/10.4415/ANN-16-01-07>.
- [168] V. Vahdatzad, *Simulation and Optimization Methods Applied to Outpatient Health Center Operations*, 2018.
- [169] J. Lee, H. Lee, M. McCuskey Shepley, Exploring the spatial arrangement of patient rooms for minimum nurse travel in hospital nursing units in Korea, *Front. Archit. Res.* 9 (4) (2020) 711–725, <https://doi.org/10.1016/j.foar.2020.06.003>.
- [170] H. Cai, J. Jia, Using discrete event simulation (DES) to support performance-driven healthcare design, *HERD* 12 (3) (Jul. 2019) 89–106, <https://doi.org/10.1177/1937586718801910>.
- [171] V. Vahdat, A. Namin, R. Azghandi, J. Griffin, Improving patient timeliness of care through efficient outpatient clinic layout design using data-driven simulation and optimisation, *Health Syst* 8 (3) (2019) 162–183, <https://doi.org/10.1080/20476965.2018.1561160>.
- [172] S. O'Hara, Planning intensive care unit design using computer simulation modeling: optimizing integration of clinical, operational, and architectural requirements, *Crit. Care Nurs. Q.* 37 (1) (2014) 67–82, <https://doi.org/10.1097/CNQ.0000000000000006>.
- [173] A. Hendrich, M.P. Chow, S. Bafna, R. Choudhary, Y. Heo, B.A. Skierczynski, Unit-related factors that affect nursing time with patients: spatial analysis of the time and motion study, *HERD Health Environ. Res. Des. J.* 2 (2) (Jan. 2009) 5–20, <https://doi.org/10.1177/193758670900200202>.
- [174] R.S. Zadeh, M.M. Shepley, L.T. Waggener, Rethinking efficiency in acute care nursing units: analyzing nursing unit layouts for improved spatial flow, *HERD* 6 (1) (2012) 39–65, <https://doi.org/10.1177/193758671200600103>.
- [175] N. Setola, S. Borgianni, M. Martinez, E. Tobarì, The Role of Spatial Layout of Hospital Public Spaces in Informal Patient-Medical Staff Interface, *International Space Syntax Symposium*, 2013 presented at the 2013.
- [176] N. Huynh, R. Snyder, J.M. Vidal, A.S. Tavakoli, B. Cai, Application of computer simulation modeling to medication administration process redesign, *J. Healthc. Eng.* 3 (4) (2012) 649–662, <https://doi.org/10.1260/2040-2295.3.4.649>.
- [177] D. Schaumann, S. Breslav, R. Goldstein, A. Khan, Y.E. Kalay, Simulating use scenarios in hospitals using multi-agent narratives, *J. Build. Perform. Simul.* 10 (5–6) (Nov. 2017) 636–652, <https://doi.org/10.1080/19401493.2017.1332687>.
- [178] J.R. Hotchkiss, D.G. Strike, D.A. Simonson, A.F. Broccard, P.S. Crooke, An agent-based and spatially explicit model of pathogen dissemination in the intensive care unit, *Crit. Care Med.* 33 (1) (Jan. 2005) 168–176, <https://doi.org/10.1097/01.CCM.0000150658.05831.D2>.
- [179] B.S. Ong, M. Chen, V. Lee, J.C. Tay, An individual-based model of influenza in nosocomial environments, in: *Computational Science – ICCS 2008*, 2008, pp. 590–599 https://doi.org/10.1007/978-3-540-69384-0_64, Berlin, Heidelberg.
- [180] Y. Meng, R. Davies, K. Hardy, P. Hawkey, An application of agent-based simulation to the management of hospital-acquired infection, in: S.J.E. Taylor (Ed.), *Agent-Based Modeling and Simulation*, Palgrave Macmillan UK, London, 2014, pp. 45–60, https://doi.org/10.1057/9781137453648_4.
- [181] J. Ferrer, M. Salmon, L. Temime, Nosolink: an agent-based approach to link patient flows and staff organization with the circulation of nosocomial pathogens in an intensive care unit, *Procedia Comput. Sci.* 18 (Jan. 2013) 1485–1494, <https://doi.org/10.1016/j.procs.2013.05.316>.

- [182] L. Milazzo, J.L. Bown, A. Eberst, G. Phillips, J.W. Crawford, Modelling of healthcare-associated infections: a study on the dynamics of pathogen transmission by using an individual-based approach, *Comput. Methods Progr. Biomed.* 104 (2) (Nov. 2011) 260–265, <https://doi.org/10.1016/j.cmpb.2011.02.002>.
- [183] I. Pelupessy, M.J.M. Bonten, O. Diekmann, How to assess the relative importance of different colonization routes of pathogens within hospital settings, *Proc. Natl. Acad. Sci. U.S.A.* 99 (8) (2002) 5601–5605, <https://doi.org/10.1073/pnas.082412899>.
- [184] M. López-García, T. Kypraios, A unified stochastic modelling framework for the spread of nosocomial infections, *J. R. Soc. Interface* 15 (143) (2018), <https://doi.org/10.1098/rsif.2018.0060>.
- [185] World Health Organization, Regional Office for the Western Pacific, *People's Republic of China Health System Review*, WHO Regional Office for the Western Pacific, 2015 Accessed: Nov. 11, 2021. [Online]. Available: <https://apps.who.int/iris/handle/10665/208229>.
- [186] L. Zhao, B. Lie, Modeling and simulation of patient flow in hospitals for resource utilization, *SNE Simul. Notes Eur.* 20 (2) (Aug. 2010) 41–50, <https://doi.org/10.11128/sne.20.tn.09976>.
- [188] S. Alam, M. Osama, F. Iqbal, I. Sawar, Reducing pharmacy patient waiting time, *Int. J. Health Care Qual. Assur.* 31 (7) (2018) 834–844, <https://doi.org/10.1108/LJHCQA-08-2017-0144>.
- [189] C.-L. Rau, et al., Using discrete-event simulation in strategic capacity planning for an outpatient physical therapy service, *Health Care Manag. Sci.* 16 (4) (Dec. 2013) 352–365, <https://doi.org/10.1007/s10729-013-9234-2>.
- [190] W. Weerawat, J. Pichitlamken, P. Subsombat, A generic discrete-event simulation model for outpatient clinics in a large public hospital, *J. Healthc. Eng.* 4 (2) (2013) 285–305, <https://doi.org/10.1260/2040-2295.4.2.285>.
- [191] Z. Dan, H. Xiaoli, D. Weiru, W. Li, H. Yue, Outpatient pharmacy optimization using system simulation, *Procedia Comput. Sci.* 91 (Jan. 2016) 27–36, <https://doi.org/10.1016/j.procs.2016.07.038>.
- [192] V. Babashov, et al., Reducing patient waiting times for radiation therapy and improving the treatment planning process: a discrete-event simulation model (radiation treatment planning), *Clin. Oncol.* 29 (6) (Jun. 2017) 385–391, <https://doi.org/10.1016/j.clon.2017.01.039>.
- [193] M. Cho, M. Song, S. Yoo, H.A. Reijers, An evidence-based decision support framework for clinician medical scheduling, *IEEE Access* 7 (2019) 15239–15249, <https://doi.org/10.1109/ACCESS.2019.2894116>.
- [194] P. Amladi, *Outpatient health care facility planning and sizing via computer simulation*, WSC '84 (1984).
- [195] A. Gharaveis, D.K. Hamilton, D. Pati, The impact of environmental design on teamwork and communication in healthcare facilities: a systematic literature review, *HERD Health Environ. Res. Des. J.* 11 (1) (Jan. 2018) 119–137, <https://doi.org/10.1177/1937586717730333>.