

Performance evaluation of ventilative cooling systems for buildings under different control parameters and strategies

Hu, Yan; Liu, Zhengxuan; Ai, Zhengtao; Zhang, Guoqiang

DOI

[10.1016/j.jobe.2022.105627](https://doi.org/10.1016/j.jobe.2022.105627)

Publication date

2023

Document Version

Final published version

Published in

Journal of Building Engineering

Citation (APA)

Hu, Y., Liu, Z., Ai, Z., & Zhang, G. (2023). Performance evaluation of ventilative cooling systems for buildings under different control parameters and strategies. *Journal of Building Engineering*, 65, Article 105627. <https://doi.org/10.1016/j.jobe.2022.105627>

Important note

To cite this publication, please use the final published version (if applicable). Please check the document version above.

Copyright

Other than for strictly personal use, it is not permitted to download, forward or distribute the text or part of it, without the consent of the author(s) and/or copyright holder(s), unless the work is under an open content license such as Creative Commons.

Takedown policy

Please contact us and provide details if you believe this document breaches copyrights. We will remove access to the work immediately and investigate your claim.

Green Open Access added to TU Delft Institutional Repository

'You share, we take care!' - Taverne project

<https://www.openaccess.nl/en/you-share-we-take-care>

Otherwise as indicated in the copyright section: the publisher is the copyright holder of this work and the author uses the Dutch legislation to make this work public.



Performance evaluation of ventilative cooling systems for buildings under different control parameters and strategies

Yan Hu^a, Zhengxuan Liu^{a,b,c,*}, Zhengtao Ai^{a,b}, Guoqiang Zhang^{a,b,**}

^a Department of Building Environment and Energy, College of Civil Engineering, Hunan University, Changsha, Hunan, 410082, China

^b National Center for International Research Collaboration in Building Safety and Environment, Hunan University, Changsha, Hunan, 410082, China

^c Faculty of Architecture and the Built Environment, Delft University of Technology, Julianalaan 134, 2628 BL, Delft, the Netherlands

ARTICLE INFO

Keywords:

Ventilative cooling
Indoor air quality
Thermal comfort
Energy saving
Control parameters

ABSTRACT

Ventilative cooling is an energy-saving technology to diminish thermal discomfort and overheating risk of buildings, meanwhile achieving high indoor air quality (IAQ). However, there is still no optimal control strategy in practice, which considerably limits its application. This study developed a typical office building model to evaluate the performance of ventilative cooling systems with different control parameters and strategies for five typical cities in different climatic zones of China. Results showed that, when the control parameter was selected as the upper limit of satisfied comfortable zone by 90% of the occupants, the adaptive thermal comfort (ATC) model, which outperformed the other models in terms of outdoor air utilization, was not necessarily optimal in terms of energy efficiency. The outdoor air utilization potential based on the indoor dry-bulb air temperature (T_d) and indoor operative temperature (T_{op}) control was similar, but the energy usage varies considerably, especially in the hot climatic zones. When the overheating period controlled based on the thermal comfort models was the same, the energy usage would be underestimated by 16%–38% without considering the effect of radiant temperature. The ATC-based control could have up to 37% of energy-saving compared to thermostatic control, but inappropriately low limits could make it less advantages to achieve energy-saving. The energy-saving potential associated with the PMV and ATC controls showed a completely opposite trend in the different climatic zones. The analysis results indicate that eliminating the drawbacks of the lower limit in the ATC model is an effective way to demonstrate energy-saving effectiveness. The findings of this study will contribute to the effective improvement of the application potential of ventilative cooling in different climatic zones.

1. Introduction

Ventilative cooling is an important technology to utilize outdoor air to improve indoor thermal comfort and energy performance of buildings, without compromising indoor air quality (IAQ) [1], which can be driven by natural and mechanical means, or the combination of both. The ventilative cooling form is one of the factors affecting energy consumption and ventilation effectiveness of buildings, which can be selected mainly based on the local climate, also including economic and individual factors [2–4]. Existing studies have shown that 8%–78% of cooling energy consumption can be potentially reduced by natural ventilation depending on local

* Corresponding author. Department of Building Environment and Energy, College of Civil Engineering, Hunan University, Changsha, Hunan, 410082, China.

** Corresponding author. Department of Building Environment and Energy, College of Civil Engineering, Hunan University, Changsha, Hunan, 410082, China.
E-mail addresses: zhengxuanliu@hnu.edu.cn, Z.liu-12@tudelft.nl (Z. Liu), gqzhang@hnu.edu.cn (G. Zhang).

weather and outdoor air quality [5]. When there is insufficient natural driving force or no openable exterior windows, natural ventilation can be replaced by more reliable and controllable mechanical ventilation. However, this inevitably leads to an increase in energy consumption and possible noise generated by the used fan. A previous study indicated that the mechanical ventilation setup with an appropriate adequate flow rate saved over 40% of energy compared to mechanical ventilation with diluted ventilation flow rate that satisfied the ASHRAE IAQ minimum requirements [6]. However, the economic efficiency and performance applicability of this alternative is still to be explored compared to natural ventilation in different climatic zones. In China, increasing number of commercial and office buildings have been using heat recovery ventilation systems as energy-saving devices for recovering heat from the exhaust gases in recent years [7]. The heat recovery ventilation system can recover approximately 60%–95% of energy in the exhaust gases and improve the energy performance of buildings [8]. If the heat recovery system is used in a ventilative cooling system that considers both IAQ and thermal comfort, the resistance of heat recovery core and dual fan operation will increase the power consumption compared to the mechanical ventilation alone. It has not been explored whether the energy saving from heat recovery system can counteract the increased operational costs in different climatic zones.

The control strategy is another major factor that affects cooling effectiveness and energy consumption of buildings. The mechanical cooling system can be used as a supplement when the cooling potential of outdoor air is insufficient. This recognized cooling strategy is commonly referred to as mixed-mode ventilation. In recent years, the control strategy for mixed-mode ventilation has received increasing attention from building designers and researchers. The operation of mixed-mode ventilation system can be controlled by the following methods: conventional rule-based heuristic control [9,10], data-driven model predictive control [11,12], or reinforcement learning control [13]. Whereas a study showed that complex algorithms and control strategies for night cooling ventilation did not perform better than simple ones [14], and the setting of control parameters for a strategy was more important than the control strategy itself [15]. Therefore, it is essential to explore the energy usage and thermal performance of different mixed-mode ventilative cooling systems based on different control parameters.

The main factor for an operational control strategy of ventilative cooling system is the thermal comfort of the occupants [16]. Indoor dry-bulb air temperature is the primary factor affecting perceived thermal comfort and has been extensively used in practice as the main control parameter of ventilation system [17–19], which is easier to achieve with control system for ventilative cooling system due to the small size and economic of temperature sensors. Williamson et al. [20] found that the indoor dry-bulb air temperature had the highest correlation with thermal sensation vote in natural ventilation buildings, confirming that it could be used as an indicator of thermal comfort. Our research group had demonstrated that the combined operation of controlled natural ventilation and air conditioning systems based on indoor dry-bulb air temperature control could lead to an energy-saving rate of 13.5%–55.6% in different climatic zones [21].

However, the indoor dry-bulb air temperature is not fully reflective of the occupants' thermal comfort. For instance, the difference between the average indoor radiant temperature and the indoor dry-bulb air temperature reaches 1.5 °C–3 °C considering the influence of solar radiation [22–24]. To address this issue, the operative temperature has been widely used, appearing in various regulatory documents and standards for assessing thermal comfort. Turhan [25] investigated experimentally that the heating, ventilation, and air conditioning (HVAC) system based on operative temperature control showed better thermal comfort with a slight increase in energy consumption in two office rooms located in Turkey. Jain et al. [26] used the operative temperature and indoor dry-bulb air temperature as thermostatic control parameters for HVAC systems. The annual cooling energy consumption was found to increase by 29.5% for clear glass windows and 14.12% for high-performance windows in high glazed buildings located in India, when the operative temperature was used in that case. However, the differences between operative temperature and indoor dry-bulb air temperature have not been explored in mixed-mode ventilation systems.

Thermal comfort is a comprehensive physiological response to the environment with certain subjective perceptions. Predicted mean vote (PMV) is an indicator combining subjective and objective factors. The PMV-based HVAC control can provide better thermal comfort than temperature-based control [23,27]. However, both the field measurement analysis [28] and the ASHRAE global thermal comfort database analysis [29] demonstrated that the usage of PMV to assess ventilative cooling in mixed-mode was inadequate in describing human comfort, which would overestimate dissatisfaction by more than approximately 15%–25%. The main deviation occurred in the natural ventilation mode, where the difference between thermal sensation vote and PMV may exceed 2.5 scales [30]. Unlike other researchers, Cheung et al. [29] analyzed that the accuracy of PMV in predicting thermal comfort was similarly low for air-conditioned, naturally ventilated and mixed-mode buildings, and the it varied strongly among ventilation strategies, building types and climate groups. Occupants' actual thermal sensations in free-running buildings in China have been identified as being different to those used to produce the international standards [31]. Yao et al. [32] proposed the adaptive PMV (aPMV) in free-running buildings by combining the advantages of the thermal equilibrium theory and the adaptive theory. The adaptive coefficient was used to correct the deviation of the PMV method. The aPMV model took into account factors such as culture, climate, social, psychological and behavioral adaptations that had an impact on the sense used to detect thermal comfort. The aPMV has been employed for the thermal comfort evaluation in Chinese standard GB/T 50785 [33]. Based on the aPMV model, Zhang et al. [34] proposed an aPMV with a variable adaptive coefficient (arPMV), and the adaptive coefficient was a function of PMV, thermal sensation vote, and ambient temperature. Compared with the aPMV, the proposed arPMV reduced the mean absolute error in the thermal sensation prediction by 24.8%–62.3% and improved the robustness in the thermal sensation prediction by 56.6%–75.4%. However, the requirement of sizeable databases for function fitting limits its development. For mixed-mode building, the aPMV model has not been proven to be applicable as a control parameter.

Differ from the adaptive PMV, many field measurements showed that, for mixed-mode buildings in summer, the sensation is not influenced by indoor air temperature, but by outdoor air temperature [35–37]. This is so-called adaptive comfort theory, which considers that the optimal indoor operative temperature for occupants who are able to interact with the building and its devices relates

primarily to the outdoor environmental conditions [38]. The adaptive thermal comfort model (ATC) has been derived from regression analyses of rigorously quality controlled thermal comfort field research databases. Most studies on mixed-mode buildings have used adaptive thermal comfort model, especially for the upper limits [39]. Aguilera et al. [40] found that using the upper limits of ATC zone in the mixed-mode buildings showed nearly 20% more energy-saving and fewer switchovers between operation modes in hot and humid climate zones, compared with the upper limits of the PMV-based comfort zone. Maryam et al. [41] suggested that the ATC model is more suitable and applicable for semi-manually and manually controlled mixed-mode buildings based on thermal sensation investigations. In automatically controlled mixed-mode building, occupants are not consciously aware of which mode the building was operating, and the comfort temperature is less correlated with outdoor temperature conditions. From the above studies, the research results on various control parameters are variable, and there is no consensus on which thermal comfort criteria should be used to control and assess mixed-mode ventilative cooling system [39]. Uncertainty selection of various models will inevitably lead to differences between the thermal comfort and energy performance of the mixed-mode ventilative cooling system.

The thermal comfort is not the only consideration for mixed-mode ventilation system. The IAQ can also exert significant influences on satisfaction and work productivity of the occupants. The overall productivity performance can be decreased by 1.1% or more for every 10% increase in dissatisfaction with IAQ [42]. For office buildings, the main air pollutants include carbon dioxide (CO₂), particulate matter 2.5 (PM_{2.5}), formaldehyde, and volatile organic compounds (VOCs). For long-time renovated buildings, the indoor emission of VOCs and formaldehyde can be ignored. Outdoor PM_{2.5} will be the representative of the main outdoor pollutants, and it can be treated with indoor air purification equipment or simple filters installed at the outdoor air inlet. The CO₂ concentration level can also be regarded as the most important indicator to represent IAQ level in spaces where occupants are the major pollutant source.

Although above-mentioned studies have already investigated control strategies for ventilative cooling system using indoor dry-bulb air temperature, operative temperature, PMV, and ATC, respectively. However, there is no comprehensive comparison for investigating the effects of these thermal comfort and IAQ control parameters acting simultaneously on the ventilative cooling system. In practice, both of these objectives need to be satisfied during the cooling period, and the thermal comfort- and IAQ-based ventilation controls interact with each other, resulting in variations in building energy consumption. In addition, few studies have been found in the existing literature to compare the different levels of ventilation forms for building cooling considering different control parameters.

Based on these, this study will conduct a comprehensive performance evaluation of ventilative cooling systems with different control parameters and strategies. The innovations of this study mainly include: 1) examining the effects of different CO₂ control strategies on the performance of ventilative cooling systems by the settings of CO₂ concentration to provide a specific reference for IAQ control methods; 2) assessing the differences in thermal comfort control parameters dedicated to various ventilative cooling systems and offering recommendations for optimal control strategies for nudging ventilative cooling practices; 3) comparing the thermal comfort and energy consumption of different levels of ventilative cooling systems for each climatic zone in China and provides a reference for designers and practitioners to make decisions on specific ventilative cooling systems.

2. Methods

The overall research method and framework are summarized in Fig. 1, which covers the following steps:

Step 1: A typical office model equipped with three different ventilative cooling systems was setup for the analysis. The location of the office was assumed to be the five representative cities in the five major climatic zones of China.

Step 2: Four common thermal comfort parameters and the IAQ parameter (CO₂) were selected as co-control parameters for the three ventilative cooling systems. The upper limit of the thermal comfort zone of 90% of occupants' satisfaction and the upper limit

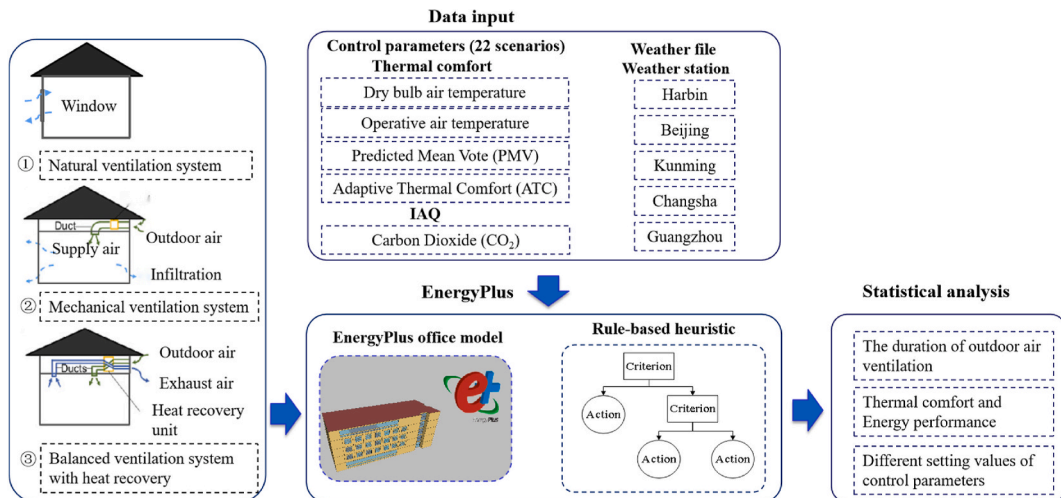

Fig. 1. Ventilative cooling systems, EnergyPlus input, and analysis workflow.

of CO₂ concentration of 1000 ppm were used as the control parameter values. These were fed into the rule-based heuristic control program, which was implemented by the energy management system of EnergyPlus.

Step 3: The thermal comfort and IAQ performance were evaluated using the percentage outside range (POR) method. The calculated electrical power consumption was used to evaluate the energy performance.

Step 4: Finally, 22 scenarios with different control parameter settings were designed and 210 simulations were carried out to discuss the influence of control parameters on the ventilative cooling system in different climatic zones.

2.1. The building model and environmental data

In this study, five typical cities located in five different climatic zones of China were selected for the performance analysis of different ventilative cooling systems, i.e., Harbin, Beijing, Changsha, Guangzhou, and Kunming, which are representatives of severe cold (SC) zone, cold zone, hot summer and cold winter (HSCW) zone, hot summer and warm winter (HSWW) zone and mild zone, respectively. A typical five-story office building was selected and simulated using representative meteorological year weather parameters in different climatic zones, as shown in Fig. 2. The climate in China varies considerably, and the design of building envelope structure in each zone should be adapted to local conditions. The heat transfer coefficients of envelopes, solar heat gain coefficients (SHGC) of windows, and the parameters related to internal loads were set according to the general code (i.e., GB 55015-2021) for energy efficiency and renewable energy application in buildings [43]. Table 1 shows the detailed input parameters for buildings in five climate zones, which were set in the EnergyPlus simulation.

Only energy usage and indoor thermal comfort results for the north-facing office room in the middle of the fourth floor were used, which excluded the thermal effects from the roof, ground, and additional external wall exposure [12]. The selected room, with the dimensions of 6 m (length) × 4 m (width) × 3.8 m (height), was assumed to be occupied from 8:00 to 18:00 during the cooling period. The cooling period of simulation was set as from May 1 to October 8.

This study investigated the performance of a mixed-mode ventilative cooling system with various outdoor air ventilation methods:

- (1) AW: window-opening ventilation and air conditioning (AC). The area of the openable window is 1.2 m² in this case, in compliance with the Chinese standard for design of office building [44].
- (2) AF: constant ventilation rate mechanical ventilation (5 air changes rate per hour) and AC. The air change rate was determined by the internal heat [15,45].
- (3) AB: balanced ventilation system with heat recovery and summer bypass (5 air changes rate per hour), and AC. The nominal heat recovery efficiency of the system for sensible heat is 76%.

Numerous studies have already demonstrated the effectiveness of EnergyPlus as one of the most preferred building performance simulation tools for simulating the thermal behavior of mixed-mode ventilation and its energy consumption [39]. This physical-based, research-grade energy analysis and thermal load modeling program have been tested and validated over the past few decades [46–48]. For instance, Neves et al. [49] experimentally verified that the operative temperature of an office with spontaneous controlled mixing ventilation simulated using EnergyPlus matched well with the measured operative temperature. Belmonte et al. [50] calibrated the IAQ performance of the EnergyPlus building model by field experiment in a naturally ventilated residential building. In previous study, Tang [51] measured the indoor air temperature of the same office room with manually controlled ventilation on October 26, 28, and 30, 2020, and used EnergyPlus to validate the simulations. The indoor air temperature variation obtained from the simulations matched well with the experimental data, indicating that the building energy model could be used for further energy simulation studies on behalf of the original building. In summary, it was deemed that the results obtained from the building model could provide a suitable estimation of the physical behavior of a real building with equivalent characteristics.

In this study, the energy management system in EnergyPlus was used to implement the custom rule-based heuristic control strategies based on various control parameters. The hourly weather data for each city used in this study was China Standard Weather Data (CSWD) developed by China Meteorological Bureau-Climate Information Center-Climate Data Office and Tsinghua University-Department of Building Science and Technology [52]. In Fig. 3, the hourly average outdoor dry-bulb air temperature was provided

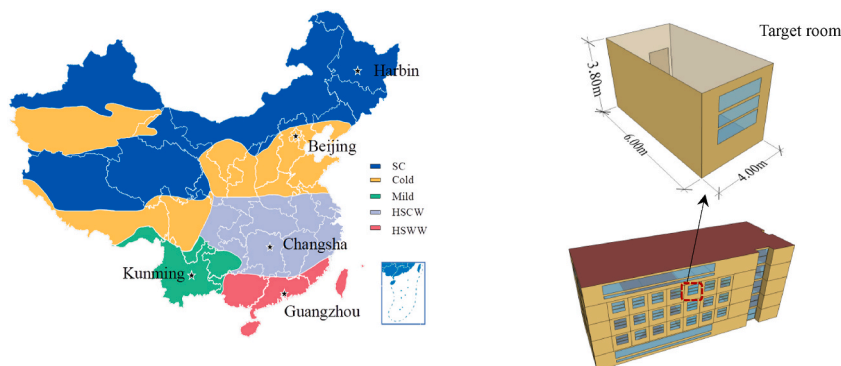

Fig. 2. The locations of the selected cities and target building model.

Table 1

The detailed input parameters of the simulated building in five climatic zones via EnergyPlus (0.20 < window-wall ratio <0.30).

Climatic zones	Envelope detail			Internal load		
	Heat transfer coefficient (W/(m ² ·K)) [43]		SHGC [43]	Occupancy density (m ² /person)	Lighting density (W/m ²)	Equipment density (W/m ²)
	Wall	Window	Window			
SC	0.35	2.3	0.48	6	13	13
Cold	0.5	2.5	0.48			
Mild	1.5	4.0	0.40			
HSCW	0.8	2.6	0.40			
HSWW	1.5	3.0	0.35			

for all the analyzed cities. Outdoor CO₂ concentration was assumed to be 400 ppm [53]. The time step for EnergyPlus simulation was 5 min.

2.2. Evaluation method for environmental and energy performance

An indicator of indoor environmental performance, i.e., the percentage outside range (POR) as proposed in the CEN/TR 16798-2:2019 standard [54], was analyzed in particular. The POR is dimensionless and represents the sum of occupancy times for which the thermal comfort parameter exceeds the defined thermal comfort value, divided by the sum of room occupancy times, as presented in Eq. (1).

$$POR = \frac{\sum timestep_{occ,ei>ei_{ul}}}{\sum timestep_{occ}} \tag{1}$$

Where *ei* represents an evaluation indicator of thermal comfort; *ei_{ul}* represents the upper limit value of the evaluation indicator; $\sum timestep_{occ}$ is the sum of room occupancy times.

Herein, the percentage of overheating period can be calculated by using the POR equation to evaluate the effects of ventilative cooling. It was recommended that PMV should lie between -0.5 and 0.5 to ensure indoor thermal comfort, and the corresponding predicted percentage of dissatisfied (PPD) was less than 10% [55]. In the ATC model, 90% acceptable comfort ranges meant that 10% of occupants were still dissatisfied with such a temperature range [55]. The comfortable indoor air temperature of an office in China was designed to operate within the range of between 24 °C and 26 °C [44]. This temperature range was assumed to be unsatisfactory for 10% of the population in this study. The upper limits of these thermal comfort models can be determined as the trigger points for mechanical cooling, as well as the cut-off points for evaluating the overheating performance. In this study, this was defined as a method-oriented control of the ventilative cooling system.

The POR indicator can also be used to evaluate the IAQ level, and the upper limit can be set at 1000 ppm. A good IAQ level was defined as the indoor CO₂ concentration below 1000 ppm over more than 90% of the occupied time [56].

Energy performance was evaluated by calculating the amount of electricity consumed of ventilative cooling system. A chain type window opener with a rated power of 50 W per operation was considered for window opening. In order to compare to natural ventilation without filtering effect and to exclude the influence of a filter on the energy consumption, both AF and AB systems did not consider the filtering device. The nominal pressure drop of constant air volume mechanical ventilation fan was about 120 Pa, and the rated power was 0.050 kW. The balanced ventilation system with heat recovery considered two fans (supply and exhaust), and the nominal pressure drop of the heat recovery core was about 90 Pa [57]. Therefore, the nominal pressure drop was about 200 Pa, and the rated power was 0.120 kW.

2.3. Control strategies for ventilative cooling

The rule-based heuristic control strategy aims to maximize the exploitation of the cooling potential of outdoor air and maintain an acceptable level of IAQ and thermal comfort. The widely used control parameters of thermal comfort of a space created by ventilative cooling system, namely, indoor dry-bulb air temperature (*T_d*), indoor operative temperature (*T_{op}*), PMV and ATC were considered. In the *T_d*, *T_{op}*, and ATC-based control systems, the outdoor air ventilation system was activated when the indoor air temperature (*T_{in}*) was higher than the upper limit of temperature (*T_{set,u}*) and the outdoor air temperature (*T_{out}*) was 2 °C [46] lower than *T_{set,u}* or when *T_{in}* was in the set-point range between the upper limit of temperature (*T_{set,u}*) and the lower limit of temperature (*T_{set,l}*). Additionally,

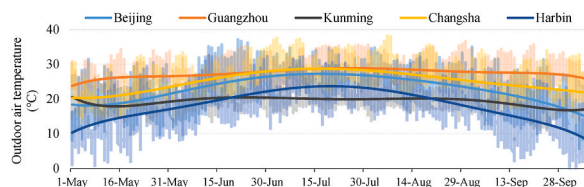

Fig. 3. Hourly average outdoor air temperature of the selected five cities.

when mean CO₂ concentration was above 1000 ppm, the outdoor air ventilation system was activated to dilute indoor air pollutants. The control block schematic diagram of ventilative cooling system can be seen in Fig. 4. In the PMV-based control system, T_{in}, T_{set,u} and T_{set,l} in the blue boxes were replaced by the corresponding PMV, but the condition in the orange box differed from the other three ventilative cooling systems. If the trigger air temperature set-point for AC operation was inversely calculated from the PMV, the calculation cost would be considerable [58]. The boundary conditions for this calculation were as follows: human metabolic rate of 1.2 Met, thermal resistance of clothing of 0.5 clo, indoor air velocity of 0.25 m/s, relative humidity assumed to be 100% in the extreme case, and average radiant temperature assumed to be 26 °C with an average difference of 2 °C [22–24] from the indoor dry-bulb air temperature. In this case, the PMV value was close to 0, and as long as the outdoor air temperature was lower than the indoor air temperature at this time, it could be considered that outdoor air had the cooling potential. Then, the condition in the orange box was replaced by T_{out} ≤ 24 °C.

In the T_d- and T_{op}-based control systems, T_{set,u} and T_{set,l} were set to 26 °C and 22 °C, respectively. In the PMV-based control system, the upper and lower limits of PMV were 0.5 and -0.5, respectively. The used comfort model in the ATC-based control system in this study was from ASHRAE 55, as seen in Eqs. (2) and (3) [55], which has been validated in previous studies [35–37]. When $\overline{T_{pma(out)}}$ was between 10 °C and 33.5 °C, the outdoor air temperature was suitable for ventilative cooling in this situation, and the control program implemented the above block schematic diagram. When $\overline{T_{pma(out)}}$ was outside of this range, the outdoor air temperature was not suitable for ventilative cooling. Once the T_{in} exceeded 26 °C, the AC system was activated. If the CO₂ concentration exceeded 1000 ppm, the AC and outdoor air ventilation were turned on simultaneously.

$$\text{Upper 90\% acceptability limit (}^\circ\text{C)} T_{set,u} = 0.31 \cdot \overline{T_{pma(out)}} + 20.3 \quad 10^\circ\text{C} \leq \overline{T_{pma(out)}} \leq 33.5^\circ\text{C} \quad (2)$$

$$\text{Lower 90\% acceptability limit (}^\circ\text{C)} T_{set,l} = 0.31 \cdot \overline{T_{pma(out)}} + 15.3 \quad 10^\circ\text{C} \leq \overline{T_{pma(out)}} \leq 33.5^\circ\text{C} \quad (3)$$

Where $\overline{T_{pma(out)}}$ is the prevailing mean outdoor air temperature, which was based on no fewer than 7 and no more than 30 sequential days prior to the day in question. $\overline{T_{pma(out)}}$ is a simple arithmetic mean of all of the mean daily outdoor air temperatures of all the sequential days [55]. In this study, 7 sequential days prior to the day in question with relatively large temperature fluctuations were considered [38].

To analyze the set-points of thermal comfort and the IAQ control parameters, a series of ventilation scenarios based on different control parameters were created, as shown in Table 2. There were 22 scenarios for each form of ventilative cooling system in this study.

3. Results and discussions

This section discusses the relationship between CO₂ trigger concentration, ventilative cooling system start-up frequency and energy usage. The outdoor ventilation times, energy usage and thermal comfort performance are compared under different scenarios. The influence of different settings of thermal comfort control parameters on energy usage and thermal comfort performance is analyzed,

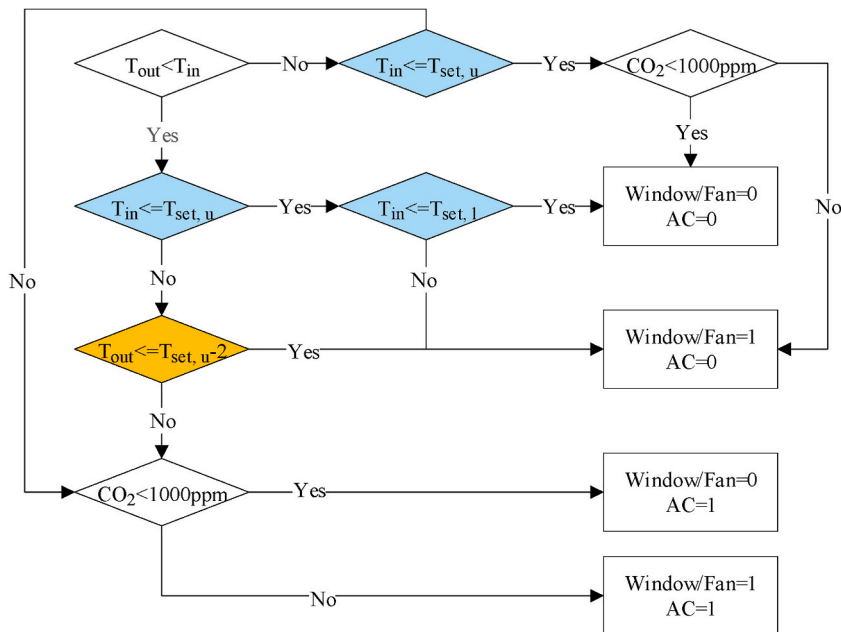

Fig. 4. Block-schematic diagram of ventilative cooling system. (0 and 1 indicate actuation states of closed/off and open/on, for window (fan) and AC operation, respectively. T_{set,u} and T_{set,l} indicate the upper and lower limits of cooling set-point, respectively.).

Table 2
Ventilation scenarios and key trigger control parameters.

Categories	IAQ (CO ₂)	Thermal comfort
Category I	1-h running mean concentrations: 800, 900, 1000, 900-800, 900-700, 900-600 ppm = (6 scenarios)	T _d : 24 °C = (1 scenario)
Category II	5-min running mean concentrations: 1000, 1000-900, 1000-800, 1000-700 ppm = (4 scenarios)	
Category III	5-min running mean concentration: 1000 ppm = (1 scenario)	T _d : 24, 25, 26 °C = (3 scenarios)
Category IV		T _{op} : 24, 25, 26 °C = (3 scenarios)
Category V		PMV: 0, 0.3, 0.5 = (3 scenarios)
Category VI		ATC1-3: T _{set,u} , T _{set,u} -0.5, T _{set,u} -1 °C = (3 scenarios)

and the discrepancies of energy usage for the same thermal comfort performance are compared across different zones. The findings can provide the valuable references for the selection of ventilative cooling forms and the corresponding control parameters for each climatic zone in China.

3.1. Determination of control parameters for IAQ

The CO₂ concentration level, which is associated with human metabolic pollutants, is considered as the IAQ control parameter. The commonly used control strategy in CO₂-based demand control ventilation system is a fixed set-point [59], or interval control method [60]. However, whether the setting of CO₂ concentration is controlled by instantaneous concentration or by mean concentration over a period of time, i.e., the time scale of set-point directly affected energy usage and the IAQ performance of ventilation system.

The mean concentration control at different time scales has been considered in various studies [61–63]. There are no guidelines for set-points and time scales of CO₂ concentration. In the following study, energy usage and start-up frequency of different ventilative cooling systems will be analyzed at different settings of CO₂ concentration. These trigger concentration settings (Category I, II) are defined in Table 2. The window is opened or the fan is turned on at the upper limit of CO₂ concentration, and the window is closed or the fan is turned off at the lower limit in interval control method. Changsha located in the HSCW zone is chosen to explore the performance of the system at various CO₂ concentration settings.

Fig. 5 shows the PORs of CO₂ concentration with different settings in ventilative cooling system. When the 1-h running mean trigger CO₂ concentration is 1000 ppm, the PORs of CO₂ concentration for all the systems does not meet the requirement of acceptable IAQ.

The dimensionless method is used to compare the energy usage and ventilative cooling system equipment start-up frequency under different categories. All the calculated datasets are based on the case of AW system (1-h running mean concentration is 900 ppm), as it has a POR of nearly 10% for CO₂ concentration. In all cases, the start-up frequency of the AC system varies within 6%, indicating that the variation of IAQ performance has a very little impact on the operation of AC system. But some disparities in the start-up frequency of outdoor air equipment are observed based on different CO₂ concentration set-points.

Ensuring PORs above 90% for CO₂ concentration and indoor air temperature, different mean concentration set-points of all cases result in the variation of 24.5%, 16.4%, and 13.3% in energy usage for the AW, AF, and AB systems, respectively. Thus, the CO₂ concentration setting should be considered carefully due to the large difference in energy usage. Fig. 6 (a) presents the energy usage and start-up frequency of ventilation equipment with 1-h running mean CO₂ concentrations at different set-points. The higher set-point for CO₂ concentration, the less energy is used and the more frequently outdoor air equipment is activated. The frequent start-up operations will result in durability problems of the outdoor air system.

The start-up frequencies of outdoor air equipment decrease by 8.3%, 1.1% and 3.0% from the case of 1000 ppm to the case of 800 ppm in AW, AF and AB system, respectively. The corresponding energy usage increases by 14.3%, 13.0%, and 7.3%, respectively. The start-up frequencies of outdoor air equipment decrease by 30.4%, 19.0% and 17.3% from the case of 900-800 ppm to the case of 900-

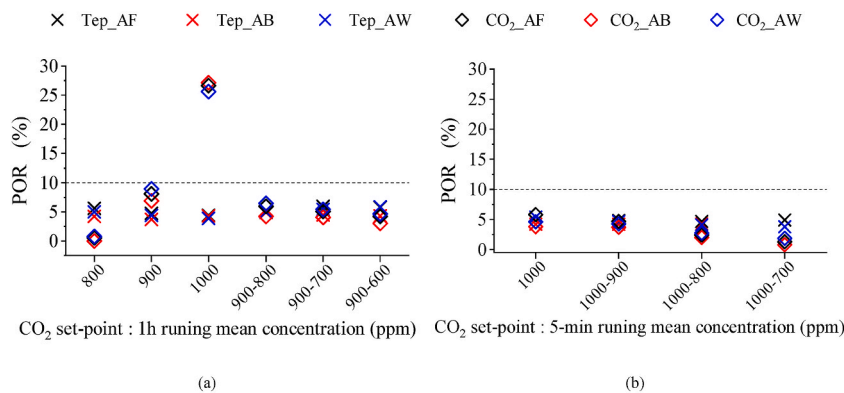

Fig. 5. PORs of CO₂ concentration and indoor dry-bulb air temperature for different ventilative cooling systems with the different set-points of CO₂ (Tep indicates the indoor dry-bulb air temperature at 24 °C).

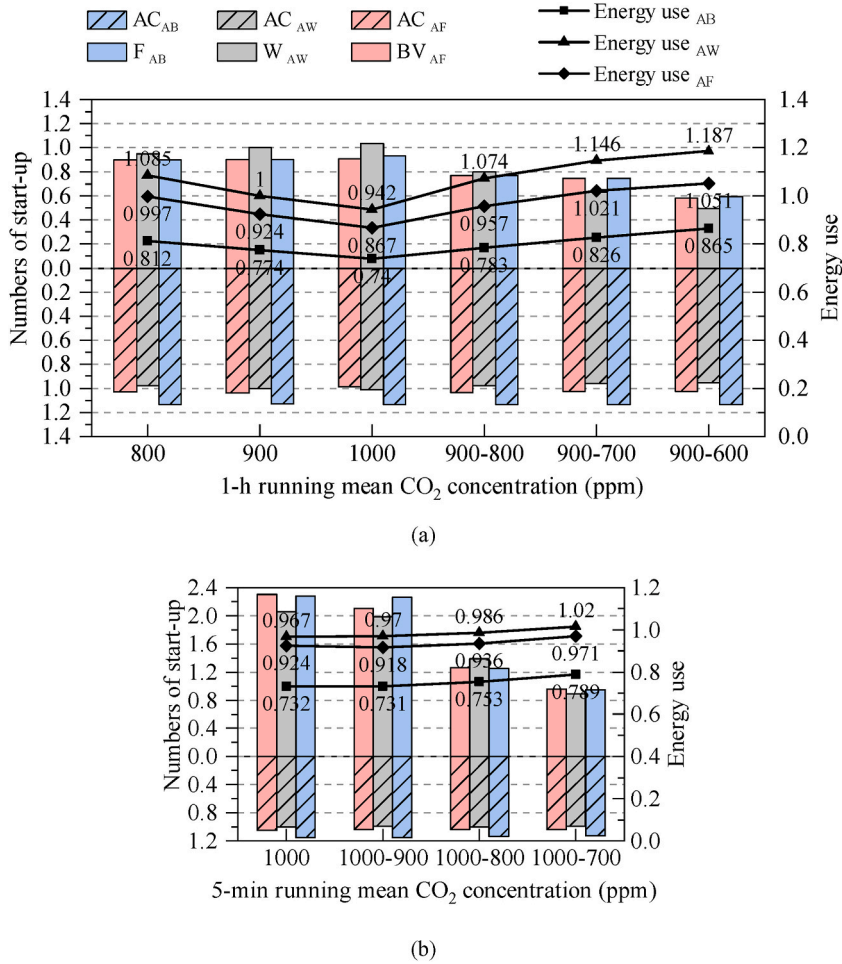

Fig. 6. Energy usage and start-up of ventilative cooling system equipment with the different set-points of CO₂. (The bar chart represents the ratio of the start-up numbers of ventilative cooling system at different set-points to that of the AW system with a 1-h running mean concentration of 900 ppm).

600 ppm in AW, AF, and AB system. The corresponding energy usage increases by 11.3%, 9.4%, and 8.2%, respectively. The above data clearly indicates that when 1-h running mean concentration is taken as the control parameter of IAQ, the interval control method has the lower start-up frequency of outdoor air equipment under the condition of equivalent energy-saving effectiveness, compared to the fixed set-point control. The most energy-efficient control parameter in Changsha (HSCW) is the fixed set-point with 1-h running mean concentration of 900 ppm.

Fig. 6 (b) presents the energy usage and start-up frequency of ventilation equipment with 5-min running mean CO₂ concentrations at different set-points. Compared to the energy usage of 1-h running mean concentration, the overall energy usage can be reduced. The short-term running mean CO₂ concentration can be determined as a control parameter to further diminish energy usage without considering the effect of start-up frequency. As can be seen from the trends, there may be a certain range between 1000-800 ppm and 1000-700 ppm, where the energy usage is basically the same as that of 1-h running mean concentration of 900 ppm and the frequency of outdoor air equipment differed little. Therefore, the same control frequency and energy usage can be achieved by long-term fixed set-point control and short-term interval control.

To be more energy efficient, the CO₂ control parameter can be determined to be a short-term running mean concentration. The set-

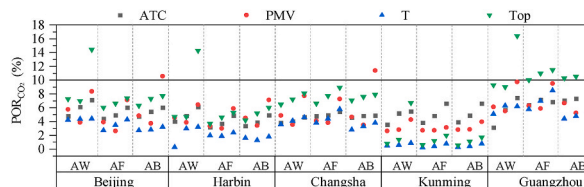

Fig. 7. PORs of CO₂ concentration for ventilative cooling system under different thermal comfort control parameters in the selected five cities.

point can be determined by the maximum allowable limit, which is 1000 ppm in this study. Fig. 7 shows the PORs of CO₂ concentration for the cases of Category III-VI in the selected five cities. In 10 out of 180 cases, the PORs for CO₂ concentration exceed 10%, and they are mainly the systems based on T_{op} control in hotter cities (Guangzhou). This is due to the difference in ventilation flow rate based on different control parameters related to thermal comfort. If CO₂ concentration is kept within the target range, the CO₂ concentration control settings for different control strategies should be determined on a case-by-case basis. However, the focus of this study is primarily on the comparison of different control parameters related to thermal comfort, and the CO₂ concentration set-points for each climatic zone will not be discussed in detail. For comparison purposes, the CO₂ trigger concentration is set at 5-min running mean concentration of 1000 ppm for all climatic zones.

3.2. The duration of outdoor air ventilation

The duration of outdoor air ventilation can reflect the utilization of outdoor air-cooling potential and IAQ. The outdoor air ventilation duration of three ventilative cooling forms in the selected five cities are illustrated in Fig. 8.

The maximum difference between the daily average duration of outdoor air ventilation based on T_d and T_{op} is only 0.3 h. Since the solar radiation is relatively weak when outdoor air shows potential for ventilative cooling, and there is no significant difference found between T_d and T_{op}. Whereas, a higher outdoor air temperature leads to an increase in the discrepancy between T_d and T_{op}, and there is no ventilative cooling potential. The daily average duration of outdoor air ventilation for various ventilative cooling forms based on T_d and T_{op} were 2.8, 4.8, 4.9, 6.1, and 7.7 h in Guangzhou, Changsha, Beijing, Harbin, and Kunming, respectively. It can be seen that Guangzhou (HSWW) has the least ventilative cooling potential. In the other cities, ventilation is carried out almost close to more than half of the time. This can be explained by the fact that the cooling potential of ventilative cooling based on T_d or T_{op} is directly related to the outdoor air temperature.

In all climatic zones, the ATC-based system shows a longer outdoor air ventilation duration than other control parameters, due to its wider thermal comfort temperature range. Compared to other indexes, the maximum difference of average outdoor air ventilation duration based on ATC control in Guangzhou, Changsha, Beijing, Harbin, and Kunming are 1.6, 1.5, 1.4, 1.1, and 0.5 h per day, respectively. Obviously, using the ATC as a control parameter in hotter areas, will allow for greater use of outdoor air-cooling resources, which also has greater potential for energy-saving. But in Kunming (mild), the ATC model does not show a better potential for

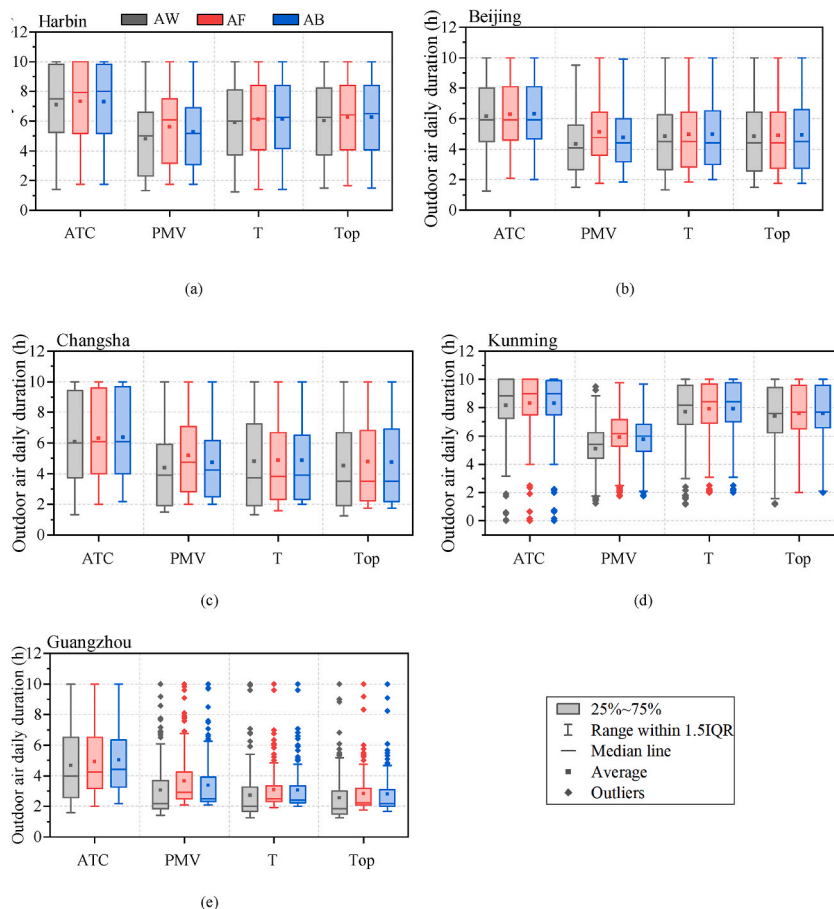

Fig. 8. The daily duration of outdoor air ventilation under different thermal comfort control parameters in the selected five cities.

utilizing outdoor air-cooling resources than other control parameters. Fig. 9 shows the upper limit of ATC model for the selected five cities compared to 26 °C. In Kunming, the upper limit of ATC model is around the control line of operative temperature (26 °C), and the average temperature is 26.3 °C with a small deviation of 0.65 °C from 26 °C. Therefore, the ATC-based system does not have more advantages in ventilative cooling period compared to the temperature-based system.

For the T_d , T_{op} , and ATC control parameters, the duration differences between these outdoor air ventilation systems are minimal. The location with the maximum daily duration of outdoor air ventilation difference is found in Guangzhou (HSWW) with 0.2–0.4 h. However, the difference based on PMV-based control is relatively obvious among the three ventilative cooling systems. The window-opening ventilation duration with high ventilation rates is the shortest, followed by the balanced ventilation system with heat recovery, and the longest is the mechanical ventilation. If the PMV is 0.5, then the operative temperature at this time is 26.3 °C when the relative humidity is 100%. In other words, when the upper limit of PMV-based control is 0.5, the trigger operative temperature is at least 26.3 °C. Theoretically, the higher temperature in PMV-based control could result in longer ventilation duration than those of T_{op} - and T_d -based control system. However, this phenomenon is only observed in Guangzhou (HSWW), with the highest daily average outdoor air temperature. It is found that the lower the average outdoor air temperature is, the shorter the outdoor air ventilation duration for the PMV model compared with T_{op} . Especially in Kunming (mild), the outdoor air ventilation duration of PMV-based control system is even significantly lower than that of T_{op} - and T_d -based control system. The reason for this is the effect of the lower limit of control system, when PMV reaches -0.5 and the operative temperature at least is 23.2 °C, the outdoor air equipment is shut down to prevent over-cooling. Whereas, the outdoor air equipment is closed when the temperature drops to 22 °C in the T_{op} - and T_d -based control ventilative cooling system.

3.3. Energy performance

Fig. 10 summarizes the cooling energy usage per unit area of ventilative cooling system under different thermal comfort control parameters. In the areas with low daily average outdoor air temperature, such as Harbin (SC) and Kunming (mild), the most suitable system for outdoor air supply is the window-opening ventilation due to the lowest energy usage. If a mechanical ventilation system is used to introduce outdoor air for cooling, occurrences of energy usage are seen in these two cities that increased by 6.9%–30.2% and 44.7%–98.3%, respectively. Also, it is absolutely unnecessary to operate a balanced ventilation system with heat recovery during the cooling period because of the ultra-high energy usage in these two cities. Moreover, data analysis of Fig. 3 shows that the outdoor air temperatures in Harbin and Kunming are below 26.1 °C and 23.5 °C for at least 90% cooling period, and there is almost no heat recovery potential. In Kunming, the most energy-efficient control parameter for the window-opening ventilation is PMV. From Section 3.2, although the outdoor air ventilation duration based on PMV is the shortest, the overheating period is the shortest as can be seen in the next Section 3.4, and the energy usage is the lowest. In Harbin, the most energy-efficient control parameter for the window-opening ventilation is T_d , followed by PMV, and it can be seen that the ATC model with a wide range of comfort temperatures doesn't show its energy-saving advantage. The main reason for the non-energy saving is that in areas with low outdoor air temperatures, half of the comfort zone is below 26 °C.

For Beijing (cold) with moderate daily average outdoor air temperature during the cooling period. Except for the ATC model, the difference in energy usage of other thermal comfort control parameters of various ventilation forms is non-significant, ranging from 5.2% to 6.4%. Generally, there is still more energy-saving for the window-opening ventilation. The most energy-efficient control parameter is T_d , followed by ATC which consumes about 13.3% more energy. When ATC model is used, the difference in energy usage of these three ventilative cooling forms reaches 13.0%.

For Guangzhou (HSWW) with the highest daily average outdoor air temperature during the cooling period, which is suitable for the balanced ventilation system with heat recovery due to the lowest energy usage. It shows lower cooling energy-savings by 6.9%–21.7% and 9.5%–20.3% compared with the AW and AF system, respectively. Because the average outdoor air temperature during the cooling period is 27.4 °C, and more than 25% of the time is higher than 29.5 °C, which is a certain gap from the comfortable indoor air temperature. This indicates that the energy-saving from the larger potential for heat recovery can offset the energy consumption generated by the heat recovery system. If the balanced ventilation system with heat recovery is not installed for initial investment or other reasons, the selection of opening windows or turning on fans will result in different levels of energy usage for different thermal comfort control parameters. For example, the AF system operation leads to 1.8% and 8.7% lower energy-savings when compares to the AW system in the T_{op} - and T_d -based control ventilative cooling system. The main reason is the increase of AC energy usage caused by hyperventilation produced by the window-opening ventilation, which can be obtained from Fig. 13. On the contrary, using the PMV and ATC control parameters, the AW system performs 2.2% and 2.8% lower energy-savings compared to the AF system. From Fig. 8 in Section 3.2, the observed outdoor air ventilation duration when PMV and ATC are taken as control parameters are longer than that when T_{op} and T_d are taken as control parameters. If mechanical ventilation is used, this will inevitably result in a large amount of fan

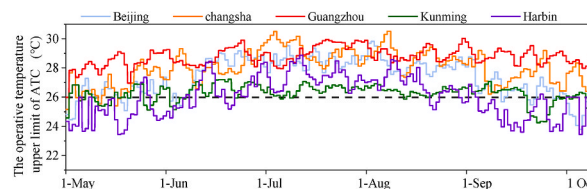

Fig. 9. The upper limit of ATC model (operative temperature) in the selected five cities.

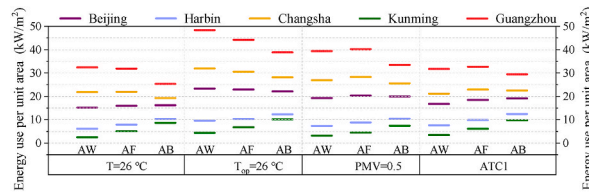

Fig. 10. Cooling energy usage per unit area of ventilative cooling system under different thermal comfort control parameters in the selected five cities.

energy being used.

For Changsha (HSCW), a similar pattern in energy performance is presented. The energy usage of ventilative cooling systems with constant ventilation rate mechanical ventilation is only increased by 4.4%–8.6% compared to the window-opening ventilation. Therefore, the mechanical ventilation is also a desirable approach to introduce outdoor air. The balanced ventilation system with heat recovery operation can save energy by 1.8%–12.2% to further reduce energy consumption compared to the window-opening ventilation. Different from Guangzhou (HSWW), the energy usage of the balanced ventilation system with heat recovery is greater than that of the window-opening ventilation when ATC is used as the control parameter. It can be explained by the limited energy-saving potential of heat recovery in this climatic zone, which is insufficient to offset the power consumption of the mechanical ventilation consumed by the introduction of large amounts of outdoor air. The result suggests that when the control parameter is the ATC model, the recommended ventilative cooling method in Changsha is the window-opening ventilation.

For the ventilation forms in Guangzhou (HSWW) and Changsha (HSCW), the most energy-efficient control parameter is the ATC model for the window-opening ventilation, while for the other two forms of ventilation, the most energy-efficient control parameter is T_d rather than ATC. The main reason is that the longer outdoor air ventilation duration based on the ATC model increases the energy usage, and outweighs the energy-saving benefits of ventilative cooling.

In summary, the mixed-mode ventilative cooling system has obvious climate adaptability, and the most energy-saving ventilative cooling form is related to the local climate conditions and the selection of thermal comfort control parameters. In particular, the ATC model is not always the most energy-efficient control parameter despite its wider comfort zone, and it depends on outdoor climatic conditions and the form of ventilative cooling. If combining the ATC model with the fixed operative temperature model, eliminating the lower temperature zone of the ATC model and keeping the higher temperature zone is an effective way to show the energy-saving advantage of the ATC model. As can be seen from Section 3.2, the outdoor air ventilation duration in different climatic zones is different. If the outdoor air flow rate is considerable, it is necessary to consider carefully whether mechanical ventilation can be used instead of natural ventilation, and whether the exhaust air needs to be heat recovered.

3.4. Thermal comfort performance

Fig. 11 illustrates the corresponding POR performance of ventilative cooling system using the upper limits of thermal comfort models. Guangzhou has the highest percentage of overheating period (26.3%–43.3%), follows by Changsha (25.3%–38.9%) and Beijing (25.1%–36.9%), and Harbin and Kunming have the lowest percentage of overheating period with 11.5%–26.9% and 12.0%–23.1%. Overall, overheating period is related to the average outdoor air temperature, but it is independent of ventilative cooling form.

Only the POR for the case of PMV = 0.5 in Kunming, so PMV is kept below 15%. The T_d mainly affecting PMV is kept at a low value during the cooling period in Kunming, so PMV is easily maintained well below 0.5. These results verify that, on the day with weak solar radiation and low outdoor air temperature, indoor thermal environment can meet the thermal comfort requirement of PMV. In order to reduce the overheating period, this can be achieved by changing the settings of control parameters. The influences of different settings of control parameters on PORs and energy usage are investigated below.

3.5. Different setting values of control parameters

In this section, the trigger value of control parameter is adjusted to a lower value. That is, Category III–VI in Table 2, for a total of 12 scenarios. The PORs and energy usage of different settings in the selected five cities are illustrated in Fig. 12.

As the value of the control parameter settings decreases, the size of the bubbles becomes smaller, which indicates a corresponding reduction in overheating period, and the bubble position indicates a consequent increase in energy usage. The rate of variation in energy usage and overheating period is the greatest for the different ventilative cooling systems based on T_{op} and T_d control, while the rate of variation is relatively flat when the control parameters are set as PMV and ATC. This is attributed to the fact that different

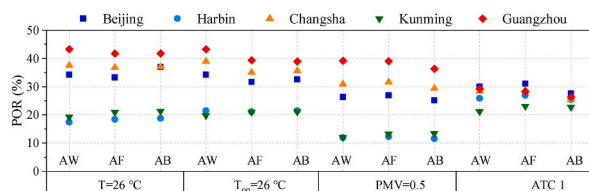

Fig. 11. PORs of ventilative cooling system under different thermal comfort control parameters in the selected five cities.

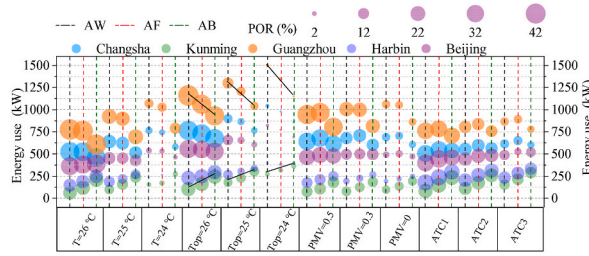

Fig. 12. PORs and energy usage of ventilative cooling system under different settings in the selected five cities. (The bubble size represents the value of POR, and the different colored dotted lines represent different forms of ventilative cooling).

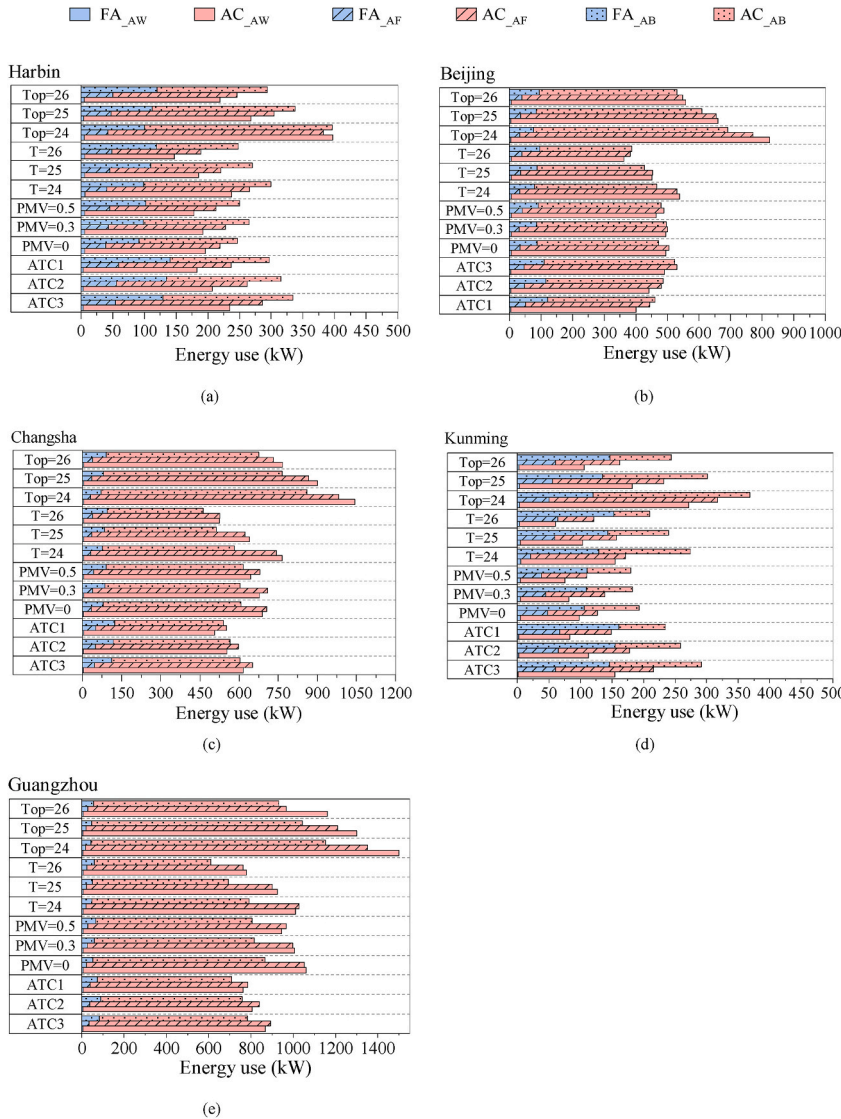

Fig. 13. Energy usage composition diagram of different settings of thermal comfort control parameters in the selected five cities. (FA: the energy usage of outdoor air equipment; AC: the energy usage of mechanical cooling equipment).

temperature variations corresponding to the changes in the values of the control parameters. The greater the variation in the gradient of energy usage (the straight-line segment in Fig. 12), the easier it is to conclude a more energy-efficient and economical ventilative cooling forms. For example, the utilization of heat recovery ventilation is more economical, if the indoor air temperature trigger set-point is 24 °C for Guangzhou (HSWW) and Changsha (HSCW). Nevertheless, in Kunming (mild), the window-opening ventilation based

on 26 °C control has more advantageous for energy-saving. Therefore, when determining the climate adaptability of a ventilative cooling form, it is important to consider not only its thermal comfort control parameters, but also the setting values of its control parameters.

Fig. 13 summarizes the energy usage composition of different settings of thermal comfort control parameters. It can be seen that the energy usage of outdoor air equipment doesn't change significantly with the variation of the settings of specific control parameters, and the great difference is mainly lied in different forms of outdoor air introduction. The average outdoor air temperature becomes lower, the energy usage for mechanical cooling in different forms of ventilative cooling becomes more similar. In the climatic zones with higher average outdoor air temperature, although the energy usage of the outdoor air equipment accounts for a small percentage of the total energy usage, different outdoor air equipment indirectly affects the energy usage of AC system. The difference in mechanical cooling energy usage accounts for a major part of the overall energy usage difference. Although the duration of outdoor air ventilation is not long, the heat recovery system still has a greater impact on the AC system when considering the thermal comfort requirement and IAQ level.

If the target value of POR is set to 10%, the trigger temperature based on T_{op} and T_d control systems should be set to no higher than 24 °C, except for Kunming (mild). The trigger value of PMV should be set at 0. The trigger value of ATC model should be set at ATC 3, but there are still some climatic zones where the POR exceeded 10%. To accurately compare the energy usage of control parameters, energy usage is calculated by interpolation or extrapolation, assuming that the indoor thermal comfort overheating period is controlled at 10% for all control parameters of the ventilative cooling systems, as shown in Table 3. This is defined as target-oriented controlled ventilative cooling system.

For the purpose of exploring the difference of energy usage among the four control parameters, the following comparisons can be made respectively.

- (1) T_{op} vs T_d : Most of the real-world practices of ventilative cooling system are the use of T_d -based control system. There is a difference in actual thermal sensation of these two types of temperature controls, and the energy usage of the three ventilative cooling forms based on T_d control is 16%–38% lower as seen from Fig. 14 (a). The energy usage caused by different ventilative cooling forms is also greatly different under the same control parameter, ranging from 1% to 21%. According to Section 3.3 on the adaptability of ventilative cooling forms, the most appropriate form of ventilative cooling system for a given area has the maximum energy-saving effectiveness.
- (2) T_{op} vs ATC: In previous studies, either the thermostatic control or the comfortable range temperature control (ATC model) was the commonly used control parameter for ventilative cooling system. The ATC-based control system can save the energy from –12% to 37% compared to the thermostatic T_{op} -based control system, as shown in Fig. 14 (b). The ATC-based control system in Harbin (SC) has the lowest overall energy-saving and even non-energy saving. The ATC-based control system in Guangzhou (HSWW) has the highest overall energy-saving. Therefore, it can be concluded that only using adaptive thermal comfort model is not always energy efficient compared to the thermostatic control, especially in mechanical ventilation systems. The main reason for the non-energy saving is the unduly low limit of ATC model.
- (3) PMV vs ATC: In Fig. 14 (c), it can be seen that in Guangzhou (HSWW) and Changsha (HSCW), energy-saving of 4%–20% can be achieved when using the upper limit of the ATC model as the cooling set-point compared to the PMV model, and that energy-saving varies considerably with climatic zone. This result is consistent with the research [40] showing that ATC-based control was more suitable for hot and humid climatic zones. This study also indicates that in climatic zones with relatively low average outdoor air temperature, the PMV-based control is more energy-saving than the ATC-based control. In particular, the energy usage of AW system based on PMV model in Kunming (mild) is extremely low, and the energy usage of ATC-based control is twice that of PMV-based control. The main reason for this phenomenon is the same as described in Section 3.2. Therefore, the energy usage of the systems controlled by PMV and ATC has a completely opposite trend on account of difference in outdoor climate, and it cannot be generalized that a system based on ATC model will be more energy efficient than that based on PMV model.

4. Conclusions

This study presents a systematic analysis of control strategies for various ventilative cooling systems based on different thermal comfort control parameters. The main conclusions are as follows:

When the ventilative cooling system implements a method-oriented control, namely, the control parameter is the upper limit of the satisfied comfortable zone by 90% of occupants.

- The adaptive thermal comfort model outperforms others for outdoor air utilization, this is especially the case for hot climatic zones. However, it is not always the most energy-efficient one in mixed mode ventilative cooling system. Increasing the lower limit of this model is an energy-efficient method.
- The outdoor air utilization potential based on T_d and T_{op} control is similar, but the energy usage varies considerably, especially in the hot climatic zones.
- Overheating period with proposed control algorithm is related to the average outdoor air temperature, but not to the form of ventilative cooling.

When the ventilative cooling system implements a target-oriented control, namely, the overheating period is determined to be the same for all the thermal comfort models.

Table 3
Energy usage when the POR is 10% based on thermal comfort models.

ei	Energy usage when POR is 10% (kW)				
	Harbin (SC)	Beijing (cold)	Changsha (HSCW)	Kunming (mild)	Guangzhou (HSWW)
Ventilative cooling form: AW					
T _{op}	263	664	890	166	1317
T _d	199	485	713	103	1054
PMV	182	495	685	81	1048
ATC	268	493	601	166	834
Ventilative cooling form: AF					
T _{op}	283	625	836	226	1201
T _d	219	474	675	160	1003
PMV	220	502	707	139	1034
ATC	317	512	641	240	871
Ventilative cooling form: AB					
T _{op}	321	583	742	295	1028
T _d	269	437	544	246	806
PMV	254	493	604	185	837
ATC	356	520	582	312	769

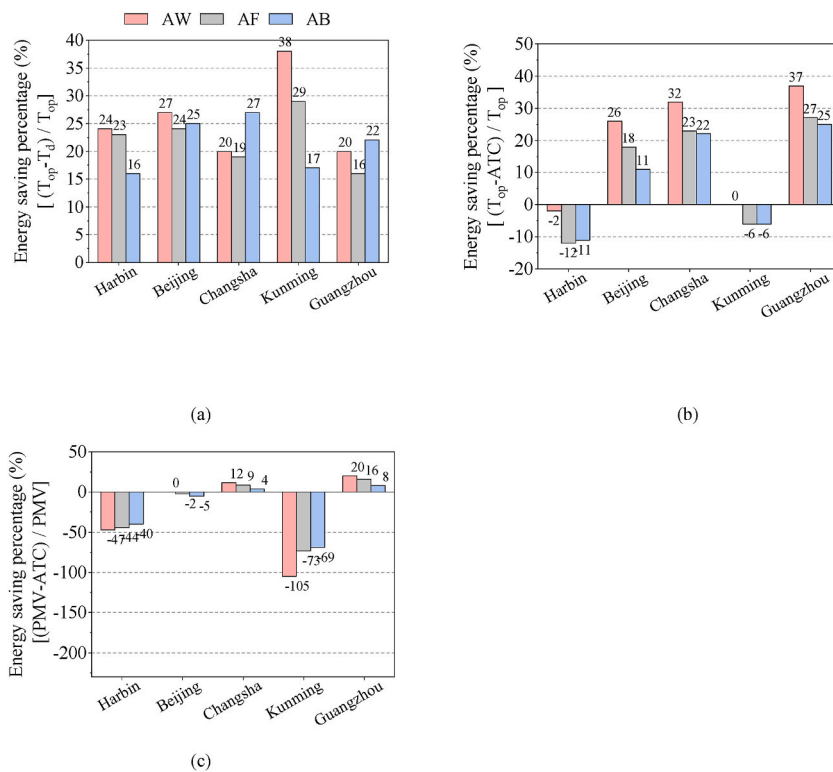

Fig. 14. Energy saving percentage resulted from the comparison of different parameters in the selected five cities.

- With an indoor dry-bulb air temperature of 26 °C as the evaluation parameter without considering the effect of radiant temperature, the energy usage will be underestimated by 16%–38%.
- The comfortable range operative temperature control provides an energy-saving of –12%–37% when compares to thermostatic control. The reason for the non-energy saving is the inappropriately low limits of adaptive model.
- The energy-saving of the ventilative cooling system controlled by PMV and ATC has a completely opposite trend in different climatic zones.
- When determining the climate adaptability of a ventilative cooling form, it is important to consider not only its thermal comfort control strategies, but also the setting values of its control parameters.

The results demonstrate that the determination of thermal comfort control parameters and the settings are important for the selection of ventilative cooling system forms in different climatic zones. However, one of the limitations of the control model is that the stepwise opening and closing of windows is not considered for the natural ventilation and variable frequency speed control is not

adopted for the mechanical ventilation. The advantage of the stepwise operation of windows is that the natural ventilation is more controllable in the intense extreme outdoor conditions (including wind speed, and air temperature, etc.), thus eliminating the risk of discomfort, overheating and being more energy efficient in many cases [64]. And the same advantage exists for variable speed fans instead of constant air volume fans. In addition, no consideration is given to the filtration of fresh air in the case of severe outdoor pollution, although to exclude its impact on the performance of ventilative cooling systems based on thermal comfort and CO₂ control. In practice, the operation of mechanical ventilation systems as well as natural ventilation still needs to consider the influence of outdoor pollutants. Therefore, more practical and precise control scheme should be investigated in the future. The current study mainly focuses on the open-loop and rule-based control. Other advanced control methods, such as model predictive control or reinforcement learning control, should be examined to explore the potential of further improving the energy saving and decreasing the thermal discomfort rate.

Author statement

Yan Hu: Writing-original draft, Software, Methodology, Investigation, Formal analysis, Data curation; **Zhengxuan Liu:** Writing-review & editing, Methodology, Supervision; **Zhengtao Ai:** Writing-review & editing, Supervision, Resources, Project administration; **Guoqiang Zhang:** Resources, Funding acquisition.

Declaration of competing interest

The authors declare that they have no known competing financial interests or personal relationships that could have appeared to influence the work reported in this paper.

Data availability

Data will be made available on request.

Acknowledgments

This research was supported by the International Energy Agency Energy in Buildings and Community Programme (Annex 62) and by the International Science and Technology Cooperation Program of China (No.2014DFA72190).

References

- [1] H. Campaniço, P. Soares, P. Hollmuller, et al., Climatic cooling potential and building cooling demand savings: high resolution spatiotemporal analysis of direct ventilation and evaporative cooling for the Iberian Peninsula, *Renew. Energy* 85 (2015) 766–776.
- [2] A. Khadra, M. Hugosson, J. Akander, et al., Economic performance assessment of three renovated multi-family buildings with different HVAC systems, *Energy Build.* 224 (2020), 110275.
- [3] Y. Zhou, Multi-level uncertainty optimisation on phase change materials integrated renewable systems with hybrid ventilations and active cooling, *Energy* 202 (2020) 117747.
- [4] Y. Zhou, S. Zheng, Multivariable optimisation of a new PCMs integrated hybrid renewable system with active cooling and hybrid ventilations, *J. Build. Eng.* 26 (2019) 100845.
- [5] Z. Tong, Y. Chen, A. Malkawi, et al., Energy saving potential of natural ventilation in China: the impact of ambient air pollution, *Appl. Energy* 179 (2016) 660–668.
- [6] H. Sha, D. Qi, Investigation of mechanical ventilation for cooling in high-rise buildings, *Energy Build.* 228 (2020), 110440.
- [7] P.M. Cuce, S. Riffat, A comprehensive review of heat recovery systems for building applications, *Renew. Sustain. Energy Rev.* 47 (2015) 665–682.
- [8] A. Mardiana-Idayu, Saffa B. Riffat, An experimental study on the performance of enthalpy recovery system for building applications, *Energy Build.* 43 (9) (2011) 2533–2538.
- [9] B. Merema, D. Saelens, H. Breesch, Analysing modelling challenges of smart controlled ventilation systems in educational buildings, *J. Build. Perform. Simul.* 14 (2) (2021) 116–131.
- [10] T. Psomas, P. Heiselberg, T. Lyme, et al., Automated roof window control system to address overheating on renovated houses: summertime assessment and intercomparison, *Energy Build.* 138 (2017) 35–46.
- [11] J. Chen, G. Augenbroe, X. Song, Lighted-weighted model predictive control for hybrid ventilation operation based on clusters of neural network models, *Autom. ConStruct.* 89 (2018) 250–265.
- [12] Y. Chen, Z. Tong, W. Wu, et al., Achieving natural ventilation potential in practice: control schemes and levels of automation, *Appl. Energy* 235 (2019) 1141–1152.
- [13] Y. Chen, L.K. Norford, H.W. Samuelson, et al., Optimal control of HVAC and window systems for natural ventilation through reinforcement learning, *Energy Build.* 169 (2018) 195–205.
- [14] A.J. Martin, J. Fletcher, Night Cooling Control Strategies, Building Services Research and Information Association (BSRIA), Bracknell, 1996. Final Report No. 11621/4.
- [15] T. Schulze, U. Eicker, Controlled natural ventilation for energy efficient buildings, *Energy Build.* 56 (2013) 221–232.
- [16] G. Chiesa, M. Kolokotroni, P. Heiselberg, *Innovations in Ventilative Cooling*, PoliTO Springer Series, 2021.
- [17] C. C. Menassa, N. Taylor, J. Nelson, A framework for automated control and commissioning of hybrid ventilation systems in complex buildings, *Autom. ConStruct.* 30 (2013) 94–103.
- [18] X. Zhang, M. Han, R. May, et al., A novel reinforcement learning method for improving occupant comfort via window opening and closing, *Sustain. Cities Soc.* 61 (2020), 102247.
- [19] H. Zhao, J. Zhao, T. Shu, et al., Hybrid-model-based deep reinforcement learning for heating, ventilation, and air-conditioning control, *Front. Energy Res.* 8 (2021).
- [20] T. Williamson, L. Daniel, A new adaptive thermal comfort model for homes in temperate climates of Australia, *Energy Build.* 210 (2020) 109728.1–109728.9.
- [21] L. Tang, Z.T. Ai, C.Y. Song, et al., A strategy to maximally utilize outdoor air for indoor thermal environment, *Energies* 14 (2021) 3987.
- [22] H.K. Dong, P.H. Mo, H.C. Dong, et al., Effect of MRT variation on the energy consumption in a PMV - controlled office, *Build. Environ.* 45 (9) (2010) 1914–1922.
- [23] J. Wu, X. Li, J. Tu, et al., A PMV-based HVAC control strategy for office rooms subjected to solar radiation, *Build. Environ.* 177 (2020), 106863.

- [24] J. Park, H. Choi, D. Kim, et al., Development of novel PMV-based HVAC control strategies using a mean radiant temperature prediction model by machine learning in Kuwaiti climate, *Build. Environ.* 206 (2021), 108357.
- [25] Turhan, Comparison of indoor air temperature and operative temperature-driven HVAC systems by means of thermal comfort and energy consumption, *Mugla J. Sci. Technol.* 6 (2020) 156–163.
- [26] V. Jain, V. Garg, J. Mathur, et al., Effect of Operative Temperature Based Thermostat Control as Compared to Air Temperature Based Control on Energy Consumption in Highly Glazed Buildings, *IBPSA Sydney*, 2011, pp. 2688–2695.
- [27] R.Z. Homod, K. Sahari, H. Almurib, Energy saving by integrated control of natural ventilation and HVAC systems using model guide for comparison, *Renew. Energy* 71 (2014) 639–650.
- [28] M.P. Deuble, R. Dear, Mixed-mode buildings: a double standard in occupants' comfort expectations, *Build. Environ.* 54 (2012) 53–60.
- [29] T. Cheung, S. Schiavon, T. Parkinson, et al., Analysis of the accuracy on PMV-PPD model using the ASHRAE global thermal comfort database II, *Build. Environ.* 153 (2019) 205–217.
- [30] J.T. Kim, H.L. Ji, H.C. Sun, et al., Development of the adaptive PMV model for improving prediction performances, *Energy Build.* 98 (2015) 100–105.
- [31] B. Li, R. Yao, Q. Wang, et al., An introduction to the Chinese Evaluation Standard for the indoor thermal environment, *Energy Build.* 82 (2014) 27–36.
- [32] R. Yao, B. Li, J. Liu, A theoretical adaptive model of thermal comfort-Adaptive Predicted Mean Vote (aPMV), *Build. Environ.* 44 (10) (2009) 2089–2096.
- [33] Ministry of Housing and Urban-Rural Development of the People's Republic of China. GB/T 50785-2012, Beijing, Evaluation Standard for Indoor Thermal Environment in Civil Buildings, China Architecture & Building Press, 2021.
- [34] S. Zhang, L. Zhang, Adaptive-rational thermal comfort model: adaptive predicted mean vote with variable adaptive coefficient, *Indoor Air* 30 (5) (2020) 1052–1062.
- [35] E. Barbadilla-Martín, J.M. Salmerón Lissén, J. Guadix Martín, et al., Field study on adaptive thermal comfort in mixed mode office buildings in southwestern area of Spain, *Build. Environ.* 123 (2017) 163–175.
- [36] C. Sun, R. Zhang, S. Sharples, et al., A longitudinal study of summertime occupant behaviour and thermal comfort in office buildings in northern China, *Build. Environ.* 143 (2018) 404–420.
- [37] M. Trebilcock, J. Soto-Muñoz, J. Piggot-Navarrete, Evaluation of thermal comfort standards in office buildings of Chile: thermal sensation and preference assessment-ScienceDirect, *Build. Environ.* 183 (2020), 107158.
- [38] S. Carlucci, L. Bai, R. De Dear, et al., Review of adaptive thermal comfort models in built environmental regulatory documents, *Build. Environ.* 137 (2018) 73–89.
- [39] L.L. Gomis, M. Fiorentini, D. Daly, Potential and practical management of hybrid ventilation in buildings, *Energy Build.* 231 (2021), 110597.
- [40] J.J. Aguilera, D.I. Bogatu, O. Berk Kazanci, et al., Comfort-based control for mixed-mode buildings, *Energy Build.* 252 (2021), 111465.
- [41] M. Khoshbakht, Z. Gou, F. Zhang, A pilot study of thermal comfort in subtropical mixed-mode higher education office buildings with different change-over control strategies, *Energy Build.* 196 (2019) 194–205.
- [42] J. Wu, J. Weng, B. Xia, et al., The synergistic effect of PM_{2.5} and CO₂ concentration on occupant satisfaction and work productivity in a meeting room, *Int. J. Environ. Res. Publ. Health* 18 (8) (2021) 4109.
- [43] Ministry of Housing and Urban-Rural Development of the People's Republic of China. GB 55015-2021, Beijing. General Code for Energy Efficiency and Renewable Energy Application in Buildings, China Publishing & Media Holdings Co., Ltd, 2021.
- [44] Ministry of Housing and Urban-Rural Development of the People's Republic of China, JGJ / T67-2019, Standard for Design of Office Building, China Architecture and Building Press, Beijing, 2019.
- [45] Y. Chen, Y.F. Zhang, Q.L. Meng, Study of ventilation cooling technology for telecommunication base stations: control strategy and application strategy, *Energy Build.* 50 (2012) 212–218.
- [46] U.S.DOE, EnergyPlus Engineering Reference: the Reference to EnergyPlus Calculations (In Case You Want or Need to Know), 2013.
- [47] U.S.DOE, Input Output Reference: an Encyclopedic Reference to EnergyPlus Inputs and Outputs, U.S. Department of Energy, 2013.
- [48] S. Emmerich, Validation of multizone IAQ modeling of residential-scale buildings: a review, *Build. Eng.* 107 (2001) 619–628.
- [49] L.O. Neves, A.P. Hopes, W.J. Chung, et al., "Mind reading" building operation behaviour, *Energy Sustain. Dev.* 56 (2020) 1–18.
- [50] J.F. Belmonte, R. Barbosa, Manuela G. Almeida, et al., CO₂ concentrations in a multifamily building in Porto, Portugal: occupants' exposure and differential performance of mechanical ventilation control strategies, *J. Build. Eng.* 23 (2019) 114–126.
- [51] L. Tang, Research on Ventilation Control Strategy to Utilize Outdoor Air Temperature and Energy Saving, Hunan University, Changsha, 2021.
- [52] https://energyplus.net/weather-region/asia_wmo_region_2/CHN.
- [53] <https://www.climate.gov/news-features/understanding-climate/climate-change-atmospheric-carbon-dioxide>.
- [54] CEN/TR 16798-2:2019, Energy Performance of Buildings-Ventilation for Buildings - Part 2: Interpretation of the Requirements in EN 16798-1-Indoor Environmental Input Parameters for Design and Assessment of Energy Performance of Buildings Addressing Indoor Air Quality Thermal Environment Lighting and Acoustics (Module M1-6), Comité Européen de Normalisation, 2019.
- [55] ASHRAE, Thermal Environmental Conditions for Human Occupancy. ANSI/ASHRAE 55-2020, American Society of Heating, Refrigerating and Air Conditioning Engineers, Atlanta, 2020.
- [56] D.L. Johnson, R.A. Lynch, E.L. Floyd, et al., Indoor air quality in classrooms: environmental measures and effective ventilation rate modeling in urban elementary schools, *Build. Environ.* 136 (2018) 185–197.
- [57] CORE C-HRV 366-UL. <https://core.life/products-and-solutions/counterflow/>.
- [58] Z. Xu, G. Hu, C.J. Spanos, et al., PMV-based event-triggered mechanism for building energy management under uncertainties, *Energy Build.* 152 (2017) 73–85.
- [59] S. Caillou, J. Laverge, R. Van Gaever, et al., Méthode de calcul per-facteurs de réduction pour la ventilation à la demande, 2014.
- [60] T.R. Nielsen, C. Drivsholm, Energy efficient demand controlled ventilation in single family houses, *Energy Build.* 42 (11) (2010) 1995–1998.
- [61] J. Laverge, N. Bossche, N. Heijmans, et al., Energy saving potential and repercussions on indoor air quality of demand controlled residential ventilation strategies, *Build. Environ.* 46 (7) (2011) 1497–1503.
- [62] S.H. Ryu, H.J. Moon, Development of an occupancy prediction model using indoor environmental data based on machine learning techniques, *Build. Environ.* 107 (2016) 1–9.
- [63] M.J.R. Lopez, G. Guyot, B. Golly, Relevance of CO₂-based IAQ indicators: feedback from long-term monitoring of three nearly zero-energy houses, *J. Build. Eng.* 44 (2021), 103350.
- [64] T. Psomas, M. Fiorentini, G. Kokogiannakis, et al., Ventilative cooling through automated window opening control systems to address thermal discomfort risk during the summer period: framework, simulation and parametric analysis, *Energy Build.* 153 (2017) 18–30.