







# A Sonic

The Sonic Act as a Design

Michael de Beer  
Methods & Analysis  
Msc 4 studio  
2017 - 2018

THE COMMONS OF VALPARAÍSO

CONSTRUCTING THE COMMONS IN THE LATIN AMERICAN METROPOLIS

2017 / 2018

“I could tell you how many steps make up the streets rising like stairways, and the degree of the arcades’ curves, and what kind of zinc scales cover the roofs; but I already know this would be the same as telling you nothing.”

Italo Calvino – invisible cities pg. 10

To listen and to make a noise, as sonic acts, formed the premise of the project. Continuing a lineage of inquiry of human conduct that is underpinned by the notion that humans engage in purposeful behaviour; the sonic act in the field of architecture questions how people behave sonically in their environments. The importance of this spatial query is underpinned by a premise positioned in the earlier research of the project, that sound is critical for experiential engagement and a defining feature of phenomenological attributes of spaces.

As with many forms of praxeological inquiries, which have given form to the typologies of buildings we have come to know and love; the project was underpinned by continual introspection as to the sonic inhabitation of spaces. Throughout the iterative design phases of the project, continual cycles of questions were being asked- What is the sonic behaviour and how does this form spatially (Vis-à-vis)? As with any academic research, this form of questioning was underpinned by a continual awareness of ones surroundings and there by informing design decisions - a methodological approach of observation and experimentation.

To account for each and every moment would be abortive. As importantly, the question moved beyond moments of interaction and rather aimed to consider the constant elements associated to particular sonic acts. In doing so the inquiry turned what may be perceived as being an ineffable subject into a defensible understanding of space and sonic action. Herein we understand that a church’s architecture does not enable a single act but rather various acts to occur - often simultaneously as moments of occupation.

Yet, the church like the library or ones kitchen enables a space of particular mediation and action. The various acts seen collectively have given form to space. In sacred structures across the world, a commonality exists in the attention to the ceiling, not only as a connection to God/ God’s but to form a resonance and reverberation to presence. Equally the intimacy of the kitchen is not only a place of work but is born from the hearth, the central fireplace of pre-industrial home/stead. It inspires and encourages intimacy amongst those that inhabit it. In this sense the inquiry of the sonic act is not defined by acoustic qualities but rather an emphasis in understand the commonalities of sonic action and employing them to determine a site specific design.

The most accessible manner in understanding the project is that of the four-box diagram tool formed during the research phase and employed during the design phase of the project. This offered a means to engage in the Sonic act of presence and its various components of intermission, intervention, intimacy and space of appearance. It enables a sonic interpretation of space and action. It is a tool for analysis and design and proved fundamental in the outcome of the project.

In defining the spatial logic of the project, the space of appearance as the public extension of sound, forms the primary route, spine, through the design. Off of this one finds instance of intimate spaces. Within this spatial logic the actions of presence may occur, be it one of intervention or intermission. The designed spaces offer a frame in which actions may be able to occur.

*Positions in Practice : Constructing the Commons in the Latin American Metropolis*

Graduation Studio (Msc 3 | Msc 4)

Valparaíso, Chile

Fall 2017 - Spring 2018

All material in this publication has been produced for academic purposes.

All rights reserved

No part of this publication may be reproduced, stored in a retrieval system, or transmitted in any form or by any means, electronic, mechanical, photocopying, recording, or otherwise, without written prior permission of the copy right owner.

The outcome of the project presents four primary spatial interventions that each hold diverse qualities for the sonic act of presence to occur. These are the learning centre; collective school environment; market square; and Sonic Vantage point. Each of which serve as precedent for the utilisation of the sonic act as being a core design tool in define the spatial logic through framing elements.

The learning centre, connected to the city, on the lowest part of the project is a public intervention. Imbedded in this environment is a sequence of spatial thresholds that define a movement from the space of appearance to an intimate one. The programmatic sequencing of the project was largely defined by the sonic acts of the learning centre. From the busy amphitheatre, a junction of the learning centre; the collectively silent space of the library, to the intimate spaces of work and reflection. The design sought to create a varied sequence of spaces not only in form and type but also materiality, in creating environments for specific acts. Small niches and courtyards offer a respite from what may be an overtly public space. Large spaces emphasise collective action, as the library as well as amphitheatre and workspaces each require sonic mediation amongst many individuals. Critically the variety of these environments relate to the commons, as collective mediation is central to the acts.

The Collective School is a private environment, dedicated to learning through play. Unlike the learning centre, the collective school's spatial logic differs from sequencing to rather a dialectic between large collective and smaller intimate spaces. The significance of this is in the operation of the school environment, as learning

is not solely orientated toward singular classrooms but rather a diverse range of spaces. In doing so allowing various activities to simultaneously occur. The collective school is thus nestled around a terraced courtyard, enabling a diverse range of activities. Critically, the ethos of the collective school is also situated toward the development of youth. It's form is one that emphasises an awareness of others, by virtue encouraging interaction through creating sonic connections.

The Market Square, a public precipice overlooking the city is a space orientated toward the fragile community. It is surrounded by frames that emphasis a connection to the city below and upper school above that reflects sound down into the square. The sonic act herein is one of public mediation, intervention in the space of appearance. As a knuckle in the city where roads, stairs and funicular join a top the hill, the focus of the space has been to provide an area for the community of Cerro Cordillera. Here the annual festival will end, the market will be and community hall will stand. At the heart of the junction is an informal amphitheatre, a space for not only celebration but a space for civil advocacy and agency where the community may meet. Adjacent to the amphitheatre is a small historic plaza, filled with foliage and a playground. On the other side, as a new intervention, the market square, with an active edge of restaurants and shops, entrance to school and sonic vantage point and community hall.

The Sonic Vantage Point, unlike the other proposed spaces, is one that is orientated toward intermission - one self and being. A tight knit of walls carved out of the cliff forms a

primary walkway off of which sonic chambers and vantage points proliferate. Imbedded in the natural surroundings of the hill the space resonates with the sound of birds and ones own footsteps. Every now and then an echo of the city far below or the hills above transports one to an awareness of oneself in a larger environment. A space that one is unable to intervene in.

These four areas of the urban framework each have a unique quality that is informed by the sonic acts that take place within. Yet it is also critical to position that the project is not only informed by sound but has a diverse range of inputs. A key issue being the role of the project within the broader context. Valparaiso is a city of exchange dominated by a temporal population that is putting strain on the fragile hill communities such as Cerro Cordillera. It is this contextually defining feature that has motivated the types of programs that have been placed on the site, with the objective to support the hill community. These socially orientated forms of infrastructure are critical to the resilience of the community; by provide key public space and institutions that support the permanent population.

Today our world has been defined by visual elements as a means of understanding through logic and proportion. Yet, a body of knowledge is slowly building around the notion of affect, positioning the importance of experience as fundamental to how we engage the world around us. This premise motivated the need to follow a project that would be informed by how one would engage and experience the space. It is a move away from the current paradigms of design and advocates for a return to being- one which I would urge you to explore.

1. Concept drawing of  
the project drawn in  
February 2018



Competing sounds  
A rushing street  
shouting vendors  
blaring music  
an engulfing encounter

A turn away  
And up we go

Aside the unyielding climb  
An agonising funicular  
it's mechanical struggle-  
a rumble, permeating  
a lush precipice

A turn away  
and in we go

Echoing cutlery  
distant screams  
a notable respite  
a chipper beat  
an intimate court[ing]

A turn away  
and through we go

Front to back  
performer to spectator  
dancing feet  
to a pattering beat  
act as appearance

A turn away  
and in we go

Buenos Dias, Hello Hello  
An embracing chamber  
the Sonicity evicted  
one on one  
the welcoming junction

A turn away  
and in we go

Studios whispers  
the turning of pages  
tip toeing  
hush hush  
a divergent volume

A turn away  
and out and in?

Suddenly Imperceptible  
eavesdropping from below  
finally quiet  
unable to intervene  
meditative reflection

A turn away  
and up we go

Step by Step  
unfolding rhythm  
dialectic presence  
oneself & the city  
a public intermission

A turn away  
and in we go

A resonating hum  
playful mediation  
youthful oratory  
familiar and engaged  
the collective

A turn away  
and ascend we shall

Gaggles and giggles  
ineffable moments  
distant humm, bark & chirp  
enclosed to exposed  
pockets of association

A turn away  
and here we are

Sonic array  
immersive appearance  
Collectivo! fruit and veg  
a youthful presence  
the cultural confluence

A turn away  
and away we go

Overlook and overhear  
a distant presence here  
rustling leaves in earthen cavities  
frame the city  
sonic vantage

## URBAN FRAMEWORK

The site sits on the spur of the hill of Cerro Cordilleraa, overlooking the city to the right.

The market, school and learning center are positioned adjacent to the funicular that climbs the steep slope between city and hill. To the South is the Sonic Vantage point that sits below the Lord Cochrane's Museum and park.

As the site is positioned in a Unesco Heritage area, the approach to the design and framework were to maintain all existing elements of the site and repair those that are in a severe state of decay - such as the viewing deck.



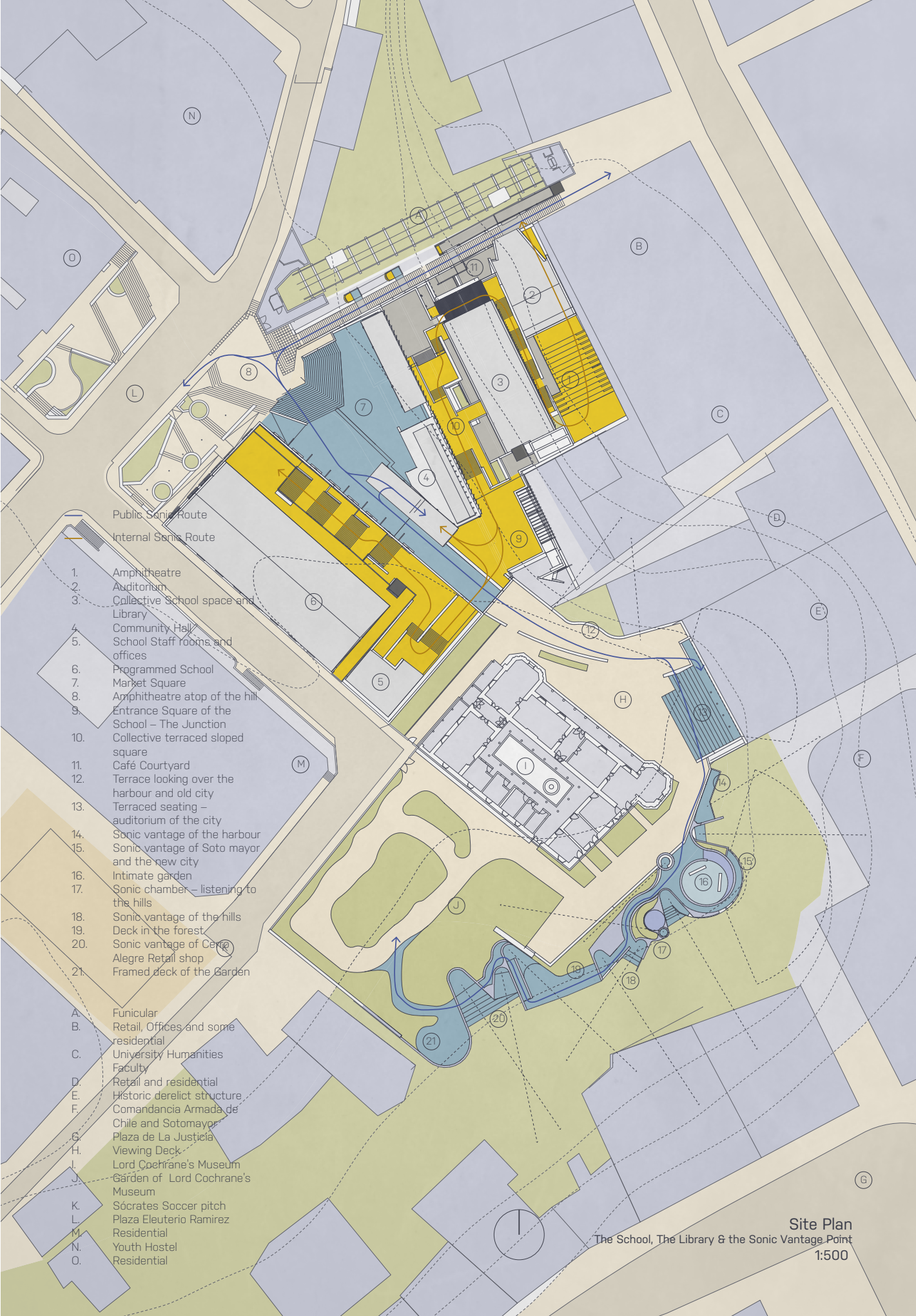

Public Sonic Route  
 Internal Sonic Route

1. Amphitheatre
2. Auditorium
3. Collective School space and Library
4. Community Hall
5. School Staff rooms and offices
6. Programmed School
7. Market Square
8. Amphitheatre atop of the hill
9. Entrance Square of the School – The Junction
10. Collective terraced sloped square
11. Café Courtyard
12. Terrace looking over the harbour and old city
13. Terraced seating – auditorium of the city
14. Sonic vantage of the harbour
15. Sonic vantage of Soto mayor and the new city
16. Intimate garden
17. Sonic chamber – listening to the hills
18. Sonic vantage of the hills
19. Deck in the forest
20. Sonic vantage of Cerro Alegre Retail shop
21. Framed deck of the Garden

- A. Funicular
- B. Retail, Offices and some residential
- C. University Humanities Faculty
- D. Retail and residential
- E. Historic derelict structure
- F. Comandancia Armada de Chile and Sotomayor
- G. Plaza de La Justicia
- H. Viewing Deck
- I. Lord Cochrane's Museum
- J. Garden of Lord Cochrane's Museum
- K. Sócrates Soccer pitch
- L. Plaza Eleuterio Ramirez
- M. Residential
- N. Youth Hostel
- O. Residential

## AXO OF PROJECT

The intervention is situated on the hill in a respectful manner to its context. Acknowledging the heights of surrounding structures and carefully climbing the hill. A critical part of the project is the extension of the public realm seen in light grey atop the hill and extending toward the Sonic Vantage point. In Yellow one sees the internal walkway of the structure that forms a continuous route that binds the buildings together.

Sotomayor, a primary square of the city is seen situated below the site and has a visual connection to the sonic vantage point. Atop the hill are primarily residential uses compared to the institutions and commercial areas below. A key intervention being the introduction of the market atop the hill, moving away from the status quo and offering the hill community a key open space for commerce and civic life.





- 1. Amphitheatre
  - 2. Auditorium
  - 3. Collective School space and Library
  - 4. Community Hall
  - 5. School Staff rooms and offices
  - 6. Programmed School
  - 7. Market Square
  - 8. Amphitheatre atop of the hill
  - 9. Entrance Square of the School – The Junction
  - 10. Collective terraced sloped square
  - 11. Safe Courtyard
  - 12. Terrace looking over the harbour and old city
  - 13. Terraced seating – auditorium of the city
  - 14. Sonic vantage of the harbour
  - 15. Sonic vantage of Soto mayor and the new city
  - 16. Intimate garden
  - 17. Sonic chamber – listening to the hills
  - 18. Sonic vantage of the hills
  - 19. Deck in the forest
  - 20. Sonic vantage of Cerro Alegre
  - 21. Framed deck of the Garden
  - 22. Sonic Chimney to the hills
- A. Funicular
  - B. Retail, Offices and some residential
  - C. University Humanities Facility
  - D. Retail and residential
  - E. Historic derelict structure
  - F. Comandancia Armada de Chile and Sotomayor Plaza de La Justicia
  - G. Viewing Deck
  - H. Lord Cochrane's Museum
  - J. Garden of Lord Cochrane's Museum
  - K. Sócrates Soccer pitch
  - L. Plaza Eleuterio Ramirez
  - M. Residential
  - N. Youth Hostel
  - O. Residential

**Axonometric Site View**  
Eastern View

## PROJECT PROGRAM

The program of the project is situated on the sonic 4 square diagram that has enabled an understanding of the types of sonic environments being formed.

The diagrams Y axis are the realms of intimacy and space of appearance. The X axis is the act of presence that is composed of intervention and intermission.

The projects various components cover the entire square, highlighting the diversity of acts that occur within. This was essential in understanding not only the form, materiality and the act but also how the building would be positioned and arranged on the site.



### The Act

Intermission

Intervention

### Realm

Intimacy

Space of Appearance



## SONIC SPACES

The following drawings represent the four key interventions in the project. Critically they aim to convey how the sonic acts may appropriate the structure. In each a variety of acts are occurring.



Library / Lower site  
The Sonic Act as Occupation

1. Listening to and watching funicular, the sonic act is intimate in the space of appearance 2. Break in Stairs: listening to the environment, intimate in the space of appearance 3. Talking at entrance: encounter classrooms, intervention in the space of appearance 4. Cafe, as an intimate act amongst known people in the public, space of appearance 5. Amphitheatre as a public act of intervention in the space of appearance 6. Walking in entrance hallway focus on oneself as an intimate act of intimation 7. Reception as a welcoming intimate space of the public (space of appearance) 8. Library workspace, a public act of silence, intervention in the space of appearance 9. discussion in library breakout space, as an intimate intervention 10. Auditorium discussion is a intimate public act of intervention 11. aware of the library and oneself, intimate act of intermission 12. Discussion in workspace, as an intimate act of intervention 13. Alone in courtyard, aware of city and school unable to intervene, an act of intermission in the space of appearance 14. Discussion in courtyard, intimate act of intervention

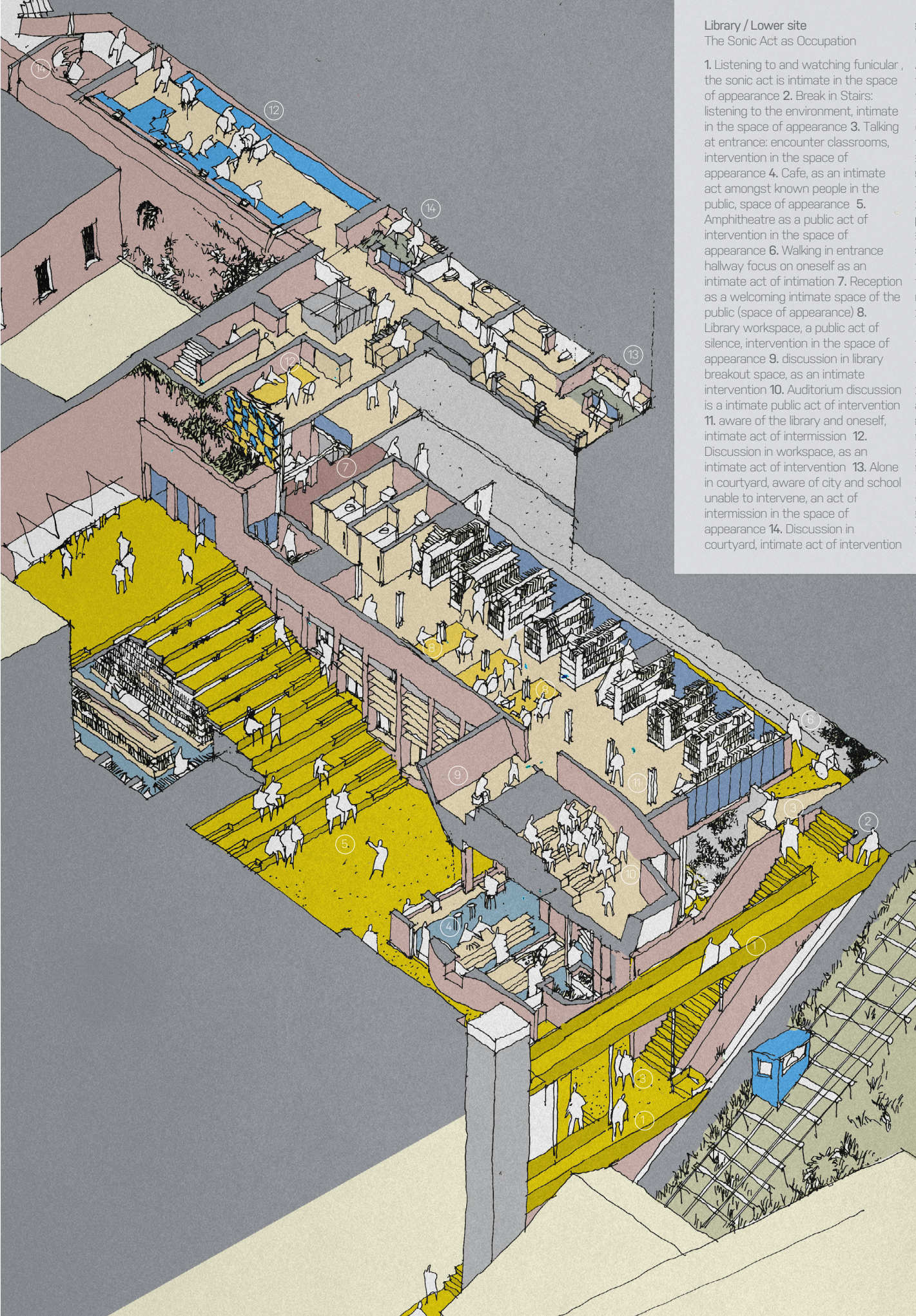



## Collective School Environment The Sonic Act as Occupation

1. Listening to the city, an intimate act of intermission 2. Walking up the stairs with a variance in soundscape drawing attention to oneself, an intimate act of intermission 3. Circular space, discussion as an intimate intervention space 4. Central playground an intervention space in the space of appearance 5. Niche spaces for collective and singular engagement, collective as an intimate act of intervention and intimate as being an act of intermission in the space of appearance 6. Break out room, a space for intimate intervention 7. double volume workspace a space of intervention in the space of appearance 8. Classroom as an intimate space of intervention 9. listening/ eavesdropping - an intimate act in the space of appearance 10. Drama, a space of intimate collective intervention 11. Practice space, intervention in the space of appearance 12. Amphitheatre, collective discussion as an intimate intervention 13. and performance as a intervention in the space of appearance

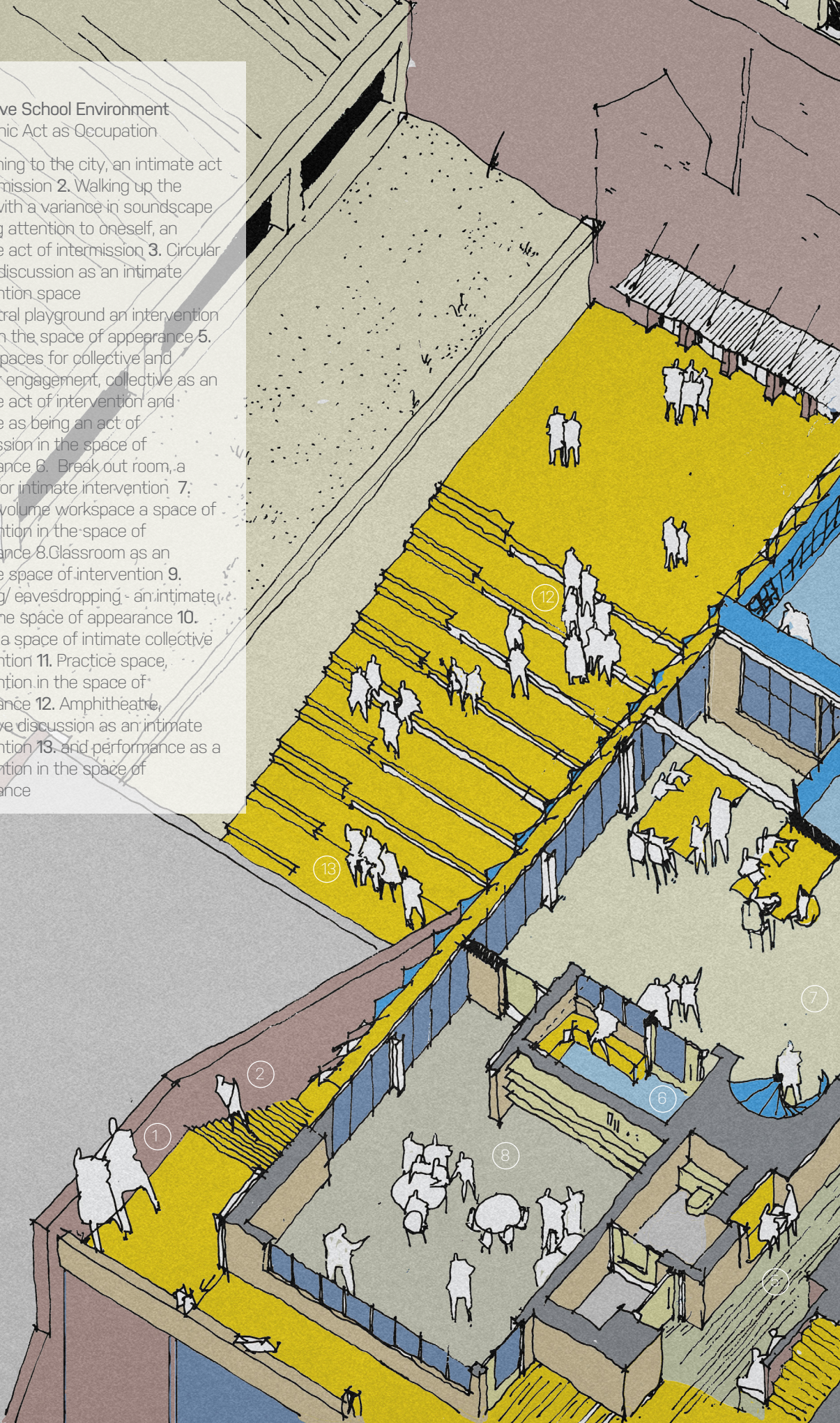



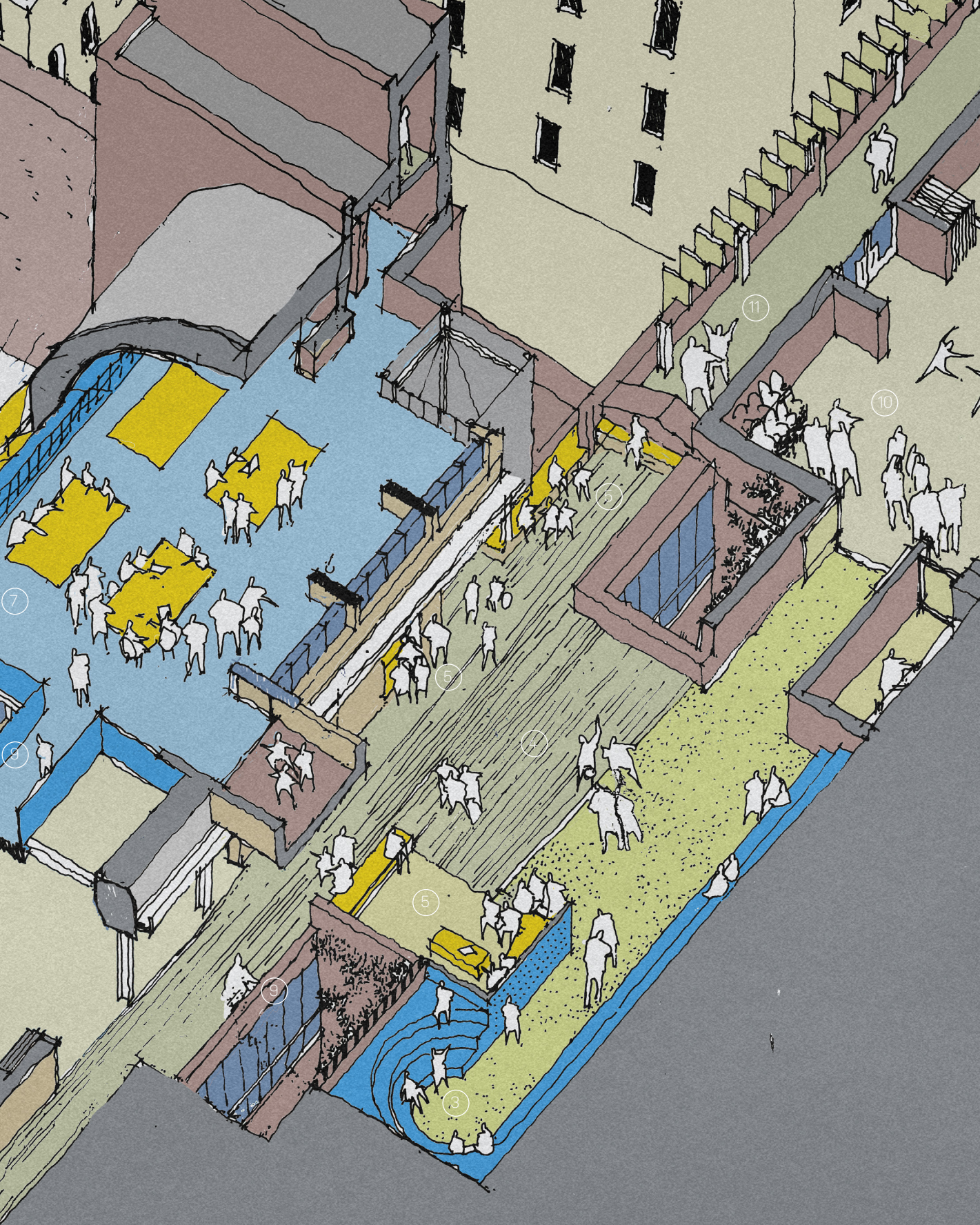



## Market Square

### The Sonic Act as Occupation

1. Performance: As people intervene and engage, the sonic act is intervention in the space of appearance 2. Restaurant: People talking and listening in known groups: Act: intervention as intimate 3. Listening to the city below: An intimate act in the space of appearance 4. The market although with intimate moments is a space of intervention in the space of appearance as hawkers engage potential buyers 5. Listening to the square above: a intimate act of the space of appearance 6. Children playing and shouting send sound down into the square the act of intervention affects the space of appearance 7. Intimate discussion: an act of intervention as intimate

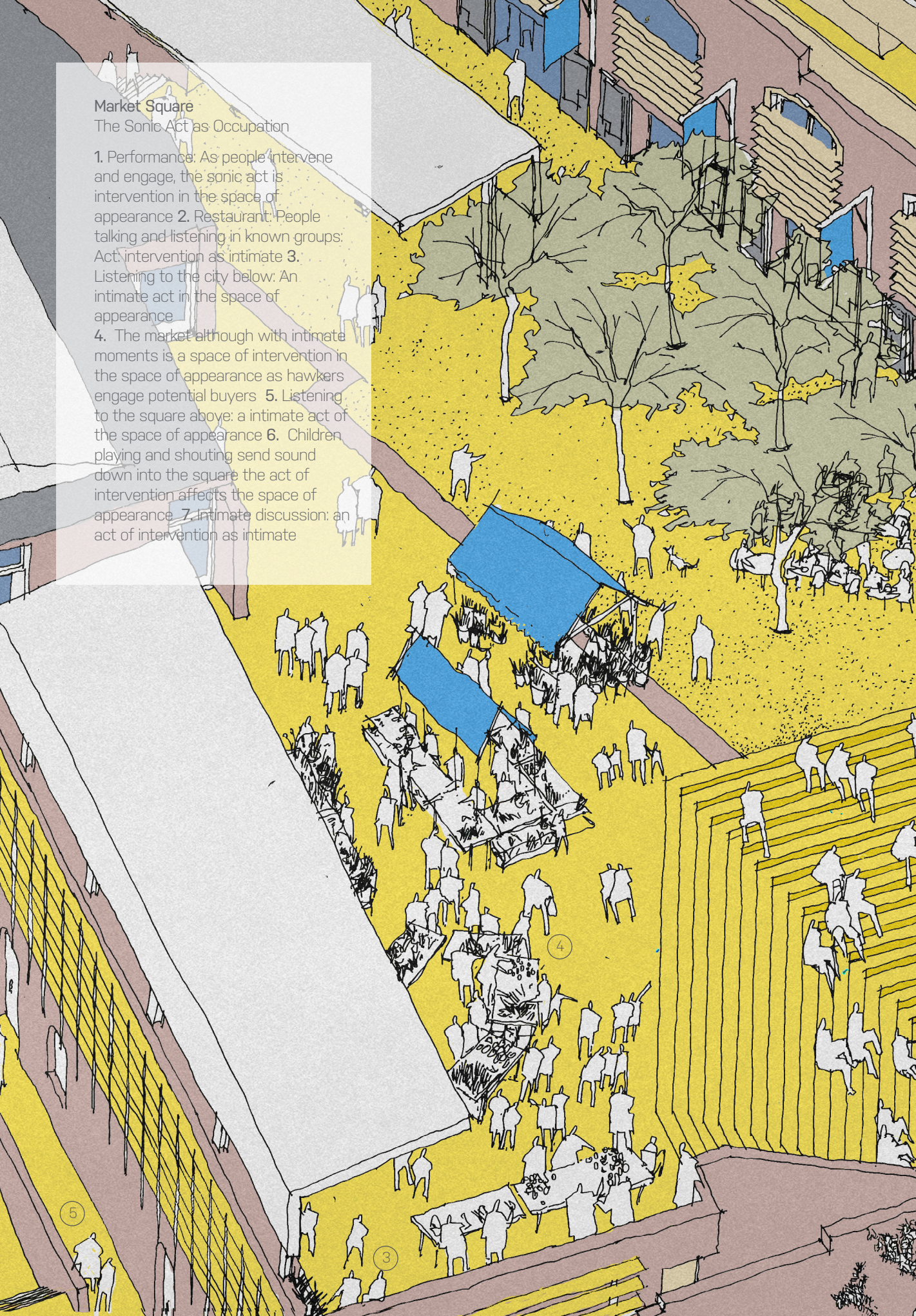



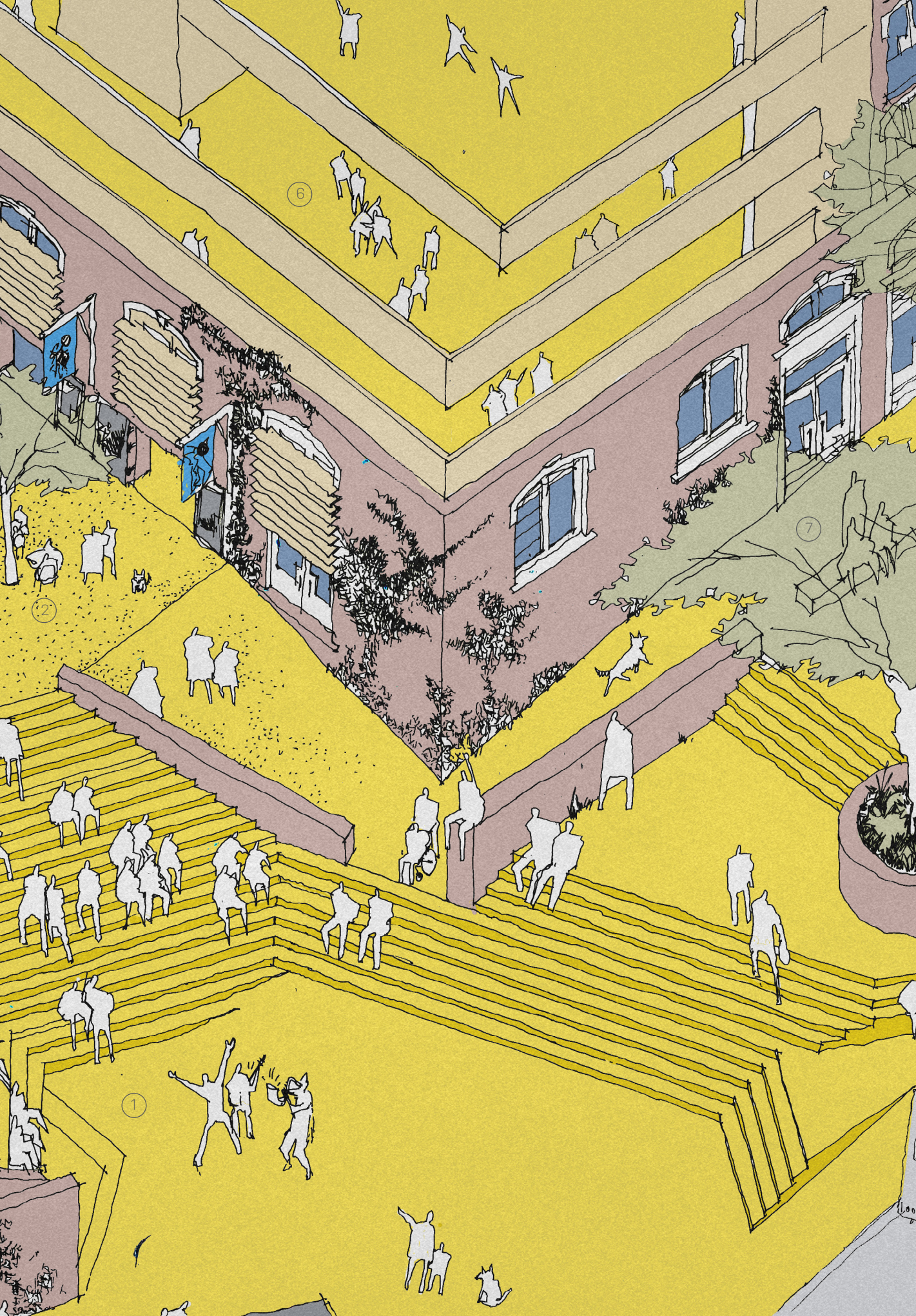



## Sonic Vantage Point

The Sonic Act as Occupation

1. Exiting viewing deck. An intervention in the space of appearance
2. Sonic chambers as intimate space of either intermission or intervention
3. Chamber walk, focus on oneself due to high reverberation, intimate intermission
4. Walking through the sonic vantage point draws attention to being as an intimate act of intermission
5. Discussion as intervention
6. listening to environment as being an act of intermission in the space of appearance
7. Courtyard, a space for intimate intervention, kids playing and bowls, it may also be a space of intermission
8. Solitary experience drawing attention to oneself and the city as an intimate intermission





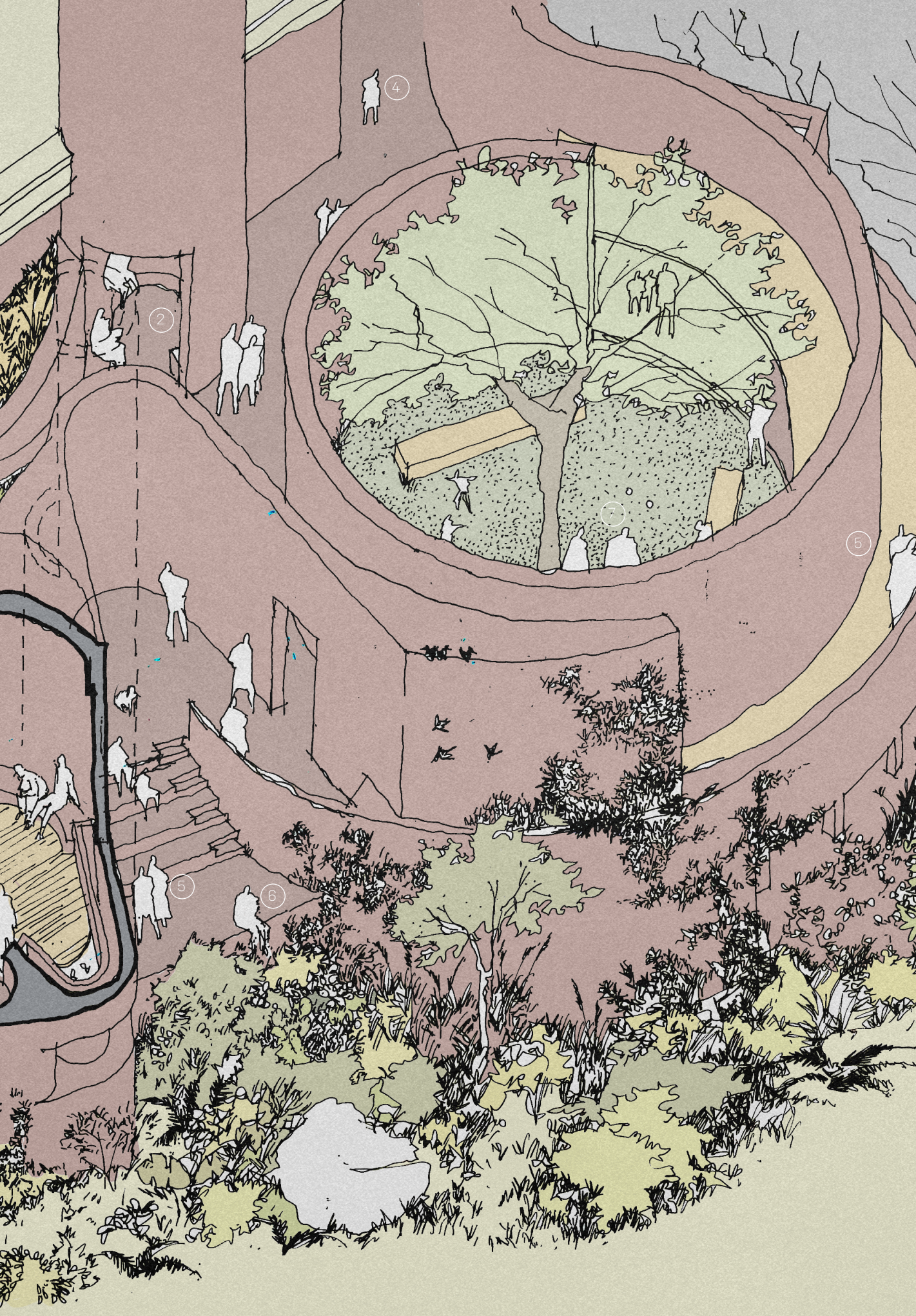





Auditorium  
The Sonic Act as Occupation

## INTERIOR

The following sketch aim to show the variety of primary interiors of the building and the activity within. From the triple volume library, to the auditorium and Collective school environment.



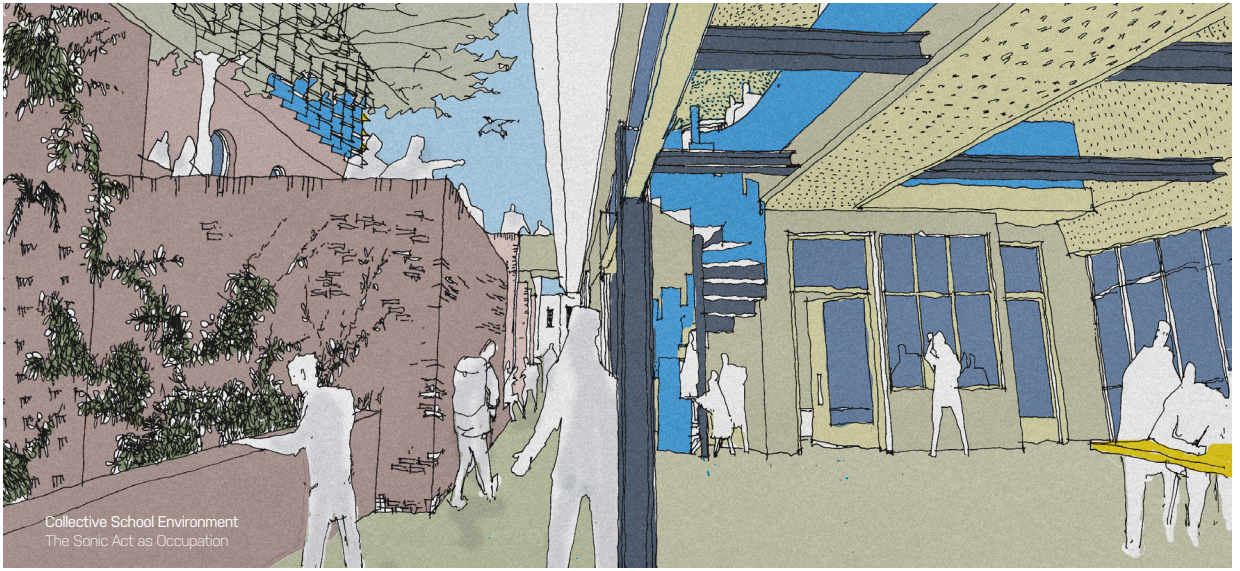

Collective School Environment  
The Sonic Act as Occupation

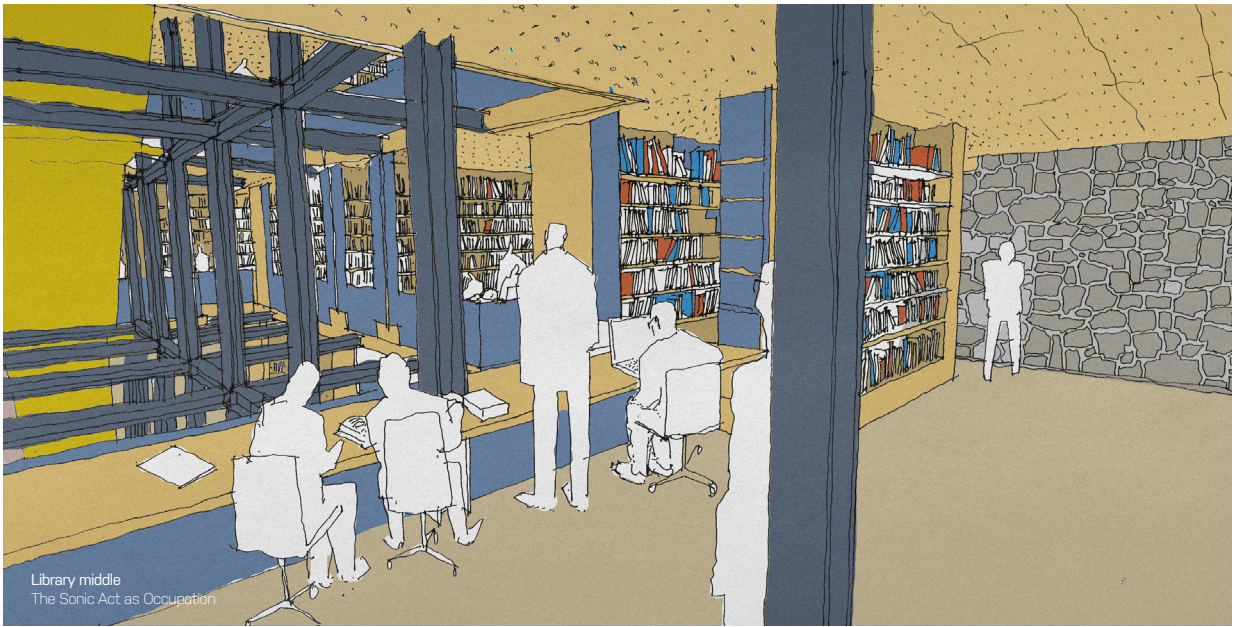

Library middle  
The Sonic Act as Occupation

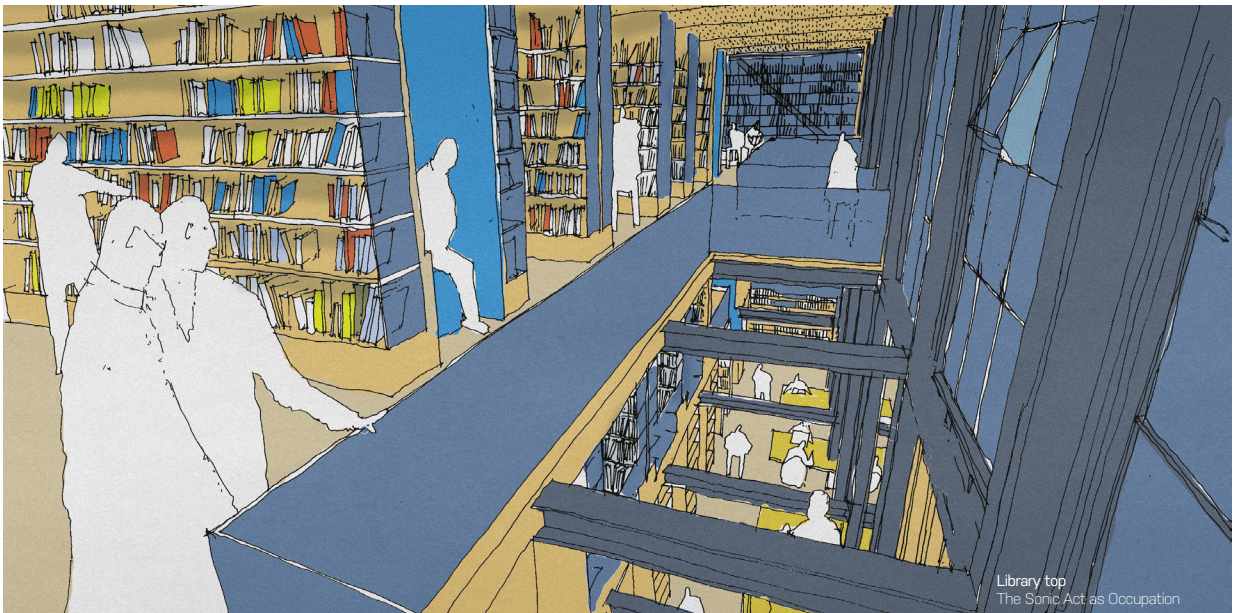

Library top  
The Sonic Act as Occupation

## PUBLIC ENTRANCE

The ground floor is the primary access into the learning center. The cafe is designed in such a way to mitigate against the reverberation of the funicular entering the space. Around this is the cafe courtyard where one is enclosed by the building, retaining wall and existing boundary wall. The Amphitheater behind the cafe forms the junction between university and learning center and is seen as a key public space intervention that can host events of various kinds or be appropriated by the daily life of Valparaiso.



# Ground Floor

Cafe, Closed stacks and work of library and Amphitheatre  
1:300



- 1. Café
- 2. Amphitheatre
- 3. Amphitheatre seating and stairs to university and library
- 4. Café Courtyard
- 5. WC
- 6. Closed stacks of library
- 7. Stairs to mezzanine: Library work space
- 8. Lift shaft and services
- 9. Lift for wheelchair access to site

- 
- A. Humanities Faculty of University
  - B. Retail, Offices and some residential
  - C. Funicular
  - D. Retail and residential



## LIBRARY

The first floor of the library holds the second entrance of the site, allowing for wheel chair access, through a long narrow corridor - designed to draw attention to oneself. At the back of the site is the reception space where the circulation core and services of the building are situated.

The library floor forms the primary area of the space, composed of a break out space and connection to the auditorium. In the library small staircases in the stacks allow one to move up through the building. Finally, the stairs, indicated as 3 on the drawing form the beginning of the internal circulation route that climbs the structure to the top.



# 1st Floor

First floor of Library as well as Amphitheatre  
1:300



1. Reception & Atrium
  2. Fire Escape and circulation throughout building
  3. External Staircase as part of auditory route and the space of appearance
  4. Entrance to Library through walkway & entry Courtyard
  5. Stacks of library
  6. Stairs to mezzanine
  7. Work spaces
  8. Reading space and work space
  9. Auditorium (primary entrance 2nd floor)
  10. Lift core
  11. Lift for wheel chair access to site
  12. Pause seating along exiting staircase
  13. Amphitheatre seating and stairs to university and library
  14. WC
- 
- A. Humanities Faculty of University
  - B. Retail, Offices and some residential
  - C. Funicular
  - D. Retail and residential
  - E. Exiting retaining wall
  - F. Slope of hill with natural vegetation

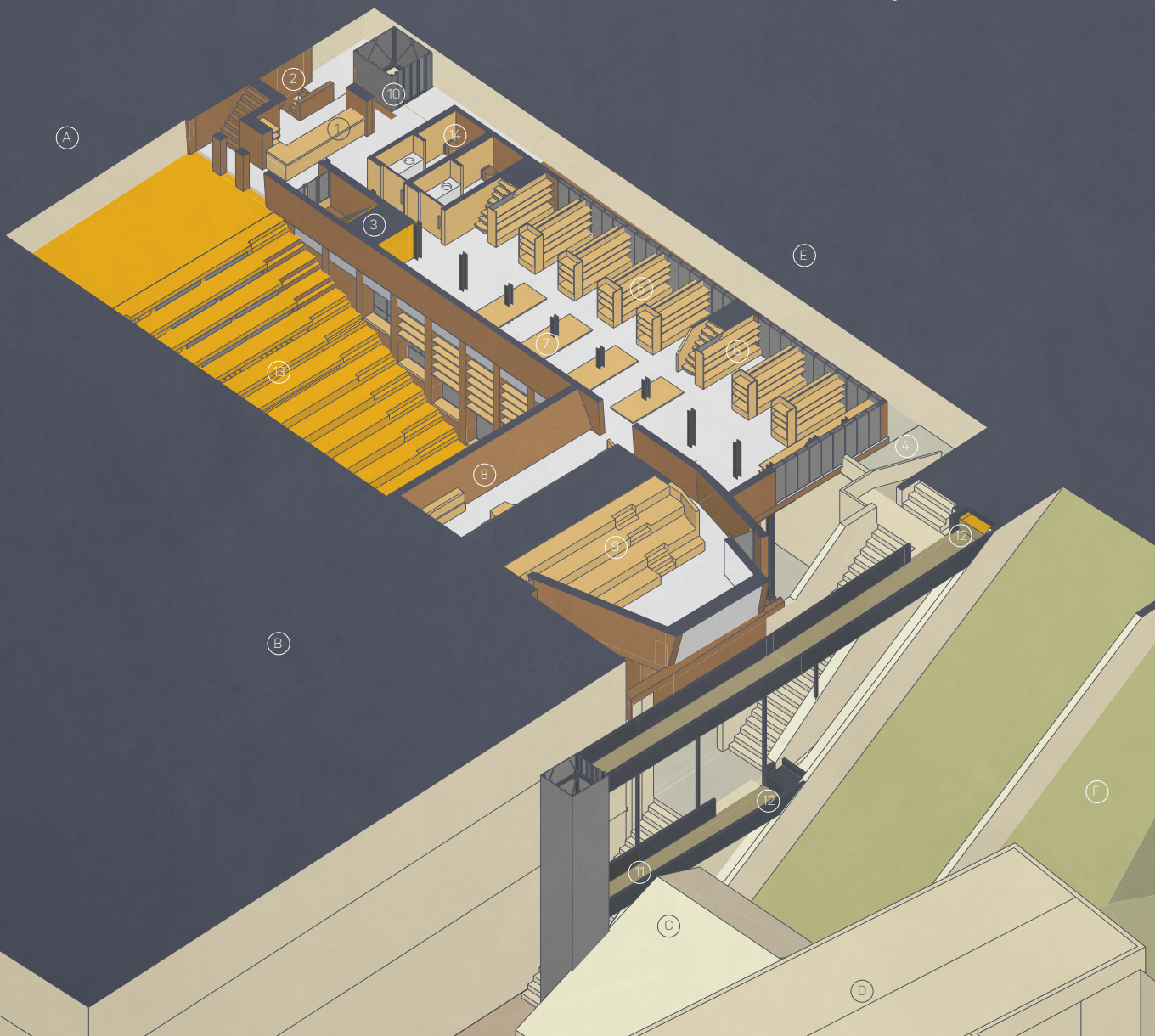

## LIBRARY & AUDITORIUM

From the yellow staircase that climbs up the structure from the reception one is able to enter the auditorium's primary entrance and the library. In the library, workspaces are integrated into the stacks, allowing for a vantage point into the void and an awareness of those using the space.

## 2nd Floor

Mezzanine of Library & entrance to Auditorium  
1:300



1. Stacks of Library and circulation
  2. Library workspaces
  3. Entrance to 2nd floor
  4. Courtyard
  5. External Staircase as part of auditory route and the space of appearance
  6. Walkway to auditorium
  7. Auditorium
  8. Amphitheatre
  9. Fire Escape and circulation throughout building
  10. Lift core
  11. Lift for wheel chair access to site
  12. Pause seating along exiting staircase
  13. WC
- 
- A. Humanities Faculty of University  
Retail, Offices and some residential
- B. Retail and residential
- C. Funicular
- D. Retail and residential
- E. Exiting retaining wall
- F. Slope of hill with natural vegetation

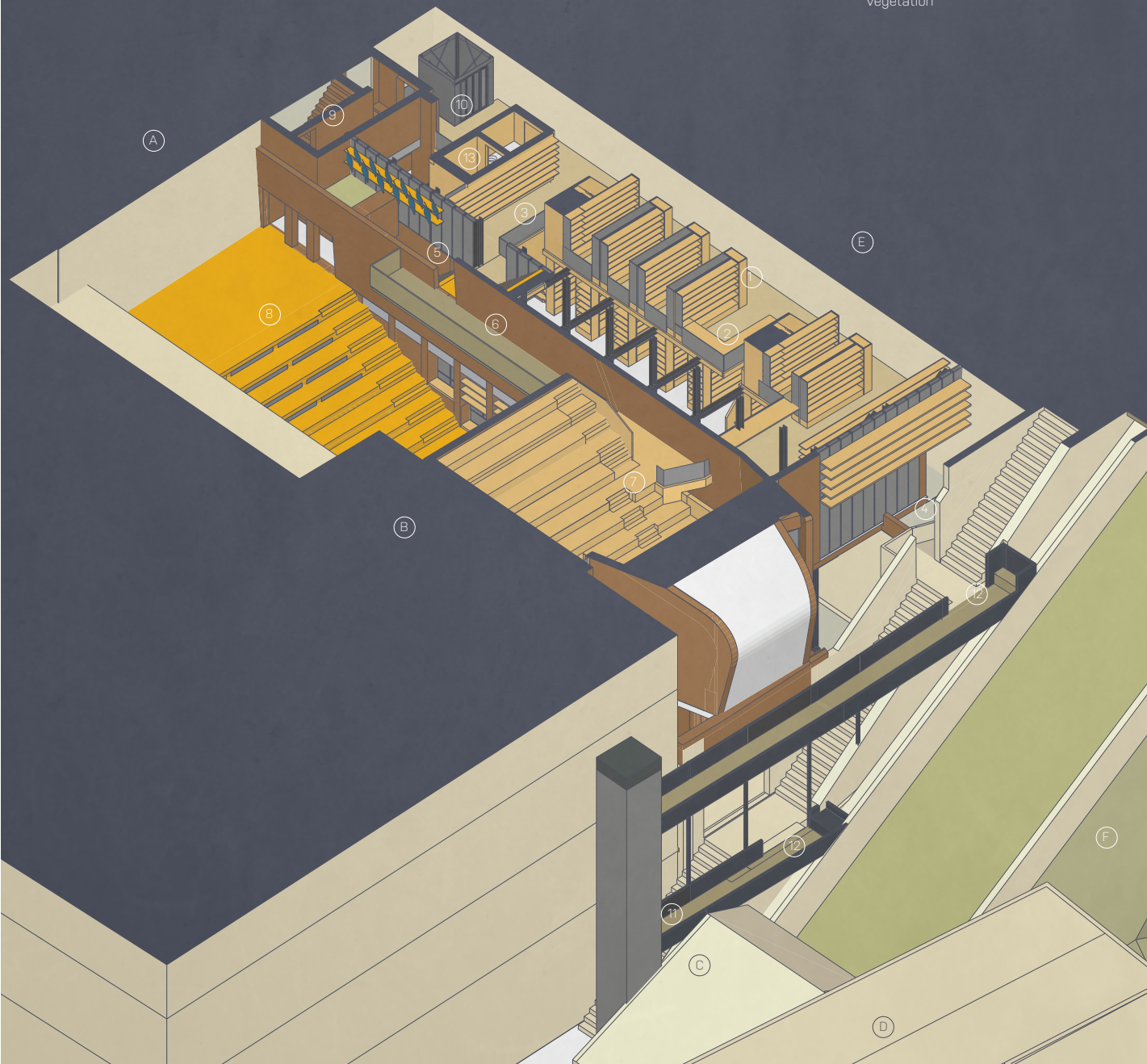

## TOP FLOOR OF LIBRARY

The stacks form the center of the library space that is surrounded by niches and workspaces. An important part of this floor is the courtyards situated against the retaining wall and niche that one can see in the top left corner. These spaces offer a very different environment for the users of the building to engage, whether it is a group discussion or simply taking a break away from the public space of the library.

On the public staircase one can also see the introduction of small seats as breaks along the massive staircase, which offer a vantage point over the surrounding area and towards the harbor.



# 3rd Floor

Top level of library stacks and the introduction of meeting rooms  
1:300



- 1. Stacks of Library and circulation
- 2. Library niche workspace
- 3. Work space
- 4. Meeting room
- 5. Outdoor niches
- 6. Walkway to auditorium
- 7. Auditorium
- 8. Amphitheatre
- 9. Fire Escape and circulation throughout building
- 10. Lift core
- 11. Triple volume – air flow
- 12. Lift for wheel chair access to site
- 13. Pause seating along exiting staircase
- 14. Fire escape
- 15. WC

- G. Humanities Faculty of University
- H. Retail, Offices and some residential
- A. Funicular
- B. Retail and residential
- C. Exiting retaining wall
- D. Slope of hill with natural vegetation

## WORKSPACE

Critical to the functionality of the library is the incorporation of areas for meetings, work and services for printing. This floor aims to provide a variety of different spaces in which people could work, read and deliberate.

4th Floor  
 Workspace of library  
 1:300



1. Open workspaces
2. Meeting rooms
3. Niches
4. Space for services (scanners and printers)
5. Small work niches
6. Courtyard
7. Storage room
8. Outdoor niche
9. Amphitheatre
10. Fire escape and secondary circulation
11. Lift core-
12. Lift for wheel chair access to site
13. Pause seating along exiting staircase
14. Fire escape
15. WC

- 
- A. Humanities Faculty of University
  - B. Retail, Offices and some residential
  - E. Funicular
  - F. Retail and residential
  - G. Exiting retaining wall
  - H. Slope of hill with natural vegetation

## THE COLLECTIVE SCHOOL ENVIRONMENT

The collective school works as a central space that is seen as a collective environment for play and learning. This primary environment is then surrounded by smaller niche spaces and classrooms that allow for diverse activities to occur.

Here you can see the tops of the small courtyards from the library, creating a sonic connection through the building. Along various walkways around the space one is either exposed to different parts of the city or entirely enclosed by the structure itself.



# 5th Floor

School Shared Work & Play Environment as well as the arts  
1:300



- A. Humanities Faculty of University
  - B. Retail, Offices and some residential
  - C. Funicular
  - D. Retail and residential
  - E. Exiting retaining wall
  - F. Slope of hill with natural vegetation
- 1. Teachers office
  - 2. Collective space
  - 3. Break-off classrooms
  - 4. Niche classroom/ reading room
  - 5. Music room
  - 6. Storeroom
  - 7. Drama room
  - 8. Break out space for drama room
  - 9. Circular niche
  - 10. Open niche
  - 11. Open play area
  - 12. Courtyard to library
  - 13. Circular staircase to mezzanine
  - 14. WC
  - 15. Connection to library and the extension of the sonic walkway
  - 16. Fire escape and circulation
  - 17. Lift core
  - 18. Amphitheatre
  - 19. Fire escape



## TERRACES AND VOLUME

This level is defined by to primary features; the terraced courtyard forming small areas for play and engagement; as well as the collective schools top level that is part of a double volume space. These two spaces, internal and external, perform a similar function in that one is sonically aware of the interactions occurring around. A key part of this is the ethos of the school that aims to encourage engagement and an awareness of other people - critical for youth development.

The central terraced courtyard is surrounded by active edges of classrooms that provide an active frame to the space.

# 6th Floor

Collective space & interior stepped courtyard with active edges  
1:300



- A. Humanities Faculty of University
  - B. Retail, Offices and some residential
  - C. Funicular
  - D. Retail and residential
  - E. Exiting retaining wall
  - F. Slope of hill with natural vegetation
- 1. Collective space
  - 2. Double volume and staircase
  - 3. Play areas, courtyards and balconies
  - 4. Music rooms and flexible classroom areas (soundproofed)
  - 5. Art room
  - 6. Storage
  - 7. Courtyards down to library
  - 8. Fire staircase and circulation
  - 9. Lift core
  - 10. Entrance to collective workspace
  - 11. Library school connection
  - 12. Amphitheatre



## ENCLOSED &amp; OPEN

The section aims to show the cafe courtyard environment that is enclosed by the building. Open to the sky, the impressive climb of the building becomes evident as it traverse the slope. The courtyard is formed in such a way to reverberate sound from the city and valley into the space, creating a sonic connection to ones environment.

In contrast the Market Square at the top is open to the city, providing space for appropriation. Rather than the defined use of a cafe, the market square is seen to be flexible and able to perform various needs of the community - from festivals, markets, to civil meetings. The space is framed by the upper school and roof that enclose the space.



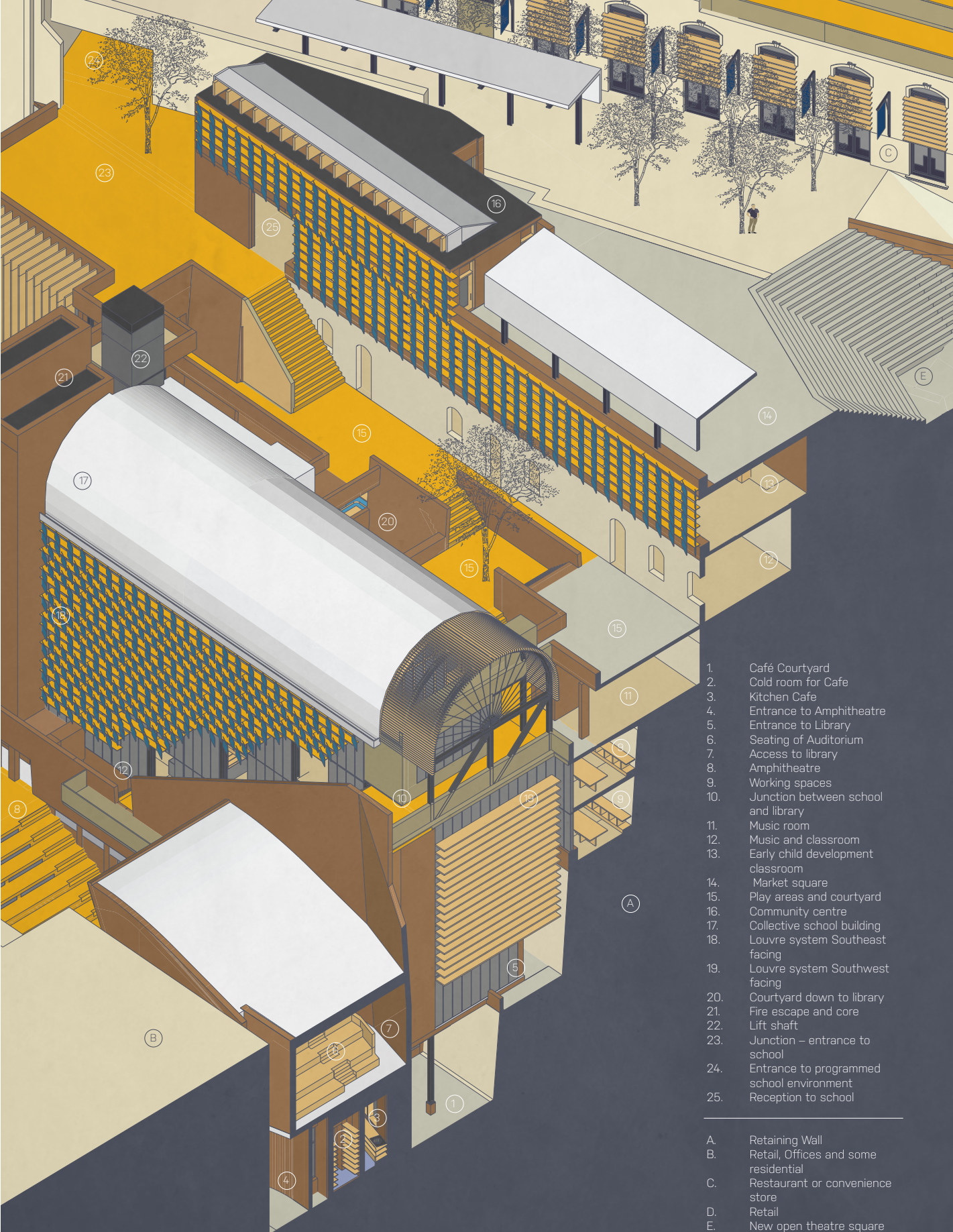

1. Café Courtyard
2. Cold room for Cafe
3. Kitchen Cafe
4. Entrance to Amphitheatre
5. Entrance to Library
6. Seating of Auditorium
7. Access to library
8. Amphitheatre
9. Working spaces
10. Junction between school and library
11. Music room
12. Music and classroom
13. Early child development classroom
14. Market square
15. Play areas and courtyard
16. Community centre
17. Collective school building
18. Louvre system Southeast facing
19. Louvre system Southwest facing
20. Courtyard down to library
21. Fire escape and core
22. Lift shaft
23. Junction – entrance to school
24. Entrance to programmed school environment
25. Reception to school

- A. Retaining Wall
- B. Retail, Offices and some residential
- C. Restaurant or convenience store
- D. Retail
- E. New open theatre square

**Section through Courtyard**

The section shows a variety of secondary spaces  
1:300



## VARIETY

The section aims to show the variety of spaces that make up the intervention. critically one can see how in the learning center one moves from larger to smaller spaces. This relates to moving from the space of appearance to more intimate environments. Conversely the school is orientated around a central courtyard.



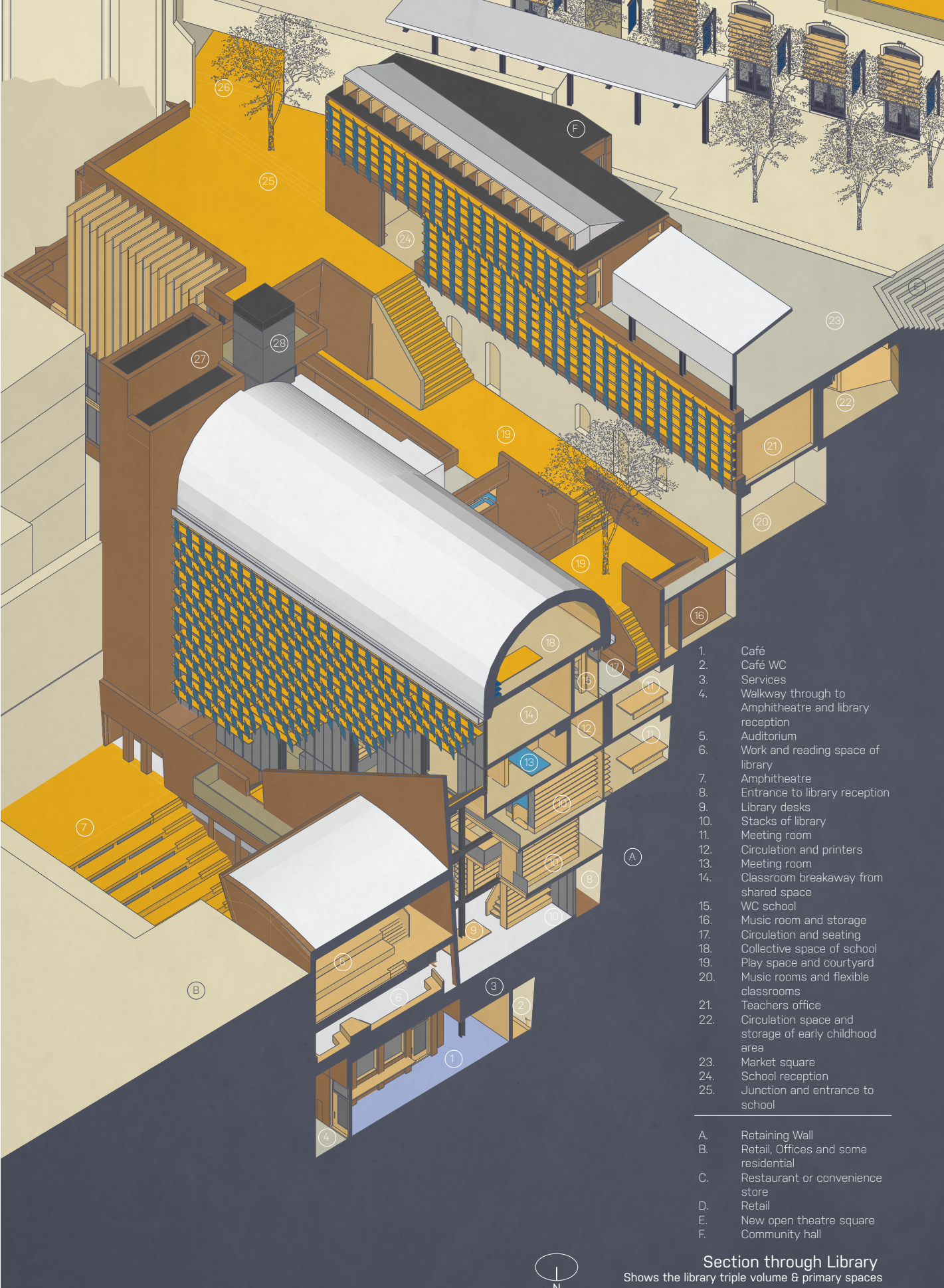

- 1. Café
  - 2. Café WC
  - 3. Services
  - 4. Walkway through to Amphitheatre and library reception
  - 5. Auditorium
  - 6. Work and reading space of library
  - 7. Amphitheatre
  - 8. Entrance to library reception
  - 9. Library desks
  - 10. Stacks of library
  - 11. Meeting room
  - 12. Circulation and printers
  - 13. Meeting room
  - 14. Classroom breakaway from shared space
  - 15. WC school
  - 16. Music room and storage
  - 17. Circulation and seating
  - 18. Collective space of school
  - 19. Play space and courtyard
  - 20. Music rooms and flexible classrooms
  - 21. Teachers office
  - 22. Circulation space and storage of early childhood area
  - 23. Market square
  - 24. School reception
  - 25. Junction and entrance to school
- 
- A. Retaining Wall
  - B. Retail, Offices and some residential
  - C. Restaurant or convenience store
  - D. Retail
  - E. New open theatre square
  - F. Community hall

**Section through Library**  
Shows the library triple volume & primary spaces  
1:300



## SONIC CONNECTION

In this section several moments of connection become apparent. The library courtyard creates a connection between library and school. The library itself and the school, creating volumes in which people would need to sonically mediate between each other. The amphitheater and auditorium walkway form a connection as they overlook one another. Here to, the terraced slope meets the junction entrance of the school, where the collective school, early childhood development center, upper school and entrance to the school meet. At this point one looks over the city before entering enclosed environments. The open junction also connects to the Market Square and sonic vantage point above.

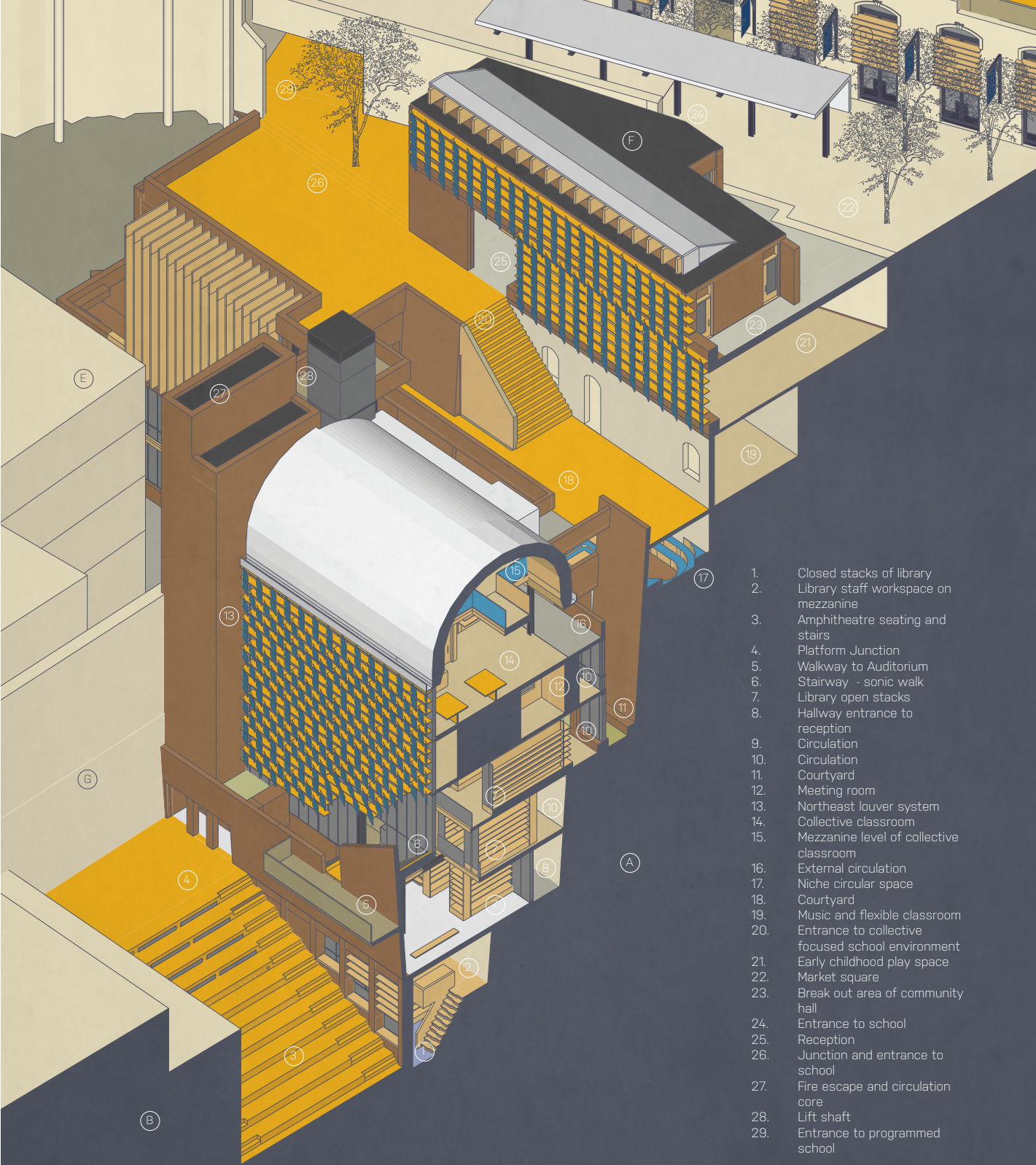

1. Closed stacks of library
2. Library staff workspace on mezzanine
3. Amphitheatre seating and stairs
4. Platform Junction
5. Walkway to Auditorium
6. Stairway - sonic walk
7. Library open stacks
8. Hallway entrance to reception
9. Circulation
10. Circulation
11. Courtyard
12. Meeting room
13. Northeast louver system
14. Collective classroom
15. Mezzanine level of collective classroom
16. External circulation
17. Niche circular space
18. Courtyard
19. Music and flexible classroom
20. Entrance to collective focused school environment
21. Early childhood play space
22. Market square
23. Break out area of community hall
24. Entrance to school
25. Reception
26. Junction and entrance to school
27. Fire escape and circulation core
28. Lift shaft
29. Entrance to programmed school

- A. Retaining Wall
- B. Retail, Offices and some residential
- C. Restaurant or convenience store
- D. Retail
- E. Humanities Faculty
- F. Community hall
- G. Exiting wall of old site structure (Brick)



**Primary Section**  
The diversity of spaces that characterise the project  
1:300

## JUNCTION

This section shows the two junction points within the buildings, namely the amphitheater and the entrance to the school. These two spaces are remarkably different. One projects out to the city, allowing the voices of children to carry in the wind, while the amphitheater is entirely enclosed. This not only speaks of the context from which they originate, hill and city, but also an ethos of approach in understanding the intention of the sonic act in these environments. The Amphitheatre forms amplification, making one aware of ones own influence in the space, as one begins to enter the university and learning center. The school entrance however is open and speaks of presence.

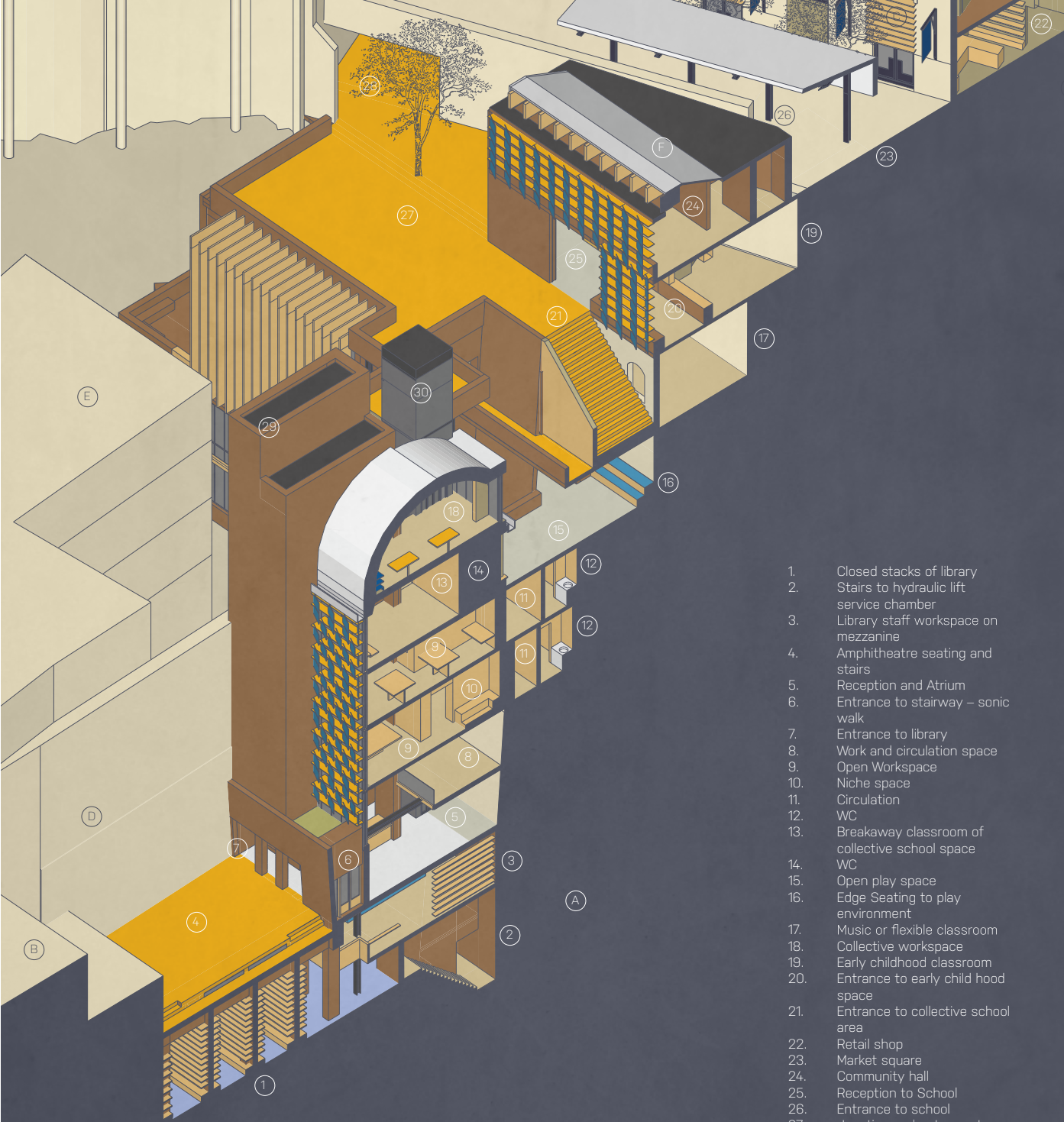

1. Closed stacks of library
  2. Stairs to hydraulic lift service chamber
  3. Library staff workspace on mezzanine
  4. Amphitheatre seating and stairs
  5. Reception and Atrium
  6. Entrance to stairway – sonic walk
  7. Entrance to library
  8. Work and circulation space
  9. Open Workspace
  10. Niche space
  11. Circulation
  12. WC
  13. Breakaway classroom of collective school space
  14. WC
  15. Open play space
  16. Edge Seating to play environment
  17. Music or flexible classroom
  18. Collective workspace
  19. Early childhood classroom
  20. Entrance to early child hood space
  21. Entrance to collective school area
  22. Retail shop
  23. Market square
  24. Community hall
  25. Reception to School
  26. Entrance to school
  27. Junction and entrance to school
  28. Entrance to programmed school
  29. Fire escape and circulation core
  30. Lift shaft
- 
- A. Retaining Wall
  - B. Retail, Offices and some residential
  - C. Retail
  - D. Exiting wall of old site structure (Brick)
  - E. Humanities Faculty
  - F. Community hall

### Support spaces Section

The primary spaces that act as supportive spaces  
1:300



## THE VALLEY

The end of the building is structured with an open roof, the junction of the school, and work places below. The reason for this is that this space is seen to be quieter than many other points of the project, as the cliff and buildings create a valley. Supporting the classrooms and workspaces are breakout spaces at the end that also form a fire-escape. These spaces aim to allow for sonic intermission, as the most intimate of environments.



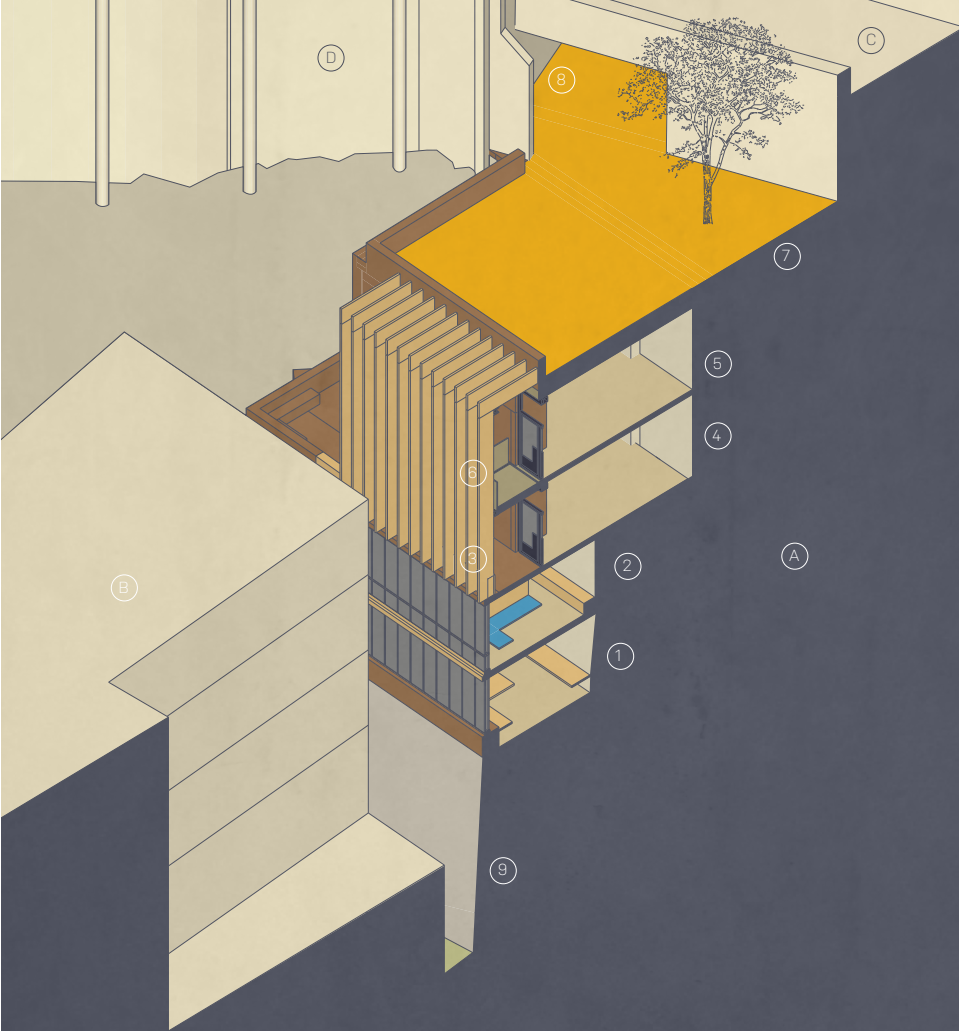

1. Work Area
2. Work area with break out spaces
3. Break out spaces for drama classrooms
4. Drama Classrooms
5. Art Classrooms
6. Balcony
7. Junction square for entrance to school
8. Entrance to programmed school

- 
- A. Retaining Wall
  - B. Humanities Faculty
  - C. Continuation of Public Sonic walk to the Sonic Vantage Point
  - D. Retaining wall



**The Interior Corner Section**  
 The topography and situation create a intimate space  
 1:300



## THE WALKWAY

The following renders run allow the binding walkway through the project. Here one is exposed to the variety of external spaces that support the intervention and highlight the significant public contribution the project aims to make to the surrounding city fabric.

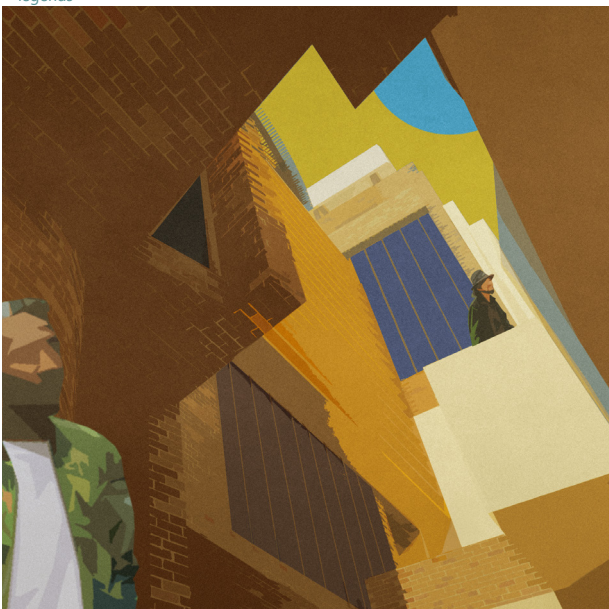
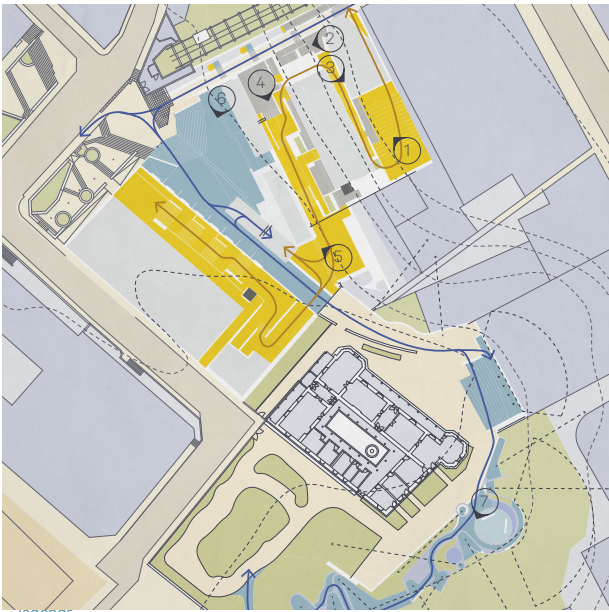





1. Amphitheater
2. Courtyard
3. Stairway adjacent to library
4. Terraced Courtyard of school
5. Entrance junction to school
6. Sonic vantage point

Market Square

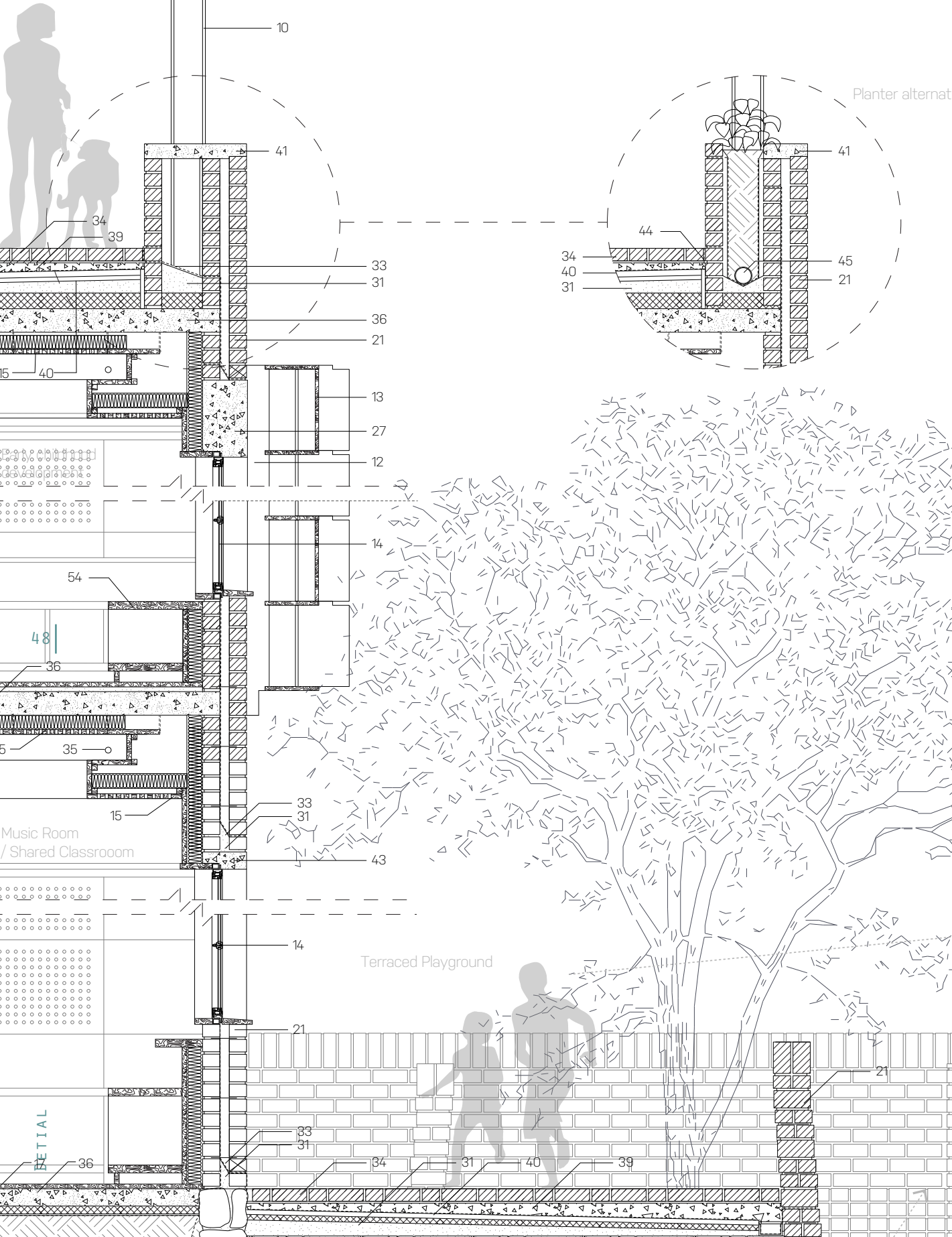

Planter alternative

Music Room / Shared Classroom

Terraced Playground

DETAIL



## Legend

1. Steel t-section 30x30, welded to steel plate connecting to frame structure.
2. 30x 600x1200 hardwood plywood with holes cut into centre, backed by Steico wood insulation
3. Steico wood insulation
4. Steel Structural Thermal Break plate 25x200x350 (attached to steel substructure). Gypsum board 51x600x1200 panels, attached to exterior of core steel structure and surfaced by damp proof membrane.
5. 100x100 bent I-beam attached to structural thermal break, forming air gap for air movement within the roof. Steel-T sections running perpendicular create substructure for 30x 600x1200 hardwood plywood panels, Damp proof membrane secure to exterior surface of plywood panels
6. 0.60 Corodek, roof sheeting for curved surfaces – final application of flexible solar modules.
7. Electrical duct
8. Gutter, fibreglass structure connected by flashing to roof structure bound by metal sheeting for support
9. 6x100x100 Steel I-Beam
10. 19x200x200 Steel I-Beam
11. 12x100x200 Steel C-Section
12. 8x100 Steel plate, welded with steel connections
13. Prefabricated Timber louvre system, finished with paint which is breathable
14. Double-glazed steel frame window and door system. Substructure contains thermal breaks.
15. 30x 600x1200 hardwood plywood with holes cut into centre, Sound Insulation Coconut fibre based
16. Steico wood insulation
17. Teak flooring system – locally produced.
18. Teak wood panelling/ Plywood, constructed to carpenter specifications.
19. 70x150 timber beam structure
20. Gypsum boarding, cut to local specification.
21. 80x110x220 engineering brick
22. Tapered Beam constructed by welded plates
23. Teak timber (locally produced) – treated for outdoor use.
24. Steel section (varied sizes)
25. Teak furniture, - table top 70x1200x2800
26. Timber mullion
27. Reinforced concrete beam, cast-in-situ
28. Teak wood panelling/ Plywood, constructed to carpenter specifications.
29. Reinforced concrete slab, 110mm thick, 3x3m gauging/movement gaps, - Steico wood insulation 50mm thick, damp-proof membrane, sand, compacted ground.
30. Screed tapered
31. Screed fill
32. Reinforced concrete foundation – castinsitu
33. Damp proof course
34. ROK brick for flooring
35. lighting
36. Cast InSitu Reinforced concrete 150mm
37. Cast InSitu Reinforced capping beam to retaining wall
38. Steico wood insulation 100mm
39. Gravel
40. Bitmum and surface treatment
41. Concrete Capping
42. Reinforced Concrete slab and beam
43. Reinforced Concrete Lintel
44. Sponge tubing, Expansion joint filler
45. 110mm pipe
46. Rock Retaining wall (Existing)
47. Bitimum layer
48. Mirco Pile foundations drilled into retaining wall
49. Rock wall
50. 110mm reinforced concrete slab with terrazzo finish (30mm)
51. Diaphragmatic box (used for dampening low frequency noise). Intial membrain of 5mm hardboard to absorb vibration, inner chamber of high density carbon fibre.
52. Timber railing
53. IBR Sheeting, attached to hardwood plywood, Sound Insulation Coconut fibre based, 30x 600x1200 hardwood plywood with holes, Steel substructure attached to 200 x 200 I-Beam
54. Earlychildhood furniture, 500 table top hieght
55. Precast concrete seating, with timber panel cut to fit (30mm thick)
56. Compacted gravel on compacted soil
57. Library Furniture - seating and storage space
58. Concrete column (elevation) base to steel frame structure connected to concrete beam.
59. Aluminium sliding door frame

ive detail

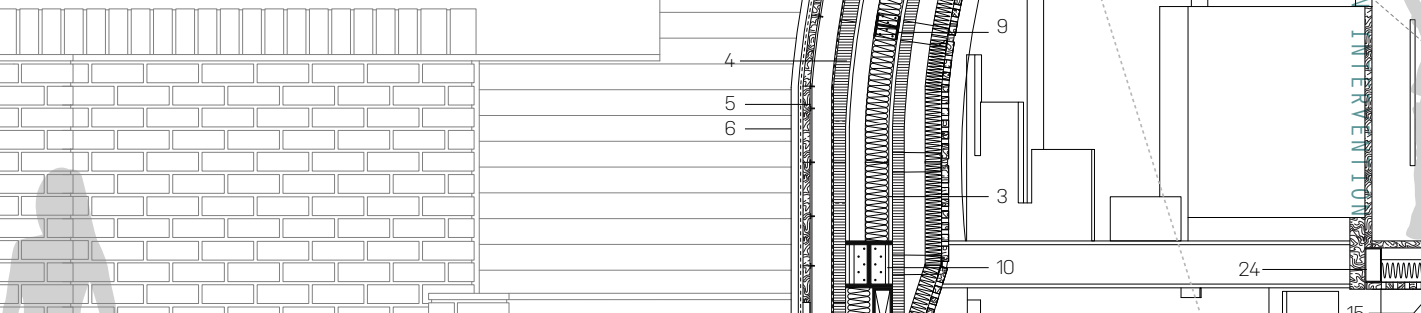



Terraced Playground

Collective School Playground / Meeting Space

50 |

DETAIL



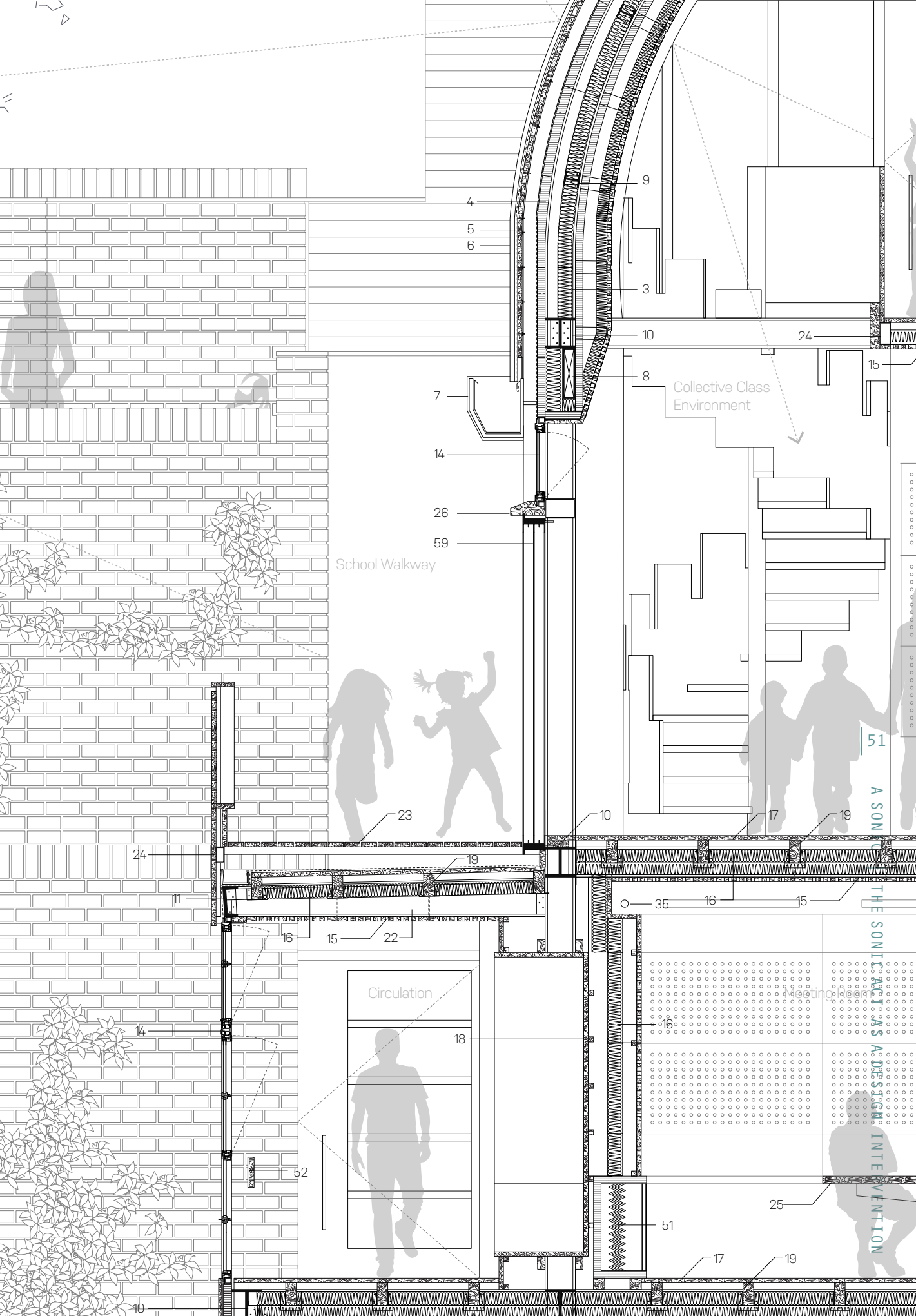

School Walkway

Collective Class Environment

Circulation

51

A SON

THE SONIC CACIOTAS  
A DESSISM: INTERVENTION

4

5

6

7

8

9

10

14

26

59

23

24

11

16

15

22

14

52

10

19

18

16

35

16

15

17

19

25

51

17

19

24

15

15

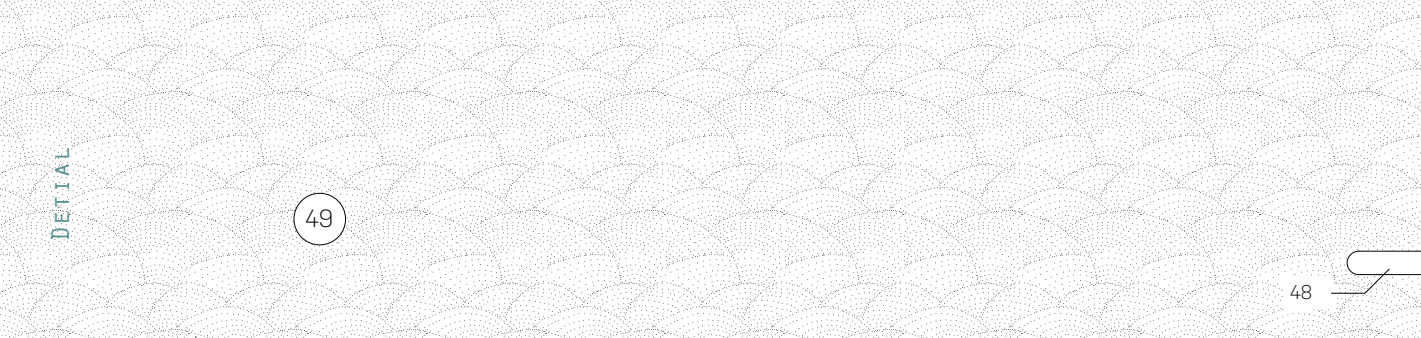
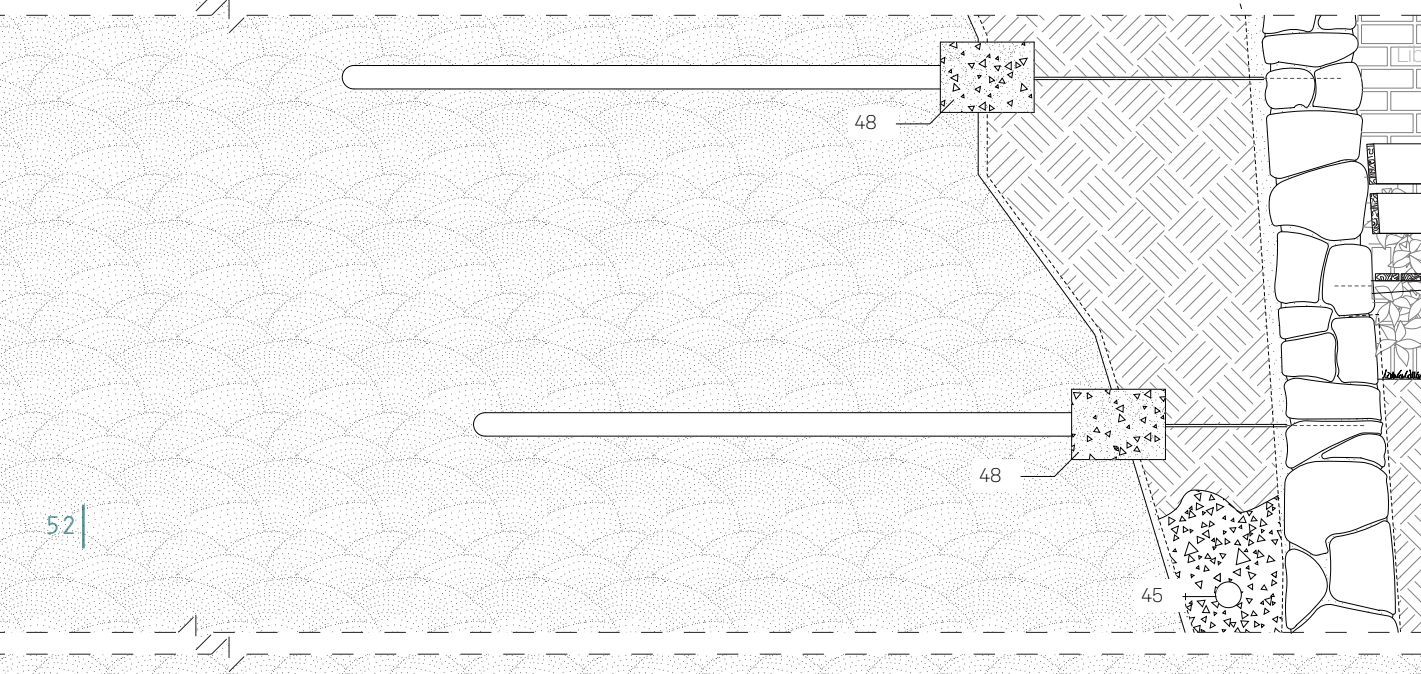
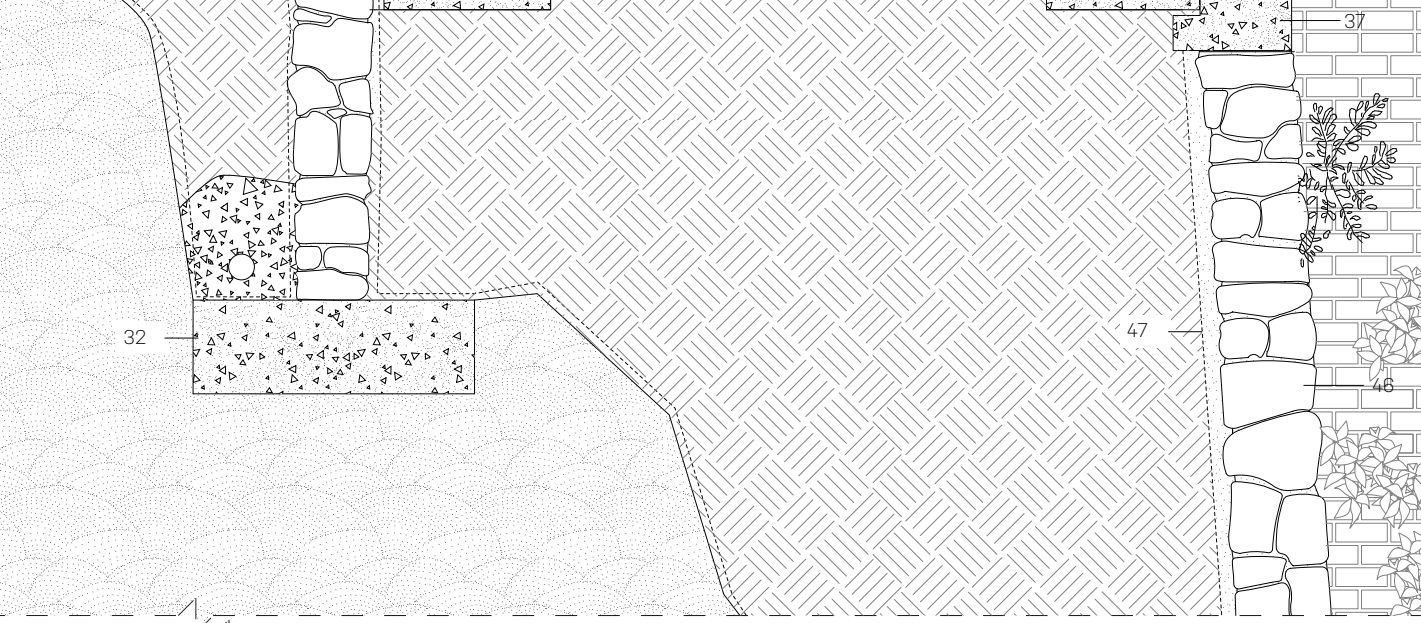



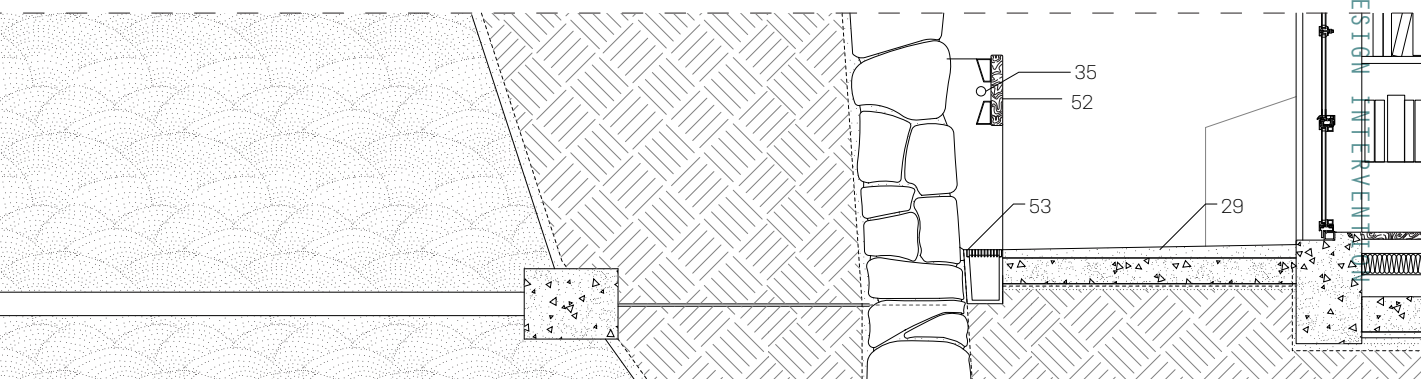
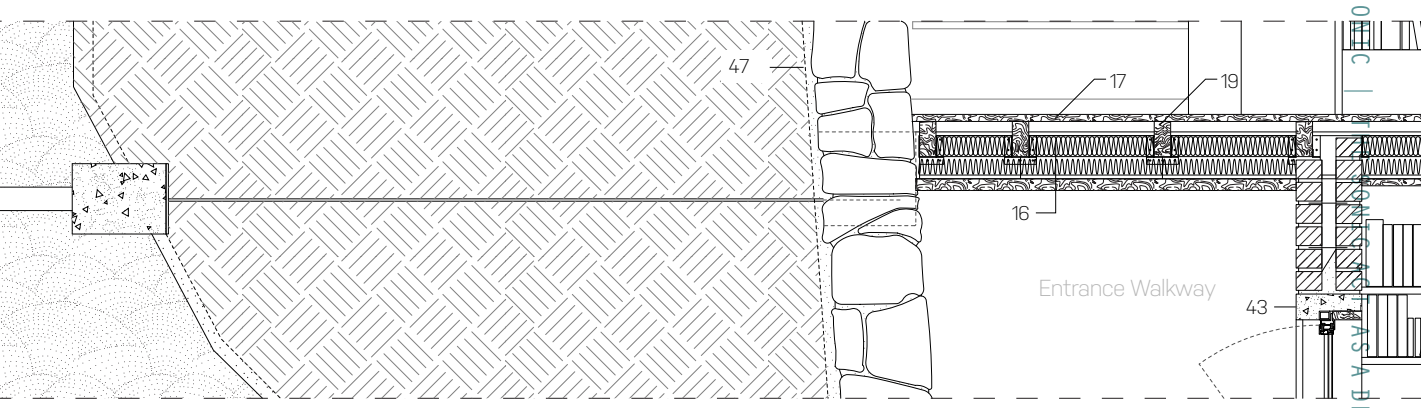
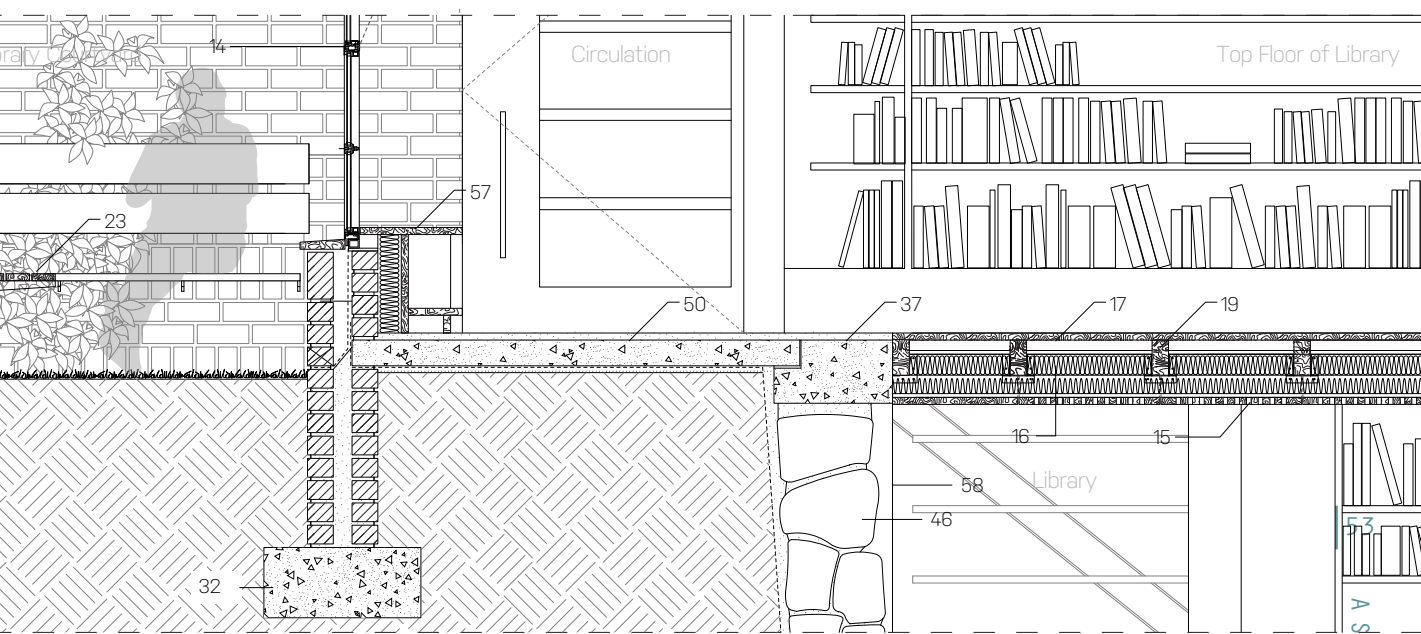
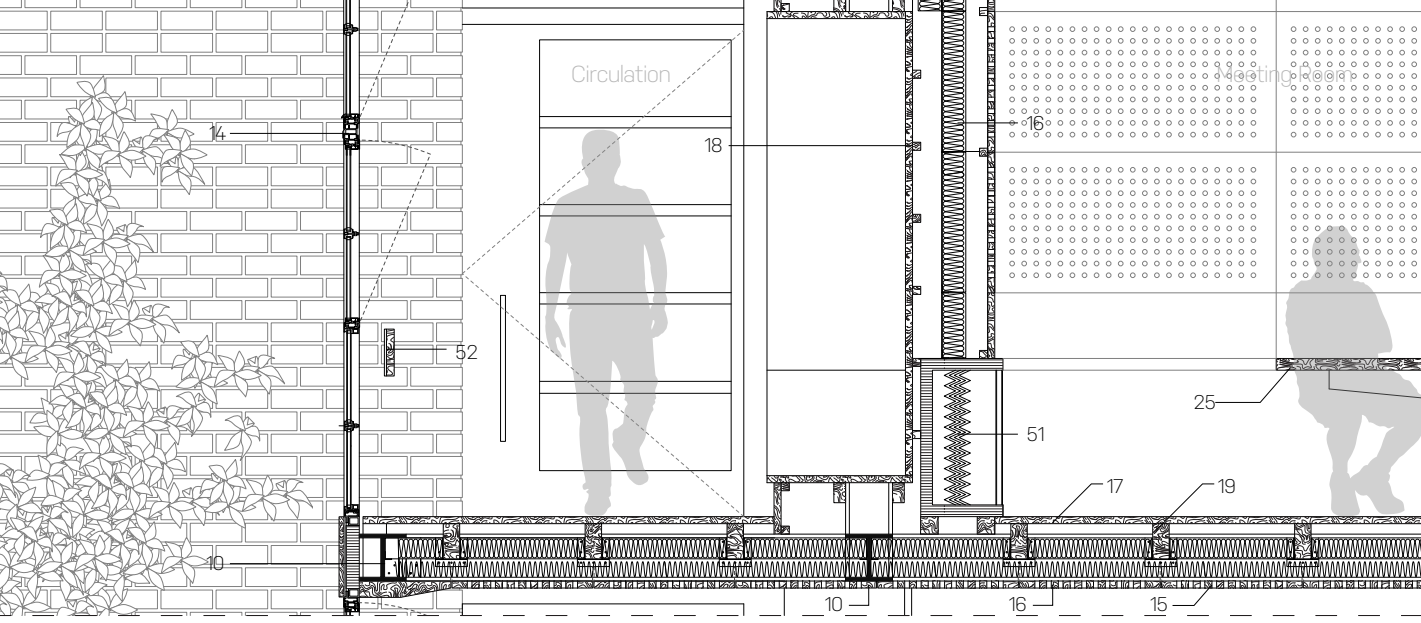

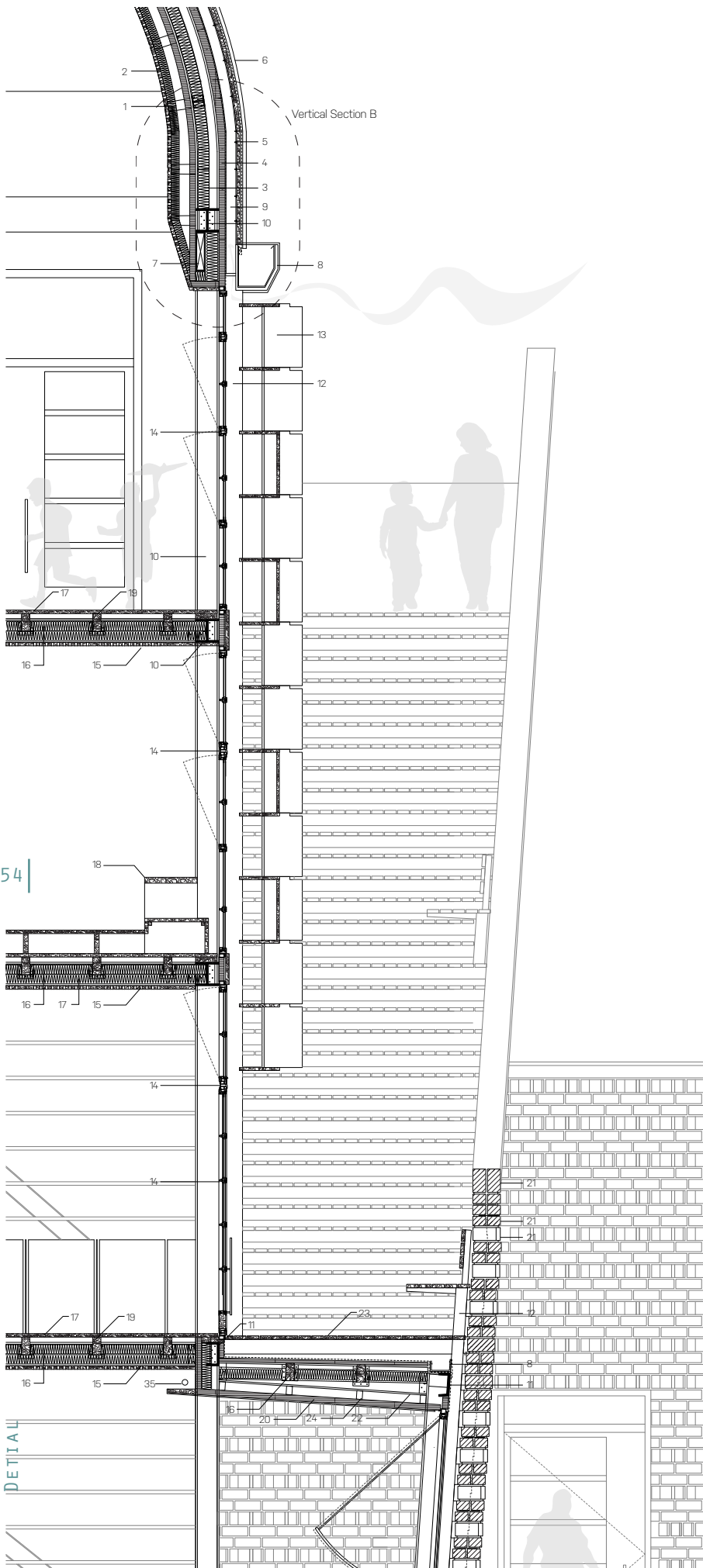

54 |

DETAIL

### Legend

1. Steel t-section 30x30, welded to steel plate connecting to frame structure.
2. 30x 600x1200 hardwood plywood with holes cut into centre, backed by Steico wood insulation
3. 100mm Steico wood insulation
4. Steel Structural Thermal Break plate 25x200x350 (attached to steel substructure). Gypsum board 5x600x1200 panels, attached to exterior of core steel structure and surfaced by damp proof membrane.
5. 100x100 bent I-beam attached to structural thermal break, forming air gap for air movement within the roof. Steel-T sections running perpendicular create substructure for 30x 600x1200 hardwood plywood panels, Damp proof membrane secure to exterior surface of plywood panels
6. 0.60 Corodek, roof sheeting for curved surfaces – final application of flexible solar modules.
7. Electrical duct
8. Gutter, fibreglass structure connected by flashing to roof structure bound by metal sheeting for support
9. 6x100x100 Steel I-Beam
10. 18x200x200 Steel I-Beam
11. 12x100x200 Steel C-Section
12. 8x100 Steel plate, welded with steel connections
13. Prefabricated Timber louver system, finished with paint which is breathable
14. Double-glazed steel frame window and door system. Substructure contains thermal breaks.
15. 30x 600x1200 hardwood plywood with holes cut into centre, backed Sound Insulation Coconut fibre based
16. Steico wood insulation
17. Teak flooring system – locally produced.
18. Teak wood panelling/ Plywood, constructed to carpenter specifications.
19. 70x150 timber beam structure
20. Gypsum boarding, cut to local specification.
21. 80x110x220 engineering brick
22. Tapered Beam constructed by welded plates
23. Teak timber (locally produced) – treated for outdoor use.
24. Steel square section
25. Teak furniture, - table top 70x1200x2800
26. Varnished teak louver system
27. Reinforced concrete beam, cast-in-situ
28. Teak wood panelling/ Plywood, constructed to carpenter specifications.
29. Reinforced concrete slab, 110mm thick, 3x3m gauging/movement gaps, - Steico wood insulation 50mm thick, damp-proof membrane, sand, compacted ground.
30. Concrete precast gutter
31. Screed fill
32. Reinforced concrete foundation – castinsitu
33. Damp proof course
34. ROK brick flooring on sand, on compacted ground.
35. lighting
36. Concrete Structural Thermal Break

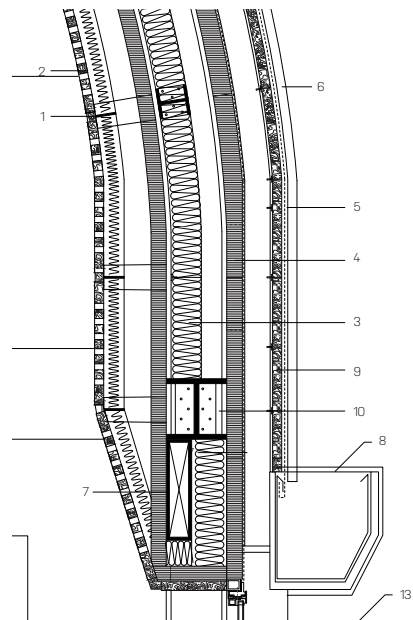



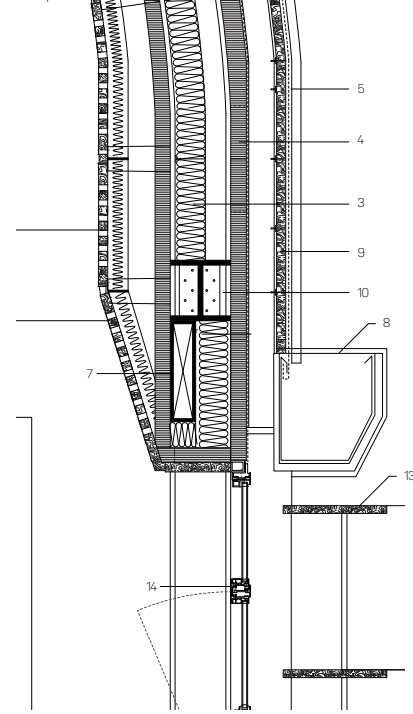
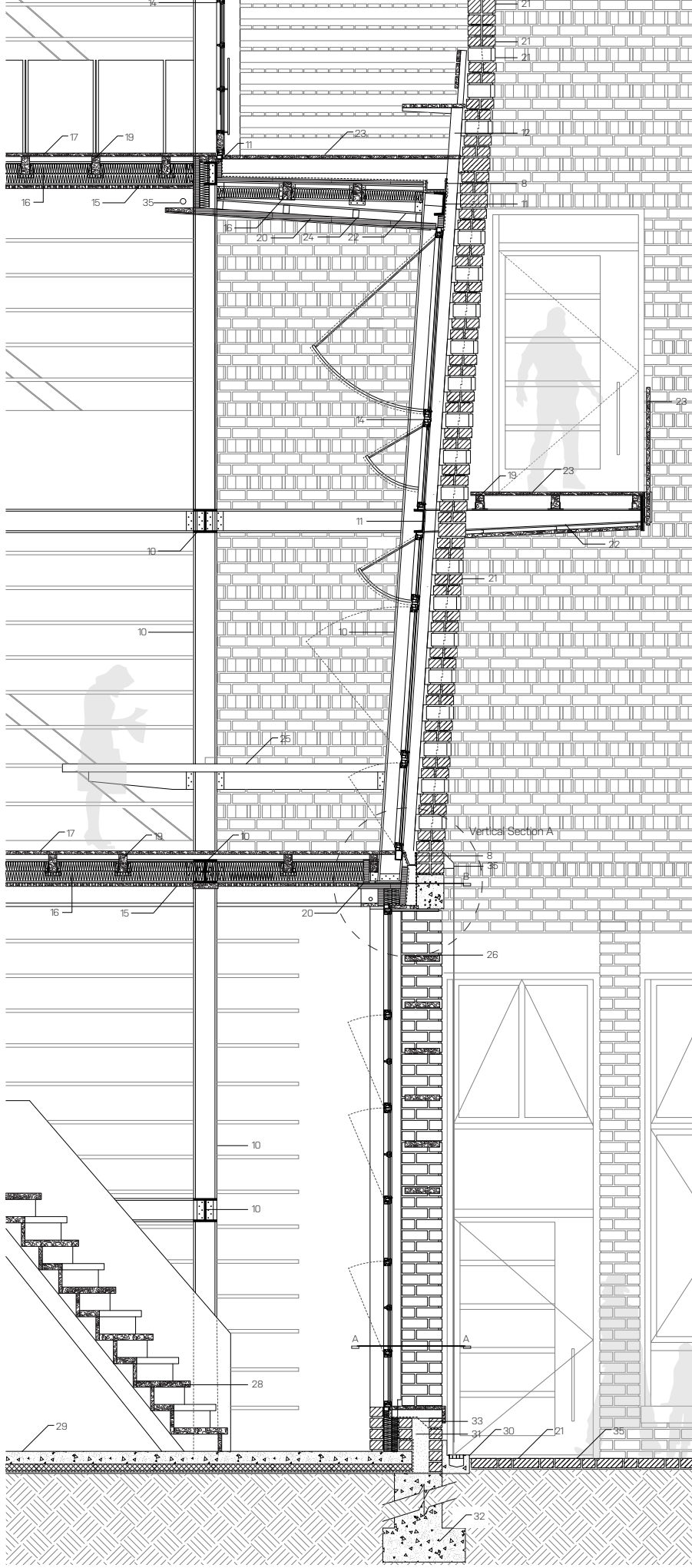

1:10 Vertical Section [B] Roof Joint

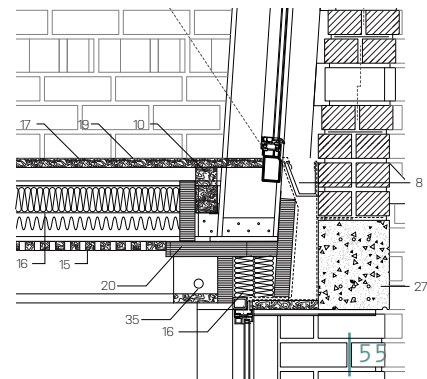

1:10 Vertical Section [A] of Column

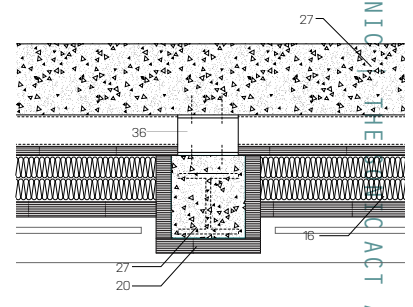

1:10 Horizontal Section [B] of Column

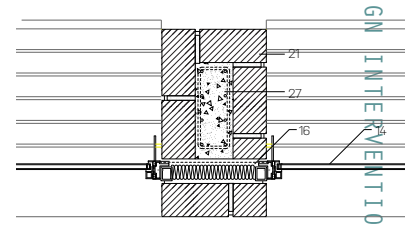

1:10 Horizontal Section [A] of Column

A SONIC INTERVENTION  
THE CONTACT AS A DESIGN INTERVENTION

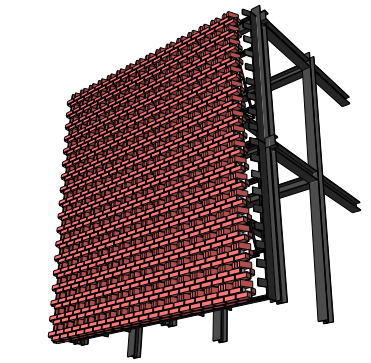

Facade exterior view  
Bricks

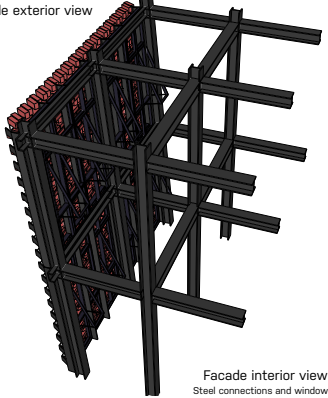

Facade interior view  
Steel connections and window

Solar Radiation System

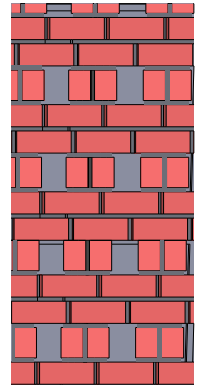

Brick Elevation  
Aligned to skew bricks 1:10

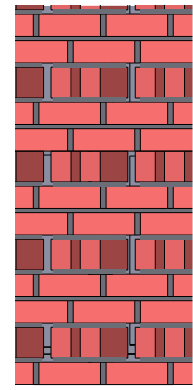

Brick Elevation  
Aligned to Facade 1:10



Interior Atmosphere  
Library interior Facade

56 | FACADE SYSTEMS

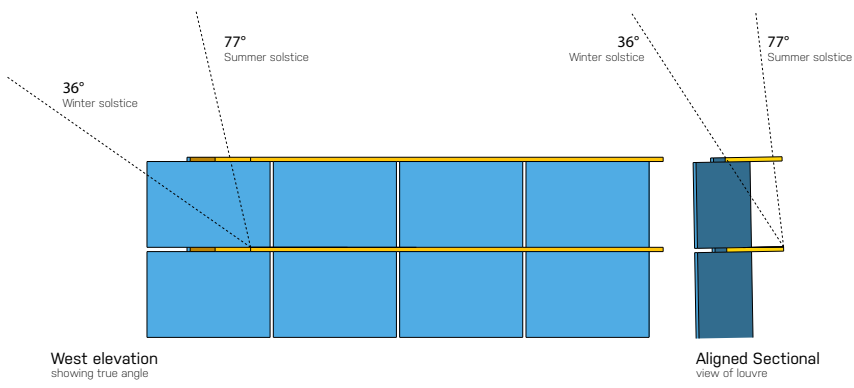

West elevation  
showing true angle

Aligned Sectional  
view of louvre

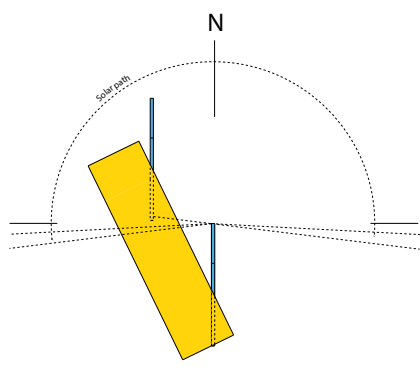

Plan of Primary Louvre System  
showing true angle

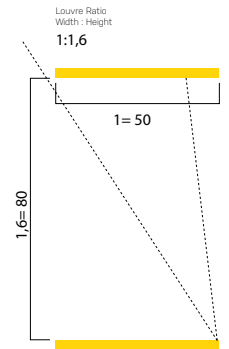

Ratio for Horizontal Louvre  
Section Northeast facing and Northwest facing

Solar Radiation System



