

Document Version

Final published version

Licence

CC BY-NC-SA

Citation (APA)

Verheij, H. J., Koedijk, O. C., van der Hout, A. J., van Koningsveld, M., & de Vriend, H. J. (2021). Part III - Ch 2 Dimensions of waterways. In M. V. Koningsveld, H. J. Verheij, P. Taneja, & H. J. de Vriend (Eds.), *Ports and Waterways: Navigating a changing world* (pp. 223-270). TU Delft OPEN Publishing.

Important note

To cite this publication, please use the final published version (if applicable). Please check the document version above.

Copyright

In case the licence states "Dutch Copyright Act (Article 25fa)", this publication was made available Green Open Access via the TU Delft Institutional Repository pursuant to Dutch Copyright Act (Article 25fa, the Taverne amendment). This provision does not affect copyright ownership. Unless copyright is transferred by contract or statute, it remains with the copyright holder.

Sharing and reuse

Other than for strictly personal use, it is not permitted to download, forward or distribute the text or part of it, without the consent of the author(s) and/or copyright holder(s), unless the work is under an open content license such as Creative Commons.

Takedown policy

Please contact us and provide details if you believe this document breaches copyrights. We will remove access to the work immediately and investigate your claim.

2 Dimensions of waterways

¹Waterways are generally confined areas through which vessels can sail. Apart from inland waterways (rivers, canals, navigation channels through shallow inland lakes), they also include port access channels and water bodies in ports. In this chapter we will consider the dimensions of waterways required for efficient, smooth and safe navigation. First, we will present design rules given in PIANC manuals and other guidelines (e.g. RVW, 2020). Secondly, we will provide information regarding simulation models and nautical safety analysis to be used in the conceptual and the final design phase respectively for port access channels, port water areas, and inland waterways.

2.1 Ship behaviour and ship-ship interactions

Apart from rudders, propellers and thrusters, there are external factors influencing the behaviour of a ship, such as wind, currents, and waves. A skipper has to take them into account when negotiating the limitations and complexities of a waterway and the interaction with the other traffic on it. But they are also factors to be considered when designing a waterway.

Basically, the motion of a ship on open water has six components, or degrees of freedom: three translational and three rotational (see Figure 2.1). The ship movements are the result of the interaction between the vessel and its surroundings. The ensuing water motion in confined water, is different from that in open water. The same goes for the interaction with other ships sailing nearby. These effects also have to be taken into account when determining the dimensions of a waterway.

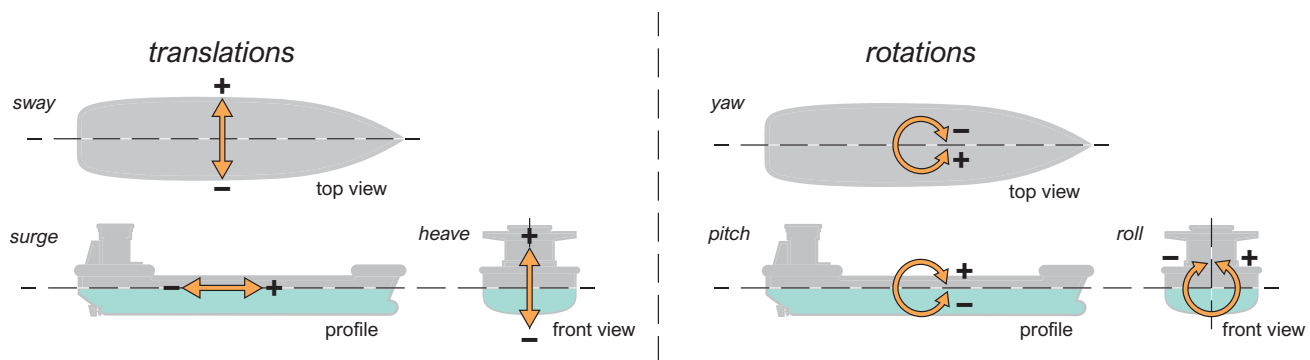

Figure 2.1: The six degrees of freedom of ship motion (by TU Delft – Ports and Waterways is licenced under CC BY-NC-SA 4.0).

The terminology of Figure 2.1 is mainly used for ship motions in waves. For ships sailing on inland waterways the following terms are used (also see Figure 2.2):

- *sinkage* – the constant downward displacement of the ship’s centre of gravity (comparable to heave which is the wave-driven, and therefore dynamic downward movement due to waves),
- *trim* – the rotation about the horizontal axis perpendicular to the ship (comparable to pitch); trim can be caused by the ship’s speed, as well as by uneven loading,
- *heel* – the rotation about the longitudinal axis (comparable to roll), usually caused by uneven loading but can also occur when a ship is sailing in a bend.
- *squat* – the combination of sinkage and trim as far as it is caused by the ship’s forward speed (note that trim may also be caused by uneven loading).

¹This chapter made use of ‘Inland Waterways. Ports, Waterways and Inland Navigation’ (Verheij et al., 2008), lecture notes for the Ports and Waterways course CIE4330 at TU Delft.

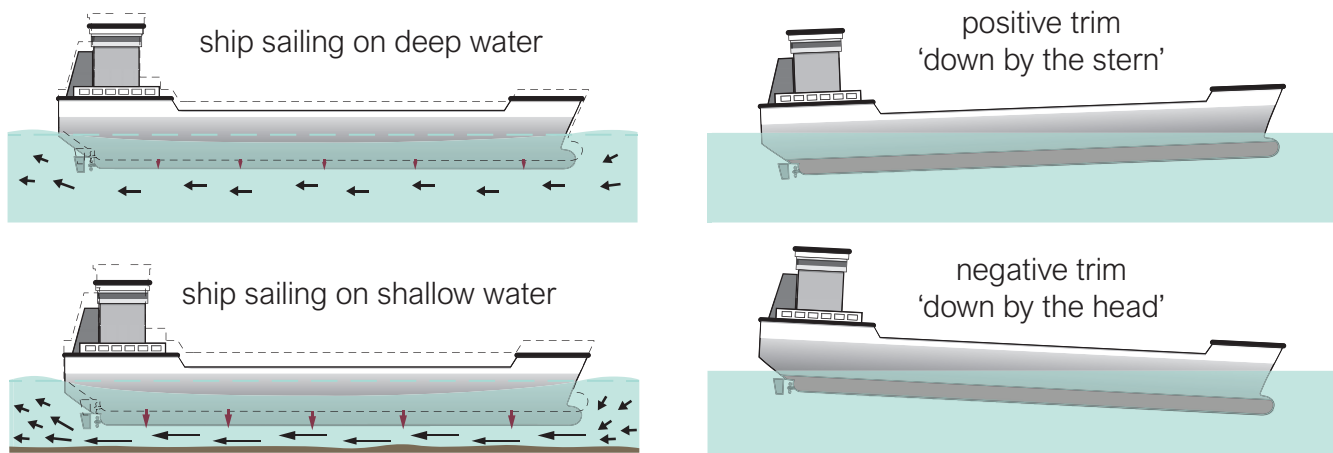

Figure 2.2: Sinkage (left) and trim (right) of a ship (by TU Delft – Ports and Waterways is licenced under CC BY-NC-SA 4.0).

Sinkage is a constant displacement (under constant conditions) in contrast to ‘heave’, which is wave-driven and therefore dynamic. Heel also occurs when a ship navigates in a bend. In confined water sinkage and trim cause a decrease of the effective nautical depth, which may influence the ship’s manoeuvrability or even lead to grounding.

In the following sections we will describe how the principal dimensions of a waterway depend on ship behaviour and ship-ship interactions.

2.1.1 Standards for the waterways depth

The depth required for waterway navigation depends on the draught of the reference vessel and its motions, which can be influenced by a range of factors (Figure 2.3).

The depth/draught ratio h_0/D_s determines the manoeuvrability of the ship. The minimum required depth of a waterway is mainly determined by the permissible draught and the speed of the design ship. In favour of a good controllability the Under Keel Clearance (UKC) cannot be taken too small. Therefore, the water level depression caused by the ship’s speed relative to the water is an important parameter to judge the UKC.

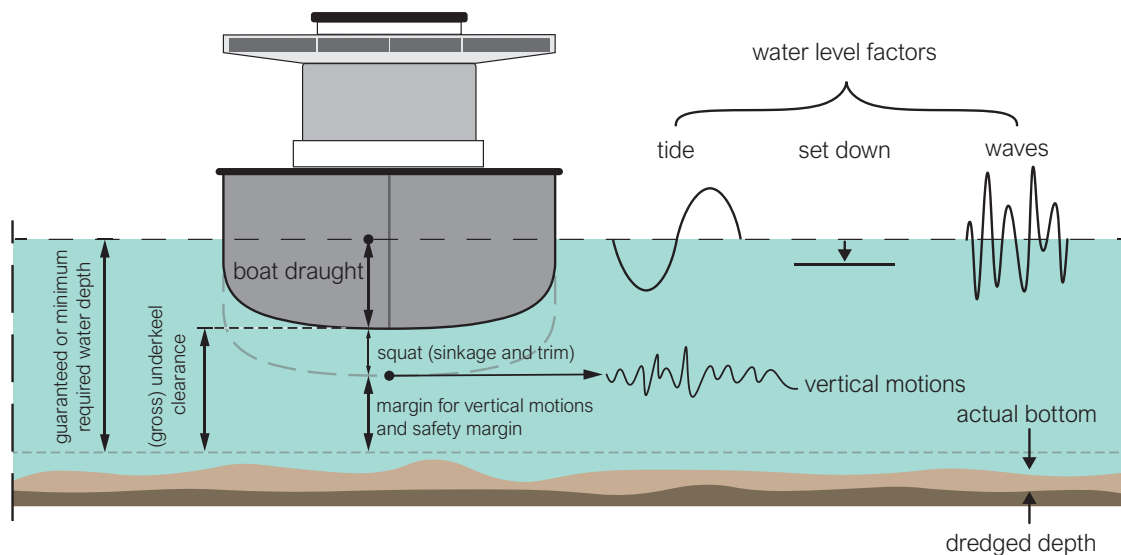

Figure 2.3: Factors influencing the required channel depth (by TU Delft – Ports and Waterways is licenced under CC BY-NC-SA 4.0).

Given the cross-sectional dimensions of a channel, the water level depression grows as the ship's speed increases. It depends on the return current, the wave pattern around the ship and the trim. As the depression increases, the ship's squat (sinkage + trim) increases and the navigation margin with respect to the channel bed decreases. The main factors determining sinkage are:

- the ship's speed relative to the water;
- the configuration of the waterway, i.e. the water depth-to-draught ratio and the ratio of the channel width over the ship's beam.

We assume the sinkage to be equal to the maximum water level depression and trim to be absent. Then sinkage and water level depression are determined by the ship's speed and the blockage coefficient, that is the ratio of the cross-sectional areas of the ship, A_s , and the channel, A_c . Schijf (1949) gives an analytical calculation method for a rectangular ship sailing in a rectangular channel, assuming a horizontal water surface in each cross-section. In that case the sinkage is equal to the water level depression. We will describe this method in Chapter 4 of this part.

The parameter h_0/D_s is meant to determine the actual required depth, in which h_0 is the depth without navigation and D_s the draught of the reference vessel. It would therefore be better to take the water level depression z into account and use $(h_0 - z)/D_s$ as a parameter. The value of z , however, depends on many factors, such as the ship's speed, the blockage coefficient and the average water depth. In case of a trapezoidal profile it is even more complicated, as the water level depression also depends on the bank slope gradient and the actual channel width. Furthermore, the water level depression increases when sailing eccentrically in the channel.

All these factors make it hard to estimate the water level depression. In order to have a first impression, Figure 2.4 shows how z/h_0 varies with A_s/A_c when adopting Schijf's simplifications. Ships are assumed to sail with the so-called attainable speed, which is at about 90% of the limit speed, that is the maximum speed at which a specific ship can physically sail (further see Section 4.1.1).

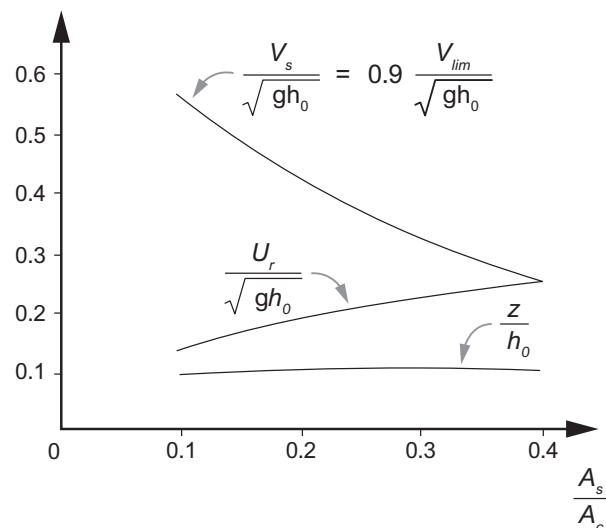

Figure 2.4: Return current velocity U_r , attainable velocity V_s (90% of the ship's limit speed V_{lim}) and water level depression at various blockage values (by TU Delft – Ports and Waterways is licenced under CC BY-NC-SA 4.0).

Figure 2.4 shows that with increasing blockage, the attainable speed reduces as the return current increases. The value of parameter z/h_0 is almost constant over the range of A_s/A_c values considered: $z/h_0 \approx 0.10$. This is half the value found if the ship would sail at its limit speed. Not only does sinkage increase rapidly at these high speeds, but the fuel consumption increases strongly and navigation gets difficult due to bottom and bank suction.

Good controllability of the ship requires sufficient depth (expressed in the h_0/D_s ratio). An indicator of controllability is the manoeuvring lane (or swept path), i.e. the width covered by the sailing ship, as sailing along a straight line is hardly possible. If the ship's course deviates from the intended one, the navigator will react by correcting the rudder or giving a power burst, depending on observation and reaction time. The sluggish response of a ship will lead to continual corrections and thus a fluctuating movement around the intended sailing line. While sailing, both the drift angle β (the angle between the longitudinal axis of the ship and the channel axis) and the rudder angle δ_r will continually change. Figure 2.5 gives an exaggerated example of this phenomenon.

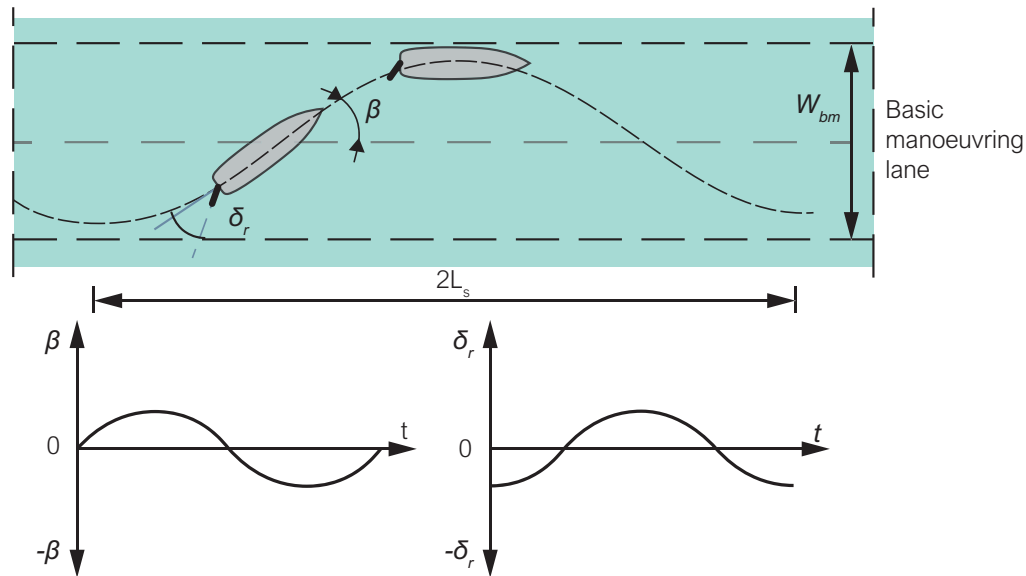

Figure 2.5: Manoeuvring lane in relation to drift and rudder angles (by TU Delft – Ports and Waterways is licenced under CC BY-NC-SA 4.0).

The drift number is defined as W_{bm}/l , in which W_{bm} is the width of the swept path and l is the distance sailed in longitudinal direction between two consecutive extreme rudder deflections, hence half the wavelength of a sweep. The drift number appears to increase with the ship's length L_s .

A variety of tests has led to the conclusion that, for good controllability on waterways of Class IV and higher, the vertical navigation margin $h_0 - D_s$ should be at least 30-40% of the reference ship's draught. For push-tow units a navigation margin of 50% is advised. In obsolete smaller waterways (Class I to III) a ratio of 20% can still be found, but with ratios h_0/D_s smaller than 1.3, controllability rapidly decreases (Figure 2.6). The navigation margin has to be larger if wind waves can cause pitching and rolling, or in case of other possible disturbances, such as cross currents, translatory surges and especially wind abeam.

The maximum possible squat determines the depth at which grounding (e.g. touching of the bottom) is unlikely. In most cases, the draught of a ship is not constant over its entire length. The point of maximum draught is determined by a combination of sinkage and trim. Where overtaking is allowed, a larger depth is needed, because the overtaking vessel first sinks into the depression of the other vessel and then has to sail at full power in order to overcome the adverse water level gradient in the last phase of the manoeuvre. Therefore, overtaking may determine the design depth of a waterway.

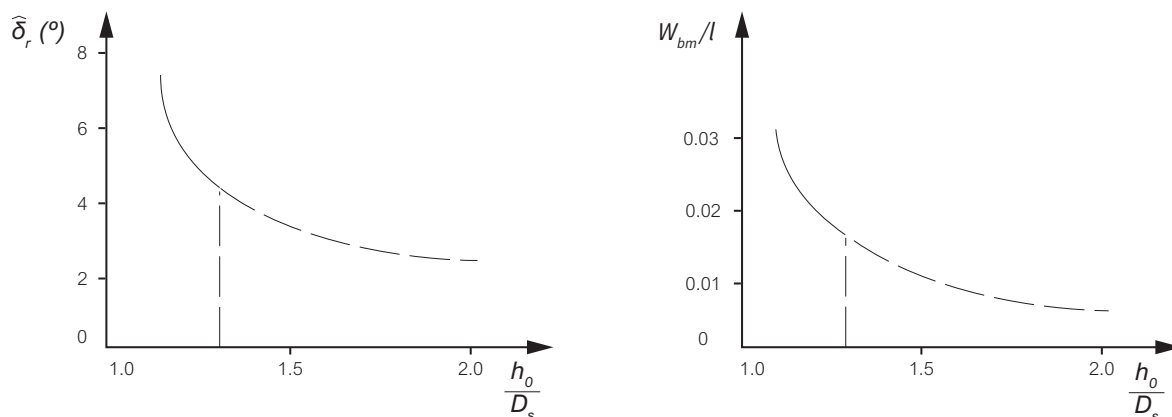

Figure 2.6: Maximum rudder angle and drift number as a function of the navigation margin (by TU Delft – Ports and Waterways is licenced under CC BY-NC-SA 4.0).

Apart from the desired navigability, a certain minimum under keel clearance is needed to prevent bed scour caused by the propeller jet. A jet may cause sediment stirring, leading to bottom irregularities and even grounding of ships with small UKCs. When a ship has run aground, the helmsman will try to set the vessel free by forcefully trying to move the ship back and forth, in that way stirring even more sediment and causing more bottom disturbance. A vicious circle is looming: running aground, more propulsion, more bottom disturbance, more running aground, et cetera.

One might apply larger values of h_0/D_s than necessary for navigability. This is favourable from a nautical point of view, as higher speeds can be attained. On the other hand, larger UKCs appear to attract ships with larger draughts, rather than ships sailing at higher speeds, since a larger draught means more cargo, so more revenue.

2.1.2 Factors influencing the required waterway width

The required width of a waterway depends on the (expected) traffic intensity and the different types of (design) vessels, but also on the swept path (Figure 2.5). A newly constructed waterway will comprise at least two navigation lanes. It may even be necessary to include a third lane, a so-called overtaking lane, if there are large speed differences between ship types. If very high traffic intensities are expected, even a fourth lane may be needed. If effects such as wind and currents are taken into account, which are discussed in RVW (2020) and PIANC (2014c), implicitly a safe waterway has been designed.

The width of a navigation lane is determined by the characteristics of the design vessels, especially their beam. In waterways with more than one lane, the beam of the largest permitted design vessel is equally defining. The number of lanes in relation to the frequency of occurrence of a specific type of ship may justify the enforcement of a speed limitation for that type. One has to make sure that two of these design ships can safely pass by each other.

A number of issues determine the total required lane width. Below we will discuss navigating along the channel centreline and navigating eccentrically. The next subsections discuss a number of special cases (viz. bends, cross-sectional discontinuities, cross and longitudinal current and ship-ship interaction).

Navigating along the centreline

When a ship sails along the channel centreline, the swept path is an important determining factor for the lane width. The swept path depends on the length of the ship itself, and as the length/beam ratio of inland vessels is more or less constant ($L_s/B_s = 6$ to 8), the occupied width can be expressed in terms of the ship's beam. Apart from the oscillating path shown in Figure 2.5, the ship can have an instantaneous drift angle under the influence of winds, currents, et cetera. The largest width (W_{bm}) covered at any instant occurs when the drift angle (β) is maximum (see Figure 2.7):

$$W_{bm} = B_s \cdot \left(\frac{L_s}{B_s} \cdot \sin \beta + \cos \beta \right) \quad (2.1)$$

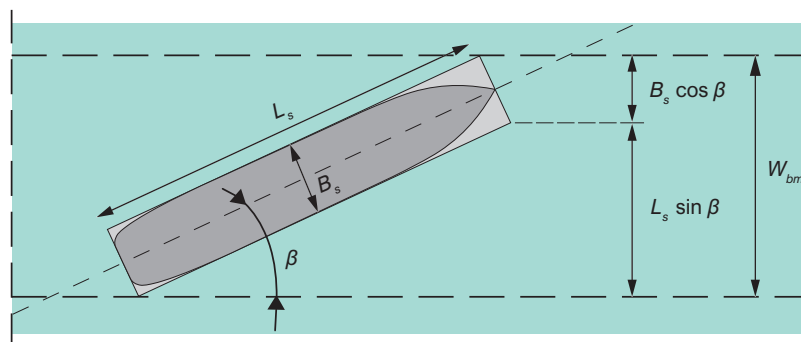

Figure 2.7: Largest width occupancy (by TU Delft – Ports and Waterways is licenced under CC BY-NC-SA 4.0).

Required lane widths found in literature range between 1.2 and 1.4 times the ship's beam for conventional ships and between 1.1 and 1.3 for push-tow units. Tests in practice, however, gave larger values, e.g. 1.5 times the beam in case of push barge units. Empty ships in situations with wind abeam obviously need larger lane widths, just like ships with poor manoeuvrability. Furthermore, the required lane width will increase for small under keel clearances ($h_0/D_s \leq 1.3$), because of the poorer controllability.

Navigating eccentrically

When a ship is sailing along the channel centreline, the water level depression and the return current are symmetric about the ship axis. Hence the ship feels no lateral force or yaw moment. This is different, however, for ships sailing eccentrically, as the symmetry of the hydrodynamic effects is disturbed. Sailing eccentrically may occur in a multi-lane channel, when passing a bridge opening if this is not located in the channel centre, when encountering or overtaking other ships, et cetera.

Schijf's set-down calculation method does not include eccentricity. In order to include this, the value of the cross-sectional area A_c has to be replaced by the so-called imaginary wetted cross-sectional area A_{ci} :

$$\frac{A_{ci}}{A_c} = 1 - \mu \cdot \frac{y}{W_s - h_0 \cdot \cot \alpha} \quad (2.2)$$

in which W_s is the channel width at the undisturbed water line, y represents the eccentricity, i.e. the distance of the ship axis from the centreline, α the slope angle of the bank and μ a coefficient depending on the type of ship, equal to 0.4 - 0.64 for pushed convoys and 1.04 - 1.28 for motor barges (PIANC, 1987).

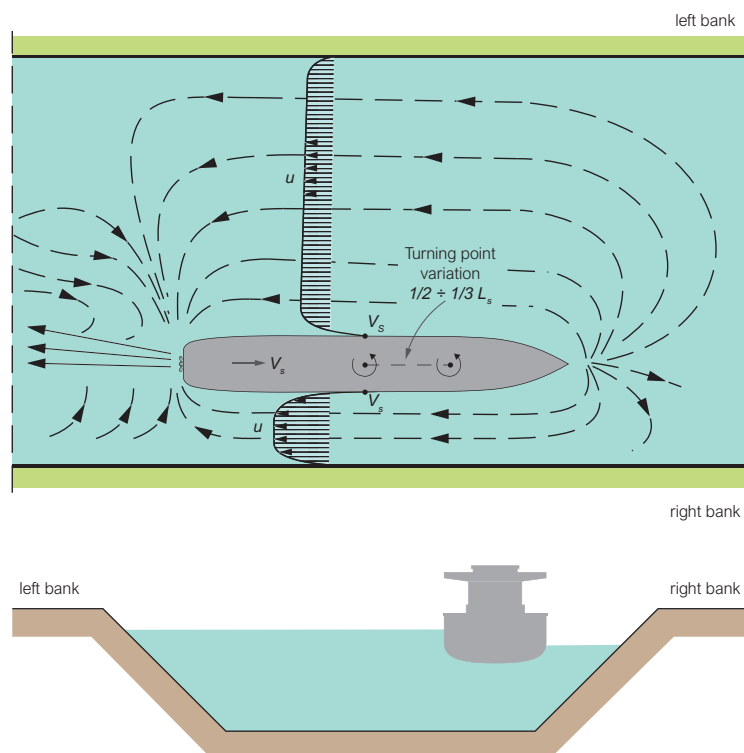

Figure 2.8: Current pattern induced by sailing eccentrically (by TU Delft – Ports and Waterways is licenced under CC BY-NC-SA 4.0).

A ship sailing eccentrically induces an asymmetric return current pattern. Yet, the discharge of the return current is about the same at either side of the ship. This means that return current velocities, hence the water level depression, are larger between the ship and the nearest bank (Figure 2.8). This creates a net force tending to push the ship to the near bank, as well as a moment tending to yaw the bow to the far bank (Figure 2.9). Bargemen call this phenomenon bank suction. Clearly, its magnitude depends on the distance between the ship and channel centreline, the speed of the ship, the blockage coefficient and the under keel clearance.

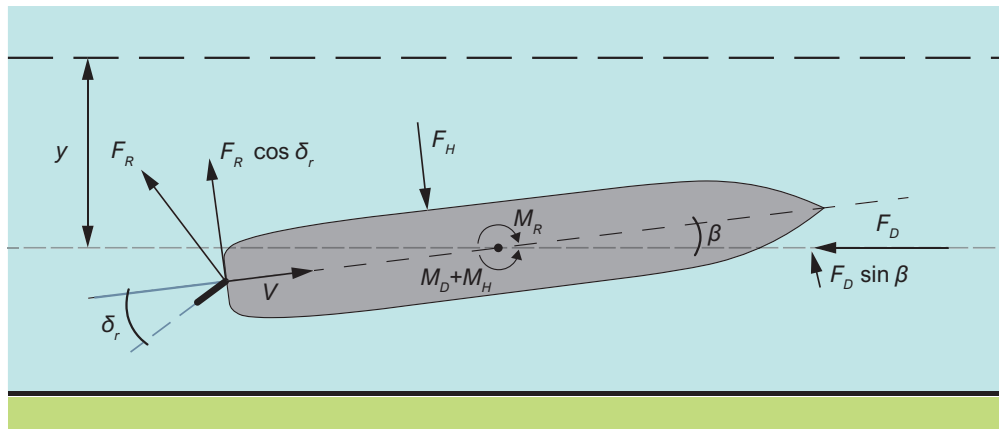

Figure 2.9: Forces on a ship sailing eccentrically (by TU Delft – Ports and Waterways is licenced under CC BY-NC-SA 4.0).

Bank suction has to be compensated by changing the rudder angle and the propeller speed. In principle, this is an unstable operation. If the rudder angle can be kept small, it leads to a course away from the bank, but if the rudder reaches its maximum deflection it may lead to a loss of controllability, with the stern hitting the bank. In the controlled situation, the navigator will try to bring the ship back to the intended course. Due to the ship's inertia, this leads to a fluctuating sailing course, like navigation along the centreline of the waterway (Figure 2.5), but now with non-zero mean rudder and drift angles (Figure 2.10). In principle, this fluctuating course would require an additional lane width compared to the situation in which the ship would sail exactly along the channel axis, but the present rules for the canal width already take this into account.

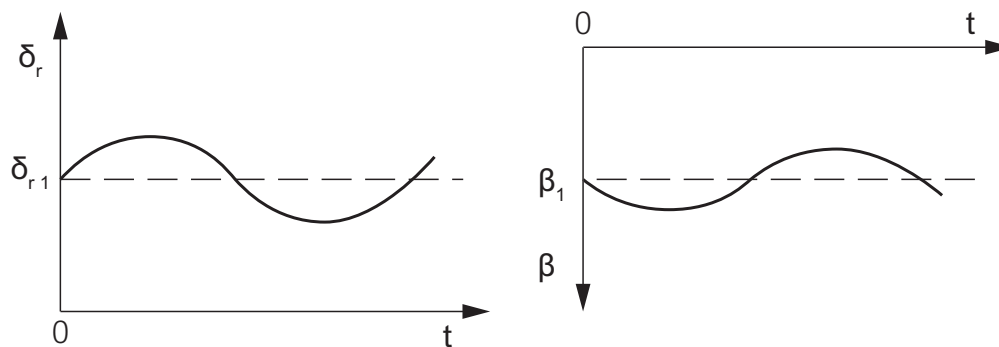

Figure 2.10: Rudder angle and drift angle when sailing eccentrically (by TU Delft – Ports and Waterways is licenced under CC BY-NC-SA 4.0).

To keep the ship in balance, both the transverse force as well as the moment have to be counterbalanced. The rudder alone is not capable of doing so, because of its fixed position behind the ship. The rudder force is adaptable by changing the rudder deflection and the number of rotations of the propeller. This balance can be achieved by not only adjusting a rudder angle, but also by giving the ship a drift angle (β) with respect to the canal centreline, resulting in an extra perpendicular counterforce at the bow. The now adjusted rudder angle is called the equilibrium rudder angle. Approximate values for the mean rudder angle are 3° for a blockage coefficient $k = 0.11$ and 15° for a blockage coefficient $k = 0.28$, both at moderate speeds (Kwik, 1992).

The situation for push-tow units sailing eccentrically may be completely different, depending on the water depth and the form of the underwater bow. Contrary to conventional ships, push barges usually have a rather blunt bow. Consequently, the water displaced by it flows in the direction of the least resistance. In case of a limited water depth, most water will flow slantwise underneath the barge towards the channel centreline. Thus, at the front side of the ship, the water level at the side of the nearest bank will be higher than at the side of the channel centre. Steering towards the bank is necessary to keep the unit from yawing away from the bank. Consequently, the position of a push barge unit sailing eccentrically will be contrary to that of a conventional ship (Figure 2.11).

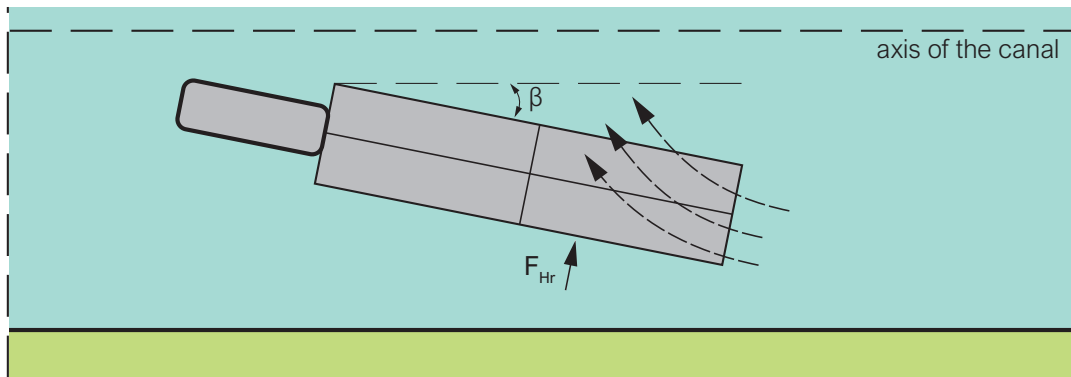

Figure 2.11: Pushed convoy sailing eccentrically (by TU Delft – Ports and Waterways is licenced under CC BY-NC-SA 4.0).

In deeper channels the displaced water will be less forced to flow slantwise. The position of the push barge unit then will become less directed toward the bank, as was proven in model tests. For a water depth of two times the ship’s draught, the unit’s behaviour will be consistent with that of a conventional ship. Such a large water depth, however, is rare in inland waterways.

2.1.3 Navigation in bends

When a vessel sails through a curved section of the fairway, the ship’s centreline will deviate from the tangent to the bend curved path. The centreline will point towards the inner bend. An extra drift angle is required to counteract the centrifugal force. The drift angle is smaller if the vessel speed or the depth are smaller, or if the bend radius is larger. The draught and wind forces are of also relevant. The latter is especially important to realise in monsoon and cyclone areas.

It is difficult to determine a proper course when passing through a bend. The navigator normally orientates on the channel banks, but in a bend this becomes problematic.

While sailing through the outer bend, the outer bank will be skirted as closely as possible. To avoid running aground on the bank, ships are usually headed slightly towards the inside bank and they sail at a slightly higher speed. Thus at the bend exit, ships may have a higher speed than otherwise desirable.

When sailing through the inner bend, the ship is directed towards the inner bank (Figure 2.12). Though this serves to make navigation easier, the disadvantage is that a large rudder angle is needed for changing course and for resisting bank suction, which is enhanced by the shallower water depth. Therefore ship speed is usually reduced here.

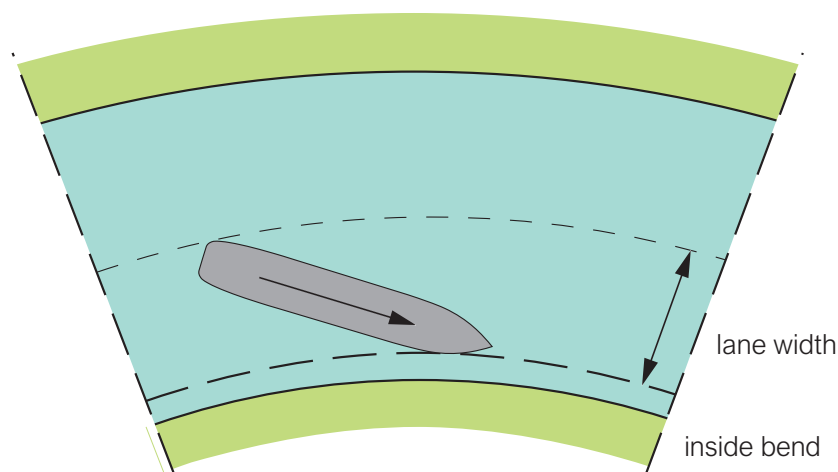

Figure 2.12: Navigation inside bend (by TU Delft – Ports and Waterways is licenced under CC BY-NC-SA 4.0).

The most difficult part of passing through a bend is the transition from a straight canal section to the bend itself. The position of the ship has to change most drastically here and the navigator will find it difficult to fix the course with respect to the banks. Figure 2.13 illustrates that large fluctuations around a certain drift angle (here 0.5°) can be the result.

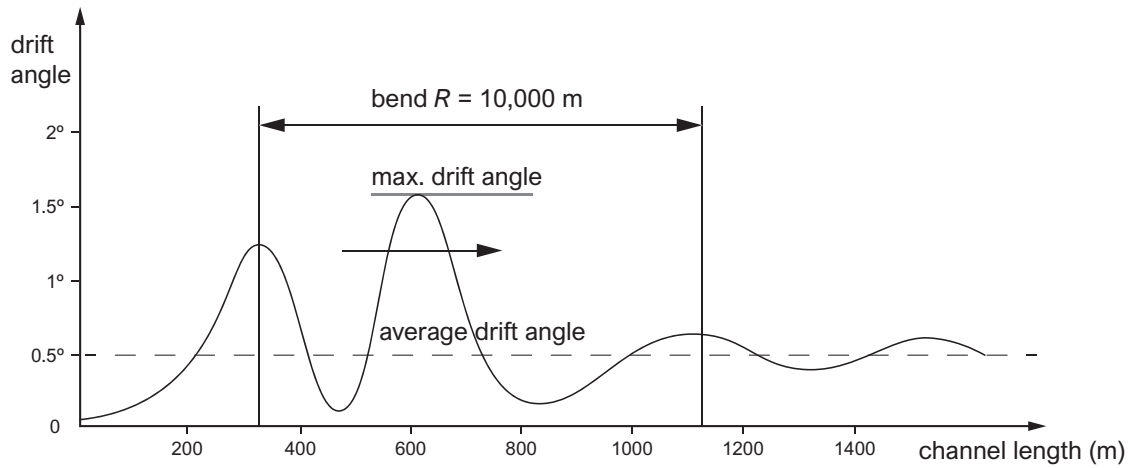

Figure 2.13: Example of the variation of a ship's drift angle when passing through a bend (by TU Delft – Ports and Waterways is licenced under CC BY-NC-SA 4.0).

Figure 2.14 gives the drift angle β as a function of the bend radius R and the ship's speed. It shows the average and maximum drift angle as obtained from tests (Schäle, 1968c,d,b,a) with push barge units of 160 m long and 9.5 m beam.

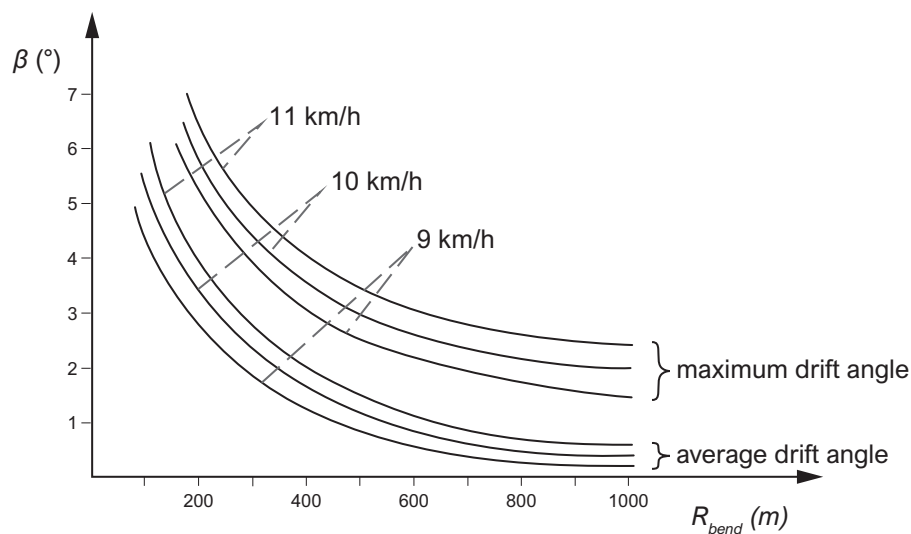

Figure 2.14: Drift angle as a function of bend radius and navigation (by TU Delft – Ports and Waterways is licenced under CC BY-NC-SA 4.0).

Especially in sharp bends the drift angle may necessitate local widening of the fairway, in order to have the same navigation safety as in a straight channel. Design guidelines specify the additional width in bends as a function of the bend radius and the vessel length.

The above applies to stagnant as well as flowing water. Yet, there are differences. Sailing along with the current requires a larger lane width because of the smaller manoeuvrability (less pressure on the rudder). Sailing against the current requires a smaller drift angle and reduces the hydraulic effects on the vessel's hull such as bank suction.

2.1.4 Cross-sectional discontinuities

Discontinuities in the channel profile require a timely response of the navigator, and therefore good visibility. A minimum visibility of four times the length of the ship is required for commercial navigation, given the long stopping distances. Navigators will slow down if the visibility is less. Recreational traffic requires a visibility of at least 100 m. Nevertheless, navigation is disturbed at an abrupt narrowing or widening of the channel cross-section.

Cross-section widening

Abrupt channel widenings may be found at ports entrances, diversions, confluences, islands and receding loading and unloading quays (Figure 2.15).

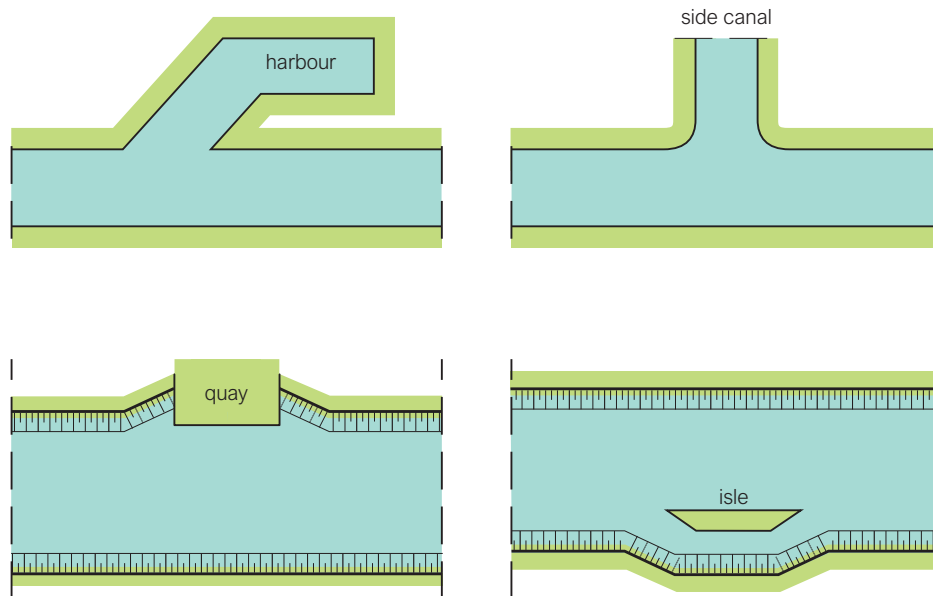

Figure 2.15: Examples of abrupt channel widening (by TU Delft – Ports and Waterways is licenced under CC BY-NC-SA 4.0).

When a ship approaches such a channel expansion, the front wave will decrease at the side of the expansion. This causes a decrease of the pressure at the bow of the ship at the side of the expansion. Consequently, the ship will tend to steer towards the expansion. A little further down another force comes into play: water flowing from the side of the expansion partly fills up the water level depression, forcing the ship away from the expansion. The passing process is illustrated in Figure 2.16.

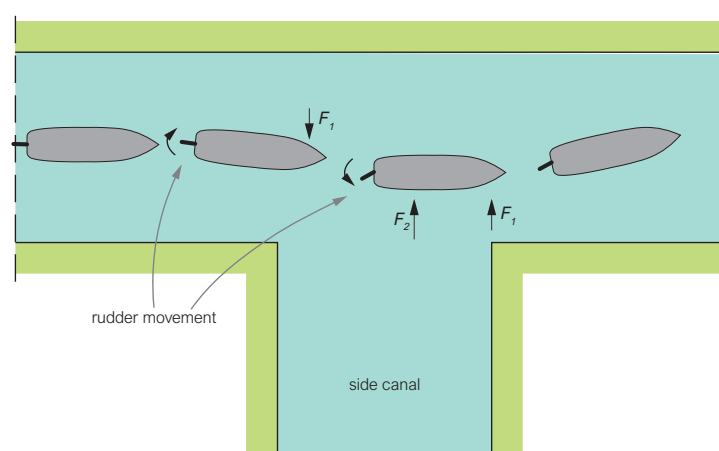

Figure 2.16: Passage of a side canal (by TU Delft – Ports and Waterways is licenced under CC BY-NC-SA 4.0).

If the width of the side canal in the situation of [Figure 2.16](#) is of the same order of magnitude as that of the main channel, the process described above will have a significant impact on the ship's manoeuvring. If the side canal is much narrower than the main channel, manoeuvring will hardly be influenced.

Cross-section narrowing

A constriction of a cross-section is to be expected in case of bridge piers, or if a wharf extends into the channel profile, see [Figure 2.17](#).

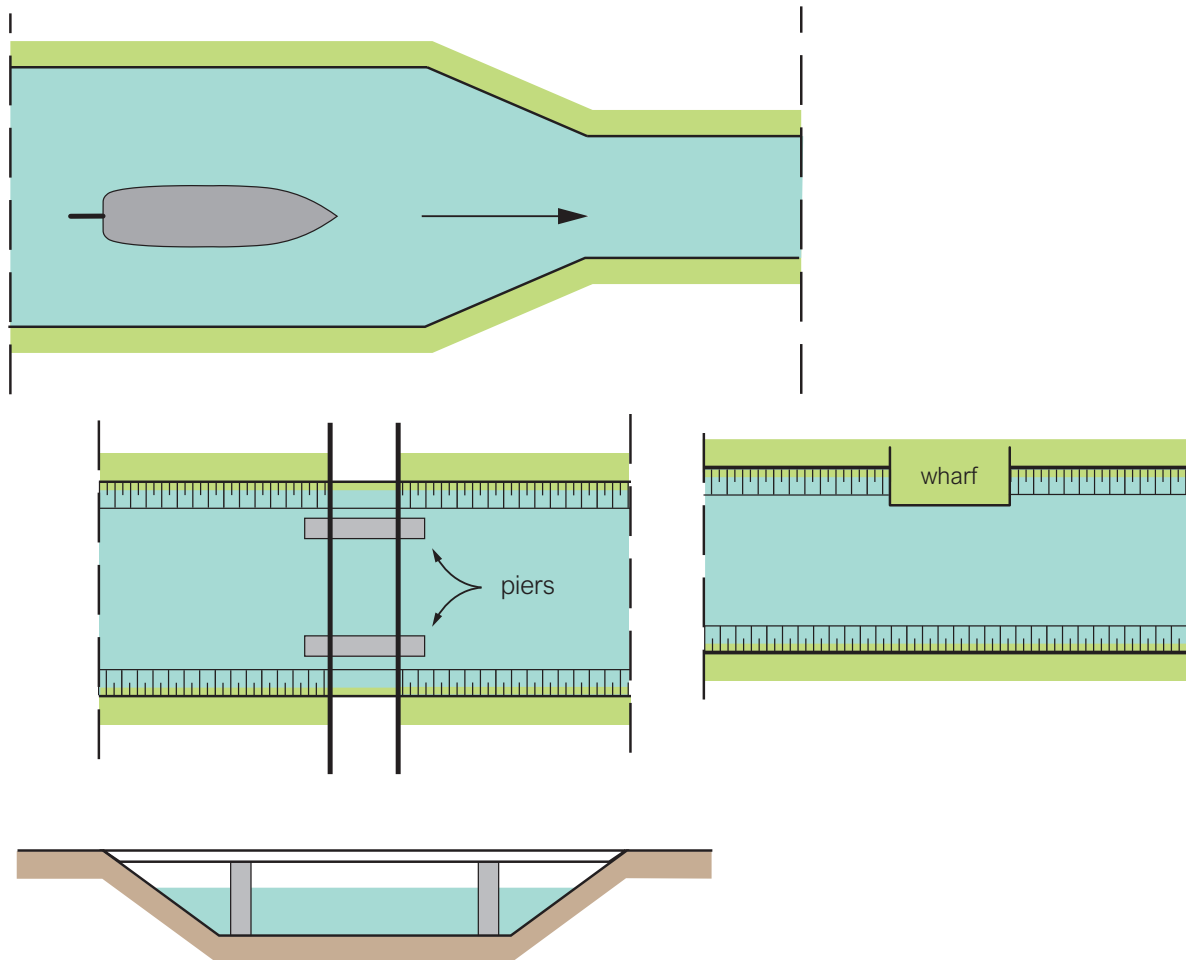

Figure 2.17: Examples of channel constrictions (by TU Delft – Ports and Waterways is licenced under CC BY-NC-SA 4.0).

A ship sailing in the centreline of an abruptly narrowing channel will cause a stronger return current, hence a deeper water level depression, so its squat will increase. If it sails eccentrically, bank suction will increase. Furthermore, the ship's speed will decrease, which induces translation waves at the discontinuity.

Passing a narrow section like a bridge requires extra force on the rudder. This can be achieved by increasing the propeller speed. Yet, the navigator needs to keep extra rudder capacity available, for instance in case of strong bank suction. In the narrow part he will therefore reduce the speed in order to have sufficient power available in critical situations.

2.1.5 Cross and longitudinal current

Another type of disturbance are longitudinal and cross-currents. A longitudinal current influences the navigation speed and the ship's manoeuvring. Concentrated cross-currents, like those caused by lateral water intakes or outfalls, may form a big hindrance to navigation.

Cross-currents exert a transverse force and a moment on the ship, causing it to sway and yaw, respectively. To counterbalance these effects the navigator has to set the ship under an angle with the straight course (Figure 2.18). In the case of an elongated cross-current field, an equilibrium drift angle will establish, depending on the cross-current velocity and the ship's speed. Once the equilibrium state has established, the rudder can be placed into the middle position.

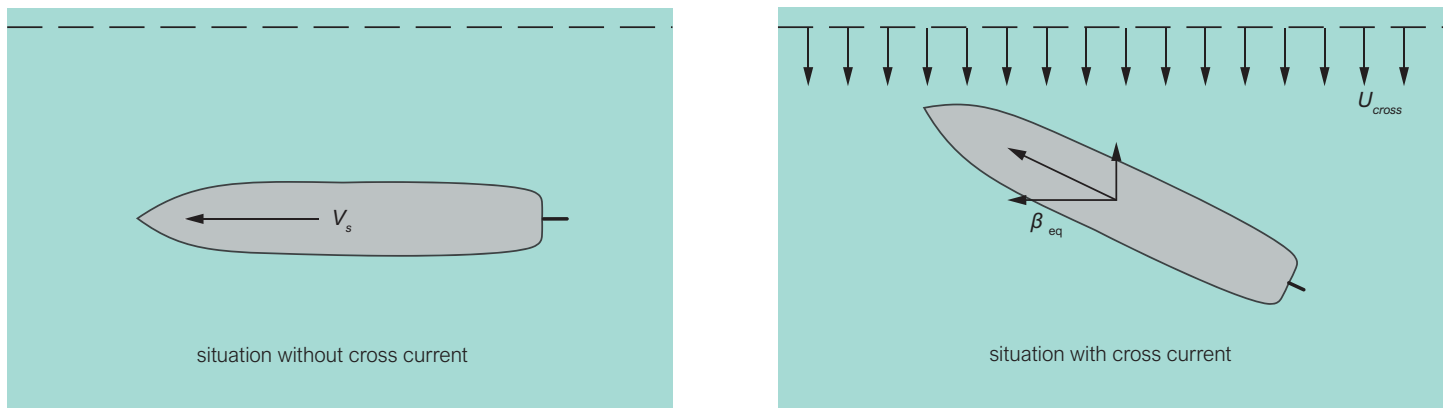

Figure 2.18: Navigation with a cross-current (by TU Delft – Ports and Waterways is licenced under CC BY-NC-SA 4.0).

The degree of hindrance to the shipping traffic depends on:

- the field over which the cross-current is active as compared with the length of the ship;
- the average cross-current velocity;
- the vertical position of the intake or outfall;
- cross-current on one side or both sides of the channel;
- distance of the sailing track to the bank, and
- the ratio of the ship speed and the cross-current velocity.

In the case of a concentrated outfall, the maximum allowable cross-current velocity depends on the cross-sectional area of the orifice. For small orifices higher cross-current velocities can be allowed than for large ones. Figure 2.19 shows the maximum cross-current velocity as a function of the orifice perimeter. It indicates in which cases further research is needed because the standard allowable velocity is exceeded. For large orifice perimeters a current velocity of 0.3 m/s appears to be acceptable. Given the navigation speeds normally encountered in shipping channels, such a velocity would lead to an extra width requirement of the order of magnitude of one ship beam. The Dutch Waterway Guidelines (RVW, 2020) presents a method for cross-currents up to 2.5 m/s.

In the case of water intake, the hindrance of a deviant current pattern is much smaller and allowable current velocities at the intake can be 1.5 times higher than for outlets. Research carried out by Meyer and Schaele (1985) found increased values for inlet velocities:

- 2 m/s for the Rhine and its tributaries
- 1.5 m/s for rivers of standard V Class
- 0.6 m/s for rivers of standard IV Class.

In channels with longitudinal currents, ships sailing upstream are faced with a considerable loss of travelling time, but their manoeuvrability is relatively good. When ships are sailing downstream at full force, their speed is relatively high, which makes it difficult to slow down within a short distance in case of unexpected traffic situations. When sailing downstream at a low speed, however, there is little pressure on the rudder, which reduces manoeuvrability. High current velocities therefore have a negative impact on traffic safety at small waterways. However, taking into account the situation near bridges, sharp bends, manoeuvring places etc., a longitudinale current (averaged over the cross-section) of 0.5 m/s is generally considered allowable.

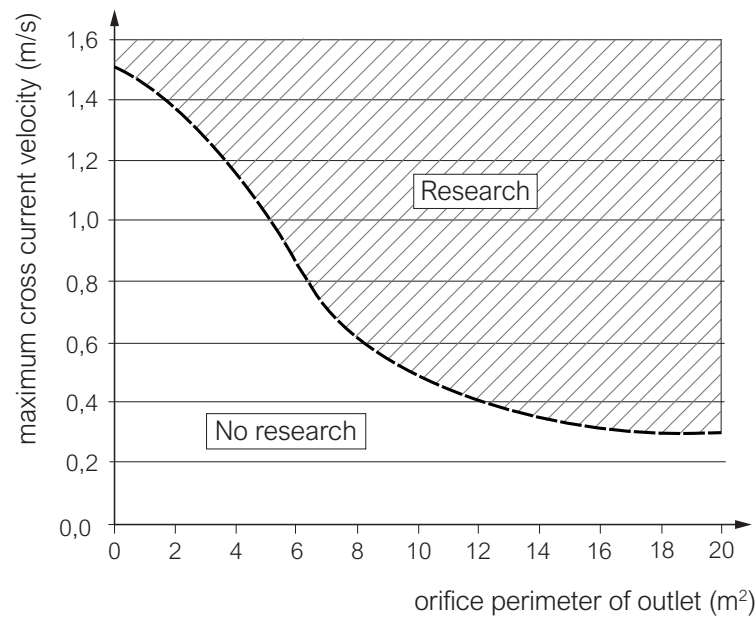

Figure 2.19: Maximum cross current velocity as a function of the orifice parameter (by TU Delft – Ports and Waterways is licenced under CC BY-NC-SA 4.0).

2.1.6 Ship-ship interaction

This section discusses the phenomena related to ship encounters and overtakings. Section 4.4.5 deals with the hydrodynamics in case of overtaking.

Encountering manoeuvre

At the start of an encounter the ships push each other aside because of the water movement around the bow. Laden ships therefore approach each other as close as possible when starting the encountering manoeuvre. The smaller of the two will reduce its speed most, since it faces a relatively larger narrowing of the cross-sectional area available, due to the blockage by the midships section of the larger ship and the associated water level depression. Just before passing, the navigator will temporarily reduce the propeller speed, in order to have sufficient power in case of hazardous situations.

When the bows are opposite to each other (Figure 2.20, Situation 1) the bows tend to yaw away, but bank suction opposes this tendency. When the ships are next to each other (Figure 2.20, Situation 2), their opposing return currents partly or completely balance out. The water level depression between the two ships will therefore be smaller than between ship and bank (Figure 2.21). The difference in hydrostatic pressure forces the ships to sway away from each other. To what extent this will happen depends on the distance between the two passing ships.

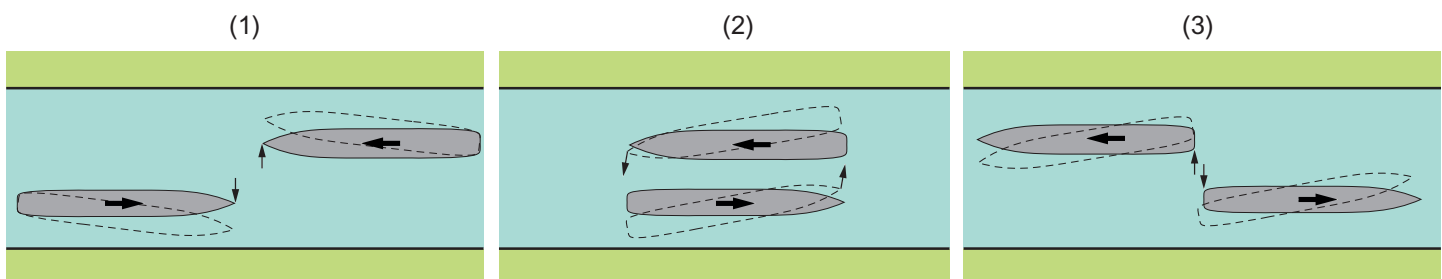

Figure 2.20: Phenomena when two ships encounter in a channel (by TU Delft – Ports and Waterways is licenced under CC BY-NC-SA 4.0).

When the bows approach each other's stern (Figure 2.20, Situation 2), the bows yaw toward the centreline and the bank suction tends to reinforce this movement. Finally, when the sterns are opposite to each other (Figure 2.20, Situation 3), the sterns yaw toward the centreline at sterns but bank suction opposes this tendency.

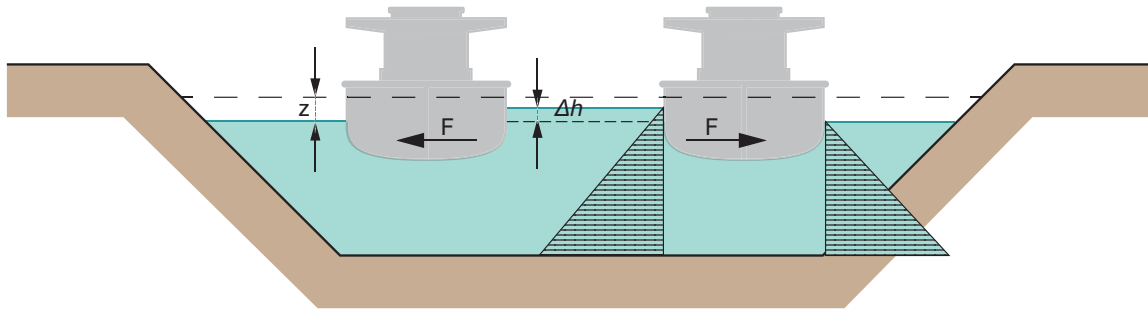

Figure 2.21: Lateral forces on encountering ships (by TU Delft – Ports and Waterways is licenced under CC BY-NC-SA 4.0).

So, apart from the mutual influence of the ships, bank suction plays a significant role. This is especially true for two types of vessels: coasters and pushed convoys. Coasters experience more bank suction because of their relatively low L_s/B_s ratio. The bow of pushed convoys is normally directed towards the bank when sailing outside the axis (cf. Figure 2.11). In an encountering manoeuvre they therefore run an even greater risk of grounding on the bank. Furthermore, the bank suction will be larger, because of the larger width of pushed convoys. Moreover, pushed convoys are less manoeuvrable than conventional motor vessels, because of their larger size, mass and inertia.

Two dangerous situations thus occur in an encountering manoeuvre. The first is the moment at which the two ships begin to feel each other's influence. They run the risk of yawing away from each other and grounding on the bank (Figure 2.22, situation a). The second situation occurs when too much rudder force is used to avoid grounding on the bank. This involves the risk of collision with a following ship or hitting the opposite bank (Figure 2.22, situation b).

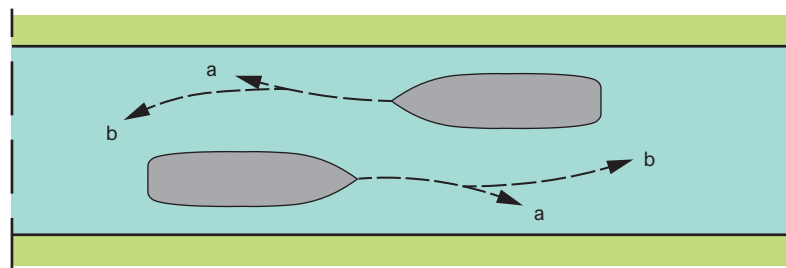

Figure 2.22: Dangerous situations during an encounter (by TU Delft – Ports and Waterways is licenced under CC BY-NC-SA 4.0).

For experienced helmsmen an encountering manoeuvre in fact only gives problems in relatively narrow waterways. Even though the forces exerted on the ships can be significantly larger than in an overtaking manoeuvre, the effect is limited because of the restricted duration of an encounter. For standard inland vessels this duration is between 10 and 30 seconds. For push convoys this may increase to 1.0 to 1.5 minutes.

Overtaking manoeuvre

At the start of the overtaking manoeuvre, the bow of the overtaking ship will be pulled towards the stern of the ship to be overtaken. Then the overtaking ship enters the area of water-level depression of the ship to be overtaken and will get drawn in. Due to this extra return current at the bow, a small change of the ship's course leads to a large change of the yawing moment.

When the two ships sail directly alongside the return current and the water-level depression of the two ships will reinforce each other. Therefore the water level will be lower between the two ships than between ship and bank.

The ships will encounter more resistance, and as the overtaking manoeuvre proceeds, they will be swaying towards each other due to the difference in hydrostatic pressure (Figure 2.23). If the ships are drawn against each other, they effectively form one ship and will inevitably lose control. Both ships will therefore try avoid getting too close to each other, but they also have to make sure that they do not ground due to bank suction.

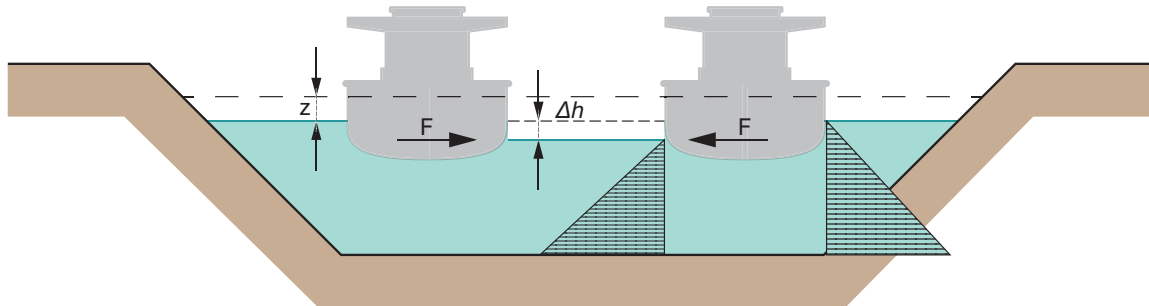

Figure 2.23: Hydrostatic pressure when ships overtake each other (by TU Delft – Ports and Waterways is licenced under CC BY-NC-SA 4.0).

In the last phase of the manoeuvre, the overtaking ship has to overcome the adverse water level gradient associated with the other ship's water level depression. The same situation as in the beginning occurs, only this phase takes much longer.

Various circumstances may make it impossible to complete the overtaking manoeuvre. For instance, the overtaking ship may have insufficient power to overcome the extra resistance. In that case the overtaking manoeuvre can be completed if the ship to be overtaken strongly reduces its speed and the overtaking ships sails at an adjusted speed in order not to be drawn against the other ship. Speed reduction, however, requires caution because the rudder pressure has to stay high enough for manoeuvrability. Practically speaking, overtaking is only feasible if the speed difference between the two ships is more than 5 km/h.

Section 4.4.5 discusses hydrodynamic phenomena associated with overtaking manoeuvres in more detail. Section 4.6 gives an examples of numerical model computations of these hydrodynamics.

Stopping distance

Another form of ship-ship interaction occurs when a ship unexpectedly stops, for instance because it has machine problems, it runs aground, or to avoid a collision. Note that it can take several minutes to bring a large ship to a stop and that the stopping distance can be several times the ship's length. The spacing between the ships must therefore be sufficient to enable the next ship to safely stop before reaching the vessel ahead.

So far, little is known about the stopping distance of a ship in a shallow channel. The stopping distance in a shallow channel is presumably a function of the blockage factor, ship speed, ship displacement and ship block coefficient. It is likely to be smaller than in deep open water due to the increased resistance caused by the enhanced return current. On the other hand, in a confined channel there will be a larger added mass of water giving the ship extra momentum. This will increase the time and distance needed for stopping.

To meet safety requirements the gap between successive ships must not be smaller than the stopping distance. This determines the maximum traffic density (the maximum number of ships per unit channel length) on a single-lane channel. In all this, the possibility of casting the anchor in an emergency has not been taken into account.

Binnenvaart Politie Reglement (BPR) and Rijnvaart Politie Reglement (RPR) mention stopping distances related to the vessel length. In general, the stopping distance is at least about 2 to 3 times the vessel length:

$$L_{st} > (2 \div 3)L_s \quad (2.3)$$

where L_{st} is the stopping distance in metres.

2.2 Inland waterways

2.2.1 Design standards for the waterway cross-section

Given the criteria for the waterway depth and width discussed in the previous section, the required dimensions of a waterway cross-section can be derived. Internationally, PIANC presents the design guidelines in use in different countries over the world (PIANC, 2019a). Recently, PIANC started a new working group (WG179) on how to deal with new ship types. In the Netherlands, Rijkswaterstaat developed the Richtlijnen Vaarwegen (RVW, 2020). Figure 2.24 summarises the Dutch guidelines (excluding the additional width required for wind effects) for the dimensions of single-lane and two-lane channels. It shows that the aforementioned width standards apply at the keel level of a non-moving ship. In case of a trapezoidal or combined rectangular-trapezoidal profile not only $h_0/D_{s, \text{loaded}}$, $h_0/D_{s, \text{unloaded}}$, but also W_d/B_s will decrease as the ship's speed increases, because of the larger water-level depression. The decrease in available width appears to depend strongly on the bank slope. For a slope of 1:4 and a water-level depression of for instance 0.40 m, the decrease in the plane of the keel is $2 \times 4 \times 0.40 = 3.20$ m.

In general, four canal profiles for commercial traffic are considered:

- Intensity profile
- Preferred profile with 2 traffic lanes
- Reduced profile with 2 traffic lanes
- One way profile

These profiles are related to the traffic intensity. For waterways with more than 30,000 vessels/year the intensity profile should be used. A normal intensity of 15,000 to 30,000 vessels/year requires the preferred profile, a low intensity of 5,000 to 15,000 vessels/year requires a preferred profile, allowing locally over short distances a reduced profile. In case of a very low intensity (less than 5,000 vessels/year) a reduced profile is possible with locally a one-way profile.

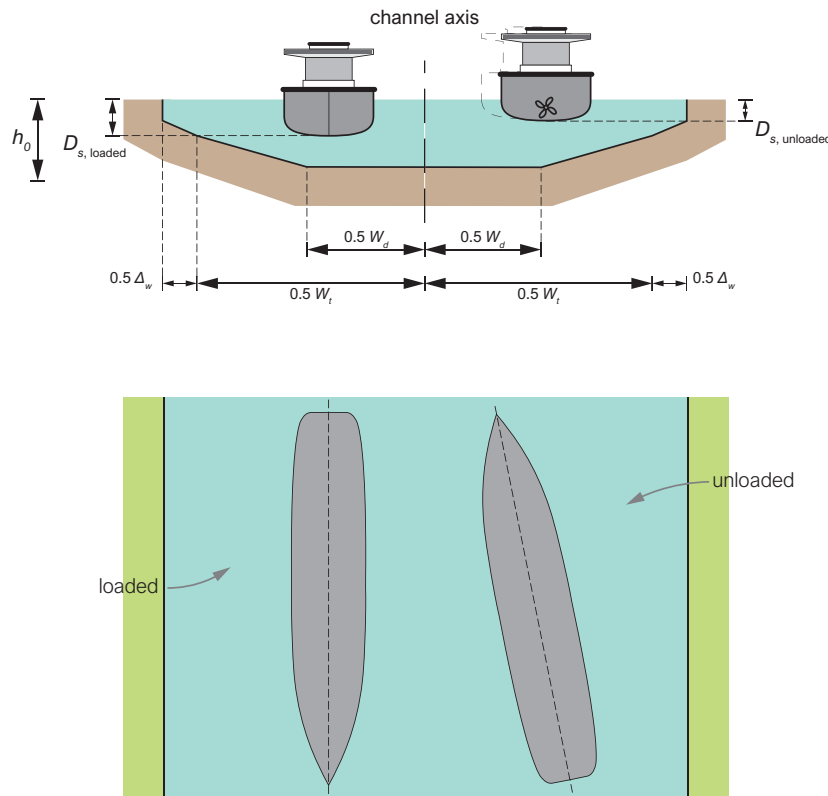

Figure 2.24: Standard for two way cross-section (reworked from RVW, 2020, by TU Delft – Ports and Waterways licenced under CC BY-NC-SA 4.0).

Table 2.1 shows the requirements for the different profiles, except for the intensity profile, which requires additional investigations.

Profile	W_d/B_s [-]	W_t/B_s [-]	h_0/D_s [-]
Preferred	2	4	1.4
Reduced	2	3	1.3
One way	1	2	1.3

Table 2.1: Normative values for the width at the bottom, the width at keel level and the water depth.

The ratio h_0/D_s determines the manoeuvrability: the larger this parameter, the smaller the average swept path. The overtaking manoeuvre is the limiting factor, because of the higher speed, hence the largest water level depression and squat. A value of $h_0/D_s \geq 1.4$ is advised for high-intensity navigation channels of Class IV and higher. For shorter access channels or channels with a low traffic intensity of a lower class (Class I to III, frequently with a reduced or one-way profile) $h_0/D_s = 1.3$ is sufficient. The ratios W_d/B_s and W_t/B_s are related to the maximum traffic intensity, given the frequency of occurrence of vessels of different types.

In addition to these normative values, the width at keel level of an unloaded vessel has to be equal to the width at keel level of a loaded vessel plus an additional width Δw for cross wind. Obviously, the channel profile is symmetrical. For the preferred profile the extra wind width is about $0.05 L_s$ at inland locations and about $0.10 L_s$ in coastal areas. Loaded vessels experience less hinder of cross wind, and therefore have no extra wind width requirement. Only vessels with a large windage, such as container vessels, experience wind hinder on inland waterways.

Apart from the depth parameter, the blockage ratio A_c/A_s is particularly important for the maximum attainable navigation speed. The Dutch guidelines, however, do not include a design value for it. Being strongly related to the navigation speed, it is a indicator of the nautical quality of the cross-section chosen. In general, the blockage ratio for a preferred profile is about 7, for a reduced profile 5 and for a one-way profile 3.5.

The maximum navigation speed in a trapezoidal channel is defined as 0.9 times the physical limit speed V_{lim} according to Schijf's method (see Section 4.1.1). The maximum speed in a rectangular channel is significantly higher than in a trapezoidal one, as we will show below.

Ship speed in a rectangular and trapezoidal channel profile

For a trapezoidal profile with slope 1:m, the width at water level is given by (also see Figure 2.25):

$$W_s = \frac{A_c}{h_0} + m \cdot h_0 = \frac{B_s}{k(h_0/D_s)} + m \cdot h_0 \quad (2.4)$$

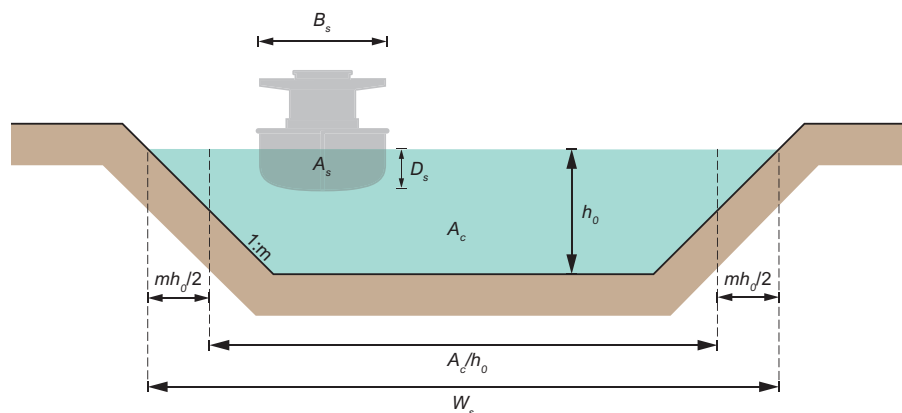

Figure 2.25: Trapezoidal canal profile (by TU Delft – Ports and Waterways is licenced under CC BY-NC-SA 4.0).

The underwater dimensions of the standard design vessel ($B_s \cdot D_s$), the bank slope and the normative standards for the waterway depth (h_0/D_s) and the blockage coefficient ($k = A_s/A_c$) determine the required trapezoidal profile dimensions, hence the (maximum) speed of $0.9 \cdot V_{lim}$.

Given the vessel speed, the return current and the water-level depression increase from a rectangular profile via a combined rectangular-trapezoidal profile to a trapezoidal profile. This difference is not only associated with the difference in blockage coefficient, but most of all with the difference in width at the undisturbed water level. This means that a higher navigation speed can be reached in a rectangular profile than in a trapezoidal profile of the same depth and cross-sectional area. In the upper panel of Figure 2.26 the width at the water surface is kept the same, in the lower panel the undisturbed water depth is the same. The water level depression increases with the Froude number. For a given blockage coefficient, it can be shown (see Section 4.1.1) that this number has to be based on the mean depth, irrespective of the cross-sectional shape. So, for a ship sailing at the limit speed:

$$Fr_{lim} = \frac{V_{lim}}{\sqrt{g\bar{h}}} = \frac{V_{lim}}{\sqrt{g \cdot (A_c/W_s)}} \tag{2.5}$$

In the situation of the upper panel of Figure 2.26 the Froude number according to Equation 2.5 is the same in either case. Therefore, the maximum navigation speed will also be the same in either case. In the situation of the lower panel, however, the Froude numbers are different. Hence the maximum navigation speed is significantly higher in the case of the rectangular channel:

$$V_{s, \text{rectangular}} = \frac{\sqrt{g \cdot h_0}}{\sqrt{g \cdot (A_c/W_s)}} \cdot V_{s, \text{trapezoidal}} = \sqrt{\frac{W_s}{\bar{W}}} \cdot V_{s, \text{trapezoidal}} \tag{2.6}$$

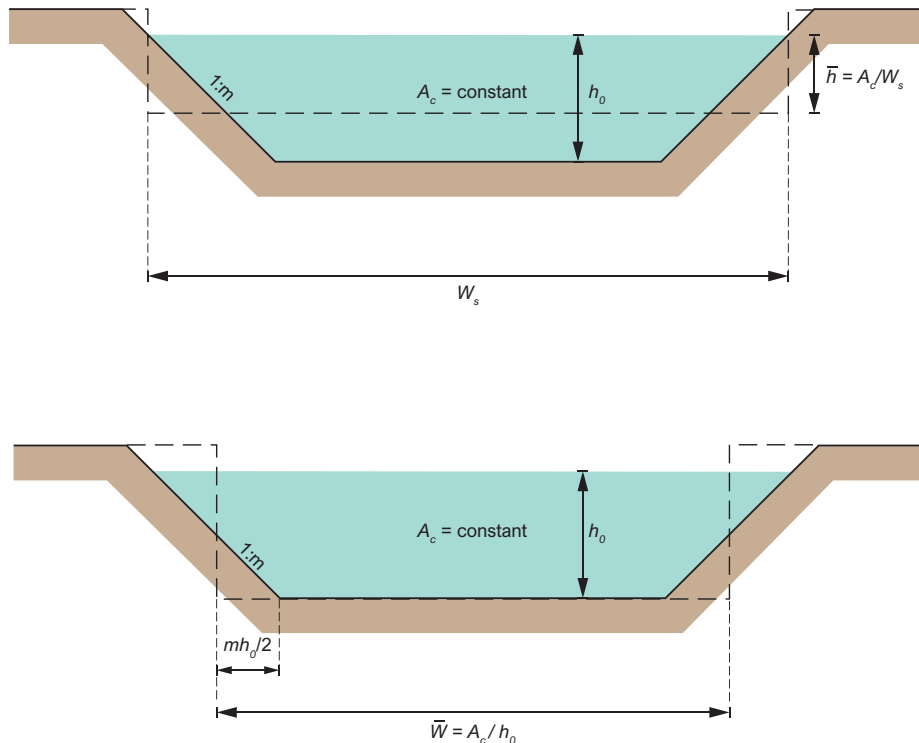

Figure 2.26: Comparison between trapezoidal and rectangular profile (by TU Delft – Ports and Waterways is licenced under CC BY-NC-SA 4.0).

Rivers

The minimum navigable profile for commercial shipping on rivers is rectangular, with a navigable width \bar{W} and a navigable depth h_0 (Figure 2.27). The width \bar{W} equals the width W_t for canals plus an extra width for cross wind and longitudinal current. The extra width for longitudinal current is only required if the current velocity exceeds 0.5 m/s; it varies between 0.5 m and 4.5 m, depending on the current velocity and the CEMT class.

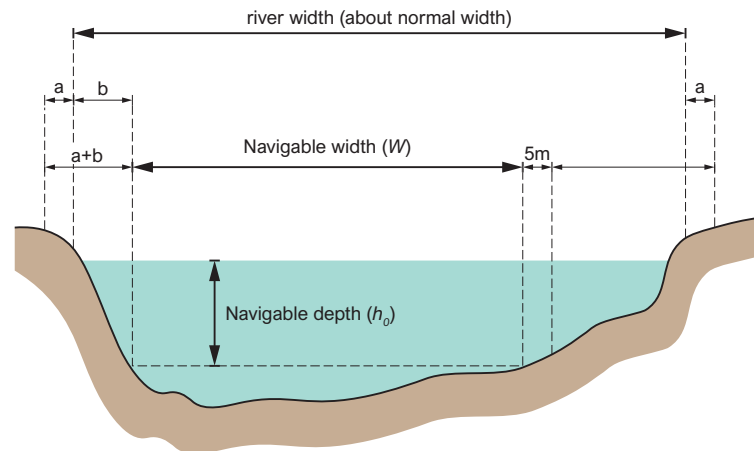

Figure 2.27: Definition of the navigable channel in a river (reworked from RVW, 2020, by TU Delft – Ports and Waterways licenced under CC BY-NC-SA 4.0).

For the river Waal, Upper Rhine and Lower Rhine in the Netherlands a minimum depth of 2.8 m has been defined as the [Agreed Low Waterlevel \(ALW\)](#); that is the water level that is exceeded 95% of the time. For the river IJssel this is 2.5 m. This has been laid down in an international agreement under the auspices of the [Central Commission for the Navigation of the Rhine \(CCNR\)](#). As the water depth varies with the discharge, the h_0/D_s ratio will often be less than 1.4, which may result in an under keel clearance of 0.3 m or less.

2.2.2 Cross-section in bends

A basic assumption in the design of a channel bend is that in the preferred cross-section two standard vessels (laden or unladen) should be able to encounter safely and smoothly. In a reduced profile encountering should be possible with speed reduction.

The required lane width for a ship passing through a bend is larger than in a straight reach (see [Section 2.1.3](#)). This is due to the ship's oblique position with respect to the canal centreline. An extra drift angle is required to counteract the centrifugal force when sailing in the bend. The oblique position is even reinforced, as navigators have difficulty fixing the course properly while passing bends. When designing a canal profile one must consider:

- that the maximum drift angle is only reached after prolonged rotation through a bend of constant radius; in a sharp bend the maximum drift angle may be reached faster; and
- a vessel sailing against the current generally has less ground speed, hence a smaller centrifugal force to compensate, so a smaller drift angle; consequently, when encountering another vessel sailing with the current, such a vessel will need less room than allowed for, in favour of the downstream vessel which needs extra space; moreover, a vessel sailing against the current can stop easily and close to the bank without any risk, in order to let pass a ship sailing downstream that occupies too much width.

For a preferred profile the bend radius should be at least 6 times the length of the design vessel (RVW, 2020). The extra width required follows from (see [Figure 2.28](#)):

$$\Delta B = \Delta B_{\text{loaded}} + \Delta B_{\text{unloaded}} = (\alpha_1 + \alpha_2) \frac{L_s^2}{R_{\text{bend}}} \quad (2.7)$$

to be added in the inner bend. Values for α_1 vary between 0.25 and 0.45, and for α_2 between 0.35 and 0.95.

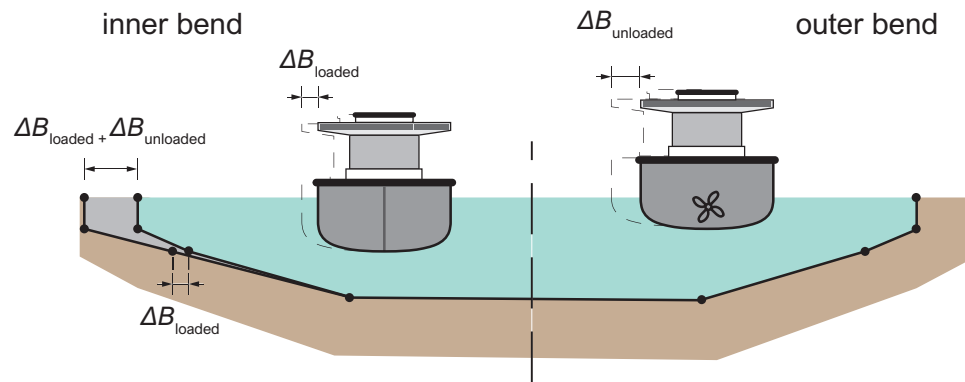

Figure 2.28: Extra width in the inner bend (reworked from RVW, 2020, by TU Delft – Ports and Waterways licenced under CC BY-NC-SA 4.0).

Transition from straight reach to a bend

It is recommendable for a good view and nautical comfort to broaden the bend at the inner bank if possible. The transition from a straight section to the widened bend has to evolve gradually, preferably under a slope of 1:20 (Figure 2.29). The transition length for $R_{bend}/L_s > 6$ (preferred profile) is $2 \cdot L_s$.

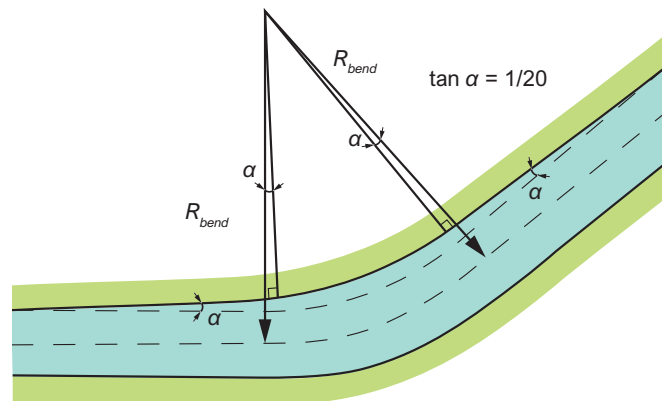

Figure 2.29: Transition from straight section to bend section (by TU Delft – Ports and Waterways is licenced under CC BY-NC-SA 4.0).

2.2.3 Natural waterways

Besides discharging water, ice, sediment, dissolved matter, et cetera, rivers also serve navigation purposes. This requires an integral approach of river management. Nevertheless, a fluvial waterway has to meet a number of requirements which are often not met in natural rivers. So, in general, rivers used for navigation need to be modified (Figure 2.30). This ranges from small interventions to complete control of the water level, permanent regulation of the bed geometry, or even canalisation.

Few waterways, whether natural or manmade, have been developed for navigation purposes only. Generally, there are combinations with other functions, such as irrigation, drainage, drinking water supply, fishing, energy generation, flood control, recreation et cetera. The present trend towards integral river management, aimed at balancing the interests of all functions, may mean that not all future needs of inland navigation can be met.

In this section we focus on the differences between canals and rivers as far as navigation is concerned. We will show that navigation on rivers is far more complicated. The varying water depth is only one complicating factor, as may appear from the characterisation below. Furthermore, we will indicate a number of measures to facilitate navigation on rivers.



Figure 2.30: One of the Rhine branches, the River Waal, with inland navigation (Image by Rijkswaterstaat).

Navigation on rivers

Although river types vary widely, a typical navigable river can be characterised as follows (also see [Figure 2.31](#)). Starting downstream the lower course is often the most suitable for navigation. As compared with the situation further upstream, it generally conveys more water, the bed slope is smaller and the water depth and the cross-sectional area are larger. Where a river debouches into the sea, tidal currents and swell may cause hindrance and sometimes hazardous situations.

Going further upstream the time-variation of the discharge is felt ever more, especially in times of drought. The bed slope increases, current velocities increase, water depths and cross-sectional areas decrease and the river becomes more winding and irregular with islands, shoals, multiple channels, et cetera.

These changes reduce the navigability: decreasing allowable draughts, increasing engine power requirement and more difficult manoeuvring, especially when passing through bends and sections with strong width variations.

Contrary to canals, the river bottom is not always parallel to the water level. Locally, shoals and holes may occur, and in bends the water depth in the outer bend is significantly larger than in the inner bend. In the transition between consecutive bends, a shallow bed ridge may occur and sometimes even one or more islands. Such a transition is often indicated as a crossing (see [Figure 2.32](#)).

Especially when the river bed is forked (cross-section II in [Figure 2.32](#)) these crossings can be very inconvenient. The most shallow sections determine the least available depth and are thus decisive for the permissible draught, hence the loading degree of the ships.

The 30% under keel clearance requirement does not apply to local shoals. A ship sailing downstream can pass the shoal by floating along with the current. By reducing the ship's speed, the water-level depression and therefore the squat and trim are also reduced. However, sufficient pressure has to be maintained on the rudder for manoeuvrability. Therefore, the ship needs to sail at a navigation speed a little higher than the current velocity.

Passing a shoal when sailing upstream is more problematic. In order to make progress, the ship has to overcome the current velocity, so it will generate a return current which will cause squat. At a shoal, the helmsman will therefore reduce the ship's speed to just above the current speed.

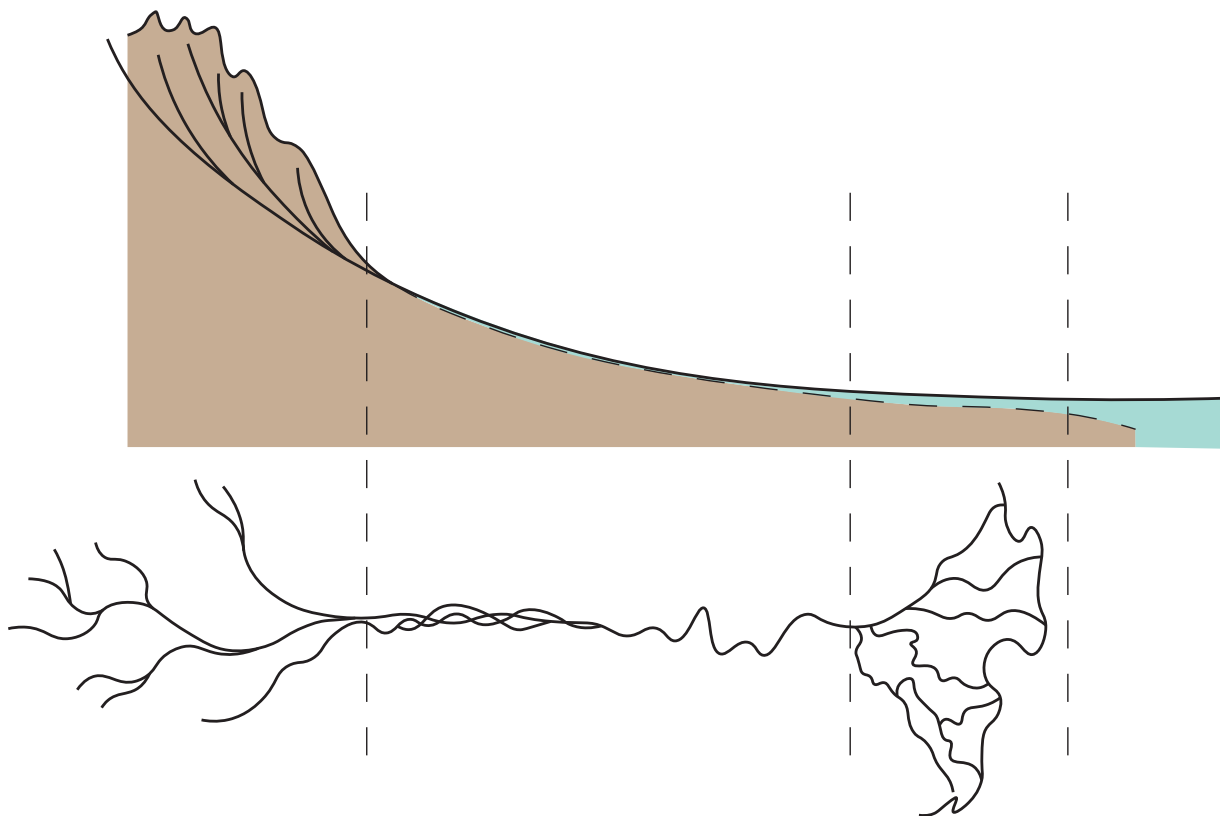

Figure 2.31: An idealised river (by TU Delft – Ports and Waterways is licenced under CC BY-NC-SA 4.0).

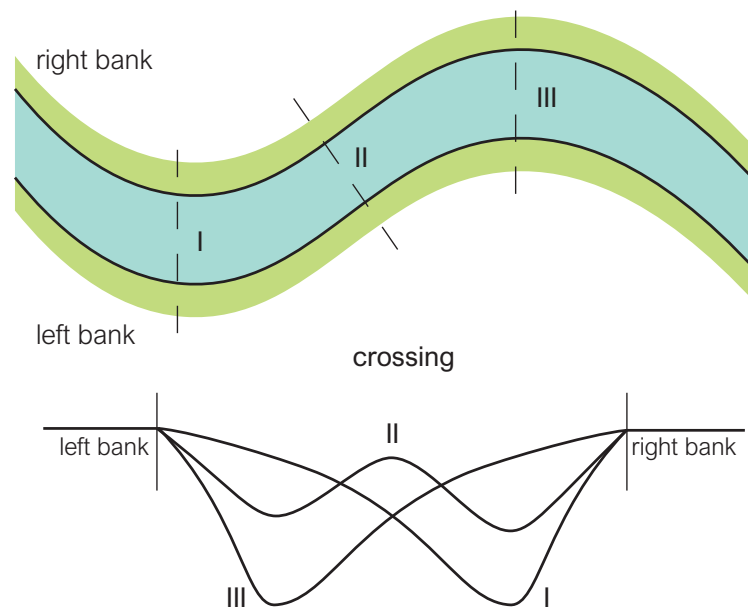

Figure 2.32: Crossing between consecutive bends in a meandering river (by TU Delft – Ports and Waterways is licenced under CC BY-NC-SA 4.0).

On a river the technique of navigation differs considerably from that in a canal. As shown in [Figure 2.33](#) a vessel sailing upstream will typically navigate in that portion of the channel with the least current velocity, in order to save fuel and make progress. In contrast, a vessel heading downstream will navigate in the zone of maximum current velocity. This may involve an extra complication, viz. crossing pathways. On the major European inland waterways this has led to the practice of ‘blueboarding’: a ship carrying a blue sign indicates that it will pass at starboardside from the encountering vessel, instead of portside. In the design of river adaptations for navigation due attention should be paid to local practices and regulations, also regarding channel and bank stability.

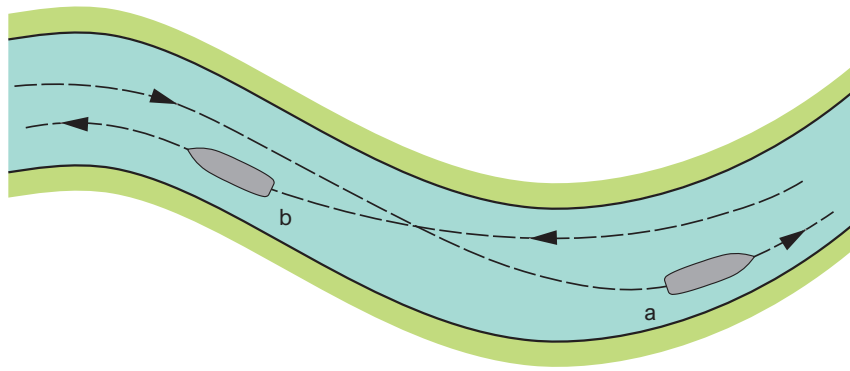

Figure 2.33: Course of vessel sailing downstream (a) and upstream (b) on a river (by TU Delft – Ports and Waterways is licenced under CC BY-NC-SA 4.0).

Bends involve extra complications. Especially the width can be restrictive for navigation. Floods may aggravate this, because during a flood the outer bends erode further, the inner bends accrete and the crossings become more pronounced. After the flood wave has passed, the opposite phenomenon occurs. The shoals will erode and the deeper parts accrete.

A further complication concerns the visibility of the shoals, which is often poor on natural waterways. Rivers often have multiple channel systems separated by sandbanks. At high water levels a channel may be hard to find. Moreover, these channels tend to constantly change their course, which sometimes makes it necessary to shift the fairway from one channel to another. Changing channel systems are especially troublesome if a river is sailed on occasionally.

Sometimes navigation from the main stem onto a tributary is hampered by sandbanks temporarily blocking the access. Banks and mooring places may become temporarily inaccessible due to sandbanks in morphologically active rivers. If inaccessibility cannot be allowed, banks and mooring places may have to be adjusted or moved due to more suitable places.

Adaptations for navigability

River adaptations are often necessary for further traffic development. Such adaptations, however, often involve considerable costs. These costs cannot always be justified by the expected traffic development in the near future. That is why adaptation plans are sometimes realised step by step, such that each step gives enough stimulus for further traffic development to justify the costs. Supply of better information on the navigation situation is often a first step.

Information for navigation Fairway authorities should have their own patrol service (or hire a private organisation) in order to provide information on the state of the fairway. Echo soundings have to be made regularly in the channel and at shallow locations. Regular announcement of least available depths on all important fairway stretches is necessary. Buoys, beacon systems, signs and signals have to be installed and maintained, as well as traffic control systems like FIS and VTS (see Chapter 5).

Buoyage should follow the so-called lateral system, indicating the channel borders, instead of the cardinal system focusing on dangers. Buoys can best be placed on the steep side of the profile; buoys on both sides of the channel are only required when it is very narrow or crowded. Especially reaches with a migrating fairway must be properly marked with buoys. Shipping at night can be facilitated with navigation lights along the banks that mark the channel.

It is important to make maps of the waterway available to users. On board of vessels there is only need for a rather simple map (situation of channel, buoys, beacons, signs, headroom, depths in harbours, kilometres, et cetera). The authorities need more detailed maps, including the whole floodplain, as a basis for a good river management.

Current information, particularly on least available depths and water level forecasts, is provided via internet, regular broadcasting programs and printed reports. Such information is crucial to determine the maximum draught of a vessel heading for a certain destination. At the same time special messages can be announced (new or moved buoys, obstructions, accidents, temporary works, et cetera).

Very High Frequency (VHF) radio is necessary for ships to maintain regular contact with traffic control centres, other ships and offices in ports and terminals. Therefore, a system of radio masts along the controlled fairway has to be installed and radio-channel frequencies have to be reserved.

Radar on board of vessels can be useful to get an overview of the other traffic, when navigation at night is expected, or when visibility is poor due to mist, heavy rainfall or sandstorms. It requires special attention to buoys, beacons and bank alignments, which must give a good radar echo at all stages and under all weather conditions. A shore-based radar chain as part of the **VTS** system can also enhance navigational safety.

Internet-based information systems are used to communicate information on passing vessels and their cargo to traffic control centres and lock and bridge operators. This saves skippers waiting time and reporting the same information at every control point on the route, and it enables lock operators to use their locks more efficiently. In case of an accident, the information enables immediate and appropriate action.

Improvement of the waterway Adaptations to natural waterways should be carried out with considerable caution. Rivers are dynamic systems, responding at a wide range of temporal and spatial scales. This means that the effects of an intervention may only manifest after some time and at various places along the river. Such interventions therefore require a thorough understanding of the dynamics of water and sediment. Mistakes may necessitate costly correction works and continuous maintenance.

A first step in improving the navigability of (alluvial) rivers could be dredging. Dredging can be divided into maintenance dredging, recurrent dredging and capital dredging.

I. Dredging

Maintenance dredging To maintain a reasonably stable channel, some dredging is inevitable. Location and amount of this type of dredging cannot be foreseen; it is basically a response to problems where they pop up. In the case of a new fairway it is recommendable to have a dredger of suitable capacity stationed nearby. After some time, the order of magnitude of the maintenance dredging volume can be estimated on the basis of experience. It will then be possible to choose the most suitable equipment.

Recurrent dredging As opposed to maintenance dredging, the locations of recurrent dredging are known. Often the least available depth is found at a crossing, where the thalweg (i.e. the locus of the deepest points per cross-section) moves over to the opposite bank. Recurrent dredging of the critical crossings in a river may increase the least available depth for the entire fairway.

The previous section described how flood waves can affect the navigability of rivers. Therefore, recurrent dredging should preferably be done shortly after the flood season. The dredged material can then be deposited in the (too) deep outer bends nearby.

Generally speaking, systematic extraction of the dredged material from the river system has detrimental large-scale and long-term effects on the river, especially on its bed slope. The dredged material should therefore be brought back into the river. The place where this can best be done depends on the situation and requires a thorough insight into the river's dynamic behaviour.

As a first step to river adaptation, recurrent dredging has advantages over more permanent interventions, such as engineering structures. It is flexible, the costs are low, and it gives insights into the river's response.

Capital dredging A one-off dredging operation needed to create a new navigable channel in a river, or to enlarge an existing one, is called capital dredging. Capital dredging is usually a large operation constituting a significant intervention in the river system.

II. Discharge regulation

A well-aligned river will accommodate low and high discharges, including flood conditions. A natural, uncontrolled river will shape itself according to the sediment supply from upstream, the discharge regime, the bed and bank composition and the downstream water level. The result, however, is not always suitable for navigation or the other functions man has attributed to the river. This is why we tend to ‘improve’ it.

Discharge regulation may be an attractive measure for navigation, but there are a few prerequisites. Firstly, the total annual run-off in a rather dry year should be large enough to keep the river navigable for a significant part of the time. Secondly, sufficient reservoir storage should be available upstream of the navigation route to significantly attenuate a flood wave.

Consider a hypothetical river with a single flood period per year and a typical discharge hydrograph as in [Figure 2.34](#). After the dry season, the river becomes navigable at point a. Towards the end of the flood period, the channel system is disturbed and the river becomes unnavigable at point b, at a higher discharge level than point a. In practice navigation will stop earlier, say at point c, so as to avoid the risk of running aground on a river bed that has undergone unknown changes. If the entire flood volume could be stored, the channel system would hardly change because the discharge would be kept approximately constant. In that case the river remains navigable until point d. In practice this will be difficult to realise, if only because of the very large storage volume required.

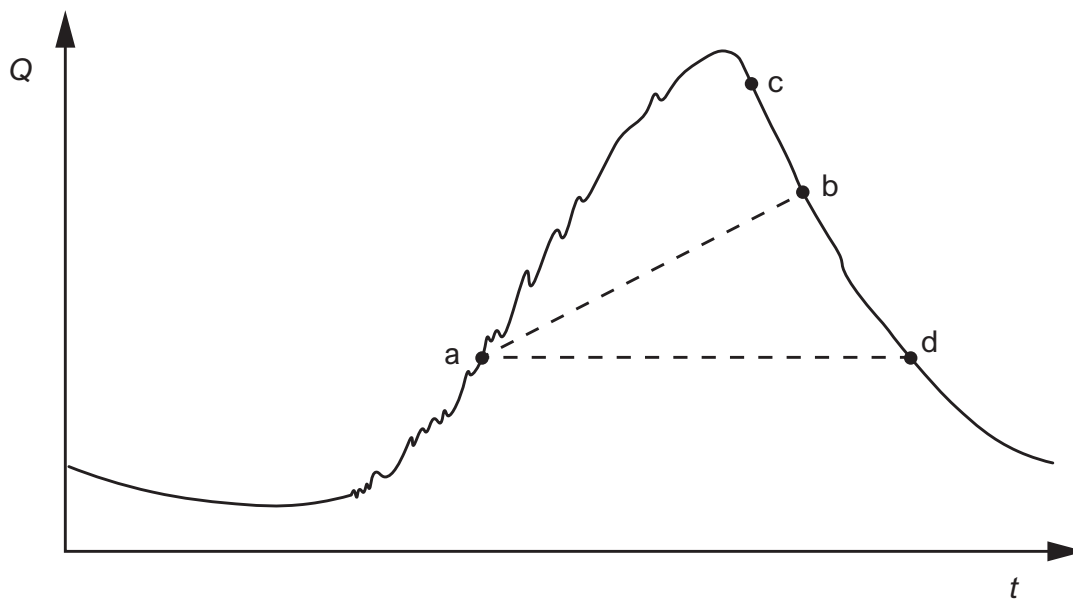

Figure 2.34: Discharge hydrograph of a hypothetical tropical river (by TU Delft – Ports and Waterways is licenced under CC BY-NC-SA 4.0).

An important aspect of discharge regulation is how to release the stored water after the flood season. The most common strategy (Option 1 in [Figure 2.35](#)) is to start releasing at the end of the flood season and maintain a constant discharge in the river, high enough to keep it navigable until the reservoir is empty or back at the water level to be maintained in the dry season. Once that point is reached, navigation may temporarily become difficult.

Since storage reservoirs are usually of a limited size, it may be impossible to store the total flood volume in an unusually wet season. In that case, the surplus flood water has to be passed on to the river, where it adds to the basic discharge and may cause disturbances of the river bed.

Depending on the demand for navigation, other strategies may be chosen. If the demand is highest towards the end of the dry season, for instance because the harvest needs to be transported, one may decide to retain the flood volume in the reservoir and release it only towards the end of the dry season.

Another possibility, if there is mainly downstream navigation, is to release the stored water in pulses (Option 2 in [Figure 2.35](#)). Downstream sailing vessels can ‘ride’ the flood waves generated by this strategy.

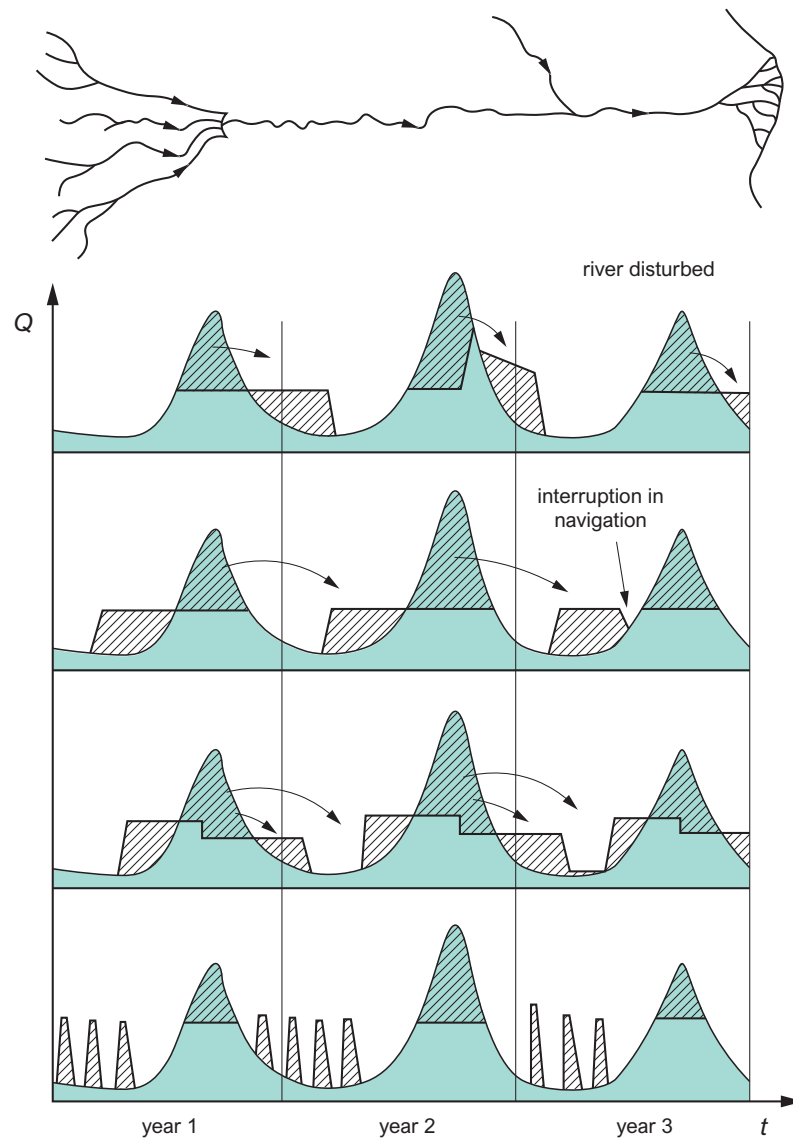

Figure 2.35: Storage release strategies (by TU Delft – Ports and Waterways is licenced under CC BY-NC-SA 4.0).

Since man-made reservoirs in rivers are expensive facilities, they are usually not built for flood water storage alone. Often they also serve hydropower production and irrigation purposes. This means that storage and release of water is not optimised for downstream navigability alone. This may lead to conflicting interests and undesired situations. The Three Gorges reservoir in the Yangtze River, China, is such a multi-purpose reservoir. Before the flood season, the water level is lowered in order to accommodate the flood water, but if the flood does not come, like in the dry year 2006, the reservoir has to be filled back to the level required for hydropower production at the expense of the discharge downstream of the dam. This constitutes a risk for functions downstream, for navigability, but also for drinking water intake, for instance.

III. Permanent regulation works

Permanent regulation works exist in many forms. Bank protection is one example, groynes and [Longitudinal Training Dams \(LTDs\)](#) to fix and confine the main channel are others. Examples of in-channel regulation works, are outer bend fills and bottom groynes, both meant to enhance the water depth in the inner bend.

When a river is locked into a set planform by such regulation works, its natural migration in the horizontal plane is stopped. This leaves only the bed for adjustment to changing conditions. Such bed responses can take place at a variety of scales, from bedform development at a scale of metres to large-scale tilting at a scale of many kilometres.

It takes a good insight into the dynamics of a river, sometimes supported by numerical models, in order to predict what the effect of certain regulation measures will be and at what spatial and temporal scales they will become manifest.

Permanent regulation works are costly operations. In order to make them economically feasible it may be necessary to also serve other purposes, such as flood protection, harbour development, freshwater supply, road and railroad crossings, et cetera.

Figure 2.36 gives two examples of river regulation works, one for the river Waal, the Netherlands, and the other for the river Vistula, Poland. They also illustrate how long it may take before a river is fully regulated.

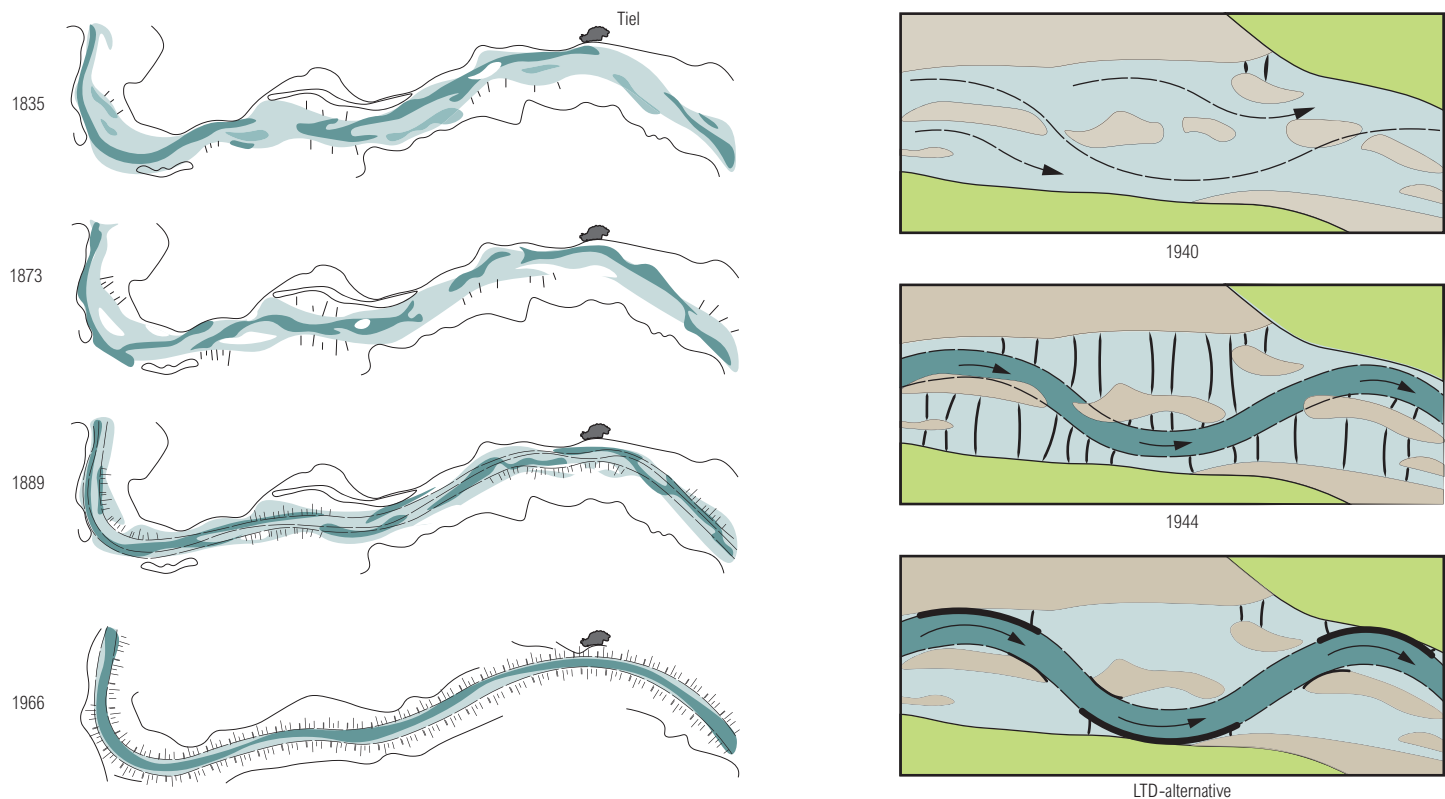

Figure 2.36: River normalisation. Left: River Waal (reworked from Jansen et al., 1979); right: River Vistula. Images by TU Delft – Ports and Waterways licenced under CC BY-NC-SA 4.0.

For a long time, groynes have been considered suitable means for river training (see Figure 2.37), but they turn out to have a number of disadvantages. Their very purpose, viz. to confine the main channel and concentrate the flow under normal conditions, positively influences water depth and navigability, but it also enhances the river's sediment transport capacity. If more supply from upstream is lacking, the river gradually reduces its slope and incises upstream. Consequently, groynes there become unnecessarily high, causing undesirable resistance under flood conditions, and in-channel structures stick out of the bottom and become obstacles to navigation. In the case of the Rhine branches in the Netherlands this has led to costly groyne lowering schemes, as well as to a pilot project with longitudinal training dams detached from the banks.

IV. Canalisation

A canalised river is equipped with weirs combined with locks to control the water level in times of low discharge. Like discharge regulation and permanent regulation works it is a costly solution. An example of a canalised river is the river Maas in the Netherlands (Figure 2.38).

An important downside of natural waterways is that they sometimes don't give access to the final destination of the transported goods. In that case, either other transport modalities are required for further transport, or a connecting canal has to be built.



Figure 2.37: The river Waal, normalised with groynes (*Rijkswaterstaat*).



Figure 2.38: Canalised river Maas, the Netherlands (by TU Delft – Ports and Waterways is licenced under CC BY-NC-SA 4.0).

Sometimes two navigated rivers are connected, such as the Rhine and the Danube, which are connected by the Rhein-Main-Donau Canal. Such a canal often contains a number of locks, in order to approximately follow the relief. At the intersection of a river and a canal, a sluice is usually required to keep the fluctuating water level of the river from penetrating into the canal.

Sometimes canalisation works are multi-purpose. The weir can be combined with a bridge, like in the case of the weir near Grave in the river Maas (Figure 2.38, left: second from the top). Also, the head difference over a closed weir may be used for low-head hydropower generation, like in the case of the Maas-weirs near Linne and Lith (Figure 2.38, left: first from the top, and right: last on the right).

2.3 Dimensions of water areas in sea ports

The previous subsections discussed ship behaviour and how this affects the dimensioning of efficient and safe inland waterways. Of key additional importance to waterborne supply chains are the dimensions of water areas in the ports, the typical begin and end points of each journey. This section addresses the dimensions of water areas in sea ports. The next section addresses inland ports. Much of the material presented in this section has been derived from or inspired by the PIANC report ‘Harbour approach channels design guidelines’ (PIANC, 2014c) and Ligteringen (2017).

2.3.1 Port approach channel

When approaching a port from the open sea, a vessel may have to cross a shallow coastal zone (Figure 2.39). The fairway across that zone is often maintained artificially at a certain width and depth. But even in case of a deep-water port the actual entrance has to be protected against waves and currents. Breakwaters serve this purpose well, but by definition they confine the access. In view of the complex local wave and current conditions at the transition between open and sheltered water, the shape and dimensions of this access are critical to safe navigation.



Figure 2.39: The Maas channel, giving access to the Port of Rotterdam (by TU Delft – Ports and Waterways is licenced under CC BY-NC-SA 4.0). Sources: EMODnet Bathymetry (EU Directorate General for Maritime Affairs and Fisheries), RWS Vaklodingen, RWS River bathymetry 1m, and RWS Actueel Hoogtebestand Nederland.

Figure 2.40 shows the main elements of an access channel. The outer part, in open water seawards of the breakwater(s), is usually marked by lateral buoys. Bends should be avoided as much as possible, in order not to complicate navigation and to avoid extra width requirements, as this involves extra capital and maintenance dredging.

The part sheltered by the breakwater(s), the inner access channel, is the extension of the outer part. It gives access to the various harbours of the port. In order to manoeuvre towards the berth, a turning basin provides the space to turn the vessel.

In the following sections we will discuss the dimensions of the various parts of access channels, turning basins, port basins and berth areas.

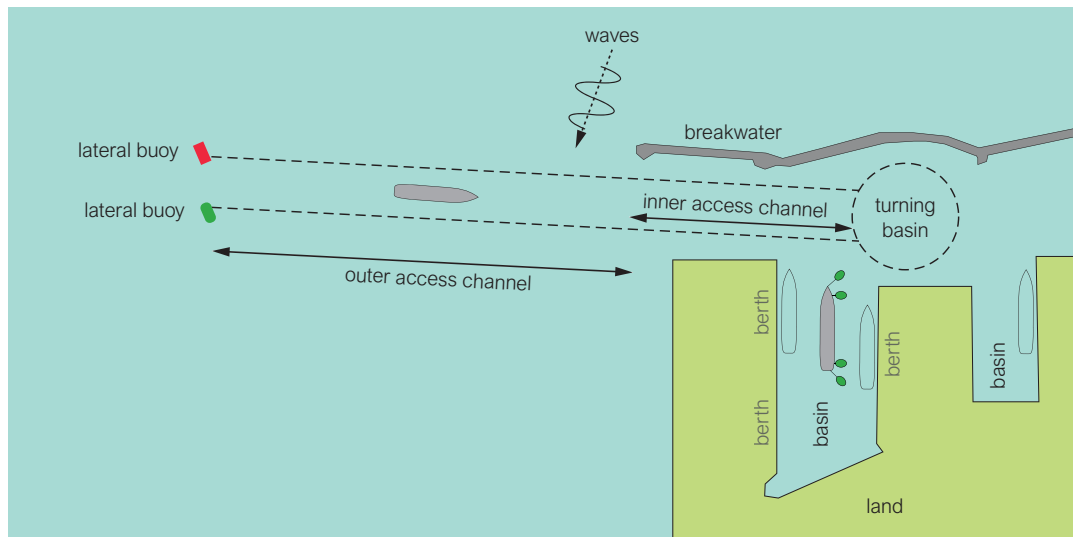

Figure 2.40: Access channel elements (by TU Delft – Ports and Waterways is licenced under CC BY-NC-SA 4.0).

2.3.2 Access channel width

Much like in inland waterways, the width of an access channel is determined by the following factors:

- the manoeuvring lane of the vessels,
- the swept path,
- the number of lanes,
- the passing distance (in case of multiple lanes),
- the bank clearance,
- the under keel clearance, and
- the seabed characteristics.

Tidal conditions may also play a role. Extra complicating elements in the outer part of the channel are wind, waves (sea and swell) and tidal currents. Consequently, for the outer channel the extra width components on top of the beam are generally larger than in inland waterways.

Manoeuvring lane or swept path

The basic manoeuvring lane provides space for the slightly sinusoidal path a vessel usually takes (also see [Section 2.1.1](#)). The width W_{bm} of the basic manoeuvring lane is therefore larger than the vessel's beam, typically $1.5 B_s$. Manoeuvrability may differ according to vessel type, water depth, wave and current conditions, visibility and aids to navigation.

Swept path

The width W_{bm} of the swept path will generally be larger than in inland channels (also see [Section 2.1.2](#)), due to stronger winds, waves and currents. [Table 2.2](#) gives the different width additions W_a to W_{bm} for different conditions. The numbers in [Table 2.2](#) are from [PIANC \(2014c\)](#) and related to moderate manoeuvrability and low speed conditions, which are characteristic of port access channels.

Like in inland channels, the under keel clearance influences manoeuvrability. This leads to an additional width requirement W_{kc} depending on the h_0/D_s ratio: $W_{kc} = 0.1 B_s$ for ratios between 1.25 and 1.5 and $W_{kc} = 0.2 B_s$ for ratios smaller than 1.25. This is added to the swept path.

The consequences of hitting the seabed differ according to its composition. Hitting soft mud will not do much damage, but hitting hard rock much more. This also translates into an additional width requirement to be added to the swept path.

Contributing factor	Condition	Width additions W_a
cross-wind	15 – 33 kn	$0.6 B_s$
	33 – 48 kn	$1.1 B_s$
cross-current	0.2 – 0.5 kn	$0.3 B_s$
	0.5 – 1.5 kn	$1.0 B_s$
	1.2 – 2.0 kn	$1.6 B_s$
long-current	1.5 – 3.0 kn	$0.2 B_s$
	> 3.0 kn	$0.4 B_s$
wave height	1 – 3 m	$0.5 B_s$
	> 3 m	$1.0 B_s$
seabed composition	soft sediment	$0.1 B_s$
	hard material	$0.2 B_s$
under keel clearance	$1.25 < h_0/D_s < 1.5$	$0.1 B_s$
	$h_0/D_s < 1.25$	$0.2 B_s$

Table 2.2: Additional width requirements (modified from [Ligteringen, 2017](#)).

Passing distance

In case of multiple lanes, the distance between passing vessels has to be large enough for safe navigation. The passing width W_p depends on the vessel speed: $W_p = 1.2 B_s$ for vessel speeds between 5 and 8 knots, and $W_p = 1.6 B_s$ for vessel speeds between 8 and 12 knots.

Bank clearance

To stay safe from the bank, a bank clearance distance is added to the channel width, depending on the bank's slope and type. For sloping banks the clearance W_b is $0.3 B_s$, for steep banks and banks of hard material (e.g. breakwaters) it is $0.5 B_s$.

Summary

In summary, the total width W of a single-lane access channel is given by (see [Figure 2.41](#)):

$$W = W_{bm} + \sum W_a + 2W_b \quad (2.8)$$

in which $\sum W_a$ is the sum of the different contributions W_a mentioned in [Table 2.2](#).

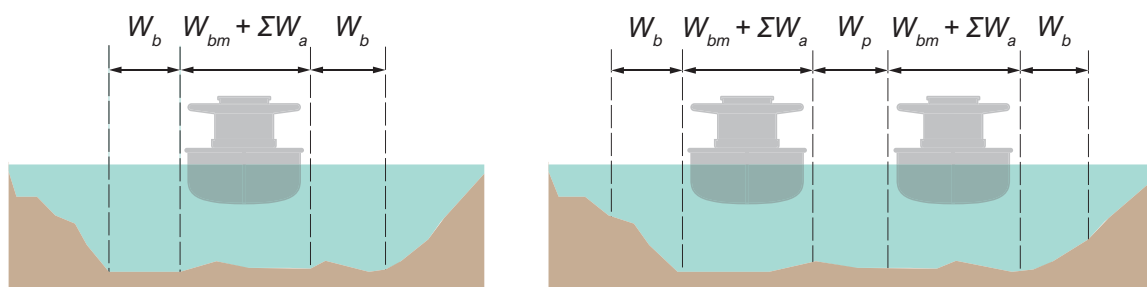

Figure 2.41: Total width of a one-way and a two-way access-channel (by TU Delft – Ports and Waterways is licenced under CC BY-NC-SA 4.0).

Similarly, for a two-lane channel we have:

$$W = 2(W_{bm} + \sum W_a + W_b) + W_p \quad (2.9)$$

This yields outer channel widths of typically 5 times the beam of the reference vessel for a single-lane channel and 10 or more times the beam in for a two-lane channel.

In a macro-tidal environment, however, another condition may be critical. If a vessel runs aground on one of the banks, the tidal current may sweep its stern to the other bank. If the channel is narrower than the length of the vessel, the vessel gets hung up on the banks and if this happens at high tide, the ship may break as the tide falls. Access channels in a macro-tidal environment must therefore have a width larger than the length of the reference vessel.

Within the shelter of the breakwaters, the environmental conditions are less severe. The inner access channel can therefore have a smaller width. At the transition between the exposed and the sheltered area, however, navigation is particularly demanding. This explains why between the outer and the inner access channel a transition zone of two to three times the vessel length is required, that gives the helmsman room to adjust the vessel's course to the new situation (Figure 2.42). This applies to a situation where a strong cross current gives rise to a drift angle for incoming ships.

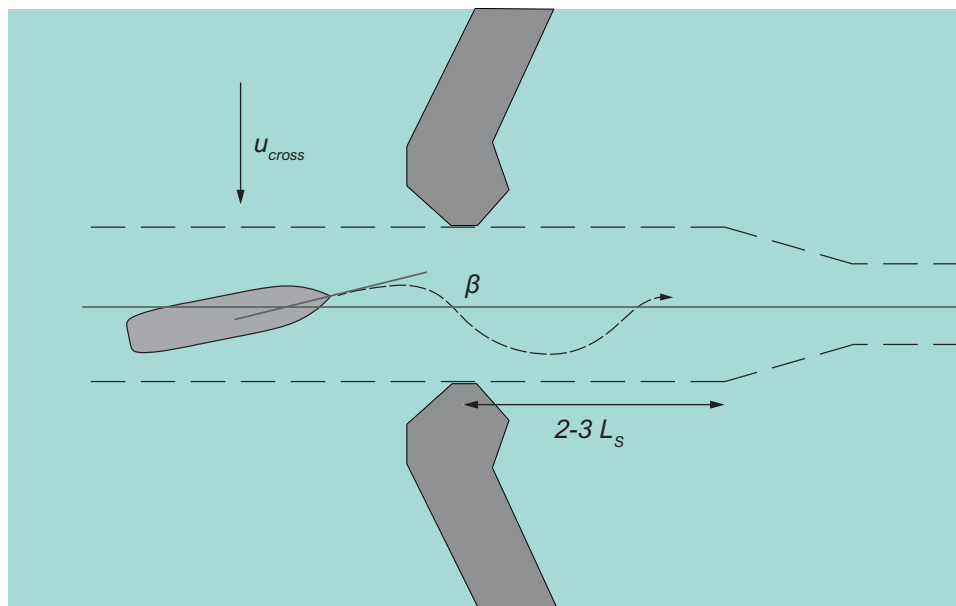

Figure 2.42: Transition zone between outer and inner channel (by TU Delft – Ports and Waterways is licenced under CC BY-NC-SA 4.0).

Example box 2.1: Access channel design: width

Suppose we have a one-way access channel suitable for a Panamax vessel ($B_s = 32.3$ m) with the following conditions:

- cross-current at peak tide: 2 knots,
- following current: none
- cross-wind: 12 m/s,
- wave conditions: $H_s = 1.5$ m,
- traffic support: VTS,
- channel depth: 14 m dredged ($h_0/D_s < 1.25$),
- bed composition: mud.

Example box 2.1 – continued on next page

Example box 2.1 – continued from previous page

Then, applying the considerations discussed above, the total required channel width can be calculated as follows:

Component	Width factor ($\times B_s$)
basic manoeuvring lane	1.5
cross current	1.6
following current	0.0
cross-wind	0.6
waves	0.5
traffic support	0.0
bed composition	0.1
channel depth <i>implication: soft sloping banks</i> $\rightarrow 2 \times$ bank clearance	0.6
Total width factor	5.1

For the Panamax vessel in this example the required channel width would therefore be 165 m.

2.3.3 Access channel depth

Apart from the width of the access channel, it is also important to estimate its required depth. The factors determining the depth of an access channel are similar to those in case of an inland channel:

- the draft of the reference vessel at rest when fully loaded,
- the vessel’s squat (sinkage, trim, heel),
- the vessel’s wave response,
- the water level, and
- the unevenness of the bed.

PIANC (2014c) suggests three different methods to establish the channel depth, depending on the stage of design. In a preliminary assessment all determining factors may be lumped into a depth/draft ratio: $h_0/D_s = 1.1 - 1.4$. PIANC (2014c) gives advice on when and how to apply these ratios, as shown in Table 2.3 for swell waves.

Wave conditions	Depth/draught ratio
sheltered water	1.1 - 1.15
$H_s \leq 1.0$ m	1.15 - 1.2
$1.0 \text{ m} \leq H_s \leq 2.0$ m	1.2 - 1.4
$H_s > 2.0$ m	1.4



Table 2.3: Left: Wave effects on the depth/draught ratio (derived from PIANC, 2014c). Right: image from www.shipspotting.com, by Sushkov Oleg.

In the port planning phase, each factor should be considered in more detail and added using a deterministic formula:

$$h_0 = D_s - T + s_{max} + r + m \tag{2.10}$$

in which:

h_0 = guaranteed depth [m], usually with respect to Chart Datum,

- D_s = draught of the design vessel at rest [m],
- T = tidal restriction [m],
- s_{max} = squat; rule of thumb: 0.5 m,
- r = response to waves; rule of thumb: $0.5 H_s$,
- m = safety margin / minimum under keel clearance [m]: 0.3 m for a soft bottom, 0.5 m for a sandy bottom and 1.0 m for a rocky bottom.

Chart Datum is the level of the lowest astronomical tide, so water levels can only be lower due to meteorological effects. The tidal restriction comes into play if vessels are only allowed into the port during a certain period around high water, the tidal window (Figure 2.43).

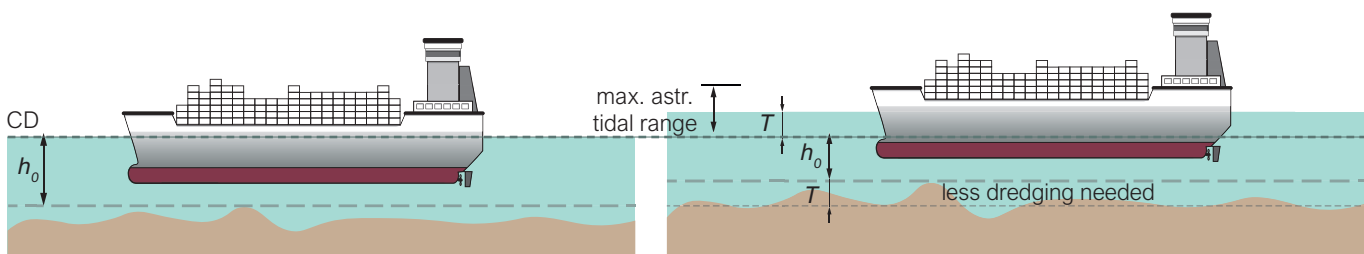

Figure 2.43: Access channel depth without (left) and with (right) tidal window (by TU Delft – Ports and Waterways is licenced under CC BY-NC-SA 4.0).

Using a tidal window reduces dredging costs, but it increases waiting times, so port operators and shipping companies are generally not in favour of it. In the final design phase, a risk-based approach with a probabilistic model is recommendable (see also De Jong, 2020).

Example box 2.2: Access channel design: depth

According to the rule of thumb, the required depth of an access channel for vessels with 12 m draught and a representative swell wave height $H_s = 2$ m amounts to $1.3 \times 12 = 15.6$ m.

If, furthermore:

- squat: $s_{max} = 0.5$ m,
- wave response: $r = 0.5 H_s = 1$ m,
- tidal restriction: $T = 0$, and
- sandy bottom $\rightarrow m = 0.5$ m,

the planning phase formula yields a required depth of $12 + 0.5 + 1.0 + 0.0 + 0.5 = 14$ m.

So the rule of thumb is on the safe (but also expensive) side.

2.3.4 Stopping

When approaching a port, a vessel has to come to a full stop, in order to be manoeuvred to the berth by tugboats. Stopping a large vessel is not a trivial matter, because of its large inertia. Even though it will have slowed down while still at sea, it has to maintain a certain speed for manoeuvrability, especially at the transition between the exposed and the sheltered zone. So when arriving at the port entrance, it will still need some distance, L_1 in Figure 2.44, to reduce its speed to a level that enables tugboats to make fast.

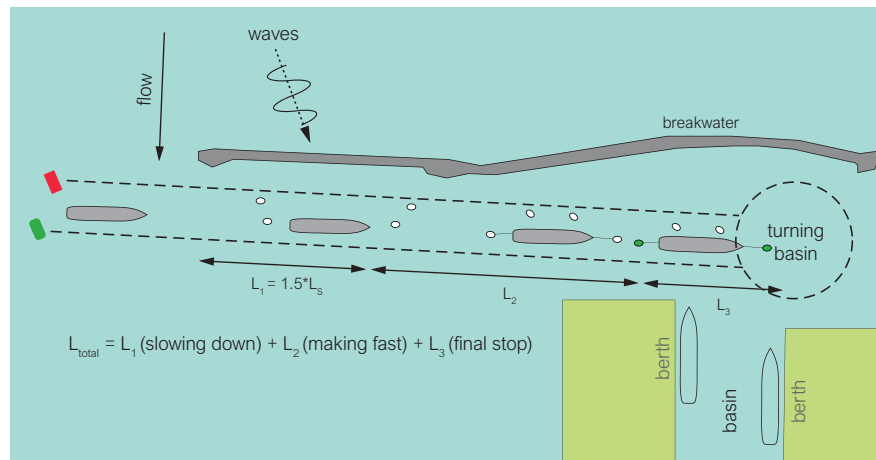

Figure 2.44: Stopping phases of a vessel approaching a port (by TU Delft – Ports and Waterways is licenced under CC BY-NC-SA 4.0).

The speed at which the vessel arrives at the sheltered zone depends on the cross-current in the exposed area:

$$L_1 = 0.75 (V_{s, \text{cross current}} - V_{s, \text{min}}) L_s \quad (2.11)$$

where $V_{s, \text{cross current}}$ is the vessel's speed when entering the sheltered zone (Figure 2.45). It equals 4 times the cross-current velocity in m/s, with a minimum of 4 knots ≈ 2 m/s. $V_{s, \text{min}}$ is the speed after slowing down over L_1 . It is equal to 4 knots ≈ 2 m/s. The second part of the stopping zone is meant for the tugs to make fast. In that zone the vessel's speed is still 4 knots and the fastening time is typically 10 minutes. This means that during this time the vessel moves 1200 m, which constitutes a significant part of the total stopping distance. The zone usually lies within the sheltered area, because tugs cannot make fast under wave conditions with $H_s = 1.5$ to 2.0 m (rather common in exposed water), nor can they exert any force on vessels moving at a speed larger than 4 knots. Once fastened, the tugs help the vessel to come to a complete stop. This takes a distance $L_3 = 1.5 L_s$.

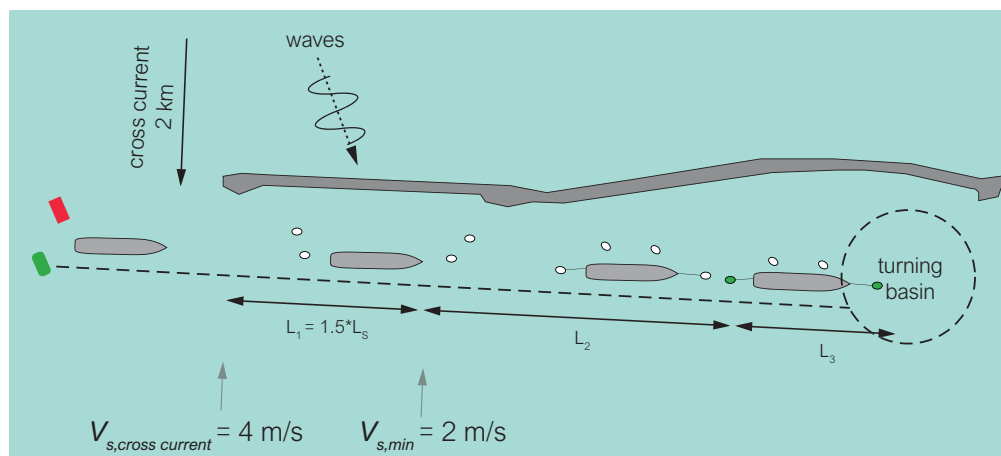

Figure 2.45: Example of the slow-down (by TU Delft – Ports and Waterways is licenced under CC BY-NC-SA 4.0).

Example box 2.3 illustrates that the total stopping distance determines to a large extent the layout of the outer port. Therefore, more detailed navigation studies are recommended to investigate possible optimisation. Fast-time and real-time navigation simulations can be of use here.

Example box 2.3: Access channel design: stopping distance

The stopping distance for a 250 m long vessel entering the sheltered zone from an exposed area with a cross-current of 2 knots (1 m/s) can be calculated as follows:

[noitemsep] Component	Contribution (m)
initial speed when entering the sheltered zone: $4 \cdot 2 = 8$ knts (4 m/s)	
slow-down to 4 knts (2 m/s): $0.75 (4 - 2) L_s = 1.5 L_s$	375
making fast: $10 \text{ mins} \cdot 2 \text{ m/s}$	1200
to full stop with tug aid: $1.5 L_s$	375
Total stopping distance	1950

2.3.5 Turning basin

In order to bring vessels into the right position for mooring, there has to be enough space in the sheltered zone to turn them (Figure 2.46).

If the vessel is turned with tug assistance, the diameter of the turning basin can be taken equal to twice the vessel length, but wind and currents may necessitate additional room, especially for vessels with a high freeboard. Further see Part II – Section 2.4.



Figure 2.46: Turning a vessel in a turning basin (left: image by william william is free to use under Unsplash Licence; right: image by TU Delft – Ports and Waterways is licenced under CC BY-NC-SA 4.0).

2.3.6 Port basins

Port basins should be sufficiently wide to allow for safe manoeuvring of vessels and tugboats, also when berths are occupied. The width requirements depend on the type of vessel and terminal. For container and general cargo terminals, a rule of thumb for the basin width is 4 to 5 times $B_s + 100$ m (Figure 2.47). In case of high cross-winds an additional width is required. With a typical vessel beam of 50 to 60 m for the largest container vessels, the basin width will be in the order of 300 to 400 m.

For dry and liquid bulk terminals the recommended basin width is 4 to 6 times $B_s + 100$ m and for long basins (longer than 1 km) it is $L_s + B_s + 50$ m.



Figure 2.47: Basin width for container terminals (left: *Panorama Elbe Hamburg Container In The Air City* by www.maxpixel.net is licenced under CC0 1.0; right: image by TU Delft – Ports and Waterways is licenced under CC BY-NC-SA 4.0).

2.3.7 Berth areas

When moored for cargo handling, a vessel should be as stable as possible. Depending on the type of cargo, ship motions reduce the loading/unloading efficiency, which translates into higher costs and longer harbour residence time. Too large motions also involve the risk of line snapping, a quite dangerous event.

Ship motions in a harbour are primarily caused by waves. This can be locally generated waves, sea and swell penetrating from outside, or resonant long waves. A vessel's response to wave motion depends to a large extent on its length, as illustrated in Figure 2.48. An additional factor is the wave direction (ahead/astern or abeam). Apart from waves, strong winds may cause vessels to move when moored. This is especially the case for vessels with a high freeboard, such as container carriers.

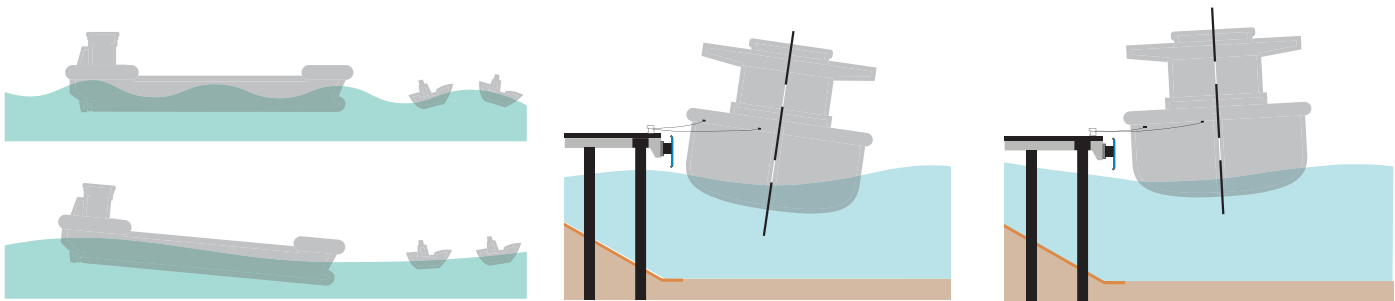

Figure 2.48: Ships in waves, left: length effect; right: moored ship in cross-waves (image by TU Delft – Ports and Waterways is licenced under CC BY-NC-SA 4.0).

Locally generated waves need a long fetch (stretch of water in the wind direction) in order to grow high enough for hindrance. In certain elongated ports, like the one of Rotterdam, this may be the case, especially for smaller vessels such as tugboats.

Wave penetration from outside mainly happens in the channel between the breakwaters, or – in case of permeable breakwaters – through the breakwaters. Especially the longer swell waves penetrate deeper into the port area. Depending on the shape of the water bodies and the presence of wave-reflecting structures, they may resonate and even increase in amplitude. This effect is even stronger for still longer waves, such as seiches, meteorologically generated long waves with a period of 10 minutes or more. One may attempt to remediate harbour resonance problems once they occur by creating wave-absorbing elements such as run-up slopes, but it is better to design the layout such that the phenomenon does not occur. This requires detailed wave penetration studies, using a physical scale model or a numerical model (Figure 2.49).

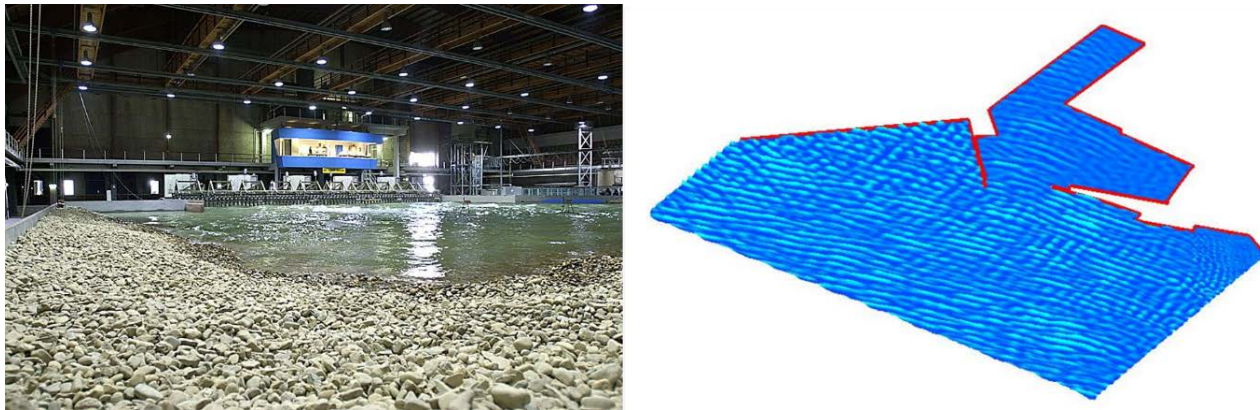

Figure 2.49: Wave penetration study tools. Left: wave basin for physical scale models. Right: numerical simulation model (left: image by Deltares; right: image by Van Vledder and Zijlema (2014) is licensed under CC BY 4.0).

The response of a vessel does not only depend on the wave height, but also on the wave period. Long vessels respond more to long waves, small vessels respond more to short waves (Figure 2.50). To calculate the dynamic response of a vessel, a Dynamic Mooring Analysis (DMA) is carried out in almost every port project. The result of the DMA shows under what wind and wave conditions downtime is expected and also what mooring forces can be expected. In Part IV – Section 4.3 we describe how simulation tools can be used in this type of analysis.

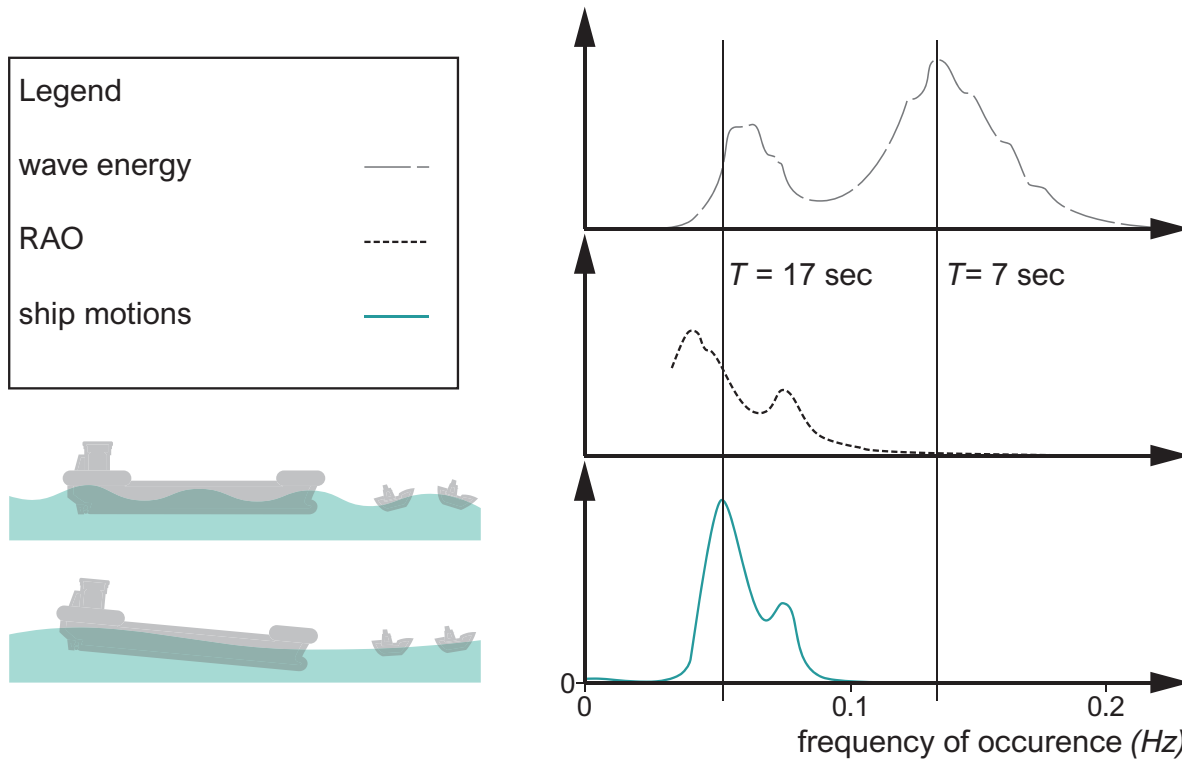

Figure 2.50: Example of a ship response spectrum for a ship sailing in deep water (by TU Delft – Ports and Waterways is licenced under CC BY-NC-SA 4.0).

Moored vessel motions may become too large for cargo handling. Under what conditions this is the case depends on the commodity: lifting a container from deep inside the hull requires a higher precision than offloading liquid bulk using flexible hoses. If a moored vessel moves too strongly, it will be asked to leave the berth, because of the risks involved.

Table 2.4 gives the operational limits of motion of various types of vessels at berth. For each type and size of vessel this can be translated into allowable wave conditions (height, period, direction).

Vessel type	Allowable vessel motions			
	Surge (m)	Sway (m)	Yaw (°)	Heave (m)
Liquid Bulk (Tankers)	2 – 3	2 – 3	1	1.5
Dry Bulk	0.5 – 1.5	0.5 – 1.0	–	0.3 – 0.5
Container	0.5	0.3	1	0.3
Ro-Ro (at a ramp)	0.3	0.2	0	0.1

Table 2.4: Allowable motions of vessels at berth (by TU Delft – Ports and Waterways is licenced under CC BY-NC-SA 4.0).

If a berth is insufficiently sheltered, one may consider reducing vessel motions by using an automated or dynamic mooring system.

2.4 Dimensions of water areas in inland ports

After discussing the basic dimensions of sea ports, we will focus on inland port water areas. After a brief typology of inland ports, we address the connection to the main fairway and some key aspects of inland port water areas.

2.4.1 Typology

Inland ports vary widely in function, size and layout (also see Part II – Section 5.5). Clearly, this has implications for the water areas in and around these ports. When distinguished by function, there are:

- cargo ports, with the usual terminal types (general cargo, dry bulk, liquid bulk, containers, cars, etc.),
- industrial ports belonging to a particular factory with specific type of cargo,
- passenger ports with one or more cruise terminals,
- service ports,
- overnight stop ports, and ports of refuge.

Another categorisation is by location with respect to the fairway and the primary flood defence:

1. *berths along the fairway* (Figure 2.51; also see Figure 2.55, port of Stein) – This is only an option if the fairway is not too busy (less than 30,000 passages per year, according to RVW, 2020) and the vessels are not too large (smaller than Class V).



Figure 2.51: Berths along the fairway (Waalgade, Nijmegen by Michielverbeek is licenced under CC BY-SA 4.0).

- ports outside the dike, so in a river floodplain (Figure 2.52) or along a canal – The terminal area has to be reclaimed (heightened), which makes it rather expensive. Furthermore, the dimensions of the floodplain determine the space available for expansion. When located on a canal, these harbours are always accessible, but when located on a river there may be downtime due to extreme floods (strong currents over the floodplain) or extreme droughts (too low water level). On a river, sedimentation in and near the mouth of the access channel may be a problem. Finally, the reclaimed area may be an obstacle to floods, thus reducing the river’s flood conveyance capacity.

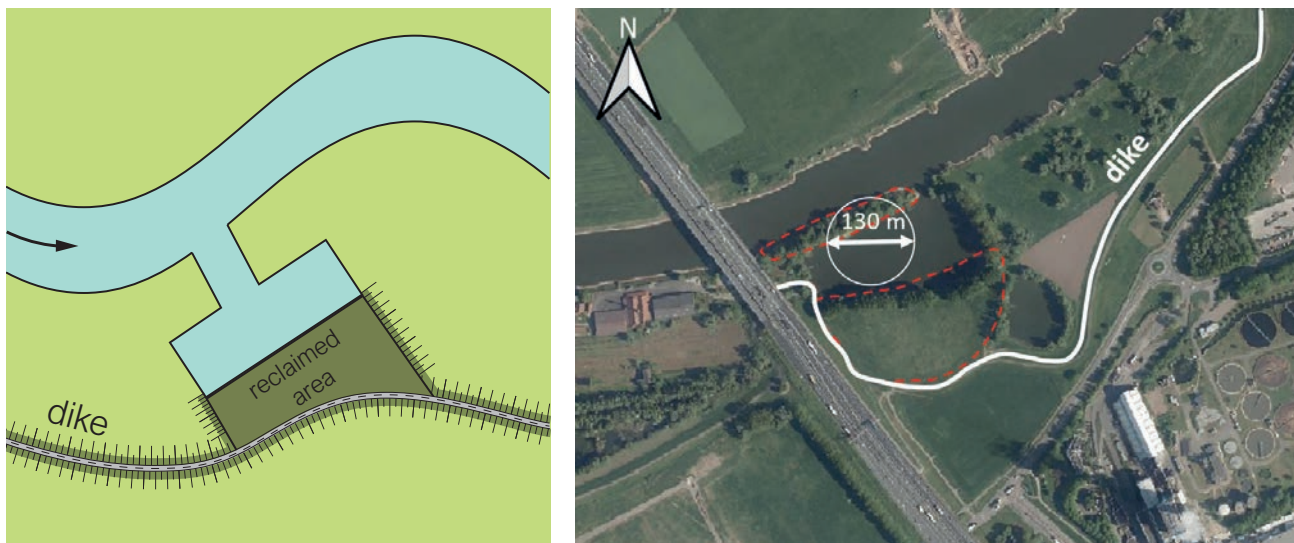

Figure 2.52: Floodplain port; left: principle; right: projected port near Westervoort on the river IJssel (left: reworked from Ligteringen, 2017, by TU Delft – Ports and Waterways licenced under CC BY-NC-SA 4.0; right: Aerial imagery background by the National Georegister (NGR) is licenced under CC BY 4.0).

- open ports surrounded by an intersection dike (Figure 2.53) – These ports are better protected against flood currents and they don’t reduce the river’s flood conveyance. The other pros and cons are largely the same as for ports outside the dike.

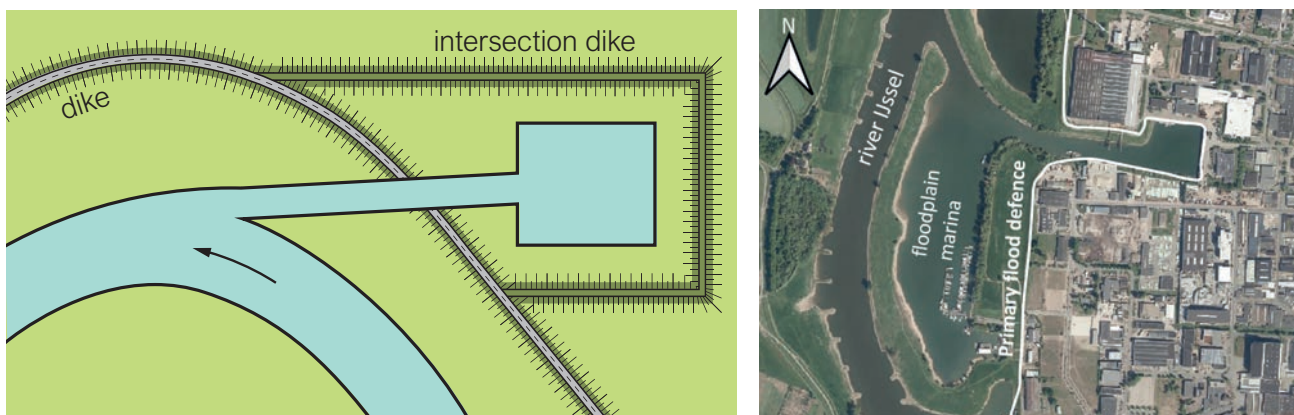

Figure 2.53: Open port behind the original dike and surrounded by an intersection dike; left: principle; right: industrial port of Zutphen on the river IJssel (left: reworked from Ligteringen, 2017, by TU Delft – Ports and Waterways licenced under CC BY-NC-SA 4.0; right: Aerial imagery background by the National Georegister (NGR) is licenced under CC BY 4.0).

- ports inside the dike, closed off with a lock (Figure 2.54) – Since in this case, the water level in the port is kept constant, it is accessible as long as the lock functions. Clearly, the lock causes delays, limits the vessel size and brings costs for construction, operation and maintenance. On the other hand, berth and terminal areas are relatively cheap and expandable. In order to compensate for locking losses during low water in the river, pumping water back into the port area may be necessary.

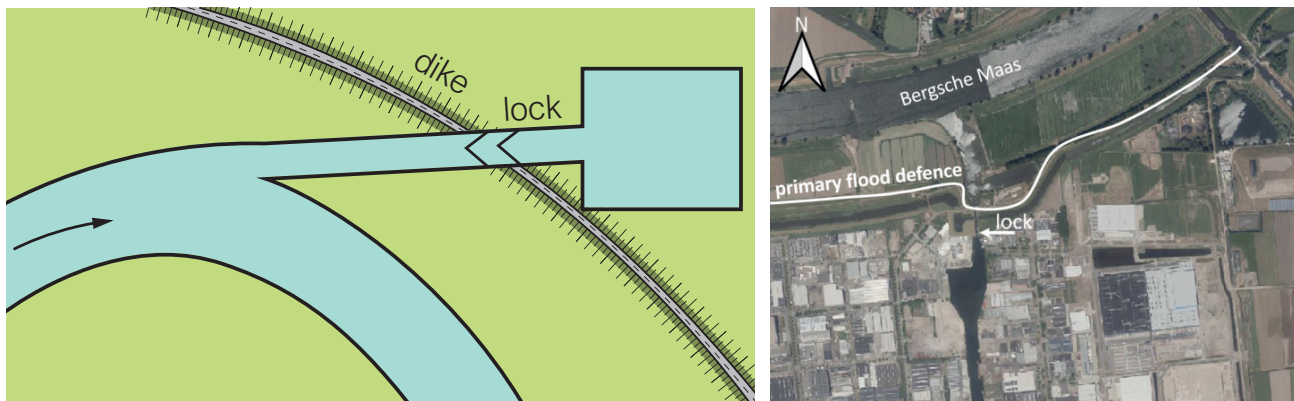

Figure 2.54: Closed port inside the dike; left: principle; right: industrial port of Waalwijk on the river Maas (left: reworked from Ligteringen, 2017, by TU Delft – Ports and Waterways licenced under CC BY-NC-SA 4.0; right: Aerial imagery background by the National Georegister (NGR) is licenced under CC BY 4.0).

2.4.2 Connection to the main fairway

It makes quite a difference whether an inland port is located on a canal, a canalised river, a regulated river with a fixed main channel or a ‘wild’ river with a migrating main channel (Figure 2.55). This goes for entrance and exit manoeuvres of the access channel, which are complicated by the presence of velocity gradients. It also goes for water level variability in the access channel and the port basins, and for sedimentation and navigability.



Figure 2.55: Left: Deutz harbour (GE), on the River Rhine (Deutzer Hafen, Poller Wiesen, Rheinbrücken by ToLo46 is licenced under CC BY-SA 4.0); right: port of Mülheim (GE), in open connection with the River Rhine (Mülheimer Hafen (Flight over Cologne) by Neuwieser is licenced under CC BY-SA 2.0).

In developing countries, situations can be more extreme. One example of a ‘wild’ river is the Ayeyarwady in Myanmar. Channels in this braided river are quite variable and often change from primary to secondary in terms of discharge and water depth (Figure 2.56).

On a river with active sediment transport, sedimentation in and near the mouth of the access-channel can be a problem. By locating the channel in an outer bend, this will be less of a problem, because the secondary flow tends to direct the transport away from the mouth. If such a location is not possible, a so-called Thijsse-egg (named after the Delft professor J. Th. Thijsse) may be a solution (Figure 2.57).

The functioning of the Thijsse-egg is based on the flow circulation inside the egg, which is separated from the main flow by a shear layer. Thus flow and sediment transport in the river are hardly disturbed and the morphological effects are negligible. The sediment that still enters the cell is transported by the secondary flow to the centre of the egg, where it piles up, ready to be removed.



Figure 2.56: Morphology of the Myitmaka River at different points in time: where to locate a port? (left: Landsat 4-5 TM L2 image courtesy of the U.S. Geological Survey processed by Sentinel Hub is licenced under CC BY; right: ‘Copernicus Sentinel data 2019’ for Sentinel data is licenced under CC BY).

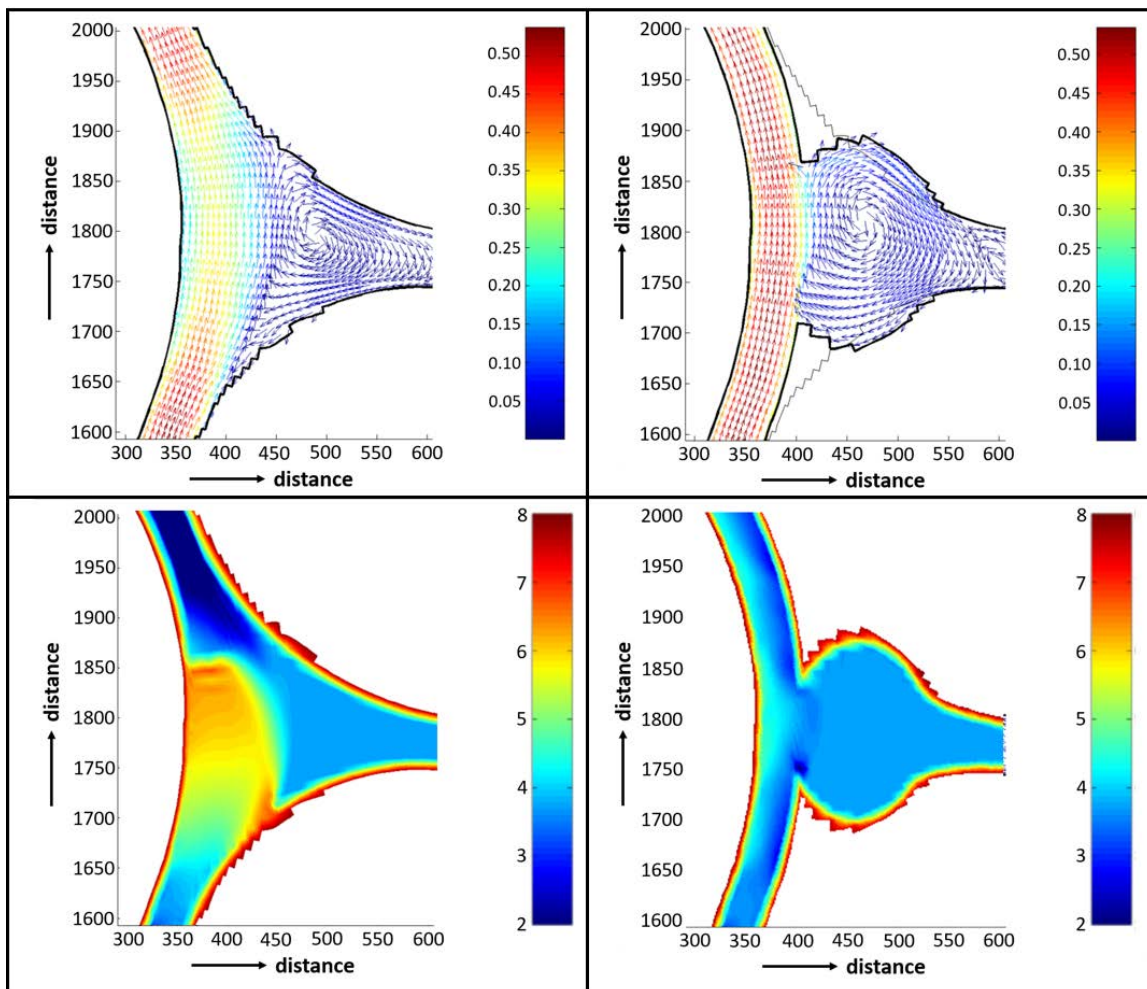

Figure 2.57: Entrance to the Emsland-Mitte Hafen near Haaren, Germany. Left: original design; right: improved design with Thijsse-egg; top: velocity field; bottom: morphology (source: Euro-Hafen Emsland-Mitte, Delft Hydraulics, report Q4072, 2006).

Apart from preventing sedimentation, the Thijsse-egg also offers extra manoeuvring space for vessels entering or leaving the access channel (Figure 2.58). Such space is needed because the vessels experience strong velocity gradients here.

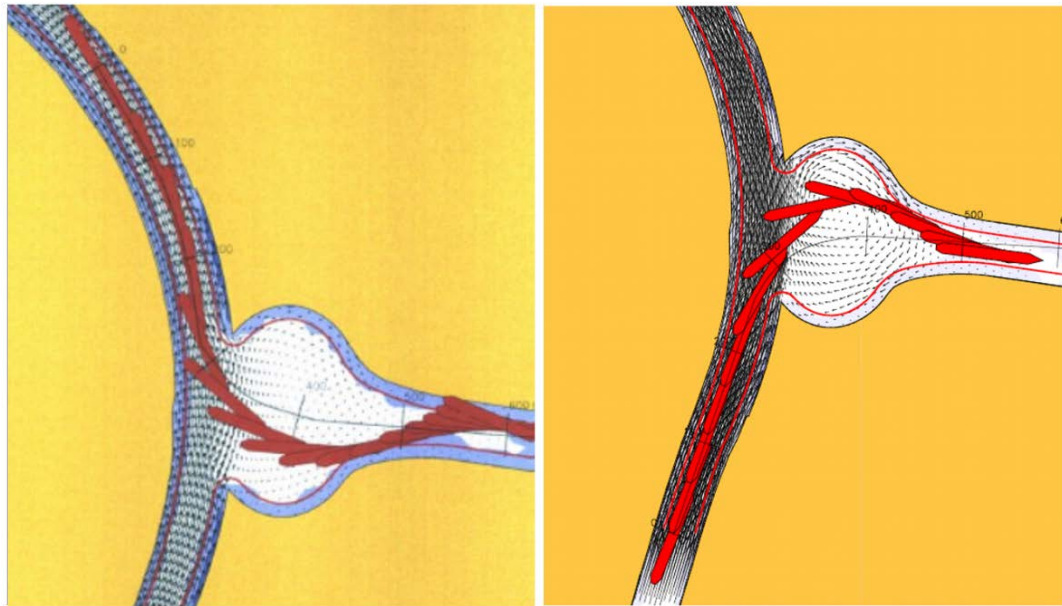

Figure 2.58: Simulated entrance manoeuvres of vessels sailing upstream (left) and downstream (right) (source: Euro-Hafen Emsland-Mitte, Delft Hydraulics, report Q4072, 2006).

Access channels not equipped with a Thijsse-egg are often built under a sharp angle with the river axis, such that the channel mouth is facing downstream (Figure 2.59). The principal objective is to prevent sedimentation in the centre of the channel mouth, in order to maintain sufficient navigable depth. For ports along a river having a basin length of at least 1000 m or more than 10 times the length of the design vessel, entering head-on and turning inside the port is preferable to entering backwards. Shape and angle of the entrance then depend on the sailing direction of most of the vessels, but generally the entrance will be perpendicular to the waterway axis.

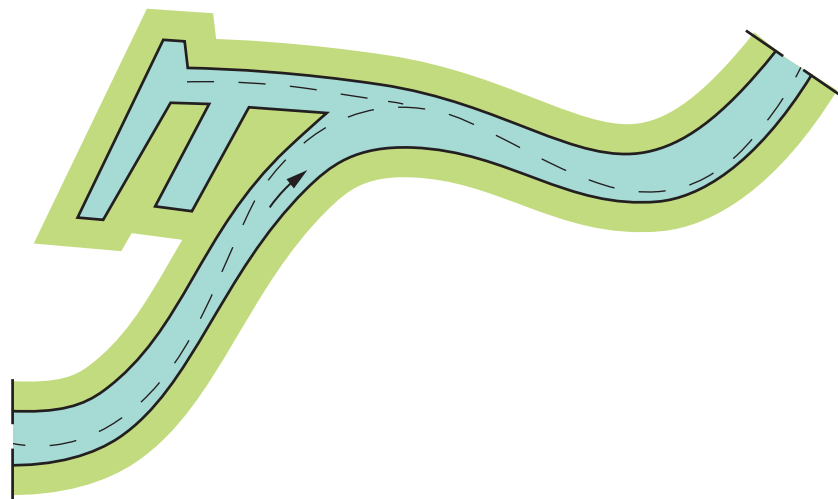

Figure 2.59: Oblique connection between a river and a port entrance (by TU Delft – Ports and Waterways licenced under CC BY-NC-SA 4.0).

Irrespective of how the access channel is connected to main fairway, safety requires that the helmsman of a vessel leaving the access channel has sufficient line of sight over the fairway and vice versa. Figure 2.60 shows what this means in terms of lines of free sight. Depending on the CEMT class and the sailing direction relative to the current direction, the line of site should be 3 to 5 times the design vessel length, with a maximum of 600 m.

In addition, it is necessary to place sufficient visual guiding along the waterway to ensure a timely start of the entrance manoeuvre, to respond to unexpected situations, and keep the ship under control in the changing current field. See for more information *Richtlijnen Vaarwegen* (RVW, 2020).

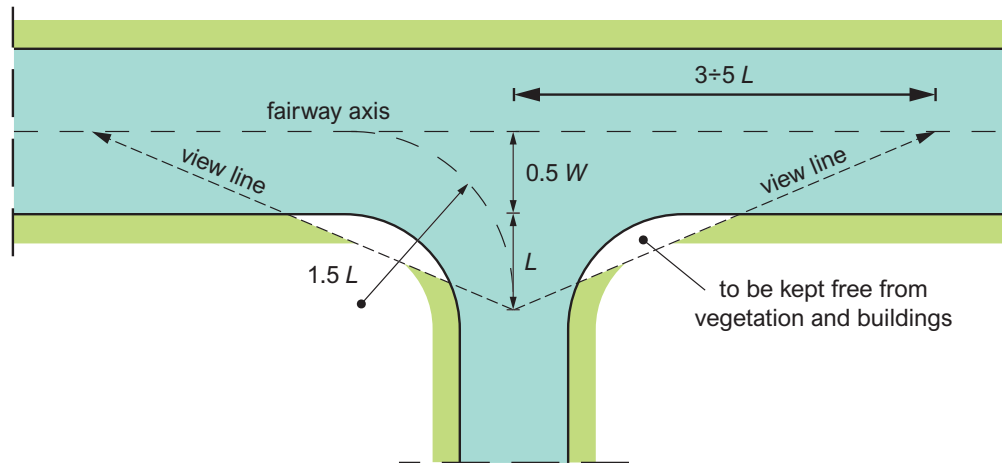

Figure 2.60: Unobstructed view lines at connections (by TU Delft – Ports and Waterways licenced under CC BY-NC-SA 4.0).

2.4.3 Port water areas

When designing a river port, a few points have to be kept in mind (RVW, 2020):

- in the river, the water level set-up induced by the port should be as small as possible,
- sedimentation, in the port as well as in the river, should be kept at a minimum,
- changes in the current pattern should be avoided and cross-current should be limited.

Access channel

Dimensional requirements to access channels of inland ports depend on the type of waterway (RVW, 2020). In general:

- the entrance should be:
 - if on a canal: as wide as possible, such that the opening enables ships to make the turn into the access channel;
 - if on a river: as narrow as possible, in order to limit sedimentation and changes in the flow pattern in the river.
- the channel inside the mouth should be:
 - if on a canal: short, as the wide entrance and the absence of a current allow a ship to sail in slowly and in control;
 - if on a river: long, as a ship sailing downstream enters at a relatively high speed due to the current and needs some distance to stop and line up.

These design principles can be used for waterways wider than 0.8 times the length of the design vessel, where the vessel can perform a large part of its turning manoeuvre at the river. At smaller waterways, a larger entrance width is required, about the length of the design vessel. Simulations will often be necessary, where sailing into the port in downstream direction will be the normative condition.

In order to limit sedimentation in the port access, it is recommended to construct a guide wall at the upstream side of the port access (unless the current changes direction, like in tidal rivers). Such a structure directs the flow towards the river axis. Moreover, it provides a clear boundary to the skippers.

The above principles result in an entrance width of about 4 times the beam of the reference vessel. For high current velocities in the river a larger width may be necessary. This can be determined in a combined hydromorphological and nautical study.

The depth should be the same as in the main fairway, with a minimum **UKC** of 1 m. It is important to consider expected future large-scale bed level changes, such as the incision of the Rhine branches in the Netherlands.

Turning basin

Turning basins (minimum diameter $1.2 L_s$) enable vessels to manoeuvre in the vicinity of a quay along a waterway or inside a port basin. In the former case, the turning basin may cover part of the main fairway, provided that this is not too busy. **RVW (2020)** states that on waterways with more than 15,000 passages of commercial vessels per year the turning vessel must stay outside the fairway lane at the opposite side.

Port basin

Dimensional requirements for the port basin are not essentially different from those in a sea port, though at a different scale. The quay length for a single vessel is 1.1 to 1.2 times the length of the design vessel. If more vessels are to be berthed side by side, $1.2 L_s$ is required per vessel. A space-efficient basin design is obtained with 2 moored vessels next to each other, at each side. This requires a basin width of 7 times the beam of the design vessel.

The depth in the basin should be the same as in the main fairway. A minimum **UKC** of 1 m is recommendable, in view of the erosive force exerted by thruster and main propeller jets.

Quays and wharves

Quays and wharves are parallel mooring locations along the waterway. On busy waterways with more than 30,000 passages/year or on waterways for **CEMT** Class V or higher, these moorings should be avoided, as regulations force passing vessels to reduce speed, in order to avoid damage to the moored vessel(s). Particular measures for a quay or wharf are not necessary, except a safety area between the berth and the shipping lane. **RVW (2020)** gives further details.

Vessels should have the opportunity to turn, if necessary, within 1000 m from the quay or wharf. On rivers vessels can make use of groynes fields and port connections to turn.

Overnight ports, recreational ports, et cetera

RVW (2020) offers special guidance for various other types of ports, including provisions such as a car boarding facility, and moorings for vessels carrying hazardous goods (blue cone vessels). It also gives a procedure to determine the required capacity.

2.5 Manoeuvring simulators, capacity models and nautical safety analysis

In the conceptual and final design stages of port access channels, port water areas and inland waterways simulation and capacity models as well as a nautical safety analyses will be necessary. Specific situations are often too complex to rely on analytical design rules only. In that case, the first estimate of the required layout will be followed by ship manoeuvring and capacity simulations. They give insight into the inherent possibilities and/or restrictions infrastructure, environmental conditions and vessel types, including the role of tugs and the effects of additional manoeuvring devices such as bow and stern thrusters. Based on the insight gained, adaptations of the infrastructure design (channel layout, manoeuvring basin and terminal layout) and/or the admittance policy can be proposed. In the initial stage of the design a fast-time simulation program will be applied; in the final stage a study on a real-time simulator may follow. Moreover, nautical safety must be studied qualitatively or quantitatively.

2.5.1 Simulation models

Manoeuvring simulators The use of Fast-Time Simulators [FastTime Simulators \(FTS\)](#) in the early stages of a design and the use of Real Time Simulators [Real Time Simulator \(RTS\)](#) in the final design stage provides insight into the behaviour of one particular vessel in the proposed layout of the port water areas, the access channel or the inland waterway. [RTS](#) models can also be used for operational applications, such as training of captains and pilots, or to find solutions for problems encountered.

SHIPMA is the fast-time manoeuvring simulator used in the Netherlands. The program is a joint development of MARIN's nautical centre MSCN and Delft Hydraulics (now Deltares). The combined expertise has led to a fit-for-purpose tool to simulate the manoeuvring behaviour of vessels in ports and waterways. In SHIPMA, a vessel is steered by a track-following autopilot which is capable to perform typical manoeuvres like turning and berthing. All hydrodynamic effects are included: shallow water, bank effects, currents, wind and waves. Moreover, tugs can be implemented. One vessel is simulated and the simulation allows to compare results of different simulations on technical and physical aspects. The output gives information on track, position, course, course deviation, distance to desired track, rudder angle. [Figure 2.61](#) shows an example of a vessel's track when entering a canal.

Another possibility is to use an [RTS](#). In principle, these simulators are based on the same principle as an [FTS](#), but the manoeuvres are carried out by pilots or skippers located in a ship's steering house with all the equipment present as in a real steering house. Even the view out of the windows looks natural since this is based on the real situation [Figure 2.61](#). The effect of a human navigator is the main difference from an [FTS](#). [Figure 2.61](#) shows a typical result of an [RTS](#) simulator study.

[RTS](#) simulators are used not only for final designs, but also for training purposes. Obviously, the costs of using an [RTS](#) are significantly higher than those of an [FTS](#).



Figure 2.61: View from a simulator bridge during an encounter situation (images by MARIN are licenced under CC BY-NC-SA 4.0).

Capacity models Apart from simulating manoeuvres it is important to determine the capacity of a waterway, port, or terminal. These type of models simulate the nautical traffic during a certain period, in order to determine not only the capacity, but also peak moments, waiting times, et cetera. In general, there are two ways to determine the various capacity aspects, viz.:

1. analytical models
2. simulation models

Examples of analytical models are the Kooman method for lock performance ([Kooman and De Bruijn, 1975](#)), yielding the waiting and passing times of locks, and queuing theory (see [Part IV – Section 2.4](#) for waiting times at ports).

The second type of capacity models are simulation models. In the Netherlands Rijkswaterstaat uses the models BIVAS, SIMDAS and SIVAK. BIVAS computes traffic volumes and intensity-capacity ratios for the Dutch waterway network. SIMDAS and SIVAK focus on the capacity of a certain reach of an open waterway (ship-ship

interaction) and near an infrastructure (ship-infrastructure), respectively. BIVAS, SIMDAS and SIVAK are discussed in more detail in (see [Part IV – Section 2.6.1](#)). Examples of studies carried out are: [Verschuren \(2020\)](#) studied the effect of low discharges at the river Rhine on the navigation with SIMDAS, and ([Van Adrichem, 2020](#)) studied the optimization of lock scheduling with SIVAK.

Recently, OpenTNSim has been developed, of which an example is given in [Part IV – Section 2.6.1](#). This model simulates (part of) a transport network.

Often analytical models suffice, but if the system becomes too complex simulation models have to be used. This can be the case, for instance, if:

- The sailing time from the anchorage to the quay cannot be neglected in relation to the servicing time;
- The number of berths is dependent on the length of the ships, and
- The tidal conditions affect the functioning of the system, etc.

2.5.2 Nautical safety analysis

Quantification of the nautical safety in ports and waterways is becoming more and more important. Safety can become critical before the theoretical capacity is reached. Up till recently, a qualitative assessment was made very often using a [Formal Safety Analysis \(FSA\)](#). However, the present trend is to use a quantitative analysis via simulation models.

Qualitative analysis The [International Maritime Organization \(IMO\)](#) recommends the [FSA](#) method in order to address the nautical safety. The methodology consists of five steps:

1. identification of hazards
2. risk assessment
3. risk control options
4. cost-benefit assessment
5. decision-making recommendations

Obviously, Steps 2 and 3 are very important. In Step 2 the probability and impact estimation per hazard must be determined. Step 3 deals with mitigating measures to reduce the probability and the impact. A part of the method is a questionnaire for retrieving expert judgement on hazards and an expert session to discuss the hazards, the mitigating measures and their effects. [Figure 2.62](#) shows the [FSA](#) methodology.

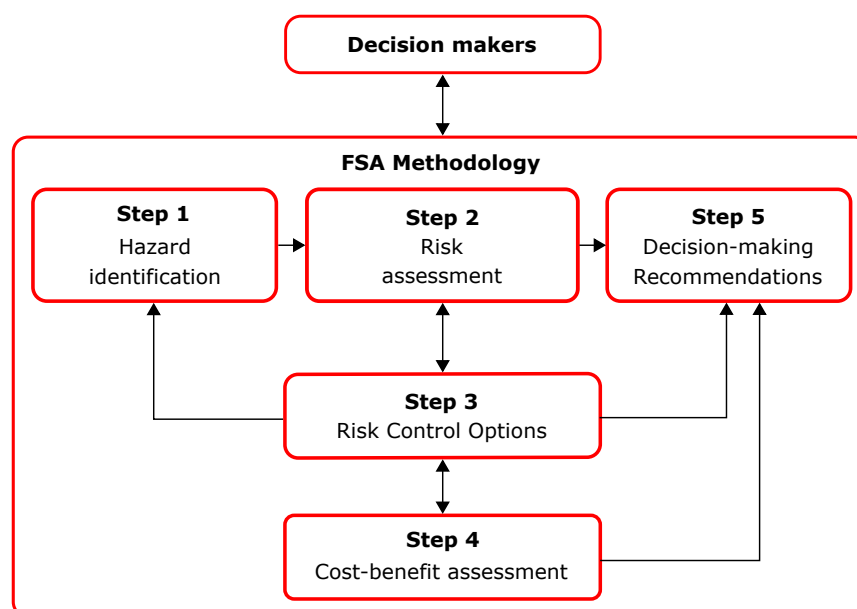

Figure 2.62: Methodology of the Formal Safety Analysis (reworked from [IMO, 2018](#), by TU Delft – Ports and Waterways is licenced under [CC BY-NC-SA 4.0](#)).

Quantitative analysis An early example of a quantitative method is SHIPRISK developed at the TU Delft by Groenveld. It was used to determine the risks during construction of Maasvlakte 2. A limitation of SHIPRISK and comparable models is that the vessels follow a predetermined fixed course. To overcome this limitation, recent research has focused on methods to simulate the real behaviour of vessels, such as manoeuvres during overtaking and encounters in various conditions with respect to wind, sight and current. [Automatic Identification System \(AIS\)](#)-data of the Nieuwe Waterweg provided statistical input.

So far, it has resulted in two validated methods:

1. Application of Artificial Force Field: the behaviour of each vessel is determined by forces which are a function of the distance to the bank, other vessels, bridge piers, et cetera (Xiao, 2014).
2. Optimal Control Approach: the vessel route is calculated by minimizing the energy use (Shu, 2019).

However, a lot of work still has to be done to derive operational models.

MARIN developed a quantitative analysis based on:

- traffic analysis
- SAMSON

The traffic analysis deals with where and how vessels actually sail. Obviously, [AIS](#) plays an important role. Based on that information density maps and track plots can be made. The method includes an intensity analysis and the determination of a route structure, finally resulting in a traffic database for the simulation model SAMSON (Safety Assessment Model for Shipping and Offshore on the North Sea). This model provides the opportunity to determine ship-ship and ship-object interactions. [Figure 2.63](#) shows an example of track plots for a windfarm in the IJsselmeer.

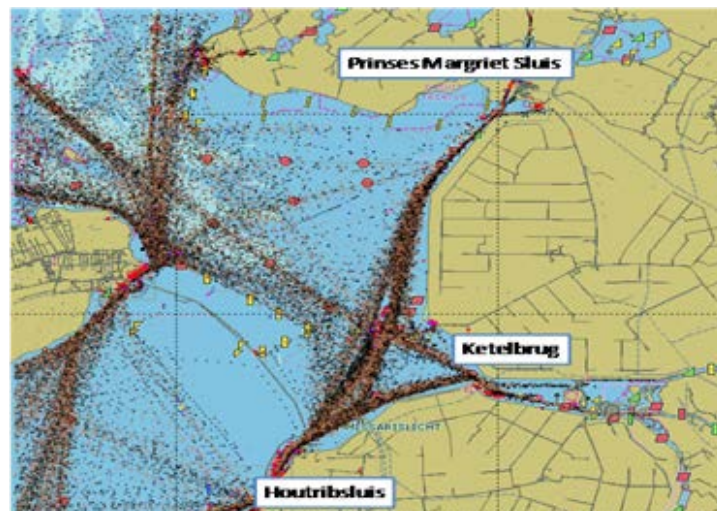

Figure 2.63: Track plots of ships on the IJsselmeer for a risk analysis of collisions between ships and wind mills of an offshore windfarm (image by MARIN is licenced under CC BY-NC-SA 4.0).