

Urban Climate Design

Improving thermal comfort in Dutch neighbourhoods

Kleerekoper, Laura

DOI

[10.7480/abe.2016.11](https://doi.org/10.7480/abe.2016.11)

Publication date

2016

Document Version

Final published version

Citation (APA)

Kleerekoper, L. (2016). *Urban Climate Design: Improving thermal comfort in Dutch neighbourhoods*. [Dissertation (TU Delft), Delft University of Technology]. A+BE | Architecture and the Built Environment. <https://doi.org/10.7480/abe.2016.11>

Important note

To cite this publication, please use the final published version (if applicable). Please check the document version above.

Copyright

Other than for strictly personal use, it is not permitted to download, forward or distribute the text or part of it, without the consent of the author(s) and/or copyright holder(s), unless the work is under an open content license such as Creative Commons.

Takedown policy

Please contact us and provide details if you believe this document breaches copyrights. We will remove access to the work immediately and investigate your claim.



Architecture
and the
Built environment

#11

2016



Urban Climate Design

Improving thermal comfort in Dutch neighbourhoods

Laura Kleerekoper

Urban Climate Design

Improving thermal comfort in Dutch neighbourhoods

Laura Kleerekoper

*Delft University of Technology, Faculty of Architecture and the Built Environment,
Department of Architectural Engineering & Technology*

Design: Sirene Ontwerpers, Rotterdam

ISBN 978-94-6186-682-0

ISSN 2212-3202

© 2016 Laura Kleerekoper

All rights reserved. No part of the material protected by this copyright notice may be reproduced or utilized in any form or by any means, electronic or mechanical, including photocopying, recording or by any information storage and retrieval system, without written permission from the author.

Unless otherwise specified, all the photographs in this thesis were taken by the author. For the use of illustrations effort has been made to ask permission for the legal owners as far as possible. We apologize for those cases in which we did not succeed. These legal owners are kindly requested to contact the publisher.

Urban Climate Design

Improving thermal comfort in Dutch neighbourhoods

Proefschrift

ter verkrijging van de graad van doctor
aan de Technische Universiteit Delft,
op gezag van de Rector Magnificus prof. ir. K.C.A.M. Luyben,
voorzitter van het College voor Promoties,
in het openbaar te verdedigen op donderdag 07 juli 2016 om 12:30 uur
door Laura KLEEREKOPER
Master of Science
geboren te Hilversum

This dissertation has been approved by the

Promotor: Prof.dr.ir. A.A.J.F. van den Dobbelsteen

Copromotor: Dr.ir. M.J. van Dorst

Composition of the doctoral committee

Rector Magnificus,	chairman
Prof.dr.ir. A.A.J.F. van den Dobbelsteen,	promotor
Dr.ir. M.J. van Dorst,	copromotor
Dr.ir. G.J. Hordijk,	daily supervisor

Independent members

Prof.dr.ir. B.J.E. Blocken,	Eindhoven University of Technology
Prof.dr.ing. L. Katzschner,	University of Kassel, Germany
Prof.dr.ir. H.W.J. Russchenberg,	Delft University of Technology
Prof.ir. D.F. Sijmons,	Delft University of Technology
Prof.dr.ir. A. van Timmeren,	Delft University of Technology, substitute member

This research was funded by Knowledge for Climatepag, which is thankfully acknowledged.

Acknowledgements

With great passion for sustainability and climate design and as follow-up on my MSc Thesis "Urban Heat", this PhD was a perfect match. I would like to express my gratitude to the TU Delft for the opportunity to devote my time on research and writing, and to augment my own and hopefully other people's understanding about climate adaptation in urban environments.

First of all I want to thank the people that guided me along this journey. Andy van den Dobbelen (promotor) for his confidence in me for being the right person on the job. For his coaching, active involvement with the content, cheerful remarks in texts and giving me the floor to present my research on many occasions. Machiel van Dorst (copromotor) for his support in the design process and broadening the research by posing questions from a different perspective. Truus Hordijk (daily supervisor) for her critic views, constructive questions, thorough reading and personal coaching.

I would like to acknowledge the committee members for reviewing this dissertation. Furthermore, I want to thank Florrie de Pater for organising the Knowledge for Climate events where I met many people from practice and fellow researchers. Peter Bosch and Vera Rovers for managing Climate Proof Cities events and the Spring course in Manchester that increased collaboration and created a bond between the researchers. Bert Blocken for his help with comprehending simulation programs. And Andreas Matzarakis for clarifying email correspondence about climate modeling and inspiring conversations during conferences and the Spring course.

I want to thank Jan Spaans from the Municipality of Amsterdam, Niels Al from the Municipality of The Hague and Jos Streng from the Municipality of Rotterdam for their guided tours, questions from a practical perspective and time to reflect on design proposals.

During this PhD a special link with the Wageningen University was founded. I want to thank Wiebke Klemm, Sanda Lenzholzer and Rudi van Etteger from Landscape Architecture for the opportunity to assist in the design atelier. From the Meteorology and Air quality department I want to thank Bert van Hove and Bert Heusinkveld for their time to explain climate processes and the opportunity to assist in traverse measurements by bike.

An important part of the design research was possible because students wanted to learn more about climate sensitive design. I want to thank you all for diving into the subject and your efforts in looking for a balance between microclimate solutions and other urban design challenges.

A special thanks goes out to Bertie Kaal for her support as a friend and fellow PhD and for the great assistance in writing papers in English and the translation of the summary of this dissertation.

Thanks go out to all my colleagues from the section Climate Design and the department of Architecture and the Built Environment for your input at PhD sessions and in personal conversations. To the ladies from the secretariat for always being there to help and making time for a chat. To Baldiri Salcedo Rahola, Wiebke Klemm and Patrick Schrijvers for our discussions on the content, sharing our PhD struggles and family events.

I would like to thank graphic designer Véro Crickx from Sirene Ontwerpers for her efforts to finalise this booklet in time.

I want to thank my mother, for she learned me to be curious, and for her assistance with field measurements and site visits. My father for his support, pride and always helping us out with chores on the house and land. My sister for assisting with lab measurements. My parents in law for their unlimited and dedicated support for actually everything that involves our family life.

My paranymphs, Fanina and Joost, thank you for supporting me at the defence ceremony. My dear friends, for sharing fun and relaxing moments and welcome distraction from the research. Pieter, for the many cheerful rides from Utrecht to The Hague. Qaliefke, for resetting my mind during our rides through the woods and over the mores.

Above all, I want to thank my husband Arjen. You always supported me and I admire your patience and positive attitude regarding this research. Especially in the last year you made it possible to spend time on writing. Parallel to this PhD journey we have gone through many changes; married, moved to our dream location, both started a new job and had two fantastic children. Very special thanks go out to my son Thijme and daughter Elize for bringing so much joy and love in my life.

Contents

Acknowledgements 7

Summary 17

Samenvatting 21

1 Introduction 25

1.1 Background and objectives 25

1.2 Research context 27

1.3 Terminology 28

1.4 Research questions 31

1.4.1 Main research question 31

1.4.2 Contextual research question 31

1.4.3 Sub research questions 32

1.5 Thesis outline 33

1.6 References 36

PART 1 Literature

2 Urban climate and climate change 39

2.1 Climate change predictions 40

2.1.1 Global climate change 40

2.1.2 Climate change predictions for The Netherlands 42

2.2 Thermal comfort 43

2.3 The urban heat island effect in the Netherlands 46

2.3.1 Measuring heat in Utrecht and Rotterdam 48

2.3.2 Mapping urban heat 51

2.4	Is urban heat stress a problem?	54
2.4.1	Heat stress	54
2.4.2	Air pollution	60
2.4.3	Energy consumption	61
2.4.4	Organic life	63
2.5	Conclusion	64
2.6	References	65
3	Inventory of climate adaptation measures	69
3.1	Vegetation	69
3.2	Water	81
3.3	Urban geometry	86
3.4	Material and colour	93
3.5	Conclusion	96
3.6	References	97
	Factsheets	103

PART 2 Simulations and Measurements

4	Urban measures for hot weather conditions in a temperate climate condition: a review study	107
4.1	Introduction	107
4.2	Methods	108
4.2.1	Comparable results	109
4.2.2	Variants description	110
4.2.3	Microclimate model ENVI-met	112
4.2.4	Simulation input	113

4.2.5	Simulation output	115
4.2.6	Justification of ENVI-met	117
4.3	Results and clarification	122
.....		
4.3.1	Set A: Pavement versus grass	124
4.3.2	Set B: Single building	125
4.3.3	Set C: Wind direction	127
4.3.4	Set D: Wind speed	129
4.3.5	Set E: Grid size	131
4.3.6	Set F: Area rotation	132
4.3.7	Set G: Two buildings	132
4.3.8	Set H: Two buildings with different heights	133
4.3.9	Set I: Different building form and climate variables	134
4.3.10	Set J: Trees	136
4.3.11	Set K: Different building form with trees	139
4.3.12	Set L: Hedges	140
4.3.13	Set M: Single building with different heights	142
4.4	Discussion and conclusion	144
.....		
4.5	References	147
.....		
5	Climate adaptation strategies: Achieving insight in microclimate effects of redevelopment options	149
.....		
5.1	Introduction	149
.....		
5.1.1	Climate adaptation for a redevelopment project	150
5.2	Methodology	152
.....		
5.2.1	Research method	152
5.2.2	Simulation methodology	153
5.2.3	Comparison of the measures on the human comfort indicator PET	153
5.3	Case-studies presentation	154
.....		
5.3.1	Simulation variants at urban block level	154
5.3.2	Simulation variants at neighbourhood level	156
5.4	Results and discussion	158
.....		
5.4.1	Comparison of the measures by temperature effect at urban-block level	159
5.4.2	Comparison of the measures by temperature effect at neighbourhood scale	167
5.4.3	Comparing measures based on thermal comfort	170
5.5	Conclusions	172
.....		
5.6	References	174
.....		
11	Contents	

6	Creating drafts in urban settings through coloured façades: Exploring a new climate adaptation measure based on thermal stratification	177
6.1	Introduction	177
6.2	Research Methodology	181
6.2.1	Air speed measurements on façade models	181
6.2.2	Air speed measurements on full scale façade	183
6.2.3	Surface temperature measurements	185
6.3	Results and Discussion	186
6.3.1	Influence of colour on air speed at façade models	186
6.3.2	Influence of colour on air speed at full scale façades	187
6.3.3	Influence of colour on the surface temperature	189
6.4	Additional Opportunities	191
6.5	Conclusions	194
6.6	Acknowledgements	195
6.7	References	195
6.8	Supplementary material	196
	Heat mitigation guidelines	197
PART 3	Research by Design	
7	Designing with microclimate: interviews with urban designers and planners	205
7.1	Introduction	205
7.1.1	Questionnaire results	207
7.2	Personal interviews	212
7.2.1	Discussion	213
7.3	Conclusion	214
7.4	Acknowledgements	215
7.5	References	215
12	Urban Climate Design	

8	Typological design solutions in the path to climate resilience supported by urban surface analysis	217
8.1	Microclimate categories based on common urban typologies	218
8.1.1	Case study selection and methodology	223
8.2	Low open urban block with moderate to much green	226
8.2.1	Couperusbuurt, Amsterdam	227
8.2.2	Jeruzalem, Amsterdam	228
8.3	Low closed urban block with moderate to much green	229
8.3.1	Tuindorp, Utrecht	230
8.3.2	Tuindorp Nieuwendam, Amsterdam	233
8.3.3	Tuindorp Oostzaan, Amsterdam	233
8.4	Low closed urban block with little green	234
8.4.1	Ondiep, Utrecht	235
8.4.2	Transvaal, The Hague	238
8.4.3	Rivierenwijk, Utrecht	241
8.5	Low closed urban block and strips with moderate green	245
8.5.1	Parkwijk, Leidsche Rijn, Utrecht	245
8.5.2	Singels, Ypenburg, The Hague	248
8.6	Low strips and open urban blocks with little to moderate green	249
8.6.1	Lunetten, Utrecht	250
8.6.2	Zevenkamp, Rotterdam	254
8.7	Middle-high closed urban block with little green	254
8.7.1	City centre Utrecht	255
8.7.2	Bergpolder-Zuid, Rotterdam	258
8.7.3	Zuidwal, The Hague	259
8.8	Middle-high/high open urban block with moderate to much green	261
8.8.1	Overvecht, Utrecht	262
8.8.2	Kanaleneiland, Utrecht	264
8.8.3	Schiebroek-Zuid, Rotterdam	266
8.9	High-rise with little green	268
8.9.1	Central station area, The Hague	269
8.9.2	Lijnbaan, Rotterdam	271

8.10	Conclusion	272
8.10.1	Summary of adaptation measures per microclimate category	273
8.11	References	277
9	Designing for the urban (micro) climate	279
9.1	Case study method to integrate adaptation	279
9.1.1	Case study method: maximisation	280
9.1.2	Approaching heat mitigation as a common sustainability issue	282
9.1.3	Political context: dedicated or mainstreaming adaptation approach	285
9.2	Couperusbuurt, Amsterdam	286
9.2.1	Neighbourhood analysis	286
9.2.2	Design integration	288
9.3	Zuidwal, The Hague	295
9.3.1	Neighbourhood analysis	295
9.3.2	Design integration	298
9.4	Bergpolder, Rotterdam	307
9.4.1	Neighbourhood analysis	308
9.4.2	Design integration	309
9.5	Design evaluation	319
9.6	Conclusion and discussion	324
9.7	Acknowledgments	325
9.8	References	326
10	Conclusions	329
10.1	Answers to the research questions	329
10.1.1	Answering the contextual research question 1	329
10.1.2	Answering the sub research question 2	330
10.1.3	Answering the sub research question 3	331
10.1.4	Answering the sub research question 4	333
10.1.5	Answering the sub research question 5	334

10.2	Discussion (limitations of the research)	335
10.3	Recommendations	338
10.3.1	Recommendations for future research	338
10.3.2	Recommendations for future planning and design	340
10.4	Final words	342
10.5	References	344

PART 4 Appendices

Appendix A	Sustainable Urban Water Management – A collection of studies about strategies and techniques	347
Appendix B	Factsheets	359
Appendix C	Simulation results	403
Appendix D	Questionnaire	407
Appendix E	Interview	409
Appendix F	Urban surface analysis	411
	Curriculum Vitae	419
	List of Publications	421

Summary

This thesis presents research into the possibilities for climate adaptation in Dutch urban areas. We want to know how cities can best prepare for extreme rainfall, droughts, and heat waves in future climates. These events are likely to become more frequent and more extreme. The focus is on heat resistance as this has been a neglected concept in Dutch urban planning.

The aim of this study is to extend our knowledge of the effects of climate-adaptation measures and to stimulate the implementation of such measures in the design of public space. Anticipating on the effects of climate change, the research was guided by the question: **Which urban design principles can be applied in specific Dutch neighbourhoods to respond to the effects of climate change, especially in terms of outdoor thermal comfort and water management?**

The three stages of the project are:

- 1 A literature review of existing knowledge on climate adaptation and knowledge gaps
- 2 Research into the specific field of urban climatology
- 3 Applied research on the broader field of urban planning

The urban climate and adaptation measures

In the evaluation of measures for climate robust urban areas it is important to gauge the extent of the effects of such measures. These effects are generally expressed in terms of air temperature. However, the comparison of results of measures from various studies is not a simple matter: there are significant differences in spatial, climatological and methodological variations adopted in these studies. Bringing results together from very specific studies may give an impression of the potential of certain measures. For example, most studies support the idea that greening has the highest effect on thermal comfort as it provides both shade and active cooling due to 'evapotranspiration'¹. Nevertheless, vegetation can also retain heat, as we can feel after sundown. Other measures that were investigated for their effects are water, urban morphology, materials and colour.

1 The sum of evaporation from the soil and transpiration of (the leaves of) plants.

Simulations and measurements

Contextual aspects and combinations of measures can seriously influence the effects of measures. To get a grip on such effects and their co-occurrence (interrelations), possible adaptations to an existing rural configuration were modelled and their effects on the microclimate were simulated using the numerical program ENVI-met. It is demonstrated that, for instance, trees combined with highly reflective façades do often not provide cooling, whereas trees combined with moderate façade colouring does.

To assess the effects of a single measure, independent of its context, single parameter simulations of thermal comfort (PET) were performed. This is the first time that such a comparative study was undertaken in The Netherlands. The complexity of the situations was increased gradually from an empty field with only pavement or only grass, to pavement with grass and a single building, moving up to a building with a few trees to many trees, multiple buildings and built forms.

During this study it became clear that airflow has a significant influence on the comfort temperature. However, cooling by means of creating drafts on a mesoscale is difficult to manage and control. The low wind speed, which is typical for Dutch heat waves, provides ventilation through thermal stratification. Airflow between warm and cool spaces only occurs with sufficient temperature differences and low wind speed. This principle was investigated on the side towards new measures because little is known about the effects of generating airflow as a result of façade colour. Measurements were performed first in a small-scale experiment in a controlled area and when results seemed promising this was extended to a full-scale situation on an average Summer's day.

Research design

In current practice, urban design pays little or no attention to the urban microclimate and urban-heat stress. Designers indicate that they have insufficient knowledge and evaluation instruments. The design study discussed in the third part of this thesis provides examples of climate adaptive applications and suggestions for design strategies.

Using urban typologies makes it possible to integrate the microclimate in the design without needing urban microclimate expertise. By analysing specific neighbourhood typologies applying a variety of microclimate indicators three simple distinctive parameters emerge:

- 1 balance between pavement and natural surfaces;
- 2 building height;
- 3 built form.

Design solutions were applied to reveal spatial implications for most of the neighbourhoods in the analysis and serve as examples and a source of inspiration. Promising and neighbourhood-specific measures were selected per neighbourhood type to support the design process.

To demonstrate how microclimates can be managed with design choices, a design case was developed in more detail for three cities. Prioritizing measures at the design stage depends on many external and intrinsic factors. The three designs in this thesis follow the same path: analysis > maximisation > optimisation > integration. When maximization focuses on thermal comfort only design measures concerning this aspect are applied. Prioritization can be applied in a three-step strategy of: warming prevention, passive cooling and active cooling. The design process is an iterative process in which promising combinations may be found in the optimization and this may require additional analysis.

This thesis hopes to build bridges between knowledge and science and the practice of the design of public space. That goal is approached with a product that unfolds from the three parts of the study:

- 1 Factsheets to simply check and evaluate mechanisms and affordances of measures;
- 2 Guidelines for the further development of knowledge of and design with urban microclimates;
- 3 A categorized set of measures to be able to select the right measure for the right neighbourhood typology.

The study is part of a consortium of complementary research projects and stakeholders with the aim to generate knowledge through research as input for councils and other stakeholders. In addition, three participating municipal councils have gained further insight into cases that were proposed by them.

Samenvatting

Dit proefschrift presenteert onderzoek naar mogelijkheden voor klimaatadaptatie in Nederlandse steden. Om steden te kunnen voorbereiden op het toekomstig klimaat willen we weten hoe steden leefbaar blijven bij extreme neerslag, droogte en hittegolven. Deze events zullen vaker voorkomen en extremer zijn. Omdat hittebestendigheid een nog relatief nieuw begrip is in de Nederlandse planning en stedenbouw, ligt hier de focus op in dit proefschrift.

Doelstelling van dit proefschrift is het vergroten van kennis over effecten van adaptatiemaatregelen en het bevorderen van de toepassing van deze maatregelen in het ontwerp van de openbare ruimte. De volgende onderzoeksvraag stuurde het onderzoek: **Welke ontwerp principes kunnen worden toegepast in specifiek Nederlandse wijken om te anticiperen op de effecten van klimaatverandering, met name op het gebied van stedelijk microklimaat en het watersysteem?**

Het onderzoek bevat drie delen met ieder een verschillende aanpak:

- 1 Een literatuurstudie ter identificatie van bestaande kennis over stedelijke klimaatadaptatie en kennishiaten;
- 2 Onderzoek binnen het specialistische vakgebied stedelijke microklimatologie;
- 3 Toegepast onderzoek binnen het brede vakgebied van de stedenbouw.

Het stedelijk klimaat en adaptatiemaatregelen

In de afweging van maatregelen voor het klimaatbestendig inrichten van stedelijk gebied is het van belang te weten hoe groot het effect is dat bereikt wordt. De effecten van maatregelen worden in de regel uitgedrukt in luchttemperatuur. Echter, een vergelijking van effecten gemeten of berekend in verschillende studies is niet zonder meer mogelijk door de grote verschillen die ontstaan door ruimtelijke, klimatologische en methodologische variaties tussen de studies. Er zijn vele specifieke studies die samen een idee geven over de potentie van een maatregel. Zo blijkt vergroening volgens de meeste studies het grootste effect op het thermisch comfort te sorteren omdat het naast schaduw ook actief koelt door evapotranspiratie². Echter, vegetatie kan ook warmte vasthouden bijvoorbeeld na zonsondergang. De andere maatregelen waarvan het effect is bestudeerd zijn water, stedelijke morfologie, materialisatie en kleurgebruik.

2 De som van de evaporatie (verdamping) uit de bodem en de transpiratie (verdamping via de bladeren) van planten.

Simulaties en metingen

Effecten van maatregelen kunnen sterk beïnvloed worden door contextuele aspecten en door combinaties van maatregelen. Om inzicht te krijgen in deze effecten en samenhang (interrelaties) zijn mogelijke aanpassingen van een bestaande stedelijke configuratie gemodelleerd en de effecten op het microklimaat gesimuleerd met het numerieke programma ENVI-met. Zo blijken bijvoorbeeld bomen in de buurt van sterk reflecterende gevels vaak geen verkoeling op te leveren, terwijl dat bij een gemiddelde gevelkleur wel het geval is.

Om het effect van een enkele maatregel te kunnen geven zonder contextafhankelijkheden zijn simulaties gedaan waarin slechts een enkele parameter wordt aangepast. Een dergelijke vergelijkende studie was nog niet eerder gedaan voor de comfort temperatuur PET en de Nederlandse situatie. Van een leeg veld met alleen verharding of alleen gras wordt de complexiteit geleidelijk opgevoerd naar gras met verharding, een enkel gebouw, een gebouw met een paar bomen, met een heleboel bomen tot aan meerdere gebouwen en gebouwwormen.

Gedurende het onderzoek werd duidelijk dat luchtstroming een grote invloed heeft op de comforttemperatuur. Echter, verkoeling door middel van luchtaanvoer op basis van mesoschaal is moeilijk te sturen en te beheersen. De lage windsnelheden die kenmerkend zijn voor hittegolven in Nederland geeft de mogelijkheid te ventileren op basis van thermische stratificatie. Tussen koele en warme plekken ontstaat luchtstroming die alleen op gang komt bij voldoende temperatuurverschil en een lage windsnelheid. Dit principe is onderzocht in een uitstapje naar een nieuwe maatregel omdat hier nog weinig over bekend is. Namelijk het genereren van luchtstroom op basis van de kleur van een gevel. Hiervoor zijn metingen uitgevoerd. Eerst op kleine schaal in een beschermde ruimte, na positieve uitkomsten is dit later herhaald op ware schaal tijdens een gemiddelde zomerdag.

Ontwerpend onderzoek

In de huidige praktijk wordt bij het ontwerp van de openbare ruimte weinig of geen aandacht aan het stedelijk microklimaat en hittestress besteed. Ontwerpers geven aan dat ze onvoldoende kennis en evaluatie middelen hebben om dit wel te kunnen. Het ontwerpend onderzoek in het derde deel van dit proefschrift geeft voorbeelden van de toepassing van klimaatadaptatie, en ondersteunende ontwerpmethodes.

Ontwerpen aan de hand van stedelijke typologieën maakt het mogelijk het microklimaat mee te nemen in het ontwerp zonder expert te zijn op het gebied van het stedelijk microklimaat. Door specifieke wijktypologieën te analyseren op basis van verschillende microklimaatindicatoren blijken er drie eenvoudige parameters onderscheidend:

- 1 verhouding tussen verharding en natuurlijk oppervlak;
- 2 gebouwhoogte;
- 3 vorm van het bouwblok.

Voor de meeste wijken uit de analyse zijn ontwerp oplossingen toegepast die de ruimtelijke implicatie weergeven en als inspiratie en voorbeeld dienen. Per wijktypologie zijn hieruit kansrijke en wijk-specifieke maatregelen geselecteerd om te ondersteunen in het ontwerpproces.

Om te tonen hoe het microklimaat kan worden beïnvloed door ontwerpbeslissingen is er voor drie steden een ontwerp casus verder uitgewerkt. Het prioriteren van maatregelen in een ontwerp proces is afhankelijk van vele externe en intrinsieke factoren. De drie ontwerpen in deze thesis volgen een methode met de volgende stappen: analyse > maximalisatie > optimalisatie > integratie. Wanneer de maximalisatie stap is gericht op thermisch comfort dan worden in deze stap op enkel dit thema ontwerp oplossingen aangewend. Vervolgens is er prioritering aan te brengen door middel van de driestappenstrategie: opwarming voorkomen, passief koelen en actief koelen. Het ontwerpproces is een iteratief proces waarin kansrijke combinaties kunnen worden gevonden in de optimalisatie en integratie stap.

Een belangrijke doelstelling van dit proefschrift is een brug te slaan tussen kennis en wetenschap, en de praktijk van het inrichten en vormgeven van de openbare ruimte. Aan deze doelstelling wordt invulling gegeven met een product vanuit de drie delen in dit onderzoek:

- 1 factsheets om eenvoudig de werking, kansen en kanttekeningen bij een maatregel te kunnen opzoeken;
- 2 richtlijnen ter verdieping van de kennis van ontwerpen met het stedelijk microklimaat;
- 3 een set aan maatregelen om de juiste maatregel voor de juiste wijktypologie te kunnen kiezen.

Dit onderzoek is onderdeel van een consortium met complementaire onderzoeksprojecten en stakeholders. Het genereren van kennis door onderzoek is input voor gemeenten en andere belanghebbenden. Drie deelnemende gemeenten hebben bovendien extra inzicht in een door hun aangedragen casus.

1 Introduction

§ 1.1 Background and objectives

In the future, global climate change will influence climate conditions in The Netherlands. Predictions by the IPCC and the KNMI forecast more extremes in temperature and rainfall or draught (IPCC, 2007, Klein Tank & Lenderink, 2009, IPCC, 2014). Climate variations resulting in changes in temperature and rainfall particularly have a large impact on human comfort and health, especially in cities. The extent of temperature differences varies in time and place as a result of meteorological, locational and urban characteristics. Especially heat accumulation in cities, the so-called Urban Heat Island (UHI) effect, will increase due to climate change, but also due to continuing expansion and densification developments in cities (Watkins et al., 2007).

Already in 1963 Olgyay (1963) considered the outdoor climate essential in urban and architectural design and developed a method to quickly get an insight in the thermal comfort situation of a location. Due to a lack of knowledge of microclimatic processes, this field is extensively studied by Tim Oke and others since 1973 (Oke, 1973, Nakamura & Oke, 1988, Oke, 1988, Bohnenstengel et al., 2004, Ali-Toudert & Mayer, 2006).

The microclimate, health and safety in cities is at risk. Partly because of the expected climate effects but also to inappropriate urban design and impact-aggravating human activities. As a result, design decisions may create undesirable effects to the urban microclimate (Evans & Schiller, 1996). With the urban microclimate we mean the outdoor climate condition within street profiles that is adjacent to the smaller scale of the indoor climate of buildings and the larger scale of the city climate. Changes in physical aspects of a neighbourhood, such as a change in the colour of pavement from light to dark, can aggravate the up heating of the urban microclimate. With the choice for a different colour or material temperature increase can be avoided.

The first objective of this research is to study the effectiveness of climate adaptation measures for Dutch cities. Numerous adaptation measures can be applied for the control of heat, air quality and precipitation, some of which can be promoted and implemented as generic solutions for the neighbourhood and city, for example 'adding green' (Oke, 1988, Katzschner, 2010, Givoni, 1998). Warmer countries have a tradition

in designing the urban microclimate, but The Netherlands does not. Information about climate adaptation possibilities is diffuse and the impact for Dutch neighbourhoods is still unclear (Mees & Driessen, 2011). It is unclear how specific adaptation measures influence each other. And: Is the effect of 20 trees on a square equal to 20 times the effect of one single tree?

The question following from the problems stated above is how climate adaptation measures relate to a specific urban context and how to apply them. There is a large variation of urban typologies in The Netherlands, and design measures have a different impact per urban typology. For example, the local climate within a dense inner city area cannot be regulated with an extensive green and water system, while such a system could work very well for a spacious neighbourhood from the sixties. A difficulty in the application of climate adaptation measures are the costs and benefits; the ones that can or should finance the measures do not have a direct benefit. Therefore, adaptation measures should not stand by themselves, but combine more urban functions that do create a benefit for the financing party. This could be as simple as a grass field that both cools the neighbourhood and adds a sports facility by placing two goals for a soccer game.

The second objective of this research is to develop design guidelines to apply climate adaptation measures in specific neighbourhood typologies in the Netherlands. The research brings together two aspects that normally are treated separately: climate adaptation and urban design. Usually first the desired urban design is made with housing, mobility, social interaction, leisure, retail and energy aspects, after which the question rises how to make it climate robust. The combination of all these aspects should, in fact, always go hand in hand because all require space.

Within the framework of this research a new domain is approached: techniques from climate installation and architecture of buildings are translated to the domain of the outdoor built environment, such as the use of sunscreens, air conditioning and climate zoning. An adaptation measure that seems promising in the control of the urban microclimate is tested in an experimental way to see if it works on a small scale. This adaptation measure consists of air flow that is generated by differences in the colour of a façade.

§ 1.2 Research context

This research project *Urban climate design* is part of the Dutch national programme Climate Proof Cities (CPC) by *Kennis voor Klimaat*. The full name of this programme is: *Climate change adaptation in the urban environment: an integrated and multi-scale approach*. The CPC project consists of five work packages, of which project number 3.6 is represented in this thesis, *Urban climate design engineering*. This thesis concerns a 4-year PhD research project at the Delft University of Technology, faculty of Architecture, Department of Architectural Engineering + Technology, Section of Climate Design, Chair of Climate Design & Sustainability. Collaboration within the CPC program was especially sought within work package 3 and with projects 1.3 and 2.4 as schematically presented in Figure 1.1.

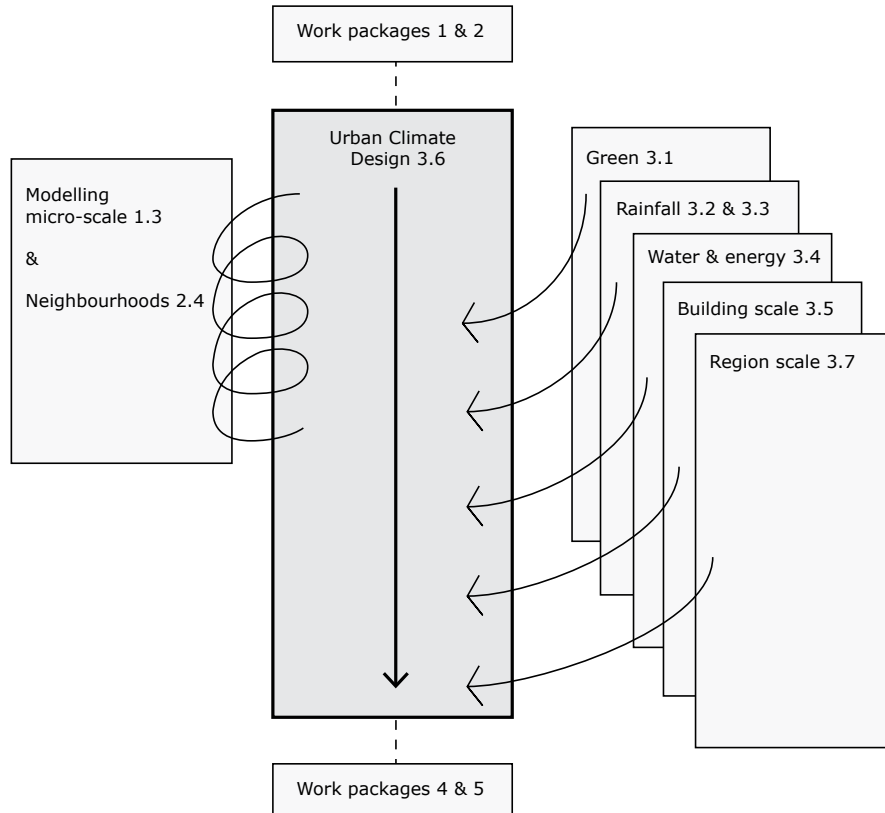

FIGURE 1.1 Collaboration of Project "Urban climate design" with other work packages and projects within the Climate Proof Cities programme.

§ 1.3 Terminology

Adaptation

Adaptation strategies focus on secondary climate effects in order to avoid tertiary effects. For example: the increase of heavy rainfall (primary effect) can lead to a surplus of water in lower areas (secondary effect), which in turn leads to flooded roads (tertiary effect). Yet not all primary climate effects can be translated in secondary effects on specific locations because the KNMI cannot provide enough temperature data from rural areas and it is not yet possible to project the effects of heat on city scale in the Netherlands (Groot et al., 2009), pag 12). Research is ongoing about these local climate effects in the urban environment.

Climate Robustness

A climate robust city is the design of urban space on which climate change has a minimal impact (Ven et al., 2009). Climate robustness is the degree in which the area is non-vulnerable in relation to a tertiary climate effect. This is explained by Groot et al. (2009) as: an increase in extreme rainfall events (primary effect) leads to an excess of water in lower areas (secondary effect), which can lead to water nuisance in urban areas (tertiary effect).

Vulnerability

As Rutger de Graaf (2009) states in his dissertation (Graaf, 2009):

“Vulnerability is often defined as the sensitivity of a system to exposure to shocks, stresses and disturbances, or the degree to which a system is susceptible to adverse effects (White, 1974; IPCC, 2001; Turner et al., 2003; Leurs, 2005), or the degree to which a system or unit is likely to experience harm from perturbations or stress (Schiller et al., 2001).”

And four ways to indicate vulnerability: “Threshold capacity is the ability of a society to build up a threshold against variation in the environment in order to prevent damage. Coping capacity is the capacity to reduce damage in case of a disturbance that exceeds the damage threshold. The third component, recovery capacity refers to the capacity to recover to the same or an equivalent state as before the disaster. Finally, adaptive capacity is the capacity of a society to anticipate on uncertain future developments. This includes catastrophic, not frequently occurring disturbances like extreme floods and severe droughts.”

The focus of this thesis is on both threshold capacity and adaptive capacity: heat waves occurring in the current climate conditions and the longer, more often and more extreme heat waves in predicted climate conditions.

Heat stress

Heat stress occurs when a body is not capable to regulate the body temperature due to high ambient temperatures or radiation loads. Heat stress can manifest in several medical conditions such as heat rash, heat cramps, heat exhaustion and heat stroke (Howe & Boden, 2007).

Impact levels

Climate change has an impact on many different levels. Climate adaptation measures should improve, alongside heat and water robustness; human health, energy consumption and ecological, economic and cultural aspects:

- Human health: Heat stress, thermal comfort (psychological benefits) – the heat wave in the summer of 2003 caused 1400-2200 extra deaths (Garssen et al., 2005) and the heat wave in 2006 was rated as the world's fourth worst natural disaster in terms of actual deaths (EM-DAT);
- Energy consumption: The world's focus for energy is on reducing Green House Gas emissions (Kyoto and Copenhagen), important are also the depletion of resources and land use related to energy;
- Ecology: "Environment is the set of conditions for life" (Jong et al., 2007), p 621), ecological development is therefore an investment in the environment instead of a cost aspect as is usual reasoned;
- Cultural: The influence of social behaviour on the effects of heat and other climate conditions;
- Economic: damage to buildings, infrastructure, crops and ecosystems because of climate change.

Urban scale levels

The urban microclimate is determined by two scale levels: the Urban Boundary Layer (UBL) and the Urban Canopy Layer (UCL) as illustrated in Figure 1.2 (Oke, 1982, Oke, 1987). The local climate in the UCL can vary significantly within a few meters. Within close distance from buildings and objects like trees most variation occurs.

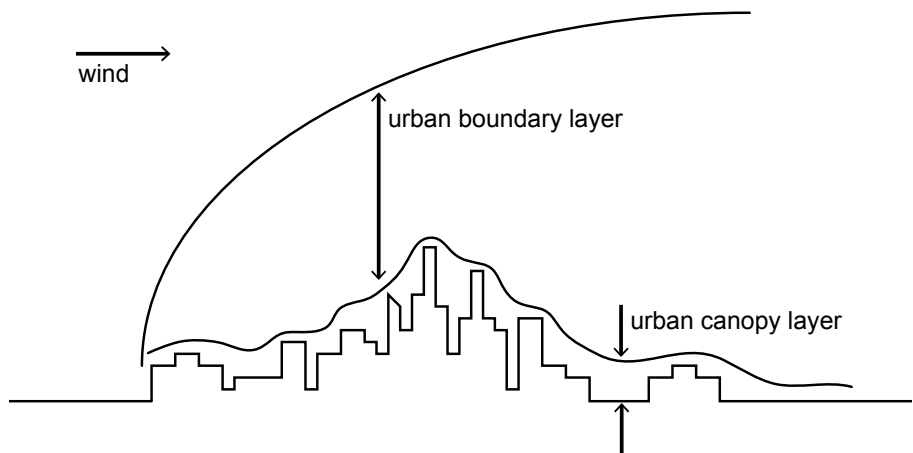

FIGURE 1.2 The Urban Boundary Layer (UBL) and the Urban Canopy Layer (UCL) based on (Oke, 1987).

The UBL above the buildings is a rather homogeneous layer that interacts with the cities surroundings and the urban characteristics of the city itself. Influencing the UCL on local level can have implications for the UBL as a whole. In this respect changes in one neighbourhood affect also adjacent neighbourhoods and other parts of the city. The UCL, on its turn, interacts with the UBL and indoor climates. The urban climate studied in this dissertation therefore relates to a range of scale levels: from the building scale up to the sub-regional scale as indicated in Table 1.1.

ELEMENT	NOMINAL RADIUS (M)
Building part	1
Building segment	3
Building	10
Building complex	30
Ensemble	100
Neighbourhood	300
Area/Village	1000
District/Town	3000
Sub-regional	10000
Regional	30000
Sub-national	100000
National	300000

TABLE 1.1 Levels of scale according to De Jong and Rosemann (2002) in 'Naming components and concepts' by de Jong & Voordt (2002).

§ 1.4 Research questions

§ 1.4.1 Main research question

To address the objective of this research the main research question is the following:

Which urban design principles can be applied in specific Dutch neighbourhoods to respond to the effects of climate change, especially in terms of outdoor thermal comfort and water management?

The main research question is answered through a contextual question and four sub questions presented in the following sections.

§ 1.4.2 Contextual research question

Q1. Impact of climate change on the urban environment (Chapter 2)

What is the impact of climate change on the urban environment in the Netherlands?

- What is the expected impact of the occurrence of climate change in The Netherlands?
- What is the effect of high(er) temperatures on the microclimate in Dutch cities?
- How do people perceive the city's microclimate, especially heat?
- How can the urban heat island (UHI) effect in Dutch cities be quantified and predicted?
- What are the effects of high(er) temperatures on health, energy and economical aspects?

§ 1.4.3 Sub research questions

Q2. Climate Adaptation Measures (Chapter 3)

Which urban design measures can contribute to thermal comfort and/or utilise climate adaptation, especially in terms of precipitation, air quality and energy?

- What are the effects on air temperature and human comfort according to literature?
- Which urban design measures can contribute to the utilisation of climate change, for instance for the energy and water system?

Q3. Effects on thermal comfort (Chapter 4, 5 and 6)

What is the indication of general and/or location specific effects of heat mitigation measures on thermal comfort in The Netherlands?

- What are the effects on air temperature and human comfort for the temperate climate condition of the Netherlands?
- Is there a difference in effect in relation to scale (urban block, neighbourhood, city)?
- How can ventilation be utilized in hot weather situations without deterioration of the wind conditions in winter?

Background question:

- What are design guidelines that evolve from the studies within research part II that can assist urban designers and planners in the design process?

Q4. Climate adaptation in Dutch Neighbourhood Typologies (Chapter 7 and 9)

Introduction question:

- What is the role of the urban microclimate in the design process according to urban designers and planners?

How to integrate microclimate in a design or planning process?

- How can climate adaptation measures be applied in an integrated design assignment, combining various heat mitigation measures, linking water adaptation measures and creating additional value in relation with energy, health, ecological, social and economic issues?

Q5. Integration of Adaptation Measures (Chapter 8)

How can neighbourhoods become climate robust considering the morphology of Dutch neighbourhood typologies?

Background question:

- What is an appropriate classification of neighbourhoods in relation to urban heat mitigation?

§ 1.5 Thesis outline

The outline of this thesis and the relation between thesis chapters and research questions is presented in Figure 1.3.

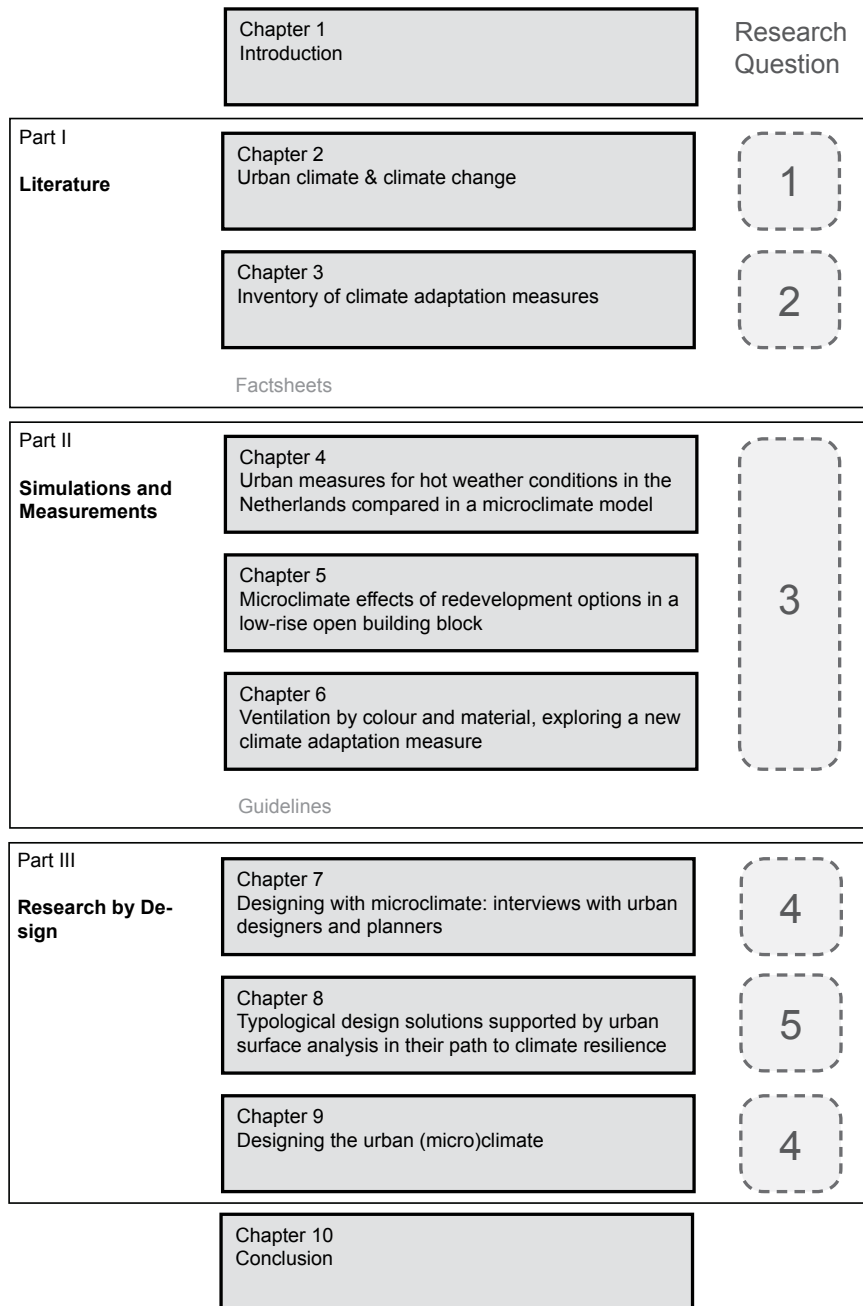

FIGURE 1.3 Research outline

Part I: climate change and adaptation measures

This thesis starts with a description of the impact of climate change on the urban microclimate in the Netherlands in chapter 2. It describes climate change predictions, recent field studies on the UHI effect in several Dutch cities, new insights into the influence of increasing temperatures on human comfort and a discussion about the role of climate change and the urban microclimate in the field of urban design. Available climate adaptation measures that influence the urban microclimate are described in chapter 3. The chapter gives an overview of the state of the art from literature about climate adaptation measures and their effects and recent results from the CPC research program as far it has been published.

Part II: effects of climate adaptation measures

The second part of this thesis studies the effect of climate adaptation measures for the temperate climate conditions in The Netherlands. To test the range of temperature variation that can be achieved numerical simulations are performed. First, a parametric study without a specific context is presented in chapter 4. This enables a comparison between measures. Second, since effects of measures on thermal comfort are very context depended and have a high spatial variability, several climate adaptation measures are simulated within a specific neighbourhood in chapter 5. Finally, chapter 6 describes an experimental test on the generation of air flow by colour.

Part III: urban climate design

In the third part of this research qualitative research methods are applied. First the role of the microclimate in the design process of urban planners and designers is inventoried through a questionnaire in chapter 7. The following two chapters apply research by design methods. These can be classified through the scheme made by de Jong & Voordt (2002) in which the large complexity that characterizes urban designs is structured in a design process. Chapter 8 presents seven most common neighbourhood typologies. For each typology case studies show which adaptation measures are most appropriate. In chapter 9 heat mitigation measures are combined with climate adaptation measures and with other urban functions in three integration designs. The design approach and illustrated examples presented in chapters 8 and 9 can be used by designers and policy makers in the process of the (re)development of Dutch urban areas.

§ 1.6 References

- Ali-Toudert, F. and Mayer, H. (2006), "Numerical study on the effects of aspect ratio and orientation of an urban street canyon on outdoor thermal comfort in hot and dry climate". *Building and Environment*, Vol. 41, No. 2, pp. 94-108.
- Bohnenstengel, S., Schlunzen, K.H. and Grawe, D. (2004), "Influence of thermal effects on street canyon circulations". *Meteorologische Zeitschrift*, Vol. 13, No. 5, pp. 381-386.
- EM-DAT "2006 disasters in numbers", International Disaster Database.
- Evans, J.M. and Schiller, S.D. (1996), "Application of microclimate studies in town planning: a new capital city, an existing urban district and urban river front development". *Atmospheric Environment*, Vol. 30, No. 3, pp. 361-364.
- Garssen, J., Harmsen, C. and De Beer, J. (2005), "The effect of the summer 2003 heat wave on mortality in the Netherlands". *Euro Surveill*, Vol. 10, No. 7, pp. 165-8.
- Givoni, B. (1998), *Climate considerations in building and urban design*, Wiley.
- Graaf, R.E. d. (2009), *Innovations in urban water management to reduce the vulnerability of cities, Feasibility, case studies and governance*.
- Groot, M., Stuyt, L. and Schuiling, R. (2009), "Klimaateffectatlas 1.0, Klimaatscan Structuurvisie", IpO, Alterra, DHV, KNMI.
- Howe, A.S. and Boden, B.P. (2007), "Heat-related illness in athletes". *The American journal of sports medicine*, Vol. 35, No. 8, pp. 1384-1395.
- IPCC (2007), "An Assessment of the Intergovernmental Panel on Climate Change, Summary for Policymakers".
- IPCC (2014), "Climate Change 2014: Synthesis Report. Contribution of Working Groups I, II and III to the Fifth Assessment Report of the Intergovernmental Panel on Climate Change", Geneva, Switzerland.
- Jong, T.M., Akker, C.v.d., Bruin, D.d., Moens, M.J., Steenbergen, C.M. and Toorn, M.W.M.v.d. (2007), *Sun wind water earth life living; legends for design*, Publicatiebureau Bouwkunde, Delft.
- Jong, T.M. d. and Voordt, D. v.d. (2002), *Ways to study and research: urban, architectural and technical design*, DUP Science, Delft.
- Katzschner, L. (2010), "Outdoor Thermal Comfort under Consideration of Global Climate Change and Urban Development Strategies". *Adapting to Change: New Thinking on Comfort, Windsor, UK, 9-11 April 2010 2010*, Network for comfort and energy use in buildings, London, pp.
- Klein Tank, A.M.G. and Lenderink, G. (2009), "Klimaatverandering in Nederland; Aanvullingen op de KNMI'06 scenario's", KNMI, De Bilt.
- Mees, H.L.P. and Driessen, P.P.J. (2011), "Adaptation to climate change in urban areas: Climate-greening London, Rotterdam, and Toronto". *Climate law*, Vol. 2, No. 2, pp. 251-280.
- Nakamura, Y. and Oke, T.R. (1988), "Wind, temperature and stability conditions in an east-west oriented urban canyon". *Atmospheric Environment*, Vol. 22, No. 12, pp. 2691-2700.
- Oke, T.R. (1973), "City size and the urban heat island". *Atmospheric Environment (1967)*, Vol. 7, No. 8, pp. 769-779.
- Oke, T.R. (1982), "The energetic basis of the urban heat island". *Quarterly Journal of the Royal Meteorological Society*, Vol. 108, No. 455, pp. 1-24.
- Oke, T.R. (1987), *Boundary Layer Climates*, Routledge, New York.
- Oke, T.R. (1988), "Street design and urban canopy layer climate". *Energy and Buildings*, Vol. 11, No. 1-3, pp. 103-113.
- Olgay, V. (1963), *Design with climate. Bioclimatic approach to architectural regionalism*, Princeton University Press, Princeton, New Jersey.
- Ven, F. v.d., Luyendijk, E. and Gunst, M. d. (2009), *Waterrobuust bouwen*, Beter Bouw- en Woonrijp Maken/SBR, Rotterdam.
- Watkins, R., Palmer, J. and Kolokotroni, M. (2007), "Increased temperature and intensification of the urban heat island: implications for human comfort and urban design". *Built Environment*, Vol. 33, No. 1, pp. 85-96.

PART I Literature

	Chapter 1 Introduction	Research Question
Part I Literature	Chapter 2 Urban climate & climate change	1
	Chapter 3 Inventory of climate adaptation measures	2
	Factsheets	
Part II Simulations and Measurements	Chapter 4 Urban measures for hot weather conditions in the Netherlands compared in a microclimate model	3
	Chapter 5 Microclimate effects of redevelopment options in a low-rise open building block	
	Chapter 6 Ventilation by colour and material, exploring a new climate adaptation measure	
	Guidelines	
Part III Research by De- sign	Chapter 7 Designing with microclimate: interviews with urban designers and planners	4
	Chapter 8 Typological design solutions supported by urban surface analysis in their path to climate resilience	5
	Chapter 9 Designing the urban (micro)climate	4
	Chapter 10 Conclusion	

2 Urban climate and climate change³

The industrial revolution brought us wealth and growth. The higher standard of life is now concerned as 'basic' in the western world and gradually increased the society's dependency on highly exergetic energy resources. The combustion of these energy resources results in exhaust of fumes containing dangerous pathogens such as carbon monoxide, sulphur dioxide, nitrogen dioxide, benzene and formaldehyde (Perry, 2015). The effect on people's health and the depletion of fossil fuels resulted in innovations to increase the efficiency of combustion and reduce harmful fumes.

Today's concern is especially focussed on the exhaust of particulate matter and the emission of CO₂. The awareness on mitigation, preventing CO₂ emissions in the atmosphere, started with the report of the World Commission on Environment and Development, which introduced the definition of sustainable development: "A development that meets the needs and aspirations of the present generation without compromising the ability of future generations to meet their needs" (Brundtland, 1987). The emission of CO₂ influences the global climate, so much is clear by now: consensus about the relationship between CO₂ emissions and global warming is very strong (IPCC, 2014b). Emissions from the past century are expected to already have an irreversible global warming effect that will especially affect the generation of our children and grandchildren. Effects often manifest on another location in the world than the places where most of the CO₂ is emitted. Moreover, places that contribute less to high CO₂ levels often have less means to protect themselves against climate hazards. Therefore, Machiel van Dorst added the importance of place to the Brundtland definition of sustainable development: "A development that meets the needs of here and now without compromising the ability of others to meet their own needs there and then" (Dorst, 2010).

This chapter outlines the context of this research and answers the following research question:

What is the impact of climate change on the urban environment in the Netherlands?

Sub-questions are:

- What is the expected impact of the occurrence of climate change in The Netherlands?
- How do people perceive the city's microclimate, especially heat?
- What is the effect of high(er) temperatures on the microclimate in Dutch cities?
- What are the effects of high(er) temperatures on health, energy and economical aspects?

3

Several passages in this chapter are originally published in Kleerekoper, L. (2009), Urban Heat. Design principles for Urban Heat Management in the Netherlands, TU Delft.

§ 2.1 Climate change predictions

§ 2.1.1 Global climate change

The rising levels of CO₂ in the atmosphere, which are predominantly caused by the combustion of fossil fuels, reinforce the naturally occurring greenhouse effect. This causes the earth's atmosphere to warm up. This is called global warming. The temperature rises more rapidly than ever before. This causes the ice on the planet to melt and leads to sea level rise, changes in wind patterns, changes in the ocean conveyor belt, etc. A record minimum of ice extent was measured in 2007, with little recovery in the years thereafter (Perovich, 2011). Some climate effects follow a linear course, but others can suddenly stop or invert. For instance, the ocean conveyor belt is based on a natural pump system called the *thermohaline circulation* that is generated by fronts of warm (thermos) and salt (haline) water, of which the latter sinks due to a higher density when cooled due to a front of fresh (less salty) water (Moinbiot, 2007). These changes influence ecosystems and affect the lives of flora and fauna and more than 40% of the human population (Dow & Downing, 2006).

The current climate models predict a global temperature rise of 1.5 to >2°C in 2100 (IPCC, 2014a). Although these models do not include scenarios with mitigation strategies which might diminish the global temperature rise, it is not likely that mitigation strategies will be able to prevent an increase of 2°C globally. This implies that we will have to adapt to climate effects caused by a global warming of at least 2°C. However, it is more likely the temperature level will not stay below 3, or even 4°C. According to the same Fifth Assessment Report by the IPCC "It is very likely that heat waves will occur with a higher frequency and longer duration. Occasional cold winter extremes will continue to occur" (IPCC, 2014a) page 10.

Destruction of water cycles

The global climate change affects regional and local climates such as urban climates. The other way around, a city can also (locally) influence its regional climate. As Kravčik et al. (2007) describe, the UHI effect causes a decrease in precipitation in the periphery of the city because it destroys the system of small water cycles. A small water cycle is the water circulation in which water from land evaporates and precipitates on the same area, see Figure 2.1 for a schematic representation. Such small water cycles occur over land, fresh water bodies, seas and oceans.

Urban environments interrupt small water cycles, resulting in rising radiant flows that push clouds to a cooler environment, leaving the periphery with less rainfall, see Figure 2.2. The rising warm air reinforces rainfall beyond the periphery. This effect is visible for the larger cities in The Netherlands (Rotterdam, Amsterdam and Utrecht) where the prevailing leeward side (North-East) receives more precipitation than the windward side (South-West) (KNMI, 2009). The warmer and dry soil of urbanised areas also accelerates the water run-off, which indirectly causes a higher sea level. Also water resource issues and the global water cycle are influenced by land use change (Harding & Blyth, 2011).

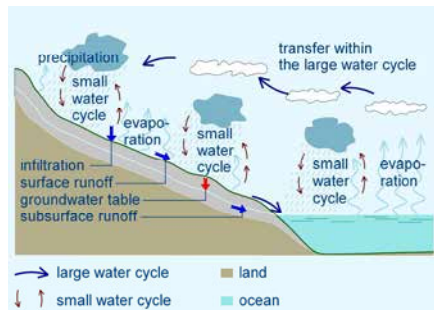

FIGURE 2.1 The large and small water cycles on land (Kravčík et al., 2007).

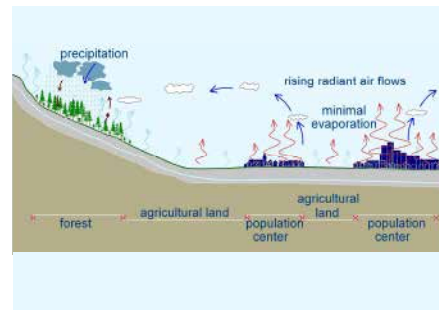

FIGURE 2.2 The impact urban areas can have on the destruction of small water cycles (Kravčík et al., 2007)

Urbanized areas do not have a direct impact on global warming due to anthropogenic heat fluxes, because they cover less than 1% of the Earth's surface and the energy released in cities is much less significant than the energy received by earth from the sun, according to Alcoforado & Andrade (2008). However, they write that most authors agree that warming of the urban atmospheres does have a slight contribution to the computation of global warming. And indirectly, cities contribute to global warming because they are a very important source of greenhouse gases. Furthermore, although its influence on global climate change may be limited, the anthropogenic heat fluxes can have a significant local impact on the urban climate.

Additional insights in the course of this research

After the first inventory of climate change predictions at the start of this research predictions and insights have evolved. Have the former predictions been adjusted and in which direction?

A study by Barriopedro et al. (2011) predicts an increase of the probability of the occurrence of 'mega-heatwaves' over highly populated areas of western Europe with a factor five to ten within the coming four decades. And other projections suggest a northward extend of heatwaves in Europe and an overall increase in extreme heat stress by the end of the 21st century: up to 30 days in duration and 7°C in amplitude

(Amengual et al., 2014). Within the same time span large changes in hourly precipitation extremes are projected: an increase of the areal average of 60 to 80% for western Europe (Lenderink et al., 2011b) and a 50% increase of the intensity of hourly precipitation extremes for The Netherlands (Lenderink et al., 2011a).

From the findings above we can conclude that the earlier climate change predictions have been endorsed by more recent studies. With greater confidence we can state that the global warming trend will lead to increasing 'heat stress' in Europe.

§ 2.1.2 Climate change predictions for The Netherlands

Global climate change and the impact on local areas vary a lot. For the Netherlands global warming does not just entail a milder climate, but also a higher frequency of weather extremes, including heat waves. The expectations are an increase in number of warm days (25°C or more) and tropical nights (20°C or more), longer warm periods (heat waves), more and longer dry periods, heavier rainfall and a chance of an increase in precipitation (Ligtvoet et al., 2015). Cities, as a result, will have to deal with heat stress and water abundance more frequently.

With respect to 1981-2010 the average temperature in the Netherlands will increase by 1.0 to 2.3°C by 2050 and by up to 3.5°C by 2085 (Ligtvoet et al., 2015). KNMI, the royal Dutch meteorological institute does not predict a future climate but gives four probable scenarios as shown in Figure 2.3.

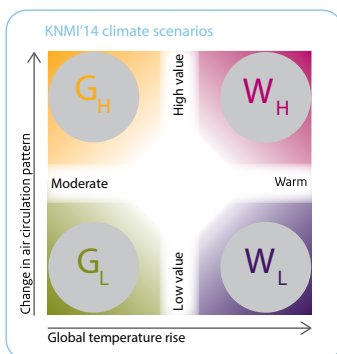

G_L-moderate: 1°C temperature increase in 2050 and 1.5°C in 2085, low influence of changes in airflow patterns West Europe;

G_H-moderate: 1°C temperature increase in 2050 and 1.5°C in 2085, softer and wetter winters caused by more winds from the west, warmer and dryer summers caused by more winds from the east;

W_L-warm: 2°C temperature increase in 2050 and 3.5°C in 2085, low influence of changes in airflow patterns West Europe;

W_H-warm: 2°C temperature increase in 2050 and 3.5°C in 2085, softer and wetter winters caused by more winds from the west, warmer and dryer summers caused by more winds from the east.

FIGURE 2.3 KNMI climate scenarios: the vertical axis indicates the wind circulation patterns from low influence to high influence. The horizontal axis indicates the world temperature difference for 2050 compared to 1981-2010 (Ligtvoet et al., 2015).

To put the temperature increase in perspective: in The Netherlands temperatures measured in 2006 and 2007 are comparable to the temperatures in central France around 1900. In 2050 summers with three weeks of heatwave are expected to occur once every two years coinciding with a lack of fresh water regularly. The KNMI considers the W and W+ scenarios as the most probable for the coming decades. After 2050 Global Warming will accelerate as will the melting of ice caps according to the Delta commission 2008 (Hof, 2009). Temperature extremes are higher around 2100 and may go up to 44°C with a chance of once in a 100 years (Sterl et al., 2010).

For the future, annual precipitation is expected to increase on average with 2.5 to 5.5 percent in 2050. Rainfall will vary more throughout the year, with longer periods of drought and intensive showers in summertime and with long wet periods in fall and winter (Ligtvoet et al., 2015).

Climate change also affects salinization due to draughts and sea level rise (Jonkhoff et al., 2008). Salt water will penetrate more easily and further into the Dutch Delta. This has a negative effect on agriculture, drink water supply and nature development.

Although climate change predictions point to both, more extremes in heat waves and precipitation, the focus of this study is on heat. As explained in the introduction chapter 1, there is a lack of knowledge about urban heat stress in Dutch cities. The following sections give insight in outdoor thermal comfort, urban heat accumulation and the related problems and opportunities.

§ 2.2 Thermal comfort

Thermal comfort is the state of mind that expresses the sense of satisfaction with the thermal environment. Thermal comfort is usually measured according to four physical variables: temperature, humidity, air speed and thermal radiation. The experience of thermal comfort depends on individual characteristics such as; clothing, sex, age, activity level and previously experienced temperatures (ASHRAE, 2004).

A comfortable air temperature depends on the kind of activity one is performing. When exercising or doing physical labour comfortable temperatures are lower than when one is working behind a desk. Enjoying the weather on a terrace or sunbathing requires even higher temperatures.

In general, wind has a large negative influence on thermal comfort. Only when air temperatures exceed 21°C a stronger air flow starts to increase comfort conditions

(Olgay, 1963). In the Netherlands the coldest winter and spring winds are North-Easterly winds, while the cooling sea breeze in summer comes from the opposite side, the South-West. This implies an important constraint when designing to use wind to cool cities in summer, this is further explained in section 3.3. The Dutch standard for wind comfort is a maximum acceptable wind speed of 5 m/s, more than 3 Beaufort, and for wind danger 15 m/s, more than 7 Beaufort (NEN, 2006). As with temperature, wind comfort is also highly dependent on the kind of activity (see Table 2.1).

ACTIVITY	APPLICABLE FOR	RELATIVE COMFORT AT WINDSPEEDS ACCORDING TO BEAUFORT			
		PLEASANT	ADMISSIBLE	UNPLEASANT	DANGEROUS
walking fast	walkway	5	6	7	8
strolling, skating	parking, building entrances	4	5	6	8
standing still or sitting down for a short period of time	parking, squares, shopping malls	3	4	5	8
standing still or sitting down for a long period of time	open air theater, terraces, stadiums, recreation areas	2	3	4	8

TABLE 2.1 Comfort criteria according to Devonport for an air temperature above 10°C (Verhoeven, 1987).

A recent study in Utrecht during a warm period in August, showed that indoor air temperatures are experienced as too warm when they reach 25 to 30°C. Moreover, 25% of the correspondents indicated 20 to 25°C as too warm. For the outdoor temperature the threshold was five degrees higher; above 25°C was perceived as too warm and more than 40% indicated 30 to 35°C as too warm outside (Helden, 2013).

Thermal comfort index PET

Although most researchers indicate effects of adaptation measures due to air temperature only, Shashua-Bar et al. (2011) observe that wind, humidity and radiation are often dominant in human comfort sensation. Comfort indicators have been developed to approximate human experience of the microclimate. They were first developed for indoor conditions, an example is Fanger's Predicted Mean Vote (PMV) (Fanger, 1970). Later, attention to the outdoor microclimate increased and outdoor comfort indicators began to be developed for specific climate zones. The appropriate indices for the temperate climate are the Universal Thermal Climate Index (UTCI) (Jendritzky et al., 2001, Fiala et al., 2012) and the Physiological Equivalent Temperature (PET) (Mayer & Höpfe, 1987). One difference between these two indices is their sensitivity on wind speed fluctuations. PET responds stronger to a reduction in wind speed while UTCI is modified stronger by an increase in wind speed (Fröhlich &

Matzarakis, 2014). During hot weather, modifications in lower wind speed are more significant because lower winds speeds often occur with this type of weather.

In the PET indicator parameters, such as air temperature T_a , mean radiant temperature T_{mrt} , air velocity v and water vapour pressured VP are weighed to the human perception of climate circumstances (Mayer & Höppe, 1987, Höppe, 1999). This indicator uses the heat-balance model MEMI, which is based on the energy-balance model for individuals.

The basis for PET calculation is the basic heat balance equation (1) for the human body (Höppe, 1999):

$$M+W+R+C+ED+ERe+ESw+S=0 \quad (1)$$

M = metabolic rate

W = physical work output

R = net radiation of the body

C = convective heat flow

ED = latent heat flow to evaporate water into water vapour diffusing through the skin

ERe = sum of heat flows for heating and humidifying the inhaled air

ESw = heat flow due to evaporation of sweat

S = storage heat flow for heating or cooling the body mass

PET (°C)	THERMAL PERCEPTION	GRADE OF PHYSIOLOGICAL STRESS
	Very cold	Extreme cold stress
4		
	Cold	Strong cold stress
8		
	Cool	Moderate cold stress
13		
	Slightly cool	Slight cold stress
23		
	Slightly warm	Slight heat stress
29		
	Warm	Moderate heat stress
35		
	Hot	Strong heat stress
41		
	Very hot	Extreme heat stress

TABLE 2.2 Ranges of the thermal index physiological equivalent temperature (PET) for different grades of thermal perception by human beings and physiological stress on human beings; internal heat production: 80 W, heat transfer resistance of the clothing: 0.9 clo (Matzarakis et al., 1999).

This study opted for the PET index as its accuracy was demonstrated by Matzarakis & Amelung (2008) for the assessment of the effects of climate change on human health and well-being. Another advantage is that the indicator has been used in many other studies, which makes it possible to compare results with other data. Additionally, the choice for this comfort indicator is in agreement with other research groups that are connected to this study within the Climate Proof Cities (CPC) project (Albers et al., 2015). And finally, it is also an understandable indicator for designers and policy makers because it gives values in the commonly known degrees Celsius.

§ 2.3 The urban heat island effect in the Netherlands

Data from The Netherlands and other countries shows that rural areas often have a considerably lower temperature than downtown areas. This so-called Urban Heat Island (UHI) effect assumes that cities accumulate heat and are consequently warmer than their surroundings (Oke, 1982). During the evening and at night the difference is at its maximum when the countryside has cooled down but the city still retains the heat that has accumulated during the day. The temperature difference with the countryside can reach +10°C. The extent of the temperature differences vary in time and place as a result of meteorological, locational and urban characteristics, see Figure 2.4.

Accumulation of heat occurs in urban areas because higher levels of solar radiation are absorbed by the materials used in cities than by natural vegetation and soils of rural areas. Due to the built form less heat radiation can escape upwards. Especially at night when the air temperature lowers, materials radiate back the heat that was absorbed during the day. In rural areas the absorbed heat can radiate back at many angles up to 180 degrees, whereas in cities a large part of the sky is obstructed by buildings. Besides radiation at night, buildings also obstruct the reflection of sunlight back into the sky. Instead, reflected sunlight is largely blocked by facades which absorb the heat. Another important factor is the lack of vegetation in urban areas. Trees provide shade and cooling by evapotranspiration. A further contribution of the UHI effect comes from transport, heating and cooling systems and industrial activities. In addition, barriers in cities block the cooling effect of wind. Chapter 3 explains the contribution to or decrease of heat accumulation through different elements in cities.

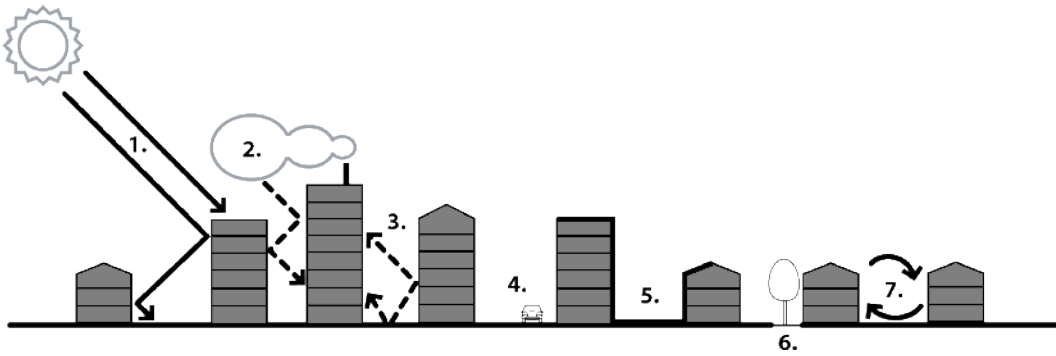

FIGURE 2.4 Causes for urban heat islands (Kleerekoper et al., 2012).

THE URBAN HEAT ISLAND EFFECT HAS THE FOLLOWING CAUSES (OKE, 1987, SANTAMOURIS & ASIMAKOPOULOS, 2001):

-
1. Absorption of short-wave radiation from the sun in low albedo (reflection) materials and trapping by multiple reflections between buildings and street surface.
 2. Air pollution in the urban atmosphere absorbs and re-emits longwave radiation to the urban environment.
 3. Obstruction of the sky by buildings results in a decreased long-wave radiative heat loss from street canyons. The heat is intercepted by the obstructing surfaces, and absorbed or radiated back to the urban tissue.
 4. Anthropogenic heat is released by combustion processes, such as traffic, space heating and industries.
 5. Increased heat storage by building materials with large thermal admittance. Furthermore, cities have a larger surface area compared to rural areas and therefore more heat can be stored.
 6. The evaporation from urban areas is decreased because of 'waterproofed surfaces' – less permeable materials, and less vegetation compared to rural areas. As a consequence, more energy is put into sensible heat and less into latent heat.
 7. The turbulent heat transport from within streets is decreased by a reduction of wind speed.
-

The physical parameters influencing heat accumulation in cities, described above, can be indicated by for example building density or the sky view factor. Oke (1973) shows that population density can be sufficient to indicate a city's UHI, especially on the neighbourhood level because this corresponds better to building densities (Steenveld et al., 2011).

The UHI effect is not a recent phenomenon, temperature measurements of the soil under cities confirm urban heat patterns and even reveal some urban history as the depth of the minimum temperature is greatest under the oldest parts of a city (Ferguson & Woodbury, 2004). In The Netherlands, weather stations are all situated in the countryside or in the vicinity of airports in order to reduce variations caused by the built-up environment. Official temperature data from inner cities are not available and this has led to ignorance about the effects of heat collection in Dutch cities.

§ 2.3.1 Measuring heat in Utrecht and Rotterdam

The first study of the UHI effect in The Netherlands has been done by Conrads (1975) who performed measurements in Utrecht in 1970-1971. This study shows a significant difference between the rural (measurement station of The Bilt) and urban temperatures particularly in daily minimum temperatures. In winter the average difference of the daily minimum temperature was 1.7°C, in Summer 2.7°C. Minimum night-temperature differences measured up to a maximum of 8°C.

After the study of Conrads, new measurements in Utrecht were done with traverse measurements by bike between 1993 and 2000 in mornings and afternoons (Brandsma et al., 2003, Brandsma, 2010). And during the CPC project, Heusinkveld (2013) organised a team to continuously measure air temperatures traversing the city by bike on a typical summer day in July 2012. Temperature differences between city and 'rural' measured up to 5.3°C in the evening and 3.3°C at the highest daytime temperature of 30.3°C. The chosen routing and the fact that it was a typical summer day and not an extreme hot day may have led to an underestimation of the UHI effect of Utrecht. Since 1971 the maximum values of the UHI effect in Utrecht have probably increased due to the following changes:

- Utrecht has grown, not just in size and population, but particularly in terms of paved surface and density of buildings;
- Human activity has changed: more traffic, higher energy consumption, more industrial activities, a 24-hour society;
- Climate change might have changed the magnitude of the UHI effect;
- Building styles, height, materials and roofing have changed, i.e. there may be an alteration in albedo (reflection level) and wind patterns;
- Dutch cities are located fairly close to one another and the countryside is continuously in a process of urbanisation. Areas that were rural in 1970 are now also dealing with the UHI effect. This implies that the rural reference station Conrads used in 1970 no longer measures temperatures isolated from urban areas (Salcedo, 2008).

The latter point implies that the UHI effect may have increased even more than indicated by the measurements. The same applies to the actual heat stress that might have increased due to higher temperatures in both city and rural area due to climate change.

In a measurement campaign amongst residents the MNU (environmental agency of the province of Utrecht) found a relation between the amount of green and in- and outdoor temperatures. Especially high temperatures in bed rooms are indicated by residents as uncomfortable. These often exceeded 25°C (Berg, 2013).

In Rotterdam Heusinkveld & Holtslag (2010) measured a maximum air temperature difference of 7°C between city and rural areas. From the traverse measurements a thermal comfort value was calculated in the Physiological Equivalent Temperature (PET). On a hot afternoon in August 2009 the PET ranged from 25 to over 50°C. In Figure 2.5 the spatial PET distribution clearly shows a hotter city centre compared to the rural area in the evening.

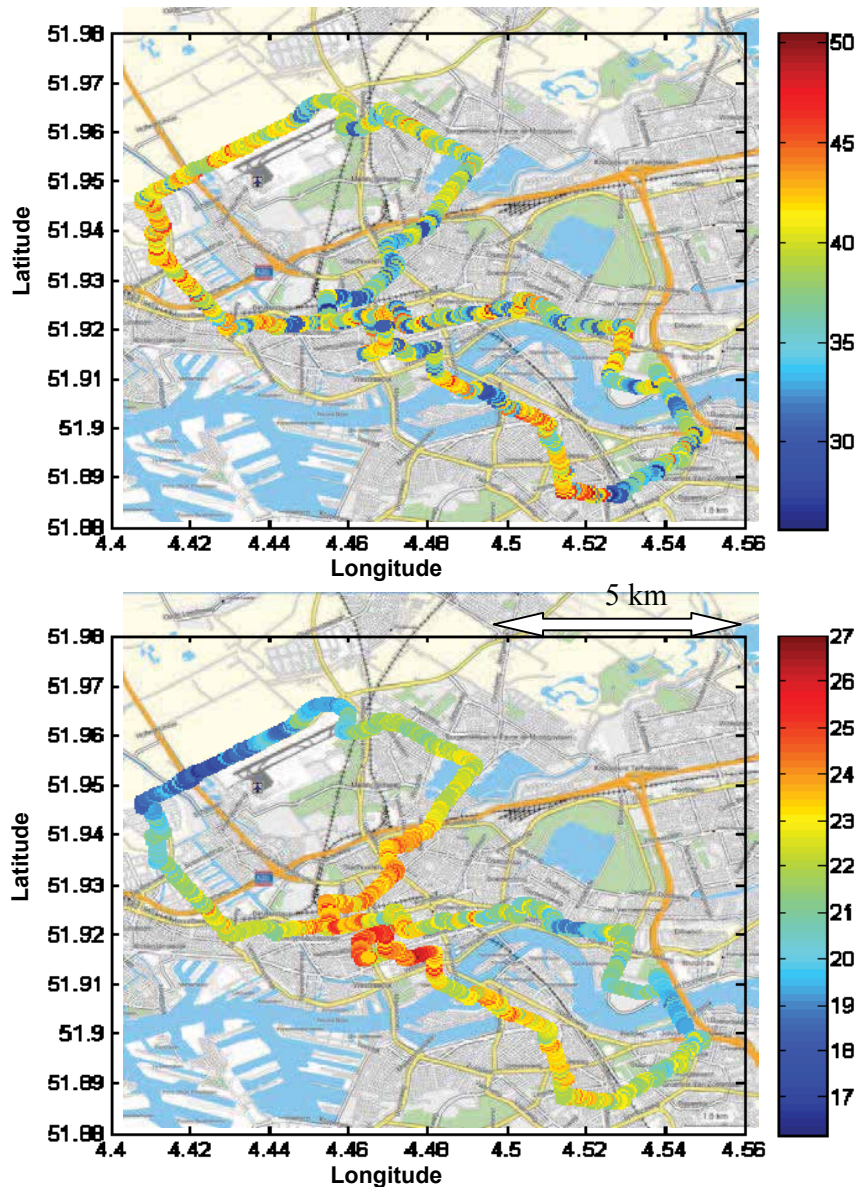

FIGURE 2.5 Traverse measurement data in PET between 14:00-16:00 h (above) and 22:00-24:00h (under) on the 6th of August 2009 in Rotterdam, The Netherlands (Heusinkveld & Holtslag, 2010).

Another source of temperature data in cities are amateur weather stations spread over all cities in The Netherlands. In an analysis by Steeneveld et al. (2011) data from over 200 amateur weather stations was collected of which only 19 stations could meet all the requirements for the analysis. According to this study most Dutch cities have a mean daily maximum UHI of 2.3°C and a 95 percentile of 5.3°C. The largest difference in heat accumulation is found in the evening, with low wind speed and little cloud cover.

§ 2.3.2 Mapping urban heat

The traverse measurements presented in Figure 2.5 in the previous section is one of the options to map urban heat. In fact, the presented PET measurements provide a lot of information about the spatial distribution of thermal comfort throughout the city. On the other hand, the method requires very specific measurement equipment, a lot of time and manpower and the retrieved data covers only a short period.

Another way to analyse heat accumulation in cities is the use of satellite imagery that show surface temperatures (Klok et al., 2012). Within the CPC project van der Hoeven and Wandl analysed the vulnerability to heat stress in the cities of Amsterdam (Hoeven & Wandl, 2013) and Rotterdam (3TU, 2014). Firstly, heat accumulation in these cities was analysed based on: surface temperatures, amount of pavement, vegetation index, percentage of space occupied by traffic and water, the building envelope index, albedo value and the average energy label. Secondly, the risk group of people experiencing problems with heat were mapped, including the unborn, new-borns and people above the age 75. Finally, the areas with a concentration of labour activities were indicated because they are expected to use more energy for cooling.

An alternative to measurements is the prediction of an urban microclimate based on physical parameters such as land use, building morphology, vegetation and pavement. A method developed by the University of Stuttgart maps heat accumulation and the most important wind situations is based on these physical parameters. This so-called 'climatope' concept gives a temperature prediction according to typical microclimate aspects (Lenzholzer, 2013, Stadtklima, 2008). The wind situation has to follow from weather stations in the vicinity of the city, where data about the strong wind situations and during hot days can be retrieved. The first climatope maps for The Netherlands were developed within the European research project 'Future Cities' to give an indication of the hot and cool areas. In The Hague, see Figure 2.6, the wind situation was not considered (Slabbers et al., 2010), while for Arnhem wind was a large component, see Figure 2.7.

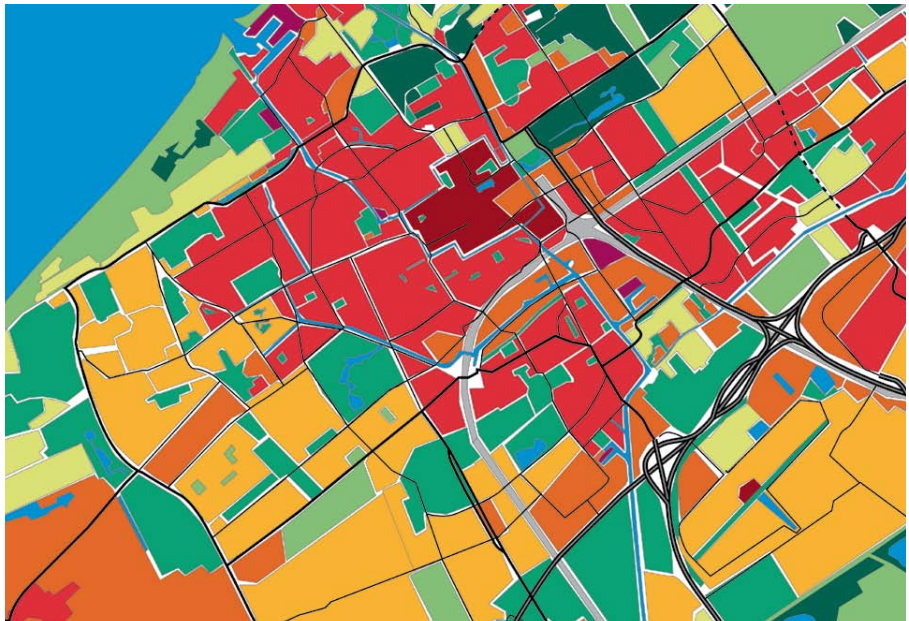

FIGURE 2.6 Climatope map of The Hague with an indication of heat islands in dark red (Slabbers et al., 2010).

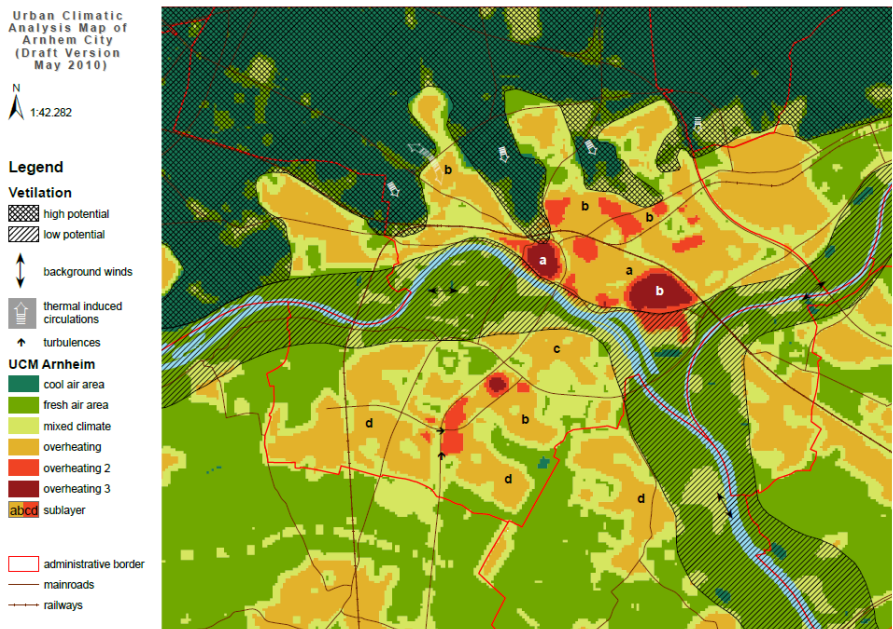

FIGURE 2.7 Urban climatic analysis map of the city of Arnhem (Heerkens, 2010).

The urban climatic analysis map (UC-AnMap) of Arnhem was further developed into an Urban Climatic Map (UCMap) system (Ren et al., 2012). The UCMap system basically translates climatic understanding from the UC-AnMap into suggestions for climate sensitive planning in a planning recommendation map (UC-ReMap) presented in Figure 2.8.

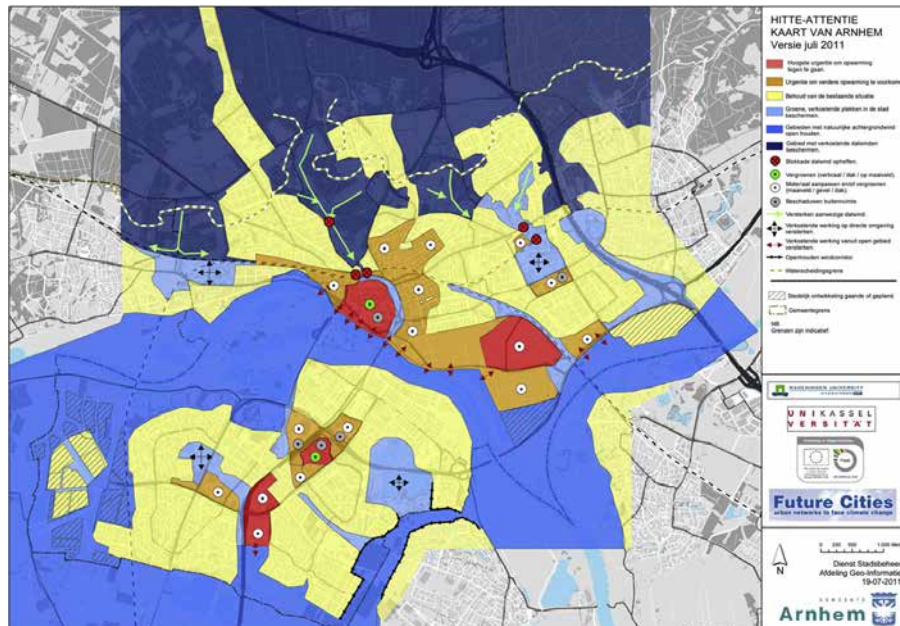

FIGURE 2.8 Planning recommendation map for the city of Arnhem (Ren et al., 2012).

Informed by the vulnerability and climatope maps problematic areas can be indicated and general recommendations can be formulated for structural visions and zoning plans. Further guidance in climate adaptation design on the smaller neighbourhood scale is provided in chapter 7 and 8.

§ 2.4 Is urban heat stress a problem?

The Dutch government plans to realise 80,000 new dwellings per year between 2012 and 2020 (Programmadirectie Verstedelijking, 2009; PBL, 2011). In the Dutch western Randstad region, at least 40% has to be realised in existing urban areas, and in the rest of the country the inner city share is 25 to 40%. As a pilot project, some office buildings will be transformed into apartments, although the majority of these new dwellings will be realised on new building sites within and outside cities. Expansion and densification of cities lead to an increase of the Urban Heat Island (UHI) effect (Oke, 1973, Rizwan et al., 2008, Steeneveld & Hove, 2010, Arnfield, 2003), together with increasing air pollution and problems with water drainage.

Together with the gradual temperature rise in the Netherlands the increasing UHI effect implies a high predictability of a warmer urban climate. Adaptation of cities and buildings to higher temperatures is important because of the following additional developments that continue to increase: air pollution, number of air-conditioners, aging of the population, less cooling of the outdoor environment due to droughts (Roggema, 2009) and densification in cities. What will happen when Dutch cities have to cope with warmer weather? Which problems can we expect? Could we benefit from this temperature rise? We need to prepare the urban environment for the changing climate in the coming 50 years and, if possible, try to create flexibility for the coming 100 years. This section discusses the risks and opportunities related to increasing temperatures in cities.

§ 2.4.1 Heat stress

When exposed to heat, humans can suffer from severe health problems. The worst effect of heat stress is temperature-related mortality, but heat stress mainly causes illness. In the Netherlands 25°C can be taken as a starting point for heat stress. According to the KNMI a heat wave occurs when the outside air temperature is 25°C or more during five consecutive days, including three consecutive days of 30°C or more (KNMI, 2013). Beside the air temperature also wind speed is relevant: during hot weather mortality decreases with higher wind speeds (Kunst et al., 1993).

A study by Daalen & Riet (2010) in the Dutch city of Tilburg indicates the largest hindrance during warm weather for elderly with health or sociological problems. This result is endorsed by a study of Kovats & Hajat (2008). These two studies indicate a general higher risk during heat waves for the following groups:

- Infants, elderly above 65 years, people who are ill, take medicines, alcohol or drugs, have overweight and pregnant women;
- Patients suffering from cardiovascular diseases and subject to the additional risk of heart failure.
- People who are unaware of the problems associated with extreme heat and do not adapt their clothing or do not take extra fluids;
- People who are unable to move from overheated places.

The following paragraphs provide more in-depth information about the effect of heat on disease, mortality, sleep and productivity and social behaviour.

Heat effects on disease

Approaching heat from the side of thermophysiology it is seen as a large stress factor for the cardiovascular system. The human body tries to release internal heat through enlarging the flow through the skin, resulting in a faster heartbeat to compensate for the lower venous return. If this primary reaction is insufficient the strong cooling mechanism is switched on: sweating (Daanen et al., 2010). When these two mechanisms fail or cannot compensate for the extreme external conditions (sometimes in combination with risk groups) there are four main diseases that can occur on the short term: heat rash, heat cramps, heat exhaustion and heat stroke (Howe & Boden, 2007).

On the long term people are very capable of acclimatization to heat. But problems occur especially when a heatwave succeeds a relatively cool period. Climate change is predicted to enlarge thermal extremes, thus the chance of explosion to heat without acclimatization increases. Nevertheless, exposition to extreme heat can have consequences on the long term. These are related to a low birth weight and congenital anomalies (Daanen et al., 2010).

Heat effects on mortality

The optimal outdoor temperature related to health, defined by the lowest mortality ratio, is 16.5°C first presented by Huynen et al. (2001). In figure 2.9 the relation between mortality and temperature in The Netherlands is given (Huynen et al., 2008). The relation implies that climate change as a negative result causes an increase in deaths due to more heatwaves, and as a positive result leads to a decrease in deaths due to milder winters. It is therefore important to strive for measures to mitigate heat stress that have low or no temperature decreasing effect in winter, e.g. trees that actually have an increasing temperature effect in winter.

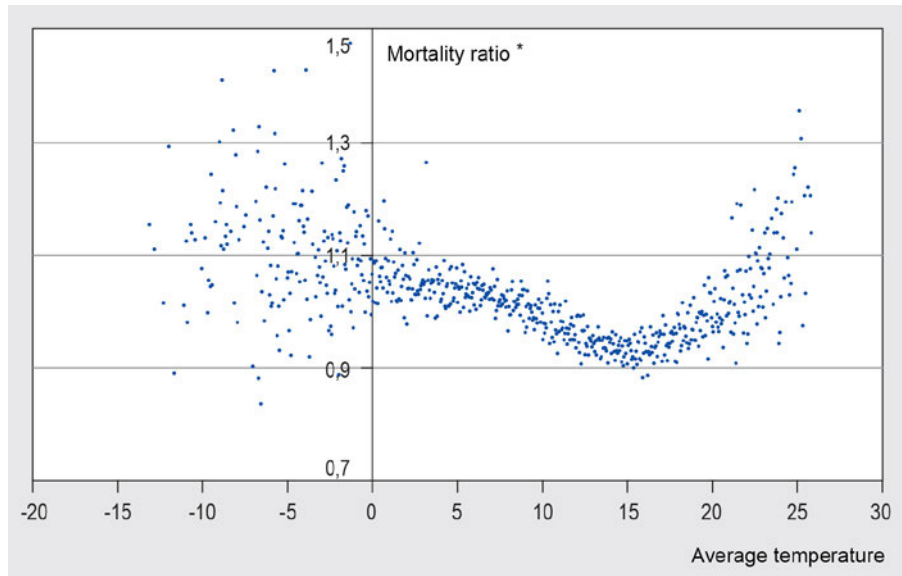

FIGURE 2.9 The relation between average temperature and mortality in The Netherlands, that was measured between 1979-1997 (*mortality ratio = observed number of deaths on day x / mean number of deaths over the whole study period) (Huynen et al., 2008).

In the period of 1979-1997 higher temperatures during heatwaves resulted in 40 additional deaths per day, an increase of 12% (Huynen et al., 2001). In 2003 a severe heatwave occurred in Europe, causing 15.000 extra deaths in France. Only a small number could be explained by the so-called *harvest effect* (Pirard et al., 2005). The harvest effect means that people die a few months earlier than they would have naturally. Also Le Tertre et al. (2006) and Kovats & Hajat (2008) conclude there was no harvest effect in 2003. The maximum temperatures in 2003 in The Netherlands were lower than in other European countries, nevertheless around 1400 deaths can be attributed to heat stress in that year (Fischer et al., 2004, Garssen et al., 2005).

In 2006 the month of July was extremely warm in The Netherlands which led to many more heat-related deaths than usual. This heat wave was rated as the world's fifth worst natural disaster in terms of actual deaths in 2006 (Table 2.3). This comparison is not entirely proportional since the deaths caused by an earthquake concerns a cross-section of the population, while extreme temperatures mainly hits the weak from society.

	DISASTER TYPE	COUNTRY	NUMBER OF KILLED
1	Earthquake (Yogyakarta)	Indonesia	5,778
2	Wind Storm (Typhoon Durian)	Philippines	1,399
3	Extreme Temperature (heat-wave)	France	1,388
4	Slides (landslide)	Philippines	1,126
5	Extreme Temperature (heat-wave)	Netherlands	1,000
6	Extreme Temperature (heat-wave)	Belgium	940
7	Wind Storm (Typhoon Bilis)	China P. Rep.	820
8	Wave/Surge (tsunami)	Indonesia	802
9	Extreme Temperature (cold-wave)	Ukraine	801
10	Flood	Ethiopia	498

TABLE 2.3 Top 10 of most significant natural disasters by number of deaths in 2006 (Hoyois et al., 2007)

Based on the data from the warm summer in 2006 the Dutch Central Bureau for Statistics (CBS) calculated that the increase of the average temperature by one degree Celsius leads to an extra mortality of about 31 persons per week. Temperature-related mortality in the Netherlands from May to August 2006 is shown in Figure 2.10 and from May to July 2010 in Figure 2.11. Garssen & Harmsen (2006 and 2010), estimate 1000 and 500 additional deaths due to the heatwaves in respectively 2006 and 2010. Temperature-related deaths are higher at an older age, especially over 80 years of age,



FIGURE 2.10 Mortality (light blue) in relation to the maximum average temperature (dark blue) during week 20 to 31 of 2006 (Harmsen & Garssen, 2006)

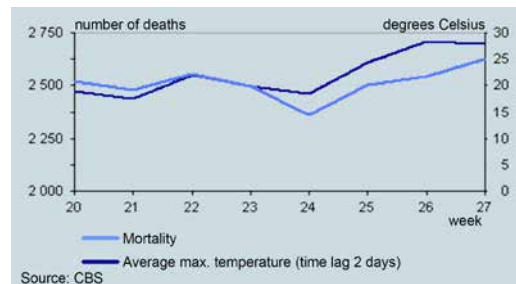

FIGURE 2.11 Mortality (light blue) in relation to the maximum average temperature (dark blue) during week 20 to 27 of 2010 (Garssen & Harmsen, 2010).

Heat effects on sleep and productivity

Sufficient sleep is essential for human's health, alertness, cognitive performance, immune system and hormonal system. With high temperatures people sleep shorter and wake up more frequently, whereby falling asleep takes longer (Buguet, 2007). A laboratory study by Raymann et al. (2008) shows that only a small change in skin

temperature of less than 1°C can have a large impact on sleeping quality. Figure 2.12 presents results from a study amongst a large group of elderly in the city of Rotterdam found a significant influence of high temperatures on sleep time and efficiency (Janssen et al., 2011).

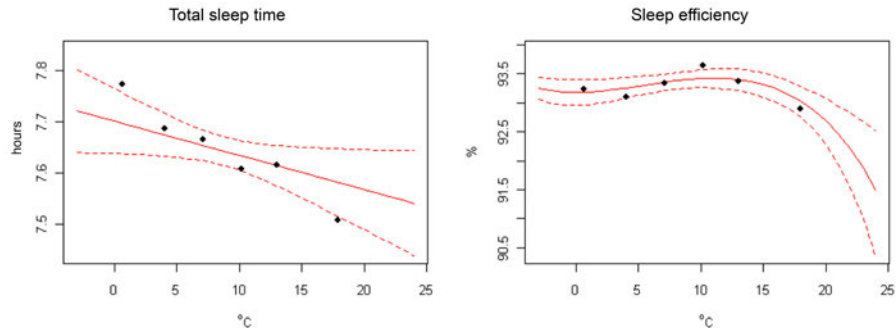

FIGURE 2.12 Total sleep time and sleep efficiency in relation to air temperature (Janssen et al., 2011).

Heat can have an influence on human performance and cause reduction in speed and increase the amount of mistakes (Hancock et al., 2007). Another known effect of increasing temperatures is the decrease of efficiency. One degree increase of the core temperature results in 1% reduction in working efficiency (Daanen et al., 2006).

When you are able to adjust your activities and adjust the work-rest regime during warm weather there will be less discomfort. This so-called self-pacing automatically occurs and illustrates the labour productivity loss due to heat. However, self-pacing is actually the best method to prevent overheating according to Mairiaux & Malchaire (1985). The method can only be effective when the task has no urgent character and does not involve productivity incentives. People that are used to work in hot conditions are better capable in choosing a regular pacing strategy (Daanen et al., 2010). An example where the method will not be effective is at extreme sport performances. The arena built for the World Cup 2014 inside the city centre of Manaus and in the extreme humid and hot climate of the Amazone should have been acclimatized much better or not built on that location in the first place. "At times it felt like I was having hallucinations due to the heat," Italian Player Claudio Marchisio said after his team defeated England in Manaus (Voogt, 2014).

For office employees self-pacing is usually not an option, which means that the temperature in the working space needs to be adjusted. The building stock in the Netherlands is not very well equipped for warm weather and offices are often too warm and unable to get rid of this heat. The productivity decreases when the temperature exceeds 25°C. Above this temperature every degree extra leads to 2% productivity

loss in an office environment (Kurvers & Leijten, 2007). Another aspect for the office climate is the remarkable difference in accepted indoor temperatures for buildings with and without extensive climate installations. In buildings that are not equipped with air treatment installations and openable windows higher temperatures are accepted in summer compared to buildings with air-conditioning and limited options to adjust to personal comfort experience (Kurvers & Leijten, 2007). A building with more freedom to adjust climate conditions to personal needs can save on energy for cooling.

A positive impact of higher temperatures on health is that people will exercise more outside (Boer et al., 2006), i.e. going on foot or by bike and do outdoor sports. This requires sufficient park and recreational space and attractive routings through the city and parks.

Heat effects on social behaviour

Not only physical factors play a role in vulnerability to heat. A correlation analysis by Scherber et al. (2014) for Berlin shows a positive relation between relative risks for hospital admissions among > 64-year-olds with respiratory diseases and population density, socio-economic conditions and the annual mean number of hot days based on the period 1971-2000. The vulnerability of an area to heat is also linked to the urban function; it is important to know whether people are working or sleeping in the area (Van Someren et al., 2002).

Adapting daily and work activities in extremely warm periods is an important factor in staying healthy and sound. Therefore, it is important to know how to act. In The Netherlands all municipalities have their own health service institute, the GGD. In 2007 a national heat emergency plan (Biggelaar et al., 2007) was developed by the GGD to support inhabitants in taking the right actions. The five most important recommendations are the following:

- 1 drink at least 2 litres per day;
- 2 avoid heavy labour between 12:00 and 16:00h;
- 3 stay inside or in the shade between 12:00 and 16:00h;
- 4 cool your body with cold water and cool spaces by closing sun blinds and, when the outside temperature is higher than inside, close windows;
- 5 take care of each other, especially elderly and ill people.

Especially recommendation 3 and 4 are depending on the existence of sufficient and accessible cool indoor and outdoor spaces. This underpins the necessity to integrate thermal comfort in urban design.

Climate change can also lead to indirect health risks due to changes in flora and fauna. More about this topic is described in section 2.4.4.

§ 2.4.2 Air pollution

Summer smog (ozone at street level) occurs during heat waves. The sun is the motor for smog production: the chemical reaction of sunlight with nitrogen oxides (NOx) and volatile organic compounds (VOCs) in the atmosphere leaves airborne particles (particulate matter) and ground-level ozone. During hot periods wind is usually scarce, which means that air pollution is not dispersed or reduced in these periods.

Air pollution is the cause of 10-25% of the increased mortality registered during heat waves in the Netherlands (Duijm, 2006). As 40% of the inhabitants in this country lives in an urban environment and 20% in a moderate urban environment the effect of air pollution is much larger than in other countries with relatively more inhabitants in rural areas (Erwich & Vliegen, 2001). Health problems caused by the bad microclimate in cities are a social problem, but also an economic problem in terms of productivity (disability insurance) and financial consequences (health insurance). Table 2.4 ranks the Netherlands as second in premature deaths due to particulate matter in European countries per year. A study of air pollution-related deaths in the Netherlands concludes that during the summer of 2003 ozone related deaths were 1400 and deaths related to particulate matter (PM) concentrations 1460 (Fischer et al., 2004). An analysis by Kunst et al. (1993) concludes that air pollution has only a negligible effect on heat-related mortality.

Hungary	11.067	0.111%
Netherlands	13.123	0.080%
Germany	65.088	0.079%
Czech Republic	7.996	0.077%
Poland	27.934	0.073%
Italy	39.436	0.066%
Belgium	10.669	0.064%
France	36.868	0.057%
Austria	4.634	0.056%
UK	32.652	0.053%
Spain	13.939	0.030%

TABLE 2.4 Premature deaths due to particulate matter in Europe per year (EU_Member_States_2000, 2005).

§ 2.4.3 Energy consumption

The building stock in the Netherlands is mainly prepared for cold periods. The predicted milder winter climate due to climate change, the balance will shift from heating to cooling. High thermal insulation values prevent loss of heat, large windows admit sunlight and generate a comfortable climate during cold periods. However, a great area of window surface, lack of prevention against solar radiation and no passive cooling systems causes overheating of buildings in warmer periods. The building stock in The Netherlands and surrounding countries is not built for warmer summer situations. Schmidt et al. (2007) show that increasing temperatures due to climate change will probably increase CO₂ emissions due to additional mechanical cooling, see Figure 2.13. In a graph from the European Commission that forecasts an increase of CO₂ emissions by 350% by 2020 for Northern countries such as Germany. The same trend of increasing temperatures and additional cooling loads is found for cities in the US where an increase of the UHI with 1°C leads to an increase of the peak electricity demand by 3 to 6% (Bretz et al., 1998).

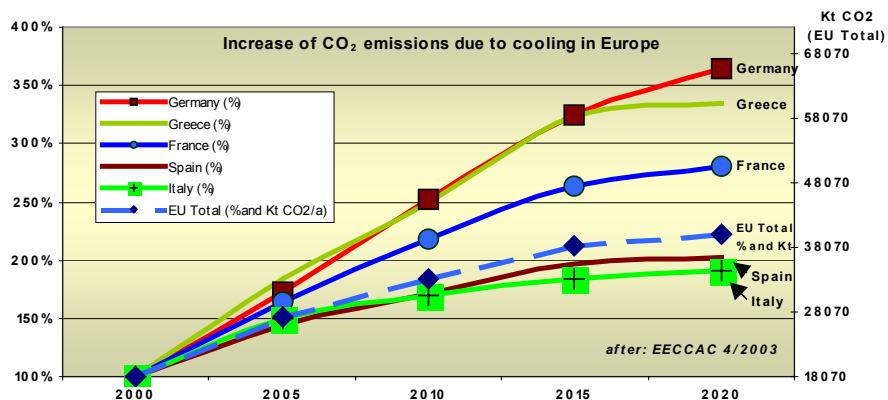

FIGURE 2.13 Increase of CO₂ emissions due to mechanical cooling in buildings in Europe (Schmidt et al., 2007).

Modern western office buildings with large glass surfaces already need to switch on their air conditioning system when the outdoor temperature rises above 12-15°C. The heat exhaust from the air conditioners warms up the city even more and contributes indirectly to an extra cooling demand. Households also tend to obtain air conditioning systems. Currently only 1% of the households is equipped with air conditioning, but in the next years this is expected to increase to 3%. More use of electricity increases the amount of greenhouse gasses which contributes to global warming. Locally, the electricity production by conventional plants causes more pollution.

Another problem occurring when electricity plants need to produce at their maximum during warm periods, is the lack of cooling water. In winter, open water is cold, which means one litre can absorb more heat than is possible with tepid water in summer; the higher the water temperature, the more water is needed to cool by one degree. Regulations in the Netherlands set limits to the water temperature that is discharged to open water, to protect the aquatic ecosystem. This cannot exceed temperatures around 30°C. According to Roggema (2009) the energy supply by power plants becomes problematic when temperatures rise above 23°C. In France the heatwave in 2003 led to a complete shutdown of six power plants and inadequate cold storage systems of 25-30% of all food related establishments (Létard et al., 2004 in Bobylev, 2009). An intelligent energy system needs to be responsive to alterations in climatic conditions, the weather and other circumstances (Dobbelsteen et al., 2010). Cities should adapt their energy systems to be able to respond on more extreme climate conditions.

Beside energy for cooling in summer, Dutch buildings need energy for heating in winter in spite of the predicted milder winter climates. The energy systems in cities can be more efficient when supply and demand of heat and cold are realized in local and decentralized connexions. For example the use of 'waste heat' from industrial processes can supply dwellings with heat and a pool can receive the heat that is produced to cool an ice rink (Tillie et al., 2009).

There are high potentials in energy consumption reduction by storing heat in summer and using this in winter. With heat pumps that deliver cold in summer, heat is a by-product. This heat can be stored in a seasonal storage such as aquifers that can deliver heat in winter. Instead of using a storage a large mass can be used as heat or cold source. An example is the use of water from the Maas river that has a rather constant temperature year-round. With heat pumps heat or cold are extracted from the water to regulate the indoor climate of the Maas tower. An extra advantage in both examples is that heat exhaust from cooling systems does not add to the urban warming. This principle can be applied to the building and neighbourhood level (Jong, 2010).

A basic step in increasing efficiency in energy consumption is to use the exergy approach. The exergy approach can ensure a better utilization of the quality of energy, which ultimately reduces the demand for high quality sources. Exergy expresses what is the amount of work that can be delivered from a given amount of energy or material, in its environment. This is also known as the quality of the energy (Jansen, 2013).

§ 2.4.4 Organic life

With a milder climate, changes occur in flora and fauna. A positive change is the increase of production of agricultural land due to higher temperatures and an extension of the growing season⁴. In the course of the twentieth century the growing season has extended with approximately 25 days (Klein Tank & Sluijter, 2003). More areas will be suitable for the production of wine and other (heat-tolerant) crops. And due to the warmer city climate during winter non-indigenous species can survive increasing biodiversity. Think of the colony of previously domestic parakeets in the Vondelpark in Amsterdam and in an increasing amount of other Dutch cities. The exotic parrot specie from tropical Africa and South-Asia was introduced as an aviary bird. Released or escaped birds were able to reproduce and settle in urban environments in The Netherlands, Germany and Belgium.

The risks for humans in changes in flora and fauna are mainly related to spreading of viruses and bacteria. These pathogenic micro-organisms often have an optimum, generally higher, temperature to become effective. Also the species (called vectors hereafter) that transfer these micro-organisms, such as mosquitos, ticks, sand flies and midges, prefer a warm and humid climate (Daanen et al., 2010). In an overview of the influence of climate change on the vector related diseases by Lier et al. (2007) especially the tick is expected to spread more pathogens. When Southern tick species spread northward rickettsioses can be introduced. The most common virus, causing Lyme's disease, has greatly increased morbidity in The Netherlands. This is partly related to milder winters and increased temperatures, but also to more small and large mammals and birds in cities and nature reserves that spread the disease and increase the tick density. The increase of tourism in natural tick habitats is also associated with the increase of Lyme's disease. After ticks the mosquito is the next most dangerous vector to transfer viruses; an example is the West Nile Virus, which spread rapidly in the USA.

Other changes that might cause nuisance include occurrence of insects earlier in the year and in greater numbers, migration and multiplying species, abundant vegetation may cause an increase in allergies. In addition, draught, heat and salinization are a threat for the availability and quality of drinking water. A decrease in supply from upstream or from precipitation increases the concentration of pollutants demanding more from the purification process. Water for drinking may not exceed 25°C in the pumping station (Slabbers et al., 2010) because higher temperatures increase the chance of bacteria growth such as legionella.

4 Growing season: number of days between first period after the 1st of January of 6 consecutive days of 5°C or more and the first period after the 1st of July of 6 consecutive days of 5°C or less (Klein Tank and Sluijter, 2003).

§ 2.5 Conclusion

This chapter discussed the impact of climate change on the urban environment and arguments the relevance of climate adaptation.

The expected impact of climate change in The Netherlands has a significant effect on the occurrence and intensity of heat waves, rainfall and periods of drought. These climate effects will have a larger impact on cities due to the physical conditions, resulting in a lower capability to cope with heat and water than rural and natural environments, and the large population that is affected. The more excessive impact on urban areas increases the urgency to adapt and amplify the importance to consider thermal comfort in urban areas in hot weather conditions. The perception of outdoor thermal comfort is a rather new area of interest in Dutch spatial planning. Without taking action, we risk heat stress related health issues and productivity loss, more air pollution, an increase in energy consumption and consequences from bacterial growth. Moreover, chances to profit from heat remain unexploited.

Although the consensus about climate change predictions is increasing, there is still a chance unlikely scenarios will determine the course of the future climate. Two reasons not to get discouraged by the uncertainties are: also the current city climate would profit from more attention to the urban microclimate and the many additional benefits related to health, energy and economical aspects turns the risk factor into a window of opportunities.

Cities have the opportunity to reduce emissions and water and heat related risks in combination with many other assets. As Schwartz (2013) states: *“Climate change action by local governments around the world is creating wealthier, healthier cities”*. This finding is based on analysed data from members of the C40 Cities Climate Leadership Group in 110 cities around the world, including Tokyo, New York, and London. The engagement of the cities on the issue of climate change, has led to the result of saving money, creating more attractive investment environments, and enabling citizens to live healthier lives. Moreover, integrating climate adaptation from the initial stage of a development plan leads to no or little additional costs, with potentially high benefits (Pijnappels & Sedee, 2010). This was concluded after analysing over a hundred development projects in the Netherlands where climate adaptation and spatial planning were considered.

Climate adaptation should be seen as a chance to improve our urban environments on many levels. A consensus on the best way to develop climate adaptive urban environments is however not constituted yet. In the first place, uncertainties and insufficient knowledge about the effect of measures for the temperate climate creates reluctance in implementation. In the following chapter the effects known from literature are given. Thereafter follow three chapters that study some specific measures through simulations and measurements.

§ 2.6 References

- 3TU (2014), "Sensing Hotterdam". Available at: <http://www.3tu.nl/bouw/en/lighthouse2014/sensinghotterdam/>, <http://www.hotterdam.eu/archive> [2015].
- Albers, R.A.W., Blocken, B. and Bosch, P.R. (2015), "Overview of challenges and achievements in the Climate Proof Cities program". *Building and Environment*, Vol. 83, pp. 1-10.
- Alcoforado, M. and Andrade, H. (2008), "Global Warming and the Urban Heat Island". *Urban Ecology*, pp. 249-262.
- Amengual, A., Homar, V., Romero, R., Brooks, H.E., Ramis, C., Gordaliza, M. and Alonso, S. (2014), "Projections of heat waves with high impact on human health in Europe". *Global and Planetary Change*, Vol. 119, No. 0, pp. 71-84.
- Arnfield, A. (2003), "Two decades of urban climate research: a review of turbulence, exchanges of energy and water, and the urban heat island". *International Journal of Climatology*, Vol. 23, No. 1, pp. 1-26.
- Barriopedro, D., Fischer, E.M., Luterbacher, J., Trigo, R.M. and García-Herrera, R. (2011), "The Hot Summer of 2010: Redrawing the Temperature Record Map of Europe". *Science (New York, NY)*.
- Berg, P. (2013), "Samenvatting resultaten onderzoeken hitte in de stad in de provincie Utrecht", MNU.
- Biggelaar, M. v.d., Huijnen, F., Plug, K., Willems, N., Bruggen, M.v., Stom, C., Bögels, A., Timmermans, J., Roessel, W.v., Vink, W. and Zierleyn, A. (2007), "Nationaal Hitteplan 2007", Ministerie van Volksgezondheid, Welzijn en Sport, RIVM, GGD.
- Bobylev, N. 2009. Urban underground infrastructure and climate change: opportunities and threats. *Fifth Urban Research Symposium 2009*. Marseille, France: World Bank.
- Boer, R., Zheng, Y., Overton, A., Ridgeway, G., Cohen, D. and Design, N. (2006), "How Neighborhoods Can Reduce the Risk of Obesity". *Pediatrics*, Vol. 118, No. 5, pp. e1381-e1389.
- Brandsma, T. 2010. Warmte-eilandeffect van de stad Utrecht. *Zenit*.
- Brandsma, T., Konnen, G. and Wessels, H. (2003), "Empirical estimation of the effect of urban heat advection on the temperature series of De Bilt (The Netherlands)". *International Journal of Climatology*, Vol. 23, No. 7, pp. 829-845.
- Bretz, S., Akbari, H. and Rosenfeld, A. (1998), "Practical issues for using solar-reflective materials to mitigate urban heat islands". *Atmospheric Environment*, Vol. 32, No. 1, pp. 95-101.
- Brundtland, G.H. (1987), "Our Common Future—Call for Action". *Environmental Conservation*, Vol. 14, No. 04, pp. 291-294.
- Buguet, A. (2007), "Sleep under extreme environments: Effects of heat and cold exposure, altitude, hyperbaric pressure and microgravity in space". *Journal of the Neurological Sciences*, Vol. 262, No. 1-2, pp. 145-152.
- Conrads, L. (1975), Observations of meteorological urban effects. The heat island of Utrecht, PhD thesis, University of Utrecht, Utrecht.
- Daalen, E. v. and Riet, N. v. (2010), "Ouderen en hittebeleving", Bureau Gezondheid, Milieu & Veiligheid GGD' en Brabant/Zeeland, Tilburg.
- Daanen, H., Es, E. v. and Graaf, J. d. (2006), "Heat strain and gross efficiency during endurance exercise after lower, upper, or whole body precooling in the heat". *International journal of sports medicine*, Vol. 27, No. 5, pp. 379-388.
- Daanen, H.A.M., Simons, M. and Janssen, S.A. (2010), "De invloed van hitte op de gezondheid, toegespitst op de stad Rotterdam", TNO, Soesterberg.
- Dobbelsteen, A.A.J.F. v.d., Keeffe, G., Tillie, N. and Kleerekoper, L. 2010. From autistic to autonomous: cities as energy-intelligent organisms. TU Delft.
- Dorst, M.J. v. (2010), "Sustainable Liveability". *Environment, Health, and Sustainable Development*, Vol. 1, pp. 111.
- Dow, K. and Downing, T.E. (2006), *The Atlas of Climate Change, Mapping the world's greatest challenge*, Earthscan, Myriad Editions.
- Duijm, F. (2006), "Hittegolf met de dag gevaarlijker", Kenniscentrum Milieu & Gezondheid, GGD Groningen, 04-06-2006.
- Erwich, B. and Vliegen, M. (2001), "Stedeling en plattelander", CBS.
- EU_Member_States_2000 (2005), "Air pollution causes early deaths": BBC. Available at: <http://news.bbc.co.uk/2/hi/health/4283295.stm> [2015].
- Fanger, P.O. (1970), *Thermal Comfort. Analysis and Applications in Environmental Engineering.*, Danish Technical Press, Copenhagen.

- Ferguson, G. and Woodbury, A. (2004), "Subsurface heat flow in an urban environment". *J. Geophys. Res.*, Vol. 109, pp. B02402.
- Fiala, D., Havenith, G., Bröde, P., Kampmann, B. and Jendritzky, G. (2012), "UTCI-Fiala multi-node model of human heat transfer and temperature regulation". *International journal of biometeorology*, Vol. 56, No. 3, pp. 429-441.
- Fischer, P., Brunekreef, B. and Lebrecht, E. (2004), "Air pollution related deaths during the 2003 heat wave in the Netherlands". *Atmospheric Environment*, Vol. 38, No. 8, pp. 1083-1085.
- Fröhlich, D. and Matzarakis, A. 2014. Human-biometeorological estimation of adaptation- and mitigation potential of urban green in Southwest Germany. *Third International Conference on Countermeasures to Urban Heat Island*. Venice, Italy.
- Garssen, J. and Harmsen, C. (2010), "Door recente hitte 500 extra doden": CBS. Available at: <http://www.cbs.nl/nl-NL/menu/themas/bevolking/publicaties/artikelen/archief/2010/2010-3172-wm.htm> [Accessed 19 July 2010].
- Garssen, J., Harmsen, C. and De Beer, J. (2005), "The effect of the summer 2003 heat wave on mortality in the Netherlands". *Euro Surveill*, Vol. 10, No. 7, pp. 165-8.
- Hancock, P.A., Ross, J.M. and Szalma, J.L. (2007), "A meta-analysis of performance response under thermal stressors". *Human Factors: The Journal of the Human Factors and Ergonomics Society*, Vol. 49, No. 5, pp. 851-877.
- Harding, R. and Blyth, E. 2011. Researchers provide extensive analysis of the world's water cycle. NERC - Centre for Ecology & Hydrology.
- Harmsen, C. and Garssen, J. (2006), "Door hitte in juli duizend extra doden": CBS. Available at: <http://www.cbs.nl/nr/exeres/CA1F091F-F641-47E6-AB18-D517143A609D.htm> [2015].
- Heerkens, M. 2010. de Urban Climate Map voor Arnhem.
- Helden, L. v. (2013), "Hittemeting", NMU.
- Heusinkveld, B. (2013), "Stedelijk warmte-eiland Utrecht", Wageningen University.
- Heusinkveld, B. and Holtslag, A. (2010), "Use of a mobile platform for assessing urban heat stress in The Netherlands". *7th Conference on Biometeorology, Freiburg, 12-14 April 2010*, pp. 433-438.
- Hoeven, F. v.d. and Wandl, A. (2013), Amsterwarm. Gebiedstypologie warmte-eiland Amsterdam, TU Delft.
- Hof, S. v.t. (2009), "Klimaat-effectatlas: inspelen op klimaatverandering", Interprovinciaal Overleg.
- Höppe, P. (1999), "The physiological equivalent temperature—a universal index for the biometeorological assessment of the thermal environment". *International Journal of Biometeorology*, Vol. 43, No. 2, pp. 71-75.
- Howe, A.S. and Boden, B.P. (2007), "Heat-related illness in athletes". *The American journal of sports medicine*, Vol. 35, No. 8, pp. 1384-1395.
- Hoyois, P., Below, R., Scheuren, J.-M. and Guha-Sapir, D. (2007), "Annual Disaster Statistical Review: Numbers and Trends 2006", Centre for Research on the Epidemiology of Disasters (CREED), School of Public Health, Catholic University of Louvain Brussels, Belgium.
- Huynen, M., Hollander, A.d., Martens, P. and Mackenbach, J. (2008), "Mondiale milieuveranderingen en volksgezondheid: stand van de kennis". *Bilthoven: RIVM*.
- Huynen, M., Martens, P., Schram, D., Weijenberg, M. and Kunst, A. (2001), "The impact of heat waves and cold spells on mortality rates in the Dutch population". *Environmental health perspectives*, Vol. 109, No. 5, pp. 463.
- IPCC (2014a), "Climate Change 2014: Synthesis Report. Contribution of Working Groups I, II and III to the Fifth Assessment Report of the Intergovernmental Panel on Climate Change", Geneva, Switzerland.
- IPCC (2014b), "Summary for policymakers", Cambridge, United Kingdom and New York, NY, USA.
- Jansen, S. (2013), Exergy in the built environment. The added value of exergy in the assessment and development of energy systems for the built environment., Delft University of Technology.
- Janssen, S.A., Vos, H., Kluzenaar, Y. d., Berg, J.F. v.d., Hofman, A. and Tiemeijer, H. (2011), "De relatie tussen omgevingstemperatuur en slaapkwaliteit van ouderen", De relatie tussen omgevingstemperatuur en slaapkwaliteit van ouderen, TNO.
- Jendritzky, G., Maarouf, A. and Staiger, H. 2001. Looking for a Universal Thermal Climate Index UTCI for Outdoor Applications. *Windsor-Conference on Thermal Standards*. Windsor, UK.
- Jong, K. d. (2010), Warmte in Nederland. Warmte- en koudenetten in de praktijk, mauritsgroen mgmc.
- Jonkhoff, W., Koops, O., Krogt, R.A.A.v.d., Oude-Essink, G.H.P. and Rietveld, E. (2008), "Economische effecten van klimaatverandering. Overstroming en verzilting in scenario's, modellen en cases", 2008-D-R0711/A, TNO Bouw en Ondergrond.
- Kleerekoper, L. (2009), Urban Heat. Design principles for Urban Heat Management in the Netherlands, TU Delft.

- Kleerekoper, L., Esch, M. v. and Salcedo, T.B. (2012), "How to make a city climate-proof, addressing the urban heat island effect". *Resources, Conservation and Recycling*, Vol. 64, No. 0, pp. 30-38.
- Klein Tank, A.M.G. and Sluijter, R. (2003), "Nederland is verder opgewarmd. De toestand van het klimaat in Nederland 2003". KNMI. Available at: http://www.knmi.nl/cms/content/71542/nederland_is_verder_opgewarmd 2015].
- Klok, L., Schaminee, S., Duyzer, J. and Steeneveld, G.J. (2012), "De stedelijke hitte-eilanden van Nederland in kaart gebracht met satellietbeelden", TNO, Climate Proof Cities, Kennis voor Klimaat.
- KNMI (2009), "Klimaatschetsboek Nederland, het huidige en toekomstige klimaat", De Bilt.
- KNMI (2013), "Hittegolf. Nader verklaard". Available at: <http://www.knmi.nl/cms/content/28253/hittegolf> 2015].
- Kovats, R.S. and Hajat, S. (2008), "Heat stress and public health: a critical review". *Annu. Rev. Public Health*, Vol. 29, pp. 41-55.
- Kravčík, M., Pokorný, J., Kohutiar, J., Kovac, M. and Toth, E. (2007), "Water for the Recovery of the Climate-A New Water Paradigm".
- Kunst, A.E., Looman, C.W. and Mackenbach, J.P. (1993), "Outdoor air temperature and mortality in the Netherlands: a time-series analysis". *American Journal of epidemiology*, Vol. 137, No. 3, pp. 331-341.
- Kurvers, S. and Leijten, J. 2007. Zomerwarmte in kantoren. *NVvA, Thema: Warmte belasting*. Nederlandse Vereniging voor Arbeidshygiene.
- Le Tertre, A., Lefranc, A., Eilstein, D., Declercq, C., Medina, S., Blanchard, M., Chardon, B., Fabre, P., Filleul, L. and Jusot, J. (2006), "Impact of the 2003 heatwave on all-cause mortality in 9 French cities". *Epidemiology*, Vol. 17, No. 1, pp. 75.
- Lenderink, G., Mok, H., Lee, T. and Van Oldenborgh, G. (2011a), "Scaling and trends of hourly precipitation extremes in two different climate zones-Hong Kong and the Netherlands". *Hydrology and Earth System Sciences*, Vol. 15, No. 9, pp. 3033-3041.
- Lenderink, G., Oldenborgh, G.J.v., Meijgaard, E.v. and Attema, J. (2011b), "Intensiteit van extreme neerslag in een veranderend klimaat", KNMI.
- Lenzholzer, S. (2013), *Het weer in de stad. Hoe ontwerp het stadsklimaat bepaalt*, Nai010 uitgevers, Rotterdam.
- Lier, A. v., Rahamat-Langendoen, J. and Vliet, H. v. (2007), *Staat van Infectieziekten in Nederland 2006*, RIVM [Host].
- Ligtvoet, W., Bregman, B., Dorland, R. v., Brinke, W. t., Vos, R. d., Petersen, A. and Visser, H. (2015), "Klimaatverandering. Samenvatting van het vijfde IPCC-assessment en een vertaling naar Nederland", ISBN: 978-94-91506-89-5, PBL (Planbureau voor de Leefomgeving), KNMI (Koninklijk Nederlands Meteorologisch Instituut), Den Haag.
- Mairiaux, P. and Malchaire, J. (1985), "Workers self-pacing in hot conditions: A case study". *Applied Ergonomics*, Vol. 16, No. 2, pp. 85-90.
- Matzarakis, A. and Amelung, B. 2008. Physiological Equivalent Temperature as Indicator for Impacts of Climate Change on Thermal Comfort of Humans. *Seasonal Forecasts, Climatic Change and Human Health*. Netherlands: Springer.
- Matzarakis, A., Mayer, H. and Iziomon, M.G. (1999), "Applications of a universal thermal index: physiological equivalent temperature". *International Journal of Biometeorology*, Vol. 43, No. 2, pp. 76-84.
- Mayer, H. and Höppe, P. (1987), "Thermal comfort of man in different urban environments". *Theoretical and Applied Climatology*, Vol. 38, No. 1, pp. 43-49.
- Moinbiot, G. (2007), *Hitte*, Jan van Arkel, Utrecht.
- Oke, T.R. (1973), "City size and the urban heat island". *Atmospheric Environment (1967)*, Vol. 7, No. 8, pp. 769-779.
- Oke, T.R. (1982), "The energetic basis of the urban heat island". *Quarterly Journal of the Royal Meteorological Society*, Vol. 108, No. 455, pp. 1-24.
- Oke, T.R. (1987), *Boundary Layer Climates*, Routledge, New York.
- Olgay, V. (1963), *Design with climate. Bioclimatic approach to architectural regionalism*, Princeton University Press, Princeton, New Jersey.
- PBL (2011), "Hoeveel nieuwe woningen moeten er in de komende tien jaar nog worden gebouwd in Nederland?". Available at: http://www.pbl.nl/nl/dossiers/wonen/veelgestelde_vragen [Accessed 19 January 2011].
- Perovich, D.K. (2011), "The changing Arctic sea ice cover". *Oceanography*, Vol. 24, No. 3, pp. 162-173.
- Perry, M. (2015), "Dangers of Exhaust Fumes". Available at: <http://www.healthguidance.org/entry/14639/1/Dangers-of-Exhaust-Fumes.html> 2015].

- Pijnappels, M.H.J. and Sedee, A.G.J. (2010), "Klimaat als kans. Adaptatie aan klimaatverandering in de ruimtelijke ordening", VROM.
- Pirard, P., Vandentorren, S., Pascal, M., Laaidi, K., Le Tertre, A., Cassadou, S. and Ledrans, M. (2005), "Summary of the mortality impact assessment of the 2003 heat wave in France". *Euro surveillance: bulletin européen sur les maladies transmissibles= European communicable disease bulletin*, Vol. 10, No. 7, pp. 153.
- Programmadirectie Verstedelijking (2009), "Rijksreferentiekader Verstedelijking, Een overzicht van prioriteiten, ambtjes en mogelijke rijksbijdragen ter bepaling van de rijksinzet bij de verstedelijgingsafspraken 2010-2020", VROM, WWI, V&W, LNV, EZ en FIN.
- Raymann, R.J.E.M., Swaab, D.F. and Someren, E.J.W. v. (2008), "Skin deep: enhanced sleep depth by cutaneous temperature manipulation". *Brain*, Vol. 131, No. 2, pp. 500-513.
- Ren, C., Spit, T., Lenzholzer, S., Yim, H.L.S., Heusinkveld, B., Hove, B. v., Chen, L., Kupski, S., Burghard, R. and Katzschner, L. (2012), "Urban Climate Map System for Dutch spatial planning". *International Journal of Applied Earth Observation and Geoinformation*, Vol. 18, pp. 207-221.
- Rizwan, A.M., Dennis, L.Y.C. and Liu, C. (2008), "A review on the generation, determination and mitigation of Urban Heat Island". *Journal of Environmental Sciences*, Vol. 20, No. 1, pp. 120-128.
- Roggema, R. (2009), *Adaptation to Climate Change: A Spatial Challenge*, Springer, page 309.
- Santamouris, M. and Asimakopoulos, D. (2001), *Energy and climate in the urban built environment*, James & James London.
- Scherber, K., Langner, M. and Endlicher, W. (2014), "Spatial analysis of hospital admissions for respiratory diseases during summer months in Berlin taking bioclimatic and socio-economic aspects into account". *DIE ERDE-Journal of the Geographical Society of Berlin*, Vol. 144, No. 3-4, pp. 217-237.
- Schmidt, M., Reichmann, B. and Steffan, C. (2007), "Rainwater harvesting and evaporation for stormwater management and energy conservation". 2007, pp. 07.
- Schwartz, A. (2013), "Can The Threat Of Climate Change Make Cities Richer And Healthier?": Fast company. Available at: <http://www.fastcoexist.com/1682421/can-the-threat-of-climate-change-make-cities-richer-and-healthier>.
- Shashua-Bar, L., Pearlmutter, D. and Erell, E. (2011), "The influence of trees and grass on outdoor thermal comfort in a hot-arid environment". *International Journal of Climatology*, Vol. 31, No. 10, pp. 1498-1506.
- Slabbers, S., Klemm, W. and Verburg, A. (2010), "Proeftuin Den Haag en Arnhem", Ministerie van VROM.
- Stadtklima (2008), *Climate Booklet for Urban Development Online - Stadtebauliche Klimafibel online*, Ministry of Economy Baden-Wuerttemberg
- Environmental Protection Department of Stuttgart, Stuttgart.
- Steenefeld, G. and Hove, L.W.A. v. (2010), "Een eerste inschatting van het 'Urban Heat Island' effect voor Rotterdam en omgeving: Een modelstudie", Wageningen University and Research centre.
- Steenefeld, G., Koopmans, S., Heusinkveld, B., Hove, L. v. and Holtslag, A. (2011), "Quantifying urban heat island effects and human comfort for cities of variable size and urban morphology in the Netherlands". *J. Geophys. Res*, Vol. 116, pp. D20129.
- Sterl, A., Oldenborgh, G.J.v., Hazeleger, W. and Dijkstra, H. (2010), "Klimaat wereld Extreme maximum temperaturen in de toekomst". Available at: http://www.knmi.nl/cms/content/81151/extreme_maximum_temperaturen_in_de_toekomst.
- Tillie, N., Dobbeltstein, A.A.J.F. v.d., Doepel, D., Joubert, M., Jager, W.d. and Mayenburg, D. (2009), "Towards CO2 neutral urban planning: presenting the Rotterdam Energy Approach and Planning (REAP)". *Journal of Green Building*, Vol. 4, No. 3, pp. 103-112.
- Van Someren, E.J.W., Raymann, R.J.E.M., Scherder, E.J.A., Daanen, H.A.M. and Swaab, D.F. (2002), "Circadian and age-related modulation of thermoreception and temperature regulation: mechanisms and functional implications". *Ageing Research Reviews*, Vol. 1, No. 4, pp. 721-778.
- Verhoeven, A. (1987), *Bouwfysisch tabellarium*, TU Delft.
- Voogt, J. 2014. Extreme heat threatens Lives Of World Cup Players. *Urban Climate News*.

3 Inventory of climate adaptation measures⁵

Following up the effects of climate change in urban areas in the previous chapter, this chapter gives an inventory of the possible measures to improve urban areas in relation to thermal comfort. Many adaptation measures to improve thermal comfort also address other climate adaptation aspects such as water nuisance and draught. This inventory comprises the effects of the adaptation measures vegetation, water, urban geometry and materials and colour. Effects are given in various parameters such as air temperature, mean radiant temperature, energy reduction and range of influence. Described effects are based on literature studies and results from the *Climate Proof Cities* program. Each sub-section concludes with strategies for implementation in which the feasibility and applicability are described by examples from practise when available.

This answers the following research question:

Which urban design measures can contribute to climate adaptation, especially in terms of heat?

Sub-questions are:

- Which urban design measures can contribute to thermal comfort and heat mitigation?
- What are the effects on air temperature and human comfort according to literature?

§ 3.1 Vegetation

Vegetation cools the environment by evaporation and transpiration (evapotranspiration) and by shading surfaces that otherwise would have absorbed short-wave radiation. During the night the high sky view factor of open fields allows heat to escape fast through long-wave radiation.

5

This section is an elaborated and updated version of the Journal article: Kleerekoper, L., van Esch, M. and Salcedo, T.B. (2012), "How to make a city climate-proof, addressing the urban heat island effect". Resources, Conservation and Recycling, Vol. 64, No. 0, pp. 30-38.

There are different types of application of vegetation in urban areas: urban forests (parks), street trees, grassland, private green in gardens and green roofs or façades. Vegetation has an average cooling effect on the air temperature of 1-6°C, but is highly dependent on the amount of water the plant or tree has available (Schmidt, 2006). In the Netherlands an extensive study amongst weather amateurs indicates a decrease of the UHI with increase of vegetation cover, with the largest impact on extremely hot days (Steenefeld et al., 2011). For the city of Rotterdam a surface transformation of 10% from paved/built to green or vice versa results in 1- 1.3°C temperature difference on the neighbourhood scale according to Klok et al. (2010).

An urban forest or a park is a green area within an urbanised environment. These areas have a lower air and surface temperature and thus form a PCI (Park Cool Island). In numerous studies it is shown that vegetated areas result in PCI's. In Figure 3.1 an overview of the average, and the range of the cooling effect of a park is given. A green area doesn't have to be particularly large in order to generate a cooling effect. According to a study in Tel Aviv, a park of only 0.15 ha had an average cooling effect of 1,5°C and at noon reached a 3°C difference (Shashua-Bar & Hoffman, 2000). A study in Göteborg shows that a large green area does generate a large cooling effect. A maximum difference of 5.9°C in summer in a green area of 156 ha was measured there (Upmanis et al., 1998). A measurement with an optic fibre cable in Rotterdam, the Netherlands shows a cooling effect of trees up to 5°C (Slingerland, 2012). Important to mention is that the trees show a larger cooling effect than buildings/shadow alone. This attempt to indicate a general effect of vegetation on human thermal comfort by analysing measurements presented in literature does give some indication of cooling effects, however, fail in comparing green measures due to a limitation in thermal comfort indicators. The most common indicator in the literature studies to measure effects is air temperature. While T_{mrt} , wind speed and relative humidity are as important. In fact, a thermal comfort indicator should be used instead, as explained in Chapter 2. Recent studies: in Utrecht traverse bicycle measurements have been performed to analyse thermal comfort. Two days of measurements on the 24th of July and 18th of August 2012 show a maximum difference between park and urban area of (Klemm et al., 2015)

When using PCI for cooling, the effect on the periphery is very important. The effect is variable, depending on airflow and other climatological circumstances. The studies mentioned above show an effect at 100 meters distance from the PCI in Tel Aviv and an effect at 1100 meters distance from Göteborg's PCI. The average range of the effect is 630 m based on the studies in Figure 3.1 (above). The effect of a PCI on the surrounding built-up area is not only depending on the size of the park. So do buildings parallel to the park border prevent intrusion of air from the park into the built-up area next to it (Upmanis et al., 1998). The park design is also playing a role: many trees providing shade whilst blocking airflow or green meadows receiving full radiation loads but cooling down quickly at night. Small and spread green has the potential to

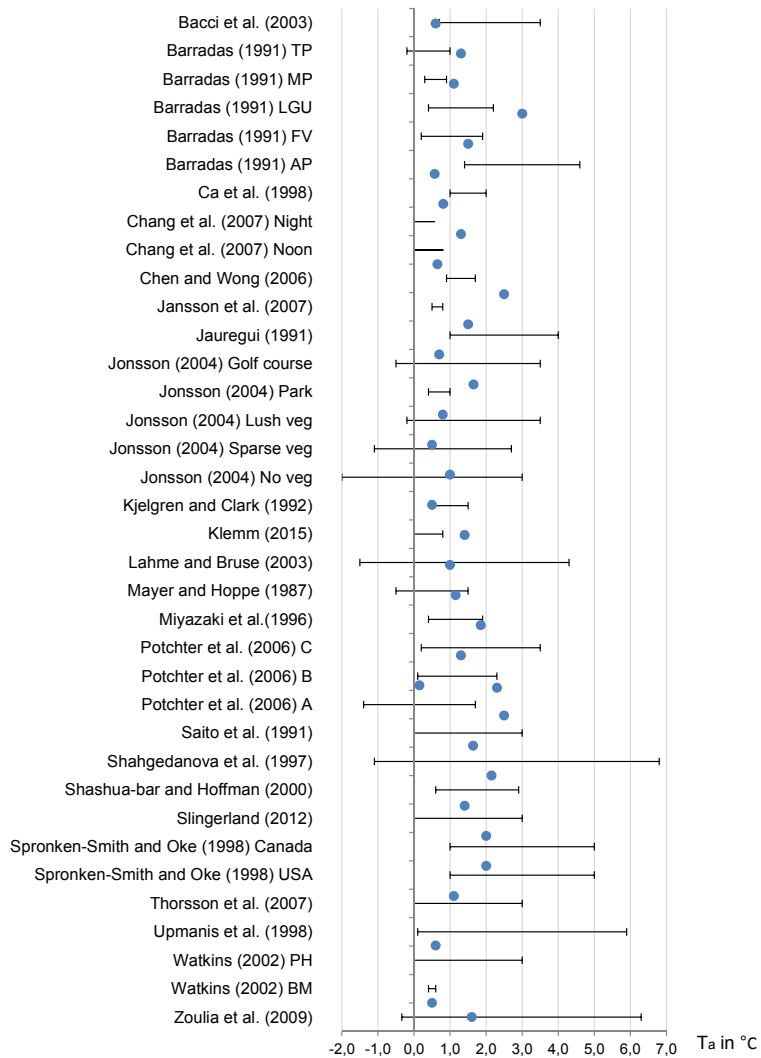

FIGURE 3.1 Park Cool Island effect measured in air temperature (Ta) in °C, an updated version of a graph by Bowler et al. (2010).

cool more urban surface than large parks with the same size in in total (Kuypers et al., 2008), see Figure 3.2.

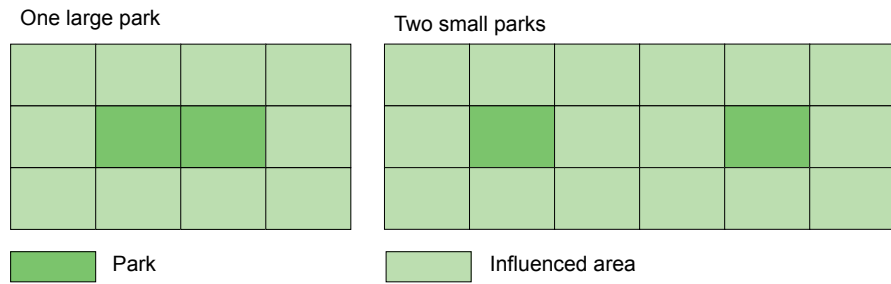

FIGURE 3.2 Two small parks may have a larger cooling influence than one large park of the same size in total (Kuypers et al., 2008).

Street trees

Street trees might seem to have a low impact on the temperature within the city because they are so dispersed, but since there are so many they actually have a big impact. On a sunny day the evapotranspiration of a tree alone cools with a power equal to 20-30 kW, a power comparable to that of more than 10 air-conditioning units (Kravčik et al., 2007). Measurements by Shashua-Bar et al. (2011) show an effect of three mature trees compared to no trees: the normalized index of thermal stress (ITS) reaches 520W without trees and 180W with trees. Trees show to have the best cooling performance in relation to thermal comfort. When looking at a larger area model runs for different climate scenarios for the Greater Manchester area in the UK show that an addition of 10% green cover (street trees and green corridors) will keep temperatures at or below current temperatures for a high emission scenario up to 2080. But a 10% decrease in urban green, which is in line with current developments, results in an increase of maximum surface temperatures of up to 8.2°C under a high emission scenario (Walsh et al., 2007). More about the effect of green on surface temperatures is described in section 3.4.

Street trees do have unwanted side effects when they, for example, block the sun in late autumn, winter or early spring or when trees damage or dirty parked cars. Such side effects can be minimised by careful selection of tree species per location. For a tree to shade a large surface of the canopy for cooling and not blocking sun for heating indoors in the cooler seasons a study of shadow patterns by Hotkevica (2013) can assist in selecting tree species and location, see Figure 3.3.

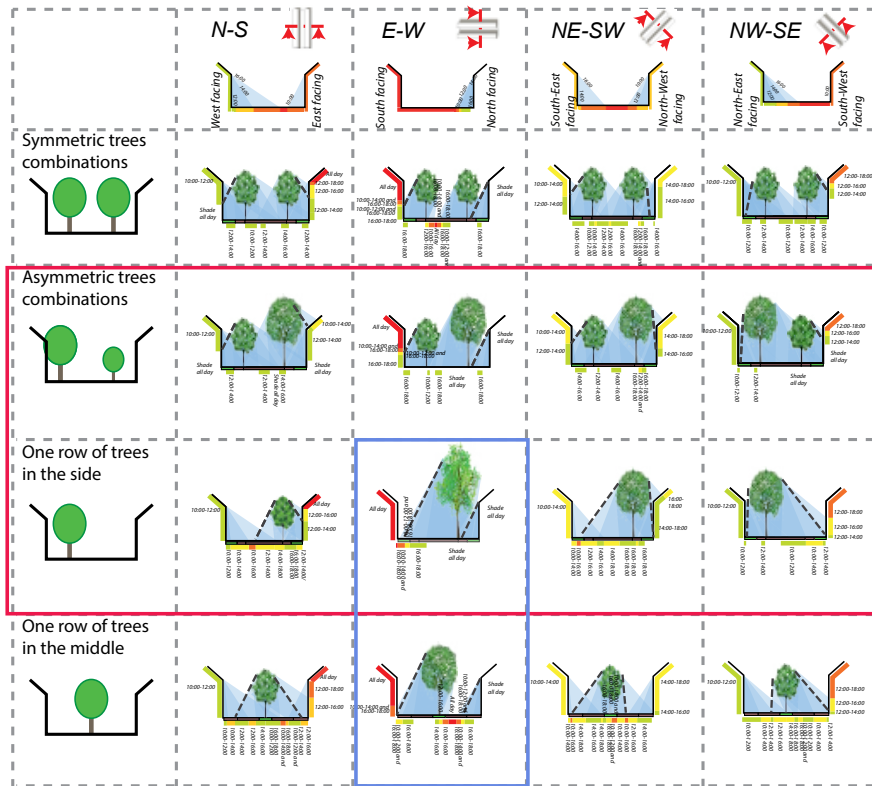

FIGURE 3.3 Selection of the most suitable solutions for street shading and keeping the solar access for the walls/windows (Hotkević, 2013)

Cooling or not?

Vegetation is not always cooler than its surrounding built environment. In winter, trees (and other objects like buildings) break the wind and obstruct long wave radiation, providing shelter and slowing down heat loss to the atmosphere. The same process occurs in summer after sunset causing areas with a lot of trees to cool down slower than areas without trees. The difference in thermal comfort between streets with and without trees is limited because of the shadow casts by the trees during the day (Wong et al., 2007), preventing heating of the stony surfaces. A meadow, opposite to trees, cooling fast after sunset due to the large sky view factor⁶, and it has a short period after sunrise in which it is cooling the environment. A drained and mowed field has a higher surface temperature than a natural field, with a maximum difference of 23°C (Kravčik et al., 2007).

6

The fraction of sky visible when viewed from the ground up from: Watson, I. and Johnson, G. (1987), "Graphical estimation of sky view factors in urban environments". Journal of climatology, Vol. 7, No. 2, pp. 193-197..

However, after most water is evaporated a natural grass field is not much cooler than bare soil. Note that artificial turf, like the rubber mats used on soccer fields have a reverse effect and heat up their environment more than bare soil and even built-up areas (Arrau, 2005), see Figure 3.4.

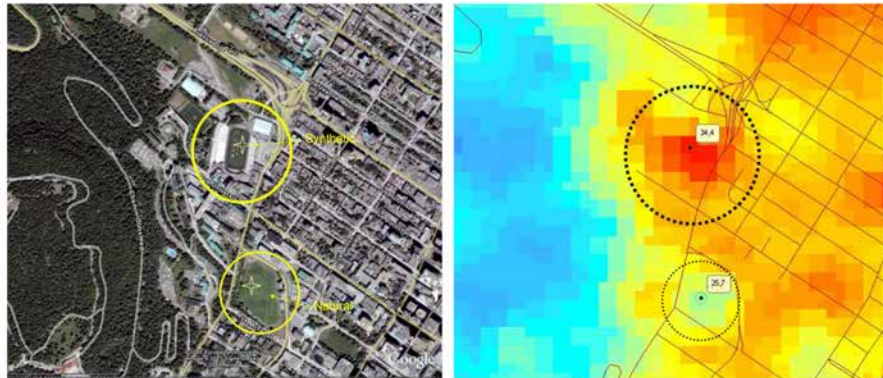

FIGURE 3.4 Aerial picture (left) and Landsat image (right) indicating the surface temperature difference between a synthetic and a natural soccer field in Montreal (Arrau, 2005).

Psychological effects

Thermal comfort is not only determined by physical processes, also psychological aspects play a role. Green urban spaces are perceived more comfortable than built environments without green (Klemm et al., 2015). Already the sight of green can improve thermal comfort. This can be all kind of green, however the green at eye level is most effective (Klemm et al., 2013). Therefore, green in front gardens or vertical façade greening can be more effective compared to (high) street trees.

Green roofs and facades

Covering a roof or façade with vegetation has a cooling effect on the urban environment and the building itself. The responsible cooling mechanisms of a green roof or facade are: evapotranspiration of the leaves, converting heat into latent heat by evaporation from the soil and preventing the absorption of short-wave radiation by low albedo materials and through shading. The indoor temperature also reduces because of the high insulation value of the green package, which will keep the heat outside in summer and inside in the winter. A measurement study in Singapore shows a maximum cooling effect of 3.3°C at 0.15 m from the green façade (Todorovic, 2013). In a review of studies done by Kikegawa et al. (2006), the effect of green facades was measured for the outdoor temperature and the effect on air-conditioner savings. The greening leads to an average decrease of 0.2–1.2°C in the near-ground air temperature and results in

a cooling energy saving of 4-40%. A study by Alexandri & Jones (2008) shows an even larger effect of green facades on energy savings ranging from 90% to 35% depending on the climate. Surface temperatures reduce a lot, for example 10-12 °C by climbing vines (Givoni, 1991). A study by wonen.nl (2010) indicates that roughly two green facades have the same cooling and air filtering capacity compared to ten mature trees. The shading of windows and west-facing walls provides the most savings in cooling energy (McPherson, 1994). A measurement study performed in the Netherlands by Ottelé et al. (2010) shows a reduction of the air temperature of 6 °C at 10cm from a green façade, which is reduced to 1 °C cooling at a meter distance. Numerous studies stress the importance of irrigation of green facades (Fallmann & Emeis, 2014, Schmidt, 2006). One litre per day per m² is sufficient for effective cooling (Hoelscher et al., 2014).

In a study by Köhler et al. (2002) an extensive green roof in Germany is tested and shows a lower surface temperature of 10 °C compared to the conventional bitumen roof. Here the cooling due to the evaporation of water is visible in the surface temperature, after all water is evaporated the isolation value of the substrate prevents the indoor spaces from heating up. Note that green roofs on high-rise buildings are not affecting thermal comfort at ground floor pedestrian levels (Ng et al., 2012).

Urban agriculture

For all different types of green, urban agriculture can be a feasible option to add green. The difference in effect on the UHI and thermal comfort is larger due to the irrigation of crop fields (Schwarz et al., 2012). When crops are harvested the effect of green is gone as well, nevertheless, bare soil is still an improvement in relation to the microclimate compared to a sealing of pavement, as described in paragraph 3.4. An additional advantage of growing crops in and around urban areas is the opportunity to lower a cities carbon footprint by decreasing the transportation of food (Havaligi, 2009, Okalebo et al., 2009).

Large scale effects

When looking at the larger scale, the cities surroundings are of influence on the inner-city climate. Although the UHI may increase with a cooler surrounding landscape, the average temperatures in urban areas may be lower. A forest or a desert like surrounding play a large role in the actual UHI value. If the aim is to control urban microclimates and prevent overheating, how should we organize the cities surroundings? Should we keep the surroundings of cities open, grow forests or create wetlands to profit from cooling in the urbanized areas? There is not a clear general answer to this matter. However, specific cases show for example that irrigated landscapes and the amount of vegetation have a cooling effect. A study by Gober et al. (2009) in Phoenix, USA, found that increasing irrigated landscapes lowers night time temperatures. Wetlands around

Beijing are 1-5°C cooler compared to downtown (Sun et al., 2012). And another study in China shows that urbanisation of rural areas does not affect temperatures when waterbodies and vegetation is kept at the same level. While temperatures do increase significantly when the urbanisation coincides with less vegetation or water (He et al., 2007). In section 3.2 about water, the relation between water and cooling effects is described more elaborately.

Additional benefits of vegetation

Air pollution reduction is an important ecosystem service vegetation provides for. The capture of particulate matter (PM) is a result of positively charged particles that are attracted by the negatively charged plants and trees. This link is stronger than the power of heavy rainfall or wind (Ottel  et al., 2010). Thus, so far all experts agree in general on the reduction of pollutants by vegetation. However, in the vicinity (0-100 m) of trees wind is obstructed and causes higher concentrations of NO_x and PM. Only with a zone of about a kilometre wide green can significantly contribute to a decrease of pollutants (Kraai et al., 2009). Measurements along a highway indicate a reduction of pollution up to 200 meters. At a further distance the influence of background concentrations becomes dominant (Hofschreuder et al., 2010). With this research Rijkswaterstaat (Ministry of Infrastructure and the Environment) has proved there is no need to plant trees for them because this would not lead to a decrease in their responsibility area. However, urban areas close to highways will benefit from the effect of trees along the highway but this is the responsibility of VROM (Schildwacht, 2010).

A sound barrier can be designed to reduce pollutants as well, using blackthorn branches and salted water (Blokland et al., 2009) or using high voltage wired screens (Ottel  et al., 2010). Within urban areas a mix of species should be planted that effectively filters out PM, nitrogen oxides (NO+NO₂), ozone (O₃) and volatile organic compounds (VOC's) (Hiemstra et al., 2008). In Table 3.1 the effectiveness per specie is given. Another way in which trees reduce air pollution is the emission reduction from cars parked in the shade (Scott et al., 1999). Besides the capture of unhealthy elements, vegetation also binds CO₂. Interestingly trees in cities grow eight times faster in urban than in rural areas (Searle et al., 2012), resulting in more CO₂ reduction per tree in cities.

Pine trees are better in filtering the air than Lime trees, respectively 19% and 10% (Hofschreuder et al., 2010).

Next to the reduction of air pollution, vegetation also reduces water pollution. Vegetation has the capability to bind heavy metals and nutrients in the soil and prevents discharge into groundwater or streams and rivers. A study by (Johnston & Newton, 2004) shows a decrease of 95% of cadmium, copper and lead can be taken out of rainwater and 16% of zinc. Also nitrogen levels reduce dramatically.

Vegetation has the potential to reduce energy consumption for cooling. Decreasing the outdoor temperature with 1 °C leads to a reduction of 6.6% electric energy demand to cool indoor in a city like Tokyo (Kondo & Kikegawa, 2003).

Urban green provides special habitats and increases biodiversity (McPherson et al., 1997). In Zurich, Switzerland, studies show that locally and regionally endangered species benefit from green roofs with natural soils from nearby and varying substrate thickness (Brenneisen, 2006). A study by Jokimaki (1999) in Oulu, Finland, indicates an increase of breeding bird species with an increase of park size, however, some species are more abundant in the smaller than in the larger parks. Many bird species have difficulties surviving the sealed and bare city landscapes. A green façade offers both resting and nesting place to the house sparrow, blackbird, song thrush, robin, starling, wren and chickadees (wonen.nl, 2010).

Water management and maintenance of biodiversity are crucial services that are anchored in landscape design. A better incorporation of the landscape as part of urban design offers great potential “to achieve identity and a sense of place” (Lehmann, 2007, page 70). The work by architects and landscape designers such as MVRDV, Ken Yeang or West 8 is aiming at this connection with the landscape and at introducing innovative green concept in buildings. “More green can make people care more about their neighbourhood and therefore are willing to work for it”, is the conclusion from a study by McCunn & Gifford (2014). Neighbourhood commitment was significantly associated with the number of ‘green’ neighbourhood attributes.

The connections we as humans subconsciously seek with nature are rooted in our biology according to Kellert & Wilson (1993). Biophilia, an hypothesis they believe in, is the innately emotional affiliation of human beings to other living organisms. “It

SPECIE	PARTICULATE MATTER PM10	NITROGEN OXIDES NO+NO ₂	OZONE O ₃	EMISSION OF VOLATILE ORGANIC COMPOUNDS
SHRUB				
<i>Amelanchier lamarckii</i>	■	■	■	●
<i>Berberis xfrickartii</i> *	■ ■	■ ■	■ ■	■ ■ ■
<i>Chaenomeles</i>	■	■ ■	■ ■	■ ■ ■
<i>Corylus colurna</i>	■ ■	■ ■	■ ■	+
<i>Euonymus (bladverliezend)</i>	■ ■ ■	■ ■ ■	+	●
<i>Euonymus (bladhoudend)</i>	■ ■ ■	■ ■ ■	+	●
<i>Hedera</i>	■ ■	■ ■	■ ■	●
<i>Ilex xmeserveae</i>	■ ■	■ ■	■ ■	+
<i>Lonicera (bladverliezend)</i>	■ ■	■ ■	■ ■	●
<i>Lonicera (bladhoudend)</i>	■ ■ ■	■ ■	■ ■	■ ■ ■
<i>Mahonia</i>	■ ■ ■	■ ■ ■	■ ■ ■	■ ■ ■ ■
<i>Potentilla fruticosa</i>	■ ■ ■	■ ■ ■	■ ■ ■	■ ■ ■
<i>Rosa</i>	■ ■ ■	■ ■ ■	■ ■ ■	■ ■ ■
<i>Spiraea</i>	■ ■ ■	■ ■ ■	■ ■ ■	■ ■ ■
CLIMBING PLANT				
<i>Clematis</i>	■ ■	■ ■	■ ■	●
<i>Fallopia</i>	■ ■ ■	■ ■ ■	■ ■ ■	●
<i>Hedera</i>	■ ■ ■	■ ■	■ ■	●
<i>Lonicera</i>	■ ■ ■	■ ■ ■	■ ■ ■	●
<i>Parthenocissus</i>	■ ■ ■	■ ■ ■	■ ■ ■	●
<i>Pyracantha</i>	■ ■ ■	■ ■ ■	■ ■ ■	●
<i>Rosa</i>	■ ■ ■	■ ■ ■	■ ■ ■	■ ■ ■
<i>Wisteria</i>	■ ■ ■	■ ■ ■	■ ■ ■	●
CONIFEROUS TREE				
<i>Ginkgo biloba</i> *	■ ■ ■	■ ■ ■	■ ■ ■	■ ■ ■
<i>Metasequoia glyptostroboides</i>	■ ■ ■	■ ■ ■	■ ■ ■	■ ■ ■
<i>Pinus nigra</i>	■ ■ ■	■ ■ ■	■ ■ ■	+
<i>Pinus sylvestris</i> *	■ ■ ■	■ ■ ■	■ ■ ■	■ ■ ■
<i>Taxus</i>	■ ■ ■	■ ■ ■	■ ■ ■	■ ■ ■
HEDGE				
<i>Carpinus betulus</i>	■ ■ ■	■ ■ ■	■ ■ ■	■ ■ ■
<i>Fagus</i>	■ ■ ■	■ ■ ■	■ ■ ■	●
<i>Ligustrum</i>	■ ■ ■	■ ■ ■	■ ■ ■	●
DECIDUOUS TREE				
<i>Acer platanoides</i> *	■ ■ ■	■ ■ ■	■ ■ ■	+
<i>Acer pseudoplatanus</i> *	■ ■ ■	■ ■ ■	■ ■ ■	+
<i>Aesculus</i>	■ ■ ■	■ ■ ■	■ ■ ■	●
<i>Ailanthus altissima</i>	■ ■ ■	■ ■ ■	■ ■ ■	■ ■ ■
<i>Alnus cordata</i>	■ ■ ■	■ ■ ■	■ ■ ■	+
<i>Alnus glutinosa</i> *	■ ■ ■	■ ■ ■	■ ■ ■	+
<i>Alnus xspaethii</i>	■ ■ ■	■ ■ ■	■ ■ ■	+
<i>Betula ermanii</i> *	■ ■ ■	■ ■ ■	■ ■ ■	+
<i>Betula nigra</i>	■ ■ ■	■ ■ ■	■ ■ ■	+
<i>Betula pendula</i>	■ ■ ■	■ ■ ■	■ ■ ■	+
<i>Betula utilis</i> *	■ ■ ■	■ ■ ■	■ ■ ■	+
<i>Carpinus betulus</i> *	■ ■ ■	■ ■ ■	■ ■ ■	■ ■ ■
<i>Crataegus xpersimilis</i> *	■ ■ ■	■ ■ ■	■ ■ ■	+
<i>Fagus sylvatica</i> *	■ ■ ■	■ ■ ■	■ ■ ■	●
<i>Fraxinus angustifolia</i> *	■ ■ ■	■ ■ ■	■ ■ ■	●
<i>Fraxinus excelsior</i> *	■ ■ ■	■ ■ ■	■ ■ ■	+
<i>Fraxinus ornus</i> *	■ ■ ■	■ ■ ■	■ ■ ■	●
<i>Fraxinus pennsylvanica</i>	■ ■ ■	■ ■ ■	■ ■ ■	●
<i>Gleditsia triacanthos</i> *	■ ■ ■	■ ■ ■	■ ■ ■	●
<i>Koelreuteria paniculata</i>	■ ■ ■	■ ■ ■	■ ■ ■	■ ■ ■ ■
<i>Liquidambar styraciflua</i>	■ ■ ■	■ ■ ■	■ ■ ■	■ ■ ■ ■
<i>Liriodendron tulipifera</i>	■ ■ ■	■ ■ ■	■ ■ ■	●
<i>Magnolia kobus</i>	■ ■ ■	■ ■ ■	■ ■ ■	■ ■ ■
<i>Malus</i> *	■ ■ ■	■ ■ ■	■ ■ ■	+
<i>Parrotia persica</i>	■ ■ ■	■ ■ ■	■ ■ ■	■ ■ ■ ■
<i>Platanus xhispanica</i> *	■ ■ ■	■ ■ ■	■ ■ ■	■ ■ ■ ■
<i>Populus</i> *	■ ■ ■	■ ■ ■	+	-
<i>Prunus</i> *	■ ■ ■	■ ■ ■	+	●
<i>Pyrus calleryana</i> *	■ ■ ■	■ ■ ■	■ ■ ■	●
<i>Quercus palustris</i>	■ ■ ■	■ ■ ■	+	-
<i>Quercus robur</i> *	■ ■ ■	■ ■ ■	+	-
<i>Salix alba</i> *	■ ■ ■	■ ■ ■	+	-
<i>Sophora japonica</i>	■ ■ ■	■ ■ ■	■ ■ ■	●
<i>Sorbus</i>	■ ■ ■	■ ■ ■	■ ■ ■	+
<i>Tilia cordata</i> *	■ ■ ■	■ ■ ■	■ ■ ■	■ ■ ■
<i>Tilia europaea</i> *	■ ■ ■	■ ■ ■	■ ■ ■	+
<i>Ulmus</i> *	■ ■ ■	■ ■ ■	■ ■ ■	+

* Given indicators are also valid for cultivars of the specie

■ : Least effective
 ■ ■ ■ : Most effective
 ■ ■ ■ ■ : Low emission
 ■ ■ ■ ■ ■ : High emission

+ Species that absorb high amounts of NO-NO₂
 + Species that lower ozone concentrations in urban areas effectively
 - Species that increase ozone concentrations in urban areas
 ● The emission of VOC's is not measurable for these species

TABLE 3.1 Effectiveness of most common species to lower the concentrations of PM, nitrogen oxides and ozone in the air (Hiemstra et al., 2008), based on studies by Donovan et al. (2005), Nowak (1995) and (Takahashi et al., 2005).

suggests that when human beings remove themselves from the natural environment, the biophilic learning rules are not replaced by modern versions equally well adapted to artefacts. Instead, they persist from generation to generation, atrophied and fitfully manifested in the artificial new environments into which technology has catapulted humanity". Therefore, humans still benefit from natural elements which manifests in for example the cost reduction for health care and medicines by green (Meier-Boschaart, 2011). This is partly related to the mental aspect, partly to the capability of green to reduce air pollution and to reduce temperatures. The numbers of heat related mortality described in paragraph 2.4.1 can be reduced by green according to a study in Melbourne; an increase of the vegetation coverage from 15% to 33% may reduce the average heat related mortality rate between 5% to 28% (Chen et al., 2014).

Green increases real estate values. Housing values can increase with 5% by greening the neighbourhood (Meier-Boschaart, 2011). Additional green has the potential to boost the existing housing stock in areas with a lot of vacancy due to shrinking. Some practical examples are given in the following sub-section.

CO-BENEFITS OF GREEN:

supports the recreational, experiential and health requirements of local people, as well as visitors;

- contributes to the way they encourage people to spend leisure time locally by reducing vehicle usage;
- increases neighbourhood commitment;
- allows urban dwellers the opportunity of being in places experienced as relatively quiet and 'different' from the city streets;
- fosters a feeling of community pride in a local area;
- supports the development and maintenance of biodiversity in urban areas;
- supports the local management of water flows and quality (rainwater drainage, sewage treatment);
- allows local composting of biodegradable waste;
- contributes to cleaning particulates out of the air, through their tree and shrub cover;
- contributes to cleaning pollutants from water;
- helps reduce the urban 'heat island' effect;
- helps reducing noise nuisance;
- increases the economic attractiveness of a city. For instance, attractive green areas can influence the decision-making processes of entrepreneurs seeking new locations for businesses, developers deciding where to invest, and tourists deciding where to visit;
- reduces energy consumption in especially summer when placed in right position;
- binds CO₂, and therefore, can be part of CO₂ reduction strategies;
- lengthens the lifespan of roofs in case of green roofs.

Beer et al., 2003, Bolund & Hunhammar, 1999) and others

Strategies for implementation

Applying more green in public spaces has a relative low cost and high acceptance among citizens. Projected benefits when planting trees is nearly three times the value of projected costs with payback periods ranging from 9 to 18 years (McPherson et al., 1997). The most effective green elements are street trees (Rosenzweig, 2006), therefore, the greening policies of different pioneer cities have had clear goals concerning the increase of the total number of trees and their heterogeneity to assure resistance to vegetal diseases (ill trees rarely affect trees from different families). Examples of these policies are given by cities like Chicago that developed green urban design guidelines (Daley, 2008) and the city of Edinburgh council that developed a quality assessment system for parks together with the organisation of partnerships, communication, promotion, finance and maintenance planning (Cairns, 2006).

Even though greening public spaces is mainly a responsibility of the municipality, it is feasible and recommendable to involve citizens in the initiative as this topic has a high public acceptance (Greenspace, 2005). Public participation has been successfully achieved in different greening initiatives. In Paris, for example, where gardening around trees was encouraged. In the Netherlands there is no special program to encourage the participation of citizens into greening the public space, however, it is commonly done and it is visible in cities like Amsterdam where some of the bricks of the sidewalks have been removed to give space to ornamental plants (Fassbinder, 2009). An option could be to locate part of the returns from new developments into a fund or an owners association that is responsible for the installation and maintenance of green (Meier-Boschaart, 2011). The most famous park in The Netherlands, The Vondelpark in Amsterdam was also an initiative from inhabitants to maintain their housing values, which was more than successful.

The involvement of citizens is even more important in long time span initiatives as in Chicago, where the first programs were mainly focused on the public space, but after 15 years of greening the city the focus nowadays is on private spaces. Increasing tree cover in this city with 10% or planting about three trees per building lot saves annual heating and cooling costs by an estimated \$50 to \$90 per dwelling according to (McPherson et al., 1997). The free tree planting service of the City of Chicago (2014) investigates the area where you want the tree to be planted and you can indicate which specie has your preference.

The promotion of green in private spaces has a higher relevance in the case of high density cities, as the municipality is not the owner of the major part of the surfaces exposed to solar radiation. In that case, initiatives like the one in Paris promoting green façades and green terraces (Artus & Roulet, 2014), the new law in Basil, Switzerland that requires a green roof on all new buildings with a flat roof (Brenneisen, 2006), or the subsidy program of green roofs in Rotterdam are defining the future trend of adaptation strategies (Gemeente Rotterdam, 2014). The municipalities of Tilburg and Sittard-Geleen have published an overview of green measures that counteract heating of urban areas to inform and convince more people of the urgency to act (Brink, 2013).

§ 3.2 Water

Water can cool by evaporation, by absorbing heat when there is a large water mass – which functions as a heat buffer - or by transporting heat out of the area by moving, as in rivers. This is already happening in Dutch cities due to existing water applications.

Water has an average cooling effect of 1-3°C to an extent of about 30-50 meters. Water applications in general are more effective when they have a large surface, or when the water is flowing or dispersed, like from a fountain. The effect of cooling by water evaporation depends on the airflow that replaces the cooled air through the city. Cooling with water, as with PCI, is dependent on weather circumstances and on the urban context. Water does not always have a cooling effect. The largest waterbody in The Netherlands, the North Sea, has a tempering effect on extreme temperatures. During warm summer periods the sea is cooler than the land surface at daytime, this reverses at night to a warmer sea than land surface, as illustrated in Figure 3.5. The role of water is therefore ambiguous, for it can cool through evaporation or possibly warm the city because stagnant water bodies store heat (Albers et al., 2015).

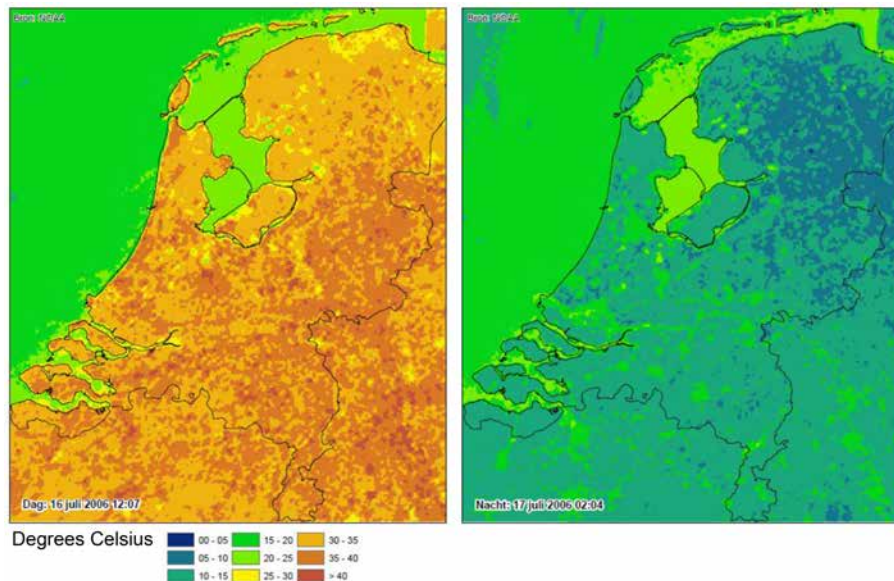

FIGURE 3.5 Surface temperature images (NOAA-AVRR) for the 16th of July 2006 on midday (left) and the 17th of July 2006 at night (right) (Klok et al., 2012).

A numerical model was developed to model the cooling effect of a water pond (Robitu et al., 2006). This study shows a cooling of the surface temperature with 29°C and an effective cooling by evaporation with sufficient air flow above the pond. In Japan, a study at a riverside showed a cooling of 2°C at a distance of 50 meters from the shore (Sukopp & Wittig, 1998) in (Milošovičová, 2010). Measurements at a small river running through the urban environment in Sheffield, UK, indicate a cooling effect of 1°C during temperatures higher than 20°C. The cooling effect reached beyond the 30 meters from the river, while at 40 meters became negligible (Hathway & Sharples, 2012). While flowing water has a larger cooling effect than stagnant water, dispersed water like from a fountain has the biggest cooling effect. Another study in Japan shows air temperature measurements on the leeward side of a fountain with a reduction of approximately 3°C. The effect of the water system can be felt (from 14.00 to 15.00 hours) up to 35 m distance (Nishimura et al., 1998).

Figure 3.6 shows the amount of solar energy reaching the earth by radiation in one year in relation with the energy flux of the total amount of evaporation in one year. This energy flux is enormous in comparison to the world's energy consumption of one year (Schmidt, 2006). It demonstrates the importance of the evaporation of water for the temperature on our planet. Also on the smaller neighbourhood or street scale evaporation of water has a significant cooling effect due to both evaporation and absorption.

Global Radiation in Relation of Evaporation (Latent Heat Flux)

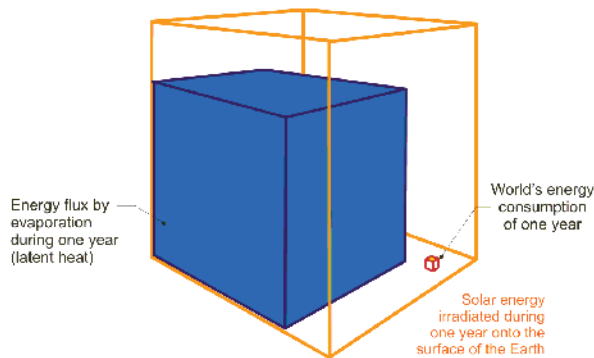

FIGURE 3.6 The amount of solar energy reaching the earth by radiation in one year in relation with the energy flux of the total amount of evaporation and the world's energy consumption in one year (Schmidt, 2006)

The Japanese have the tradition sprinkling water on the streets to cool there urban spaces. Figure 3.7 demonstrates this so called 'Uchimizu' tradition. This method proves most effective in mornings and late afternoons in direct sunlight. The temperatures drops 2-4°C by sprinkling 1L/m² per half an hour (Takahashi et al., 2010). In France preliminary test results in Lyon show a temperature reduction of

5-8°C (Wikhydro, 2013). A test in the Netherlands shows this principle is also effective for Dutch urban areas. In a test where water was sprinkled over asphalt the cooling effect was 2°C close to the ground and 1°C at a height of 2 meters when 1 mm of water evaporates. When infinite amount of water is available the cooling effect increases up to 6°C close to the ground and 2°C at a height of 2 meters (Slingerland, 2012).



FIGURE 3.7 Japanese tradition of watering the streets 'Uchimizu' (Wordpress, 2010).

Instead of a green roof, water on rooftops can have a significant cooling effect on the indoor air temperatures. Important for water on roofs is a shading device with preferably a low emissivity that prevents rapid heating of the water. A simulation study shows a decrease in the mean maximum indoor air temperature from 31.7°C to 29°C with a ventilated roof pond with an aluminium cover (AIVC, 2013, page 400 and 635).

Cooling with water has its limitations; a high moist concentration in the air slows down the evaporation process (Park, 2001, page 292). An often heard argument stating that evaporation of water is decreasing thermal comfort due to the increase of humidity is rather confusing. In fact, this is mixing up two aspects. Firstly, the increase of humidity can slow down the perspiration rate by the skin (when air temperature is above 24°C and humidity above 60% (Ihle, 2006)) and therefore decrease comfort. Secondly, the evaporation of water results in both increase of humidity and decrease of air temperature, the latter is usually more dominant in the thermal comfort sensation (Djamila et al., 2014). Nevertheless, water often has a small effect on the microclimate but it does influence the subjective perception as being felt cooler (Katzschner, 2009). Large water bodies respond slowly to heating during the day, but also cool down slowly. Therefore they can support the urban heat island effect at night (Steenveld et al., 2011).

An analysis of surface temperatures in the 73 largest cities in the Netherlands shows that cities with a larger water surface have a larger Surface Heat Island (SHI) at night. An increase of 10% surface water increases the SHI on average with 1.3°C (Klok et al., 2012).

Strategies for implementation

From a strategic point of view, the promotion of the use of water infrastructures to benefit from the evapotranspiration effect is difficult due to the high costs involved. Only the implementation of fountains can be seen as a good cost effective option in specific spaces with a high use, like commercial streets or squares. With a smart fountain design it is possible to use the same space for other purposes in winter time.

The cooling effect of large water elements is more significant in the built-up area at the lee-ward side of the water and wider streets enhance this cooling effect (Sukopp & Wittig, 1998 in Milošovičová, 2010). The design of the waterfront has a large impact on the cooling effect of a river at a height of 1.5 m. A study by Murakawa et al. (1991) demonstrates that a 4.3 m high embankment shortens the range of the cooling effect by about 70 metres.

In addition to the cooling effect from evaporation, water plays another crucial role in heat adaptation due its contribution to the increase of green infrastructure. More vegetation adds extra water buffering capacity, which is useful in case of heavy rain fall, and it increases the effectiveness of the evapotranspiration from vegetation, which depends on the amount of water available. That is why the promotion of green infrastructure must go together with the promotion of better rain water management.

FACTS ABOUT WATER USE BY PLANTS AND THE RELATION BETWEEN IRRIGATION AND COOLING:

On average plants transpire 5mm (several litres per square meter per day) on a sunny day in the temperate climate zone when sufficient water is available. However, some plants are able to evaporate as much as 20 litres of water per day (Kravčík et al., 2007);

Sap flow measurements show an increase of evaporation going further into the growing season starting from about 10 litre per day towards over 500 litres a day per tree;

Increasing irrigated landscaping lowers night time temperatures in the city of Phoenix, USA. The greatest reductions occur in the least vegetated neighbourhoods (Gober et al., 2009);

When both the city and countryside are wet, differences in the energy balance between them will be small. In dry conditions the city tends to heat up more than the countryside, while urban irrigation can mitigate (perhaps even reverse) this (Oke, 1982).

Promoting the use of permeable pavement and temporary water storage infrastructure is a beneficial strategy in case of droughts and flooding. Water storage in public spaces is one of the proposals of the city of Rotterdam in the design of new development areas of the city. Some of the designs include multifunctional spaces as in the case of the “water plaza”; a multifunctional public space for storage of rainwater surplus initiated by Urbanisten (Boer et al., 2010). The first realisation of this concept is the Bellamyplein (Figure 3.8.1) and a larger and very prestigious follow-up is the Benthemplein (Figure 3.8.2) where water storage is combined with a basketball court, skating park and outdoor theatre.



1



2

FIGURE 3.8 The neighbourhood water square Bellamyplein (1) - photo from Wijnbergh (2013) - and the city centre water square Benthemplein (2) - photo from Schubert (2014) - in Rotterdam.

On a lower scale, several municipalities in the United States are creating reference guides about pavement options for low used traffic zones, like private paths, terraces and parking spaces. In the City of Portland, Oregon, green streets, ecoroofs, trees, and other green infrastructure is used to manage stormwater, protect water quality and improve watershed health (Hauth, 2014). In Germany all water falling on the Postdammerplatz needs to evaporate or used in the adjacent buildings (Köhler et al., 2002). In The Netherlands the platform Amsterdam Rainproof involves citizens, policymakers, companies and entrepreneurs in the water management of their direct environment (Rainproof, 2014). On the website you can find examples, participate in projects and join the community via social media. Municipalities have the ability to set a clause on the drainage of rainwater from private terrain. A directive is to cope with rainfall of at least 25 mm in one hour on private property. Solutions can be technical such as a large storage tank without benefit for the local climate. But when they are adding more natural surface – such as de-paving, more vegetation or green roofs – thermal comfort will improve likewise.

Many guidelines, toolboxes and technical solutions are available for sustainable urban water management. In Appendix A you find a selection of these.

§ 3.3 Urban geometry

The built form has a relation with several heat accumulation parameters. This section starts with describing the relation of the built form with direct solar radiation, shading and radiative interaction, followed by its influence on air flow. The third relation described, concerns the volume/surface ratio and the heat accumulation in stony surfaces.

Radiation and shading

Building density and geometry are composition variables that influence the incidence of radiation on materials that can store heat, and the trapping of radiation by multiple reflections between buildings and street surface. In the morning the shadow casting of constructions cause a delay in heating (Pietersen-Theeuwes 2015). Obstruction of the sky by buildings results in a decreased long-wave radiative heat loss from street canyons. The heat is intercepted by the obstructing surfaces, and absorbed or radiated back to the canyon. Energy consumption is therefore related to urban configuration: an increase in urban density leads to an increase of inter-building effects. Especially energy consumption in dwellings, more than for example office buildings, depends on the surrounding building density and typology. Here the inter-building effect determines more than 70% of the energy demand (Pisello et al., 2014).

Overheating by solar radiation in summer can be reduced with high ratios of street height to street width (H/W) (Futcher, 2008). As in many Mediterranean cities the narrow streets create shadow (Nickson, 2007). However this may also reduce air flow, promote multiple solar reflections, trap anthropogenic heat and lower the sky view factor. These last negative effects may do more harm than the positive shading effect. Even if the measure would help in summer, in winter even more buildings will overshadow other buildings. In a cool winter climate this leads to uncomfortable situations. Therefore increasing street width is preferable to maximize solar gain in winter (Esch et al., 2012). Here individual buildings need to be designed to collect the sun and not shade others (Dobbelsteen et al., 2010, Keeffe & Martin, 2007). A better alternative to shade buildings are trees and green walls, which are green in summer and transparent in winter. Also, operable shading devices can be used in summer and can be easily removed in winter.

The previous paragraph already suggests that there is not one optimal H/W ratio general applicable in all conditions. According to Emmanuel (2005) and Oke (1988) in most cases we can aim for a H/W ratio of 0.4-0.6 if the streetscape does not consist of dark, impermeable paving and of buildings built with conventional, heat-absorbing materials but would involve sufficient greening measures, low-albedo surfaces and rainwater catchment elements (Milošovičová, 2010).

The morphology of the building blocks in cities have an influence on outdoor thermal comfort. A study that considered five urban forms in the climate of The Netherlands shows that the closed urban block (courtyard) provides the highest thermal comfort conditions. The main influencing factors are duration of direct sun and T_{mrt} (mean radiant temperature) (Taleghani et al., 2015).

The radiation load in a street is also dependent on the orientation of the street. According to a study in an idealized urban canyon by Herrmann & Matzarakis (2010) a North-South oriented street has highest values of T_{mrt} and East-West lowest values during midday. The Figure 3.9 composed by Hotkevica (2013) shows the diurnal solar exposure for summer and winter and four different H/W ratios. East-West oriented streets have a high radiation load in summer, where the South facing façade gets the full load and the North facing side of the streets remains unexposed. This offers pedestrians the choice to be in the shade or sun. In winter the radiation load is very limited. In North-South oriented streets the radiation load is higher and more distributed throughout the street over the whole day. In winter the spread and higher radiation load increases outdoor and indoor comfort and reduces energy demand for heating.

The use of arcades, or overhanging facades, is a common urban geometry in warm countries. These are most efficient for N-S and NW-SE oriented streets (Ali-Toudert & Mayer, 2007). An important side effect is the reduction of indoor daylight, especially for the higher latitude. Therefore, too much shade must be avoided (Lin et al., 2010).

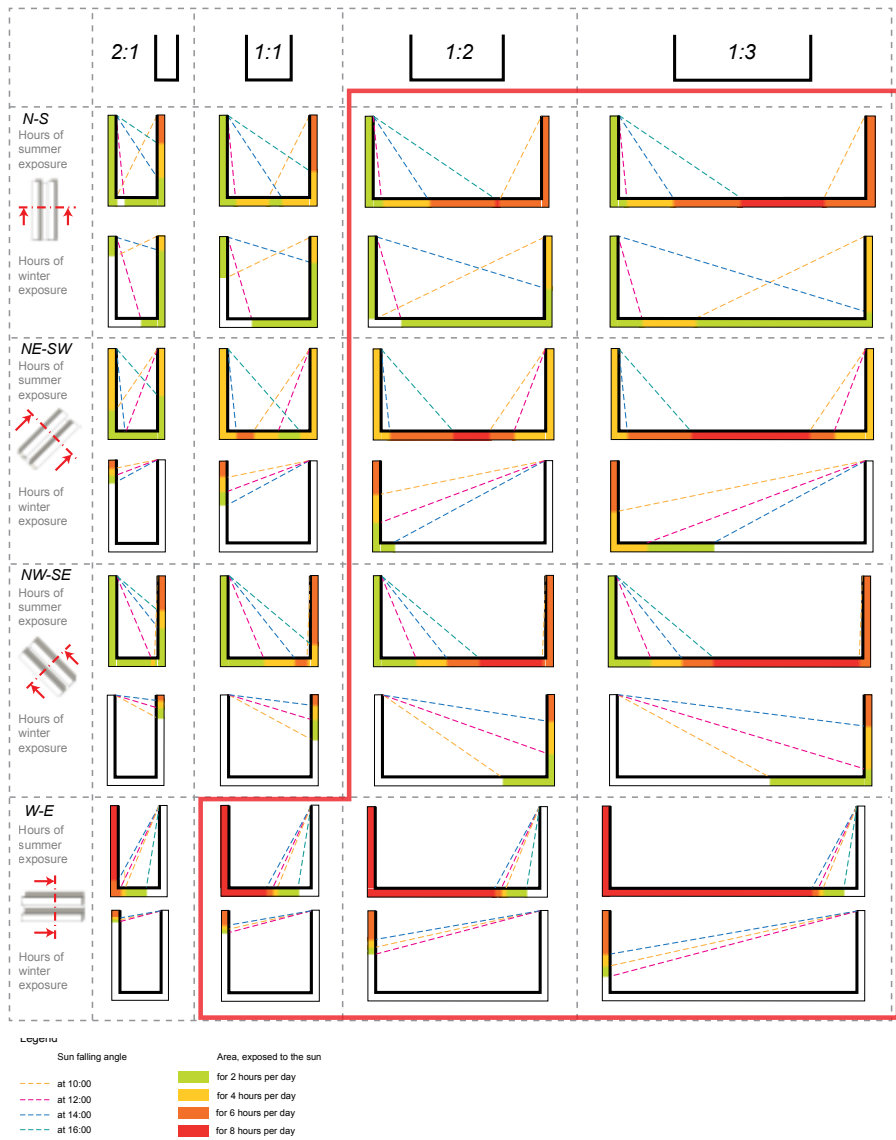

FIGURE 3.9 Diurnal solar exposure analysis of street canyons (Hotkevic, 2013).

Air flow

Built form also influences wind speed. Wind transports the turbulent heat out of a street canyon. Designing with wind can lead to effective cooling of buildings and urban areas. In many warm countries wind is an important cooling factor. In the Netherlands, wind is a controversial measure for cooling. Stimulating wind for ventilation in summer can lead to a very unpleasant or even dangerous situation in winter. The orientation of streets will therefore bring some design challenges, especially taking into account both solar and wind orientation.

Another way to improve ventilation is to generate a mix of the air in the canopy layer⁷ with the air from the boundary layer⁸. One way to obtain this mix is to adjust the canopy layout. Figure 3.10 gives the relation between H/W ratio and type of wind pattern that occurs in a canopy with wind from the side. Ventilation in street canyons is preserved at a height to width ratio up to 0.6 due to the wake interference flow regime. Streets with a H/W ratio of 0.2 or lower have a good air mixing over the entire width of the street. A H/W ratio of 0.2 and 1.6 leads to a small isolated circulation field on the leeward side which contains less fresh air. Figure 3.11 shows the characteristic vortices in relation to the H/W ratio. At a height to width ratio of more than 1.6 there is almost no mix of the canopy and boundary layer (Xiaomin et al., 2006). Another way to increase the exchange of air between the canopy and boundary layer is to introduce a mix of high and low buildings (Givoni, 1998, p. 284). The mix of the two layers also takes place with slanted roofs. These generate effective natural wind ventilation at the 'mouth' openings of urban street canyons. This is a much more effective means for improving natural ventilation than increasing building spacing according to Rafailidis (1997).

7 the air space in a street profile

8 the layer of air above the roughness elements of a surface (forest, cities, etc.)

Flow regimes		FIWF	IRF	WIF		SF	
H1/W	Sini	0.02	0.125~0.1	0.2	0.667	1.667	
	Present		0.1	0.18	0.66	1.57	
Vortices characteristic		Two co-rotative vortices			One main vortex	Contra-rotative vortices	

1

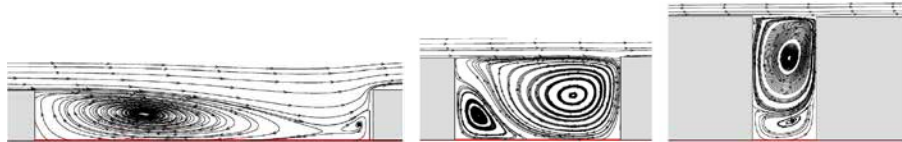

2

FIGURE 3.10 Wind patterns in a street profile in relation with the H/W ratio (1) and wind patterns for H/W ratios of 0.17 (left), 0.5 (middle), 2 (right) (2) (Xiaomin et al., 2006)..

When trees placed in the street these have a large influence on the wind pattern. Trees with a dense crown placed close to each other will deflect wind currents, while an open crown will decrease wind speed. Trees can decrease ventilation in streets, with lots of traffic this will lead to poor air quality. Because trees also provide shade and active cooling by evapotranspiration the effect on thermal comfort is not unambiguous.

To increase ventilation streets can also be oriented to the prevailing wind direction. In the Netherlands this is not favourable because of the negative effects during the winter months. During heat waves the North-Eastern wind prevails in the Netherlands. However, the yearly prevailing wind comes from the opposite direction (South-West) and during periods of cold weather, the wind, even comes from the same (South-West) direction, see Figure 3.11. Thereby, the wind speed is often very low during a heat wave which implies a limited cooling potential. Locally, there may be other prevailing wind directions, when using the prevailing wind direction also study the local prevailing direction during cold waves and stormy weather.

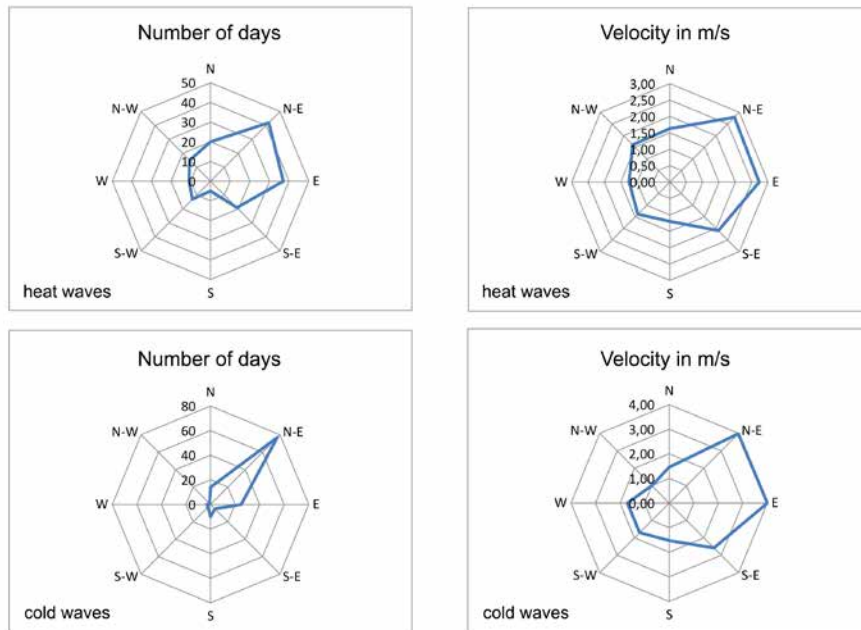

FIGURE 3.11 Wind rose giving the number of days (left) and the average wind speed (right) per cardinal direction during heat waves (above) and cold waves (below) between 1950 and 2011, based on KNMI data.

Next to varying the H/W ratio of streets, alternative building structures can modify air flow patterns. With open urban blocks or buildings in an open field deeper penetration of air into the built-up area is possible (Sukopp and Wittig, 1998, p. 158 in Milošovičová, 2010, pag 29).

In a temperate climate air flow generated due to differences in heated surfaces has a significant advantage above orienting or guiding airflow because it only increases airflow when desired. A study originally focussed on decreasing air pollution indicates that higher surface temperatures can increase the mixture of air in canopy with upper air layer when leeward side and ground is heated, when the windward side is heated an opposed recirculation motion tends to develop which causes less vertical exchange (Sini et al. 1996). Therefore, especially South-West facing facades are suitable in the generation of airflow because these are heated the most by solar radiance and are the leeward side when the prevailing wind is coming from the North-East during heatwaves.

Another principle based on airflow generation between hot and cool spots is the 'park breeze effect'. This effect can be developed within 250 meters from a park border and is most pronounced from two to six hours after sunset (Eliasson & Upmanis, 2000). This principle can therefore be used to support the summer-night cooling of indoor environments.

Volume/surface ratio

All city elements are interrelated. When we conclude that low-density urban areas accumulate more heat than compact high-density areas because the low buildings and large space between buildings allow more solar exposure, the analysis is too superficial. In reality higher building density often coincides with a lower presence of vegetation, a lower wind speed, less radiation to the sky (trapped by building walls) and a higher heat load from buildings and increased outdoor activities. All this affects the heat storage, resulting in higher temperatures and slower cooling at night time in high-density areas (Givoni 1998, p. 269). Other studies by Oke (1988) and Pisello et al. (2014) strengthens this conclusion by showing respectively, an empirical relationship between larger H/W ratios and a higher maximum UHI and the relation between increasing densities and energy consumption due to inter-building effects. A study by Hamilton et al. (2009) illustrates the contribution of anthropogenic heat with the finding of an annual average heat emission across London of around 9 W/m^2 . In street canyons with high densities this constitutes a large part of the total energy input.

City size is not an adjustable feature, but can play a role in policy making. The larger the city, the bigger the UHI effect. In this respect sprawled developments should be avoided. T.R. Oke has developed a prediction method of the UHI effect for the European city. With the following equation the maximum difference between the rural and the urban temperature can be predicted according to the amount of inhabitants; $\Delta T_{u-r(\max)} = 2.01 \log P - 4.06$ (Oke, 1973). According to this method the predicted UHI effect for Utrecht with around 300.000 inhabitants would be 6.9°C and for Rotterdam with around 610.000 inhabitants 7.6°C . Especially for Rotterdam this corresponds with recent traverse measurements that resulted in an UHI effect of 7°C Rotterdam Heusinkveld & Holtslag (2010). A policy that could result from the prediction model is a maximum acceptable UHI and therefore a maximum to the population growth of a city. Note that population density is best applied on the neighbourhood level because this corresponds better to building densities (Steenefeld et al., 2011).

Cities have a larger surface area compared to rural areas and therefore more heat can be stored. Compact buildings have less external facades and therefore less heat storage. Instead of population densities or even building densities, heat accumulation is more related to the FSI (Floor Space Index). The FSI is the ratio between the total floor space (adding building layers) and the built foot print (Berghauer Pont & Haupt, 2009). A study by Milošovičová (2010) for Berlin recommends to keep the FSI under 3.5 for the sake of urban heating.

Strategies for implementation

Influencing the built form of a city from a policy standpoint is rather difficult and more using climatic parameters. Nevertheless certain cities have included clear and rigorous spatial parameters in their urban planning guidelines. The city of Stuttgart

has published an interesting booklet of climate change adaptation for urban planners (Baumüller et al., 2012). Only cities with enough resources have the opportunity to develop this kind of guidelines as they are completely site dependant. However, in the case of the Netherlands, some results could be extrapolated to other cities because of the similar topography in vast zones of the country. Moreover, new developments starting from scratch, can easily take spatial parameters into account.

§ 3.4 Material and colour

The evaporation from urban areas is decreased because of ‘sealing surfaces’ – less permeable materials, and less vegetation compared to rural areas. As a consequence, more energy is put into sensible heat and less into latent heat.

While permeable materials allow cooling by evaporation, hard materials accumulate heat. Next to that, short-wave radiation is absorbed in low albedo materials. Results of increasing albedo were computed in a simulation model for Sacramento, California. By increasing the albedo city-wide from 25 to 40 percent, a temperature drop of 1-4°C can be achieved. Increasing the building albedo from 9 to 70% can reduce the annual cooling demand with 19%. Simulations showed a reduction of 62% in cooling energy demand when both the city-wide albedo and building albedo are increased (Taha et al., 1988).

The temperature difference between materials can be very large. During heat waves the temperature in cities can accumulate day by day when there is no cooling wind or enough green to compensate. A research project in Singapore focussed on the difference in temperature on building facades due to dark or light colours. A maximum temperature difference of 8°C to 10°C on the external wall was measured during 13.00 and 16.00 hours. Also the façade material in relation to the cooling time-lag was studied in Singapore. Three types were tested; a brick, a concrete and a hollow block wall. The brick wall had the longest time lag, followed by the concrete wall. The hollow block wall cooled at the fastest rate (Wong et al., 2004). The thermal admittance of materials also plays a significant role. Materials like brick store more heat, and radiate this heat into the air during night time until sunrise. Hollow block concrete has a smaller thermal admittance and therefore stores less heat.

Researchers from Lawrence Berkeley National Laboratory (LBNL), USA, estimate that: “if all buildings in the greater Los Angeles area had a cool roof system, the total energy and smog savings (i.e., lower hospital bills and fewer lost workdays caused by smog inhalation) would be about half a billion dollars per year” (Akbari & Bretz, 1998).

To control climate indoors, phase change materials (PCM's) in walls and construction materials are available on the market. PCM's have the capability to absorb or release heat when the material changes from solid to liquid and vice versa. In fact, we can say PCM's form a latent heat storage system. Would they be useful in outdoor climate conditioning as well? When applied in outdoor façade and roofing claddings the materials could store even more heat. This is only desirable if the material changes from liquid to solid (releasing heat) under 20 degrees Celsius. This is possible with for example salt capsules (Thermusol, 2015). Note that if the transition temperature is higher than 20 degrees, the UHI effect would be aggravated at night.

The absorbed heat at the façade and roof surfaces for outdoor cooling has the potential to produce heat or electricity. Panels with photovoltaics (PV) produce electricity and form a shadow device for roofs which lowers the energy demand for cooling (Kapsalis et al., 2013). PV pavement has proved to decrease surface temperatures with 5°C and ambient temperatures with 2°C (AIVC, 2013, page 946). Solar collectors are surfaces where water tubes run along that absorb heat and transport the heat to a heat exchanger where this heat can be used or stored. Collectors in roads are developed to keep roads from freezing in winter. It turns out that only 20 percent of the stored heat in summer is needed for the road. This leaves enough heat for 600 households (Cuiper, 2007). The same collector is also able to generate cold. The inside temperature in an elderly home does not exceed 23°C with outdoor temperatures above 30°C for several days.

The influence of the colour of pavement and claddings reaches further than surface temperature and radiation load. Colours can also influence airflow. As explained in section 3.3 about ventilation, airflow can be generated (on calm, sunny days) between a cool place such as a park and a hot space such as a dark paved square. Colour induced airflow is elaborately explained in chapter 6. A dark surface in combination with a solar chimneys increases the rate of air movement even more (Bronsema, 2013).

Strategies for implementation

Changing the thermal property of the different surface materials of the city is the cheapest way to reduce the urban heat island effect. Even though the effects of this strategy are lower than the effects achieved using vegetation, the price and the technical feasibility allow covering bigger surfaces, achieving better results (Rosenzweig et al., 2006).

Even though all surfaces exposed to solar radiation have the potential to improve their thermal properties, the most common strategies carried by different municipalities are based mainly on the change of street pavement and roofs, commonly known as cool pavements and cool roofs.

Numerous research projects have been carried around the properties of the cool pavements. Several cities have introduced this strategy in their plans to mitigate the UHI effect, as in the case of Houston (Hitchcock, 2004). Unfortunately there are no experiences yet of implementation on a large scale.

The pavement of spaces with a low use rate like parking spaces or private roads could be different to allow for a higher permeability; bricks instead of asphalt, or even bricks with holes allowing grass to grow in them. This strategy is mainly promoted among private users, individuals and companies as has been already mentioned in the section 4.2 referred to water issues.

Applying cool roofs has been pointed by several studies as a very good strategy to deal with the urban heat island effect, nevertheless, this strategy isn't as popular among politicians as greening the city, which is the common trend at the moment. Nevertheless, in California cool roofs have been introduced in the Building Energy Efficiency Standard regulation of the state, and will be in effect on the first of January 2010 (California energy commission , 2009).

Regardless the place where solar collectors are applied - on roofs, facades or roads – all have the double benefit to contribute to the climate control indoor and outdoor. An average single family home consumes about 45 Gigajoule (GJ) per year for space heating and hot water. For new constructed and renovated dwellings an average of 28 GJ is a common heat demand. One square meter of asphalt collector delivers about 0.8 GJ. This leads to a required collector surface of 35- 60 m² with an additional heat pump to supply one dwelling (Dijkink, 2008). This great potential should be exploited better.

§ 3.5 Conclusion

This chapter provides an overview of measures that influence the urban microclimate. These are measures that can contribute to the adaptation to higher temperatures and extreme heat stress. The measures are categorised in vegetation, water, urban geometry and material and colour. This leaves out measures in relation to social behaviour such as drinking enough water, look for cool spots and adapt clothing, activities and daily rhythm to higher temperatures. These aspects have been discussed in the previous chapter.

Most literature indicates effects in air temperature, some in surface temperature and only a few in a human thermal comfort index. The local context and conditions in which effects are analysed and the method to analyse play a large role. Comparing effects, therefore, is not found useful.

Form the four sections in this chapter some general conclusions can be extracted:

- Vegetation has the largest cooling potential for daytime heat stress;
- Water is especially important in supporting vegetation;
- The cooling effect of green and water are large because they affect the physical and mental perception of thermal comfort;
- A broad street with a height to width ratio of at least 0.66 is favourable to narrow streets in the Dutch climate. This is only true if the street design provides sufficient shadow devices (e.g. trees) and cool pavement.
- Pavement, facades and roofs can be transformed from uncontrolled heat accumulators into climate regulators.

Climate resilience in relation to heat stress is not only a matter of creating the coolest place possible. It opens a window of opportunities to utilise climate change in meeting energy ambitions or in coping with extreme rainfall.

The findings in this chapter are input for the factsheets introduced hereafter, at the end of part one. This is a means to translate the scientific knowledge from this and the previous chapter for practitioners. The second part of this thesis aims to increase insight in the effect of measures in relation to thermal comfort. The effects are studied through numerical simulations and measurements.

§ 3.6 References

- (2009), "Building Energy Efficiency Standards": California Energy Commission. Available at: <http://www.energy.ca.gov/title24/2005standards/index.html>.
- (2014), "Tree planting", Chicago, USA: City of Chicago. Available at: http://www.cityofchicago.org/city/en/depts/streets/provdrs/forestry/svcs/tree_planting.html [Accessed 22 August 2014].
- AIVC. (2013), "Energy conservation technologies for mitigation and adaptation in the built environment: the role of ventilation strategies and smart materials". *AIVC: 34th AIVC Conference, 3rd TightVent Conference, 2nd Cool Roofs Conference, 1st venticool Conference, Athens, Greece, 25-26 September 2013* 2013, pp.
- Akbari, H. and Bretz, S. 1998. Cool systems for hot cities. *Professional Roofing*. Ernest Orlando Lawrence Berkeley National Lab., CA (US).
- Albers, R., Bosch, P., Blocken, B., Dobbelsteen, A.A.J.F. v.d. Hove, L. v., Spit, T., Ven, F. v.d., Hooff, T. v. and Rovers, V. (2015), "Overview of challenges and achievements in the Climate Adaptation of Cities and in the Climate Proof Cities program". *Building and Environment*, Vol. 83, pp. 1-10.
- Alexandri, E. and Jones, P. (2008), "Temperature decreases in an urban canyon due to green walls and green roofs in diverse climates". *Building and Environment*, Vol. 43, No. 4, pp. 480-493.
- Ali-Toudert, F. and Mayer, H. (2007), "Effects of asymmetry, galleries, overhanging facades and vegetation on thermal comfort in urban street canyons". *Solar Energy*, Vol. 81, No. 6, pp. 742-754.
- Arrau, C.P. 2005. Five synthetic soccer fields and their surface temperature derived from Landsat 5. Montreal: University of Quebec.
- Artus, J. and Roulet, A. (2014), "Végétalisation des murs et des toits", 22 August 2014, Mairie de Paris.
- Baumüller, J., Reuter, U., Hoffman, U. and Kapp, R. (2012), *Climate Booklet for Urban Development. Indications for Urban Land-Use Planning*, Ministerium für Verkehr und Infrastruktur Baden-Württemberg, Stuttgart, Germany.
- Beer, A., Delshammar, T. and Schildwacht, P. (2003), "A changing understanding of the role of greenspace in high-density housing: A European perspective". *Built Environment*, Vol. 29, No. 2, pp. 132-143.
- Berghauser Pont, M.Y. and Haupt, P.A. (2009), *Spacematrix. Space, Density and Urban Form*, Delft University of Technology.
- Blokland, G., Hoogwerff, J. and Tollenaar, C. (2009), "Invloed schermen op de luchtkwaliteit, Eindrapport onderzoek naar de werking van (geluids)schermen op de luchtkwaliteit", Ministerie van Verkeer en Waterstaat en Ministerie van Volkshuisvesting, Ruimtelijke Ordening en Milieubeheer.
- Boer, F., Jorritsma, J. and Peijpe, D.v. (2010), *De Urbanisten en het wonderde waterplein*, 010 Publishers.
- Bolund, P. and Hunhammar, S. (1999), "Ecosystem services in urban areas". *Ecological Economics*, Vol. 29, No. 2, pp. 293-301.
- Bowler, D.E., Buyung-Ali, L., Knight, T.M. and Pullin, A.S. (2010), "Urban greening to cool towns and cities: A systematic review of the empirical evidence". *Landscape and Urban Planning*, Vol. 97, No. 3, pp. 147-155.
- Brenneisen, S. (2006), "Space for urban wildlife: Designing green roofs as habitats in Switzerland". *Urban Habitats*, Vol. 4, No. 1, pp. 27-33.
- Brink, M. (2013), Tegen de hitte. Groen en de opwarming van de stad, Drukkerij Tripiti, Rotterdam.
- Bronsema, B. (2013), *Earth, Wind & Fire: Natuurlijke Airconditioning*, Doctor degree Dissertation, Delft University of Technology.
- Cairns, W.J. (2006), "Edinburgh Public Parks and Gardens Strategy", The city of Edinburgh council.
- Chen, D., Wang, X., Thatcher, M., Barnett, G., Kachenko, A. and Prince, R. (2014), "Urban vegetation for reducing heat related mortality". *Environmental Pollution*, No. 0.
- Cuiper, N. 2007. Warmte uit asfalt weer in de mode. Voordelen voor milieu en gezondheid maken asfaltcollectoren aantrekkelijk. *Energy Magazine*.
- Daley, R.M. (2008), "Adding green to urban design. A city for us and future generations", City of Chicago.
- Dijkink, H.J. 2008. De Zonnegweg. De weg als innovatieve energie leverancier. *Otar*.
- Djamila, H., Chu, C.-M. and Kumaresan, S. (2014), "Effect of Humidity on Thermal Comfort in the Humid Tropics". *Journal of Building Construction and Planning Research*, Vol. 2014.
- Dobbelsteen, A.A.J.F. v.d., Keeffe, G., Tillie, N. and Kleerekoper, L. 2010. From autistic to autonomous: cities as energy-intelligent organisms. TU Delft.
- Donovan, R.G., Stewart, H.E., Owen, S.M., MacKenzie, A.R. and Hewitt, C.N. (2005), "Development and application of an urban tree air quality score for photochemical pollution episodes using the Birmingham, United Kingdom, area as a case study". *Environmental science & technology*, Vol. 39, No. 17, pp. 6730-6738.

- Eliasson, I. and Upmanis, H. (2000), "Nocturnal airflow from urban parks-implications for city ventilation". *Theoretical and Applied Climatology*, Vol. 66, No. 1, pp. 95-107.
- Emmanuel, M.R. (2005), *An urban approach to climate-sensitive design: strategies for the tropics*, Taylor & Francis.
- Esch, M.M.E. v., Looman, R.H.J. and Bruin-Hordijk, G.J. d. (2012), "The effects of urban and building design parameters on solar access to the urban canyon and the potential for direct passive solar heating strategies". *Energy and Buildings*, Vol. 47, pp. 189-200.
- Fallmann, J. and Emeis, S. 2014. Cool Cities – Clean Cities? The effect of UHI mitigation strategies on urban air quality. *Third International Conference on Countermeasures to Urban Heat Island*. Venice, Italy.
- Fassbinder, H. 2009. Klimatstrategien in europäischen Städten: Begrünung als urbane Überlebenskunst. Paris & Amsterdam: Vorreiter in Sachen Begrünungsinitiativen. *7. Internationalen Gründach-Symposium*. Ditzingen, Germany.
- Fletcher, J.A. 2008. 658-ICE TEA CITY. 25th Conference on Passive and Low Energy Architecture. Dublin.
- GemeenteRotterdam (2014), "Groene Daken". Available at: <http://www.rotterdam.nl/groenedaken> [Accessed 22 August 2014].
- Givoni, B. (1991), "Impact of planted areas on urban environmental quality: a review". *Atmospheric Environment. Part B. Urban Atmosphere*, Vol. 25, No. 3, pp. 289-299.
- Givoni, B. (1998), *Climate considerations in building and urban design*, Wiley.
- Gober, P., Brazel, A., Quay, R., Myint, S., Grossman-Clarke, S., Miller, A. and Rossi, S. (2009), "Using Watered Landscapes to Manipulate Urban Heat Island Effects: How Much Water Will It Take to Cool Phoenix?". *Journal of the American Planning Association*, Vol. 76, No. 1, pp. 109-121.
- Greenspace (2005), "Final report".
- Hamilton, I.G., Davies, M., Steadman, P., Stone, A., Ridley, I. and Evans, S. (2009), "The significance of the anthropogenic heat emissions of London's buildings: A comparison against captured shortwave solar radiation". *Building and Environment*, Vol. 44, No. 4, pp. 807-817.
- Hathway, E.A. and Sharples, S. (2012), "The interaction of rivers and urban form in mitigating the Urban Heat Island effect: A UK case study". *Building and Environment*, Vol. 58, No. 0, pp. 14-22.
- Hauth, E. (2014), "Sustainable Stormwater Management": City of Portland. Available at: <http://www.portlandoregon.gov/BES/34598> [Accessed 21 January 2015].
- Havaligi, N. 2009. Climate change and food security in cities. *Fifth Urban Research Symposium 2009*. Marseille, France: World Bank.
- He, J.F., Liu, J.Y., Zhuang, D.F., Zhang, W. and Liu, M.L. (2007), "Assessing the effect of land use/land cover change on the change of urban heat island intensity". *Theoretical and Applied Climatology*, Vol. 90, No. 3-4, pp. 217-226.
- Herrmann, J. and Matzarakis, A. 2010. Influence of mean radiant temperature on thermal comfort of humans in idealized urban environments. *7th Conference on Biometeorology*. Freiburg, Germany: Albert-Ludwigs-University of Freiburg.
- Heusinkveld, B. and Holtslag, A. (2010), "Use of a mobile platform for assessing urban heat stress in The Netherlands". *7th Conference on Biometeorology, Freiburg, 12-14 April 2010*, pp. 433-438.
- Hiemstra, J.A., Schoenmaker - v.d. Bijl, E. and Tonneijck, A.E.G. (2008), "Bomen, een verademing voor de stad".
- Hitchcock, D. (2004), "Cool Houston! A plan for cooling the region", Houston Advanced Research Centre, Houston, United States.
- Hoelscher, M.T., Nehls, T., Jaenicke, B., Walikewitz, N. and Wessolek, G. 2014. Quantification of Cooling Processes by Facade Greening: Shading, Insulation and Transpiration. *Third*
- Hofschreuder, P., Kuypers, V., Janssen, S., Maerschack, B. d., Erbrink, H. and Wolff, J. d. 2010. Effect of vegetation on air quality and fluxes of NOx and PM-10 along a highway. *CLIMAQS Workshop 'Local Air Quality and its Interactions with Vegetation'*. Antwerp, Belgium.
- Hotkevica, I. (2013), *Green elements in street canyons. Research by design for heat mitigation and thermal comfort in urban areas.*, Mcs, Wageningen University.
- Ihle, C. (2006), *Klimatechnik mit Kältetechnik*, Wolters Kluwer Deutschland.
- Johnston, J. and Newton, J. (2004), "Building Green. A guide to using plants on roofs, walls and pavements", Greater London Authority.
- Jokimaki, J. (1999), "Occurrence of breeding bird species in urban parks: effects of park structure and broad-scale variables". *Urban Ecosystems*, Vol. 3, No. 1, pp. 21-34.
- Kapsalis, V.C., Vardoulakis, E. and Karamanis, D. 2013. Simulation of the cooling effect of the roof added photovoltaics. *AIVC: 34th AIVC Conference, 3rd TightVent Conference, 2nd Cool Roofs Conference, 1st venticool Conference*. Athens, Greece.

- Katzschner, L. 2009. THERMAL COMFORT EVALUATION FOR PLANNING IN CITIES UNDER CONSIDERATION OF GLOBAL CLIMATE CHANGE. *SASBE 2009*. Delft.
- Keeffe, G. and Martin, C. (2007), *MSA Yearbook*, Manchester School of Architecture.
- Kellert, S. and Wilson, E. (1993), *The biophilia hypothesis*, Island Press, Washington, DC.
- Kikegawa, Y., Genchi, Y., Kondo, H. and Hanaki, K. (2006), "Impacts of city-block-scale countermeasures against urban heat-island phenomena upon a building's energy-consumption for air-conditioning". *Applied Energy*, Vol. 83, No. 6, pp. 649-668.
- Kleerekoper, L., Esch, M. v. and Salcedo, T.B. (2012), "How to make a city climate-proof, addressing the urban heat island effect". *Resources, Conservation and Recycling*, Vol. 64, No. 0, pp. 30-38.
- Klemm, W., Heusinkveld, B.G., Lenzholzer, S., Jacobs, M.H. and Hove, B. v. (2015), "Psychological and physical impact of urban green spaces on outdoor thermal comfort during summertime in The Netherlands". *Building and Environment*, Vol. 83, pp. 120-128.
- Klemm, W., Lenzholzer, S., Heusinkveld, B. and Hove, B.v. (2013), "Towards green design guidelines for thermally comfortable streets". *PLEA 2013 e Conference on passive and low energy architecture, [Munich, Germany, PLEA proceedings 2013]*, 2013, pp.
- Klok, L., Broeke, H.t., Harmelen, T.v., Verhagen, H., Kok, H. and Zwart, S. (2010), "Ruimtelijke verdeling en mogelijke oorzaken van het hitte-eiland effect", TNO-034-UT-2010-01229_RPT-ML, TNO Bouw en Ondergrond, Utrecht.
- Klok, L., Schaminee, S., Duyzer, J. and Steeneveld, G.J. (2012), "De stedelijke hitte-eilanden van Nederland in kaart gebracht met satellietbeelden", TNO, Climate Proof Cities, Kennis voor Klimaat.
- Köhler, M., Schmidt, M., Grimme, F.W., Laar, M., de Assunção Paiva, V.L. and Tavares, S. (2002), "Green roofs in temperate climates and in the hot-humid tropics—far beyond the aesthetics". *Environmental management and health*, Vol. 13, No. 4, pp. 382-391.
- Kondo, H. and Kikegawa, Y. (2003), "Temperature variation in the urban canopy with anthropogenic energy use". *Pure and Applied Geophysics*, Vol. 160, No. 1, pp. 317-324.
- Kraai, A., Maarschalk, B.d. and Vermeulen, A. (2009), "Invloed vegetatie op de luchtkwaliteit, Eindrapport onderzoek naar de invloed van vegetatie op de luchtkwaliteit langs snelwegen", Ministerie van Verkeer en Waterstaat en Ministerie van Volkshuisvesting, Ruimtelijke Ordening en Milieubeheer.
- Kravčík, M., Pokorný, J., Kohutiar, J., Kovac, M. and Toth, E. (2007), "Water for the Recovery of the Climate-A New Water Paradigm".
- Kuypers, V., Vries, B.d. and Peeters, R.G.J.M. 2008. Groen voor Klimaat.
- Lehmann, S. (2007), "Sustainability on the Urban Scale: 'Green Urbanism' - Mark II". *Journal of Green Building*, Vol. 2, No. 3, pp. 59-78.
- Lin, T.-P., Matzarakis, A. and Hwang, R.-L. (2010), "Shading effect on long-term outdoor thermal comfort". *Building and Environment*, Vol. 45, No. 1, pp. 213-221.
- McCunn, L.J. and Gifford, R. (2014), "Interrelations between sense of place, organizational commitment, and green neighborhoods". *Cities*, Vol. 41, Part A, No. 0, pp. 20-29.
- McPherson, E. (1994), "Cooling urban heat islands with sustainable landscapes". *The ecological city: Preserving and restoring urban biodiversity*, pp. 161-171.
- McPherson, E., Nowak, D., Heisler, G., Grimmond, S., Souch, C., Grant, R. and Rowntree, R. (1997), "Quantifying urban forest structure, function, and value: the Chicago Urban Forest Climate Project". *Urban Ecosystems*, Vol. 1, No. 1, pp. 49-61.
- Meier-Boschaart, M. 2011. De waarde van groen: het geld ligt voor het oprapen. *Stedelijk interieur*. Amersfoort: Elba Media.
- Milošovičová, J. (2010), *Climate-Sensitive Urban Design in Moderate Climate Zone: Responding to Future Heat Waves*, Msc.
- Murakawa, S., Sekine, T., Narita, K.-i. and Nishina, D. (1991), "Study of the effects of a river on the thermal environment in an urban area". *Energy and buildings*, Vol. 16, No. 3, pp. 993-1001.
- Ng, E., Chen, L., Wang, Y. and Yuan, C. (2012), "A study on the cooling effects of greening in a high-density city: An experience from Hong Kong". *Building and Environment*, Vol. 47, No. 0, pp. 256-271.
- Nickson, A. 2007. Preparing London for inevitable climate change. *Hot places - Cool spaces*. Amsterdam: Climate changes Spatial Planning.
- Nishimura, N., Nomura, T., Iyota, H. and Kimoto, S. (1998), "NOVEL WATER FACILITIES FOR CREATION OF COMFORTABLE URBAN MICROMETEOROLOGY". *Solar Energy*, Vol. 64, No. 4-6, pp. 197-207.
- Nowak, D.J. (1995), "Trees pollute? A 'TREE' explains it all". *Proceedings of the 7th National Urban Forestry Conference*. Washington, DC: American Forests, 1995, pp. 28-30.

- Okalebo, S.E., Mwasi, B. and Musyoka, R. 2009. "Green based" planning that integrates urban agriculture into eldoret mixed landscape in response to climate change. *Fifth Urban Research Symposium 2009*. Marseille, France: World Bank.
- Oke, T.R. (1973), "City size and the urban heat island". *Atmospheric Environment* (1967), Vol. 7, No. 8, pp. 769-779.
- Oke, T.R. (1982), "The energetic basis of the urban heat island". *Quarterly Journal of the Royal Meteorological Society*, Vol. 108, No. 455, pp. 1-24.
- Oke, T.R. (1988), "Street design and urban canopy layer climate". *Energy and Buildings*, Vol. 11, No. 1-3, pp. 103-113.
- Ottelé, M., Bohemen, H. v. and Fraaij, A. (2010), "Quantifying the deposition of particulate matter on climber vegetation on living walls". *Ecological Engineering*, Vol. 36, No. 2, pp. 154-162.
- Park, C. (2001), *The environment: principles and applications*, Routledge.
- Pisello, A.L., Castaldo, V.L., Poli, T. and Cotana, F. (2014), "Simulating the Thermal-Energy Performance of Buildings at the Urban Scale: Evaluation of Inter-Building Effects in Different Urban Configurations". *Journal of Urban Technology*, Vol. 21, No. 1, pp. 3-20.
- Pietersen-Theeuwes, N.E.; Steeneveld, G.J.; Ronda, R.J.; Rotach, M.; Holtslag, A.A.M. (2015) "Cool city mornings by urban heat", *Environmental Research Letters* 10 (11). - p. 10.
- Rafailidis, S. (1997), "Influence of building areal density and roof shape on the wind characteristics above a town". *Boundary-Layer Meteorology*, Vol. 85, No. 2, pp. 255-271.
- Rainproof (2014), "Amsterdam Rainproof". Available at: <https://rainproof.nl/>.
- Robitu, M., Musy, M., Inard, C. and Groleau, D. (2006), "Modeling the influence of vegetation and water pond on urban microclimate". *Solar Energy*, Vol. 80, No. 4, pp. 435-447.
- Rosenzweig, C. (2006), "Mitigating New York City's Heat Island with urban forestry, living roofs and light surfaces", New York City Regional Heat Island Initiative.
- Rosenzweig, C., Solecki, W. and Slosberg, R. (2006), "Mitigating New York City's heat island with urban forestry, living roofs, and light surfaces". *A report to the New York State Energy Research and Development Authority*.
- Schildwacht, P. 2010. Questions about the effectiveness of green in cleaning air from traffic pollutants.
- Schmidt, M. 2006. The contribution of rainwater harvesting against global warming. *IWA World Cogress and Exhibition*. Vienna: IWA Publishing, London, UK.
- Schubert, H. (2014), "New European Architecture": A10.eu. Available at: <http://www.a10.eu/magazine/issues/56/water-square-rotterdam.html> [2015].
- Schwarz, N., Schlink, U., Franck, U. and Großmann, K. (2012), "Relationship of land surface and air temperatures and its implications for quantifying urban heat island indicators—An application for the city of Leipzig (Germany)". *Ecological Indicators*, Vol. 18, No. 0, pp. 693-704.
- Scott, K.I., Simpson, J.R. and McPherson, E.G. (1999), "Effects of tree cover on parking lot microclimate and vehicle emissions". *Journal of Arboriculture*, Vol. 25, No. 3, pp. 129-142.
- Searle, S.Y., Turnbull, M.H., Boelman, N.T., Schuster, W.S.F., Yakir, D. and Griffin, K.L. (2012), "Urban environment of New York City promotes growth in northern red oak seedlings". *Tree Physiology*, Vol. 32, No. 4, pp. 389-400.
- Shashua-Bar, L. and Hoffman, M. (2000), "Vegetation as a climatic component in the design of an urban street: An empirical model for predicting the cooling effect of urban green areas with trees". *Energy and Buildings*, Vol. 31, No. 3, pp. 221-235.
- Shashua-Bar, L., Pearlmutter, D. and Erell, E. (2011), "The influence of trees and grass on outdoor thermal comfort in a hot-arid environment". *International Journal of Climatology*, Vol. 31, No. 10, pp. 1498-1506.
- Sini, J., Anquetin, S. and Mestayer, P. (1996), "Pollutant dispersion and thermal effects in urban street canyons". *Atmospheric Environment*, Vol. 30, No. 15, pp. 2659-2677.
- Slingerland, J. (2012), Mitigation of the Urban Heat Island effect by using water and vegetation, Delft University of Technology.
- Steeneveld, G., Koopmans, S., Heusinkveld, B., Hove, L. v. and Holtslag, A. (2011), "Quantifying urban heat island effects and human comfort for cities of variable size and urban morphology in the Netherlands". *J. Geophys. Res*, Vol. 116, pp. D20129.
- Sukopp, H. and Wittig, R. (1998), "Stadtökologie. Ein Fachbuch für Studium und Praxis. 2. Überarbeitete Auflage", Stuttgart: Gustav Fischer Verlag, Stuttgart, Jena, Lübeck, Ulm.
- Sun, R., Chen, A., Chen, L. and Lü, Y. (2012), "Cooling effects of wetlands in an urban region: The case of Beijing". *Ecological Indicators*, Vol. 20, No. 0, pp. 57-64.
- Taha, H., Akbari, H., Rosenfeld, A. and Huang, J. (1988), "Residential cooling loads and the urban heat island--the effects of albedo". *Building and Environment*, Vol. 23, No. 4, pp. 271-283.

- Takahashi, M., Higaki, A., Nohno, M., Kamada, M., Okamura, Y., Matsui, K., Kitani, S. and Morikawa, H. (2005), "Differential assimilation of nitrogen dioxide by 70 taxa of roadside trees at an urban pollution level". *Chemosphere*, Vol. 61, No. 5, pp. 633-639.
- Takahashi, R., Asakura, A., Koike, K., Himeno, S. and Fujita, S. 2010. Using snow melting pipes to verify the water sprinkling's effect over a wide area. *Sustainable techniques and strategies in urban water management, 7th International Conference*. Lyon, France: Novatech.
- Taleghani, M., Kleerekoper, L., Tenpierik, M. and Dobbelsteen, A.A.J.F.v.d. (2015), "Outdoor thermal comfort within five different urban forms in the Netherlands". *Building and Environment*, Vol. 83, pp. 65-78.
- Thermusol (2015), "K-Block. Het alternatief".
- Todorovic, M.S. 2013. Green roofs and vertical greenery systems evaluation - heat and mass transfer modelling and experimental quantification. AIVC.
- Upmanis, H., Eliasson, I. and Lindqvist, S. (1998), "The influence of green areas on nocturnal temperatures in a high latitude city (Göteborg, Sweden)". *International Journal of Climatology*, Vol. 18, No. 6, pp. 681-700.
- Walsh, C.L., Hall, J.W., Street, R.B., Blanksby, J., Cassar, M., Ekins, P., Glendinning, S., Goodess, C.M., Handley, J., Noland, R. and Watson, S.J. (2007), "Building knowledge for a changing climate, Collaborative research to understand and adapt to the impacts of climate change on infrastructure, the built environment and utilities", Newcastle University.
- Watson, I. and Johnson, G. (1987), "Graphical estimation of sky view factors in urban environments". *Journal of climatology*, Vol. 7, No. 2, pp. 193-197.
- Wikhydro (2013), "Wiklimat: Limiter l'effet d'îlot de chaleur urbain à Lyon". Available at: http://wikhydro.developpement-durable.gouv.fr/index.php/Wiklimat:Limiter_l'effet_d'ilot_de_chaleur_urbain_%C3%A0_Lyon_2015].
- wonen.nl (2010), "Feestelijke onthulling groene gevels Stokviswater", Rotterdam.
- Wong, N., Lee, S., Li, S., Ananda, R. and Tan, K. 2004. Thermal performance of façade materials and design and the impacts on indoor and outdoor environment. *Unpublished research project report, Department of Building, National University of Singapore*.
- Wong, N.H., Kardinal Jusuf, S., Aung La Win, A., Kyaw Thu, H., Syatia Negara, T. and Xuchao, W. (2007), "Environmental study of the impact of greenery in an institutional campus in the tropics". *Building and Environment*, Vol. 42, No. 8, pp. 2949-2970.
- Wordpress (2010), "Disaster Prevention in Tokyo", Tokyo: wordpress.com. Available at: <https://tokyo5.wordpress.com/2010/09/01/disaster-prevention/> 2015].
- Xiaomin, X., Zhen, H. and Jiasong, W. (2006), "The impact of urban street layout on local atmospheric environment". *Building and Environment*, Vol. 41, No. 10, pp. 1352-1363.

Factsheets

The complete compilation of factsheets is presented in Appendix B of the online version of this dissertation.

FACTSHEETS

Klimaatadaptatiemaatregelen in het stedelijk gebied.
Ter voorkoming van hittestress, verbetering van het watersysteem en de luchtkwaliteit.

BOMEN
Beschadelen van bomen kan tot ernstige schade aan de boom leiden. Dit kan bijvoorbeeld gebeuren door het verwijderen van de kroon of het afbreken van de stam. Het is belangrijk om bomen te beschermen en te onderhouden om de stadsklimaat te verbeteren.

BESCHADENEN GEDEKAMEN
Beschadening van de dakrand kan tot lekkages en schade aan de gevel leiden. Het is belangrijk om de dakrand te onderhouden en te beschermen om de kwaliteit van de woning te verbeteren.

REFLECTERENDE MATERIALEN
Reflecterende materialen kunnen helpen om de hittestress te verminderen door de zonlichtreflectie te verhogen. Dit kan bijvoorbeeld worden gedaan met reflecterende verf of folie op de gevel of dak.

ENERGIE CONCEPTEN
Energieconcepten kunnen helpen om de energieverbruik te verminderen en de hittestress te verminderen. Dit kan bijvoorbeeld worden gedaan met energiebesparende lampen, isolatie en zonnepanelen.

WATERELEMENTEN
Waterelementen kunnen helpen om het watersysteem te verbeteren en de hittestress te verminderen. Dit kan bijvoorbeeld worden gedaan met regenwaterputten, waterloze planten en waterfontein.

STADSBOSSEN EN PARKEN
Stadsbossen en parken kunnen helpen om de hittestress te verminderen door de schaduw te bieden en de lucht te verkoelen. Het is belangrijk om stadsbossen en parken te onderhouden en te uitbreiden.

Auteurs: Laura Kleerekoper
TU Delft, faculty of
Architecture, Climate Design
lkleerekoper@gmail.com

PART 2 Simulations and Measurements

	Chapter 1 Introduction	Research Question
Part I Literature	Chapter 2 Urban climate & climate change	1
	Chapter 3 Inventory of climate adaptation measures	2
	Factsheets	
Part II Simulations and Measurements	Chapter 4 Urban measures for hot weather conditions in the Netherlands compared in a microclimate model	3
	Chapter 5 Microclimate effects of redevelopment options in a low-rise open building block	
	Chapter 6 Ventilation by colour and material, exploring a new climate adaptation measure	
	Guidelines	
Part III Research by De- sign	Chapter 7 Designing with microclimate: interviews with urban designers and planners	4
	Chapter 8 Typological design solutions supported by urban surface analysis in their path to climate resilience	5
	Chapter 9 Designing the urban (micro)climate	4
	Chapter 10 Conclusion	

4 Urban measures for hot weather conditions in a temperate climate condition: a review study⁹

After the inventory of climate adaptation measures in the previous chapter, we now know which measures are available. To be able to make choices between adaptation measures, more insight is required in their relative effect, as well as in the effect of measures in a specific context and when combined with each other. In this chapter the effects on thermal comfort of various adaptation measures is studied with model calculations.

This chapter discusses the effects of urban design and meteorological parameters on thermal comfort for pedestrians at street level, partly answering the research question: **What is the indication of general and/or location specific effects of heat mitigation measures on thermal comfort in The Netherlands?**

And with a focus on simulation outcomes in the thermal comfort indicator it answers the sub question: What are the effects on air temperature and human comfort for the temperate climate condition of the Netherlands?

§ 4.1 Introduction

Although there is an increasing interest in the urban microclimate, there seems to be a lack of knowledge about which climate adaptation measures perform better in terms of summer comfort. Planners and policy makers need to know more about the potential cooling effect of a measure. For example, the choice between stimulating wind or changing pavement materials depends highly on the potential cooling effect of these measures.

9

This chapter presents an extended version of the Journal article 'Urban measures for hot weather conditions in a temperate climate condition: a review study' (In submission for publication in Journal of Renewable and Sustainable Energy Reviews).

Many adaptation measures have been tested in specific contexts or locations across the world (Carter, 2011, Bowler et al., 2010). However, for the temperate climate zones only few studies and simulations have been conducted in this field. Various studies that have focussed on similar climatic conditions give an idea of the effect of some measures within a specific urban context (Mees & Driessen, 2011). However, a straightforward comparison of the effects of adaptation measures can lead to ambivalent results because the effects on thermal comfort are highly context dependent. Moreover, a comparison is practically impossible with all the different weather and climate conditions, the numerous methods to measure or simulate and the many different comfort indicators.

Therefore, this study aims to comprehensively review and gain insight in the effects on thermal comfort within comparable conditions on a hot summer situation. The research question is two-fold. Firstly, do all measures result in the same cooling range? And if not, the second question is whether there are significant differences between measures? An answer to the first question may reveal many possibilities for adaptation strategies while the second might suggest measures that should be studied in more detail and applied more often. This leads to the question of which measures require more research and which could be implemented more frequently. This study therefore focusses on a mix of parameters: influence of buildings, orientation, wind direction and wind speed, pavement versus grass, trees and hedges. In addition we look at the influence on results of changes in model grid size.

All the different measures are assessed with the thermal comfort indicator PET (Physiological Equivalent Temperature). Often effects of climate adaptation measures are assessed based on air temperature, neglecting the effects of wind, radiation and humidity. PET links these important climate aspects to the physiology of the human body. Finally, this study additionally aims to evaluate the simulation results with the microclimate model ENVI-met with field measurements and other available studies from literature. From the simulated variants a selection of eight (A-H) most interesting variants is made to present in this chapter.

§ 4.2 Methods

The research methods used in this study, the sequence and relations between them, are described in this section and presented schematically in Figure 4.1.

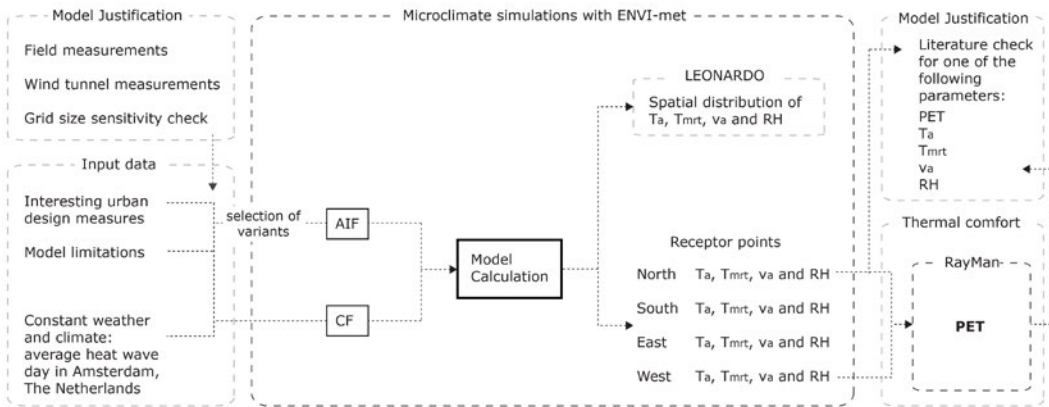

FIGURE 4.1 Research schema

§ 4.2.1 Comparable results

Comparing results from other studies can be challenging because they are often placed in a different context, in various climates and weather conditions. Their measurement methods or simulation models may also vary and present results in a different way. The context plays an important role in the effect urban measures have. For instance, adding a tree in an empty street has a different effect than adding a tree in a street that already has trees. The climate and weather conditions on a specific location also influence the effect of urban measures, e.g., close to the equator shadow devices or narrow streets increase thermal comfort during much of the year, while in regions further away from the equator narrow streets are too dark and cold in winter because of the lower sun angle. Measurement methods may be inconsistent in type of equipment, stationary measurements, traverse measurements or satellite imagery, the height and location of the measurements and the number of measurement points. Another factor making comparisons more complex is caused by the availability of many different thermal comfort indicators: air temperature, mean radiant temperature or a comfort indicator such as Universal Thermal Climate Index (UTCI), Physiological Equivalent Temperature (PET) or Predicted Mean Vote (PMV). And furthermore, as Shashua-Bar et al. (2011) observed, even though most researchers indicate effects of adaptation measures in air temperature, the effect of vegetation on air temperature is negligible while the effect of vegetation on thermal comfort is substantial.

Together, all these methodological variables do not allow for an objective comparison of effects of urban measures. To achieve a comparable set of measures the in- and

output parameters need to be of the same kind. In addition, significant variations in urban geometries obstruct a comparative approach. This study therefore starts out from the most basic form: a building block in an open field. The analysis of the influence of urban measures is based on changing parameters within the same plot.

§ 4.2.2 Variants description

A set of variants is analysed on the basis of mutual differences in air temperature and thermal comfort. The selection of urban design- and meteorological parameters in this study is mainly based on the capacity of the simulation program ENVI-met and the practical value they can have for urban development. Apart from the variants chosen for this study, many other relevant variants could have been included. However, the number of simulation variants is limited for reasons of time and to keep the analysis manageable. Furthermore, the simulations presented in this chapter cover different urban settings compared to previous studies with a focus on the urban canopy layer (Ali-Toudert & Mayer, 2006, Ali-Toudert & Mayer, 2007).

Figure 4.2 gives an overview of the variants that are simulated. In sets A through I a total of 35 variants are studied. The first variant is an open field with different land-surface covers: brick pavement, grass and a combination of these two. The same land surface cover is used for the other simulation variants. In set B, a single 8 metres tall building is studied. Set C shows the effects of changes in wind direction (North, South, East, West, North-East and South-West) and set D concerns the effects of wind speeds (1.0, 1.5, 3, and 6 m/s). The path of the sun from East to West causes changes in up heating when grass and brick pavement sides change orientation in set E. In set F differences in building height for a single building are studied. The effects of adding a building of the same height (8m) is studied in set G. Set H contains trees in different positions and different tree-coverage ranging from 3 trees in a row to the whole area planted with trees. Finally, in set I the accuracy of results in relation to different grid sizes is tested, comparing a grid of 0.5*0.5m, 1*1m, 2*2m and 5*5m.

Variants overview

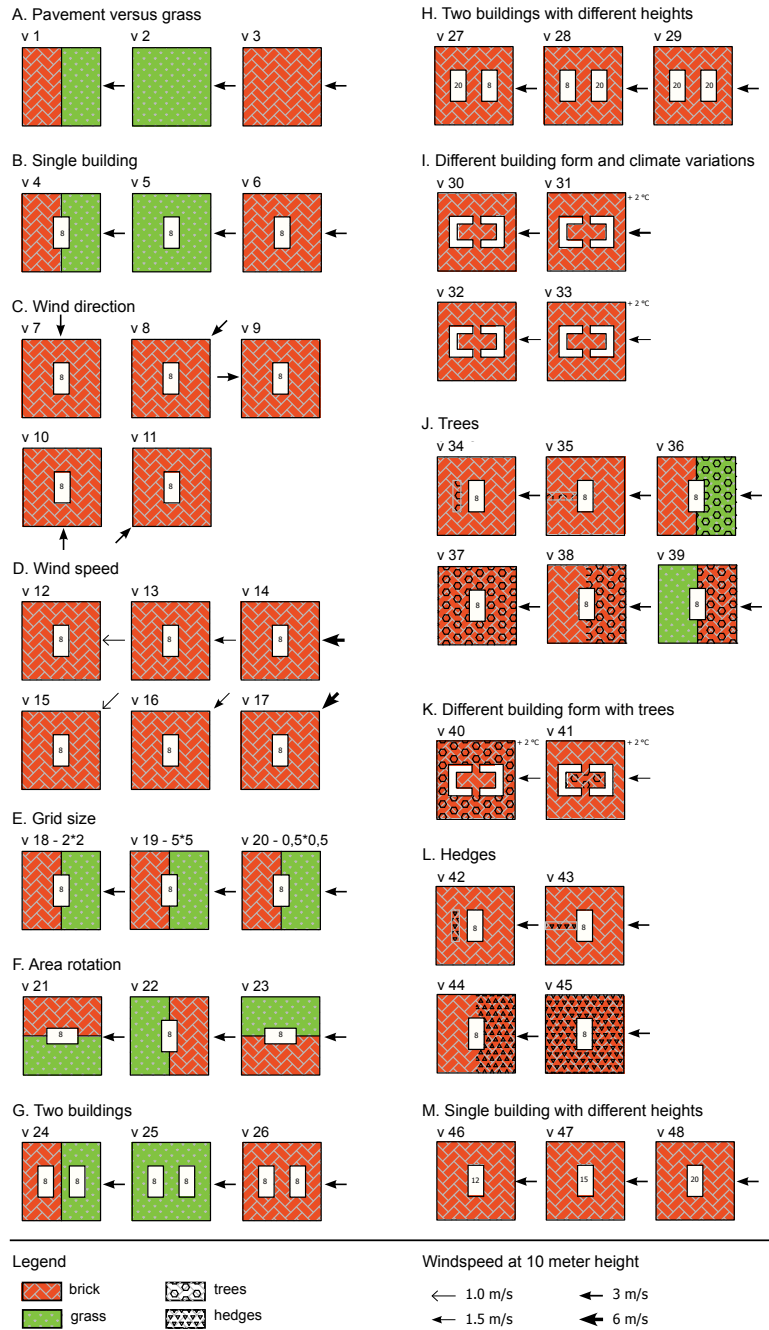

FIGURE 4.2 Overview of the simulated variants.

§ 4.2.3 Microclimate model ENVI-met

The comparative study uses the microclimate model ENVI-met. The main advantage of ENVI-met is that it calculates the microclimatic process in a daily cycle and allows for the inclusion of various building shapes and heights as well as vegetation. The program provides an accurate insight of the microclimate at street level. ENVI-met is a three-dimensional non-hydrostatic numerical simulation model that calculates exchange processes in, on and between urban elements with a high spatial (0.5 to 10 m) and temporal (10 s) resolution (Bruse & Fleer, 1998). In a description of the model ENVI-met 3.0, which is the version used in the presented study, the used formulae and numerical aspects are documented, including: main wind flow, temperature, humidity, turbulence, radiation fluxes and individual soil properties such as thermodynamic and hydraulic conductivity or albedo (Bruse, 2004). This simulation model seeks to reproduce the main processes in the atmosphere that affect the microclimate on a well-founded physical basis (Ali-Toudert & Mayer, 2006).

The basic concept to describe three-dimensional turbulent flow is given by the non-hydrostatic incompressible NavierStokes equations in the Boussinesq- approximated form (1.1 – 1.3):

$$\frac{\partial u}{\partial t} + u_i \frac{\partial u}{\partial x_i} = -\frac{\partial p'}{\partial x} + K_m \left(\frac{\partial^2 u}{\partial x_i^2} \right) + f(v - v_g) - S_u \quad (1.1)$$

$$\frac{\partial v}{\partial t} + u_i \frac{\partial v}{\partial x_i} = -\frac{\partial p'}{\partial y} + K_m \left(\frac{\partial^2 v}{\partial x_i^2} \right) - f(u - u_g) - S_v \quad (1.2)$$

$$\frac{\partial w}{\partial t} + u_i \frac{\partial w}{\partial x_i} = -\frac{\partial p'}{\partial z} + K_m \left(\frac{\partial^2 w}{\partial x_i^2} \right) + g \frac{\Theta(z)}{\Theta_{ref}(z)} - S_w \quad (1.3)$$

With $u_i = (u, v, w)$, $u_i = (x, y, z)$ for $i = 1, 2, 3$.

As the flow is incompressible in ENVI-met, ρ does not change for any fluid parcel, and $\frac{D\rho}{Dt} = 0$. Therefore, the Continuity equation is reduced to:

$$\frac{\partial u}{\partial x} + \frac{\partial v}{\partial y} + \frac{\partial w}{\partial z} = 0 \quad (2)$$

Where,

$f (=10^4 \text{ sec}^{-1})$ is the Coriolis parameter,
 p' is the local pressure perturbation, and
 Θ is the potential temperature at level z .

Compared to other models and methods to calculate urban microclimate conditions, the ENVI-met model is the most appropriate for the calculation of human comfort on street level. Other models that can be used to calculate outdoor conditions are for example: SOLWEIG, ANSYS Fluent (CFD) and RayMan. The SOLWEIG model is a radiation model that is very accurate in predicting the T_{mrt} . The model is developed

by Göteborg University (Lindberg et al., 2008). A measurement and modelling study shows that both, SOLWEIG and ENVI-met give an accurate prediction of the T_{mrt} within a range of 4°C (Katzschner & Thorsson, 2009). However, SOLWEIG does not calculate air flow. The computational fluid dynamics (CFD) models such as, ANSYS Fluent, are developed to predict air flow and turbulence. The models can be extended with a radiation and heat balance and an evaporation module (Defraeye et al., 2012). Modelling with Fluent is very precise and used to test the aerodynamics of, for example, vehicles or to calculate flow in indoor spaces. The simulation output would give an unnecessary high detail level for this study. The RayMan model, in contrast with CFD modelling, has a very short running time. Like the SOLWEIG model, RayMan calculates radiation and generates the T_{mrt} , however does not include multiple reflections between buildings. A large advantage of the model is the possibility to generate output in common thermal comfort indexes like the PET and PMV (Matzarakis et al., 2007).

§ 4.2.4 Simulation input

Two files need to be created to set the conditions for the simulation in ENVI-met: the Area Input File provides the model information and the Configuration File the climatic conditions.

The location is the same for all simulations and is positioned in the temperate climate zone of the Netherlands, in Amsterdam, with latitude 52.22 and longitude 4.53. The Area Input File (AIF) has 120*120*20 (x*y*z) grid cells with a grid size of 1*1*2 m (x*y*z), thus a domain size of 120*120*40m (x*y*z) for all variants except for set M where the grid size varies from 5 m to 0.5 m. The reference building height is 8 metres. The specific properties of the buildings, pavement and vegetation used for the simulations in this study are given in Table 4.1. Most of the properties are pre-sets in the ENVI-met program.

MATERIAL/VEGETATION	VALUE	UNIT
Albedo Brick pavement	0.3	
Grass xx	0.5	m (height)
Hedges dense	2	m (height)
T2 < tree 15 m very dense, leafless base	15	m (height)
Albedo walls	0.2	
Albedo roofs	0.3	
Heat transmission walls	2.5	W/m2 °C
Heat transmission roofs	3.3	W/m2 °C

TABLE 4.1 Pre-sets and chosen properties for materialization in ENVI-met.

In ENVI-met data can be retrieved in so-called 'receptor points'. These function as measurement points where data can be extracted for every z grid. In Figure 4.3 the location of the receptors placed at the North, South, East and West side of the area is shown.

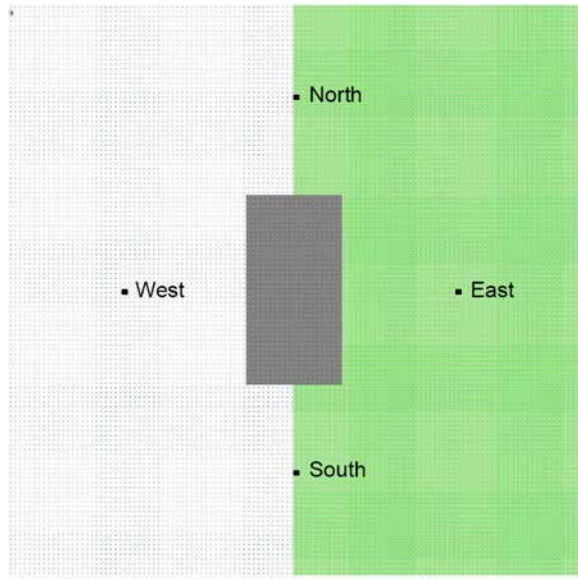

FIGURE 4.3 The Area Input File with the four receptor points at the North, South, East and West side of the area.

The meteorological input data for the simulations in ENVI-met do not correspond directly to one particular date. To be able to look at changes in wind direction, wind speed and initial temperature a more standardized situation is needed. The values for the reference situation are chosen based on the average circumstances during a heat wave day in the period 1950 through 2011 in the Netherlands, De Bilt (KNMI, 2011). The chosen date in the AIF is 21-06-2005 because this is the longest day of the year with the highest sun angle. In Table 4.2 the input data is given.

INPUT	VALUE	UNIT
Start Simulation at Day	21.06.2005	DD.MM.YYYY
Start Simulation at Time	5:00:00	HH:MM:SS
Total Simulation Time	24.00	Hours
Save Model State	60	min
Wind Speed in 10 m ab. Ground	3	m/s
Wind Direction (0:N,90:E,180:S,270:W)	90	
Roughness Length z0 at Reference Point	0.1	
Initial Temperature Atmosphere	296 (23)	K (°C)
Specific Humidity in 2500 m	7	g Water/kg air
Relative Humidity in 2m	65	%
Database Plants	[input]\Plants.dat	

TABLE 4.2 Configuration File input parameters in ENVI-met.

§ 4.2.5 Simulation output

The thermal comfort indicator PET introduced in chapter 2.2 is the main evaluation index used for this study because it fits outdoor conditions and the temperate climate zone (Höppe, 1999). The data from the four receptor points in Figure 4.3 can be loaded separately in any other data processing program. The four main parameters air temperature (T_a), mean radiant temperature (T_{mrt}), airspeed (v_a) and relative humidity (RH) are selected and converted in PET. For the conversion of the output data from ENVI-met in PET the RayMan program is used (Matzarakis et al., 2007) already mentioned in section 4.2.3.

Although PET is a common human thermal comfort indicator, most studies of the effectiveness of cooling measures give their results in air temperature. Therefore, the comparison of results from this study with other studies is also based on the average air temperature from the four receptors. In the following section the simulation results are presented in average PET and air temperature. A more detailed insight into the influencing factors for the PET is shown with the PET per receptor point and, if necessary, the basic data from which the PET is generated. Zooming into the basic data like this helps to explain why an urban measure leads to up-heating or cooling. The basic data can be analysed through the visualisation model LEONARDO. The colourful images of the separate parameters give a quick overview of the spatial distribution pattern of the air temperature (Figure 4.4), wind speed (Appendix C Figure C.1), mean radiant temperature (Appendix C Figure C.2) and relative humidity (Appendix C Figure C.3).

Variants overview - output in air temperature

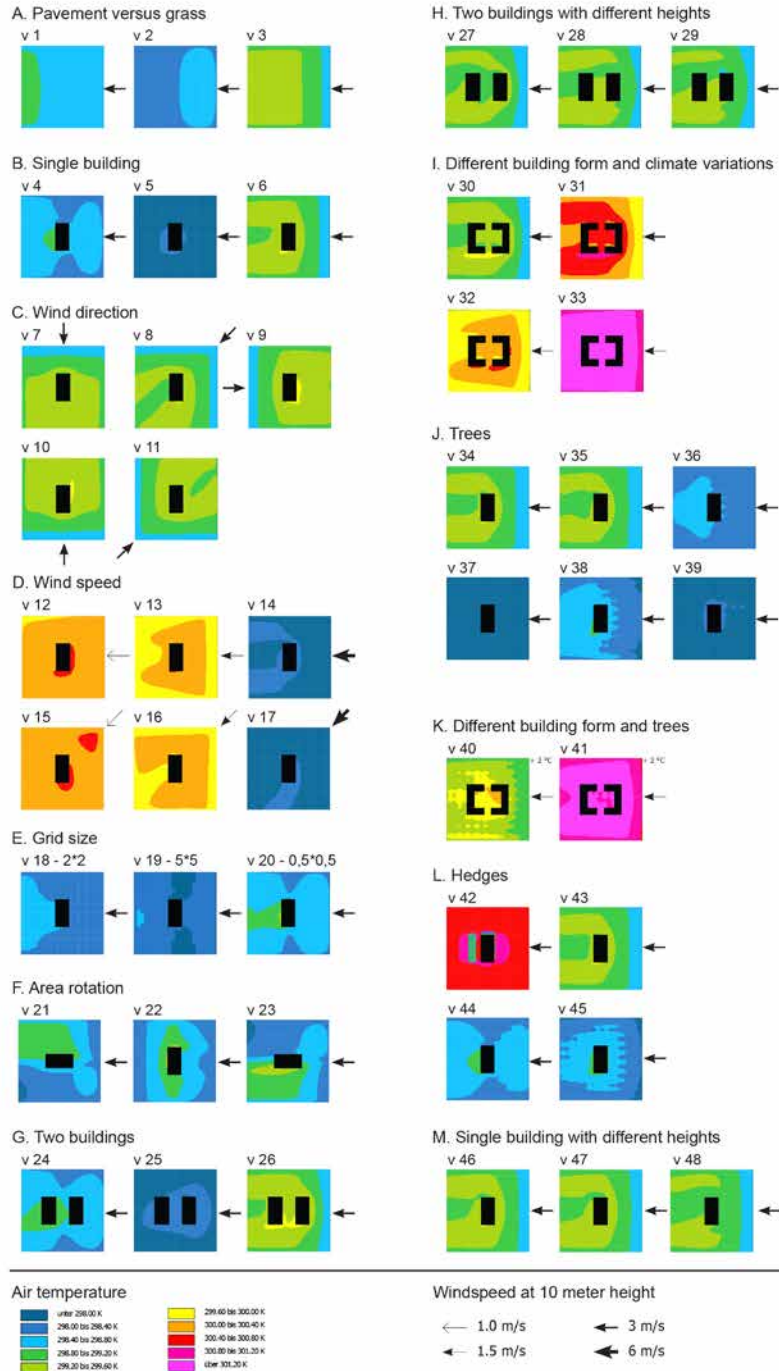

FIGURE 4.4 The air temperature at 13:00 h at 1 metre height by the graphic program LEONARDO.

§ 4.2.6 Justification of ENVI-met

In this section several methods are used to show that the accuracy of ENVI-met results is appropriate for the comparison of different urban forms. In the first section a validation of ENVI-met is done by comparing field measurements of different paving materials with simulation results of different paving materials. The second section makes use of wind tunnel measurements with comparable urban compositions. Followed by, the explanation of the justification and clarification of results, through comparing them with results found by others in literature. Finally, a computational grid size sensitivity check is done.

Field measurements versus simulation

In this section the ENVI-met model is validated through a comparison of measurements and simulations results of the two paving materials grass and brick, both on a winter day. The measurements were done in two courtyards of buildings on the campus of the Delft University of Technology, Delft, the Netherlands: the Science Centre with grass (Figure 4.5-a) and the Chem Tech building with brick pavement (Figure 4.5-b). Two Escort Junior data loggers (Figure 4.5-c) were used to measure air temperature with an interval of 30 minutes. The sensor for air temperature was protected by a bin with aluminium cover (Figure 4.5-d) to minimise the effect of radiation.

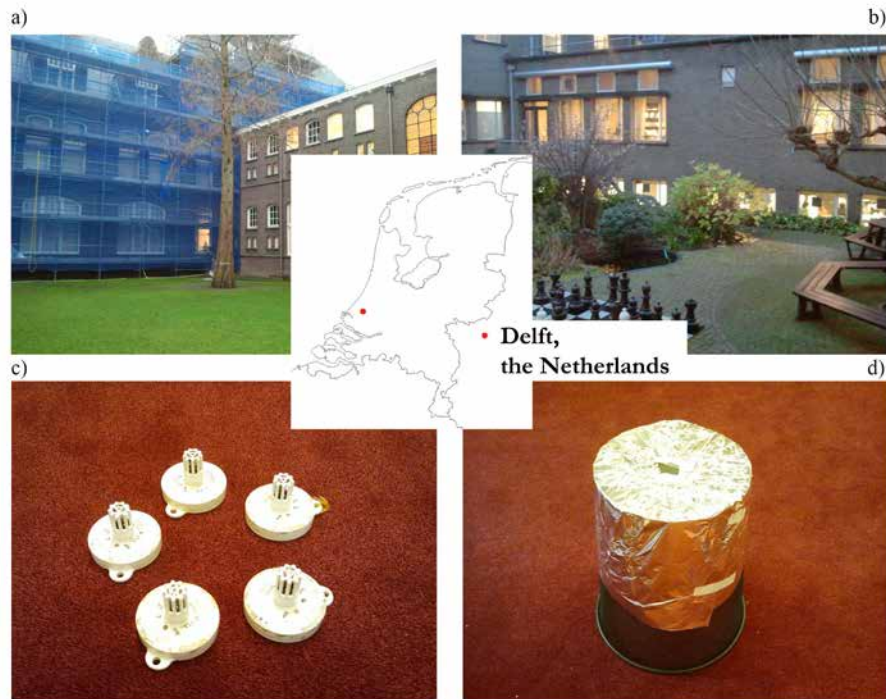

FIGURE 4.5 a) the measurement location for the grass field at the Science centre and the location Delft as the place of validation; b) the measurement location for the brick pavement; c) Escort Junior data loggers used for the measurements; d) a bin with aluminium cover to shield the data loggers.

For the measurement and simulations a sunny day was chosen, the 19th of December 2013, to avoid discrepancies between measurement and simulation results due to cloudiness. To do these simulations an ENVI-met Area Input File (AIF) and a Configuration File are needed, as explained in sections 4.2.4 and 4.2.5 respectively. The simulation input data for the 19th of December 2013 are presented in Table 4.3. The simulation results are collected in so called receptor points. For the validation we looked at the average of the four receptor points.

INPUT	VALUE	UNIT
Start Simulation at Day	18.12.2013	DD.MM.YYYY
Start Simulation at Time	5:00:00	HH:MM:SS
Total Simulation Time	37.00	Hours
Save Model State	60	min
Wind Speed in 10 m ab. Ground	5.7	m/s
Wind Direction (0:N,90:E,180:S,270:W)	208	
Roughness Length z0 at Reference Point	0.1	
Initial Temperature Atmosphere	280 (7)	K (°C)
Specific Humidity in 2500 m	7	g Water/kg air
Relative Humidity in 2m	86	%
Database Plants	[input]\Plants.dat	

TABLE 4.3 Table 4.3: Configuration File input parameters in ENVI-met for the 19th of December 2013.

The measured and simulated air temperatures are shown in Figure 4.6. Here it becomes clear that the difference in air temperature between the measured and the simulated data do not differ more than 2 °C. The root-mean-square deviation (RMSD) is calculated to indicate the accuracy of the simulated data on a winter day for the Netherlands. The RMSD is a frequently used measure of the differences between values predicted by a model and the values actually observed. The RMSD between measured air temperature and simulated air temperature in the performed field study is 0.94 °C for brick and 0.74 °C for grass. The maximum difference between measured and observed data is 1.8 °C for brick and 1.6 °C for grass. The hourly fluctuations in the measurement data are not found in the simulation results because the model calculates with starting values, and these are not forced into another direction because of a change of weather.

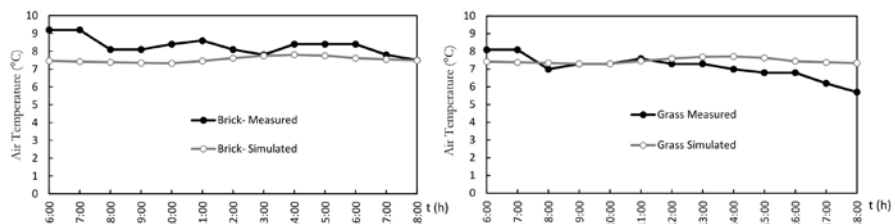

FIGURE 4.6 Simulation results with the ENVI-met model and field measurements at the campus of the Delft University of Technology on the 19th of December 2013, with on the left results for the brick pavement and on the right for the grass field.

Validation with wind tunnel measurements

Wind is one of the four main thermal comfort indicators, and therefore, a main parameter in the PET. In this study the simulation results are compared to wind tunnel measurements by Beranek (Beranek, 1979, Beranek, 1984). This is a very extensive wind tunnel study that shows wind patterns for different forms of buildings and various wind directions. These wind tunnel results can be used to validate simulation results, as it is already done in a study about the typical wind flow pattern around buildings and its influence on pedestrian level (Blocken & Carmeliet, 2004).

In Beranek's wind tunnel study a scour technique is used to analyse the wind pattern at pedestrian level. The scour technique consists of two parts. First, dry sand is sprinkled over the turntable in a uniform layer, and wind speed is increased in steps until all the sand has been blown away. In the second part, the same uniform sand layer is created and the same steps of wind speed are now performed with a building on the turntable. The sand erosion that occurs with each step of wind speed is photographed after it has reached a steady state. The total wind pattern at ground level is visualised by combining the erosion patterns of all the steps. In this study ENVI-met results in wind speed are compared with results measured in a wind tunnel study in set C and M, section 4.3.3 and 4.3.13 respectively.

Computational grid size sensitivity check

The influence of grid size is important in the evaluation of thermal comfort with computer models. Grid size determines how detailed buildings, the site layout and other objects can be modelled and what the distance is between the points that are calculated. In practise the minimum and maximum grid size in ENVI-met is 0.5×0.5 and 10×10 metres respectively. Depending on the detail level of information one may need to retrieve, the grid size can be chosen. In an earlier study the grid size of 5×5 metres turned out to be too coarse to give insight in the effect of climate adaptation measures within a street profile or neighbourhood square (Kleerekoper et al., 2012).

The influence of grid size is studied in set M with four different grid sizes: 0.5×0.5 metres (v20), 1×1 metre (v4), 2×2 metres (v18) and 5×5 metres (v19). In the average PET of the four receptor points a larger grid size results in a lower PET. The average PET decreases by increase of grid size with: 36.9°C ; 37.8°C ; 36.6°C and 35.9°C for respectively 0.5×0.5 ; 1×1 ; 2×2 and 5×5 metres. The grid size step from 1×1 to 0.5×0.5 results in a difference of less than 1°C . While the grid size step from 2×2 to 1×1 results in 1.2°C in PET. We consider a deviation of 1°C in PET the threshold for deviations caused by the grid size. Therefore we use a grid of 1×1 in this study.

The difference caused by grid size in air temperature is smaller than in PET. Figure 4.7, clearly shows that a grid size of 0.5×0.5 instead of 1×1 metre does not make a lot of difference in air temperature prediction. In less than 10% of the area the air temperature

increases with a maximum of 0.4°C. However, with a grid size of 2*2 instead of 5*5 metre the air temperature changes in about 50% of the area with a maximum of 0.4°C. Both results, in PET and air temperature require a grid size of 1*1 metre or smaller.

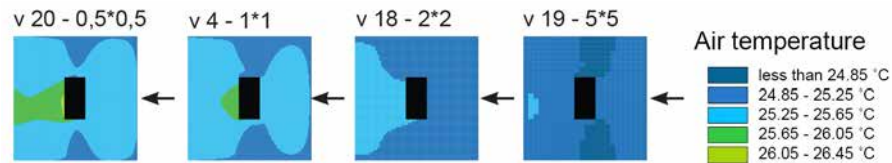

FIGURE 4.7 The air temperature at 13:00 h at 1 metre height for the grid size variants (from left to right) 20, 4, 18 and 19 by ENVI-met.

Justification and clarification with measurements and simulations from literature

Next to the validation of the ENVI-met results with field measurements and wind tunnel studies, the simulation results are compared to results found in literature. Depending on the parameter(s) changed in the variant study, the effects are analysed in PET, air temperature, mean radiant temperature, wind speed or relative humidity. To clarify or justify the effects calculated with the ENVI-met model, the results are compared with field measurements or simulations by others and theoretical principles in sets A, B, D, E, G, H, I and J.

Discussion on reliability of ENVI-met

Due to the complexity of modelling the microclimate, some processes in ENVI-met are simplified and standardised. Model limitations, for example, are the overestimation of daytime temperature because the heat storage in building surfaces is not calculated (Spangenberg et al., 2008), the global radiation is somewhat overestimated, and at night the missing heat storage in building surfaces leads to an underestimation (Bruse & Fler, 1998). Also the meteorological inputs at the boundary conditions are limited (Fahmy & Sharples, 2011) this makes it difficult to approach measurement series done in the field. This functionality will be included in the new version ENVI-met 4.0 (Yang et al., 2013) which is in development. In a study of the 'Stadtgarten' in Essen, Germany, the differences between modelled data and observed data are in the range of +1.5 to -1.0°C (Lahme & Bruse, 2003). A study in Singapore also concludes that the ENVI-met simulation supports the data generated from the field measurement (Yu & Hien, 2006). ENVI-met is less suitable to reproduce exact temperatures for a specific day, but gives insight in the micrometeorological processes in urban environments. The simulation model makes it possible to compare and analyse temperature differences as well as the temperature distribution for different urban situations (Klok, 2010). The accuracy of calculations depends heavily on grid size, details in the model and input parameters.

The validation with field measurements in Delft, the Netherlands, as described in this section and by Taleghani et al. (2014), indicates that the influence of different urban materials on air temperature can be calculated with an accuracy of about 80% and with an average deviation between 0.74-0.94°C by the ENVI-met model. However, this does not give hundred percent confidence in the accurateness of other microclimate parameters. Therefore, the use of ENVI-met is justified in this study with several additional methods: with wind tunnel measurements from literature; a computational grid size sensitivity check; and with measurements and simulations described in literature with results in air temperature, surface temperature and wind speed. The direction of the effect - cooling or up-heating -, and the magnitude of the effect in relation to the other urban changes are accurate for the type of conclusions in this study. It would take a different approach to validate the absolute value of the outcomes by ENVI-met. In any case, basic knowledge about the urban microclimate and experience with modelling programs is still required to interpret simulation outcomes.

In the chosen application the effects of urban measures can be compared objectively. Real-time weather influences or differences in climate do not occur because the same input parameters are used for all simulations. To test the influence of differences in wind speed and wind direction set C and D have slightly different input parameters.

§ 4.3 Results and clarification

The results from the simulations introduced in the previous sections are presented and discussed per set of variants. The variants are analysed at three different points in time, at 13:00, 21:00 and 04:00 h. The PET temperature at 21:00 ranges from 15 to 23°C and at 04:00 h from 12 to 20°C, both have a difference of 8°C from minimum to maximum temperature. At 13 o'clock the difference in PET is larger, 21°C, ranging from 34 to 55°C. The wider range shows more detail and enables a more precise comparison between the variants. Therefore, the results will be compared based on the values at 13:00 h. This moment of the day is also representative for the accumulation of heat in urban configurations. Figure 4.8 shows the average PET for the four receptor points at 1 metre height together with the average air temperature. In the following paragraphs the results are analysed for the different sets of adaptation measures A till M.

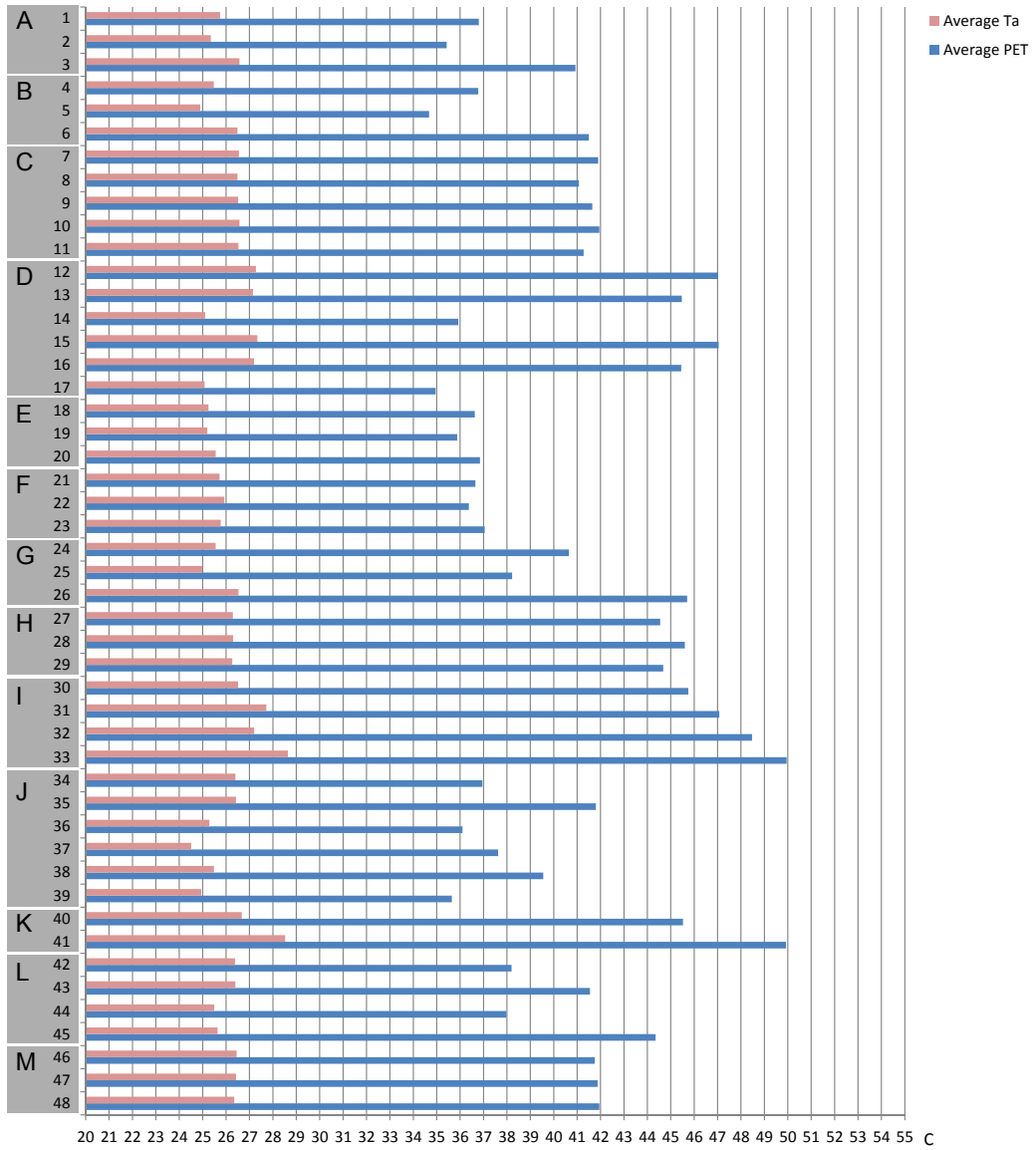

FIGURE 4.8 The average PET and air temperature on 13:00 h at 1 metre height.

§ 4.3.1 Set A: Pavement versus grass

The simulation results for the variants in set A (Figure 4.9) show that the brick pavement (variant 3) feels 6 °C warmer than the grass surface (variant 2). The bricks give a homogenous PET distribution across the area, while the grass variant has a slight PET increase on the East side and a slight decrease on the West side. The expectation is that grass lowers the wind speed which would result in a PET increase at the West side instead of the East side. The simulations indeed show a decrease in wind speed at the West side but also a drop in humidity and air temperature relative to the East side, resulting in an overall decrease in the PET temperature on the West side.

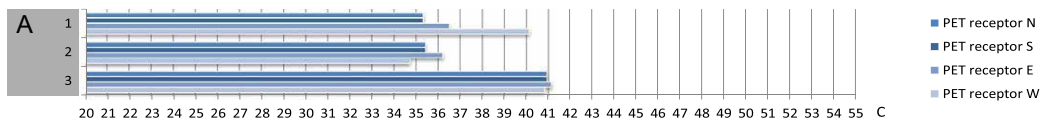

FIGURE 4.9 The PET for pavement versus grass in variant 1, 2 and 3 in set A at 13:00 h at 1 metre height

Variant 1 combines grass at the East side and brick pavement at the West side. The 50% grass coverage causes a PET decrease of 3.5 °C within the same area. The presence of the grass also lowers the PET for people who are at the brick (West) side. The difference is almost 1 °C compared to the brick variant without grass (variant 3). The effect of the 50% grass on the East side (variant 1) results in the same low PET in the North and South receptor as the variant with 100% grass coverage (variant 2). Thus, a 6 °C cooling effect is measured in comparison with the brick variant (3). This implies that with only half the amount of grass, more than half of the area has an effectively lower PET.

To compare the simulation output from ENVI-met in set A with results by others a different indicator than PET or air temperature is needed since there are no studies about surface materials that give their result in one of these two indicators. Luckily, there are studies that analyse the effect of pavement and grass by the surface temperature. In a study by Onishi et al. (2010) a multivariate linear regression model is used to compare a parking lot with 100% concrete or asphalt pavement versus 100% grass coverage and showed a significant decrease of the surface temperature. The maximum cooling of the maximum daily surface temperature due to grass is 8 °C, while the average decrease of the whole area surface temperature is 0.3 °C (Onishi et al., 2010). Another study that simulated surface temperatures for different land-covers indicates a maximum cooling effect of tall grass compared to concrete of 22 °C (Herb et

al., 2008). Here the simulation model was built up with surface heat transfer equations and a numerical approximation of the 1-D unsteady heat diffusion equation. Finally, a study done in Manchester measured a maximum cooling effect of 24°C by a grass surface instead of concrete pavement (Armson et al., 2012).

ENVI-met makes it possible to generate a spatial map of the surface temperature so we can compare the results from the studies described above with the simulation results. The surface temperature calculated by ENVI-met is around 29°C for grass and 41°C for brick pavement, as shown in Figure 4.10. This means that the simulations show a difference in surface temperature of around 12°C between grass and brick. The surface temperature per material is dependent on external factors like the air temperature, wind speed and solar intensity and on material properties such as conductivity, thermal capacity and moisture within the material or permeability of the pavement. The high variability of external factors explains the large range of the surface temperature differences of 8 and 24°C found by other studies comparing grass and brick pavement. The simulated difference of 12°C in ENVI-met lies within this range.

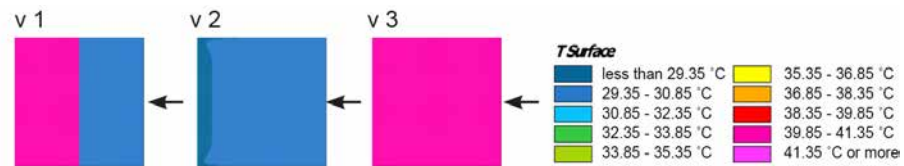

FIGURE 4.10 The surface temperature of the pavement and grass variants in set A at 13:00 h by ENVI-met.

§ 4.3.2 Set B: Single building

When a single building of 8 metres tall is placed in the middle of the area in set B (Figure 4.11) the effect of brick pavement and grass is similar to the situation without building. The difference in PET between brick pavement (variant 6) and grass surface (variant 5) ranges from 6°C at the North, South and East side to 8°C at the West side. The building blocks the wind and therefore increases the PET at the leeward side of the building. The West side of variants 4, 5 and 6, is 1-3°C warmer compared to the variants 1, 2 and 3 without a building. The North and South side of the area is 1-1.5°C cooler with building than without building. This decrease in PET can be explained by the acceleration of airflow at the sides of the building as shown in Appendix C Figure C.1.

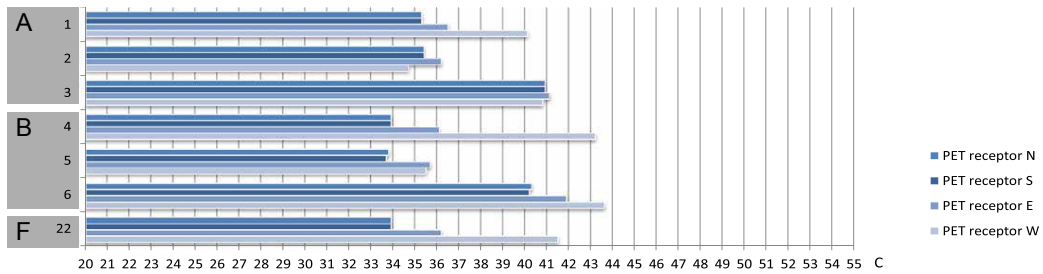

FIGURE 4.11 The PET for a single building in variant 1 to 6 and 22 in set B at 13:00 h at 1 metre height.

Another parameter that can be studied in this context is the influence of a single building on thermal comfort. The average PET is 1 °C cooler with building than without for a situation with grass, as shown in Figure 4.8. For the situation with brick the average PET is 0.5 °C warmer with building than without. As can be expected, the receptor points show a higher variability per receptor compared to the average value. Looking at the PET difference per receptor that is caused by a building, this is 1 to 3.5 °C warmer and 1 to 1.5 °C cooler. The influence of urban geometry is usually measured or simulated within an existing urban context or a standardised canopy profile (Lahme & Bruse, 2003, Thorsson et al., 2011, Oke, 1988). There are many studies specifically focused on the airflow around a single building. The effect of buildings on the wind pattern is studied in detail in set C and M, section 4.3.3 and 4.3.13 respectively.

Besides the effect buildings have on wind, they also affect the mean radiant temperature (T_{mrt}) in the direct surrounding of the building. The reflectivity of the façade influences the amount of shortwave radiation that is reflected. The more radiation is reflected, the higher the T_{mrt} in the surroundings of the building. Apart from increased reflectivity, a building also casts a shadow which leads to a decrease of the T_{mrt} in the shadow location. The simulation results in Appendix C Figure C.2 show that with a facade albedo of 0.2 the building increases the T_{mrt} up to 1 °C when the building is surrounded by pavement (variant 6). When the building is surrounded by grass the building does not increase the T_{mrt} within its surrounding. Looking at the average PET the same trend is visible in Figure 4.8: the PET increases with 0.5 °C when a building is placed in the brick pavement variant and the PET decreases with 0.7 °C when it is placed in the grass variant. Thus, a building can cool, and also heat up the pedestrian area, depending on the location and the wind direction, sun orientation, building properties and the materialization and greening of the surrounding. More research is needed to know the effects on the PET with alternative albedo values and building heights.

From set B with a single building the effect of grass can be analysed more thoroughly. Variants 1 and 4 show the effect of grass when it is situated at the windward side of the area. In both variants the stony leeward side (West) shows a higher PET than the grass at the windward side (East). Is this still the case when the grass is situated at the opposite leeward side? In this case the leeward side has a 50% grass coverage, as in variant 22. The PET at the North and South side in variant 22 is the same as for variant 4. The expectation is that the West side of variant 22 is cooler than in variant 4 because of the grass and the East side is warmer due to the brick pavement. The results meet this expectation: the West side (grass) is 1.7°C cooler and the East side (brick) is 0.1°C warmer. We can conclude that grass is cooler than brick, regardless the East or West orientation or the wind direction.

The results above show that grass gives a lower comfort temperature compared to brick pavement in all cases: in an open field, in combination with a building and at both the leeward and windward side. Grass even lowers the temperature of the surrounding paved area with 1°C. The PET between grass and brick pavement ranges from 0.1 to 8°C.

§ 4.3.3 Set C: Wind direction

The next set of variants look into the effect of the difference in wind direction in set C (Figure 4.12). A general conclusion from these simulations is that the leeward side of the building is 1.5-3°C warmer when the wind direction is perpendicular to the building. When the wind arrives at the building at an angle (variants 8 and 11) instead of perpendicular to the facade, the temperature distribution around the building is more equal and results on average in the coolest situation, as presented in Figure 4.4. The difference in the average PET goes up to 0.9°C. When the wind arrives at the short side of the building, as in variant 7 and 10, the PET increases most. The highest PET arises at the leeward side of the building.

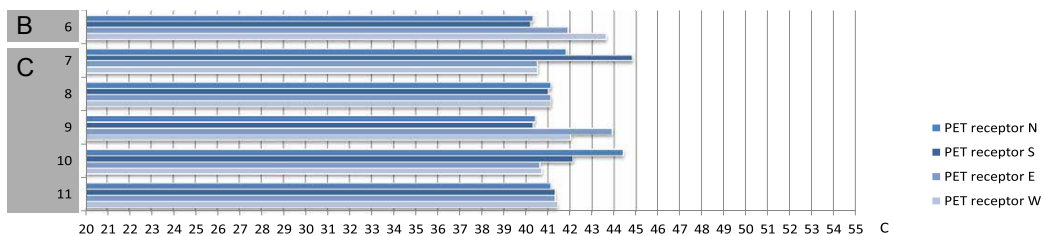

FIGURE 4.12 The PET for a single building in variant 1 to 6 and 22 in set B at 13:00 h at 1 metre height.

As explained in the method section 4.2.6 simulation results in wind pattern and wind speed are compared to wind tunnel measurements. In Figure 4.13 the result of the wind tunnel study by Beranek is placed next to and is combined with the simulation output from ENVI-met for a comparable building and wind angle. Building variant 8 and wind tunnel test a4 both have a width of 20 m and length of 40 m, only the height of the buildings differs from each other: in ENVI-met the modelled building is 20 m high (due to model limitations) and the wind tunnel scale model (scale 1:300) is 70 m high. The wind tunnel experiments are done with a wind hinder parameter $\alpha = 2.0 - 1.8 - 1.6 - 1.4 - 1.2 - 1.0 - 0.8$. These are visualised with lines and the increase is shown in light- to dark grey.

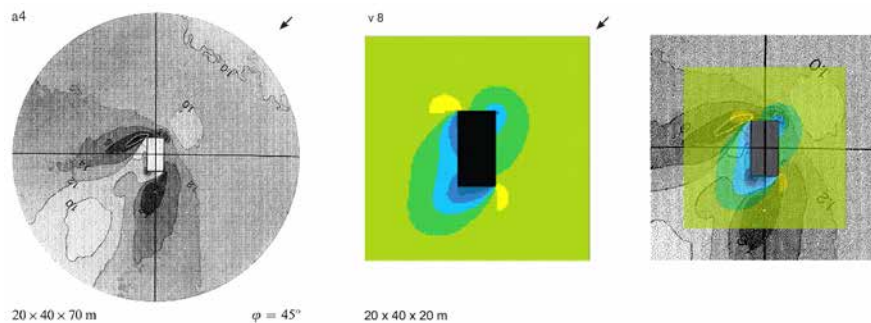

FIGURE 4.13 The influence of a rectangular building on the wind speed on the ground floor. On the left (a4) the result from the wind tunnel study (Beranek, 1979) for a building size of 20*40*70 (w*l*h), in the middle (v8) the result from the ENVI-met simulation at 13:00 h for a building size of 20*40*20 (w*l*h), and on the right the two outcomes combined.

The wind tunnel result and the ENVI-met simulation outcome can first be compared to the kinds of changes in wind pattern caused by a building. Both show a wake field on the windward and the leeward side of the building. The other important correspondence between the two is the high-pressure field on the windward corners of the building.

The next element of comparison would be the magnitude and form of the wind patterns. However, a problem arises because the models do not show the same information exactly. The different grey shades in the wind tunnel tests correspond to a sand pattern formed with a certain wind speed, while the ENVI-met outcome shows the steady state situation after 8 hours of calculation starting with an incoming wind speed of 3m/s on 10 metres height. The wake field behind and in front of the building are larger for the wind tunnel test than for the simulation outcome. The same goes for the high-pressure area around the corner which is larger for the wind tunnel test. This difference is clearly a result of the difference in building height shown in Figure 4.14.

The size of the pressure area typical of a building of 25 metres high is very similar to the size of the pressure area typical of the building of 20 metres high in the ENVI-met simulation.

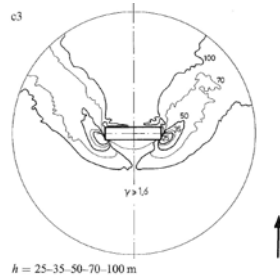

FIGURE 4.14 The influence of a rectangular building - 20*80 (w*I) - on the wind speed on the ground floor for the building heights 25, 35, 50, 70 and 100 metre tested in a wind tunnel (Beranek, 1979).

§ 4.3.4 Set D: Wind speed

In set D the effect of wind speed is simulated, as shown in Figure 4.15. The variants 12, 13, 6 and 14 have wind from the East and a speed of 1, 1.5, 3 and 6 m/s at 10 m respectively above the ground. And the variants 15, 16, 8 and 17 have wind from the North-East and the same speed of 1, 1.5, 3 and 6 m/s respectively. A higher wind speed results in a lower PET for the tested wind speeds from 1.0 up to 6 m/s. The range of the temperature effect is similar for both wind directions from the East and the North-East. The effect on the PET in relation to the wind speed is shown in Table 4.4.

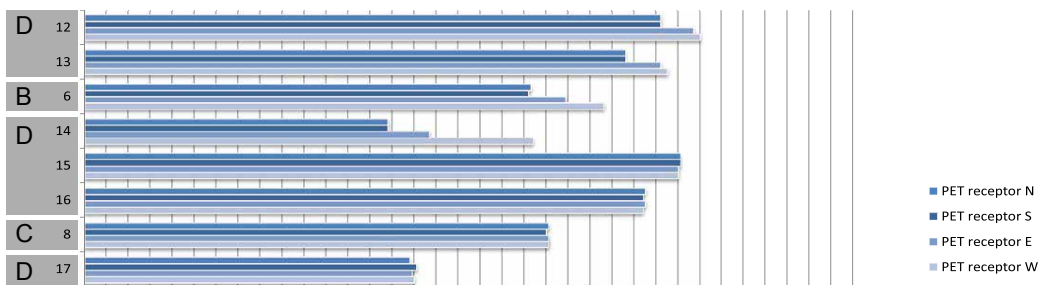

FIGURE 4.15 The PET for the wind speed in variant 12, 13, 6, 14, 15, 16, 8 and 17 in set D at 13:00 h at 1 metre height

WIND SPEED:	EAST	NORTH-EAST
from 1 to 1.5 m/s	- 1.6°C	- 1.7°C
from 1.5 to 3 m/s	- 4°C	- 4.5°C
from 3 to 6 m/s	- 5.6°C	- 6.1°C

TABLE 4.4 Effect of wind speed on PET in °C.

It is now interesting to verify whether the temperature changes correspond with the theory. In Figure 4.16 Victor Olgyay shows the wind velocity theoretically needed to restore comfort when temperatures and relative humidities are out of the comfort zone (Olgyay, 1963). An increase in wind speed from 1 to 1.5 m/s and from 1.5 to 3 m/s theoretically results in cooling effects of respectively 0.67°C and 1.22°C. This is a lower cooling effect than predicted by ENVI-met. The larger temperature drop given in Table 4.4 can mean that ENVI-met overestimates the effect of wind speed on air temperature and humidity. Moreover, the wind speed at the receptor points is lower than the wind speed at 10 m above the ground, which should theoretically result in an even smaller temperature drop.

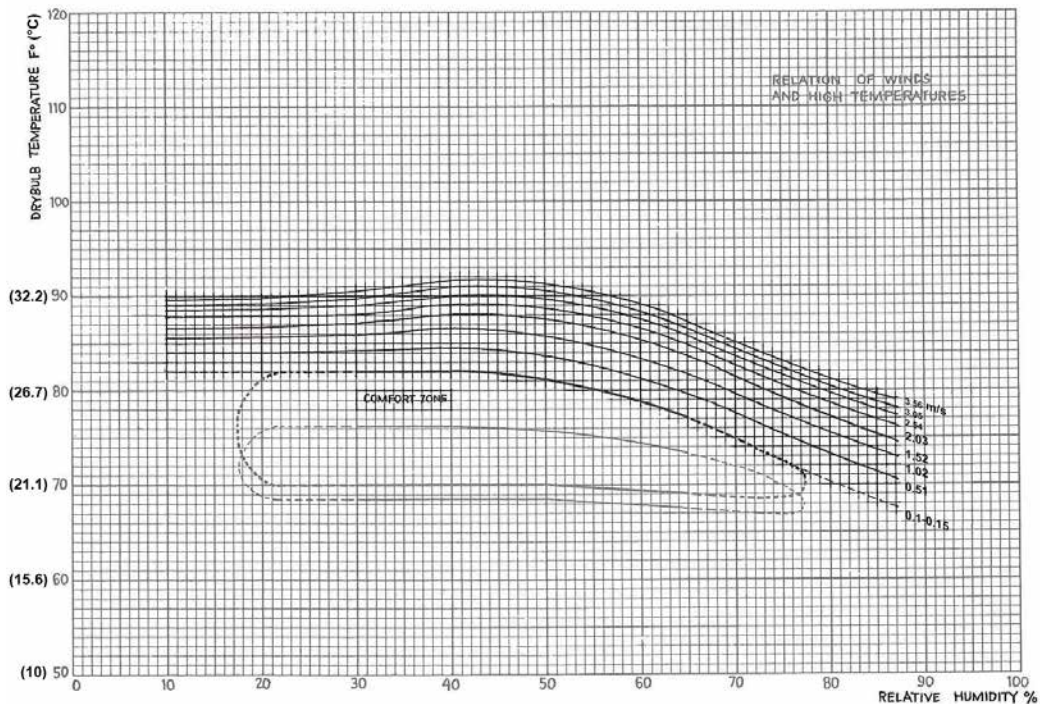

FIGURE 4.16 Relation of winds and high temperatures (Penwarden, 1973).

Studies of wind speeds are generally focussed on the cold winter situation where higher wind speeds cause discomfort from 5 m/s or more and danger from 15 m/s (Beranek, 1979, Penwarden, 1973). Therefore, the effect on the cold winter situation should always be considered when considering higher wind speeds to increase comfort in hot weather conditions.

§ 4.3.5 Set E: Grid size

The influence of grid size is studied in set E with four different grid sizes: 0.5*0.5 (v20), 1*1 (v4), 2*2 (v18) and 5*5 (v19). In Figure 4.17 the effect on the PET at the receptor points is shown. There is not more than 1°C difference between the North and South side of the area. The difference in grid size results in a change of the PET of maximum 1.4°C at the East side and 5°C at the West side. The PET per receptor point does not show a linear increase or decrease with a larger grid size. In the average PET of the four receptor points a larger grid size results in an underestimation of the PET. The average PET decreases by increase of grid size: 36.9°C; 37.8°C; 36.6°C and 35.9°C for respectively 0.5*0.5; 1*1; 2*2 and 5*5.

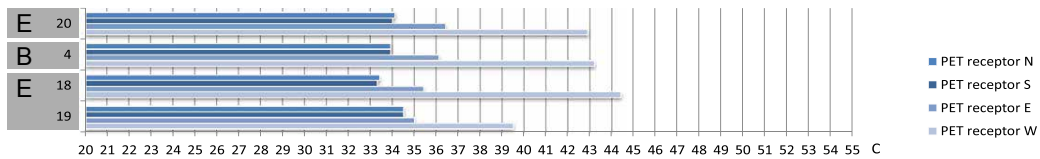

FIGURE 4.17 The PET for grid size in variant 20, 4, 18 and 19 in set E at 13:00 h at 1 meter height.

The influence of grid size is not a parameter that can improve thermal comfort, but is important in the evaluation of thermal comfort with computer models. Grid size determines how detailed buildings, the site layout and other objects can be modelled and what the distance is between the points that are calculated. In practise the minimum and maximum grid size in ENVI-met is 0.5*0.5 and 10*10 meters respectively. Depending on the detail level you need to retrieve information at, the grid size can be chosen. From an earlier study we know that a grid size of 5*5 meters is not small enough to give insight in the effect of climate adaptation measures within a street profile or square (Kleerekoper et al., 2012). The results presented in Figure 4.18 clearly show that a grid size of 0.5*0.5 instead of 1*1 meter does not make a lot of difference in PET or air temperature prediction. However, a grid size of 5*5 meter or more varies significantly in PET and air temperature and in temperature distribution within the area.

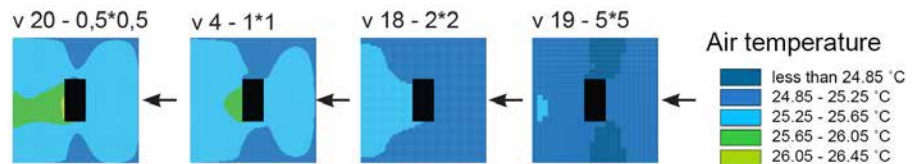

FIGURE 4.18 The air temperature at 13:00 h at 2 meter height for variant (from left to right) 20, 4, 18 and 19 by ENVI-met.

§ 4.3.6 Set F: Area rotation

The rotation of the area results in a different wind angle in combination with a different sun angle. The average PET of the four receptor points does not vary more than 0.6°C between the variants 4 and 21 to 23, presented in Figure 4.8. The separate PET per receptor point varies more, from 0 to 3.2°C . The separate receptors only differ from each other in the North and South receptor, which is a coherent output because the northern and southern half switch from grass to brick. Variant 4 and 22 have been discussed in section 4.3.2 where grass resulted in a lower PET compared to brick.

Grass can improve the comfort sensation and even eliminate discomfort sensation hours when combined with trees (Shashua-Bar et al., 2011). From this study it can be concluded that the influence of vegetation on air temperature is negligible on the small scale of the building block, while the contribution on thermal comfort is substantial. However, on the large scale, vegetation does affect air temperature significantly (Bowler et al., 2010). The radiant exchange is usually the dominant factor in human thermal comfort sensation.

Another study that looked into the cooling effect of grass calculated the difference in sensible heat flux between grass and asphalt (Takebayashi & Moriyama, 2009). The reduction was $100\text{-}150\text{ W m}^{-2}$ during the day and around 50 W m^{-2} at night. Even though there is a significant effect of grass cover on the sensible heat flux, the effect on air temperature was estimated on 0.1°C . This corresponds to the small effect on the air temperature of 0.0°C and 0.17°C calculated by ENVI-met.

§ 4.3.7 Set G: Two buildings

In set G the effect of two buildings, both 8 metres tall, is simulated in the variants 24, 25 and 26. The results from these variants can be compared with the variants 4, 5 and 6 which have a single building. Figure 4.19 shows the effect on the PET. The PET

values at the North and South side do not change with two buildings instead of one. But, at the East and West side the PET is significantly higher for the variants with two buildings. In the case of two buildings the PET at the western receptor increases with 7.7 to 10.1 °C compared to the corresponding variants with a single building. The eastern receptor shows an increase of 4.9 to 6.4 °C. The main responsible parameter is the wind speed that is lowered drastically at the East and West receptors because the receptor points are closer to the building façade. Because of the smaller distance to the façade, the radiation also increased slightly due to multiple reflection of shortwave radiation and long wave radiation from the building facade. In this case, the addition of buildings results in extra up heating at 13:00 h because of the decreased wind speed and the additional reflection from facades. Especially the space in between buildings is changed substantially with additional radiation and a lower wind speed, as shown in Appendix C Figures C.1 and C.2

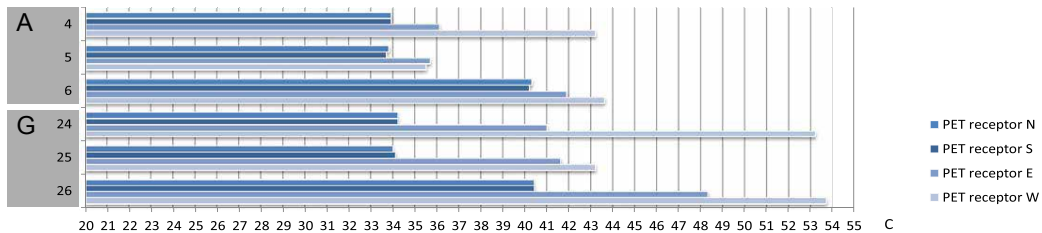

FIGURE 4.19 The PET for two buildings in variant 4 to 6 and 24 to 26 in set G at 13:00 h at 1 metre height.

Although the addition of buildings can lead to a lower wind speed and increase radiation on street level, they also cast shadow and high buildings can bend airflows downwards and increase wind speed at street level. The two latter principles will lower human thermal comfort. These principles, together with heat storage in hard surfaces, result in a cooler city in the morning compared to the surroundings of the city. Still in the afternoon and at night, cities are warmer than their surroundings.

§ 4.3.8 Set H: Two buildings with different heights

In set H (Figure 4.20) the two buildings have a different height of 8 and 20 meters in variants 27 and 28. The wake fields in front and behind the taller building are larger and have a lower wind speed. Therefore the building of 20 metres has a higher PET at the leeward (West) side in variant 27. And for the same reason the high building in

variant 28 has a higher PET at the windward (East) side. If we zoom into the parameters for the PET at one meter height we can conclude that the increase in PET is not partly caused by an increased radiation from the facades. On the North and South side the taller building has a higher air pressure which results in a lower air temperature (see Figure 4.3) compared to the building of 8 meters high.

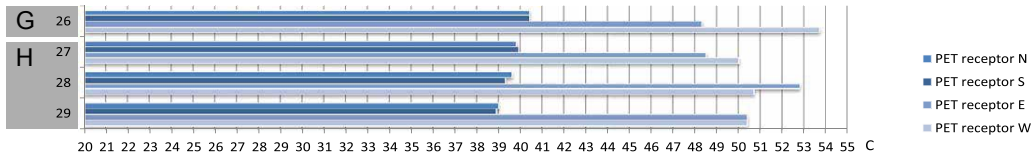

FIGURE 4.20 The PET for two buildings in variant 26 and 27 to 29 in set H at 13:00 h at 1 metre height.

Variant 29 has two buildings of 20 meters high and can be compared to variant 26. The taller buildings in variant 29 result in an overall lower PET compared to variant 26 of 1 °C. Due to the higher wind speed at the North and East side of the building the air temperature is decreased as well. The taller the building in an open field, the higher the wind speed becomes at ground level. The wind is directed down between 2/3rd and 3/4th of the building height (Peterka et al., 1985). The higher the building the stronger the wind force that hits the building, again increasing the wind speed at ground level. However, when buildings are built close to each other and have a H/W (height to width) ratio between 1 and 2 the air flow will not be directed downward, but will skim over (Xie et al., 2007).

§ 4.3.9 Set I: Different building form and climate variables

In set I the built form is changed to a building ensemble of two buildings that form a semi enclosed courtyard. The different building form in variant 30 is compared with the two rectangular shaped buildings of variant 26 in Figure 4.21. The PET hardly shows any difference in the reference points. Only the West side is slightly warmer with the courtyard form. If we look at the temperature distribution the air temperature differs especially inside the semi enclosed courtyard. Here the air temperature at one metre high is lower due to the shadow of the building. The effect of the shadow on the PET will be a temperature decrease; however, the PET may also remain the same or even increase because also wind speeds are lower in the semi enclosed space.

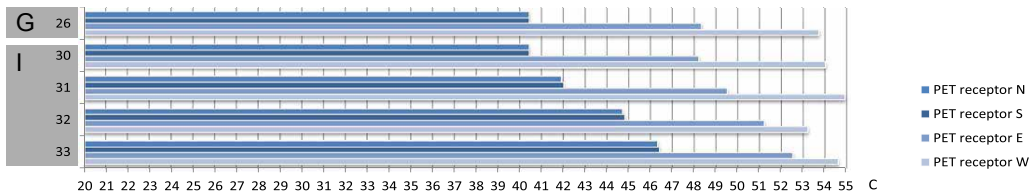

FIGURE 4.21 The PET for different building form and climate variables in variant 26 and 30 to 33 in set I at 13:00 h at 1 meter height..

Moreover, the semi enclosed courtyard (variation 30) in comparison with the open canyon (variation 26) can provide more shading before and after noon (the moment we discussed in the previous paragraphs). In accordance with several studies that indicate the dominant role of radiation in thermal comfort, we can argue that although the semi enclosed courtyard is less ventilated, it can provide more sun protection. On this account, Yezioro et al. (2006) showed by a field measurement of summer thermal comfort within courtyards in a hot and arid climate that, although the air temperature difference between shaded and unshaded areas was only 0.5°C , the mean radiant temperature was different up to 30°C .

In set I also two external parameters are changed. What happens if the initial temperature is two degrees higher or the wind changes from 3 to 1.5 m/s considering the semi enclosed courtyard? The initial temperature increase of 2°C results in an increase of the PET of $1\text{-}1.5^{\circ}\text{C}$. The change in air speed has a greater effect on the PET. This results in a $3\text{-}4^{\circ}\text{C}$ increase of the PET at the North, South and East side and a 0.8°C decrease at the West (leeward) side. When the two external changes are applied at the same time the result on the PET is an increase of almost 6°C at the North and South side, 3°C at the East side and more than 0.5°C at the West side.

The combination of the two external parameters, the lower wind speed and higher initial temperature, result in more than the sum of the two separate PET values at the North and South side and less than the sum of these two at the East and West side. The sum of the PET from the two external parameters would be $4\text{-}5.5^{\circ}\text{C}$ instead of the simulated 6°C at the North and South side. At the East and West side the combination of the two results in a lower PET compared to the sum of the two applied separately. This result emphasises the difficulty in giving standardised cooling ranges for adaptation measures and the importance of local circumstances.

§ 4.3.10 Set J: Trees

Simulations of the overall effect, different positions, amount of trees, and different contexts are analysed in set H. The overall effect of trees during daytime is predominantly a cooling effect. The average PET of the four receptor points is given in Table 4.5. The variants with trees are 1.9-5.8°C cooler, except for variant 35 with three trees perpendicular to the building façade which has an up heating effect of 0.3°C.

	AVERAGE PET (°C)
Variant 6	41.5
Variant 34 parallel	37.0
Variant 35 perpendicular	41.8
Variant 36	36.1
Variant 37	37.6
Variant 38	39.6
Variant 39	35.7

TABLE 4.5 The average PET from the four receptor points for the variants 6, 36, 37, 38 and 39.

All variants with a grid of trees on the East side (variant 36 - 39) have a significant cooler PET at the East receptor. The result is a PET between 22 and 32°C as shown in Table 4.6. Thus, the trees result in the cooling of the PET of 10 to 20°C compared to the PET of variant 6 without green. In all variants the trees cause a lower air temperature and especially a lower radiant temperature. The varying wind speed is also related to the presence or absence of grass. However, in this case the lower wind speed does not overrule the cooling effect of the air and radiant temperature on the PET.

EAST RECEPTOR	PET (°C)	TEMP (°C)	RH (%)	WIND (M/S)	RADIATION (°C)
Variant 6	41.9	26.58	66.67	1.79	69.37
Variant 36	29.4	25.24	80.29	1.52	42.18
Variant 37	29.9	24.30	76.05	2.44	50.76
Variant 38	31.7	25.42	74.88	2.33	51.64
Variant 39	21.9	24.78	66.69	1.58	24.27

TABLE 4.6 The four parameters that influence the PET at the East receptor for the variants 6 and 36 to 39.

Different positions of trees in relation to a façade are analysed in variants 34 and 35: a row of three trees on the leeward side of a single building, respectively parallel and perpendicular to the facade. The average PET of the four receptor points show a difference of 4.8°C between variant 34 and 35 in Table 4.5. The receptor on the West

side is responsible for this large difference, as shown in Figure 4.22. When the trees are placed parallel to the building, the receptor on the West side indicates a PET of 26 °C. If the trees are placed perpendicular to the building, the PET increases with almost 10 °C to a PET of more than 45 °C. The latter situation even results in a higher PET than in variant 6 where no trees are present

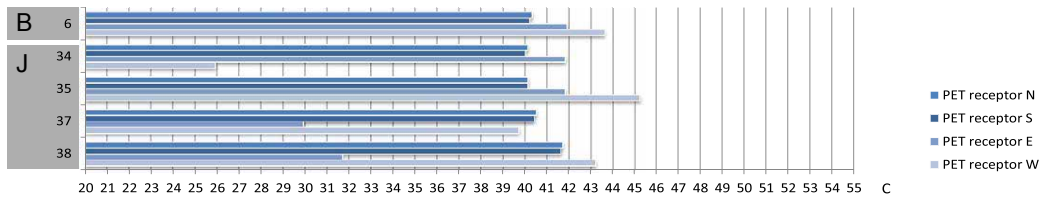

FIGURE 4.22 The PET for trees in variant 6, 34, 35, 37 and 38 in set J at 13:00 h at 1 metre height

Zooming into the PET components given in Table 4.7, it is clear that the large difference in the West receptor between variant 34 and 35 is caused by the difference in radiation. In variant 34 the receptor is most likely shaded by one of the trees resulting in a decrease of the radiant temperature of 41 °C. The trees also reduce wind speed, which has a counter-effect and causes a slight up heating. Variant 6 without trees has a higher wind speed and therefore a cooler PET of more than 1 °C compared to variant 35.

WEST RECEPTOR	TEMP (°C)	RH (%)	WIND (M/S)	RADIATION (°C)
Variant 6	26,19	62,31	1,27	69,66
Variant 34 Parallel	26,09	63,45	0,75	28,68
Variant 35 perpendicular	26,21	62,89	0,94	69,69

TABLE 4.7 The four parameters that influence the PET at the West receptor for the variants 6, 34 and 35.

The amount of trees is analysed by placing only three trees in variants 34 and 35, a grid of trees (45 trees) covering half of the area in variants 36, 38 and 39 and a grid of trees covering the whole area in variant 37 (81 trees). In Table 4.5 the average PET per variant indicates that more trees do not necessarily lead to a lower thermal comfort sensation. For example, variant 37, with a grid of trees covering the whole area, is not the coolest. The lowest average PET is achieved in variant 39 with trees at the windward side.

The effect of trees can be different depending on the context they are placed in. In this set of variants the different contexts are: trees placed in a grass field (variant 36) or in pavement (variant 39). Comparing the variants in Figure 4.23 that have grass at the opposite side with and without trees we can see the effects of these parameters applied together. In Figure 4.24 the simulation outcome per receptor is given. The North and South receptors show a higher PET of 2-6 °C for the variants with trees (36 and 39) compared to the variants without trees (4 and 22). The receptor at the East side shows a lower PET of 6-14 °C for the variants with trees (36 and 39) compared to the variants without trees (4 and 22). The trees have a local cooling effect because they do not lead to a cooler PET at the other receptor points, they even increase the PET at the leeward side of the trees because of a lower wind speed. The average cooling result of trees planted at the East side is given in Figure 4.8 and is about 1 °C. The receptor at the West side shows a higher PET of 2-4 °C for the variants with grass at this side (22 and 39).

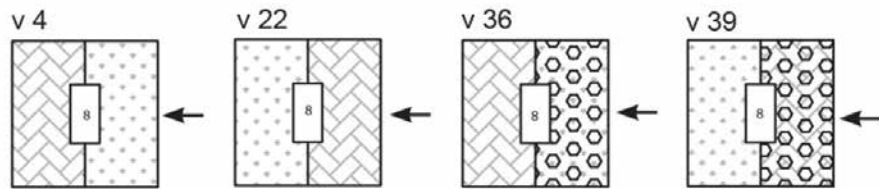

FIGURE 4.23 Variant 4 with grass on the East side, variant 36 has additional trees on the East side, variant 22 has grass on the opposite West side and variant 39 has additional trees on the East side.

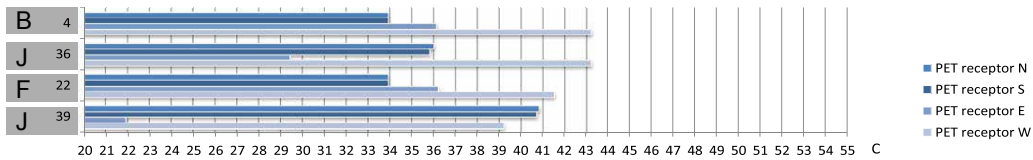

FIGURE 4.24 The PET for trees in variant 4, 36, 22 and 39 in set J on 13:00 o'clock at 1 metre height.

The analysis of these simulations with trees shows that the measurements at the receptor points are highly influenced by the exact location. Thermal comfort can be increased on a hot day in the shade of a tree, while the same tree could decrease comfort when the person stays, simultaneously, under the sun and in the wake of the tree. The large variation within a small distance from a tree gives people a choice where

they feel most comfortable in relation to their kind of activity. Other studies confirm that trees can locally improve comfort significantly by shading (Shashua-Bar et al., 2011, Armson et al., 2012, Scott et al., 1999, Oke et al., 1989). Also the evaporative cooling effect of trees can be significant for thermal comfort sensation and is highly dependent on the availability of water (Schmidt, 2009).

§ 4.3.11 Set K: Different building form with trees

In set K the same built form as in set I is simulated, this time vegetation is included. The initial temperature and wind speed are the same as for variant 33; that is 33°C and 1.5 m/s. In Figure 4.25 the PET values at the receptor points are shown. The West and East receptor show a lower PET of 4-13°C with trees around the building (variant 40). The average cooling effect of the four receptors with trees (v40) compared to the same situation without trees (v33) is 4.5°C as shown in Figure 4.4

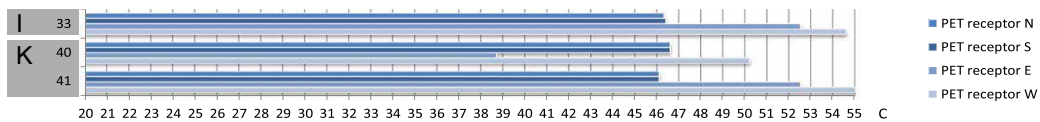

FIGURE 4.25 The PET for different building form and trees in variant 33, 40 and 41 in set K at 13:00 h at 1 meter height..

For variant 41, with trees in the courtyard of the building, the East and West receptor remain almost the same. The only difference is an increase of the PET at the West receptor of almost 0.5°C. This can be explained by the decrease in air speed at this side because of the trees. The North and South side show a little decrease of almost 0.5°C. This could be explained by the height of the trees in the courtyard, these are 15 meters high and extend the building height of 8 meters. A taller building, or in this case a building with taller trees in the courtyard will increase wind speed at the building sides parallel to the wind direction.

§ 4.3.12 Set L: Hedges

In set L situations with hedges are simulated with variants 42 to 45, and the results are shown in Figure 4.26. These can be compared with variants 34, 35, 38 and 37 that have trees instead of hedges.

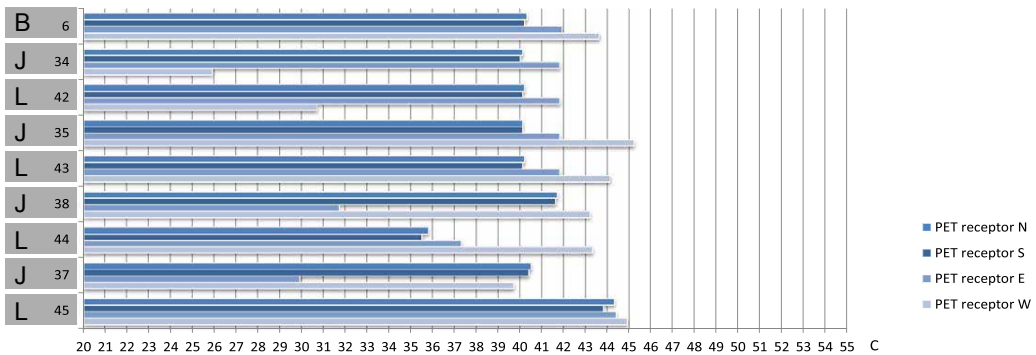

FIGURE 4.26 The PET for hedges in variant 6, 34, 42, 35, 43, 38, 44, 37 and 45 in set L at 13:00 h at 1 meter height.

The first comparison that can be made is the reference situation variant 6 that has a single building and brick pavement and no vegetation at all versus variant 34 with a perpendicular row of trees and variant 42 with a perpendicular row of hedges. The only receptor that shows a difference between these variants is the receptor at the West side, Table 4.8 shows the simulation outcome per parameter. The PET here drops with 13°C with hedges and 18°C with trees. The next comparison we can make is between the same reference variant 6 and the variants with a row of trees parallel to the building in variant 35 and a row of hedges in variant 43. Again, only the receptor at the West side shows a difference in PET, but this time the PET increases for both trees and hedges with respectively 1.6 and 0.5°C compared to the reference situation. In this case, the trees and hedges reduce radiation at the receptor point with around 50% when placed parallel to the building. This does not necessarily mean that this organisation of trees next to building results in a lower PET, therefore more receptor points are needed.

WEST RECEPTOR	PET	TEMP (°C)	RH (%)	WIND (M/S)	RADIATION (°C)
Variant 6	43.6	26.19	62.31	1.27	69.66
Variant 34 parallel	25.9	26.09	63.45	0.75	28.68
Variant 42 parallel	30.7	25.97	63.87	0.66	38.99
Variant 35 perpendicular	45.2	26.21	62.89	0.94	69.69
Variant 43 perpendicular	44.1	26.03	63.10	1.14	69.71

TABLE 4.8 The four parameters that influence the PET at the West receptor for the variants 6, 34, 42, 35 and 43.

The trees and hedges at the East side in variants 38 and 44 do not influence the West receptor a lot, they both cause a slight decrease of 0.3°C. At the East side the temperature drops with both trees and hedges: the trees cause a larger cooling of 10 °C, the hedges cool less, almost 5°C. The North and South side turn out cooler than the reference variant in the case with hedges, but warmer in the case with trees. This contra effect is caused by the high influence on the wind speed by the trees. The North and West receptors are in the wake field of the trees.

In variants 37 and 45 the whole area is planted with respectively trees and hedges. The variant with hedges is clearly warmer than the variant with trees and even warmer than the reference variant that has no vegetation at all. In Table 4.9 the separate parameters are given. From this table it becomes clear that the trees (variant 37) increase wind speed that flows under the tree crowns at the eastern receptor point, whereas the 2 meter high hedges (variant 45) decrease the wind speed at the measurement point. Trees also lower the PET because of their shading effect which results in a lower radiation. The hedges have a higher PET than the variant with trees and even the reference situation (variant 6) because they reduce the wind speed but do not provide shading. The latter could be true for a pedestrian that does not receive shading by a hedge, but the measurement point at 1m height should.

EAST RECEPTOR	PET	AIR TEMP (°C)	RH (%)	WIND (M/S)	RADIATION (°C)
Variant 6	41.9	26.58	66.67	1.79	69.37
Variant 37	29.9	24.30	76.05	2.44	50.76
Variant 45	44.4	25.90	71.05	1.03	69.48

TABLE 4.9 The four parameters that influence the PET at the East receptor for the variants 6, 37 and 45.

§ 4.3.13 Set M: Single building with different heights

In set M a single building with different heights is simulated: 8m (v6), 12m (v46), 15m (v47) and 20m (v48). The results in Figure 4.27 clearly shows that the most important parameter for the PET influenced by building height is the wind speed. The wind speed decreases at the East and West side and increases at the North and South side. This is a common known effect. The air temperature decreases at all receptor points with increasing building height. But this is overruled in the PET by the change in air speed. The average PET given in Figure 4.4 shows a slight increase of the PET with increasing building height 41.5 – 41.8 – 41.9 – 42.0 °C. Most important in this case is to emphasize the locality of the effects of wind: The lee- and windward side of buildings have a higher PET with increasing building height due to wake fields and at the corners of the building the PET is lowered because wind speed increases at these points

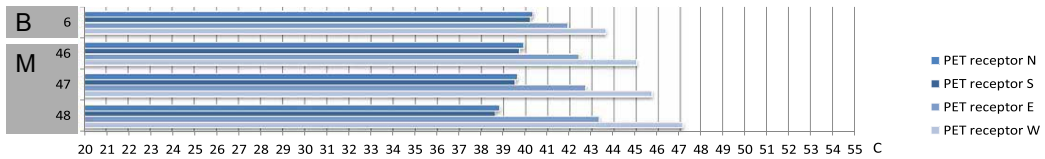

FIGURE 4.27 The PET for a single building with different heights in variant 6 and 46 to 48 in set M at 13:00 h at 1 meter height.

As announced in paragraph 3.2 and explained in paragraph 3.3 we can compare the outcome of the simulations with a wind tunnel study (Beranek, 1979). In Figure 4.28 the result of the wind tunnel study by Beranek is placed next to and is combined with the simulation output from ENVI-met for a comparable building. Building variant 48 approaches the wind tunnel test the best. Both have a width of 20 m and length of 40 m, only the height of the buildings differs from each other: in ENVI-met the modelled building is 20 m high and the wind tunnel scale model (scale 1:300) is 25m high.

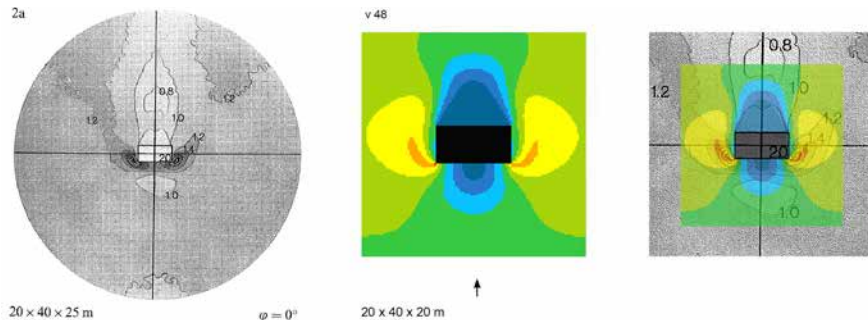

FIGURE 4.28 The influence of a rectangular building on the wind speed on the ground floor. On the left (2a) the result from the wind tunnel study (Beranek, 1979) for a building size of 20*40*25 (w*l*h), in the middle (v48) the result from the ENVI-met simulation at 13:00 o'clock for a building size of 20*40*20 (w*l*h) and on the right the two outcomes combined.

Like described in section 4.3.3, the wind tunnel result and the ENVI-met simulation outcome can first be compared on the direction of the effect. Also in this case, both show a wake field on the windward and the leeward side of the building. And both show the high pressure field on the windward corners of the building.

The next element of comparison, the magnitude and form of the wind patterns, show a better correspondence between the wind tunnel and simulation outcome. The wake fields behind the building have the same size and a very similar form, the same counts for the high pressure fields on the windward corners of the building. The wake field in front of the building shows a different form in the wind tunnel and simulation outcome. The wind tunnel result is not symmetric due to local and temporal turbulence, while the simulation outcome does show a symmetric wind pattern. The other difference between the two is a somewhat higher pressure area in front of the building with a thin layer of a low pressure area directly at the building wall and a low pressure area at some more distance to the building. The simulation outcome does not show such an area with increased pressure in front of the building. In Figure 4.14 the wind pattern that belongs to different building height is illustrated.

From the discussion above we can conclude that ENVI-met has an accurate prediction of the wind behaviour concerning the location of the effects on changing wind flow by a building. It is more difficult to conclude whether the magnitude and form of the wind pattern are accurate, from the comparisons in this study we can say that ENVI-met gives an adequate prediction to estimate the PET. The accuracy of the predicted wind speed cannot be estimated by the comparative method used in this study.

§ 4.4 Discussion and conclusion

In this chapter effects of changes in the urban context and weather on thermal comfort are compared based on the PET (Physiological Equivalent Temperature). The simulations start with very simple situations and increase complexity step by step. The higher the complexity, the more difficult it is to predict the effect on thermal comfort at a specific location. This is in accordance with the findings of a study by Gulyás et al. (2006), which states that: “complex urban environments can result in very different and often extreme comfort sensations even within short distances”. Most simulation results we found can be explained by known effects about wind flow around buildings and trees and by looking at the changes in air temperature, humidity, wind speed, and mean radiant temperature.

The method used in this study allows a comparison between the effects of urban changes on thermal comfort because the simulations are all based on the same model and have the same input and output parameters. It is the first time such an extended comparison is done for the temperate climate. In addition, the detailed analyses show the underlying principles of some microclimatic effects. One finding from the simulations is that the type of pavement can have a significant effect for the whole area, while the effect of trees depends highly on the position of the tree and the receptor (measurement) point. Multiple receptor points are used to get an overview of the effect within the area. The more points there are, the better the effect can be estimated and evaluated. The average PET of the receptor points gives the overall effect in an area. However, a rationale is important to determine whether you need improved thermal comfort in the whole area or perhaps only on a few spots. A recommendation is to place the measurement points in places where the designer/researcher wants people to feel comfortable. Thus the focus will be on getting the best results at these specific locations.

The methodology section 4.2 gives a description of the limitations in the ENVI-met model. Differences in urban situations can be compared accurately with the model which is based on sound and proven formulae. A summary of the simulation results is presented in Table 4.10.

	MAXIMUM Δ PET FOR A SINGLE RECEPTOR POINT ($^{\circ}$ C)	AVERAGE Δ PET ($^{\circ}$ C)
A. Effect of grass versus pavement	-8	-5.5
B. Single building versus empty field	-8	-0.6 – 0.7
C. Wind direction (the range)	3	0.0 – 0.9
D. Wind speed from 1 to 6 m/s	-12.4	-11.6
E. Grid size		
F. Area rotation		
G. One building versus two buildings	10	3.5 – 4.2
H. Two buildings with different heights versus two buildings with the same height	-3.5 and 4.5	-1.1 – 0.9
I. Semi closed courtyard building versus two rectangular buildings	0.2	0.1
J. Single building without trees versus with trees	-20	-5.8 – 0.3
K. Semi closed courtyard building without trees versus with trees	-16	-0.5 – -0.1
L. Single building without hedges versus with hedges	-13	-2.9 – 3.5
M. Single building with different heights: 8 meter versus 20 meter	-1.5 and 3.5	0.5

TABLE 4.10 The maximum effect on the PET measured at one of the receptor points and the average effect in PET of the four receptor points for the set of variants A to D and F to H.

Below, the main findings from the summary in Table 4.10 are discussed and the effects are described separately in the sections that follow. Vegetation shows to be the most effective in cooling, as many other studies have also indicated. The maximum cooling effect found in this study with trees is 20 $^{\circ}$ C and with grass 8 $^{\circ}$ C. Interestingly, the average cooling effect considering a whole area leads to a different order of effectiveness, which especially indicates the significance of wind speed on the PET, where an increase of wind speeds results in a lower PET. Also the addition of buildings can have a significant effect, but is very depended on the surrounding context, whether it leads to up heating or not. Building form and height seem to have a smaller significance compared to vegetation, wind speed and amount of buildings.

The comparison of grass with pavement shows that grass gives a lower comfort temperature compared to brick pavement in the following cases: in an open field, in combination with a building and at both the leeward and windward side. Grass even lowers the surrounding paved area with 1 $^{\circ}$ C. The difference in PET between grass and brick pavement ranges from 0.1 to 8 $^{\circ}$ C, with an average of 6 $^{\circ}$ C.

The influence of a single building can lead to cooling, but can also increase the PET at pedestrian level, depending on the location in combination with the wind direction, sun orientation, building properties and the materialization and greening of the surrounding. In this study the effect of a building placed on a grass field leads to cooling, while when placed on brick pavement the building leads to an increase of the PET. More research is needed to know more about the effects on the PET of various albedo values and building heights.

The direction of the wind caused a difference in the average PET (from four receptor points) around the single building up to 0.9°C. The leeward side of the building is 1.5-3°C warmer when the wind direction is perpendicular to the building. The effect of a higher wind speed results in a lower PET. For the tested wind speeds from 1 m/s to 1.5 up to 6 m/s the PET at the windward side decreases between 1.6 and 6.1°C.

By turning the area, situations are studied in which the wind does not blow across grass and then brick pavement but only across one of these materials. In this case the grass side does not show a cooler PET than the brick side, as was the case in the variants described in the second paragraph of this section. The parameter responsible for this contradicting effect is a decrease in wind speed caused by the grass.

The addition of buildings creates cooler and warmer areas because of their impact on shadow pattern, wind speed, and long- and shortwave radiation. In general, buildings provide a cooler direct environment in the morning and a warmer afternoon and evening. Changing the building form from a square to a courtyard mainly creates warmer areas around midday due to the sheltered areas from wind.

Trees and other vegetation cause a lot of variation within an area. Thermal comfort can be increased on a hot day in the shade of a tree, while the same tree could decrease comfort when the person is in the sun and in the wake of the tree. The large variation within a small distance from a tree gives people a choice where they feel most comfortable in relation to their kind of activity.

Note that the conclusions given above, apply to the specific simulation variants chosen for this study. In a different urban context, another climate or with deviating input parameters, urban changes might lead to another outcome in terms of thermal comfort. Many more variants are interesting to analyse in the same manner, especially the amount and position of vegetation, higher buildings, different building configurations and the effect of the albedo of roofs and facades on thermal comfort.

The general conclusion from this study is that large temperature effects can be achieved with measures that influence wind speed and mean radiant temperature. Yet these effects remain local. Measures that influence air temperature and humidity are more effective on a wider scale. A shadow device, for example, that protects people

waiting for the bus normally does not contribute much to thermal comfort in the rest of the street, in contrast to a tree that offers shade and also cools the air actively by evaporating water, and therefore, has a wider range of influence. In the case of a bus stop more properties are important to consider, such as: protection from rain, space for the bus lane and aesthetics. In the design of a bus stop the best of both worlds could mean the integration of a grass roof or climbing plants which have both a large local effect as well as a small effect on the city climate. The answer to the question from the introduction: 'which measures require more research or should be implemented more frequently?' is described above and is related to the desired effect. Thermal comfort in the outdoor environment is not a static situation, but depends on people's activities, clothing, age and acclimatization. Always consider the broader perspective when designing within the urban microclimate.

§ 4.5 References

- Ali-Toudert, F. and Mayer, H. (2006), "Numerical study on the effects of aspect ratio and orientation of an urban street canyon on outdoor thermal comfort in hot and dry climate". *Building and Environment*, Vol. 41, No. 2, pp. 94-108.
- Ali-Toudert, F. and Mayer, H. (2007), "Effects of asymmetry, galleries, overhanging facades and vegetation on thermal comfort in urban street canyons". *Solar Energy*, Vol. 81, No. 6, pp. 742-754.
- Armson, D., Stringer, P. and Ennos, A.R. (2012), "The effect of tree shade and grass on surface and globe temperatures in an urban area". *Urban Forestry & Urban Greening*, Vol. 11, No. 3, pp. 245-255.
- Beranek, W. (1984), "Wind environment around single buildings of rectangular shape". *Heron*, Vol. 29, No. 1, pp. 4-31.
- Beranek, W.J. (1979), *Beperken van windhinder om gebouwen*, Kluwer Technische Boeken BV, Deventer.
- Blocken, B. and Carmeliet, J. (2004), "Pedestrian wind environment around buildings: literature review and practical examples". *Journal of Thermal Envelope and Building Science*, Vol. 28, No. 2, pp. 107-159.
- Bowler, D.E., Buyung-Ali, L., Knight, T.M. and Pullin, A.S. (2010), "Urban greening to cool towns and cities: A systematic review of the empirical evidence". *Landscape and Urban Planning*, Vol. 97, No. 3, pp. 147-155.
- Bruse, M. (2004), "ENVI-met 3.0: updated model overview". Available at: <http://www.envi-met.com/> [Accessed 26-11-2013].
- Bruse, M. and Fleer, H. (1998), "Simulating surface-plant-air interactions inside urban environments with a three dimensional numerical model". *Environmental Modelling and Software*, Vol. 13, No. 3-4, pp. 373-384.
- Carter, J.G. (2011), "Climate change adaptation in European cities". *Current Opinion in Environmental Sustainability*.
- Defraeye, T., Blocken, B. and Carmeliet, J. (2012), "CFD simulation of heat transfer at surfaces of bluff bodies in turbulent boundary layers: Evaluation of a forced-convective temperature wall function for mixed convection". *Journal of Wind Engineering and Industrial Aerodynamics*, Vol. 104, pp. 439-446.
- Fahmy, M. and Sharples, S. (2011), "Urban form, thermal comfort and building CO2 emissions – a numerical analysis in Cairo". *Building Services Engineering Research and Technology*, Vol. 32, No. 1, pp. 73-84.
- Gulyás, Á., Unger, J. and Matzarakis, A. (2006), "Assessment of the microclimatic and human comfort conditions in a complex urban environment: Modelling and measurements". *Building and Environment*, Vol. 41, No. 12, pp. 1713-1722.
- Herb, W., Janke, B., Mohseni, O. and Stefan, H. (2008), "Ground surface temperature simulation for different land covers". *Journal of Hydrology*, Vol. 356, No. 3-4, pp. 327-343.

- Höppe, P. (1999), "The physiological equivalent temperature—a universal index for the biometeorological assessment of the thermal environment". *International Journal of Biometeorology*, Vol. 43, No. 2, pp. 71-75.
- Katzschner, L. and Thorsson, S. 2009. Microclimatic Investigations as Tool for Urban Design. *The seventh International Conference on Urban Climate*. Yokohama, Japan.
- Kleerekoper, L., Dobbelsteen, A.A.J.F. v.d., Dorst, M.J. v. and Bruin-Hordijk, T. d. 2012. Climate Proofing Cities - Analysing the effects of heat adaptation measures in Bergpolder-Zuid in Rotterdam. *New Urban Configurations*. Delft, The Netherlands.
- Klok, L. (2010), "Hittebeperkende klimaatmaatregelen voor Rotterdam onderzocht met Envi-met microschaal klimaat simulaties", 034.21618, TNO, Kennis voor Klimaat.
- KNMI (2011), "Lijsten en extremen". Available at: <http://www.knmi.nl/klimatologie/lijsten/index.html>.
- Lahme, E. and Bruse, M. (2003), "Microclimatic effects of a small urban park in a densely build up area: measurements and model simulations". *Fifth International Conference on Urban Climate, Lodz, Poland, 2003*, Department of Meteorology and Climatology Faculty of Geographical Sciences University of Łódź, pp. 273.
- Lindberg, F., Holmer, B. and Thorsson, S. (2008), "SOLWEIG 1.0 - Modelling spatial variations of 3D radiant fluxes and mean radiant temperature in complex urban settings". *International Journal of Biometeorology*, Vol. 52, No. 7, pp. 697-713.
- Matzarakis, A., Rutz, F. and Mayer, H. (2007), "Modelling radiation fluxes in simple and complex environments—application of the RayMan model". *International Journal of Biometeorology*, Vol. 51, No. 4, pp. 323-334.
- Mees, H.L.P. and Driessen, P.P.J. (2011), "Adaptation to climate change in urban areas: Climate-greening London, Rotterdam, and Toronto". *Climate law*, Vol. 2, No. 2, pp. 251-280.
- Oke, T.R. (1988), "Street design and urban canopy layer climate". *Energy and Buildings*, Vol. 11, No. 1-3, pp. 103-113.
- Oke, T.R., Crowther, J.M., McNaughton, K.G., Monteith, J.L. and Gardiner, B. (1989), "The Micrometeorology of the Urban Forest [and Discussion]". *Philosophical Transactions of the Royal Society of London. Series B, Biological Sciences*, Vol. 324, No. 1223, pp. 335-349.
- Olgay, V. (1963), *Design with climate. Bioclimatic approach to architectural regionalism*, Princeton University Press, Princeton, New Jersey.
- Onishi, A., Cao, X., Ito, T., Shi, F. and Imura, H. (2010), "Evaluating the potential for urban heat-island mitigation by greening parking lots". *Urban Forestry & Urban Greening*, Vol. 9, No. 4, pp. 323-332.
- Penwarden, A.D. (1973), "Acceptable wind speeds in towns". *Building Science*, Vol. 8, No. 3, pp. 259-267.
- Peterka, J.A., Meroney, R.N. and Kothari, K.M. (1985), "Wind flow patterns about buildings". *Journal of Wind Engineering and Industrial Aerodynamics*, Vol. 21, No. 1, pp. 21-38.
- Schmidt, M. 2009. Rainwater harvesting for Mitigating Local and Global Warming. *Fifth Urban Research symposium 2009*. Marseille.
- Scott, K.I., Simpson, J.R. and McPherson, E.G. (1999), "Effects of tree cover on parking lot microclimate and vehicle emissions". *Journal of Arboriculture*, Vol. 25, No. 3, pp. 129-142.
- Shashua-Bar, L., Pearlmutter, D. and Erell, E. (2011), "The influence of trees and grass on outdoor thermal comfort in a hot-arid environment". *International Journal of Climatology*, Vol. 31, No. 10, pp. 1498-1506.
- Spangenberg, J., Shinzato, P., Johansson, E. and Duarte, D. (2008), "Simulation of the influence of vegetation on microclimate and thermal comfort in the city of São Paulo". *Revista SBAU, Piracicaba*, Vol. 3, No. 2, pp. 1-19.
- Takebayashi, H. and Moriyama, M. (2009), "Study on the urban heat island mitigation effect achieved by converting to grass-covered parking". *Solar Energy*, Vol. 83, No. 8, pp. 1211-1223.
- Taleghani, M., Tenpierik, M., Dobbelsteen, A.A.J.F. v.d. and Sailor, D.J. (2014), "Heat in courtyards: A validated and calibrated parametric study of heat mitigation strategies for urban courtyards in the Netherlands". *Solar Energy*, Vol. 103, No. 0, pp. 108-124.
- Thorsson, S., Lindberg, F., Björklund, J., Holmer, B. and Rayner, D. (2011), "Potential changes in outdoor thermal comfort conditions in Gothenburg, Sweden due to climate change: the influence of urban geometry". *International Journal of Climatology*.
- Xie, X., Liu, C.-H. and Leung, D.Y. (2007), "Impact of building facades and ground heating on wind flow and pollutant transport in street canyons". *Atmospheric Environment*, Vol. 41, No. 39, pp. 9030-9049.
- Yang, X., Zhao, L., Bruse, M. and Meng, Q. (2013), "Evaluation of a microclimate model for predicting the thermal behavior of different ground surfaces". *Building and Environment*, Vol. 60, pp. 93-104.
- Yezioro, A., Capeluto, I.G. and Shaviv, E. (2006), "Design guidelines for appropriate insolation of urban squares". *Renewable Energy*, Vol. 31, No. 7, pp. 1011-1023.
- Yu, C. and Hien, W.N. (2006), "Thermal benefits of city parks". *Energy and Buildings*, Vol. 38, No. 2, pp. 105-120.

5 Climate adaptation strategies: Achieving insight in microclimate effects of redevelopment options¹⁰

The previous chapter is an almost theoretical approach to study thermal comfort effects. The increasing complexity from an open field to a single building and finally a combination of various vegetation types gives insight in the relative effects of changes in the urban environment on thermal comfort. This chapter aims to answer a part of the research question: What is the indication of general and/or location specific effects of heat mitigation measures on thermal comfort in The Netherlands? Here location specific effects of climate adaptation measures on the microclimate are studied for a specific urban type common for the Netherlands that can be characterised as *low-rise open urban blocks of houses* (Berghauser Pont & Haupt 2009). Sub-research questions answered are: What are the effects on air temperature and human comfort for the temperate climate condition of the Netherlands? And: Is there a difference in effect in relation to scale (urban block, neighbourhood, city)? The results provide adaptation solutions for this specific neighbourhood and input for the generic design guidelines for the Netherlands at the end of part III.

§ 5.1 Introduction

Urban development projects usually do not respond to existing microclimatic variations, nor do they attempt to make beneficial changes to the urban thermal environment. As a result, many design decisions create undesirable effects in the spaces around buildings or at the scale of the urban thermal environment (Evans & Schiller, 1996).

Especially urban heating will increase due to a combination of climate change and expansion and densification developments (Watkins et al., 2007), in chapter 2 this is

10

This chapter presents the Journal article 'Climate adaptation strategies: Achieving insight in microclimate effects of redevelopment options' (Kleerekoper 2015). Section 5.1 and 5.2 have been adjusted to better connect to the other thesis chapters.

described in detail. Microclimate changes in cities can be influenced by the design of buildings and the surrounding public and private areas (Oke, 1988, Katzschner, 2010), in chapter 3 the design measures are described in detail. Urban orientation and structure can also have an effect on the microclimate. Although research has been done into cooling effects of design measures to improve the urban microclimate, little is known about the actual impact on Dutch neighbourhoods (Mees & Driessen, 2011). The urban typology is diverse in The Netherlands and cooling effects can vary significantly in urban type.

This article reports on a first study of the effects of design decisions made on the microclimate of a specific urban type common for The Netherlands. The urban type can be characterised as *low-rise open urban blocks of houses* (Berghauser Pont & Haupt, 2009). In chapter 8 the common urban types are further elaborated. The selected area, the *Couperusbuurt* (Figure 5.1), was built in 1960 under the urban master plan *Algemeen Uitbreidings Plan* by Van Eesteren (1934) to the West of Amsterdam, known as Amsterdam Nieuw-West (Feddes, 2011).



FIGURE 5.1 Urban structure of the Couperusbuurt, Amsterdam (Bosatlas, 1999 & Middel, 2002).

§ 5.1.1 Climate adaptation for a redevelopment project

Until the 19th century, urban areas in The Netherlands were built to provide shelter from rain, wind and cold. In 1901 national building regulations were introduced in the building sector to improve human comfort and health. In the following decades, the concept of ‘dwelling’ developed under the modernist movement. The open urban blocks that dominate the urban area of Amsterdam Nieuw-West were designed according to the basic ideas of this architectural style: light, air and space. Figure 5.2 shows one of the green open blocks of the *Couperusbuurt*.



FIGURE 5.2 Impression of the Couperusbuurt in Amsterdam, The Netherlands.

Since the completion of this area in the 60's, people's needs for dwelling size and facilities have changed. However, people's comfort needs have not changed significantly therefore the focus for this case study lies on preserving the actual climate conditions. The existing green and openness can be preserved, while redevelopment takes place to improve dwelling conditions. The redevelopment plan requires a mix of dwelling types and sizes, additional dwellings and parking facilities. The local council wishes to attract a wider range of people by proposing to integrate extra parking space inside the housing blocks and to add one to two levels to the buildings. These proposals will be analysed on their impact relating to heat accumulation. The adjustments are first simulated separately, followed by sets of measures that potentially affect and intensify each other. It is essential for planners and policy makers to know what combinations are effective and those that are not. No figures or general conclusions are currently available to describe the effects of the combinations of adaptation measures.

§ 5.2 Methodology

§ 5.2.1 Research method

This study concerns the effects found in a single urban type. Effects on the microclimate can be measured in actual temperature or in differences of comfort level. Both are considered in this study. The results will point to solutions for this specific neighbourhood and provide input, together with outcomes of other research projects, for generic design guidelines for The Netherlands.

In this study we focus on a number of specific measures: street trees, grass fields, pavement materials roof and façade colours, and building height. Vegetation and pavement materials are analysed within three alternatives for a parking solution inside an urban block. Figure 5.3 shows the existing situation and the three parking variants. The effect of the measures is evaluated at two different scale levels. First, the effects on the temperature distribution at the urban-block level and secondly, the effects at the neighbourhood scale. The climate adaptation measures were analysed on their relative effect on increasing or decreasing temperature or comfort level.

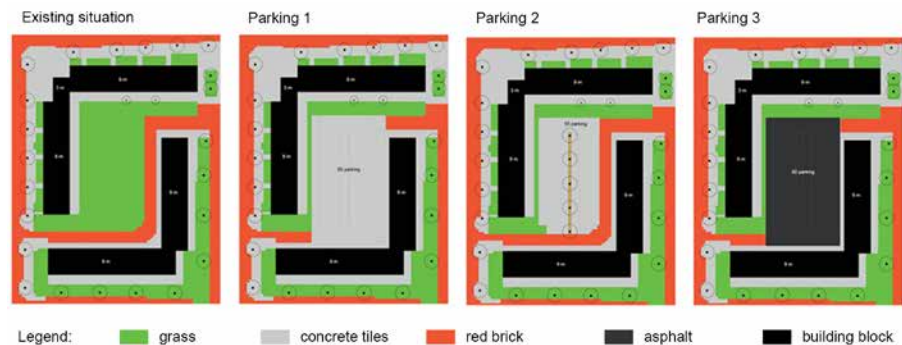

FIGURE 5.3 The existing situation and the three parking variants that were modelled in ENVI-met

§ 5.2.2 Simulation methodology

To evaluate design measures applied in the *Couperusbuurt* the neighbourhood was analysed with the ENVI-met micro climate model (Bruse & Fler, 1998). In section 4.2.3 the model is introduced in more detail.

The climate condition for the simulations in this study is based on an average heat-wave situation in The Netherlands (summarized in Table 5.1) occurring from 1950 through 2011 (KNMI, 2011). The predominant wind direction during heat and cold waves is North-East to East. It is notable that wind from the South is rare during a heat wave (Figure 3.11 in chapter 3). The yearly average wind direction is South-West to West, also the strongest winds come from the South West, which is exactly opposite to the wind direction during heat and cold waves. If air-flow is desired during warm periods it is important to take notice of the effect of stimulating flows during cold and stormy weather. In The Netherlands both the orientation of the average wind direction and prevailing wind during heat waves, result in an undesired colder situation in autumn, winter and spring.

Daily average wind speed	2.2 m/s
Prevailing wind direction	N-E
Daily average temperature	296 K (23°C)
Daily average humidity	65%

TABLE 5.1 Climate conditions on an average day in a heat wave in the period 1950 through 2011 in The Netherlands, The Bilt.

§ 5.2.3 Comparison of the measures on the human comfort indicator PET

This study opted for the PET comfort indicator that was also used in the previous simulation chapter. The PET indicator is introduced in chapter 2.2. To calculate the PET values in this study a ‘measurement point’ is chosen at a height of 1.5 metre in the middle of the urban block. The RayMan program (Matzarakis et al., 2007) was used to convert the output data from ENVI-met into PET.

§ 5.3 Case-studies presentation

The first step in this study is to model and calculate the reference situation, which is based on the actual configuration and land use. Then, for various situations, the development of the air temperature is calculated and evaluated. In the variants 1 to 12, only one of the parameters changes, compared to the reference situation or the previous variant. Variant 13 combines parameter values that resulted in higher temperatures, while variant 14 combines parameter values that resulted in lower temperatures. The focus of the analyses is at the urban block and neighbourhood level.

§ 5.3.1 Simulation variants at urban block level

Table 5.2 gives the parameters per variant at block level. For the façade and roof albedo realistic values are used; these are given in Table 5.3 (Taha et al., 1988, Prado and Ferreira, 2005, Oke et al., 1989, Peutz, 2009). Variant 0 represents the existing situation where most variants will be compared. Variants 1-4 have a different land cover in the inner court yard with additional trees in variant 2. Variants 5-12 and 25-30 have only one changed parameter compared to the existing situation. The varying parameters are building height, roof albedo and facade albedo. In variants 13-24 the parameter changes in the variants mentioned above are combined in different ways.

VARIANT	PARKING SITUATION	ALBEDO FACADES	ALBEDO ROOFS	BUILDING HEIGHT (M)	ROOF TYPE
0 existing	Only grass	0.2	0.3	9	Slanted
1 no green	Only pavement	0.2	0.3	9	Slanted
2 parking 1	Parking 1	0.2	0.3	9	Slanted
3 parking 2	Parking 2	0.2	0.3	9	Slanted
4 parking 3	Parking 3	0.2	0.3	9	Slanted
5 height 12 m, slanted roof	Only grass	0.2	0.3	12	Slanted
6 height 12 m, flat roof	Only grass	0.2	0.3	12	Flat
7 height 15 m, flat roof	Only grass	0.2	0.3	15	Flat
8 albedo facades 0.40	Only grass	0.4	0.3	9	Slanted
9 albedo facades 0.60	Only grass	0.6	0.3	9	Slanted
10 albedo facades 0.10	Only grass	0.1	0.3	9	Slanted
11 albedo roofs 0.05	Only grass	0.2	0.05	9	Slanted
12 albedo roofs 0.85	Only grass	0.2	0.85	9	Slanted
13 mix 1	Parking 1	0.4	0.05	9	Slanted
14 mix 2	Parking 2	0.2	0.85	9	Slanted
15 mix 3	Parking 2	0.6	0.85	15	Flat
16 mix 4	Parking 2	0.1	0.85	15	Flat
17 mix 5	Parking 3	0.4	0.05	9	Slanted
18 mix 6	Only grass	0.4	0.05	9	Slanted
19 mix 7	Only pavement	0.4	0.05	15	Flat
20 mix 8	Parking 2	0.4	0.85	15	Flat
21 mix 9	Parking 2	0.2	0.85	15	Flat
22 mix 10	Parking 2	0.1	0.05	15	Flat
23 mix 11	Parking 2	0.4	0.05	15	Flat
24 mix 12	Parking 2	0.3	0.05	15	Flat
25 albedo facades 0.30	Only grass	0.3	0.3	9	Slanted
26 albedo facades 0.50	Only grass	0.5	0.3	9	Slanted
27 albedo facades 0.70	Only grass	0.7	0.3	9	Slanted
28 albedo facades 0.80	Only grass	0.8	0.3	9	Slanted
29 albedo roofs 0.50	Only grass	0.2	0.5	9	Slanted
30 albedo roofs 0.70	Only grass	0.2	0.7	9	Slanted

TABLE 5.2 The variants at urban block level with their parameter values.

MATERIAL	TYPE/COLOUR	ALBEDO
Concrete pavement		0.40
Asphalt		0.20
Sandy soil		0.30
Bitumen	Black	0.05
Roofing	White Ecoséal	0.85
Ceramic tiles	Red	0.30
Aluminium/Stainless steel	Blank	0.60
Brick	White/light colour	0.40
Brick	Red	0.20
Brick	Dark	0.10

TABLE 5.3 The albedo of the façade, roof and pavement materials used in the variants.

§ 5.3.2 Simulation variants at neighbourhood level

Table 5.4 gives the parameters per variant at neighbourhood level. In the neighbourhood variants all roofs are flat due to the limitations with modelling roof shapes. The corresponding variant simulated at the urban block scale is also given. Not all urban block variants are simulated at the neighbourhood scale due to limitations in computing time.

VARIANT	PARKING SITUATION	ALBEDO FACADES	ALBEDO ROOFS	BUILDING HEIGHT (M)	ROOF TYPE
0 existing corresponding block variant 0	Only grass	0.2	0.3	9	Flat
1 no green corresponding block variant 1	Only pavement	0.2	0.3	9	Flat
2 parking 1 corresponding block variant 2	Parking 1	0.2	0.3	9	Flat
3 parking 2 corresponding block variant 3	Parking 2	0.2	0.3	9	Flat
4 parking 3 corresponding block variant 4	Parking 3	0.2	0.3	9	Flat
5 height 15 m corresponding block variant 7	Only grass	0.2	0.3	15	Flat
6 albedo facades 0.4 corresponding block variant 8	Only grass	0.4	0.3	9	Flat
7 albedo facades 0.6 corresponding block variant 9	Only grass	0.6	0.3	9	Flat
8 albedo facades 0.1 corresponding block variant 10	Only grass	0.1	0.3	9	Flat
9 albedo roofs 0.05 corresponding block variant 11	Only grass	0.2	0.05	9	Flat
10 albedo roofs 0.85 corresponding block variant 12	Only grass	0.2	0.85	9	Flat
11 mix 1 corresponding block variant 13	Parking 1	0.4	0.05	9	Flat
12 mix 2 -	Parking 2	0.2	0.85	9	Flat
13 mix 4 -	Parking 2	0.6	0.85	9	Flat
14 mix 3 corresponding block variant 15	Parking 2	0.6	0.85	15	Flat

TABLE 5.4 The variants at neighbourhood level with their parameter values.

Note that the simulations are performed without actual cars on the parking lot. This is representative for the use of these parking lots, which are mostly empty during daytime and occupied in the evenings. During the day the pavement receives a lot of radiation, which is stored as heat then released after sun-set. The expectation is that cars do not influence the release of heat. In a case where the parking lot is occupied during the day, the expectation is that the daytime thermal comfort decreases due to additional reflection, while night time temperatures will remain lower. However, they will still be higher compared to the existing situation with only grass. It is expected that heat released from the cars themselves is temporary and negligible.

§ 5.4 Results and discussion

This results and discussion section starts with the results from the case studies presented in the previous section. A third sub-section discusses the simulation results based on thermal comfort instead of air temperature differences.

The temperature effects of the variants in the first two sub-sections are analysed on two aspects. One aspect concerns the temperature extremes that occur in an area due to its urban configuration. Because of these extremes, the maximum and minimum temperatures at 01:00 PM in the variants are compared to the maximum and minimum temperatures in the reference situation at the same time. The other aspect is the size of the area where temperatures, compared to the reference situation, are higher or lower. The calculated average temperature for the reference situation is 27°C (300 K). The light-green colour in Figure 5.4 indicates 27-27.5°C. In order to compare the variants with each other as well as with the reference situation, grid cells that are higher or lower than the reference situation are counted and the difference from the reference situation is then given as a percentage.

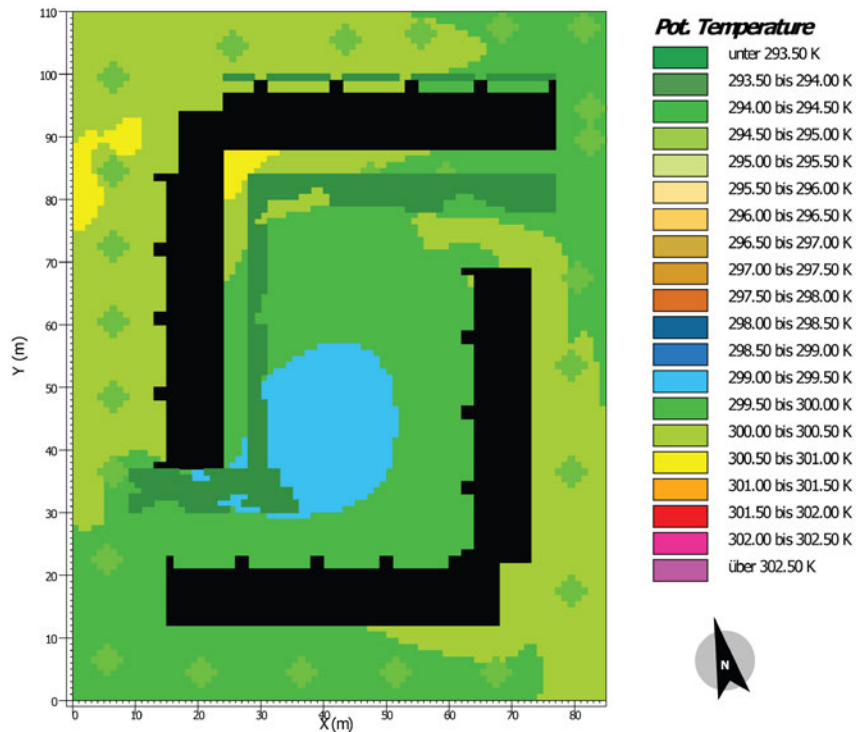

FIGURE 5.4 ENVI-met simulation output for the reference situation at 01:00 PM at urban block level.

§ 5.4.1 Comparison of the measures by temperature effect at urban-block level

The simulation results at the urban block level are presented in this section. First an overview of all measures is given. Thereafter, separate themes are discussed in the following order: vegetation and land cover scenarios, building heights, roof albedos, façade albedos and a mix of different adaptation measures.

The temperature extremes that occur at 01:00 PM in the simulation at block level at two meters height are given in Figure 5.5. In the minimum temperatures, the largest difference between the reference situation and the simulation variants occurs when there is no green (variant 1 and 19). None of the variants result in lower minimum temperatures than the reference situation. Adjusting building height and albedo properties (variants 5-12) does not show a large effect for these minimum temperatures, but it does show urban cooling and heating effects for the maximum temperatures. Increasing the building height to 15 metres (variant 7) and a highly reflective roof (variant 12) result in the largest temperature decrease of the maximum

temperatures. This implies that increasing the amount of shadow with higher buildings and reflecting solar radiation at roof level have the highest impact on temperature extremes in the area.

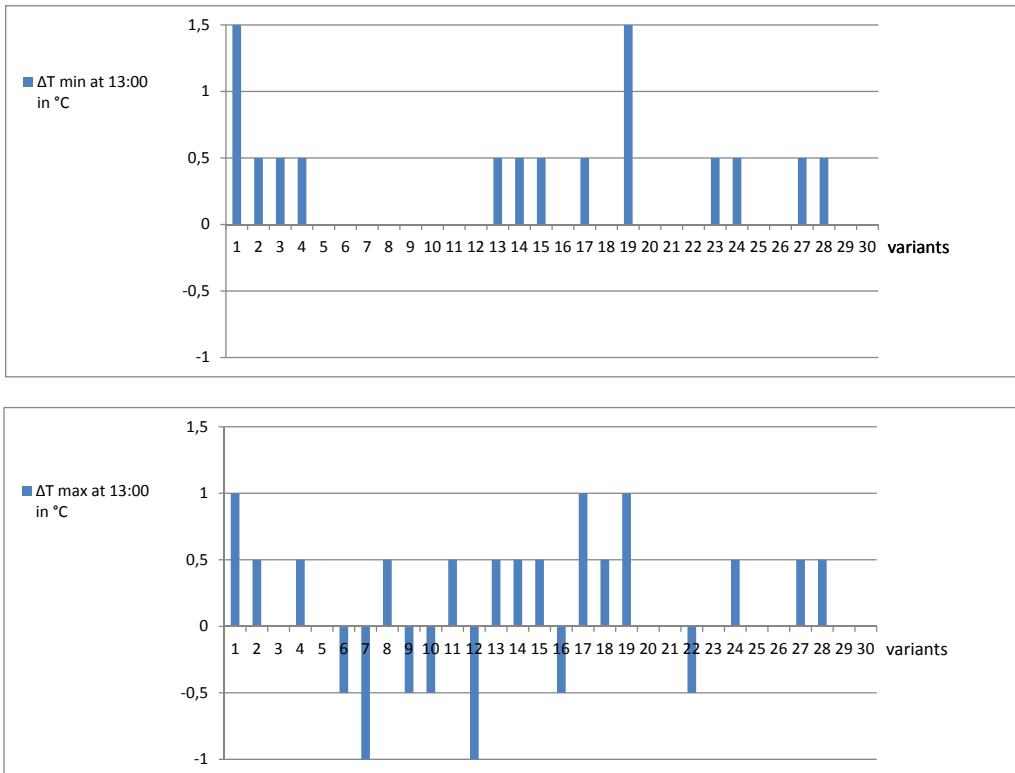

FIGURE 5.5 The minimum and maximum air temperature difference between the reference situation and the variants for 01:00 PM at urban block level. Above: minimum temperatures (ΔT_{\min} block x - ΔT_{\min} block ref), below: maximum temperatures (ΔT_{\max} block x - ΔT_{\max} block ref).

Apart from the variant without green, there are two other variants that result in a temperature increase of 1°C. The combination without green, with a dark roof, a medium-dark façade and 15 metre tall buildings (variant 19) has a higher temperature increase, mainly because of the lack of green and the dark roofs. This variant also has the highest minimum temperatures. The combination of an asphalt parking space and dark roofs (variant 17) also leads to a 1°C temperature increase of the maximum temperature, even though this simulation includes trees and hedges, in contrast to variant 19. Important to mention here is that the area that is prone to temperature increases is very small (Figure 5.6). It is also interesting to compare variant 17 with

variant 13, where variant 17 has trees on the concrete parking space and variant 13 is the same except for the trees. The simulation results show that the trees on a parking space may lead to higher temperatures. This could be explained by the blocking of airflow or the obstruction of reflection from facades to the sky. The differences in minimum and maximum temperature between the variants give a limited indication of temperature effects. It does not indicate the size of the area with the highest or lowest temperatures.

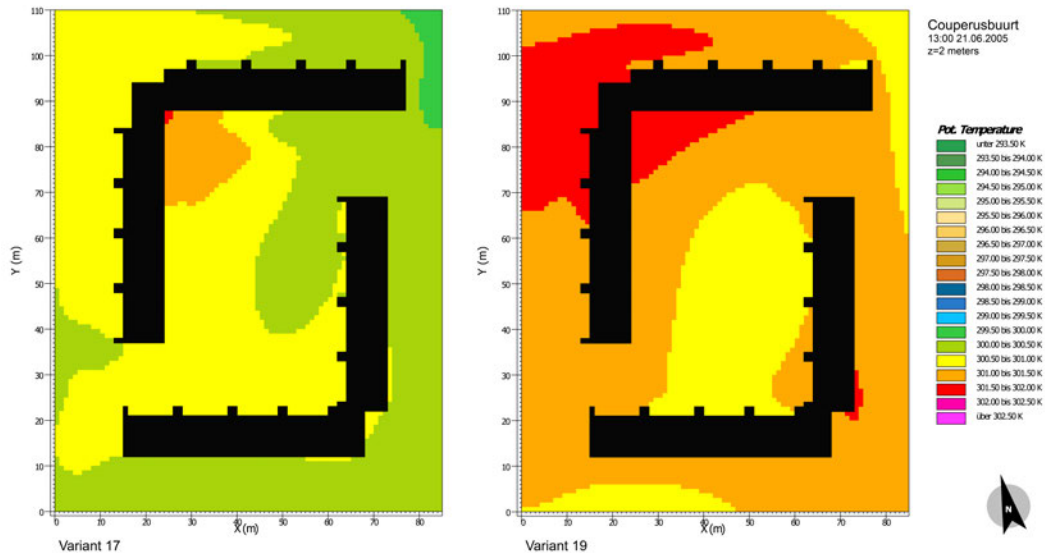

FIGURE 5.6 ENVI-met simulation output for mix 5 (v17) on the left and mix 7 (v19) on the right at 01:00 PM at urban block level.

For a better insight into the temperature distribution per variant, the following sections discuss the area percentage that reaches 27°C or more.

Many studies have endorsed the cooling effect of vegetation (Kleerekoper et al., 2012). However, a clear general effect of trees, for example, is not so easy to formulate. A tree performs differently with variations in size, form, species, water availability and its direct environment. Trees next to water perform differently than when they are surrounded by pavement or when they stand next to a tall building. Figure 5.7 shows that existing vegetation has a large cooling effect in the case of the *Couperusbuurt*. Without green the whole area would be 1 to 2°C warmer (variant 1).

Generally the effect of different pavement materials is measured by looking at the surface temperatures. A study of land covers indicates that the average monthly and average daily maximum temperatures increases from grass, bare soil, concrete pavement to asphalt (Herb et al., 2008). In Figure 5.7 the difference in paving material shows a heating effect on the air temperature of around 10% of the area when asphalt is used instead of concrete tiles. Variant 3, which has concrete pavement with trees, results in the coolest parking variant. Nevertheless, 20% of the area still has higher temperatures compared with the existing situation. In the following paragraphs other parameter changes are analysed for their effect on the air temperature. In the last section combinations are analysed in order to counteract the 20% heating of the area by a new parking situation.

Differences in temperature distribution around a building block for different green and pavement scenarios

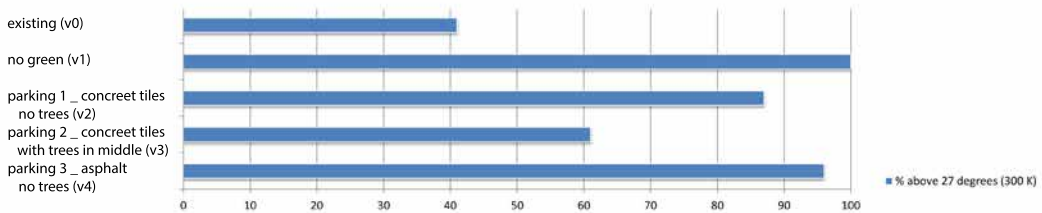

FIGURE 5.7 The percentage of the area where the calculated temperature at 2 meter height is 27°C or more for different green and pavement scenarios.

Increasing building height results in a cooler environment due to more shadow (Figure 5.8). The flat roofs (variant 6) have the same height as the top of the slanted roofs (variant 5), which also results in more shadow, and thus a cooler direct surrounding. With a roof height of 15 meters the whole area remains cooler than the threshold of 27°C. This is also due to the chosen time of 13:00hrs when shadows of buildings still have a delaying effect on temperature increase. At 21:00 the high buildings cause a heating (compared to the reference situation) of 0.5-1.0°C in about 30% of the area.

Differences in temperature distribution around a building block for different building heights

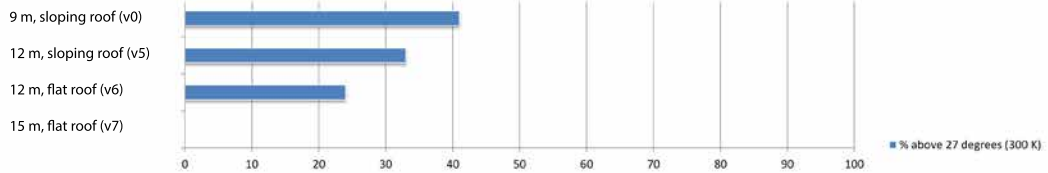

FIGURE 5.8 The percentage of the area where the calculated temperature at 2 meter height is 27°C or more for different building heights.

The albedo of roofs at 9 metres height shows a clear relation with the air temperature at 2 metres height around the urban block (Figure 5.9). The higher the roof albedo, the more radiation is reflected, the cooler the surrounding area becomes. With a lower roof albedo from 0.3 to 0.05 (darker) as with variant 11, the air temperature at 2 metres height is increased by 0.5 to 1°C, a temperature increase show in 7% of the area. Even though this is a relatively small area, the warmer air is in close proximity of the building and can have a large effect on indoor comfort as well. The variants with a higher roof albedo show a similar cooling effect in 6 to 10% to even more than 40% in variant 12. In this last variant the albedo is increased from 0.3 to 0.85, which decreases the air temperature at 2 metres height up to 0.5°C.

Differences in temperature distribution around a building block for different roof albedos

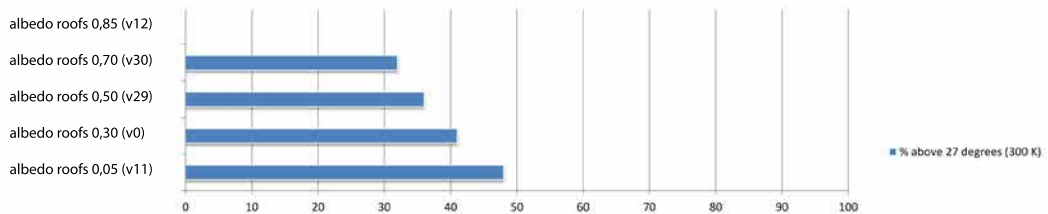

FIGURE 5.9 The percentage of the area where the calculated temperature at 2 meter height is 27°C or more for different roof albedos

This result strengthens the findings of other studies where a higher roof albedo is suggested as a cooling measure. Roof albedo is a measure that has influence at the building, neighbourhood and city scale. A study for the hot climate of California, USA, concludes that a higher roof albedo is the most effective and economic way to lower temperatures city-wide (Bretz et al., 1998). The results from the simulations in this

study suggest that a higher roof albedo is also effective for the temperate climate of The Netherlands. A study on the effect of albedo on the indoor comfort shows that the amount of overheating hours is influenced by increasing the value of the albedo. An increase of the albedo value from 0.3 to 0.8 causes a decrease in the amount of overheating hours with 20-50% (Haak, 2012).

It is remarkable that facades with a higher albedo do not always show a decrease in temperature. The simulations in Figure 5.10 result in an increased temperature due to a change in façade albedo from 0.2 in variant 0 to 0.3, 0.5, 0.7 and 0.8 in respectively variant 25, 26, 27 and 28. This difference can be a result of the effect of high albedos on the overall heat balance. In this case the heat is reflected from the façade to the street or the opposite façade where it is changed into latent heat. This is different from the cooling effect that trees have on the heat balance where radiant heat is converted to energy to grow and evaporate water.

Differences in temperature distribution around a building block for different facade albedos

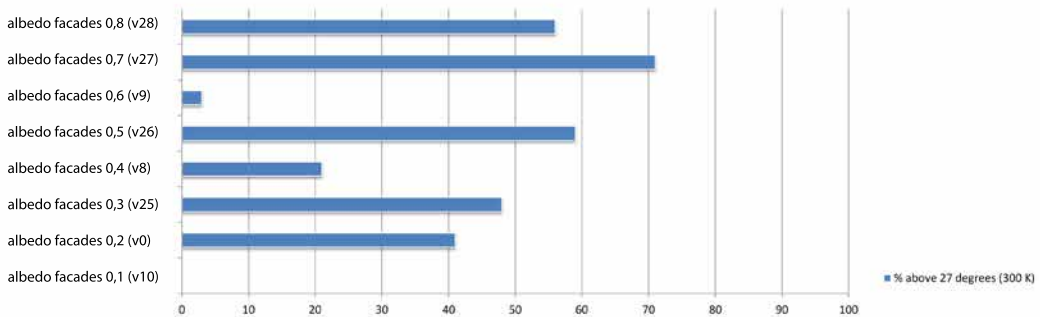

FIGURE 5.10 The percentage of the area where the calculated temperature at 2 meter height is 27°C or more for different facade albedos.

A peculiar result is the temperature decrease when the albedo is increased to 0.4 and 0.6 (variant 8 and 9) and when it is lowered to 0.1 (variant 10). The simulated air temperature at two metres height does not show a linear relation with the façade albedo. The varying temperature results could be explained by the local difference in heating. Here, only the temperature at two metres height is considered, while the heat could be accumulating elsewhere. The question is what is causing the decrease in temperature with a very low albedo? A probability is that, heat that is not reflected is absorbed by the façade material and when temperatures drop at night this energy will be released. More research is required to confirm this idea.

When climate adaptation measures are combined they can amplify or counteract their heating or cooling effects. The largest cooling effect of the combined measures is 28% of the area in variant 16 (Figure 5.11). This variant combines the coolest option for all parameters including parking situation with trees; very low façade albedo; very high roof albedo; and high building height. In variant 22 only the roof albedo is changed to a relatively low albedo, compared to variant 16. There is a slight heating of the area, but the other cooling parameters counteract the effect of the pavement enough to result in a cooler situation than the existing situation with the grass field. Variant 21 has a slightly higher façade albedo (0.1 to 0.2), compared to variant 16. The slight change in façade albedo has in this case more influence on the area than the large change in roof albedo. Variant 14 is the same as variant 21, except for the building height. The change in building height from a 15 metre flat roof to a 9 metre high slanted roof (in combination with a façade albedo of 0.2, a very high roof albedo and trees in the middle of the parking lot) results in cooling of 7% of the area, compared to the existing situation. All combinations discussed here can counteract the heating effect of the extra pavement that is needed for parking spaces. The largest cooling effect is reached with an increased building height of 15 metres.

Differences in temperature distribution around a building block for a mix of different adaptation options

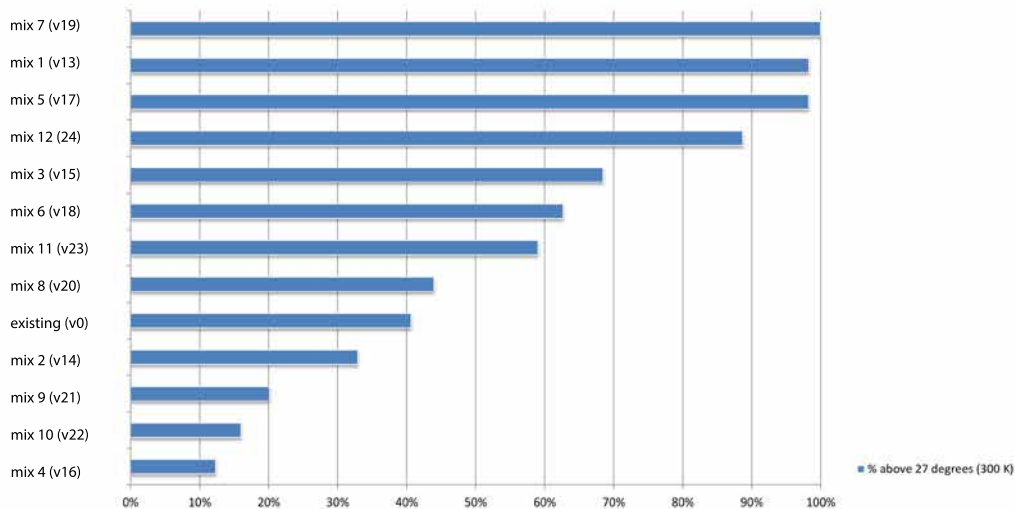

FIGURE 5.11 The percentage of the area where the calculated temperature at 2 metres height is 27°C or more for different combinations of parameters.

On the other hand a combination of adaptation measures that individually decrease temperatures do not always result in an expected overall cooling effect. A combination that should be avoided is the combination of increased façade albedo when there are trees close to the building. The parking variant with trees in the middle and a very high roof albedo is simulated for different façade albedo's in variant 14 and 15. In variant 14 the façade albedo is the same as the reference situation (0.2). The heating effect of the extra pavement for the parking lot is counteracted by the high roof albedo and trees on the parking lot. In fact, these two elements result in an even cooler area than the existing situation. The higher façade albedo of 0.6 in variant 15 results in heating in 35% of the area. An explanation for this result could be the extra reflection from the facades that is not returned to the sky because the trees obstruct the reflection and trap the heat beneath their leaves.

Another remarkable result is the relatively large difference in heating between variant 23 and 24, while they only have a small difference in façade albedo; 0.4 for variant 23 and 0.3 for variant 24. In this case, the 0.1 decrease in façade albedo leads to heating in 30% of the area. This implies that façade albedo has a large effect on the air temperature. Based on the simulations in this research it is difficult to draw any conclusion about the coolest façade albedo because there is not a linear relation with increasing albedos and air temperature. The specific context that is modelled and the height and distance from the facade have a significant influence on the effect of the façade albedo.

When parameters are combined that individually lead to heating, they all lead to temperature increase. In variant 13 and 17 the combination of adaptation measures that solely lead to higher temperatures cause a temperature increase of 1 to 2°C in a large part of the area. The combination of effects leads to more heating than the hottest parking variant (variant 4) alone. In both variants there are no trees on the parking lot and the buildings have a low roof albedo. From these results, we can conclude that the combination of a dark roof with extra pavement should be avoided because this will lead to extra heating.

If the whole area is paved, as is the case in variant 1, and this is combined with a low roof albedo the result is a temperature increase of 2°C (variant 19). The higher building height that leads to a decrease of air temperature in a significant part of the area, as simulated in variant 7, does not counteract the effect of the extra pavement. In variant 23 all parameters are equal to variant 19 except for the amount of vegetation and thus pavement; the extra vegetation in variant 23 leads to cooling in 40% of the area, compared with variant 19. From this we can conclude that the amount of pavement versus vegetation is more dominant for the air temperature than building height. If extra pavement is added and the amount of vegetation is decreased, a higher building height does not counteract the heating effect.

The results presented so far imply that urban cooling measures can result in better performance once applied in combination, but that this is not always the case and that they might even counteract one another's cooling effect.

§ 5.4.2 Comparison of the measures by temperature effect at neighbourhood scale

In this section we present the simulation results at the neighbourhood level. The differences between the minimum and maximum temperatures are given, followed by the differences in percentage of the area where temperatures are higher or lower compared to the reference situation. The calculated average temperature for the reference situation is 25°C (298 K). The dark blue colour in Figure 5.13 indicates 25-25.5°C. To compare the variants with each other and with the reference situation the grid cells that are higher or lower than this reference situation are counted and the difference from the reference situation is given in percentages in Figure 5.14.

The first clear difference for the existing situation between block (Fig. 5.4) and neighbourhood (Fig. 5.12) level is a difference in the prevailing temperature. Calculations on neighbourhood level result around two degrees cooler than block level. The temperature magnitude is 2°C at the scale of the urban block. As expected, the temperature magnitude is larger at neighbourhood scale, where $\Delta T = 3^\circ\text{C}$.

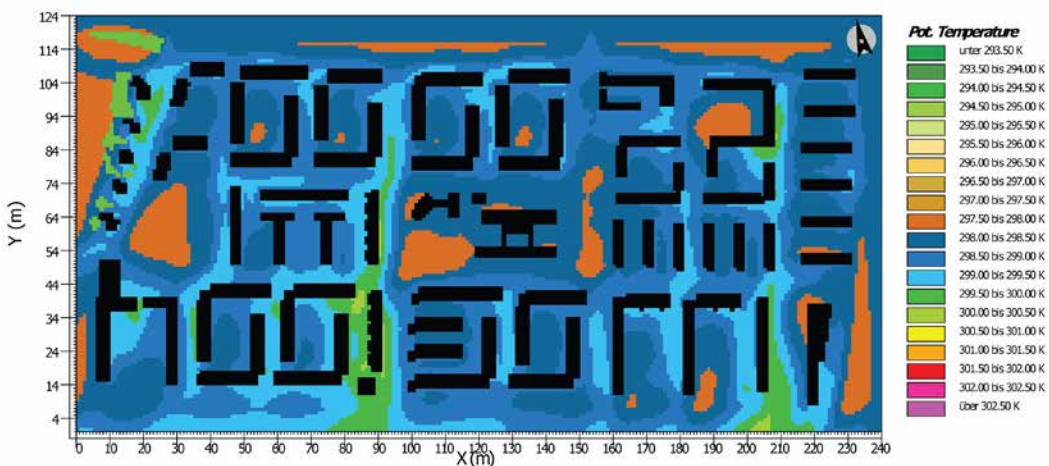

FIGURE 5.12 ENVI-met simulation output for the reference situation at 01:00 PM at the neighbourhood level.

As with the urban block results, the simulation results at the neighbourhood (Figure 5.13) do not show large differences in the minimum and maximum temperatures between variants, at least not larger than 0.5°C. There is no clear relationship between the increase or decrease of minimum temperatures at urban block and neighbourhood level. The minimum and maximum temperatures of an entire neighbourhood do not represent the potential heat stress that might be experienced locally. If only one area is heating up significantly because it is an open square without shadow elements, the same square will not show a much higher temperature if the pavement material inside the building block is changed to asphalt. For a more detailed analyses we look also here at the difference in the size of the area that is affected.

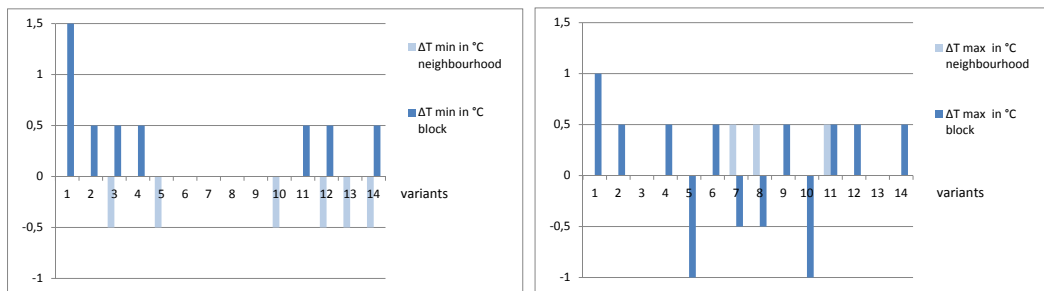

FIGURE 5.13 The minimum and maximum temperature difference between the reference situation and the variants for 01:00 pm at neighbourhood level with the corresponding urban block variant. Left: minimum temperatures ($\Delta T_{\min \text{ neighb. } x} - \Delta T_{\min \text{ neighb. ref}}$), right: maximum temperatures ($\Delta T_{\max \text{ neighb. } x} - \Delta T_{\max \text{ neighb. ref}}$)

When comparing the area that is influenced by a variant compared to the reference situation, all the neighbourhood variants, have a smaller magnitude than the corresponding variant at block level. In Figure 5.14 the percentage of the area that is cooler or warmer is given for both block and neighbourhood level. We expect that most of the variants have the same direction in effect: if the variant is cooler at urban block scale, it is also cooler at the neighbourhood scale. However, differences can occur when the heat is reflected outside of the boundaries of the urban block, but stay within the boundaries of the neighbourhood. This is the case for the maximum temperatures in variants 7 and 8 as explained in the following paragraphs.

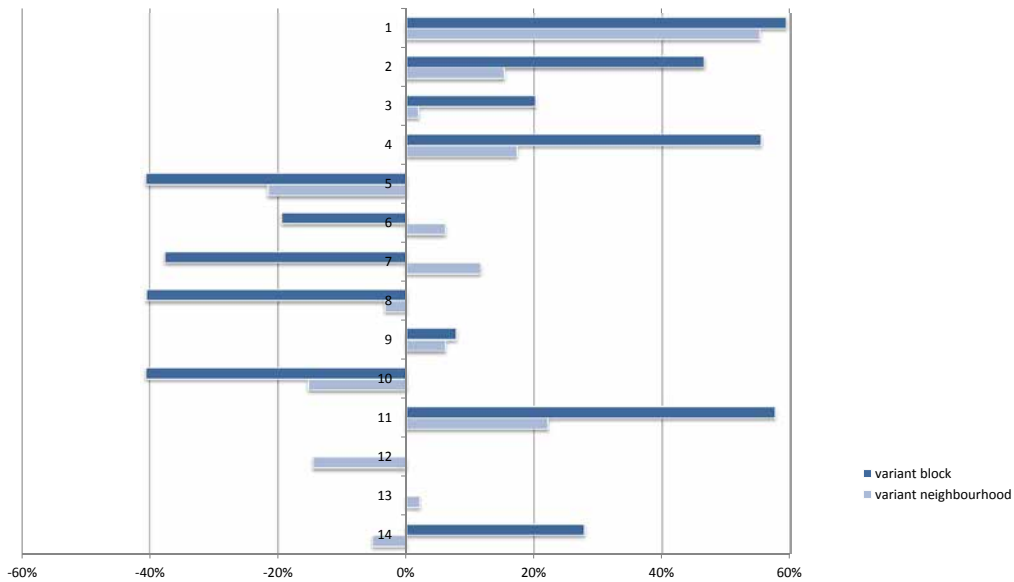

FIGURE 5.14 The percentage of the area where the calculated temperature at 2 metres height has increased or decreased compared to the reference situation at block and neighbourhood level

Areas without green heat up the most at both urban block and neighbourhood level (variant 1). At neighbourhood level this variant has by far the largest impact. The other variants all follow the line of the effects at block level. Replacing the existing grass field with concrete pavement (variant 2) leads to higher temperatures, as is the case for asphalt (variant 4). Trees have a significant cooling effect at the neighbourhood level, also the trees above pavement as in variant 3. The higher buildings in variant 5 lead to a large area with cooler temperatures. Note that the effect of building height can be different in the late afternoon.

For roof albedo we also find a clear relation between the neighbourhood and the building block level. A lower roof albedo (variant 9) shows an increase in temperature and a higher roof albedo (variant 10) a significant decrease in temperature.

The simulation results show contrasting effects for the variants with a different façade albedo. The variants 8, 0, 6 and 7 have an albedo of respectively 0.1; 0.2; 0.4; 0.6. When the albedo increases, the temperature at neighbourhood level increases. Such a linear effect is not visible at the urban block scale. An explanation for this difference is that reflection from the façade causes an extra heat load at street level within a certain distance from the façade but at a different distance it results at less heat load. At neighbourhood level a higher albedo does not result in more heat loss to the sky or boundary layer. Instead it increases the overall temperature.

§ 5.4.3 Comparing measures based on thermal comfort

The calculated PET values in Figure 5.15 show large differences between the variants: the differences between variants in PET are larger than in air temperature alone. Because the comfort indicator is strongly influenced by radiant heat, large differences occur when the measurement point is in or out of the shade. In variant three the area is obviously perceived as the coolest, this is caused by the shade on the measurement point of the trees in the middle of the urban block.

An unexpected difference was found between variant 1 (without vegetation) and variant 2 (parking variant with concrete pavement instead of the green meadow) where the air temperature and the PET give a contradictory result. The variant without green results in a cooler PET value than the parking variant, even though the parking variant is surrounded by hedges. The variant without green does result in a higher air temperature and mean radiant temperature. An explanation for this difference in PET is possibly the lower airflow from 1.15 m/s for variant 1 to 0.93 m/s for variant 2, and the higher relative humidity respectively 54% and 57%. The surrounding vegetation blocks the wind and increases the relative humidity and therewith counteracts the higher air temperature and radiation resulting in a cooler thermal perception.

Another contrasting effect between the PET and the air temperature shows with variant 2 (parking variant with concrete pavement) and variant 4 (parking variant with asphalt). This difference can be explained by looking at the height of the measurement point at 1.5 metres. At this point the heat of the asphalt has less influence on the air temperature. For the comfort indicator the reflected radiance from the light concrete pavement predominates. A similar effect is perceived on a snow plain where the reflected light can cause sunburn and allows skiing without jackets and sleeves, despite of the low air temperature. The cooler experience at 1.5 metres height on asphalt instead of concrete pavement does not say anything about how it feels to walk here on bare feet. The asphalt material itself will heat up more than the concrete tiles, which will result in warmer feet.

The former section showed a clear correlation between a higher roof albedo and a lower air temperature. The PET does not show the same trend in the simulations performed, nor can we conclude from these simulations on the effect of façade albedo on thermal comfort.

Finally, the combination of variants only shows a decrease in temperature for variants 14, 15 and 16. These all have parking with trees in the middle and a high reflective roof. But the same parameters do not lead to the same cooling intensity for variants 20 and 21. They have differences in façade albedo which might cause extreme differences in the perceived temperature.

Differences in Physiological Equivalent Temperature on building block level

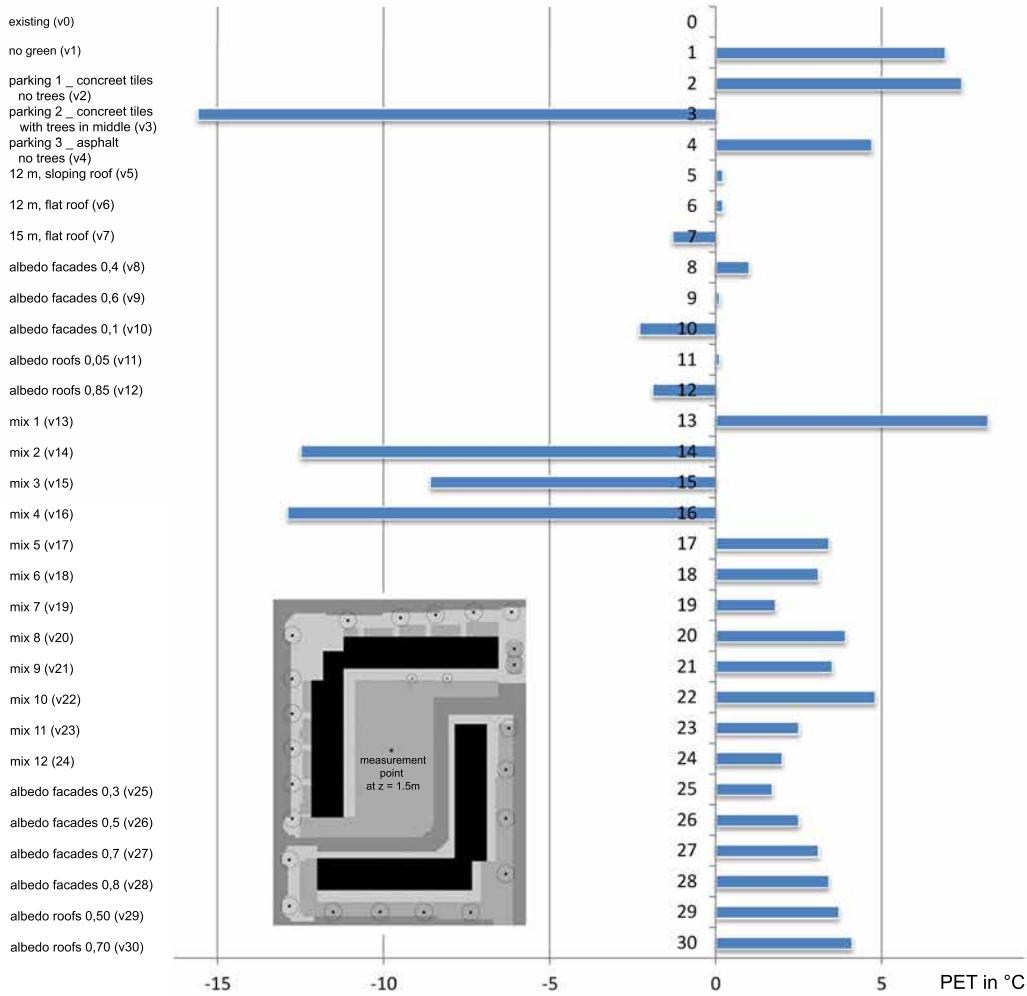

FIGURE 5.15 The effect of different variants on the Physiological Equivalent Temperature (PET) compared to the existing situation.

§ 5.5 Conclusions

The simulations discussed in this chapter indicate the effects of single adaptation measures at the urban block and neighbourhood level. Measures that lead to cooling in the studied area are: adding vegetation, increasing the building height and a higher roof albedo. Measures that lead to heating are adding pavement and a lower roof albedo. At building block level the effect of the façade albedo does not result in a clear linear relation with higher or lower temperatures. However, at neighbourhood level there is a clear relation and this study demonstrates that a higher façade albedo leads to heating.

Results concluded that increasing the amount of shadow by heightening buildings and increasing the reflection of solar radiation at roof level have the highest impact on the maximum temperatures in the studied neighbourhood. For larger height to width ratios additional building layers could also lead to temperature increase. Note that creating shadow on South facing walls by vegetation could even have a higher impact, but was not tested for this neighbourhood. The study does reconfirm the significant cooling effect of vegetation, which has by far the largest potential to diminish heating compared to the other studied adaptation measures.

The three simulated parking variants give an insight into the consequences of changing a grass field in the middle of an urban block into a paved parking lot. All the parking variants result in extra heating of the area, even when trees are added in the middle of a parking lot, the results still do not compare favourably to the comfort levels of grass. In addition to the positive effect of the grass field on thermal comfort, it also offers additional benefits such as recreational space, air filtering, a habitat for flora and fauna, mental benefits, etc. All these aspects should be considered before making the decision to create parking spaces inside the open building blocks.

In this study, various combinations of individual cooling adaptation measures do not always result in better performances overall. Even so, trees might not always lead to cooling, and their effect depends on the context in which they are placed. They might obstruct reflection of heat to the sky and block cooling airflow. On the other hand, the combination of variants that individually lead to a hotter environment all resulted in extra heating. More variants need to be tested to get conclusive information about the best combination of adaptation measures in their context.

The simulations performed at both the urban block and neighbourhood level correspond well. The effects at the urban block level have a greater magnitude than at neighbourhood level. This could simply be caused by larger volumes being less influenced by the changes in the variants. The urban block and neighbourhood level only show a different outcome for the façade albedo as described in the first paragraph of this section.

Finally, the coolest paved scenario (variant 3 and 16) calculated for the redevelopment of the *Couperusbuurt* was a parking lot paved with concrete tiles and planted with trees in the middle. In addition, highly reflective roofs and increased building height lowers the temperatures even more.

Temperature effects were measured in air temperature and the thermal comfort indicator PET. However, due to model limitations, this solely provides an indication of the direction of the effect and an indication of the relative difference in temperature effect between the variants. It does not provide an exact temperature prediction. The air temperature and PET result in different outcomes for the same variants. The variants may even contrast, as with a cooling variant measured in air temperature and a heating variant when measured in PET. This study considered a fixed measurement point for the PET value, this contributed to the understanding of thermal perception and the parameters in the built environment that can influence it. A direct comparison between air temperature and PET failed to offer definite conclusions. A reason for this dissimilarity is the domination of the direct local environment of the measurement point on the PET value.. The PET can vary enormously from shadow to sun or from sheltered from wind to fully exposed, while the air temperature varies only a little. To make an analysis of an area based on the PET, a set of measurement points spread over that area is required.

General conclusions from this case study include the following: Vegetation can be the most effective measure to prevent heat accumulation, depending on the reflectiveness and distance from facades. A higher reflectivity of roofs seems to lead to a cooler environment at street level, while a higher reflectivity of facades can cause extra heating. Future research is needed to indicate the tipping points of albedo and height to width ratios in relation to urban heating. With taller buildings the amount of shadow increases, as a consequence less heating occurs. Such overshadowing being a positive scenario in summer, but not in winter. This study focussed on one specific typology, in addition, other typologies should be studied to realize more climate proof neighbourhoods.

After the location specific measures that were analysed in this chapter, the following chapter aims to indicate effects without context dependencies.

§ 5.6 References

- Ahmad, S. (1992), "Some effects of urban parks on air temperature variations in Kuala Lumpur, Malaysia". Cut-est '92 Conference on Thermal Environment, Special in Tohwa: The second Tohwa University International Symposium, Fukuoka, Japan, 7-10 September 1992.
- Albers, R., Bosch, P., Blocken, B., Dobbela, A.A.J.F. v.d., Hove, L. v., Spit, T., Ven, F. v.d., Hooff, T. v. and Rovers, V. (2015), "Overview of challenges and achievements in the Climate Adaptation of Cities and in the Climate Proof Cities program". *Building and Environment*, Vol. 83, pp.1-10.
- Ali-Toudert, F. and Mayer, H. (2006), "Numerical study on the effects of aspect ratio and orientation of an urban street canyon on outdoor thermal comfort in hot and dry climate". *Building and Environment*, Vol. 41, No. 2, pp. 94-108.
- Berghauer Pont, M.Y. and Haupt, P.A. (2009), *Spacematrix. Space, Density and Urban Form*, Delft University of Technology.
- Bosatlas (1999), *De Grote Bosatlas*, Wolters-Noordhoff, Groningen.
- Bretz, S., Akbari, H. and Rosenfeld, A. (1998), "Practical issues for using solar-reflective materials to mitigate urban heat islands". *Atmospheric Environment*, Vol. 32, No. 1, pp. 95-101.
- Bruse, M. and Fleer, H. (1998), "Simulating surface-plant-air interactions inside urban environments with a three dimensional numerical model". *Environmental Modelling and Software*, Vol. 13, No. 3-4, pp. 373-384.
- Ca, V., Asaeta, T. and Abu, E. (1998), "Reductions in air conditioning energy caused by a nearby park". *Energy and Buildings*, Vol. 29, No. 1, pp. 83-92.
- Defraeye T, Blocken B., Carmeliet J. (2012) "CFD simulation of heat transfer at surfaces of bluff bodies in turbulent boundary layers: Evaluation of a forced-convective temperature wall function for mixed convection". *J Wind Eng Ind Aerod*; 104-106 p. 439-446.
- Esch, M.M.E. v., Bruin-Hordijk, T. d. and Duijvestein, K. 2007. The influence of building geometry on the physical urban climate: a revival of 'light, air and space'. PLEA2007— The 24th Conference on Passive and Low Energy Architecture. TU Delft.
- Evans, J.M. and Schiller, S.D. (1996), "Application of microclimate studies in town planning: a new capital city, an existing urban district and urban river front development". *Atmospheric Environment*, Vol. 30, No. 3, pp. 361-364.
- Fahmy, M. and Sharples, S. (2011), "Urban form, thermal comfort and building CO2 emissions – a numerical analysis in Cairo". *Building Services Engineering Research and Technology*, Vol. 32, pp. 73-84.
- Feddes, Y. (2011), *De groene kracht. De transformatie van de Westelijke Tuinsteden Amsterdam*, SUN, Amsterdam.
- Fiala, D., Havenith, G., Bröde, P., Kampmann, B. and Jendritzky, G. (2012), "UTCI-Fiala multi-node model of human heat transfer and temperature regulation". *International Journal of Biometeorology*, Vol. 56, No. 3, pp. 429-441.
- Fröhlich, D. and Matzarakis, A. (2014) "Human-biometeorological estimation of adaptation- and mitigation potential of urban green in Southwest Germany". *Third International Conference on Countermeasures to Urban Heat Island, Venice, Italy*.
- Fletcher, J.A. (2008) "658-ICE TEA CITY". *25th Conference on Passive and Low Energy Architecture*. Dublin.
- Haak, A.J.C. (2012), "Climate change and heat stress in residential buildings. Evaluation of adaptation measures.", TU Eindhoven.
- Herb, W.R., Janke, B., Mohseni, O. and Stefan, H.G. (2008), "Ground surface temperature simulation for different land covers". *Journal of Hydrology*, Vol. 356, No. 3-4, pp. 327-343.
- Höppe, P. (1999), "The physiological equivalent temperature - A universal index for the biometeorological assessment of the thermal environment". *International Journal of Biometeorology*, Vol. 43, No. 2, pp. 71-75.
- IPCC (2007), "An Assessment of the Intergovernmental Panel on Climate Change, Summary for Policymakers".
- Jauregui, E. (1991), "Influence of a large urban park on temperature and convective precipitation in a tropical city". *Energy and Buildings*, Vol. 15, No. 3-4, pp. 457-463.
- Jendritzky, G., Maarouf, A. and Henning, S. (2001) *Looking for a Universal Thermal Climate Index UTCI for Outdoor Applications*. Windsor Conference on Thermal Standards. Windsor, UK: Network for Comfort and Energy Use in Buildings.
- Katzschner L, Thorsson S. (2009) *Microclimate Investigations as Tool for Urban Design*. In *The seventh International Conference of Urban Climate*, Yokohama, Japan.

- Katzschner, L. (2010), "Outdoor Thermal Comfort under Consideration of Global Climate Change and Urban Development Strategies". Adapting to Change: New Thinking on Comfort, Windsor, UK, 9-11 April 2010 2010, Network for comfort and energy use in buildings, London, pp.
- Kleerekoper, L., Esch, M.M.E. v., and Salcedo, T.B. (2012), "How to make a city climate-proof, addressing the urban heat island effect". Resources, Conservation and Recycling, Vol. 64, No. 0, pp. 30-38.
- Kleerekoper, L., Dobbelsteen, A.A.J.F. v.d., Hordijk, T., Dorst, M.J. v. and Martin, C. (2015), "Climate adaptation strategies: achieving insight in microclimate effects of redevelopment options". Smart and Sustainable Built Environment, Vol. 4, No. 1.
- Klein Tank, A.M.G. and Lenderink, G. (2009), "Klimaatverandering in Nederland; Aanvullingen op de KNMI'06 scenario's", KNMI, De Bilt.
- Klok, L. (2010), "Hittebeperkende klimaatmaatregelen voor Rotterdam onderzocht met Envi-met microschaal klimaatsimulaties", 034.21618, TNO, Kennis voor Klimaat.
- KNMI (2011), "Lijsten en extremen". Available at: <http://www.knmi.nl/klimatologie/lijsten/> [Accessed August 2014].
- Lahme, E. and Bruse, M. (2003), "Microclimatic effects of a small urban park in a densely build up area: measurements and model simulations". Fifth International Conference on Urban Climate, Lodz, Poland, 2003, Department of Meteorology and Climatology Faculty of Geographical Sciences University of Łódź, pp. 273.
- Lewis, J., Nicholas, F., Seales, S. and Woollum, C. (1971), "Some effects of urban morphology on street level temperature at Washington DC". Journal of Washington Academic Science, Vol. 61, pp. 258-265.
- Lindberg F, Holmer B, Thorsson S. (2008) "SOLWEIG 1.0 – Modelling spatial variations of 3D radiant fluxes and mean radiant temperature in complex urban settings". Int J Biometeorol; 52.
- Matzarakis, A., Rutz, F. and Mayer, H. (2007) "Modelling radiation fluxes in simple and complex environments—application of the RayMan model". International Journal of Biometeorology, Vol. 51, No. 4, pp. 323-334.
- Matzarakis, A. and Amelung, B. (2008) "Physiological Equivalent Temperature as Indicator for Impacts of Climate Change on Thermal Comfort of Humans". Seasonal Forecasts, Climatic Change and Human Health. Springer.
- Mayer, H. and Höpfe, P. (1984), "Die Bedeutung des Waldes für die Erholung aus der Sicht der Humanbioklimatologie". Forstwissenschaftliches Centralblatt, Vol. 103, No. 1, pp. 125-131.
- Mees, H.L.P. and Driessen, P.P.J. (2011), "Adaptation to climate change in urban areas: Climate-greening London, Rotterdam, and Toronto". Climate law, Vol. 2, No. 2, pp. 251-280.
- Middel, G. (2002) "TOP 10 data set P1661". Topografische-Dienst, Data Archiving and Networked Services.
- Nishimura, N., Nomura, T., Iyota, H. and Kimoto, S. (1998), "Novel water facilities for creation of comfortable urban micrometeorology". Solar Energy, Vol. 64, No. 4, pp. 197-207.
- Oke, T.R. (1988), "Street design and urban canopy layer climate". Energy and Buildings, Vol. 11, No. 1-3, pp. 103-113.
- Oke, T.R., Crowther, J.M., McNaughton, K.G., Monteith, J.L. and Gardiner, B. (1989), "The Micrometeorology of the Urban Forest [and Discussion]". Philosophical Transactions of the Royal Society of London. Series B, Biological Sciences, Vol. 324, No. 1223, pp. 335-349.
- Peutz (2009), "Energetische aspecten bij toepassing Ecoseal EP White dakbedekking", E 376-1, E 376-2.
- Prado, R.T.A. and Ferreira, F.L. (2005), "Measurement of albedo and analysis of its influence the surface temperature of building roof materials". Energy and Buildings, Vol. 37, No. 4, pp. 295-300.
- Rafailidis, S. (1997), "Influence of building areal density and roof shape on the wind characteristics above a town". Boundary-Layer Meteorology, Vol. 85, No. 2, pp. 255-271.
- Robitu, M., Inard, C., Groleau, D. and Musy, M. (2004), "Energy balance study of water ponds and its influence on building energy consumption". Building Services Engineering Research and Technology, Vol. 25, No. 3, pp. 171-182.
- Shashua-Bar, L. and Hoffman, M. (2000), "Vegetation as a climatic component in the design of an urban street: An empirical model for predicting the cooling effect of urban green areas with trees". Energy and Buildings, Vol. 31, No. 3, pp. 221-235.
- Shashua-Bar L, Pearlmuter D, Erell E. (2011) "The influence of trees and grass on outdoor thermal comfort in a hot-arid environment". Int J Climatol, 31(10), p. 1498-1506.
- Spronken-Smith, R.A. and Oke, T.R. (1998), "The thermal regime of urban parks in two cities with different summer climates". International Journal of Remote Sensing, Vol. 19, No. 11, pp. 2085-2104.
- Taha, H., Akbari, H., Rosenfeld, A. and Huang, J. (1988), "Residential cooling loads and the urban heat island--the effects of albedo". Building and Environment, Vol. 23, No. 4, pp. 271-283.
- Topografische-Dienst (2002), TOP 10, Data Archiving and Networked Services.

- Watkins, R., Palmer, J. and Kolokotroni, M. (2007), "Increased temperature and intensification of the urban heat island: implications for human comfort and urban design". *Built Environment*, Vol. 33, No. 1, pp. 85-96.
- Wong, N.H., Lee, S.E. and Li, S. (2007), "Thermal Performance of Facade Materials and the Impacts on Indoor and Outdoor Environment", Singapore.
- Yang, X., Zhao, L., Bruse, M. and Meng, Q. (2013) "Evaluation of a microclimate model for predicting the thermal behavior of different ground surfaces". *Building and Environment*, Vol. 60, pp. 93-104.
- Yu, C. and Hien, W.N. (2006), "Thermal benefits of city parks". *Energy and Buildings*, Vol. 38, No. 2, pp. 105-120.

6 Creating drafts in urban settings through coloured façades: Exploring a new climate adaptation measure based on thermal stratification ¹¹

In the previous chapter the effect of numerous adaptation measures is described in relation to thermal comfort. The results show that increasing wind speed can be an effective cooling measure. However, the cold winter climate and the prevailing wind direction during heat and cold waves make it difficult to actually use this principle. Moreover, proven adaptation measures such as, more vegetation or water, are not always possible because of a lack of space or undesired aesthetic effects. This chapter answers the sub question: How can ventilation be utilized in hot weather situations without deterioration of the wind conditions in winter?

An alternative option for more fresh and cool air in a street canyon is to make use of façade colours to accelerate wind speed. Differences in colour and materials already influence the air flow in street canyons, but in an uncontrolled manner. If we could employ this principle for the improvement of thermal comfort it potentially has a large impact on many cities in the world. This chapter gives the results of a first exploratory research based on measurements on scale models and at full scale. This pilot study shows that the principle works and advocates further research. For example, more research is required to examine if the cooling effect is significant in the perception of pedestrians.

§ 6.1 Introduction

In order to control the thermal comfort conditions in an urban setting there are four physical parameters that can be influenced: air temperature, radiant temperature, humidity and wind speed. There are quite some climate adaptation measures available

11

This chapter is published as Journal article: Kleerekoper, L., Dobbelsteen, A.A.J.F. v.d., Ham, E. v.d., Hordijk, T. and Martin, C. (2015), "Creating drafts in urban settings through coloured façades: Exploring a new climate adaptation measure based on thermal stratification". *Urban Climate*, Vol. 14, Part 2, pp. 290-300.

(Kleerekoper et al., 2014, Kikegawa et al., 2006, Carter, 2011, Mees & Driessen, 2011), these measures include protecting and enhancing urban vegetation and water bodies; decreasing the area of hard surfaces; the use of 'cool' materials and implementing sustainable drainage systems (SUDS).

There are many streets where additional vegetation or water is not an option because of a lack of space or technical difficulties. Options to reduce temperatures in these streets are to add coverings such as canvas sheets to provide shade; providing spraying nozzles to cool by evaporation; increasing the surface albedo of pavement or ventilating the streets to bring in cool air (Nishimura et al., 1998, Nikolopoulou & Steemers, 2003). The latter option could be done by orientating streets to the prevailing wind direction or using wind directing elements during hot summer periods.

For The Netherlands the prevailing wind direction during heat waves is North-East. Unfortunately this is also the prevailing wind direction during cold waves, and moreover, the strongest and year-round prevailing wind direction is exactly opposite: the South-West. Therefore, streets oriented from N-E to S-W will be less comfortable in especially winter and during stormy weather. In addition, the measure will not be that effective because wind speed is usually very low during heat waves, around 0.5-2.5 m/s (KNMI, 2011). Another way to bring cool air in a street canyon during sunny weather could be to accelerate the process of thermal stratification. On a larger scale this process is known from situations where cool airflow is generated from a park to a hot urban area adjacent to this park (Eliasson & Upmanis, 2000). On the smaller scale of a street the use of temperature differences could be used to accelerate airflows.

Therefore the hypothesis tested in this paper is as follows:

The colour and material of a façade influences the thermal stratification process in a street profile, so with a darker coloured façade the air will rise more rapidly along the façade's surface, increasing wind speed at street level and increase the mixture of air between the canopy layer and the city's boundary layer.

We know hot air rises: the stratification of air in a street canyon can have a strong influence on the circulation. With an ambient wind speed lower than 3-4 m/s, which is the case during heat waves, air flow processes are dominated by gravitational forces (Santamouris et al., 2001). A stable stratification can reduce the circulation of air, while convective stratification can intensify it (Bohnenstengel et al., 2004). We also know that dark colours absorb solar radiation and light colours reflect radiation. In Table 6.1 an overview is given of the effect of heated urban surfaces that has been studied by various scholars.

	TYPE OF STUDY	MAIN CONCLUSION	REFERENCE
Numerical studies	A heated building wall by solar radiation	Thermal heating of the building wall modifies the local air flow around buildings significantly.	(Dimitrova et al., 2009)
	The effect of bottom heating on urban street canyon flows	Thermal heating of the ground plays a significant role in determining flow fields within street canyons. The upward flow induced by buoyancy force can either strengthen or weaken vortices and modify the vortex structure.	(Kim & Baik, 2001)
	The effect of heated façade and ground surfaces on urban street canyon flows	The heating of surfaces leads to a strong buoyant force close to the solid boundaries that receive direct solar radiation. The effect of the façade heating strongly depends on the height/width (H/W) ratio of the street canyon.	(Xie et al., 2007)
Wind tunnel measurements	The effect of solar radiation on stratification and mixing of air in a street canyon	The mixing of air in a street canyon is higher in case of an unstable stratification. When the atmosphere is stable, wind speeds decrease and less mixing of air occurs between canyon and layers above the canyon.	(Uehara et al., 2000)
	The effect of heated facades	In case the heated façade is at the windward side, the buoyancy force might not be enough to turn around the direction of the airflow.	(Kovar-Panskus et al., 2002)
Water tank experiments	Investigation of the convection flow induced by street floor heating.	The fluid experiments show that, with calm ambient wind, the flows in a street canyon are completely driven by thermal force from the bottom heating, and that the convection can reach the upper atmosphere of the canyon.	(Huizhi et al., 2003)

>>>

	TYPE OF STUDY	MAIN CONCLUSION	REFERENCE
Full-scale measurements	Investigate of urban canyon flow patterns in relation to air pollution by traffic	The solar radiation drives the thermal motions and triggers the photochemistry which has a significant impact on the evolution of pollutant distribution in time.	(Vachon et al., 1999)
	Differences in air temperature between air above and within the canyon	In an East-West oriented canyon in Japan differences in air temperature between air above and within the canyon only occurred within 0.5 m from the floor or façade surface. And there is a large surface-to-air temperature difference for facades that receive direct solar radiation.	(Nakamura & Oke, 1988)

TABLE 6.1 Prior studies into the effect of heated urban surfaces on air flow.

From the numerical and experimental studies mentioned above we can conclude that the heating of a façade has a strong influence on the movement of air within a street canopy when the prevailing wind speed is low. The studies indicate a change – strengthened or weakened – in the circulation pattern where vortexes change direction, and even additional vortexes appear with the increase of surface temperatures. The buoyancy effect of bottom heating in a scale model proved to be strong enough to reach the upper part of the street canyon. In combination with the numerical model result, which determined the strong buoyant force due to façade heating, the expectation is that the effect of heated facades is also strong enough to reach the upper part of the façade and therefore improves the mixing of air between the canyon and the upper layers.

This paper aims to answer the question whether we can make use of coloured façades to accelerate the rising of air in a street canyon in order to attract cooler air into the canyon. Differences in colour and materials already influence the air flow in street canyons, but in an uncontrolled manner. Different colours and materials were therefore studied for their effect on the air speed by means of an experimental test with a scale model. Full scale measurements were carried out on a warm day with low wind speed.

This study is a first step in the development of a new climate adaptation measure which could be applicable to many cities across the world that have to deal with heat stress or air pollution in their cities. An important connotation is the possible up-heating effect of the indoor environment when no precautionary measures are taken. Nevertheless, the proposed adaptation measure offers a new possibility for urban designers and policy makers to acclimatise urban areas where other measures are practically impossible.

§ 6.2 Research Methodology

In order to study the effect of façade colour and material on airflows two types of measurements were executed, those of wind speed and surface temperature. The measurements were first performed (with scale models) outside and inside on warm summer days. The results of these measurements are presented in detail by Kleerekoper et al. (2014) and are briefly summarized in this paper.

The scale model study indicates a significant difference in generated air speed by a black and a white surface. Air speed measurements at full scale were needed to confirm the principle at street scale. Therefore, two full-scale façades were studied on a moderate warm day with relatively low wind speeds.

§ 6.2.1 Air speed measurements on façade models

The air speed measurements are performed inside (Figure 6.1a) and the surface temperature measurements outside (Figure 6.1b). The weather conditions on the measurement days are given in Table 6.2 for De Bilt in The Netherlands with latitude 52° 7' 0" N and longitude 5° 11' 0" E.



FIGURE 6.1 a. The indoor laboratory set (left) and the anemometer measuring the speed of the vertical air flow (right) (27-08-2013); b. The surface temperature of black coated aluminium and bare aluminium (left) measured with a thermal camera (right) (05-09-2013).

DATE	TYPE OF MEASUREMENT	AVERAGE AIR TEMPERATURE IN °C	RELATIVE HUMIDITY	AVERAGE WIND SPEED IN M/S	PREVAILING WIND DIRECTION
23-08-2013	Surface temperature outdoor	20.2	72 %	2.2	77 ° (East)
27-08-2013	Air flow indoor laboratory	17.8	65 %	2.3	42 ° (North-East)
05-09-2013	Surface temperature outdoor	22.4	72 %	2.7	135 ° (South-East)
27-08-2014	Air flow and surface temperature outdoor	14.2	81 %	1.9	107 ° (East-South/East)

TABLE 6.2 Weather conditions on the days of measurement, De Bilt, The Netherlands.

The generation of air flow is tested in an experimental study with a scale model in two colours: black and white. The model consists of two flat panels representing a street canyon on a scale of 1:20. The size of the street canyon is 20*10*9 (100*50*45 cm) and has a height to width (H/W) ratio of 0.9.

For a first indication of the influence of colour on air speed the scale model was placed in a semi-enclosed, sunny space outside. In the outdoor environment the prevailing wind could have out ruled the effect of the different façade colours on upward air flow. Even so, the measurements show a difference between the black and white façade model in average and maximum airspeed. Because differences in airspeed are small all other airspeed measurements are done indoors to avoid the influence from the actual wind field.

The indoor experiment was executed in a non-isolated space. Before each measurement the airflow was measured to ensure there were no draughts in the space that could influence the wind speed measurements. The measurement equipment was an anemometer with a velocity range of 0 - 20 m/s, an accuracy of ± 0.25 m/s and a resolution of 0.01 m/s; see Figure 6.1a. The measurement point is directly above the middle of the panel that receives radiation. To measure the vertical wind direction generated due to the buoyancy effect, the anemometer is placed horizontally with the opening at a distance of 1 cm from the surface of the panel. A 1000W lamp was used to simulate the sun. As the lamp needed time to heat to full capacity, upwind speed measurements were conducted at the beginning, after 30 minutes and after one hour. The cooling time lag of the up heated surfaces was tested at least one hour after switching off the heat source following a period of up heating. After the heat source is switched off the wind speed was measured directly and about 5 and 10 minutes later. Each measurement was repeated at least three times to exclude occasional differences due to movements of for example the executors of the measurements. The anemometer used was not equipped with a data logger, therefore all measurements were performed with two persons: one reading the display and keeping the time schedule, the other noting down all measurements. Each air speed measurement lasts one minute, noting the maximum, minimum and average temperature displayed by the anemometer.

§ 6.2.2 Air speed measurements on full scale façade

The air speed measurements on two full scale facades were executed on the 27th of August 2014. The weather conditions on this measurement day are given in Table 6.2 for de Bilt in The Netherlands. The test location was the *Zonnebaan* in the *Lage Weide* neighbourhood of the city of *Utrecht*. It was chosen because the site has two eight-metre tall façades with a white and a black colour next to each other. The façades are facing South-West, which has the largest potential to heat up. There are no obstructions in the 16-metre wide street nor in front of the 10-metre tall façades (Figure 6.2).



FIGURE 6.2 A map of the measurement location and images of the measurement setup at the white (left) and black (right) façade (27-08-2014).

The measurements were performed with a single air speed measurement device along with a thermal camera and a thermocouple sensor. The airspeed measurement device was a hot wire thermo-anemometer with datalogger (Extech, model SDL350). The air speed measurement device has an accuracy of 0.1 m/s and a resolution of 0.01 within the range of 0.2-5.0 m/s. The thermal images were taken with the thermal camera Flir T440. In front of both facades 11 measurement points were chosen. Figure 6.3 gives the location of the measurement points. The thermo-anemometer measures the airflow in one direction only, the majority of the measurement points measured the vertical flow, while points 8, 9 and 10 measured the horizontal flow.

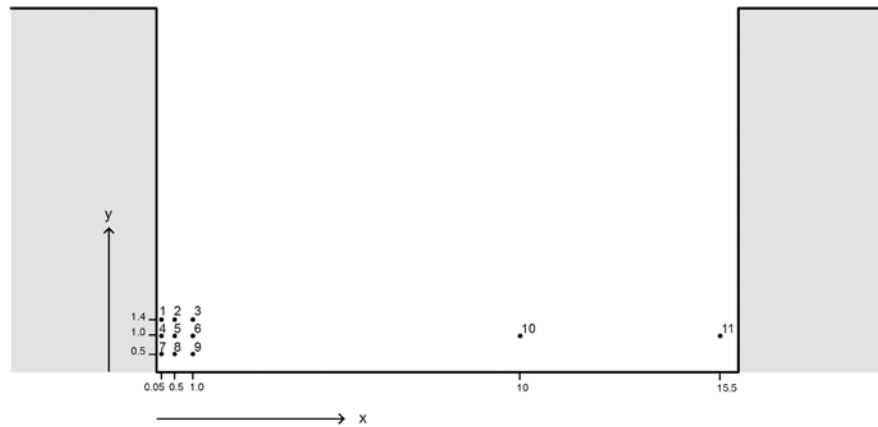

FIGURE 6.3 Street profile with the measurement points in a grid of 0.05, 0.5 and 1 m from the façade and a height of 0.5, 1.0 and 1.4 m. In addition a point in the middle and a point half a meter in front of the opposite façade were measured at a height of 1.0 m.

The measurement points were all measured twice for the black and white façade, see Table 6.3 for the time intervals. The air speed was stored every second during five continuous minutes. Due to a limit in time the last measurement set for both facades was shortened to 3 minutes. These measurement intervals are chosen to ensure a comparable solar angle for both facades with an orientation towards the South-West. With this orientation the sun is perpendicular to the façade at 14:00 h. The measurements with the thermal camera show a peak surface temperature at 14:30 h due to heat accumulation in time. The highest façade temperatures occur between 13:30 h and 15:30 h.

TIME INTERVAL	12:00-13:30 H	13:30-15:00 H	15:00-17:00 H	17:00-18:00 H
Façade	black	white	black	white

TABLE 6.3 Time intervals for the black and white facade.

§ 6.2.3 Surface temperature measurements

After measuring the airflows a control measurement was done to see whether the surface temperature indeed was the generating factor. To test the difference in temperature between materials and between colours, an infrared camera (FLIR T440) was used to measure surface temperatures. The surface temperature measurements at the façade models were taken each hour during the course of a whole day. The analysed façade model materials were brick, wood and aluminium (blank and with a black and white coating).

At the full scale façades the thermal images were taken before each measurement set to see the temperature development of the façades. An additional thermocouple was used once to check whether the thermal images reflect the same surface temperature.

§ 6.3 Results and Discussion

§ 6.3.1 Influence of colour on air speed at façade models

As explained in the introduction, the hypothesis tested in this study is whether a darker colour leads to a higher wind speed. Figure 6.4 shows the windspeed measurement results after measuring both, black and white panels, eight times. The average measured windspeed with a black panel was 0.37 m/s and with a white panel 0.28 m/s. The average difference in wind speed between the black and white panel was 0.09 m/s. This means an increase of 32% from white to black. The average error was 0.07 m/s, this minimises differences in wind speed. Nevertheless, the trend of higher wind speeds with dark colour compared to light still stands.

We need to place the difference in wind speed of 0.09 m/s in perspective to be able to give an indication of the effect at the full scale. However, scaling wind speed due to convection is very complicated because there is not a one to one relation. To be able to appoint scaling effects the test model can be constructed in a water tank. In this exploring study there was no possibility to do so. Therefore, the full scale measurements presented in the proceeding section are performed to see whether the difference in air speed is of similar significance. Another uncertainty in the results is caused by the accuracy range of the air speed measurement equipment. The uncertainty is minimized by repeating the same measurements at least three times.

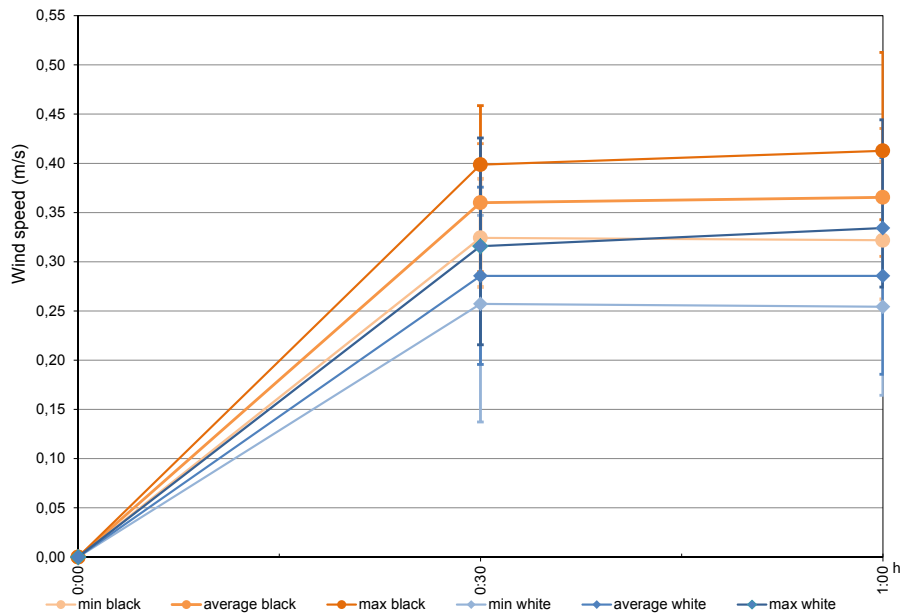

FIGURE 6.4 Wind speed measured after 0, 0:30 and 1:00 h for a black (orange colour in graph) and white (blue colour in graph) aluminium panel in an indoor space on the summer day 27-08-2013 (based on 8 measurements).

§ 6.3.2 Influence of colour on air speed at full scale façades

The measurement results from one day of measurements in front of alternately a white and a black façade are presented in the supplementary material section 5.3, Figure 6.10. The graphs show the wind speed distribution per measurement point. This distribution presents the frequency at which a certain wind speed occurs during equal time intervals. In points 1, 2, 3, 8, 9 and 10 there is a clear difference in air speed between the black and white façade, while the points 4, 5, 6, 7 and 11 do not reflect this clear difference. Another observation of the measurement results is that the measurement points 1, 4 and 7, which are close to the façade, and also point 2, 3 and 5, measure longer periods with very low (< 0.1 m/s) wind speed for the white façade than for the black façade. The low wind speed frequency varies from 100-180 for the white façade and 20-120 for the black façade.

In the points where we measure a clear difference in wind distribution between the black and the white façade the wind speed occurring most can be read as the top of the graph. Figure 6.5 shows these points in a larger resolution. In point 1, 2 and 3 the wind speed occurring most at the white façade is around 0.2 m/s and at the black façade

0.4 m/s, an increase by a factor of two. In point 8 and 9 at the white façade the peak is again around 0.2 m/s while the peak at the black façade is around 0.6 m/s. This is an increase by a factor of three. In the middle of the street point 10 shows a peak of 0.4 m/s at the white and 0.8 m/s at the black façade, which is again an increase by a factor two.

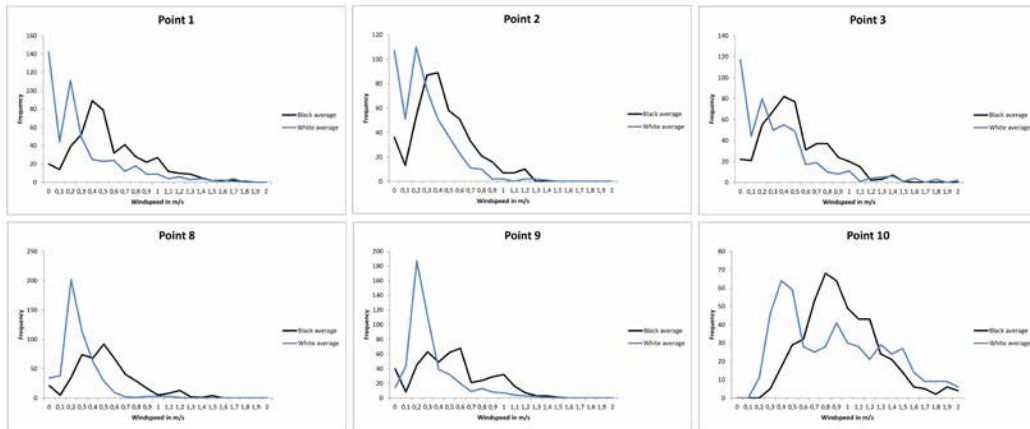

FIGURE 6.5 The frequency of airspeed occurrences over an interval of 8 minutes for the measurement points 1, 2, 3, 8, 9 and 10.

The measurement points that do not show a clear difference in wind speed at the black or white façade might be positioned within a rotating vortex where the air flow is generally lower or has another direction. At point 11, positioned close to the opposite façade on the shadow side, no influence is noticeable from the two different façade colours.

The distribution of wind speed follows a normal distribution in an open field. In an area with obstacles such as buildings the distribution of wind speed usually follows the so-called Weibull distribution (Voorden, 1982). All measurement points, except for number 10, have a wind distribution that is similar to the Weibull distribution. Number 10 is the only measurement point further than 1.5 metre from a façade and approximates an open field more than the other points. Therefore the distribution comes close to a normal distribution. Another difference is the larger influence of natural occurring wind gusts that are noticeable in front of both facades. The wind speed measurements are based on only two measurements of 5 minutes per measurement point. Therefore, further analyses looking into the mean standard

deviation or a statistical test (in this case a Mann-Whitney test should be used) were not considered relevant.

Even though the measurement day does not represent a heatwave day and during this day quite some cloudy moments and wind gusts occurred, it was still possible to measure a significantly higher air speed at the black façade in comparison with the white façade. We expect a greater difference on days with more sunshine hours, a higher temperature and less wind gusts.

§ 6.3.3 Influence of colour on the surface temperature

The test panels indicate the difference between several materials. The surface temperatures measured at the panels are given in Figure 6.6. The maximum surface temperature difference between the black and white panel was 33°C. This is also the largest temperature difference that occurred, implying that the surface temperature difference between materials is smaller than between coloured aluminium. The three different materials brick, wood and bare aluminium show a maximum temperature difference of 17°C between aluminium and brick. Wood shows a slightly higher temperature compared to bare aluminium, with a maximum difference of 5°C. Brick is heating up much more, and shows a maximum difference of 16°C compared to bare aluminium. The same sequence as we see here in up heating is expected to appear with the wind speed measurements: from white aluminium to bare aluminium, wood, brick and finally to black aluminium.

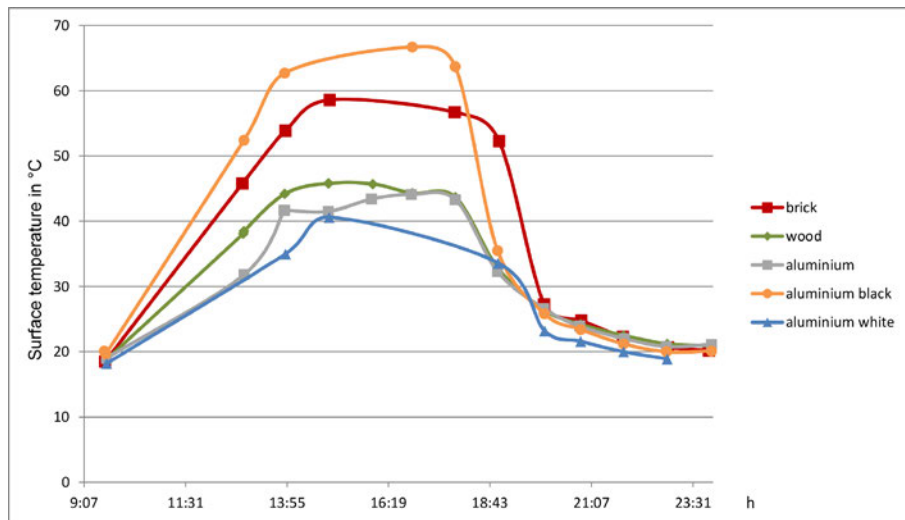

FIGURE 6.6 Surface temperature for the materials brick, wood, bare aluminium, black coated aluminium and white coated aluminium panel measured in the outdoor on the summer day 23-08-2013.

From the surface temperature measurements the time lag of the brick façade is clearly visible. The use of brick instead of aluminium in combination with façade colours will probably prolong the effect of the heat accumulation on air movements after sunset. This can be of value when the sky view factor of the street is low which prevents cooling down by radiating heat to the sky.

At the full scale façade the temperature difference between the white and the black façade was at its maximum around 16:30 h. At this time of the day the average difference was 15 °C. Figure 6.7 shows the thermal camera measurements around 16:30 h. The façade has a temperature gradient itself, where the top of the façade is 2 to 4 °C warmer than the bottom part.

The temperature difference between the black and white façade determine the difference in wind speed induced by the façade. Table 6.4 presents the differences between the two facades on the measurement day for the early afternoon and the late afternoon. The facades are facing South-West, which means they start to receive solar radiation only after midday. This is the moment a difference in temperature starts to evolve. Around 14:00 h the sun angle is perpendicular to the façade, but still high in the zenith. In the late afternoon, as the sun lowers, the impact of the solar radiance continues to be fierce when the air is clear. This is expressed in the much greater difference in temperature and airspeed for the black and white façade in the late afternoon compared to the early afternoon.

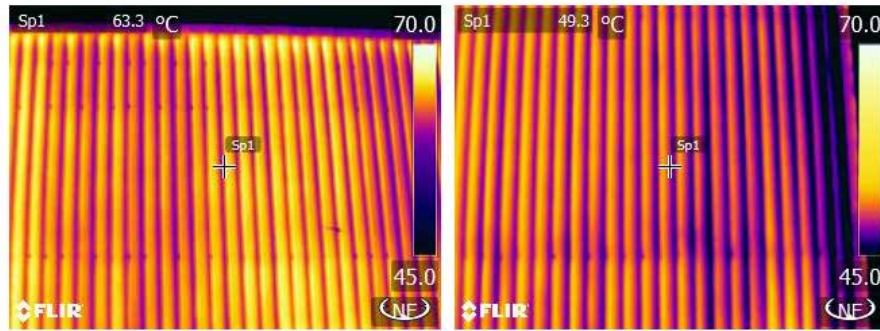

FIGURE 6.7 Thermal image of black (left) and white (right) façade around 16:30 h.

TIME PERIOD	TS BLACK-TS WHITE (°C)	V BLACK-V WHITE IN POINT 1 (M/S)	V BLACK-V WHITE IN POINT 10 (M/S)	V BLACK-V WHITE IN POINT 11 (M/S)
12:00-15:00	2	0.09	-0.45	-0.03
15:00-18:00	14	0.38	0.63	0.09

TABLE 6.4 Difference in surface temperature (Ts black-Ts white) and the average wind speed (v black-v white) in measurement point 1, 10 and 11 between the black and white façade for two time periods.

§ 6.4 Additional Opportunities

Increasing façade temperatures for the benefit of outdoor thermal comfort also affects the indoor climate. The 'hot' façade needs extra attention to prevent extra up-heating of the indoor environment. Better thermal insulation and a heat-reflecting foil could mitigate these negative effects, as presented in Figure 6.8. The same picture also presents the opportunity to collect heat gained by the façade during the day: this can be achieved by means of a heat collector integrated into the outer wall, which is connected to a hot water tank or to seasonal storage. With this principle the air generation by the solar-heated façade is at its maximum at daytime and the accumulated heat is quickly absorbed when the seasonal storage is activated to minimize the nocturnal heat island effect. This is important for more climate-robust cities. In wintertime collected solar heat can serve functional purposes. In this case, climate adaptation meets climate mitigation. Both effects should be studied further to validate potential gains.

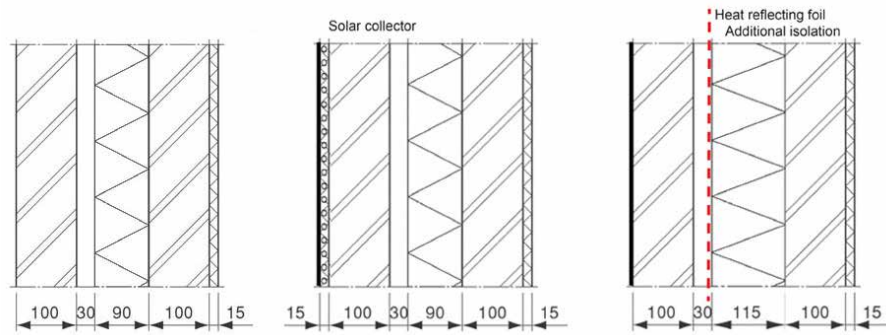

FIGURE 6.8 Left: common cavity wall. Middle: cavity wall with black façade colour and solar collector system to harvest heat. Right: cavity wall with heat reflective foil and additional isolation to prevent heating of the indoor spaces.

The two measurement tests presented in this paper both indicate a larger wind speed with a darker façade surface. To substantiate the findings, a next step would be to test the draft principle with a CFD model. This model can then test different options of façade colours, determining the strongest acceleration effect with a certain amount of painted surface, or with a glass panel to create an urban solar chimney. In addition, the so-called zebra-stripe effect can be tested: black and white stripes potentially contributing to the cooling effect by generating air flow from light to dark. See Figure 6.9 for illustrations of different painting options.

The solar chimney principle is used in passive climate design for buildings (Bronsema, 2013) and could improve the ventilation of a street canopy in addition to façade colouring. With a solar chimney wind gusts have a smaller impact on the airflow. A stronger and steadier air flow is expected from the technique. In addition, a solar chimney may increase the mix of cool air from the boundary layer above the roofs with the air from lower parts of the canopy. A dark facade without the chimney effect may cause more air circulation and a higher speed, but not necessarily a mix with air above. This leads to an increase of comfort due to a higher wind speed, but may not discharge the up-heated air from the canopy layer to the upper boundary layer above the urban area.

Building further on the results of this study, hot surfaces can also be combined with cool spots such as parks. Air flows are then guided from the cool spot to the hot spot.

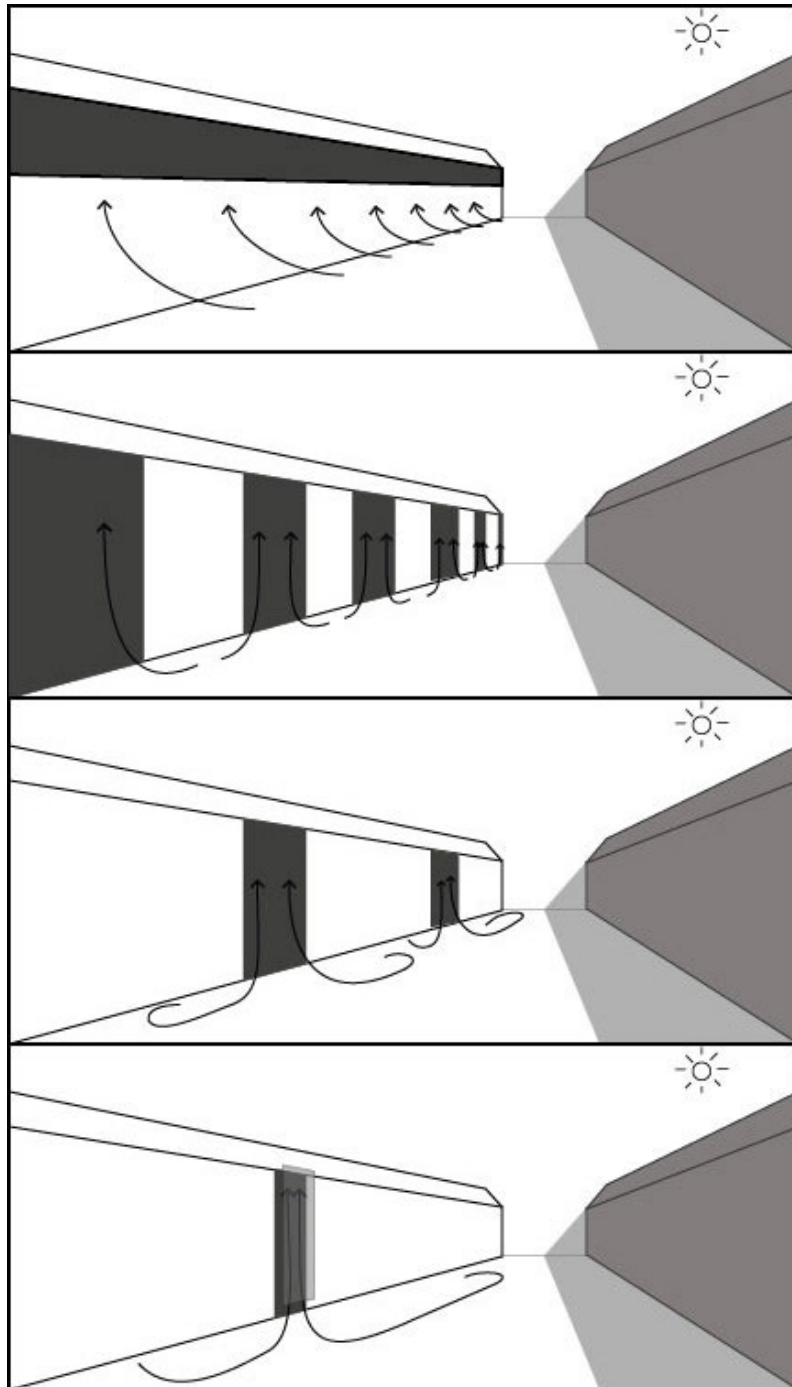

FIGURE 6.9 Painting options from top down: the upper part of the façade is painted dark, the façade of dwellings are painted dark alternately, only a few dwelling facades are painted dark and a small vertical strip is painted dark with a glass plate in front.

§ 6.5 Conclusions

This paper discusses exploratory research in the use of coloured façades to enhance an increase of wind speed to improve thermal comfort in urban spaces on hot days with a prevailing low wind speed. The initial hypothesis was that a cool draft can be generated by creating a local hot spot with an open connection (e.g. a street or a square) to a cool spot. In this paper the effect of a dark façade on air speed is compared to a light façade.

The two measurements of wind speed and surface temperature indicate a higher wind speed with a dark façade compared to a light façade. Also the material of the façade influences the surface temperature, hence the acceleration of the wind speed.

In the lab test using scale models the generated wind speed between 0 to 0.5 m/s was low due to the relatively small heated surfaces and the limited power of the alternative radiation source (construction light). The low wind speeds require a higher accuracy in measurement equipment than that available for this study (0.25 m/s). The scale model results also require a valid method to upscale the results from 1:20 to full scale.

With the full scale measurements inaccuracies are avoided. In this case the higher wind speed (between 0 to 2.5 m/s) was measured with a measurement device with a higher accuracy of 0.1 m/s. Nevertheless, in this set up, the weather (wind gusts and clouds) can have an influence on the measurement results: the measurement intervals are not parallel but consecutive. The intervals are chosen with comparable radiation loads regarding the solar angle. Follow-up measurements should include simultaneous measurements along the complete height of the façade.

Colouring facades to increase thermal comfort is a relatively low-cost strategy and its influence on occupation of public space is negligible. Both indicate a good feasibility. This however, depends on the influence on the aesthetic value of the building(s).

An important connotation is the negative effect that the darker façade might have on the indoor climate. Existing measures can be applied to prevent an increase of the indoor temperature and even make use of the additional heat captured in the façade. Some ideas for this were proposed in this paper. Further research into these solutions is recommended. This paper also advocates for further study on the perception of pedestrians. Further research is needed to confirm the significance of the increased wind speed in thermal comfort sensation.

§ 6.6 Acknowledgements

This study was funded by the governmental institute in the Netherlands, *Knowledge for Climate* and city stakeholders among which Rotterdam, The Hague, Amsterdam and Utrecht. The research projected is a sub research of the research program *Climate Proof Cities*.

We want to thank Huug Schuil for his assistance in constructing the laboratory set up, Cécile and Ria Kleerekoper for conducting the measurements, Ruud and Marjan Stroeve for facilitating the laboratory space, and Frans Baak and Eric Buitenhuis for their cooperation with the full-scale measurements.

§ 6.7 References

- Bohnenstengel, S., Schlunzen, K.H. and Grawe, D. (2004), "Influence of thermal effects on street canyon circulations". *Meteorologische Zeitschrift*, Vol. 13, No. 5, pp. 381-386.
- Bronsema, B. (2013), *Earth, Wind & Fire: Natuurlijke Airconditioning*, Doctor degree Dissertation, Delft University of Technology.
- Carter, J.G. (2011), "Climate change adaptation in European cities". *Current Opinion in Environmental Sustainability*.
- Dimitrova, R., Sini, J.-F., Richards, K., Schatzmann, M., Weeks, M., Garcia, E.P. and Borrego, C. (2009), "Influence of thermal effects on the wind field within the urban environment". *Boundary-Layer Meteorology*, Vol. 131, No. 2, pp. 223-243.
- Eliasson, I. and Uprmanis, H. (2000), "Nocturnal airflow from urban parks-implications for city ventilation". *Theoretical and Applied Climatology*, Vol. 66, No. 1, pp. 95-107.
- Huizhi, L., Bin, L., Fengrong, Z., Boyin, Z. and Jianguo, S. (2003), "A laboratory model for the flow in urban street canyons induced by bottom heating". *Advances in atmospheric sciences*, Vol. 20, No. 4, pp. 554-564.
- Kikegawa, Y., Genchi, Y., Kondo, H. and Hanaki, K. (2006), "Impacts of city-block-scale countermeasures against urban heat-island phenomena upon a building's energy-consumption for air-conditioning". *Applied Energy*, Vol. 83, No. 6, pp. 649-668.
- Kim, J. and Baik, J. (2001), "Urban street-canyon flows with bottom heating". *Atmospheric Environment*, Vol. 35, No. 20, pp. 3395-3404.
- Kleerekoper, L., Ham, E.v.d., Hordijk, T. and Dobbelssteen, A.A.J.F.v.d. 2014. Ventilation by colour and material, exploring a new climate adaptation measure. *Third International Conference on Countermeasures to Urban Heat Island*. Venice, Italy.
- KNMI (2011), "Lijsten en extremen". Available at: <http://www.knmi.nl/klimatologie/lijsten/index.html>.
- Kovar-Panskus, A., Moulinneuf, L., Savory, E., Abdelqari, A., Sini, J.-F., Rosant, J.-M., Robins, A. and Toy, N. (2002), "A wind tunnel investigation of the influence of solar-induced wall-heating on the flow regime within a simulated urban street canyon". *Water, Air and Soil Pollution: Focus*, Vol. 2, No. 5-6, pp. 555-571.
- Mees, H.L.P. and Driessen, P.P.J. (2011), "Adaptation to climate change in urban areas: Climate-greening London, Rotterdam, and Toronto". *Climate law*, Vol. 2, No. 2, pp. 251-280.
- Nakamura, Y. and Oke, T.R. (1988), "Wind, temperature and stability conditions in an east-west oriented urban canyon". *Atmospheric Environment*, Vol. 22, No. 12, pp. 2691-2700.
- Nikolopoulou, M. and Steemers, K. (2003), "Thermal comfort and psychological adaptation as a guide for designing urban spaces". *Energy and Buildings*, Vol. 35, No. 1, pp. 95-101.

- Nishimura, N., Nomura, T., Iyota, H. and Kimoto, S. (1998), "Novel water facilities for creation of comfortable urban micrometeorology". *Solar Energy*, Vol. 64, No. 4, pp. 197-207.
- Santamouris, M., Papakonstantinou, K. and Georgakis, C. 2001. Natural ventilation in urban-areas. *URBVENT report, Contribution to Task*.
- Uehara, K., Murakami, S., Oikawa, S. and Wakamatsu, S. (2000), "Wind tunnel experiments on how thermal stratification affects flow in and above urban street canyons". *Atmospheric Environment*, Vol. 34, No. 10, pp. 1553-1562.
- Vachon, G., Rosant, J., Mestayer, P. and Sini, J. (1999), "Measurements of dynamic and thermal field in a street canyon, URBCAP Nantes 99". *Proceedings of the 6th Int. Conf. on Harmonisation within Atmospheric Dispersion Modelling for Regulatory Purposes, 1999*, pp. 11-14.
- Voorden, M.v.d. (1982), *Windhinder*, Delft University of Technology.
- Xie, X., Liu, C.-H. and Leung, D.Y. (2007), "Impact of building facades and ground heating on wind flow and pollutant transport in street canyons". *Atmospheric Environment*, Vol. 41, No. 39, pp. 9030-9049.

§ 6.8 Supplementary material

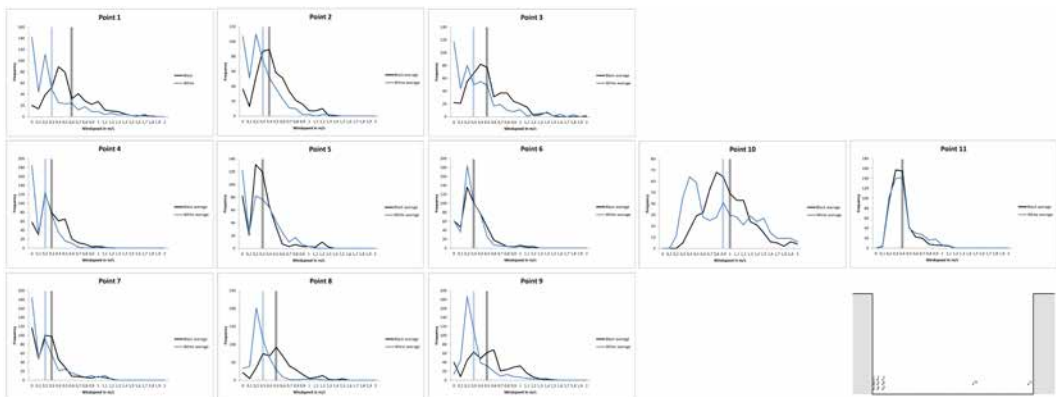

FIGURE 6.10 The frequency of airspeed occurrences over an interval of 8 minutes with an indication bar for the average wind speed for the measurement points 1 to 11 and the location of each measurement point.

Heat mitigation guidelines

The design guidelines presented in this section originate from various studies described in the previous chapters 4, 5 and 6. Guidelines based on literature are presented concisely and originate from chapter 2 and 3. The guidelines go beyond specific locations, however, they are not applicable everywhere. Heat mitigation guidelines are contextual and related to other design interventions. The list of guidelines presented here does not aspire to collect guidelines from other studies nor to be new and innovative per se. As the guidelines evolve from the research within this project they can strengthen or question conclusions from other studies. In addition, they offer urban designers and policy makers grip on specific issues concerning heat mitigation and climate adaptation. Conclusions from parallel research projects that are part of the same research consortium Climate Proof Cities are used as input for mainly chapter 3.

Vegetation

Plant trees strategically

The simulated effect of trees on thermal comfort (PET) is larger than all other simulated measures in this study. Trees reduced the maximum PET with 20°C in close proximity of the trees. This is for a large part related to the shadow casting of trees that prevents heating of urban surfaces. Also on a wider range from the trees the potential cooling effect in comfort sensation can be very significant. On the other hand trees can also have a slightly heating effect due to the obstruction of air flow. The cooling effect depends on the specific location, and time of the day. Important in placing trees is weighing where the cooling effect of a tree is most desired and does not obstruct too much light in buildings or on commercial terraces.

Do not combine trees with highly reflective façades

The more heat is reflected from the façade, the more heat is trapped under the tree crowns.

De-pave and grow grass and flowers

A ground cover of grass instead of pavement can decrease the average comfort temperature PET with 5.5°C. The more area cover is vegetated, the larger is the cooling effect during warm weather. When only half of the area is covered with grass instead of

pavement a cooling of 3.5°C above grass and 0.5°C above pavement can be achieved. A spread mix of grass and pavement will probably level out temperature differences. Depending on the use of the space cooler and hotter spaces can be created.

From literature

- Park Cool Islands (PCI) have a cooling effect up to 100 metres: with a park every 200 metres a complete urban area can be effected;
- The park breeze effect is working within 250 meters;
- Avoid artificial soccer fields: they heat up even more than the regular urban tissue during the day;
- Green roofs significantly lower the roof surface temperature. The measure is therefore effective on the indoor thermal comfort and, when applied on large scale, on the urban boundary layer. Irrigation is key in cooling factor;
- Green facades are effective for indoor comfort during daytime and they prevent heating of the façade. Especially in the late afternoon and evening façade greening reduces the re-radiation of heat to the outdoor space because the facades did not accumulate as much heat as would be the case without greening. Irrigation is key in cooling factor;
- Green facades have a large effect on thermal comfort because they influence the thermal perception of people (more visual-eye height).

Water

The simulations performed in this research are not accurate enough in the cooling potential of water to present new guidelines.

From literature

- Flexible water catchment and ground water serves flood prevention, infiltration and evaporation;
- Catch rain water with flexible water levels or underground storage to buffer water for dry periods and relief the sewage system and water treatment plants;
- Slowly infiltrate a part of the rainwater catchment to supplement the groundwater level and to provide space for new heavy rainfall;

- When groundwater levels lower during hot and dry periods the buffer should be employed to secure the cooling effect of evaporation;
- Irrigated landscapes provide cooling: therefore the amount of water and vegetation in new developments must be preserved;
- Spraying water on streets is a locally effective measure provided that the water supply is sufficient;
- Water has a large effect because it influences thermal perception of people;
- Large, especially flowing, water bodies have a cool potential during the day. Small water bodies heat up easily, after a longer warm period also large water bodies may increase temperatures in cities.

Built form

Compensate for additional buildings

In general additional buildings result in higher average and maximum temperatures. Locally shadow casts of buildings and the heat absorbing materials can result in lower temperatures, especially in the morning. When the new building surfaces mimic a natural surface or the surface is shaded the contribution of the building to heat accumulation can be decreased.

Additional building layers can result in both heating or cooling of the direct surroundings of the building

An additional building layer results in: more shade, less ventilation and more heat trapping. The magnitude depends on the orientation, H/W ratio, materials and objects in the street.

Do not create wind shelter without offering shading facilities

Wind plays a very significant role in thermal comfort sensation and should be considered in both warm and cold weather situations. In urban design wind is usually an element we want to block or deviate to increase comfort at street level whole year round. Be aware that during hot weather periods this can lead to extremely high temperatures. Make sure that (temporary) shading devices keep the sheltered space comfortable.

Be careful with orienting on the prevailing wind direction if cold or strong winds come from the same or opposite direction

Increasing ventilation is very effective in subtropical climates with high temperatures year-round. Be careful with directing airflows in colder climates to avoid uncomfortable and dangerous situations.

From literature

- Height to width ratio: For countries in the temperate climate zone and a low sun angle, wide streets with a height to width ratio below 0.66 with seasonal shadow elements are preferable above narrow streets. This allows ventilation and space for green;
- Increasing street width is preferable to shadowing buildings with buildings in temperate climate zones: winter situation;
- E-W oriented streets have one (the south façade) side with an extreme radiation load. This can be effectively shaded with a single row of trees. N-S oriented streets have a higher radiation load over the whole day and provide more outdoor comfort in winter;
- A mix of building heights, slanted roofs and open urban blocks increase ventilation;
- A higher density generally leads to higher temperatures.

Material and colour

Avoid reflective facades

For countries in the temperate climate zone and a low sun angle, light and reflective facades can decrease thermal comfort at street and especially neighbourhood level. Thus do not increase albedo above 0.4 to avoid heat trapping in the canopy layer.

Encourage reflective roofs

Light roofs have a positive effect on the urban heat island when applied on a large scale. The effect on comfort at street level depends on the building height. On the even smaller building level it decreases up heating of the upper floor considerably.

Air flow

Orientation of streets and squares on the prevailing wind direction to cool Dutch cities during heatwaves is not effective. Instead, make use of locally generated air flows. This can be achieved by increasing differences in surface temperatures, placing solar chimneys or on a somewhat larger scale by combining PCI's and hotspots (max 250 metres distance).

Make use of smart facades for indoor and outdoor climate control

Thermal induced air flows generated by dark coloured (smart) facades or hot and cool spots are a means to create cooling when other options such as green or shadow devices are not appropriate or desirable.

General

T_{mrt} and wind speed have a large and local effect.

T_{air} and humidity have a small and wide spread effect.

PART 3 Research by Design

		Research Question
	Chapter 1 Introduction	
Part I Literature	Chapter 2 Urban climate & climate change	1
	Chapter 3 Inventory of climate adaptation measures	2
	Factsheets	
Part II Simulations and Measurements	Chapter 4 Urban measures for hot weather conditions in the Netherlands compared in a microclimate model	3
	Chapter 5 Microclimate effects of redevelopment options in a low-rise open building block	
	Chapter 6 Ventilation by colour and material, exploring a new climate adaptation measure	
Guidelines		
Part III Research by Design	Chapter 7 Designing with microclimate: interviews with urban designers and planners	4
	Chapter 8 Typological design solutions supported by urban surface analysis in their path to climate resilience	5
	Chapter 9 Designing the urban (micro)climate	4
	Chapter 10 Conclusion	

7 Designing with microclimate: interviews with urban designers and planners

In the second part of this thesis effects of climate adaptation measures on thermal comfort were studied. With a better understanding of the effectiveness the 'best' solution in relation to thermal comfort can be selected. Nevertheless, this might not be the most appropriate solution considering the site specific conditions. What considerations determine a particular design choice? This question frames the research by design studies in the third part of this thesis.

It is particularly interesting for this research to know why a designer decides to apply, or not to apply, climate adaptation measures when is asked to develop an integrated design with the utmost account of thermal comfort at street level. With more insight in the approach of designers to the theme a design method can be developed that fits to the actual role of urban microclimate in the design and planning process. And gives an indication of what output from this research can be of importance to strengthen the role of the theme. In this chapter a group of designers and planners is asked to give insight in their way of thinking through a questionnaire and an in-depth-interview. The results enables answering the sub-question: What is the role of the urban microclimate in the design process according to urban designers and planners?

§ 7.1 Introduction

Microclimate design is often not a central theme in design projects. Even in education the subject does not yet receive full attention, except for some individual student projects where they can choose their own conceptual framework and priorities. The educational project *Green-blue infrastructure for a resilient and healthy city* did place the theme centrally, and therefore, offered a great chance to work on climate adaptation design with a diverse group of Msc students in landscape design and urban planning. The design atelier was organised in the spring semester of 2014 at Wageningen University, The Netherlands. With a questionnaire and individual interviews the attitude towards climate adaptation and the role it plays in the design process are analysed. This chapter aims to discuss the place of climate adaptation in

the design process and does not address the content of the designs. In chapter 8 some of the student projects are presented substantively.

In the setup of the design atelier 28 students were assigned to 4 tutors with a different background; two landscape architects, a cultural geographer and a spatial planner. All groups had the same assignment formulated by two delegates of the city of Utrecht: an advisor from the province of Utrecht and a project manager from the municipal department responsible for green. The assignment was as follows: improvement of the green-blue infrastructure in and around the city of Utrecht and its contribution to the recreational network, the ecological network, hydrology and microclimatic functioning of the city. In the first eight weeks each of the four groups focussed on a different part of the city to analyse the green-blue infrastructure and the ecosystem services connected to it. The multidisciplinary approach of this design atelier also requires a view on other urban systems and values such as mobility and history. A common vision and objectives were developed as a start-up to the individual phase in the last four weeks. In the individual phase three of the four tutors continued, thus one student group was divided over the other three.

To resume, all four groups worked on the same assignment, all students shared the same client (the province and municipality of Utrecht), but there was variation between the groups and the individual student projects due to the influence of the tutors that have a different background and personal prioritization.

The **main question** addressed in this survey is:

What is the role of the urban microclimate in the design process according to urban designers and planners?

The main research question is answered through a questionnaire and personal interviews in the following two sections.

1 Questionnaire

To gain insight in the role of the urban microclimate in the design process according to urban designers and planners, the following sub-questions were addressed in the questionnaire form (see Appendix D for the complete form) and filled-in by all participating students:

- 1 What was the importance of the four ecosystem services of green-blue infrastructure in the design process?
Where do most designers see chances for combinations with microclimate?
Where do most designers see conflicts with microclimate?
What role do designers dedicate to the theme microclimate if they can choose between

central theme, repeating problem or precondition?
 Was there an influence of the tutor on the importance of the role of the microclimate?
 The first question positions the urban microclimate in relation to the three other ecosystem services (social, ecology and hydrology) that had to be addressed according to the assignment. Question two and three are very much related to the main research question 'How to integrate microclimate in a planning or design process?' In the integration process links with other design issues need to be made to come to a holistic design. When the aim is to find promising combinations of microclimate measures with other urban design aspects, the students will encounter conflicts as well. Question four is directed at finding out the position that thermal comfort and the microclimate occupy in the design process. Do they think this theme is suitable to act as a concept or framework, or is it one of the elements that is applied when it provides a positive result in combination with other elements. For example the framework during the design process can be 'the life course-proof neighbourhood' in which climate adaptation has an important role because the elderly and infants should be able to reside. Finally, question five is to test whether the earlier implied relation between personal motivation or focus of a tutor influences the role of the urban microclimate in the students their design process.

§ 7.1.1 Questionnaire results

1. What was the importance of the four ecosystem services of green-blue infrastructure in the design process?

In the questionnaire the students were asked to what extend the four different ecosystem services play a role in their design process. One of these services concerns the microclimate, which scored as the most important role. The scores in Table 7.1 show that social services of green and blue are regarded as the most important and hydrology the least important.

THEME	AVERAGE ROLE: 7 (LARGE) - 1 (SMALL)	TOTAL SCORE OF 196	POSITION OF IMPORTANCE
social	5,7	160	1
microclimate	5,3	147	2
ecology	4,4	122	3
hydrology	3,7	104	4

TABLE 7.1 Rating of the four ecosystem services addressed in this design atelier scored by the individual students.

Microclimate has a high priority in this group of designers. All four ecosystem services are stated as equal in the design brief. However, as introducing microclimate to students is a main didactic aim of this course, students received more information and lectures about microclimate compared to the other three. Another consequence of this didactic aim, is that students deliberately chose the course, knowing to learn about designing with the urban microclimate. This has probably influenced the prioritization of the students, showing that despite of the extra attention microclimate design received, social services of green are still seen as more important.

In fact, without the clear didactic focus on the microclimate the priority of the theme would probably have been lower. In a study by (Pijpers- van Esch, 2015) the microclimate theme was assigned with the second lowest importance amongst 11 themes in total. This result is based on interviews with mainly urban designers, also architects and a landscape architect, who did not have special interest in or focus on microclimate design.

2. Where do most designers see chances for combinations with microclimate?

In an open question in the questionnaire the students were asked which urban functions or design elements can be combined with microclimate design. Even though this is an open question, many answers coincide. In Table 7.2 the answers are presented. The combination of ecology and microclimate is mentioned most of all, followed by a combination with recreation and social cohesion or social functions. Other frequently mentioned combinations with microclimate are hydrology, aesthetics of public space and green or trees in general.

COMBINES WITH MICROCLIMATE	SCORE
ecology	10
recreation (routes)	9
social cohesion/functions	9
hydrology	7
aesthetics public space/street scape (green)	5
green/trees	5
buildings	2
experience of outdoorspaces	2
thermal comfort	2
green and blue	2
attracting more environmental friendly companies	1
economy	1
large scale and small scale	1
new developments	1

>>>

COMBINES WITH MICROCLIMATE	SCORE
ecosystem services	1
climate change mitigation	1
climate change adaptation	1

TABLE 7.2 Design elements that can be combined with microclimate design according to the students.

3. Where do most designers see conflicts with microclimate?

In line with sub-research question B, this was an open question as well. Where many students could easily give two examples of good combinations with microclimate, naming conflicting aspects turns out to be more difficult. In Table 7.3 the conflicting aspects named by the students are presented. The preference of people or their awareness is named most often as conflicting aspect with microclimate design. Followed by existing buildings or districts and insufficient space that prevent solutions to improve the microclimate.

CONFLICTS WITH MICROCLIMATE	SCORE
people's preference/awareness	6
existing buildings/districts	5
insufficient space	5
infrastructure/traffic	4
economy	2
finance	2
planning	1
lack of data	1
ownership	1
south-west facing facades	1
policy/governmental plans	1

TABLE 7.3 Design elements that can be in conflict with microclimate design according to the students.

A general difference between the answers of sub-question B and C is the practical opportunities that were mentioned that have to do with integrating climate adaptation measures in the urban structure. While conflicts are more often related to planning and governance aspects. Clearly the physical aspects of existing buildings and infrastructure and competition in the occupation of space are definitely considered in conflict with climate adaptation measures.

4. What role do designers dedicate to the theme microclimate if they can choose between central theme, repeating problem or precondition?

This question aims to find out what position thermal comfort and microclimate occupied in the design process during the atelier. Did the students place it very central as a concept or guiding theme, more to the background as one of the preconditions their design has to meet or is it a struggle to design with? Within the five generic elements in the design process distinguished by Dooren et al. (2014) all three have a different place. When the urban microclimate is seen as guiding theme (2), it provides inspiration and helps creating a coherent and consistent result. In case the microclimate is a precondition in the design process, in all domains (3) the designer has to make choices considering also the microclimate. In case the microclimate is perceived as a repeating problem there are two elements in the design process that are insufficient to be able to work with the theme: either the frame of reference (4) does not provide enough solutions (rules of thumb/guidelines), or the laboratory (5) of sketching and modelling does not enable reflection or evaluation of the solutions.

FIVE GENERIC ELEMENTS IN THE DESIGN PROCESS ARE (DOOREN ET AL., 2014):

- 1) experimenting or exploring and deciding,
 - 2) guiding theme or qualities,
 - 3) domains,
 - 4) frame of reference or library,
 - 5) laboratory or (visual) language.
-

Table 7.4 presents the position of thermal comfort and the microclimate in the design process according to the students. The outcome of this question suggests that climate adaptation can function well as both, a central point and precondition. Nevertheless, more than 20 percent of the students struggled with the subject where it became a repeating problem. The questionnaire only allowed a forced choice between three options. The role of the urban microclimate might have more nuances. Many of the respondents indicated that the theme will have a different role depending on the location, assignment and client.

	SCORE	
central theme	10	36%
repeating problem	6	21%
precondition	10	36%
blanco	2	7%

TABLE 7.4 Position of microclimate in the design process in this atelier according to the perception of individual students.

1 **Was there an influence of the tutor on the importance of the role of the microclimate?**

For sub-research question A the questionnaire asked students: 'To what extent did microclimate play a role in your design process?' on a scale of 1 (small) to 7 (large). The relation between this question and the tutor of the student gives insight in the influence the tutor has on the position of the subject 'microclimate' in the design process. When we look at the correlation between the role of the microclimate and the tutor of the group phase there is almost no correlation: -0.11). While the correlation with the individual tutor turns out to be high: -0.73 . In Figure 7.1 the correlation is presented in a graph. From Tutor 1, to Tutor 2, to Tutor 3 the attention/priority for the microclimate decreases.

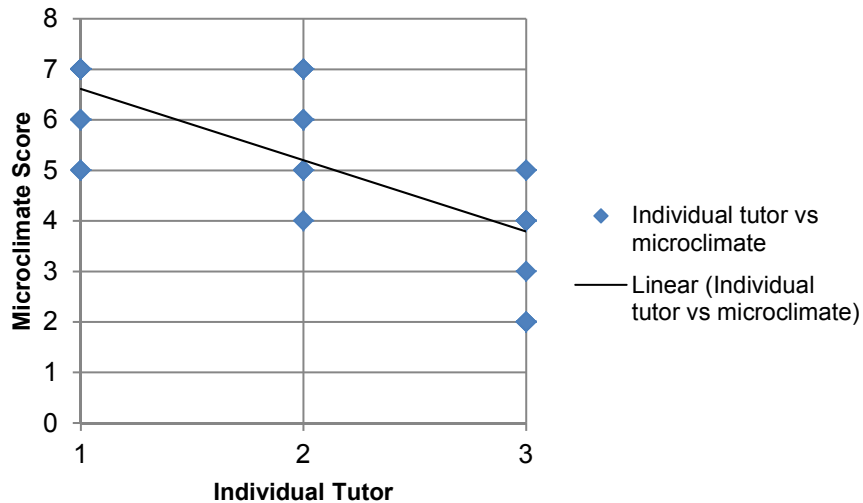

FIGURE 7.1 The correlation between the individual tutor and the role microclimate plays in the perception of the student.

From the high negative correlation between tutors and the microclimate importance we can expect that Tutor 1 finds microclimate more important than Tutor 2 and 3 and Tutor 3 finds it less important than Tutor 1 and 2. Figure 7.1 does not show the amount of times a microclimate score occurs. To make clear how the average score of

the role of the microclimate in the students their design process varies per tutor, the total score is divided by the amount of students of each tutor, see Table 7.5.

	AVERAGE SCORE OF THE ROLE OF THE MICROCLIMATE ACCORDING TO STUDENTS	IMPORTANCE OF THE MICROCLIMATE IN FUTURE DESIGN AND DESIGN EDUCATION ACCORDING TO TUTOR	ROLE OF MICROCLIMATE IN THE TUTORING OF THIS ATELIER
Tutor 1	6.3	6	7
Tutor 2	5.9	5	5
Tutor 3	3.4	4	6

TABLE 7.5 The average score of the role of the microclimate by students and the importance of the microclimate in future design and design education and in the tutoring of this atelier per tutor.

Looking at what the tutors find more important in future design the score of the students is clearly related. However, when you ask them what role the microclimate has played in their tutoring during this atelier the outcome is slightly different. The answer of this question can be relevant to what role the microclimate normally has, or will have, in their design education. Tutor 2 is very much acquainted with the subject and already incorporates it in education, while for Tutor 3 the subject was quite new and introduced it for the first time to students. Compared to former education the role of the microclimate was relatively large for Tutor 3, but in amount of time spend or emphasis on the subject, this tutor probably did less than the other two.

§ 7.2 Personal interviews

Next to the questionnaires, students were asked for an in-depth interview if they had the opportunity to meet after the end of the course. This resulted in 12 evaluation interviews about the individual design process. These interviews offered the opportunity to ask more about personal motivation and ambition and elaborate on what difficulties planners and designers encounter when designing the urban microclimate.

The questions that were asked randomly during the conversation are given below and the answers to these questions are discussed in the next section and shortly summarized in Appendix E.

- 1 Inherent to design is to make choices. Within this atelier there was a lot of freedom in choosing a location and program in which the green-blue network with its four ecosystem services had to be optimally embedded. What was your personal ambition or motivation beforehand?
- 2 What part of your design is a success?
- 3 Is there an element you had to drop during the design? Did you choose a variant that is not the best option in relation to the microclimate or thermal comfort? If yes, why?
- 4 Does the theme 'urban microclimate' promote your inspiration?
- 5 Did you have enough information available? What could have helped you further in designing with microclimate?
- 6 What position will the theme microclimate have in your future designs?

§ 7.2.1 Discussion

Based on the personal ambition and motivation of the designer at the start of the course (question A) a student is seen as an proponent of the importance of the urban microclimate when the intention was to learn more about or learn how to design with the micro climate. Among the 13 students, six can be seen as advocates of the urban microclimate. We can conclude that when the student is an advocate, the theme 'urban microclimate' provides them with inspiration (question D) and was for almost all of these students part of the successful elements in their design (question B). This starting point, however, did not always lead to choices in favour of the microclimate. In many cases the character or ambience of an area was found more important than choosing the best option in relation to thermal comfort (question C).

Independent from the starting point of the students, the guidelines provided were often found too general or the desire to know more about a specific aspect or being able to simulate results left students unsatisfied about the real contribution of their design proposals to the micro climate (question E). This relates to interview question 4 where some students indicated to see the theme as a repeating problem that might be due to a lack of frame of reference (rules of thumb/guidelines) or insufficient skills in sketching and modelling disabling reflection or evaluation of the solutions. Only 4 of the 13 students did not miss information or knowledge about the microclimate. Many indicated that more 'clear' and straight forward solutions and guidelines would be helpful. On the other hand, the provided book, guidelines and/or expert supervision was used and appreciated by more than 2/3rd of the students, advocates or not.

After following the course, a large majority of 70 percent of the students expect the urban micro climate to be a pre-condition in their future designs (question F). Notable is that none of the interviewees see it as a repeating problem. Instead, a few stated only to apply a microclimate measures when it provides an additional

benefit in combination with other elements. The approach to the microclimate theme depends for a lot of designers on the project, location or on the client. This implies that factsheets, guidelines and a design method to improve the urban microclimate are useful for a large group of designers and planners regardless their approach to the theme.

§ 7.3 Conclusion

This section evaluates the integration of climate adaptation in the design process by a survey amongst MSc students within a design atelier.

The sub-research question that was addressed by this survey - **‘What is the role of the urban microclimate in the design process according to urban designers and planners?’** - leads to the following main conclusion:

The approach to the urban microclimate varies, and depends on the designer, client and context. These three determine whether the urban microclimate plays the role as central theme, repeating problem or precondition.

Although the group of respondents to the questionnaire and in-depth interview was relatively small, more insight is gained in the way urban designers and planners approach the urban microclimate during the design process.

An interesting finding from the survey is that most of the designers and planners indicated that the urban microclimate will play an important role in their future designs. A large majority sees it as a pre-condition. This insight emphasises that a group of urban designers and planners is and can be convinced of the need to integrate climate adaptation into the design process.

Another finding is the need of additional knowledge and ‘clear’ information on climate adaptation measures. This thesis supplements this need through various means: Factsheets about climate adaptation measures as outcome of the first literature part explain measures and indicate chances and risks. Guidelines from the second simulation and measurement part add to or strengthen findings from literature. A set of measures per neighbourhood typology function as guiding models and a method to integrate adaptation measures as possible design process is presented in this third part of the thesis. This output aims to strengthen the role of the urban microclimate in the design and planning process.

The group planners and designers participating in this study choose the course to learn more about the urban microclimate which means they have an interest in the subject. Planners and designers without this interest might judge the role of the microclimate in design differently. This would be interesting to study further.

Another interesting question that relates to the study presented here is: is there a difference in the design process of plans that have an improved microclimate and plans that do not result in such improvements?

The following chapter builds on the conclusions in this chapter by providing additional knowledge and clear information in the form of a set of measures per neighbourhood typology and a method to integrate adaptation measures.

§ 7.4 Acknowledgements

I want to thank Rudi Etteger and Wiebke Klemm from the Wageningen University for offering the opportunity to participate in the expert supervision team of the Msc course and enabling the questionnaire and interviews. Furthermore, I want to thank the students for their cooperation with the questionnaire and interviews.

§ 7.5 References

- Dooren, E.v., Boshuizen, E., Merriënboer, J.v., Asselbergs, T. and Dorst, M.J.v. (2014), "Making explicit in design education: generic elements in the design process". *International Journal of Technology and Design Education*, Vol. 24, No. 1, pp. 53-71.
- Pijpers- van Esch, M.M.E. (2015), Designing the urban microclimate. A framework for a design-decision support tool for the dissemination of knowledge on the urban microclimate to the urban design process., page 73, TU Delft.

8 Typological design solutions in the path to climate resilience supported by urban surface analysis ¹²

In the previous chapter the role of the urban microclimate in the design process is discussed. This chapter assists planners and designers to increase the role of the microclimate in their design. To merge microclimate solutions with urban design challenges, this chapter explores the spatial implication of climate adaptation measures in specific Dutch neighbourhood typologies. The research question addressed is: How can neighbourhoods become climate robust considering the morphology of Dutch neighbourhood typologies?

The scale is a determining aspect in the decision-making process regarding climate adaptation measures. Usually the neighbourhood scale is chosen because this can be managed by municipalities or housing corporations. However, the effects of measures in the first place is on the local street scale. Because many neighbourhoods have a characteristic building typology and organisation of the public space it is possible to give a general statement of the most appropriate measures. For example, historic urban areas have a completely different starting point than garden cities.

In this chapter a new categorisation of neighbourhoods is presented to combine microclimate indicators with traditional urban typologies. A qualitative method based on case studies is used to come to general climate adaptation measures or strategies per microclimate category. All neighbourhood case studies start with an analysis of the physical properties, followed by at least one design solution or strategy. The design solutions and strategies are input for the general conclusions per microclimate category. This part of the thesis can be described as 'typological research' according to the scheme made by de Jong & Voordt (2002), presented in Figure 8.1. In the case studies the context is variable (different neighbourhoods) and the object is determined (different cases per microclimate category). Each separate case study is, however, a 'design study' in itself, with one specific neighbourhood and thus determined context and variable climate adaptation solutions (objects),

12

The content of this chapter is accepted for publication in the proceedings of the North American Symposium on Climate Adaptation: Kleerekoper, L., Kluck, J., & Dobbelsteen, A.A.J.F. v.d. (2016), "Selection support framework fostering resilience based on neighbourhood typologies".

		OBJECT	
		<i>Determined</i>	<i>Variable</i>
CONTEXT	<i>Determined</i>	Design research	Design study
	<i>Variable</i>	Typological research	Study by design

FIGURE 8.1 Types of design related study by de Jong & Voordt (2002).

§ 8.1 Microclimate categories based on common urban typologies

For the analysis of the microclimate of a specific location or area several methods exist. However, these methods require specialist input data and often make use of complex calculation models or time-consuming interviews. More information about these methods can be found in chapter 2. The method described in this section allows a first indication of the most appropriate microclimate measures without the use of extensive data-analysis or computer modelling. The classification of the neighbourhoods in a category can be based on many characteristics. For the ultimate goal of formulating design guidelines a generalisation of urban areas is required. This section describes the translation of urban typologies to microclimate categories.

Traditionally, urban typologies are classified in relation to their construction period, built form and organisation of the public and private space (Wassenberg, 1993, Ibelings, 1999, Baeten et al., 2004, Lorzing et al., 2008). Besides, the common urban typologies other methods of classification have emerged to support decision makers with the appropriate data about their cities and regions. In 1998 a classification of residential environments was made according to the level of urbanity by the *Woonbehoefte-onderzoek* (WBO). The result is three main typologies from urban, to suburban, to village and rural environments (ABF, 2006). In the beginning of the twentieth century the reflection on a period of fifty years of constructing for housing shortage asked for more insight in the quality of urban areas. The *Rosetta-methode* redefines the WBO residential areas into five main typologies: highly urban, urban, suburban, village and rural (Prins et al., 2010). Although this recent classification offers insight in the quality and ambiance of an urban area it does not offer a differentiation of the main aspects that are required to improve the microclimate.

For the microclimate there are many parameters of interest such as the size of paved surface, type of material, colour, amount and type of vegetation, amount and type of water, height and width of the streets and inner courtyards, openness, orientation and

built form. More background information about the urban microclimate is available in chapter 2. For cities in the US a climate classification according to physical parameters have been made by Stewart & Oke (2012). Here many parameters are needed to come to a classification, some features are overlapping or indicating the same process. To increase the accessibility for urban designers and planners working with the urban microclimate, this study brought the amount of parameters down from ten to three, see text box Table 8.1. The three most important determinants for the microclimate in which Dutch neighbourhoods distinguish themselves are building height, form of footprint and the percentage of green/water in relation to the urban surface, as given in Table 8.2. These three parameters are also selected as indicators by an extensive typological research in Dutch urban types by Berghauer Pont & Haupt (2009). The three parameters enable a classification based on microclimate categories and on traditional urban typologies used by urban designer and planners.

PARAMETERS BY STEWART & OKE (2012) FOR US CITIES	PARAMETERS DUTCH NEIGHBOURHOOD CLASSIFICATION			
	Building height	Footprint	Percentage green/water	Argumentation parameter selection
Sky view factor	x	x		Sky view factor, canyon aspect ratio and mean building height are all indicators for radiation loads and air flow patterns. The building height in combination with the type of footprint alone, is however, sufficient to make a classification for the common neighbourhoods in The Netherlands. Nevertheless, the height to width ratio (canyon aspect ratio) is certainly needed in the design process where choices for adaptation measures need to be made.
Canyon aspect ratio	x	x		
Mean building height	x			
Building surface fraction		x	x	Building surface fraction, impervious surface fraction and pervious surface fraction are all indicators for evaporation rate, heat storage, reflection and water infiltration. The combination of the type of footprint and the percentage of green or water is sufficient to determine a classification. Nevertheless, the fraction of stony and natural surface is certainly needed in the design process where choices for adaptation measures need to be made.
Impervious surface fraction			x	
Pervious surface fraction		x	x	
Terrain roughness class				No distinctive role in Dutch neighbourhoods
Surface admittance				Minor distinctive role in Dutch neighbourhood typologies
Surface albedo				Minor distinctive role in Dutch neighbourhood typologies
Anthropogenic heat flux				No distinctive role in Dutch neighbourhoods

TABLE 8.1 Important determinants for the microclimate in which Dutch neighbourhoods distinguish themselves.

BUILDING HEIGHT	FOOTPRINT	PERCENTAGE GREEN/WATER
Low (up to 3 layers)	Strip	Little green (0-10%)
Middle high (4-6 layers)	Open urban block	Moderate green (10-30%)
High (7-10 layers)	Closed urban block	Much green (30-50%)
High-rise (9 and more layers)	Spread buildings	Abundant green (50-100%)

TABLE 8.2 Categorization of urban types (based on Berghauser Pont & Haupt 2009) in relation to the microclimate

The relationship between the paved ground surface and the roof and wall surface varies per building morphology and density and is a valuable indicator for the urban microclimate. The heat accumulation in the stony materials, reflection of radiation between these surfaces are for a large extend responsible for urban heating. In American cities wall and roof surfaces in areas of tall, densely spaced buildings exceed the ground surface. Conversely, wall and roof areas of low density single-family detached houses form only a small proportion of the ground surface area (Ellefsen, 1991). In Canada walls are 28% to 54% of the total surface area in the city (Voogt & Oke, 1997).

The parameters given in Table 8.2 are determined using a combination of GIS (ArcMap) mapping, Google Earth aerial images and personal photographs or Google Street view. The source map for the analysis is the TOP10NL (Middel, 2002). The building height is based on the average height and the form of footprint on the TOP10NL. The percentage of green and water requires a combination of different sources: the municipal green ground surface can simply be calculated from the TOP10NL maps, for green roofs and private gardens Google Earth is used to determine a percentage of the private area that can be counted as green. A complete overview of the urban surface analysis is presented in Appendix F.

In addition to the three parameters given above also land use, height/width ratio, function (residential, mixed urban functions, industry, city centre, office park, agriculture, sports and recreation), density (inhabitants per hectare, dwellings per ha, FSI, GSI) and street trees are important for the urban microclimate. These are not directly part of the categories, but are appointed by the explanation per microclimate category in sections 8.2 – 8.9.

Form the additional parameters in the paragraph above, especially street trees are an important issue. In the percentage of green/water the municipal green on the ground surface, green on roofs and private green in gardens are all included. However, street trees were not included in the balance because not all municipalities could provide GIS data with street trees and their properties.

To provide a clear idea of the characteristics of the microclimate categories they are coupled to common urban typologies and their period of origin in Table 8.3. The urban

typologies that are related to the microclimate categories in this chapter are mainly based on the typology description in 'An urban typology' (Lorzing et al., 2008). For example: the *historical city blocks constructed before 1910* pertain to the category *middle high closed urban block with little greenery* and the *post-war garden city with low-rise*, which dominate the Western part of Amsterdam, pertain to the category *low open urban block with moderate to much greenery*.

URBAN TYPOLOGY		MICROCLIMATE CATEGORY		
Typology	Period	Height	Footprint	Green
Historical city block & pre-war city block	before 1910 '10-'30	Middle high	Closed urban block	Little green
Garden town	'10-'30	Low	Closed urban block	Moderate to much green
Residential housing	'30-'40	Low	Closed urban block	Little green
Post-war garden city low-rise	'45-'55	Low	Open urban block	Moderate to much green
Post-war garden city high-rise	'50-'60	Middle high/high	Open urban block	Moderate to much green
Community neighbourhood	'75-'80	Low	Strips Open urban block	Little to moderate green
Sub-urban expansion - Vinex	'90-'05	Low	Strips Closed urban block	Moderate green
High-rise city centre	'60-present	high-rise	Spread buildings	Little green

TABLE 8.3 Relation between microclimate category and urban typology

Before 1910 the urban architecture was mainly focused on the traditional closed urban block. These blocks are constructed per plot by mainly private parties. After 1910 the development of complete urban blocks started with the influence of housing corporations. In the 10-30s city expansions were built according to the garden city idea (here referred to as garden towns), based on the ideas of Howard, who strived to provide the working population a better dwelling environment than the unhealthy industrial metropolis. In subsequent years, the garden city concept was left to make way for residential housing that was mainly aimed at providing a home for as many families as possible without much attention to social services and green.

After the second world war a lot of extra living space had to be built because of the bombings, the stagnated construction of dwellings during the war and the rapidly growing population thereafter. In the years 50-60s, the first high-rise housing arose. The basic idea was to create more light, air and space, in spite of the high density. The post-war garden cities can be divided into four different types: strips, stamps, courts

and high-rise. To limit the amount of microclimate categories the four typologies are merged to two; strips and stamps are represented by *post-war garden cities low-rise* and courts and high-rise are represented by *post-war garden cities high-rise*. The most distinctive element of the low-rise typology is the transformation from street to stamps where the inner-courtyard becomes part of the public space. The high-rise typology is yet a step further into the free use of (green) space around buildings, with a totally autonomous traffic system.

Ten years later, the community neighbourhood was introduced as a safe place for children to grow up, and there were many so-called 'cauliflower districts' developed. 'Cauliflower' relates to the characteristic pattern of complex forms and meandering streets with low traffic zones. These neighbourhoods often have both private gardens and a relatively large amount of municipal green. Also, there was a tendency to develop concentrated growth areas outside the city.

In the years 1980 - 1990, the compact city was trending, this is still an important aspect of the development strategies today. These densification developments do not form a uniform microclimate category, nor can they be studied as a complete neighbourhood. Therefore, this is not included in the classification.

Next to the compact city the subsequent Vinex (translated: Fourth Note on Spatial Planning Extra) expansions emerged. The Vinex areas or sites which are designated for large-scale construction along the edges of big cities are the most recent effectuation of the desire of most Dutch to live in a land-based house with a private garden. The first Vinex locations were purely focused on housing which meant travelling to and from the city for many activities such as working, shopping and cultural. The recent urban areas are realised with a lot of attention for greenery and water to create an attractive environment.

The Dutch cities will continue to grow due to population growth, but also because of ongoing migrating from the countryside to the city. Highly urbanized areas in town centres have to deal with more users and, where possible, cities strive for more compactness. When redeveloping city cores it is important to keep a focus on the future quality of life.

§ 8.1.1 Case study selection and methodology

The qualitative research method used in this chapter is based on case studies. These case studies are located in the four major cities of the Netherlands: Amsterdam, Rotterdam, The Hague and Utrecht. The municipalities of these four cities are stakeholders within the research project and have the role in the process of providing data, indicating problem areas from their point of view and respond with feedback on design solutions and strategies. In this section the methodology and the selection of case studies is further explained.

The case studies presented in this section provide insight in the type of adaptation measures that are fit for a certain microclimate category. For each category at least two neighbourhoods are analysed and elaborated with a design solution or strategy. In Table 8.4 the case studies are presented in an overview with the neighbourhood typology and microclimate category as explained in the previous section.

Typology		Microclimate category			neighbourhood 1	neighbourhood 2	neighbourhood 3
		height	urban block	green			
Post-war garden city low-rise	'45-'55	low	open	moderate to much green	Slotermeer, Couperusbuurt <i>Amsterdam</i>	Watergraafsmeer Jeruzalem* <i>Amsterdam</i>	
Garden town	'10-'30		closed	moderate to much green	Tuindorp, <i>Utrecht</i>	Tuindorp Nieuwendam* <i>Amsterdam</i>	Tuindorp Oostzaan* <i>Amsterdam</i>
Residential housing	'30-'40			little green	Ondiep <i>Utrecht</i>	Transvaal <i>Den Haag</i>	Rivierenwijk <i>Utrecht</i>
Sub-urban expansion - Vinex	'90-'05			moderate green	Leidsche Rijn, <i>Utrecht</i>	Ypenburg* <i>Den Haag</i>	
Community neighbourhood	'75-'80		strokes	little to moderate green	Lunetten <i>Utrecht</i>	Zevenkamp* <i>Rotterdam</i>	
			spread				
		middle-high	open				
Historical city block & pre-war city block	before 1910 '10-'30		closed	little green	City Centre, Geertebuurt <i>Utrecht</i>	Bergpolder-Zuid <i>Rotterdam</i>	Zuidwal <i>Den Haag</i>
			strokes				
			spread				
Post-war garden city high-rise	'50-'60	high	open	moderate to much green	Overvecht <i>Utrecht</i>	Kanaleneiland <i>Utrecht</i>	Schiebroek Zuid <i>Rotterdam</i> jaren 60
			closed				
			strokes				
			spread				
		high-rise	open				
			closed				
			strokes				
High-rise city centre	'60-present		spread	little green	Station area, <i>Den Haag</i>	Lijnbaan* <i>Rotterdam</i>	

* this neighbourhood is analysed only on urban surfaces, no location specific adaptation options are proposed

TABLE 8.4 Selection of case study neighbourhoods based on microclimate categories

As can be seen in the Table above, the categories have two or three case studies. The aim in the beginning of the study was to select at least two neighbourhoods for all categories to come to a stronger general conclusion. However, due to a limit in time and collaboration and education possibilities not all neighbourhoods are elaborated with a design. Therefore, general conclusions about these microclimate categories should be read with this limitation in mind.

As inevitable in conducting practical case study research, there are unpredictable factors determining the course of the process. As a result, the case studies differ in size, the presented section of a neighbourhood does not always exactly match the area presented in the design solution(s) and there is quite some difference in the elaboration detail of the design solutions. These inequalities are a result from the different ways the design solutions are developed. Some case studies are done by the author, some by students (MSc, BSc and grammar school) and others by colleague researchers of the CPC programme. However, the area chosen for the analyses of the land and urban surfaces always is a representative section with, for example, a representative amount of green at the border and a homogenous or mixed building type. Already with the development of castles and its community and facilities the occupancy and land use of this type was very characteristic (Tummers & Tummers-Zuurmond, 1997). In Figure 8.2 the castle and the surrounding formal gardens and buildings are shown. In Table 8.5 the case study details are presented.

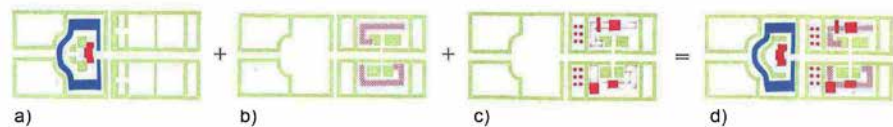

FIGURE 8.2 The castle within the formal garden (a), plus the dwellings for the castle community (b), plus the facilities (c), together form the characteristic castle typology (d) (Tummers & Tummers-Zuurmond, 1997).

SECTION	NEIGHBOURHOOD	CITY	AREA IN HA	LEVEL OF DETAIL	TYPE OF DESIGNER
6.2.1	Slotermeer, Coupereusbuurt	Amsterdam	27	location specific design proposal(s)	urban designer/researcher (author)
6.2.2	Watergraafsmeer, Jerusalem	Amsterdam	30	not applicable	
6.3.1	Tuindorp	Utrecht	55	general ideas for microclimate category	
6.3.2	Tuindorp Nieuwendam	Amsterdam	47	not applicable	
6.3.3	Tuindorp Oostzaan	Amsterdam	56	not applicable	
6.4.1	Ondiep	Utrecht	49	elaborate neighbourhood design	urban designer/researcher (author)
6.4.2	Transvaal	Den Haag	82	elaborate neighbourhood design	urban designer/researcher (author)
6.4.3	Rivierenwijk	Utrecht	77	location specific design proposal(s)	Msc students landscape architecture
6.5.1	Leidsche Rijn, Parkwijk	Utrecht	42	location specific design proposal(s)	Msc students landscape architecture
6.5.2	Ypenburg	Den Haag	57	not applicable	
6.6.1	Lunetten	Utrecht	127	location specific design proposal(s)	students Lyceum
6.6.2	Zevenkamp	Rotterdam	124	not applicable	
6.7.1	Centrum, Geertebuurt	Utrecht	19	location specific design proposal(s)	Msc students landscape architecture
6.7.2	Bergpolder Zuid	Den Haag	38	general ideas for microclimate category and location specific design proposal(s)	researchers CPC
6.7.3	Zuidwal	Den Haag	51	location specific and neighbourhood design(s)	urban designer/researcher (author)
6.8.1	Overvecht	Utrecht	43	location specific design proposal(s)	Msc students landscape architecture
6.8.2	Kanaleneiland	Utrecht	67	location specific design proposal(s)	Msc students landscape architecture
6.8.3	Schiebroek-Zuid	Rotterdam	69	location specific design proposal(s)	urban designer
6.9.1	Station area, Uilebomen	Den Haag	29	location specific design proposal(s)	urban designer/researcher (author)
6.9.2	Lijnbaan, Cool	Rotterdam	61	not applicable	

TABLE 8.5 Case study details, including: size, level of detail and type of designer per case.

In the following sections, the microclimate categories are discussed individually. There is a brief description of the level of heat accumulation and its causes in these neighbourhoods. Including an indication of the ventilation and solar radiation load due to the height-to-width ratio (H/W ratio) of street canopies and inner courtyards and green elements. In addition, the type of green and the public and private character of green is discussed. The general introduction of microclimate categories are followed by practical case studies. Each case study is introduced based on its location in the city and an analysis of the relation of natural and stony land surface and urban surface. The latter urban surface analysis, adds an important dimension: the included vertical surfaces receive a lot of radiation due to the relative low sun angle in the Netherlands. Transforming these vertical surfaces have a large effect and therefore should be visible in the relation stony versus natural before and after the transformation. After this short introduction one or more design solution(s) are presented. The individual case studies are summarized in a general discussion about the applicability of measures and the most appropriate measures for that particular microclimate category.

§ 8.2 Low open urban block with moderate to much green

The garden city has a particular urban plan that breaks with the traditional urban block in which the inner courtyard is private property, Figure 8.3. There are several variations of urban blocks in the low-rise neighbourhoods, such as the L-shaped blocks that form semi-enclosed squares, but also straight strips. Entrances of dwellings are situated at both the outside and inside of the blocks. The strip buildings often have a park along the back side. The streets between the blocks have an average width of 15 meters. The inner courtyard has a size of 40 * 60 meters and is surrounded by buildings of two layers and a roof, inside the inner courtyard winds a public road. The H/W ratio is thus between 0.6 and 0.3. The open interior without fences and predominantly grass provides a better ventilation.



FIGURE 8.3 Example of a low open urban block with moderate to much green in West Amsterdam.

§ 8.2.1 Couperusbuurt, Amsterdam

The Couperusbuurt is part of Slotermeer on the West of Amsterdam. Its garden city roots very well emerge looking at the land surface cover in Figure 8.4. Almost half of the area has a natural surface, which is a large achievement definitely taking into account the quite high Floor Space Index (FSI) of 0.6 due to the six layer buildings at the South-East part of the area. The facades form a relatively large part of the stony surface.

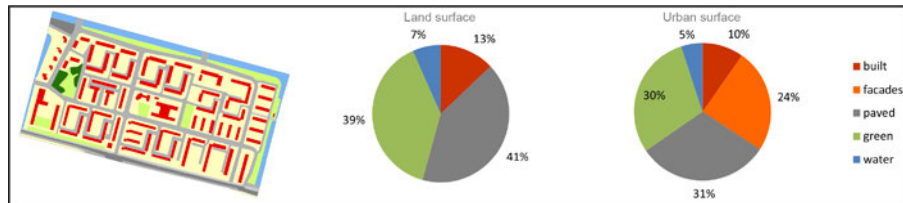

FIGURE 8.4 The relation between stony and natural surfaces in the Couperusbuurt neighbourhood, Amsterdam, with and without the vertical façade surface, map source TOP10NL (Middel, 2002).

The neighbourhood is on the list of the municipality for redevelopment. Dwellings need to be upgraded and, as an extension of the upgrade, also the amount of parking places should increase. There are several ways to achieve this goal, however, the most apparent option is to use the inner courtyards. Chapter 5 describes the simulations and results of the effect of this change in function. Figure 8.5 shows an impression of a situation in which the courtyard is used for parking without a decrease in thermal comfort. This can be achieved by planting trees in the middle, using permeable concrete grass tiles and changing the roof colour to light and reflective and the façade colour to a middle-dark tint.



FIGURE 8.5 Above: existing semi-public inner courtyard. Underneath: Adaptation measures which improve thermal comfort and increase parking space are light roofs, middle-dark facades, additional trees and permeable pavement with grass.

In the proceeding chapter, section 9.2, the strategy for the Couperusbuurt is elaborated further. An important feature of the strategy is determining an appropriate additional user function of the inner courtyard to increase the value for both residents and passers-by. For a more sustainable water system the courtyards could additionally function as water retention and infiltration points. The small apartments could be transformed into more spacious dwellings without decreasing indoor and outdoor comfort by taking into account solar access. As a result of the transformation from two apartments into one-family houses the need for additional parking space is reduced drastically. As part of the redevelopment strategy energy opportunities such as solar panels or seasonal storage will increase the real estate value and lifespan.

§ 8.2.2 Jeruzalem, Amsterdam

The Jeruzalem neighbourhood is situated in a polder named Watergraafsmeer and was constructed directly after the second world war. Compared to Couperusbuurt this neighbourhood has somewhat more built surface and less open water. However, the relation between stony and natural urban surfaces is very similar, see Figure 8.6. The achieved FSI in this neighbourhood is with 0.4 a bit lower compared to the Couperusbuurt because Jeruzalem has more two storey buildings.

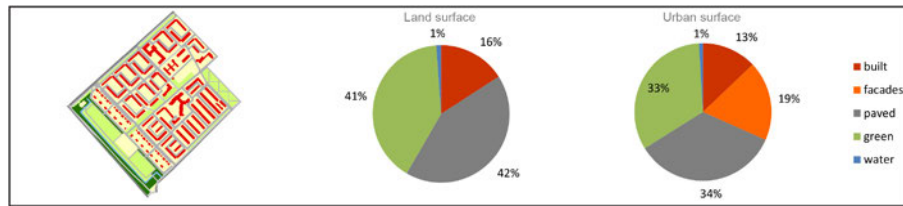

FIGURE 8.6 The relation between stony and natural surfaces in the Jeruzalem neighbourhood, Amsterdam, with and without the vertical façade surface, map source TOP10NL (Middel, 2002).

For this neighbourhood no design is made. The above diagrams and map show the large similarity with the other garden city. The expectation is that similar measures will be appropriate here. This needs to be confirmed to strengthen the conclusion at the end of this section.

The garden cities have sufficient green space and the challenge is to preserve this. However, when redeveloping these areas especially this green is in danger of disappearing. In the garden cities most of the green is semi-public and managed by the municipality, this is in contrast to the garden towns presented in the preceding section where the green is predominantly private area. Often the quality of the semi-public green is low and there are few functions linked to the green. This could be part of the solution: by improving the quality of the green and linking multiple functions to it the value of the green will increase and it will not simply be dismissed.

The semi-public inner courtyards have a green meadow in the middle of about 30*50m. The functions linked to this area cannot be confined to residents only because it would blur the public character. Even so, public functions are not in place either because the residents can experience that as an infringement of their privacy. After all, it concerns their backyard. When a social function of peaceful nature and attracts just a small number of people at the same time it will give less friction. For example a route to walk the dogs, water storage, butterfly and bee gardens, fruit and nut orchards, etc.

§ 8.3 Low closed urban block with moderate to much green

In the garden town you will find mostly single-family homes with two to three building layers. The streets have a sufficiently width of about 15-20 meters that offers place for front gardens on both sides of the street, see Figure 8.7. The inner courtyards have an average width of 25 meters, here the aspect ratio is 0.6 to 0.36. In these streets, the green in the front possibly has a lot of influence on the air flow, it may slow down the wind.



FIGURE 8.7 Example of a low closed urban block with moderate to much green, Tuindorp neighbourhood, Utrecht.

In this type of neighbourhood, there is only a moderate risk of heat stress because there is a lot of greenery in general. However, this green is mostly situated in the private front and back gardens. Therefore, the most important focus here is maintaining the private green. The current trend of paving extensive parts of the garden will have more impact here than in other neighbourhoods where many municipal green is present in the streets. The strategy in these neighbourhoods may include the promotion of greenery in private gardens and the addition of street trees in strategic locations.

§ 8.3.1 Tuindorp, Utrecht

Situated at the North side of the city centre of Utrecht Tuindorp is a very popular neighbourhood, only separated from the historical city centre by the Griftpark. The neighbourhood has a typical relation between green, paved, built and facade surface as well as a common FSI for this category of 0.5, see Figure 8.8.

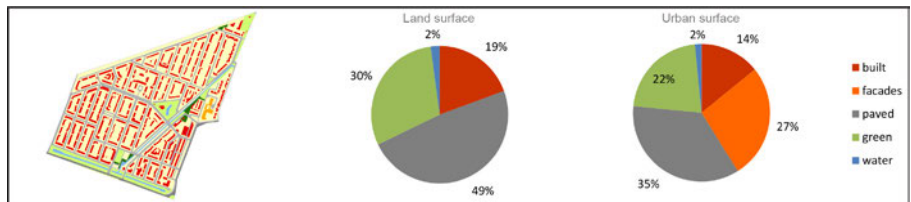

FIGURE 8.8 The relation between stony and natural surfaces in the Tuindorp neighbourhood, Utrecht, with and without the vertical façade surface, map source TOP10NL (Middel, 2002).

The relatively large amount of green in the garden town is not due to municipal green. In Figure 8.9 the black hatched areas indicate municipal green. All other green is privately owned in the front and back gardens attached to dwellings. To stimulate house owners to plant a tree the municipality could offer to plant an almost mature tree for free. A variety of tree species to choose from will give people the feeling of self-control and increases the biodiversity in a street canopy. Figure 8.10 shows an example of a tree in a front garden in Tuindorp Utrecht.



FIGURE 8.9 The black hatched areas indicate municipal green and water.



FIGURE 8.10 A large tree in the front garden compensates lack of trees in the street.

Since there is almost no municipal green in the street canopies infiltration of rainwater has to be realised on or under the road and sidewalks or in the private gardens. The latter option could be feasible in this garden town because people are rather engaged with their gardens. Encourage people to act through a discount on the water tax when all rain water from their lot is infiltrated and provide them with inspiring examples.

For the road permeable pavement is an option to increase infiltration, however, this does not prevent nuisance with heavy rainfall events and is not a visible element. It is important people can see water treatment devices to increase their awareness and engagement. An alternative option to cope with the water is to install infiltration units with a large storage capacity along the sidewalks. Water is temporarily stored here, and while infiltrating into the ground the water is purified with a filter. Still, an overflow to the sewage is needed for the extreme rainfall events. Instead of the overflow the choice can be made to accept water nuisance on the street for the few occasions this happens. In this neighbourhood streets are lower than the sidewalks and front gardens which prevents water to flow inside basements and front doors. The overflow to the sewage can also be an intermediate solution until most private gardens do not discharge their rainwater to the street and sewage. Figure 8.11 shows an impression of possible water storage and infiltration units.



1



2

FIGURE 8.11 Existing street (1) and impression of water infiltration units (2).

§ 8.3.2 Tuindorp Nieuwendam, Amsterdam

On the North-East side of Amsterdam Tuindorp Nieuwendam is surrounded with parks and large water bodies. As presented in Figure 8.12 the percentage of green is similar to other garden towns, whilst the direct surroundings comprise a lot of green and therefore a large cooling potential. Because the Schellingwouderbreek lake partly belongs to the neighbourhood the area of water is relatively large. The FSI of 0.4 does not deviated a lot from the other garden towns.

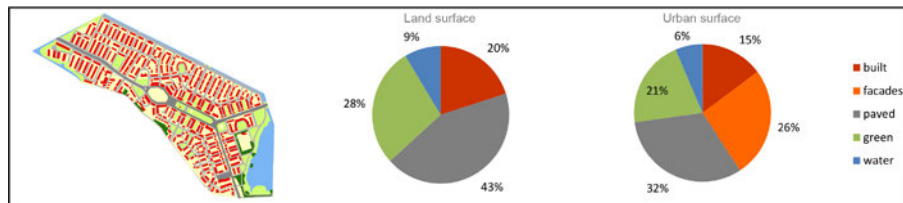

FIGURE 8.12 The relation between stony and natural surfaces in the Tuindorp Nieuwendam neighbourhood, Amsterdam, with and without the vertical façade surface, map source TOP10NL (Middel, 2002).

For this neighbourhood no design is made. The above diagrams and map show the large similarity with the other two garden towns. The expectation is that similar measures will be appropriate here. This needs to be confirmed to strengthen the conclusion at the end of this section.

§ 8.3.3 Tuindorp Oostzaan, Amsterdam

Tuindorp Oostzaan is also situated at the North of Amsterdam, but more to the West. This neighbourhood is not surrounded by parks and water bodies just as with Tuindorp Nieuwendam. However, it is within close distance to the rural polder area. As the previous two garden towns, also Tuindorp Oostzaan has a typical relation between green, paved, built and facade surface as well as a common FSI of 0.5 for this category, presented in Figure 8.13.

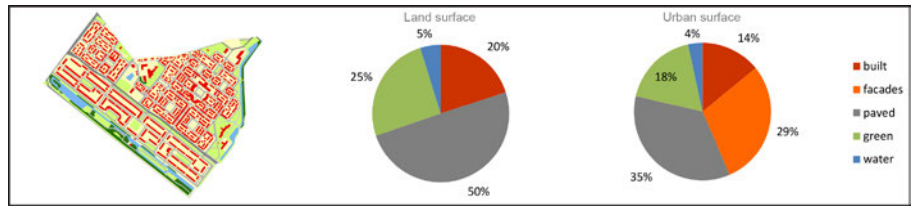

FIGURE 8.13 The relation between stony and natural surfaces in the Tuindorp Oostzaan neighbourhood, Amsterdam, with and without the vertical façade surface, map source TOP10NL (Middel, 2002).

For this neighbourhood no design is made. The above diagrams and map show the large similarity with the other two garden towns. The expectation is that similar measures will be appropriate here. This needs to be confirmed to strengthen the conclusion below.

As is the case with the garden cities, the garden towns have sufficient green space and the challenge is to preserve this. The difference with the garden cities is the owner of green: in the garden cities the major part of green is private. Strategies should be aimed at private owners to conserve green. Promoting green in a subtle manner is to inspire people and to create awareness about the importance and benefits of green. Another option is to offer trees, hedges or plants for free to the inhabitants. Through the water board or council tax charges can be adjusted to the degree of pavement in gardens, or charge less taxes when rainwater is collected and infiltrated on site.

§ 8.4 Low closed urban block with little green

The urban residential areas with single family houses of two to three layers are characterized by the relatively narrow streets with little greenery, see Figure 8.14. The streets have an average width of 10 m, where the many parking lots leave little room for street trees. The H/W ratio of the streets is 0.9 and 0.6 and of the inner courtyards 0.4 to 0.6. This provides only limited ventilation and is particularly a problem in the streets with heavy traffic. Front gardens and backyards are paved to a great extent. The total amount of paving in this neighbourhood category is very high.



FIGURE 8.14 Example of a low closed urban block with little green, Heesterbuurt and Transvaal neighbourhood, The Hague.

§ 8.4.1 Ondiep, Utrecht

Ondiep is a working class neighbourhood situated along the river Vecht at the North side of the city centre of Utrecht. As presented in Figure 8.16 Ondiep is a very stony neighbourhood with over 3/4th of hard surface. In this category the percentage of green is not even that low because of the sport fields at the border of the area. The FSI varies a lot within this category, depending on the building height. In Ondiep the FSI is 0.4 with on average two to three building layers.

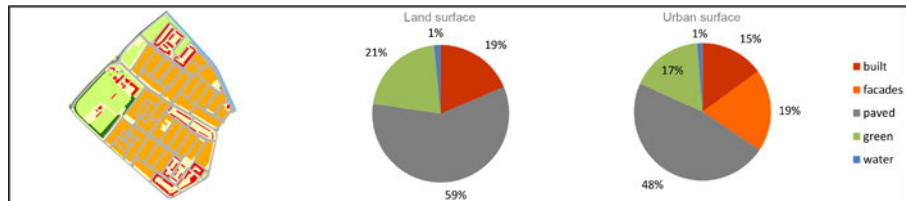

FIGURE 8.15 The relation between stony and natural surfaces in the Ondiep neighbourhood, Utrecht, with and without the vertical façade surface, map source TOP10NL (Middel, 2002).

The case study Ondiep is done parallel to the case study Transvaal, the latter one will be described in the following section 8.4.2. Based on an extensive literature review, design criteria were formulated to enable an assessment of the designs. The criteria are the following:

- All dwellings are to be situated within 200m from a green area with a minimum size of 0.15 ha;
- The preferred street orientation is perpendicular to green areas;
- Green filter are to be placed in streets with a high traffic pressure;

- New dwellings should replace an equal amount of dwellings or more, but with a larger dwelling surface;
- Combinations of green with water should be made where possible;
- A lack of greening possibilities in streets should be compensated with surface water, green façades and permeable pavements;
- Flat roofs should be transformed to green roofs or be covered with a reflecting light surface;
- Slanted roofs should have PV-T panels or a reflecting light surface.

Considering the criterion 'all dwellings are to be situated within 200m from a green area', a large part in the middle of the neighbourhood does not meet this standard in the current situation, see Figure 8.16. The design plan for Ondiep is based on improving the routings with green zones and waterways in combination with other heat diminishing measures. Important for the renovation plan is to keep the demolition of dwellings to a minimum.

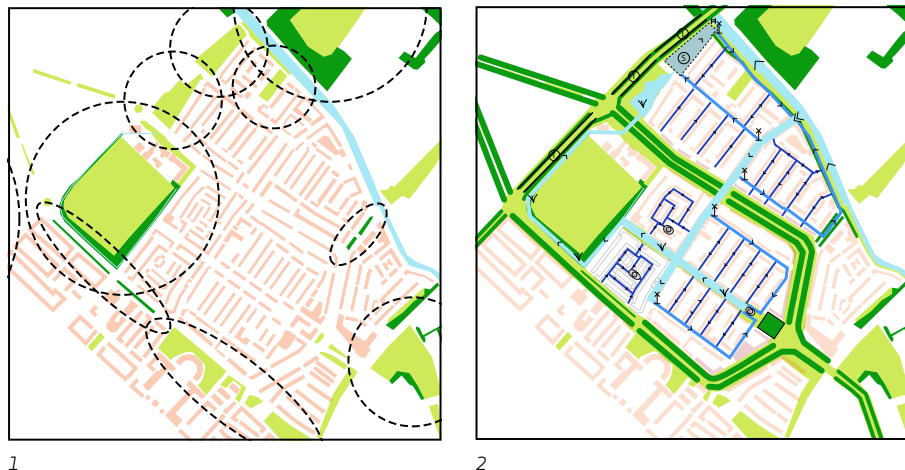

FIGURE 8.16 1. Green in Ondiep with a circle of 200 meters from the green; 2. Design for green zones and an integral water system.

The building plan for Ondiep provides more space for green along the main route by transforming closed building blocks along this route into single buildings with two additional layers. In this way, both the amount of living space and the H/W ratio is preserved.

The additional green along the main routes, has an important cooling function, but also needs to filter out air pollution. This is illustrated in Figure 8.17 deciduous trees are placed close to the buildings because they let through sunlight in winter and

coniferous trees keep their air filtering capacity year round. A water storage under the pavement provides trees with water to keep their cooling capacity during dry periods. The other green zones have a more intimate and quiet character, these improve thermal comfort, offer more recreational space and routings.

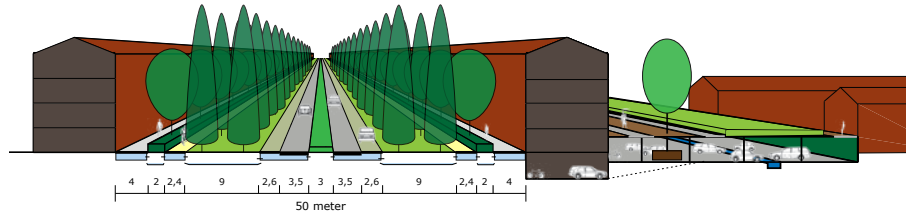

FIGURE 8.17 Section of the car and bus route through the neighbourhood.

In the design for Ondiep the main function of water applications is to supply trees with enough water to maximise their cooling capacity. Additionally, the water that runs through the streets absorbs heat. An integral water plan is calculated to incorporate other aspects of a sustainable water system; the dwellings discharge all wastewater, except for toilet flushing, onto the surface water where helophyte plants clean it. The water system has a fluctuation of 800 mm to deal with heavy rainfall. Seasonal storage and water supply for trees and households is all taken into account in the space needed for storage.

Water needs to circulate in order to preserve a good quality. Water also demands a lot of space, especially when the edges need to be natural slopes. In many streets this space is simply not available. However, there are other possibilities; for example lift the water up to street level. This so called 'shallow water' has to be pumped up from the surface water to a shallow canal, that in this way, ensures a water circulation. Rainwater from roofs and pavement streams into a drain at surface level and is collected in the shallow canals.

The design plan for the Ondiep neighbourhood shows how the design criteria can be applied in a practical situation. The applied measures might not be the most effective ones with regard to minimizing heat accumulation, but the best in relation to the existing spatial situation and the impact on social and financial aspects.

The literature review, methodology and the adaptation strategy for Ondiep and Transvaal were published in 'How to make a city climate-proof, addressing the urban heat island effect' (Kleerekoper et al., 2012) and 'A Heat Robust City. Case study designs for two neighbourhoods in the Netherlands' (Kleerekoper et al., 2011). A detailed description of the neighbourhood design can be found in 'Design principles for Urban Heat Management in the Netherlands' (Kleerekoper, 2009).

§ 8.4.2 Transvaal, The Hague

Transvaal has a central location in the city The Hague. Within this category with little green the percentage of green is even lower: only six percent of the total urban surface is natural surface. Interesting in the relation between pavement, roofs and facades is that they all have an equal share of about 30% which comes close to the category of middle-high closed urban blocks with little green in the historical city centres, see Figure 8.18. In line with the large façade surface, also the FSI of 1.8 is the largest within this category.

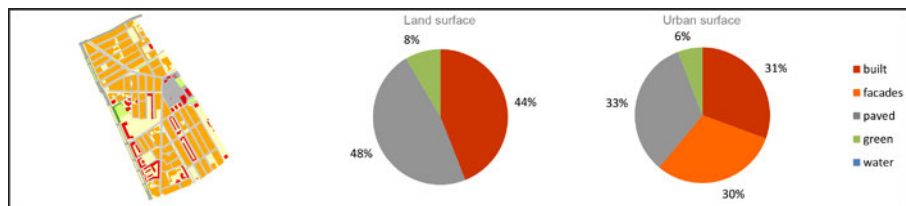

FIGURE 8.18 The relation between stony and natural surfaces in Transvaal in The Hague, with and without the vertical façade surface, map source TOP10NL (Middel, 2002).

The case study Transvaal is done parallel to the case study Ondiep, described in the previous section 8.4.1. Ondiep and Transvaal are both constructed in the same period. Both have social issues, but there is an essential difference. The dwelling density in Ondiep is quite high: 44 dwellings per hectare. However, this is low in comparison to Transvaal where 98 dwellings occupy a hectare. As for the more lively and multicultural Transvaal neighbourhood, another approach is chosen to test if the design principles are generically applicable. There is a high pressure on public space, quite some litter on the streets and hardly any green except for some lonely young trees, in Figure 8.19 the green space are indicated next to the squares and redevelopment areas.



FIGURE 8.19 1. Green in Transvaal with strategic renovation plan; 2. Transvaal with green squares, green roofs, new building typology in the middle and the water system. .

In Transvaal the renovation process has already started with the main square and some housing projects. The new square is working quite well in social respect, but in terms of heat accumulation it is a missed chance. Especially regarding the name of the square, 'Wijkpark' (district park), you would expect much more green. The most cost-effective measure for this square is to maintain the layout and to fill the large paved open space with water and add water jets that switch on when it is a warm day.

In the rest of the neighbourhood there are many stony open spaces. Streets have no green, no front gardens, just pavement and cars. The little green in the squares is too tiny to hold out against the intense (ab)use. As a consequence squares are designed with only stony elements and have no shelter from sun, wind or rain. These areas can become cooling islands if they are designed with more green, water and shading. There are quite a lot of little squares spread over the whole neighbourhood. More than 95% of the buildings have a flat roof, which creates the potential to form a green roof landscape. When the measures of greening the squares and creating green roofs are combined the area will meet the criteria '200m from green'. An extra advantage of roof gardens in this neighbourhood is the creation of more outdoor living space. The integral design is presented in Figure 8.19.

In addition to green roofs and extra vegetation on squares there is an excellent solution for this busy neighbourhood in green facades. There are some alleys cutting through building blocks that can transform into an oasis of peace - surrounding the citizens with green and flowering walls.

At the South-East side a building block will be demolished to create space for a public park. A green walkway cutting through building blocks connects the rest of the neighbourhood to the park and the Haagsche market. The demolished dwellings will be compensated for at the North side of Transvaal that is now a pavement desert with some industrial activities. The current activities like paper recycling, a bakery, etc. do not conflict with dwellings. The ground floor space will mainly be occupied by these light industrial activities, and on top of this layer seven storeys with apartments with a view over the green roof landscape are added. . The new apartment buildings have a green façade (a vertical garden) so that they become part of the green roof landscape.

In Transvaal, the introduction of water connects the *Zuiderpark* at the South with a canal in the North. Just like in Ondiep there is not enough space for the implementation of surface water. Here too the water is pumped up into shallow canals, but the canals are not as wide as in Ondiep and do not run through grass but through paved surface, see Figure 8.20 for two examples. At crossings and busy areas the canal is covered with a decorative grill. The shallow canals lead the water to some squares along the main street where it is pumped up by fountains or other water elements.



1



2

FIGURE 8.20 1. Shallow water in commercial street Amiens, France; 2. Shallow water in Park 't Loo, Apeldoorn, The Netherlands.

A part of the middle of the neighbourhood will be demolished and newly built. This brings the opportunity to reserve space for seasonal water storage that allows trees to cool at their maximum. The new structure of the site differs a lot from the rest of Transvaal. Instead of closed building blocks apartment buildings of three to four storeys high are surrounded by deciduous trees, allowing sunlight through in winter and shading facades and windows in summer.

§ 8.4.3 Rivierenwijk, Utrecht

Rivierenwijk is again a working class neighbourhood situated at the south of the city centre of Utrecht. More than 80% of the urban surface is stony material, conform this category, see Figure 8.21. However, this neighbourhood has a relatively low percentage of façade surface because the buildings only have one to two layers. Therefore, also the FSI of 0.2 is low for this category.

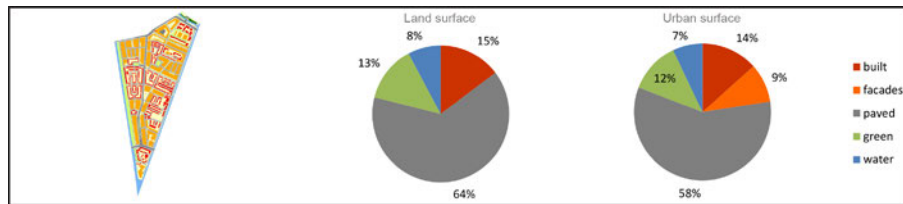

FIGURE 8.21 The relation between stony and natural surfaces in the Rivierenwijk neighbourhood, Utrecht, with and without the vertical façade surface, map source TOP10NL (Middel, 2002).

Rivierenwijk is a neighbourhood with low closed urban blocks with little green. Compared to Ondiep and Transvaal the streets have somewhat more small trees and the buildings have more aesthetical value. Therefore rigorous redevelopments would affect the attractive neighbourhood characteristics. Instead smaller interventions are more appropriate, such as, removing tiles along the facades for flowers or climbing plants, green facades, change the type of pavement to permeable and light coloured and improve dwellings with larger overhangs and roof insulation. See Figure 8.22 for an impression.



1



2

FIGURE 8.22 1: existing situation Geulstraat in the Rivierenbuurt neighbourhood, Utrecht; 2: impression of the street when tiles are removed for plants and additional pedestrian space is created by removing the parking places at one side of the street.

Rivierenwijk has an additional asset that can contribute to alleviate heat stress. Along the West side of the neighbourhood runs the Merwede canal with a long stretched green belt, the Merwedeplantsoen. However, the space is not used as such by the inhabitants because of the bad accessibility and because housing boats close off the view on the canal. Figure 8.23 and 8.24 show a plan that opens up some spots along the water where a path or a platform facilitates extra experience of the water. The same path provides an attractive routing through the green without disturbing the additional functions like a soccer field or sheltered place with seating's.



1



2

FIGURE 8.23 1. Neighbourhood border (dashed line) and the Merwedeplantsoen (dotted line); 2: the re-design of the green belt by Yuche Liu, WUR



1

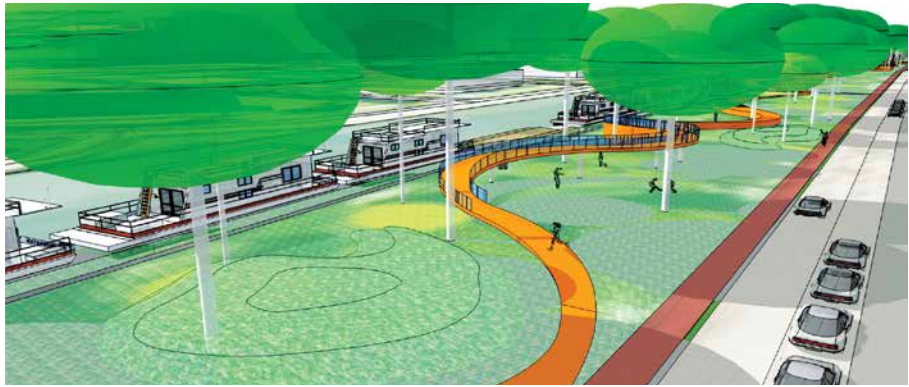

2

FIGURE 8.24 1: Existing situation of the Merwedeplantsoen in the Rivierenbuurt neighbourhood, Utrecht; 2: impression of the re-design of the green belt by Yuche Liu, WUR.

The target measures in these neighbourhoods are tiny gardens along the facade, green facades, the type of pavement and parking solutions combined with a structure for climbing plants. Because of the many flat roofs at a low height in these neighbourhoods the roof surface can be used to improve thermal comfort at street level. By providing roofs with a white reflective coating solar radiation is reflected which prevents up heating on street level and contributes to a cooler indoor environment, especially on the top floor. Also green roofs with a sufficiently thick substrate layer contribute to cooling on both street level and indoor space. In addition, green roofs have a positive effect on rain water discharge, biodiversity, and extend the life of your roof. In case there is no possibility to add more green the generation of ventilation is especially important. This can, for example, be done by more height differences of the buildings or by using the principle of 'hot' and 'cool' places between which the air will be moving.

When a parking or mobility solution can be found which leaves more space in streets free, a double line of trees can be planted or trees at the side that receives most solar radiation. In some cases, trees as espaliers can provide a solution when the

position of the tree cannot be placed far enough from a building wall. Many of these neighbourhoods do have green spaces in between or along the urban blocks. These green spaces can function as a cool spot where people seek comfort when the right facilities are present.

§ 8.5 Low closed urban block and strips with moderate green

In the latest expansion areas, called VINEX districts, there is more space in the street profile for green strips and trees, see Figure 8.25. The streets are on average 20 meters wide, with buildings of two to four and up to eight storeys. The average H/W ratio is 0.5, which means there probably is a moderate ventilation of the streets.



FIGURE 8.25 Example of a low closed urban block and strips with moderate green, Ypenburg district, The Hague.

§ 8.5.1 Parkwijk, Leidsche Rijn, Utrecht

Parkwijk-Zuid is a recent development in the Leidsche Rijn district on the West side of Utrecht. Even though the name presumes a large amount of green in the form of parks, the amount of green does not match the garden towns nor garden cities presented in sections 8.2 and 8.3. The large amount of pavement as shown in Figure 8.26 can be attributed to few green in the street and private gardens. The FSI is 0.4 which is a normal average for single-family row houses.

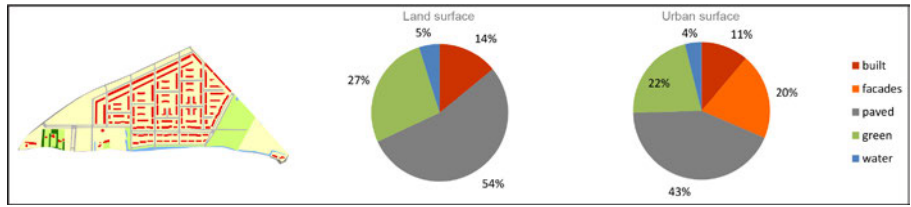

FIGURE 8.26 The relation between stony and natural surfaces in the Parkwijk neighbourhood of the Leidsche Rijn district in Utrecht, with and without the vertical façade surface, map source TOP10NL (Middel, 2002).

With Leidsche Rijn Utrecht made a step over the large barrier with the Amsterdam-Rijnkanaal and the A2 highway in 2006. In 2014 the area had grown to 28.700 inhabitants. Due to stagnating housing prizes from 2008 the projection of 80.000 inhabitants will not be achieved soon. By the time it has, Leidsche Rijn will cover about 25% of the inhabitants of the city Utrecht. The aim is to connect the Leidsche Rijn with the city centre by a one kilometre long roof park over the highway, see the impression in Figure 8.27.



FIGURE 8.27 The Leidsche Rijn roof park designed by DS Landschapsarchitecten (destadutrecht.nl 2012).

Between the roof park and the Amsterdam-Rijnkanaal there is space for the development of new dwellings. This new area can profit from the microclimate qualities of both, the park and the water front. A boulevard along the water would provide a scenic route to the city centre for inhabitants in the Leidsche Rijn, a fresh stroll for people living in the new area and a new experience of their city for people living on the other side, see Figure 8.28 for an impression.



FIGURE 8.28 Boulevard along the Amsterdam-Rijnkanaal by Rosanne Schrijver, WUR (Schrijver et al., 2014).

Because Leidsche Rijn is such a large new area a community needs to be founded. Functions such as playgrounds, sport fields and recreation are accommodated for throughout the whole area. These places are for everyone to make use of, however, a location where people can develop something together is not foreseen yet. The central location of the Prinses Amalia Park is a perfect location to improve the sense of community through urban agriculture. Figure 8.29 shows a way of organizing such an initiative.

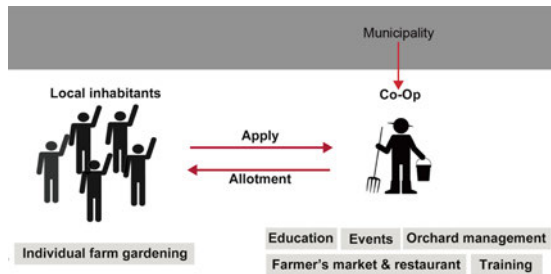

FIGURE 8.29 Urban agriculture as basis for a local community by Changsoon Choi, WUR.

The park has special restrictions due to archaeological remains, this is translated in only grass field in the present situation. These underground conditions can also provide a structure for a varied landscape: some places are fit for fruit trees, others only for allotment gardens with additional soil protection and others for local farmer's market, restaurant and events, see Figure 8.30 for an impression. Adding trees contribute to the microclimate conditions in the park and drawing on people to spend their time here will improve their thermal comfort perception.



FIGURE 8.30 Boulevard along the Amsterdam-Rijnkanaal by Changsoon Choi, WUR.

§ 8.5.2 Singels, Ypenburg, The Hague

Singels is part of the new development area on the North-East of The Hague, named Ypenburg. This neighbourhood lives up to its name and has a single encircling the neighbourhood. In this neighbourhood the green areas are more spread through the area than in Parkwijk presented in the previous section. However, the amount of green within the street profile and private gardens is very similar, see Figure 8.31. The FSI is lower compared to Parkwijk because on average buildings have one floor less.

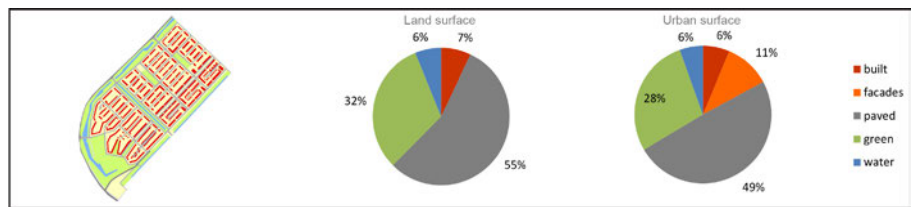

FIGURE 8.31 The relation between stony and natural surfaces in the Singels neighbourhood, in the Ypenburg district of The Hague, with and without the vertical façade surface, map source TOP10NL (Middel, 2002).

For this neighbourhood no design is made. The above diagrams and map show the large similarity with the other VINEX neighbourhood. The expectation is that similar measures will be appropriate here. This needs to be confirmed to strengthen the conclusion below.

The VINEX districts are usually designed with more attention for greenery and water. In particular between quarters and along roads there is a lot of greenery and water,

but also the residential streets have a single or double row of trees. Nevertheless, the degree of pavement is quite high because of the many parking lots, and above all the lack of trees in the private gardens which are paved to a large extent with dark anthracite tiles. In fact, a similar approach is needed as for the garden towns: inspire people and create awareness about all benefits and important functions green has to offer. Think of a way to stimulate planting additional green by distributing trees, hedges or plants for free, or adjust water board and council tax charges to the degree of pavement in gardens or collecting rainwater on site.

§ 8.6 Low strips and open urban blocks with little to moderate green

In the community neighbourhoods (in Dutch referred to as cauliflower neighbourhoods) streets have an average width of 18 meters with an inner courtyard of about 35 meters. Buildings have 2 to 3 floors, which gives a H/W ratio of 0.5 to 0.3. This results in somewhat more ventilation and more green than in urban residential neighbourhoods described in section 8.4. With the establishment of the neighbourhood many green strips of grass, trees and / or shrubs were designed. Dwellings often have a front garden, the private back gardens are relatively small, which leaves space for a shared courtyard, see Figure 8.32. Here, too, the trend of extensive paving is clearly visible. The distinctive design of the cauliflower neighbourhood as with courtyards and secluded places provides a varied microclimate and no immediate risk of heat stress. Yet even here the emerging pavement is a threat for a comfortable microclimate. There have been coming lots of cars since the 1970s, when these neighbourhoods were developed. The once so charming streets and courtyards have been seized by the car.



FIGURE 8.32 Example of low strips and open urban blocks with little to moderate green, in Maarsse.

§ 8.6.1 Lunetten, Utrecht

Lunetten is a so-called 'cauliflower' neighbourhood situated on the South border of Utrecht. The neighbourhood has a green belt around it as a buffer between the houses and two highways. Due to this green belt the amount of natural surface in the neighbourhood is quite high, more than 40% as presented in Figure 8.33. In addition, green is also incorporated in the open urban blocks and between blocks. On the other hand, the space in the streets is mainly dedicated to the car. The FSI is 0.3 which is lower than average one-family dwellings. The low FSI can be explained by the large green belt around the area. This is a typical green structure for this typology (Ubink & Steeg, 2011). Within the green belt surrounding the dwelling area there are five forts dating from 1822 which are part of the famous Dutch water defence line. Water played an important role in the defence function of the forts. The challenge in Lunetten is to expand the possibilities to experience and use the green belt and to improve the direct surroundings of the dwellings that are very stony.

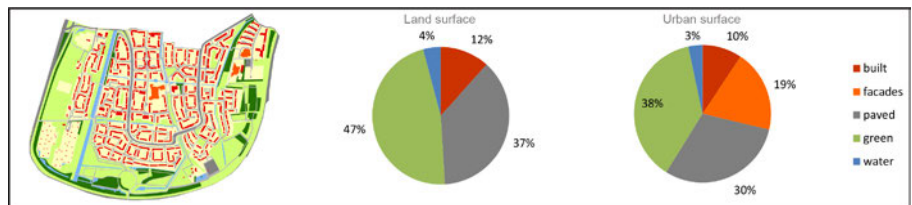

FIGURE 8.33 The relation between stony and natural surfaces in the Lunetten neighbourhood, Utrecht, with and without the vertical façade surface, map source TOP10NL (Middel, 2002).

The large amount of stony surface in the street canopies in this neighbourhood has to be reduced and replaced by green to improve the outdoor climate. The parking space for cars is hardly sufficient in the current situation. Therefore, additional green should to be combined with car parking or additional parking place elsewhere. There is a large variety in the organisation of parking around the building blocks. In Figure 8.34 an example is given of a car parking possibility just beneath ground level with a semi-public garden on top with picnic and BBQ facilities. The additional trees provide shading of the facades. In Figure 8.35 the street does not provide enough possibilities to combine additional trees and green with parking. To improve the local climate the parking zone is transformed in a lowered green zone with flowers where water infiltrates slowly. To compensate the parking places additional parking places are realised along the ring road (Figure 8.36). Here the parallel road is transformed in a double deck parking with green walls. Under the deck is only accessible for inhabitants that have a permit, on top of the deck visitors can place their vehicle. Figure 8.38 shows an impression of the ring road with additional parking.



1



2

FIGURE 8.34 1. Existing parking place; 2. Impression of combined parking and roof garden unit.



1



2

FIGURE 8.35 1. Existing street with parking; 2. Impression of a street with calm traffic due to a narrow trail next to grass tiles, wadi and street trees.



1



2

FIGURE 8.36 1: Existing situation of the Simplonbaan in the Lunetten neighbourhood, Utrecht; 2: impression of additional parking on the parallel street.



FIGURE 8.37 Parking facility along the Simplonbaan to create space for green and water close to dwellings.

In the existing situation the green belt surrounding the urban blocks is used to stroll, bike, play sports, picnic, sunbathing and walking the dog. The water canals in this green belt provides a place to fish, swim, play with small boats and ice skating in winter. Thus for many the green offers a cool spot to spend leisure time. Nevertheless, the most vulnerable people, elderly and babies, have less access to the green because most paths are not wheelchair and baby stroller friendly. A solid routing through the green belt with many benches, fitness equipment for especially elderly and kids will increase the accessibility for this vulnerable group. Space for community activities is lacking in the existing situation. With fruit gardens with berries and fruit trees Lunetten can make their own marmalade and with a tent construction summer evenings with music, dance, pancakes and workshops can be organised.

In the heart of the neighbourhood a grass field functions as park, meeting place and soccer field. To improve the contribution of the park as cool spot for the inhabitants it can be transformed into a water square according to the designs of the Urbanisten (Boer et al., 2010) that have realised such a system on the Benthemplein in Rotterdam. Besides a cool spot, the water square for Lunetten is also a means to retain precipitation water. Retaining water and infiltrating it locally alleviates the sewage, canals and rivers in times of heavy rainfall. Moreover, it supplements the groundwater level which provides trees with sufficient water in dry and warm periods. The water square for Lunetten could be divided into two areas: a small playground that fills up with the first rain shower, a second large basin normally functions as a soccer field and transforms into a lake with persistent rainfall. Cools et al. (2015) show an impression of the water square in Figure 8.38.



FIGURE 8.38 Impression water square (Copyright scale model and photo: Cools, T., Gent, A. and Kools, V. (Cools et al., 2015))

To prevent overheating inside dwellings a relatively cheap and simple option is to paint the roof tiles white. When a roof is directed to the South, South-West or South-East PVT-panels (photovoltaic and thermal) can serve as shading device and roof cooling device (AIVC, 2013, by Vasilis C Kapsalis) at the same time. Windows should be equipped by flexible sunscreens and facades can be shaded by vegetation. The latter option provides cooling for both the indoor and outdoor climate.

§ 8.6.2 Zevenkamp, Rotterdam

The Zevenkamp neighbourhood is situated to the North-East of Rotterdam. The neighbourhood is separated by the highway A28 to the South and touches the Wollenfopperpark and the Zevenhuizerplas along the North side. The neighbourhood does not have such a large amount of green around the dwelling area as Lunetten in the previous section, but still a larger percentage of green than most garden towns have, see Figure 8.39. The FSI of 0.5 is common for one-family dwellings.

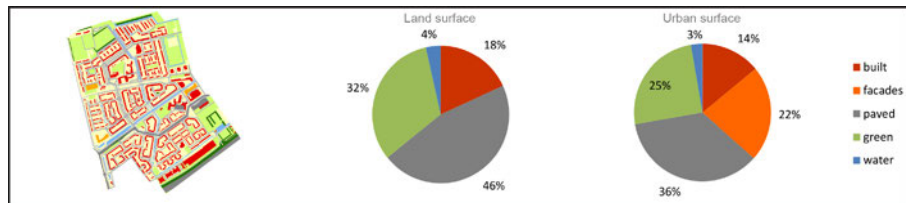

FIGURE 8.39 The relation between stony and natural surfaces in the Zevenkamp neighbourhood, Rotterdam, with and without the vertical façade surface, map source TOP10NL (Middel, 2002).

For this neighbourhood no design is made. The above diagrams and map show the large similarity with Lunetten. The expectation is that similar measures will be appropriate here. This needs to be confirmed to strengthen the conclusion below.

This type of neighbourhood mostly benefits from solutions that combines car parking with greenery and shading elements. Reducing the number of cars is not directly an option here because the neighbourhoods are often at a great distance from the centre. One could think of (electric) car sharing or parking on the edge of several building blocks. Thus when more space becomes available it can be used for additional playgrounds, more trees, rainwater harvesting and infiltration meadows. Also here white roofs and green walls can be used to improve thermal comfort.

§ 8.7 Middle-high closed urban block with little green

Historic city centres in the Netherlands have a high density and a lot of pavement in the public domain, see Figure 8.40. On the contrary, the inner courtyards are often an oasis of green and regularly contain large mature trees. Unfortunately, these courtyards are becoming more stony as well with terraces, parking or additional constructions.

This urban typology concerns in the Netherlands often a height of about 12 meters (3-5 storeys) with a street width of 5-12 m and a block width of about 30 meters. The inner courtyards are often packed for more than half with building extensions and sheds, which makes the height to width ratio vary. The H/W ratio between building height and width of the street and the inner courtyard is thus around 2.4 and 0.4.



FIGURE 8.40 Example of a middle-high closed urban block with little green, the historical city centre of Utrecht.

With a H/W ratio above 1.5 and a wind direction perpendicular to the street, there is almost no mixing between the air in the street and the layer above. Therefore the fresh air supply will be bad here. In the wider road sections, the air mixing is reasonable, this is also depending on the wind speed. Furthermore, the north-south oriented streets have sufficient shading in the morning and afternoon of the narrow street width. At noon, there is hardly any shadow because the streets offer little room for trees with a broad crown. East-west streets have a larger solar heat load on the facades facing south, it may heat up considerably, especially in the afternoon.

§ 8.7.1 City centre Utrecht

The historical city centre of Utrecht is relatively green for this category. 16% of natural urban surface, presented in Figure 8.41, is formed by the wide single with park around the centre, a canal through the centre and the inner courtyards which are relatively green. The façade surface covers most of the urban surface, which is a common appearance in this category. The FSI of 1.4 is a common density for city-centre neighbourhoods in the Netherlands.

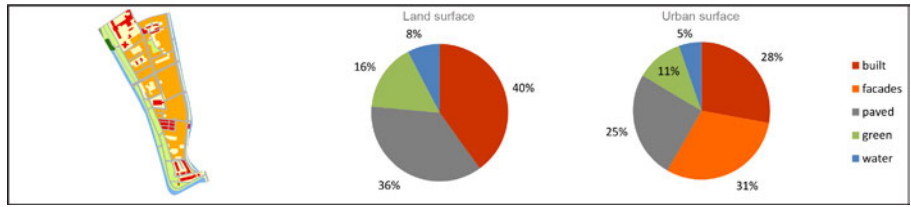

FIGURE 8.41 The relation between stony and natural surfaces in the Geertebuurt neighbourhood, Utrecht, with and without the vertical façade surface, map source TOP10NL (Middel, 2002).

To get rid of accumulated heat in compact city centres ventilation in streets or squares can be increased. For the Vredenburgplein next to the central station in Utrecht three variants of solar chimneys are presented in Figure 8.42. A solar chimney generates a draft of air because the air in the chimney heats up and then rises. The first variant is a large central chimney that draws air from 4 directions, in the second variant multiple solar chimney are attached to the south façade and the third variant is a composition of smaller solar chimneys that have a very local effect and interact with each other.

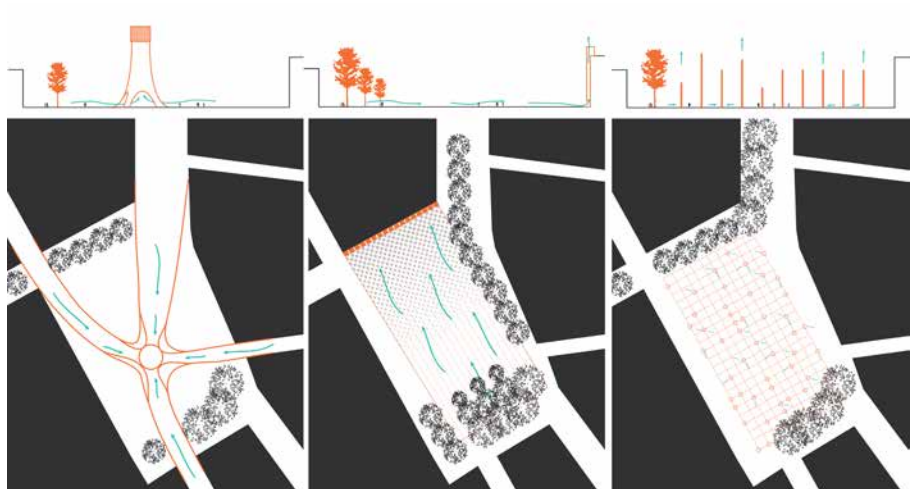

FIGURE 8.42 Three variants of ventilating solar chimneys by Vincent Peters (Schrijver et al., 2014).

For the design of the square the smaller individual poles offer the most opportunities. In Figure 8.43 and 8.44 the solar chimneys play a big role in the square composition, the poles also offer a structure for the market stalls and can include street lighting.



FIGURE 8.43 Vredenburgplein with ventilating solar chimneys by Vincent Peters, WUR.



1



2

FIGURE 8.44 Impression of different use of the Vredenburgplein by Vincent Peters, WUR.

§ 8.7.2 Bergpolder-Zuid, Rotterdam

Bergpolder is a central neighbourhood in Rotterdam and part of Het Oude Noorden (the old northern part of the city). Almost 95% of the urban surface is hard stony material. The little amount of green presented in Figure 8.45 is mainly related to the lack of green in the street, private inner courtyards and very little park space. However, the official neighbourhood contour does not include the Bergsingel and the Bergselaan along the edges of the neighbourhood. These roads contain a broad green and/or water element. Although these are half the size of the single around the centre of Utrecht, they do balance out the relation between the urban surfaces closer to the values for the city centre of Utrecht. In addition, the FSI is the same for these two neighbourhoods, which is 1.4, and the façade surface is again the dominant urban surface.

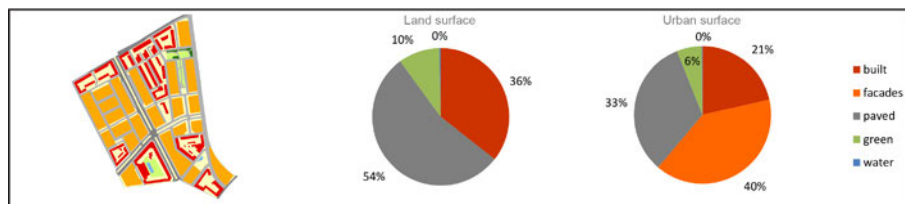

FIGURE 8.45 The relation between stony and natural surfaces in Bergpolder in Rotterdam, with and without the vertical façade surface, map source TOP10NL (Middel, 2002).

Interesting about the neighbourhood is its feasibility and attractiveness for young people; more than half of the inhabitants is younger than 34 years. There actually is almost no possibility to stay within the neighbourhood once you form a family because of the small, relatively cheap apartments. The housing corporation Vestia and the municipality of Rotterdam have developed a master plan to improve the housing quality and increase the variety in housing stock for a better mix of inhabitants. The redevelopment also involves energy reduction, improvement of social functions, green and parking (Ginter et al., 2011). Figure 8.46 presents an illustration of additional green.



FIGURE 8.46 Illustrative image for additional green from the master plan (Ginter et al., 2011).

The CPC research programme, which is the overall project under which this thesis resides, selected this neighbourhood as an integration case where all projects could bring in expertise and add to each other's work. The additional studies for Bergpolder are described further in the following chapter, section 9.4.

§ 8.7.3 Zuidwal, The Hague

In The Hague the Zuidwal neighbourhood is a mix of historical dwellings and some post-war dwellings with many commercial activities. In Figure 8.47 the relation between natural and stony land and urban surface is presented. The neighbourhood has, with more than 95%, an even larger share of stony urban surface than the previous two cases in this category. And the share of the façade surface is almost 3/4th of the urban surface. In line with the more dominant façade surface the FSI of 2.8 is higher as well.

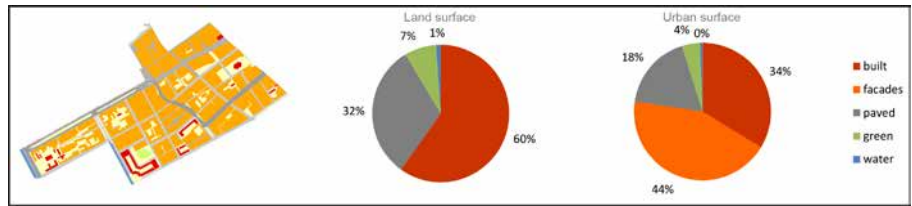

FIGURE 8.47 The relation between stony and natural surfaces in the Zuidwal neighbourhood, The Hague, with and without the vertical façade surface, map source TOP10NL (Middel, 2002).

In one of the central shopping streets of The Hague, the Grotemarktstraat, the outdoor climate is not regulated to provide a thermally comfortable place for shopping or passing through. However, applying measures is a big challenge: every square metre is occupied; on the ground, the facades, the underground and even in the air. Planting trees is extremely difficult due to the underground tunnel underneath and the lack of space on the ground floor. Even though cabling runs through because of the tram, high up in the canopy, space is still available. There already is a support system for Christmas decoration, with some additional attachment points, this could also held up canvas sheets to provide shade on hot sunny days.

In the proceeding chapter, section 9.3, the strategy for Zuidwal is elaborated further.

This typology is characterised by the great pressure on public space and limited options in historical or monumental buildings and protected townscapes. Where planting trees is extremely difficult because the parking pressure is too high or large numbers of shoppers and market stalls prevent this, there are other options that can provide for a better thermal comfort during hot days. Creating a comfortable environment can be critical for entrepreneurs and their business.

The opportunities to improve thermal comfort in this highly urbanised areas can be divided into temporary and flexible measures and into solid and robust measures. Temporary and flexible measures are for example canvas sheets above streets and plazas, the spraying of fine water droplets at pedestrian routes, watering the streets to reduce the radiant heat from stony surfaces, seating elements shaded in summer and protected from wind in winter and place elements that can generate ventilation during hot periods. By temporarily putting up canvas sheets above streets or squares the radiation load decreases. Canvas sheets are not suitable in streets with motorized traffic because the exhaust will be trapped in the canopy. The decrease of air circulation due to the canvas sheets is also in the evening a delaying factor in cooling down. This is not necessarily a problem if it is an area with mostly commercial functions. An additional advantage is that the canvas can protect against rain also. In addition, note that it is important to offer different microclimates within the neighbourhood. Therefore, be selective in the streets that are equipped with a canvas covering.

Among fixed robust measures are included pergolas covered with deciduous climbers, arcades along south facades, coverings over a part of the street or a walkway, shallow water streams through the street (see example Freiburg in chapter 3), fountains, white roofs, green roofs, facade vegetation (climbers) or green facade (many individual plants), individual trees with large crowns and preventing heat exhaust or seasonal storage system. With arcades people always have the choice to walk in the shelter from sun and rain in summer and from wind and rain in winter. Nevertheless, in the interior behind the arcade more artificial light will be needed. For all fixed robust measures considering the winter situation is especially important. Hence, the importance of deciduous climbing plants.

§ 8.8 Middle-high/high open urban block with moderate to much green

The typical garden city with high-rise buildings is spaciouly designed with a lot of greenery and often water elements between buildings, see Figure 8.48. The high-rise buildings with an average of 30 meters are usually mixed with low terraced housing. The distance between the tall buildings is about 100 meters and between the terraced houses 21 m. The H/W ratio is thus successively 0.3 and 0.4. This gives the impression that the ventilation is limited, however this is not the case because the tall buildings are staggered relative to each other and thus do not form a closed 'street profile'. Moreover, those tall buildings actually increase wind speed at street level because they partially deflect the stronger winds from above.



FIGURE 8.48 Example of a middle-high/high open urban block with moderate to much green, Ommoord in Rotterdam.

§ 8.8.1 Overvecht, Utrecht

North of Utrecht, Overvecht covers a large area with high-rise garden city blocks. The official district *Zambesidreef and surroundings* presented in Figure 8.49 is a representative part of the area. The percentage of natural urban surface is lower compared to the low-rise garden city presented in section 6.2. Instead, it is similar to the percentage of natural urban surface in the low-rise garden towns in section 6.3. The paved and façade surface have an almost equal share in this category. Despite the large height of some of the buildings, the façade surface is not dominating. The FSI of this category is with 0.8 quite high compared to other suburban neighbourhoods.

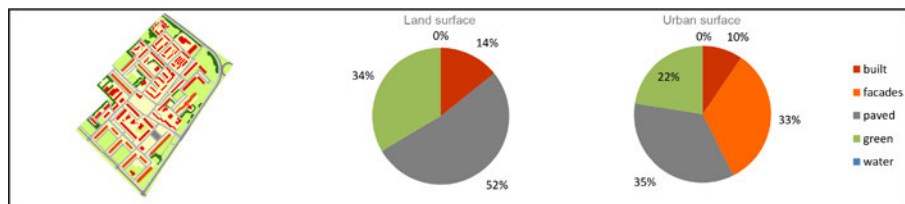

FIGURE 8.49 The relation between stony and natural surfaces in the Overvecht neighbourhood, Utrecht, with and without the vertical façade surface, map source TOP10NL (Middel, 2002).

The Overvecht garden city has abundant (semi-)public space, but does not provide people with a comfortable outdoor space. By re-designing the semi-public space of the inner courtyards with the concept of 'personalisation and identity' both the micro climate and the social cohesion can be improved. The design comprises three main interventions: allocate a plot (or shared plots) in the inner courtyard to each household (or group of households), transform ground floor into semi-public space and extend the greening of courtyards to other building blocks, linking the semi-public green to the large green structure (Beer et al., 2003).

In Figure 8.50 a design plan for the inner courtyard is given, the existing trees are preserved, a public path provides access to and a walkway through the courtyard. Adding green and providing people the possibility to create their own outdoor space improves the outdoor comfort. In addition the ventilation in the courtyard can be improved by opening up the ground floor (partially), see Figure 8.51. With the latter measure the winter situation should be taken into account, where flexible openings can be a solution. By linking the open courtyards to the large green structure more diversity in routings is created and more people can find a suitable outdoor space according their preference, see the green structure in Figure 8.52.

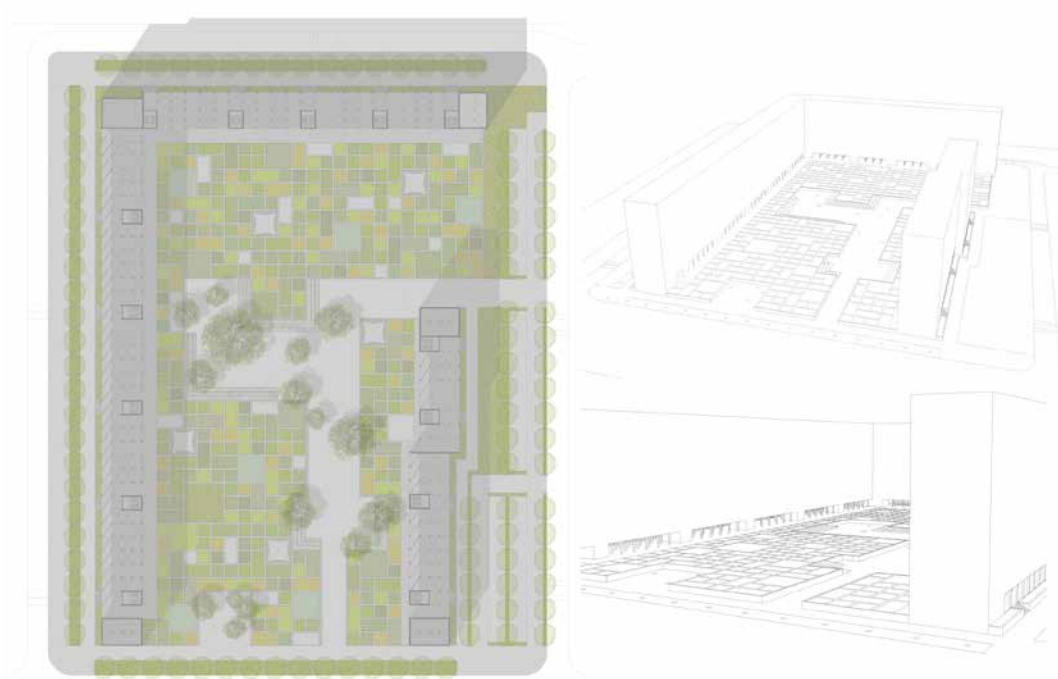

FIGURE 8.50 Private allotment gardens in the semi-public inner courtyard by Frederico Lia, WUR.



FIGURE 8.51 Opening up the ground floor for ventilation and sheltered community space by Frederico Lia (Schrijver et al., 2014)

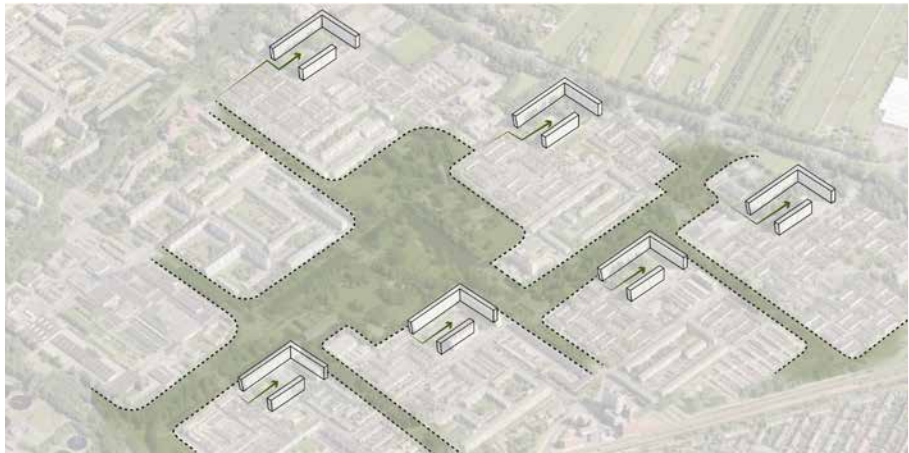

FIGURE 8.52 Extending green structure Overvecht by Federico Lia, WUR.

§ 8.8.2 Kanaleneiland, Utrecht

Kanaleneiland is a neighbourhood situated on the West side of Utrecht. It is very similar to the previous neighbourhood in urban surface cover, where the main difference is a larger percentage of water, see Figure 8.53. The FSI is with 0.7 a little lower, but still higher than other suburban areas.

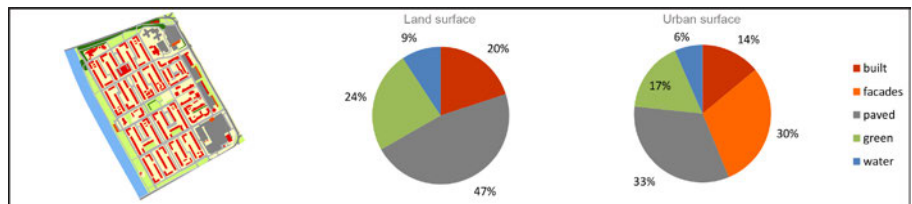
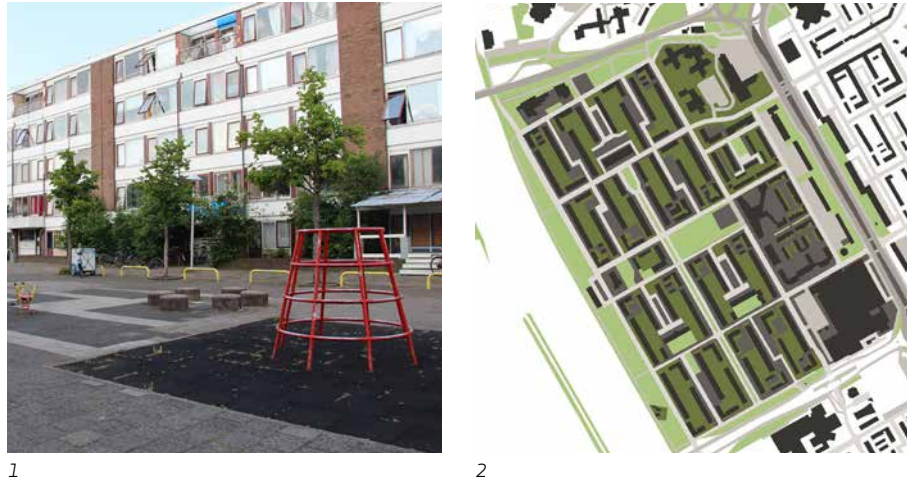

FIGURE 8.53 The relation between stony and natural surfaces in the Kanaleneiland neighbourhood, Utrecht, with and without the vertical façade surface, map source TOP10NL (Middel, 2002).

Kanaleneiland is somewhat different from Overvecht: Buildings are lower, generally 18 m high and are placed parallel and often form a street canopy. And instead of only public green, there are semi-public gardens and parks in the inner courtyards, see Figure 8.54. These differences presume less ventilation and less urban green for recreation. Students from Wageningen interviewed inhabitants about their thermal comfort and found that especially the indoor conditions and the public space at the building entrance was experienced too warm and uncomfortable.



1. Photo of the front side of a building in Kanaleneiland; 2. An analysis of the building blocks and the green by Jules Neefjes, WUR.

In order to improve the microclimate of the buildings and the outdoor space in front of the buildings, flexible and temporary elements can be used that people can position themselves. For the building different kind of structures onto which green climbing plants can grow upwards can give diversity in shadow and appearance, see Figure 8.55 for an impression.



FIGURE 8.55 Greening plan of a building front by Sander Smits, WUR.

§ 8.8.3 Schiebroek-Zuid, Rotterdam

Schiebroek is situated on the North-West side of Rotterdam. The urban surface cover, presented in Figure 8.56, varies with the previous neighbourhoods in this category in the amount of natural and paved surface. The percentage of pavement is smaller and percentage of natural surface larger. Nevertheless the achieved FSI of 0.8 is still high.

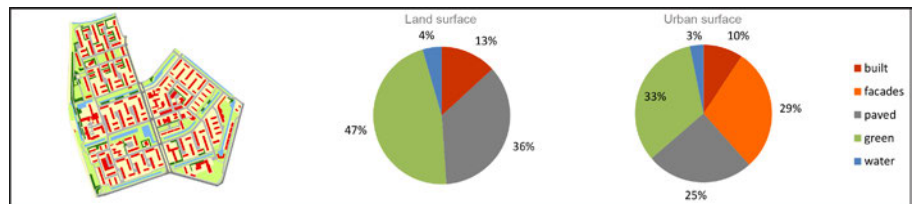

FIGURE 8.56 The relation between stony and natural surfaces in the Schiebroek neighbourhood, Rotterdam, with and without the vertical façade surface, map source TOP10NL (Middel, 2002).

Schiebroek-Zuid has a similar building typology as Kanaleneiland, however the available green space is much larger. Here the housing association Vestia initiated a redevelopment programme, called 'Beautiful and sustainable Schiebroek-Zuid'. A design studio showed the possibilities of enhancing urban agriculture in the neighbourhood, see Figure 8.57. The comprehensive ambition is to combine professional urban agriculture with private initiatives by inhabitants.



FIGURE 8.57 Impression of sheltered promenade and urban agriculture in Schiebroek-Zuid (Bosschaert, 2010).

With appointing a project leader, Vestia initiated the redevelopment program. Local inhabitants can request assistance in developing a kitchen garden. The corporation facilitates the small fences, tools, fruit trees, compost and a glass house was constructed. The project turns out to be very popular and people love to take care of their herbs, vegetables and flowers, see Figure 8.58. Children often want to participate and when the products are ready, proudly bring their yield home. The deal is: who helps who can harvest. Together a yearly harvest market is organised, with the returns people want to invest in their garden and organize events for the children.



1



2

FIGURE 8.58 Inhabitants work in the communal gardens (1) and cook an 'iftar meal' for their neighbours (2) in Schiebroek-Zuid (Zeevat, 2014).

The large size (70*100m) of the public inner courtyards are very suitable for special functions, such as water treatment area with reed plants, mixed cropping (urban agriculture or vegetable gardens), a petting farm, water playground, dog training field, lawn or events area with fixed barbecues and permissions for ice cream, snack or Dutch doughnut stand. Throughout the neighbourhood one can think of: walking paths, paved paths for cycling and inline skating, trail for mountain bikers.

§ 8.9 High-rise with little green

The highly urbanised areas in the Netherlands are not numerous, but when there, they are used very intensively, see Figure 8.59. Meaning many people benefit from a comfortable outdoor space in these areas. The building height varies between 50 to 100 meters and the average street width is about 12 meters. This means a H/W ratio of 4 to 8 in some places. This H/W ratio is in the street profile somewhat lower because many high-rise buildings have a wide foot of a number of floors around the high-rise tower. This building foot additionally provides protection from the deflected wind by the high-rise towers.

The large amount of pavement and high building density are factors that increase up heating. There is quite some shadow from buildings, but that does not eliminate up heating, and once heated, these areas retain the heat for a long time. On the other hand, the great variety in building heights relatively provides a lot of ventilation. This also causes strong wind gusts with stormy weather.



FIGURE 8.59 Example of high-rise with little green, Turfmarkt neighbourhood in The Hague.

§ 8.9.1 Central station area, The Hague

The central station area in The Hague connects the public transport hub with the inner city. The official district name is Uilebomen. In the Netherlands districts like this, with many high-rise buildings, are not very common. However, many people from inside and outside the city use the area, which means the microclimate affects many people. In this category the urban surface cover consist almost completely of stony materials. With a very dominant façade surface covering almost 60% of the urban surface, see Figure 8.60. Not surprisingly, the FSI in Uilebomen of 3.2 is the highest among all case neighbourhoods in this study.

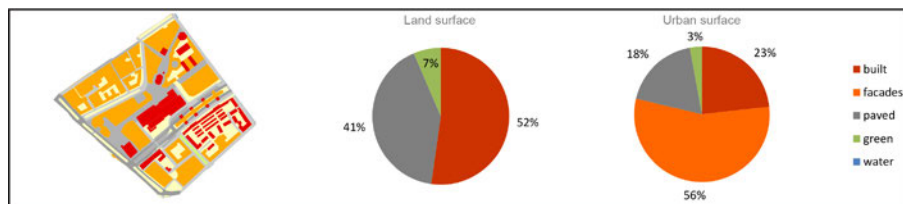

FIGURE 8.60 The relation between stony and natural surfaces in Uilebomen, the Station area in The Hague, with and without the vertical façade surface, map source TOP10NL (Middel, 2002).

The large amount of dark surfaces of the Spuiplein in The Hague offers the possibility to harvest heat and/or electricity from the pavement and facades. Figure 8.61 shows options to harvest heat from facades. The façade can produce 100% of the heat demand of the theatre or 30% of the electricity demand of the theatre. The square could provide heat for 60 households per year.



FIGURE 8.61 Three images left: examples of thermal solar collectors with semi-transparent façade. Right: Spuiplein and Theatre, The Hague.

Because of the high altitude of the buildings along the Turfmarkt wind can be used to generate electricity. The common turbines are depending on a certain wind direction. A small wind turbine type called Turby also transits vertical airflow. In order to increase the efficiency even more other techniques can be used, such as the EWICON developed by the TU Delft, which is based on moving water droplets or the Wind Dam by Chetwood Associates which catches and channels the wind. Figure 8.62 shows the two wind energy generators.



1



2

FIGURE 8.62 1. energy generation from water droplets with the EWICON; 2. Wind Dam by Chetwood Associates

From the central station in The Hague an underpass leads to the city centre. This underpass has no issues during hot weather, but wind drafts make it an uncomfortable place during the cold periods of the year. With a porous wall or urban curtains you can create a wind barrier to improve thermal comfort. In Figure 8.63 the underpass is inspired on the wind portals by Najla El Zein.



FIGURE 8.63 Wind portals in the underpass from the central station to the Turfmarkt in The Hague.

§ 8.9.2 Lijnbaan, Rotterdam

The Lijnbaan in Rotterdam is the heart of the city. In Figure 8.64 the land and urban surface cover is presented. Again the amount of natural surface cover is extremely low. The relation between pavement and built land surface is different from the station area in The Hague, resulting in a lower FSI of 1.6.

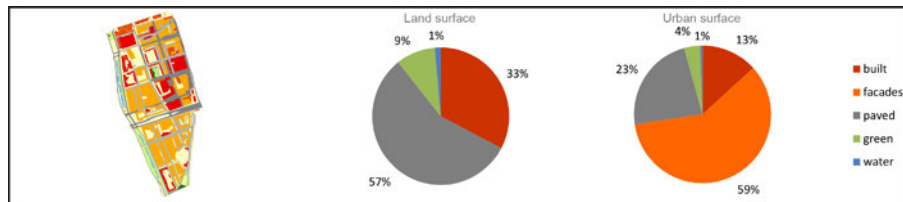

FIGURE 8.64 The relation between stony and natural surfaces in Cool, the Lijnbaan in Rotterdam, with and without the vertical façade surface, map source TOP10NL (Middel, 2002).

For this neighbourhood no design is made. The above diagrams and map show the large similarity with the other highly urbanised city centre. The expectation is that similar measures will be appropriate here. This needs to be confirmed to strengthen the conclusion below.

Applicability of solutions for heat stress are very dependent on the function of the area. Locations that serve as an outdoor living area need to offer both shade for pedestrians and sunny spots for terraces or benches. Because these areas attract many people from inside and outside the city (such as employees, passengers and tourists), it is important to offer a diversity of places: sheltered spots out of the wind, shady spots and perhaps places covered from rain.

Here it is important to reduce the extensive amount of pavement, for example, by realizing roof parks, but these large surfaces can also be used to transform solar energy into thermal energy or electricity. In sub-section 9.3.2 follows a sample calculation of solar collectors in the pavement of the Spuiplein and the facade of the adjacent theatre. Besides capturing heat in paving and facades, the prevention of the exhaust of anthropogenic heat is important in these areas. This does not so much concern the cooling towers on top of high buildings, but mostly the heat exhaust of motorized traffic and refrigeration installations in restaurants and food shops on ground level. It would be better if all exhaust air leaves the building at the top.

§ 8.10 Conclusion

The aim of the case study designs in this chapter is to get to a set of general climate adaptation measures per neighbourhood typology. This addresses the sub-research question: How can neighbourhoods become climate robust considering the morphology of Dutch neighbourhood typologies?

In the previous sections the appropriate measures for a specific microclimate category were extracted after the presentation of two or three examples with design solutions, strategies and complete neighbourhood designs. The main design solutions are summarized and presented in a matrix in sub-section 8.10.1.

With the sets of measures given in this chapter urban designers and planners have guidance in appropriate measures for a large part of the existing urban areas in The Netherlands. Herewith, climate sensitive choices in the initial stage of the design process are possible without profound knowledge of the urban microclimate.

Instead of using professional simulation programs or extensive GIS mapping, the urban designer or planner can place an area in one of the microclimate categories introduced in this chapter. These categories are based on building height, form of footprint and the percentage of green/water in relation to the urban surface. With the urban surface also the vertical façade surfaces should be included. It is recommended to include street trees or tree canopy density in future analysis. The current rapid development of geographical data registration of all elements in public space facilitates the inclusion of street trees in future analyses. This subsequently raises a new question: what is the best way to include trees in an urban surface analysis? Counting the crown cover as green surface ignores the surface cover under the tree crown which has a different effect when paved than when covered with vegetation.

In addition to the three physical aspects, the microclimate categories are coupled to common urban typologies (Lorzing et al., 2008) that are often used by urban designers and planners to characterize a neighbourhood. The physical aspects and urban typologies are well-known parameters for urban designers and planners. To strengthen the generic conclusions in this chapter each neighbourhood typology should be complemented with at least three design proposals.

Although this chapter enables categorizing and selecting measures without the necessity of specialised knowledge about the urban microclimate, the actual implementation of measures does require more knowledge and understanding of the field. More insight in heat mitigation measures and their effects is provided in chapter three. In some cases the effect of (a combination of) measures is not obvious. Here simulation of future scenarios can be of importance in the decision making process. In the following chapter the measures proposed per microclimate category are input for three integrated design studies.

§ 8.10.1 Summary of adaptation measures per microclimate category

This sub-section presents a summary of the measures that fitted a neighbourhood typology in the design studies presented in this chapter. In Table 8.6 heat mitigation measures are indicated per neighbourhood category in a matrix. In the case of the residential neighbourhoods, the historical city centres and garden city high-rise neighbourhoods three designs are made. The measures presented for these neighbourhoods can be regarded as generic, while the other presented measures need to be considered as a possible example. More design studies concerning these neighbourhood typologies are needed to come to a generic set of measures.

Low open urban block with moderate to much green (garden city low-rise)

- Promote green in private gardens;
- Increase the value of semi-public green: improving quality of green and attach multiple functions to the green areas. The semi-public inner courtyards have a green lawn of about 30*50m. The functions linked to these areas cannot be confined to residents only because it would blur the public character. Even so, public functions are not in place either because the residents can experience that as an infringement of their privacy. After all, it concerns their backyard. When a social function of peaceful nature attracts just a small number of people at the same time it will give less friction. For example a route to walk the dogs, water storage, butterfly and bee gardens, fruit and nut orchards, etc.

Low closed urban block with moderate to much green (garden town)

- Promoting green in a subtle manner: inspire people and create awareness about the importance and benefits of green. Another option is to offer trees, hedges or plants for free to the inhabitants. Or, through the water board or council tax, charges can be adjusted to the degree of pavement in gardens, or charge less taxes when rainwater is collected and infiltrated on site;
- Add street trees on strategic places.

Low closed urban block with little green (residential neighbourhood)

- Tiny gardens along the facade and green facades;
- Type of pavement: semi-pavement, permeable pavement, light colours;
- Parking solutions combined with a structure for climbing plants;
- Flat roofs can contribute to thermal comfort at street level: a white reflective coating, a green roof with a sufficiently thick substrate layer;
- In case there is no possibility to add more green the generation of ventilation is especially important. This can be achieved through more height differences of the buildings or by using the principle of 'hot' and 'cool' places between which the air will be moving (thermal draft);
- Find parking solutions: streets can be planted with a double line of trees or one line of trees at the side that receives most solar radiation. In some cases, trees as espaliers can provide a solution when the position of the tree cannot be placed far enough from a building wall.

Low closed urban block and strips with moderate green (VINEX)

- Promote green in private gardens, also try to discourage the use of dark anthracite tiles;
- Parking solutions combined with green and shadow elements.

Low strips and open urban blocks with little to moderate green (cauliflawer neighbourhood)

- Parking solutions combined with green and shadow elements. Reducing the number of cars is not directly an option here because the neighbourhoods are often at a great distance from the centre. One could think of (electric) car sharing or parking on the edge of several building blocks. Thus when more space becomes available it can be used for additional playgrounds, more trees, rainwater harvesting and infiltration meadows;
- Green facades;
- White roofs.

Middle-high closed urban block with little green (historical city centre)

- Temporary and flexible measures: canvas sheets above streets and plazas, the spraying of fine water droplets at pedestrian routes, watering the streets to reduce the radiant heat from stony surfaces, seating elements shaded in summer and protected from wind in winter and place elements that can generate ventilation during hot periods;
- Fixed and robust measures: pergolas covered with deciduous climbers, arcades along south facades, coverings over a part of the street or a walkway, shallow water streams through the street, fountains, white roofs, green roofs, facade vegetation (climbers) or green facades (many individual plants).

Middle-high/high open urban block with moderate to much green (garden city high-rise)

- Promote green in private gardens;
- Increase the value of semi-public and public green. The large size (70*100m) of the public inner courtyards are very suitable for special functions, such as a water treatment area with reed plants, mixed cropping (urban agriculture or vegetable gardens), a petting farm, water playground, dog training field or as an events area with fixed barbecues and permissions for ice cream, snack or Dutch doughnut stand. Throughout the neighborhood one can think of: walking paths, paved paths for cycling and inline skating, trail for mountain bikers.

High-rise with little green (high-rise city centre)

- Offer a diversity of places: sheltered spots out of the wind, shady spots and perhaps places covered from rain;
- Reduce the extensive amount of pavement, for example, by realizing roof parks;
- Large paved or facade surfaces can also be used to transform solar energy into thermal energy or electricity;
- Reduce the exhaust of antropogenic heat: car free zones, design buildings that do not need air conditioning and make sure all exhaust air leaves the building at the top.

Microklimaat categorie	Middelhoog gesloten bouwblok met weinig groen	Laag gesloten bouwblok met matig tot veel groen	Laag gesloten bouwblok met weinig groen	Laag open bouwblok met matig tot veel groen	Middelhoog open bouwblok met matig tot veel groen	Lage strokenbouw en open bouwblok met weinig tot matig groen	Lage strokenbouw en gesloten bouwblok met matig groen	Hoogstedelijk centrumgebied
Wijktypologie	Historische binnenstad	Tuinwijk/dorp	Woonwijk	Tuinstenen laag	Tuinstenen hoog	Bloemkoolwijk	Vinex	Hoogstedelijk centrumgebied
maatregel								
bomen								
straatbomen								
parken								
groene routes								
grasvelden								
particulier groen stimuleren								
stadslandbouw								
vertikaal groen								
groengeluidsscherm								
begroeide arcades met bladverliezende klimplanten								
wadi's								
waterelementen (fontein)								
water vernevelen								
waterpleinen								
waterspeelplekken								
grachten en kanalen behouden of uitbreiden								
afkoppelen regenwater								
regenton/tank								
open water (verzonken)								
infiltratie punten (evt in combi met wadi's)								
natuurlijke oevers								
helofyten								
filter/grijswatersysteem								
bewateren van de straat								
katoenen doeken boven de straat								
schaduelement voor zitbank								
wind beschermingselement								
vaste arcades langs zuid gevel of als los element								
orientatie op zon tbv binnenklimaat								
bevorderen ventilatie								
reflecterend/licht dak								
groendak								
materialen met lage warmte accumulatie								
verharding verminderen openbaar terrein								
verharding verminderen prive terrein								
permeabele materialen								
atropogene warmte productie voorkomen of omzetten								
Asfalt/gevel collectoren								
voortlichting								
klimaatbeheersing								
koele en veilige plekken in risicogebieden								

goed toepasbaar
toepasbaar
matig toepasbaar
moeilijk toepasbaar



TABLE 8.6 Matrix with heat mitigation measures per neighbourhood category.

§ 8.11 References

- ABF (2006), "ABF Woonmilieutypologie", ABF Research BV, Delft.
- AIVC. (2013), "Energy conservation technologies for mitigation and adaptation in the built environment: the role of ventilation strategies and smart materials". *AIVC: 34th AIVC Conference, 3rd TightVent Conference, 2nd Cool Roofs Conference, 1st venticool Conference, Athens, Greece, 25-26 September 2013* 2013, pp.
- Baeten, J., Berg, J.J., Betsky, A., Bergeijk, H. v., Ibelings, H., Kuipers, M., Steenhuis, M., Vletter, M. d., Teunissen, M. and Stissi, V. (2004), *Gewoon architectuur 1850-2004*, NAI, Rotterdam.
- Beer, A., Delshammar, T. and Schildwacht, P. (2003), "A changing understanding of the role of greenspace in high-density housing: A European perspective". *Built Environment*, Vol. 29, No. 2, pp. 132-143.
- Berghauer Pont, M.Y. and Haupt, P.A. (2009), *Spacematrix. Space, Density and Urban Form*, Delft University of Technology.
- Boer, F., Jorritsma, J. and Peijpe, D. v. (2010), *De Urbanisten en het wondere waterplein*, O10 Publishers.
- Boschaert, T.G., E., Vight, M. v.d. (2010), "Mooi en duurzaam Schiebroek-Zuid. Visie boek.", Vestia, Estrade.
- Cools, T., Gent, A. v. and Kools, V. (2015), "Op welke wijze kan de leefbaarheid in Lunetten worden vergroot?", Goois Lyseum.
- Destadutrecht.nl (2012), Inspraakavond over inrichting nieuwe 'Dakpark A2'. Retrieved from <http://www.destadutrecht.nl/de-wijk/nieuws/4091/inspraakavond-over-inrichting-nieuwe-dakpark-a2>
- Ellefsen, R. (1991), "Mapping and measuring buildings in the canopy boundary layer in ten U.S. cities". *Energy and Buildings*, Vol. 16, No. 3-4, pp. 1025-1049.
- Ginter, D., Hornis, F., Koot, Y., Ruijven, M. v., Bakker, J., Wingerden, R. v., Verhagen, B., Faber, M., Gorter, C., Pang, K.C. and Burgmeijer, E. (2011), "Masterplan Bergpolder Zuid", Rotterdam.
- Ibelings, H. 1999. *Nederlandse stedenbouw van de 20ste eeuw*. Rotterdam: NAI.
- Jong, T.M. d. and Voordt, D. v.d. (2002), *Ways to study and research: urban, architectural and technical design*, DUP Science, Delft.
- Kleerekoper, L. (2009), *Design principles for Urban Heat Management in the Netherlands*, TU Delft.
- Kleerekoper, L., Dobbeltstein, A.A.J.F. v.d., Dorst, M.J. v. and Hordijk, G.J. 2011. *A Heat Robust City. Case study designs for two neighbourhoods in the Netherlands*. *World Sustainable Building Conference 11*. Helsinki.
- Kleerekoper, L., Esch, M. v. and Salcedo, T.B. (2012), "How to make a city climate-proof, addressing the urban heat island effect". *Resources, Conservation and Recycling*, Vol. 64, No. 0, pp. 30-38.
- Lorzing, H., Harbers, A. and Schluchter, S. (2008), *Een stedenbouwkundige typologie*, NAI, Rotterdam.
- Middel, G. (2002), *TOP 10 data set P1661*, Topografische-Dienst, Data Archiving and Networked Services.
- Prins, E., Bos, R., Stam, A., Berg, R. v.d., Witteman, B., Meijer, F., Witsen, P.P. and Fuchs, P. (2010), "Rosetta-methode. Een gemeenschappelijke taal voor woonmilieus in de regio".
- Schrijver, R., Hetem, V. and Takeda, M.A. (2014), *Green-blue infrastructure for a resilient and healthy city*, Wageningen University.
- Stewart, I.D. and Oke, T.R. (2012), "Local climate zones for urban temperature studies". *Bulletin of the American Meteorological Society*, Vol. 93, No. 12, pp. 1879-1900.
- Tummers, L.J.M. and Tummers-Zuurmond, J.M. (1997), *Het land in de stad*, THOTH, Bussum.
- Ubink, M. and Steeg, T. v.d. (2011), *Bloemkoolwijken: analyse en perspectief*, SUN, Amsterdam.
- Voogt, J.A. and Oke, T.R. (1997), "Complete Urban Surface Temperatures". *Journal of Applied Meteorology*, Vol. 36, No. 9, pp. 1117-1132.
- Wassenberg, F. (1993), *Ideeën voor naoorlogse wijken*, Delftse Universitaire Pers, Delft.
- Zeevat, C. (2014), "Stadslandbouw in Schiebroek-Zuid": Vestia. Available at: <http://stadslandbouwschiebroek.blogspot.nl/>.

9 Designing for the urban (micro) climate

In this chapter the results of all previous chapters are input for the development of three integrated urban development strategies.

For climate adaptation measures to be part of the 'standard' design process, urban designers and policy makers need to have clear guidelines at their disposal (Pijpers- van Esch, 2015). A first assistance in selecting heat mitigation measures was presented in the previous chapter. Common neighbourhood typologies are classified in relation to heat accumulation and appropriate heat mitigation measures are presented for that specific typology. Using this guide for the pre-selection of adaptation measures does not require an extensive analyses of the urban microclimate and enables urban designers and policymakers to quickly scan the adaptation options for the area. Still, the choice for a particular measure is rather arbitrary.

This chapter tests how heat mitigation measures can be integrated in a planning or design process for three different assignments in different neighbourhoods. The sub-question that will be answered is: How can the transformations proposed per neighbourhood typology be applied in an integrated design assignment, combining various heat mitigation measures, linking water adaptation measures and creating additional value in relation with energy, health, ecological, social and economic issues?

The sub-questions answered in this and the preceding chapter are input for the research question: How can microclimate be integrated into a planning or design process?

§ 9.1 Case study method to integrate adaptation

This section describes the method that is used to integrate climate adaptation measures in the design process for the three case studies presented in this chapter. A method to focus on heat mitigation measures and integrate these in complex redevelopment tasks is the maximisation method presented in the next sub-section. Zooming in, a choice between heat mitigation measures can be made by the proposed strategy to prioritize heat mitigation measures inspired by the 'Trias ecologica' in the second sub-section. Zooming out, the choice for a certain measure is depending on the political field as well. This is explained in the third sub-section.

§ 9.1.1 Case study method: maximisation

The method of ‘research by doing’ is used to answer the (sub-)research questions stated above and can be described as ‘design research’ according to the scheme in Figure 8.1 developed by de Jong & Voordt (2002). They can be placed under ‘design research’ because for each integration case study the context and the objects (climate adaptation measures) are determined.

A design process, however structured or processed, is always intertwined with unconscious considerations of the designer. Van Dooren et al. (2014) describe designing as a complex, personal, creative and open ended process. To reduce the arbitrariness of design decisions the methods presented in this section form a basic thread in the three integrated design studies.

All three case studies have the aim to improve the outdoor microclimate and climate robustness of an area. This common aim composes a certain level of maximisation in the design process. The maximisation method developed by Duijvestein (2002), schematically presented in Figure 9.1, is a method for urban design that aims to clarify the choices made in the process in relation to selected environmental theme(s). In this research the maximisation theme is thermal comfort. A design process develops from analyses to design within the minds of designers and stakeholders and is often inconceivable. With the maximisation method the spatial consequences are revealed with a one-sided thematic design. The three case studies in this chapter follow the same integration process with the same sub-questions presented in Table 9.1.

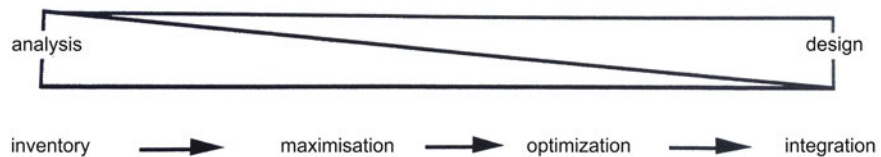

FIGURE 9.1 Environmental aspects provide structure and direction in the transition between analysis and design (Duijvestein, 2002).

ANALYSIS			MAXIMISATION	OPTIMISATION	INTEGRATION
Development task	Adaptation task	Political context	What are best options in relation to thermal comfort and neighbourhood characteristics?	What are best options in combination with other climate adaptation options?	What are best options in combination with other context related aspects?

TABLE 9.1 Design integration process aiming at increasing thermal comfort.

Maximisation of thermal comfort in urban design

The maximisation step requires a choice between heat mitigation measures, while optimisation and integration ask for a broader view and coincide with an increase of complexity. According to Kabat (2010) the chosen measures have a greater feasibility when they are flexible, no-regret and go hand-in-hand with monitoring & ability to incorporate new scientific insights. However, feasibility alone is not a strong enough argument for a choice that influences people their lives. This is in line with the statement of de Jong & Voordt (2002) that within the range of the probable and possible solutions only a part is also desirable, see Figure 9.2. He states that: *“The designer has the task of exploring improbable possibilities, especially when the most probable development is not the one preferred. Because of their improbability, these possibilities are not predictable, one has to design them”* (Jong & Voordt, 2002, page 339). The grey areas in the figure relate to uninteresting possibilities for design with desirable but impossible (1) and desirable, probable and possible (2) scenarios. In the first case scenarios are not realistic and in the second case no additional dedication is needed for realization. The most interesting solutions are, as stated above, the possible, desirable and improbable (3) solutions. In this study, most of the design proposals can be assigned to this scenario as climate adaptation solutions are often not the common solutions and therefore less probable. The probable, possible, but undesirable scenarios (4) need consideration to transform these in a desirable scenario, while scenarios that are possible, but not probable nor desirable, do not need attention because they will simply not happen.

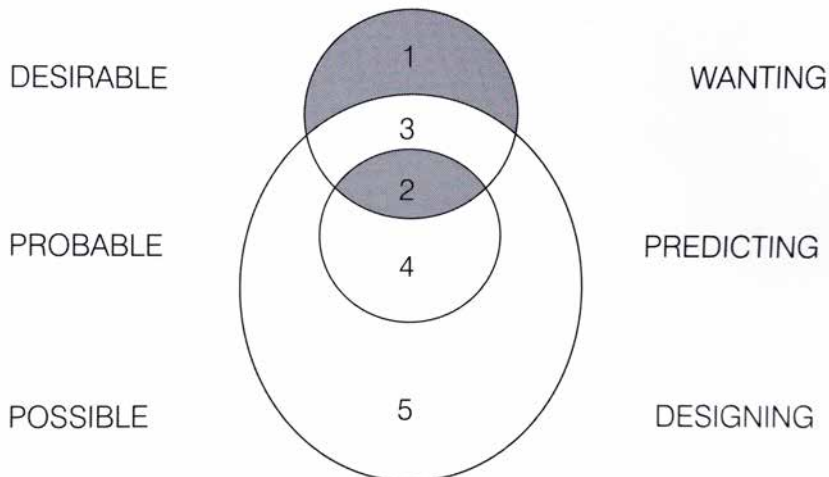

FIGURE 9.2 Views of the future (Jong & Voordt, 2002).

This research has a focus on the relatively new design field of outdoor thermal comfort for hot weather extremes. And therefore the maximisation on thermal comfort is elaborated further than the other steps. In the first instance the effectivity of a measure seems to be of great importance in prioritising measures. In chapter 3 and 4 a search for most effective measures in air temperature and thermal comfort is done through literature review and computer simulations. Due to the great variability in effectiveness within space and context it is not possible to order adaptation measures without ending up with broad ranges that overlap and many exceptions and reservations. An alternative can be to test adaptation measures by simulation of the actual context. This method requires a lot of expert knowledge about the urban microclimate, advanced simulation skills and takes a long time for modelling and calculation time and computer capacity. Such simulations can indicate a difference between effectiveness, but due to unavoidable simplifications in modelling and calculations, results remain inaccurate to a certain extend. And, not all possible solutions can be analysed, this especially counts for innovative ideas. Moreover, urban designers and policy makers generally do not have extensive knowledge about the urban microclimate nor do they have the time, skills and budget to perform computer simulations.

Each case study has been shortly introduced in the preceding chapter concerning physical parameters like built form, H/W ratios and percentages of green and stony surfaces. In this chapter each case study start with a recap of that analyses and a description of the political context of the city. Thereafter, the integral design is thematically discussed indicating whereas the heat mitigation measures prevent heating, cool passively or actively. In the closure the measures from the set of measures for the neighbourhood typology in chapter 8 that are not part of the design are discussed. Integration is not a step afterwards, but already happens in the mind of the designer considering the different maximisation and optimisation options. In section 9.5 the design process is evaluated by discussing the intertwined combinations of heat and other climate adaptation measures (optimisation) and of heat mitigation and other urban development tasks (integration).

Choices within the design process are made by the author in the cases Couperusbuurt and Zuidwal, while adaptation options in Bergpolder are made by different designers and researchers involved in the CPC project.

§ 9.1.2 Approaching heat mitigation as a common sustainability issue

Better safe than sorry, certainly counts when dealing with climate change adaptation. To prevent heat stress related problems in urban areas the possible adaptation measures can be divided into three steps: preventing heating up, use passive cooling

and active cooling. This three stepped strategy is an alternative version of the ‘Trias ecologica’ developed by Duijvestein (1993) and presented in Table 9.2. The Trias ecologica is inspired by the work of ecologist van Leeuwen (Jong et al., 2015).

	IN	OUT
Step 1	the prevention of unnecessary consumption	the prevention of waste
Step 2	the use of infinite sources	the recycling of waste
Step 3	the sensible use of finite sources	the processing of waste sensibly

TABLE 9.2 The three-step strategy as described by Prof C.A.J. Duijvestein (Jong et al., 2015).

The Trias ecologica is often used to prioritize measures to maximum environmental benefits for energy, material and water flows. An example is the Ecodevice model that is based on the same type of considerations and is applicable on many scale levels (Tjallingii, 1996). Lysen (1996) changed the three step strategy to ‘Trias energetica’ with the steps 1: reduce the demand, 2: use renewable resources, 3: solve the resuming demand efficiently and clean. More recently the ‘New Stepped Strategy’ developed by Dobbelsteen (2008) adapts the ‘Trias ecologica’ to the building design process with the steps 1: reduce consumption (using intelligent and bioclimatic design), 2: reuse waste energy streams, 3: use renewable energy sources and ensure that waste is reused as food.

For a sound argumentation in the choice of heat mitigation measures an additional strategy to prioritize these measures is needed next to the preselection per neighbourhood typology in chapter 6. Inspired by the ‘Trias ecologica’ a three step approach to prevent heating up guides the design process and choices for adaptation options in a structured way:

- 1 Prevent heating up;
Use passive cooling,
Use active cooling considering the ‘New Stepped Strategy’.

This approach favours measures from the first step above the second and third. After all, when heating up can be prevented according to step 1, cooling, either passive or active in step 2 and 3, does not need consideration. The steps are described briefly in the following sections, a more elaborated explanation can be found in the online course that is developed with several partners of the CPC project and the Open University (Kleerekoper & Dobbelsteen, 2015).

Preventing heating up

Preventing heating up by the sun has three aspects of which the prevention of solar irradiation from urban to building scale is the first. This can be done by trees, canvas

sheets above public spaces, increasing the compactness of buildings and equip buildings with sunscreens. The second aspect is to reflect solar radiance back to the atmosphere by increasing roof and pavement albedos. The third aspect is to prevent the absorption of heat by using materials with low heat absorption capacity, apply thin and light façade claddings and use thermal isolation to prevent heat intrusion through the façade.

Preventing heating up by anthropogenic sources aims at reducing the heat people produce with all urban activities, including dwelling, transportation, sports, etc. The heat exhaust from cooling buildings mechanically with air conditioning should be avoided. This is in fact heating up the outdoor temperatures which is again of influence on the indoor temperatures. Buildings with sufficient thermal isolation and sunscreens need less cooling (energy) and have a lower heat emission to the outdoor space. A means to reduce anthropogenic heat is to replace traditional combustion engines with electrical ones. Another way to achieve reduction of heat emission is to re-use waste heat, with for example a pool that receives heat from an ice rink's cooling installation and supplies nearby dwellings with space heating.

Passive cooling

Passive cooling with ventilation should be looked at on different scale levels. On the large scale urban ventilation is depending on types of airflow and wind conditions in The Netherlands. This type of airflow originates from differences in atmospheric pressure. As soon as the airflow arrives at urban areas the flow is influenced by obstacles and transforms into secondary air flows and turbulence. The secondary horizontal air flows can be influenced by creating contrasts in openness and obstruction. Dense tree lines or building volumes can guide or deviate airflows and porous and scattered trees can let airflow penetrate an area. Air flow on street scale can be influenced by creating thermal inducement because of thermal differences. Both, the location where hot air rises and the direction from which cooler air is attracted can be influenced. And finally, on the building scale differences in air pressure and thermal inducement can be used to ventilate indoor spaces. For cooling, the principle of summer-night ventilation can cool down building elements that absorb heat during the day such as concrete floors and walls.

Passive cooling with water basically implies increase of evaporation. Waterbodies such as rivers, lakes, canals and urban water elements often have a relatively small effect on the air temperature. Nevertheless, it can make a large difference in the perception people's thermal comfort when they can see, and even better, touch the water. Also trees cool through evaporation of water, the so-called evapotranspiration process, and thus function as urban air conditioners. Next to waterbodies and trees, also permeable and water absorbing surfaces can contribute to cooling during hot days.

Active cooling

In order to actively cool with water technological systems are needed. With flexible groundwater level management more rain water can be infiltrated and groundwater can be used in dry periods for vegetation or cooling of urban surfaces (or people). Cooling air through the fine spraying of water is a commonly known effect of fountains, and the recent trend of spraying even finer mist on busy public spaces or terraces is even more effective. Active cooling of buildings can be achieved with water running along roofs and walls absorbing heat, or with water storage on roofs which is covered from the sun during the day and exposed to the sky to accelerate the cooling of water at night.

In the previous paragraph described the cooling effect of evaporation of water. Another active cooling method for urban surfaces is based on the absorption capacity of water. Analogous to heat collector panels on roofs, other urban surfaces can serve as heat collectors where the absorbed solar heat is discharged via water running in tubes through or behind the stony surface. The discharged heat can be used directly, for example pre-heating hot tap water or a nearby swimming pool, or saved for the winter period in a seasonal storage system. This is still an unconventional solution, but with large amounts of stony surfaces in urban areas that contribute to heating up we can make use of and strive for a sustainable energy system in combination with climate adaptation.

§ 9.1.3 Political context: dedicated or mainstreaming adaptation approach

In this thesis the importance of a good microclimate in cities is argued in chapter 2. However, this is hardly ever the most important factor in weighing urban design solutions. Is climate adaptation a goal in itself that must be achieved, or is it one of the many elements that should be addressed properly in achieving a climate resilient urban area? A study about the differences between a dedicated or mainstreaming approach in urban policy is done by Uittenbroek et al. (2014). In this section the findings of this research are summarised and extended to the design process.

Dedicated approach

In the dedicated approach political or client commitment is given directly to climate adaptation. Politicians or clients will provide resources to achieve the objectives. The direct political or client commitment provides opportunities, such as political pressure and new organizational structures, but may also lead to unclear positioning of policies. It can lead to innovative designs and techniques that are an example and inspiration for others. The approach also involves the risk of neglecting other essential elements of urban design or investing a lot of money without the certainty of future extreme changes in climate.

Mainstreaming approach

In the mainstreaming approach commitment of individual stakeholders to a climate resilient design is a crucial precondition in achieving this. For policy this means “an attempt to obtain indirect political commitment for climate adaptation by framing the issue as an added value to existing policy objectives” (Uittenbroek, 2014) page 71. This approach usually does not lead to changes in the organizational structures and routines. No or limited additional resources are made available and existing resources are difficult to reallocate because they are labelled to another objective. For the design process it implies that, although climate adaptation is one of the general requirements on the design brief, for each planning or design choice climate adaptation has to ‘compete’ with other aspects. In this way, the achievement of climate adaptation objectives rely on individual choices of the planning and designers involved. In case of a dedicated team of supporters of climate adaptation, the approach can lead to a well-balanced plan that achieves to combine many assets and objectives. On the other hand, without motivation for and knowledge about climate adaptation there is the risk of not achieving a climate resilient development. Friend et al. (2014) have a rather pessimistic view on the potentials in governance and state that: “...generally there is such a fundamental failure of urban governance that there is often nothing to mainstream into...”.

The three case studies presented in this chapter are all situated in a different political context. Where the Municipality of Amsterdam clearly chose to mainstream climate adaptation into the different departments and organisation layers, the municipality of Rotterdam chose the dedicated approach. In The Hague no conscious decision was made how to approach climate adaptation as an organisation, resulting in a random attention to the subject throughout the organisation.

§ 9.2 Couperusbuurt, Amsterdam

This sub-sections presents the case study for the Couperusbuurt neighbourhood, Amsterdam.

§ 9.2.1 Neighbourhood analysis

In the previous chapter the Couperusbuurt neighbourhood was introduced as a non-problematic area in terms of outdoor thermal comfort. However, redevelopments considered by the municipality form a threat for the green characteristics and for the

urban microclimate. This section introduces options to improve thermal comfort in combination with other assets for the neighbourhood.

Within the CPC consortium an analyses of the vulnerable areas to heat is made for the city of Amsterdam by Hoeven & Wandl (2013), as introduced in section 2.3.2 in this thesis. With a geographical information system (GIS) the heat island of Amsterdam is based on eight parameters: pavement index, shadow, green index. Infrastructure for traffic, building envelope index, water, energy label and temperature difference. The analyses is presented in figure 9.3, showing a large spreading in hot areas over the whole city. Locations with vulnerable groups such as elderly and babies are located in the outskirts, especially on the western part of the city. While concentrations of labour activities is largest in the city centre. For the Couperusbuurt neighbourhood, which is situated in this western part, this means that liveability for these groups need to be protected.

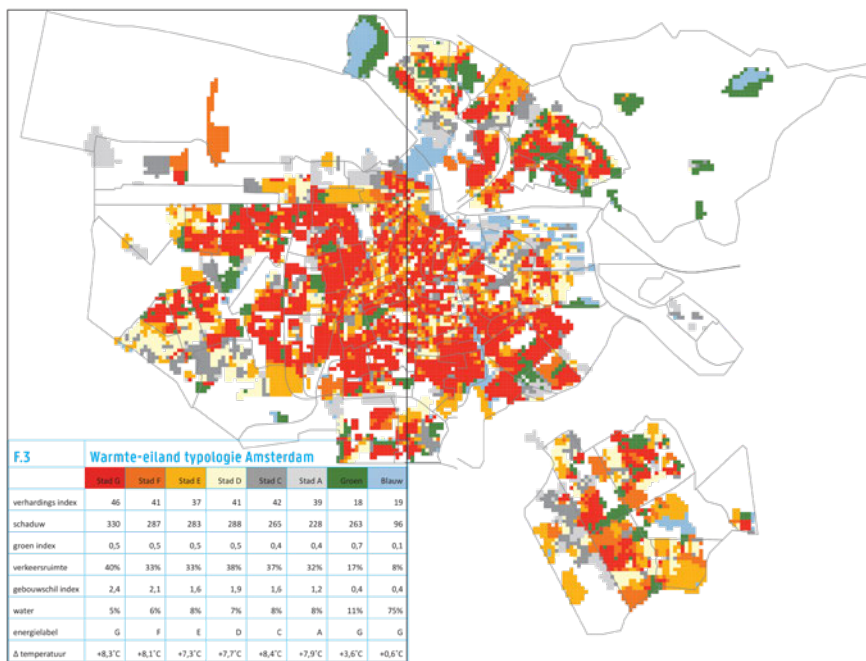

FIGURE 9.3 Physical heat map of the city of Amsterdam (Hoeven & Wandl, 2013).

Political context of Amsterdam

The municipality of Amsterdam chose not to place climate adaptation on the political agenda in the period 2010-2014 in which the CPC project was running. In a study by Uittenbroek et al. (2014) the political context is described in detail. In short

she states that the three main topics receiving political attention were: economic growth, social empowerment and sustainable investments. Although it received less attention, climate change was addressed through climate mitigation actions relating to CO₂ reduction and investments in new ways of energy generation. According to the responsible alderman climate adaptation (meaning water management) is not an issue of discussion, opposed to energy transition which is a controversial topic that requires political agenda-setting.

Despite the lack of political dedication to climate adaptation, the issue is addressed in the policy documents of the departments of spatial planning and water. With the compact city approach that is applied in Amsterdam, extra attention is given to the improvement of the green infrastructure and vulnerability of the water system. Pilot projects were based on 'existing' budgets, such as a subsidy for green roofs that was made available from resources to improve the green infrastructure. The political context in Amsterdam did not aim at a specific performance on climate adaptation which makes climate related responses dependent on individuals within the different departments.

§ 9.2.2 Design integration

The design for the Couperusbuurt neighbourhood is described in this sub-section by means of thematic descriptions.

Enlarging floor space delicately

To attract a larger variety of people to the Couperusbuurt neighbourhood, as the municipality strives for, the small houses need to be redeveloped. To meet the current housing needs of the middle class society the floor space per dwelling, energy performance and amount of parking spaces should increase. The redevelopment proposed here provides for the prevention of up heating of the outdoor environment and an increase of floor space. In following sections is dealt with the energy performance and parking spaces.

At the moment there are two type of dwellings surrounding the courtyards: single family houses with two floors and an attic and mostly ground floor apartments with small private garden which have a second apartment with attic on top. Each floor counts around 54m², with 108m² for a single family house. The average floor space of a contemporary apartment is 78m² and a single family dwelling in the Amsterdam region is 125m² (CBS, 2013). With one additional building layer or additional dormers on the roof the current buildings can be expanded to spacious single family houses of 162 m² and 135 m² respectively.

An additional building layer decreases the solar access in the courtyards, and therewith also reduces the risk of heat stress (Kleerekoper et al., 2015). In case the green in the courtyards is maintained, there is no need to reduce the current risk for heat stress. The access of solar radiation in winter and moderately warm days is even very welcome. This would plead for no additional building layers. However, due to the composition of the wide inner courtyards and the position of the roads along the north side of the buildings the additional building layer will have no significant impact on the solar access inside the houses and gardens. It even provides extra shading on the paved road surfaces, see sketch in Figure 9.4. Nevertheless, it will have a significant impact on gardens and buildings along streets that run in between the courtyard blocks, especially the streets running North-South, with a width up to 20 meters. Therefore, these streets will not have an additional building layer, but dormers to transform the attack into a valuable living space. In Figure 9.5 the building strips with dormers and with an additional building layer are indicated. In a few building strips the floor space per apartment remains the same to maximize the variety in housing supply. On the North-East side of the neighbourhood the three courtyards have a different form and size compared to the rest. Here the exception in the redevelopment strategy of no increase in floor space makes sense. The same goes for the two buildings along the *Burgemeester Rendorpstraat*.



FIGURE 9.4 Sketch of solar angle (61.5°) on the 21 of June at noon with two or three building layers in section AA' in Fig 9.5.



FIGURE 9.5 A redevelopment strategy to increase floor space and the variety in housing supply with attention to solar access indoor and gardens.

Although a higher H/W ratio usually decreases ventilation within a street or courtyard, a differentiation in building heights will increase turbulence and therefore a better mix of air between the canopy layer in streets and courtyards and the boundary layer above the buildings. A better mixing of these layers will accelerate cooling and improve air quality. For the same reason pitched roofs have preference above flat roofs.

Energetic opportunities

First of all, the redeveloped buildings need improved isolation and sunscreens to prevent indoor overheating. When no air-conditioning units will be necessary this also contributes to the prevention of outdoor heat accumulation. With the transformation of, mostly South-East oriented, building strips with an additional building layer an ideal opportunity for solar panels on roofs occurs, for both thermal and electrical panels. Heating energy in winter can be saved by heat and cold storage in the ground per courtyard. A great advantage is the possibility to extract cold from the ground in summer to bring down indoor temperatures without air-conditioning units. In Amsterdam the city heating network can be supplied with additional heat when the seasonal heat and cold demand is not in balance. The building renovation should be adopted to the energy opportunities with for example low temperature heating systems and additional insulation.

Preserving green with courtyard identity

The wish of the municipality to use the inner courtyards for parking is the most economic option to increase parking space. And with some additional measures to the buildings, pavement and additional trees this does not directly decrease

thermal comfort. This was concluded from the simulations presented in chapter 5. Nonetheless, the additional paved surface contradicts with the aim to prevent additional heating up in the first place. Moreover, it would be a destructive option regarding the special garden city concept which is carefully designed throughout all scale levels, from courtyard, to neighbourhood, to district, to park city (Feddes, 2011). Typical for the garden city is the 'in-between' scale which are the green strip and the park strip in the green structure and the neighbourhood and district street in the traffic system. These 'in-between' elements are the connecting elements for green and allow a free choice in the routing network. Figure 9.6 schematically illustrates the green structure. The tree structure follows the hierarchic road structure.

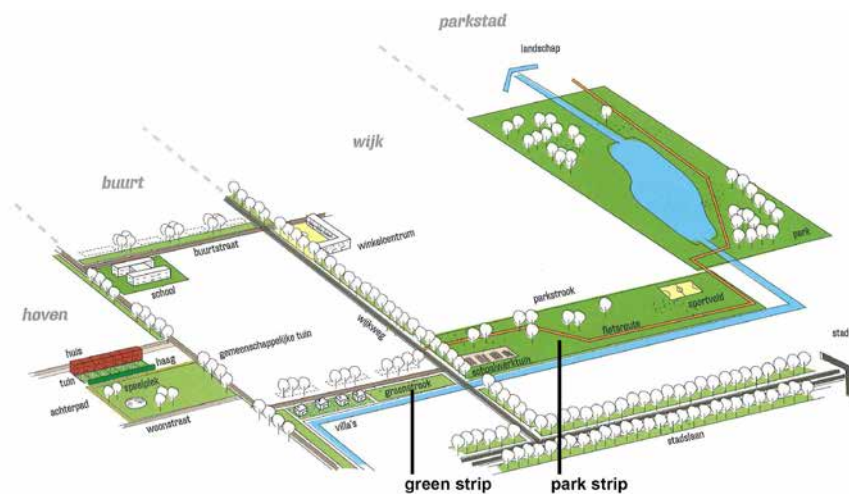

FIGURE 9.6 Schematic illustration of the green structure of most parks in Amsterdam Nieuw-West; they form an entity through different scale levels (Feddes, 2011)

According to the second step, passive cooling needs to be preserved. The chance of preservation can be increased by assigning a function to green space so that the value for inhabitants increases. An alternative function to the inner courtyard should not only enlarge the dwelling comfort, but also fit in the typical green structure where it serves the other scale levels. The additional function to the green is a delicate decision since the dwellers of the courtyard should not be hindered by the new activities. Therefore, a sports field or private allotment gardens would not be appropriate. One can think of a playground, community garden, butterfly and bee garden, water retention basin or infiltration point or fruit and nut orchard.

Increasing parking space

As stated before, additional pavement is not desirable because it leads to an increase in heating up, in this case the additional parking places will also decrease the passive cooling capacity of the grass. This argues not to sacrifice green for parking, especially if there are alternatives to exploit. The current parking space is around 0.6 places per dwelling. With the transformation of two apartments to a single family house the amount of parking space automatically doubles to 1.2 places per dwelling without adding any physical places. No additional parking places are needed, as is explained below.

NO NEED FOR ADDITIONAL PARKING PLACES

The national parking standard per dwelling varies from 1.6 places per dwelling for social housing to 2.3 places for the expensive housing segment (CROW, 2012). This standard does not consider additional factors like public transport possibilities and regulation through parking permits and pay parking which have substantial effect on the parking demand (Bos & Martens, 2015). The Nieuw-West city district has decided to deviate from the national standards weighing the current and projected growth of car ownership and the stimulant they want to create for built parking and alternative initiatives. The parking standard is set to 1.0 places per dwelling for social housing to 1.3 places for the free sector (Gemeente_Amsterdam, 2012).

Travelling by car within Amsterdam is not very attractive because it takes longer than traveling by bike or public transport and parking is a dreadful waste of time and money. On the other hand the alternatives are quite attractive. There is a tram and bus line running along the South side of the neighbourhood. And it takes only 15 minutes by bike to reach the historical centre of Amsterdam and 20 minutes to the central train station. For trips outside the city a car could be more convenient or even indispensable. With the many car sharing companies we can choose from nowadays, the amount of private parking spaces can be further reduced. The high connectivity and density of functions is a unique feature of large metropolitan city like Amsterdam which allows for lower parking standards and offers great opportunities for a different use of the public space.

Another approach to interventions that increase (future) problems with water and heat stress is to demand compensation. This can, for example, be in the form of a green covering over and water storage under the parking or active cooling facilities.

Integrated water system

The Couperus neighbourhood is enclosed by roads that form a dike ring of about 1.5 meter high. The transition from the higher road to the neighbourhood is done with a slope along the high traffic road and with staircases and green along the road next to the canals, see Figure 9.7. Further improvement of the microclimate can be achieved by regulating the water level within the area. More water infiltration supplies trees with enough water to evaporate and cool at full potential. Independent water regulation starts with disconnecting pluvial water discharge from the sewage. This cannot be achieved by simply discharging to the large body of surface water because of the dike ring. The courtyards, green strips and park strips could be very functional to a more sustainable water system that increases the passive cooling capacity.



FIGURE 9.7 The South side (1) has a sloping edge and the North side (2) has stairs to enter the neighbourhood. Dwellings have a higher entrance level than the door to the back yard.

Figure 9.8 presents a water system for the area. The surplus of water is collected in two main buffers with infiltration points. The water will infiltrate up to a minimum level. The water is directed to the basins by open gutters which only contain water during rain fall. Some are integrated in the street or pedestrian pavement, the main discharge flows are integrated in the green strips along the road. In case the maximum buffer capacity is reached, a pump discharges the water to the surface water on the other side of the dike. In case of extra heavy rainfall an additional overflow discharges to the sewer. The extra water infiltration is only possible if the groundwater level may vary. Most of the buildings in Amsterdam are founded on wooden poles which have the risk of rotting when they extend above the groundwater level. After 1920 the wooden foundation poles have a concrete extensions to keep the wooden pole head under water (Gemeente_Amsterdam, 2010). The Couperusbuurt has no risk of rotting because the foundation poles are entirely made of concrete. Therefore the water level may vary according to amount of precipitation and water consumption by vegetation.



FIGURE 9.8 Design of a new water system for the Couperus neighbourhood to disconnect all rain water from the sewage and infiltrate it in the ground or discharge it to the surface water.

The inner courtyards all have their own buffer or infiltration facilities, as illustrated in Figure 9.9 (a and b). Especially in combination with the alternative function that is addressed to it, interesting new urban spaces can evolve. A butterfly and bee garden could be very well combined with, wet flower beds, small water streams and ponds that eventually dry out after the rain, like the example of.. in Figure 9.9 (c). A playground is much more fun with water elements in it, as shown in the example of a water playground in The Hague in Figure 9.9 (d).



1



2



3



4

FIGURE 9.9 Design of water infiltration bodies(1) and water buffer (2) in the courtyards and water garden Darwinpark in Zaandam (Bakker, 2012) (3) and water playground in The Hague (Vos) (4).

Important for an optimal infiltration is to infiltrate at both, the front and the back side of buildings (Votel, 2015). To achieve this the municipal infiltration system described in the previous paragraphs should be complemented with infiltration in private gardens along the roads. Additional benefit in this case can be less pavement and increase of cooling capacity of green close to the dwellings.

§ 9.3 Zuidwal, The Hague

This sub-sections presents the case study for the Zuidwal neighbourhood, The Hague.

§ 9.3.1 Neighbourhood analysis

This neighbourhood was introduced in the previous chapter as part of the historical city centre of The Hague with a commercial character and additional post-war dwellings. The percentage of green and water is very low, less than five percent of the total amount of urban surfaces. Even for this type of neighbourhood, where large pressure on public space and high density of buildings are common, the amount of natural surfaces is relatively low. Street trees are only appearing on squares and along the canal. In the meanwhile, the outdoor space is used intensively, increasing the importance of healthy and comfortable conditions.

In the design process, research and design studies are parallel. Where the design studies raise questions it is sometimes possible to answer or test hypothesis with a research

study. This particular design process started off with the question which neighbourhood is interesting for the municipality of The Hague as a pilot study? A neighbourhood with a high heat accumulation potential was found most interesting. Therefore a first hotspot analyses was performed by a colleague in the CPC project pointing out Zuidwal as hotspot. The following intermezzo gives a short description of the study.

HOTSPOT ANALYSES

Before leaping to possible solutions, insight in the difference of heating up in this neighbourhood compared to other areas in the city provides a better understanding of the heat accumulation and the possible solutions.

LAND SURFACE TEMPERATURE

Several parameters assessed through remote sensing imagery can be used as UHI indicators. One of these indicators is the diurnal Land Surface Temperature. Diurnal LST images provide an overview of the city areas that tend to heat up during the day. Depending on the heat storage capacity of the material this heat is either released to the atmosphere and/or to the interior of the buildings during day time, or during night time.

The land surface temperature analysis of The Hague has been carried out based on satellite imagery (Landsat 5 TM) retrieved during the heatwave of 2006, on the 16th of July at 10:33 h presented in Figure 9.10.

In the Hague several neighbourhoods present average diurnal LST above 41°C: Schildersbuurt, Transvaal, Zuidwal, Brinckhorst and Kerketuinen.

STORAGE HEAT FLUX

Another relevant UHI indicator is the storage heat flux. Storage heat flux maps identify public spaces within a city that tend to radiate more heat at night, but also building roofs with higher heat storage capacity, and therefore a higher potential interior discomfort.

The energy balance equation can be written as:

$R_n = G + H + LE$ (Asrar, 1989), where R_n is the net radiant energy absorbed by the surface, G is the storage heat flux, that is the energy dissipated by conduction into the ground or into the building materials, H is the sensible heat flux, that is the energy dissipated by convection into the atmosphere (its behaviour varies depending on whether the surface is warmer or colder than the surrounding air), and LE is the latent heat flux, that is the energy available for evapotranspiration.

For the storage heat flux analysis of The Hague the same satellite imagery used for the land surface temperature has been imported into ATCOR 2/3 (atmospheric topographic correction software for satellite imagery).

In Figure 9.11 the storage heat flux in The Hague is presented. Two neighbourhoods show an average storage heat flux above 90 W/sqm: Zuidwal and Uilebomen. Zuidwal is (as indicated above) a mix between 17th century Dutch dwellings with post-war dwellings whereas Uilebomen is the high rise district of The Hague.

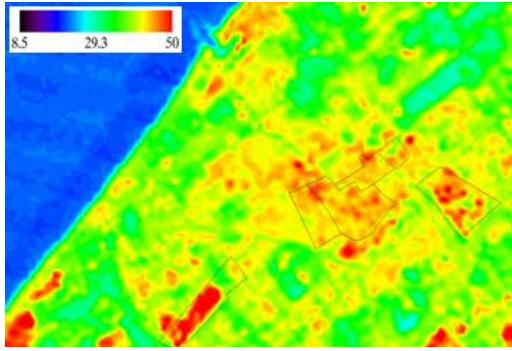

FIGURE 9.10 Land surface temperature image from the 16th of July 2006 at 10.33 UTC.

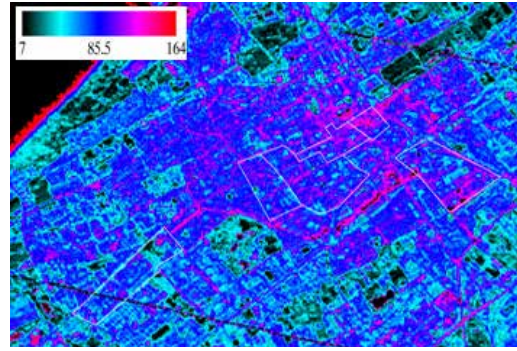

FIGURE 9.11 Storage heat flux image from the 16th of July 2006 at 10.33 UTC.

The neighbourhood that has both, a high LST during the day and a large storage heat flux is Zuidwal. In this area temperatures are relatively high at day time and at night it takes a longer time to cool down compared to other neighbourhoods. Regarding the intensive use of the public space in this part city and the partly residential use of the buildings comfort improvement has the potential to effect many people.

This hotspot analyses is carried out by Echevarria Icaza (forthcoming).

The following sub-section shortly describes the political context and the paragraphs thereafter introduce options to improve thermal comfort in combination with other redevelopment themes for the neighbourhood.

Political context of The Hague

While in Amsterdam a clear choice was made to mainstream climate adaptation in the different departments of the municipality, The Hague did not make an explicit choice. According to the two principles of the dedicated and mainstreaming approach neither is applicable to The Hague. The city district *Haaglanden* (Stadsgewest Haaglanden) has established a regional plan (Structuurplan) that presents the ambition to reduce CO₂ emissions with 30% by 2020 and become 'climate neutral' by 2050 (Witsen, 2008). In this document, no ambition in relation to climate adaptation is mentioned. Nevertheless, there was interest and cooperation from the municipality in the case

study projects of the CPC. Continuity of climate related projects and knowledge is insecure since the city district *Haaglanden* has terminated all operations on 1-1-2015. The district will continue partly within the Metropole Rotterdam The Hague.

§ 9.3.2 Design integration

The design for the Zuidwal neighbourhood is described in this sub-section by means of thematic descriptions.

Shading

In one of the central shopping streets of The Hague, the Grotemarktstraat, the outdoor climate is actually not regulated to provide a thermally comfortable place for shopping or passing through. However, applying measures is a big challenge: every square metre is occupied; on the ground, the facades, the underground and even in the air. Planting trees is extremely difficult due to the underground tunnel underneath and the lack of space on the ground floor. Even though cabling runs through because of the tram, high up in the canopy, space is still available. In the Mediterranean climate, heating of the outdoor space is often prevented by shading devices that cover the whole canopy.

Although a canvas sheet is a solution that belongs to the first priority to prevent heating, in most streets with traffic running through it is not an option because of the reduction air quality. Besides, the shading device is only in place in summer and has no benefits during the rest of the year. An extra benefit of covering a street is the protection against rain. However, compared to trees that have many additional benefits throughout the year, canvas awnings do not serve that many additional benefits.

In case of the Grotemarktsstraat planting large trees is not an option. Moreover, the application takes only a minor intervention since there already is a support system for lightening. And the enterprises and municipality are considering an extension of the system for Christmas decoration. With some additional attachment points, the support system could held up canvas sheets to provide shade on hot sunny days and Christmas decoration and lighting in the winter months. In Figure 9.12 an impression of the Grotemarktstraat with the shading device is presented.



FIGURE 9.12 The Grotemarktstraat in The Hague with canvas sheets to improve thermal comfort on hot days.

The canvas sheets are a temporal measure that will be in place during the hottest period of the year. Nevertheless, the street needs sufficient daylight which can be achieved through the use of light colours, some level of translucency and only covering the North side of the street. In any case, a shading device will reduce indoor daylight as well which might lead to more artificial lighting.

SIMULATION OF EFFECTS ON THERMAL COMFORT

To analyse the effect a canvas shading device can have on thermal comfort the street and surrounding area is modelled and simulated in ENVI-met. Together with the existing situation and two other options that could be possible on the location: trees on the North side of the street and light roofs with an albedo of 0.85 instead of 0.3. In Figure 9.13 the modelled area and the receptor points A to I are presented on a map. In Figure 9.14 the outcome of the simulations is presented in a graph.



THE ENVI-MET INPUT PARAMETERS ARE BASED ON A TYPICAL HEAT WAVE DAY THAT HAVE OCCURRED IN THE LAST 50 YEARS:
 Start Simulation at Day (DD.MM.YYYY): =21.06.2005
 Start Simulation at Time (HH:MM:SS): =05:00:00
 Total Simulation Time in Hours: =10.00
 Save Model State each ? min =60
 Wind Speed in 10 m ab. Ground [m/s] =2.2
 Wind Direction (0:N..90:E..180:S..270:W..) =45
 Roughness Length z0 at Reference Point =0.1
 Initial Temperature Atmosphere [K] =296
 Specific Humidity in 2500 m [g Water/kg air] =7
 Relative Humidity in 2m [%] =65

FIGURE 9.13 The model input in ENVI-met showing the Grotemarktstraat and surrounding in The Hague with receptor points A to I.

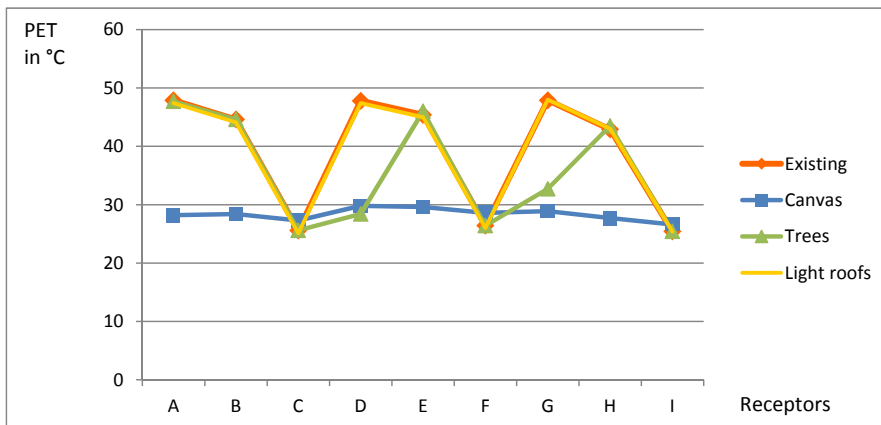

FIGURE 9.14 ENVI-met simulation to analyse the effect of three different adaptation measures on thermal comfort (PET) in the Grotemarktstraat at 13:00 h at a height of 1 meter.

The North side and middle of the street receive the most solar radiation, this is visible in receptor points A, B, D, E, G and H. The canvas sheets lower the PET with about 20°C. The receptor points C, F and I are already shaded by the adjacent buildings at 13:00 h. Interesting enough the canvas sheets cause a slightly higher PET here of around 2°C. This can be explained by the reduction in ventilation caused by the covering sheets. The effect of a single row of

small trees along the North side reduce the PET on this side of the street with 0 to 22°C, depending on the distance from the trees. Light roofs do not significantly reduce the PET. Probably the building height of 15 to 27 meters is too high for an effect on street level. Important to notice is that there is no negative effect at street level either. While for indoor spaces and the city wide UHI the effect can be of importance.

The Zuidwal neighbourhood has many more shopping streets, mainly the streets perpendicular to the Grotemarktstraat. These North-South streets need additional shading devices, such as trees with a wide crown, to keep pedestrians comfortable on the middle of the day. The area knows many narrow streets, these do not provide sufficient ventilation in combination with car emissions. Car use should be avoided in these streets, for example by introducing one way traffic streets or expanding the pedestrian area.

Roofs and façades in control of the urban climate

When the ratio of roof and façade surfaces is much larger than the ground surface they form great potential in controlling the urban climate, but also to produce heat and electricity on a sustainable way. Instead of focussing on one optimal measure that cools passively (reflective or vegetated surfaces) or actively (collectors), a mix of green, white and thermal/electric coverings is a more realistic strategy which enables combinations with user preferences. Depending on the shape of the roof, the construction of the building, the indoor comfort requirements, the electricity and gas consumption and the use of the roof, a choice can be made for the roof or facade covering. In Figure 9.15 the map illustrates adaptation options, including the above mentioned. The other measures presented in the map are dealt with in the following sections.

The use of facades and roofs in conditioning the urban climate can be done passively or actively. Passive measures include stimulating air flow with façade colours or solar chimneys, see chapter 3, section 4 and chapter 6 for more information about these principles. Also increasing the evaporation from these surfaces provides more cooling, for example with green roofs and facades or sponge materials that absorb water. These will be difficult to apply because of the monumental status of most of the buildings. Facades facing a courtyard have less strict regulations, here constructions for climbing plants to shade South and West facing walls are recommended

Zuidwal Den Haag

- - - underground storage for runoff water to supply trees and spray systems in hot an dry periods
- waterplaza to store water with heavy rainfall
- green wall with ivory
- green wall with structural support
- ● ● trees or ivy pergola
- green roofs
- - - underground storage for runoff water to supply trees and srpay systems in hot an dry periods
- flexible canvas sheets
- energy wall that insulates indoor climate
- shadow device for pedestrians and cylists
- permeable pavement
- asphalt collectors
- energy roofs, pv panels or boiler panels catch radiation and use solar heat/light
- existing urban fabric
- ||||| narrow street (H/B > 1,57) NW-SE
car free zone for better air quality
- ||||| narrow street (H/B > 1,57) NE-SW
low car zone for better air quality
- ||||| existing car free zone
- gallery providing shelter for pedestrians against sun and rain
- white roofs cool indoor and outdoor climate
- existing urban fabric



FIGURE 9.15 The Zuidwal neighbourhood in The Hague with a wide range of climate adaptation measures to improve thermal comfort on hot days.

Active cooling measures include the use of running water along roofs and facades or the use of running water within the façade cladding. Especially the latter one could be a realistic option in this historical area because it does not have to show on the outside. With cooling the façade and roof surface both, the outdoor and indoor temperatures are reduced. An energy wall can harvest the heat from the façades in summer to heat up the indoor space in winter. Such a cooling system requires a cold source like a large lake or river or an aquifer for seasonal heat and cold exchange. With using the heated water from the collector wall directly for hot tap water or indirectly for heating in winter the urban climate control system supports indoor climate control and can lead to significant reduction in energy consumption. An alternative is to use an absorption chiller that can use hot water of 55-90°C to cool water to 5-10°C. The cooled water can be used to cool indoor, semi-outdoor spaces and provide cool pavement at places where many people gather or where children play. Another option for the same type of places could be to work with *phase change materials* (PCM's) that absorb energy transforming from solid to liquid. In section 3.4 and 3.5 these energy principles are explained and in the following section the energy potential for a specific location is further elaborated.

Energy producing Spuiplein

To approximate self-sufficiency in energy consumption, which is unavoidable in meeting the national energy agreement before 2020 (SER, 2013), additional options and sources must be used. The first thing to do is: look for possibilities to consume less energy; second: reuse energy; and only as a third step: produce the energy demand that is left with renewable sources (Tillie et al., 2009). In the case of linking climate adaptation to mitigation the first step is already covered in by the previous proposed measures. Indoor comfort and energy consumption have a strong relation in our present-day buildings. Therefore, measures to control the outdoor climate are beneficial in reducing energy consumption for indoor climate control. Vice versa, when no air conditioning units exhaust hot air from inside to the outdoor environment, the first priority to prevent heating is achieved. The second step where the two objectives meet is to re-use heat, which cools the outdoor space in summer (second priority, active cooling) and reduces energy consumption for indoor space heating in winter or other functionalities. Finally, the third step is producing electricity and meanwhile avoiding radiation to reach the roof surface or indoor spaces and to avoid multiple reflection into street canyons (first priority, prevent heating).

The previous paragraphs also tell us that not all roof surface is available for energy production, because another functionality might be preferable. If we look at the potential of the available roof surface when completely dedicated to energy production, only 20% of the electricity and 60% of the heating demand in Zuidwal can be supplied. In Figure 9.16 the energy consumption and in Figure 9.17 the potential production from roofs for heating and electricity is given for 6 hotspot neighbourhoods in The Hague.

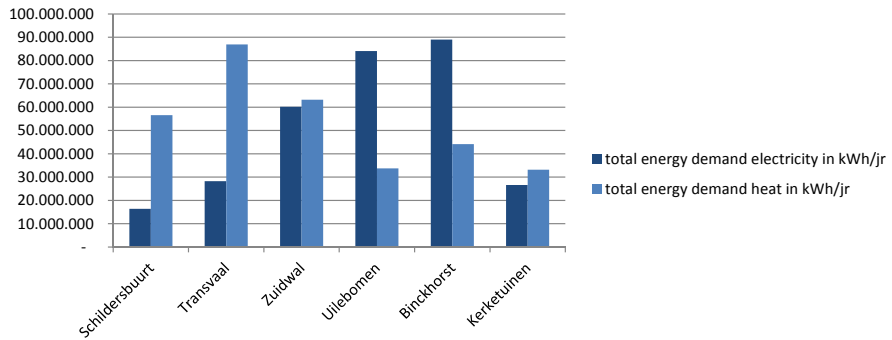

FIGURE 9.16 Total energy demand per neighbourhood for electricity and heat in kWh per year (source municipality of The Hague).

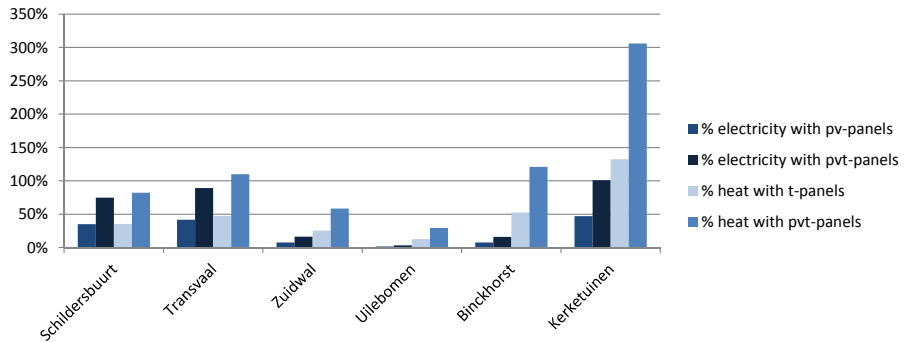

FIGURE 9.17 The potential energy production from the available roof surface in relation to the demand per neighbourhood. The yield is divided in electricity and heat production and shows the difference between using 50% photovoltaic and 50% thermal panels and using a combined panel producing electricity and thermal energy at the same time.

A large square, such as the Spuiplein adjacent to the Zuidwal neighbourhood, has the potential to produce energy. An additional asset, besides the large paved surface of 3600 m², is the dark colour of the pavement that absorbs the solar radiation even more, see Figure 9.18. In the Netherlands heat collectors in pavement have an average yield of 268 kWh/m² per year (Hoes, 2008, Loomans, 2001). As a hypothetical example this square could produce 882,000 kWh per year and provide enough heat for 60 households.



FIGURE 9.18 The Spuiplein in The Hague (Source picture: Fleur van Paridon).

The buildings surrounding the square and facing the South could be transformed into energy walls. The South-West facing wall of the two theatres have a surface of 840 m². Vertical pv-collectors produce 70 kWh/m² per year on average (Meer, 2008, Matuska & Sourek, 2006) resulting in a potential energy production of 60 MWh per year. This would cover about 30% of the electricity demand of the theatre (Stimular, 2015). In case there is opted for a heat producing façade, the yield is about 280 kWh/m² per year (Matuska & Sourek, 2006). The façade fully compensates the relatively low gas demand of the theatre, of around 17.000 m³ per year, and additionally covers the demand for 14 households (Stimular, 2015). The Hague has a city heating network that could easily be deployed to use the heat from the asphalt and/or façade collectors in case no seasonal storage will be realised on site.

The calculation for the heat and electricity production of the façade is based on the fully closed façades of the theatres. In addition, the glass facades of the entrance, lobby and foyer could be used. With transparent systems the yield is lower compared to the closed system, but spaces keep their visual connection to the outdoor space, see Figure 9.19.



FIGURE 9.19 multi-functional facade elements with integrated evacuated-tube collectors enable a view outside developed by University of Stuttgart (BINE, 2013).

Water management

Besides the canal running along the edge of the neighbourhood, rainwater has no other way to leave the streets than through the sewage. Due to the intense use of the public space the ground surface is almost completely sealed. When streets need maintenance or complete redevelopment replacing existing pavement with a permeable variant provides trees with more water enabling passive cooling of the third priority. The permeable pavement alleviates the sewage during peak rainfall events. Also green roofs and facades can contribute to less discharge via the sewage system.

A recent development in urban water management is the combination of urban facilities and water retention to cope with peak rainfall events such as the water plaza Benthemplein in Rotterdam. In the Zuidwal neighbourhood the Kerkplein is a relatively small urban square far from any open surface water. The square can be designed to combine underground water storage in tanks and temporal water storage for infiltration. During peak rainfall events the surplus of water is collected in the open basins. Water is slowly discharged to the underground storage tanks and in case the limit in capacity of the basins is reached it can be discharged quickly to the tanks. The tanks can be used for watering the roof gardens and street trees (second priority, passive cooling), create water mist (third priority, active cooling) or even for flushing toilets. The basins are combined with the existing functions on the square. The first rain water drops are collected in the shallow basins along the tram tracks. A basin with a floating terrace is filled up next, which is discharged long after the rain has stopped so you can have a drink in the sun remembering, and even receiving mist from, the rainfall event of a few days before. A second basin can have the form of a small theatre in the open to support live music, theatre play or book readings. The usual function of a water square as a playground for children is not appropriate for this historical city centre location.

§ 9.4 Bergpolder, Rotterdam

This sub-sections presents the case study for the Bergpolder neighbourhood, Rotterdam.

§ 9.4.1 Neighbourhood analysis

The previous chapter introduced this neighbourhood as one of the old parts of the city centre of Rotterdam. The area has a large ratio of stony surfaces within the urban block structure, while around the neighbourhood the main roads are supported with broad green belts. The following paragraph describes the political context in Rotterdam, the sub-section thereafter introduces options to improve thermal comfort in combination with other assets for the neighbourhood.

The same analyses as presented for Amsterdam in section 9.2.1 is developed for the city of Rotterdam (Hoeven & Wandl, 2015). The analyses is presented in figure 9.20, showing a large spreading in hot areas over the whole city. Locations with vulnerable groups such as elderly and babies are located in the outskirts, especially on the western part of the city. While concentrations of labour activities is largest in the city centre. For the Couperusbuurt neighbourhood, which is situated in this western part, this means that liveability for these groups need to be protected.

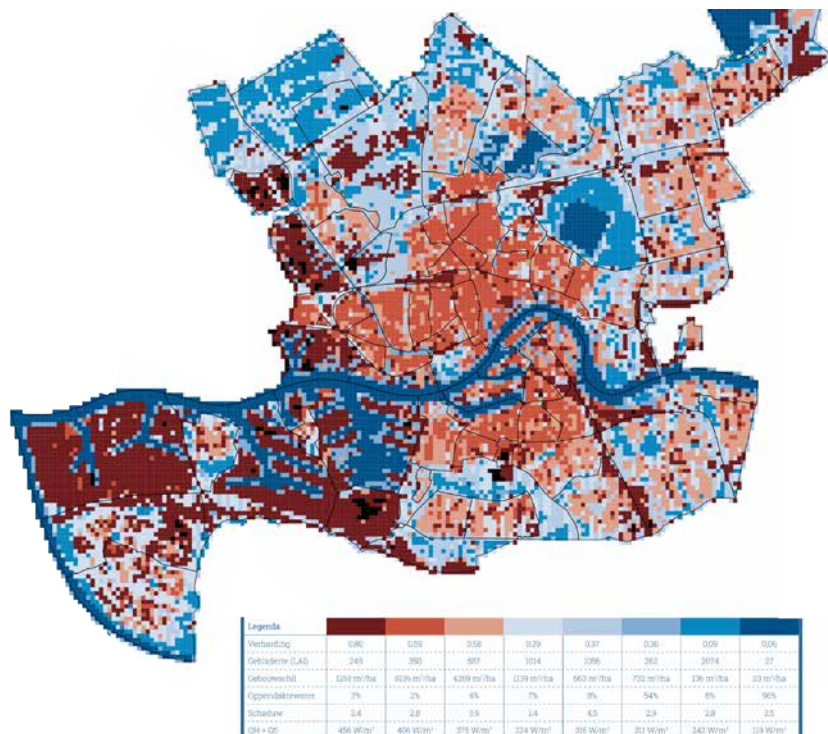

FIGURE 9.20 Physical heat map of the city of Rotterdam (Hoeven & Wandl, 2013).

Political context Rotterdam

The municipality of Rotterdam introduced the Rotterdam Climate Initiative in 2008 from where the Rotterdam Climate Proof (RCP) program was initiated. The RCP program aims for: a reduction of CO₂ emissions by 50 percent by 2025 (in relation to 1990); a 100 percent climate proof city by 2025; and strengthen the city's economy (Molenaar et al., 2010). According to Uittenbroek et al. (2014) this political objective led to a dedicated approach. To provide safety, accessibility and a liveable urban environment, there was a need for 'smart water management'. Because this need was framed as a strength that could profile Rotterdam as a leading city in water and climate solutions, politicians were willing to commit to the issue. A budget and responsibility for the RCP program was assigned to the new climate bureau. An important output of the RCP programme is the policy document Rotterdam Adaptation Strategy (RAS) which received input from research and pilot projects initiated and funded by the RCP program. The specific budgets and political objectives enabled the realization of a floating pavilion, water plaza and green roofs. The Bergpolder case can be seen as one of the research projects within the RCP program. In this case study, objectives of the CPC project and RCP program were joint.

§ 9.4.2 Design integration

The design for the Bergpolder neighbourhood is described in this sub-section by means of thematic descriptions.

Integration project of Climate Proof Cities (CPC)

The Bergpolder Zuid neighbourhood was pointed out by the CPC programme as integration project for all CPC partners. Within the integration project workshops were organised for researchers and stakeholders from the municipality of Rotterdam and the housing association Vestia to come to collective research objectives and to discuss intermediate results (Groot et al., 2014). Figure 9.21 presents the timeline of the project.

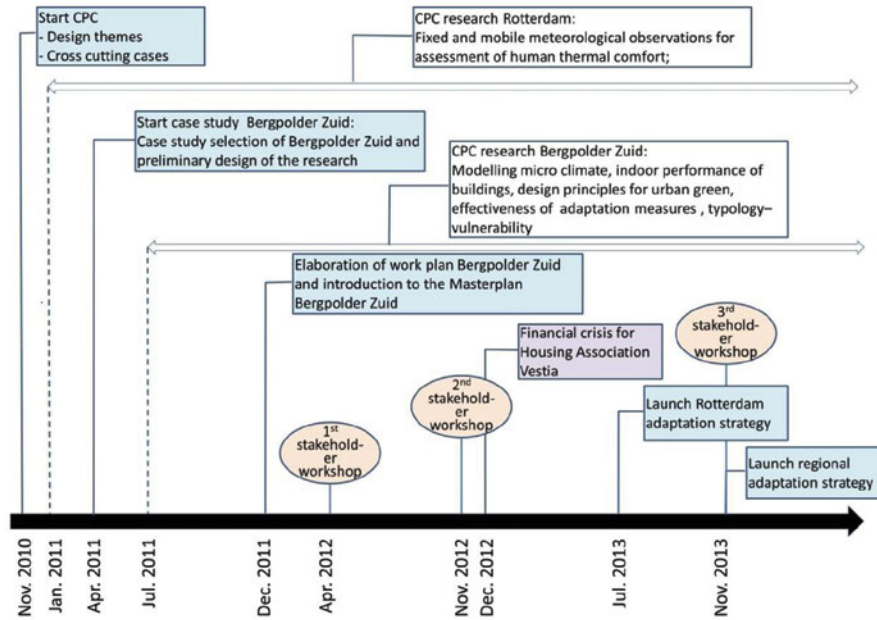

FIGURE 9.21 Timeline presenting the integration project Bergpolder Zuid in the CPC research framework (Groot et al., 2014).

The collaboration of different research groups working on one case provides detailed insight in the effects of a wide range of measures to improve thermal comfort. From measures for indoor to outdoor and for day, night or both. Figure 9.22 presents the range of effect of measures in time of day and type of space. The scheme is useful to keep designers and policy makers aware of the different type of effects that can be achieved instead of only focussing on the magnitude of the cooling effect. If you want to improve thermal comfort in a residential area night ventilation is of greater importance than in an area with offices and shopping streets that is almost deserted at night.



FIGURE 9.22 Overview of climate adaptation measures and their range of effect in time and space.

The integrated research in Bergpolder Zuid started off with observations of the microclimate with fixed and mobile measurements. Compared to the rural surrounding several inner-city areas, including Bergpolder, are over 8 °C warmer in the evening and at night on warm summer days (Hove et al., 2015). The master plan developed by the housing association and the municipality of Rotterdam (Ginter et al., 2011) is simulated in the ENVI-met model to analyse the impact on the air temperature. The results do not indicate a relevant difference as described by Kleerekoper et al. (2012) and presented in Figure 9.23. Therefore, additional measures are needed for a climate proof redevelopment strategy. The following paragraph describes studies into the effect of adaptation measures, mainly water and vegetation, through model simulations and urban design studies by various researchers and designers involved in the integration case.



FIGURE 9.23 Simulation results by ENVI-met in potential air temperature for 7-8-2013, 13:00h at a height of two meters. Yellow indicates 25.5-26°C and orange 26-26.5°C (Kleerekoper et al., 2012).

Outdoor and Indoor overheating prevention

The orientation and H/W ratio are determining parameters to prevent heating of the outdoor environment (first priority). Regulation of solar access can be further influenced by street trees. Different street profiles and orientation require a different tree planting scheme. In Figure 9.24 the solar exposure is given with an appropriate planting scheme for three streets in Bergpolder-Zuid.

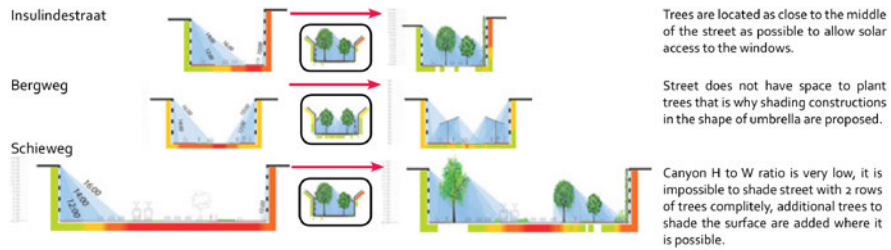

FIGURE 9.24 Solar exposure, appropriate greening scheme and actual design according to the local conditions for three streets in Bergpolder-Zuid (Hotkefica, 2013)

In Bergpolder-Zuid a mix of building types can be found; from historical, via post war, to present-day architecture. The outdoor climate has an influence on the indoor climate and vice versa when, for example, air conditioning is switched on. Simulations are performed with Building Energy Simulation to determine the most effective adaptation measure in reducing indoor temperatures; see Table 9.3. The effect of insulation decreases with newer construction because they already have good insulation values. Overall the best results can be achieved with a sufficient overhang. Also opening windows, increasing the roof albedo and applying a vegetated roof show substantial effects. Note that increasing the facade albedo is less effective in cooling the indoor temperature than increasing the roof albedo. Moreover, a reflective facade can decrease outdoor thermal comfort due to the extra radiation load, as concluded in chapter 5. Another point worth mentioning is the fact that operable windows only have an effect when the outdoor temperature is lower than indoors.

MEASURE	REDUCTION IN OVERHEATING HOURS (%)			
	TYPE 1	TYPE 2	TYPE 3	TYPE 4
Insulation	-7 - 61	-3 - 44	-2 - 30	-1 - 18
Thermal mass	-4 - 4	-1 - 6	0 - 6	0 - 7
Albedo	49 - 91	35 - 69	25 - 58	20 - 51
Overhang	30 - 67	49 - 95	62 - 98	70 - 99
Opening of windows	55 - 67	77 - 96	82 - 89	83 - 91
Vegetated roof	33 - 66	22 - 64	17 - 57	14 - 47

TABLE 9.3 Simulation results in overheating hours for six adaptation measures for the indoor climate of four different dwelling types: dwelling type 1 is a reference dwelling built before 1974, dwelling type 2 is a reference dwelling from 1974 - 1991, dwelling type 3 is a reference dwelling from 1992 - 2011 and dwelling type 4 represents a new dwelling constructed after 2011 (Haak, 2012)

For all building types a specific structure for greening the façade can be designed, see Figure 9.25 for various solutions. A large advantage of overhangs or a façade structure with deciduous climbing plants is the solar gain in winter when the leaves have dropped.



FIGURE 9.25 Various façade structures for climbing plants: window and balcony with overhang (1 and 3) and whole façade (2 and 4) (Liu & Shan, 2012).

Temperature effects of trees and water in Bergpolder

Water and trees can be applied to achieve a passive cooling effect (second priority). A project directed to study the effect of trees and water on the air temperature used two different measurement methods: a glass fibre cable and sap flow in trees. The study indicates a cooling by trees with an average of 3°C. And although the effect of the existing surface water is more complicated to measure, the results indicate a cooling effect of about 1°C (Slingerland, 2012).

To see whether additional surface water could improve thermal comfort in the neighbourhood on warm days, three locations with a water pond are simulated. The simulated ponds are around 600m² and have a depth of 0.3m, see Figure 9.26. The water ponds show to decrease the air temperature with 1 to 2°C at a height of 1.8 metres. The roof pond shows an even higher cooling up to 3.9°C (Toparlar et al., 2013).

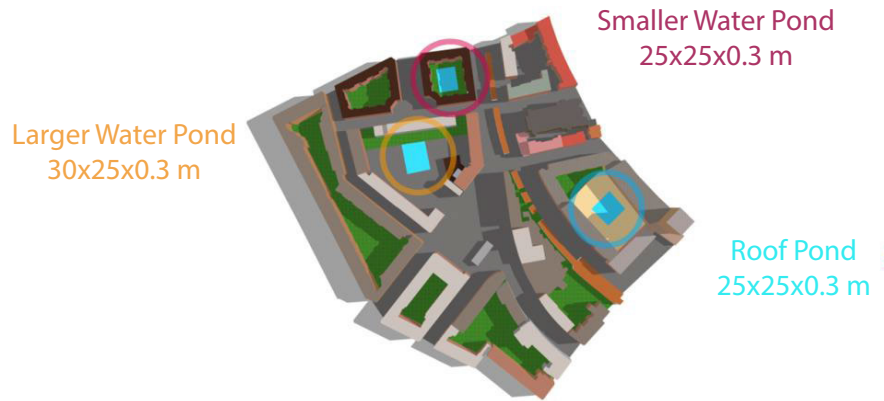

FIGURE 9.26 Water ponds on three locations in Bergpolder-Zuid (Toparlar et al., 2013).

Another cooling option with water is wetting streets, this urban cooling method cools actively (third priority). In Japan this has evolved into an essential tradition called 'Uchimizu'. A test in Rotterdam shows a substantial cooling effect with wetting streets. But if we want to apply this a large amount of water is required, which should be stored somewhere. Rotterdam already has a large water tank that could be exploited for urban cooling. The water storage of 10.000m³ in the parking garage of the museum park would be enough to wet the whole city centre four times (Slingerland, 2012). Depending on the weather forecast, this storage space needs to be emptied since its main function is to prevent flooding during heavy rainfall, see Figure 9.27. A difficulty with spraying pavement and roofs is the lack of additional benefits besides cooling. It might be combined with cleaning the streets, but this is usually done with a water saving cleaning car wiping the streets instead of using a water hose.



FIGURE 9.27 Water storage for heavy rainfall under parking garage Rotterdam (source: IABR.nl)

Cooling breeze on square

A passive cooling method (second priority) can improve thermal comfort on the Insulindeplein and adjacent Insulindestraat. As presented in chapter 6, a dark façade can increase ventilation during warm weather. A former chocolate factory along the Insulindestraat was appointed for redevelopment in the master plan. This opens the opportunity to replace the front façade and apply a multifunctional façade. With a dark colour the façade will reach higher temperatures, causing heating of the air near the façade. The heated air will rise due to the buoyancy effect attracting colder air.

Reference can be made to the former chocolate factory by the use of the dark colour of cacao. In combination with the name of the factory written in the alley an historical value for the neighbourhood is preserved. In Figure 9.28 and 9.29 the building with the dark façade is indicated with the expected generation of air currents.



FIGURE 9.28 Expected thermal induced air currents with a dark façade of the old chocolate factory at the Insulindeplein



FIGURE 9.29 Expected thermal induced air currents with a dark façade drawn into the master plan Insulindeplein

The dark façade can have a negative impact on indoor thermal comfort and energy use in summer, whereas it can have a positive effect on both aspects in winter. To improve thermal and energetic conditions in summer a ‘smart’ façade needs to be developed. A façade with a heat collector to regulate the generation of ventilation and make use of the captured heat can provide the following function: When the radiant force of the sun decreases in the afternoon, the air current is no longer needed. If the collector is switched on at this time of day the accumulated heat in the facade can be extracted cooling both, the indoor and outdoor environment. In any case, the smart façade needs to have additional isolation and sunscreens in front of windows to decrease overheating during the day. The heat collector can harvest heat whole day long in spring and autumn as a regular collector system since in this time of year additional cooling of the outdoor is not needed.

Combining cultural values with cooling measures

Passive cooling measures (second priority) such as additional green can be combined with the preservation of cultural elements in a neighbourhood. In Bergpolder an unused elevated railway track running through the neighbourhood offers opportunities

for community green in the form of a stroll path, urban farm land and restaurants and bars, see Figure 9.30. This concept of giving new life to deserted railways proves very successful in other cities. The highline in New York is the most famous example, other examples are the Promenade Plantée in Paris and the Cypres Community Garden in Vancouver.



1



2

FIGURE 9.30 railway park (Liu& Shan, 2012).

In the area biking is a common transportation mode, as goes for all Dutch cities. However, parking places for bicycles are scarce and if they are facilitated they blemish the street view. Figure 9.31 shows the consequences in the Bergpolderstraat. With a smart parking solution for bikes, see Figure 9.32, that also adds green to the street and functions as water infiltration point this becomes a feasible measures to improve thermal comfort.



FIGURE 9.31 Bicycles parked on unintended locations (left) and intended locations are insufficient and chaotic (right).

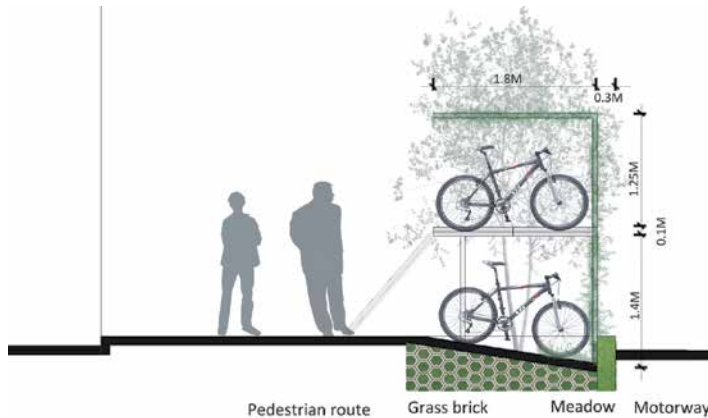

FIGURE 9.32 Smart parking solution for bikes combined with structure for climbing plant (Liu & Shan, 2012).

§ 9.5 Design evaluation

The three integrated design proposals from the previous sections are the output of the followed design process described in section 9.1. The process includes an analysis of the development task, adaptation task and political context, and a maximisation, optimisation and integration step. In Table 9.4 the results of these steps are shortly summarised per case study. Although this design process guides design choices, these choices are still partly based on personal considerations of the designer. This means also other options are possible and can be 'as good'. In fact, this arbitrary aspect is inherent to design and another designer might favour another possibility. The proposed design options therefore are an hypothesis to improve thermal comfort within the specific contexts of the neighbourhoods. This section concludes with reflections on the design processes for each case study.

	NEIGHBOURHOOD AND DESIGNER	COUPERUSBUURT, AMSTERDAM BY AUTHOR	ZUIDWAL, THE HAGUE BY AUTHOR	BERGPOLDER, ROTTERDAM BY AUTHOR AND CPC CONSORTIUM PARTNERS
Analysis	Development task	More variability in housing stock, more parking space	Many constraints: underground track under street, many monuments	More variability in housing stock, increase attractiveness
	Adaptation task	Preserve or compensate green Starting point: preliminary development plans municipality; what are effects on climate resilience of the neighbourhood?	Prevent overheating of shopping customers/passers-by Starting point: inquiry municipality; which neighbourhoods have high heat stress probability?	Prevent heat stress indoor and outdoor Starting point: master plan housing association and municipality; what are effects on thermal comfort and what are 'quick wins'?
	Political context	Mainstreaming approach	No specific political approach	Dedicated approach
Maximisation	What are best options in relation to thermal comfort and neighbourhood characteristics?	Prevent heating: redevelopment of buildings with additional insulation and sunscreens, increase of shadowed pavement with additional building layer and street trees, offer alternatives for additional pavement for parking; Passive cooling: preserving existing green, add surface water, infiltrate rain water; Active cooling: fluctuating groundwater level.	Prevent heating: shading with urban canvas sheets and street trees, reflective roofs; Passive cooling: green facades and roofs, white roofs; Active cooling: solar collectors in walls, roofs and pavement, water storage on square, spraying water mist.	Prevent heating: shading with street trees on optimal location, redevelopment of buildings with additional insulation and green; Passive cooling: water ponds, greening facades, roofs and street furniture, cooling breeze through dark façade colour; Active cooling: sprinkling water on pavement and/or roofs.
Optimisation	What are best options in combination with other climate adaptation options?	Extreme precipitation: additional surface water, wadi's, open gutter system, more vegetated and permeable surface; Drought: more rain water infiltration, flexible groundwater level.	Extreme precipitation: water square decreases risk of flooding; Drought: permeable pavement for water infiltration, water storage on square.	Extreme precipitation: water ponds, street trees and additional vegetated surfaces delay water runoff.

>>>

	NEIGHBOURHOOD AND DESIGNER	COUPERUSBUURT, AMSTERDAM BY AUTHOR	ZUIDWAL, THE HAGUE BY AUTHOR	BERGPOLDER, ROTTERDAM BY AUTHOR AND CPC CONSORTIUM PARTNERS
Integration	What are best options in combination with other context related aspects?	Energy: isolation, sun-screens, lower outdoor temperature in summer, limiting parking space (no increase car use), clean production (collectors and PV cells on roofs and walls); Health: mental benefits provided by green, no increase of PM; Ecology: green habitat for flora and fauna, increase biodiversity (variations in green and additional water); Value: preservation of cultural historical characteristics of green structure, increase value and use of green, relief of sewage system (less discharge), additional floor space without decreasing comfort conditions.	Energy: reflective and green roofs, clean production (collectors and PV cells on roofs, walls and square); Health: mental benefits provided by green walls and roofs; Ecology: green habitat for flora and fauna; Value: increase attractiveness shopping streets in summer (improved comfort conditions), roof parks provide additional outdoor space, relief of sewage system (less discharge).	Energy: isolation, sun-screens, green roofs and walls, energy production by smart façade chocolate factory; Health: mental benefits provided by additional street trees, green walls and roofs, high rail park; Ecology: green habitat for flora and fauna; Value: roof parks provide additional outdoor space, redevelopment of building blocks (mix of housing, housing quality), increase attractiveness by additional street trees, redesign of square, parking under square preserves valuable public space.

TABLE 9.4 Overview of results per step within the integrated design process of the case studies

Couperusbuurt, Amsterdam

The starting point for this case study was set by the preliminary plans of the municipality and their request to gain insight in the effects these would have on the climate resilience of the neighbourhood. Parallel to the integrated design process to improve the outdoor thermal comfort, effect studies with computer modelling provided feedback on several adaptation measures.

From the two proposed measures to improve thermal comfort in the set of measures for the *low open urban block with moderate to much green*, preserving the existing green is a feasible option in this neighbourhood. Also additional measures to prevent heating or increase cooling capacity are applicable within the specific urban context. Especially the preservation of the existing green can be combined with many additional benefits. Optimizing climate resilience is possible with adding facilities for water retention, infiltration and buffer storage in the green spaces. Sufficient space within street profiles enables the transportation of water to the green spaces. The additional benefits of the green with water facilities are numerous and include health and

economic benefits. The renovation of the buildings offer opportunities to increase comfort condition indoor and outdoor in combination with reduction of energy consumption and even energy production.

An important recommendation from this case study is the importance to preserve the ordering principles where the Westelijke Tuinsteden and many other neighbourhoods built between 1950 and 1960 are founded on. These principles have resulted in areas with a comfortable urban microclimate that have the opportunity to adapt to extreme heat waves and heavy rainfall events. From cultural-historical perspective green has a great value, with climate change the same green regains significance.

Zuidwal, The Hague

The municipality of The Hague did not have questions about a particular area, but first needed an indication of the areas that have a high probability of heat stress. Thus, a heat risk analysis was the first step to come to a case study location. The heat risk analysis was done by a partner within the CPC project. The Zuidwal neighbourhood is expected to accumulate more heat than other areas and is an intensive used area with high density. Also in this case study computer modelling provided feedback on the effects of measures on thermal comfort. But in contrast to the thorough effect study for Couperusbuurt the modelling for Zuidwal was limited to one street and only a few measures.

The two proposed measures to improve thermal comfort in the set of measures for the *Middle-high closed urban block with little green* both prove to be applicable in the specific context within Zuidwal. The canvas sheet is an example of the temporary and flexible measures and green roofs and facades of fixed and robust measures. Optimizing climate resilience is possible by gradually replacing pavement with permeable materials increasing infiltration, technical and civil water buffers can be combined with other urban function of a square. The integral design is a collection of many individual measures that need consideration per building or street.

Bergpolder, Rotterdam

In Bergpolder the starting point was again different than the former two cases. Here the municipality and housing association already developed a complete master plan. These stakeholders were interested in the effect of the master plan on thermal comfort condition and if there are 'quick wins' that could be realised without having to alter the complete design or having to allocate a significant larger budget. Another difference compared to the former cases is that the adaptation measures proposed are a collection of expert studies from the collaborating CPC partners.

The set of measures for Bergpolder are initially the same as for Zuidwal since they both belong to the category *Middle-high closed urban block with little green*. In this case a flexible measure that sprays pavement and roofs with water is proposed, however no additional benefits are linked to this measure. While fixed and robust measures such as a dark façade to generate ventilation and additional vegetation do add other benefits. Optimizing climate resilience did not receive enough attention in this case study due to the separate working groups all focusing on a very specific question. The integral design, that was the starting point of the case study, is further improved by the expert studies in relation to thermal comfort conditions. The proposed measures do not require a complete revision of the master plan and most additional costs imply a larger investment with returns on the building scale.

The collaboration of different research groups working on one case lead to a large variety of results. However, the potential of such a unique combination of experts was not fully exploited. The measurement and modelling studies did not focus on the same locations and used different indices to indicate effects of heat stress. Another difficulty in the process was the change in financial means of the housing association that limited the involvement of the most important stakeholder to a minor role.

Although the Bergpolder case was embedded in the RCP program within the dedicated political approach of the municipality of Rotterdam, the area developments did not reach the status of example project where the city could profile itself with. This can be devoted to the explicit focus on research and the change in the economic situation of the municipality and involved housing association.

General conclusion

From the evaluation above I can conclude that the maximisation on thermal comfort often is specific per neighbourhood and location. Optimisation possibilities regarding heavy rain fall and drought can be combined with many heat mitigation measures. However, this depends a lot on the water system, building fundamentals and available space above and under the ground. Integration of measures to improve thermal comfort and deal with heavy rain fall and drought is needed to secure qualitative developments and liveability. In essence, the additional benefits that can be realised together with climate adaptation measures are similar per case study. Reduction of energy demand is an automatic result of lower outdoor and indoor temperatures. Moreover, making use of 'waste heat' through collectors and solar cells clean energy and heat becomes available for other purposes and is a way to prevent heating of the outdoor or indoor space. Using passive and natural cooling techniques, such as ventilation and green, health condition improve i.e. air quality, mental state and more space for outdoor recreation in green. Additional green provides a habitat for flora and fauna and on a larger scale connects habitats. Another common added value of adaptation measures is the possibility to increase the attractiveness of an area and improve aesthetic values.

§ 9.6 Conclusion and discussion

This chapter proposes the maximisation method and an additional prioritisation method to integrate climate adaptation into the design process. The methods are tested in three different neighbourhood designs.

The transformations proposed per neighbourhood typology in the previous chapter are merely a preselection and do not cover all suitable options. Neither do they provide a way how to integrate the measures into the design process. The sub question addressed in this chapter aims to cover this gap: 'How can the transformations proposed per neighbourhood typology (Q4) be applied in an integrated design assignment, combining various heat mitigation measures, linking water adaptation measures and creating additional value in relation with energy, health, ecological, social and economic issues?'

In the method proposed the maximisation step is one of the components of the integration design process. The process starts with analysing the development and adaptation tasks and the political context or view of the client. As the project progresses the focus shifts from analysing to designing. In the first maximisation step, solutions solely directed towards improving thermal comfort in summer are projected on the area. Within the maximisation step a prioritisation based on the 'Trias ecologica' is proposed: 1) prevent heating up; 2) use passive cooling, 3) use active cooling considering the 'New Stepped Strategy'.

The second optimisation step, is directed at linking the favourable solution for thermal comfort to solutions that increase the total resilience of the area to climate change. In this study the additional adaptation task is confined to heavy rainfall events and drought. Measures against flood due to sea level rise or rivers are generally not dealt with at the neighbourhood level and are covered by an extensive research field already. The third and last integration step, aims to find relations between the thermal comfort and adaptation measures and other development tasks in the area. Increasing the quality of life is an important asset for all neighbourhoods. While increasing variance in housing supply is only relevant for some neighbourhoods. Although the three design steps have an order in complexity, which is increasing from maximisation, via optimisation, to integration, it is an iterative process. Solutions that might not seem very promising in the maximisation step can be a 'quick-win' when combined with a development task in the integration step. The other way around is also possible; a very effective measure in relation to thermal comfort might not have links to other developments and therefore lack argumentation and financial means for realisation.

The three design cases in this study show that the maximisation method is applicable for different cases. A strong element of the method is the freedom it provides in

analyses tools, combination of design domains and evaluation tools or criteria. Independent on the available data, mapping and simulation tools, time and expert knowledge the method can still guide the design process. The result is not necessarily the best adaptive design, however a balanced design between climate measures and other assets for a neighbourhood. The method is now tested in three neighbourhoods in the Netherlands. Although they can be seen more as an exercise rather than a real test case since the neighbourhoods did not actually started with redevelopment due to the cuts in public resources of municipalities and housing corporations.

The three design examples represent only two of the seven common neighbourhood typologies presented in the previous chapter. More cases are needed to confirm the applicability of the method in all neighbourhood typologies. In addition it would be interesting to test the method for cases outside the Netherlands. This could be combined with classifying specific neighbourhood typologies for a country or climate zone. Even without a new classification of neighbourhoods test cases in other climate zones are very relevant to test whether the method is universally applicable. In case of different climate zones the first maximisation and the second optimisation step should be redefined towards the climate challenges the area is facing.

The sub-question answered in this chapter contributes to the research question *'How to integrate microclimate in a planning or design process?'* by proposing a method that guides the design process. The method makes explicit which steps are followed and which are not. Thus, not all designs contain a similar analyses of the heat accumulation in the area, nor do they all contain similar computer simulations that indicate the effectiveness. This is actually a reflection of everyday practice where the means and necessity of both types of analyses will vary per situation. Moreover, an important objective of this research is to increase the attention and action in relation to climate adaptation in daily practice. This is attained by offering a set of measures in the previous chapter, a method to structure the design process in this chapter accompanied by three examples.

§ 9.7 Acknowledgments

I would like to express my gratitude to Jan Spaans from the municipality of Amsterdam Nieuw-West, Niels Al from the municipality of The Hague and Jos Streng and Lissy Nijhuis from the municipality of Rotterdam for their input, questions and reflection on the case studies.

§ 9.8 References

- Bakker, M. (2012), "Over Zaansgroen en meer! Watertuin Darwinpark Zaandam": wordperss. Available at: <https://zaansgroen.wordpress.com/2012/08/17/watertuin-darwinpark-zaandam/> 2015].
- BINE (2013), "Facade collectors with perspective": University of Stuttgart, BINE Information Service. Available at: <http://www.bine.info/en/publications/publikation/fassadenkollektoren-mit-durchblick/> 2015].
- Bos, E. and Martens, M. (2015), "Hoeveel parkeerplaatsen zijn er nodig bij een nieuw bouwplan?", Spark and Ecorys.
- CBS (2013), "Twee derde van alle woningen eengezinswoning". Available at: <http://www.cbs.nl/nl-NL/menu/themas/bouwen-wonen/publicaties/artikelen/archief/2013/2013-twee-derde-van-alle-woningen-eengezinswoning-pub.htm> 2015].
- CROW (2012), "Kencijfers parkeren en verkeersgeneratie".
- Dobbelsteen, A.A.J.F. v.d. (2008) Towards closed cycles-New strategy steps inspired by the Cradle to Cradle approach. *PLEA 2008 – 25th Conference on Passive and Low Energy Architecture (CD-rom)*. Dublin: UCD.
- Dooren, E.v., Boshuizen, E., Merriënboer, J.v., Asselbergs, T. and Dorst, M.J. v. (2014), "Making explicit in design education: generic elements in the design process". *International Journal of Technology and Design Education*, Vol. 24, No. 1, pp. 53-71.
- Duijvestein, C. (1993), *Ecologisch bouwen*, Studiegroep StadsOntwerp & Milieu (SOM), Faculteit der Bouwkunde, Technische Universiteit Delft.
- Duijvestein, C. (2002), *Het nieuwe ecologisch bouwen*, StadsOntwerp & Milieu (SOM), Faculty of Architecture, Delft University of Technology.
- Echevarria Icaza, L. (forthcoming), *Urban design measures to adapt Dutch cities and regions to the UHI*, Delft University of Technology.
- Feddes, Y. (2011), *De groene kracht. De transformatie van de Westelijke Tuinsteden Amsterdam*, SUN, Amsterdam.
- Friend, R., Jarvie, J., Reed, S.O., Sutarto, R., Thinphanga, P. and Toan, V.C. (2014), "Mainstreaming urban climate resilience into policy and planning; reflections from Asia". *Urban Climate*, Vol. 7, No. 0, pp. 6-19.
- Gemeente_Amsterdam (2010), "Achtergrond funderingen in Amsterdam". Available at: http://www.zuid.amsterdam.nl/wonen_en/bouwen/funderingen-zuid/funderingen/ 2015].
- Gemeente_Amsterdam (2012), "Creatief parkeren in Nieuw-West. Nota parkeernormen, Uitwerking Parkeerbeleidsplan 2012-2020", Stadsdeel Nieuw-West.
- Ginter, D., Hornis, F., Koot, Y., Ruijven, M.v., Bakker, J., Wingerden, R.v., Verhagen, B., Faber, M., Gorter, C., Pang, K.C. and Burgmeijer, E. (2011), "Masterplan Bergpolder Zuid", Rotterdam.
- Groot, A.M.E., Bosch, P.R., Buijs, S., Jacobs, C.M.J. and Moors, E.J. (2014), "Integration in urban climate adaptation: Lessons from Rotterdam on integration between scientific disciplines and integration between scientific and stakeholder knowledge". *Building and Environment*, No. 0.
- Haak, A.J.C. (2012), "Climate change and heat stress in residential buildings. Evaluation of adaptation measures.", Eindhoven University of Technology, Eindhoven, The Netherlands.
- Hoes, H. 2008. *Energie ligt op de straat. Sterrebeek*: Vito, Terra Energy.
- Hoeven, F.v.d. and Wandl, A. (2013), *Amsterwarm. Gebiedstypologie warmte-eiland Amsterdam*, TU Delft.
- Hoeven, F.v.d. and Wandl, A. (2015), *Hoe ruimte Rotterdam warmer maakt, hoe dat van invloed is op de gezondheid van inwoners, en wat er aan te doen is*, Delft University of Technology, Faculty of Architecture.
- Hotkevica, I. (2013), *Green elements in street canyons. Research by design for heat mitigation and thermal comfort in urban areas*, Mcs, Wageningen University.
- Hove, L.W.A. v., Jacobs, C.M.J., Heusinkveld, B.G., Elbers, J.A., Driel, B.L. v. and Holtslag, A.A.M. (2015), "Temporal and spatial variability of urban heat island and thermal comfort within the Rotterdam agglomeration". *Building and Environment*, Vol. 83, pp. 91-103.
- Jong, T.M. d. and Voordt, D. v.d. (2002), *Ways to study and research: urban, architectural and technical design*, DUP Science, Delft.
- Jong, T.M. d., Vries, G. d., Tjallingii, S., Duijvestein, C. and Sijmons, D. (2015) *The theory of Chris van Leeuwen. Some important elements*. TU Delft.
- Kabat, P. 2010. *Climate Proofing in the Netherlands: Dutch climate research in practice. Deltas in Times of Climate Change*. Rotterdam, pp 14.
- Kleerekoper, L. and Dobbelsteen, A.A.J.F. v.d. (2015), "De ontwikkeling van lokale klimaatadaptatie strategieën": Open Universiteit, Kennis voor Klimaat. Available at: www.coursesites.com.

- Kleerekoper, L., Dobbelsteen, A.A.J.F. v.d., Dorst, M.J. v. and Bruin-Hordijk, T. d. (2012) Climate Proofing Cities - Analysing the effects of heat adaptation measures in Bergpolder-Zuid in Rotterdam. *New Urban Configurations*. Delft, The Netherlands.
- Kleerekoper, L., Dobbelsteen, A.A.J.F. v.d., Hordijk, T., Dorst, M.J. v. and Martin, C. (2015), "Climate adaptation strategies: achieving insight in microclimate effects of redevelopment options". *Smart and Sustainable Built Environment*, Vol. 4, No. 1.
- Liu, Y. & Shan, Y. (2012), Greening Building Blocks to Mitigate Heat. A landscape-based design research in residential areas of Rotterdam., MSc, Wageningen University.
- Loomans, M.G.L.C. (2001), "De Asphaltcollector-berekening van de energetische opbrengst bij gemiddelde weersomstandigheden voor de proefvelden te Hoorn", TNO.
- Lysen, E.H. 1996. The Trias Energetica - Solar Energy Strategies for Developing Countries. *Eurosun Conference*. Freiburg.
- Matuska, T. and Sourek, B. (2006), "Façade solar collectors". *Solar Energy*, Vol. 80, No. 11, pp. 1443-1452.
- Meer, A. v.d. (2008), "De gevel als energiesysteem": Duurzaamgebouwd. Available at: <http://www.duurzaamgebouwd.nl/visies/20080912-de-gevel-als-energiesysteem> 2015].
- Molenaar, A., Barneveld, N.v., Goedbloed, D., Jacobs, J., Jager, W.d., Koeijer, D. d., Kuitert, M., Nimwegen, M. v., Pol, P., Streng, J., Veelen, P. v. and Wirschell, N. (2010), "Rotterdam Climate Proof Adaptation Programme 2010. The Rotterdam challenge on water and climate adaptation", Rotterdam Climate Initiative.
- Pijpers- van Esch, M.M.E. (2015), Designing the urban microclimate. A framework for a design-decision support tool for the dissemination of knowledge on the urban microclimate to the urban design process., TU Delft.
- SER (2013), "Energieakkoord voor duurzame groei", Sociaal-Economische Raad, Den Haag.
- Slingerland, J. (2012), Mitigation of the Urban Heat Island effect by using water and vegetation, Delft University of Technology.
- Stimular (2015), "Milieubarometer podia en theaters": Stichting Stimular. Available at: <http://www.milieubarometer.nl/theater> 2015].
- Tillie, N., Dobbelsteen, A.A.J.F. v.d., Doepel, D., Joubert, M., Jager, W. d. and Mayenburg, D. (2009), "Towards CO2 neutral urban planning: presenting the Rotterdam Energy Approach and Planning (REAP)". *Journal of Green Building*, Vol. 4, No. 3, pp. 103-112.
- Tjallingii, S. (1996), Ecological conditions. Strategies and structures in environmental planning., Delft University of Technology.
- Toparlar, Y., Blocken, B., Janssen, W., Hooff, T. V, Montazeri, H. and Timmermans, H. (2013), "Computational modeling of evaporative cooling to reduce air temperatures during heat waves with application to Bergpolder Zuid". *6th European and African Conference on Wind Engineering, Cambridge, 7-11 July 2013* 2013, pp. 1-8.
- Uit123 (2016), Available at: <http://www.uit123.nl/den-haag/lucent-danstheater/>
- Uittenbroek, C.J. (2014), How mainstream is mainstreaming?: The integration of climate adaptation into urban policy, Dr, Utrecht University.
- Uittenbroek, C.J., Janssen-Jansen, L.B., Spit, T.J.M., Salet, W.G.M. and Runhaar, H.A.C. (2014), "Political commitment in organising municipal responses to climate adaptation: the dedicated approach versus the mainstreaming approach". *Environmental Politics*, Vol. 23, No. 6, pp. 1043-1063.
- Vos, P. "'Bijen op School" Basisschool Wonnebald", Den Haag: Groen en Doen. Available at: <http://www.groenendoen.nu/projecten/1452/bijen-op-school-basisschool-wonnebald/> 2015].
- Votel, M. (2015), Controlling minimum groundwater levels in urban areas. Evaluation of groundwater recharge systems in Dordrecht.
- Witsen, P.P. (2008), "Haaglanden in 2020, internationaal sterk en duurzaam ontwikkeld. Het regionaal Structuurplan 2020 in vogelvlucht", Stadsgewest Haaglanden, Delfgauw.

10 Conclusions

This dissertation concludes by answering the main research question posed in section 1.3:

Which urban design principles can be applied in specific Dutch neighbourhoods to respond to the effects of climate change, especially in terms of outdoor thermal comfort?

The main question will be answered by addressing the contextual question and sub questions. In addition, this chapter offers recommendations for future practice and research and evaluates the scientific and social contributions.

§ 10.1 Answers to the research questions

§ 10.1.1 Answering the contextual research question 1

What is the impact of climate change on the urban environment in the Netherlands?

The local climate in cities is different from rural areas: cities are generally warmer. The future climate change predictions indicate a temperature increase for The Netherlands up to 3.5°C by the end of this century. Furthermore, heatwave occurrence and intensity increases in the Northern part of Europe. Climate change predictions also indicate more heavy rainfall events. This has an impact on urban areas and can be prepared for through smart urban design. The knowledge about this theme is further developed and receives attention in ongoing studies. Therefore, this research includes heavy rainfall as a sub-theme.

The effect of heatwaves is amplified in cities where evaporation from vegetation and soil is often minimal and heat accumulates in the stony materials and building volumes. Many parameters and several programs can be used to indicate heat accumulation. The choice for a certain analyses method depends on the context, size of the area of interest and required accuracy.

High temperatures in cities have an effect on people's thermal comfort perception. In the temperate climate of The Netherlands where people long for the summer after the cold and dark winter months we can hardly imagine 'overheating' and have our mind set to keep our in- and outdoor spaces warm and sheltered. Higher temperatures decrease energy use for heating if we manage to avoid the use of air conditioning in summer. Moreover, warm temperatures offer the opportunity to spend more time outside when outdoor spaces are kept within the comfort range. Uncomfortably high temperatures lead to avoidance of outdoor spaces, less productivity, increase of energy use for cooling and more insects and microbes. Beyond uncomfortable temperatures heat is related to an increase in mortality.

The impact of climate change results in a decrease of comfort in urban areas and can even increase mortality in relation to heat. To keep cities in The Netherlands comfortable new developments and redevelopment projects should contribute to the cities' microclimate, engaging the opportunity to reduce emissions and water- and heat-related risks in combination with many other assets.

§ 10.1.2 Answering the sub research question 2

Which urban design measures can contribute to thermal comfort and/or utilise climate adaptation, especially in terms of precipitation, air quality and energy?

Climate adaptation measures can be subdivided in designing with: green (section 3.1), water (section 3.2), urban geometry (section 3.3) and material and colour (section 3.4). The combination of green and water measures amplify a cooling effect; for the other measures there is no proof of such synergy. Vegetation has the largest cooling potential with an average range from 0.5 to 3°C and with a maximum up to 7°C. Note that the effects are always related to the context: the effect of one single tree placed on an empty square is not equal to a tree placed amongst 20 existing trees.

The feasibility of measures is greater when they do not only contribute to an improvement of the microclimate but also add to others levels. Green measures for example add to air quality, psychological well-being and aesthetical value. Measures that employ water to cool can be combined with water management, water treatment, re-use of water and sustainable energy systems. The urban geometry plays a large role in the access of wind and sun to the built environment; therefore, it has a large influence on thermal comfort, energy and air quality. Roofs and facades influence both the outdoor and indoor climate, depending on their colour or material (including vegetation and water) and in addition have a strong relation with energy use for cooling and aesthetical values.

The wide range of possible measures allows designers to merge climate adaptation measures with other design decisions. As a guide to assist in choosing between interventions the factsheets in Appendix B describe possible measures and discuss the opportunities and threads.

§ 10.1.3 Answering the sub research question 3

What is the indication of general and/or location-specific effects of heat mitigation measures on thermal comfort in The Netherlands?

As concluded above, the context (urban environment, climate, latitude, etc.) of the placement of a tree is relevant for the cooling effect of that tree. This context dependency is true for all heat mitigation measures. Therefore a general cooling effect can only be indicated within a temperature range. A study that minimised differences in context indicates some general effects through numerical simulations.

Air temperature or thermal comfort?

Most studies found in literature analyse cooling effects to air temperature only. Air temperature is relatively easy to measure due to the type of equipment and costs. Another positive aspect is the wide-spread acquaintance of this parameter that allows comparisons with many other measurement or simulation studies. Unfortunately, air temperature alone does not tell us much about the thermal comfort condition on a specific location. The comfort indicator PET (Physiological Equivalent Temperature) also includes air flow, radiation and humidity. In this respect the PET is a better indicator for outdoor thermal comfort.

The PET measurement is dominated by the direct local environment of the measurement point. It varies more than the air temperature: the PET can be very different at one metre distance, while the air temperature is not. Therefore the measurement method is very important when analysing PET. More receptor points lead to a better estimation and evaluation of the effect. The average PET of multiple receptor points gives the overall effect in an area. Still a rationale is important to determine whether you need improved thermal comfort in the whole area or maybe only on a few spots. The recommendation from this study is to place the measurement points on the spots where you want people to feel comfortable and thus focus on the best results at these points.

Effects on thermal comfort

Measures that lead to cooling (in terms of the PET) in the studied areas are: adding vegetation, increasing the building height, a higher roof albedo and a higher wind speed. Measures that lead to up-heating are adding pavement and a lower roof albedo. The simulations reconfirm the significant cooling effect of vegetation. It has by far the largest potential to diminish up-heating, compared to the other adaptation measures studied.

Results from the study that minimised differences in context are presented in Table 4.11 in section 4.4. For example: Adding three trees next to a building results in a decrease of the maximum PET with 20°C, grass versus pavement results in a cooling of 8°C and an additional building can either result in a cooling of 8°C or increase the PET with 10°C degrees.

The H/W (height to width) ratio determines the effect of building height and wind speed. With a high H/W ratio the increase in building height reduces ventilation and radiation of heat back to the atmosphere; the additional shadow has limited effect on street level. With a low H/W ratio an increase in building height leads to a more significant reduction of ventilation, but the shadows directly prevent up-heating at street level. The tipping points for the combined effect of ventilation and shadow on thermal comfort are interesting for further study. Nevertheless, the recommendation coming forth from this study focused on the Netherlands is to strive for broad streets (low H/W ratios) and provide shadow with 'porous' elements for optimal ventilation and with flexibility in shading for seasonal variation. An obvious choice to achieve this are deciduous trees, not only because they also cool actively by evapotranspiration, but have many more assets.

Urban block and neighbourhood level

The simulations performed at both the urban block and neighbourhood level have a good correspondence. The effects at the urban block level have a greater magnitude than at neighbourhood level, but the sequence of up-heating or cooling is the same. The greater magnitude could be caused simply by the larger volume of the neighbourhood domain that is influenced less by the changes in the variants. The urban block and neighbourhood level only show a different outcome for the façade albedo. The effect of the façade albedo does not result in a clear linear relation with higher or lower temperatures at the urban block scale. However, at neighbourhood level there is a linear trend, which shows that a higher façade albedo leads to up-heating.

Airflow by colour

A first exploratory research studied the use of façade colours to enhance an increase of draught and wind speed to improve thermal comfort on hot days with little air movement. The hypothesis is that a cool draft can be generated by creating a local

hot spot with an open connection (e.g. a street or a square) to a cool spot. Wind speed measurements on scale models and at full scale indicate a higher wind speed in case of a dark façade compared to a light-coloured façade. The colour and material of a façade influences the surface temperature, and therefore the possible acceleration of air movement. Building further on the results of this study, designated hot surfaces can be combined with cool spots such as parks. Air flow is then guided from the cool spot to the hotspot.

§ 10.1.4 Answering the sub research question 4

How to integrate the urban microclimate in a design process?

As an introduction to the design method discussed in the following paragraphs, an insight in the role of the urban microclimate in the design process frames the moment of this part of research. The urban microclimate is – at the moment of research – not a theme considered substantially by urban designers and planners. In a design atelier that was dedicated to the urban microclimate the students filled in a questionnaire and were interviewed afterwards. The main question to be answered through the questionnaire and interviews was: What is the role of the urban microclimate in the design process according to urban designers and planners? The majority stated that the role of the urban microclimate in their future designs will depend on the context and client. And is mostly seen as a pre-condition of a qualitative urban space. Additional knowledge about climate adaptation measures is a missing element to have enough confidence in designing for a better urban microclimate.

The urban microclimate can be integrated in a design process by working according to the maximisation method. The method provides a larger role of the urban microclimate in the design process without ignoring other elementary elements of urban development. In this method three steps guide you in the decision making process between the different themes. Before choices can be made an analysis of the area, the development and adaptation tasks and the political context or view of the client is required.

The first step is the *maximisation step*, where solutions are solely directed towards improving one theme. In this research the central theme is thermal comfort in summer. Within the maximisation step a prioritisation based on the 'Trias Ecologica' is proposed to make a choice between measures: 1) prevent heating up; 2) use passive cooling, 3) use active cooling considering the 'New Stepped Strategy'.

In the second step, the *optimisation* step, is directed at linking favourable solutions for thermal comfort to solutions that increase the total resilience of the area to climate change. Here thermal comfort measures that also address heavy rainfall or drought have preference.

The third *integration* step, aims to find relations between thermal comfort and adaptation measures and other development tasks in the area. The other developments can relate to for example energy, health, ecological, social and economic issues.

A complementary answer to the research question is given through three design examples. In three different cities in the Netherlands the maximisation method is applied to showcase examples of the integration of climate adaptation in the design process. It shows that the same method can result in different designs with a lot of freedom in the use of tools, evaluation methods and stakeholder involvement. And last but not least, the designs can motivate and inspire planners and designers.

§ 10.1.5 Answering the sub research question 5

How can neighbourhoods become climate robust considering the morphology of Dutch neighbourhood typologies?

Chapter 8 proposed a neighbourhood typology classification as a first selection instrument of heat mitigation measures.

Microclimate categories

Many indicators can be used to classify urban areas according to their potential to accumulate heat. However, the existing classifications do not align with neighbourhood typologies commonly used by urban planners, designers and policy makers. Therefore, the microclimate typologies presented in this study are aligned with the typology description in 'An urban typology' (Lorzing et al., 2008). The three most important indicators that can distinguish Dutch neighbourhoods in their potential to accumulate heat form the basis of the microclimate categories. These are: building height, form of footprint and the percentage of green/water in relation to the urban surface. The latter 'urban surface analyses' requires additional attention, since it is not limited to the ground surface as usual, but also includes building facades.

Design concepts

The aim of the case study designs is to come to general climate adaptation measures per neighbourhood typology. For seven Dutch neighbourhood typologies a set of climate adaptation measures was selected based on an urban surface analysis and case study designs. These design concepts - presented in section 8.10.1 - guide urban planners, designers and policy makers in choosing climate adaptation measures.

Neighbourhoods can become climate robust by determining the *microclimate category* and apply options from the proposed *design concept* presented per microclimate category.

§ 10.2 Discussion (limitations of the research)

At the start of this research Jos Streng (one of the stakeholders within the Climate Proof Cities (CPC) consortium) posed the following question: "How much adaptation do I get for my euro?" Also the other decision-making parties wanted to know the quantitative effect in order to be able to show the effect of their project (and the public money needed to achieve this). For water safety and nuisance there are existing tools and calculation methods to deal with future scenarios and to calculate what is needed to prevent damage. In order to set a threshold for heat, the CPC consortium was requested to say something about the maximum acceptable temperature, the maximum acceptable UHI or another approach directed at vulnerable groups and their threshold levels.

With such hard thresholds climate adaptation will definitely receive more attention, but it is doubtful if that will also lead to more qualitative and comfortable urban space. I do not think that an ambition expressed in a number of cooling degrees should be formulated. This is not realistic, feasible nor beneficial and raises new questions in how to measure the achieved difference. If you choose to express achievements in degrees difference of the *urban heat island* (UHI) you might as well heat up the surroundings of the cities to accomplish the aims. Where will you measure temperature differences? At which height? In air temperature; or a comfort index such as *physiological equivalent temperature* (PET) or *universal thermal climate index* (UTCI); or in surface temperatures? Do you use one measurement point, a dense grid, glass fibre cables or traverse measurements? Do you measure next to a tree, always in the shade, on roofs, indoor and outdoor?

This research started off with the aim to approach climate adaptation measures both quantitatively and qualitatively. In the first period many simulation studies were performed. We wanted to know the general effect of individual measures, such as

the ΔT achieved with 1 tree compared to the ΔT with 10 trees and ΔT achieved with 1 m² of water compared to 10 m², etc. Due to context and weather dependency of cooling effects no general value could be given. Within the case studies the effects of for example 1 tree vary depending on distance to buildings and other trees, on height, material and colour of the buildings and on the materialisation of the pavement where the tree is placed in. A range of cooling effects approximates our aim, however the values have a large overlap.

In an attempt to out rule most of the context depending parameters we simulated different cooling measures in the same model domain and the same weather and input parameters. Gradually increasing complexity from an open field with different materialization (grass, pavement and half grass/half pavement), changing wind speed and direction, adding one building with different heights, adding two buildings with different heights, changing building form, adding trees in different quantities and positions, adding hedges in different quantities and positions. Many more variations are interesting to analyse, however the limitations in time forced to draw a line somewhere.

Time limitations also confined the amount of simulations in the context of existing urban environments. Simulating multiple adaptation measures for the common types of neighbourhoods in The Netherlands were impossible due to long modelling and running time. Even if there would have been time for a very extensive simulation study for all typologies, the inaccuracies and uncertainties that always occur with computer modelling and simulations undermine the value of such a study. Moreover, the program version ENVI-met 3.1 that was used, was not able to simulate all applicable measures; leaving out measures such as water bodies, energy walls, solar chimneys, green walls, blue roofs, and more innovative ideas. While these measures could be beneficial in heat control and have other positive assets.

As mentioned before, the urban microclimate can be assessed in different parameters. To improve the quality of the urban space and address health issues, human thermal comfort is the most important indicator in this research. A difficulty with thermal comfort is that it is not always measurable: for example a better accessibility and use of green does not result in a degree difference, but the experience of inhabitants does improve; a water playground does not have to be big to offer a place to cool your feet, this has a large effect on thermal comfort, but is hardly measurable in degrees. That means that effects shift from quantitative to qualitative. Here the design studies and guiding models provide a lead.

The urban context knows many actors and domains, the political context varies per city (district) and changes every 4 years, and the physical urban microclimate has a high spatial and temporal variability. All these variables lead to a complex process in planning and design. Simplification of the context does not seem to lead to simple and

general design guidelines that always have a predictable temperature effect wherever applied. To be able to give general guidelines, the level needs to be rather abstract or additional context dependencies must be described. To give an example, an abstract guideline is: 'green generally has the highest cooling potential compared to other measures'. While when placed in a context and daily cycle the guideline can be more precise: 'trees placed in a street canopy with little green, generally have a large cooling effect during the day and can cause a time-lag in cooling down at night'.

Heat mitigation is just one aspect to consider in a qualitative urban space or liveable urban environment during only the summer season. Therefore, measures are preferable when they coincide with additional benefits to liveability or for example energy reduction, even when their cooling effect is smaller compared to a measure that does not have additional benefits. This preference changes when hot conditions are so severe that people escape the city during summer months, as is the case in a city like Madrid. Adaptation measures should always be seen in perspective, also water related measures that are preventing damage by occasional events. Water risks are often seen as more relevant than heat risks, although temporary water on the street can stay within acceptable proportions. Long-term developments often have low priority for authorities because of the difficulty in accomplishing goals within the four years of governing. Nevertheless, goals can still be quantified with stating for example: "I made sure that there is knowledge available to be a resilient city in the climate of 2050" or "The mortality increase per degree Celsius during heatwaves should not be higher in 2050 than in 1990.

The consortium where this research was part of concluded the following: *"The degree of vulnerability in Dutch cities varies strongly within the urban environment. Therefore, the most efficient way to increase climate resilience in cities is through many relatively small and local measures that are tailored to the specific context. A lot of these measures can coincide with major maintenance or renovations. Success is depending on collaboration of many and a diverse range of stakeholders and parties"* (Rovers et al., 2014).

The vulnerability of cities varies strongly depending on location, soil and morphology. The interpretation that many small measures are the answer, is a debatable conclusion because it leaves out measures such as cool air draughts, large green (infra)structures and measures like green and cool roofs that have an effect on the urban climate when applied in large quantities. I believe each type of urban space or each neighbourhood typology requires a different approach, not necessarily by small and local measures only.

More adaptation strategies have been developed within the CPC project concerning heat- and water-related adaptation measures or guidelines and strategies for policy. These can be found on the website knowledgeforclimate.nl or on ruimtelijkeadaptatie.nl.

In this research the redevelopment of existing urban areas is seen as the biggest challenge aiming at climate resilience. New developments were not addressed specifically. Nevertheless, findings in this research from part one and two are also applicable for new developments.

An important aspect in the urban microclimate domain is indoor thermal comfort. Even though it was not the focus of this research, it does require attention because of the many relations with outdoor thermal comfort. The impact of the urban heat island indoor is most pressing at night where it causes sleeping disorders. More attention should go out to the prevention of heating up indoor spaces in summer. Hence, passive means such as solar shading, cool roofs, green walls etc. are important for the indoor climate control. Moreover, they contribute to the outdoor climate in reducing the anthropogenic heat exhaust from air conditioners and – in case of green walls – can cool the environment through evaporation and reduce heat emittance after sunset.

§ 10.3 Recommendations

The field of research with a focus on the urban climate and climate resilience is rapidly expanding. Even so, plenty of challenges still need to be addressed in future studies. In this section some of these are discussed.

§ 10.3.1 Recommendations for future research

Trees versus percentage of green

In this study the percentage of green is expressed based on the land use in the TOP 10 NL (Middel 2002), and an estimation of percentage of green based on google earth imagery. Street trees are not included in the surface analyses. How to easily add tree cover or just street trees? Existing methods such as the NDVI (Normalized Difference Vegetation Index) is a graphical indicator for the amount of green surface for satellite imagery. Here a tree crown above pavement results in the same index as a tree crown above grass. On the large scale this difference might not be relevant, but on the neighbourhood and street scale it is. Another method is the Leaf Area Index (LAI) which is defined as the one-sided green leaf area per unit ground surface area. This approach results in an additional index for trees next to green surfaces.

Water cooling potential

The effect water elements have on the urban microclimate is generally quite small. With wide rivers or canals it is the combination of the water and ventilation that increases the effect. With shallow water the heat absorbed by the water quickly reaches a point where it becomes a heat source after sunset. Water can be very effective in cooling when sprayed, but this effect remains very local. A question that is interesting for future research is: how can we use water for cooling in existing streets? How can the sewage system or city heat transport network contribute to cooling?

Simulation versus design tool

In common practice, little information is consulted about the urban microclimate during the design process. One reason is the lack of a microclimate analyses tool that is tailored to the existing urban or building design tools. An idea could be to make an add-on for Sketch-up or Revit that is compatible with BIM software or use the commonly used Geographical Information System (GIS). Another focus for research would be to increase accuracy and decrease running time.

Façade colouring

In chapter 6 of this thesis an explorative study in creating drafts through façade colouring is presented. Further research questions in this area are:

- What is the ideal or maximum distance for this principle to work optimally?
- What should the temperature difference be?
- Is this principle only working from one street-end to another, or does it allow for crossings or winding roads?
- What is the influence of street trees on the increased airspeed?

Building further on the results of creating drafts through façade colouring (chapter 6), hot surfaces can also be combined with cool spots such as parks. Air flows are then guided from the cool spot to the hot spot.

Outdoor and indoor climate control

The influence of outdoor climate regulators on the indoor climate and vice versa are interesting for further research. For example, the reflectivity of the building envelope seems to sort different effects applied on the façade or the roof. The effect of a reflective roof on the indoor climate is larger than the effect of a reflective façade. And, the effect of a reflective roof on the outdoor climate generally leads to cooling, while a reflective façade can locally cause heating of urban spaces. Is there an optimum for both indoor and outdoor climate? Can we set a range for a save albedo for roofs, facades and roads.

Thermal comfort tipping points

A recommendation from this study is to strive for broad streets (low H/W ratios) and provide shadow with porous elements for optimal ventilation and flexibility in shading for seasonal variation. Nevertheless, the tipping points for the combination effect of ventilation and shadow on thermal comfort are interesting for further study.

Typologies

The typologies presented in chapter 8 have not all been elaborated into (at least three) design solutions. In order to generalise and strengthen the set of adaptation measures per neighbourhood typology more case studies need to be done. Another valuable expansion in line with this method is to find the specific measures for water robust neighbourhoods.

§ 10.3.2 Recommendations for future planning and design

Water plan & heat plan

A new development plan needs to meet norms and zoning plans. The water plan (in Dutch: watertoets) is a governance tool to embed ambitions and requirements of the water system. Ambitions for water management can be described in type of systems and their performance in amount of water in mm. If we want our urban environments to be as resilient to heat as we make them resilient for rainwater, a heat plan (in Dutch: hittetoets) should be developed that can be part of the environmental impact report. This could consist of heat maps indicating thermal comfort conditions, vulnerable people and buildings. A design for a new development should address the vulnerable areas. If a threshold is desired more research is needed to be able to determine the threshold value and the software to produce heat prediction maps needs further development.

An alternative option to deal with heat can be to address it in a qualitative way. A municipality can set an ambition in heat adaptation measures. For example: each square meter of pavement should be accompanied with a square meter of natural surface, either on the ground, façade or roof. Or, the neighbourhood typologies can be used as a framework. They can be further developed into three levels of resilience to heat accompanied by (a set of) measures to reach that level; a municipality can determine the ambition level in line with the available budget.

Climate control and energy reduction

The artificial climate control inside buildings demand a lot of energy. With climate sensitive design of the outdoor environment indoor cooling and heat demand can be reduced. Another means to reduce energy demand by buildings is to use seasonal storage supplied by urban surfaces. These 'smart' surfaces can contribute to indoor and outdoor climate. More of these win-win situations should be implemented.

Taxes

More natural surface in urban areas contributes to the microclimate and water management. A discount on water taxes can motivate people to de-pave their garden or install a green roof or green facade. Water boards can apply this financial incentive when private property owners store and infiltrate a rain shower up to 25 mm per hour. Note that after installing storage devices yearly control is required to make sure this is still the case.

When more and more private property buffers rain water, the municipal water system can be scaled down. This does mean that private areas than have a responsibility in water management that must be very clear and may even need to be included in the zoning plan. Damage by flooding is not insured if a private party does not meet the zoning plan requirements.

Responsibility

As Bosch & Pasztor (2012) state in their report: 'Estimating and documenting costs (and benefits) is essential in gaining political support to the design of adaptation strategies'. Such estimations often exclude qualitative benefits like improved health, ecological values and happiness. When this is the case, the responsibility that politicians and designers of urban space have in their profession to aim for qualitative living environments is disregarded. Planners and designers need to be aware of quality and liveability.

Urgency and threshold

The new 'Delta decision spatial adaptation' (Deltaprogramma, 2015) forces municipalities to consider climate adaptation measures in order to keep urban areas water robust and climate resilient. This leaves an open interpretation of the definition of water robust and climate resilient. What are the thresholds we find acceptable in relation to heat stress? How do we dedicate financial means to climate adaptation purposes? Or should all measures have co-benefits to be able to allocate money for realization?

Costs and benefits

When the financial picture of adaptation measures is asked, an overview of the realisation costs, maintenance costs and prevented damage costs for a certain period is possible for rain water. For heat, costs can be difficult because measures are not only applied for the sake of cooling. And, often they concern new ideas that still have to be developed. Prevented damage costs are even more difficult to adopt in a financial overview. The gains such as less heat related deaths or doctor visits requires a value for human lives. A gain, such as higher labour productivity or better sleep quality, might not be of interest for the party that is in the position to invest. When the problem owner and investor are different parties the values created do not result in arguments to invest. When these issues are not overcome by developing parties themselves, municipalities should demand a climate adaptation action or ambition level to enforce investments to cope with extreme weather events. It is likely that cities will come up with ways to pursue adaptation measures since there usually is the desire to be 'sustainable', 'liveable' or 'happy'.

§ 10.4 Final words

The research in this thesis offers a better understanding of the effects of urban design measures that can contribute to the urban microclimate. The thesis indicates potential strategies and proposes solutions to improve the climate resilience of urban areas.

The scientific contribution of this research is to generate knowledge on how to apply climate adaptation measures in a specific urban context. To start with, a profound inventory of the cooling effects described in literature is published for the scientific field (Kleerekoper et al., 2009) and the practical field (Döpp et al., 2011). This research project indicates promising combinations of adaptation measures in interaction with other urban functions. An example is the numerical analyses of different design variants for an urban block (Kleerekoper et al., 2015b) or the typological design solutions for climate resilient neighbourhoods (chapter 8). In the design process new ideas for adaptation measures and strategies are generated. Such as an explorative study to increase thermal comfort through passive ventilation based on façade colouring (Kleerekoper et al., 2015a).

The practical findings in this research relate to the effectiveness and applicability of measures. To bridge the gap between the extensive and complex scientific knowledge about climate adaptation measures and the practical world where time is money factsheets (Appendix B) are developed to assist urban designers, planners and policy makers in the design process. To inspire people and motivate action in realizing climate

robust urban areas an informative movie is produced (Kleerekoper et al., 2013). For anyone interested to learn more about the urban micro climate and climate resilience the online course “The development of local climate adaptation strategies” (in Dutch) is available (Kleerekoper & Dobbelsteen, 2015). The case studies in this research have been appointed by municipalities. In several meetings with stakeholders questions and new insights were exchanged enriching both the redevelopment project in practice and the research case study.

This research approached the design of urban neighbourhoods in relation to its influence on the urban microclimate. In the context of the Climate Proof Cities (CPC) research project it is the neighbourhood scale level and focus on design that distinguishes this research. Close related studies concern the work of Echevarria Icaza (forthcoming) on the larger city scale and Hooff et al. (2014) on the building scale. Parallel to the simulations performed in this study Schrijvers (forthcoming) developed a calculation program to reach a higher accuracy in urban modelling. Various supplementary studies with a focus on water and thermal comfort were part of the CPC project. From which especially the work on thermal comfort and green by Klemm et al. (2015) has a close relationship to this research. The implementation of measures coming from research above requires a view on the governance of climate adaptation. The analyses by Uittenbroek (2014) provides a view on the applicability of climate adaptation measures within the governance context in The Netherlands.

Beyond the CPC project, this research links to the design of public spaces such as squares and parks in the work of Lenzholzer (2013) and the development of a framework for a decision support tool by Pijpers- van Esch (2015). They address the complex interaction of different parameters in urban microclimate and urban design in general in different combinations and level of scale and detail. And therefore, can be seen as complementary to this research and vice versa.

Climate robust design stands for comfortable, healthy and safe urban environments. Adaptation to climate change should both prevent damage caused by and seek benefits from climate change. The numerous co-benefits of green plea for preservation and extension of green. Especially relations between climate control and energy reduction and production are promising in highly urbanized areas: combine indoor and outdoor climate control. Urban areas can benefit from improvements in thermal comfort and energy systems, even in their current situation. Therefore, this research is still relevant even if, against predictions, climate change effects do not intensify.

§ 10.5 References

- Bosch, P. and Pasztor, A. (2012), "Guideline costs of adaptation measures", TNO.
- Deltaprogramma (2015), "Werk aan de delta. De beslissing om Nederland veilig en leefbaar te houden.", Deltaprogramma 2015.
- Döpp, S., Klok, L., Janssen, S., Jacobs, C., Heusinkveld, B., Kleerekoper, L., Lenzholzer, S., Brolsma, R., Blocken, B., Bosch, P.R., Heijden, M. v.d., Daanen, H., Timmermans, H., Hensen, J., Broeke, H.t., Klemm, W. and Uittenbroek, C. (2011), "Kennismontage Hitte en Klimaat in de Stad", Climate Proof Cities Consortium.
- Echevarria Icaza, L. (forthcoming), *Urban design measures to adapt Dutch cities and regions to the UHI*, Delft University of Technology.
- Hooff, T., van, Blocken, B., Hensen, J.L.M. and Timmermans, H.J.P. (2014), "On the predicted effectiveness of climate adaptation measures for residential buildings". *Building and Environment*, Vol. 82, pp. 300-316.
- Kleerekoper, L. and Dobbelseen, A.A.J.F. v.d. (2015), "De ontwikkeling van lokale klimaatadaptatie strategieën": Open Universiteit, Kennis voor Klimaat. Available at: www.coursesites.com.
- Kleerekoper, L., Dobbelseen, A.A.J.F. v.d., Ham, E. v.d., Hordijk, T. and Martin, C. (2015a), "Creating drafts in urban settings through coloured façades: Exploring a new climate adaptation measure based on thermal stratification". *Urban Climate*, Vol. 14, Part 2, pp. 290-300.
- Kleerekoper, L., Dobbelseen, A.A.J.F. v.d., Hordijk, T., Dorst, M.J. v. and Martin, C. (2015b), "Climate adaptation strategies: achieving insight in microclimate effects of redevelopment options". *Smart and Sustainable Built Environment*, Vol. 4, No. 1.
- Kleerekoper, L., Esch, M.M.E. v. and Salcedo Rahola, T.B. (2009), "How to make a city climate-proof, addressing the urban heat island effect". *Resources, Conservation & Recycling*, Vol. Special Issue: Climate Proofing Cities.
- Kleerekoper, L., Lenzholzer, S., Molenaar, A., Goedbloed, D. and Ammers, H. (2013), "Voor een beter stadsklimaat": Kennis voor Klimaat. Available at: <http://www.youtube.com/watch?v=t9Ph-MKZ3q4> [2015].
- Klemm, W., Heusinkveld, B.G., Lenzholzer, S. and Hove, B. v. (2015), "Street greenery and its physical and psychological impact on thermal comfort". *Landscape and Urban Planning*.
- Lenzholzer, S. (2013), *Het weer in de stad. Hoe ontwerp het stadsklimaat bepaalt*, Nai010 uitgevers, Rotterdam.
- Lorzing, H., Harbers, A. and Schluchter, S. (2008), *Een stedenbouwkundige typologie*, Ruimtelijk Planbureau, NAI, Rotterdam.
- Middel, G. (2002), *TOP 10 data set P1661*, Topografische-Dienst, Data Archiving and Networked Services.
- Pijpers- van Esch, M.M.E. (2015), *Designing the urban microclimate. A framework for a design-decision support tool for the dissemination of knowledge on the urban microclimate to the urban design process.*, TU Delft.
- Rovers, V., Bosch, P. and Albers, R. (2014), "Eindrapport Climate Proof Cities 2010-2014", Knowledge for Climate, Climate Proof Cities Consortium.
- Schrijvers, P.J.C. (forthcoming), *Urban Climate at Micro-Scale: Analysis and Adaptation*, Delft University of Technology.
- Uittenbroek, C.J. (2014), *How mainstream is mainstreaming?: The integration of climate adaptation into urban policy*, Dr, Utrecht University.

PART 4 Appendices

Appendix A Sustainable Urban Water Management – A collection of studies about strategies and techniques

Although the focus of the thesis is on urban heat stress, urban areas also need to be prepared for heavy rainfall events. In this appendix strategies and techniques about sustainable urban water management are collected. The first part concerns strategies for the design design and the second part presents techniques for sustainable water management .The third part shows options for water storage.

A.1 Strategies for design

A.1.1. Water management

Managing flood risks

Catchment scale:

- Flood attenuation and temporary water storage, including use of greenspace

Neighbourhood scale:

- Sustainable drainage systems
- Widening drains to increase capacity
- One-way valves
- Green roofs
- Managing flood pathways to cope with heavy rainfall events

Building scale:

- Rain proofing and overhangs
- Flood resilient materials
- Removable household products
- Raising floor levels

Managing water resources and quality risks

Catchment scale:

- Abstraction controls and licensing
- Managing point source pollution
- Creative use of waste water from treated sewerage
- Upland and lowland reservoirs

Neighbourhood scale:

- Effective storm overflow management
- Tighter water efficiency standards
- Separate drainage systems for surface water and foul water
- Water reclamation and reuse
- Utilisation of low grade aquifers for irrigation of trees and green space in urban areas
- Sustainable drainage systems
- Xeriscaping¹³

Building scale:

- Rainwater harvesting and storage
- Water efficient fixtures and fittings
- Grey water recycling

The diagrams in Figure A1 and A2 summarise the range of actions and techniques available to increase adaptive capacity. Details are given in the report (Shaw et al., 2007).

13

Xeriscaping refers to landscaping and gardening in ways that reduce or eliminate the need for supplemental water from irrigation.)

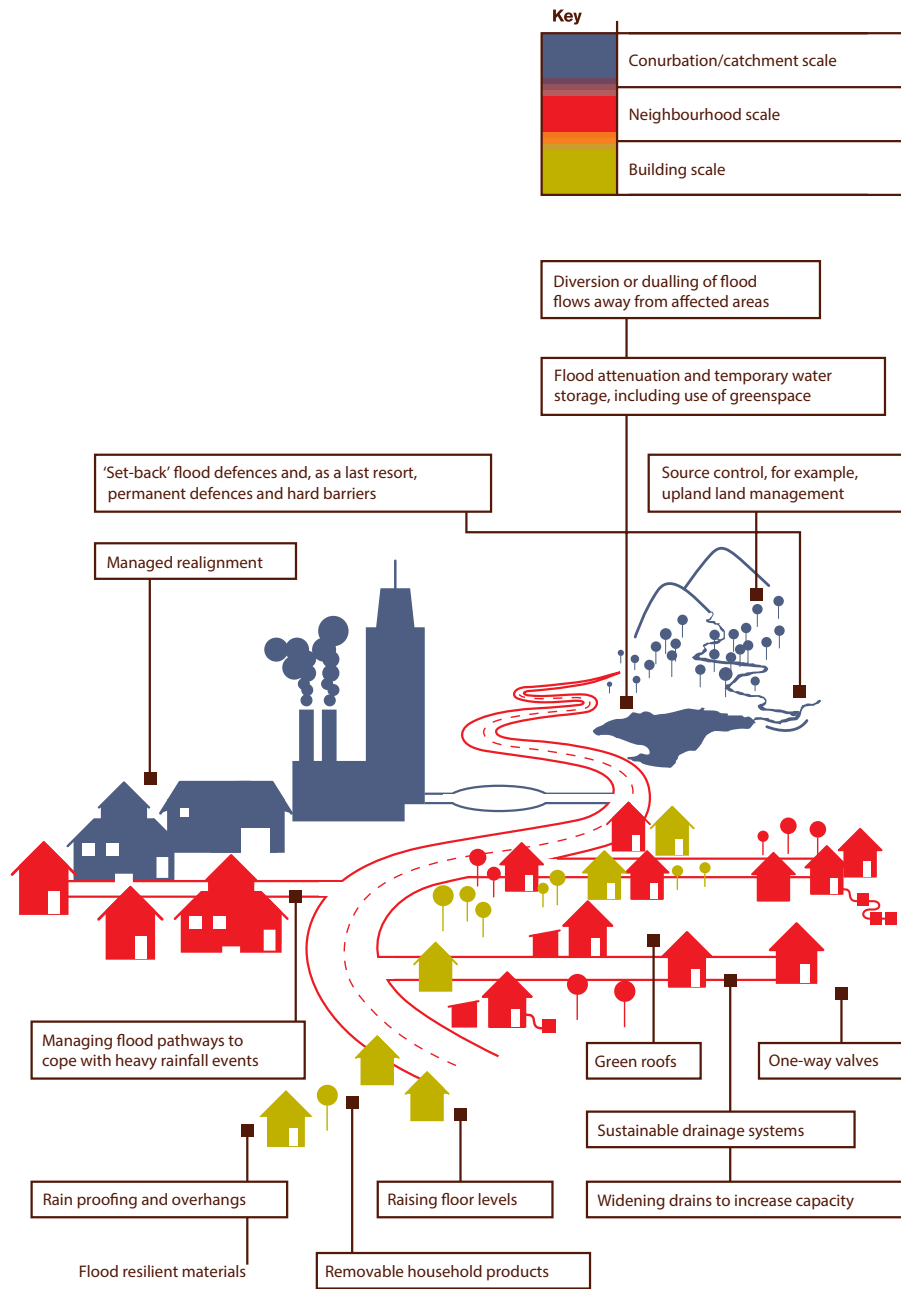

FIGURE APP.A.1 Range of actions and techniques available to increase adaptive capacity (Shaw et al., 2007).

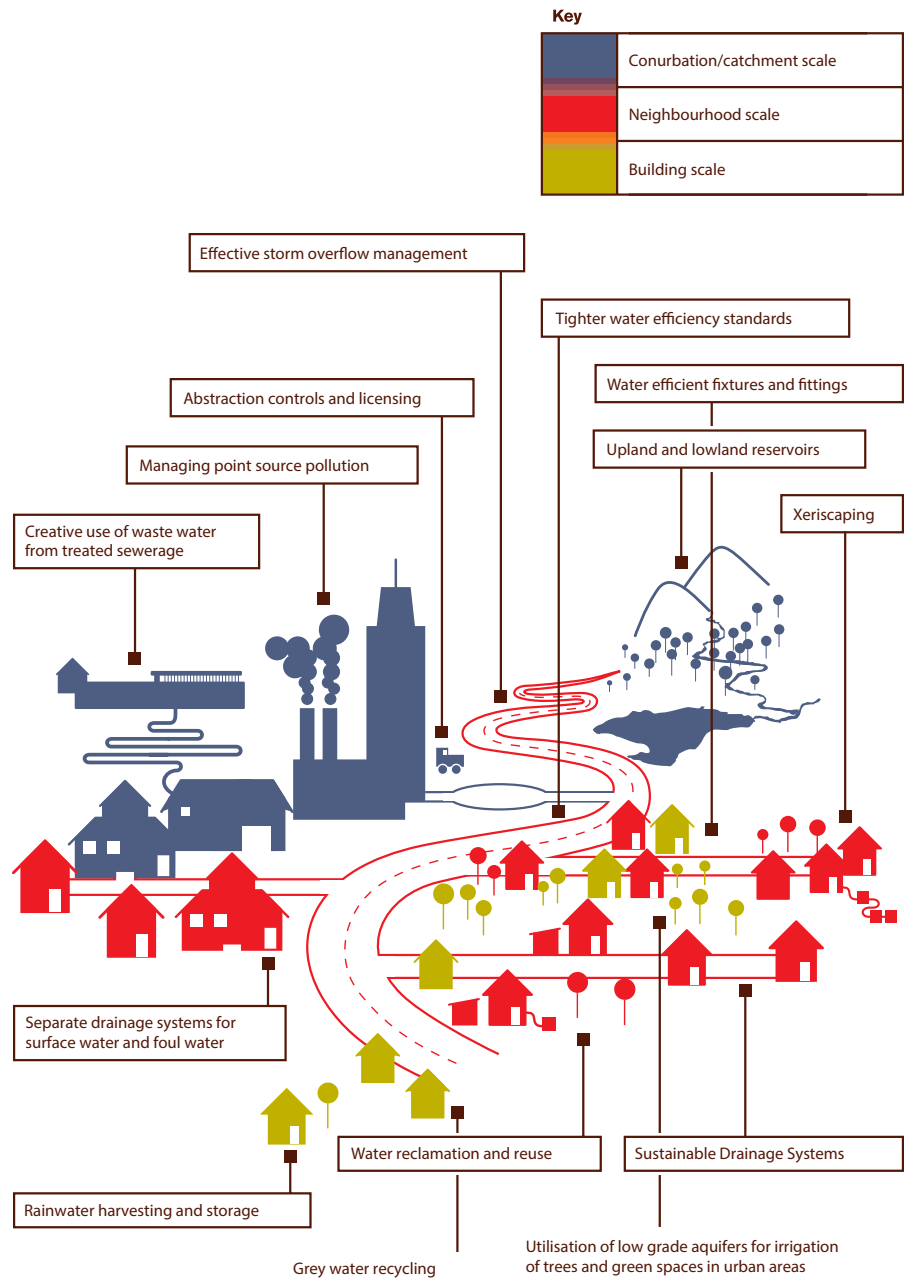

FIGURE APP.A.2 Range of actions and techniques available for managing water resources and quality risks (Shaw et al., 2007).

Thirteen guiding models for water storage in the Dutch river areaS

The analytical scheme can be filled out as follows (see right page). The overview presented in Figure A3 illustrates several water storage techniques which are possible in various spatial strategies, or where 'active' or 'passive' techniques are an issue. An active water storage technique entails the need for digging operations and water that must be pumped into a specific location. Passive water storage means that an embankment is constructed to facilitate additional water storage on the (existing) water disc.

Guiding models:

- 1 Enlarged water ribbons, a substantial addition to the inner-dike ecological main structure;
- 2 Flexible level management, change the water storing capacity;
- 3 Historical quays, new functions for a forgotten remarkable landscape element;
- 4 City and village edges, looking for new habitats and characteristic sceneries;
- 5 Built-up areas, water storage in the immediate living environment;
- 6 Mineral and potable water extraction, the water board emphasis cooperation with public utilities;
- 7 New Dutch water line (Nieuwe Hollandse Waterlinie), seasonal and/or peak storage in the former inundation fields;
- 8 Water and greenhouses, sophisticated water technology makes high-level horticulture less dependent;
- 9 Water estate, living/working in a green/blue rural area;
- 10 Water in sight!, living and working at the water on sight locations;
- 11 Decrease land surface, digging off left-over areas, all small parts are useful;
- 12 Water storage on land, blue services for temporary water storage;
- 13 Sports water park, sport and recreational areas, also suitable for inundation.

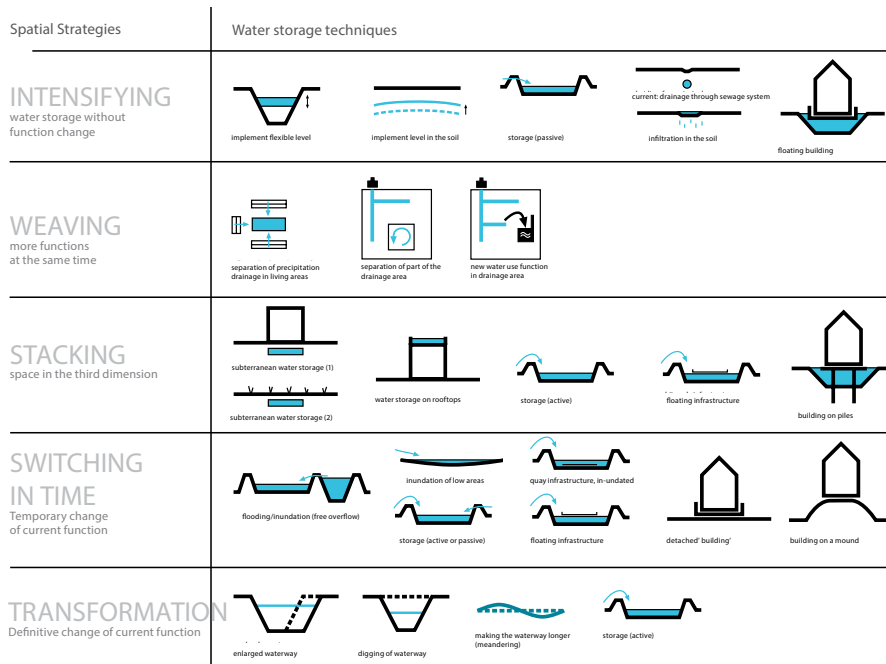

FIGURE APP.A.3 Overview of water storage techniques for each spatial strategy (McCarthy et al., 2004)

Urban Green-Blue Grids

Design tool for sustainable and resilient cities by the use of green-blue grids (Potz and Bleuzé, 2012)

Design principles and case studies for water management

Innovations in urban water management to reduce the vulnerability of cities (Graaf, 2009)

Building water robust

- Design guidelines water robust building (Ven et al., 2009)
- Water robust dwelling types (Roggema, 2009, pag 208)
- www.waterbestendigbouwen.nl

Flood risk as spatial challenge

Guidelines for floodrisk management for rivers and the sea (Pols et al., 2007)

Method to develop sustainable water management

Transdisciplinary/game (Haasnoot et al., 2009)

Watering our cities

The capacity for Water Sensitive Urban Design to support urban cooling and improve human thermal comfort in the Australian context (Coutts et al., 2013)

A Toolkit for Delivering Water Management Climate

Adaptation Through the Planning System

This toolkit is developed for national policy and therefore has a high abstraction level (ESPACE, 2005). The three themes addressed are: responding to pressures on water resources, responses to address flood risks and responses to increase built structure resilience.

A.2 Techniques

A solution for separate rainwater discharge on top of the existing sewage system

The municipality of Best, a town in the South of the Netherlands, has the ambition to completely separate rain water discharge from the sewage system. They placed a styrofoam manhole on top of a vulnerable old drain tube from the overflow. Due to a lack of space and the soil condition a concrete pit of 20 tons was no option (Bouwereld, 2010). The new lightweight pit decreases costs for sewage treatment, is a gain for the environment and reduces the risks of water nuisance in the centre.

SUDS

SUDS approaches include:

- Preventive measures including good housekeeping and rainwater harvesting;
- Reduced UHI effect by filter strips and swales. These are vegetated landscape features with smooth surfaces and a gentle downhill gradient to drain water evenly off impermeable surfaces;
- Infiltration devices, such as soakaways, which allow water to drain directly into the ground;
- Green roofs (see below) and reuse of water;
- Permeable and porous pavements;
- Basins, reed beds and ponds designed to hold water when it rains.

<http://www.ciria.com/suds/sites/>

Upton One Urban Extension, Northamptonshire

One of Upton's key features is its SUDS which manages rainwater run-off and promotes local biodiversity. Consisting primarily of linked swales, SUDS at Upton provide the underlying basis of the landscape structure, and is connected with the streets and built form. A company has been established to manage the SUDS and maintain communal courtyards. Rainwater harvesting has also been incorporated.

The plan was created through a collaborative design exercise putting the community at the heart of decision-making. Design Codes were used by partners as the basis for drawing up development briefs, and for assessing developer proposals prior to submission for planning permission. This strong community-oriented process emphasises environmental responsiveness and aims to minimise future running costs.

More info: www.northampton.gov.uk

National Trust Properties, Boscastle

Following devastating floods at Boscastle in 2004, impermeable wall finishes on vulnerable buildings have been replaced with limewash. This allows walls to dry out after inundation. Internally, suspended floors have been converted to solid floors to reduce the impact of any future flooding, and electrical points have been raised off the ground.

The Engineering Historic Futures project provides better understanding of the wetting properties and drying processes in historic buildings.

More info: www.nationaltrust.org.uk and www.ucl.ac.uk/sustainableheritage/historic_futures.htm

CDS sewer overflow unit

The CDS sewer overflow unit provides the following applications to treat storm water runoff:

- Treatment of stormwater runoff from residential, commercial and industrial land uses to remove: Trash, debris, vegetation, coarse and medium sediments and some fine sediments;
- Treatment of stormwater runoff from parking lots and vehicle service and storage facilities to: Capture oil and grease using sorbents within the separation chamber;
- Protect stormwater pumping facilities from the negative impacts of rock, coarse & medium sediment, grit, trash and debris.

More info: <http://lakes.chebucto.org/SWT/cds.html>

Constructed Wetlands for Wastewater Treatment

An environmental wastewater treatment solution that relies on marsh plant roots for filtration.

Wetlands can be custom designed and built, or purchased as a system. Some system components can retrofit existing septic systems. The components of a complete system include: a filtered, two-cell septic tank (or two plain tanks, or a stabilization pond); a bermed or retained cell(s) that contains an impermeable liner, a gravel substrate, mulch and water-loving plants; a distribution system including header pipe, distribution pipe within the cell, collection pipe, water level control structure, various cleanouts and possibly pumps; and a drainage field if required by regulatory agencies. Treated water is high quality and could, in the right conditions, be directly released to a river or aquifer. Low-flow plumbing fixtures can act as a "pretreatment" method to minimize required cell area.

Costs vary enormously depending on the chemical qualities of the wastewater and the site conditions. A complete system for a house (not including design) can range from \$2,000 to \$10,000. Downsizing the leach field can offset other costs depending on codes and local regulations. A properly constructed and maintained wetland can last much longer than conventional septic systems.

More info: <http://www.toolbase.org/Technology-Inventory/Sitework/constructed-wetlands>

Drip Irrigation Leach Field

The system must be designed by a registered professional engineer. Small vibratory plows or trenchers may be used to install drip emitter lines. The system should definitely be arranged so that it drains by gravity. All components except the piping should be protected from freezing. Because of the small size of the orifices, an effective effluent filter is needed, of the reusable cartridge type. Some means, such as the regular injection of herbicide into the piping, must be provided to inhibit root growth into the orifices. A control panel and an elapsed time counter are essential accessories. The pump chamber (as well as the septic tank) should have easily accessible access risers with child-proof and slip-resistant lids.

This system offers three primary benefits. First, it is a "green" technology, because the water, instead of disappearing into the ground, is usefully recycled to sustain necessary plant growth. Second, because the tubing is in shallow trenches and is flexible, the field can be woven around existing trees and shrubs, areas that could not support any other type of effluent disposal except a spray system (see On-Site Sewage Disposal Systems - Overview). Third, the system does not have to be level or even, although there are limits on the amount of slope allowed. Although reports indicate that the discharge of

nitrate is reduced, Massachusetts has not rated the system as nitrogen-reducing in lieu of further data. According to NSFCH, In a 1989 study of LPP use among different counties in North Carolina, it cost an average of \$2,600 to install an LPP system for a three-bedroom house. They also estimated the average installation cost of LPP systems ranging from \$1,500 to \$5,000, inversely related to the extent of its use within a county. The Texas Cooperative Extension quotes costs between \$4,000 and \$10,000, while the City of Austin describes a system costing \$15,000 and requiring nearly \$50 a month maintenance (size not specified).

More info: <http://www.toolbase.org/Technology-Inventory/Plumbing/drip-irrigation-leach-field>

Gravel-less pipes

Single pipes are laid in a trench, and can form a gentle curve. Multiple pipe systems can be laid side-by-side in a bed array, with the pipes displacing the normal drainrock. Installation time can be reduced compared with a gravel system. The Enviro-Septic system is complete with end adapters.

Gravel-less pipes eliminate the labor in placing tons of drainrock aggregate. Eliminating the equipment needed to spread the aggregate reduces undesirable compaction of the surrounding soil and disruption to nearby shrubs and trees. The cost varies considerably, but is comparable for conventional gravel-less pipes to a gravel system of above-average cost. The Enviro-Septic system, because it requires a reduced length of trench, may be less costly than a conventional system. Observation ports can be added that allow inspection of the system for bio-mat buildup.

More info: <http://www.toolbase.org/Technology-Inventory/Plumbing/gravel-less-pipe-leach-fields>

Zuiverende voorzieningen

Lamellenseparatoren, helofytenfilter, bezinkbak/bezinkvijver, bodempassage, doorlatende verharding (Rombout et al., 2007).

Rain

Treatment and management of precipitation water on industrial/business terrains (Boogaard and Hulst, 2004)

Database rainwater

(Boogaard and Lemmen, 2007)

Overview sewage disconnection techniques

(Boogaard and Do, 2003)

A.3 Water storage

Double function: motorway and flood buffer

A storm water management and road tunnel in Kuala Lumpur, Malaysia, which normally functions as a double deck motorway, however during flash floods the tunnel is closed for traffic and functions as a storm water collector (SMART Project, 2006):

A vertical groove for installing a water barrier at the entrance to underground stations (Bobylev, 2009)

Rain water on private property

With a green roof, lowered lawn and storage crate heavy rain fall can be stored up to the disastrous rain shower in Copenhagen in 2011: a rain shower of 150mm in three hours (Luijtelaar, 2015)..

Environmental friendly swales (wadi's)

How can swales contribute more to hydrological, ecotoxicol and ecological aspects (Boogaard et al., 2003).

A.4 References

- Bobylev, N. 2009. Urban underground infrastructure and climate change: opportunities and threats. *Fifth Urban Research Symposium 2009*. Marseille, France: World Bank.
- Boogaard, F.C. and Do, T.T. (2003), "Beslisboom aan- en afkoppelen verharde oppervlakken 2003", R001-425929TTD-D01-U, WtW, Tauw bv.
- Boogaard, F.C. and Hulst, W.v.d. (2004), "Omgaan met hemelwater bij bedrijfs- en bedrijventerreinen", STOWA, Utrecht.
- Boogaard, F.C., Jeurink, N. and Gels, J.H.B. (2003), "Vooronderzoek natuurvriendelijke wadi's, Inrichting, functioneren en beheer", STOWA, RIONED, Utrecht.
- Boogaard, F.C. and Lemmen, G.B. (2007), "Database regenwater, Achtergrondrapport", 2007-W09, STOWA, Utrecht.
- Bouwereld (2010), "Eerste rioolput van EPS in Nederland". Available at: http://www.bouwwereld.nl/web/Actueel/Nieuws/Nieuws/11217/Eerste-rioolput-van-EPS-in-Nederland.htm?nb=newsletter&editie=20-07-2010&link=Eerste%20rioolput%20van%20EPS%20in%20Nederland&WT.mc_id=mail_newsletter_20-07-2010&date=20100720.
- Coutts, A.M., Tapper, N.J., Beringer, J., Loughnan, M. and Demuzere, M. (2013), "Watering our cities: The capacity for Water Sensitive Urban Design to support urban cooling and improve human thermal comfort in the Australian context". *Progress in Physical Geography*, Vol. 37, No. 1, pp. 2-28.
- ESPACE (2005), "A Toolkit for Delivering Water Management Climate Adaptation Through the Planning System.", Land Use Consultants, London.
- Graaf, R.E.d. (2009), Innovations in urban water management to reduce the vulnerability of cities, Feasibility, case studies and governance.
- Haasnoot, M., Middelkoop, H., Van Beek, E. and Van Deursen, W. (2009), "A method to develop sustainable water management strategies for an uncertain future". *Sustainable Development*.
- Luijtelaar, H.v. (2015), "Regenwater (voorzieningen) op eigen terrein": Stichting RIONED. Available at: <http://www.riool.net/documents/10180/1a0f31cc-6533-4bad-9431-315093d62b32> november 2015].
- McCarthy, B., Opdam, E., Roelofs, B. and Koning, K.d. (2004), "Guiding models for waterstorage", ESPACE-project, Nijmegen.
- Pols, L., Kronberger, P., Pieterse, N. and Tennekens, J. (2007), "Overstromingsrisico als ruimtelijke opgave", Ruimtelijk Planbureau, Den Haag.
- Potz, H. and Bleuzé, P. (2012), Urban green-blue grids for sustainable and dynamic cities, coop for life, Delft.
- Roggema, R. (2009), *Adaptation to Climate Change: A Spatial Challenge*, Springer.
- Rombout, J., Boogaard, F.C., Kluck, J. and Wentink, R. (2007), "Zuiverende voorzieningen regenwater, Verkenning van de kennis van ontwerp, aanleg en beheer van zuiverende regenwatersystemen", STOWA, Utrecht.
- Shaw, R., Colley, M. and Connell, R. (2007), "Climate change adaptation by design, a guide for sustainable communities", TCPA, London.
- Ven, F.v.d., Luyendijk, E. and Gunst, M.d. (2009), *Waterrobuust bouwen*, Beter Bouw- en Woonrijp Maken/SBR, Rotterdam.

Appendix B Factsheets

Factsheets are developed to assist urban planners and designers during the design and planning process. The factsheets are written in Dutch to address especially these practitioners.

	Regio	Stad	Wijk	Perceel
vegetatie			straatbomen	bomen
			grasvelden	
			parken	
			groenedaken	vertikaal groen
			wadi's	
		stadsbossen en parken		
		groene routes		
			groen geluidsscherm	particulier groen
		natuurlijke zones		stadslandbouw
water			waterelementen	
	open water en waterparken		waterpleinen	regenton/tank
		grachten en kanalen		
		afkoppelen regenwater		
		open waterafvoer		
		infiltratie punten (evt. combi met wadi)		
			natuurlijke oevers	
		helofyten filter/grijswatersysteem		
bebouwingvorm	herontwikkel-/uitbreidingsstrategie		beschaduwden gebouwen	
		regenwater bestendig bouwen		
		oriëntatie op zon t.b.v. binnenklimaat		
		bevorderen ventilatie		
		gevel- en dakoppervlak		
materiaal			reflecterende materialen	
			materialen met lage warmte accumulatie	
			luchtstroming door ΔT	
			permeabele materialen	
energie	exergie concepten			
		antropogene warmte		
			asfalt/gevel collectoren	

INHOUD

	pagina
Inleiding	4
Vegetatie	5
Water	18
Bebouwingsvorm	29
Materiaal	35
Energie	39
Literatuurverwijzingen	42



INLEIDING

Voor u ligt een bundel van factsheets ter ondersteuning van afwegingen in het ontwerp van de openbare ruimte in relatie tot het stedelijk microklimaat en klimaatadaptatie.

Deze bundeling van kennis en voorbeelden is samengebracht op basis van het promotieonderzoek *Urban Climate Design* aan de Technische Universiteit Delft, afdeling Architectural Engineering and Technology. Het onderzoeksproject was tevens onderdeel van het nationale consortium *Climate Proof Cities*, onderdeel van *Kennis voor Klimaat*.

Het doel van de factsheets is het presenteren van bestaande en innovatieve klimaatadaptatiemaatregelen. De wetenschappelijke kennis uit het onderzoek is vertaald in het Nederlands en in beeld om de toepassing in de praktijk te vergroten.

De factsheets zijn geordend in vijf categorieën: vegetatie, water, bebouwingsvorm, materiaal, energie en overig. Deze kunnen tijdens besprekingen en ontwerpessies op tafel komen om een beeld van de mogelijkheden te geven en vervolgens tot een selectie te komen. Ook als digitaal document kunnen de sheets snel inzicht in mogelijke maatregelen geven.

De informatie over de verschillende onderwerpen verschilt in hoeveelheid bestaande kennis en is soms wel en soms niet veel toegepast. Om dit te kunnen aangeven zijn deze apart in de vakken met kansen en kanttekeningen opgenomen. De factsheet zijn niet samengesteld om een overzicht te geven van alle kennis over de onderwerpen. Voor meer kennis over effecten van maatregelen en ontwerp toepassingen kunt u het proefschrift of gepubliceerde artikelen uit dit onderzoek raadplegen.



BOMEN

SCHAALNIVEAU: STAD | WIJK | STRAAT | PERCEEL

hitte

verkoeling door evapotranspiratie en schaduw werking

water

lucht

luchtfilter voor fijnstof en VOC's



Individuele bomen hebben vooral een verkoelend effect door hun beschaduwing. Het beschaduwen van gebouwen kan een energiebesparing voor koeling van wel 25 tot 80% opleveren (Meier 1991).

In steden zijn er twee type locaties waar bomen worden geplant: op een verharde plek (de stoep, een plein of langs de weg) waar ze bestrating beschaduwen of op open plekken waar ze gras beschaduwen. Een studie voor New York toont aan dat door alle grasvelden te beplanten met bomen de middagtemperatuur in Manhattan met 1°C zal dalen. (Luley, et al 2002).

In Chicago zijn de kosten en baten bij het planten van bomen onderzocht; de baten zijn bijna drie keer zo veel als de kosten. De terugverdientijd varieert tussen de 9 en 18 jaar. Een boom in de stad heeft een levensduur van gemiddeld 40 jaar, reken je winst maar uit. Om meer bomen in het straatprofiel van Chicago te krijgen zijn privétuinen interessant, hier ligt weinig bekabeling en riolering, hebben de bomen een langere levensduur, volgroeien bomen beter en zorgen de bomen dicht bij de woning voor meer energiebesparing (Mc Pherson 1997).

Voor de regio Manchester in het Verenigd Koninkrijk is berekend dat een toename van het bomen areaal met 10% de temperaturen in 2080 op hetzelfde niveau zal houden bij een hoog emissie scenario (Walsh et al., 2007).



Bomen beschaduwen glazen gevel, TU Eindhoven



Parkeren in groene nissen

Kansen

- Loofbomen hebben in de zomer het positieve effect van beschaduwing en in de winter het positieve effect van het doorlaten van de schaarse zonneschijn door het verliezen van hun blad;
- Bomen die parkeerplaatsen beschaduwen verminderen de verdamping van de vluchtige organische stoffen uit brandstof tanks;
- Door bestaande bomen te beschermen kan een nieuw ontwikkelingsgebied reeds volwassen bomen hebben met al hun positieve effecten;
- Een boomaanplant project kan gecombineerd worden met het gebruik van water van zuiveringsinstallaties. Dit water wordt nu op oppervlaktewater geloosd, de vele nutriënten verslechteren de waterkwaliteit, terwijl bomen hier juist van profiteren (Akbari, et al. 1992).

Kanttekeningen

- Er is niet altijd ruimte voor bomen. Een leiboom kan hierbij uitkomst bieden. Andere alternatieven zijn bijvoorbeeld pergola's of gevelgroen;
- Reserveer bij de planning ruimte voor bomen;
- Bomen kunnen de luchtcirculatie te veel beperken, ook dan zijn de bovengenoemde alternatieven inzetbaar;
- In warme droge periodes hebben bomen in steden een tekort aan water, om dit te voorkomen kan regenwater in de bodem worden geïnfilteerd of opgeslagen in plaats van al het water de stad uit te voeren.

TU Delft

Kleerekoper, L.



GROENE DAKEN

SCHAALNIVEAU: WIJK | PERCEEL

hitte

verkoeling door evapotranspiratie en isolatie van gebouwen

water

vertraagde afvoer en waterberging

lucht

luchtfilter voor fijnstof en VOC's

Vegetatie op daken en gevels koelen door evapotranspiratie (evaporatie en transpiratie van planten) en doordat de schaduw van de beplanting opwarming voorkomt. Het binnenklimaat blijft koeler door de isolatiewaarde van een vegetatielaag.

In vergelijking met een dak met zwarte dakbedekking zijn de pieken in oppervlakte temperatuur bij een groendak gemiddeld 33°C lager (Gaffin, et al 2010). Een groendak zorgt bovendien voor een vertraagde afvoer van regenwater. Door het substraat en de plantenwortels wordt het water langer vastgehouden en gefilterd. De waterafvoer kan op regionale schaal met 2,7% verminderen wanneer slechts 10% van de gebouwen een groendak hebben (Mentens, 2006). de waterretentie kan oplopen tot 82,8% per individueel gebouw (VanWoert et al, 2005).

Er kan ook worden gekozen voor extra wateropslag op het dak waarmee de beplanting altijd voldoende water ter beschikking heeft en meer kan koelen door verdamping. Ook kan dit water worden ingezet voor bijvoorbeeld toiletwater.



Groendak Bibliotheek TU Delft



Intensief Groendak Garderen

Kansen

- Energiebesparing in de zomer én winter;
- Mogelijkheid om te combineren met een grijswatersysteem;
- De levensduur van daken wordt verlengd;
- Vermindering luchtvervuiling (ozon en fijnstof);
- Aantrekkelijke stedelijke omgeving;
- Habitat voor vogels en ander organisch leven;
- Groene daken zijn op zowel platte als schuine daken toe te passen. De maximale helling bedraagt ongeveer 45 graden. Een plat dak, tot een helling van 6 graden, is goedkoper.

Kanttekeningen

- Extensieve begroeiing van daken kan kostbaar zijn in aanleg en onderhoud, vooral wanneer de constructie moet worden verzwaard om het gewicht van het dak te kunnen dragen;
- Het uiterlijk van het gebouw wordt beïnvloed door de vegetatie. Dit is niet altijd het gewenste uiterlijk;
- Water dat van een groendak komt bevat meer nutriënten dan regenwater. Dit geeft een extra belasting voor traditionele waterzuiveringsinstallaties. Door waterzuivering te combineren met bijvoorbeeld een algen kwekerij kan hier juist van geprofiteerd worden.

VERTICAAL GROEN

SCHAALNIVEAU: WIJK | PERCEEL

hitte verkoeling door evapotranspiratie en schaduw werking

water extra waterverdamping

lucht luchtfilter voor fijnstof en VOC's

Groengevels verkoelen door verdamping en beschaduwing, maar beschermen de gevel ook tegen temperatuur-, uv- en piekbuienbelasting.

Bij grondgebonden systemen wortelen klimplanten in de bodem en wordt onderscheid gemaakt in directe gevelbegroeiing of indirecte gevelbegroeiing waarbij een klimhulp noodzakelijk is.

Bij niet grondgebonden systemen groeien planten in een substraat of worden gevoed door een geavanceerd regelsysteem.

Een studie in Tokyo toont een koeffect van gevelgroen op de omgeving en het binnenklimaat aan. In de zomer werd een temperatuurverschil dicht bij de grond gemeten van 0,2–1,2 °C. De simulaties lieten ook een vermindering in het energieverbruik voor koeling zien van 4–40%. Vooral in woonstraten werd een grote energie besparing bereikt. (Kikegawa, et al 2006)



Musée du quai Branly, Jean Nouvel



Institute of Physics, Berlin-Adlershof

Kansen

- Planten verdampen meer wanneer ze een overvloed aan water hebben dan als ze te weinig water hebben. In de zomermaanden van juli tot en met september is gemeten aan de waterconsumptie van de testplant 'Wisteria sinensis' namelijk 420 liter per dag voor in totaal 56 planten. Dit staat gelijk aan een koeling van 280 kWh per dag voor een binnengebied van het Berlin-Adlershof (Schmidt 2006);
- Groene gevels dienen als warmte-isolatie door hun luchtbuffer en beperken van het warmte verlies door remmen van de wind.

Kanttekeningen

- Groene gevels kunnen veel onderhoud vergen, dit is afhankelijk van de soort begroeiing, vorm van de gevel en de klimaatomstandigheden;
- Het uiterlijk van het gebouw wordt voor een groot deel bepaald door de vegetatie. Het type groengevel moet in overeenstemming zijn met de beoogde uitstraling van het gebouw.



PARTICULIER GROEN

SCHAALNIVEAU: PERCEEL

hitte

verkoeling door
evapotranspiratie en
schaduw werking

water

tijdelijke waterberging
en extra waterinfil-
tratie

lucht

luchtfilter voor fijnstof
en VOC's

Een groot deel van het stadsoppervlak wordt ingericht door particulieren. Vaak resulteert dit in veel verharding en weinig groen. Als hier verandering in kan worden gebracht levert dit heel veel winst op. Er kan een significant verkoelingseffect en extra ruimte voor waterretentie behaald worden. Er kunnen meer bomen, grote gras- en plantzones, opritten met halfverharding en waterpartijen worden aangelegd.

Ook blijkt dat groen op particulier terrein vaak het meest effectief is en daarom ook de beste kosten-batenverhouding heeft:

Een studie in Chicago wijst uit dat door de hoeveelheid bomen in de stad met 10% te vermeerderen hoge besparingen in gebouwen op koeling en verwarming kan worden behaald (Mc Pherson 1997). Met name het planten van bomen op privé kavels is zeer kostenefficiënt. Bomen op deze locaties zijn relatief goedkoop te realiseren, hebben een hoge levensverwachting en groeien uit tot gezonde bomen. Daarbij leveren bomen direct voordelen aan de gebouweigenaar in kosten besparing op energie, schonere lucht en waardestijging vanwege de esthetische en sociale bijdrage van bomen.



Eduard François, L'Immeuble qui Pousse, Montpellier, France



Kastanjelaan, Arnhem

Kansen

- Particulier groen stimuleren door bij de aanleg van tuinen ondersteuning te bieden is vaak een goede investering. Door de juiste planten en bomen te kiezen kan dit worden afgestemd op de capaciteiten en wensen van de eigenaar;
- Ook initiatieven van bewoners kunnen leiden tot vergroening van de wijk. Een burger organisatie als Permablitz toveren tuinen in een dag om tot permacultuur waar de bewoners hun eigen voedsel kunnen verbouwen (www.eindhoven.transitiontowns.nl);
- Een goed begin is het halve werk, wanneer een tuin goed en onderhoudsvriendelijk is aangelegd is de kans groot dat de tuin groen blijft.

Kanttekeningen

- Het motiveren van bewoners voor een groene tuin zonder deze een verplichting op te leggen is niet altijd gemakkelijk. Belangrijk hierbij is het aantrekkelijk en eenvoudig maken van groen op eigen grond. Bijvoorbeeld door als gemeente planten en tuinadvies aan te bieden en te laten zien wat het kan opleveren in energiebesparing, extra comfort, in voedsel productie, meer vogeltjes in de tuin of in waarde stijging van je huis.

TU Delft



Kleerekoper, L.

PARKEN

SCHAALNIVEAU: STAD | WIJK

hitte verkoeling door evapotranspiratie, schaduw, radiatie en koude luchtstroming

water waterretentie en -infiltratie

lucht luchtfilter voor fijnstof en VOC's



Een stedelijk bos of park is een groengebied binnen een stedelijke omgeving. Deze groengebieden hebben een lagere lucht- en oppervlaktetemperatuur. Deze koelere plekken worden in de wetenschappelijke stukken een Park Cool Island (PCI) genoemd. Een PCI werkt verkoelend door: evapotranspiratie van bomen en planten, evaporatie van oppervlaktewater en/of vocht in de bodem en het genereren van een koude luchtstroming. Gedurende de nacht zorgen open velden voor een snelle afkoeling vanwege de hoge uitstralingsfactor naar de hemelkoepel.

Het temperatuurverschil tussen een park en zijn omgeving is gemiddeld 1-7°C, dit blijkt uit een vergelijking van studies. Een groengebied hoeft niet groot te zijn om een verkoelend effect te hebben. Volgens een studie in Tel Aviv heeft een park van 0,15 ha een koeleffect van 1,5°C en rond het middag uur maar liefst 3°C ((Shashua-Bar & Hoffman, 2000). Een andere studie in Göteborg toont aan dat een groter groengebied ook een grotere koeling genereert. In een park van 156 ha werd een maximum temperatuurverschil van 5,9°C in de zomer gemeten (Upmanis, et al 1998).



Lange Voorhout, Den Haag



Sonsbeekpark, Arnhem

Kansen

- Een stedelijk bos zou tijdens een hittegolf als koude plek kunnen dienen;
- Interessant is de koelende werking van het groen op de omgeving. In Tel-Aviv hadden de kleine parken een reikwijdte van 100 meter vanaf de rand van het park. De reikwijdte van het koeleffect van het groen was in Göteborg meer dan een kilometer;
- Bij nieuwbouwprojecten ligt een grote kans om groengebieden te combineren met stedelijke gebieden met een hoge dichtheid;
- Plan specifiek ruimte voor parken bij stadsuitbreiding.

Kanttekeningen

- Het koeleffect van een park wordt door vele factoren beïnvloed en is daarom niet altijd gelijk of goed te voorspellen. Zowel op het temperatuurverschil en de reikwijdte van het koeleffect zijn de volgende aspecten van invloed: het lokale klimaat, weersomstandigheden, geografie, bebouwingsvorm en stadsomvang;
- Het realiseren van grote groengebieden binnen een bestaande stedelijke structuur is alleen mogelijk wanneer een gebied op grote schaal wordt herontwikkeld. Zelfs dan is de kans groot dat de druk van ontwikkelaars om meer te bouwen zo groot is dat het groen wordt gereduceerd.



GRASVELDEN

SCHAALNIVEAU: WIJK | STRAAT | PERCEEL

hitte

verkoeling door evapotranspiratie en warmte radiatie naar de hemelkoepel

water

extra waterinfiltratie, tijdelijke waterberging

lucht

luchtfilter voor fijnstof en VOC's

Open grasvelden zijn met name 's nachts belangrijk voor de afkoeling van een gebied. Gedurende de dag zijn open grasvelden minder effectief met betrekking tot koelen dan een groengebied met bomen. Overdag vangt een open veld veel zonlicht waardoor het vocht in de bodem verdampt, waarna deze oppervlakte snel opwarmt. 's Nachts keert dit om in een snelle afkoeling. Warmte kan vrij naar de hemelkoepel stralen omdat er geen obstakels zijn die de warmte reflecteren of vasthouden.

Om de opwarming van een grasveld te minimaliseren is het ook hier van belang dat de grond voldoende vocht bevat. Het grasveld heeft een koelend effect doordat het water verdampt. Een grasveld moet niet te vaak worden gemaaid of gedraineerd om als koeling te kunnen fungeren.

Vegetatie absorbeert ook vervuiling uit regenwater. Zware metalen en nutriënten binden zich aan de grond zodat deze niet in grondwater of oppervlaktewater komen. Meer dan 95% van het cadmium, koper en lood kan uit regenwater worden gefilterd en 16% van het zink. (Johnston & Newton 2004)



Park Lepelenburg, Utrecht

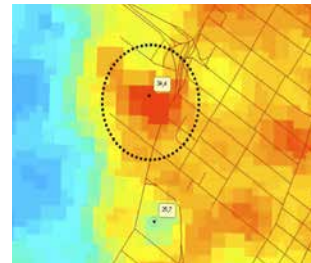

Warmtekaart Montreal, Canada

Kansen

- Een grasveld kan met vele functies gecombineerd worden; speelplaats, voetbalveld, honden uitlaatveld, picknickplaats, visplek, festivalterrein, etc.;
- Een habitat voor kleine dieren, insecten en ander organisch leven;
- Een open grasveld kan fungeren als waterinfiltratie gebied (wadi) en vangt fijnstof af;
- Als parkeerplaats in combinatie met halfverharding;
- Open plekken in parken dragen bij aan overzicht en veiligheid;
- Aantrekkelijke stedelijke omgeving
- Grond een aantal belangrijke functies, waaronder het filteren van water en koolstofafvang (Vrscaj et al 2008). Grasvelden behouden deze functie in tegenstelling tot verharding en bebouwing.

Kanttekeningen

- Voetbalvelden zijn koude plekken binnen een warmere stedelijke omgeving, in de warmte kaart rechts boven is het zuidelijke groene veld dan ook licht blauw gekleurd. Echter, de nieuwe trend van kunstgrasvelden vormt een gevaar met betrekking tot hittestress. Het noordelijke veld heeft een kunstgrasmat en is niet alleen minder koel, de oppervlaktetemperatuur is zelfs warmer dan dat van het omliggende stedelijke gebied. Het gaat om een verschil van 8,7°C tussen een natuurlijk- en kunstgrasveld;
- Een grasveld als stedelijk groen wordt soms gezien als groen met weinig kwaliteit. Verhoog de kwaliteit door er functies aan te verbinden, selectief te maaien (meer bloemen en bijen) of door open grasvelden te combineren met bomen, struiken en planten.



Kleerekoper, L.

Factsheets

10

Vegetatie

STRAATBOMEN

SCHAALNIVEAU: WIJK | STRAAT

hitte

verkoeling door evapotranspiratie, schaduw werking en reflectie van straling

water

extra waterinfiltratie

lucht

luchtfilter voor fijnstof en VOC's, kunnen ook vervuilde lucht vasthouden



De impact van bomen in het straatprofiel op de temperatuur in een stad lijkt niet groot te zijn omdat deze erg verspreid door de stad staan. Het aantal bomen is echter enorm waardoor dit effect juist vrij groot is.

Bomen werken in het stedelijk gebied ook als luchtfilter voor fijnstof, stikstofoxiden en vluchtige organische stoffen (VOS). Loofbomen filteren met name ozon en stikstofoxiden en naaldbomen vooral fijnstof en VOS. Het voordeel van naaldbomen daarbij is dat deze het hele jaar door de luchtzuiveren. Voor een optimale zuivering van de vervuilde lucht is het belangrijk dat de bomen poreus zijn (minimaal 40%) zodat de lucht er doorheen in plaats van over heen waait.

Een bomenrij die in meer of mindere mate open is, laat een deel van de wind door, in tegenstelling tot een groene windsingel of een bos. De windsnelheid neemt minder af dan bij een dichte singel, maar het beschermde gebied met een lage windsnelheid is veel groter. Dit gebied kan een lengte hebben van 15 tot 20 maal de boomhoogte.

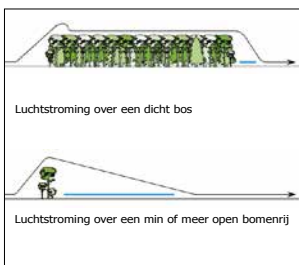

Luchtstroming over groen (Hiemstra et al 2008)



Burgemeester van Tuylkade, Utrecht

Kansen

- De positie van bomen in een verharde omgeving maakt ze zachte en kwetsbare elementen. Hierdoor brengen ze een andere dimensie in de anders zo harde oppervlakten van bestrating en gebouwen;
- Bomen reageren op de seizoenen; in de koude winter zijn bomen warmer dan hun omgeving en tijdens de warme zomerperiode zijn bomen juist koeler dan hun omgeving.

Kanttekeningen

- Bomen in het straatprofiel zijn kostbaarder in aanplant en behoeven meer onderhoud dan die in een park;
- Bomen met een dichte en wijde kruin kunnen een afgesloten scherm van verse lucht belemmeren. Uitlaatgassen van auto's blijven zo in de straat hangen. Wees hierop bedacht bij de selectie van de boomsoort en de positie van de bomen in het straatprofiel. Met het oog op elektrisch vervoer kan wellicht een dichter bladerdek worden geaccepteerd. Maar ook dan blijft voldoende ventilatie van drukke verkeersstraten belangrijk vanwege ander fijnstof van bijvoorbeeld banden.

TU Delft

Kleerekoper, L.



STADSLANDBOUW

SCHAALNIVEAU: WIJK | STRAAT | GEBOUW

hitte

verkoeling door
evapotranspiratie

water

extra waterinfiltratie

lucht

luchtfilter voor fijnstof
en VOC's

Stadslandbouw voorziet stadsbewoners van voedsel en is een alternatieve invulling van de groene ruimte. Het effect hiervan op het stedelijk klimaat is vergelijkbaar met dat van een park. Het geeft verkoeling door evapotranspiratie van planten en infiltreert en consumeert water.

Er zijn vele voorbeelden waarin tuinen, parken en ook daken geschikt zijn gemaakt voor het verbouwen van groente en fruit in de stad. Een vaak voorkomende vorm van stadslandbouw is de stadsboerderij. Deze leveren een meerwaarde voor zowel de stad, de boer en de burgers. Inkomsten uit landschapsbeheer en directe verkoop van verse producten zijn voordelen voor de boer. Ook biedt de stadsboerderij recreatiemogelijkheden in de buurt.

Nieuwe vormen van stadslandbouw kunnen geïntegreerd zijn in een woon- of kantoorgebouw of in een gestapelde vorm. Hierin kunnen afvalstromen uit gebouwen, zoals water en warmte, worden benut voor het produceren van voedsel.

Verticale landbouw is een nieuwe vorm van voedsel productie waarmee de menselijke voetafdruk verlaagd kan worden.



Straten worden moestuin



Eagle Street Rooftop Garden, New York

Kansen

- Steden zijn afhankelijk van omliggend land en voor een groot deel zelfs het buitenland wat betreft hun voedselvoorziening. Zelfvoorzienend zijn in voedsel kan voor steden heel belangrijk worden wanneer transportkosten in de toekomst hoger worden en er voedsel schaarste ontstaat door mislukte oogsten en bevolkingstoename;
- Zie ook parken, groene daken en groene gevels voor voordelen van vegetatie.

Kanttekeningen

- Voedsel productie vereist naast ruimte ook veel water. Steden met een beperkte water toevoer zullen opslag moeten zien te realiseren. Dit kan op of onder gebouwen, onder de grond of in oppervlakte water met voldoende diepte.

GROEN GELUIDSSCHERM

SCHAALNIVEAU: STAD | WIJK

hitte verkoeling door
evapotranspiratie en
luchtzuivering

Een groen geluidsscherm combineert geluidsisolatie met het filteren van de lucht en voegt kwaliteit toe aan de omgeving ten opzichte van een onbegroeid geluidsscherm. De begroeiing wordt na het opbouwen van het scherm geplant tegen of op het scherm. Na verloop van tijd ontstaat een geheel begroeide wand.

water extra waterinfiltratie

Voor de begroeiing wordt vaak gekozen voor klimop (Hedera Helix), maar ook Bruidssluier (Fallopia), Vuurdoorn (Pyracantha), Hondсроos (Rosa canina) of de Duinroos (Rosa pimpinellifolia) zijn goede opties voor het filteren van fijnstof en/of VOC's. (Hiemstra, 2008)

lucht luchtfilter voor fijnstof
en VOC's



Leenderweg, Eindhoven, foto: R. Burg



Tabaksteeg, Leusden

Kansen

- Met name de esthetische kwaliteit van een groen geluidsscherm is een extra argument om zuiverende planten toe te voegen;
- In de stedelijke omgeving is ook de verkoelende werking van planten van belang;
- Planten voorkomen vormen van vandalisme zoals graffiti;
- Dieren vinden bescherming en voedsel in een begroeid scherm.

Kanttekeningen

- Aanleg en onderhoud van het groen is een extra investering, maar omdat een groen scherm op minder weerstand zal stuiten verdient zich dit terug. Er kan ook met een minder ontworpen scherm volstaan omdat de constructie voor een groot deel overgroeit en het uiterlijk meer wordt bepaald door het type plant dan de materiaal keuze.

WADI'S

SCHAALNIVEAU: WIJK | STRAAT

hitte verkoeling door
evapotranspiratie

water extra waterinfiltratie,
tijdelijke waterber-
ging

lucht luchtfilter voor fijnstof
en VOC's



In een wadi wordt het regenwater wordt opgevangen. Het zijn brede verlaagde greppels of (kleine) grasvelden waarin het water wordt vastgehouden voordat het naar de bodem en het oppervlaktewater stroomt. Een laag humusrijke grond onder het gras van de wadi's zorgt ervoor dat eventuele vuildeeltjes achterblijven. Het water wordt zoveel mogelijk in het gebied vastgehouden om de waterstanden op peil te houden. Als de grondwaterstand laag is zal het regenwater infiltreren. Is de grondwaterstand te hoog dan zorgt een drainagesysteem ervoor dat het geïnfiltreerde regenwater naar het oppervlaktewater wordt afgevoerd.

Een voorbeeld zijn de wadi's in Ruwenbos in Enschede: de wadi's zorgen dat 99% van het regenwater in de bodem infiltreerd. Vegetatie en bodem dragen hierdoor meer bij aan koeling in warme periodes. De wadi's vormen hier een landschappelijk onderdeel van de wijk en zorgen voor een wisselend beeld. Een groot deel van het jaar staan de wadi's droog en slechts op gemiddeld 3 dagen per jaar treedt de overstort (slokop) in werking.

Wadi's zijn in aanleg goedkoper dan een ondergronds afvoerstelsel. De aanleg per strekkende meter is weliswaar hoger, maar doordat er minder dan de helft aan lengte hoeft te worden gelegd kom je op een besparing van zo'n 40%. De onderhoudskosten liggen echter wel hoger omdat hierin het groenonderhoud moet worden meegenomen (Bruins 2009).

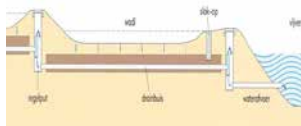

Prinsipe Wadi (bron: Waterschap Regge en Dinkel)



Wadi, Ruwenbos, Enschede

Kansen

- Wadi's zorgen niet voor meer muggen. Ze staan namelijk nooit lange tijd onder water en dus komen er geen muggen op af. Een goed werkende wadi staat enkele uren na een hevige regenbui alweer droog, max na 24h;
- Vaste planten in een wadi zorgen voor betere infiltratie en minder maaibeurten. Dit geeft een divers beeld en is goed voor bijen en vlinders (Hop 2011).

Kanttekeningen

- Dit watersysteem brengt met zich mee dat het regenwater zo schoon mogelijk moet blijven. Aan bewoners wordt daarom gevraagd ervoor te zorgen dat er geen hondenpoep, strooizout, autowaswater of zwerfvuil op straat en in de wadi's terecht komt;
- Ook moet de infiltratiecapaciteit van de bodem in tact blijven. Dit betekent dat slib en bijvoorbeeld bladeren op tijd moeten worden verwijderd.



STADSBOSSEN EN PARKEN

SCHAALNIVEAU: STAD | WIJK

hitte

verkoeling door
evapotranspiratie en
beschaduwing

water

extra waterinfiltratie

lucht

Een stedelijk bos of park is een groen gebied binnen een stedelijke omgeving. Deze groen gebieden hebben een lagere lucht- en oppervlaktetemperatuur. In de wetenschappelijke literatuur worden deze koelere plekken een Park Cool Island (PCI) genoemd. De karakteristieken van een PCI die leiden tot koelen zijn; evapotranspiratie van bomen en planten, evaporatie van oppervlakte water en/of vocht in de bodem. Gedurende de nacht zorgen open velden voor een snelle afkoeling vanwege de hoge radiatie factor naar de hemel koepel.

Een park is bij warm weer gemiddeld 1-8°C koeler dan zijn stedelijke omgeving afhankelijk van de grootte en opbouw van het park (Bowler et al. 2010). Het koeleffect van een park op de omgeving is erg wisselend en reikt van 100 tot 1000m van het park. Hierbij hebben kleine en verspreide parken meer effect op de stedelijke omgeving dan eenzelfde oppervlakte aaneengesloten park.

Indien een park een koelende functie moet vervullen is de aanwezigheid van water van groot belang. In de gematigde klimaatzone is de koeling door bladverliezende bomen normaal gesproken hoger dan die van naaldbomen. Er zijn planten en bomen die, zolang ze voldoende water ter beschikking hebben, maar liefst 20 liter per m2 kunnen transpireren op een zonnige dag.



Central Park, New York City



Green Park, London, UK

Kansen

- Vermindering luchtvervuiling (ozon en fijnstof);
- Koude luchtstromen vanuit bosrijke parken de stad in;
- Aantrekkelijke stedelijke omgeving
- Habitat voor vogels en ander organisch leven;
- Energiebesparing (een stijging van de buitentemperatuur van 1.0 °C leid tot een extra elektrische energie vraag van 6.6% om binnenruimtes te koelen);
- Bescherming tegen het afsluiten van waardevolle grond met bebouwing en verharding. In steden vervult de grond een aantal belangrijke functies, waaronder het filteren van water, koolstof afvang en in sommige gevallen voedselproductie.

Kanttekeningen

- Ruimte voor groen in steden is schaars, van bebouwd naar groen is vaak geen optie, anders om wel;
- Bomen zijn weinig flexibel, bij de planvorming moet al rekening worden behouden met de snel transformerende steden van tegenwoordig;
- Bomen hebben tijd nodig om te groeien en het kost tijd voordat hun koelende werking optimaal is.

TU Delft

Kleerekoper, L.



GROENE ROUTES

SCHAALNIVEAU: STAD | WIJK

hitte

verkoeling door
evapotranspiratie en
schaduw werking

water

extra waterinfiltratie

lucht

Groene routes kunnen als een verkoelende zone in een stad werken. Bomen werken hier door te koelen (evapotranspiratie) en het voorkomen van opwarmen door hun schaduw. Groenelementen kunnen ook de windsnelheid verminderen, dit is een gunstig effect in winter, maar kan het verspreiden van koele lucht in de zomer verhinderen.

Het koeleffect van groene zones is erg afhankelijk van het soort groen en de inrichting die er aan wordt gegeven. Dit geldt met name ook voor de concentratie fijnstof in de lucht. Om fijnstof maximaal te kunnen afvangen, en minder op te sluiten tussen gevels en het bladerdek, is het belangrijk dat de vegetatie poreus genoeg is om de wind door te laten, maar wel zoveel mogelijk bladoppervlak bevat om de fijnstof af te vangen.



Oranjekanaal, Emmen



Maliebaan, Utrecht

Kansen

- Een groene route door de stad kan regenwater opvangen en zo voorkomen dat straten blank komen te staan;
- Een groene berm of waterloop kan als migratie route fungeren voor flora en fauna;
- Door een aantrekkelijke route naar de stad te creëren wordt langzaam vervoer gestimuleerd.

Kanttekeningen

- Door verkeersaders te vergroenen kan de concentratie fijnstof te hoog worden wanneer er een 'groentunnel' ontstaat. De groenstructuur dient dan voldoende open te zijn om dit te voorkomen;
- Voor groen is ruimte nodig, ruimte die in dit geval concurreert met de behoefte aan extra rijbanen of een aparte fiets strook. De uitdaging is het groen op een creatieve manier toe te passen waardoor een groen toepassing niet direct minder mobiliteit betekend.



NATUURLIJKE ZONES

SCHAALNIVEAU: REGIO | STAD

hitte koele luchtstroming en koele bufferzone tussen stedelijke gebieden

water extra waterinfiltratie, water buffer, zoet water voorziening

lucht grootschalige afvang van CO2 en fijnstof, zuurstof productie

De grote natuurgebieden in Nederland met bijzondere waarde vanuit ecologisch oogpunt zijn onderdeel van de Ecologische Hoofdstructuur (EHS) van Nederland die in 1990 is geïntroduceerd en in 2018 voor een groot deel zal zijn gerealiseerd. Het doel van de EHS is om de droge en natte natuur uiteindelijk als een netwerk op elkaar aan te laten sluiten en te verbinden met Europese natuurgebieden. Vanuit Europa worden waardevolle natuurgebieden beschermd binnen het Natura 2000 netwerk dat is gericht op de bescherming van habitat en soortenrijkdom.

Natuurlijke zones zijn van belang voor het behoud van schoon water, zoet drink water en voor het opvangen van extremen (nat en droog).



Tongerenseheide, Veluwe, EHS en Natura 2000 gebied

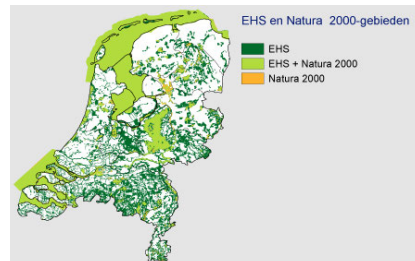

EHS en Natura 2000 (Planbureau voor de Leefomgeving)

Kansen

- Grote natuurgebieden reguleren hun eigen temperatuur en water balans en kunnen werken als buffer voor stedelijk water;
- Recreatief gebruik van de gebieden kan economisch impuls geven aan de regio;
- Het aaneensluiten van natuurgebieden vergroot de biodiversiteit en is essentieel in het gezond houden van populaties;
- Locale en duurzame hout productie.

Kanttekeningen

- De spanning tussen verstedelijking en vergroening om verbindingen te realiseren is een grote uitdaging.



WATERELEMENTEN

SCHAALNIVEAU: WIJK | STRAAT | PERCEEL

hitte

verkoeling door evaporatie

water

waterbeleving en deel van systeem voor opvang, vertraagde afvoer, berging en zuivering

lucht

Waterelementen hebben met name een verkoelend effect wanneer water doorstroomt, of nog beter, wordt verneveld. Stromend water kan sneller warmte absorberen en verneveld water verdampt veel meer. Verkoeling van een waterelement kan tot zo'n 30 m afstand effect hebben (Nishimura, et al 1998).

Fonteinen hebben vooral een psychologisch effect. Ze geven een gevoel van frisheid en ontspanning. Uit metingen blijkt echter dat ze minder effectief verkoelen in vergelijking tot bomen. (Lenzholzer 2008)

Indien een privé tuin wordt ingericht met een waterelement heeft dit direct effect op de omgeving waar mensen in verblijven. In situaties waar bijvoorbeeld bomen geen optie zijn kan het daardoor toch een geschikte maatregel zijn.



Bedriegertjes



Trevi fontein, Rome

Kansen

- Waterelementen hebben een esthetische waarde voor de stad en maken stedelijke ruimtes aantrekkelijker;
- Waterelementen kunnen worden ingericht en ontworpen als speelplek. Let wel op dat de waterkwaliteit hierbij heel belangrijk is;
- Waterbeleving is belangrijk, door water zichtbaar te maken creëer je bewustzijn;
- In combinatie met wateropslag, berging of infiltratie voorzieningen kunnen waterelementen bijdragen aan een integraal watersysteem in een wijk.

Kanttekeningen

- Stedelijke waterelementen vertonen vaak een snelle opwarming door het geringe watervolume. Dit vermindert de verkoelende werking maar kan vooral leiden tot groei van algen of bacteriën. Door een waterelement aan te sluiten op een groter systeem kan dit voorkomen worden;
- Waterelementen hebben een minder verkoelend effect dan bijvoorbeeld bomen. Deze hebben daarnaast ook nog een schaduw functie en kunnen als paraplu dienen, met name soorten met schermvormige kronen.



REGENTON/TANK

SCHAALNIVEAU: PERCEEL

hitte

in droge tijden voldoende water voor de tuin

Regenwater van daken kan worden opgevangen in een regenton of water tank. Het opgeslagen water kan in een droge periode voor de tuin worden gebruikt. Hiermee ontzie je tijdens een bui het riool en de zuiveringsinstallatie en in een droge periode bespaar je kostbaar drinkwater.

water

waterberging tijdens piek buien en wateropslag

Een grote watertank kan voldoende water opslaan om ook de auto te wassen, te gebruiken voor toiletspoeling en evt. een geheel grijswatersysteem te voeden.

lucht



Regenton



Regenton, drop of water



Watertank

Kansen

- Waterberging voor het bewateren van de tuin, autowassen en/of grijswatersysteem, afhankelijk van de hoeveelheid opslag;
- Door water op te vangen wordt het riool en de waterzuiveringsinstallatie minder belast.

Kanttekeningen

- Een regenton kan een broedplaats voor muggen worden indien deze niet goed is afgesloten;
- Bij opslag voor grijswatersystemen moet tijdens de bouw goed opgelet worden dat de verschillende watersystemen goed worden aangesloten.

TU Delft

Kleerekoper, L.



OPEN WATERAFVOER

SCHAALNIVEAU: WIJK | STRAAT | PERCEEL

hitte verkoeling door evaporatie en indirect door waterbeleving en evapotranspiratie door bomen

water water berging tijdens piek buien en water afvoer

lucht

Dit zijn systemen die water afvoeren naar drainage punten of oppervlaktewater. Een open waterafvoer kan tijdelijk of permanent water bevatten.

Een waterafvoer die het water van daken naar een verzamelpunt in de wijk transporteert bevat alleen water wanneer het regent. Vanuit een tijdelijke watergoot kan het water op een infiltratie punt, opslag of een permanente goot uitkomen.

Let op bij drukke verkeerswegen dat het water dat hier vanaf stroomt vervuild is en dus niet gemengd moet worden met schoon oppervlakte water of zonder filter geïnfiltreerd kan worden.

Een permanent watersysteem moet voldoende diep zijn om extra water af te kunnen voeren en dient onder een verloop aangelegd te worden. Indien er geen aanvoer van hoger gelegen gebied mogelijk is, kunnen er pompen worden ingezet om het water te laten circuleren.



Waterafvoer, Freiburg



Waterafvoer, Amiens



Waterafvoer, Nijmegen

Kansen

- Ondiepe waterlopen in de stad kunnen ingezet worden tijdens warm weer: door het water te vernevelen, door het oververharding van drukke straten te laten vloeien;
- Ook kan het watersysteem stadsbomen in droge periodes van voldoende water voorzien om ze zo optimaal te laten koelen.

Kanttekeningen

- In drukke winkel- en verkeersstraten kan een waterloop onveilige situaties opleveren. Zorg op kritieke- en oversteekpunten daarom voor een veiligheidsrooster;
- Een watersysteem waar altijd water in staat dient te worden gevoed door een externe bron of een grote waterpartij zodat het water niet te snel opwarmt.

INFILTRATIEPUNTEN

SCHAALNIVEAU: WIJK | STRAAT | PERCEEL

hitte

verkoeling door evapotranspiratie door water toevoer aan bomen

water

water berging tijdens piek buien en water afvoer

lucht

Infiltratiepunten in de stad en tuin houden de grondwaterstand in gebieden met veel verharding op peil. Dit is belangrijk voor vegetatie met name voor de groei en het koelvermogen van bomen.

Infiltratiepunten zorgen ook voor minder belasting van het riool en daarmee een lager risico te zullen overstromen. Het water wordt naar infiltratiepunten geleid waar het geleidelijk naar de bodem wordt afgevoerd. Zo staan er aangewezen plekken even blank en blijven de straten en tunnels begaanbaar. Door minder water via het riool af te voeren worden ook waterzuiveringsinstallaties minder belast wat tot kostenbesparing leidt.

Er zijn vele mogelijkheden voor het infiltreren van water. Veelal is het niet direct zichtbaar waar zich een infiltratiepunt bevindt. Dit gebeurt namelijk ondergronds met bijvoorbeeld infiltratiekragen of grind. Bovengronds kan dit worden gecombineerd met een water element of een verlaagd deel op een plein waar slechts tijdelijk water in staat. Er is ook bestrating dat water infiltreert van wegen en parkeerplaatsen.

Een met gras bedekt infiltratiepunt wordt een wadi genoemd, zie desbetreffend thema. Ook halfverharding is een middel om meer water in de bodem te infiltreren.



Infiltratiepunt in de wijk met tijdelijke waterberging



Aanleg infiltratiekragen onder een vijver

Kansen

- Schoon regenwater vult grondwater aan. Dit zorgt voor extra koeling door vegetatie en minder bodem daling;
- Tijdens piekbuien wordt het riool minder belast wat leidt tot minder straten die blank komen te staan;
- Waterzuiveringen worden minder belast.

Kanttekeningen

- Infiltratiepunten kunnen op veel verschillende manieren worden aangelegd en er zijn verscheidene systemen. Let op, infiltratie putten en kolken werken minder goed bij een hoge grondwaterstand, en de aanleg van infiltratiekragen is een extra investeringspost;
- In gebieden met een hoge grondwaterstand is meer grondwater soms niet gewenst;
- Er bestaat kans op vervuiling van het grondwater. Bij beperkt vervuild oppervlak moeten er extra zuiveringsmaatregelen worden genomen. Bij intensieve bestrijdingsmiddelen, gladheidsbestrijdingsmiddelen en transport van vervuilde vracht is afkoppeling niet wenselijk.

TU Delft

Kleerekoper, L.



WATERPLEINEN

SCHAALNIVEAU: WIJK

hitte

verkoeling door evaporatie, afkoelen door zwemmen

water

water berging tijdens piek buien, water beleving

lucht

Waterpleinen hebben een dubbele functie in de stad. In de eerste plaats is het een openbare ruimte die als (speel)plein kan worden ingericht. Daarnaast vervult het een bergingsfunctie voor regenwater tijdens piekbuien. Het plein wordt gebruikt als centrale ruimte in het waterhuishoudkundige systeem. Water in de wijk wordt op het plein opgevangen en tijdelijk vast gehouden. Vanuit dit bassin kan het water vervolgens infiltreren of via het riool geleidelijk worden afgevoerd.

Het plein staat voor 95% van de tijd droog, daarom moet er veel aandacht worden besteed aan de inrichting van het plein in droge toestand. Na een hevige regenbui loopt het plein vol en verandert de vorm en gedaante van het plein.

Een waterplein of reeks van water verzamelplaatsen in de wijk kan behalve een oplossing voor regenwater zijn ook bijzondere openbare ruimtes creëren. Zo kan waterberging met sport en speel plekken, natuurlijke zones, verkeersremmende maatregelen, monumentale elementen of een waterzuiveringssysteem worden gecombineerd. Een plein kan behalve een open bassin ook een gesloten of permeabel bassin hebben of een drijvend oppervlak hebben dat omhoog komt met regen.



Waterpleinen, De Urbanisten



Benthemplein, Rotterdam

Kansen

- Tijdelijke piekberging van regenwater in combinatie met een functie als spelen, verkeer, kunst en/of waterzuivering;
- Ontlasting van het riool;
- Bijzondere openbare ruimtes;
- Ook met regen reden om naar buiten te gaan.

Kanttekeningen

- Water bij speelplekken moeten aan veel regelgeving voldoen, dit vergt extra aandacht, waarbij niet vergeten mag worden dat de ruimte vooral met droog weer, namelijk 95% van de tijd, een aangename en bruikbare plek is.

TU Delft



Kleerekoper, L.

WATERSPEELPLEKKEN

SCHAALNIVEAU: WIJK

hitte

verkoeling door evaporatie en indirect evapotranspiratie, afkoelen door zwemmen

water

water berging tijdens piek buien, water beleving

lucht

Waterspeelplekken geven kinderen de mogelijkheid water te beleven. De speelplaatsen kunnen stedelijk of natuurlijk worden ingericht en er kan permanent of alleen tijdens of na regenval water ter beschikking zijn. De speelplaatsen kunnen bij warm weer voor verkoeling zorgen.

De waterspeelplekken kunnen ook extra water bufferen tijdens piekbuien.



Waterspeelplaats De Potmarge, Leeuwarden



Aquaducten



Culemborg

Kansen

- Beleving van water voor kinderen;
- Verkoeling tijdens warme dagen;
- Extra water buffer.

Kanttekeningen

- De waterkwaliteit is erg belangrijk. Bij stilstaand water bestaat de kans op bacteriële verontreiniging bij warm weer. Er kan worden gewerkt met pompen geïntegreerd in de speeltoestellen of continu stromend water. Bij verbinding met groot oppervlakte water is kans op bacteriële verontreiniging een stuk kleiner.

TU Delft

Kleerekoper, L.



GRACHTEN EN KANALEN

SCHAALNIVEAU: STAD | WIJK

hitte

verkoeling door evaporatie en indirecte evapotranspiratie door water toevoer aan bomen

water

water berging tijdens piek buien en water afvoer

lucht

Steden zijn vaak gebouwd aan rivieren, de zee en kanalen vanwege hun belangrijke rol in het transport. Maar water bracht ook het gevaar van overstromingen. Nederland heeft, als geen ander land een lange historie van water management. Dit heeft geleid tot vele variaties in water applicaties binnen de Hollandse steden.

Water kan koelen door evaporatie en door absorptie. De opgenomen warmte kan door stroming de stad worden uitgevoerd. In het algemeen koelt water meer als het stroomt en door het te vernevelen, zoals een fontein doet, wordt een nog groter koeleffect bereikt. Het koeleffect binnen de stad hangt vooral ook af van de luchtstroming die de verkoelde lucht door de stad verspreid.

Het koeleffect van water in steden met een Nederlands klimaat is nog niet gekwantificeerd. Studies in warmere klimaatzones geven een koeleffect van 1-3°C op een afstand van 30 meter. Een studie in Japan laat een temperatuur reductie van ongeveer 3°C op een afstand 35 meter aan de lijzijde van een fontein zien. Het gemeten effect van het watersysteem kan worden gevoeld van 14.00 tot 15.00, op andere momenten van de dag is het temperatuurverschil kleiner (Nishimura, et al 1998).



Oudegracht, Utrecht



Keizersgracht, Amsterdam

Kansen

- Combinatie van koelfunctie en wateropslag/buffer;
- Maken gebruik van relatief constante temperatuur (warmtepomp);
- Water voor stedelingen als afkoel plek; waterspeelplaats, kunststrand of in een vernevelmachine;
- Aantrekkelijke stedelijke omgeving;
- Combinatie met transport en recreatie;
- Voeding/vocht voor flora en fauna;
- Habitat voor organisch leven;
- In Nederlandse steden speelt water vaak een belangrijke rol in de geschiedenis van de stad, in de vorm van havens, rivieren of kanalen. Door deze wateren te herintroduceren of opnieuw vorm te geven kan deze geschiedenis de stad verrijken.

Kanttekeningen

- Water in de stad kan bij warm weer tot gezondheidsproblemen leiden;
- Bij de introductie van nieuwe waterlopen moet ook ontworpen worden op droge en warme periodes;
- Water lopen in de stad vergen aandacht en onderhoud.

TU Delft



Kleere koper, L.

AFKOPPELEN REGENWATER

SCHAALNIVEAU: WIJK | STRAAT | PERCEEL

hitte

water

water bufferen, afvoeren of infiltreren

lucht



Schoon regenwater dat op verharde oppervlakken valt, stroomt vaak samen met vuil afvalwater via het rioelstelsel naar de rioelwaterzuiveringsinstallatie. Hier wordt het 'schone' regenwater gezuiverd. Dat is niet alleen zonde, maar veroorzaakt ook steeds meer problemen. Doordat het steeds harder regent, raken de rioelbuizen sneller overbelast. Het gevolg is dat de rioelbuizen overstorten op het oppervlaktewater en er vervuild water in de sloten en rivieren stroomt. Een deel van dit probleem is te voorkomen door het regenwater af te koppelen van het rioel.

Bij afkoppelen is er onderscheid tussen terreinen in openbaar eigendom en terreinen in particulier eigendom. Momenteel worden in Nederland vooral openbare terreinen en alle nieuwbouwprojecten afgekoppeld. In de toekomst zullen ook steeds meer bestaande particuliere eigendommen worden afgekoppeld. Sinds 1 januari 2008 kan de gemeente voor nieuw te bouwen woningen het opvangen van hemelwater op eigen terrein verplicht stellen, in alle situaties die zich daarvoor lenen. Voor bestaande bebouwing geldt geen wettelijke verplichting.



Afkoppelen regenwater naar oppervlakte water



Afkoppelen regenwater naar gescheiden rioel

Kansen

- Minder belasting op het rioel waardoor overstorten minder vaak in werking treden en straten minder vaak blank staan;
- Dit betekent respectievelijk schonere oppervlakte water en minder overlast voor het verkeer;
- Waterzuiveringsinstallaties hoeven minder water te verwerken;
- Zoet en schoon water kan worden opgeslagen voor droge tijden.

Kanttekeningen

- Een gescheiden rioelstelsel betekent hogere investeringskosten. Bij afkoppeling en infiltratie op locatie moet daar aandacht en ruimte voor zijn;
- Bij bestaande woningen is het niet gemakkelijk bewoners tot actie aan te zetten om een voorziening te maken om hun regenwater in de eigen tuin op te vangen.

TU Delft

Kleerekoper, L.



NATUURLIJKE OEVERS

SCHAALNIVEAU: WIJK | STRAAT

hitte verkoeling door evaporatie en indirect evapotranspiratie door water toevoer aan bomen

water water berging tijdens piek buien en water afvoer

lucht luchtfilter voor fijnstof en VOC's

Ruimte voor water wordt steeds belangrijker met de toename van hevige buien, maar ook mel langere droge periodes die leiden tot daling van de grondwaterstand en verzilting.

In het Zuiderpark in Rotterdam is extra oppervlakte water gerealiseerd om regenwater te kunnen opvangen bij piekbuien. Om voor extra bufferruimte te zorgen is gekozen voor 50% van de oever breed en natuurlijk aan te leggen. Naast de functie van water buffer zijn natuurlijke oevers ook veilige en interessante plekken voor kinderen om te spelen en vervullen deze een ecologische en waterzuiverende functie.



Zuiderpark, Rotterdam



Leidschrijn, Utrecht

Kansen

- Extra waterberging;
- Recreatieve functie en beleving;
- Habitat en waterzuivering.

Kanttekeningen

- Natuurlijke oevers nemen meer ruimte in beslag en vergen regelmatig onderhoud, wat overigens niet betekend dat het beheer daardoor in zijn geheel duurder wordt.

OPEN WATER EN WATERPARKEN

SCHAALNIVEAU: REGIO | STAD

hitte

verkoeling door evaporatie en indirect evapotranspiratie door water toevoer aan bomen

water

water berging tijdens piek buien en water afvoer, toevoer van vers water

lucht

Waterparken bestaan voor een groot gedeelte uit permanent water. De ligging is vaak nabij stedelijk gebied zodat het bereikbaar is voor een grote groep mensen. Hier kan verkoeling worden gezocht op warme dagen, maar kan men ook bij kouder weer uitwaaien en zich uitleven. Het koelvermogen van deze parken is groter dan kleinere stads vijvers, maar door de ligging buiten de stad koelt het park in beperkte mate de directe woonomgeving. Bij een gunstige windrichting voert een waterpark koelere lucht aan.

Waterparken zijn van essentieel belang voor het koelvermogen van het water in de stad. Grachten, kanalen en vijvers worden gevoed met vers en koel water uit deze oppervlakte wateren buiten de stad.

De grote wateroppervlakken zijn ook belangrijk als buffer voor het opvangen van regenwater bij veel neerslag en als watervoorraad bij droogte.

In waterparken kunnen zomer en winter activiteiten met water zijn. In het park kunnen verblijfplaatsen zijn voor zwemmen, vissen, picknicken, etc. Bij een groot wateroppervlak kan actief watersport worden uitgeoefend.



Gaasperplas, Amsterdam



Loosdrechtse plassen, recreatie

Kansen

- Koele plek nabij stedelijk gebied;
- Recreatie functie;
- Kan belangrijke bijdrage leveren aan de waterhuishouding van steden;
- Afhankelijk van de aanleg en het beheer kan het een goede habitat vormen voor met name trek vogels.

Kanttekeningen

- Vergen een groot oppervlak;
- Kosten van aanleg en beheer kunnen door de juiste functies in het park te plaatsen worden terugverdiend.

TU Delft

Kleerekoper, L.



HELOFYTEN FILTER/GRIJSWATERSYSTEEM

SCHAALNIVEAU: WIJK | PERCEEL

hitte

verkoeling door evaporatie en indirecte evapotranspiratie door water toevoer aan vegetatie

water

zuivering en hergebruik water berging tijdens piek buien

lucht

luchtfILTER voor fijnstof en VOC's

Door water te zuiveren en te hergebruiken besparen we veel zoet water. Door het decentraal te doen en met natuurlijke processen is er minder geld, energie en een transportleiding nodig om ons watersysteem te onderhouden.

Met name een helofytenfilter heeft een grote koelcapaciteit omdat de planten letterlijk met hun wortels in het water staan.



Grijswater systeem



Helofytenfilter

Kansen

- Minder belasting van het riool en waterzuiveringsinstallaties waardoor minder energie, onderhoud en chemicaliën nodig zijn;
- Tijdens droogte wordt minder schaars zoet water verbruikt en dit blijft bovendien op locatie i.p.v. te worden afgevoerd naar zee;
- Bewoners worden zich bewuster van hun waterverbruik en de schoonmaakmiddelen die ze gebruiken;
- Een wijk bereikt een hogere mate van zelfvoorzienendheid.

Kanttekeningen

- Een natuurlijk waterzuiveringsstelsel is kwetsbaar voor schadelijke stoffen, bewoners moeten zich enigszins aan het systeem conformeren;
- Voor een natuurlijk waterzuiveringsstelsel moet ruimte worden gereserveerd of vrijgemaakt. Er kan ook een deel van de zuivering ondergronds plaatsvinden;
- Hergebruik van water roept bij veel mensen in eerste instantie weerstand op vanwege angst voor besmetting. Dit is ongegrond wanneer de aanleg goed wordt gedaan en aansluitingen goed worden gemonteerd.

TU Delft



Kleerekoper, L.

BESCHADUWEN GEBOUWEN

SCHAALNIVEAU: STRAAT | GEBOUW

hitte

voorkomen van opwarming van buiten- en binnenklimaat

Het beschaduwen van gebouwen kan een groot verschil in gevoelstemperatuur opleveren. De straling die door de verharde oppervlakken van de stad worden versterkt door weerkaatsing levert een extra warmte last op voor het menselijk lichaam. Door deze extra straling weg te nemen wordt de gevoelstemperatuur verlaagd (Mayer & Matzarakis 2010).

water

Zonwering kan ook aan de gevel worden bevestigd of binnen worden aangebracht. Hierbij is zonwering aan de buitenkant effectiever dan binnen. Bij binnenzonwering warmt de ruimte tussen het glas en de zonwering toch op en moet dit weggeventileerd worden. Bij de toepassing van luiken als zonwering is er in de winter ook een isolatie functie wanneer deze gesloten zijn.

lucht

voorkomt reactie van zonlicht met VOC tot smog vorming

Een overstek met de juiste afmeting en positie boven het raam is in het Nederlandse klimaat ideaal. In de zomer wordt de hete middag zon geblokkeerd, maar kan de ochtend- of avondzon en de laagstaande zon in de winter wel voor een behaaglijk binnenklimaat zorgen. Wanneer deze laagstaande zon niet onder de schaduw voorziening doorschijnt dient de schaduw toepassing flexibel genoeg te zijn om dit jaarlijks te monteren en demonteren.



Zonneshermen, Malaga, Spanje

Kansen

- Zonneshermen boven de straat kunnen als decoratie iets toevoegen aan het straatbeeld;
- Een dubbele functie als overkapping tegen hete zon en regen;
- Een flexibele inzetbaarheid: wanneer zon gewenst is kan het scherm eenvoudig worden ingetrokken.

Kanttekeningen

- Het zonnesherm moet goed bevestigd kunnen worden, dit kan bij monumentale panden op problemen stuiten. Er kan dan aan lantaarnpalen of een aparte constructie worden gedacht;
- In Nederland wisselen hete en stormachtige periodes elkaar soms snel af. De doeken moeten dus tegen hevige regen en windstoten kunnen.

TU Delft

Kleerekoper, L.



ORIËNTATIE OP DE ZON

SCHAALNIVEAU: WIJK | STRAAT

hitte

bepalend voor opwarming van buiten- en binnenklimaat

water

lucht

De oriëntatie van gebouwen op de zon is in Nederland normaal gesproken gebaseerd op de winter situatie. Om in de koudere maanden profijt te hebben van natuurlijk licht en warmte worden gevelopeningen aan de zuidkant groter ontworpen dan aan de noord kant. Om oververhitting in de zomer te voorkomen zijn er vele mogelijkheden van zonwering, zie ook 'beschaduwden van gebouwen'.

De oriëntatie van straten op de zon heeft veel invloed op het klimaat in de straat en de bebouwing. In de meeste stratenpatronen heeft dit nauwelijks een rol gespeeld bij de aanleg. Andere factoren, zoals verkeersdoorstroming en omliggende stratenpatronen, zijn vaak bepalend voor de oriëntatie.

Oost-West oriëntatie is warmer dan Noord-Zuid oriëntatie (Klok, L.2010). Bij deze oriëntatie vangen straten zomers meer zonlicht in de ochtend en eind van de middag, maar op het heetst van de dag geven ze meer schaduw in tegenstelling tot Noord-Zuid georiënteerde straten. Bij een Oost-West oriëntatie vangen de gevels relatief meer zonlicht in de winter dan in de zomer (Esch et al, 2012).

De meest optimale oriëntaties zijn NO-ZW en NW-ZO voor de combinatie van binnen en buiten comfort. Deze oriëntaties vangen voldoende licht in de winter, zijn goed te beschaduwden in de zomer en leveren een goede prestatie voor het buiten comfort in de zomer (Ali-Toudert & Mayer 2006).



Stad van de zon, Heerhugowaard

Kansen

- Er kan energie voor verwarming en koeling worden bespaard met een gunstige oriëntatie.

Kanttekeningen

- Winter en zomer klimaat stellen tegenstelde eisen, de optimale oriëntatie is afhankelijk van het gebruik/functie van de straat en gebouwen;
- Er zijn vele andere factoren die de oriëntatie van een straat en gebouw bepalen, de inrichting van een straat is meer bepalend in de mate van opwarming.

TU Delft

Kleerekoper, L.



BEVORDEREN NATUURLIJKE VENTILATIE

SCHAALNIVEAU: STAD | WIJK | STRAAT

hitte

warme lucht vervangen voor koele lucht en beïnvloeden menselijk comfort

water

lucht

luchtvervuiling weg ventileren



Er kunnen in steden luchtstromingen worden beïnvloed door het geleiden van wind langs gebouwen en groenstroken. Windstromen worden afgebogen of geremd. Bij het stimuleren van wind ter verkoeling moet altijd rekening worden gehouden met situaties waarin harde wind voor oncomfortabele of zelfs gevaarlijke situaties kan leiden.

Tijdens warme dagen is er vaak weinig wind, waardoor koele luchtstromen van buiten de stad minder makkelijk de stad binnen komen. Er kan met lage windsnelheden (max 0.5 m/s) wel verkoeling zijn van de plaatselijke stromingen die ontstaan door temperatuurverschillen van oppervlakken. Wanneer na zonsondergang de hoge temperatuur van straten en gevels de lucht doet stijgen wordt er in het geval van de aanwezigheid van een park koude lucht aan gezogen. Doordat deze lucht ook weer opwarmt ontstaat er zo een luchtstroming van het park naar de hete plek. Deze stroming blijft twee tot zes uur na zonsondergang doorgaan. Deze luchtstroming heeft invloed tot 250 meter van de rand van een park (Eliasson & Upmanis 2000). Ook kunnen spoor trajecten door de stad voor koele luchtstroming zorgen (Cenedese & Monti 2003).

Opwarming van de gevel aan de lizzijde verhoogd de menging van lucht uit straat met luchtlaag erboven. Opwarming van de loefzijde verslechterd deze: afname luchtkwaliteit (Sini et al. 1996). En schuine daken zorgen voor een mix van de lucht in de straat met de lucht daarboven (Rafailidis 1997).

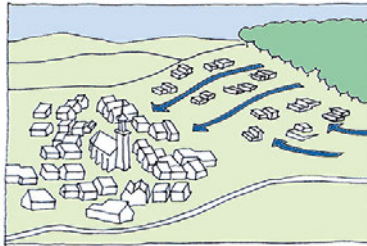

Luchtstroming (groenblauwenetwerken.com)



Brede straten in Parijs, Haussmann

Kansen

- In een structuurvisie is het mogelijk een bepaalde openheid van bepalende gebieden te stellen. Door bijvoorbeeld een max aan bebouwingsdichtheid en hoogte te stellen.

Kanttekeningen

- Oriënteren op een windrichting is in Nederland niet gunstig: de wind komt tijdens hete en koude extremen beide uit het noordoosten en de hardste wind uit tegengesteld richting, het zuidwesten. Daarbij is de windsnelheid tijdens hete extremen ook vaak heel laag waardoor een mogelijk koeffect gering blijft;
- Bij het geleiden van luchtstroming spelen vele factoren een rol welke soms moeilijk te voorspellen is en zeer variabel zijn.

TU Delft

Kleerekoper, L.



GEVEL- EN DAKOPPERVLAK

SCHAALNIVEAU: STAD | WIJK | STRAAT | PERCEEL

hitte warmte accumulatie

water verdamping en vertraging in regenwaterafvoer

lucht

Gevels van gebouwen hebben veel impact op het stedelijk microklimaat. De traditionele bakstenengevel zoals we die in Nederland kennen kan veel warmte absorberen. In de ochtend kan dit tot een vertraging in opwarming leiden, maar in de avond geven de gevels nog na zonsondergang warmte af. Andere materialen zoals kunststof en staal slaan minder warmte op en dragen daarmee minder bij aan het nachtelijke hitte eiland.

Een ander aspect van gevels is de reflectie van zonlicht. Wanneer een gevel veel zonlicht reflecteert ontvangen gebouwen, de straat, objecten en mensen een grotere stralingsbelasting. Dit kan leiden tot hogere temperaturen buiten, maar ook bij een tegenoverliggend gebouw kan de binnentemperatuur oplopen. Omdat straling de comforttemperatuur sterk beïnvloed hebben reflecterende gevels een negatief effect op het thermisch comfort buiten in de zomer. Daarbij geeft een lichte buitengevel slechts een kleine temperatuurverlaging binnen een gebouw.

Een hoge reflectie van het dakoppervlak heeft op binnen- en buitentemperatuur een verlagend effect. Omdat de straling terug naar de hemel reflecteert wordt deze niet in de stad in warmte omgezet.

Een gevel- of dakoppervlak kan positief bijdragen aan het microklimaat wanneer deze door bijvoorbeeld vegetatie wordt beschaduwd en actief water verdampt. Een groengevel of -dak zorgt bovendien voor vertraagde afvoer van regenwater. Ook andere materialen kunnen bijdragen aan vertraagde afvoer, zoals veel reliëf of sponsachtige materialen.



Hundertwasser-Haus, Wenen, Oostenrijk



Hortus Conclossus water wall, Duitsland

Kansen

- Gevels en daken worden momenteel niet ingezet voor het reguleren van het buitenklimaat terwijl deze gemiddeld 40% van het stadsoppervlak beslaan;
- De functie van daken en gevels is in de meeste gevallen eenzijdig het beschermen van invloeden van buiten. In tegenstelling tot de concurrentie om ruimte op straat bieden gevels en daken de ruimte om het buitenklimaat te beïnvloeden.

Kanttekeningen

- Gevels en daken zijn gebouwonderdelen en zijn met name privé-eigendom. Particulieren zullen moeten worden overtuigd of gestuurd om een rol te kunnen vervullen voor het stedelijk klimaat;
- Onderhoud, duurzaamheid en uitstraling zijn aspecten die de keuze voor een gevelmateriaal en kleur voor een groot deel meewegen.

TU Delft

Kleerekoper, L.



REGENWATER BESTENDIG BOUWEN

SCHAALNIVEAU: STAD | WIJK | STRAAT | PERCEEL



mogelijk meer verdamping



voorkomen schade door extreme neerslag



Een wolkbreuk kan in korte tijd voor veel water op straat en in tuinen zorgen. Wanneer er te weinig ruimte binnen een gebied is om dit water te bergen zal er veel water via riool- of hemelwaterafvoeren moeten wegstromen. Indien het afvoersysteem overloopt komt water op straat te staan of kan zelfs kelders en huizen binnenstromen.

In Nederland is het beleid nu gericht op regenwater 'vasthouden, bergen en (vertraagd) afvoeren'. De meeste straten worden gedimensioneerd op een bui van 20mm in een uur. In de toekomst zullen extremere buien voorkomen en is de norm van 60mm een beter uitgangspunt. Ter vergelijking, in Kopenhagen viel in 2011 een bui van 150 mm in twee uur.

De inrichting van het stedelijk gebied heeft veel invloed op het wel of niet ontstaan van wateroverlast. Door stoepranden of een holle weg aan te leggen voorkom je in de meeste gevallen dat water woningen inloopt. Drempels bij buitendeuren geven een extra bescherming. Bij winkels waar geen drempels gewenst zijn zal er op straat meer nodig zijn om extreme buien goed af te voeren. Het is vaak mogelijk waterafvoer aan te sluiten op openbaar groen.

Ook op privé terrein zijn veel mogelijkheden water te bergen, infiltreren en zelfs hergebruiken. Wat de bijdrage op het totale watersysteem kan zijn is te berekenen met bijvoorbeeld Rain Tools van RIONED. Belangrijk is dat particulieren hun potentiële bijdrage in de waterbalans in hun straat zien. Door de inrichting van de tuin aan te passen met minder verharding of door bijvoorbeeld groene daken aan te leggen kan er veel meer water lokaal worden vastgehouden of infiltreren.

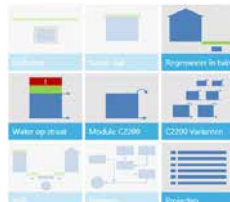

Raintools.nl



Wateroverlast Groningen in juli 2011 (Trouw)

Kansen

- Minder water in het (gemengde) riool betekend minder belasting op zuiveringsinstallaties;
- Bij extreme buien kan relatief schoon regenwater naar oppervlakte water worden afgevoerd ipv een overstort van vuil water uit het riool;
- Er zijn kansen voor wateroplossingen in combinatie met groen in de straat, op daken en gevels, in particuliere tuinen, bedrijventerreinen.

Kanttekeningen

- Extreme buien komen vaker voor, maar wanneer en op welke plekken in Nederland die extreme bui - die eens in de 100 jaar valt - komt blijft gissen. Het is goed om te bedenken wat in dat geval acceptabel is.

HERONTWIKKEL-/UITBREIDINGSSTRATEGIE

SCHAALNIVEAU: REGIO | STAD

hitte verkoelende zones tussen steden, omvang stad en locatie keuze stadsuitbreiding

water

lucht

Factoren die van invloed zijn op het UHI effect over de gehele stad (meso-schaal) zijn naast weersinvloeden de omvang van de stad, de bebouwing en materialen in de stad en de temperatuur van de omliggende omgeving.

Hoe groter de stad, hoe groter het UHI effect. Dit fenomeen is aangetoond met vele studies over de hele wereld. Hitte accumuleert in steden vanwege het ontbreken van bomen, enorme verharde oppervlaktes, obstakels die ventilatie met wind blokkeren en door menselijke activiteiten zoals verkeer, industrie, koelen van gebouwen, etc.

T. R. Oke, beroemd onder klimatologen m.b.t. zijn onderzoeken naar het UHI effect, heeft een methode gevonden waarmee het UHI effect kan worden voorspelt voor een Europese stad. Aan de hand van het aantal inwoners van de stad kun je met de volgende formule het maximale verschil in temperatuur tussen de stad en het platteland voorspellen:

$$\Delta T_{u-r}(\max) = 2.01 \log P - 4.06 \text{ (Oke, 1973).}$$

Wanneer de verkoelende werking van de omgeving op de stad in kaart is gebracht kan blijken welke gebieden van belang zijn. Door deze open te houden en niet te bebouwen blijven ze verkoelen. De formule van Oke is indicatief, er is wel degelijk een verschil tussen wijken in hitte-opbouw. Wanneer een nieuwe wijk met veel aandacht voor het microklimaat wordt ontworpen draagt deze minder bij aan de opwarming van aangrenzende wijken dan een standaard ontwikkeling.



Groen-blauw raamwerk, Provincie Zuid Holland



Kanaalzone, Apeldoorn

Kansen

- Veel groen en water op alle schaalniveaus verbetert de leefbaarheid van de stedelijke omgeving;
- Met name groene plekken binnen 200 van de woning en parken in en om de stad zijn belangrijk voor mensen om verkoeling op te zoeken.

Kanttekeningen

- Wanneer een zone of gebied wordt aangewezen als 'klimaat buffer' of verkoelende zone om zo stedelijke ontwikkeling mogelijk te maken is het gevaar dat in de loop van tijd ook die zone zal worden ontwikkeld. Dit pleit voor voldoende groen ook binnen straten en wijken.

TU Delft

Kleerekoper, L.



REFLECTERENDE MATERIALEN

SCHAALNIVEAU: STRAAT | PERCEEL

hitte

voorkomt opwarming van materialen waardoor minder warmte vrijkomt na zonsondergang

De reflectie factor van een materiaal heeft invloed op de hoeveel zonlicht dat wordt weerkaatst en hoeveel er wordt opgenomen in het materiaal. Reflecterende materialen verminderen opwarming van gevels, daken en bestrating. Dit is gunstig voor het binnenklimaat. En buiten vermindert dit de lange golf straling, met name in de avond en nacht is dit effect van belang.

water

Zoals hiervoor omschreven bij gevel- en dakoppervlak, kan de korte-golf straling een tegenoverliggende gevel of mensen en objecten in de straat juist extra stralingsbelasting bezorgen. Deze weerkaatsing spreekt nauwelijks een rol bij daken.

lucht

De reflectie factor wordt ook wel de albedo van een materiaal genoemd en wordt bepaald door de kleur en de ruwheid van het oppervlak van een materiaal. Hoe hoger de albedo, hoe meer licht er wordt weerkaatst. Zo heeft asfalt een gemiddelde albedo van 14%, baksteen 30%, aluminium en staal 60%, en verse sneeuw 80%.

Resultaten van een toenemende albedo zijn berekend in een simulatiemodel voor Sacramento, Californië. Door het verhogen van de albedo van een gehele stad van 25 naar 40%, kan een temperatuurdaling van 1-4 °C worden bereikt. Het verhogen van het gebouw albedo van 9 naar 70% kan de jaarlijkse vraag naar koeling met 19% verminderen. (Taha et al., 1988).



Vejer de la Frontera, Spanje

Kansen

- Lichte, of reflecterende gevels zorgen naast minder warmte afgifte na zonsondergang aan de buitenlucht ook voor minder opwarming van binnen ruimtes;
- Materialisatie en kleur kunnen een relatief goedkope en simpele ingreep zijn, met name in gebieden waar weinig mogelijkheden voor andere hitte beperkende maatregelen zijn.

Kanttekeningen

- Het zonlicht dat door hoge reflectie wordt weerkaatst bereikt voor een groot deel alsnog omliggende gevels, bestrating en mensen waar de straling alsnog resulteert in opwarming.;
- Hoge reflectie in gevels en bestrating kan voor ongewenste situaties zorgen, zoals verblinding van verkeersdeelnemers;
- In een klimaat waar het weer vaak vochtig en bewolkt is vergen lichte kleuren meer onderhoud door ververing;
- In de winter kunnen hoge albedo waardes een verhoging in energieverbruik opleveren. Echter, een studie naar witte daken in New York toonde aan dat een hoog albedo geen verhoging van het energieverbruik voor verwarming oplevert (Gaffin et al. 2010).

TU Delft

Kleerekoper, L.



LAGE WARMTE ACCUMULATIE

SCHAALNIVEAU: WIJK | STRAAT | PERCEEL

hitte

beperkt opwarming van gevels en straten waardoor minder warmte vrijkomt na zonsondergang

water

lucht



Naast reflectie (albedo) speelt het absorptie vermogen van materialen ook een rol bij het opwarmen. Harde materialen, zoals baksteen kunnen veel hitte opslaan.

Harde materialen in de stad zorgen in de ochtend uren voor een vertraging van de opwarming van de stedelijke omgeving. 's Avonds wanneer de temperatuur daalt geven deze materialen de opgeslagen warmte weer langzaam af waardoor dit juist leidt tot een vertraagde afkoeling van de stedelijke omgeving.

Een onderzoek uit Singapore onderzocht drie materialen: baksteen, beton en een holle baksteen (Wong Nyuk, 2007). De baksteen bleef het langste warmte afgeven na zonsondergang, daarna beton en de holle baksteen was het eerste afgekoeld. Doordat er minder materiaal in de holle baksteen zit kan deze minder warmte accumuleren.

Er is ook verschil in de snelheid waarmee een materiaal warmte kan opnemen en afgeven. Zo warmen staal en aluminium snel op en koelen ook weer snel af. Hierdoor wordt het stedelijke hitte-eiland overdag versterkt, maar na zonsondergang is de warmte snel weer verdwenen.

Zie bijlage warmte capaciteit voor een vergelijking van materialen



Van links naar rechts: traditionele baksteen, betonsteen, holle baksteen

Kansen

- Materialisatie kan een relatief goedkope en simpele oplossing zijn, met name in gebieden waar weinig mogelijkheden voor andere hitte beperkende maatregelen zijn;
- Materialen die minder warmte opnemen zijn vaak ook lichter waardoor de fundering ook lichter kan worden uitgevoerd.

Kanttekeningen

- Wanneer gevel die minder warmte accumuleert betekent dit niet dat er minder warmte naar binnen toe slaat. Hiervoor zal de juist isolatie voor moeten worden toegepast.

TU Delft

Kleerekoper, L.



LUCHTSTROMING VIA ΔT

SCHAALNIVEAU: WIJK | STRAAT | PERCEEL

hitte

luchtstroming bevordert de comfort temperatuur tijdens hitte

water

lucht

meer ventilatie geeft een betere luchtkwaliteit



Met het principe 'warme lucht stijgt' kan er op verschillende schaalniveaus luchtstroming worden gecreëerd.

Gebouwen met een atrium of een zonneshoorsteen zoals ontwikkeld door Bronsema (2013) verzamelen warme lucht door zonnestraling via een glazen gevel. Door het grote temperatuurverschil tussen binnen en buiten ontstaat er trek. Gebouwen kunnen op deze manier verse luchttoevoer krijgen zonder dat hier mechanische ventilatie voor nodig is.

In straten is de ventilatie voor een groot deel afhankelijk van de hoogte/breedte verhouding en de aanwezigheid en positie van bomen. Hier kunnen lokale verschillen in luchtstroming worden gecreëerd door een oppervlak extra te laten opwarmen. Hier zal de lucht vervolgens (sneller) stijgen. Meer ventilatie verbetert het comfort tijdens hete dagen en waarschijnlijk zal er meer verse/koele lucht de straat worden ingezogen (Kleerekoper et al. 2015).

Op pleinen of in een buurt kan een park dat grenst aan een plein of straat voor een verkoelende luchtstroming zorgen. Tot op 250 m van het park kan een koele luchtstroming ontstaan naar een warme stenige plek (Eliasson & Upmanis 2000).



Zonneshoorsteen, ontwikkeld door Bronsema



Zwarte parel, Rotterdam

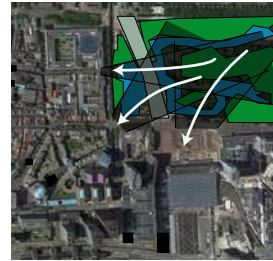

Malieveld en Haagse Bos voorzien binnenstad van koele lucht

Kansen

- Verbeterd comfort en minder energiegebruik kunnen samen gaan;
- Deze oplossing legt geen ruimtebeslag op de locatie waar verkoeling is gewenst;
- Luchtstroming op basis van thermiek werkt alleen bij zonnig en windstil weer en heeft daarmee geen nadelige effecten in de winter.

Kanttekeningen

- Donkere materialen zorgen plaatselijk voor meer warmte, dus houd daar rekening mee in relatie tot functie en eventueel gebruik van die warmte.

TU Delft

Kleerekoper, L.

PERMEABELE MATERIALEN

SCHAALNIVEAU: WIJK | PERCEEL

hitte

bevordert infiltratie en verbeterd daarmee verkoelend vermogen van vegetatie

water

infiltratie is een middel om water van verhard oppervlak te draineren

lucht

Materialen die water doorlaten dragen bij aan de waterafvoer van (semi-)verhard oppervlak. Hiermee kan water in de ondergrond infiltreren. Afhankelijk van de bodemsoort en grondwaterstand kan deze extra infiltratie vegetatie voorzien van voldoende vocht tijdens warme en droge periodes. Een boom met voldoende toegang tot vocht zal meer verdampen en daarmee meer verkoelen.

Indien de grondsoort onvoldoende infiltratiecapaciteit heeft kan er onder de halfverharding een granulaat worden aangebracht of een krattensysteem worden aangelegd. Zo kan er ondergronds veel water worden opgeslagen. Er zijn ook systemen die het opgeslagen water langzaam of alleen in tijden van droogte aan de bomen afgeven.



Grassplittegel, Sporthal, Almelo



Waterdoorlatend asfalt en bestrating

Kansen

- Water infiltratie is mogelijk zonder verlies van verhard oppervlak, ofwel intensief ruimtegebruik;
- Grasbeton zorgt voor extra verkoeling door verdamping;
- Kan gecombineerd worden met een lichte kleur verharding.

Kanttekeningen

- Vergt voldoende onderhoud om waterdoorlatende functie te behouden: blad, vuil en zand verwijderen;
- De afvoercapaciteit van waterdoorlatende verharding is relatief laag. Hierdoor heeft het een beperkt effect in berging van piek buien;
- Grasbeton kan bij intensief gebruik kaal worden waarmee het zijn groene aanzicht en extra verkoelende werking door verdamping van het gras verliest;
- Infiltratie is niet in alle grondsoorten mogelijk;
- Bij hoge grondwaterstanden kan extra infiltratie ongewenst zijn.

TU Delft



Kleerekoper, L.

ENERGIE EN EXERGIE CONCEPTEN

SCHAALNIVEAU: STAD | WIJK

hitte

voorkom warmte uitstoot van gebouwen, benut warmtestromen en oogst warmte

water

lucht

verminder verbranding van fossiele bronnen voor daling van fijnstof en CO₂ uitstoot



Het huidige energie systeem kan efficiënter, bijvoorbeeld door 'afvalwarmte' te gebruiken en koude- en warmtevraag op elkaar aan te sluiten. Zo kan de restwarmte van industriële processen gebouwen verwarmen en kan een zwembad water verwarmen met de warmte die vrijkomt van de koelinstallatie van een ijsbaan (REAP).

Naast het beter gebruik maken van 'reststromen' kan een exergie benadering zorgen voor een betere benutting van de kwaliteit van energiebronnen, waardoor uiteindelijk de vraag naar hoogwaardige bronnen reduceert. Exergie drukt uit wat de hoeveelheid arbeid is die kan worden geleverd uit een bepaalde hoeveelheid energie of materiaal, in zijn omgeving. Dit wordt ook wel de kwaliteit van de energie genoemd (S.C. Jansen 2013 thesis).

Bij een verbrandings- of elektromotor wordt brandstof of elektriciteit verbruikt, bij beide processen komt warmte vrij. In het geval van koude productie is de restwarmte een bijproduct, terwijl deze bij warmteproductie kan worden ingezet om het doel te behalen.

Door slim met warmte om te gaan en warmte uitstoot door koeling te voorkomen warmt de stad in de zomer minder op en kan flink op energie worden bespaard. Dit kan door slimmer te koppelen bij gelijktijdige warmte- en koude vraag zoals hierboven beschreven. Een andere optie is het realiseren van opslag: een warmtepomp levert *koude* in de zomer, het bijproduct *warmte* kan worden opgeslagen en in de winter worden ingezet om te verwarmen. Dit principe kan op gebouw of wijk niveau worden toegepast.



Aansluiten reststromen in Zweden (Jong 2010)

Kansen

- Het stedelijk hitte eiland neemt af doordat er minder restwarmte vrijkomt;
- Kan een bijdrage leveren aan de emissie doelstelling van de gemeente;
- Ontginning van landschappen voor het winnen van fossiele brandstoffen richt veel schade aan ecosystemen aan, door de potentie van deze grondstoffen beter te benutten draagt dit bij aan behoud van deze ecosystemen.

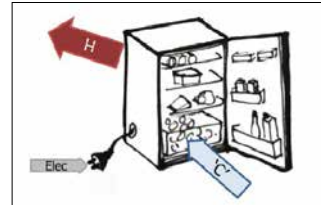

Een koelkast is een netto producent van warmte (Jansen 2015).

Kanttekeningen

- Er zal eerder een tekort aan koelcapaciteit dan aan warmtecapaciteit zijn wanneer meer woningen een EPC van 0,4 (norm per 1-1-2015) of zelfs 0 bereiken;
- Bij het gebruik van reststromen kunnen conflicten optreden wanneer een reststroom afneemt waardoor de afnemer te weinig warmte aanvoert krijgt.

TU Delft

Kleere koper, L.



ANTROPOGENE WARMTE

SCHAALNIVEAU: STAD | WIJK | PERCEEL

hitte

voorkomt warmte uitstoot van gebouwen, benut warmtestromen en oogst warmte

water

lucht

vermindert verbranding van fossiele bronnen voor daling van fijnstof en CO₂ uitstoot

Antropogene warmte is de warmte uitstoot veroorzaakt door menselijke activiteiten. Warmte afkomstig van bijvoorbeeld verkeer en koelinstallaties dragen bij aan de hogere temperaturen in steden. Airconditioners onttrekken warmte aan gebouwen en geven dit af aan de buitenlucht. Daarmee wordt de omgeving om het gebouw warmer en wordt veel elektriciteit verbruikt. In de regel betekent meer energieverbruik meer warmte uitstoot.

Het beschaduen van airconditioners is een zeer effectieve manier om energie te besparen (Akbari, et al. 1992). Echter, het voorkomen van het gebruik van airconditioners heeft de voorkeur. Dit kan door passieve ventilatie en goede zonwering al in het gebouwontwerp mee te nemen. Denk aan overstekken waar lage zonnestanden wel de binnenruimte in hefst, winter en voorjaar kunnen verminderen of flexibele zonwering.



Airconditioners aan een gevel

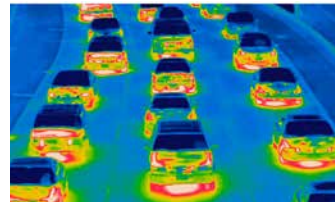

Warmte uitstoot auto's, door Turner, T. in national geographic 2009.

Kansen

- Warmte uitstoot moet zoveel mogelijk beperkt worden, en heeft de mogelijkheid te worden hergebruikt zoals omschreven in de factsheet energie concepten.

Kanttekeningen

- Het inzetten van antropogene warmte vereist net als het inzetten van reststromen veel afstemming en goede afspraken over aan- en afvoer.

TU Delft

Kleerekoper, L.



ASFALT- EN GEVELCOLLECTOREN

SCHAALNIVEAU: WIJK | PERCEEL

hitte

voorkomt warmte uitstoot van gebouwen, benut warmtestromen en oogst warmte

water

lucht

vermindert verbranding van fossiele bronnen voor daling van fijnstof en CO₂ uitstoot



Asfalt- en gevelcollectoren bieden de mogelijkheid om zonne-energie af te vangen en direct of via seizoensopslag te gebruiken voor het verwarmen van gebouwen en warm tapwater. Bij seizoensopslag kan het asfalt in de winter sneeuw- en ijsvrij worden gehouden. Doordat de temperatuur van het verhard oppervlak minder extreem heeft met dit systeem, wordt ook de levensduur verlengd. Een langere levensduur levert materiaal, energie en financiële winst op, en zorgt ook voor minder overlast van wegwerkzaamheden.

Er zijn verschillende systemen om warmte uit asfalt te onttrekken, de meest gebruikte methode is via een buizen systeem in het asfalt. Hieronder vallen het *Road Energy System* en het *Winnerway system*. Een andere optie is een poreuze laag beton tussen twee waterdichte lagen asfalt zoals bij het *Zonneweg-systeem* wordt toegepast.

Een asfalt collector levert gemiddeld 0,8 GJ per m² per jaar, dat betekent dat er ongeveer 25 - 35 m² nodig is om een woning van warmte en warm tapwater te voorzien (Cuiper 2007).

Ook voor stedelijk comfort zouden collectoren in asfalt en gevels een rol kunnen spelen, met name in de avond situatie. Deze oppervlakken geven nog lang na zonsondergang warmte af aan de lucht. Indien het materiaal zijn warmte al aan de collector heeft afgestaan zal deze nachtelijke opwarming minder zijn. Er is nog niet aangetoond of en hoeveel dit verkoelend effect werkelijk is. Wellicht is het effect verwaarloosbaar omdat warmte van grote open vlaktes, zoals grote parkeer plaatsen bijvoorbeeld, makkelijk aan de hemel wordt afgegeven.

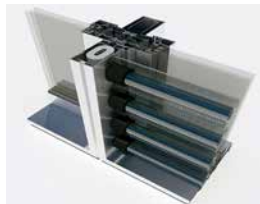

Collector voor glasgevel, Universiteit van Stuttgart



Asfaltcollector, Göteborg, Zweden

Kansen

- Met name interessant op plaatsen waar groen en wind niet als koel element kunnen worden ingezet;
- Geeft het oppervlak dat nu voor ongecontroleerde opwarming zorgt een belangrijke rol in meer controle over het stadsklimaat;
- Grote kans is het voorkomen van air-conditioners waarmee energie verbruik en extra warmte productie wordt verminderd. En natuurlijk het verminderen van energie verbruik in de winter voor verwarming.

Kanttekeningen

- Wanneer men kiest voor een asfalt collector, dan kan men het buitenklimaat niet meer conditioneren met bomen of andere schaduw systemen;
- Een asfalt collector is per definitie waterdicht en draagt dus niet bij aan vertraagde afvoer of infiltratie van water.

TU Delft

Kleerekoper, L.



LITERATUURVERWIJZINGEN

Akbari, H., Davis, S., Dorsano, S., Huang, J. and Winnett, S. (1992), "Cooling our communities, A guidebook on tree planting and light-colored surfacing", U.S. Environmental Protection Agency Office of Policy Analysis Climate Change Division.

Ali-Toudert, F. and Mayer, H. (2006), "Numerical study on the effects of aspect ratio and orientation of an urban street canyon on outdoor thermal comfort in hot and dry climate". *Building and Environment*, Vol. 41, No. 2, pp. 94-108.

Bowler, D.E., Buyung-Ali, L., Knight, T.M. and Pullin, A.S. (2010), "Urban greening to cool towns and cities: A systematic review of the empirical evidence". *Landscape and Urban Planning*, Vol. 97, No. 3, pp. 147-155.

Bronsema, B. (2013), *Earth, Wind & Fire: Natuurlijke Airconditioning*, Doctor degree Dissertation, Delft University of Technology.

Bruins, G. 2009. *Aanleg en beheer regewatersystemen. Van stedelijke wateropgave naar robuust watersysteem. Waterschap Regge en Dinkel.*

Cenedese, A. and Monti, P. (2003), "Interaction between an inland urban heat island and a sea-breeze flow: A laboratory study". *Journal of Applied Meteorology*, Vol. 42, No. 11, pp. 1569-1583.

Cuiper, N. 2007. *Warmte uit asfalt weer in de mode. Voordelen voor milieu en gezondheid maken asfaltcollectoren aantrekkelijk.* *Energy Magazine.*

Eliasson, I. and Upmanis, H. (2000), "Nocturnal airflow from urban parks-implications for city ventilation". *Theoretical and Applied Climatology*, Vol. 66, No. 1, pp. 95-107.

Esch, M.M.E.v., Looman, R.H.J. and Bruin-Hordijk, G.J.d. (2012), "The effects of urban and building design parameters on solar access to the urban canyon and the potential for direct passive solar heating strategies". *Energy and Buildings*, Vol. 47, pp. 189-200.

Gaffin, S.R., Rosenzweig, C., Eichenbaum-Pikser, J., Khanbilvardi, R. and Susca, T. (2010), "A temperature and seasonal energy analysis of green, white and black roofs", Columbia University, Center for Climate Systems Research, New York.

Hiemstra, J.A., Schoenmaker - v.d. Bijl, E. and Tonneijck, A.E.G. (2008), "Bomen, een verademing voor de stad".

Hop 2011) Hop, E.C.M. Hop (2011) *Vaste planten in openbaar groen. Voor functionele en onderhoudsvriendelijke toepassingen.* All-Round Communications, Boskoop.

Jansen, S. (2013), *Exergy in the built environment. The added value of exergy in the assessment and development of energy systems for the built environment.*, Delft University of Technology.

Johnston, J. and Newton, J. (2004), "Building Green. A guide to using plants on roofs, walls and pavements", Greater London Authority.

Jong, K.d. (2010), *Warmte in Nederland. Warmte- en koudenetten in de praktijk, mauritsgroen mgmc.*

Kikegawa, Y., Genchi, Y., Kondo, H. and Hanaki, K. (2006), "Impacts of city-block-scale countermeasures against urban heat-island phenomena upon a building's energy-consumption for air-conditioning". *Applied Energy*, Vol. 83, No. 6, pp. 649-668.

Kleerekoper, L., Dobbelsteen, A.A.J.F.v.d., Ham, E.v.d., Hordijk, T. and Martin, C. (2015), "Creating drafts in urban settings through coloured façades: Exploring a new climate adaptation measure based on thermal stratification". *Urban Climate*, Vol. 14, Part 2, pp. 290-300.

Klok, L. (2010), "Hittebeperkende klimaatmaatregelen voor Rotterdam onderzocht met Envi-met microschaal klimaatsimulaties", 034.21618, TNO, Kennis voor Klimaat.

Lenzholzer, S. (2008), "A city is not a building-architectural concepts for public square design in Dutch urban climate contexts". *Journal of Landscape Architecture*, Vol. 2008, No. 1, pp. 44-55.



Luley, C., Bond, J. and Agencies, C. (2002), "A plan to integrate management of urban trees into air quality planning": Davey Resource Group, New York. 61].

Mayer, H. and Matzarakis, A. (2010), "Projekte des Meteorologischen Instituts der Albert-Ludwigs-Universität Freiburg im Rahmen der BMBF Forschungsinitiative klimazwei", 22, Meteorologisches Institut der Albert-Ludwigs-Universität Freiburg, Freiburg.

McPherson, E., Nowak, D., Heisler, G., Grimmond, S., Souch, C., Grant, R. and Rowntree, R. (1997), "Quantifying urban forest structure, function, and value: the Chicago Urban Forest Climate Project". *Urban Ecosystems*, Vol. 1, No. 1, pp. 49-61.

Meier, A. (1991), "Measured cooling savings from vegetative landscaping". *Energy efficiency and the environment: Forging the link*.

Mentens, J., Raes, D. and Hermy, M. (2006), "Green roofs as a tool for solving the rainwater runoff problem in the urbanized 21st century?". *Landscape and Urban Planning*, Vol. 77, No. 3, pp. 217-226.

Nishimura, N., Nomura, T., Iyota, H. and Kimoto, S. (1998), "Novel water facilities for creation of comfortable urban micrometeorology". *Solar Energy*, Vol. 64, No. 4, pp. 197-207.

Oke, T.R. (1973), "City size and the urban heat island". *Atmospheric Environment* (1967), Vol. 7, No. 8, pp. 769-779.

Rafailidis, S. (1997), "Influence of building areal density and roof shape on the wind characteristics above a town". *Boundary-Layer Meteorology*, Vol. 85, No. 2, pp. 255-271.

Schmidt, M. 2006. *The contribution of rainwater harvesting against global warming*. IWA World Congress and Exhibition. Vienna: IWA Publishing, London, UK.

Shashua-Bar, L. and Hoffman, M. (2000), "Vegetation as a climatic component in the design of an urban street: An empirical model for predicting the cooling effect of urban green areas with trees". *Energy and Buildings*, Vol. 31, No. 3, pp. 221-235.

Sini, J., Anquetin, S. and Mestayer, P. (1996), "Pollutant dispersion and thermal effects in urban street canyons". *Atmospheric Environment*, Vol. 30, No. 15, pp. 2659-2677.

Taha, H., Akbari, H., Rosenfeld, A. and Huang, J. (1988), "Residential cooling loads and the urban heat island--the effects of albedo". *Building and Environment*, Vol. 23, No. 4, pp. 271-283.

Upmanis, H., Eliasson, I. and Lindqvist, S. (1998), "The influence of green areas on nocturnal temperatures in a high latitude city (Göteborg, Sweden)". *International Journal of Climatology*, Vol. 18, No. 6, pp. 681-700.

VanWoert, N., Rowe, D., Andresen, J., Rugh, C., Fernandez, R. and Xiao, L. (2005), "Green Roof Stormwater Retention-- Effects of Roof Surface, Slope, and Media Depth". *Journal of Environmental Quality*, Vol. 34, No. 3, pp. 1036-1044.

Vrscaj, B., Poggio, L. and Marsan, F. (2008), "A method for soil environmental quality evaluation for management and planning in urban areas". *Landscape and Urban Planning*, Vol. 88, No. 2-4, pp. 81-94.

Walsh, C.L., Hall, J.W., Street, R.B., Blanksby, J., Cassar, M., Ekins, P., Glendinning, S., Goodess, C.M., Handley, J., Noland, R. and Watson, S.J. (2007), "Building knowledge for a changing climate, Collaborative research to understand and adapt to the impacts of climate change on infrastructure, the built environment and utilities", Newcastle University.

Wong, N.H., Lee, S.E. and Li, S. (2007), "Thermal Performance of Facade Materials and the Impacts on Indoor and Outdoor Environment", National University of Singapore, Singapore.



Appendix C Simulation results

This appendix presents the simulation results in addition to the air temperature results in Figure 4.4 are represented graphically in wind speed (Figure C.1), mean radiant temperature (Figure C.2) and humidity (Figure C.3).

Variants overview - output in wind speed

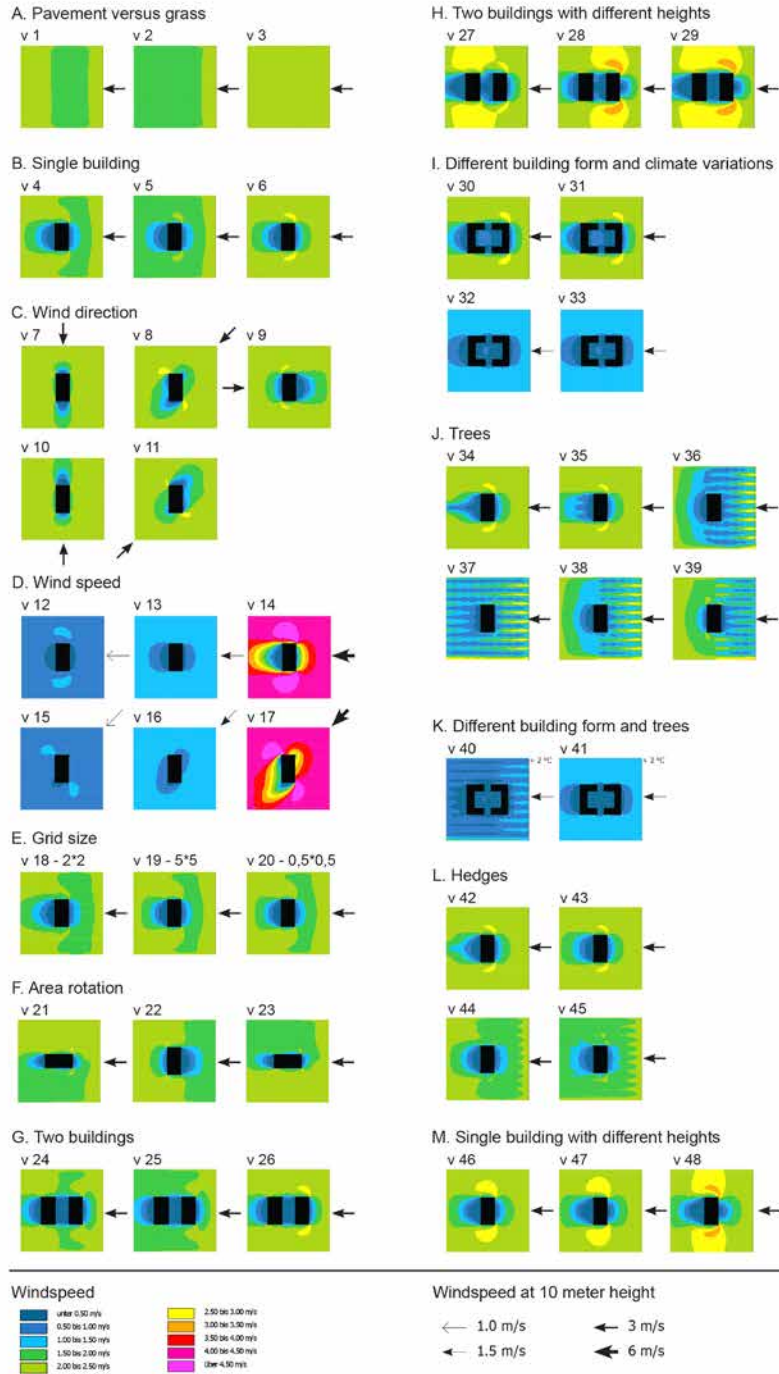

FIGURE APP.C.1 The wind speed on 13:00 o'clock at 1 metre height by the graphic program LEONARDO.

Variants overview - output in mean radiant temperature

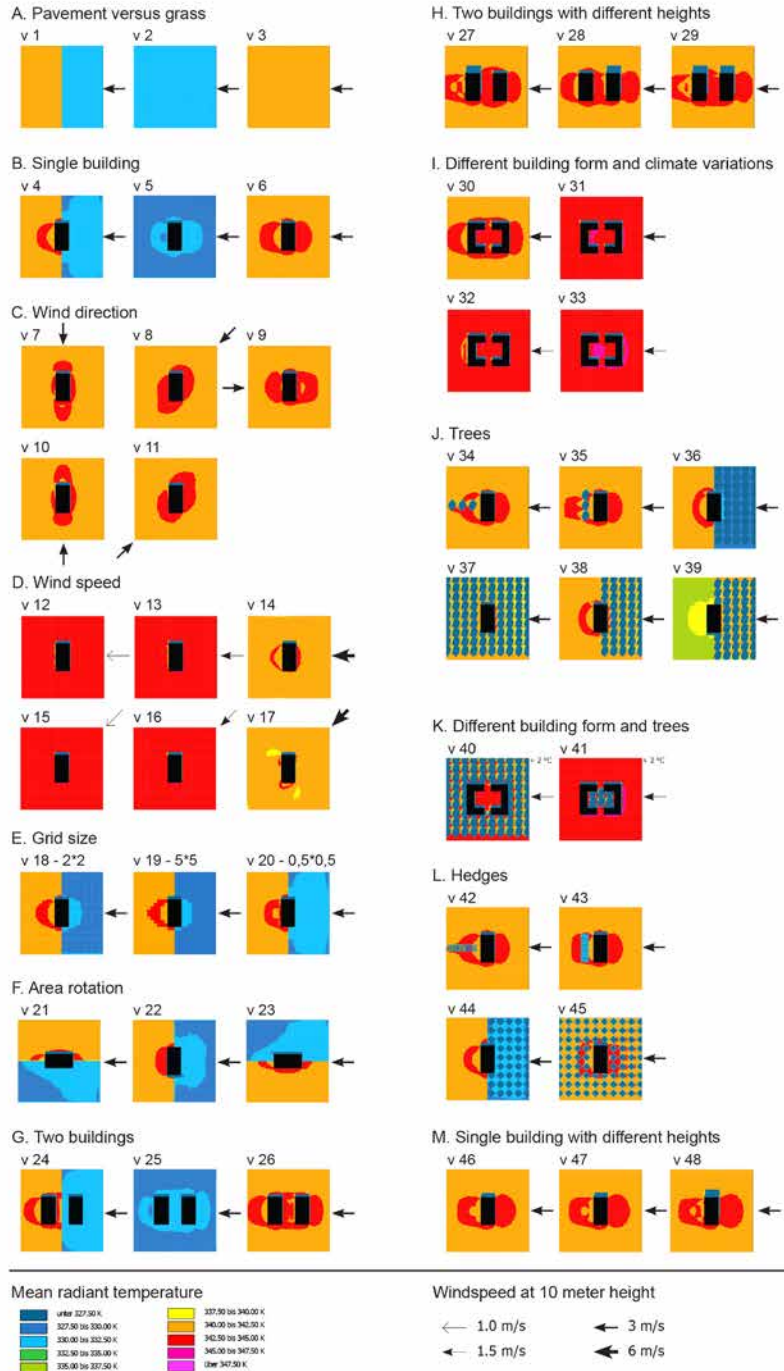

FIGURE APP.C.2 The mean radiant temperature on 13:00 o'clock at 1 metre height by the graphic program LEONARDO.

Variants overview - output in relative humidity

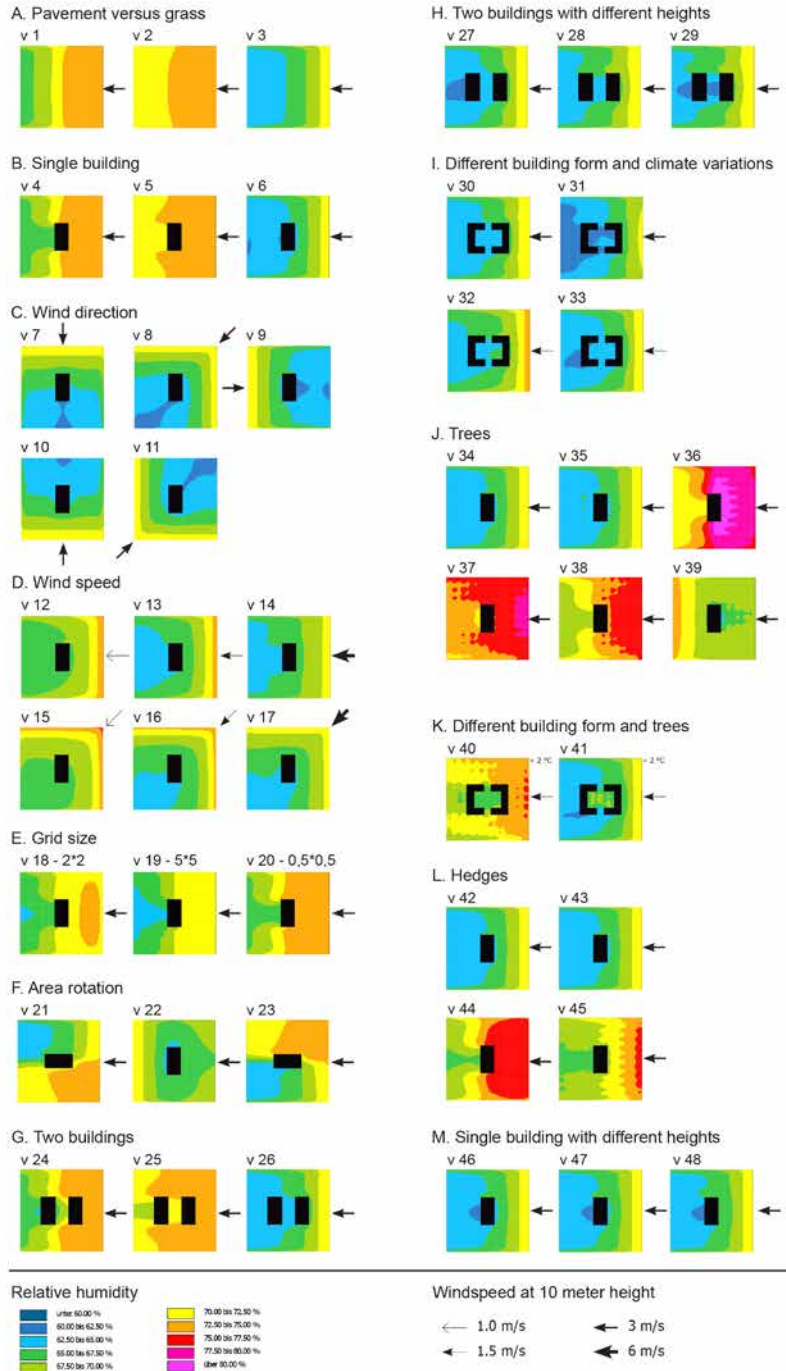

FIGURE APP.C.3 The humidity on 13:00 o'clock at 1 metre height by the graphic program LEONARDO.

Appendix D Questionnaire

This Appendix contains the questionnaire forms for students (Figure D.1) and teachers (Figure D.2).

WUR Atelier Spring 2014

For the research we are working on we would like to ask you some questions about your design process. Could you fill in the questions and hand it in before you leave?

Name: _____
Teacher group phase: _____
Teacher individual phase: _____

	Very strong	Not at all
To what extent did ecology play a role in your design proces?	7 - 6 - 5 - 4 - 3 - 2 - 1	
To what extent did social aspects play a role in your design proces?	7 - 6 - 5 - 4 - 3 - 2 - 1	
To what extent did microclimate play a role in your design proces?	7 - 6 - 5 - 4 - 3 - 2 - 1	
To what extent did hydrology play a role in your design proces?	7 - 6 - 5 - 4 - 3 - 2 - 1	

Microclimate is in my design a: central theme repeating problem precondition

Microclimate can be combined with: _____

Microclimate conflicts with: _____

	Strong role	Not at all
What role will the microclimate play in your future designs?	7 - 6 - 5 - 4 - 3 - 2 - 1	

Can I contact you for an evaluation talk? Thursday 12-6 Friday 13-6
Email: _____

Thank you for filling in this form, for any questions you can contact me at: l.kleerekoper@tudelft.nl

Kind regards,
Laura Kleerekoper

FIGURE APP.D.1 Student form questionnaire.

For the research we are working on we would like to ask you some questions about your tutoring

Name: _____
Background: _____
Specialization: _____

	Very strong	Not at all
To what extent did ecology play a role in the tutoring sessions?	7 - 6 - 5 - 4 - 3 - 2 - 1	
To what extent did social aspects play a role in the tutoring sessions?	7 - 6 - 5 - 4 - 3 - 2 - 1	
To what extent did microclimate play a role in the tutoring sessions?	7 - 6 - 5 - 4 - 3 - 2 - 1	
To what extent did hydrology play a role in the tutoring sessions?	7 - 6 - 5 - 4 - 3 - 2 - 1	

Microclimate is in my view: central theme repeating problem precondition

Microclimate can be combined with: _____

Microclimate conflicts with: _____

	Strongly agree	Strongly disagree
In future design education I will include the microclimate	7 - 6 - 5 - 4 - 3 - 2 - 1	

Thank you for filling in this form, for any questions you can contact me at: I.kleerekoper@tudelft.nl

Kind regards,
Laura Kleerekoper

FIGURE APP.D.2 Tutor form questionnaire.

Appendix E Interview

In this Appendix a summary of the answers to the questions below, that were randomly asked during the personal interviews, are given in Table A.1.

- 1 Inherent to design is to make choices. Within this atelier there was a lot of freedom in choosing a location and program in which the green-blue network with its four ecosystem services had to be optimally embedded. What was your personal ambition or motivation beforehand?
- 2 What part of your design is a success?
- 3 Is there an element you had to drop during the design? Did you choose a variant that is not the best option in relation to the microclimate or thermal comfort? If yes, why?
- 4 Does the theme 'urban microclimate' promotes your inspiration?
- 5 Did you have enough information available? What could have helped you further in designing with microclimate?
- 6 What position will the theme microclimate have in your future designs?

The students that are considered advocates of the urban microclimate are underlined in Figure E.1.

	A	B	C	D	E	F
Student 1	get acquainted with microclimate theme, work with water and ecology	the many objects that needed improvement are all addressed by the design	Had to drop designing the wooden path along the Vecht due to time limits Not the best choice for microclimate along the North side due to sun exposure, but view on canal	Yes, it is interesting since many aspects you work with as landscape architect are related	good info: group map, climatope map, simple and straight guidelines W. Klemm helpful	pre-condition, shade easy to work with, wind is not
Student 2	design for the different cultures	the flexibility offers many possibilities to solve social aspects	the freedom in use of the squares could turn out worse for the microclimate, but this social value is more important in this case	No, for this location the theme did not offer many possibilities	good info: connecting building architecture with landscape design Missed info: learning software skills to analyse microclimate effects	pre-condition, but already many factors to consider depends on project/location
Student 3	connecting Leidsche Rijn with Utrecht	well founded strategic plan	water element along street and water play ground were not elaborated due to focus on boulevard	No	good info: climatope map, book S. Lenzholzer missed info: guidelines W. Klemm too general	pre-condition depends on client
Student 4	focus more on the urban context to achieve more microclimate effects	the higher level of attractiveness, partly because of microclimate improvements, that allow people to stay for a longer period	water purification with helophytes failed, the floating docks would have been multifunctional for boats to attach, cooling by evapotranspiration, a green appearance and water purification. But canal too small and too many water traffic stairs along canal stony material (lees for microclimate) user-friendly was more important	Yes, provides guidance and facilitates the generation of ideas	good info: book S. Lenzholzer missed info: guidelines W. Klemm too general, use of icons or small sketches are useful	pre-condition
Student 5	show people the relevance of microclimate measures, with interest in policy and the big pictures	the developed strategy can be used during the start-up meetings	for translation from theory to local municipality no time left microclimate needs to be linked to other developments, as is the case with mitigation. However the longer pay-back period and different owner of investment and profit is a	Yes, this time it was new and offered inspiration	missed info: not sufficient data for climatope map, more attention should be dedicated to sense of urgency	pre-condition, not as additional benefit because it is too important for that
Student 6	subject not new, aim to explore further than green measures only	the location required an innovative approach, guiding airflow turned out add spatial qualities as well	the essential evaluation of the principle was not possible due to time limit	Yes, this time it was conceptual	good info: book S. Lenzholzer	additional benefit
Student 7	more good examples from in practice must convince people to take action	succeeded in re-using old bridge for new function, appearance and added green	aim to connect to parks over the river did not succeed, even though the construction of the bridge would probably hold it, no time to find out for sure	Yes, because of visibility on the small scale	good info: clear definitions missed info: a construction engineer for the bridge	additional benefit, important as landscape architect to have this knowledge
Student 8	interested in biophilic cities	the realised connection between city centre and old industrial area	not very successful in combining industrial functions with recreation or dwelling	Yes, to some extend	missed info: learning software skills (GIS)	central theme/concept for problematic areas, pre-condition in other cases
Student 9	no final visions, but human tailored planning	flexible planning was realised, next to adding green and designing visual ideas	the thought of providing rules for green implementation would exceed the course knowledge	Yes, provides a direction and inspiration	good info: input from interviews	additional benefit, no pre-condition because value of green is not urgent enough in the Netherlands
Student 10	adding value to the urban space for people and only improve microclimate where necessary	creating a platform for initiatives by inhabitants	the platform is not dedicated to microclimate, but does offer the possibility in the process due to a limit in time no feedback from the municipality on the platform was possible	Yes, this time it was new	missed info: book S. Lenzholzer not detailed enough, guidelines W. Klemm too general	additional benefit, no pre-condition (better not to mention microclimate but link it to other aspects like water)
Student 11	exploring the green-blue infrastructure and hydrological aspects	system planning approach led to a good design	microclimate as a system was very complicated, did not turn into specific design decisions	No	missed info: not enough knowledge about microclimate and lack of awareness of inhabitants (urgency from province: their task to raise awareness)	pre-condition depends on client and location
Student 12	working with water infiltration and small scale design	the balance between existing values and new program	connecting two side streets to the water system could not be realized because of the 3% limit of natural discharge	Yes, especially the aspect that diversity in microclimates is important	good info: book S. Lenzholzer, guidelines and personal advice W. Klemm	pre-condition, with more knowledge now easier to integrate in the design
Student 13	involving an industrial area in the experience of citizens	from interviews people expressed the desire to experience the industrial area nearby, an alternative routing combined this desire with additional ecological values	elevated route has no green or protection from the elements due to the industrial character. There are few places along the way that do provide shelter	Yes	good info: book S. Lenzholzer and Brown missed info: no consensus about designing with wind, more knowledge would help	pre-condition, with more knowledge now easier to apply

FIGURE APP.E.1 Answers from the 12 students to the questions A to F in an evaluation interview.

Appendix F Urban surface analysis

The urban surface analysis used in chapter 7 to classify neighbourhood typologies is presented underneath in a complete overview.

Amsterdam

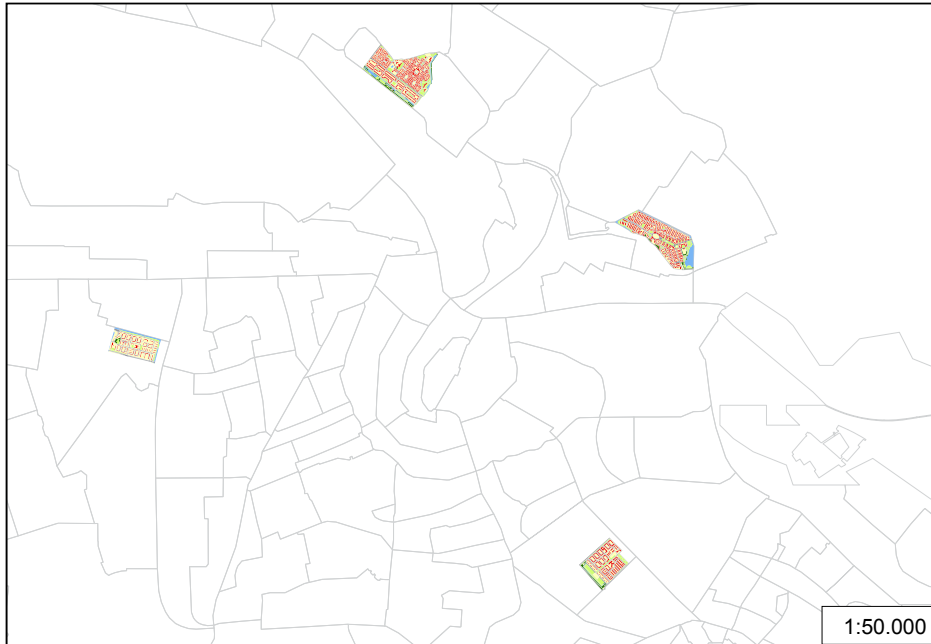

The Hague



FIGURE 10.1 Caption

Rotterdam



Utrecht



FIGURE 10.2 Caption

Land surface

Urban surface

Low open urban block with moderate to much green

Couperusbuurt, Slotermeer, Amsterdam

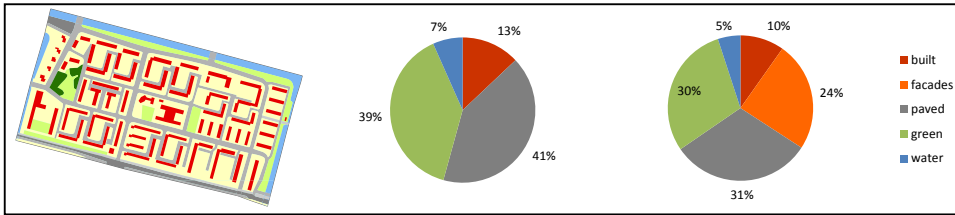

Jeruzalem, Watergraafsmeer, Amsterdam

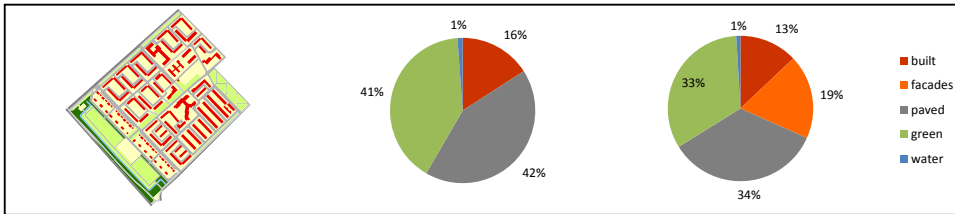

Low closed urban block with moderate to much green

Tuindorp, Utrecht

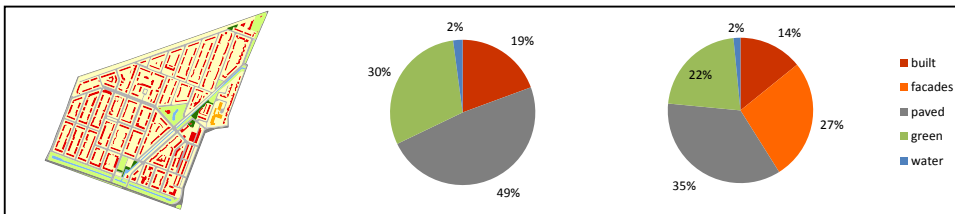

Tuindorp Nieuwendam, Amsterdam

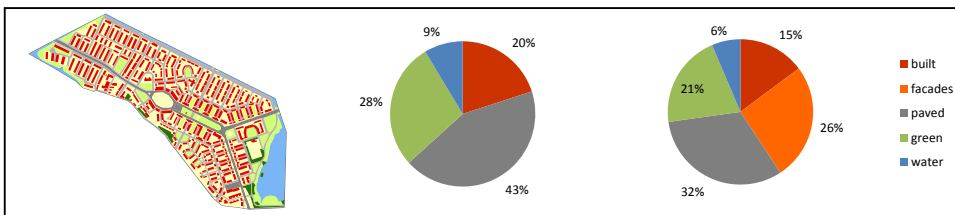

Tuindorp Oostzaan, Amsterdam

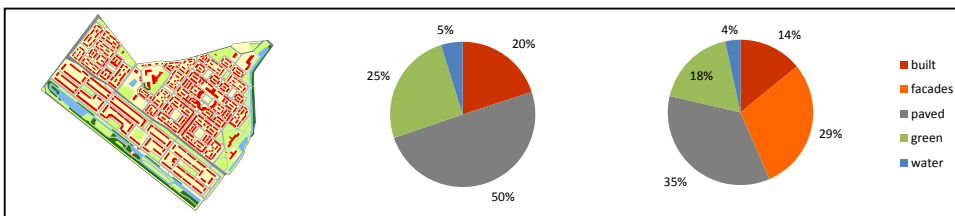

FIGURE 10.3 Caption

Land surface

Urban surface

Low closed urban block with little green

Ondiep, Utrecht

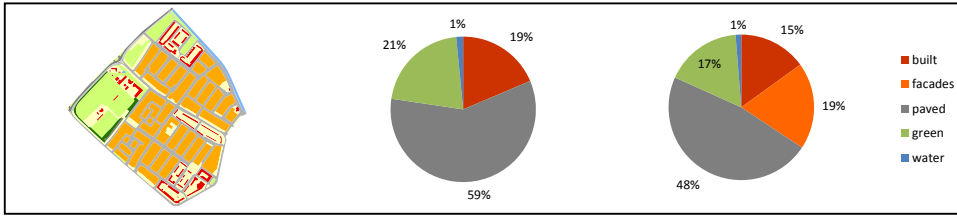

Transvaal, The Hague

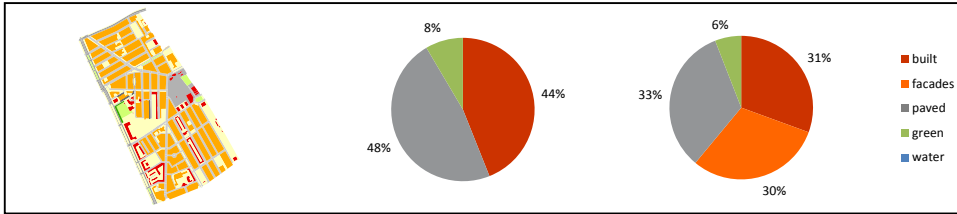

Rivierenwijk, Utrecht

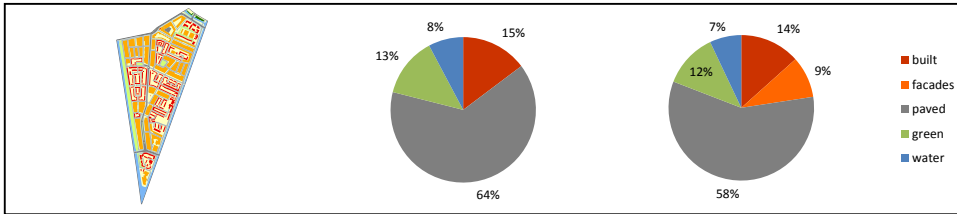

Low closed urban block and strips with moderate green

Parkwijk-Zuid, Leidsche Rijn, Utrecht

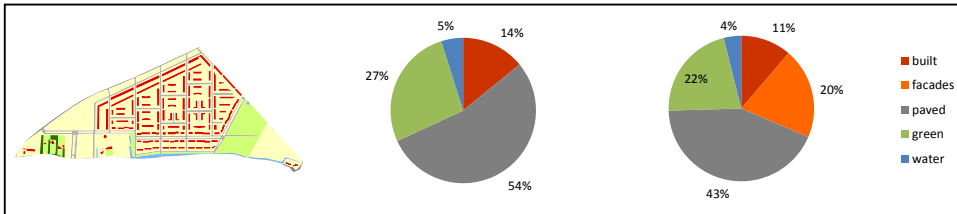

Singels, Ypenburg, The Hague

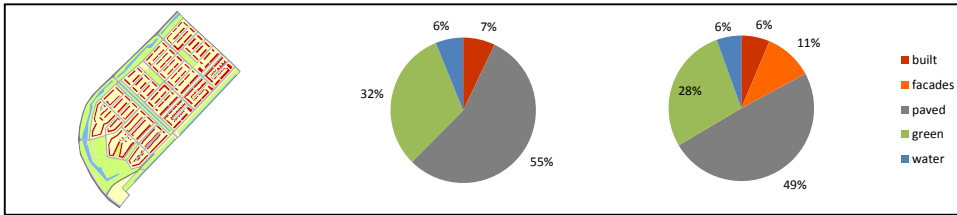

FIGURE 10.4 Caption

Land surface

Urban surface

Low strips and open urban blocks with little to moderate green

Lunetten, Utrecht

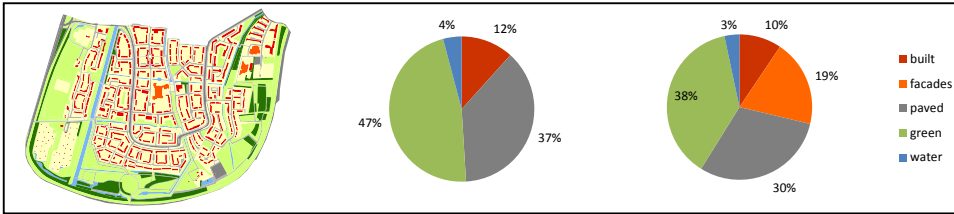

Zevenkamp, Rotterdam

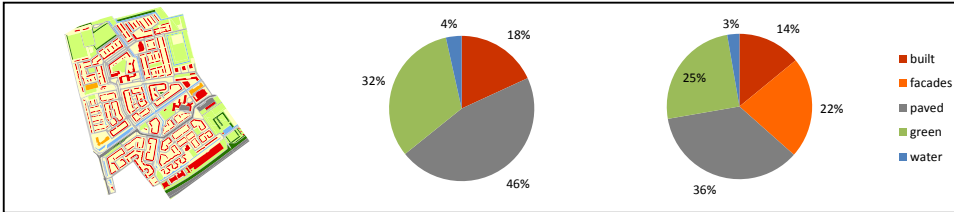

Middle-high closed urban block with little green

Geerte buurt, City centre, Utrecht

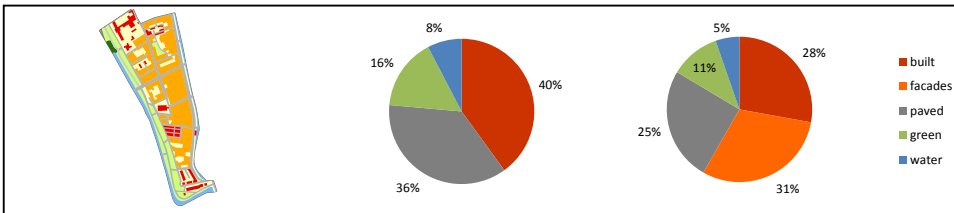

Bergpolder, Rotterdam

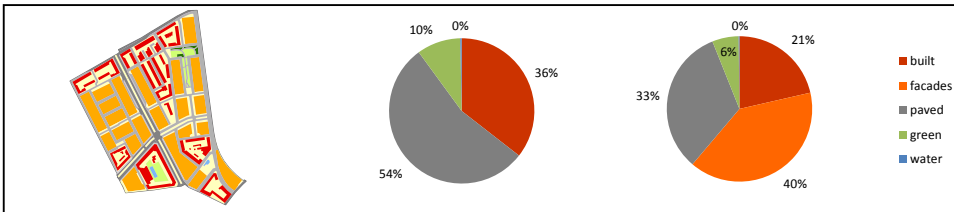

Zuidwal, City centre, The Hague

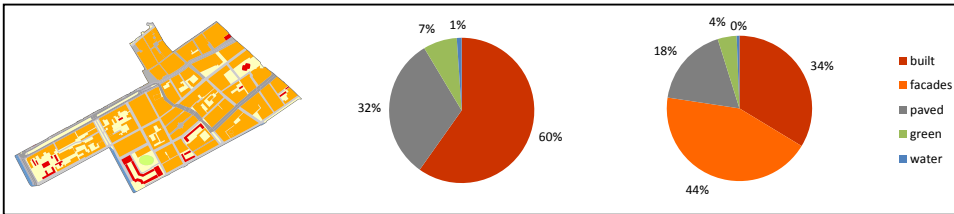

FIGURE 10.5 Caption

Land surface

Urban surface

Middle-high/high open urban block with moderate to much green

Overvecht, Utrecht

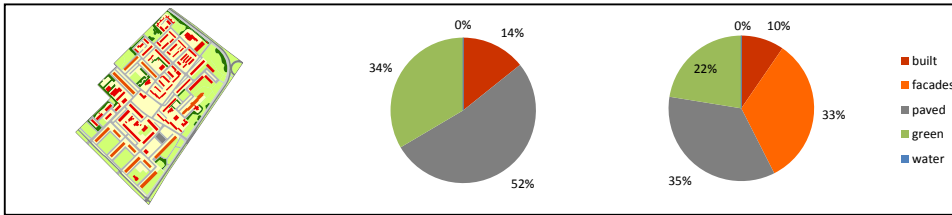

Kanaleneiland, Utrecht

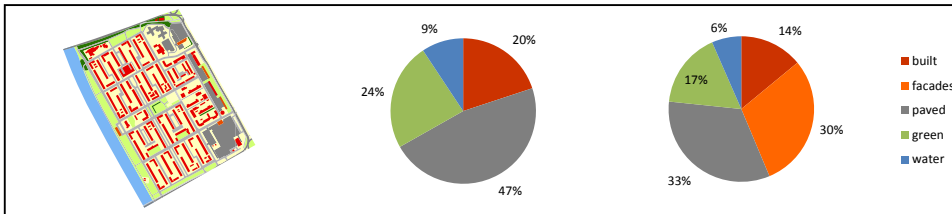

Schiebroek Zuid, Rotterdam

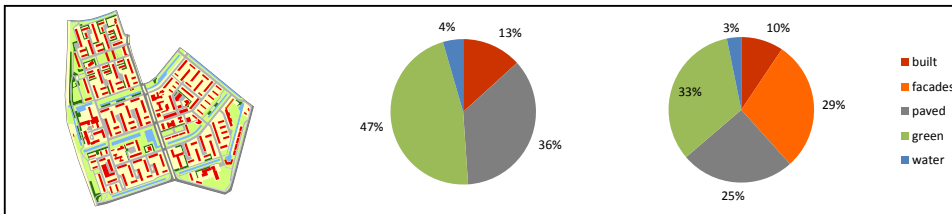

High-rise with little green

Station area, The Hague

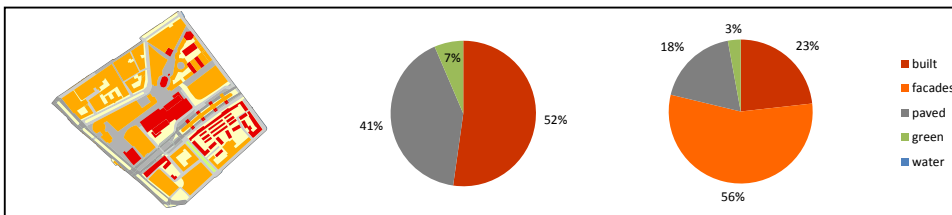

Lijnbaan, Rotterdam

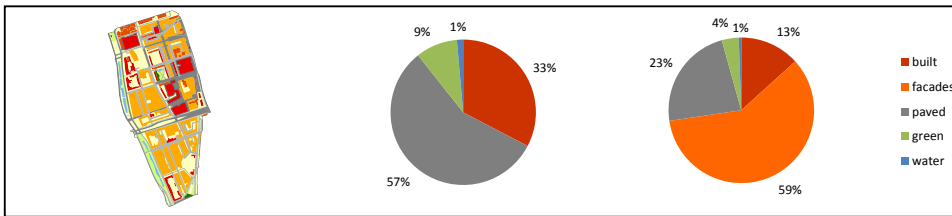

FIGURE 10.6 Caption

Land surface

Urban surface

Industrial area

Binckhorst, The Hague

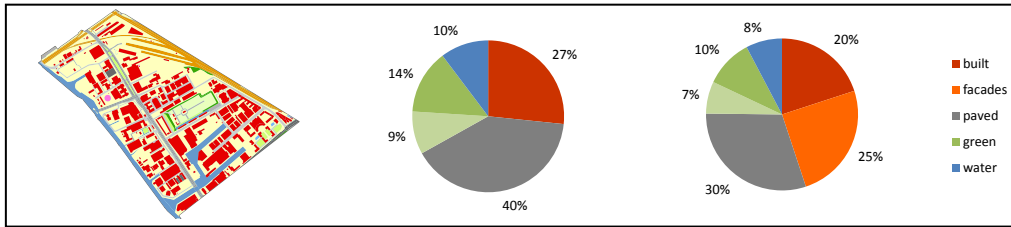

Kerkeruinen, The Hague

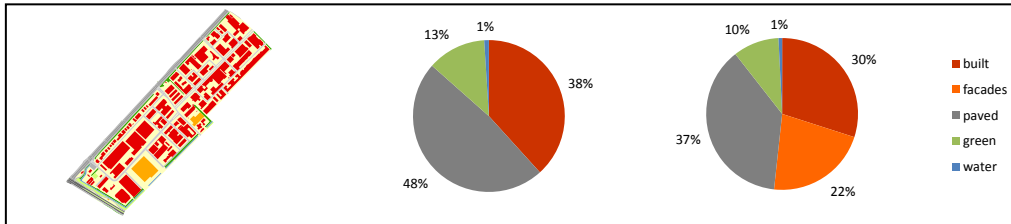

FIGURE 10.7 Caption

Curriculum Vitae



Laura Kleerekoper was born Februari 8, 1983 in Hilversum, The Netherlands. She studied at the Faculty of Architecture of the Delft University of Technology. She received a Master degree in Urbanism in 2009 with the annotation 'Technology in Sustainable Development' (TiSD).

Before starting her PhD research in 2010 she worked for BuildDesk to advise in sustainable urban development projects. She collaborated in a research project studying Delta plans, working both in Amsterdam for urban design studio Defacto and at the TU Delft. Additionally she organised workshops in sustainable building and urban design with Em. Prof. Kees Duijvestein and provided technical drawings for building permits for private clients.

During her PhD research she published several journal and conference papers and transferred knowledge to practice through magazine articles and presentations.

In September 2015 Laura became part of a team of experts in climate adaptation at the Amsterdam University of Applied Sciences. With this research the knowledge from the PhD research is advancing further and is translated to practice. The research team collaborates with municipalities to directly apply solutions when a street is in the development phase.

List of Publications

- Kleerekoper, L., 17-05-2010, Klimaatrobuuste steden, Cobouw, 113, Pag. 11 (popular scientific article article)
- Kleerekoper, L., 2011, Heat mitigation in Dutch cities by the design of two case studies, 5th AESOP Young Academics Network Meeting 2011, Track B: Resilience Thinking and Climate Change, The Netherlands
- Döpp, S., Klok, L., Janssen, S., Jacobs, C., Heusinkveld, B., Kleerekoper, L., Lenzholzer, S., Brolsma, R., Blocken, B., Bosch, P., Heijden, M. van der, Daanen, H., Timmermans, H., Hensen, J., Broeke, H. ten, Klemm, W., Uittenbroek, C., mei 2011, Kennismontage. Hitte en Klimaat in de Stad, Climate Proof Cities Consortium, Ministerie van Infrastructuur en Milieu, Deltaprogramma Nieuwbouw en Herstructurering, TNO-060-UT-2011-01053 (in Dutch)
- Kleerekoper, L., Dobbelsesteen, A.A.J.F. van den, Dorst, M.J. van, Hordijk, G.J., 2011, A Heat Robust City. Case study designs for two neighbourhoods in the Netherlands, Sustainable Building 2011, Helsinki
- Kleerekoper, L., Esch, M. M. E. v., Salcedo, T. B., 2012. How to make a city climate-proof, addressing the urban heat island effect. Resources, Conservation and Recycling, 64, 30-38
- Kleerekoper, L., Hordijk, G.J., Dorst, M.J. van, Dobbelsesteen, A.A.J.F. van den, 2012, Coupling climate adaptation strategies: achieving synergies in a neighbourhood in Amsterdam-West, SASBE 2012, Sao Paulo
- Kleerekoper, L., maart 2012, Bouwfysicablad (in Dutch)
- Kleerekoper, L., Dobbelsesteen, A. A. J. F. v. d., Dorst, M. J. v. & Bruin-Hordijk, T. D. 2012. Climate Proofing Cities - Analysing the effects of heat adaptation measures in Bergpolder-Zuid in Rotterdam. EAAE / ISUF New Urban Configurations 2011. Delft, The Netherlands
- 'Science for Environment Policy', 11 October 2012, Counteracting the urban heat island effect with effective planning, European Commission DG Environment News Alert Service. Available: http://ec.europa.eu/environment/integration/research/newsalert/pdf/301na2_en.pdf
- Kleerekoper, L., Dobbelsesteen, A. A. J. F. v. d., Bruin-Hordijk, T. D., Dorst, M. J. v., 2012, Thermisch comfort in de stad, Bouwfysicablad. (in Dutch)
- Visscher, R., 2013, Climate adaptive measures for neighbourhoods, TU Delta
- Dobbelsesteen, A. A. J. F. v. d., Kleerekoper, L., 2013, Stedelijk klimaatontwerp en stedelijke klimaatinstallaties. Rooijlijn. (in Dutch)
- Kennis voor Klimaat, 2013. Voor een beter stadsklimaat. Available: <http://www.youtube.com/watch?v=t9Ph-MKZ3q4>. (in Dutch)
- Kleerekoper, L., Ham, E.R. van den, Hordijk, G.J. & Dobbelsesteen, A.A.J.F. van den, 2014. Ventilation by colour and material, exploring a new climate adaptation measure. Third International Conference on Countermeasures to Urban Heat Island. Venice, Italy
- Taleghani, M., Kleerekoper, L., Tenpierik, M., Dobbelsesteen, A. A. J. F. van den, 2015. Outdoor thermal comfort within five different urban forms in the Netherlands. Building and Environment 83, 65-78
- Kleerekoper, L. 2015. Future city design. Amsterdam: Transform. Available: <http://urbantransform.eu/2015/02/05/future-city-design/2015>
- Kleerekoper, L., Dobbelsesteen, A. A. J. F. v. d., 2015. De ontwikkeling van lokale klimaatadaptatie strategieën. Open Universiteit, Kennis voor Klimaat. Available: www.coursesites.com Login: username: kvkuser, password: adaptatie (in Dutch)
- Kleerekoper, L., Dobbelsesteen, A. A. J. F. v. d., Hordijk, T., Dorst, M. J. v., Martin, C., 2015. Climate adaptation strategies: achieving insight in microclimate effects of redevelopment options. Smart and Sustainable Built Environment, 4
- Kleerekoper, L., Dobbelsesteen, A. A. J. F. v. d., Hordijk, G. J., Martin, C., 2015. Creating drafts in urban settings through coloured façades: Exploring a new climate adaptation measure based on thermal stratification. *Urban Climate*, 14, 290-300
- Kleerekoper, L., Taleghani, M., Dobbelsesteen, A. A. J. F. v. d., Hordijk, G. J., 2016, Urban measures for hot weather conditions in a temperate climate condition: a review study (in review for publication in Renewable and Sustainable Energy Reviews)
- Kleerekoper, L., Kluck, J. Dobbelsesteen, A. A. J. F. v. d., 2016, Selection support framework fostering resilience based on neighbourhood typologies. North American Symposium on Climate Adaptation, New York, USA (in press)

