

IT-induced public sector transformation

Proefschrift

ter verkrijging van de graad van doctor
aan de Technische Universiteit Delft;
op gezag van de Rector Magnificus prof. ir. K.C.A.M. Luyben,
voorzitter van het College voor Promoties,
in het openbaar te verdedigen
op vrijdag 6 juli 2012 om 15:00 uur
door

Anne Fleur Eke VAN VEENSTRA

ingenieur in de Technische Bestuurskunde
doctorandus in de Politicologie
geboren te Haarlem.

Dit proefschrift is goedgekeurd door de promotor: Prof. dr. Y.-H. Tan

Copromotor: Dr. ir. M.W.F.H.A. Janssen

Samenstelling promotiecommissie:

Rector Magnificus,	voorzitter
Prof. dr. Y.-H. Tan,	Technische Universiteit Delft, promotor
Dr. ir. M.F.W.H.A. Janssen,	Technische Universiteit Delft, copromotor
Prof. mr. dr. J.A. de Bruijn,	Technische Universiteit Delft
Prof. dr. V.A.J. Frissen,	Erasmus Universiteit Rotterdam
Prof. mr. dr. E.F. ten Heuvelhof,	Technische Universiteit Delft
Dr. F.E. Bannister,	Trinity College Dublin
Dr. A. Zuurmond,	Kafkabrigade
Prof. dr. ir. P.M. Herder,	Technische Universiteit Delft, reservelid

Dr. A. Zuurmond heeft als begeleider in belangrijke mate aan de totstandkoming van dit proefschrift bijgedragen.

ISBN 978-90-8891-438-6

Printed by Proefschriftmaken.nl || Uitgeverij BOXpress

Published by Uitgeverij BOXPress, 's-Hertogenbosch

Cover design by Johanna van Doorn

Copyright © 2012 by A.F.E. van Veenstra. All rights reserved. No part of this publication may be reproduced, stored in a retrieval system, or transmitted in any form or by any means, electronic, mechanical, photocopying, recording, or otherwise, without the prior permission of the copyright owner.

Alice: Would you tell me, please, which way I ought to go from here?

The Cat: That depends a good deal on where you want to get to.

Alice: I don't much care where.

The Cat: Then it doesn't matter much which way you go

Alice: ...so long as I get somewhere.

The Cat: Oh, you're sure to do that, if only you walk!

From: *Alice in Wonderland* by Lewis Carroll, 1865

Preface and acknowledgements

This is a study into IT and public administration. Politicians and policy-makers are always looking for ways to improve the functioning of government: to make it more efficient, more effective, and more service-oriented. This constant reinvention of government is often referred to as public sector transformation. The role of information technology (IT) in this transformation is overestimated as well as underestimated. Underestimated since many politicians and public officials do not seem to be aware of its potential and overestimated by some managers as a means to solve all their organizational problems. The aim of this study is to investigate the notion of IT-induced transformation. This notion is concerned with IT as a means of public sector transformation by changing its organizational structure.

The objectives of transformation change over time. When this study commenced, transformation was all about realizing better service delivery, while current efforts are directed at achieving transparency and open government. Often, new promises of transformation are made before old ones are achieved. To move beyond the political promises of reinventing public administration, this study operationalizes IT-induced transformation before it investigates how it takes place in practice. This study is made up of separate eight chapters, that can be read independently. Therefore, some overlap is inevitable. The introduction (chapter 1) and conclusion (chapter 7) can be read to get an overview of the set-up and the main findings of this study. Furthermore, a summary (in English) and samenvatting (in Dutch) are provided. Parts of this study have been published in academic journals, conference proceedings, and in edited book chapters. A full list of publications by the author is also provided.

I am grateful to the many that have contributed to this study. First and foremost I thank Marijn Janssen, my copromotor, and Arre Zuurmond, who contributed greatly to this study. Your guidance was invaluable. Furthermore, I thank my promotor Yao-Hua Tan as well as the other committee members for their time and for providing valuable feedback. To all my colleagues of the TPM-ICT group: thanks for your support, especially to Nitesh Bharosa, Bram Klievink and Mark de Reuver, who provided useful input. Also thanks to those of you that I shared an office with: Gustav Aagesen, Ralph Bendrath, Yiwei Gong, Fatemeh Nikayin, Potchara Pruksasri, Danai Skournetou, and Anneke Zuiderwijk – van Eijk. You were great company! Last, but not least, I thank my family and friends for their support throughout the whole process. Bauke, Lucienne, Erik and Lise: I love you. To my paranimfen Marie-Lise van Veenstra and Catharine van Wijmen: thanks for sharing my burden 'on stage'! And many thanks to Johanna van Doorn for the cover design.

Table of contents

1	Introduction.....	1
1.1	From e-government to t-government.....	1
1.2	The emergence of t-government.....	3
1.2.1	Informatization: digitizing current activities.....	3
1.2.2	E-government: electronic service delivery.....	4
1.2.3	T-government: organizational change leveraging IT.....	5
1.3	IT-induced public sector transformation.....	6
1.3.1	Information technology in e-government.....	6
1.3.2	Transformation as a product: objectives and outcomes.....	7
1.3.3	Transformation as a process: approaches to analyze change.....	9
1.4	Research questions.....	10
1.5	Relevance of this study.....	12
1.6	Research methodology.....	13
1.7	Outline of this study.....	16
2	Operationalizing transformation.....	17
2.1	Public sector reform.....	17
2.1.1	Theoretical strands of public sector reform.....	17
2.1.2	Weberian bureaucracy.....	19
2.1.3	New Public Management.....	21
2.1.4	Public Value Management.....	25
2.1.5	Objectives of IT-induced transformation.....	32
2.2	Leveraging information systems.....	32
2.2.1	Institutional and governance layer.....	33
2.2.2	Organizational layer.....	35
2.2.3	Business process layer.....	36
2.2.4	Technology layer.....	37
2.2.5	Mechanisms of IT-induced transformation.....	38
2.3	Conceptualizing IT-induced transformation.....	39
3	Theoretical perspectives on transformation.....	41
3.1	Contingency theory.....	41
3.1.1	Contingencies impacting organizational structure.....	42
3.1.2	Contingency theory in information systems research.....	46
3.1.3	Using contingency theory for IT-induced transformation.....	48
3.2	Structuration theory.....	51
3.2.1	Giddens' mutual constitution of agency and structure.....	51
3.2.2	Structuration theory in information systems research.....	53
3.2.3	Using structuration theory for IT-induced transformation.....	57
3.3	Combining contingency and structuration theory.....	61

4	Case studies of transformation.....	63
4.1	Case study design	63
4.1.1	Relevance and applicability of case study research.....	63
4.1.2	Case study selection	64
4.1.3	Case study methodology.....	66
4.2	Case study 1: Standard Business Reporting (SBR).....	67
4.2.1	Origins and historical overview of NTP and SBR.....	68
4.2.2	Objectives and outcomes of NTP and SBR.....	71
4.2.3	Stakeholders.....	74
4.2.4	Technology.....	77
4.2.5	Business processes and information flows	80
4.2.6	Governance	80
4.2.7	Transformational objectives and mechanisms.....	81
4.3	Case study 2: Omgevingsvergunning ('environmental permit').....	82
4.3.1	Origins and history of the Omgevingsvergunning.....	83
4.3.2	Objectives of the Omgevingsvergunning.....	85
4.3.3	Stakeholders.....	87
4.3.4	Business processes	89
4.3.5	Technology.....	90
4.3.6	Governance	92
4.3.7	Transformational objectives and mechanisms.....	93
4.4	Discussion of the case studies	94
5	Case study analysis.....	95
5.1	Analysis of transformational outcomes and mechanisms.....	95
5.1.1	Transformational objectives and outcomes	95
5.1.2	Transformational mechanisms.....	102
5.1.3	Findings.....	109
5.2	Analysis of the transformation process.....	110
5.2.1	A contingency analysis of IT-induced transformation.....	110
5.2.2	A structurational perspective on IT-induced transformation	113
5.2.3	Findings.....	118
5.3	Outcomes and factors of IT-induced transformation.....	119
6	Quantitative study among local governments.....	123
6.1	Transformation in Dutch municipalities.....	123
6.2	Research set-up.....	125
6.2.1	Research model.....	125
6.2.2	Sample	128
6.2.3	Measures.....	130
6.2.4	Constructs	133
6.3	Results	135
6.4	Limitations and discussion.....	138

7	Conclusion	141
7.1	Outline of a theory of IT-induced transformation	141
7.2	Operationalizing IT-induced transformation	145
7.3	Outcomes of transformation in practice	146
7.4	Factors influencing IT-induced transformation	148
7.5	Limitations	151
7.6	Recommendations for further research	152
8	Epilogue: public service or public value?	155
8.1	The persistence of hierarchical accountability	155
8.2	The public value management agenda	156
8.2.1	Balancing public values	156
8.2.2	Professionalization of the workforce	157
8.2.3	The role of transparency	158
8.3	Enhanced enforcement and control by the government	159
	References	161
	Appendix 1: Documents studied for the case studies	175
	Appendix 2: Survey	177
	Summary	181
	Samenvatting	187
	Publications by the author	193
	Curriculum Vitae	197

1 Introduction

[T]he real benefit of e-government lies not in the use of technology per se, but in its application to processes of transformation (UNPAN, 2008).

IT-induced transformation is undertaken by public administrations around the world to improve their performance. By changing their organizations, it aims to leverage information technology (IT) and realize public sector transformation (Irani, Elliman & Jackson, 2007). However, it is contested whether any real transformation takes place in the public sector as a result of IT implementation. While some authors point at the changes that have taken place (Dawes, 2008; Fountain, 2001a; Gascó, 2003), others claim that most has stayed the same (Coursey & Norris, 2008; Goldfinch & Wallis, 2010; Kraemer & King, 2006). To explain this gap, this study investigates the phenomenon of IT-induced transformation to find out which factors influence its occurrence. To emphasize that this study is concerned with an empirical phenomenon rather than the rhetoric of public officials aiming to improve public administration (often referred to as transformational e-government, or *t-government*) the concept of IT-induced transformation is conceived. *IT-induced transformation* is defined as long-term, multi-dimensional, and multi-level organizational change of the public sector leveraging IT to realize public sector transformation. After having described the emergence of *t-government*, this chapter introduces, defines and elaborates IT-induced transformation and develops a methodology to investigate the concept.

1.1 From e-government to t-government

Electronic government (*e-government*) is used by governments around the world to improve their operations and serve their citizens better (Curtin, Sommer & Vis-Sommer, 2004; OECD e-Government Studies, 2005). It is rooted in the introduction of the internet in the 1990s, which enabled the development of governmental websites for improved service delivery and the set-up of systems for information exchange between government organizations (Chen, 2002; Wimmer, 2002). While earlier research on public sector information systems (see, for example, Bozeman & Bretschneider, 1986; Caudle, Gorr & Newcomer, 1991) focused on the *informatization* of government (Zuurmond, 1994), after 1995 the term e-government became common (Scholl, 2009). By now, most developed countries have created basic e-government infrastructures (Janssen, Chun & Gil-Garcia, 2009), made up by a plethora of e-government initiatives to improve service delivery to citizens and businesses, while at the same time making government operations more efficient and effective.

While e-government is generally seen to focus on the use of IT to improve service delivery to citizens and businesses, it can be more broadly defined as “the use of any and all forms of information and communications technology (ICT) by governments and their agents to enhance operations, the delivery of public information and services, citizen engagement and public participation, and the very process of governance” (Curtin et al., 2004, p. 2). Public administrations generally perform three functions:

constituting effective policies as instruments of collective choice, making political choices that define and protect communities, and delivery of services (Kirlin, 1996). The definition of e-government thus includes the use of IT to enhance government operations in all three areas. To make the distinction between the different strands that exist within e-government, this study considers e-government to only include the use of IT in the field of service delivery. The use of IT to enhance the two other strands of government operations are named e-participation (concerning policy-making) and e-democracy (concerning the political process). These two strands of literature are not part of this study.

The introduction of IT in public sector organizations can be seen to have had a positive influence on their efficiency (Dawes, 2008; Fountain, 2001a; Gascó, 2003). Exchanging information electronically improves government agencies' operational activities. Furthermore, service delivery has gained considerable attention as public organizations set up websites, introduced mechanisms for interaction and transactions, and formed portals in which multiple organizations collaborate (Layne & Lee, 2001; Veenstra & Janssen, 2011). It must be noted, however, that public services differ from service delivery in the private sector, for reasons such as public services not being voluntary and the necessity to realize equity. Although many studies adopt the customer metaphor in the context public service delivery, many argue that this notion is not appropriate, as governments hold some form of power over those that use the services (Fountain, 2001b; Jos & Tompkins, 2009). Therefore, when considering service delivery of public organizations, the policy objectives behind the services cannot be left out of scope.

Current e-government initiatives aim to move beyond merely improving operations by enhancing efficiency and improving service delivery. They often aim to leverage benefits of the use of IT (Irani et al., 2007) to induce objectives such as 'transparent government', and 'proper accountability' (UNPAN, 2008; West, 2004). These objectives of e-government, however, may not be realized as long as governments are organized as functional hierarchies, and until the siloes of government activities are broken down (Bannister, 2001). By aiming for a shift in government from hierarchical policy definition and execution to horizontal, networked government, e-government reaches beyond its initial purposes of merely making current government operations more efficient by striving for the wider *transformation* of the public sector. "E-government is being increasingly seen as an enabler for a longer-term transformation of government that goes far beyond online service delivery" (OECD e-Government Studies, 2005, p. 164). Hence, the efforts aiming to leverage IT to improve the working of government is known as *transformational e-government*. This term was first introduced in the UK (Dhillon, Weerakkody & Dwivedi, 2008; Irani et al., 2007). While e-government focuses on improving service delivery to citizens and businesses, t-government aims to make the public sector as a whole more effective (Veenstra, Klievink & Janssen, 2011).

Empirical research has, however, found that the transformational objectives attributed to t-government are not achieved – at least not yet (Coursey & Norris, 2008; Dhillon et al., 2008; Weerakkody & Dhillon, 2008; West, 2004). Whereas t-government is considered to be one of the main drivers for public sector transformation (Dhillon et al., 2008; Gupta & Jana, 2003; Irani et al., 2007; Kim, Pan & Pan, 2007; Lenk, 2002; Snellen, 2002), it has been argued that not much of the promised transformation is realized as, instead, e-government initiatives are mainly seen to digitize and automate existing practices (Coursey & Norris, 2008; Dhillon et al., 2008; Gascó, 2003; Goldfinch & Wallis, 2010; Kraemer & King, 2006; West, 2004). As IT-implementation usually merely

reinforces current institutions, not resulting in any transformation (Fountain, 2001a), some literature claims that organizational transformation is necessary to leverage the benefits of IT (Gregor, Martin, Fernandez, Stern & Vitale, 2006).

This study originates in this discussion on whether t-government is just another promise of better government, or whether its objectives and outcomes are actually achieved in practice. The claim that e-government will transform the public sector altogether was made before (see, for instance, Baum, Di Maio & Caldwell, 2000). But the emphasis on the transformative character of e-government recently gained more attention (e.g. Dhillon et al., 2008; Gascó, 2003; Irani et al., 2007; Moon, 2002; Scholl, 2005b; Veenstra et al., 2011; West, 2004). As t-government has become a value-laden term often used by government officials to refer to a whole range of promises of better public administration, the empirical concept *IT-induced transformation* is constructed to be able to distinguish the outcomes of this study from the rhetoric in government. Therefore, the objectives of this study are *to explore the outcomes of IT-induced transformation and to investigate which factors influence the occurrence of these outcomes*. The start of this inquiry lies in the emergence of t-government.

1.2 The emergence of t-government

The emergence of t-government can be divided into three phases. A first phase in the development is the informatization of organizations, in which current activities were digitized (Zuurmond, 1994). During this phase, which ended at the start of the widespread use of the internet in the mid-1990s, governments are mainly experiencing the same changes as businesses through the use of IT. It mainly presents the prerequisite for the later organizational changes and transformation taking place in organizations. The second phase of transformation in public organizations can be seen to focus primarily on realizing improved service delivery for their clients, in addition to achieving efficiencies by automating government processes. The latest phase focuses on the transformation of organizations leveraging the performance of IT – and is still continuing today. For practical reasons, the developments are described using examples from the Netherlands. These developments often coincide with developments around the world, but as the Netherlands is the context of this study, the generic description of e-government is mainly based on the developments in this country.

1.2.1 Informatization: digitizing current activities

While governments identified the potential of computerization for improving the quality and efficiency of its work processes early on (Schwarz & Brock, 1998), the development of e-government really started off in the mid-1990s with the introduction of the internet. Still, before this time some projects were undertaken that would turn out to be crucial for the development of e-government. These projects focused on creating efficiencies by making work processes faster and decreasing the number of mistakes as a result of manual processing, on reducing paperwork by automating high-volume transactions processing, as well as on ensuring basic connectivity (Dawes, 2008; Schwarz & Brock, 1998). This phase in t-government development is thus characterized by making current activities and work processes more efficient by digitizing and automating them.

This period is called the informatization of government organizations. Zuurmond (1994) defines informatization to include more than the mere introduction of computers

in organizations. Besides the introduction of IT to automate large parts of the information in organizations, it includes the introduction of specific expertise in IT by training the personnel of organizations working in IT-related functions, the (re)development of information flows and relations necessary for the information support of the organization, changing the structure of the organization in which the IT is introduced, and the development of an information policy as a separate policy within the organization (Zuurmond, 1994). The potential of IT to change organizations was in this stage already manifesting itself. By the early 1990s it was seen that “the infusion of IT into government jobs and workplaces had major impacts on skills, work processes, job design, organizational structures and controls” (Dawes, 2008, p. S89).

An example is the introduction of the Gemeentelijke Basisadministratie (GBA) in the Netherlands. The GBA is the municipal citizens’ registry keeping track of all inhabitants of a municipality. In the 1920s and 1930s this registry was already highly standardized, albeit still paper-based. Between 1984 and 1994 citizens’ registries in all municipalities were digitized: from now on municipalities entered the names, dates of birth and marital status of its inhabitants in the computer and making the computer file the source data – thereby effectively rendering paper files obsolete (Bogaard, Lintsen, Veraart & Wit, 2008). However, “the waves of IT change that occurred before the late 1990s had very little transformative impacts. Office automation processes were extensively adapted to and fitted in with the preexisting organizational culture of public sector agencies. Once functions were routinized to the point of being handled automatically, organizational cultures tended to downgrade their importance for managerial performance” (Dunleavy, Margetts, Bastow & Tinkler, 2005, p. 478). Thus, while the phase of informatization was mainly characterized by organizations realizing the potential of IT to make their work practices more efficient, the changes that took place can be considered preconditions for transformative changes.

1.2.2 E-government: electronic service delivery

The emergence of the internet ensured that in this second phase the focus of e-government initiatives shifted from making organizations operate more efficiently to realizing electronic service delivery (Bellamy & Taylor, 1996; Dawes, 2008; Dhillon et al., 2008; Morgeson III & Mithas, 2009; Wimmer, 2002). “The automation of decision-making has progressed steadily from the back office – the financial/administrative final stage of case handling – to the front office – the initial intake of the client” (Snellen, 2002, p. 189). An inequality in the development of e-government initiatives between the front office and the back office was seen to emerge (Bellamy & Taylor, 1996). To illustrate this shift: in the Netherlands, between 1990 and 1996, all policies adopted by the central government aimed to digitize service delivery of government organizations – albeit without dropping the objective of IT to make the internal functioning of government organizations more efficient. These initiatives led to the development of many governmental websites and portals. Every government organization created their own website for providing information to citizens as well as enabling some transactions such as filling out online forms.

While at first service delivery processes were merely automated by the creation of governmental websites, later e-government initiatives aimed at realizing more advanced, such as personalized, pro-active, and integrated services (West, 2004). The personalization of service delivery was, for instance, embodied by a personalized portal ‘MijnOverheid.nl’ (‘MyGovernment.nl’). Pro-active service delivery can be achieved by

pre-filling data, such as done by the Inland Revenue Service (IRS). The IRS shows all data already gathered in the tax forms to be filled out by citizens and businesses. Integrated service delivery is achieved when multiple organizations, each performing a specific part of the service delivery process, act in a coherent manner, which is perceived as integrated service delivery by customers (Veenstra & Janssen, 2011). Of the three more advanced forms of digital service delivery, the latter has gained most attention as it is believed that this will especially bring advantages for citizens and businesses not having to provide the same data to multiple government organizations. In the Netherlands, one example is the set-up of the OL2000 portal that was meant to integrate all service delivery of the Dutch government.

E-government projects thus shift their focus from mere information provisioning and interaction with the public, to aligning internal effectiveness and efficiency with the externally oriented front office, as well as intra- and inter-organizational collaboration and integration (Scholl, 2005a), in order to realize more advanced service delivery. “While early e-Gov projects focused on government-to-public information and interaction, the second and third wave of e-Gov projects also emphasize internal effectiveness and efficiency along with intra- and interdepartmental as well as intra- and inter-branch integration” (Scholl, 2004, p. 1). Thereby, the objectives of transformation came into sight. “What is understood as a reform aimed at both improved customer service and cost savings through innovations borrowed from the private sector, the move toward e-government can be recognized as part of a broader trend in public administration reform that emphasizes the ability of the public sector to overcome many, if not most, of its perceived deficiencies” (Morgeson III & Mithas, 2009, p. 742).

1.2.3 T-government: organizational change leveraging IT

In the third phase of t-government development focus shifted to transforming organizations to make government more effective beyond making them more efficient and realizing online service delivery. This shift took place partly as a result of the disappointment in e-government not realizing real transformation. Many governments therefore embark on setting a transformational agenda, making transformation a priority (Irani et al., 2007). The reason for this is that the transformational objectives of e-government now need to be achieved: “the central role that IT and information system changes now play in a wide-ranging series of alterations to how public services are organized as business processes and delivered to citizens or customers” (Dunleavy et al., 2005, p. 468). The government of the UK adopted a transformational strategy that aims to radically change the way the government operates internally and externally between 2005 and 2011 by focusing on increasing the amount of data availability and to allow data sharing between departments (Dhillon et al., 2008; Weerakkody & Dhillon, 2008).

E-government focuses mostly on service delivery to citizens and businesses, and most Western countries established a digital front office including some transactional services (Coursey & Norris, 2008; West, 2004). Furthermore, interoperability within and between organizations was realized to make operations more efficient. However, the objectives of t-government go beyond digitizing existing service delivery. Horizontal and vertical integration of back office and front end systems is expected to take place (Layne & Lee, 2001). The United Nations, foresee ‘seamless’ integration with full integration of e-services across administrative boundaries (UNPAN, 2002). It encompasses “the changing nature of relationships from hierarchical command-and-control to an interactive collaboration among governments, citizens, businesses, public sector

employees, and other government” (Esteves & Joseph, 2008, p. 119), affecting the relationships and governance within the whole public sector. T-government is, thus, concerned foremost with the integration of activities and collaboration between organizations to serve citizens better.

Little agreement, however, is found on what transformational e-government means (Bannister & Connolly, 2011c) and on its results (Foley & Alfonso, 2009). It is seen to include as much as nine defining elements: user-centric services, joined-up government, one-stop government, multi-channel service delivery, flexibility, efficiency, increased human skills, organizational change and change of attitude of public servants, and value innovation (Parisopoulos, Tambouris & Tarabanis, 2009), as well as having a central role for trust (Bannister & Connolly, 2011c). Currently, however, empirical studies do not (yet) observe in practice much of this enhanced service delivery, organizational change, value innovation, or increased transparency and accountability to take place (Coursey & Norris, 2008; Dhillon et al., 2008; West, 2004). Instead, they claim that most public agencies are still struggling to build efficient service channels and add transaction services. Therefore, within the new wave of t-government, transformation now becomes an explicit objective.

1.3 IT-induced public sector transformation

IT-induced transformation – the empirical construct for investigating t-government – is defined as multi-dimensional, multi-level, and long-term organizational change of the public sector leveraging the value of IT to realize public sector transformation. This section will elaborate this definition. To start our inquiry, first the technology involved in t-government projects inducing these changes is briefly discussed. Then, the notion of transformation is taken a closer look at. Transformation generally refers to a *product* as well as to a *process* (Tosey & Robinson, 2002). This means that it is both used to denote the *outcome* of a change process, as well as the *process of change* itself. Both aspects of transformation will be looked at. From this section it will become clear that IT-induced transformation is a concept building upon the scientific traditions of *public sector reform* and *leveraging IT through organizational change*. These traditions will be described in chapter 2 to identify the specific objectives and mechanisms of IT-induced transformation. Furthermore, different theoretical approaches of how to study change processes will be identified: *contingency theory* and *structuration theory*. These will be elaborated in chapter 3 to develop theoretical lenses that are used in the empirical part of this study.

1.3.1 Information technology in e-government

There will be no transformed government without sophisticated technology (Chatfield, 2009). Although IT was introduced in government before, e-government really set off to change the public sector after the emergence of the internet on a global scale in the 1990s. Up to then, the IT used in public and private organizations mainly aimed to make processes faster, first by introducing mainframe computing and later by introducing distributed computing via desktop computers (Schwarz & Brock, 1998). The widespread use of the internet gave rise to a new generation of technologies that allow networked computing: web technologies. These technologies are based on internet

protocols to enable sharing and distributing of information in a real-time manner and over long distances if necessary.

Web technologies ensured the emergence of web services. “A web service is a self-describing, self-contained software module available via a network such as the Internet, which completes tasks, solves problems, or conducts transactions on behalf of a user or application” (Papazoglou, 2008, p. 46). This allows activities, in the form of services, to take place in different places and times, to be combined for a specific purpose. In this way, web services can be seen as separate modules. As a result, networks of modular services emerge that fulfill specific objectives, avoiding duplication of efforts. “The services-oriented vision offers many benefits to enterprises, and the creation of a class of enterprise services allows us to create services that are modular, accessible, well-described, implementation-independent, and interoperable” (Fremantle, Weerawarana & Khalaf, 2002, p. 80). Web services thus led to the necessity of standardization to interoperability.

A paradigm that uses web services as the main construct to support the development of distributed application is service-oriented architecture (SOA) (Fremantle et al., 2002). The widespread development and use of web services and SOA, has led to the development of e-government infrastructures (Janssen et al., 2009), which are made up of different generic services that can be (re-)used by government organizations to create their own web services. In the Netherlands, this was pursued by setting up the *nationaal uitvoeringsprogramma (NUP)* and its follow-up *iNUP*, which establish a number of e-government building blocks. These building blocks include a national identification number, a national authentication mechanism, and a number of vital registries such as the citizens’ registry, the businesses’ registry, the vehicles’ registry and the land registration. These building blocks can be used by government organizations to set up their own services.

The introduction of IT in government is considered one the most important developments in modern public administrations (Snellen, 2002). The distributive character of IT is considered to be central: “greater levels of investment in information technology are associated with smaller firms and less vertical integration. [...] [F]irms that adopt decentralized organizational structures and work structures do appear to have a higher contribution of information technology to productivity” (Brynjolfsson & Hitt, 2000, p. 36). In short, while IT is not the driver of this shift, it is paramount in inducing it. “Information technology facilitates much wider forms of organization and distribution of governmental activities” (Andersen & Kraemer, 1995, p. 437).

1.3.2 Transformation as a product: objectives and outcomes

The development of an e-government infrastructure that can be used by government organizations is expected to spur the transformation of the public sector. When transformation has taken place, the new situation is considered to be of “qualitative difference from what existed before” (Tosey & Robinson, 2002, p. 102). Organizational transformation can be seen to have taken place when efforts are undertaken that involve “large-scale, planned, strategic, and administrative change” (Fernandez & Rainey, 2006, p. 168). The changes that are about to take place as a result of t-government, are thus second-order changes rather than first-order changes (Scholl, 2005b). While first-order changes are incremental and planned establishing minor improvements, second-order changes represent “multi-dimensional, multi-level, qualitative, discontinuous, radical organizational change involving a paradigmatic shift” (Scholl, 2005b, p. 3).

Comparing this type of change to the outcome of IT-induced transformation means that more can be expected to change than digitizing current practices of the public sector. Following developments in the private sector, the qualitative difference of IT-induced transformation aims for “the exploitation of e-government such that benefits can be realized” (Irani et al., 2007, p. 327). The qualitative difference is operationalized by change into multiple directions (multi-dimensional) and on multiple layers (multi-level). In other words, nothing less than a *reform* of the public sector is aimed for. Although a qualitative difference can also mean that a substantial worsening of the performance of government organizations takes place, this option cannot be regarded as desirable; hence the strong focus on performance enhancement in this study. Generally, “‘reform’ [...] strongly implies not just change but beneficial change – a deliberate move from a less desirable (past) state to a more desirable (future) state” (Pollitt & Bouckaert, 2004, p. 15).

The first element of this transformation is concerned with the multiple dimensions of IT-induced transformation. It is concerned with a complex set of changes into multiple directions, such as structure, coordination, management, and culture. Secondly, transformation is invasive, with changes taking place at multiple organizational layers, such as the technology and the business processes. And thirdly, an element is added to the definition of IT-induced transformation that is concerned with the duration of the changes. Such changes are only expected to happen over a longer period of time. Therefore, IT-induced transformation is expected to occur in the long term, requiring at least a few years. Only then are the outcomes of this transformation process expected to lead to a paradigmatic shift making organizations qualitatively different than before – instead of just quantitatively different by being more efficient. Hence, IT-induced transformation concerns multi-dimensional, multi-level, and long-term changes leveraging IT to realize public sector reform.

“[P]ublic management reform consists of deliberate changes to the structures and processes of public sector organizations with the objective of getting them (in some sense) to run better” (Pollitt & Bouckaert, 2004, p. 8). Since the emergence of e-government, it was linked to new management paradigms in government (Beynon-Davies, 2007; Chatfield, 2009; Cordella & Iannacci, 2010; Dawes, 2008; Morgeson III & Mithas, 2009). “National governments worldwide are engaged in public service reform initiatives and e-government initiatives. The two initiatives may run in parallel in some governments with very little overlap or coordination. Alternatively, in others e-government initiatives are means for implementing public service reform policy goals” (Chatfield, 2009, p. 135). More specifically, e-government is often linked with the objectives of introducing management practices from the private sector (Morgeson III & Mithas, 2009). “e-Government is very often conceived as a powerful instrument to achieve the public administration reforms envisaged by the new public management (NPM) ideology” (Cordella & Iannacci, 2010, p. 53).

However, as the NPM paradigm is often declared a failure (see, for example, Dunleavy et al., 2005), current reform initiatives focus on the creation of public values (Moore, 1995; Stoker, 2006). Public Value Management (PVM) takes place through continuous assessment by public officials of whether they indeed create value directly for citizens, or by strengthening the role of government (Cresswell, Burke & Pardo, 2006; Moore, 1995). Public value cannot be created by public administrations alone, but is generated in a network of organizations, in which public and private parties collaborate (Stoker, 2006). A related approach focuses on the changes in public values delivered by

governments that occur as a result of t-government (Bannister & Connolly, 2011a, 2011b). Where e-government is often linked to NPM, t-government is linked to PVM.

IT-induced transformation as a product thus represents a set of changes into multiple directions aiming for public sector reform: the *transformational objectives*. These objectives are to be realized by changes aiming to leverage IT to realize transformation on multiple levels: the *transformational mechanisms*. Chapter 2 operationalizes transformational objectives and mechanisms. The transformational objectives are derived from the literature on public sector reform and the mechanisms from the literature on leveraging IT. Hence, IT-induced transformation is a multidisciplinary concept building upon the theoretical traditions of public sector reform from the field of Public Administration and the strand of literature on leveraging IT by changing the organizational structure from the field of Information Systems.

1.3.3 Transformation as a process: approaches to analyze change

IT-induced transformation is expected to be a cumbersome process as “value realization from IT depends on time-consuming investments in organizational change” (Gregor et al., 2006, p. 249). Furthermore, transformation can refer to a paradigm shift of fundamental assumptions as well as to a gradual change in behavior of individuals within an organization, leading to second-order changes that are characterized as discontinuous and radical (Scholl, 2005b; Tosey & Robinson, 2002). Measuring or identifying this type of change can be easy when undertaken after the transformation process is over, but considering the invasive, complex and long-term nature of the process, determining its scope and outcomes during the process may be very difficult. A simple gap analysis will likely not be sufficient in such cases. Therefore, an instrument needs to be developed that is able to capture the intricacies of the change process when is still ongoing.

In the field of e-government, developments are often analyzed stage-wise, in which the transformational stage is seen as the highest, or final stage (e.g. Andersen & Henriksen, 2006; Dhillon et al., 2008; Layne & Lee, 2001; Moon, 2002; UNPAN, 2002; West, 2004). An instrument for describing the development of e-government from this perspective is a maturity model or a stages-of-growth model (e.g. Andersen & Henriksen, 2006; Gupta & Jana, 2003; Janssen & Veenstra, 2005; Klievink & Janssen, 2009; Layne & Lee, 2001; UNPAN, 2002; West, 2004). Such models are based on the idea that organizations pass through stages of maturity or sophistication. In practice, the highest stages are often not achieved and these models can thus be considered as prescriptive rather than descriptive (Coursey & Norris, 2008). Their linear, uniform nature may capture some of the high-level processes, but it allows for very little variation among government organizations or among different organizational cultures. Furthermore, their practicality is contested. While they may provide policy-makers with some horizons for formulating their objectives, they provide very little guidance for the people undertaking the changes in practice, let alone to be used as indicators for measuring and identifying change for research (Maheshwari, Veenstra & Janssen, 2011). Therefore, more elaborate organizational theories may be useful to identify changes in the organizational structure.

Stage models and organizational theory often incorporate an implicit teleological assumption that changes in structure occur as a result of purposeful actions, seeing change “as a repetitive sequence of goal formulation, implementation, evolution, and modification of goals based on what was learned” (Ven & Poole, 1995, p. 516). Based on

this way of thinking, many theories on organizational change have been formulated, predicting a specific change of the organizational structure. A main conception of organizational change within organization theory is that it occurs in reaction to an ever-changing environment (Schwarz & Huber, 2008), in order to realize better outcomes or performance (Galbraith, 1973). This vision is captured by contingency theory. Contingency theory is a theoretical stream within organization theory that emphasizes the factors in the environment that lead to specific outcomes. It emerged as a result of the search for the optimal organization given the specific circumstances. It assumes that the structure of organizations changes when the circumstances change (Galbraith, 1973).

A different way of looking at organizational change is by taking a dialectic perspective (Robey & Boudreau, 1999; Ven & Poole, 1995). This perspective understands change, instead of as an objective, discernable sequence of action, as a mutually influential process of action and structure (Robey & Boudreau, 1999; Ven & Poole, 1995). Homburg (2009) emphasizes the importance of social shaping of technology for public sector transformation. This shaping can take place by institutions (North, 1990; Powell, 1991), but also by human action (Fernandez & Rainey, 2006). A theoretical perspective on organizational change taking both institutional and human forces into account is structuration theory (Giddens, 1979, 1984). To be able to understand the complex change process involved in realizing IT-induced transformation, both contingency and structuration theory will be used for looking at the changes taking place.

Contingency theory and structuration theory are meta-theories having certain worldviews rather than predicting specific outcomes of change. This means that they can be used for deriving factors that influence change rather than that they prescribe which changes take place. While both theories stem from the field of sociology (Giddens, 1984; Thompson, 1967) and are widely applied in the field of information systems. They have spin-offs in specific theoretical strands that look into organizational changes taking place as a result of the use of information technology (Morton & Hu, 2008; Orlikowski, 1992, 2000; Pertusa-Ortega, Molina-Azorin & Claver-Cortes, 2010; Poole & DeSanctis, 2004; Wamba & Chatfield, 2009). These theories take a complementary view to change, which allows for the identification of complementary insights from the analyses. The contingency and the structural perspectives of looking at change will be elaborated in chapter 3.

1.4 Research questions

IT-induced transformation aims to realize public sector reform by leveraging IT through organizational change. Simply stated, while e-government is highly concerned with realizing better service delivery and creating efficiencies, t-government is concerned with making the public sector more effective. However, governments are known for their bureaucratic ways of working and their hierarchical and fragmented policy-implementation in 'siloes' that may not suit the needs and wishes of citizens and impedes change (Bannister, 2001). While some identify transformational efforts being undertaken by governments (Dhillon et al., 2008; Moon, 2002; Scholl, 2005b), others point out that there is a lack of empirical evidence of public sector transformation taking place (Coursey & Norris, 2008; Kraemer & King, 2006; West, 2004). To understand this apparent contradiction, this study explores how IT-induced transformation takes place. Therefore, the main research question is:

How does IT-induced transformation take place?

Three research questions are identified that help answering the main research question step by step. The first question deals with operationalizing the central concept of this study – IT-induced transformation. It is concerned with ‘transformation-as-a-product’, building on literature from the field of Public Administration to derive objectives for public sector reform and on the field of Information Systems to derive mechanisms leveraging IT. This notion, which builds on theoretical concepts, is not clearly defined yet, requiring elaboration:

What are the objectives and mechanisms of IT-induced transformation?

After this literature study the empirical investigation commences. Little is known about the outcomes of transformational efforts. Specifically, the changes in the organizational structure of government are looked into. By looking into the objectives and mechanisms that are found in practice, the outcomes of IT-induced transformation are investigated, as are the means by which they are achieved:

What are the outcomes of IT-induced transformation in practice?

After the outcomes of transformation have been identified, the third research question is concerned with ‘transformation-as-a-process’ by investigating the factors that influence transformation. For this, two theoretical perspectives are developed, based on contingency and structuration theory. Using these theoretical perspectives, the third research question is:

Which factors influence the occurrence of these outcomes?

These research questions are graphically represented in a conceptual model, which is shown in figure 1.1. This model functions as an overview of this study and of the concept of IT-induced transformation.

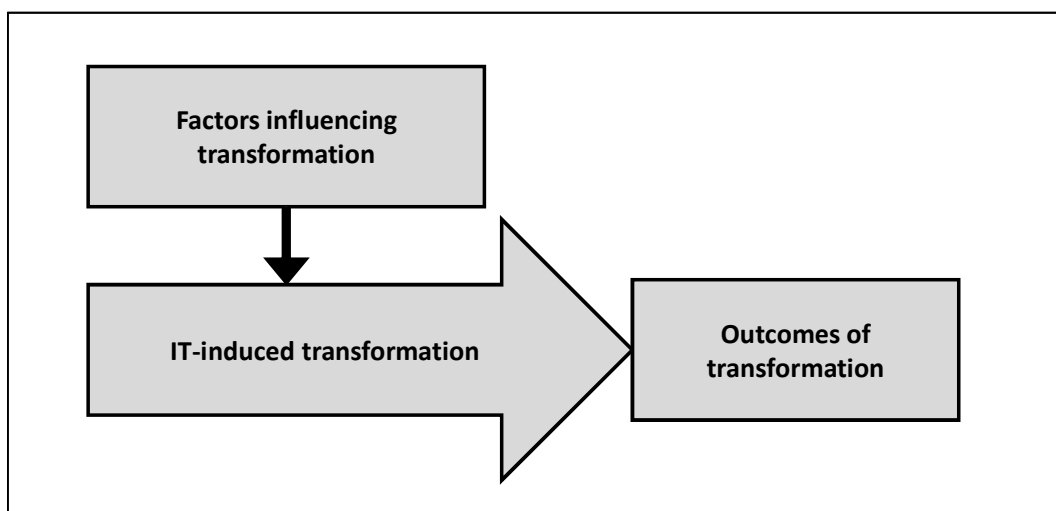

Figure 1.1: Model of IT-induced transformation.

The three building blocks in this figure both present the three research questions and the different elements of transformation that will be explored. This is an explorative study rather than a study in which hypotheses are tested. Therefore, this conceptual model aims to detail the different building blocks rather than to test the relationships between clearly defined concepts. After developing the theoretical concept of IT-induced transformation by operationalizing its mechanisms and objectives, this study investigates outcomes and factors that influence IT-induced transformation.

1.5 Relevance of this study

This study into IT-induced transformation and its effects on public administration is both scientifically and practically relevant. A gap exists in the literature and practice between those authors and policy-makers that foresee transformational effects that will manifest themselves after implementation of e-government and those that claim that few effects of this transformation are observed in practice. This study aims to fill this gap by investigating IT-induced transformation as well as the factors that influence its occurrence. It builds upon earlier research on (transformational) e-government and aims to advance theory development in this field. Furthermore, this study may advance the understanding of politicians and policy-makers on the role of IT in achieving public sector transformation.

Over the past decades the research field of e-government “has advanced past the stage of infancy” (Scholl, 2009, p. 2). The term e-government emerged in the mid-1990s, but studies into the influence of IT in the public sector predate this term. A recurring discussion in studies of the e-government research field, however, is that most e-government research is empirically based, lacking theoretical foundations (Gronlund & Horan, 2005; Heeks & Bailur, 2007; Yildiz, 2007). While the quantity of studies has gone up, the depth has remained similar, with many studies lacking theoretical findings (Gronlund & Andersson, 2006). Many papers present case study research, without moving beyond empirical accounts of change. This study aims to go a step further. Besides presenting a detailed overview of changes in administrations undertaking e-government efforts it also derives outcomes and factors influencing IT-induced transformation. Furthermore, by presenting a method for measuring change, it will be able to make generalizable statements on transformation, thereby contributing to theory development.

One reason for this lack of common theoretical foundations is that e-government is essentially a multidisciplinary research field dealing with ‘wicked’, unstructured problems, and “[i]ntegration and interdisciplinarity has proved to be more and more difficult as more disciplines with different paradigms and standards begin to interact” (Scholl, 2009, p. 23). IT-induced transformation is among those complex and unstructured research problems that have been mentioned to benefit from using a multidisciplinary approach (Scholl, 2007). This study uses such a multidisciplinary approach by building on literature both from the field of Public Administration and the field of Information Systems. Besides making a contribution to the field of e-government, this study thus also contributes to the broader research fields of Public Administration and Information Systems.

While the debate whether transformation is taking place is ongoing, politicians and policy-makers are constantly aiming to realize transformation. Reading the newspapers, one can often see them making promises of reform. Over the past years the transformational component of e-government is increasingly emphasized (Bannister &

Connolly, 2011c; Dhillon et al., 2008; Irani et al., 2007; Veenstra et al., 2011) and this study will provide practical insights into the changes that are expected to take place and the factors that influence these changes. In practice, we often see that the expectations and promises of politicians and policy-makers are not met by the actual outcomes, especially concerning large IT-projects (WRR, 2011). So policy-makers may use these insights for crafting policies that actually achieve public service transformation instead of continuing to fall short of this goal. In the Netherlands, from May 2012 onwards a parliamentary investigation into the failure of many large governmental IT-projects will take place. This study may provide policy-makers with lessons-learned and recommendations for ensuring that these types of failure do not occur in the future.

The Netherlands has a relatively large public sector, accounting for around 45,5% of GDP in 2008 (CBS, 2009), and this percentage has risen during the recent financial crisis. Although spending on service delivery represents only a fraction of this budget, increasing efficiency and effectiveness of the public sector could make a big difference. Currently, politicians and policy-makers are facing the challenge of having to decrease public spending. One way of making the public sector more efficient as well as more effective may be by using IT in a smarter way, by accompanying IT-investments with transformational efforts. Identifying factors enabling or impeding efforts of IT-induced transformation, could contribute to the current aims of the Dutch government to increase performance of its organizations by using IT-induced transformation to leverage investments in e-government.

1.6 Research methodology

The aim of this research is to explore IT-induced transformation in order to find its outcomes and the factors that influence the occurrence of these outcomes. The purpose of this explorative study is to develop theory on IT-induced transformation. Eisenhardt (1989) describes the process of inducing theory from case study research. Case study research has proven itself increasingly valuable to the field of Information Systems (Walsham, 1995). According to Eisenhardt (1989), this approach is especially appropriate in new topic areas. T-government is a new topic area as the focus on the transformational aspect of e-government is seen to have started fairly recently. Eisenhardt's approach, which will be followed in this study, is shown in Table 1.1.

As shown in this table, an interpretative study starts off by defining a research question and the constructs that are to be explored. In this chapter the first part of the first step is undertaken: deriving the research questions. Although the main construct of this study – IT-induced transformation – is already introduced in this chapter, it will be operationalized further using a literature review in the next chapter. The definition of good constructs is especially important for developing measures for these constructs (MacKenzie, 2001). To retain theoretical flexibility during this literature review, it is undertaken into multiple academic disciplines to identify objectives of IT-induced transformation as well as possible factors influencing outcomes. Based on this literature research, the conceptual model presented in figure 1.1, will be elaborated to include objectives and mechanisms of IT-induced transformation.

Table 1.1: Process of building theory from case study research (from: Eisenhardt, 1989, p. 533).

Step	Activity	Reason
Getting started	Definition of research question	Focuses efforts
	Possibly a priori constructs	Provides better grounding of construct measures
	Neither theory nor hypotheses	Retains theoretical flexibility
Selecting cases	Specified population	Constrains extraneous variation and sharpens external validity
	Theoretical, not random, sampling	Focuses efforts on theoretically useful cases – i.e. those that replicate or extend theory by filling conceptual categories
Crafting instruments and protocols	Multiple data collection methods	Strengthens grounding of theory by triangulation of evidence
	Qualitative and quantitative data combined	Synergistic view of evidence
	Multiple investigations	Fosters divergent perspectives and strengthens grounding
Entering the field	Overlap data collection and analysis, including field notes	Speeds analyses and reveals helpful adjustments to data collection
	Flexible and opportunistic data collection methods	Allows investigators to take advantage of emergent themes and unique case features
Analyzing data	Within-case analysis	Gains familiarity with data and preliminary theory generation
	Cross-case pattern search using divergent techniques	Forces investigators to look beyond initial impressions and see evidence through multiple lenses
Shaping hypotheses	Iterative tabulation of evidence for each construct	Sharpens construct definition, validity and measurability
	Replication, not sampling, logic across cases	Confirms, extends, and sharpens theory
	Search evidence for “why” behind relationships	Builds internal validity
Enfolding literature	Comparison with conflicting literature	Builds internal validity, raises theoretical level, and sharpens construct definitions
	Comparison with similar literature	Sharpens generalizability, improves construct definition, and raises theoretical level
Reaching closure	Theoretical saturation when possible	Ends process when marginal improvement becomes small

Although the third part of Eisenhardt's first step is actually not doing something, it is addressed in this study by using meta-theories for its investigation. Ideally, in this start-up phase, neither hypotheses nor theory should be identified as this allows for theoretical flexibility. This ensures that the phenomenon under study will be used for inducing – instead of testing – theory. For this reason, this study uses two meta-theories that make general statements on change rather than that they represent testable theories on change for analyzing the transformation process. These meta-theories do not prescribe a direction into which this change may take place. Rather, the two theoretical perspectives point at fields that may influence change in general to enable an investigation into these areas.

The second step of Eisenhardt's approach – selecting cases – uses theoretical sampling. This form of sampling is not random, but its purpose is “to choose cases which are likely to replicate or extend the emergent theory” (Eisenhardt, 1989, p. 537). In this study, the cases are selected to explore IT-induced transformation by seeing whether its objectives are met – or not. Considering that IT-induced transformation is still a novel development that is not yet adopted by many government organizations, two innovative cases were selected: the Standardized Business Reporting (SBR) and Omgevingsvergunning programs. As an approach of using a single case study is usually considered inferior to an approach using multiple cases (Yin, 1989), multiple case studies will be carried out. Yin (1989) asserts that a small number can already be successful for theory formulation and theory testing. In this study, these two cases were chosen representing efforts of a multi-level, multi-dimensional and long-term nature.

Both cases were studied in retrospect to capture the long-term nature of IT-induced transformation. While the cases have many similarities in terms of objectives, scope, technology deployed, and multitude of stakeholders, different factors were identified to have an effect on the outcomes. This allows for comparing the variances in the outcomes and develop propositions. Case studies have to be carried out carefully obeying clear guidelines (Eisenhardt, 1989; Klein & Myers, 1999). The aim of the case study research is to find out how IT-driven transformation takes place in practice by looking at which transformational objectives are achieved through the deployment of which transformational mechanisms. Specifically, it looks at which organizational changes take place. Furthermore, it aims to investigate which factors drive, guide and impede these changes. After the case studies are presented, a within-case and cross-case analysis is carried out using. An objective of the case analysis is to structure the evidence found, while cross-case analysis allows for the identification of patterns (Eisenhardt, 1989). By applying the case study protocol and comparing the two cases, it is possible to identify similar as well as differing outcomes.

To see whether the findings of the case study analysis also hold in a different environment, as well as to validate the findings from the cases, this study carries out a second empirical analysis. While the two cases represent innovative cases in the Netherlands, local governments are often considered laggards of e-government adoption (Morgeson III & Mithas, 2009). To study whether IT-induced transformation really took hold in government, a quantitative analysis is carried out among local governments. Using survey research, ninety municipalities in the Netherlands were investigated. Surveys are especially useful to predict behavior and to make generalizations (Newsted, Huff & Munro, 1998). Surveys generally have three characteristics: they come up with quantitative descriptions of certain aspects of a population, they collect information by asking predefined questions to the respondents, and they collect information of a subset of the study population (the sample) in such a way that generalizations about the whole

population can be made (Pinsonneault & Kraemer, 1993). Thus, in order to grasp the complexity of the IT-induced transformation, several data collection methods are used. Using multiple methods will make the study richer and more reliable (Mingers, 2001).

Based on the findings of the case analyses and the quantitative analysis, an outline of a theory of IT-induced transformation is subsequently formulated by confronting the findings from the empirical studies to the findings from the literature. Drawing on the empirical studies, a number of generalizable conclusions is formulated that can be tested in further research.

1.7 Outline of this study

This chapter introduced the concept of IT-induced transformation and developed a methodology for an explorative study into the matter with the aim to build theory on its outcomes and the factor influencing these outcomes. The remainder of this study is divided over seven chapters. Operationalizing transformation 'as a product' takes place in chapter 2 by identifying its objectives and mechanisms based on literature. It uses the two research traditions IT-induced transformation builds upon: public sector reform (from the field of Public Administration) and leveraging IT by organizational change (from the field of Information Systems). Chapter 3 is concerned with IT-induced transformation 'as a process', by developing two perspectives for studying the phenomenon. These perspectives are developed based on contingency theory and structuration theory. At the end of these chapters the conceptual model of IT-induced transformation is fully operationalized.

The next three chapters comprise the two empirical studies that are part of this research. Chapters 4 and 5 present and analyze the two explorative case studies carried out to understand the complexity of transformational e-government in practice. These two case studies of transformational efforts in the Netherlands are the Standard Business Reporting and Omgevingsvergunning programs. The case study methodology as well as a description of both cases is presented in chapter 4, and the case study analysis in chapter 5. The second empirical study is a quantitative study of IT-induced transformation among Dutch municipalities. The set-up and findings of this quantitative study can be found in chapter 6. The purpose of these chapters is to test the model of IT-induced transformation, including its outcomes and the factors influencing these outcomes, in practice. Finally, chapter 7 presents the conclusions of this study as well as recommendations for further research, and chapter 8 discusses the implications of these conclusions in an epilogue.

2 Operationalizing transformation

[Information technology] will move into the managerial scene rapidly, with definite and far-reaching impact on managerial organization (Leavitt & Whisler, 1958).

IT-induced transformation was defined as multi-level, multi-dimensional, and long-term organizational change, through the implementation of IT for reform purposes, in order to achieve a situation that is qualitatively different than before. Hence, it builds upon two theoretical traditions: public sector reform (based on the research field of Public Administration) and organizational change leveraging information technology (IT) (from the literature on Information Systems). The objective of this chapter is to operationalize IT-induced transformation by identifying its objectives and mechanisms. The objectives are derived from the literature on public sector reform, and the mechanisms are derived from the literature on leveraging IT. At the end of this chapter the operationalized conceptual model of this study is presented that can be used for the empirical investigation.

2.1 Public sector reform

The objective of e-government as a factor contributing to public sector reform originates in the 1990s. At that time, a change in management practices could be observed and “ICTs began to be viewed as strategic assets for government with the potential to help policy makers and program managers redesign and integrate services to support critical stakeholder relationships and overarching policy goals” (Dawes, 2008, p. S89). E-government, thereby, became linked to the reform agenda of governments around the world (Cordella & Iannacci, 2010; Dawes, 2008; Homburg, 2009; Morgeson III & Mithas, 2009). In chapter 1 it was found that while e-government is often linked to New Public Management (NPM) to achieve efficiencies, t-government is usually linked to Public Value Management (PVM) in order to achieve greater effectiveness. To identify the objectives of IT-induced transformation, this section presents an overview of the literature on public sector reform.

2.1.1 Theoretical strands of public sector reform

Public sector reform is concerned with improving the functioning of government. It serves multiple purposes:

“Public management reform is usually thought of as a means to an end, not an end in itself. To be more precise we should perhaps say that it is potentially a means to multiple ends. These include making savings (economies) in public expenditure, improving the quality of public services, making the operations of government more efficient, and increasing the chances that the policies which are chosen and implemented will be effective. On the way to achieving these important objectives, public management reform may also serve a number of intermediate ends, including

those of strengthening the control of politicians over the bureaucracy, freeing public officials from bureaucratic constraints that inhibit their opportunities to manage, and enhancing the government's accountability to the legislature and the citizenry for its policies and programs. Last, but not least, one should mention the symbolic and legitimacy benefits for management reform" (Pollitt & Bouckaert, 2004, p. 6, emphasis in original).

The objectives that are referred to span the width of governments' activities and purposes, including cost savings, the outcomes that are to be achieved by the government, and the values that are considered. Such change, however, is expected to take a long time: "The full benefits of major changes in the processes and structures of public agencies normally cannot be harvested until three, four, five, or even more years after a reform program has been launched" (Pollitt & Bouckaert, 2004, p. 7).

The theoretical public sector reform strands that are linked to e-government and t-government – NPM and PVM – are compared with the traditional form of government – bureaucracy – in table 2.1. Based on the literature, differences were found in a number of dimensions, such as the organizational structure, and the role of public officials. Transformation from one to the next reform strand can be seen as a multi-dimensional transformation. Although bureaucracy is strictly speaking not a reform agenda, but a representation of traditional public administration, it is included in this section. Being the organizational logic that the reform agendas are trying to steer away from, it is necessary to understand its basics.

Table 2.1 is composed by combining elements of similar comparisons by a few authors: Denhardt & Denhardt (2000), Dunleavy et al. (2005), Stoker (2006), Bourgon (2007), and O'Flynn (2007). It should be noted that the table uses *ideal types* of public sector management rather than that it represents the actual situation in governments at any given time. Ideal types are used in this study as a description of a specific phenomenon, not referring to a desired situation seen from a normative standpoint. In practice, a mix of elements and characteristics will be found instead of the ideal types described in this table. Traces of the ideal types of public organizations presented in this section are found in today's public administrations (Bourgon, 2007). In the next sections the three ideal types of public sector management will be elaborated based on literature.

Table 2.1: Comparison of ideal types of public sector management (based on Denhardt & Denhardt (2000); Dunleavy et al. (2005); Stoker (2006); Bourgon (2007); and O'Flynn (2007).

	(Weberian) bureaucracy	NPM	PVM
Purpose of the public sector	Realizing political goals	Mitigating market failure	Creating public value
Role of government	Policy-making and implementation	Catalyst for actions of private parties	Serving and empowering
Role of the public	Clients and electorate	Customers	Citizens
Role of public managers in achieving political goals	Following procedures	Attaining output targets	Coordinating actions within networks of organizations
Formulation of public value	Politicians formulate laws by consulting experts	Aggregation of individual preferences	Complex process of interactions; result of a dialogue
Discretion of administrators	Limited; standardization of tasks	Room for attaining entrepreneurial goals	Discretion necessary, limited by political accountability
Motivation of administrators	Public service; wages and status: protected and privileged profession	Entrepreneurial spirit; ideal of smaller government	Public service; contributing to society
Public sector ethos	Monopoly on public value	Customer satisfaction	Dialogue and collaboration
Mechanisms for achieving policy objectives	Implementing government programs	Realizing policy objectives by private parties	Networks of public and private organizations
Accountability	Hierarchical: administrators are accountable to elected politicians; there is a focus on following procedures	Market-driven: aggregation of preferences leads to desired output for large groups of customers, via public-private contracts	Pluriform: administrators have to follow the law, societal values, political norms, professional standards and citizens' interests
Organization structure; service delivery	Hierarchical	Private sector / agencies put at a distance from central government	Networks / pluriform
Purpose of democratic process	Accountability to citizens	Setting targets	Entering a dialogue

2.1.2 Weberian bureaucracy

Modern governments arose across Europe in the nineteenth century with the rise of rational legal bureaucracies (Weber, 1972 [1920]). Before the emergence of modern society, most societies were still feudally organized, often with a hereditary leadership in place. In Weber's vision the rational legal bureaucracy was the ideal organizational

structure for executing the public function that governments need to perform, which, compared to traditional structures, was to be favored for its efficiency as well as its equity (Weber, 1972 [1920]). He postulated this ideal type in order to understand the rise and spreading of capitalism and against traditional (feudal) and charismatic ideal types of leadership. His ideas on how public administration is to be organized are still wide-spread among public administrations world-wide.

A way to understand the rational legal bureaucracy is to compare it to the traditional ideal type, in which leadership needs a staff of loyal administrators. While in the traditional leadership this staff is merely an extension of its leader, in a bureaucracy civil servants are rationalized and functionalized. In other words, the civil service becomes a profession in itself. Strictly dividing administrators from the political functions by making them accountable to these (elected) politicians enables them to continue working for different governments of a different political flavor. A functioning democracy is, thus, considered important for the Weberian bureaucracy to function properly. Furthermore, a Weberian bureaucracy has a strong respect for the law (Bourgon, 2007). To carry out tasks in an impartial manner, a high standardization of activities takes place, which gives civil servants minimal discretion in executing tasks. A Weberian bureaucracy is, thus, typically characterized as “a hierarchically structured, professional, rule-bound, impersonal, meritocratic, appointed, and disciplined body of public servants with a specific set of competencies” (Sager & Rosser, 2009, p. 1137).

Bureaucracies are, firstly, *hierarchically* organized, representing a clear division of labor “whereby complex administrative problems are broken down into manageable and repetitive tasks” (Stoker, 2006, p. 45). In line with this division of tasks, also accountability is organized hierarchically, by aggregating all tasks and by making the top of the pyramid responsible for all actions. “[T]he offices of the organization are ordered according to the principle of office hierarchy, in which lower offices are controlled and supervised by designated higher offices” (Heugens, 2005, p. 550). This leads to the second characteristic of *centralization* as a result of the monocratic hierarchy of public administration that emerges.

Thirdly, bureaucracies are strongly characterized by *formalization* by having in place a paper-based system of keeping files of all tasks that are carried out (Sager & Rosser, 2009; Stoker, 2006). All actions undertaken in the bureaucracy are noted and stored on paper to ensure accountability. “[A]ctions and decisions are recorded in formal files to accommodate subsequent consultations and appeals” (Heugens, 2005, p. 550). Also the distinction between private wealth and public means is clearly specified: “the means of production or administration [officials] use belong to the organization and may not be appropriated” (Heugens, 2005, p. 550).

Fourthly, the *specialization* of civil servants is an important characteristic of the Weberian bureaucracy. The civil service becomes a true profession, usually for life, ensuring continuity: “officials are employed within a full-time career structure in which continuity and long-term advancement is emphasized” (Stoker, 2006, p. 45). Administrators are trained to perform a public task, and they are promoted on the basis of merit: “bureaucrats are appointed to administrative offices because of their skills (meritocracy) and not because of their ancestry. The public servants’ education is important, and bureaucrats are supposed to be highly specialized professionals” (Sager & Rosser, 2009, p. 1137).

And finally, bureaucracies are characterized by a *standardization* of controllable tasks that are carried out according to pre-defined rules and norms to ensure impartiality

(Stoker, 2006). This means that bureaucrats have little discretionary space for making their own decisions. Instead, their tasks are clearly defined.

In most Western capitalistic states the Weberian bureaucracy became wide-spread and its fundamental characteristics are still visible today. However, as bureaucratic structures expanded, problems became associated with them. First and foremost they became known for their *lack of flexibility* (Bourgon, 2007). Some public goods, as a result of their complexity, require greater flexibility of organizations to realize them, including knowledge-based activities, which require a high level of discretion. The Weberian bureaucracy with its pre-defined tasks and focus on following procedures cannot deliver the amount of flexibility necessary for certain tasks, often leaving citizens frustrated. Although, according to Weber, bureaucracies represent the most efficient organizational form, nowadays, they are most often linked with concepts such as red tape and inefficient decision structures: “the very structures that ensure continuity and stability are major inhibitors of change” (Bannister, 2001, p. 66). It should be noted, however, that Weber was not concerned with the practical implications of bureaucracies, but with formulating an ideal type for governments in the industrial age.

The second problem with bureaucracies follows from the delivery of complex goods: the *blurring of the distinction between politics and administration* (Bourgon, 2007; Poulsen, 2009). In the Weberian bureaucracy, accountability is organized by administrators reporting towards elected leaders, while the administrators themselves are expected to remain impartial and exercise limited discretion in executing their tasks (Bourgon, 2007). This form of accountability is often seen as ‘procedure accountability’, in which administrators are mainly responsible for following the right procedures (Poulsen, 2009). In practice, however, as experts, they increasingly have a responsibility for formulating the right policies and as such their work becomes increasingly political in nature (Bourgon, 2007). This may blur the strict distinction between politics and administration as formulated by Weber.

Furthermore, the very structure of bureaucracies has led them to develop into large monopolies that are unable to interpret the real wishes and needs of citizens. “Public service organizations [...] tend to be dominated by *producer interests*. Unlike private sector organizations, the power of the producer is not held in check by countervailing incentives and demands. As a result, public service organizations tend to be neither efficient in terms of saving public money nor responsive to consumer needs” (Stoker, 2006, p. 45, emphasis added). Instead of seeing their actions as services to be delivered to citizens and businesses, they often see the tasks to be carried out as targets in itself. Thus, bureaucracies became associated with red tape and inefficiency (Bourgon, 2007). These problems associated with bureaucracies have led to the emergence of public sector reform agendas from the 1980s onwards.

2.1.3 New Public Management

The collection of management styles that emerged in the late 1980s as a reaction to the problems of traditional hierarchical bureaucracies is commonly named New Public Management (NPM). NPM should not be seen as a coherent set of management principles, but, instead, as a variety of management styles that share one important objective: the introduction to the public sector of private sector practices, which are considered to be more efficient and to treat citizens as customers (Bourgon, 2007; Goldfinch & Wallis, 2010; Osborne & Gaebler, 1992; Stoker, 2006). Elements of this reform agenda can be found in governments around the world, although the

pervasiveness and the emphasis of these reforms differs (Dunleavy et al., 2005; Goldfinch & Wallis, 2010; O'Flynn, 2007; Pollitt & Bouckaert, 2004). Its development is a result of the reorientation of public administrations to go back to their 'core business' (Bekkers & Zouridis, 1999).

Through the introduction of private sector practices, NPM, thus, focuses on achieving greater *efficiency* and *value for money* in public sector organizations (Bourgon, 2007; Goldfinch & Wallis, 2010; Homburg, 2009; Osborne & Gaebler, 1992). By stimulating an 'entrepreneurial spirit' of managers and the introduction of competition a decrease of costs is to be realized (Dunleavy et al., 2005; Stoker, 2006) through "greater discipline and parsimony in resource use" (O'Flynn, 2007, p. 354). A "purchaser-provider divide within organizations" (Stoker, 2006, p. 45), resulted in outsourcing as well as privatization of activities (Dunleavy et al., 2005). "Internal and external market or quasi-market mechanisms [are] to imitate market competition, including the widespread use of competitive mechanisms, written contracts, 'contracting-out' and ultimately privatization" (Goldfinch & Wallis, 2010, p. 1101).

This led to the *disaggregation* of government; the splitting up of large public sector organizations to realize flatter organizations (Dunleavy et al., 2005; Homburg, 2009). One of the central ideas of NPM to increase efficiency is "to fragment monopolistic public service structures and develop incentives and tools to influence the way that they operate. [...] The aim is to create an organizational home for the client or consumer voice within the system to challenge the power of producers. [...] New public management then seeks to dismantle the bureaucratic pillar of the Weberian model of traditional public administration." (Stoker, 2006, p. 45). The purpose is to create "[d]ecentralized structures with smaller, multiple and often single purpose agencies and putatively flexible and innovative staff, replacing highly centralized bureaucracies" (Goldfinch & Wallis, 2010, p. 1100).

Besides greater efficiency, NPM is to realize more *responsive service delivery* than traditional bureaucracies (Bourgon, 2007; O'Flynn, 2007). Governments adopted the 'customer' metaphor for businesses and citizens (Fountain, 2001b; Goldfinch & Wallis, 2010; Osborne & Gaebler, 1992) to emphasize the importance of service delivery. Instead of the focus on carrying out pre-defined, standardized tasks as in the Weberian bureaucracy, which leads to a focus on the procedure of the tasks to be carried out (Poulsen, 2009), focus shifts to realizing output and results as well as the provisioning of services for citizens and businesses (Goldfinch & Wallis, 2010). Suddenly, bureaucrats were not only responsible for following the right procedure, but they also had to ensure a favorable outcome of their actions (Poulsen, 2009).

In order to realize the 'right' output and service delivery in a cost-efficient manner, an *incentivization* of management activities was pursued. This means that public managers, following their counterparts in the private sector, now became accountable for strict performance targets and incentives (Stoker, 2006). The performance of public tasks became strictly controlled by targets and rewards for achieving these targets (Denhardt & Denhardt, 2000; Dunleavy et al., 2005; Stoker, 2006). Shifting away from rewarding performance in terms of a professional public sector ethos, to a greater emphasis on specific performance incentives (Dunleavy et al., 2005; Homburg, 2009). The use of contracts as an organizing mechanism of economic activity (O'Flynn, 2007), enforces the implementation of these strict targets by the reporting of output achieved (Goldfinch & Wallis, 2010).

This focus on performance targets led to the introduction of *managerialism*, by replacing the specialized professional civil servant by professional managers. A life-long

career in the civil service was no longer the norm and the human resources (HR) regime aimed to promote administrators on the basis of their specialized skills, was replaced by contractual arrangements, performance pay, and management approaches to achieve productivity gains in order to attain the strict targets (Bourgon, 2007). “Motivation of public servants [became] based on financial incentives rather than professional ethos or duty, with contracts [...] being a key part of this process; [and] politicians taking a back-seat with respect to ‘operations’, setting the broad parameters of ‘policy’ or ‘strategy’ and leaving day-to-day business to professional managers.” (Goldfinch & Wallis, 2010, pp. 1100-1101). The business of public administration was, thereby, left to managers instead of administrators (Homburg, 2009). Accountability shifted from mainly procedure accountability towards clearly defined goals to assure their delivery (Poulsen, 2009).

At the time these management styles were introduced, the recognition of *the role of IT* in modernizing public administration and adapting to the changing needs of citizens emerged (Bourgon, 2007; Dawes, 2008; Dunleavy et al., 2005). It was seen that IT could support a leaner and more decentralized organizational structure. Therefore, the use of IT became intertwined with many of these objectives for a leaner public administration as it was embraced by politicians and policy makers as an instrument for delivering many of the NPM objectives. One example is the implementation of Management Information Systems to gather performance indicators to see whether public managers achieve their targets. Also the rise of e-government as an instrument for achieving better service delivery can be seen as part of this uptake of IT in public administration.

NPM-based reform was not implemented in the same way around the world, but many differences between countries exist. Politt & Bouckaert (2004) make a distinction between four basic types of reform: tightening up of existing controls (e.g. budget cuts), ‘modernizing’ public administration by using management practices inspired by the private sector and political reforms in order to make government organizations more responsive and flexible, the introduction of market mechanisms to increase competitiveness, and fourth, strategies based on minimizing or ‘hollowing out’ the state by means for introducing mechanisms of privatization and/or contracting out of public services (Martin, 2003; Pollitt & Bouckaert, 2004). Furthermore, among countries different degrees of adoption can be seen to exist: while Anglo-Saxon countries embraced these new management practices, countries such as Germany and France stayed further away from it, while in other countries (among which the Netherlands) implemented NPM-practices using a bottom-up approach resulting in reform rhetoric but less invasive changes (Martin, 2003; Pollitt & Bouckaert, 2004).

Through NPM “governments and government agencies have succeeded in privatizing previously public functions, holding top executives accountable for performance goals, establishing new processes for measuring productivity and effectiveness, and reengineering departmental systems to reflect a strengthened commitment to accountability” (Denhardt & Denhardt, 2000, pp. 550-551). However, a number of problems emerged related to the introduction of NPM.

A first problem was that while NPM ensured a more efficient and entrepreneurial public sector, the reforms that took place ensured greater *fragmentation* of the public sector (Bourgon, 2007), as individual government agencies were only accountable for their own activities and tasks. According to its critics NPM, thereby, merely reinforced the traditional Weberian silo’s in the organization instead of ensuring enhanced coordination (Ask & Grönlund, 2008; Dunleavy et al., 2005; Stoker, 2006). Others have argued that this will lead to the hollowing out of the state, in which an increasing

dependency on other parties and networks of parties will leave governments to lose power (Milward & Provan, 2000). Some have, therefore, argued that NPM does not fit well with developments in the field of e-government (see, for instance, Ask & Grönlund, 2008). Over time, therefore, some of the disaggregation elements have been reversed, while the competition and incentivization elements are still being implemented (Dunleavy et al., 2005).

A second problem is related to the new style of *managerialism*:

“A problem with claims of NPM coherence is that aspects of the NPM agenda seem contradictory. We have a call to let ‘managers manage’. However, there can be the introduction of more central and highly specified controls through contracting out, performance evaluation and accountability mechanisms, which in some cases limit managerial autonomy – or at least make it highly problematic [...] simply the form of bureaucracy being changed and NPM initiatives being ‘layered’ [...] upon existing structures. As such, perhaps bureaucracy [...] increased. [...] They are now supplemented by a ‘new red tape’ of output, outcome and other measures, invasive and time-consuming accountability and evaluation controls, limits on professional autonomy and self-regulation [...]. Management, non-professional and non-operational staff numbers in many parts of state sectors actually increased, as did administrative costs” (Goldfinch & Wallis, 2010, pp. 1103-1104).

This had its effect on the *ethos of the civil service*: “under NPM a flawed but still working and powerful public sector ethos was broken up by [...] performance-based systems” (Dunleavy et al., 2005, p. 473). The “erosion of public-private distinction may also worsen the “motivation problem” among public employees who are often inspired by intrinsic incentives such as the mission of public service to serve greater public interests rather than narrow private concerns” (Haque, 2001, p. 74).

A fifth problem of NPM that emerged is characterized by the emergence of *perverse effects* (Bruijn, 2002). These occur when the formulation of incentives has led to optimization according to these incentives, instead of to the wishes and needs of citizens. The very incentives that are designed for improved public services then result in outcomes that are undesired. “It is increasingly clear that for the new model of public management, there is certain theory-practice discrepancy or rhetoric-reality gap” (Haque, 2006, p. 319). “Thus transition [...] towards an overwhelming concern for results may encourage public managers to pay more attention to the predetermined productivity targets, while making them less responsive to the changing needs and expectations of citizens beyond the confines of such managerial targets. In other words, a businesslike management attitude may be incompatible with the people-oriented behavior expected from public service” (Haque, 2001, p. 68).

Finally, NPM led to a *diminishing problem-solving space for citizens*: although citizens are more approached as customers, the customer-centeredness is often constructed from the government’s point of view. “NPM changes [...] had powerful adverse impacts on citizens’ autonomous capacities” (Dunleavy et al., 2005, p. 475). Thus, although this new management paradigm has had a big impact on governments around the world, to overcome its negative implications, some of its characteristics are being reversed or altered.

2.1.4 Public Value Management

PVM emerged in reaction to NPM as well as to the traditional Weberian bureaucracy (Dunleavy et al., 2005; Stoker, 2006). It envisages to overcome the negative implications of both (O'Flynn, 2007), such as the inefficiency of bureaucracy and the fragmentation of government. The point of departure for PVM is that governments have lost a great deal of their vision of what needs to happen for society as a whole: they need to focus on creating public value. Furthermore, it addresses the need for coordinating activities of the public sector. This is a result of the need for joined-up services to overcome fragmentation (6, 2004) as well as for greater flexibility to address the complex issues of this time. It, therefore, emphasizes the role of governance, instead of hierarchical government, a trend that already started at the time of introducing NPM. As such, PVM can be considered a reaction to as well as building on NPM to overcome some of its negative elements. Although some simply declare NPM to be dead (Dunleavy et al., 2005), PVM and NPM have much in common. For the clarification of the concept, however, it will be described as a reaction to NPM.

Like NPM, PVM is the name of a group of ideas rather than a clear theory on public administration. It emphasizes different elements of putting the realization of public value central to all government interventions (O'Flynn, 2007; Stoker, 2006). Different authors have come up with similar names. Denhardt & Denhardt (2000), for example, call their version *New Public Service*, Bourgon (2007) *New Public Administration*, and Dunleavy et al. (2005) emphasize the role of information systems in their *Digital-Era Governance*. All of these perspectives, however, clearly emphasize the two central elements of PVM: realizing public value for citizens and governance in networks of organizations. Furthermore, in these post-NPM reform agendas IT is central to achieving their goals (Dunleavy et al., 2005). Because of the focus on public value, this study uses the term PVM. The main characteristics, objectives and challenges of PVM will be elaborated in this section.

Public value creation

The public value perspective is an attempt to create an integrated and holistic vision on value for society, instead of merely aggregating individual preferences, which can be seen as the NPM-perspective of value (O'Flynn, 2007). It is, therefore, often emphasized that within the public value framework, *outcome*, rather than *output* is realized (Alford & O'Flynn, 2009; Karunasena, Deng & Singh, 2011). This refers to the role of government in focusing on defining value in such a way that it “has meaning to people, rather than what a public-sector decision-maker might presume is best for them” (Alford & O'Flynn, 2009, p. 176). As it can only be determined by negotiation, politics is central to establishing what public value is (Stoker, 2006), and it is therefore likely that it differs from area to area. More than that of its predecessors, the focus of PVM is “on ethical dimensions and values in motivating public servants and a more positive view of the state sector in general” (Goldfinch & Wallis, 2010, p. 1106).

Several people have attempted to create an overview of the public values public administrations may deliver, such as Jorgesen (2007), who identifies as much as 72 public values, divided into seven categories: public sector's contribution to society, transformation of interests to decisions, relationships between public administrators and politicians, relationship between public administrators and their environment, intra-organizational aspects of public administration, behavior of public-sector employees, and relationship between public administration and the citizens. Also in the

context of e-government, public values have been identified and divided into four categories, such as individual, societal, organizational and political (Nour, AbdelRahman & Fadlalla, 2008), and social, financial/economical (*sic*), operational, and strategic/political (Raus, Liu & Kipp, 2010). Public value creation is not exclusively the domain of the government, but also citizens and businesses play a part (Jorgesen, 2007).

Besides determining which value is to be delivered, the next question is for whom (Smithson & Hirschheim, 1998). Public value can be directly delivered to the 'customers' of governments (citizens) as well as increase the value of public administration for society as a whole (Cresswell et al., 2006). For Moore (1995) the core of PVM is that services delivered to citizens as well as public interventions need to be judged on the basis of their merit for society and economy. In an environment of rapid change, public managers need to concentrate on creating value, and not just on how to implement mandated policies consistently and efficiently. Many emphasize that the public sector is different by nature from the private sector, and its interventions cannot be characterized by market failure justifications alone, as happens in the NPM-approach (Kirlin, 1996; O'Flynn, 2007; Stoker, 2006).

Therefore, public value can only be realized when an adaptable, learning-based approach is taken on by public managers (Moore, 1995; Stoker, 2006). "The influence of scientific management [in Weberian bureaucracies] led to an expectation that it would be possible to define the 'correct' procedures and to control clearly defined and predictable tasks" (Bourgon, 2007, p. 19). However, service delivery often requires a level of discretion of civil servants and emphasizes leadership of public managers. "Leaders have taken the place of the managers found in NPM, with a focus on 'transformational' leadership to deliver greater organizational performance and effectiveness, with the ability to generate employee commitment and motivation being a key factor in the performance" (Goldfinch & Wallis, 2010, p. 1106). Public value creation, thus, not only refers to an end-goal but also to a means.

According to Moore (1995), a strategy for public organizations must meet three requirements: be aimed at creating something valuable, be legitimate and politically sustainable, and be operationally and administratively feasible. Public values can, however, be conflicting, which can lead to difficulties in determining which value to pursue. It was found that especially values that are 'non mission-based', which means that they are not the central 'mission' of a policy that is to be implemented, can easily be forgotten in the implementation (Piotrowski & Rosenbloom, 2002). For example, in pursuing more safety, ensuring citizens' privacy may easily be forgotten. "[F]ocusing on results may weaken commitment to democratic-constitutional values by default" (Piotrowski & Rosenbloom, 2002, p. 643). Creating public value cannot sacrifice other values too much. The first objective of PVM is, thus, the realization of public value through a continuous assessment of which value is to be delivered and to whom.

Network formation

The second element of PVM is the collaboration of public organizations in networks in which also private parties may take part, both in the policy making and in the policy implementation phase. According to Stoker (2006), only by involving relevant stakeholders, such as elected politicians, civil servants and other important stakeholders, a decision can gain legitimacy. "The judgment of what is public value is collectively built through deliberation involving elected and appointed government officials and key stakeholders. [...] Networks of deliberation and delivery are central features of this governance approach" (Stoker, 2006, p. 42). In the Weberian

bureaucracy this role was exclusive to elected politicians. In Moore's view, public managers demonstrate 'public value-seeking leadership', by acting in networks (Moore, 1995). Administrators are, thus, involved in the decision making process as they are relevant stakeholders, but their discretionary space should be constrained by politicians (Alford & O'Flynn, 2009).

Also in the implementation of policies, the network approach is emphasized. Organizations are increasingly dependent on each other for carrying out their tasks as societies are become more complex (Castells, 2000; Stoker, 2006). Information is spread among different stakeholders. Therefore, inclusion of these different stakeholders will ensure better decision making as more knowledge is available to policy makers (McDermott, 2010). Client and contractors, thereby, become partners rather than that the government acts as a sponsor, making an approach possible that focuses on challenges and change, rather than permanence and stability, such as in traditional bureaucracies (Stoker, 2006). Denhardt & Denhardt (2000) also emphasize the responsibility of the government in being serviceable and empowering, to enable private parties and citizens to better carry out their activities. The government should, in their vision, take on a role as facilitator, instead of a steering role, as emphasized by Osborne & Gaebler (1992).

Although some claim that governance in networks may lead to a 'hollowing out of the state' (Milward & Provan, 2000), others consider government to still play an important role in networks of decision making and policy implementation. Remaining able to steer and control in these networks, however, requires different strategies (Poulsen, 2009). "Networked governance [...] requires the state to steer society in new ways through the development of complex networks and the rise of more bottom-up approaches to decision making" (Stoker, 2006, p. 41). Furthermore, the need for more coordination supported by the use of IT has recently gained greater attention (Dunleavy et al., 2005; Stoker, 2006). Thus, a second objective for PVM is to develop ways to coordinate action within networks.

Joined-up, integrated service delivery

Integrated service delivery can be seen as the element of PVM most strongly contradicting NPM, by overcoming the disaggregation of government tasks by "reintegration of government into more coherent public sector or government-wide processes" (Dunleavy et al., 2005, p. 470). Services are provided by the government using a holistic approach (Bourgon, 2007), when multiple government organizations or levels of government are involved. This is closely related to the 'joined-up government' (JUG) (6, 2004) and 'whole-of-government' approaches (6, 2004; Christensen & Laegreid, 2007). These approaches also developed as a reaction to the management paradigms under the flag of NPM that strongly focused on efficiency and customer satisfaction (Dunleavy et al., 2005), thereby also realizing fragmentation of government services.

JUG is defined as the "consistency between the organizational arrangements of programs, policies, or agencies, which may enable them to collaborate" (6, 2004, p. 106). It "was presented as the opposite of "departmentalism", tunnel vision, and "vertical silo's". It denotes the aspiration to achieve horizontal and vertical coordination in order to eliminate situations in which different policies undermine each other" (Christensen & Laegreid, 2007, p. 1060). Although NPM ensured that, in contrast to the Weberian bureaucracy, customers became the focus of attention again, the clients' wishes were often interpreted by the bureaucrats, to be able to deliver services in an efficient manner

through fragmented activities. While NPM was strongly client-centered, the disaggregation of tasks meant that, in practice, citizens often had to go to multiple organizations to get a specific service.

Similarly, the related whole-of-government approach is about adopting strategies of coordination and integration to overcome fragmentation of government (Christensen & Laegreid, 2007). While NPM was mainly concerned with vertical coordination by performance management, whole-of-Government is concerned with horizontal coordination overcoming “fragmentation, self-centered authorities, and a lack of cooperation and coordination” (Christensen & Laegreid, 2007, p. 1060). It is expected that the whole-of-government approach of focusing on better coordination and reducing duplications in business processes will become even more important in times of economic recession and government budget cuts (Ojo & Janowski, 2010). Goldfinch & Wallis (2010) emphasize that the whole-of-government approach is even more important in service delivery of difficult or irregular cases:

“This post-NPM agenda [...] includes a rejection of much of the agency theory inspired ‘agencification’ that led to smaller and sometimes numerous single purpose agencies, and instead a move towards a more integrated public service [...] embraced a more integrated and state-wide focus on policy, a focus on strategy and a move from just output reporting to focus on broader and longer-term ‘outcomes’, ‘managing for results’ and ‘whole-of-government’ [...], particularly in the case of ‘wicked issues’ that fall between agency boundaries, and connections across boundaries between agencies, between the center and local government agencies, and between the public and private sector (Goldfinch & Wallis, 2010, pp. 1105-1106).

A third objective for PVM is, thus, to join-up services and operations of government organizations.

Citizenship and participation

The fourth characteristic of PVM is a focus on citizenship and participation. Bourgon (2007) sees renewed citizenship as the starting point for modernizing the public sector. To create public value, citizens will need to be part of the process that determines what public value is. In order to have good input from citizens, they need to be well-informed (Benington, 2009). Citizenship in terms of PVM is, therefore, more than the aggregate of citizens’ preferences, as held by the NPM paradigm (Goldfinch & Wallis, 2010; Smith & Huntsman, 1997). Citizens are “a member of a social and political community including rights and responsibilities” (Bourgon, 2007, p. 17). They have to “look beyond self-interest to the larger public interest, adopting a broader and longer-term perspective that requires a knowledge of public affairs and also a sense of belonging, a concern for the whole and a moral bond with the community” (Denhardt & Denhardt, 2000, p. 552).

The most important role of the public official is to help citizens articulate and meet their shared interests (Denhardt & Denhardt, 2000). “[P]ublic administrators should focus on their responsibility to *serve and empower citizens* as they manage public organizations and implement public policy” (Denhardt & Denhardt, 2000, p. 549, emphasis in original). Public value “often depends upon processes of co-creation with citizens and users at the front-line [...] which requires the creation of a well-informed “public” with the consciousness and the capability to engage actively in this kind of democratic dialogue” (Benington, 2009, p. 232). “[I]nformation and communication technologies are opening up opportunities for these new forms of networked

governance and public service to provide more integrated tailor-made services to diverse groups of citizens and local communities” (Benington, 2009, p. 245).

There seems to be a mutual reinforcing effect in this. While citizens being able to look beyond their own interests is essential to PVM, they will have to trust their government first (Pollitt, 2007). At the same time, a focus of civil servants in empowering citizens and in letting citizens participate in decision making processes, is likely to have a positive effect on the development of citizenship, in which citizens will feel like they ‘own’ the government. Participation can thus both follow as well as cause a sense of citizenship. PVM, thus, requires a fundamental change in the attitude of both citizens and civil servants. Citizens are expected to behave as informed shareholders, while administrators are expected to behave as value-creators in networks. A fourth objective is to realize this change in attitude. As the former is very difficult to influence, this challenge will be left out of the analysis, but the latter can – to a certain extent – be influenced by governments.

Public accountability and transparency

The final characteristic is a focus on transparency and on newer forms of accountability. The idea behind the increased focus on transparency is that information that is maintained by a government is “a national asset” (McDermott, 2010, p. 401). Transparency is also central to the idea of ‘open government’, announced by the President of the United States, Barack Obama, on his first day in office (McDermott, 2010). Open government has clear links with PVM, as its other central dimensions are coordination/joining up and participation of citizens (McDermott, 2010). IT is usually seen to have an important role in making governments more transparent (Meijer, 2009).

Transparency is increasingly seen as a crucial factor for governments in being accountable by making government actions visible to citizens. Accountability has many different forms (Gortmaker, Janssen & Wagenaar, 2005; Haque, 2000; Michels & Meijer, 2008; Monfardini, 2010; Poulsen, 2009; Roberts, 2002; Stoker, 2006). Generally, it can be defined as “explanation and justification of actions and decisions; that is, the actor who is accountable furnishes information about what s/he is doing, how and why, while at the same time somehow offering the party to whom s/he is accountable, opportunity to respond” (Michels & Meijer, 2008, p. 168). In the Weberian bureaucracy this mainly meant fiscal or regulatory accountability (probity) (Stoker, 2006), which is also called procedure accountability (Poulsen, 2009). This means that bureaucrats do not have to account for the outcomes of their actions much, as long as they follow strict procedures and fiscal rules.

Within the NPM-paradigm focus shifted for the first time to the results of government action. By giving public managers the right targets and let them operate in a competitive environment, they are supposed to be efficient as well as accountable. Thus, the type of accountability that became more important is efficiency accountability (i.e. value for money) (Stoker, 2006). This meant that public managers were being held accountable for following procedures as well as becoming responsible for achieving output targets (that needed to be in line with political objectives) (Denhardt & Denhardt, 2000). This focus on results remains within PVM, but again, also newer forms of accountability emerge, in addition to the existing forms (Haque, 2000). “[T]he transition from government to governance corresponds to a change in the interpretation of administrative accountability” (Poulsen, 2009, p. 117). Now focus shifts towards program accountability (achievement of desired outcomes) (Stoker, 2006).

For public value delivery, governments are responsive to citizens on the basis of the 'overall performance indicators' of society (Bourgon, 2007). These are, however, not formed in a vacuum, but in dialogue. "Accountability [within PVM] is achieved by negotiated goal setting and oversight" (Stoker, 2006, p. 52). Because of decision-making and service delivery in networks, accountability can almost never be traced to one person or organization (Stoker, 2006). This requires forms of accountability that are more horizontally oriented (Michels & Meijer, 2008). Besides that it is difficult to define the outcomes to which the public sector can be held accountable, also dilemma's occur between procedure and program accountability (Poulsen, 2009). The problem is that multiple accountability relationships exist next to each other, often overlapping each other (Roberts, 2002). "[A]lthough new modes of governance have been introduced, and new interpretations of accountability have become more and more comprehensive, neither conventional modes of governance nor older interpretations of accountability have disappeared. Thus what we see is a co-existence of competing traditions of governance, and thereby different and sometimes contradictory interpretations of administrative accountability, which, for the individual civil servant, create potential dilemmas" (Poulsen, 2009, p. 117).

The final objective is, thus, to organize accountability in new ways by ensuring that governments become more responsive and transparent to citizens. In governance, the civil service also takes on a new role, more focused on policy making, which is not exclusive to politicians any longer, as it is in the Weberian world view (Poulsen, 2009). It is likely that the traditional roles of public managers, that were already changing under influence of the NPM paradigm to focusing on output, will need to shift to focusing on outcome. Following Haque (1994), in this study this will be named the 'public accountability' of public managers.

Criticism of PVM

Although PVM has not been around long enough to be able to fully determine its consequences, some initial concerns have been raised. The nature of PVM has been questioned (Alford & O'Flynn, 2009), as well as its general applicability (Lonsdale, 2007; Pochard, 2007; Pollitt, 2007). Furthermore, questions have been raised on the way in which equity will be realized (Stoker, 2006), and more practical, the implementation in practice (Christensen & Laegreid, 2007). Finally, this section will discuss briefly how much PVM is actually different from NPM. These concerns will be briefly discussed in this section.

First of all the question remains whether PVM is an empirical theory or a normative prescription (Alford & O'Flynn, 2009). According to Moore (1995), PVM – like NPM – is both. Like the Weberian bureaucracy and NPM, it promotes a normative set of values, but it also represents an empirical account of changes that can be seen to take place world-wide. Alford & O'Flynn (2009), subsequently, list four approaches to public value: public value as a paradigm (a shift in thinking about public sector operations), public value as a rhetoric (designed to protect interests of public managers), public value as a narrative (a description of the phenomenon to create legitimacy), and public value as a perspective on performance (a new way of measuring outcomes). Goldfinch & Wallis (2010) have described some of the consequences of these different perspectives of PVM. They describe that a narrative is often used to serve particular interests, for example to 'win people over' for the normative aspect of the paradigm (Goldfinch & Wallis, 2010). A difficulty is, however, that these different perspectives are currently used interchangeably. While this study recognizes its different uses, it is specifically

addressing the empirical evidence. Therefore, four core objectives have been distilled that will be looked into in practice.

Secondly, some question the applicability of PVM. These authors emphasize that PVM, is only relevant to a specific environment (Lonsdale, 2007; Pochard, 2007; Pollitt, 2007). Lonsdale (2007) and Pochard (2007) assert that the possibilities for social responsibility and citizenship only emerge in times when the basics of a working state are realized. Only when fundamental elements, such as safety and security are realized for its citizens, there is room for issues the addressed in PVM (Lonsdale, 2007). PVM is formulated from the perspective of government as a response to citizens' quasi-daily needs, but a government's duty goes beyond that: it needs to ensure safety and security, and that "this role does not necessarily rely on the same character of public administration as that providing direct service to the citizen [...] [but] must be able to act by employing fully its traditional prerogatives of a public power in terms of regulation, control and sanction" (Pochard, 2007, p. 28). According to the same reasoning, PVM is seen as only applicable to and useful for the rich and developed countries, "a theory for the fortunate few" (Pollitt, 2007, p. 40). Others, however, see in the elements related to 'good governance' also a role for the developing countries in which it can be applied to diminishing corruption (Bertot, Jaeger & Grimes, 2010).

A third concern that is raised is how to ensure equity. The thought behind questioning this, is that in case there is more room for discretion – as is implied in each of the four objectives of PVM, there is more room for not treating everyone equally. Thus, along with determining public value, accountability is cyclical and evaluation needs to be performed continuously, instead of pre-defining stringent targets and holding people accountable for these targets (Stoker, 2006). This needs to be part of the work of public managers (Moore, 1995). This is reinforced by the notion that accountability is measured against values negotiated in networks of stakeholders: "public value does appear to have a decidedly context-dependent character" (Stoker, 2006, p. 50). There is also a danger that civil servants may push both politicians and citizens to the sidelines, as policy formulation happens in networks and the best informed party may have most power. According to Stoker (2006), the key to solving this issue is to foster a strong public sector ethos among civil servants, not unlike the ethos that existed in Weberian bureaucracies.

A fourth concern raised is that it will be very difficult to implement PVM because of the inheritance of the Weberian silo's, that have been largely reinforced by NPM. This existence cannot be seen only as a sense of disaggregation, it is also a sign of maturity of organizations to have a division of labor and having specialized employees. Furthermore, unless targets for creating horizontal coordination are set to overcome fragmentation (Bannister, 2001), these targets will be difficult to become full-fledged instruments of public sector change. Christensen & Lægreid (2007) describe in their work on whole-of-governance that this may require a long-term bottom-up effort, rather than a top-down effort. In order to achieve its objectives, these challenges need to be addressed by PVM.

Finally, questions are raised on the relation between PVM and NPM. It remains unclear whether the two reform agendas are fundamentally different or that PVM represents effectively a new phase in the shift from government to governance that started under NPM (Wise, 2002). While PVM positions itself as a reaction to NPM, it is not conclusively argued that it represents an entirely new public reform paradigm. The main differences between the two are the focus on disaggregation of activities and the creation of multiple agencies within NPM, and the focus on holistic service delivery and

joining-up services within PVM. But these aspects of PVM can also be seen as corrections or repairs of some of the less successful elements of NPM while retaining its core elements of becoming more responsive to citizens. Rather than encouraging public officials to be more entrepreneurial they now focus on public value. As such, PVM can be regarded as a continuum of NPM, in which public sector reform to make government more responsive and effective remains central, but is complemented by a call for greater transparency and accountability (Lonsdale, 2007).

This argument is supported by NPM having a much larger and much more comprehensive body of literature than PVM. While NPM has resulted in world-wide public sector reform programs, this is not observed regarding to PVM. As such, it can be concluded that the main shift within the public sector remains that from the vertical organization of government to horizontal governance (Castells, 2000; Klijn, 2008), and that PVM may rather present an evolution of NPM than an actual disruption. This is in line with the notion of t-government evolving from e-government. For the analytical purpose of deriving the objectives of IT-induced transformation, they are presented as different reform agendas, but it will become clear in the future whether they are actually more in line with each other or that PVM will grow into a different paradigm.

2.1.5 Objectives of IT-induced transformation

This section used literature on public sector reform to identify the objectives of IT-induced transformation. By looking at the history of public sector reform and its aims, four objectives for IT-induced transformation to achieve are formulated:

1. The **creation of public value** for citizens directly or by increasing the value of public administration, through ongoing assessment of the value to be realized;
2. Policy formation and execution through **collaboration in networks**, that may include public organizations as well as private parties;
3. Setting up **integrated service delivery** and **joined-up government** through the coordination of activities of different departments and organizations; and
4. Realizing **public accountability**, for a large part by making public administrations more transparent.

As described in chapter 1, these objectives closely resemble the objectives for t-government. Literature on public sector reform is, however, much less specific on how to achieve those objectives. Therefore, the next section presents literature on leveraging IT from the field of Information Systems to identify mechanisms that are undertaken by governments aiming for IT-induced transformation.

2.2 Leveraging information systems

The promise of IT as a factor in transforming organizations has been made from the start of the computer age (see, for instance, Leavitt & Whisler, 1958), but IT in itself was not found to result in real transformation of public administration (Danziger & Andersen, 2002; Fountain, 2001a; Kraemer & King, 2006). Thus, organizations started to look for additional drivers to realize the promises of IT-induced transformation. In the literature on IT-enabled transformation in the private sector, organizational changes were found to leverage IT (Brynjolfsson & Hitt, 2000; Gregor et al., 2006; Venkatraman, 1994). As they were considered successful in businesses, these practices were followed

by the public sector (Weerakkody & Dhillon, 2008). Foley & Alonso (2009) found that transformational IT-projects, which are IT-projects accompanied by organizational changes leveraging IT, to be up to three times more beneficial for governments and citizens than other IT-projects.

This section discusses, based on literature, organizational changes that aim to leverage IT to identify transformational mechanisms. This overview does not aim to give an exhaustive overview of all mechanisms that may contribute to IT-induced transformation, but it represents an overview of the mechanisms that are commonly found in the literature on leveraging IT in order to realize transformation.¹ As IT-induced transformation was defined as multi-level and multi-dimensional change, these mechanisms are found on multiple organizational layers (Gil-Garcia, Chengalur-Smith & Duchessi, 2007; Gil-Garcia & Pardo, 2005; Veenstra et al., 2011). This section identifies mechanisms of IT-induced transformation on four layers: the institutional and governance level, the organizational level, the business process level, and the technology level.

2.2.1 Institutional and governance layer

The first layer on which transformational mechanisms are deployed is the institutional and governance layer. This layer transcends individual organizations by providing the context in which IT-induced transformation takes place. The importance of political, legal and governance aspects to leverage the value of IT in the public sector has been widely emphasised (Fountain, 2001a; Gascó, 2003). Moreover, others point out that although institutional and governance aspects are often hard for individual organizations to influence directly, they may present limitations to changing the public sector (see, for example, Gil-Garcia et al., 2007; Gil-Garcia & Pardo, 2005; Veenstra et al., 2011). Four categories of governance barriers to integrated service delivery can be identified: political barriers related to visibility, structural barriers related to interjurisdictional tensions, operational/managerial barriers related to interoperability, and cultural barriers (Kernaghan, 2005). As a lack of proper governance presents such a major impeding factor to realizing IT-induced transformation (Liu & Hwang, 2003), this section looks into the role of governance.

Governance

Governance is a very broad term, referring to multiple – interrelated – phenomena. Governance in its broadest sense refers to all process and actions that take place within public administration and between public administrations and others (Klijn, 2008). More specifically, governance refers to the notion that the role of public administration in society is changing: instead of a centrist, hierarchically oriented government, public administrations need to take on a coordinating role within a network of parties to be able to deal with the complexities of today's society (Castells, 2000). In this sense, governance thus – confusingly – refers to a specific form of governance in its broadest meaning, which sees governments not as the main stakeholder in processes of governance but rather as 'just one stakeholder' aiming to influence the outcome of these processes. Hence, in the literature many referrals to the shift 'from government to governance' can be found (Hutter & Jones, 2007; Jessop, 2002; Klijn, 2008).

¹ This section is based on a paper published by the author (Veenstra et al., 2011).

Central to this shift is the notion that governments are no longer the only, nor the major, steering party within a network. To create public value, governance thus refers to the coordination of the actions of different parties, without the necessity of a hierarchically dominant party. “[G]overnment refers to the idea of the state exercising coordination and steering through hierarchy, bureaucracy, laws, rules and detailed regulation. Governance, on the other hand, implies that the state comes to rely less on the conventional means of government and more on governance through networks, based on interdependence, negotiation and trust among a number of public and private actors involved in the governing of society” (Poulsen, 2009, p. 118). Outcomes of the actions within such a network takes place through interactions between the different parties (Koppenjan & Klijn, 2004). In table 2.2 the governance perspective is compared to the traditional government perspective.

Table 2.2: Government and governance perspective (based on Bharosa, Wijk, Janssen & Winne, forthcoming).

	Government	Governance
Realizing public value	Public administration	Multiple parties, through interaction
Process of regulation and control	Hierarchy: determining regulations and controlling compliance to norms	Network: coordination of norms

Besides this wider meaning of governance as a phenomenon, governance can also be seen to take place in a more specific context, such as an approach towards individual projects – or to IT in an organization (Huang, Zmud & Price, 2010; Liu & Hwang, 2003; Veenstra, Aagesen, Janssen & Krogstie, forthcoming; Weill & Ross, 2005). In this context, governance is the organization of the guidance of a project, to which different approaches can be distinguished. Two well-known approaches are an engineering, or project-oriented approach and a more ‘governance’, or process-oriented approach (Bekkers, 2007; Bellamy & Taylor, 1998; Bruijn, Heuvelhof & Veld, 1998). Some similarities can be observed with table 2.2, as the former can be seen as hierarchical command and control approach to a project, in which IT is considered to be value-free that can be managed in a planned manner (Bekkers, 2007), while the latter can be seen to take into account the horizontal character of a network of actors that need to be included in order to create a shared understanding (Bruijn et al., 1998; Koppenjan & Klijn, 2004).

Thus, governance in this study refers to an orientation of the government that allows coordination of activities within a network of actors that collaborate to achieve public values. Since this requires a fundamental overhaul of the public sector as a whole, individual organisations need to consider their position within this transformation and keep in mind the possibilities of integrating their activities with other public agencies (Veenstra et al., 2011). Several authors have concluded that for the type of transformation that is aimed for by IT-induced transformation, a governance approach is considered necessary to make the changes (Bekkers, 2007; Bellamy & Taylor, 1998). As IT-induced transformation can no longer be a change performed by a single organization, the inclusion of different stakeholders and their interests is of great

importance for realizing transformation (Scholl, 2005a). Therefore, a first transformational mechanism is the set-up of governance.

2.2.2 Organizational layer

On the organizational level, the second layer on which transformational mechanisms are identified, changes considered to leverage the value of IT are related to the formation of service delivery chains. To realize client-oriented service delivery it is necessary to break down the stovepipes that exist within governments (Bannister, 2001). Instead, services need to become the coordinating force of activities from different departments. Furthermore, to realize proper integrated service delivery, the service chains that emerge need go beyond the services delivered by individual organizations to include activities from multiple organizations (Veenstra & Janssen, 2011). As such, public service chains are formed within networks of government organizations that may also include private organizations if they contribute to the services to be delivered. Therefore, in this section the formation of service chains within (public) networks are looked into.

The formation of service delivery chains in networks of organizations

An important objective for public service delivery is to realize integrated service delivery. This is achieved when multiple organizations, each performing a specific part of the service delivery process, act in a coherent manner, which is perceived as integrated service delivery by customers (Veenstra & Janssen, 2011). “In the past it was common that the workflow was taken as a starting point for the organization of public service delivery. That proved ‘inefficient’ from a client’s perspective: clients were confronted with an organization they could not comprehend, with different departments and different civil servants for a single service and generally citizens were confronted with slow and compartmentalized service delivery” (Bekkers & Zouridis, 1999, p. 184). Enhancing the service delivering front office alone, however, does not achieve this kind of improved public services. Also the processes in the back office need to be attuned to serve the front end (Dhillon et al., 2008; Scholl, 2005a).

This leads to the formation of service chains within organizations that aim to integrate the actions performed by different departments. The concept of service chains to realize integrated service delivery is based on the concept of value chains (Porter, 1985), in which different actors perform a chain of activities. Products pass through all activities of the chain in order, and at each activity the product gains some value. The chain of activities gives the products more added value than the sum of the independent activity's value. This means that the vertically oriented, hierarchical structure of ‘siloes’ governmental departments needs to be transformed into a more network-oriented structure around these service chains (Bannister, 2001). And the development of these service chains does not stop at the border of organizations. Besides the formation of service delivery chains within government organisations, the integration of activities and joined-up service delivery extends to greater collaboration between organizations (Kamal, Weerakkody & Jones, 2009).

More collaboration is thus emerging within networks of organizations (Danziger & Andersen, 2002; Reddick, 2009). However, this is not happening without problems: there is “a dramatic failure of administrative bodies to co-operate. Instead of taking a joined-up approach to citizen service, parochial approaches still prevail in many countries. Each level of government, each local government competing with its

neighbors, and each agency stumbles forward into the information age without caring much about what the other do" (Lenk, 2002, p. 88). Others, too, see the lack of coordination between departments as a serious threat to the formation of service delivery chains (Ebrahim & Irani, 2005; Janssen & Cresswell, 2005). Therefore, in order to leverage IT, a change in the organizational structure is considered necessary: a horizontalization of the organization by creating a network structure (Gregor et al., 2006). Therefore, the second transformational mechanism is the formation of service chains within networks of organizations.

2.2.3 Business process layer

The third level of changes is the business process layer. "[A] significant component of the value of information technology is its ability to enable complementary organizational investments such as business processes and work practices" (Brynjolfsson & Hitt, 2000, pp. 24-25). Business processes are defined as "a collection of activities that takes one or more kinds of input and created an output that is of value to the customer" (Hammer & Champy, 1993, p. 35). The concept of a process can be traced back to Adam Smith, who was among the first to posit that a division of tasks increases productivity in his book *Wealth of Nations* (Kim & Ramkaran, 2004). As IT-induced transformation is concerned with governance within network structure in which multiple organizations collaborate, it will need "business processes that can be continuously optimized and expanded outside the enterprise and outside internal enterprise systems" (Dhillon et al., 2008, p. 164). This section looks into the notion of business process change.

Business process change

Arguably the aspect that is most central to t-government efforts is the redesign of business processes: "the objective of the transformational stage of e-government implies that process reengineering is needed to rethink the value propositions of the government and how they function in serving citizens more efficiently and effectively" (Dhillon et al., 2008, p. 165). And the need for process change goes beyond the delivery of integrated services (Veenstra et al., 2011). "Whilst the early e-government efforts focused on e-enabling front-office processes, now e-government is emphasizing the reengineering of back-office processes. These efforts are commonly branded as transformational stage e-government (or t-government)" (Dhillon et al., 2008, p. 162).

Business process change, or re-engineering, has been at the centre of the literature on leveraging IT for businesses (Hammer, 1990; Hammer & Champy, 1993). Business process re-engineering is defined as "the fundamental rethinking and radical redesign of business processes to achieve dramatic improvements in critical contemporary measures of performance such as cost, quality, service and speed" (Hammer & Champy, 1993, p. 32). Similarly, "process reengineering is needed to rethink the value propositions of the government and how they function in serving citizens more efficiently and effectively" (Weerakkody & Dhillon, 2008, p. 3). Generally, business process change engages in a redesign of business processes, similar to a clean-slate approach rather than an incremental evolution. Business process re-engineering is "an approach usually associated with the aggressive exploitation of information and communication technologies" (Bellamy & Taylor, 1996, p. 56). It can thus be seen as a form of second-order change (Scholl, 2005b).

Central elements of business process change are to organize around outcomes rather than tasks, have the administrators who use the output of the process perform it, and capture information once at its source (Kim & Ramkaran, 2004). The aim of these principles is instead of letting people carry out simple repetitive tasks, to let them re-use activities and information carried out by others and making decisions on the outcomes of processes by those who use the outcomes. This is to ensure optimal use and re-use of information. Changing business processes in this way thus means to have a look at how they currently work (Hammer & Champy, 1993) in order to define the core values of an organizations and optimize the work practices around this (Pralahad & Hamel, 1990).

An extensive process of business process change will need to take place before transformation can be realised (Dhillon et al., 2008; Scholl, 2005a). The changes in business processes include the set-up of shared service centres in which several departments integrate certain activities that are common to more than one business process (Janssen & Joha, 2006). To realize IT-induced transformation, government organizations will need to integrate or create interoperability in their back offices (Dhillon et al., 2008) and break down their silo structure (Bannister, 2001; Dhillon et al., 2008).

However, often practice turns out to be much more resistant to change than expected thereby proving that reality is much more stubborn than those advocating business process change state (McNulty, 2003; Sarker & Lee, 1999). Failure rates among these radical change processes are considered high (McNulty, 2003; Sarker & Lee, 1999). Among the reasons for this high failure rate that are cited are the strong focus on IT as a 'magic bullet' (Markus & Benjamin, 1997), and a lack of communication and ability to involve people in the change process (Markus & Benjamin, 1997; Sarker & Lee, 1999; Scholl, 2005a). Although these high failure rates are reported, business process change is still often used by those aiming to undertake organizational transformation, also in the public sector.

Scholl (2005a) sees in the more inclusive approach of the many stakeholders in government business process change an opportunity for a higher success rate in the public sector. "Although e-gov [business process change] BPC projects seem to follow patterns and employ techniques similar to their private sector counterparts, the different principles of governance in the public sector make e-gov BPC projects intrinsically more complex. Due to the distribution of powers, e-gov BPC projects seemingly necessitate far higher degrees of consensus among salient stakeholders as well as pre-negotiated outcomes than is typical in the private sector. Distributed control and accountability, however, comes with more distributed sharing of burden also leading to more ownership in process, project, and outcome" (Scholl, 2005a, p. 44). The third transformational mechanism is thus the undertaking of business process change.

2.2.4 Technology layer

The last layer that is looked into for identification of transformational mechanisms is the technology layer. An overview of technology involved in t-government projects was provided in chapter 1. Additional to these trends in distributive computing and service oriented architectures, another aspect of IT-induced transformation can be identified that supports the trend interconnecting distributed services: enterprise architecture. Enterprise architectures are used to create an overview of current information systems, to designed the desired state of information systems and can comprise also elements of governance on how to get from the current to the desired state. Therefore, enterprise

architectures are increasingly seen as a method for managing IT-induced transformation for realizing interoperability and coherence between activities (Jarke, Loucopoulos, Lyytinen, Mylopoulos & Robinson, 2011; Schmidt & Buxmann, 2011). Therefore, this section looks into enterprise architecture.

Enterprise architecture

While enterprise architecture (EA) is merely a “codified understanding covering elements ranging from organization till infrastructure” (Janssen, 2012, p. 24), it is increasingly seen as a method for managing change and transformation: “EA planning is part of a reform paradigm in e-government where IS is perceived a central vehicle in administrative reforms and transformation” (Hjort-Madsen, 2007, p. 334). Enterprise architecture is traditionally defined by IEEE Computer Society (2000) as “the fundamental organization of a system embodied by its components, their relationships to each other and to the environment and the principles guiding its design and evolution” (Lankhorst & al., 2009). While it has many different purposes it is generally seen as a blueprint of an organization, including its business processes and information technology showing the relationships between all the different elements and its environment.

Traditionally, the purpose of EA is to effectively align the strategies of enterprises with their business processes and the coordination of their resources (Ebrahim & Irani, 2005; Zachman, 1987). Enterprise architectures define and interrelate data, hardware, software, and communication resources, as well as the supporting organization required to maintain the overall physical structure required by the architecture (Richardson, Jackson & Dickson, 1990; Zachman, 1987). For this reason, similarities have been observed between architectures and city planning, which has often led to the use of the blueprint metaphor for enterprise architecture (Schmidt & Buxmann, 2011). To guide these developments in practice, many different models have been proposed, such as the Zachman framework (Zachman, 1987) and The Open Group Architecture Framework (TOGAF) (Group, 2009).

Besides their traditional functions of realizing interoperability and creating alignment between business and IT (Doucet, Gotze, Saha & Bernard, 2008; Henderson & Venkatraman, 1993; Luftman, 2004), EA is increasingly seen as a way to stabilize and manage the ongoing development of IT (Jarke et al., 2011; Schmidt & Buxmann, 2011), as it results in more flexible information technology and efficiency. “IT architecture modularity helps sustain IT alignment by increasing IT agility, and [...] decentralization of IT governance strengthens this relationship” (Tiwana & Konsynski, 2010, p. 288).

In a survey, 75% of respondents indicated that they would like to see enterprise architecture as a means for enabling transformation (Janssen, 2012). The existence of isolated, overlapping in function and content, highly fragmented, and unrelated computerized applications have led to ‘isolated islands of technology’ (Peristeras & Tarabanis, 2000). Architecture is an instrument that can be used to guide IT-induced transformation and ensure that the individual efforts of departments and organizations are coordinated. The fourth, and final, transformational mechanism is thus the deployment of enterprise architecture to manage IT development.

2.2.5 Mechanisms of IT-induced transformation

This section has identified four transformational mechanisms of IT-induced transformation on different layers: the institutional and governance level, the

organizational level, the business process level and the technology. Besides, digitizing current operations, IT-induced transformation, includes the following transformational mechanisms:

1. The set-up of **governance** in a process-oriented manner;
2. The formation of **service delivery chains** within networks of organizations;
3. **Business process change** of the back office of organisations; and
4. **Enterprise architecture** for managing IT developments.

As described in the previous chapter, these mechanisms are usually present in t-government projects and programs. While they do not represent the only (possible) aspects of t-government efforts, they are the aspects that are most widely used for realizing transformation. Now both the transformational objectives and mechanisms have been defined, IT-induced transformation can be operationalized in the next section.

2.3 Conceptualizing IT-induced transformation

IT-induced transformation for exploring the occurrence and outcomes of t-government, has not been sufficiently defined and operationalized in the literature (see chapter 1). Therefore, this chapter aimed to operationalize the first building block of the model of IT-induced transformation: its objectives and mechanisms. It does not mean to set all efforts of IT-induced transformation in stone, but rather to highlight the main common characteristics. Based on the literature on public sector reform from the field of PA, and on leveraging IT from the field of IS, this operationalization of IT-induced transformation is visualized in figure 2.1.

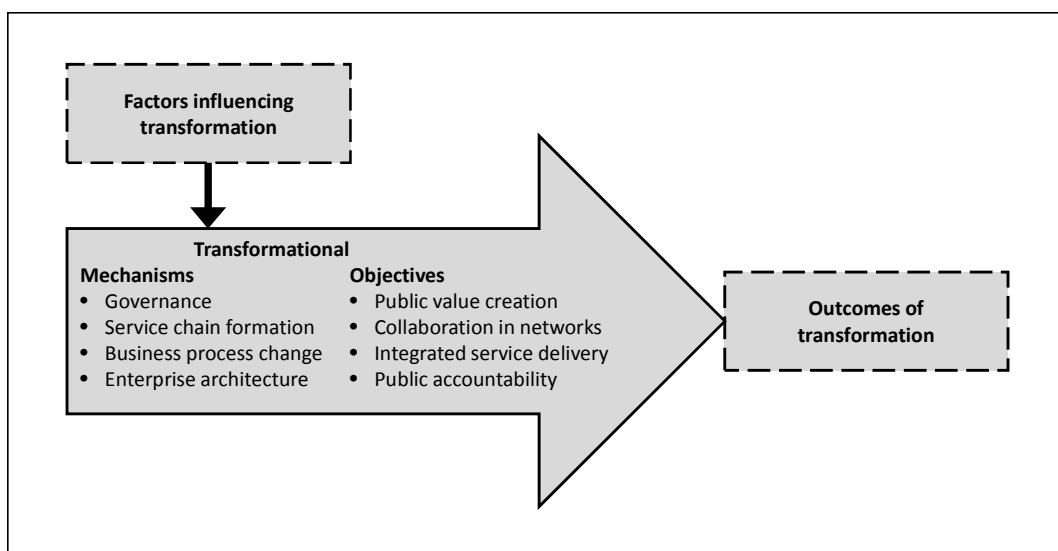

Figure 2.1: Model of IT-induced transformation, operationalized.

Figure 2.1 is an elaboration of the conceptual model of this study presented in chapter 1. This chapter shows that conceptualizing IT-induced transformation using the literature on PVM and on mechanisms leveraging IT is useful. Both the objectives and mechanisms are often mentioned in connection to t-government (Bannister & Connolly, 2011a,

2011c; Chatfield, 2009; Dawes, 2008; Gascó, 2003; Irani et al., 2007; Veenstra et al., 2011). IT-induced transformation is related to the wider shift within public administration that holds that public organizations increasingly need to rely on their role within networks of stakeholders to influence the outcomes of processes. In all these objectives and mechanisms, the aim for a shift from a vertical command-and-control structure to a horizontal governance and network structure is clear. Generally, IT-induced transformation can thus be seen to fit in the wider shift from government to governance (UNPAN, 2008).

From this overview of objectives and mechanisms also a discrepancy between the more reform-oriented objectives and the engineered changes that are aimed for by the transformational mechanisms becomes clear. Literature on transformation thus encompasses both type of changes, depending on the body of literature. The question is however whether these engineered changes will lead to reform-related changes in practice. To further explore this, in the next chapter, the process of transformation will be taken a closer look at. In chapter 3 two theoretical lenses are presented that help to investigate the process of IT-induced transformation to explore the occurrence of the transformational objectives and the role of the transformational mechanisms in realizing these objectives.

3 Theoretical perspectives on transformation

It is the interplay between different perspectives that helps one gain a more comprehensive understanding of organizational life (Ven & Poole, 1995).

IT-induced transformation requires a long-term change process. Besides identifying the mechanisms, objectives, and outcomes of transformation, it is also necessary to understand the process of transformation by investigating the factors that influence its outcomes. Using different theoretical strands, two perspectives are developed for exploring factors that influence the occurrence of transformation. In the literature a wide variety of theories on organizational change and transformation exists, emphasizing different drivers and aspects of change. This chapter derives two theoretical perspectives for looking at change: from contingency theory and structuration theory. Contingency theory assumes that the structure of organizations fits the circumstances in which it operates and changes when these circumstances change (Galbraith, 1973). Structuration theory holds that phenomena are constituted through the mutually influential forces of structure and agency (Giddens, 1984). The chapter will be concluded with how these perspectives can be used for the empirical investigation of IT-induced transformation.

3.1 Contingency theory

A main conception of change within organization theory is that it occurs in reaction to an ever-changing environment (Schwarz & Huber, 2008) in order to realize better outcomes or performance. Depending on certain factors (*contingencies*), organizations adapt and organize themselves to achieve the best possible outcomes given these external factors. Contingency theory can thus be seen as a meta-theory assuming that changes in the environment impact internal organizations. It is used in many studies for identifying factors that impact organizational characteristics, such as structure (Galbraith, 1973), decision-making (Lawrence & Lorsch, 1967), and the workforce (Woodward, 1965). More recently, contingency theory has been applied and adapted to the field of Information Systems (IS) to account for organizational changes such as the emergence of networks (Castells, 2000) as a result of the adoption and use of information technology. The changes that were found include a decrease of the transaction costs between different parts (Malone, Yates & Benjamin, 1987), and the realization of fit between business and IT (Henderson & Venkatraman, 1999). This section first discusses the 'traditional' contingencies impacting organizational structure before it moves on to discuss the role of contingency theory in the IS field. Subsequently, a contingency perspective on IT-induced transformation is formulated.

3.1.1 Contingencies impacting organizational structure

Contingency theory assumes that there is no universal optimal way of organizing; the structure of an organization fits the circumstances in which it operates and changes when these circumstances change to realize optimal performance (Galbraith, 1973). Before its emergence, organization theory was dominated by the notion that there is an optimal way of organizing: the bureaucracy (Heugens, 2005; Lounsbury & Carberry, 2005). In the 1960s, contingency theory emerged to account for differences between organizations when the environment was found to impact the internal organization (Lawrence & Lorsch, 1967). Contingency theorists consider organizations as having to deal with external uncertainty, while simultaneously imposing internal rationality to coordinate action (Thompson, 1967). Besides 'external' contingencies such as the complexity and uncertainty of the environment, 'internal' contingencies such as the nature of the work performed and the technology used were seen to lead to different ways of organizing (Woodward, 1965). Contingencies, however, are not seen to lead to an infinite number of different organizational forms, but rather a few archetypical organizational configurations emerge given a specific situation (Mintzberg, 1983). This section first discusses the 'internal' and 'external' contingencies and their impact on organization structure. Then, after discussing several organizational configurations and their main characteristics, a configuration for IT-induced transformation is formulated.

Internal contingencies: tasks and technology

Internal contingencies are concerned with the nature of the work performed, characterized by the type of tasks performed in an organization and the technology that is deployed, impacts organizations (Gupta, Dirsmith & Fogarty, 1994). Perrow (1967) and Thompson (1967) found the type of tasks that are performed to be contingent on organizational structure. Perrow (1967) investigated the frequency and the complexity of the work performed and found that routine tasks lead to specialization, formalization, hierarchy, and centralized power in organizations, whereas non-routine tasks are better performed under the opposite conditions. He also introduced the notion of 'fit', which is inherent to contingency theory, referring to the degree the tasks performed and characteristics of the organization match: the better the fit, the better the performance (Perrow, 1967).

Thompson (1967) distinguishes three attributes of the work performed: task variability, task difficulty, and task interdependence. Organizations perform a variety of tasks, and how these tasks are linked is therefore of influence on the organizational structure. He discerns three basic forms of interdependence: pooled (interdependence is minimal but different parts do contribute to the overall goal), sequential (the output of one part is the input for the next), and reciprocal (the outputs of the parts are of consequence to each other) (Thompson, 1967). The degree of coordination necessary to perform this tasks is larger for each form of interdependence; meaning that pooled interdependence needs least and reciprocal interdependence most coordination. Since coordination of activities is a central characteristic of organizations, all of these characteristics were found to impact how organizations are structured.

The use of technology in organizations is also found to impact the organizational structure (Pfeffer & Leblebici, 1977; Thompson, 1967; Woodward, 1965). The studies on the effect of technology on organizations undertaken in the 1960s looked into the effects of the production technology. Thompson (1967) distinguishes between long-linked technology (such as in manufacturing), mediating technology (that link different parts or

organizations), and intensive technology (that require feedback from the object it is used upon) functions. These technology functions are thus linked to the way work is organized and are likely to have a 'fit' with the nature of the work. Repetitive tasks with sequential interdependence are likely performed using long-linked technology, while mediating technology is likely supporting reciprocal interdependence. Thompson's work thus shows that contingencies often coincide in fixed pairs.

Woodward (1965) found the choice for a specific production technology to determine the span of control, the centralization of authority, and the formalization of rules and procedures. She discovered that through increased use of technology, organizations change from non-hierarchical to hierarchical. Again, this change coincides with a change in the nature of the work performed: from simple customized products to batches of similar products. But when organizations start using even more technology, they move back to being non-hierarchical, depending on the volume of technology that is used and the intensity with which it is used (Woodward, 1965). This change is related to a shift to producing of volumes, rather than batches. She thus found relations between technology, organization structure, and performance. Similar to Perrow (1967) who found that there needs to be a fit between organizational structure and the nature of the tasks performed, Woodward (1965) introduced the idea of 'alignment': organizational structure and technological requirements need to match for better performance.

External contingencies: uncertainty and complexity of the environment

Lawrence & Lorsch (1967) and Thompson (1967) focus on how the environment impacts the structure of organizations. The best-known external contingencies are the uncertainty and complexity of the environment (Gupta et al., 1994; Pfeffer & Leblebici, 1977). The uncertainty in which organizations operate impacts the internal development of organizations: the more organizations are faced with uncertainty, the more organically they organized themselves (Mintzberg, 1983). And the more homogeneous and stable the environment, the more formalized and hierarchical the form (Lawrence & Lorsch, 1967).

The uncertainty of the environment thus impacts the degree of formalization of the organization (Mintzberg, 1983). When the environment of an organization is stable, organizations tend to organize themselves using command-and-control accountability resulting in a more hierarchical organizational form with well-defined processes, but in a very uncertain environment organizations tend to use informal coordination mechanisms. Galbraith (1973) identified three characteristics of the structure of an organization under uncertainty: rules and procedures, decentralization of decision making, and professionalization of the work force. He found that organizations rather make stricter rules accompanied by decentralization of decision making and a more professional workforce when they are faced with an uncertain environment.

While the uncertainty impacts the formalization of processes, the complexity of the environment has an impact on the decentralization of the organizational structure (Mintzberg, 1983). This means that a complex requirement needs a more specialized and higher educated workforce to make decisions in a complex context, taking into account may different aspects. Mintzberg (1983), therefore, sees four different types organizations to emerge according to these two parameters of complexity and uncertainty. Thus, two different types of organic and two types of bureaucratic organizations emerge. In a stable and simple environment a centralized decision-making structure can be found with formalized processes. In an uncertain and simple environment organic organizations with clear command-and-control lines are likely be

found. Organizations in a stable and complex environment are often organized as decentralized bureaucracies. And uncertainty and complexity are seen to impact organizations to emerge as organic organizations with decentralized decision-making processes.

The environment can thus be seen as contingent on organizational structure: the greater the complexity and uncertainty, the more organizations formulate rules and procedures leaving decision making to the lower levels in the hierarchy: the professionals. As the uncertainty is only seen to increase over time, the shift from a hierarchical organizational structure to a more decentralized structure is seen to take place also in between organizations. As a result of an increasingly complex and interwoven society, the network structure is often considered to be the optimal organizational form of today (Castells, 2000).

Organizational configurations

The previous sections showed that contingencies are likely to coincide in fixed patterns. Henry Mintzberg (1983) therefore refutes that it is possible to mix and match organizational characteristics in an endless number of ways and rather sees several organizational configurations to emerge depending on internal and external contingencies. He thus sees organizational forms to emerge depending on their contingencies as well as their organizational characteristics: an effective organizational structure requires both contingencies and organizational characteristics and the organizational characteristics among each other to be attuned (Mintzberg, 1983).

The central characteristic of these organizational configurations is their main coordinating mechanism, coordinating the work of the different parts within an organization (Mintzberg, 1983). Where Weber (1972 [1920]) identified *authority structure* as the main element characterizing bureaucracies, Mintzberg (1983) defines four – and later adding a fifth – more coordinating mechanisms for his organizational configurations (Mathesen, 2009). The coordination mechanisms form a continuum of horizontal coordination, with direct authority is most strongly centralizing, and informal coordination least. Furthermore, two other characteristics are seen to be important to attune to the coordination mechanism: the most important part of the organization (the core of the organization), and the decentralization of decision-making. His six archetypical configurations are briefly introduced.

Informal coordination is used in very simple as well as in very complex organizations. In small and very simple organizations everyone knows each other and can directly communicate to synchronize their actions. In very complex organizations, on the other hand, it is not be possible to standardize coordination in any way. In smaller, but not simple, organizations *direct management* is used to coordinate actions. “Direct supervision involves having one individual take responsibility for the work of others” (Mathesen, 2009, p. 1149). And as soon as organizations grow further, standardization (of tasks, outputs, or abilities) is used to coordinate actions (Mintzberg, 1983). *Task standardization* makes sure that the content of every step of the work processes are pre-defined. An example is the different steps of a production process that are carried out many times a day. *Output standardization* takes place when the output of a certain task is standardized. *Standardization of ability* is often seen in organizations with a highly educated workforce, such as in a legal practice or in a hospital where doctors know how to make decisions and collaborate based on their education. Later on, Mintzberg added a sixth coordination mechanism (*standardization of norms*), which attributes most

importance to an ideology in an organization that acts as an all-pervasive force for employees (Mathesen, 2009).

The coordinating mechanisms are not independent on other organizational characteristics, such as the professionalization of the workforce. For example, direct management usually takes place in organizations where the strategic management layer is most important. Task standardization can often be found in large organizations where routine tasks are performed and where the planning layer of the organization (designing the tasks and the work of the workforce) is most important (*machine bureaucracies*). In organizations where abilities are standardized and the workforce is the most important part, professionals have a large degree of autonomy in determining how they carry out their work (*professional bureaucracy*). And in complex organizations with a highly educated workforce, often simple coordination is used (*adhococracy*). Mintzberg, thus, concluded that alignment is necessary both in between the internal and between the internal and the external factors to realize a high performance in organizations (Mintzberg, 1983).

The emergence of a networked configuration

The previous sections introduced three important contingencies – the type of tasks performed, the technology used, and the uncertainty of the environment, and the notion of organizational configurations. This section looks at the impact of information technology on these contingencies to identify expected outcomes – and an organizational configuration that may emerge as a result of the introduction of information technology in organizations: a network. First the impact of IT on organization and the work will be investigated, followed by the impact on the environment. Finally, an outline of the network configuration will be sketched.

Pfeffer & Leblebici (1977) applied Woodward's ideas to the use of information technology in organizations and also found that the use of more technology leads to the formation of hierarchical structures. "The more extensive the information technology, the more the number of departments, and the more levels in the organizational hierarchy there were. [...] [I]t was found that information technology was positively related to the number of levels in the hierarchy, the number of departments, the amount of decentralization, and was negatively related to the amount of formalization of decision rules" (Pfeffer & Leblebici, 1977, p. 258). But while Pfeffer & Leblebici (1977) found decentralization to take place, Leavitt & Whisler (1958) predicted a centralization of decision making as a result of the increased use of information technology, with top managers taking on a larger proportion of the strategic and creative functions.

Leavitt & Whisler (1958) identified three aspects that determine the degree to which jobs become routinized: ease of measurement, economic pressure, and the acceptability of programming by the present jobholder. As a result they predicted the middle management layer to break into two parts: a bigger portion will be programmed and added to the operational layer, a smaller portion (the 'free' creative portion) will move upwards. As a result, they predict that the morale of the operational level will matter less, as their work will be routinized anyway. And mobility up the line will become more uncommon. According to Leavitt & Whisler (1958) introducing IT will lead to centralization of decision-making and the middle management will disappear. Thus, a flatter and team-oriented organization based on commitment rather than control will emerge that eliminates bureaucratic hierarchy, thereby increasing centralization of decision-making (Schwarz & Brock, 1998).

Malone (1999) claims to solve this apparent contradiction in a similar manner to Woodward (1965): using more technology is likely to lead to more centralization, and using even more technology leads to decentralization. "Our research suggests that unconnected, decentralized decision makers should be common when communication costs are high. When communication costs fall, centralized decision making becomes more desirable. When they fall still further, connected, decentralized decision making becomes desirable in many situations" (Malone, 1999, p. 142). Generally, the internal contingencies of tasks and technology, depending on their routine and intensity respectively, are seen to be positively related to specialization, formalization, hierarchy, and centralized power. But the latter two characteristics diminish as soon as even more technology is used.

Regarding the environment, since the emergence of the information society, networks and organizations adopting a network approach are on the rise (Castells, 2000). He describes that this happens as a result of an increasingly complex and interwoven society, driven by the speed of information sharing using information technology. The rise of networks can thus be seen as a result of a change in an important contingency: the complexity, uncertainty, and interdependence of the environment. To deal with this kind of increased complexity, this requires the distribution of knowledge among specialists rather than monolithic organizations (Barley, 1996). The increased use of IT, thereby, allows for room for outsourcing activities and further specialization of organizations into defining their core activities (Prahalad & Hamel, 1990).

The expectation of an organizational configuration that will emerge as a result of the increased use of information technology is that it will be a networked organizational structure. While Williamson (1975) distinguished between markets and hierarchies, over time thus a third, distinct organizational structure emerged: the network (Thompson, 2003). The central characteristic of a networks is the creation of coordination, without setting up an hierarchical structure, but using different coordination mechanisms (Chisholm, 1989). While in a hierarchy outcomes are designed according to specific formalized rules, and in markets outcomes emerge more or less spontaneously, in a network outcomes can occur both spontaneously, or they can be designed (Thompson, 2003). Similarly, coordination can occur through formalized guidance, but it can also occur spontaneously (Thompson, 2003).

The way networks are organized and how they can be managed, is widely discussed by (Milward & Provan, 2003; Provan & Milward, 2001). Networks are likely to emerge as a result of an increasingly complex environment on the one hand, but also as a result of more routinized tasks becoming automated. Organizational characteristics associated with this networked configuration are a decentralization of decision-making and a professionalization of the workforce.

3.1.2 Contingency theory in information systems research

The introduction of information systems in organizations has led to changes in these organizations. In other words, information systems can be seen as contingent on organizational characteristics (Leavitt & Whisler, 1958; Malone, 1999; Pfeffer & Leblebici, 1977; Schwarz & Brock, 1998). These changes in the organizational structure as a result of the introduction of IT include the centralization and decentralization of decision-making, the professionalization of the workforce, and the emergence of networks. Furthermore, some authors in the field of IS have adapted contingency theory to account for organizational changes that they observed. This section discusses two of

these adapted theories that may be used for developing a perspective on IT-induced transformation: transaction cost theory and business-IT alignment. First the influence of information technology on the height of transaction costs is discussed, and then the work on business-IT alignment will be introduced to discuss the notion of 'fit' between information technology and organizations for be aligned to realize the best performance.

Transaction costs

Information technology has been found to have a negative influence on the height of the *transaction costs* (Malone et al., 1987). Transaction costs occur as a result of friction in the economic systems (Coase, 1937); when activities that contribute to a result are performed outside a system. Examples of transaction costs are costs that occur as a result of negotiations between parties, deliveries of goods, consultations on the design of a product, and production costs (Malone et al., 1987). The use of IT ensures that information can be shared more easily, leading to a decrease of these kind of costs. The decrease in the transaction costs, is thus also instrumental in the rise of the networked structure.

Transaction cost theory holds that the height of the transaction costs – the costs of coordinating an action – determines the very existence of organizations (Coase, 1937; Williamson, 1975). Traditionally, two different organizational forms were distinguished: hierarchies and markets (Coase, 1937) – the latter rather referring to a lack of organization. According to this theory, the concept of transaction costs is central to the distinction between performing an activity within an (hierarchical) organization or by the market. "It suggests why firms must consolidate some stages of production (e.g. because they involve dedicated assets) and why they are better off procuring the fruits of other stages via the market (e.g. because off-site production does not lead to penalties)" (Heugens, 2005, pp. 547-549).

When transaction costs are high it may make more sense to incorporate certain activities into the hierarchy, whereas when they are low, they may be best left to the market (Williamson, 1975). Several factors related to the result to be produced influence the height of the transaction costs, such as asset specificity (the degree to which a product can only be made by a certain party), uncertainty, and the frequency of a certain transaction (Williamson, 1985). When the asset specificity and the complexity of the product description are higher, the transaction costs will increase and it will be more difficult to create this result in a market situation. The frequency of a transaction is likely to decrease the transaction costs, making transaction costs higher in a market situation where there is a singular transaction than in a situation in which transactions are re-occurring between two parties and negotiations have already taken place (Malone et al., 1987). Therefore, transaction costs play a role in decisions on *sourcing* where a choice is made on producing a product or service within or outside of the organization.

Transaction costs are found to decrease dramatically as a result of the use of information technology, which diminishes asset specificity and complexity of product information (Malone et al., 1987). IT makes it easier to make communicate between different parties and better and easier communication makes that products become less specific to certain parties. When transaction costs are lower, the less likely organizations are to develop actions in-house, but they are rather acquired through the market. The first application of contingency theory to the field of information systems, thus looks at the role of information technology on the height of transaction costs. Transaction costs, in turn, influence organizational structure and other organizational characteristics.

Therefore, transaction cost theory can, for example, be used to demonstrate the impact of technological developments on coordination mechanisms (Clemons & Row, 1992).

Business-IT alignment

The concepts of fit and alignment are central to contingency theory. This fit should be in place between organizational structure and the nature of the tasks performed (Perrow, 1967), and also between the organizational structure and the technology deployed (Woodward, 1965), leading to the emergence of fixed organizational configurations (Mintzberg, 1983). The notion of fit has been adopted by the field of IS, creating the research field of business-IT alignment (Doucet et al., 2008; Henderson & Venkatraman, 1993; Luftman, 2004). Business-IT alignment refers to a continuous and dynamic process of realizing a fit between IT and business needs (Tiwana & Konsynski, 2010).

Henderson & Venkatraman (1993) see alignment as the degree of fit between business strategy, IT strategy, business infrastructure, an IT infrastructure. The purpose of creating fit is to increase the performance of organizations. “[T]hose organizations that successfully align their business strategy with their IT strategy will outperform those that do not” (Chan & Reich, 2007, p. 298). There is thus a relation between IT structure and competitive strategy: organizations having a conservative strategy are more likely to have a centralized IT structure, while entrepreneurial organizations tend to have a decentralized IT structure (Tavakolian, 1989).

Although alignment takes place between different organizational aspects, literature primarily focuses on strategic alignment, which is “the degree to which the business strategy and plans, and the IT strategy and plans, complement each other” (Chan & Reich, 2007, p. 300). But there is also another branch of alignment: structural alignment. This is “the degree of structural fit between IT and the business. Structural alignment is influenced by the location of IT decision-making rights, reporting relationships, (de)centralization of IT, and the deployment of IT personnel” (Chan & Reich, 2007, p. 300). In line with contingency theory, alignment should happen both internally – to the organizational processes, and externally – to the characteristics of the industry (Earl, 1989).

Many theorists thus use contingency theory to identify factors influencing organizational performance by realizing different forms of alignment (see, for example, Cao, Wiengarten & Humphreys, 2011; Morton & Hu, 2008; Pertusa-Ortega et al., 2010; Zott & Amit, 2008). The role of alignment is to create consistency between information technology and various organizational characteristics. In line with contingency theory “organizational performance depends on the fit between organization context and structure and process” (Drazin & Van de Ven, 1985, p. 515). In the shift towards a network, according to business-IT alignment, all aspects of an organization, including IT, need to be in line with one another for organizations to perform well.

3.1.3 Using contingency theory for IT-induced transformation

In the previous sections, a number of contingencies impacting organizational structure were discussed, followed by some applications of contingency theory to the information systems field. The tasks performed and the technology used, as well as the complexity and uncertainty of the environment of an organization are contingent on organizational structure. These contingencies are seen to impact the organizational structure, leading to the formation of configurations, characterized by their main coordination mechanism, their organizational core and the decentralization of decision-making. Application of

contingency theory to the field of information systems identifies outcomes of the use of information technology: the decrease of transaction costs and business-IT alignment. In this section, these elements will be used to formulate a contingency perspective for investigating IT-induced transformation. Also the application to practice and pitfalls of contingency theory will be discussed to increase our understanding of the use of contingency theory for studying IT-induced transformation.

A contingency perspective on IT-induced transformation

Contingency theory can be used to explain variation among organizational characteristics (Gupta et al., 1994). It does so by identifying the differences in internal and external factors that may explain for the differences in organizational characteristics. The central characteristic for organizations is their main coordinating mechanism. A contingency perspective on IT-induced transformation will thus investigate the changes in the coordination mechanisms (and their related organizational characteristics of the organizational core and the decentralization of decision-making) used and the factors influencing these changes. These factors can be found by looking at the type of tasks performed, the technology that is deployed, and through changes in the uncertainty and complexity of the environment in which organizations operate. Regarding the use of information technology, they were found to impact the height of the transaction costs, and the emergence of networks, the contingency perspective can thus be used to identify factors that may influence these organizational changes.

Firstly, the contingency perspective on IT-induced transformation will look into the changes in the central coordinating mechanism, the organizational core, and the decentralization of decision-making to see whether this has led to a new organizational configuration. The notion of alignment holds that if this change is taking place, other organizational characteristics, such as the centrality of decision-making, as well as the information technology need to be aligned to the new forms of coordinating. The use of IT is expected to lead to a networked configuration. Therefore, the case studies will be analyzed to find coordinating mechanisms that allow for coordination of activities in a networked structure. Change or transformation from the contingency perspective can thus be defined as a change in the central coordination mechanism and related organizational characteristics as a result of changes in contingencies.

Secondly, factors will be identified that impact the organizational changes taking place. Traditionally, contingencies were identified from within and outside of the organization: internal factors, such as the nature of the tasks performed and the technology deployed, and external factors such as the uncertainty and complexity of the environment. Therefore, these areas are looked into more closely to see which aspects are changed in order to identify contingencies. Especially the role of information technology in the changes that can be observed is explored. IT is considered to change organizations through a decrease in transaction costs by means of which a networked structure is expected to emerge. But also other factors are explored that may account for the outcomes of the transformation process.

Application of contingency theory

Literature using contingency theory for its empirical study usually first identifies potentially influencing factors from the literature. Then, these factors are tested qualitatively or quantitatively. These types of investigations are, for example, used to explore the fit between Mintzberg's organizational configurations and ERP

implementation (Morton & Hu, 2008), and to investigate factors that influence value creation from RFID supply chain projects (Wamba & Chatfield, 2009). Similar to this chapter, these examples build a contingency model based on literature and apply the model to an empirical study, but this study is explorative rather than validating. This means that instead of testing a few clear contingencies such as in the examples mentioned, this study has identified broad categories to which contingencies may belong, such as the type of tasks performed or the technology deployed.

Two major issues related to the use of contingency theory are raised in literature: the lack of investigation into organizational performance and the vagueness of the concept of fit. The first issue that is raised is that many of the studies using contingency theory merely investigate the congruence of organizational structure and technology rather than the effect on organizational performance (Drazin & Van de Ven, 1985). Although these studies identify the co-occurrence of contingencies and organizational characteristics, this is not yet a full investigation using contingency theory, which would also include a study of the effect on the performance of organizations. Therefore, this study of investigating IT-induced transformation takes place in two steps. Firstly, using case study research, a number of contingencies will be derived. These contingencies will be validated and extended using independent empirical data to identify whether those factors also realize a better performance of organizations regarding their service delivery.

The second set of issues related to the application of contingency theory to empirical studies, is the lack of clarity of the notion of fit (Schoonhoven, 1981). The theory becomes no clearer than that a specific strategy should be 'appropriate for' (Thompson, 1967), 'conform to' (Woodward, 1965), or be 'consistent with' (Lawrence & Lorsch, 1967), without any formal quantification of what this means. Also in business-IT literature this vagueness persists, often leaving the exact notion of what constitutes this fit untouched. While many studies of business-IT alignment conclude that there is a need for fit on many different levels, they rarely explain what this fit looks like in practice (Chan & Reich, 2007). Rather, literature on business-IT alignment merely correlates attributes of technology with characteristics of the organizational structure (Barley, 1990). Using a qualitative method, this study aims to look beyond merely finding correlations and aims to derive factors that are seen as influencing performance rather than merely coinciding the changes taking place.

Criticism on contingency theory

Besides the issues related to the application of contingency theory to empirical research (Drazin & Van de Ven, 1985), some more fundamental problems are raised concerning the lack of a dynamic and reflexive view on change (Barley, 1990; Chan & Reich, 2007). Contingency theory is generally considered as a static theory (Barley, 1990; Chan & Reich, 2007). It sees change almost as a mathematic formula: if a factor changes, the organization changes in a logically following way. And, if an organization acts differently, this variation needs to be accounted for by seeing a differences among factors influencing the organization.

Because of this static vision authors do not see any room for interpretation of technology in specific contexts (Barley, 1990). Thereby, contingency theory ignores the roles humans and institutions can play in a change process. Contingency theory, in essence, sees change in organizations to take place as a result of an adjustment to an outside change, rather than driven by human action or by changes in institutions. Other theories take a different viewpoint. "Many organizational change studies focus on

understanding the effectiveness of various managerial interventions intended to increase organizational productivity” (Schwarz & Huber, 2008, p. S2). Fernandez & Rainey (2006), for example, identify strategies for managers to undertake successful change, thereby emphasizing the role actors can play in a change process.

Others consider changes in organizations to occur as a result of an institutional isomorphism that leads them to imitate each other (DiMaggio & Powell, 1983), rather than as a result of a natural law of change resulting from a change in the environment. The abundance of bureaucratic forms in organizations is, in their view, not a result of the bureaucracy being the most efficient organizational structure, but as a result of a consensus on bureaucracy being the most common form of organizations (DiMaggio & Powell, 1983). Institutions are the formal and informal rules that constrain human economic behavior, such as actor behavior and interactions, legal rules and culture, values and attitudes (North, 1990).

This criticism cannot be solved within the contingency theory perspective. Rather, this will be mitigated using a complementary theoretical perspective. Two other factors influencing change should be considered: human agency deliberately conducting change (Fernandez & Rainey, 2006; Schwarz & Huber, 2008) and institutional forces (DiMaggio & Powell, 1983; North, 1990). These aspects of transformation will be discussed in the next section, where a second theoretical perspective for investigating IT-induced transformation is discussed that does take these elements into account: structuration theory.

3.2 Structuration theory

Structuration theory describes how human actions as well as the social structure shape social phenomena (Giddens, 1979, 1984). While organization theory is concerned with the reaction of organizations to changes in their environment, structuration theory takes on a more social constructivist perspective. Where organization theory formulates influences of cause and effect to determine which factors influence the outcomes of a process, structuration theory is more concerned with the dynamics of the process itself through the emphasis on the continuous mutually constituting nature of structure and agency. Therefore, it can be considered useful for studying processes of transformation. Although Giddens does not make any specific references to the use of structuration for explaining the implementation and adoption of technology, his theoretical legacy may have become the most widely-used theory in the field of information systems (IS) (Jones & Karsten, 2008). After discussing Giddens’ work on structuration, an overview is presented of the application of structuration theory in the field of IS. Although widely used within the IS field, structuration theory is hardly used in literature on e-government. Therefore, the final section of this chapter addresses the use of structuration theory for understanding the process of IT-induced transformation.

3.2.1 Giddens’ mutual constitution of agency and structure

Structuration theory holds that structure and agency are a mutually constitutive duality and that the two cannot be examined separately. In this view, change occurs as a result of human actions as well as the social structure shaping social phenomena. The founder of structuration theory is sociologist Anthony Giddens (1938-). Giddens’ strongly criticizes positivist and overly interpretative sociological studies (Giddens, 1979; Jones

& Karsten, 2008). In contrast to contingency theory, Giddens rejects objectivism in the field of the social sciences and, instead, finds them to rely on interpretation (Jones & Karsten, 2008). He is, however, also critical of interpretative methodology. Where he finds positivists to be too weak on action, he finds interpretative research often too weak on structure. Therefore, he aimed to overcome the structure/action dichotomy of many of the social theories by declaring all social phenomena to be mutually constituted through social structure *and* human action. In his view, structure is reproduced by ongoing human action either reinforcing or changing structure, while, at the same time, structure enables and constrains human action (Giddens, 1979, 1984). “Thus, social phenomena are not the product of *either* structure *or* agency, but of both” (Jones & Karsten, 2008, p. 129).

To understand Giddens’ structuration theory, it is important to understand his definition of structure and his view on the role of human action. Structure needs to be considered as an abstract phenomenon. “In Giddens’ theory, structure is understood to be an abstract property of social systems. Structure is not something concrete, situated in time and space, and it lacks material characteristics” (Orlikowski & Robey, 1991, p. 147). “[S]tructure has no physical instance and is only given substance through what people do” (Jones & Karsten, 2008, p. 132). Giddens defines structure as “rules and resources, organized as properties of social systems” (Giddens, 1984, p. 25). Human agency is voluntaristic as, according to Giddens, actors always have a choice to act as they want, unless they are being forced to do otherwise (Jones & Karsten, 2008): “As a leading theorem of the theory of structuration, I advance the following: *every social actor knows a great deal about the conditions of reproduction of the society of which he or she is a member. [...] The proposition that all social agents are knowledgeable about the social systems which they constitute and reproduce in their action is a logically necessary feature of the conception of the duality of structure*” (Giddens, 1979, p. 5, emphasis in original).

For analytical purposes, Giddens distinguishes three dimensions of structure: signification, domination, and legitimation, with corresponding dimensions of interaction: communication, power, and sanctions, which are linked through modalities of, respectively, interpretative schemes, facilities, and norms (Jones & Karsten, 2008).

“Interpretative schemes are standardized, shared stocks of knowledge that humans draw on to interpret behavior and events, hence achieving meaningful interaction. *Facilities* are the means through which intentions are realized, goals are accomplished, and power is exercised. *Norms* are the rules governing sanctioned or appropriated conduct, and they define the legitimacy of interaction with a setting’s moral order. These three modalities determine how the institutional properties of social systems mediate deliberate human action and how human action constitutes social structure. The linkage between the realms of social structure and human action is referred to as the “process of structuration” (Giddens, 1979)” (Orlikowski & Robey, 1991, p. 148, emphasis in original).

This is shown in figure 3.1.

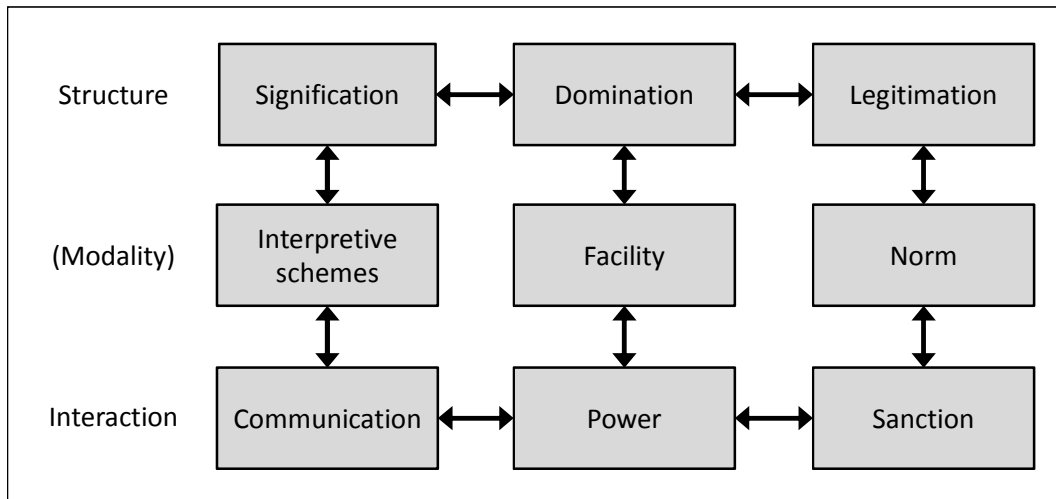

Figure 3.1: The dimensions of the duality of structure (based on Giddens, 1984, p. 29).

Giddens' modalities can be used to study change in practice, as these can be seen as the manifestations of the dimensions of structure. The non-dualistic nature of structuration theory "may be seen to avoid determinism of either the technological or social kind [...]; its dynamic conceptualization of structure as being continuously produced and reproduced through situated practice, which facilitates the study of change" (Jones & Karsten, 2008, p. 128). Identifying modalities can shed light on the underlying process of structuration, as well as the forgoing of these modalities can shed light on action. While in Giddens' view social science can, fundamentally, only rely upon interpretation, he does not reject more positivist data gathering techniques, such as surveys for specific investigations (Jones & Karsten, 2008).

3.2.2 Structuration theory in information systems research

While Giddens hardly refers to technology in his work on structuration theory, it has become a widely used theory in the field of IS, with over 300 papers having citing his work (Jones & Karsten, 2008). This is not surprising, as "structuration should be applicable [...] to any aspect of IS research studying the relationship between IS and organizations (or society, more generally)" (Jones & Karsten, 2008, p. 138). In one of his few references to technology, Giddens explicitly rejects the influence of technology itself, but asserts that, instead, it is only given meaning through humans enacting with technology. "Technology does nothing, except as implicated in the actions of human beings" (Giddens & Pierson, 1989, p. 82). Therefore it can be no surprise that structuration research is most often used in IS research "where the importance of social "factors" is more widely recognized [...] [and] where there is perceived to be the greatest scope for agency" (Jones & Karsten, 2008, p. 138). Its main advantages for the IS field are summarized as:

"Adopting structuration theory to the study of organizations and technology allows us to overcome several limitations of prior one-sided perspectives: (i) The determinism and reification of technology plaguing objectivist theories is tempered by a recognition that organizations exist only through ongoing human action. (ii) The extreme voluntarism advocated by subjectivist theories is restrained by a

recognition that organizational properties become institutionalized and assume objective identities beyond easy reach of acting individuals. (iii) The lack of attention paid to contextual and historical factors by much of the objectivist and subjectivist research is redressed by focusing on the context of interaction, and by integrating the action of humans with the ongoing stream of social practices that produce and reproduce social systems over time” (Orlikowski & Robey, 1991, p. 164).

Besides applying structuration theory to the field of IS to gain a greater understanding in the mutual influences of structure and action, authors using structuration theory in the field of IS have both sought to extend the theory to fit studies of technology (Orlikowski, 1992; Poole & DeSanctis, 2004). It is considered especially useful for explaining outcomes of IT-implementation that do not match expectations (Poole & DeSanctis, 2004; Pozzebon & Pinsonneault, 2005). “Structuration theory advocates a departure from technological or organizational determinism and an emphasis on interpretive approaches that at the same time do not fail to account for the unanticipated consequences of actions” (Meneklis & Douligeris, 2010, p. 72). Furthermore, structuration theory can be very useful for explaining the influence of the environment, especially the existing information systems, on a new information system under development (Chae & Poole, 2005). The best known adaptations of structuration theory to the field of IS are the *duality of technology* (Orlikowski, 1992) and *Adaptive Structuration Theory* (DeSanctis & Poole, 1994). Most of the studies in the field of IS using structuration theory follow either of those adaptations (Pozzebon & Pinsonneault, 2005).

Duality of technology

Orlikowski extended structuration theory to the domain of IS to develop “a new theoretical model with which to examine the interaction between technology and organizations” (Orlikowski, 1992, p. 398), which she calls *the structurational model of technology*. Her work contends that both the view that technology shapes organizational properties as well as the view that human agency shapes technology are incomplete. Applying structuration theory “offers a solution to the dilemma of choosing between subjective and objective conceptions of organizations and allows to embrace both” (Orlikowski, 1992, p. 403). The duality of technology is conceptualized as follows:

“The duality of technology identifies prior views of technology [...] as a false dichotomy. Technology is the product of human action, while it also assumes structural properties. That is, technology is physically constructed by actors working in a given social context, and technology is socially constructed by actors through the different meanings they attach to it and the various features they emphasize and use. However, it is also the case that once developed and deployed, technology tends to become reified and institutionalized, losing its connection with the human agents that constructed it or gave it meaning, and it appears to be part of the objective, structural properties of the organizations” (Orlikowski, 1992, p. 406).

Furthermore, she contends that “technology is *interpretively flexible*” (Orlikowski, 1992, p. 405, emphasis in original). This refers “to the degree to which users of a technology are engaged in its constitution [...] during development or use. Interpretive flexibility is an attribute of the relationship between humans and technology and hence it is influenced by characteristics of the material artifact [...], characteristics of the human agents [...], and characteristics of the context” (Orlikowski, 1992, p. 409). Thus, the

structurational model of technology consist of three components: human agents, technology, and institutional properties (Orlikowski, 1992). In her view, there is a time-space discontinuity between the *design mode* and the *use mode* of technology: “many of the actions that *constitute* the technology are often separated in time and space from the actions that are *constituted by* the technology” (Orlikowski, 1992, p. 407, emphasis in original).

“In the *design mode*, human agents build into technology certain interpretive schemes (rules reflecting knowledge of the work being automated), certain facilities (resources to accomplish that work), and certain norms (rules that define the organizationally sanctioned way of executing that work). In the *use mode*, human agents appropriate technology by assigning shared meanings to it, which influence their appropriation of the interpretive schemes, facilities, and norms designed into the technology, thus allowing those elements to influence their task execution” (Orlikowski, 1992, p. 410). Hence, in her view, the institutional characteristics of an organization can be reinforced or transformed by technology, such as information systems: “while personal action of human agents using technology has a direct effect (intended and unintended) on local conditions, it also has an indirect effect (often unintended) on the institutional environment in which the agents are situated” (Orlikowski, 1992, p. 406).

To be able to apply the rather abstract level of structuration theory to practice, Orlikowski proposed an extension to her structuration model of technology. She developed a *practice lens* for the “ongoing changes in both technologies and their use” (Orlikowski, 2000, p. 405). This practice-oriented understanding is concerned with how “human action *enacts* emergent structures through recurrent interaction with the technology at hand” (Orlikowski, 2000, p. 407, emphasis in original). She applies this lens to the ways in which technology is enacted by human action when it is implemented in different organizations and social structures. Orlikowski (2000) refers to the constitution of structures of technology by regular human interaction through the shaping of the set of rules and resources as emergent technology structures:

“Through their regularized engagement with a particular technology [...] users repeatedly enact a set of rules and resources which structures their ongoing interactions with that technology. [...] [I]n their recurrent practices, users shape the technology structure that shapes their use. Technology structures are thus external or independent of human agency; they are not “out there” embodied in technologies simply waiting to be appropriated. Rather they are virtual, emerging from people’s repeated and situated interaction with particular technologies” (Orlikowski, 2000, p. 407).

In her analysis, she distinguishes different enactments that depend on the technology, on the human actors and their prior experiences and on the institutions and norms that exist in the organization. She shows that structuration theory can thus account for how the implementation of technology in practice can differ from the intentions in the design mode. “Identifying types of structures of technology use should help both researchers and practitioners better understand how and why people are likely to use their technologies and with what (intended and unintended) consequences in different conditions” (Orlikowski, 2000, p. 432). She also sees opportunities for her model to use in combination with other theories, such the organizational forms of Mintzberg (Orlikowski, 1992). “The structurational framework affords a way of investigating not only the movement of technology through time-space, but also across organizational

boundaries, potentially providing a basis for analyzing interorganizational relations of learning, influence, and dependence” (Orlikowski, 1992, p. 422).

Adaptive Structuration Theory (AST)

As well as other structurational models, the AST framework also describes the interplay between advanced information technologies, social structures, and human interaction (DeSanctis & Poole, 1994, p. 125). AST proposes “a framework for studying variations in organization change that occur as advanced technologies are used [...]. According to AST, adaptation of technology structures by organizational actors is a key factor in organizational change. [...] There is an interplay between the types of structures that are inherent to advanced technologies (and, hence, anticipated by designers and sponsors) and the structures that emerge in human action as people interact with these technologies” (DeSanctis & Poole, 1994, p. 125). AST thus seeks “to modify Giddens’ structuration theory to address the mutual influence of technology and social processes” (Jones & Karsten, 2008, p. 141).

The AST framework distinguishes two ways in which the social structures enact technology:

“The social structures provided by an advanced information technology can be described in two ways: structural features of the technology and the spirit of this feature set. *Structural features* are the specific types of rules and resources, or capabilities, offered by the system. [...] [Structural] features bring meaning (what Giddens calls “signification”) and control (“domination”). Spirit is the general intent with regard to values and goals underlying a given set of structural features. [...] The spirit is the “official line” which the technology presents to people regarding how to act when using the system, how to interpret its features, and how to fill in gaps in procedure which are not explicitly specified. The spirit of a technology provides what Giddens calls “legitimation” to the technology by supplying a normative frame with regard to behaviors that are appropriate in the context of the technology” (DeSanctis & Poole, 1994, p. 126).

AST addresses two central concepts: *structuration* and *appropriation*. The structuration of AST is similar to that of Giddens (1979; 1984) and Orlikowski (1992):

“The act of bringing the rules and resources from an advanced information technology or other structural source into action is termed *structuration*. Structuration is the process by which social structures (whatever their source) are produced and reproduced in social life. [...] The structures provided by a technology may be used directly, but more likely they are invoked in combination with other structures. The array of alternative structures available to groups can affect which technology structures are selected for use, how the results are interpreted, and how they are applied. AST is consistent with contingency theories in proposing that use of advanced information technologies may vary across contexts” (DeSanctis & Poole, 1994, p. 125).

A second concept within the AST framework is *appropriation*, which refers to technology not being implemented in an organization in a predestined manner, but rather through ongoing human action (Orlikowski, 1992), appropriating technology “faithfully or unfaithfully” (Jones & Karsten, 2008, p. 141). Appropriation occurs when people decide whether or not to use technology and how technology structures are used (DeSanctis & Poole, 1994, p. 407); they represent “the immediate, visible actions that evidence deeper

structuration processes” (DeSanctis & Poole, 1994, p. 125). Appropriations are determined by human action, not by the technology design, although this technology structure naturally shapes human action (DeSanctis & Poole, 1994, p. 407). These are considered equivalent to Giddens’ modalities of structuration, as structural features can be appropriated through “a variety of *appropriation moves*” (Jones & Karsten, 2008, p. 141, emphasis in original).

Also AST sees opportunities for applying structuration theory in combination with other theories. It defined a detailed method for analyzing the processes of structuration and appropriation at different levels for explaining the interplay between technology and structure. The framework can help to derive specific propositions, such as: “**Given** advanced information technology and other sources of social structure, $n_1 \dots n_k$, **and** ideal appropriation process, **and** decision processes that fit the task at hand, **then** desired outcomes of advanced information technology will result” (DeSanctis & Poole, 1994, p. 131). There are multiple contingencies for the conditions under which appropriation will take place best, and clear propositions for the structuration and appropriation that is expected can be derived. Furthermore, recommendations are provided for undertaking structurational analysis at the different levels. Their conclusion is that the type of analysis can be used to answer questions on the impact of technology on organizations (DeSanctis & Poole, 1994).

3.2.3 Using structuration theory for IT-induced transformation

Like contingency theory, structuration theory is a meta-theory that cannot be applied directly to formulate hypotheses and test them. Rather, it represents a perspective on the world that can be used to investigate IT-induced transformation. The previous sections have discussed Giddens’ ‘original’ structuration theory as well as the adaptations used in the field of information systems that investigate the ongoing use of IT. In this section these different interpretations of structuration theory will be used to formulate a structurational perspective on IT-induced transformation. This perspective complements the contingency perspective by taking a view on human agency and social structure rather than by identifying factors that may naturally lead to certain organizational outcomes. Furthermore, the application of the structurational perspective to empirical research as well as some issues associated with structuration theory are discussed to present the context of findings from a structurational analysis.

A structurational perspective on IT-induced transformation

Structuration theory is recently used in literature to study e-government (or e-business) implementation to account for intended and unintended outcomes of individual IT-projects (Basetihalli, Kim, Lee & Noh, 2010; Chu & Smithson, 2007; Gil-Garcia, Canestraro, Costello, Baker & Werthmuller, 2008; Herrera & Gil-Garcia, 2010; Meneklis & Douligeris, 2010). However, few of these studies look beyond a single case study to account for intended and unintended changes on the level of public administration at a whole. Still, it was observed that notions of structuration do shape public sector transformation as a whole. “Public service transformation initiatives sometimes transform institutions, whereas at the same time, institutions, through judicial and professional norms, and through power structures and path dependencies, shape ways in which technologies are designed and used in specific practices” (Homburg, 2009, p. 1). Therefore, the use of structuration to study the mutual influence of human agency and social structure on IT-induced transformation is likely to lead to new insights.

Fountain (2001a) was among the first to look at why many e-government projects lead to different organizational changes than intended, and found the enactment of the organizational structure to play a major role. "The Internet is often used to reinforce an old institutional structure rather than open the possibility for innovative public service" (Fountain, 2001c, p. 250). E-government can thus be described from a structural point of view: "E-government policies shape the choice and design of ICT projects so that technologies become carriers of the e-government policies' goals and aims. [...] [T]hese interests carried by technology are enacted by public sector organizations in their daily base actions and routines [...] so that the outcome of e-government reforms is shaped by the e-government policies' aims and goals, the technological characteristics shaped by these policies, and the organizational practices, which ultimately shape the actual outcomes of the reforms" (Cordella & Iannacci, 2010, p. 53).

This can be used to formulate a structural view on IT-induced transformation: government policies shape IT-projects by turning the technology into carriers of these policy goals to realize organizational transformation. But these IT-projects and the technologies they aim to introduce are enacted by the organizations (and their daily routines and practices) in which they are implemented. The outcomes of IT-induced transformation are thus influenced by the policies formulated by the government, which shape the IT-projects that are undertaken, which are at the same time shaped by the organizations and their daily practices in which they are implemented. The policies formulated can thus be seen as the social structure structuring technology, and the organizations and their daily practices can be seen as instances of appropriation. However, defining IT-induced transformation in this way takes place at an abstract level and it does not account for individual factors playing a role in the unexpected outcomes of such change projects.

Therefore, this study uses structuration theory to take the investigation of IT-induced transformation one step further. First, it looks at the individual cases to investigate the structuration and appropriation that take place. Then, this study compares the two cases to identify factors that may account for these processes of structuration and appropriation that lead to IT-induced transformation. To allow for the identification of factors that influence the occurrence of IT-induced transformation, Adaptive Structuration Theory (AST) will be used. Unlike Orlikowski's duality of structure, AST can be used to explain variation among the case studies and to account for the factors that influence the changes that take place as a result of the implementation of information systems. Thereby, AST can lead to outcomes that are complementary to contingency theory, explaining the factors that allow for faithful or unfaithful appropriation (DeSanctis & Poole, 1994).

AST thus focuses on two key concepts: structuration and appropriation. While structuration is concerned with what is defined in Giddens' framework as the dimensions of signification and domination, appropriation is concerned with the dimension of legitimation. These three dimensions have their corresponding dimensions of interaction – communication, power, and sanctions, which are linked through modalities of, respectively, interpretative schemes, facilities, and norms. These dimensions are investigated one by one to explain for the structuration that is taking place. Furthermore, the dimension of legitimation can be used investigate whether the 'spirit' of the technology was implemented, leading to faithful – or unfaithful – appropriation. While the processes of structuration and appropriation will first be presented for each case, through a cross-case analysis the factors accounting for the occurrence of unexpected outcomes will be derived.

Application of structuration theory

Similar to contingency theory, structuration theory is a “meta-theory – a way of thinking about the world – rather than a middle range theory about specific phenomena that can be explored or tested directly and empirically” (Orlikowski & Robey, 1991, p. 165). Therefore, its use for empirical work and the research methodologies have been widely discussed (see, for example, Rose, 1998). “[S]tructururation theory is complex, involving concepts and general propositions that operate at a high level of abstraction. [...] [It] is not easily coupled to any specific research method or methodological approach, and it is difficult to apply empirically” (Pozzebon & Pinsonneault, 2005, p. 1353). One of the main issues is that the mutual influence of human action and social structure is hard to separate for empirical purposes. Therefore, some authors have sought to extend Giddens’ work to make it more instrumental for empirical studies (Orlikowski, 2000; Stones, 2005). To allow for investigation of structuration, these authors separate the description of human action and social structure. This leads to an empirical division of enquiries into the process of structuration, also across time (the ‘duality’ of technology) to explain variance.

The application of structuration theory to the field of IS has thus led implicitly to a separation of the two sides of the duality (human action and social structure) for empirical reasons. Both (Orlikowski, 1992; Poole & DeSanctis, 2004) rely on this method to be able to explain the variance among structurational developments. The duality of technology (Orlikowski, 1992) relies on this separation to account for differences in the enactment of the same technology among different organizations. In doing so, (Poole & DeSanctis, 2004) consider themselves to be in line with Giddens: “Giddens (1984) acknowledges the value of decomposing structuration in this articulation of two alternative strategies for research: the analysis of strategic conduct and institutional analysis. The *analysis of strategic conduct* takes institutions as a backdrop and focuses on how actors draw on and reproduce the structures of the system in social practices. The *analysis of institutions* (systems) assumes that strategic conduct is going on but focuses on the structural characteristics of institutions and their long-term development” (Poole & DeSanctis, 2004, p. 213). While researchers need to bear in mind that it may be difficult to distinguish the two in practice, it can thus be used in this way for empirical analysis.

Regarding the research methodology, “structuration theory leaves decisions about research settings, procedures, measurements, and analytic tools to the researchers themselves. It offers no more than general strategies for research conduct” (Poole & DeSanctis, 2004, p. 3). Therefore, structuration theory can make use of a variety of different research instruments and methodologies. A common application of structuration theory is through the use of case studies (see, for example, Basettihalli et al., 2010; Chu & Smithson, 2007; Cordella & Iannacci, 2010; Fountain, 2001a; Gil-Garcia et al., 2008; Greenhalgh & Stones, 2010; Herrera & Gil-Garcia, 2010). Also in this study two cases will be investigated closely to identify the processes of structuration to account for the outcomes that are unexpected from the view of contingency theory. As it is not possible to see processes of structuration outside its specific situation, rather than drawing vague conclusions about the role of power, these findings cannot be tested quantitatively. But, the findings will be compared in between the cases to see whether any patterns can be identified.

Criticism of structuration theory

Although Orlikowski's work as well as AST have found its way into many studies on information systems (Jones & Karsten, 2008; Pozzebon & Pinsonneault, 2005), a major issue remains related to the use of structuration theory in the field of Information Systems. This issue originates in the problem that structurational approaches often take too generic a view on information systems, without taking the specific characteristics of system into account (Chae & Poole, 2005). To deal with the challenge of applying structuration theory to investigate the domain of information systems, (e.g. Orlikowski, 2000; Poole & DeSanctis, 2004) interpret Giddens' definition of structure to also include material matters such as information technology. This is debated to be in line with Giddens' work (Jones & Karsten, 2008, 2009; Pozzebon & Pinsonneault, 2005).

This debate focuses on whether it is possible to treat (information) technology as a structural property that is enacted by human action to explain for outcomes of IT-implementation in practice. More fundamentally, however, this concerns the question of whether structure can be embodied in (information) technology. According to Giddens, structure cannot be *embedded* in technology, as, by his definition, it cannot be separated from the human mind (Jones & Karsten, 2008). He, accordingly, defines social structure as memory traces in the human mind (Giddens, 1984). To solve this issue, both Orlikowski (1992; 2000) and DeSanctis & Poole (1994) identify elements that can be seen as proxies to circumvent the actual embodying of structure in technology. Orlikowski (2000) uses *technologies-in-practice* (enacted structures of technology) to circumvent this issue. "Technology structures are not external or independent of human agency, but exist in the form of a set of rules of behavior and the ability to deploy resources [...] that emerge from people's interactions with the technology at hand – *technologies-in-practice*" (Pozzebon & Pinsonneault, 2005, pp. 1357-1358, emphasis in original).

AST, on the other hand, defines independent sources of structure, which opens up the possibility for technology to possess structural features. "[T]echnology is seen as one source of social structures (i.e., sets of rules and resources), which are embedded in technology by designers during development and then dynamically changed as users interact with technology" (Poole & DeSanctis, 2004, p. 211). However, this extension of Giddens' theory to attribute technology with structural features, is criticized by others to maintain that this extension may not be in line with the original version of structuration theory (Jones & Karsten, 2008). "What is preserved in physical artifacts may [...] be "traces" of structuration processes, but are not themselves structures, at least as Giddens defines them" (Jones & Karsten, 2009, p. 593).

The main problem is that "[o]ther approaches treating structure in ways that do not fit with Giddens' definition [...] cannot necessarily assume that their concept of structure will share these properties" (Jones & Karsten, 2008, p. 146). "IS research that focuses on observable facts to the neglect of social actors' knowledgeability and reflexivity, that seeks to employ structuration in pursuit of invariant social laws, or, more generally, that assumes an epistemological equivalence between the social and natural sciences is at odds with central principles of Giddens' position and would seem to risk missing some of its key insights" (Jones & Karsten, 2008, p. 145). The issue of whether (information) technology possesses structural characteristics is not yet completely solved, as some assert that technology can be seen as an instantiation of structure (Poole, 2009). This study will follow the more general claim that – rather than actual structure – traces of structure can be found in technology (Cordella & Iannacci, 2010; Jones & Karsten, 2008).

3.3 Combining contingency and structuration theory

Both contingency theory (Schoonhoven, 1981) and structuration theory (Jones & Karsten, 2008) are meta-theories, rather than clearly defined theories presenting testable predictions. Hence, they require adaptation to be used for investigating the notion of IT-induced theory in order to derive factors influencing the transformation process. Therefore, this chapter used both theoretical perspectives to create a framework tailored for the issue of IT-induced transformation, that can be used to investigate this matter. These two theoretical perspectives are used to carry out an explorative case analysis and comparison in chapter 5, rather than to produce with testable propositions.

IT-induced transformation, as identified in the previous chapters, represents a shift to a more horizontal nature of government, induced by and leveraging the value of IT. While the previous chapter aimed at identifying these objectives and mechanisms, this theoretical chapter develops theoretical perspectives on the transformation process, to investigate the factors influencing occurrence of the transformation and the realization of the expected objectives, as well as the unexpected outcomes. The first theoretical perspective – derived from contingency theory – investigates the outcomes and factors influencing the occurrence of these outcomes. The second perspective – derived from structuration theory – allows an in-depth look into the process of transformation in practice to account for the unexpected outcomes. This is visualized in figure 3.3.

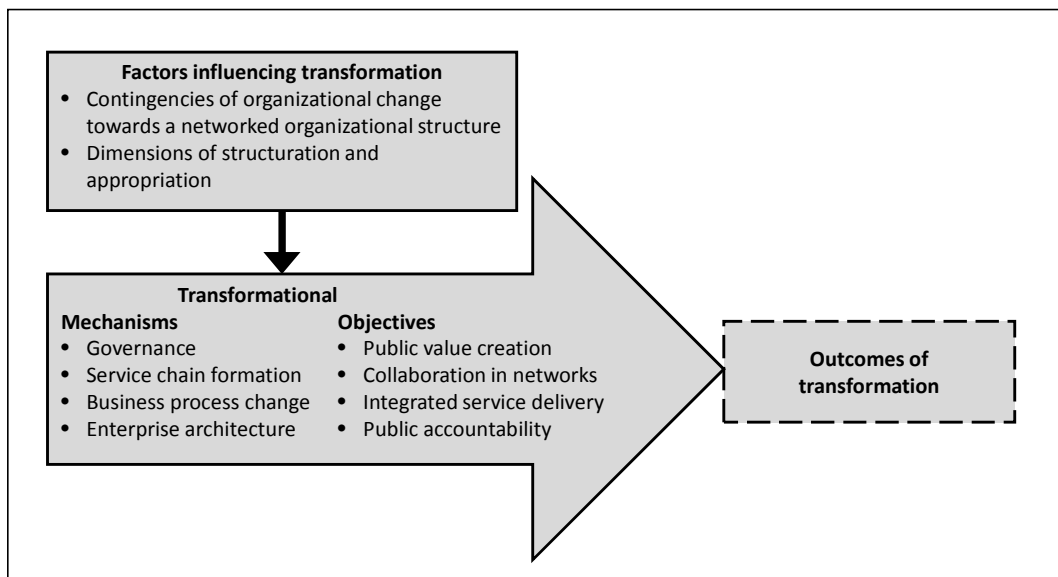

Figure 3.3: Model of IT-induced transformation, with factors influencing the outcomes.

Several authors (e.g. Orlikowski, 1992; Poole & DeSanctis, 2004) found that contingency and structuration theory are complementary. While contingency theory aims to explain the optimal organizational structure as an outcome of factors in its external as well as its internal environment to account for variances between different outcomes, structuration theory looks at the mutual influence of structure and agency to account for the development of (unexpected) outcomes. While contingency theory is useful for generating theory that is generalizable and can predict future action, it does not explain

how transformation is taking. Rather, it aims to explain variance between different outcomes as a result of different inputs that influence the process. Structuration theory, on the other hand, is very useful to explain the (unexpected) outcomes of change in specific situations, but it cannot be easily used to make general predictions.

The use of two complimentary theoretical lenses is intentional. The use of complementary theoretical lenses to create a rich overview of a certain organizational phenomenon is often encouraged for overcoming perceived deficiencies of both theoretical lenses (Jones & Karsten, 2008) and to create a mutual exchange between IS research and social science (Orlikowski & Barley, 2001). Examples of studies using two theoretical perspectives include the use of positivist approaches to test the validity of interpretative approaches (Lee, 1991), the use of institutional theory and resource dependence theory to explore the conditions of radical transformation in state-owned enterprises (Erakovic & Wilson, 2005), the use of transaction cost theory and institutional theory to understand organizational design adoption (Roberts & Greenwood, 1997), contingency theory and institutional theory to investigate coordination and control in government (Gupta et al., 1994), and cultural and structural perspectives on organizational learning (Moynihan & Landuyt, 2009).

Crowston & Myers (2004) even combine three research perspectives (economic, institutional, and socio-cultural) to gain a full understanding of the phenomenon of industry transformation and the role of information technology. They maintain that just using one perspective for their analysis would not give full insight into the matter (Crowston & Myers, 2004). Similarly, the combination of the contingency and structurational perspectives on IT-induced transformation is considered useful to gain a fuller understanding of the phenomenon. While the one perspective can be used to investigate whether the outcomes and contingencies of transformation match the objectives and mechanisms, the other perspective can be used to investigate the forces that influence the transformation process. In the case study analysis of chapter 5, they are, thus, applied one by one to the case studies presented in chapter 4 to gain a broader, rather than a deeper insight of IT-induced transformation in practice.

4 Case studies of transformation

It is the intimate connection with empirical reality that permits the development of a testable, relevant, and valid theory (Eisenhardt, 1989).

This chapter presents the empirical investigation of IT-induced transformation. For this, an interpretative method is used: explorative case study research. Two cases of IT-induced transformation are presented: the Standard Business Reporting (SBR) and Omgevingsvergunning (Wabo) programs. Both of these cases aim for a multi-dimensional transformation of government, to which IT is central. As these programs were developed over multiple years, they are studied in retrospect to capture their intricacies from the start until the current situation. Because transformational projects usually have a timespan beyond that of a PhD project, case studies were selected that were conceived before this study in order to be able to investigate a larger part of the programs. First the case study design will be presented, including the criteria for selecting these specific cases and the case study methodology. Then, both cases will be described and some first conclusions are drawn. In the next chapter, a systematic comparison of the cases will be made to refine the conceptual model derived from literature.

4.1 Case study design

Originating in the social sciences, case study research was proven valuable to be applied to the field of information systems (Walsham, 1995). In fact, most of the research on e-government today is case study-based (Gronlund & Horan, 2005). Doing case study research requires the careful design of a methodology that obeys clear guidelines in order to be able to make generalizations (Eisenhardt, 1989; Klein & Myers, 1999). It requires that the objectives of the case study research are clear, that a careful selection of cases is made and, that a protocol for the interpretative study is designed. These issues are addressed in this section.

4.1.1 Relevance and applicability of case study research

Case studies are a method for conducting interpretive research. They are most suitable in situations when “a *“how” or “why” question* is being asked about *a contemporary set of events*, over which the investigator has *little or no control*” (Yin, 1989, p. 9, emphasis added). They are, thus, first of all useful to investigate or understand (causal) relations between phenomena (answering questions such as “how did something happen?” or “why did something take place?”). Secondly, they are useful for explaining contemporary events, as opposed to, for instance, histories, which are usually applied to ‘dead’ subjects, leaving out the opportunity of carrying out interviews with stakeholders. And thirdly, they allow for a study of uncontrollable circumstances, as opposed to, for example, experiments that are used in for doing a study under controlled circumstances.

These characteristics make case study research especially appropriate for developing theory in new topic areas (Benbasat, Goldstein & Mead, 1987; Eisenhardt, 1989), such as the investigation of IT-induced transformation and the factors influencing its outcomes.

Another important matter to case study research is the role of the context of the phenomenon under study. This is reflected in Yin's definition of a case study: "an empirical inquiry that investigates a contemporary phenomenon within its real-life context, especially when the boundaries of the phenomenon and context are not clearly evident" (Yin, 1989, p. 13). He states that "you would use the case study method because you deliberately wanted to cover contextual conditions – believing that they might be highly pertinent to your phenomenon of study" (Yin, 1989, p. 13).

Several objections can be heard with respect to case study research, such as the lack of rigor, the feeble basis for generalization, and the duration and complexity of the study (Yin, 1989). Yin dismisses these three sources of criticism for reasons of a lack of clear research design in many papers, without this necessarily having to do with the method per se. The solution to doing rigorous and generalizable case study research is in the structure of executing the research: "the case study as a research strategy comprises an all-encompassing method – covering the logic of design, data collection techniques, and specific approaches to data analysis" (Yin, 1989, p. 14). A case study design, including the systematic selection and description of the cases as well as a systematic analysis afterwards to ensure validity of the findings, needs to be set up: "A research design is the logic that links the data to be collected (and the conclusions to be drawn) to the initial questions of the study" (Yin, 1989, p. 19).

During the design of a research strategy for case studies, four conditions related to the quality of the design need to be addressed: construct validity, internal validity (only for explanatory or causal case studies and not for descriptive or exploratory case studies), external validity, and reliability (Yin, 1989). These conditions, except for the second condition of internal validity which need not be addressed considering that this research is exploratory in nature, will be addressed in the case study design. *Construct validity*, which establishes correct operational measures for the concepts under study (MacKenzie, 2001), is addressed by applying the same framework – developed in the previous chapter, to the cases. *External validity*, which establishes the domain to which a study's findings can be generalized (Lee & Baskerville, 2003), is addressed in the case study selection section. And *reliability*, demonstrating that the operations of a study can be repeated, yielding the same results, is addressed by designing a clear case study methodology and protocol.

4.1.2 Case study selection

While an approach of using a single case study allows for in-depth investigation, it is usually considered less suitable for making generalizations than an approach using multiple cases (Yin, 1989). Therefore, to allow for cross-case analysis and comparison, multiple case studies are investigated in this study. In order to be able to generalize on the basis of these cases and to ensure external validity, they need to be sufficiently comparable regarding the subject to be generalized on. Therefore, theoretical sampling is used for the case study selection. "[T]he goal of theoretical sampling is to choose cases which are likely to replicate or extend the emergent theory" (Eisenhardt, 1989, p. 537). For this purpose, a list was made of all the characteristics the cases need to display based on the definition of IT-induced transformation derived in chapter 1 and operationalized based on the literature in chapter 2. The first criterion is that all cases

are from the public sector. Furthermore, among the transformational dimensions are many outcomes that related to the perceived effectiveness for citizens, such as public value and service delivery. Therefore, the second criterion is that the public organizations under study are service delivering organizations, such as municipalities or executive organizations. Thirdly, as this study deals with IT-induced transformation, information technology needs to be at the heart of the changes taking place in the service delivery. Thus, the first three criteria are:

1. The cases are in the public sector. There may be similarities to cases in the private sector, but these are outside the scope of this study;
2. The public organizations under study are service delivering organizations, such as municipalities or executive agencies; and
3. IT-induced transformation requires IT to be central to the transformation process enabling changes in business processes and information flows.

Furthermore, the objectives and mechanisms of transformation presented in chapter 2 must be central to the case studies to investigate whether they realize the desired changes. IT being central to the type of change, is not considered sufficient to be able to speak of IT-induced transformation. It needs to aim for realizing public value beyond making government operations more efficient and more service-oriented. And it needs to aims for realizing joined-up government and collaboration in networks through business processes change. To be able to investigate whether the situation after transformation is qualitatively different than before (Tosey & Robinson, 2002), two more criteria that are derived from chapter 2 are formulated:

4. The case studies undertake extensive business process change to form service chains that are citizen-centered and aim for public value creation; and
5. Inter-departmental or even inter-organizational collaboration is undertaken to integrate service delivery and realize joined-up government.

To understand the complexity involved, all criteria need to be met. As studying transformation means investigating long-term change spanning several years, case studies are selected that can be studied in retrospect. This means that the cases that will be studied have been developing for some time and are nearing completion. Cases that ended in the past were not considered for practical reasons as it would be much harder to find documentation. A disadvantage, however, of cases that are still under development, is that they tend to be biased towards issues that are important in the current time, rather than over time. Although this bias is difficult to overcome, this was attempted by making a historical overview based on publicly available documents that were published over the course of the programs and by also interviewing experts external from the case as well as persons that were involved in the past but not anymore.

The two cases used in this study match the criteria defined. The first case is the Standard Business Reporting (SBR) program, which aims to standardize (financial) reporting. The origins of this case go back to 2004, thereby meeting the requirement of being a long-term change program. The second case is the introduction of the 'environment permit' (Omgevingsvergunning, Wabo), a joint permit including (nearly) all permits concerning the living and working environment, such as building permits, which originates in 2003. In both cases, many stakeholders were involved and these cases concerned long-term projects, resulting in a large complexity. Both case studies were carried out in the Netherlands. The main reason for this is a practical one. Being

located in the country and speaking the language allowed the researchers to easily access information and people involved in the case studies. Furthermore, although culture is always an important factor in research, it was not a focus of this research and it was therefore kept as a constant for all cases, deciding, therefore, to carry out all cases in the same cultural setting. And finally, this allowed studying publicly available documents in addition to the interviews.

4.1.3 Case study methodology

The case studies under investigation were initiated before the start of this study. Therefore, a retrospective view is used for the case study analysis. To be able to study the structuring within the cases, besides investigating the context of the study and the actors that are involved, a timeline of significant events is constructed to understand the unfolding of the cases. "The only sure way to determine the nature of a structuring process is to study it as it unfolds, either through direct observation or through analysis of reliable archival data that preserves time ordering of events" (Poole & DeSanctis, 2004, p. 218). For each of the case studies, a combination of desk research and semi-structured interviews was used. As an introduction to both cases, an extensive review was carried out including policy documents, articles from magazines, web pages and weblogs, concept laws and research reports on the two cases. The documents studied for each of the cases are listed in appendix 1.

After the desk research was carried out, for the SBR case study twelve people were interviewed over a period of three months at the start of 2010, and two more in the summer of 2011. For the Omgevingsvergunning case study nine people were interviewed over a period of a year and a half, with a concentration of interviews between January and March 2010 and in the summer of 2011.² The interviewees were asked questions into the transformational objectives of the cases and the mechanisms undertaken, such as the formation of networks for realizing joined-up government. All interviews lasted between one hour and three hours, some of which were spread out over multiple sessions. At most interviews two interviewers were present and at a few one interviewer. This allowed the interviewers to compare notes and, in some cases, to interpret contradicting observations. In most cases, the interviewees were asked to respond to the case study description and evaluate the findings.

Interview data were gathered in a predefined format used by all interviewers to ensure internal validity. Before deciding on whom to interview a stakeholder analysis was performed to determine which stakeholders should be involved (these stakeholder analyses are part of the case descriptions in the next sections). Then, out of each stakeholder group at least one representative was interviewed to gain a balanced overview of all different perspectives on the cases. Using a snowballing technique, during the process, interviewees were asked to name useful respondents and on the basis of their recommendations, further invitations and interview requests were sent out. To validate the findings from the interviews with stakeholders, experts were

² These case studies were originally carried out as part of study for the Dutch board of administrative burden reduction (Actal) in 2010 (Janssen, M., Veenstra, A.F. van, Groenleer, M., Voort, H. van der, Bruijn, H. de, and Bastiaanse, C. (2010) "Uit het zicht: Beleidsmaatregelen voor het versnellen van het gebruik van ICT-toepassingen voor administratieve lastenverlichting". Adviescollege Toetsing Administratieve Lasten, The Hague). To update the findings from 2010 and to gather additional information that was useful for this study, a few extra interviews were carried out in 2011. For further details on the interviewees, see the Actal research report.

interviewed that are not direct stakeholders in the case studies. We especially asked the experts to give feedback on the case study description to find out if it presents a balanced overview of the cases.

For the purpose of clarity and to get a rich overview of the cases, the case descriptions are made up of a number of elements. These elements give structure to the case description and allow analysis on the basis of these different angles for looking at the case study. They also allow for the exploration of the theoretical concepts presented in the previous chapters. These elements are:

1. Origins and historical overview;
2. Objectives and ambitions;
3. Stakeholders and their main benefits, risks and costs;
4. Functionalities and main components of the IT involved;
5. As-is and to-be situations of architecture, business processes and information flows; and
6. Governance of the project.

These elements are included to investigate the outcomes and mechanisms of IT-induced transformation in the cases as well as the factors that influence the realization of these outcomes. In the remainder of this chapter the two case studies are described.

4.2 Case study 1: Standard Business Reporting (SBR)

Standard Business Reporting (SBR), the follow-up of the Dutch Taxonomy Project (Nederlands Taxonomie Project, NTP), is a government program aiming to standardize (financial) reporting of businesses required by law. Examples of such reports are tax filing and information provisioning to the central bureau of statistics. The ultimate goal of the SBR program is to standardize all reporting of businesses to the government, but it has singled out a few reporting processes to start with. The SBR program consists of implementing three components. Firstly, it creates a shared taxonomy defining the main elements necessary for reporting and their relations: the Dutch Taxonomy (Nederlandse Taxonomie, NT). Secondly, it uses a data markup language ensuring technical standardization: the international eXtensible Business Reporting Language (XBRL) standard. And thirdly, it builds an infrastructure for all information sharing, which is currently known as DigiPoort.

NTP was mainly concerned with the development of the NT. The NT comprises all concepts that are necessary for the reporting of small and medium sized enterprises (SMEs) and the Inland Revenue Service (IRS), the Chambers of Commerce (CoC), and the Central Bureau of Statistics (CBS). Furthermore, a consortium of commercial banks also developed a taxonomy (the Banking Taxonomy, BT) for its contact with companies in their role of credit suppliers. To facilitate the information exchange based on the NT and XBRL the development of a generic infrastructure is part of the program. However, at around the time that NTP was renamed into SBR, the use of NT/XBRL was found to be significantly less than expected. Therefore, large changes were made to the governance of the program, which led to an increase of the use of NT/XBRL. Currently, the national IT maintenance organization Logius is responsible for maintenance of the NT and DigiPoort, and for further developments. From 2013 onwards, the use of SBR will be obligatory for financial reporting of businesses.

By standardizing (financial) reporting, the program is expected to transform the process on multiple levels and into multiple dimensions – beyond merely standardizing

the current order of activities. The changes take place on multiple levels. The technology, business processes, organization, and governance are expected to change. This will, in time, lead to changes in the value proposition of businesses, as well as business process change within businesses and government organizations, leading to new business models. Besides changing the technical format of the reports and introducing a common taxonomy, it also enables the use of new forms of controls by the government. Therefore, the changes can be considered to be multi-dimensional. It is also a long-term process as it has taken place over several years and implementation is still ongoing. Thus, the SBR program can be seen as a case of IT-induced transformation.

4.2.1 Origins and historical overview of NTP and SBR

The NTP program set out to build a complete and integrated taxonomy for all financial reporting of businesses to the government. NTP was started in 2004 by the Ministry of Justice (responsible for the domain of annual reports of companies) and the Treasury (responsible for the fiscal domain). Shortly afterwards, the Ministry of Economic Affairs (responsible for the domain of statistics) also joined. Other parties that were involved from the start are XBRL-Nederland³ and the National Accountants Institute Nivra.⁴ The main advantage of a generic taxonomy is that the government provides uniform specifications. This means that for all their reporting processes businesses can use the same specifications. From the start of the project, it was clear that the gains would lie in creating such a common taxonomy rather than in using a common data standard. An expert meeting that took place in 2007, concluded: *“The largest gain to be expected of implementation of XBRL is that it is a catalyst for harmonization of definitions within the public sector.”* The focus, thus, was on standardizing the content (NT) and not the data format (the form, XBRL), although this was – naturally – a prerequisite for standardizing the information exchange.

In 2005 the first version of the taxonomy was ready and the first tests were carried out. The NT was, thereby, formally ready for use. The program aimed for widespread implementation in 2006 to ensure large-scale use in 2007. In May 2006 the Minister of Justice Donner was the first to officially register an annual report using the NT. To spur the use of the taxonomy and to confirm the joint effort of public and private parties, representatives from the intermediaries, software companies and public parties signed an agreement on June 9th 2006 to encourage implementation of the NT and the XBRL format.⁵ On April 5th 2007, also representatives of businesses, VNO-NCW and MKB Nederland,⁶ signed the agreement. The expiration date was set five years later, on June 9th 2011, but throughout this period, parties could join and sign the agreement.

In this agreement, a link was made between the NTP program and a decrease of the administrative burden of businesses. The promise of this decrease was mainly built on the development of a common process infrastructure. The idea behind this is that if businesses not only use the same taxonomy and the same data standard but also a single process infrastructure, large efficiencies can be achieved. Businesses in the Netherlands

³ A foundation set up to stimulate and spread the use of XBRL in the Netherlands. Members of the foundation mainly consists of accountants, representatives of the public sector and software companies.

⁴ Koninklijk Nederlands Instituut van Register Accountants (Nivra), which is the representative of the large register accountants (RA) in the Netherlands.

⁵ An overview of all organizations that signed the agreement can be found via <http://www.sbr-nl.nl/item/convenantpartners.html>.

⁶ VNO-NCW is the general representing body of businesses, MKB Nederland represents SME's.

will then spend less time and effort on their contact with the government. It was estimated that 350 million euros per year could be saved⁷ as a result of the introduction of a uniform manner (taxonomy, data standard, and infrastructure) of electronic reporting. The decrease of this burden would mainly originate in the use of an electronic infrastructure for all processes of reporting rather than in using the NT or the XBRL standard. According to the expert meeting in 2007, the establishment of a link between NTP and a decrease of the administrative burden was also a political decision. Diminishing the administrative burden of businesses was one of the key objectives of the government in office at that time.

The agreement made on June 9th 2006 consists of a number of actions to be undertaken by all parties. Public organizations would make sure that their processes would be ready to start working with the NT and XBRL. Intermediaries, such as accountancies, would facilitate their customers by making sure that the efficiency gains realized will be passed on. Software companies would develop accountancy software and financial software that supports data exchange in the XBRL format. And representative organizations, such as the representative of SMEs, agreed to promote and stimulate the use of NT/XBRL among their members. A final agreement was the development of a common infrastructure to facilitate the reporting processes. To enable actual data exchange between businesses and the government, a process infrastructure is necessary. This infrastructure set out to facilitate all reporting to the government, not just those reporting processes that are part of NTP. It used to be called common infrastructure (Gemeenschappelijke Infrastructuur, GEIN, in Dutch), but later switched its name to DigiPoort.

However, not all of these parties acted upon these agreements. The IRS already digitized many of their processes using their own format (bapi). Therefore, they were not initially willing to switch to another data format. The accountancies were often unwilling to pass on efficiency gains to their clients, as this would eliminate their potential gains from adoption. Instead, some intermediaries felt threatened by the use of SBR as they fear that they will go out of business when the information exchange is standardized and digitized. A situation emerged in which none of the parties moved forward while waiting for each other to act. Therefore, at the end of 2009, the program entered a new phase and changes to the governance of the program were made as it became the responsibility of Logius.⁸ The main task of this renewed start of the program was to make sure that the gains promised in the agreement would be achieved and the program's goals will be attained. By that time, the program had been renamed to SBR to reflect its shift in focus from creating a taxonomy to creating a common reporting process, including a process infrastructure. Logius now maintains the NT as well as DigiPoort.

On June 11th 2009, a second agreement related to SBR was signed: the vWia agreement.⁹ This agreement concerns a pilot project on simplified profit tax filing for SME's. It was not a large-scale commitment as the June 9th agreement was, but rather a smaller-scale example of how uniform reporting can benefit businesses. It, thus,

⁷ The realization of these 350 million euro's worth of budget cuts was estimated to be spread out over multiple years: 50 million in 2006, 300 million in 2007 and 70 million euro's in 2008.

⁸ Logius is the national maintenance organization, carrying out service management of the Dutch government's generic electronic infrastructure.

⁹ Shortened profit tax filing (verkorte Winstangifte voor de vennootschapsbelasting, vWia in Dutch) is a simplified, or rather, shortened form of the regular profit tax filing especially designed for SMEs to make use of XBRL. SMEs do not have to use the complete profit tax forms, but can make use of this simplified version.

represents an application of the XBRL-format and the NT for a specific reporting process. For SMEs filing their annual report represents a substantial task, as they have to send two different annual reports to the IRS and the Chamber of Commerce. The annual report is used by the IRS to calculate profit taxes, by the Chambers of Commerce to store in their register, and by banks for the assessment of credit applications. New legislation was created to ensure that SMEs now only have to publish a single annual report (their fiscal annual report, which was originally intended for the IRS): the 'bill co-incidence' ('Wet samenvat', BW 2:396). The bill allows SMEs to publish their fiscal annual report, where they first had to send a commercial annual report, to the Chamber of Commerce and the banks. Having to publish only one type of annual report decreases the administrative costs of SMEs. This pilot project also aims to stimulate the larger-scale use of SBR in the long run.

The vWia agreement also led to the development of an extension of the NT by a consortium of commercial banks for credit application and evaluation. Banks require additional information to the fiscal annual report to assess credit applications. On June 9th 2009 this consortium announced that it will be able to receive applications for credit using SBR by April 1st 2010 as part of a pilot. Banks could, as a result of receiving standardized applications for loans, handle these applications easier and process them faster. They, thereby, lower their transaction costs in the credit application process. It was estimated that the banks should be able to decrease the interest percentage for these clients by one percentage point for these loans as a result of implementing SBR. But again in this process, the question remains whether banks are willing to invest in process efficiency but then give away the profits to businesses. Many claim that the move of the banks to start working with XBRL will prove a major driver of the use of SBR, as the banks may, in time, may make the use of SBR for credit applications obligatory. The banking consortium uses a separate taxonomy (the BT), which is an extension of the NT. In time, it is expected that Logius will maintain several separate sub-taxonomies for the use of SBR in different sectors.

For the IRS the vWia pilot also presented the opportunity to combine the SBR program with one of its own programs aimed at changing their control process. It introduces a leaner form of control to be exerted on the tax filing process. This is called 'horizontal control'. In this type of control the process is designed in such a way that the work-flow and decision making automatically comply with relevant rules and regulations. It conducts several checks throughout the supply chain. Companies in the supply chain are required to build in these controls in their existing enterprise systems. This offers the possibility for the regulator to check whether a company is compliant with regulations, which reduces the regulatory burden on compliant companies. When put into practice, these companies are expected to save a lot of money. This form of control thus relies on agreements made with businesses upfront and only incidental checks at the end of the process, instead of having to control all tax forms that are filed. It relies on mutual trust between business and IRS and uses statistical methods and incidental checks on whether the accountants have compiled reasonable reports.

Throughout 2010 the use of SBR increased – finally achieving some of its projections – and on May 30, 2011 it was announced that using SBR for financial reporting will become obligatory from January 1st, 2013. Implementation of SBR is, thus, still in the try-out phase, in which only a handful of businesses submit their financial reports to government agencies using the XBRL-standard. Furthermore, only SMEs are currently supported by the NT; large companies are not yet within the scope of the program. The NT currently supports the following financial reporting processes: income tax, profit tax

(for different forms of businesses), international trade flow tax, VAT, and profit tax for SMEs as well as simplified profit tax for SMEs (IRS); annual reports (CoC); short-term statistics, investment statistics, and production statistics (CBS). Although the scope of SBR comprises all legally required financial reports just mentioned, the IRS and Chambers of Commerce are currently using the format only for a small part of their operations, while the CBS is not yet ready to work with XBRL.

4.2.2 Objectives and outcomes of NTP and SBR

The SBR program has two major objectives. The first is to standardize financial reporting and increase the quality of the data exchange. The second objective is to make the data exchange more efficient and decrease the administrative burden of businesses. Furthermore, as the program progressed, two further outcomes should be noted. The first is the emergence of the possibility to increase compliance by improving the quality of government controls on the financial reports. And a second outcome is the emergence of new business opportunities through business process change. Although these two outcomes are not explicit objectives of SBR, they became increasingly important and are likely to be outcomes of the SBR program.

Standardizing financial reporting to realize better data quality

The quality of financial reporting is expected to be higher when the NT and XBRL are used for the data exchange. When using a common taxonomy, greater clarity is obtained over the meaning of elements in the reports. A common data standard allows for automatic data processing, which decreases the chance of mistakes entering the data. Direct data exchange between the accountancy software of businesses and the systems of the respective government organization is thus likely to increase data quality. Data are captured at the source and they are labeled. This means that mistakes as a result of manual copying of data no longer occur, as data are copied automatically. Furthermore, this allows performing real-time checks for mistakes in the data. For example, when information submitted is incomplete or when numbers do not add up, the submission of reports can be rejected right away, resulting in a higher acceptance rate. Finally, providing businesses with a uniform set of specifications is expected to lead to more clarity for businesses.

Efficiency gains and the decrease of the administrative burden of businesses

While standardization is expected to increase the quality of the data exchange, the creation of a common infrastructure is expected to realize efficiency gains. Thereby, SBR is expected to diminish the administrative costs of businesses for their contact with the government. An example of this is the harmonization of the fiscal and commercial annual reports. This means that annual reports no longer need to be published twice but fiscal reports for the IRS can be re-used by the Chamber of Commerce and the banks. Another example is the expectation that the use of SBR in the banking sector will make the decision on whether to continue supply of credit worth less than one million euros a fully automated process, solely performed by IT – without any interference of an account manager or accountant. A third example is that intermediaries will spend much less time on gathering the necessary information, as this financial information will largely be generated automatically.

Although these efficiency gains can be a reason for businesses to use SBR for their financial reports, the notion of decreasing the administrative burden of businesses is

mainly political. By making it an explicit goal, the government put pressure on the program. Especially, because many of the decrease foreseen did not take place, or will take place at a later time than was claimed initially. Some accountants even claim that their initial investments are higher than their potential gains. For example, the filing of fiscal reports is now limited to the vWIA of SMEs. The director of one of the software companies making XBRL-enabled software: *"In 2006 the law was changed in order for small companies to be able to publish only their fiscal annual reports. The government, however, did not realize that some other parties are only interested in commercial annual reports."* Many of the efficiency gains are thus to be expected in the future. Some, often smaller, accountants, however, fear running out of business when financial reporting can be done in a standardized and digitized manner.

Furthermore, others (such as the intermediaries that were interviewed in this project) expect that the largest efficiency gains will not be made on the business side, but on the government side. Large-scale standardized tax filing, for example, is expected to ensure large efficiency gains for the IRS, while the CBS will be able to process and compare their statistics more easily. However, also the IRS claims that their investments are higher than their gains. They argue that they switched to digital tax filing for businesses already in 2005, based on a different data standard. Only switching standards does not represent a large gain in efficiency any more. The project manager of SBR-implementation from the IRS stated: *"For the IRS implementing SBR mainly requires investments, as our information exchanges are almost 100% electronic already. The reasons for the IRS to implement SBR is to increase the quality of the data exchange and create more and better collaboration among the organizations involved."*

All the potential efficiency gains, however, are tightly intertwined with the NT and the implementation of the process infrastructure. A Logius project leader: *"XBRL as such does not realize a decrease of the administrative burden, as it is about the way in which it is applied. An increase in quality leads to a decrease of administrative costs for the whole chain of organizations, but this can vary for individual companies."* Currently, however, both the infrastructure and the taxonomy are still under development. Although the basic NT is finished, it needs to be updated every year as well as extended to additional information exchange processes. And even though the basic infrastructure is realized, the DigiPoort interface does not support all information exchanges yet. Only when SBR is implemented for all financial reporting processes are most efficiency gains to be expected.

Smarter ways to ensure compliance

Furthermore, the use of SBR is expected to result in better compliance. This will happen in three ways. First of all, the automatic and standardized information exchange allows for the performance of a few easy checks on whether the tax forms that have filled out are complete and that no mistakes are made. A number of automated checks can be performed on financial data, allowing for early warnings of mistakes or irregularities. This allows controlling bodies to detect these mistakes or irregularities sooner or even rejecting submission of the data on this basis. Currently, such easy to detect mistakes cost the IRS a lot of time to detect and correct. Especially in the tax forms of SMEs many mistakes are detected, and correcting them takes a lot of time.

Secondly, the standardized way of information exchange provides opportunities for the IRS as it allows for automatic comparison and the detection of outliers of patterns. Although such checks do not have any legal basis yet, these are opportunities for the future, in which increased control and supervision of financial activities will become

likely. Furthermore, it is expected that the supervisors of the financial markets will be able to better assess the quality of risk assessments by credit issuing organizations.

And thirdly, and perhaps most importantly, in the future a new form of control for the IRS is likely to emerge. In the vWia tax filing process, it is expected that only tax forms will be submitted to the IRS that can be approved right away using 'horizontal control'. This new form of control by the IRS is based on an agreement between the IRS and businesses to form a relationship on the basis of trust. Horizontal control deals with input and output checks in a chain to see whether they add up. First, these newer forms will be introduced for physical goods such as importing agricultural products, as this is much harder to implement for financial reports and services. This is realized by giving each other full insight into their financial information – within the boundaries of the law. Within this context, the IRS only needs to check the quality of the tax filing compiled by an intermediary. As this has many advantages for the IRS, the organization, in turn, bestows some benefits upon the businesses that allow the IRS to perform such elaborate reporting, such as green lane treatment and less regular controls.

Besides this being only a development for the future, the IRS also has some questions regarding the effectiveness of horizontal control in specific situations. For example, in a situation where a company complies with the rules of horizontal control, but does not actually comply with the law. These situations still need to be resolved. Furthermore, this new form of control requires the IRS officials involved to be more specialized and educated. This means that they are likely to be paid more, and that they have to receive more training. Horizontal control is, therefore, only more efficient when a majority of the businesses are compliant.

New business opportunities and process reengineering

New business opportunities arise through standardization of financial reporting and the implementation of a uniform process infrastructure. When more and more businesses and government organizations start using SBR for their information exchange processes business models and processes are likely to change. This is likely to result in new business opportunities. For example, in time, it will also be possible to report non-financial data using SBR, such as data on insurances or inventory systems, and to allow for process integration crossing boundaries of individual companies. It will be possible, for example, to integrate financial software with inventory software that can be used to automatically, instead of manually, include data on the state of the inventory in the annual report. Adoption of SBR is thus expected to spur new initiatives and opportunities as increased standardization will allow organizations to invent new services and activities that were not possible before.

Both existing and new parties are expected to invent new services. So-called service providing organizations, for example, introduce information exchange platforms based on SBR to facilitate the information exchange between a business and an intermediary, such as an accountant. By introducing these process changes and new business models, in time, new profitable services may emerge that will change the whole landscape of the intermediaries. According to the Chairman of the Standardization Board: *“Large budget cuts in private parties as well as in the public sector become possible [by implementing SBR]. This already happened in other European countries.”* A related opportunity is the use of SBR for benchmarking. Standardization allows easier comparison of data, for instance between companies within the same sector. It is expected that reinventing the processes of financial reporting will result in large changes for the whole sector. While

some intermediaries and service providers see this as an opportunity, others mainly see it as a threat to their business.

4.2.3 Stakeholders

The stakeholders involved in the SBR program are shown in figure 4.1.

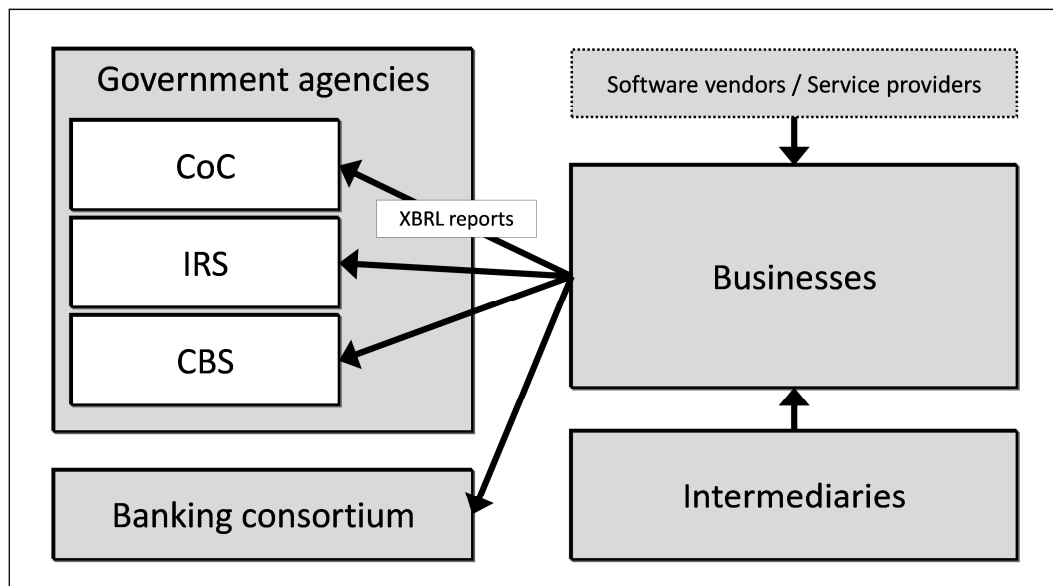

Figure 4.1: Simplified overview of the stakeholders involved in SBR.

First of all, the public organizations that are on the ‘receiving’ side are stakeholders: the IRS, CoC and CBS. The second group of stakeholders is the banking consortium, consisting of ABNAMro, ING and the Rabobank. A third group of stakeholders is the group of intermediaries, mainly comprising accountants. The fourth group of stakeholders consists of businesses obliged to report their financial situation to the government. The software companies developing (financial) software for businesses and intermediaries supporting XBRL data form the fifth group. A final group of organizations are the so-called XBRL service providers. These are those organizations (and in some cases they can also belong to the group of software providers or the group of intermediaries) that deliver services to support the processes of financial reporting. The fifth and sixth group of stakeholders will be largely left out of this stakeholder analysis, as their role is not so important for the investigation of IT-induced transformation. Each of the groups is discussed in more detail.

Government organizations

The public organizations involved will use SBR for their operations that are concerned with processing the financial reports of businesses. The organizations that are currently part of the SBR program are the IRS, the Chambers of Commerce and the CBS. It is widely believed that these organizations have a great incentive for implementing SBR, as standardization and automation of their data exchange with companies will make business processes and data processing much more efficient. According to the expert

meeting that took place in 2007: *“There are many advantageous effects for these public agencies: for the automation of government processes XBRL will be a huge cost saving.”*

Of the three organizations taking part in the program the IRS is currently the organization that is most expected to gain from SBR. But the organization also needs to make large investments to replace its current software with software based on XBRL. It has invested large amounts of money and time into enabling the electronic filing of taxes by businesses, which became obligatory on January 1st 2005. As a result, many of the gains to be made by automating and digitizing its business processes were already made when implementing these systems. The IRS, but also intermediaries and business, see therefore less of a gain than in some other countries that had not yet automated the process of tax filing. Now, the main changes are on the software level, not on the business process level. Still, to allow for further standardization and the implementation of newer forms of control also the IRS sees gains from implementing SBR.

All three public organizations involved are still in the early phases of SBR adoption, although its use becoming obligatory for filing income tax on January 1st, 2013, is likely to spur developments greatly at the IRS. The CBS is not yet ready to work with SBR. In the future, other government organizations are expected to join the parties currently involved in SBR.

Banking consortium

The banking consortium currently consists of three banks: ABNAmro, ING and Rabobank. The banks have joined the SBR program to increase their efficiency in the field of credit supplies and lending. According to an interviewee from a bank, it is expected that the use of SBR in the banking sector leads to greater efficiency as some activities of the bank such as credit issuance can be performed solely by IT without any interference of an account manager or accountant by implementation of a predefined format. The request of information from businesses will be carried out fully automatically by standardized protocols determining whether to accept or reject credit applications. It has been calculated that, for example, banks could offer organizations using SBR for submitting a credit application one percentage point discount on their interest percentage.

Generally, the banking consortium is expected to benefit from implementing SBR in a number of ways: operations such as the assessment of credit issuance will become more efficient, standardization of data will enhance the quality of this credit assessment, a better overview of the actual financial situation of businesses can be gained, and supervision of the financial sector will become better as it will be easier to assess the credit issuance processes. This will also make it possible to hold individuals accountable for decisions. But, for the banks to make these changes to their processes, they need to have enough incentives to do so.

The banking consortium developed its own taxonomy and process infrastructure instead of using the NT and the generic infrastructure. By 2012 they expect to that 80% of information exchanged with SMEs will be electronic using SBR. Therefore, in the words of one of the interviewees at the one of the banks: *“The adoption of XBRL by banks could function as accelerator for persuading businesses to start using the standard.”* The banking consortium has declared that they will not keep their taxonomy and infrastructure exclusively for themselves, but open it to other banks as well.

Intermediaries

The intermediaries mainly comprise accountancies. These accountancies have several ways of using SBR in their business:

1. For publishing legally required annual reports;
2. For simplified tax filing;
3. For credit reports; and
4. For benchmarking and giving advice.

The group of accountancies is quite diverse. There are a few large international accountancies and many smaller companies operating locally. Using SBR can make the work of accountants more efficient as they need to carry out fewer tasks and create fewer reports. According to one of the interviewees, working at a major accountancy: *“Now we use around 50% of our time for gathering data and around 50% for our core business, which is compiling reports and giving advice to our customers. When SBR is fully implemented, we expect the former percentage to drop to around 20% of our time, leaving much more time for doing our core business. We, thus, expect that we can get more work done when SBR is fully operational. Furthermore, we expect that we can use SBR to expand our activities by creating new business opportunities, such as benchmarking”* (Senior manager of PWC, a large accountancy firm). An accelerated effect may appear when auditing software can be linked to or integrated into the XBRL software, enabling better and faster data checks. A model of continuous auditing can, then, be introduced, with more checks performed automatic.

The consequences for accountancies are thus expected to be large: “XBRL is about your [accountancy] office and specifically about the question whether your office will remain relevant where it concerns the collection and composition of financial information”.¹⁰ But the consequences of the implementation of SBR, however, may be different for the different types of accountancies. The large accountants claim to see many opportunities to expand their business, while the smaller companies often feel that their core business, which is gathering data and compiling financial information, is threatened by becoming automated.

As it is no longer necessary to spend time on gathering data when it can be processed automatically, especially the smaller accountancies fear a loss of work. They often consider SBR to pose a threat to their business. *“Three hundred of the eight hundred jobs in the business of compiling and publishing annual reports will disappear. This will be especially damaging for the smaller companies that see less opportunities to change their core business to consulting”* (Senior manager at PWC). In the original agreement to spur implementation of SBR it was foreseen that the intermediaries would be able to cut their costs and pass on the benefits to their customers. But as accountancies feel threatened, this may not be happening in practice, as they may not be willing to pass on the efficiency gains that SBR will bring to their customers.

For all accountants working with SBR will mean that some of their activities will change radically. Currently, intermediaries compile a financial report that is, subsequently, checked or ‘validated’ by its ‘face-value’ – its quality and reliability on paper (also when it is, for instance, a digital .pdf file). XBRL-documents, however, are not the same as these full annual reports currently published, but a collection of all necessary data in XBRL-code. Giving the approval (‘accountantsverklaring’) is, therefore, not possible in the current manner. Therefore, among accountants an important

¹⁰ Accountancy Nieuws, May 30 2008.

discussion point is how to be able to give the ‘assurance’ that the XBRL-files are correct. Discussions on how to solve this have pointed at possibilities of giving assurance on the data-level instead of on the current document-level, but also very different approaches comparable to the horizontal control of the IRS are discussed. Furthermore, electronic authorization and delegation are being considered.

Businesses

For businesses having to report their financial data to comply with regulations, SBR presents mainly ‘just another’ set of regulations to comply with. Currently most organizations employ intermediaries for publishing their financial reports and therefore it is expected that the introduction of SBR will not change anything for them. *“For publishing their annual reports and filing their taxes, 95% to 99% of the businesses employ an intermediary. SME’s will, thus, not start using XBRL themselves to create these reports,” according to the website Accountant.nl.*¹¹ For these businesses, no clear improvements in the work processes will likely manifest themselves.

They will, however, possibly notice the introduction of XBRL and NTP by having to make an effort enabling their intermediaries to use SBR for financial reporting. For instance, they may need to label their financial administration differently (once). In case the company’s labeling of the financial administration differs from the NT, a business needs to ensure that the two can be linked. This will also allow the IRS to monitor much more closely the transactions of these businesses. To enable these controls, the business will also have to code (‘tag’) their transactions. In practice, this may be done by software providers for their customers. In the longer run, however, some estimate that a business will spend 30% less on its accountant as a result of implementing SBR. According to the CEO of a software company, *“entrepreneurs, accountants and accountancies will not see much decrease of the administrative burden. First they will have to invest. Later the advantages will be the savings in time.”*

Service providers

It is expected that the introduction of SBR will lead to new services being offered by third parties to businesses. This group of stakeholders is not yet clearly defined. Intermediaries are expected to move into this ‘service provisioning’, but also new parties can set up services, such as software companies developing software based on SBR. An example of the former could be that accountants will provide additional services to businesses besides checking and making up the annual reports. An example of the latter could be that software providers build in new integrative functions into their software. Furthermore, service providers may start forming data exchange platforms for communications between businesses and their accountants. The group of XBRL service providers is thus a heterogeneous group. The service providers have in common that they deliver services to the chain of financial reporting, but this can take place in multiple ways.

4.2.4 Technology

XBRL data format

eXtensible Business Reporting Language (XBRL) is a data format that can be used to standardize the exchange of financial reports. This standard is based on eXtensible

¹¹ www.accountant.nl, January 15th 2008.

Markup Language (XML), which is a set of rules for electronic data encoding, widely used for data exchange over the internet using web services. XML has served as the basis of hundreds of more specific languages for data exchange in many domains. XBRL was developed for financial reports and it is now the international standard for financial data exchange. To be able to use the XBRL data format (the technical standard) it is also necessary that the organizations exchanging data give the same semantic meaning to the information that is exchanged.

XBRL is an open standard, meaning that its specifications are freely accessible. The format is developed by XBRL International, an organization aimed at the development of XBRL. What is referred to as XBRL consists of three elements: a taxonomy, an instance document and a style sheet. A taxonomy, comparable to a dictionary, is a collection of definitions ('tags') that need to be reported. It does not have a formal link to the technical format of XBRL and new taxonomies can be developed freely. There are some internationally used taxonomies,¹² some of which are also incorporated into the NT. As financial reporting requirements change over time as a result of changing legislation, taxonomies also change. Maintenance of the taxonomy is, therefore, of great importance and is currently done by Logius. Logius is concerned with publishing new versions of the NT, as well as with maintaining the current version.

The instance document is a digital imprint of data that refers to a definition in the NT. This is, thus, an instance of financial data. Software applications can digitally read this report. The style sheet is meant to publish the instance documents in a for humans understandable manner. It is used to put a lay-out on an instance document, making a financial report look exactly like the current financial reports on screen as well as on paper. This is, thus, a tool to visualize a financial report based on the XBRL data format. Style sheet also make converting the XBRL-files into other formats (such as .pdf or HTML) possible.

Software

XBRL-based software will need at least seven basic functionalities:

- Reading the taxonomy;
- Building and extending the taxonomy as well as maintaining these extensions;
- Mapping reports to the elements within the taxonomy;
- Creating an XBRL-report (instance document);
- Checking ('validating') whether the report is created according to technical and content-related demands;
- Sending the XBRL-report and keeping track of the report at the same time (the audit trail); and
- Presenting the XBRL-report in a for everyone readable manner (the style sheet).

The place where the tags are labeled and maintained is important for the way business processes will change. For longterm benefits, the tags need to be interoperable with the financial administration and with other software packages, to allow real-time generation of XBRL-documents. To allow for these tags are, thus, best maintained within the financial administration, even though SBR does allow the creation of XBRL-documents after a compilation of financial data has been made.

¹² Examples are IFRS and US GAAP, of which NL GAAP is the Dutch version.

Process infrastructure

To support the technical data exchange between businesses and public agencies a generic process infrastructure was developed and maintained by Logius. This infrastructure (based on SOA) transfers documents from a supplying party to public agencies using Digipoort. Digipoort (formally known as Overheidstransactiepoort, OTP), is the generic interface for all large data transactions of other parties to the government. Digipoort is also maintained by Logius. Before the report is sent authentication, authorization and validation services can be called on. The process infrastructure keeps track of the status of a report within the process. This status information can be accessed by businesses to check whether a report was processed properly. In case it was not processed properly, the cause can be asserted (for instance if the information was sent without the right authorization).

Between August 2005 and January 2007, the requirements (definitief Programma van Eisen, dPvE) for the process infrastructure were developed, listing those functionalities that have to be realized to be able to exchange data on legally required financial reports based on the NT. These functionalities are developed independently of the NT, ensuring the possibility of re-use. The process infrastructure consists of four components: the process service, the server bus, the services and the portal. The process server takes care of the control of the processes and ensures that the services are activated at the right moment. The service bus transports the information flows between the businesses or their intermediaries and the government agencies that require the financial reports. The following services, which can be activated by the process server, are provided in the process infrastructure:

- Supply service: supplying the financial reports to the government organizations;
- Verification service: checking whether the supplier (business or intermediary) uses a valid certificate and whether the supplier is indeed a delegate for the business supplying its data;
- Validation service: checking whether the report is complies with demands of XML, XBRL and the NT;
- Retour service: offers government organizations the option of supplying return information;
- Status information service: offers information on the status of processing the financial reports;
- Return status information service: offers information on the status of the return information;
- Validation service: one or more ‘validators’, applications checking XBRL-documents for technical aspects.

The portal enables supply of XBRL-documents and gaining insight in the status information.

The NT and its maintenance

In the Netherlands, the development of the NT has become central to the adoption of SBR. Thereby, the SBR program allows not only standardization of the data exchange format (XBRL) but also of the definitions of the data itself (the NT). The data that businesses are required to fill out used to be determined solely by the public agencies businesses need to report to. Within SBR, these definitions are captured in the NT. The quality of the NT is, however, contested. One of the interviewees stated: *“The degree to which these financial reports can be created having sufficient quality to comply with the*

law using the Dutch Taxonomy is contested” (Implementation manager Logius). Furthermore, the current policy is to enable parties to develop taxonomies freely. The main advantage of this freedom is to enable as much parties as possible to enjoy the benefits that standardization and integration of information systems offers by implementing SBR. But on the other hand it poses a risk to the current users and to the degree of standardization, as different taxonomies may, again, use different definitions. This will lead to multiple taxonomies being used in parallel.

4.2.5 Business processes and information flows

For compiling legally required financial reports using SBR, businesses usually send their financial data to their intermediary, or, perhaps, to a SBR service provider (which may be the same organization), using XBRL-enabled software. In some occasions, the businesses themselves deliver their financial reports to the government organizations, but this likely accounts for less than 5% of the information submitted. The intermediary or the service provider, then, compiles the right data format and publishes the reports to comply with regulations. After authentication is confirmed, data can be sent from the intermediary or the service provider to one of the public agencies (IRS, CoC, or CBS) using the generic process infrastructure. A generic overview of the information exchange is presented in figure 4.2.

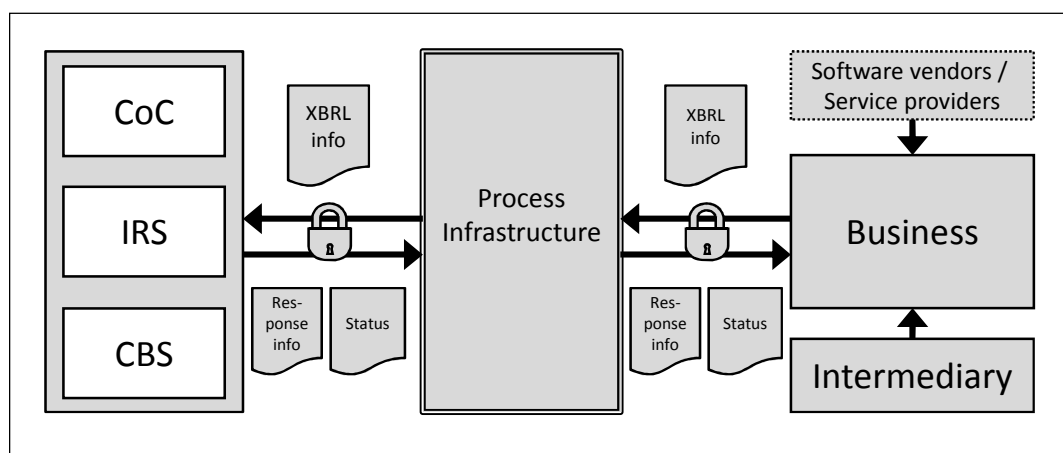

Figure 4.2: Generic overview of the information exchange in SBR.

4.2.6 Governance

The representatives of the government agencies that will be at the receiving end of the XBRL messages at the central government level, the Ministries of Finance, Justice and Economic Affairs, make up the group of organizations that are formally responsible for the implementation of SBR. They have signed the agreement and set up and funded the NTP and SBR projects. At the end of 2008 the budget for implementing the program was 22.4 million euro. Between 2004 and 2008 the role of the steering group was quite modest, leaving much of the development of the NT and the implementation of XBRL to the project implementation.

After 2009, the governance of the project changed as Logius became responsible for the SBR program, and at that time, after it was feared that many of the objectives of the SBR program would not be met, the steering group became more involved in the project. One of the main problems of the project until 2009 was that a number of innovative aspects were implemented at the same time. The project leader of SBR implementation at the IRS: *“The SBR program was mistaken in the complexity of the program. The NTP tried to achieve too many gains at the same time; the objectives were piled upon one another. It is necessary to reduce the number of innovations or to implement them phase-wise, and not all at the same time.”* Since the changes to the government structure in 2009, the use of SBR has greatly increased and in 2011 the decision was made to make SBR obligatory on January 1st, 2013, for the filing of income tax. This decision is likely to have a great impact on implementation.

Currently, the steering group having decision making authority roughly consists of three levels: the council, the platform, and the expert groups. The SBR council (SBR Beraad in Dutch), in which all main parties from the side of the government (Ministry of ELI, Logius, IRS), the representative bodies of businesses (representative body of businesses, representative body of SMEs), the banks, and several representative bodies of the intermediaries, is the highest decision making authority on SBR. On a daily basis, the SBR platform is responsible for the link between the SBR council and the expert groups and it is responsible for the progress of the SBR program. The expert groups are specialized groups that give advice on three topics: data, marketing-communication and processes & technology.

Logius, which maintains the NT as well as the process infrastructure, is responsible for maintaining the IT-related building blocks that make up the national e-government infrastructure once they are developed. It is a public agency under the responsibility of the Ministry of the Interior and Kingdom Affairs. Furthermore, as a result of this role, they have become responsible for the implementation process, such as the development of a mechanism for updating the NT, which is a condition for adoption of the taxonomy, and a project team was set up for this purpose. One of the actions that was undertaken by Logius to spur SBR implementation, was to have the XBRL data standard put on the *‘use, or explain’* list of standards of the Dutch Standardization Board. The standards that are on this list need to be applied to governmental IT-projects of over 50.000 euros (the threshold for public procurement projects), or it needs to be explained to the Standardization Board why a different standard was chosen for a specific project.

4.2.7 Transformational objectives and mechanisms

This case study described the different aspects of the SBR program, which is an effort of IT-induced transformation. To give an overview of the objectives, mechanisms, and factors involved, the model of IT-induced transformation is used (see figure 4.3). On the left side of the model the manifestations of the four transformational mechanisms are shown and on the right side the outcomes per transformational objective are presented. In the next chapter the transformational mechanisms and objectives, as well as the factors influencing the transformation process will be discussed and elaborated.

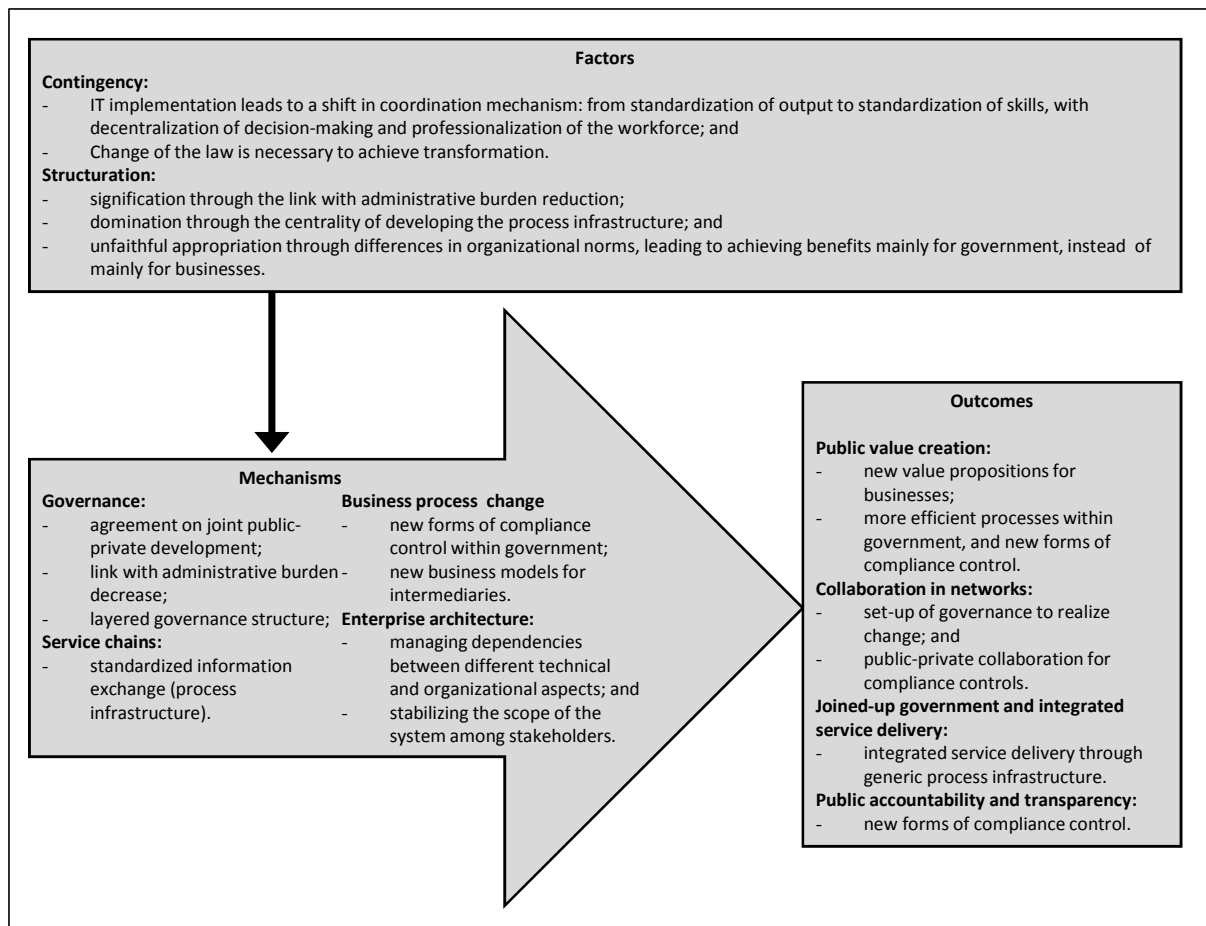

Figure 4.3: IT-induced transformation in the SBR case.

4.3 Case study 2: Omgevingsvergunning ('environmental permit')

The Omgevingsvergunning case study concerns the introduction of a new law (Wetsvoorstel algemene bepalingen omgevingsrecht, Wabo) which replaces around twenty-five permits in the area of living, spatial planning and the environment by one single permit. The idea is that such an 'umbrella permit' will realize efficiency gains (administrative burden reduction) for the citizens and businesses that apply for such permits. Instead of having to apply for all of them separately, they now only have to apply for only one: the environmental permit (Omgevingsvergunning in Dutch). The separate permits all concern actions undertaken in the 'living environment', hence the name of the new permit. Examples of permits that are comprised in this law include the construction permit, environmental permit, exploitation permit, driveway permit and the permit for cutting of trees.

The introduction of this law is carried out by the Ministry of Housing, Spatial Planning and the Environment (Ministerie van Volkshuisvesting, Ruimtelijke Ordening en Milieu, VROM, which changed its name into Infrastructure and Environment, Infrastructuur en Milieu (I&M) in 2010¹³). But also other permits concerning the living environment

¹³ This Ministry was merged with the Ministry of Traffic and Water Management in the Fall of 2010 and this merged organization was called the Ministry of Infrastructure and the Environment (Ministerie van Infrastructuur en Milieu in Dutch, I&M). As the main part of this program was carried out by the 'old'

issued by municipalities and provinces, or in the area of monumental care and nature preservation, which are not the responsibility of VROM, are taken up in this joint permit, to increase efficiency gains. Thus, multiple organizations, as well as multiple levels of government, are involved. Joining these permits into one comprehensive permit allows this permit to be requested, handled and issued at once, at one organizational level: the municipalities.

To realize further efficiency gains, the introduction of this law is linked to the development of a portal for requesting this joint permit online. This portal is called the environmental portal online (Omgevingsloket Online, OLO). Although all municipalities have access to the portal by e-mail, many do not connect their systems directly to the OLO. It is not obligatory to use the online portal for permit requests, as they can also be made on paper. The joining up of the permits and the use of the portal both aim at making the permit requests easier for the applying parties as well as for the municipalities and at achieving efficiency gains. The Omgevingsvergunning case can thus be seen as an instance of IT-induced transformation as it aims for multi-level and multi-dimensional change over a longer period of time.

4.3.1 Origins and history of the Omgevingsvergunning

The idea to integrate the many different permits that aim to regulate the direct environment of citizens and businesses originated at the Ministry of VROM in 2003 as part of the program to decrease the number of VROM laws and regulations (the Modernizing VROM regulations program). In 2006, the set-up and implementation of the Omgevingsvergunning was decided upon by the Minister. Although the permits of different government levels, such as the municipalities and the provinces, were included in the Omgevingsvergunning, the project was initiated and led by VROM. Joining-up activities from these several government organizations by including around twenty-five different permits for which around 2600 different forms exist, is expected to result in more client-centered service delivery.

This joining-up is not limited to the permit itself, but also to the infrastructure for the permit request. This that citizens and businesses will be able to use a single portal for filing the permit request, and that the request will be processed according to a single procedure after which the applicant receives a single legal decision. This means that municipalities will now also perform the intake of permit requests for which they are not the authorized party to decide upon the permit request. Therefore, the introduction of the Omgevingsvergunning will result in some shifting of tasks between government organizations involved, across governmental levels. The introduction of the Omgevingsvergunning is also followed by the a new way of controlling the regulations concerning the living environment: within newly set up regional executive agencies. This means that not only the requesting of permits, but also the control of regulations concerning the living environment will be done in a joined-up manner including multiple organizations.

Originally, the starting date of the Wabo was aimed to be January 1st, 2008, but it was delayed several times in both the Second and First Chamber of Parliament until October 1st, 2010. A first version of the new law was sent to the Second Chamber on October 18th,

Ministry of VROM, this old name of the Ministry will be used throughout most of the case description before 2010. Only when this case study refers to actions undertaken after the merger, the name I&M is used.

2006 and the final version was finally approved by the First Chamber on March 23rd, 2010. The process thus took around three and a half years. The reasons for these delays included that the legal framework was considered insufficient and the elections that took place in the meantime meant that the discussions on the bill in Parliament were postponed until a new government was formed. The main problem, however, was the readiness of the OLO. In the Wabo bill, the Wabo was linked to the OLO, ensuring that the technology would have to be ready before the bill could be passed. This turned out to be a main discussion point for the Members of Parliament in both Chambers.

As part of the process, from 2006 onwards, pilots have been carried out within municipalities and provinces covering different aspects of the Omgevingsvergunning. These pilots aimed at testing the changes in business processes and the technology of the OLO. For example, some municipalities tested the necessary changes in the business process of municipalities to support the permit requests online. These pilots were to be reported on in 2007, so their results could be used for supporting the decision to implement the Wabo. To determine the scope and outlook of the OLO, the different government agencies involved were invited to provide input on the design of the portal. They, however, desired very different things. While the provinces wanted a full portal to create one place to communicate with all municipalities, many municipalities initially only wanted a thin form for the permit request. Also some other municipalities wanted complicated synchronization modules to be able to remain working with their own systems.

As a result of the political process, the pilots that were carried out, and the diverging wishes and negotiations between the different government organizations involved, the scope and the function of the OLO changed several times during the project. First, it would only include a form for filling out a permit request. Over time, this developed into a decision tree structure in which also process information was included. However, this led to the project becoming unmanageable after which the scope of the project was downsized again to only include a 'permit check' for checking whether and which permits are required in a specific case, and a mailbox in which information can be stored that can be viewed by both the requesting party and the government. Furthermore, some changes were made to the design during the process. For example, the possibility of dividing large construction projects into several smaller projects for which different permits are requested was added as some large projects do not know at the start yet which permits they will need to request over time. Municipalities can still choose whether to use the OLO or not, as it will also remain possible to file permit requests on paper.

Since January 2010 the beta version of the OLO is operational for provinces and municipalities. All of them are already linked to the this version to be able to practice with the technology and the new ways of working. Also in this phase some improvements have been made, and since then several newer versions have appeared that included these improvements. *"Provided that the information technology works, the Wabo can be implemented on July 1st, 2010"*, according to the Minister. In June 2010, however, it was decided by the Minister and the representing bodies of the municipalities and the provinces to make October 1st of the same year the starting date, to give them some more time to prepare for the implementation. On October 1st 2010, the Wabo was finally implemented. However, many municipalities can still only take in permit requests on paper. Even though they have access to the OLO, these municipalities do not use it for the actual permit processing.

The implementation of the Wabo and the OLO is accompanied by a new way of joined-up controls of whether regulations are followed. Although it is not part of the Omgevingsvergunning project, it has strong links to it. These new controlling agencies are called regional executive agencies (regionale uitvoeringsdiensten in Dutch, or ruds), that will become responsible for compliance controls of all laws and regulations in the living environment. The idea is that when all the activities of the multiple governmental levels are joined up, controls will be easier and more complete, and potential discrepancies or contradictions will be overcome. Implementation of these ruds is still ongoing, and not all provinces (that are responsible for the implementation) are ready for implementation.

4.3.2 Objectives of the Omgevingsvergunning

The objectives of the Omgevingsvergunning foremost aim to make the permit requests of citizens and business easier and thereby cheaper and faster, decreasing their administrative burden. The project leader at VROM: *“Central to the project is the value that it delivers to clients no longer having to fill out multiple permit requests.”* At the same time, the objectives also aim to make the government more efficient. Except for the objectives of decreasing the administrative burden for citizens and businesses, realizing efficiencies within municipalities, and decreasing the lead time of the permit request, another outcome can be identified. Implementation of this joined-up permit request has spurred new ways of controlling compliance with regulations. All four elements are discussed in this section.

Decrease of the administrative burden

The Ministry of VROM estimated the environmental permit to realize a decrease in the administrative burden of around 130 million euros for citizens and businesses: 105 million for businesses and 25 million for citizens every year. Also it is estimated that around 18.000 hours of administrative burden for citizens will be diminished every year.¹⁴ This is to be realized by joining up and by digitizing the permit requests; instead of having to fill out multiple requests, now, only one needs to be filled out, and this can be done online. This is expected to be more customer friendly by reducing the amount of paperwork for the permit requests. In the future, the efficiencies achieved by the municipalities may lead to a decrease in the handling fee that needs to be paid to the municipality for the permit request.

A representative of *Bouwend Nederland*, the organization representing the construction companies in the Netherlands, expects that some of these gains will be achieved, but not all of them. *“The advantage of the use of the OLO can be seen for about 80% of the permit requests. The use of OLO for the other 20% is irrelevant, as a result of the complexity of these requests.”* This view is confirmed by a representative of a large (infrastructure) construction company: *“The Wabo will have an advantage for the ‘static projects’ having a clear scope and timeline. It offers the advantages of uniform procedures, a streamlined process and the opportunity of comprehensive controls. The administrative costs for projects of architects and smaller project developers will have a definite positive effect as a result of the reduction of the lead time from twenty-six weeks to a maximum of eight weeks after receiving the request within which a municipality has to decide on*

¹⁴ <http://www.rijksoverheid.nl/onderwerpen/omgevingsvergunning/nieuws/2010/06/01/definitieve-invoeringsdatum-wabo-1-oktober-2010.html>.

whether to give out the permit or not. For the more complex and dynamic projects it remains to be seen whether any costs can be reduced.”

Another issue that remains, is neither the municipalities nor the technology were ready for implementation. The representative of the construction company: *“Extra time was necessary for the process of defining laws and regulations more carefully. At the start of the process, the definition of the Wabo was not set clearly. Later on the delays came about as a result of the practical working process not being translated into laws. Still, some aspects of the law are not yet well defined. These may be implemented in OLO and in hindsight it can be determined by a judge whether this was according to legislation.”* A related issue was that in the Wabo bill the link was made with the OLO. This means that Parliament could only pass the bill when it was clear that the technology would be ready for implementation. The problem was, however, that it was virtually impossible to determine what it means that the technology is ‘ready’. Newer, and better, additions can always be made.

Efficiency gains at the municipal level

The Omgevingsvergunning and the joined-up, comprehensive way of handling permit requests also aim to realize a more efficient way of working within municipalities. The project manager of large municipality describes how the Wabo is seen by his organization as an instrument for the wider implementation of digital service delivery. *“It is part of the migration to electronic service delivery such as through the use of digital forms.”* However, some questions remain on whether the changes are not too many and too large in scope for the municipalities to be implemented. The representative of *Bouwend Nederland*: *“We need to be prepared for troubles with the IT and in changing the culture that may last for at least three years and it remains to be seen whether the expected decrease of administrative costs will be achieved. The past has also taught us that municipalities are not willing to reduce the handling fee to be paid when efficiencies are realized.”*

In the majority of municipalities, however, the OLO is still not used (permit requests are still done on paper) and if it is used, often documents are printed in the back office, thereby not resulting in any efficiencies in the process of municipalities. A related issue is that municipal officials may not be sufficiently trained for the new situation and that organizations are not ready to implement the OLO in such a way that it will be beneficial for their organization. The representative of the construction company: *“Extra training may need to be given to officials at the municipalities to deal with the complex permit requests. Another option is to leave part of this to the expertise of the large building companies that often request permits and, thereby have a lot of experience.”* Amsterdam is an example of a municipality where large-scale training, using a ‘Wabo-cockpit’ is provided.

Another issue related to joining-up permit requests is that it will be difficult to determine which permits have to be requested upfront. Sometimes, during a construction process, new issues emerge that need to be dealt with, such as the discovery of endangered species living in a specific area. A representative of a mid-sized municipality is concerned: *“Both the situation that constructions are halted halfway because of the discovery of an endangered species and the situation that research needs to be carried out before each permit request are undesirable.”* Other municipalities, however, find that the law does not change anything. The representative of a large municipality: *“What is going to change? Instead of ten decisions, we now put a staple through them and call it one legal decision. A lot is being implemented, but the number of*

people benefiting is quite small. It would have been better if laws would have been deleted or made simpler and if all municipalities would charge the same for a permit request. Those aspects would mean much more for our clients.”

Faster decision making

Furthermore, the procedure of filing and handling the permit is expected to shorten, as the lead time of issuance will now be equal to the lead time for one permit, instead of the separate (and often differing) lead times for the different permits. Another advantage for customers is that all permits can be requested at once, at one organization, using one procedure, even when multiple government organizations perform the role of decision-maker. However, this advantage also has an inherent disadvantage, as it means that the requesting parties will need to hand in all permit requests at once. This may mean that more administrative costs will be made for a permit request that is not approved. Therefore, it is possible to divide a building project into several phases, and request permits accordingly. According to a representative of *Bouwend Nederland* this also means that the requesting parties may be expected to change their culture and become more precise in their requests. Otherwise, the time gains may not be achieved at all. A related issue is that businesses will take more time to prepare their requests, involving also municipal officials. In this case, while the official lead time of the permit request shortens, the total lead time will remain the same as a shorter official lead time may mean extra time for the preparation of the permit request, in which also the municipality takes part. Thus, whether gains are expected to include a faster decision time in practice thus remains to be seen – especially for the complex cases.

Better compliance with regulations

In 2012 ruds are expected to take over the control of whether regulations are followed properly. Municipalities, provinces and water boards cooperate in these ruds on the control of compliance with regulations concerned with the living environment. This is expected to also make the controls more efficient, as inspections on the multiple regulations from the different government levels can be joined up. This is meant to ensure a higher quality of both the control and permit processing processes, as a result of better and more precise criteria and responsibilities for controls providing them with a legal basis. Although this is not part of the Omgevingsvergunning program (and thereby not an explicit objective), it can be (partly) seen as an outcome of the implementation of the Wabo. The joining-up of the front office has thereby given rise to the need for also joining-up the back office of the permit compliance controls.

4.3.3 Stakeholders

Multiple stakeholders are involved in implementing the Omgevingsvergunning. First of all these include the government organizations that are responsible for implementation and for processing and handing out the permit requests: the Ministry of VROM/I&M, the provinces, and the municipalities. The latter will also become the responsible government party for the intake of the permit requests on behalf of the other government organizations. On the side of citizens and businesses, also architects and builders can be involved, as they may be the ones, in practice, to carry out the permit requests for their clients. Official responsibility for the permit requests remains with the citizens and businesses. An overview of the stakeholders involved in the OLO that is developed for the joined-up permit request is shown in figure 4.4.

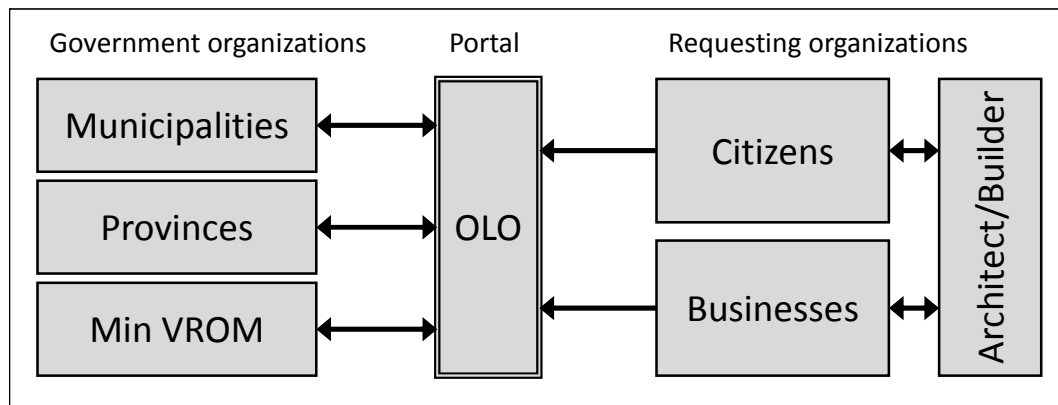

Figure 4.4: Overview of stakeholders involved in the Omgevingsvergunning.

Ministry of VROM/I&M

This Ministry was responsible from the beginning for the implementation of the Omgevingsvergunning. It outsourced the development of the OLO to an external supplier. After implementation, the Ministry also remains responsible for issuing certain permits in the living environment, such as the permit requests that relate to any land used for military purposes. Similarly, the old Ministry of Traffic and Water Management (now merged with VROM into the Ministry of Infrastructure & the Environment, I&M) is responsible for commissioning all permits related to water, and the old Ministry of Economic Affairs (now merged with the Ministry of Agriculture into the Ministry of Economic Affairs, Agriculture and Innovation, ELI) for all requests related to mining activities. These Ministries retain these responsibilities, but now the intake is taken over by the municipalities that need to coordinate their actions with the Ministries. Naturally, the permit requests that are the responsibilities of Ministries are those that are rarely requested, unlike those that are the responsibility of the municipalities.

Municipalities and provinces

The municipalities will act as the representatives of the government that are responsible for the intake and the handling of the permit requests. They are responsible for all standard requests, while the provinces are responsible for the requests that may have a stronger effect on the environment. Of all the government organizations, they will thus have to make most of the changes to their business processes. Many of the requesting parties, however, especially those that often request the more complex permits, consider extra flexibility to the design of the municipalities to be necessary. The functionality of the OLO is determined by the project leaders at the Ministry of VROM and by the representing bodies of the municipalities (Vereniging Nederlandse Gemeenten, VNG) and the provinces (Interprovinciaal overleg, IPO).

The municipalities now perform the intake of all Omgevingsvergunning permit requests. For the cases in which multiple organizations have to collaborate to issue an Omgevingsvergunning, service agreements have been made on which organization pays the handling costs. Such agreements have been made between provinces, water boards, and the municipalities, but also between the central government and the local governments. In all cases, the coordinating role is taken over by the municipalities from the citizen or business that no longer has to coordinate requesting all the necessary permits of different government agencies. The different government organizations that are involved pay fees to the municipalities for the permit handling. This has resulted in

the shifting of tasks between municipalities and provinces and in some cases to the broadening of tasks of the municipalities. The provinces, however, are reluctant to hand over these tasks until the ruds are set up as they fear a lack of control if the responsibilities are handed over earlier.

During this whole process of governments asking each other for advice on the issuance of permits (which often means in practice that they request a 'declaration of no objections' from each other), the legal term for ruling on such a permit needs to be respected. If this does not happen, the *lex silencio positivo* (the silent positive law) determines that the permit can be considered issued simply on the basis of the lead time being longer than the legal term for a permit issuance. In order to coordinate this process, municipalities consider the coordinating role of IT indispensable. According to an official of a large municipality: *"Because of this maximum term, IT is indispensable, otherwise we are not able to send messages back and forth in time."*

Requesting parties: citizens, businesses and architects or builders

Often, at least in the more complex cases, are the requesting parties represented by an architect or a building company for filing the permit request.

4.3.4 Business processes

The main changes in the business processes of the municipalities, as well as of the different government organizations involved, is the coordination of the different processes of determining whether permits are given out or not. This is a complex integration process, as large differences exist between the different processes and the different permit issuing processes have not been integrated. Rather, they have been linked by the issuance of a new law, the Wabo. This complexity is enhanced by the different organizations and government levels involved (municipalities, provinces, ministries) and their representative bodies (VNG for the municipalities, IPO for the provinces and different e-government projects at the national level that were also involved). The business process of the Omgevingsvergunning consists of four subsequent steps: the preparation step and the three steps that make up the main permit request process. The first step of the main process is a permit checking step, which means finding whether a permit request is actually necessary or whether doing only an announcement is sufficient. The second step is the decision making by the government organization(s) in a coordinated manner. And the third step is archiving the permit request. The different steps will be discussed one by one.

Preparation

Although the preparation is not actually a step of the process of performing a permit request by a citizen or a business and handling the permit request by the government, it can be an extensive process step that is important for the quality of the permit request. Currently, around 80% of the permit requests need to be resubmitted as they are not complete, or mistaken. As such, the preparation of the permit requests proves to be one of the greatest bottlenecks in the process. The objective of this step is to create a permit request that can be processed after it has been submitted.

Request

The request can be divided into several permit requests, if necessary, when the requesting party cannot foresee yet which permits may be required in a later stage of a

project. Furthermore, in this phase also the link with the addresses and buildings registry (Basisregistratie Adressen en Gebouwen, BAG) is important, as this is the main source for how the current situation is of the objects for which the request is made. The information that is known from the BAG will be filled out automatically in the request form for a permit. In turn, when a permit is granted, the BAG will need to be updated according to the new situation. The same goes for the link with the registry that contains the value of properties (Wet Waardering Onroerende Zaken, WOZ), in case that it is altered by the permit that is granted. Not all permit request will lead to changes in the BAG or WOZ. For example, taking down a tree does not lead to mutations.

Decision-making

First it will be decided whether the request has been filed at the right organization. If this is not the case, it will be rerouted using the OLO. Depending on whether it is a full permit request of merely an announcement, a number of checks are performed, such as on whether it is complete and correct. In some cases, additional information is requested. In this case the process will start from the beginning as soon as the additional information has been received from the client. During the decision-making process the government bodies involved in processing the different aspects of the permit requests, stay in contact using the dossier module of the OLO, in which information can be stored. In this way, they also communicate their decisions on the different aspects of the permit.

Archiving

After the legal decision has been made and communicated, the permit request will be archived. The dossier module cannot be used for this, so there is an option of sending all information to the back office of the respective organization. Archiving is still an issue that needs to be addressed properly. The archive law has different demands for different permits, and this it needs to be specified for the Omgevingsvergunning that acts as an umbrella for the different permits.

4.3.5 Technology

The OLO is the supporting module for the online request of an Omgevingsvergunning permit. This allows citizens and businesses to request these permits digitally as well as follow the process of their permit request online, through the website www.omgevingsloket.nl. Municipalities can still choose whether to use the OLO or not, as integrated permit requests – thereby complying with the new Wabo law – can also still be done on paper. When the OLO is linked to information systems that support the internal processes of determining whether to grant a permit or not, these processes can be automated, leading to efficiency gains. Furthermore, also an automatic link can be made with the vital registries for addresses and buildings as well as the registration that contains the value of property. The use of the OLO is free for municipalities and provinces, as its maintenance is done by the Ministry of I&M. The OLO is developed by a consortium of software developers.

The OLO consists of three parts, each supporting a process step of the permit request and issuance. The first part is a 'permit check' to see whether a permit request is necessary or whether making an announcement is sufficient. The second part is the request form for filing the actual permit request. And the third part is the dossier module, which contains the dossier of the permit request. The first document that becomes part of this module is the permit request form that was filed. While it is

obligatory for municipalities to implement the request module, this is not the case for the dossier module.

Permit check

The decision tree is also a 'permit check' for checking whether a permit is required for the activity that will be undertaken. Using this decision tree, it becomes clear for which activities a permit is necessary and who is the responsible government organization. In case a permit is not necessary at all, the process will be terminated. For some of the most common combinations of permit requests, shortcuts are available. The use of these shortcuts means that the decision tree is no longer necessary for determining which permits need to be requested. Four different requests are possible, each having its own conditions and subsequent actions:

1. Requesting an Omgevingsvergunning for one or multiple activities;
2. Making an announcement for undertaking a certain activity for which a permit is not necessary;
3. A combined permit request, when a combination of a permit request as well as an announcement is necessary; and
4. Requesting permission for activities for which a permit is not required, for example for activities that are not bound to specific regulations. In this case, an announcement is not necessary, but the requesting party receives the conditions through the OLO.

Request module

The request form can be both filed digitally and on paper. For the digital request from citizens their DigiD, the national authentication mechanism, is necessary. For businesses a new identification mechanism is currently under development. Using the decision tree, the parts of the form that are applicable for this permit request are already determined. The request form can be accessed and its contents saved during the process. Furthermore, the municipalities can be asked to help prepare the permit request. Different registries can be linked to the request module, through using a BSN (burgerservicenummer, the unique identification number for all Dutch citizens) or the equivalent for businesses (bedrijvenidentificatienummer, BIN). Some registries that can be linked to the form are the citizens registry Gemeentelijke Basisadministratie (GBA), the businesses registry NHR, and the buildings and addresses registry BAG. Also attachments can be added.

The permit handling procedure starts officially as soon as the permit request is received. This information can be sent via e-mail to a functional mailbox or using the OLO request module. The requesting party subsequently receives a confirmation of the request, containing a copy of the request in .pdf format, the details on the request such as the time of filing the request and information on the procedure, contact details of the municipality, and a hyperlink to the request in the OLO. The request form can also be linked to the back office processes of the municipality to allow for automatic processing.

Dossier module

The dossier module is the part of the system in which the responsible persons from the municipalities and provinces carry out their task of processing the permit request. It is designed in such a way that multiple experts can access the information as well as that status information is accessible for all parties involved in the request. It is used to exchange information across government organizations and across governmental levels.

The use of this module is optional. It consists of a request dossier to which also the requesting party has access and a processing dossier that is only accessible by the different governmental organizations. There are three options for handling the permit request, depending on how the government organization that is responsible for the permit processing uses the dossier module of the OLO. As using this module is not compulsory for government organizations, they can choose how to implement it: to implement it centrally in the OLO or in the back office of the organization. This leads to three different options for using the dossier module.

Firstly, an organization can make use of the central dossier module that is part of the OLO. They can decide to do this for example because they are not able to make a link between this module and their own mid office or back office. All documents related to the permit request will then be stored centrally. By using the OLO all documents in the dossier can be accessed and manipulated. All the actions related to the permit will be carried out in the OLO. Secondly, all actions regarding permit handling take place in the systems of a government organization. The documents that also have to be accessed by other parties will be duplicated and stored centrally. However, this is only a filing mechanism, as all official decisions will be made using the systems in the back office of the responsible organization. And thirdly, all documents are automatically copied to the systems of the government that is handling the permit requests. In this case, governments need to make their own connection to the OLO, but when this is realized, all handling and filing of the request can be done automatically through the connection between the dossier module in the OLO and the organizations' back office systems.

However, the realization of the link between the dossier module and the municipal back offices does not go smoothly. One of the main reasons was the lack of knowledge at the Ministry of VROM on the municipalities' needs. Municipalities have very different information systems in place in their back offices making it very difficult to cater for a solution that fits the needs of all these different systems and municipalities. Still, it was often – mistakenly – thought that the generic functions of the OLO would support the more specific functions of the municipalities. Instead of enabling automatic processing, now many municipalities still need to make manual connections to the OLO. Therefore, an additional technical solution was implemented to enable automatic transmission of back office information to the dossier module. Very few municipalities are able to choose for the automatic option, only a few very large municipalities are able to do this. According to the representative of a mid-sized municipality: *“Although we expect that the digitization will ensure efficiency gains, implementation of the systems takes time.”*

4.3.6 Governance

The main governance mechanism in Omgevingsvergunning program is the Wabo law. By making clear it from the start that it needs to be implemented at a certain moment, it has been a major driving force in the development of the OLO. Implementing the Omgevingsvergunning and developing the OLO was the responsibility of the Ministry of VROM/I&M. While the representing bodies of the provinces (IPO) and the municipalities (VNG) were involved, they were not responsible for the developments. To solve bottlenecks in the process and involve local governments, a number of pilots was carried out to create best practices. While some of these pilots were successful, others were not, and the pilots thus had a mixed effect on the readiness of local governments. This model of negotiating the best solution for all parties was chosen to enable the development of a solution that would indeed be acceptable to all. However, these negotiations turned out

to be much harder than expected and in order to proceed, some decisions were made that were not supported by all different parties.

The need for a coordination role in the permit requesting process has led to the set-up of so-called regional bureaus that have the purpose of the making sure that permit requests do not get lost in the information exchange between organizations. Furthermore, they also keep a sharp eye on the lead times to make sure that these are not too long leading to a default issuance of the requested permit. For the development of the ruds, an agreement was made in the summer of 2009 between the central government, the IPO, and the VNG. In this agreement they made decisions on the responsibilities of the ruds, such as for activities that are considered ‘more than local’ or too complex for one municipality to rule. The set-up of the ruds will not lead to new legislation. This is considered to be something that is best left to the municipalities and the provinces.

4.3.7 Transformational objectives and mechanisms

The different aspects of the Omgevingsvergunning case study described in this section can be used to elaborate the model of IT-induced transformation (see figure 4.5). The transformation mechanisms (shown on the left side) and outcomes (shown on the right side) are elaborated in chapter 5. Furthermore, the factors influencing the transformation process are shown on the top side of the model.

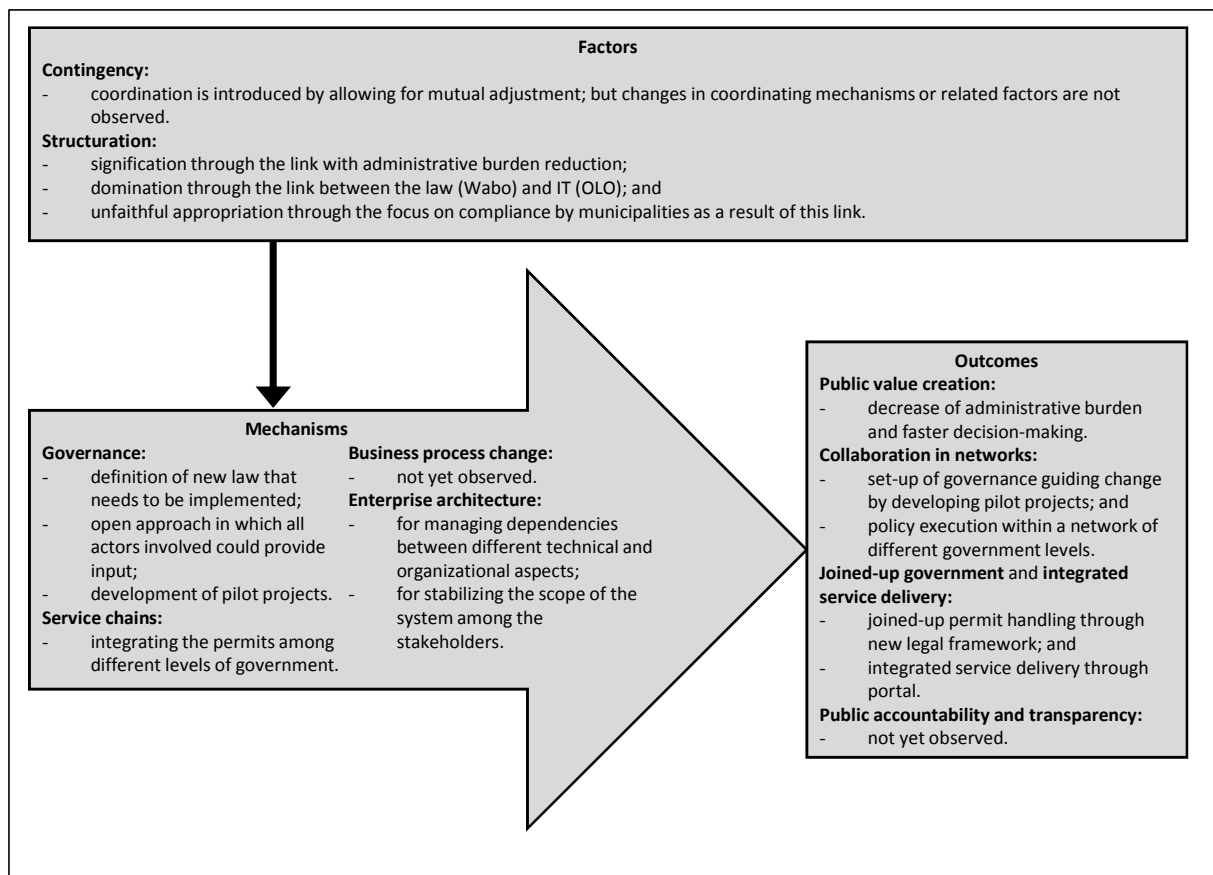

Figure 4.5: IT-induced transformation in the Omgevingsvergunning case.

4.4 Discussion of the case studies

This chapter presented two case studies of IT-induced transformation. Two innovative t-government programs were described, as well as their objectives, mechanisms, and outcomes. In the next chapter, a cross-case analysis is carried out, using the theoretical perspectives of chapter 2 and 3. While both cases represent instances of IT-induced transformation, at first sight, it appears that in the SBR case transformation has taken place, while in the Omgevingsvergunning transformation it cannot yet be observed. The reason for this may be sought among the differences that appear between the two cases. These noted differences are briefly discussed in this section, and will be elaborated in more detail in the next chapter. Three aspects are mentioned: their approach to service delivery, the degree to which changes are made to the existing processes, and their approach to making changes to legislation.

The first difference is that while both cases aim to decrease the administrative burden of citizens (Omgevingsvergunning) and businesses (both cases), they aim to do so by different means. In the Omgevingsvergunning the focus is on creating integrated service delivery while the SBR case is all about standardization. In this way, the Omgevingsvergunning presents a single front to citizens and businesses, while SBR requires a single front from businesses. The cases thus seem to take an almost opposite effort to service delivery, as the government goes to lengths to improve this in the Omgevingsvergunning case, but in fact requires businesses and their accountants to do the same in the SBR case. It is thus not accidental that some find that the real decrease in administrative burden takes place in government and not among businesses.

The second difference is the degree to which changes are made to business processes. While the SBR case leads to business process change in and among several organizations, the Omgevingsvergunning merely adds extra activities to the current (offline) processes, automating the current processes rather than looking at how they can be improved using IT. It can also be observed that implementation of the SBR program is a more invasive and complex case study, as this aims for change into multiple directions leading to the development of new business models over time, while the OLO merely joining-up existing processes. Still, in time, more invasive changes may also be observed in the Omgevingsvergunning case.

The third difference is their approach to making changes in legislation. In both cases legislation is or will be changed to ensure that the objectives of the cases will be achieved. The SBR case took an inclusive approach to governance, involving (representatives) of all stakeholders until they would be ready to implement the changes in the law that would be inevitable over time. In the second case the changes in legislation were implemented in a top-down manner, even though for the design of the technical support a model of negotiation was adopted in which all parties were involved. This has led to local governments not being ready for implementation of the OLO in the most efficient way. It is expected that these three differences influence the cross-case analysis and that they result in different outcomes of IT-induced transformation.

5 Case study analysis

New business opportunities arise through the standardization of reporting and the implementation of a process infrastructure (senior manager of a large accountancy, 2010).

This chapter investigates the outcomes of IT-induced transformation and the factors that influence the transformation process. By looking at whether the objectives and mechanisms of IT-induced transformation identified in chapter 2 are achieved or deployed in the case studies, the model of IT-induced transformation is operationalized. Then, using the two theoretical lenses on transformation developed in chapter 3, the transformation process of both cases will be investigated to identify factors influencing the outcomes of IT-induced transformation. The purpose of the cross-case analyses is to identify similarities and differences between the case studies as well as between theory and practice. At the end of this chapter, conclusions on the outcomes and factors influencing IT-induced transformation are drawn.

5.1 Analysis of transformational outcomes and mechanisms

IT-induced transformation was defined in chapter 2 as multi-dimensional, multi-level, and long-term organizational change leveraging IT to realize public sector reform. In this section the transformational objectives and mechanisms found in the case studies of chapter 4 – SBR and Omgevingsvergunning – are compared to those derived from literature on IT-induced transformation in chapter 2. Furthermore, the findings from the two cases are compared.

5.1.1 Transformational objectives and outcomes

In chapter 2 four transformational objectives were derived from the literature on public sector reform: public value creation, collaboration in networks, integrated service delivery and joined-up government, and public accountability. These four transformational objectives are used as a starting point and per objective a comparison is made with the transformational outcomes observed in the case studies to explore whether the transformational objectives were achieved or not. Also the differences between the manifestation of the objectives in two cases will be described.

Public value creation

The first transformational objective defined in chapter 2 is the creation of public value through a continuous assessment of the value that is to be realized by public officials (Moore, 1995). Public value can be created directly for citizens or businesses (the ‘customers’ of governments) or by increasing the value of public administration for society as a whole (Cresswell et al., 2006). In this section, public value creation in the SBR and Omgevingsvergunning case studies will be investigated to see for whom it is

created and by which means value is created. Also, any changes in the value proposition over time will be noted and analyzed.

At the start of the SBR program, when it was still called NTP, public value was aimed for by the introduction of a semantic standard (as well as an information standard) to increase the quality of (financial) reporting and compliance control. This has advantages both for businesses and government organizations. For businesses, uniform specifications for multiple reporting processes enable standardization and re-use of information for different types of reports. *“Direct data exchange between the accountancy software of businesses and the systems of the respective government organization will increase data quality,”* according to a representative of a large accountancy. For government organizations, standardization enables automation of the information exchange and the control process, ensuring that fewer mistakes are made. For example, through the use of automatic checks before submission, a higher percentage of complete reports can be achieved. Furthermore, better data quality likely leads to better compliance controls, as data can be exchanged directly from the systems of organizations to the government. Thus, public value creation within SBR aimed for an increase in the quality of reporting, which is likely to result in better compliance.

Over time, the focus on the quality of the reporting process shifted to a focus on efficiency and cost savings for both businesses and the government. The introduction of semantic and information standards is complemented by the set-up of a generic infrastructure in the SBR program. The use of this generic infrastructure for financial reporting is expected to decrease the costs businesses incur in reporting by enabling automatic assembly and re-use of information that is to be sent to the government. As soon as the goal of building a process infrastructure was added to the program, public value in the SBR program became mainly defined in terms of financial gains for businesses. The Ministry of Finance calculated these gains to amount to around 350 million euros. Financial gains were not only expected for businesses, but also for the government organizations involved. They will also be able to re-use and share information and a uniform infrastructure for data exchanges also diminishes the costs they incur for their compliance controls. According to the expert meeting that took place in 2007: *“There are many advantageous effects for these public agencies: for the automation of government processes XBRL will be a huge cost saver.”*

Moreover, the SBR program is expected to alter the value proposition of the whole information chain. Besides an increase in the quality of the data exchange and the decrease of the administrative burden of businesses and government organizations, new business models are expected to emerge. As the whole chain of organizations uses the same standard, this gives rise to opportunities for new services created on the basis of this standards. On the government side, the Inland Revenue Service (IRS) is developing new ways to check compliance based on input and output controls for the whole chain ('horizontal control'). Accountancies, on the side of the private sector, see opportunities for integrating different information systems within organizations that allow for easier creation of annual reports. As a result of the increased data quality gathering data is expected to take up less time, the work of accountants is likely to decrease. To make up for the expected income losses, they are likely to develop new services. *“We expect that we can use XBRL to expand our activities by creating new business opportunities, such as benchmarking”* (senior manager of a large accountancy firm).

In addition to optimizing and adding services to the current processes, new players likely enter the market. These could, for example, give advice to organizations on how to optimize their information technology using XBRL. On the basis of the new reporting

standard, they may also introduce new services. Instead of having an accountant gather all the necessary information (besides his core business of performing a check on these reports), the data collection may be automated. Program manager at Logius: *“Platforms for financial reporting may emerge that assemble all the information necessary for creating the reports and subsequently configure all the necessary reports for the businesses.”* Furthermore, new services related to electronic authentication and delegation allow for better identification of whether the right (authorized) person is submitting the information. Also standardization may enable new links between information systems, such as a link between the inventory software and the software from which the annual reports are created. While these possibilities are not yet available, they may change the financial reporting processes leading to new value propositions and business models.

Another aspect of public value creation is the method by which value is created. A new manner of working is expected to emerge around a continuous assessment of what constitutes public value and how it can be best achieved rather than only creating the value that is determined upfront. This will emerge together with the newer forms of control on the government side and with the introduction of automatic information gathering on the side of the intermediaries. As both accountants and public officials need less time for gathering data, automatic data gathering will give them more time to carry out checks and controls. This will, in time, lead to a different type of employee. On the side of the IRS, for example, the standard checks on the reports will be performed automatically, while specialized professionals will carry out the more complex controls of compliance based on the automated checks. And on the side of the intermediaries it is expected that those accountants now mostly performing the more simple tasks in the accounting process – such as gathering and presenting the right information for their clients, may run out of business as this will be largely taken over by software. On both sides, thus, more highly educated professionals are necessary. *“The IRS is currently wondering what to do with this. Will they need to hire highly skilled inspectors in the future, also requiring a higher payment than is the case today?”* (consultant, involved in the SBR program).

In the Omgevingsvergunning case public value is created by facilitating the permit request process of all permits that are related to the living environment (e.g. building permits) at once in order to make it easier for citizens and businesses to request such permits. This is expected to lead to a decrease of the administrative burden of the applicant as well as to faster processing of the permit requests on the side of the government. According to the website www.omgevingsvergunning.nl: *“In the [OLO portal for permit request] you can use one digital request form for all activities (such as building, cutting trees, and demolishing). And one legal decision is made upon your request.”* Although this may provide the opportunity of making processes within and between government organizations more efficient, it is predominantly aimed at creating public value for the ‘customers’ of government. Furthermore, also an increase in efficiency for the government is expected to be realized, as communications on permit requests and the processing of these permits between the different levels of government will be performed using IT.

Over time, also for the Omgevingsvergunning a new institution for compliance control will be introduced to match the new permit request process: the ruds (regional executive agencies or regionale uitvoeringsdiensten). Within the ruds the controls of whether the rules that apply to the permits are aggregated in the same way as for the application process, realizing a match between the application for and control of permit

requests. As these ruds are not yet in place, it is not clear if this will lead to new ways of public value creation within public administration.

While neither case is deliberately deploying a PVM-perspective for assessing the public value that is realized, both cases aim to create public value for the 'customers' of government as well as for public administration itself. But while in the SBR case value creation is taking place on both sides, in the Omgevingsvergunning case public value is as of yet mainly created for citizens. While in the future also in this case efficiencies may be created within government, this is not yet happening. While the continuous assessment of public value creation is not observed yet, it is expected to play a role in the future. In the SBR case, through the introduction of horizontal control, this is already taking place.

Collaboration in networks

The second transformational objective that was identified is policy formation and execution through collaboration in networks (Stoker, 2006). To deal with the complexity of today's world, governments are increasingly dependent on other parties as knowledge and expertise is scattered. This collaboration can take place between public organizations only, but also between the public and the private sector. Public organizations will have to play a different role in these networks as they are no longer able to control everything top-down (Koppenjan & Klijn, 2004). Instead, they have to play the role of coordinator or facilitator to steer the network towards attaining the desired goal. One of the questions regarding the collaboration within networks is whether this will 'hollow out' the state, which means that the role of the state may become too insignificant to remain in control (Milward & Provan, 2000).

In the policy formation phase of the SBR project, collaboration within the XBRL Nederland platform was a driving force in creating a common perspective on the use and relevance of the international XBRL standard and uniform reporting processes. However, formation of a networked structure did not take place. Rather, this collaboration focused on setting up a platform governing the necessary changes. Within the platform that can be joined by any party that wishes to do so, organizations share practices and give input to the development process. The set-up of governance is expected to lead to the creation a shared vision that enables developing joint policies for SBR. *"There is no use in simply making the use of XBRL obligatory, but to create real gains you have to make sure that all parties see the need for it"* (senior manager at a large accountancy).

Within the SBR program also the implementation of the XBRL standard, NT taxonomy and DigiPoort infrastructure took place in a collaborative effort between public and private organizations. The governance structure consists of working groups that can be joined by organizations from both the public and the private sector, while Logius is responsible on a daily basis. Similar to the way in which the banking consortium developed its own taxonomy on the basis of the same international XBRL standard, other organizations may develop their own taxonomies and infrastructures on the basis of XBRL. The discussion of whether Logius is indeed the right organization for the daily governance is not yet resolved. *"Many wonder whether it should be a government organization such as Logius that maintains the NTP. But for now there is not yet another organization that can take on this role. One possible solution is to create a new organization that is dedicated to this purpose in the future"* (project manager SBR within Logius).

While the set-up and implementation of the legal side of the Omgevingsvergunning was the responsibility of the Ministry of VROM/I&M, in the policy formulation and the execution some collaborative efforts were put in place to govern the changes taking place. In order to stimulate acceptance of the OLO at the local level, pilot projects were carried out. Furthermore, the representative bodies of the municipalities (VNG) and provinces (IPO) were involved, which resulted in negotiations on the design. While the provinces wanted a full portal for the communication with the municipalities, many municipalities initially only wanted a thin form for the permit request so they would be able to continue working with their own systems. Also private companies were consulted for the design of the OLO, which resulted, for example, in the possibility of requesting permits in batches throughout a complex construction project, instead of all at once such as in the case of relatively simple construction projects of citizens. Still, while for governing changes collaborative efforts were set up, implementation remained very much the responsibility of the Ministry of VROM/I&M.

Processing permits within the new framework of the Omgevingsvergunning becomes a joint effort of government organizations on the national, provincial and municipal level. This has led to a shift in tasks among government organizations. The intake of the permit requests now mainly takes place at the municipal level that will organize the integration of the different permit trajectories, also those that are the responsibility of other government organizations. Furthermore, for the set-up of the ruds, in order to match the capabilities of permit processing, also some shifts in tasks between the municipalities and provinces are expected. Although these changes do not take place within the legal authority of organizations – organizations responsible for certain permits remain responsible for the execution of these regulations, but for the permit processing they do need to collaborate to ensure a timely response.

Although the policy formation and the execution phase are clearly collaborative efforts, the traditional top-down role of government is not at all eliminated. Rather, a governance structure is set up to guide changes. For all the reporting processes the compliance control remains the responsibility of the individual government organizations as they have a firm legal basis. Still, these controls will be performed in an innovative – and potentially more effective manner in the future. In the SBR case this happens in a public-private collaboration partly based on trust, and in the Omgevingsvergunning case multiple levels of government collaborate. Therefore, the government will have to play a different role. But as in both cases government organizations remain, despite the network formation that takes place, firmly in control over their main legal authority – controlling the reports and the permit requests, it is not expected that a ‘hollowing out’ of the state will take place.

Joined-up government and integrated service delivery

The third transformational objective is creating joined-up government and integrated service delivery through the coordination of activities of different departments and organizations. Joining-up can be broadly defined as a “consistency between the organizational arrangements of programs, policies, or agencies, which may enable them to collaborate” (6, 2004, p. 106). While joining-up refers to a coordination at the policy level, integrated service delivery refers to a joining-up in a more concrete manner. Integrated service delivery is achieved when the services of multiple organizations, each performing a specific part of the service delivery process, are presented in a coherent manner for customers (Veenstra & Janssen, 2011).

In the SBR case, joined-up government is aimed for by introducing common standards: to increase understanding of each other's actions through the creation of a semantic standard and to facilitate automatic data exchange by implementing a common data standard. Especially the first is an attempt to join up government by creating consistency: *"The largest gain to be expected of implementation of XBRL is that it is a catalyst for harmonization of definitions within the public sector"* (XBRL expert meeting, 2007). This has even spilled over to other sectors, such as to the banking sector which is also aiming to create a shared taxonomy for their credit application activities. It should be noted that this joining-up taking place at the government level does not mean that all organizations will use the same definitions but rather that they are able to translate each other's concepts. The same goes for the banks and between the different taxonomies that may be created in the future. The goal is not to synchronize all concepts, but rather to provide a dictionary.

At the same time the SBR program also realizes integrated service delivery by creating uniform specifications for the interfaces between businesses' information systems and those of the government. DigiPoort, will, in time, facilitate all data exchange between businesses and the government, also for other processes. DigiPoort is part of a generic information infrastructure that allows businesses to not only standardize their data exchange with the government, but also standardize the way in which the data are exchanged. *"In time, this will lead to an interface that can be used for all the contact with the government, which may lead to further innovation and standardization of other information exchange between businesses and the government"* (project manager at Logius). This means, in fact, that businesses can use one information exchange interface for all their contact with the government.

Joining up government and integrating delivery are certainly the main objectives of the Omgevingsvergunning case study. Joining up government is realized by integrating the different permits within the different levels of government that are concerned with the living environment and by harmonizing the legal maximum terms of these regulations. In the Wabo around twenty-five different permits are integrated. For all these permit requests in the living environment now one legal framework is introduced, which means that they need to be processed within one legal maximum term and by creating one uniform decision, even while this is taken by multiple government organizations. In practice, this means that the government organizations involved in a permit handling process need to coordinate their actions to ensure that taking a decision does not take longer than the legal maximum term. Otherwise, according to the *lex silencio positivo* (the silent positive law), a permit will be issued just on the basis of the legal maximum term being crossed.

Integrated service delivery is realized by introducing a portal for the application of an Omgevingsvergunning permit. Thus, besides harmonizing the different regulations within a single legal framework, also the requesting process is integrated as it can now be requested using a portal: the OLO. According to the website www.omgevingsvergunning.nl: *"In the [OLO portal for permit request] you can use one digital request form for all activities (such as building, cutting trees, and demolishing). And one legal decision is made upon your request."*

While for both cases creating joined-up government is an important objective, the means of achieving it differs. While for SBR the focus is on standardization of data and semantics, within the Omgevingsvergunning a joining-up of different regulations is taking place. Furthermore, for both cases integrating service delivery is also important. While within the SBR case a common interface is designed, in the Omgevingsvergunning

case a portal is built through which communications between the ‘customers’ and the government and in between government organizations can take place. It is thus important to note that there are multiple mechanisms for ensuring joined-up government and integrated service delivery.

Public accountability and transparency

The fourth transformational objective is setting up public accountability and transparency. Traditionally, accountability is a hierarchical matter, when lower echelons of government report to the higher echelons. Now governments increasingly operate in networks in which also semi-public and private parties take part, being accountable for actions performed by the network as a whole presents practical challenges. While accountability is usually defined in terms of whether a procedure is followed properly (Weber, 1972 [1920]), or in terms of realizing sufficient output (Osborne & Gaebler, 1992), now also the outcomes of governmental actions are under scrutiny (Poulsen, 2009). As all three objectives of accountability need to be achieved, accountability requires negotiation on whether the right actions are performed and the right outcomes are realized. However, this negotiation raises the question of how equity can be maintained (Stoker, 2006). One of the ways in which this is pursued is by making actions of public administrations more transparent (McDermott, 2010). Transparency is in this case a prerequisite rather than an objective in its own right.

In the SBR case different forms of accountability are present. Firstly, the traditional hierarchical, or procedural, accountability. This is present within government organizations controlling the financial reports of businesses. These controls are based on regulations, thereby ensuring procedural accountability. Secondly, output accountability was introduced in the reporting processes by introducing the business case of the administrative burden reduction. The automation of these processes was largely realized by January 2005 when businesses were required to file their taxes online. Thereby, huge efficiency gains were realized. making the introduction of the new XBRL standard less attractive from that perspective. The project manager of SBR-implementation from the IRS: *“For the IRS implementing SBR mainly requires investments, as our information exchanges are almost 100% electronic already.”*

At the same time, newer forms of accountability can be observed to be introduced in the SBR case. The ‘horizontal control’ that is used by the IRS can at first sight be seen as a form of public accountability. Public accountability is facilitated by the introduction of a standard that makes it possible to compare input and output of processes beyond the reporting process. Multiple checks will be implemented ensuring that businesses are compliant. By using horizontal control, accountability becomes a joint responsibility of businesses and the government. While the IRS still has to account for its actions on the Ministerial level, the greater degree of cooperation and insight into the businesses’ processes represents a shift towards public accountability by changing the business processes requiring a different coordination mechanism: trust rather than a relationship based on the law. *“In this type of control the process is designed in such a way that the work-flow and decision making automatically comply with relevant rules and regulations. This form of control thus relies on agreements made with businesses upfront and only incidental checks at the end of the process, instead of having to control all tax forms that are filed. It relies on mutual trust between business and IRS and uses statistical methods and incidental checks on whether the accountants have compiled reasonable reports”* (researcher involved in SBR program).

An important question is whether this kind of public accountability will also realize equity. Some organizations will qualify for horizontal control, while others may not. The IRS includes every organization that is willing to comply with the goals of horizontal control, while they get less compliance controls in return. On the basis of the process information that businesses provide to the IRS, the risks involved are calculated and it is determined whether additional checks are necessary. Therefore, it must be concluded that while transparency does not play a role in the SBR program the main basis for equity remains legislation, which is the responsibility of the IRS. While elements of public accountability are seemingly introduced, accountability remains firmly organized in a hierarchical manner. Public accountability is thus not really observed in the SBR case.

In the Omgevingsvergunning case study also different forms of accountability can be observed. Firstly, municipalities as well as the other government organizations remain responsible for their own decisions on whether to hand out a permit or not. This remains a hierarchical process, based on the law, realizing hierarchical accountability. Secondly, output or efficiency accountability is introduced by creating one permit which acts as an umbrella for several permits, thereby increasing efficiency. By having to coordinate their actions, different government organizations jointly process a permit request that has to respond to clear output targets. The representative of a large construction company: *“The administrative costs for projects of architects and smaller project developers will have a definite positive effect as a result of the reduction of the lead time from twenty-six weeks to a maximum of eight weeks after receiving the request within which a municipality has to decide on whether to hand out the permit or not.”*

The introduction of the Omgevingsvergunning is accompanied by the a new way of compliance control of the regulations concerning the living environment: the ruds. This means that not only the request of permits, but also the enforcement of all regulations will be done in a joined-up manner including multiple organizations as well as organizational levels. But similar to the SBR case, public accountability and transparency were not found to play a large role in the Omgevingsvergunning case. In the current form, the Omgevingsvergunning does not stand a large risk of not being able to achieve equity, as all permit requests will be processed on the according legal basis of the individual government organization making the decision.

While the essence of hierarchical accountability in its different forms does not change in the case studies – the appropriate government organization still needs to make a decision or perform a control on the legal basis that is applicable, newer forms of accountability have been added. Output contracts have been introduced to ensure efficiency accountability and, in the SBR case also some experiments with public accountability are conducted. However, the main form of accountability observed in the cases remains traditional, hierarchical accountability. Public accountability is – effectively – not observed.

5.1.2 Transformational mechanisms

After the transformational objectives have been identified and compared, this section looks into the transformational mechanisms that are deployed in the cases to realize transformation. In chapter 2, four transformational mechanisms were identified from the literature on t-government: governance, formation of service delivery chains, business process change, and enterprise architecture. This section looks into the case

studies to see how they deploy these mechanisms and to which outcomes they lead – to derive factors of IT-induced transformation that influence these outcomes.

Governance

The set-up of governance in the cases was already observed to take place as a common way of setting up collaboration in networks in both cases. Government organizations are increasingly dependent on other organizations and they have to collaborate for their actions to take effect. This section looks at the mechanisms by which governance is set up. Governance implies that organizations have to coordinate their actions and manage their interdependencies, supported by IT. A central issue for governance on which parties within a network need to agree is on the coordination of norms (Bharosa et al., forthcoming).

Governance through the coordination of norms took place within the SBR case by formulating the XBRL agreement of 2006, which was signed by many different parties – public and private: representatives of the intermediaries, software companies, and the public organizations involved. In this agreement a number of activities related to XBRL and NTP implementation were combined, such as the promise of government organizations to adapt their processes for using XBRL, and that of the software companies to build software for XBRL-based reporting. A year later this agreement was also signed by representatives of businesses and throughout the time that the agreement is valid other parties were allowed to join. It was thus an open agreement for every party that would like to be part of the XBRL movement. *“Based on positive business cases abroad where the international XBRL standard was successfully implemented, it was thought that it would be naturally compelling to all parties involved to adopt the NTP,”* according to a project manager from Logius.

A related governance mechanism was to make the link between this agreement and the objective of administrative burden reduction. The estimate of saving 350 million euros per year, mainly by the creation of a common process infrastructure, was meant to create another incentive for businesses to start using the NTP. Furthermore, according to the expert meeting in 2007: *“The establishment of a link between NTP and a decrease of the administrative burden was a political decision.”* Diminishing the administrative burden of businesses was one of the key objectives of the government in office at that time. A noteworthy part of the agreement was, however, that intermediaries were supposed to pass on (part of) their efficiencies to businesses by decreasing their fees. While efficiency is likely to be a reason for intermediaries to adopt XBRL/NTP, the attractiveness of adoption is likely to be diminished by having to pass on these gains to their clients.

After the large changes in the project management in 2009, a new governance structure was put in place. The old governance structure consisted mainly of a steering group of representatives of the government agencies that will be at the receiving end of the XBRL messages at the central government level: the Ministries of Finance, Justice, and Economic Affairs. Program manager at Logius: *“Their role was limited, as they had little understanding of the SBR program.”* As implementation did not go as desired, the new governance structure included a larger role for a steering group having real decision making authority. This group currently consists of three levels: the SBR council, the SBR platform, and the expert groups. The SBR council, in which all government parties (Ministry of EL&I, Logius, IRS), businesses (representative body of businesses VNO-NCW, representative body of SMEs MKB-NL), the banks, and the intermediaries are represented, is the highest decision making authority on SBR. Furthermore, expert

groups on several functional topics (data, marketing-communication and processes & technology) give advice to the SBR platform that is responsible on a daily basis for the progress of the SBR program, and for the link between the SBR council and the expert groups.

A final governance mechanism observed was the decision to make SBR obligatory for all reporting in the income tax process on January 1st, 2013. Before, to spur SBR implementation, the XBRL data standard was put on the *'use or explain'* list of standards of the Dutch Standardization Board. When a standard is on this list this means that it either has to be used in public procurement projects, or that an explanation has to be provided. But the decision of making SBR obligatory for financial reporting signifies that all organizations involved agreed that XBRL/NTP will be the one standard used for financial reporting. As it was taken after a lot of the changes had been made already, it be seen as an outcome of the transformation process rather than a deliberate mechanism to spur the implementation of SBR.

Governance through the coordination of norms does not play a large role in the Omgevingsvergunning case as this was very much a top-down initiative from the Ministry of VROM/I&M that merely had to be implemented by local governments. Furthermore, implementation does not require organizations to change their core activities related to permit processing, as every organization remains responsible for its own set of regulations on which the permit is based. Therefore, governance only was necessary to determine the functionality of the technology. As it was clear from the beginning that the Wabo would be implemented anyhow – something the municipalities and provinces would have to deal with at some point, governance was mainly concerned with how the technical support, in the form of the OLO, would look like.

A strategy was chosen in which all government organizations that were involved could provide their wishes and demands concerning the functionality. E-services expert: *"The strategy to have an open governance structure involving all the representative bodies of the municipalities and provinces was deliberate, as the final solution will need to be accepted by all involved, otherwise implementation will be difficult"*. Therefore, as the local governments will have to implement the OLO and the Wabo in their own organization, a communal approach was taken towards creating the specifications of the OLO. On behalf of the municipalities and provinces, their representative bodies, VNG and IPO respectively, were involved to provide input to the design of the OLO. This resulted in several changes in the scope of the project. While the municipalities wanted a slim module that would be easy to implement in their organizations, the provinces wanted a communication system that would allow them to directly add their information. The middle ground became the dossier module that could be accessed by all organizations. A related governance strategy was to carry out a large number of pilot projects that would enable municipalities and provinces to get used to the different aspects of the Omgevingsvergunning, both on the legal (Wabo) and on the functional (OLO) side.

In this approach also the businesses that were expected to work with the new law and the OLO were included and asked to provide their input. Especially the larger permit requesting organizations such as large infrastructural construction companies provided their input. One of the changes in the design of the OLO this brought about was that the permit request could be divided into multiple requests for the different phases of the project. While it is useful for a citizen that wants to build an extension to a house requiring, for example, a building permit and a cutting permit for a tree that is in the way to file one permit request, this is entirely a different matter for a construction company building a highway extension over a period of three years. The representative

of a large infrastructure construction company: *“The administrative costs for projects of architects and smaller project developers will see a definite positive effect as a result of the reduction of the leadtime from twenty-six weeks to a maximum of eight weeks after receiving the request within which a municipality has to decide on whether to hand out the permit or not. For the more complex and dynamic projects it remains to be seen whether any costs can be reduced.”*

A final governance mechanism was the decision to make it clear from the start that the Wabo law would be implemented when the OLO was ready. However, it is difficult to determine what constitutes ‘ready’. Does this mean that the first tests were successful? Or that every municipality has made an automatic link to the system? This meant in practice that every time the OLO was tested and some problems surfaced, implementation of the Wabo was postponed. While the link between the Wabo and OLO was meant to spur developments, in the end it led to a delay between the targeted implementation date and the actual implementation date of two years and nine months.

Contrary to the approach used in the SBR program, in the Omgevingsvergunning case the implementation of a new law was determined at the start. While in the SBR program the creation of a new law was an outcome of the process, in the Omgevingsvergunning case it was a prerequisite. Furthermore, a clear link was made between the Wabo and the OLO in the Omgevingsvergunning case, while in the SBR case, the solution was sought in creating a compelling solution that would be useful to adopt both on the government side and on the side of businesses and their intermediaries. Only after the SBR methodology was considered useful by most involved parties, the decision of making SBR obligatory for businesses filing their income tax by 2013 was made to ensure that other reporting standards can be phased out, making its processing by the IRS more efficient.

Formation of service delivery chains

The formation of service delivery chains in previously stove-piped organisations was identified as a second transformational mechanism. It is linked to the objective of integrated service delivery, as service chains are usually formed to realize service delivery performed by multiple departments within one organization, or even by multiple organizations. In a service chain, the different steps of a business process, performed by different organizations, are assembled and presented as an integrated action (Veenstra & Janssen, 2011). This means that the different departments and organizations need to agree on issues such as which information to exchange, on the format in which this information is exchanged, on how to achieve secure connections and on how to adhere to privacy regulations. Service chains are typically formed within a network of organizations. Within one network, multiple chains may exist. Multiple degrees of collaboration exist between service chains, ranging from nearly integrated departments to a loosely coupled information exchange.

In the SBR case collaboration is set up around the generic process architecture DigiPoort. Although it is not a classic form of a service chain, in DigiPoort several government organizations collaborate to make sure that businesses are able to use this infrastructure for multiple reporting processes. As DigiPoort is designed as a standardized interface rather than a physical service chain linking activities, agreements between the different parties involved are largely concerned with standardization. But in order for DigiPoort to work correctly, also agreements need to be made about matters such as sending a confirmation of receipt to the party that is submitting an annual report. This can happen, for example, when it has been received by the front office

interface of DigiPoort, or when it has been transferred to the destination within the government agency on the receiving end. A project manager at Logius: *“Various legal requirements for sending out confirmation receipts exist. These need to be built in DigiPoort in accordance with the legal frames of all the different parties involved”*.

The Omgevingsvergunning case is a classic example of integrated service delivery in which several organizations collaborate to form a service chain. The organizations collaborate on processing the permit request as if it was performed by one organization. Through the use of the dossier module, they can perform their own tasks in such a way that the requesting party does not notice any difference between the municipality processing the whole process and different government organizations collaborating on the permit request. Although it can be considered a rather ‘thin’ service chain as actions are not performed sequentially creating interdependencies other than performing the permit processing within the required timeframe. The communication between the different levels of government mainly consists of requests of a ‘declaration of no objections’ from each other, in order to respect the legal maximum term for ruling on such a permit. According to an official of a large municipality: *“Because of this maximum term, IT is indispensable, otherwise we are not able to send messages back and forth in time.”*

While the OLO represents a classic example of integrated service delivery through the set-up of a (‘thin’) service chain, DigiPoort can be considered a standardized infrastructure that can be used by businesses for all their contact with the government. Although both technical solutions need to make clear agreements on issues to which they are legally bound (such as the maximum term for issuing a permit or sending a confirmation receipt), within neither case it was found that strong mutual interdependencies were introduced between organizations. DigiPoort and OLO act as a common interface and information depository respectively that can be used by different public organizations, without having to interact much with each other.

Business process change

The third transformational mechanism is business process change of the back office of organisations. While there are some links with the previous mechanism of creating chains for service delivery, business process change mainly focuses on the process level and on making the processes as efficient and effective as possible. Often, during the construction of service chains, business process change is deployed to see whether processes cannot only be integrated to benefit service delivery to citizens and businesses but to also benefit the government organizations by making their processes more efficient. Business process change aims to let people re-use each other’s actions and information – by capturing it once at its source, in order to create outcomes rather than output or tasks (Kim & Ramkaran, 2004). Changing business processes in this way thus means having a look at how they currently work (Hammer & Champy, 1993) in order to define the core values of an organizations and optimize the work practices around this (Pralahad & Hamel, 1990).

In the SBR case individual reporting processes make use of the same semantic and data standards as well as the same generic process infrastructure. This has led and is expected to continue to lead to extensive business process change both on the government side and on the business side. As some of the processes have already been automated, such as income tax reporting of businesses, which became obligatory in 2005, the SBR program is used to implement efficiency gains. On the side of the government, SBR is used to standardize all reporting to different government

organizations such as the IRS, the Chambers of Commerce and the statistics bureau CBS, enabling the re-use of information. This is expected to lead to large efficiency gains according to the expert meeting that took place in 2007: *“There are many advantageous effects for these public agencies: for the automation of government processes XBRL will be a huge cost saving.”* Furthermore, the IRS is able to use newer forms of compliance control. Having standardized processes provides the opportunity to implement horizontal control, in which multiple checks will be performed throughout the process, automatically checking whether organizations are compliant.

But also on the business side SBR provides the opportunity of making reporting more efficient and effective. Intermediaries, using software that is built using XBRL specifications, see many opportunities to redesign the process of reporting. According to one of the interviewees, working at a major accountancy: *“Now we use around 50% of our time for gathering data and around 50% for our core business, which is compiling reports and giving advice to our customers. When SBR is fully implemented, we expect the former percentage to drop to around 20% of our time, leaving much more time for doing our core business. We, thus, expect that we can get more work done when SBR is fully operational. Furthermore, we expect that we can use SBR to expand our activities by creating new business opportunities, such as benchmarking”* (senior manager of a large accountancy firm). These business opportunities also include the emergence of new platforms for automatically collecting all information necessary for reporting and providing it to the respective government organizations from there.

In the Omgevingsvergunning case study, little evidence of process change is found. Rather, the different levels of government are creating integrated service delivery, as behind the front office the different permit handling processes of the different government levels are performed in an autonomous manner. Connecting the organizational systems to the OLO would create efficiencies as this means that permit requests could be handled automatically, but this is not yet realized in many municipalities. Most of municipalities still access the OLO using e-mail instead of integrating the generic functionalities into their own systems and processes. According to a representative of a mid-sized municipality: *“Although we expect that the digitization will ensure efficiency gains, implementation of the systems takes time.”* This means that the Wabo and the OLO are likely to give rise to business process change in the future, but at the moment few efficiencies are achieved for government organizations.

While in the SBR case the focus is on business process change, in the Omgevingsvergunning case this does not take place yet. From the interviews it appeared that it is difficult for government organizations to realize service chains and business process change at the same time. In the SBR case the reporting processes of the IRS were automated a few years back. Therefore, the SBR program was specifically used to achieve efficiencies. In the Omgevingsvergunning the step of automating current processes is taken, which may result in process efficiencies over the next few years. While the idea of business process change is that automation provides the opportunity to redesign processes from the first moment on, achieving both at the same time appeared too complex in these case studies. As a project leader from Logius stated: *“First you need to automate the current processes and only after that, the re-design process starts. Otherwise, no progress can be booked”*. In these cases it observed that service chain formation and business process change may not go well together in transformational projects.

Enterprise architecture

Enterprise architecture for managing the IT developments within networks of organizations is the fourth transformational mechanism that was identified from the literature. Traditionally, enterprise architecture focuses on aligning the processes of businesses with their strategies and on showing the interdependencies between the different information systems on the different organizational layers. Enterprise architectures define and interrelate data, hardware, software, and communication resources, as well as the supporting organization required to maintain the overall physical structure required by the architecture (Richardson et al., 1990; Zachman, 1987). Nowadays, enterprise architecture is increasingly seen as a governance mechanism stabilizing developments. Therefore, enterprise architectures are increasingly seen as a method for managing interoperability and coherence between activities (Jarke et al., 2011; Schmidt & Buxmann, 2011).

For the process infrastructure in the SBR case an enterprise architecture was developed in 2006. Based on generic specifications that were derived from the national enterprise architecture NORA, the predecessor of DigiPoort was designed in a separate program. In the SBR case, however, one of the main problems of the program – at least until 2009 – was that a number of innovative aspects were implemented at the same time. The project leader of SBR implementation at the IRS: *“The SBR program was mistaken in the complexity of the program. The NTP tried to achieve too many gains at the same time; the objectives were piled upon one another. It is necessary to reduce the number of innovations or to implement them phase-wise, and not all at the same time.”* Although an architecture had been designed to show all the dependencies between the different elements of the process infrastructure it was not used to manage and stabilize developments. Only after 2009, when the program already suffered severe delays, the architecture of the process infrastructure was simplified, and some elements were left out. Since then, the project team and the steering committee focus on implementing the few developments that have been selected.

In the Omgevingsvergunning case enterprise architecture was clearly used as a governance mechanism. The different government organizations that were involved, as well as the larger clients of the Omgevingsvergunning permit, were asked to provide input for the design of the OLO. These different negotiations took place during the design of the OLO. For example, to realize sufficient influence on the permit request process at the municipalities, the provinces wanted a fully automated system that allowed them to provide direct input to the municipalities. And the municipalities didn't feel like changing their processes and systems too much and therefore wanted a technical solution that was thin, or fully flexible to be integrated into their own systems. Enterprise architecture was used to manage all these demands to show their implications and eventually to create a compromise between the different demands. An e-services expert: *“After the project had the idea of developing an extensive tree structure for the permit request, it became too complex and unmanageable. As a result the project was downsized to only include a ‘permit check’ for checking whether and which permits are required in a specific case, and a mailbox in which information can be stored that can be viewed by both the requesting party and the government.”*

For the development of the information systems in both cases – the process infrastructure in the SBR program and the OLO in the Omgevingsvergunning case study, enterprise architecture was used to get an overview of the interdependencies between the different technical and organizational elements. Moreover, in both cases the use of enterprise architecture led to the project becoming manageable after the scope of the

systems widened and became too complex. To gain control of the developments again, architecture was used to simplify the design and create support for a shared design among the different organizations involved.

5.1.3 Findings

This section analyzed the transformational objectives and mechanisms of the two case studies of chapter 4. The objectives of the two cases share many similarities, such as creating public value for the ‘customers’ of government and for public administration itself, setting up governance to govern change and realizing joined-up government. Furthermore, in neither case public accountability was implemented. Differences between the two programs were also observed. While for both cases creating joined-up government is an important objective, the mechanisms of achieving it differ. SBR focuses on standardization of data and semantics to create a joint process infrastructure, while the Omgevingsvergunning focuses on the joining-up of different regulations. Furthermore, both cases realize integrating service delivery, but while within the SBR case a common interface is designed, in the Omgevingsvergunning a portal is built through which all communication between the ‘customers’ and the government and in between government organizations takes place.

Other findings of the case analysis are that while the continuous assessment of public value creation method is not observed yet, it is expected to play a role in the future leading to newer ways of control and to new ways of working. Another observation is that although it is clear that both the policy formation and the execution phase are collaborative efforts, the traditional top-down role of government is not eliminated. Instead, it was found that the remaining hierarchical accountability impedes the creation of a networked structure. To govern change among the government organizations involved, governance mechanisms were set up. In both cases, compliance control remains the responsibility of individual government organizations as they have a firm legal basis. The hierarchical accountability is thus far from being replaced.

Also the transformational mechanisms within the two cases share many similarities. In both cases an open governance structure was adopted coordinating the norms of government organizations, leaving room for the different government organizations and their jurisdiction to carry out their tasks in the way that is optimal for them. As government organizations have a large degree of autonomy in the Netherlands, this is often considered the best way of implementing such complex programs. Another similarity is the use of the enterprise architecture not only for getting an overview of the interdependencies between the different technical and organizational elements, but also for stabilizing the programs, especially after the programs widened their scope in such a way that the programs became unmanageable.

Besides similarities, also differences can be observed between the transformational mechanisms in the two cases, such as in the formation of service chains and business process change. While the Omgevingsvergunning is a classic example of integrated service delivery in which multiple organizations collaborate to provide services to citizens or businesses in an integrated manner, DigiPoort of the SBR case can be seen more as a standardized interface that can be used by businesses for all their contact with the government. And while in the SBR case the focus is on business process change, in the Omgevingsvergunning case this seems not to take place yet. From the interviews that were held, it appeared that it is difficult for government organizations to realize service chains and business process change at the same time.

Two observations should be noted especially regarding the mechanisms and factors that influence the outcomes of IT-induced transformation in the cases. Firstly, it was observed that setting up governance is central to the transformation process. Also the more technical elements such as architecture are seen to contribute to the governance. Secondly, a difference appeared between the two cases in their approaches towards legislation. In the SBR program making the use of XBRL obligatory for reporting was an outcome of the transformation process, while in the Omgevingsvergunning the implementation of a new law was determined at the start. The strong link between the law and the technology in the latter case led to a focus on being compliant among the municipalities instead of on realizing efficiencies and process change. It thus seems that legislation as an outcome is more successful in terms of the other transformational objectives than legislation as a starting point. The next step is to look into the process of change using theoretical perspectives based on organization theory and structuration theory.

5.2 Analysis of the transformation process

IT-induced transformation is not a linear process that has a clear start or end. Determining whether at some point the transformational objectives and mechanisms are present does not determine which factors influence this process. The two theoretical lenses developed in chapter 3 are used to analyze the cases from a process perspective. The contingency perspective identifies factors that influence the outcomes of transformation through performance optimization, while the structurational perspective explores the interplay between structure and agency that determines the (unintended) outcomes of transformation. After an analysis of the transformation process of the individual case studies, the similarities and differences of the cases will be identified to identify factors that influence the occurrence of IT-induced transformation.

5.2.1 A contingency analysis of IT-induced transformation

IT-induced transformation is seen from the perspective of contingency theory as a change in the coordinating mechanism and the related organizational characteristics as a result of the introduction of IT. This change is expected to lead to a networked organizational configuration. The investigation of IT-induced transformation from the perspective of contingency theory takes place by looking at the case studies to find which factors influence this change. This investigation takes place in two steps. Firstly, it explores the changes in the coordinating mechanism and related organizational characteristics. Coordinating mechanisms are central to organizational configurations that emerge as a result of internal and external contingencies. Secondly, the factors are identified that influence the changes found. Besides exploring the traditional contingencies such as the nature of the work performed and the influence of the environment, an important contingency that is investigated is the impact of IT find out whether it contributes to the changes in organizational structure.

A contingency analysis of SBR

The SBR case study is concerned with the implementation of a common semantic and technical standard as well as with the set-up of a process infrastructure for reporting by businesses to the government. The common semantic and technical standards can be

considered preparatory steps for the development of the process infrastructure, as these standards are necessary for developing a common data exchange method. In the longer run, the development of this SBR infrastructure may lead to the introduction of new services and activities both on the side of the government and on the side of businesses and their intermediaries. Therefore, SBR is expected to fundamentally change the way financial reporting is done: a new organizational configuration is expected to emerge. It is expected that this configuration will be a network based on the uniform process infrastructure for information exchange. First the outlines of this configuration will be investigated, followed by an exploration of the contingencies.

Central to an organizational configuration is its coordinating mechanism. Related to the coordinating mechanism is the degree to which decision-making takes place (de-) centrally. The coordination of activities between the different parties that are involved in the SBR program takes place through the introduction of standards: a semantic standard (the NTP taxonomy), a data standard (XBRL), and a process infrastructure (DigiPoort). Standardization of these elements requires adaptations and developments from all organizations involved. Businesses – and especially their intermediaries – need to implement different information systems based on the XBRL standard. Government organizations need to adjust their processes and infrastructure to be able to receive data based on XBRL and re-use it. Many gains are expected from the introduction of these standards. An expert meeting that took place in 2007, stated: *“The largest gain to be expected of implementation of XBRL is that it is a catalyst for harmonization of definitions within the public sector.”*

The introduction of this set of standards results in the standardization of output between the different organizations. Still, this cannot be considered an actual shift in coordination mechanism, as this coordinating mechanism already existed before the introduction of these standards. In the past, government organizations informed businesses which information to provide and in which format. For example, the IRS expected businesses (or their intermediaries) to provide their data not only in a specific technical format (the bapi standard), but also in a specific information format (the standardized annual report). The only difference is that now this standardization of output takes places across different government parties and not just between businesses and individual government organizations. The organizational structure and central coordinating mechanism thus remain the same and only the technical and semantic aspects of the information exchange change.

In the longer term, however, the introduction of this standardized data exchange is expected to lead to more intrusive changes. Instead of standardization of output, the coordinating mechanism is expected to shift towards standardization of skills. Within the IRS, this may take place when controls are carried out through the horizontal control system. For this type of controls the process is designed in such a way that the workflow and decision making automatically comply with relevant rules and regulations. The IRS then conducts several checks that businesses are required to implement throughout the supply chain. This offers the possibility for the regulator to check whether a company is compliant with laws and regulations. The project manager of SBR-implementation from the IRS stated: *“The reasons for the IRS to implement SBR is to [...] create more and better collaboration among the organizations involved.”* Thus, in this system, instead of a batch-processing view of controls, a process view is taken, similar to the view on production moving from batch-processing to production in processes described by Woodward (1965).

For the related organizational characteristics this means that the organizational core is to shift and that a decentralization of decision-making is likely to take place. Within the IRS, currently the techno-structure is the organizational core. This is the part of the organization that designs the tasks and processes the executive staff has to carry out. In a situation with horizontal control, the executive staff will have more decision-making power and they will have to be more educated than is currently expected. *"The IRS is expecting to hire more higher educated employees in the field of enforcement to carry out horizontal control"* (consultant, involved in the SBR program). In this new situation, the power of the techno-structure has been partly taken over by the IT. The information systems now pre-scribe to public officials how to act in simple cases of enforcement. The higher educated officials will be left to deal with the complex cases, basing their decisions on the data provided by the system of horizontal control. Furthermore, higher educated officials are necessary to design the information systems used.

A related process is expected to take place within the accountancies. They are expected to automate their simple tasks, such as the gathering of relevant information, through which they will have more time to focus on their actual professional tasks, such as compiling annual reports. According to one of the interviewees, working at a major accountancy: *"Now we use around 50% of our time for gathering data and around 50% for our core business, which is compiling reports and giving advice to our customers. When SBR is fully implemented, we expect the former percentage to drop to around 20% of our time, leaving much more time for doing our core business"*. Also for the accountancies this means that a decentralization of decision-making is expected to take place. They too can spend more time on advising their clients instead of complying with pre-specified rules of the techno-structure of their organizations.

It can thus be concluded that changes in the coordinating mechanism occur – but only when horizontal control is implemented and the business processes at the side of the accountancies are changed. Then, a shift from standardization of output to standardization of skills is expected to take place. Still, when this is realized, there is one coordinating mechanism that remains hierarchically oriented. This is vertical accountability, embodied by the regulations for businesses and intermediaries stating what financial reports should like, and, for example, including the law stating that the use of XBRL for reporting becomes obligatory by January 1st, 2013. This means that while some elements of a networked structure emerge through the decentralization of decision-making, also hierarchical relations remain important. This is likely to cause friction between horizontal processes and the requirements of vertical accountability.

The main factor influencing these expected changes is the implementation of a common process infrastructure. Hence, these changes are the result of the implementation of IT, which can thus be considered a contingency. Similar to the conclusions of Malone (1999), implementation of information systems is expected to lead to a more hierarchical structure at first, creating processes of batch processing. These steps have been taken by, for example, the IRS to create their current systems of control and processing information. The project manager of SBR-implementation from the IRS: *"Our information exchanges are almost 100% electronic already. The reasons for the IRS to implement SBR is to increase the quality of the data exchange and create more and better collaboration among the organizations involved."* The introduction of SBR is expected to lead to the introduction of a process view on production, leading to a decentralization of decision-making by increasingly professional executive staff, as expected by Woodward (1965).

A contingency analysis of the Omgevingsvergunning

The Omgevingsvergunning case is concerned with the implementation of a uniform permit for all activities in the direct environment: the environmental permit. To facilitate the application process of filing for an environmental permit, an information system is designed to support the application and handling processes: the OLO. This system is to be implemented in all municipalities, provinces, and other government organizations that are involved in the handling of permits that are joined under the umbrella of the environmental permit. However, the organizational structure and work processes of none of these organizations are seen to change yet.

As the organizational structure was not seen to change, introduction of the Omgevingsvergunning is not expected to have any consequences for the central coordinating mechanism. In the case study, a simple form of coordination – through the use of a dossier module to which organizations connect using e-mail, is implemented between the municipalities and provinces: mutual adjustment. Within individual government organizations permit requests are processed through standardization of processes, but this is not observed in between organizations. The formation of a service chain among the government organizations involved has little consequence for the organizations other than that the dossier module introduces a mechanism of mutual adjustment where there was none before. Subsequently, no changes in the organizational structure, the organizational core, or the decentralization of decision-making were observed.

Two future developments may give rise to a shift in coordinating mechanisms and related organizational characteristics. The first is the connection of the information systems within municipalities to the OLO dossier module. This may allow for process change resulting in greater efficiencies in the work processes of the municipalities. Currently, even if the OLO is used, documents are printed in the back offices. The second is the introduction of a new way of controlling the regulations concerning the living environment: the ruds. This will result in joined-up control of regulations concerning the living environment, besides joined-up service delivery. When all the activities of the multiple governmental levels are joined up, controls will be easier and more complete, and potential discrepancies or contradictions can be more easily overcome. This may lead to process changes in the future. Since these two developments are still ongoing, it is not yet possible to observe organizational changes, nor derive contingencies.

5.2.2 A structural perspective on IT-induced transformation

The structural perspective on IT-induced transformation investigates the interplay of human action and social structure. By looking at the policy aims that are formulated and how these influence the IT, which is at the same time also enacted by the organizations in which it is implemented, it aims to identify factors that influence the outcomes of these policies. Following the framework of Adaptive Structuration Theory (AST), the processes and outcomes of *structuration* and *appropriation* are investigated (DeSanctis & Poole, 1994). Structuration is investigated by looking at the dimensions of signification and domination, their corresponding human interactions – communication and power – and their modalities of norms and interpretive schemes. Furthermore, appropriation of the ‘spirit’ of information technology, with its human interaction through sanctions and its modality of resources, is investigated to determine whether technology is being used ‘faithfully or unfaithfully’ (DeSanctis & Poole, 1994). Using cross-case analysis, subsequently similarities and differences between structuration and

appropriation in the cases will be investigated to derive factors that influence the outcomes of the transformation process.

A structural analysis of SBR

The Standard Business Reporting (SBR) program develops a semantic standard, a data standard, and a process infrastructure to create a common reporting methodology for businesses to the government. Its policy aim (structuring the technology) is thus to standardize financial reporting by creating a process infrastructure. Organizations that are involved on the side of the government, as well as on the business side may appropriate this infrastructure in a different way. To investigate structuration and appropriation, the three dimensions of signification, domination, and legitimation will be investigated, by looking into human (and organizational) actions constituting structure by communication, power, and sanctions respectively through their modalities of interpretative schemes, facilities, and norms. These three dimensions will be investigated one by one.

Policy aims can be imposed on technology through signification. Signification occurs when communication, drawing upon interpretative schemes – standardized and shared knowledge, gives meaning to a certain practice. In the SBR this was demonstrated in several ways. It was observed at the start of the program (when it was still called NTP) when the need for an XBRL-based taxonomy was communicated and subsequently set up. In order to standardize financial reporting, the set-up of the NT (Dutch taxonomy) was called for and decided upon. An existing international standard (XBRL) was used, which can be seen as an interpretative scheme that was enacted upon to create the NT. The Chairman of the Standardization Board: *“Large budget cuts in private parties as well as in the public sector become possible [by implementing XBRL]. This already happened in other European countries.”* The call for a common taxonomy to enable standardized reporting can be seen as communication that enacts upon the interpretative scheme of the international experience with XBRL. The idea to set up the NT thus represents an instance of signification.

A similar process of signification was observed in the development of the banking taxonomy, where the banks jointly develop a common semantic standard for credit applications to decrease the transaction costs and make the process of credit applications and handling more efficient. This too was based on the knowledge of and the experience with the XBRL-standard and the NT, which acted as interpretative schemes. The notion of creating the banking taxonomy and automating the credit application process to decrease the costs can be seen as instances of signification: *“It is expected that the use of SBR in the banking sector leads to greater efficiency as some activities of the bank, such as credit issuance can be performed solely by IT without any interference of an account manager”* (bank employee responsible for XBRL implementation). The notion of setting up a common banking taxonomy can also be seen as an instance of structuration.

Arguably the most powerful instance of signification was the link that was made between SBR and administrative burden reduction in the joint agreement of June 9th, 2006. To spur the use of the taxonomy (and XBRL) and to confirm the joint effort of public and private parties, representatives from the intermediaries, software companies, representatives of businesses, and public parties signed an agreement to encourage implementation of the NT and the XBRL format. Through this agreement they communicated their commitment to XBRL and the NT. The notion of being able to achieve an administrative burden reduction was mainly based on the use of a common

process infrastructure. The idea behind this is that if businesses not only use the same taxonomy and the same data standard but also a single process infrastructure, large efficiencies can be achieved. Businesses in the Netherlands will then spend less time and effort on their contact with the government. It was estimated that 350 million euros per year could be saved as a result of the introduction of a uniform electronic manner (uniform taxonomy, data standard, and infrastructure) of reporting. The interpretative scheme of this business case led to the joint agreement (an instance of signification). A related form of communication is renaming the program to SBR to reflect the notion of creating a methodology rather than just a taxonomy (implied by the name NTP).

The second dimension of structuration is domination. Domination is the process of structuring that takes place through human action exerting power through certain facilities or resources towards. This was most clearly observed when power was exerted by Logius in turning the program around at the end of 2009. The main goal of this renewed start of the program was to make sure that the objectives of the program, as written down in the joint agreement would be achieved. Logius thereby gained the responsibility for implementation and received a large amount of funding for this. This domination through creating facilities for implementation is considered necessary, as the basic infrastructure and methodology of SBR needs to be in place before any efficiency gains are expected. A Logius project leader: *“SBR as such does not realize a decrease of the administrative burden, as it is about the way in which it is applied. An increase in quality leads to a decrease of administrative costs for the whole chain of organizations, but this can vary for individual companies.”*

The third dimension is legitimation, which can be seen as an instance of appropriation. Appropriation is concerned with the faithful (‘as intended’) or unfaithful (‘not as intended’) adoption of technology. Legitimation can be seen as an instance of this as it is concerned with legitimizing a norm, enacted by sanctions if this norm is not followed. In the SBR case, there were as many instances of appropriation as there were organizations involved. Before the involvement of Logius, little domination took place and appropriation mainly occurred unfaithfully as the objectives of the joint agreement made on June 9th 2006 were not achieved. A main reason for this unfaithful appropriation was that the amount and location of the administrative burden reduction was contested, showing that the joint agreement and the business case were enacted upon in different ways by different actors.

The intermediaries, such as the accountancies, would facilitate their customers by making sure that the efficiency gains that are made will be passed on to their customers. However, there is little incentive for the intermediaries to invest in implementing XBRL into their processes, if they have to pass on the gains from using SBR to their customers. The same is the case for the banks that are expected to pass on their gains to their customers, which may not entice them to invest heavily either. Also the business case of the administrative burden reduction is disputed by businesses and their accountants. Some accountants claim that their investment into the XBRL-based software is higher than their potential gains. For example, the filing of fiscal reports is now limited to the vWIA of SME’s, and definitions used for reporting by the larger companies are not yet included in the NT. Many efficiency gains are thus expected to occur in the future. Furthermore, many (smaller) intermediaries felt threatened by the use of SBR as they fear that they will go out of business when the information exchange is standardized and digitized. Finally, while in the agreement the administrative burden reduction was calculated to take place on the side of businesses and their clients, many intermediaries expect that the largest efficiency gains will actually be made on the side of the

government. These factors were influencing the unfaithful appropriation on the side of the businesses.

The public organizations agreed that they would make sure that their processes would be ready to start working with NT and XBRL. They are also expected to gain from the implementation of SBR. Large-scale standardized tax filing, for example, is expected to realize large efficiency gains for the IRS and for the CBS that will be able to process and compare their statistics more easily. However, also the IRS claims that their investments are actually higher than their gains, as they already switched to digital tax filing for businesses in 2005, based on a different data standard. The project manager of SBR-implementation from the IRS stated: *“For the IRS implementing SBR mainly requires investments, as our information exchanges are almost 100% electronic already.”* Therefore, they were less willing to change again to another data format as efficiency gains for their own organization are smaller. The parties involved thus legitimized their actions through enacting upon different norms – based on their organizational objectives and expected gains, thereby appropriating the agreement differently. Without sanctions to make sure that the agreement is appropriated faithfully, every party involved enacts the agreements drawing upon their own norms, instead of the shared norm.

After Logius stepped in, more faithful appropriation through the dimension of legitimation can be observed, as many of the organizations involved began to follow up on the agreements made (as a result of the process of domination). One reason for this was that many of the expected gains were adjusted reflecting the joint efficiency gains that may be expected rather than the unrealistic business case that was made earlier. Many of these organizations thereby began to enact upon the expected efficiency gains, but also upon the other advantages that are expected, such as the standardization of information, which allows for automatic checks, which likely reduce the number of errors in the reporting process. A result of this faithful appropriation is the introduction of the law making the use of XBRL obligatory for 2013. This means that all parties have to follow up on this new norm, otherwise they will be sanctioned.

Another instance of legitimation is the introduction of horizontal control by the IRS. This leaner form of control exerted on the tax filing process aims to perform multiple checks in the process of organizations deploying XBRL and the process infrastructure. This means that, when it is implemented, organizations need to appropriate technology faithfully – according to the norms of the law. Otherwise, sanctions are likely to follow. The IRS was in this case able to enact upon their own norms and be able to carry out their public task. This meant that the IRS was more willing to adopt the process infrastructure as this suits their own norms. This is also the case for the accountancies and the banks, but they lack the capability to legitimize their purposes by creating a new law – even though they may be able to enforce their standards upon their clients. The dimension of legitimation is thus potentially most powerful when observed on the side of government.

A structural analysis of the Omgevingsvergunning

Also in the Omgevingsvergunning case, which is concerned with the implementation of a uniform law for all legislation regarding the immediate living environment, the three dimensions of structuration and appropriation can be observed: signification, domination, and legitimation. The policy aim to replace twenty-five existing permits in the area of living, spatial planning and the environment by just one single permit structures the information technology envisioned: a portal through which all these

permit can be applied at once. Appropriation is taking place in all municipalities and at the provincial level, as they need to implement the new law and the portal. The idea is that such an ‘umbrella permit’ will realize efficiency gains (through administrative burden reduction) for citizens and businesses that apply for these permits.

Signification is a dimension of structuration drawing upon interpretative schemes. In this case, signification occurred through the connection of the Omgevingsvergunning with administrative burden reduction. This took place within the Ministry of VROM by setting up the Modernizing VROM regulations program. By enacting on the knowledge about creating efficient processes, this program, which was mainly concerned with creating a joined-up law, linked this new law to the development of a uniform portal that can be used to apply for the environmental permit. The VROM website states concerning the Omgevingsvergunning: *“All applications are sent to one portal: the OLO. In this portal you can use one digital request form for all activities (such as building, cutting trees, and demolishing). And one legal decision is made upon your request.”*

The second dimension of structuration – domination – is observed in the Omgevingsvergunning case by the creation of the Wabo law. This enforces implementation through determining that a law will need to be implemented by all municipalities. This is effectively a form of exercising power by the Ministry of VROM that enacts this facility to dominate the implementation process.

The third dimension – legitimation, which determines the appropriation of a system, is observed to take place through the link of the Wabo to the technology to be implemented. Municipalities needed to implement both the Wabo and the OLO for the Wabo to become operational. However, this has led to unfaithful appropriation for two reasons. Firstly, it led to superficial implementation of the OLO in order to ensure compliance, but not yet a proper imbedding in all processes. As a representative of a large municipality stated: *“What is going to change? Instead of ten decisions, we now put a staple through them and call it one decision.”* And secondly, this led to the Wabo bill being postponed a number of times in Parliament as it meant that the technology needed to be ready, but what constituted ‘ready’ could not be easily determined.

During the implementation process appropriation was attempted by the use of pilot projects to make sure that all parties involved became used to the OLO and to be able to learn from these pilots. One example where the pilots influenced the actual design was when, using the knowledge of the large construction companies, the possibility of dividing large construction projects into several smaller projects for which different permits are requested was added. A representative of a mid-sized municipality explains their initial concern with having to request all permits upfront: *“Both the situation that constructions are stopped halfway because of the discovery of an endangered species and the situation that research needs to be carried out before each permit request are unwanted.”* This process of using pilots to realize legitimation of the system was thus in some ways successful.

Legitimation was attempted by the Ministry by negotiating with the municipalities and provinces to determine the scope and outlook of the OLO. The organizations that were involved, however, had different norms and enacted these norms by sanctioning the development (by not implementing the OLO or by demanding a different design). While the provinces demanded a full portal to create one location for their communication with municipalities, many municipalities initially only wanted a thin form for the permit request. Yet other municipalities wanted complicated synchronization modules to be able to keep working with their own systems. In the end, a thick dossier module was designed, and the portal only includes a ‘permit check’ for

checking which permits are required in a specific case, and a mailbox in which information is stored that can be viewed by the requesting party and the government organizations involved. The scope and the function of the OLO were thus changed several times, as different processes of legitimation could be observed throughout the process.

In some cases unfaithful appropriation led to complications. As the process was attempted to be automated completely (even though this is not nearly the case just yet), the use of additional technology was required. A representative of an construction company explained: *"The use of extra-large scanners at municipalities may become necessary to digitize the application process. Some of the building plans are so complex that it is almost impossible to apply for a permit electronically in any other way"*. Furthermore, multiple organizations call for the need to add extra flexibility to the design. The representative of the large construction company: *"There is little room for explanation on the digital request form. Additional flexibility will need to be realized to be able to handle also the complex permit requests."* However, this extra flexibility may also lead to municipalities asking for additional information, thereby diminishing the gains of the administrative burden reduction that were expected. This indicates that unfaithful appropriation took place as the project was watered down at some points to no longer implement the 'spirit' of the Omgevingsvergunning.

5.2.3 Findings

Using contingency theory to analyze the transformation process shows that in both cases coordination is introduced in a network of organizations that were previously not (continuously) coordinating their actions. The Omgevingsvergunning introduced coordination through mutual adjustment and the SBR process infrastructure introduced output standardization. Furthermore, the SBR process infrastructure is expected to lead to a shift in coordinating mechanism in the longer run: from output standardization of standardization of skills. For the Omgevingsvergunning, this may also take place in the future when individual municipalities also attune their organizations to the OLO or when the ruds are set up, but this is not yet observed. Thus, while for the SBR case a change in the central coordinating mechanism is likely to be observed in the future – indicating organizational transformation, this is not the case for the Omgevingsvergunning case.

The main factor influencing this shift in is the introduction of information technology, influencing the height of the transaction costs and the type of tasks that are performed. This leads to a decentralization of decision-making and a professionalization of the workforce that performs more complex tasks as the simple tasks are automated. In line with the findings of Woodward (1965) and Malone (1999) it was observed that the introduction of information technology first leads to more hierarchical processes, before a decentralization of decision-making takes place. Still, through the process of hierarchical accountability, some forms of hierarchical control remain firmly in place. This remaining hierarchical force is expected to cause friction with the shift towards decentralized decision-making and a networked structure.

Using structuration theory to analyze the transformation process shows that structuration mainly takes place through a process of domination to ensure that the policy goals are embodied in the technology. Furthermore, it shows that technology is often unfaithfully appropriated as a result of organizations enacting it drawing upon their own norms and objectives. In both cases structuration takes place through the

processes of signification and domination, but the latter dimension is more influential. Signification draws upon interpretative schemes communicating the policy aims and domination draws upon facilities to impose control.

In both cases signification takes place through drawing upon the notion of administrative burden reduction. In the SBR case this is communicated by the joint agreement, and the Omgevingsvergunning case this is communicated by the set-up of the OLO. However, in both cases signification did not lead to the desired outcomes. Domination took place in the SBR case by the role of Logius using resources for building and maintaining the NT and the process infrastructure and for active coordination and governance among the different organizations involved. In the Omgevingsvergunning case the Wabo can be considered an important facility that was used to achieve the implementation of the OLO.

Appropriation takes place unfaithfully in both cases as a result of the enactment upon different norms and objectives by the organizations that are involved. In the SBR case the business case of administrative burden reduction is not accepted. On the side of the businesses, intermediaries dismiss it for three reasons: it threatens their existence, they have to pass on the efficiency gains to their customers, and they see the real benefits to occur on the side of the government. Furthermore, the IRS, which is the main organization involved, needs to invest heavily while smaller gains were expected than were seen abroad. In the Omgevingsvergunning case, municipalities appropriate the technology unfaithfully as they focus predominantly on being compliant with the Wabo rather than with the ‘spirit’ of the technology. Appropriation is thus seen to be central to the outcomes of IT-induced transformation as the policy goals embodied in the IT-projects are usually implemented by other organizations (having different norms and objectives) than where they are defined.

Considering the importance of domination and appropriation in these cases, there is one stakeholder in both cases that is not able to influence the implementation process. This is the – assumed – most benefiting party: businesses (in both cases) and citizens (in the Omgevingsvergunning case). As long as they are not involved in the implementation process, they do not determine the outcomes. Therefore, in both cases, the technology is dominated and appropriated in such a way that they mainly benefit the government organizations involved, rather than the ‘end users’. This does not mean that no benefits for citizens are observed, but rather that more benefits are achieved on the side of the government.

5.3 Outcomes and factors of IT-induced transformation

Based on the analysis of the two cases, it can be observed that in neither case transformation has taken place. While transformational outcomes are observed in the SBR case, it cannot be said that the case is fully transformed. A networked structure was not observed. Instead, public organizations remain responsible for their own processes, and accountability is still mainly taking place in a hierarchical manner. This impedes transformation. In the Omgevingsvergunning case the current processes are merely automated and joined up rather than that transformation is taking place. Two further outcomes of IT-induced transformation were observed. The first is the role of a change in legislation. In both cases, to make transformation possible, a change needed to be made in legislation. It was thus found that a change in legislation is a prerequisite for IT-induced transformation. Furthermore, in both cases transformation was found to focus on setting up governance rather than on changing the organizational structure.

Finally, a last outcome regarding IT-induced transformation was observed through the structurational analysis. It finds IT-induced transformation not only as a potential benefit for citizens and businesses, but mainly for government organizations themselves, contrary to the usual e-government and t-government efforts. While these mention the potential for these organizations, they usually emphasize the potential gains for the customers of government: citizens. The use of this perspective reveals that many of the transformational efforts are in effect undertaken to improve the processes of government. Hence, there are also fewer incentives to undertake efforts to realize transparency as this would likely benefit citizens more than it would benefit government organizations on the short term. This does not mean that there are no benefits for citizens and businesses, but these cases reveal that IT-induced transformation leads to more benefits being achieved on the side of government.

This chapter analyzed the objectives and mechanisms of IT-induced transformation in practice as well as the outcomes and the factors influencing the occurrence of IT-induced transformation by using the case studies of chapter 4. In the next chapter, a quantitative analysis of IT-induced transformation will be performed to find whether the objectives, mechanisms, outcomes, and factors that were found are also found in a different environment: local governments. This chapter concludes by summarizing the outcomes and factors of IT-induced transformation found in the case studies (see table 5.1).

Table 5.1: Findings from the case analysis.	
Transformational objectives	Public value creation
	Collaboration in networks
	Joining-up government by developing standards for information exchange
	Joining-up government by uniform regulations
	Integrated service delivery by creating a common interface
	Integrated service delivery by creating a uniform portal
Transformational mechanisms	Open governance process
	Service chain formation
	Business process change
	Enterprise architecture as governance instrument
Contingency analysis	Introduction of coordination between different parts
	Coordination through standardization of output
	Coordination through standardization of skills
	Horizontal organizational development
	Decentralization of decision-making
Structurational analysis	Administrative burden reduction and business cases as interpretative schemes leading to signification.
	Technology development and coordination and governance as facilities and resources that result in domination.
	Norms are enacted differently per organization involved, resulting in (un)faithful appropriation.

While three transformational objectives – public value creation, collaboration in networks, and joining-up government and integrating service delivery – were found to take place in the case studies, the fourth objective – public accountability – was not yet

observed. Therefore, based on the findings from the case studies, for the former three categories items are included in the survey research.

The second category of items that is included in the quantitative study means to test whether any differences can be observed between the transformational mechanisms used in the cases. In both cases the transformational mechanisms were seen to be concerned with setting up governance. Even the more technically oriented mechanisms such as enterprise architecture were used to govern change among the organizations involved. Therefore, items on governance will be included to test whether this tendency is also found in the quantitative study. While the two cases deploy comparable mechanisms for governance and architecture, the other two mechanisms – service chain formation and business process change – were deployed differently across the cases. To test whether deploying these different mechanisms also leads to different outcomes in the quantitative study, items on these transformational mechanisms are also included.

From the analysis of the transformation process using a contingency perspective, the most important finding is that IT is seen to be contingent on the organizational structure. While in the SBR case a shift in the coordinating mechanism can be observed, this is not the case for the Omgevingsvergunning case. To test the influence of IT, items that concerning the coordination strategy of organizations are also included in the quantitative study. These questions will explore which coordination strategy is likely to lead to IT-induced transformation.

From the structurational perspective it became clear that in the cases the dimensions of domination and appropriation are most influential in determining the outcomes of IT-induced transformation. To find how domination influences IT-induced transformation among local governments, factors exploring management strategies will be included in the survey research. Appropriation takes place through organizations enacting the technology by drawing upon their own norms and objectives. Although this is likely to determine how the IT-project will be implemented, it is more difficult to be included in the quantitative study, as this may be different for every organization. Therefore, these factors are left out of the survey.

6 Quantitative study among local governments

This questionnaire reads like a list of missed opportunities (municipal consultant after filling out the survey, 2008).

To find whether IT-induced transformation really took hold in public administration, a quantitative study is carried out into transformation among local governments. From the cases, it became clear that different outcomes may be expected from deploying similar mechanisms of IT-induced transformation. Therefore, factors influencing these outcomes were identified. These mechanisms, objectives, outcomes and factors of IT-induced transformation are investigated using survey research. The study is carried out among a representative population of ninety municipalities in the Netherlands. This chapter first presents the context of IT-induced transformation in municipalities before it moves on to the research set-up and the findings. Furthermore, at the end of this chapter the findings and limitations of the study will be discussed.

6.1 Transformation in Dutch municipalities

This study aims to find out whether IT-induced transformation has taken root in local government. It investigates IT-induced transformation among Dutch municipalities. The choice for a study among municipalities was made for three reasons. The first reason is that local governments are appointed as the first point of contact for public service delivery in the Netherlands (Hiemstra, 2003; Jorritsma, 2005; VNG, 2010). This means that any study on public service innovation needs to look into municipalities as this is where it will be most likely experienced by citizens. Secondly, to investigate whether IT-induced transformation really took hold within public administration, extending the findings of chapter 5 requires an empirical study in an environment that has the reputation of being less innovative. While the two case studies in the previous chapter can be considered innovative cases in the Netherlands, municipalities have the reputation of being resistant to change – especially compared to the private sector (Morgeson III & Mithas, 2009). Municipalities are considered suitable for investigating how transformation takes place in a different environment. Thirdly, a quantitative study requires a number of comparable cases. To be able to generalize, a relatively large and homogeneous group is necessary. Unlike the two explorative cases in the previous chapter, the large group of municipalities in the Netherlands enables such comparison.

In the Netherlands, municipalities are responsible for the largest part – around 70% – of all services provisioning to citizens and businesses (Hoogwout, 2003). But by 2015 this percentage should have increased to around 80% of services provided when they are to become a ‘one-stop-shop’ for citizens and businesses (Jorritsma, 2005; VNG, 2010). This choice is made based on the idea that municipalities are best equipped with specific local knowledge for understanding the needs of their citizens. This means that they have to integrate and coordinate many different service processes. Most municipalities, however, do not have sufficient means and knowledge to perform all these e-government projects and develop their own information systems. As a result,

different national policy initiatives have been undertaken to guide the municipalities in their development of electronic services. Furthermore, to increase their effectiveness, many municipalities are collaborating in consortia to create shared services or setting up shared service centers. The idea behind this is that when municipalities share their funds they can develop better services than by developing services for a single organization, while maintaining the ability to customize services to local conditions. Both the creation of top-down policy programs and collaborating in consortia are likely to lead to more uniform service delivery.

Although supporting the municipalities in their services development is a compelling idea, in practice it represents an enormous challenge. The 415¹⁵ Dutch municipalities represent a very diverse group, which makes the design of uniform e-government services difficult. In the Netherlands, there are four large cities (Amsterdam, Rotterdam, Den Haag, and Utrecht) that have more than 300.000 inhabitants. As Amsterdam (with around 800.000 inhabitants) and Rotterdam (around 600.000 inhabitants) are again much larger than the other two, they are subdivided in boroughs with their respective elected councils. In total there are around 25 municipalities that have more than 100.000 inhabitants, and the vast majority of municipalities has far fewer inhabitants. To ensure some common views among these organizations, the representative body VNG (Vereniging Nederlandse Gemeenten) represents the municipalities at the national level. But in practice, the larger municipalities send their own representation, thereby often reducing the role of the VNG to represent the majority of smaller municipalities.

The first policy initiatives developed at the national level aimed to realize a percentage of electronic services of 65% of public service delivery in 2007 (Actieprogramma 'Andere Overheid', 2003), which was later increased to 75%. As many municipalities had difficulties achieving this percentage, a national program was set up that aimed to develop generic aspects of electronic service delivery for municipalities: the EGEM (short for e-gemeenten or e-municipalities) program, which was set up in 2003. However, due to a lack of funding and expertise in many local governments, these developments were implemented more slowly than expected. Therefore, an extension of the EGEM program was set up: the EGEM i-teams (short for implementation teams). In the EGEM-i program, municipalities receive a budget to hire a consultant, who helps them to write an implementation plan for the development of their electronic front office and its supportive services. These consultants also focus on the coherence between the different initiatives developed within a municipality. The EGEM i-teams program ended in 2009 and was followed up by the establishment of a quality institute for Dutch municipalities (kwaliteitsinstituut Nederlandse gemeenten, KING). This foundation aims to develop generic products for municipalities as well as support them in the implementation of their services.

At the same time, a number of separate programs was initiated that aimed to set up generic building blocks that can be used for creating electronic services. For example, a national identification mechanism was developed, as well as a common portal for all citizens' services. To consolidate these separate developments, in 2008 the national executive program of service delivery and e-government (national uitvoeringsprogramma, NUP) was set up that defined a set of nineteen generic building blocks and six example projects. These generic building blocks and example projects are not just for municipalities, but for the government as a whole, and the NUP program aimed at the implementation of the building blocks in all service delivering government

¹⁵ This is the number of Dutch municipalities as of January 1st, 2012. Due to re-organizations, this number slowly decreases year by year.

organizations. Because the objectives outlined in the NUP program were not yet fully achieved after its expiration date, the NUP program was followed up by the iNUP program in 2011. The iNUP program aims at consolidation by ensuring implementation of these generic building blocks in all organizations. At the same time, it focuses on standardization and the set-up of vital registries. These are generic and unique data sets for, for example, citizens, businesses, properties, cars, etc. All these building blocks can be used for realizing electronic services.

The policy programs and generic building blocks form the context in which municipalities develop their electronic services. The variety of these initiatives show how many different policies and building blocks municipalities have to implement to become the main point of contact for citizens and businesses. While the larger municipalities have sufficient resources and expertise to implement all these developments, the vast majority of the smaller municipalities have many difficulties to do so. Municipalities have to deal with a lot of developments at the same time, which aim to change their organization in multiple dimensions (e.g. data sets, portals, identification and authentication mechanisms), on multiple levels (such as the technical, business process, and organizational level) over a longer period of time (the changes started in 2005 and will be going on for at least another couple of years). Thus, the changes taking place can be seen as IT-induced transformation.

6.2 Research set-up

To find whether IT-induced transformation has taken root in local governments, this quantitative study investigates the transformational objectives and mechanisms as well as the factors influencing IT-induced transformation among Dutch municipalities. Surveys are especially useful to make generalizations (Newsted et al., 1998). They collect information of a subset of the study population (the sample) in such a way that generalizations about the whole population can be made (Pinsonneault & Kraemer, 1993). This study was concerned with the organizational developments that were undertaken to improve service delivery. Many studies have looked into e-government development of local governments (see, for example, Bovaird & Loffler, 2002; Coursey & Norris, 2008; Ho, 2002; Holden, Norris & Fletcher, 2003; Koh, Prybutok & Zhang, 2008; Moon & Norris, 2005; Reddick, 2009; West, 2004), as well as into the relationship between technology, organizational change and performance (e.g. Brynjolfsson & Hitt, 2000; Croteau & Bergeron, 2001; Gregor et al., 2006) but no quantitative study was undertaken yet that combines transformational objectives and mechanisms to investigate their relations. First the research model of this study is presented, followed by the sample and the measures that are used.

6.2.1 Research model

This quantitative study aims to investigate whether IT-induced transformation took hold among Dutch municipalities. Thereby, it implicitly aims to see whether the findings from the previous chapter can be generalized. In the case studies, all transformational mechanisms were deployed, but not all objectives of IT-induced transformation were achieved. Furthermore, factors related to management and coordination were found to influence the outcomes of transformation. Based on the model of IT-induced transformation, the research model of this quantitative study is developed (see figure

6.1). Figure 6.1 shows that besides investigating the relation between the transformational mechanisms and objectives, also the factors influencing IT-induced transformation that were derived are included in the model. Their relation to the transformational objectives will also be investigated.

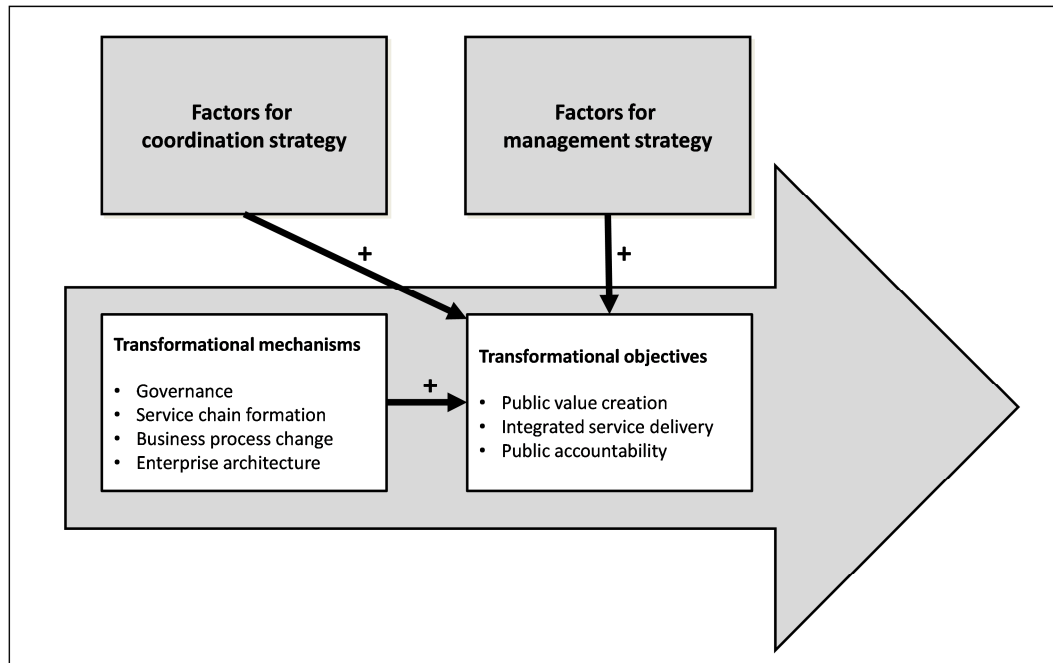

Figure 6.1: Research model of this study, based on the model of IT-induced transformation.

The case analysis in chapter 5 found that three of the four transformational objectives were achieved in at least one of the two cases: public value creation, integrated service delivery and collaboration in networks. One of these objectives (collaboration in networks) was left out of the research model in figure 6.1. The reason is that the questions that were included in the study were primarily concerned with service delivery of individual municipalities and this aspect could not be investigated.¹⁶ For the category of public accountability, items measuring prerequisite factors will be included rather than items measuring public accountability itself, as this is not yet observed in practice. As the case analysis of chapter 5 found all four transformational mechanisms present in the case studies, these are all included in the research model. Furthermore, the factors identified from the contingency and structurational analysis in chapter 5 were divided into two categories: management strategies and coordination strategies. The proposition is that all the transformational mechanisms and the factors identified from chapter 5 are positively related to the transformational objectives.

Quantitative studies are sometimes found to have a common method bias (Spector, 2006). This means that when a group of people is asked to answer questions both on dependent and independent variables that share a tendency to be biased, the correlation

¹⁶ The survey was carried out to establish the state of transformation and electronic service delivery among Dutch municipalities as part of a research project for the Alliantie Vitaal Bestuur between 2007-2010 (Veenstra, A.F. van, and Zuurmond, A. (2010) "Transformatie van gemeenten: een kwantitatief onderzoek rondom de Ketensimulaties". *Alliantie Vitaal Bestuur*, The Hague).

may be inflated. One way of overcoming this bias is to use multiple – independent – data sources. If in that case, any correlations are found, they are more likely to indicate a relation between two concepts. On the left side of the model of figure 6.1 two different groups of respondents were included to separate between the transformational mechanisms and the factors derived from chapter 5 (for further explanation, see section 6.1.2). However, a likely problem with multiple data sources may be that respondents conceptualize the same items in different ways. Thereby, no correlations may be found at all even though two concepts are, in fact, be related.

On the right side of the model, to measure the quality of electronic service delivery also additional data sources are used. These additional sources were collected by two different national e-government benchmarks: the *Monitor.Overheid.nl* benchmark and the *5Beloften.nl* benchmark (see figure 6.2). The former, which was abandoned in 2011, rates government organizations' websites according to their functionalities in six categories: (publication) standards, transparency, service delivery, personalized service delivery, interactive links, and accessibility. To investigate the outcomes of IT-induced transformation, the scores for service delivery, personalized service delivery, and transparency are included. The other three measurements are merely indicators of certain technical standards have been implemented by the municipalities, rather than indicators of transformation, and are left out.

The *5Beloften.nl* benchmark ranks the degree to which five different promises that were made by government organizations about their service delivery are implemented in practice: service delivery is citizen-centered, services are delivered fast and securely, collaboration between government organizations takes place, citizens' data are gathered only once, and organizations are transparent and accountable. As all of these promises are in some way related to IT-induced transformation, all five are included in the quantitative analysis.

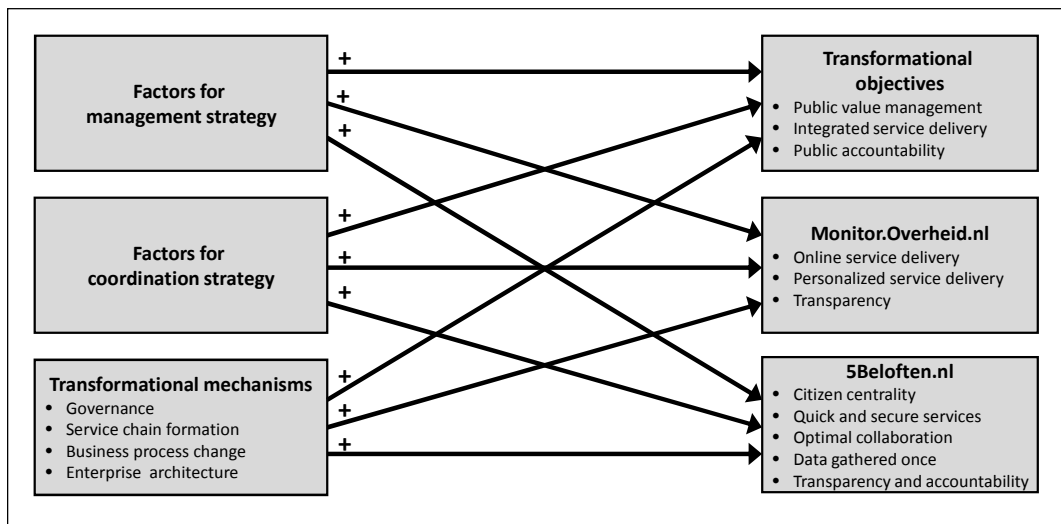

Figure 6.2: Research model of this study including the additional data sources.

To keep track of all the factors that are included in this quantitative research, the model of IT-induced transformation is no longer recognizable. But, effectively, this research model is based on the model that is central to this study, by investigating the relations

between the transformational mechanisms and objectives, and the relations between the factors influencing IT-induced transformation and the transformational objective. Finally, also the additional data sources are included. For these sources also their relation to the transformational mechanisms and factors will be investigated.

6.2.2 Sample

This study was carried out among local governments involved in one of the programs sponsored by the central government aiming to realize coherent implementation of the e-government infrastructure in Dutch municipalities. The reason for investigating these municipalities is that this program offered the opportunity of doing survey research. Between 2007 and 2009, the EGEM i-teams program supported 375 municipalities in designing an implementation plan for electronic services. These municipalities received funding for hiring a consultant, who is an expert in the development of electronic services in municipal organizations. The main task of these consultants was to write an implementation plan for coherently implementing electronic service delivery, as well as the supporting infrastructure components and services, and changing the organization accordingly. Thus, part of this plan is the formation of a strategy on how to transform the organization in order to leverage the components that make up this infrastructure.

When these consultants enter the municipalities, many of the municipal officials are not aware of the developments and changes that need to take place. Therefore, part of the EGEM i-teams program is a simulation game. A simulation game is a setting in which a limited number of participants imitate a real-life situation within a short time-frame. The goal of this simulation game is to create awareness about the importance of information sharing to allow for the creation of service delivery chains. The participants of the game were selected by the consultant on the basis of their involvement in electronic services development. From every municipality taking part in the support program, around fifteen employees participated in the simulation game. Many of the smaller municipalities joined up to play the game together, thereby sending up to eight employees from the respective municipalities to participate in the game. These simulation games thus provided an opportunity to gather data among municipalities involved in electronic service development.

Two different surveys were set up – one for every group of respondents: consultants and participants. The reason for this is that while the consultants have an overview of the objectives and mechanisms of the transformational initiatives in the municipalities, this is harder to assess for individual employees as they have little means of comparison. The municipal officials are asked to provide insights from their daily work practice to gather data on the transformational factors deployed within their municipalities. Thus, one survey was set up for employees concerned with e-government implementation at the local level to assess the transformational factors. In the other survey, the consultants were asked to assess the transformational objectives and mechanisms in the municipal organization. Some consultants are hired by multiple municipalities. To become such a consultant, they all followed a course developed by the EGEM-i program to ensure uniform electronic services development among different municipalities. Therefore, they are considered to have a common outlook on the degree to which municipalities have implemented and achieved the transformational objectives and mechanisms. The response rates are shown in table 6.1.

Table 6.1: Response rates.			
	Number invited	Number of cases (n)	Response rate
Consultants	104	70	66%
Municipal employees	1768	681	39%
Number of municipalities of which employee data gathered	104	90	87%
	443*		20%
Number of municipalities of which consultant data gathered	104	70	66%
	443*		16%
* Total number of municipalities in the Netherlands in 2008.			

Over the course of a year (2008), 104 local governments took part in the simulation game. The municipalities that took part in this study were thus not randomly selected, but were selected only on the basis of playing the simulation game in this particular year. In practice, this meant that the majority of these municipalities have fewer than 100.000 inhabitants, and only a few participating organizations have more than that, while none of the large municipalities took part. The consultants and participants of the simulation game of all of these municipalities were invited to participate in this research. 681 Participants from 90 municipalities responded, which represents an average of 7.6 participants per local government, with an range of 1 to 22 responses per municipality (median = 8). Furthermore, consultants from 70 different municipalities responded resulting in a full data set of these 70 municipalities. Response rates thus varied from 39% to 66% (see table 6.1).

To account for the differences among the scores attributed to their municipality by the employees, this group of respondents is categorized according to their function category (divided into operations, staff, policy maker, support staff, line management, and board members) some statistics are provided on the function categories of this group of respondents. table 6.2). Table 6.2 shows that a third of the participants considers themselves to be a line manager. The second largest group of participants (more than 20% percent) are the policy-makers. The smallest group represents the board members (usually aldermen), of which only a few (3%) participated in the game. In order to create an average score for each municipality, the average of the participants' scores was taken to allow for the construction of a data set on the municipal level.

Table 6.2: Function categories of the participants taking part in this study.		
	Frequency	Percentage
Operations	119	17.4
Staff	71	10.4
Policy-maker	146	21.4
Support staff	93	13.6
Line management	231	33.9
Board member	21	3.1
Total	681	100

To investigate whether the group of municipalities that took part in this study is representative of the whole population of municipalities in the Netherlands, a t-test was conducted to find out whether the benchmark scores of Monitor.overheid.nl of these municipalities are compatible with those that are not included in this study. The 5Beloften.nl benchmark was not yet carried out at the time of this study, therefore it is not possible to compare against this benchmark. This t-test shows that there is no significant difference between the scores regarding service delivery ($t(441) = 1.163$, $p = 0.25$), personalized service delivery ($t(441) = 0.420$, $p = 0.68$), and the total ($t(441) = 0.972$, $p = 0.33$) scores on the Monitor.overheid.nl benchmark of the municipalities that participate in this study and the municipalities that did not participate in this study. Therefore, the municipalities that participated in this study can be considered representative for the electronic services performances of municipalities in the Netherlands.

6.2.3 Measures

Measures were constructed for the transformational objectives and mechanisms. These measures were validated in interviews with five experts on e-government implementation in the Netherlands in 2007 and 2008. The members of this group of experts all had at least a few years of experience with e-government projects, and included two researchers, one representative from the Ministry of the Interior, and two consultants. They were invited to reflect on the list of operationalized transformational mechanisms and objectives, which resulted in extending the measures for the coordination and management strategies. Subsequently, the survey questions and the set-up of the research along the simulation game were tested with two municipalities at the end of 2007, to find whether the respondents properly understand the questions. This led to a few adjustments in how questions were phrased to make them more understandable. In the Spring of 2008, the data gathered at the first 19 simulation games were again analyzed to investigate whether the response rate was sufficient and whether any issues related to the response to the survey could be identified. This resulted only in very minor technical adjustments and the survey was continued throughout 2008.

Both the consultants and the participants were asked to score 'their' municipality in their current state on a scale of 1 to 10. The questions were grouped logically in a number of categories corresponding with the research model (see Appendix 2). Most of the items were normally distributed, as absolute values of skewness and kurtosis were mostly below 1.0, but two items were removed as they are not normally distributed: ISD_5 (presence of a tracking and tracing facility) and PA_3 (option of correcting personal data online) (see table 6.3). The reason for these not being normally distributed is likely to be related to these functionalities hardly being deployed by any municipality. For both functionalities, out of the data set only one municipality was found to score higher than a five.

Table 6.3: Measures for the transformational objectives (assessment by the consultant).	
Item	Please indicate to what extent this has been realized in the municipality? (10-point scale; lowest possible quality – highest possible quality)
ISD_1	Coherent presentation of services
ISD_2	Integration of electronic forms
ISD_3	Functional separation of front office and back office
ISD_4	Presence of standard authentication mechanism
ISD_5*	Presence of tracking and tracing functionality
PVM_1	Ability to make an appointment with a case manager online
PVM_2	Appointing case managers to customers
PVM_3	Pro-actively approaching customers to point out their rights
PA_1	Pre-filling information in electronic forms
PA_2	Online access to personal information
PA_3*	Allowing for online correction of personal information
* Removed from the final measurement model	

Table 6.4: Measures for quality of online service delivery (national e-government benchmark <i>Monitor.overheid.nl</i>).	
Item	According to a checklist regarding the functionalities of its website, how does a municipalities score on these aspects? (Percentage; 0% to 100%)
Monitor online service delivery	Online service delivery
Monitor personalized service delivery	Personalized service delivery
Monitor transparency	Transparency

Table 6.5: Measures for quality of online service delivery (national e-government benchmark <i>5Beloften.nl</i>).	
Item	Please indicate to what extent this has been realized in the municipality? (5-point scale; completely not realized – completely realized)
5Beloften citizen centrality	Service delivery is citizen-centered
5Beloften quick and secure services	Citizens can handle their affairs quickly and securely
5Beloften optimal collaboration	Optimal collaboration between government organizations
5Beloften data gathered once	Citizens' data are gathered only once
5Beloften transparent and accountable	Organizations are transparent and accountable

Table 6.6: Items of management strategy (assessment by the participants).	
Item	Please indicate to what extent this has been realized in the municipality? (5-point scale; completely not realized – completely realized)
MS_1	Strategies for online service delivery aim for diminishing the administrative burden of customers
MS_2	Process managers control organizational processes coherently
MS_3	Processes are managed coherently, instead of controlling dispersed activities
MS_4	Management is informed if a customer cannot be helped in a standard service delivery process
MS_5	Management has attention for removing bottlenecks from business processes
MS_6	Management takes time to remove bottlenecks from business processes
MS_7	Different departments are managed coherently
MS_8*	Process managers have an overview of organizational processes
MS_9 (R)*	Departments have a large degree of autonomy
* Removed from the final measurement model	
(R) Reversely coded	

The items gathered for the right side of the model – for the transformational objectives (assessed by the consultants), and from the Monitor.Overheid.nl and 5Beloften.nl benchmarks – are shown in the tables 6.3, 6.4, and 6.5 respectively. The items gathered for the left side of the model (the transformational factors and mechanisms that are assessed by the participants and the consultants respectively) are shown in tables 6.6, 6.7, and 6.8.

Table 6.7: Items of coordination strategy (assessment by the participants).	
Item	Please indicate to what extent this has been realized in the municipality? (5-point scale; completely not realized – completely realized)
CS_1	Departments meet regularly to discuss business procedures
CS_2	Departments have made service level agreements
CS_3	All necessary documents, access codes, keys, etc. are provided to new employees at the same time
CS_4	Departments coordinate business process in a centralized manner
CS_5	Communication takes place on differences in data between departments
CS_6	Individual employees attune their activities to those of colleagues in different departments
CS_7*	Different departments cooperate on law enforcement
* Removed from the final measurement model	

Table 6.8: Items of transformational mechanisms (assessment by the consultant).	
Item	Please indicate to what extent this has been realized in the municipality? (5-point scale; completely not realized – completely realized)
Gov_1	Management information is stored
Gov_2	Management supports decisions being made on the basis of architectural principles
Gov_3	Control data are stored
SCF_1	Entire service delivery process can be completed online
SCF_2	Activities are performed automatically without any human interference
BPC_1*	Departments share databases
BPC_2*	Business processes do not perform the same activities twice
EA_1	The architecture is well-documented
EA_2	The organization has developed enterprise architecture
EA_3 (R)	Architecture is developed on the basis of information systems
EA_4*	Architecture is developed on the basis of work processes
EA_5*	Architecture development is initiated from the business side
* Removed from the final measurement model	
(R) Reversely coded	

6.2.4 Constructs

To find whether the items gathered by the survey research measure similar aspects, a principal axis factor structuring using Oblimin rotation is carried out to construct factors. Oblimin rotation assumes that there are correlations between the factors, rather than that they are completely independent. This is suitable for a study on IT-induced transformation as it may very well be that a municipality undertaking some mechanisms of transformation, also undertakes others at the same time. Four separate factor analyses are carried out for each of the aspects of the research model (except for the benchmark scores). The reliability of the factor analyses is considered sufficient if the Kaiser-Meyer-Olkin (KMO) measure of sampling adequacy, which tests whether the partial correlations among variables are small, exceeds .6 (and preferably even exceeds .7).

The first group is the group of items relating to the transformational objectives (see table 6.9). Three factors were constructed: *public accountability*, *integrated service delivery*, and *public value management* (referring to those elements that require an overhaul of the municipal organization in order to create public value for citizens and businesses). As shown in table 6.9, reliability of all factors exceeds the .7 benchmark value.

The factor constructed for public value management is correlated to the factors constructed for both public accountability ($r = .326$, $p < 0.01$) and integrated service delivery ($r = .381$, $p < 0.01$), while public accountability and integrated service delivery are not correlated. While access to data and integrated service delivery can be performed separately, this indicates that transformation through public value management needs both other forms of service delivery. Furthermore, the use of the national identity mechanism (ISD_4) is clearly found to be a prerequisite for accessibility of citizens' data.

Table 6.9: Factors constructed for the transformational objectives (KMO = .720).

Factors constructed	Cronbach's alpha	Average variance extracted	Items	Standardized factor loading
Public accountability	.71	.51	PA_1	.92
			ISD_4	.64
			PA_2	.52
Integrated service delivery	.78	.55	ISD_1	.85
			ISD_2	.69
			ISD_3	.68
Public value management	.72	.45	PVM_1	.85
			PVM_2	.67
			PVM_3	.42

The second group of items comprises the transformational mechanisms, assessed by the consultants (see table 6.10). Three factors were constructed (*service chain formation*, *business-IT alignment*, and *governance*) and four items were removed (BPC_1, BPC_2, EA_4, and EA_5). Both items included for business process change were removed, indicating that this may not take place in the municipalities included in this study. The factors that were constructed are shown in table 6.10. Reliability of all factors constructed exceeds the .6 benchmark value.

This factor analysis confirms the findings of chapter 5, in which a clear tendency to use enterprise architecture as an instrument for IT-governance was identified. Factors related to enterprise architecture and to governance are seen to be reconfigured into two different factors: one seeing it as an instrument for business-IT alignment, and the other for more operational IT-governance, focusing on information technology. Hence, these two constructs were renamed to reflect these findings.

Table 6.10: Factors constructed for transformational mechanisms (KMO = .782).

Factors constructed	Cronbach's Alpha	Average variance extracted	Items	Standardized factor loading
Service chain formation	.75	.60	SCF_1	.73
			SCF_2	.81
Business-IT alignment	.85	.53	Gov_1	.86
			Gov_2	.79
			EA_1	.63
			EA_2	.62
Governance	.60	.44	EA_3	.76
			Gov_3	.56

The third group was the group of transformational factors related to management strategy. These questions were asked to the participants (municipal employees) (see table 6.11). Two factors were constructed: *external management strategy* and *internal management strategy*, while removing two items: MS_8 and MS_9. The value exceeds the .7 benchmark, indicating that the factors are reliable.

Table 6.11: Factors constructed for management strategy (KMO = .744).				
Factors constructed	Cronbach's alpha	Average variance extracted	Items	Standardized factor loading
External management strategy	.74	.42	MS_1	.82
			MS_2	.65
			MS_3	.64
			MS_4	.42
Internal management strategy	.78	.53	MS_5	.74
			MS_6	.88
			MS_7	.50

For organization development (see table 6.12) the same pattern was followed, constructing two factors: *tactical coordination*, referring to ways in which departments have made agreements about their collaboration and *operational coordination*, referring to ways in which individuals have attuned their actions to others in the organization. One factor was removed: CS_7. Reliability of all factors exceeds the .6 benchmark value.

Table 6.12: Factors constructed for coordination strategy (KMO = .777).				
Factors constructed	Cronbach's alpha	Average variance extracted	Items	Standardized factor loading
Tactical coordination	.65	.38	CS_1	.70
			CS_2	.60
			CS_3	.54
Operational coordination	.78	.52	CS_4	.79
			CS_5	.76
			CS_6	.61

Average variance extracted, however, is overall low, indicating that the degree that the factor explains the variance of the items is quite low. A likely reason for this is that the items that make up a factor do not necessarily relate to exactly the same concept, but rather to a few related actions that are undertaken by municipalities at the same time. Comparing these outcomes to the findings from the case studies in chapter 5 will gain more insight in whether these represent coherent transformational studies. This will be described in section 6.2. Discriminant validity was found to be acceptable.

6.3 Results

A multiple regression analysis is carried out to investigate whether the factors constructed for the left side of the research model are correlated with the factors constructed for the transformational objectives and with the scores from the national e-government benchmarks. Multiple regression analysis can be used to investigate relations between variables. To perform this regression analysis, the average factor scores were computed from the items belonging to the factor constructed. The beta

values from the regression analysis are shown in table 6.20. The factors that were not found to correlate are not shown in table 6.13.

The multiple regression analysis shows that all factors constructed from the transformational mechanisms are related to one or all transformational objectives. Service chain formation was even found to correlate with all three transformational objectives. None of the factors constructed for management or coordination strategy were found to correlate with the factors constructed for the transformational objectives. External management strategy was found to correlate with one of the 5Beloften.nl benchmark scores: quick and secure services, but none of the other factors constructed for management or coordination strategy was found to correlate with any other indicator for transformation. These findings indicate that within Dutch municipalities the more technically oriented transformational mechanisms are found to impact the transformational objectives that are related to electronic service delivery, with service chain formation as the strongest indicator (see table 6.13).

Table 6.13: Stepwise regression models for factors influencing the quality of service delivery.

Transformational objectives and benchmark scores	Transformational mechanisms and management and coordination strategies	B	R² (adjusted)
Public accountability	Service chain formation	.394**	.256
	Governance	.309*	
Integrated service delivery	Service chain formation	.341**	.100
Public value management	Service chain formation	.323*	.219
	Business-IT alignment	.283*	
Monitor online service delivery	Service chain formation	.298*	.150
	Governance	.265*	
Monitor personalized service delivery	Service chain formation	.473**	.209
Monitor transparency	Service chain formation	.295*	.070
5Beloften Quick and secure services	Service chain formation	.407**	.284
	External management strategy	.269*	
5Beloften Optimal collaboration	Business-IT alignment	.296*	.071
5Beloften Transparent and accountable	Service chain formation	.279*	.061

* p<0.05; ** p>0.01

From this survey research it becomes clear that IT-induced transformation was not observed among Dutch municipalities. Although some of the transformational mechanisms (most notably service chain formation) are correlated to transformational objectives and the indicators of service delivery from the e-government benchmarks, this cannot be considered transformation. Similar to the case studies, the municipalities show little change towards a networked structure displaying public accountability. Municipalities in the Netherlands are, instead of undertaking transformational efforts, still aiming to realize electronic – integrated – service delivery to create public value to citizens. As one of the consultants involved in the simulation game stated, after filling out the survey: *“This questionnaire reads like a list of missed chances”*.

The municipalities deploy technical means such as enterprise architecture for setting up governance among the different departments. One of the reasons for this is that the central government is pushing for the municipalities to implement the NUP building blocks at least at a minimum level. Thus, no efforts nor outcomes of transformation were found among the municipalities. Subsequently, no factors influencing these outcomes could be observed either. One external management strategy (concerned with customer desires such as administrative burden reduction, integrated service delivery, and customer care) was found to be positively related to service delivery.

To find whether municipal organizations were indeed not undertaking any transformation efforts, these findings were compared to two instances of IT-induced transformation in which local governments are involved. The first is the Omgevingsvergunning case, in which municipalities play a large role. And the second is the Social Support Bill (Wet Maatschappelijke Ondersteuning, WMO), which aims to create a portal to support those in society that need support to function independently. This latter can be considered an effort of IT-induced transformation as it aims for a change on multiple levels (institutional, organizational, process, and technical), into multiple dimensions (creating efficiency, administrative burden reduction, and social support), over multiple years (the Bill was passed in 2007, and the development of the portal is still ongoing). Both will be briefly looked into to find whether municipalities are undertaking transformational efforts.

As the Omgevingsvergunning case is extensively discussed in the previous chapter, and it was already found that little transformational efforts were undertaken, this seems to confirm the findings from the survey research. A representative of a large municipality stated regarding the Omgevingsvergunning: *“What is going to change? Instead of ten decisions, we now put a staple through them and call it one decision. A lot is being implemented, but the number of people benefiting is quite small. It would have been better if laws would have been deleted or made simpler and if all municipalities would charge the same for a permit request. Those aspects would mean much more for our clients.”* Thus, in the Omgevingsvergunning, little evidence of process change is found. While connecting the municipal information systems to the OLO would mean that efficiencies could be created by realizing process change, this is not yet realized in many municipalities and provinces. Instead, most of these organizations still access the OLO using e-mail. According to a representative of mid-sized municipality: *“Although we expect that the digitization will ensure efficiency gains, implementation of the systems takes time.”*

Looking at the WMO case, however, some indications of transformation may be observed.¹⁷ Firstly, the WMO case is associated with the set-up of various portals, which can be seen as an instance of integrated service delivery. Some of these portals are set up by municipalities themselves. In such a portal several organizations collaborate. Therefore, it is an effort of collaboration in networks. This collaboration is set up as many of the customers of the WMO may have some additional requests for support. A representative of the municipality: *“The sooner this support is provided, the better the chance for recovery. Therefore, different organizations collaborate in the portal and share information on a particular customer, if that customer agrees on this sharing of information”*. Also in this case, governance is found to play a large role in the formation of such networks, as the different organizations involved need to agree on which party

¹⁷ The findings from the WMO case were obtained from a research project carried out for the Ministry of the Interior (Veenstra, A.F. van, and Janssen, M. (2012) “Publieke waarde van keteninformatisering”. Ministry of the Interior and Kingdom Affairs, The Hague).

will provision of the facilities or the social support in another way. Service chain formation is thus observed to be an instrument for setting up governance.

Furthermore, the WMO case aims to create public value both to citizens directly and by strengthening the role of the government. Firstly, it aims to create better social support. According to a representative of the municipality: *“The project aims to provide as much support as possible from the direct environment of the citizen. Rather than providing the citizen with a facility (such as the provisioning of walking aid) right away, first a structured assessment is made whether the request of the citizen can be solved in a different way. For example by getting some help doing groceries by a neighbor. The reason for this is – naturally – to diminish the costs that municipalities make for these facilities”*. The set-up of the portal has thus led to business process redesign within municipalities, but also in between the organizations involved. Finally, this portal may even support public accountability in the future, as processes and decisions made can be published and made transparent for citizens. But this is not yet observed.

Although, similar to the cases in the previous chapter, transformation is not observed in the WMO case, it can be considered a transformational effort. While it may not yet have achieved the level of sophistication of the SBR case, there are signs that elements of transformation may be achieved in the future, through the set-up of transparency and public accountability, and process redesign. While this cannot be considered conclusive evidence, it does show that municipalities are able to undertake transformational efforts, even though it was not observed in the survey research. The limitations of the survey research are discussed in the next section.

6.4 Limitations and discussion

This chapter set out to explore whether the notion of IT-induced transformation developed in the previous chapters is rooted in public administration. To do so, this study investigated IT-induced transformation in Dutch local governments. As a result of having been targeted by numerous policy initiatives, their development of electronic services can be considered as a multi-dimensional, multi-level and long-term change process. The choice for municipalities was made because they are to become ‘one-stop-shops’ for service delivery to citizens and businesses in the Netherlands. In contrast to the two case studies, municipalities represent cases of IT-induced transformation in a different – less innovative – environment.

While this study found correlations between transformational mechanisms and transformational objectives as well as the e-government benchmark indicators of service delivery, no real transformation was found to take place among municipalities. As a consequence, factors related to management and coordination strategies were not observed to influence the transformational outcomes. Only external management strategy was correlated to the indicator for service delivery from the 5Beloften.nl benchmark. Validation of these findings by looking at additional qualitative research from the WMO case suggesting that, in practice, municipalities do undertake transformational efforts. This section discusses why these results may not show in this survey research by discussing the limitation of this study. Five limitations are discussed: four are based on the research set-up, and one concerns the context of IT-induced transformation in local governments.

A first limitation is the bias in the data; there is a strong focus on technology. There are three reasons for this likely being a bias in the data rather than the reality among municipalities. The first is the bias introduced by the consultant that is hired to give

advice to municipalities on the implementation of the e-government building blocks. Although also other aspects of the transformation form part of the implementation report, technology is a major focus. As this was one of the main challenges for the municipalities at the time they were participating in this study, this also led to a focus on technology in this survey. Hence, it may have led to finding the more technology focused transformational mechanisms being most significantly related to the transformational objectives. Secondly, it may have been introduced by the participants of the game. They were selected by the consultant on the basis of their involvement with electronic services development in their organization. Although this ensured that the persons participating in the survey were acquainted with the situation, there is also a risk that they too are mainly focused on the technical aspects. This may cause other aspects to be less to the forefront of their minds. And thirdly, this may be caused by the fact that many technical aspects are measured by e-government benchmarks. An outcome of benchmarks in practice is often that the elements that are measured become targets in itself in order for organizations to meet the benchmark standards (Janssen, Rotthier & Snijkers, 2004). As these technical measures are assessed in the e-government benchmarks, they may become one of the main concerns for the municipalities.

A second limitation of this study is the timing – 2008. Municipalities taking part in this study may not have undergone transformation yet. Moreover, they take part in the government program precisely because they want to improve their performance in the field of e-government and undertake transformation. Therefore, the data obtained are expected to reflect this limited and partial transformation. Still, the vast majority of Dutch municipalities took part in this program (375 of the 443 municipalities that existed in 2008), indicating that most of them are still in the process of undertaking IT-induced transformation. Thus, the lack of significant correlations for transformational aspects could be a result of this research having been carried out at a time in which almost all local governments are still in the process of implementing e-government initiatives. Transformational efforts manifest themselves only on the longer term.

A third limitation is the development of the questions. Only a limited number of questions could be asked. This means that rather than doing a full assessment of all transformational elements that municipalities undertake, a selected was made. Furthermore, the selection of the indicators that became part of the survey were not only set up with this study in mind. One of the main objectives of the research project was to set up a database for information on the state of transformational efforts in municipalities that could be re-used by other researchers. This means that no all questions that are central to this dissertation could be included.

A fourth limitation is the use of multiple data sources. It requires a balancing act between the risk of common method bias, and the risk of using multiple data sources. In the former case correlations may be observed only because data originates in the same source. The latter case may present the same information slightly differently leading to correlations not being observed while concepts are, in fact, related. As for the former risk, this problem is largely overcome as few of the data originate in the same source, while a number of correlations across sources are found. Regarding the latter risk, this cannot be determined as it remains unknown which other correlations would have been possible. But considering that often the same transformational mechanisms are correlated to similar transformational objectives and indicators from the e-government benchmarks, it appears that also this risk is mitigated.

A fifth limitation concerns the size of Dutch municipalities. As described in section 6.1, the vast majority of municipalities is small. Studies on e-government development in

local governments have often observed that larger municipalities perform better in developing e-government (see, for example, Moon & Norris, 2005). It is generally believed that the reason for this is the limited budget for developing IT-services of smaller municipalities. Some municipalities are therefore collaborating, forming IT service centers and sharing resources. As the number of municipalities in the Netherlands is slowly decreasing as a result of mergers between local governments, their sophistication in the development of e-government services may increase.

These limitations may explain the occurrence of correlations between the transformational objectives and mechanisms, and they may also explain the absence of correlations between the factors influencing IT-induced transformation found in chapter 5 and its objectives. Although the external management strategy was found to correlate with one of the benchmark scores, indicating that an externally oriented management strategy focusing on creating client centered services for citizens and diminishing the administrative burden for businesses may lead to better service delivery, it may be too early to conclude it that influences IT-induced transformation.

7 Conclusion

“[T]ransformation” functions variously as a description of something that has happened, as a claim that something has been achieved, and as promise or an aspiration about what might have been achieved (Tosey & Robinson, 2002).

This study investigated IT-induced transformation and explored the factors that influence it. IT-induced transformation was defined as long-term, multi-dimensional, and multi-level organizational change leveraging IT to realize public sector reform. It is concerned with the strand of e-government aiming to transform public administrations beyond making them more efficient and customer-oriented. While e-government focuses on automating current processes and implementing IT, t-government aims for change that will make the public sector more effective. However, while t-government is often mentioned as a potential force to change public administrations, few studies have operationalized or tested it. Therefore, this study operationalized IT-induced transformation based on the literature and subsequently investigated its efforts in practice. This chapter presents the conclusions of this study and recommendations for further research.

7.1 Outline of a theory of IT-induced transformation

The investigation into IT-induced transformation took place in three steps. Firstly, the objectives and mechanisms of IT-induced transformation are identified based on the literature. Then, based on an empirical investigation, its outcomes are studied: ‘transformation-as-a-product’. Thirdly, the factors influencing IT-induced transformation are identified. For this step, two theoretical perspectives are developed that can be used to analyze ‘transformation-as-a-process’. These perspectives are based on contingency and structuration theory. These theories are complementary, likely resulting in a rich insight into the transformation process.

The contribution of this study to the literature is threefold. The first contribution is the operationalization of the notion of IT-induced transformation. Although a lot is written about t-government, no clear operationalizations of of this notion were found (see chapter 1). This study created the model of IT-induced transformation (see figure 7.1) and more details were added based on the outcomes of the empirical studies. The second contribution to the literature is the identification of outcomes of and factors influencing IT-induced transformation. These factors are subsequently used to further operationalize the model shown in figure 7.1. The third contribution is the use of the combination of the theoretical perspectives based on contingency and structuration theory. This was found useful for studying IT-induced transformation.

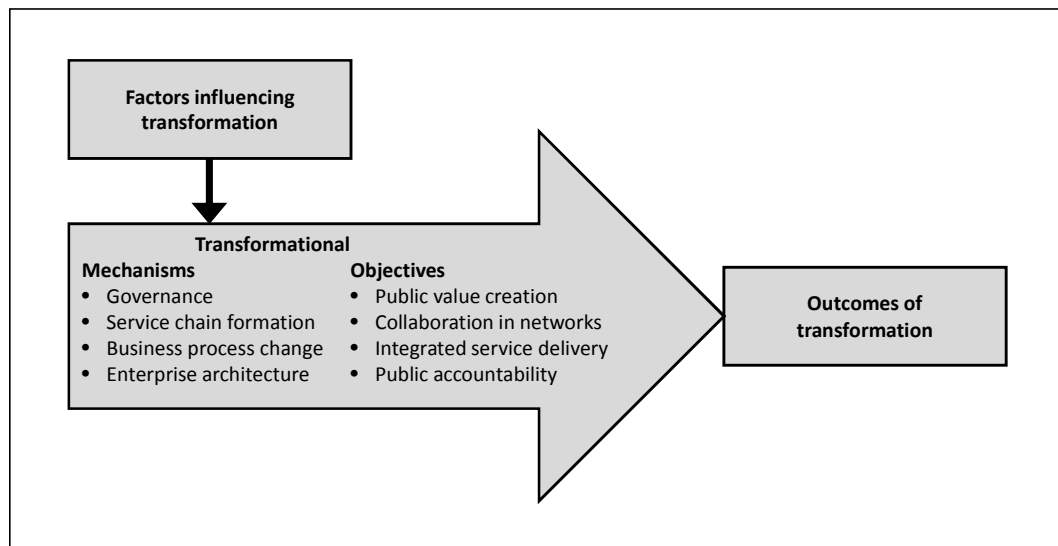

Figure 7.1: Model of IT-induced transformation.

In this research, IT-induced transformation was operationalized as deploying a set of engineered change efforts ('transformational mechanisms') leveraging IT in order to realize a set of organizational and institutional changes aiming for public sector reform ('transformational objectives') (see chapter 2). Four transformational mechanisms were derived from the literature on how t-government is undertaken in practice: governance, service chain formation, business process change, and enterprise architecture. These mechanisms are to achieve four transformational objectives, derived from the literature on public sector reform: public value creation, collaboration in networks, integrated service delivery, and public accountability. The transformational mechanisms and objectives are also shown in figure 7.1.

The empirical investigation took place using two cases studies – the *Standard Business Reporting* (SBR) and the *Omgevingsvergunning* programs – and by conducting a survey among Dutch municipalities. While all transformational mechanisms were deployed in the cases, they represent different stages of development. While the SBR case is undertaking business process change, the *Omgevingsvergunning* undertook service chain formation (see chapter 4). Thus, the cases cover two different types of transformational efforts. The choice for conducting a survey among municipalities was made to find whether IT-induced transformation is taking hold of government. As municipalities are to become the main point of contact for citizens and businesses with the government, t-government would likely make a big impact there.

However, in neither case study full transformation – let alone public service reform – was observed (see chapter 5). While collaboration between organizations in networks emerged, accountability remains organized in a hierarchical manner impeding organizational transformation. Rather than representing a shift to a networked organizational structure of government, IT-induced transformation is concerned with the set-up of governance to guide changes in the collaboration between public organizations. This focus on governing change was also observed in the technical transformational mechanisms that were deployed in the cases, such as enterprise architecture. While many e-government initiatives focused on the implementation of technology, t-government initiatives were thus found to focus on governing change.

Therefore, IT-induced transformation was found to refer to the *objective* of transformation rather than to an already established *outcome*.

While investigating the transformational objectives and mechanisms in the two case studies, four notable additional factors were found to influence IT-induced transformation: the technology that is used, a change in legislation, the different norms and objectives across organizations involved, and power exerted by the government (see chapter 5). Firstly, it was confirmed in the case studies that by introducing technology, aspects of organizations change (see, for example, Woodward, 1965; Malone, 1999). The implementation of IT was found to lead to changes in the coordinating mechanism. Furthermore, it was also found to lead to decentralized decision-making and a professionalization of the workforce. Technology was thus found to be contingent on the organizational structure.

Secondly, it was found in the case studies that IT-induced transformation is spurred by a change in legislation, facilitating new forms of coordination among public organizations. In both cases the use of specific information systems became part of the legislation to enable the wide-spread use and spur transformational efforts.

Thirdly, differences between norms and objectives of public organizations lead to these organizations also enacting IT differently. By drawing upon their own norms and organizational objectives during implementation, they often implement the technology in a different way than intended. The policies driving the transformational efforts have implicit objectives and aims, which may or may not be in line with the objectives and aims of the public organizations implementing the technology. Organizations thus enact technology to suit their own organizational purposes. This leads to differences in the use of IT across public organizations.

Fourthly, the power public organizations exert during the transformation process leads to a bias in t-government projects towards strengthening the role of the government rather than that of citizens. As a result, IT-induced transformation usually results in more benefits for the government itself – such as more efficient processes, than in improved service delivery. While citizens and businesses often benefit from IT-induced transformation, government organizations usually benefit even more. This may seem conflicting with the objectives of t-government. Most transformational efforts are undertaken to facilitate improved service delivery. However, it may be less conflicting than it appears at first glance. Strengthening the role of the government, for example by improving compliance, also represents public value. Still, it may explain why transparency and public accountability, which would benefit citizens and businesses more than government organizations, are not observed in the case studies.

The limited transformation found in the case studies was confirmed by the findings from the survey that was performed among municipalities (see chapter 6). While municipalities undertake technically oriented efforts to improve electronic service delivery, these efforts were not found to result in any changes in the organizational structure. Based on the empirical studies, the model of IT-induced transformation presented in figure 7.1 was elaborated. Details were added to the different aspects of the model (see figure 7.2). In the case studies and the survey research it was found that this model is useful for conceptualizing IT-induced transformation as it captures how organizations undertake t-government.

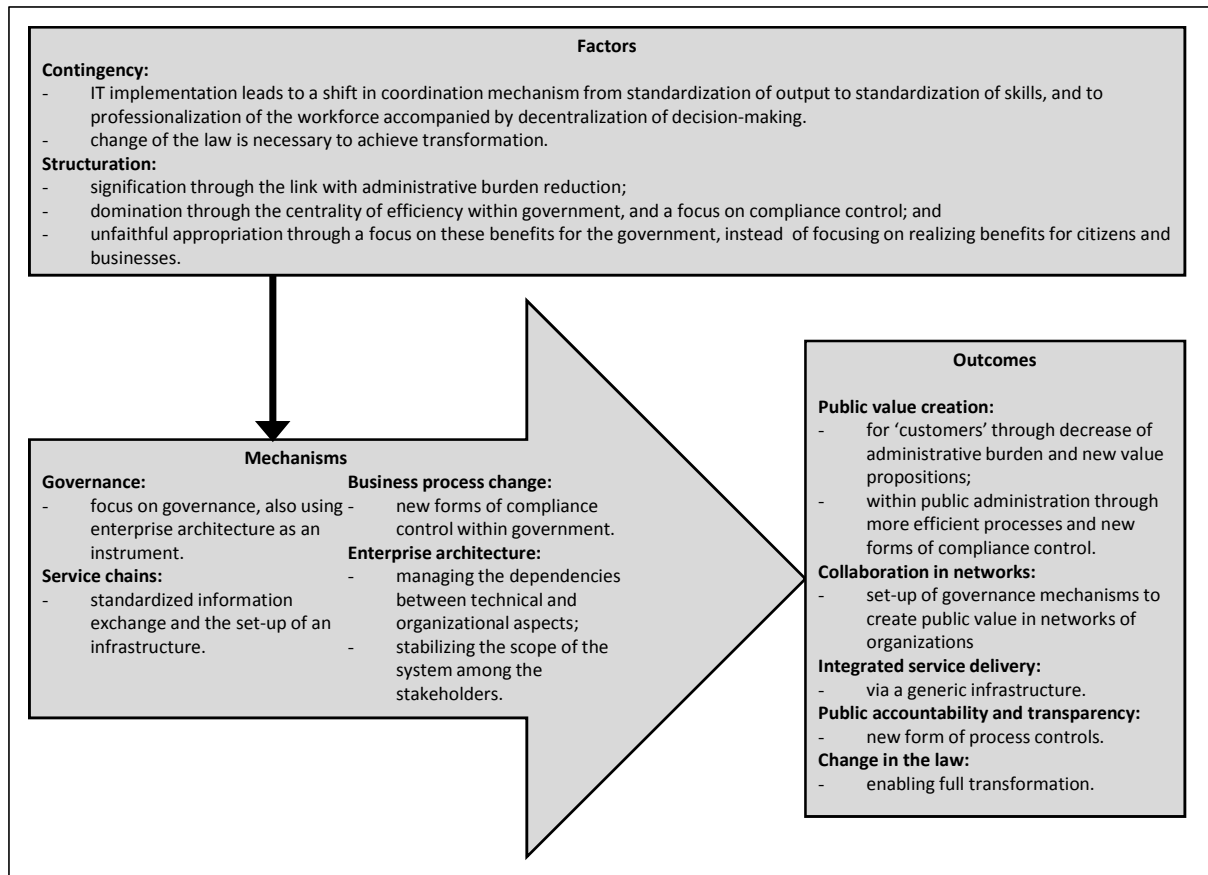

Figure 7.2: Model of IT-induced transformation, based on the empirical investigations.

Literature on transformational e-government hardly focuses on creating theory but usually presents anecdotal lessons from empirical studies. Therefore, this study developed theory that can be further tested and refined in order to advance studies of t-government. This study contributes to the literature in three ways. The first contribution is the operationalization of IT-induced transformation. In the literature often loosely connected objectives and mechanisms are mentioned that are said to be undertaken in t-government efforts (see, for example, Parisopoulos et al., 2009), while the relation between these transformational aspects is rarely defined – let alone tested. This study found, based on the empirical studies, that IT-induced information in practice is undertaken by engineered change efforts in order to achieve institutional and organizational changes.

The second contribution to literature is the formulation of outcomes of IT-induced transformation. Rather than leading to organizational transformation resulting in a networked structure of government as often projected in the literature (see, for example, Irani et al., 2007), IT-induced transformation was found to set up governance to realize collaboration within networks of public organizations.

The third contribution to the literature is the development of two theoretical lenses for studying t-government. Studies into e-government and t-government often lack theoretical grounding (see, for example, Yildiz, 2007). Combining two complementary theoretical perspectives, this study developed a theoretical approach for studying complex transformational efforts that was found useful to derive factors influencing the

transformation process. In the next sections, the three sub-research questions are revisited and answered in detail and the contributions to literature are elaborated.

7.2 Operationalizing IT-induced transformation

The first research question is concerned with operationalizing the concept of IT-induced transformation: *What are the objectives and mechanisms of IT-induced transformation?* IT-induced transformation is defined as long-term, multi-dimensional, and multi-level organizational change leveraging IT to realize public sector reform. The definition of IT-induced transformation thus links objectives of public sector reform to mechanisms of engineered change. While rooted in the literature on e-government, it essentially builds on theoretical concepts developed in two research fields: Public Administration (PA) and Information Systems (IS). During the 1990s, governments came to see IT as a means for achieving objectives of improving their service delivery and efficiency, and eventually for realizing public sector reform. Therefore, the first research question was answered by looking at the literature on the ideal types of public administration and public sector reform from the field of PA to derive transformational objectives, and by looking at literature on leveraging IT from the field of IS to derive transformational mechanisms.

Transformational objectives

Public sector reform emerged as a reaction to the issues associated with bureaucracy. The German sociologist Max Weber (1864-1920) developed the notion of bureaucracy as an ideal type for public administrations in the industrial age. Nowadays, however, bureaucracies are often associated with inefficiency and red tape. To make governments more efficient and responsive by introducing clear output targets and client-centered service delivery, a first wave of public sector reform took hold, commonly referred to as New Public Management (NPM) (Osborne & Gaebler, 1992). At the time when NPM emerged, governments started to recognize the potential of IT in modernizing public administration. The objectives of e-government, thereby, became aligned with the objectives of NPM. However, NPM had many issues of its own, such as a fragmentation of the public sector and the realization of perverse effects through the focus on output. Therefore, current public sector reform agendas focus on public value creation. Hence, the latest wave of reform efforts is often called Public Value Management (PVM) (Moore, 1995; Stoker, 2006).

This wave is mainly concerned with the wider shift in government from vertically oriented organizations to network-oriented organizations. However, rather than a distinct reform paradigm it should be seen as a continuation of NPM aiming to overcome some of its negative effects. Based on PVM, four transformational objectives of IT-induced transformation were derived:

1. The **creation of public value** for citizens directly or by increasing the value of public administration, through ongoing assessment of the value to be realized;
2. Policy formation and execution through **collaboration in networks**, that may include public organizations as well as private parties;
3. Setting up **integrated service delivery** and **joined-up government** through the coordination of activities of different departments and organizations; and
4. Realizing **public accountability** and making public administrations more transparent.

Transformational mechanisms

Quickly after the introduction of computing into organizations, the premises of organizational change or even transformation took hold. Initially, research on information systems in the public as well as the private sector did not find any transformational outcomes beyond more efficient communication and processes. Others found that IT-implementation was indeed able to make organizations more productive or that organizations were transformed through IT-implementation, but they concluded that this mainly took place in organizations that introduced additional organizational changes leveraging IT (Brynjolfsson & Hitt, 2000). These organizational changes include aligning IT with the business (Venkatraman, 1994), undertaking extensive business process change (Hammer & Champy, 1993), and making organizations flatter and more network-oriented (Castells, 2000).

From the theoretical field of IS, four mechanisms of IT-induced transformation are derived that are used to undertake t-government efforts and that aim to leverage IT and guide organizations to a more horizontally oriented organizational structure:

1. **Governance** to guide developments;
2. The formation of **service delivery chains**, in previously stove-piped organisations;
3. **Business process change** of the back office of organisations; and
4. **Enterprise architecture** for ensuring interoperability between organizations.

The combination of using literature from the PA and IS domains is useful to identify the objectives and mechanisms of IT-induced transformation. However, this combination also signals some inherent problems with t-government as it links engineered changes to objectives of public sector reform. While the former has an operational nature, the latter is seen to take place more on the institutional level, requiring long-term changes also in the culture and daily practice of organizations. The question is thus whether these outcomes can be observed in practice.

7.3 Outcomes of transformation in practice

The second research question is: *What are the outcomes of IT-induced transformation in practice?* This research question was answered by investigating two case studies of IT-induced transformation and by conducting a survey among Dutch municipalities. The cases of IT-induced transformation are the *Standard Business Reporting* program and the introduction of the *Omgevingsvergunning*. The main outcomes from the cases and the survey are summarized in table 7.1.

Table 7.1: Outcomes of IT-induced transformation.			
	SBR (case study)	Omgevingsvergunning (case study)	Municipalities (survey)
Creation of public value	Administrative burden reduction; better quality of reporting process	Administrative burden reduction; joined-up service delivery for citizens and businesses	Electronic service delivery to citizens and businesses
Collaboration in networks	Governance is set up to implement standardized reporting	Government organizations jointly process a permit request	Collaboration in networks is found in practice, but not in this study
Integrated service delivery	A joint process infrastructure is set up to allow for standardized reporting	The permit request process is joined-up and supported by a portal	Municipalities are to become the single point of contact for citizens
Public accountability	Not observed	Not observed	Not observed

Outcomes of transformation in the SBR and Omgevingsvergunning case studies

The SBR program is concerned with standardizing the (financial) reporting of businesses by introducing a data standard and developing a process infrastructure. The Omgevingsvergunning case has joined up twenty-five permits in the living environment, which is supported by a portal that can be used to apply online for this ‘umbrella permit’. The two case studies were selected as they represent innovative change programs aiming at multi-level, multi-dimensional, and long-term organizational change leveraging IT to realize public sector reform.

Most transformational objectives, such as public value creation, collaboration in networks, and integrating service delivery, were found to be achieved in the case studies. However, the fourth objective – public accountability – was not observed. Accountability is still taking place in a hierarchical manner impeding the shift towards a network structure. Instead, IT-induced transformation was observed to focus on setting up governance to coordinate the actions of organizations that collaborate in a network. Furthermore, in both cases a change in legislation was made, which was found to be a requirement for realizing IT-induced transformation. The transformational objectives and mechanisms observed in the case studies are discussed one by one.

Public value creation was observed in both cases, but only in the SBR case it is expected to result in a continuous assessment of activities and whether they still result in creating the right public value. This will likely play a role in the future leading to newer ways of compliance control (through the introduction of horizontal control). Collaboration in networks results in the set-up of governance to guide changes within the network of organizations in both cases. Integrated service delivery was realized by the formation of a service chain in the Omgevingsvergunning case, and by standardization in the SBR case. Public accountability was not observed to be realized in either case. For all the reporting processes the compliance control tasks remain the responsibility of individual government organizations (and thereby remains siloed) as they have a firm legal basis.

While all transformational mechanisms are deployed in the case studies, they do not deploy the same mechanisms. The set-up of governance was clearly observed in both

cases. The use of enterprise architecture was also seen to contribute to governance. The other two transformational mechanisms – service chain formation and business process change – are deployed differently in the two cases. While a service chain is set up in the Omgevingsvergunning, in the SBR case an interface for communications between business and the government was developed. Business process change was found to be deployed in the SBR case, but not in the Omgevingsvergunning case. This has led to new value propositions within government and for businesses and their intermediaries.

Outcomes of transformation in Dutch municipalities

The second empirical investigation looked into the transformational efforts undertaken by local governments, using survey data collected among ninety Dutch municipalities. The choice for sending a survey to municipalities was made for three reasons. First of all, it allows for making generalizations for a specific population – local governments, thereby investigating whether transformation really took hold in government. Secondly, municipalities are to become the single point of contact for all contact with the government in the Netherlands, and therefore their performance of public service delivery is especially important. And thirdly, to obtain a large enough sample of comparable cases, as municipalities are the only instance of government organizations of which there are enough to allow for generalization.

The past years, municipalities faced a constantly changing set of policies aimed at transforming them. Many municipalities participated in a program aiming to spur e-government and the adoption of the national e-government infrastructure building blocks. As these municipalities were focused on transformation, they were invited to participate in this study. This resulted in ninety municipalities taking part in the survey, representing 20% of all municipalities in the Netherlands.

A multiple regression analysis using SPSS found correlations between the more technically oriented transformational mechanisms on the one hand and the transformational objectives as well as e-government benchmark scores on the other hand. The transformational mechanisms that showed correlations are the formation of service chains, the set-up of governance and realizing business-IT alignment. The latter mechanism refers to creating a relation between the organizational structure and the IT that is deployed within organizations. However, these correlations only show that municipalities are concerned with the implementation of technical means for improving electronic service delivery. Rather than realizing transformation, these factors aim to digitize the current processes of municipalities. This confirms the findings from the case studies that transformation was not observed.

7.4 Factors influencing IT-induced transformation

The third research question is: *Which factors influence the occurrence of these outcomes?* This research question is concerned with ‘transformation-as-a-process’ and is answered using two complementary theoretical perspectives on transformation, based on contingency theory and structuration theory. The choice for these two theories was made for three reasons. Firstly, they are complementary, likely gaining a rich insight into the transformation process. Secondly, these theories are both used to explain organizational change and are at the same time well-rooted in the field of IS, having spin-offs that are used in this research field. And thirdly, they are both meta-theories aiming at explaining change at a more abstract level instead of testing clearly defined outcomes of change, thereby allowing for theoretical flexibility.

The findings based on this analysis are summarized in table 7.3. This investigation shows that the combination of the two perspectives can be considered useful to study the process of IT-induced transformation. By using both perspectives factors that influence the transformation process, which are complementary rather than overlapping, are derived.

Table 7.2: Factors influencing the outcomes of IT-induced transformation.			
	SBR (case study)	Omgevingsvergunning (case study)	Municipalities (survey)
Coordinating mechanism changes as a result of the use of IT	Coordinating mechanism shifts from output to skill-based standardization	Introduction of a coordinating mechanism: mutual adjustment	No changes observed
Domination through facilities for infrastructure development and a change in legislation	Infrastructure development was leading in creating a joint understanding of reporting; change in legislation is necessary to spur transformation	The Wabo was a driving factor in the transformational efforts; a change in legislation upfront led to a focus on compliance instead of on transformation	Changes in the law are also instrumental in driving transformation in municipalities, but this was not observed in this study
Appropriation of policies	NT and process infrastructure are appropriated in such a way that they likely benefit governments more than businesses	OLO was appropriated in such a way that only the minimal compliance with the Wabo was realized	Not observed

Contingency theory

Contingency theory assumes that there is no optimal way of organizing; change is a result of organizations responding to changes in their environment to realize the best performance (Galbraith, 1973). Contingency theories that emerged in the 1960s identified four main contingencies: two internal contingencies – the tasks performed and the use of technology, and two external contingencies – the uncertainty and the complexity of the environment. Rather than that these contingencies independently influence organizational outcomes, organizations and their characteristics are seen to develop into a limited number of configurations (Mintzberg, 1983). These configurations are defined by their central coordinating mechanism. Contingency theory is thus concerned with the issue of ‘fit’ or alignment of different organizational characteristics.

Contingency theory can be used to derive factors influencing the transformation process. To find whether any changes in the organizational structure are made, the central coordinating mechanism was investigated. In both cases a coordinating mechanism is introduced in a network of organizations that were previously not coordinating their actions. While in the Omgevingsvergunning coordination takes place through mutual adjustment, in the SBR program a shift in the coordinating mechanism is expected to occur: from output standardization to standardization of skills. The main factor influencing this shift is the use of IT, influencing the type of tasks that is

performed. As simple tasks are automated, the use of IT leads to a decentralization of decision-making and professionalization of the workforce. As a result of accountability remaining vertically oriented, friction is expected to occur throughout the transformation process.

Structuration theory

Structuration theory holds that social phenomena are constituted by the interplay of structure and agency. It was founded by the sociologist Anthony Giddens (1938-). The theory distinguishes three dimensions of structure: signification, domination, and legitimation. Investigating these sources of structuration can reconstruct change processes and derive forces that influence change. Although Giddens does not specifically apply his theory to technology in general, nor to IT specifically, many studies in the field of IS use structuration theory. Poole & DeSanctis (2004) developed *Adaptive Structuration Theory* (AST) to allow for the explanation of variance in the adoption and use of technology, thereby identifying aspects and factors influencing the specific outcomes of the process of structuration. AST is further concerned with the appropriation of IT, referring to whether IT is properly adopted or not.

Using structuration theory to analyze the transformation process shows that structuration mainly takes place through a process of domination ensuring that policy goals are embodied in technology. Drawing upon facilities to impose control, domination took place in the SBR case using resources for building and maintaining the NT and the process infrastructure. In the Omgevingsvergunning case the Wabo can be considered an important facility that was used to achieve the implementation of the OLO. Signification was observed to take place, most specifically through drawing upon the interpretative scheme of administrative burden reduction, but its effect was not as forceful as that of domination.

The case studies further show that technology is often appropriated unfaithfully as a result of organizations enacting IT drawing upon their own norms and objectives. Thereby, they alter the norms and objectives embedded in the technology. In the SBR case the business case of administrative burden reduction is not accepted by the organizations involved. In the Omgevingsvergunning case, municipalities appropriate the technology unfaithfully as they focus predominantly on being compliant with the Wabo rather than that they use the technology to allow for process change in their organization. Appropriation is thus seen to be central to the outcomes of IT-induced transformation as the policy goals embodied in the IT-projects are usually implemented by other organizations (drawing upon different norms and objectives) than by the organization that defines the policy objectives.

Considering the importance of domination and appropriation in these cases, there is one group of stakeholder in both cases that is not able to influence the implementation process. These are the – assumed – benefiting parties: businesses (in both cases) and citizens (in the Omgevingsvergunning case). As long as they are not involved in the implementation process, they do not determine the outcomes. A clear example is that the smarter ways of control and compliance are outcomes of IT-induced transformation that strengthen the role of the government rather than the role of citizens. At the same time, this may explain why the purposes of greater transparency and social accountability, which would benefit citizens and businesses, are rarely met. It was thus found that IT-induced transformation more often strengthens the role of the government than that it realizes public value for citizens and businesses.

7.5 Limitations

As a result of the choice for the theoretical perspectives as well as the method used for the empirical work, this study has some limitations. Effectively, every choice that is made guiding the research design and set-up may present a limitation. Although the choices concerning the research design were carefully made, these need to be discussed as they determine the extent to which the findings and conclusions presented in this chapter can be generalized. The limitations range from the more practical limitations concerned with the execution and interpretation of the empirical research to the fundamental limitations that follow from the use of the specific theoretical perspectives. A first limitation is the normative nature of t-government and, thereby, IT-induced transformation. A second set of limitations follows from the choice for and the methods used in the empirical studies. The use of PVM and the choice for specific mechanisms leveraging IT present a third set of limitations. A fourth set of limitations follows from the choice for the combination of the theoretical perspectives of contingency and structuration theory.

The first limitation is the normative nature of t-government. This – inevitably – leads to some bias in the concept of IT-induced transformation. This study defined transformation as multi-level, multi-dimensional, and long-term change, which was derived from the literature on t-government. This definition formed the model of IT-induced transformation, resulting also in a biased model. If other bodies of literature would have been used, they may have provided other normative insights for reform. Still, this study found that the definition used and the model derived from the literature corresponded with how t-government was undertaken in practice. Therefore, while normative, the model was considered useful.

The second set of limitations is related to the choice for the empirical studies. The two cases studies of IT-induced transformation were carefully selected based on the characteristics of transformation. Still, the findings from the case studies may not be generalizable to all cases of transformation as also the findings from these two cases were found to differ (see chapter 5). Regarding the survey that was conducted, at the end of chapter 6 its limitations were discussed. These were mainly practical limitations, referring to the specific context in which the survey was conducted. There were, however, also more fundamental issues regarding the timing and sampling of the survey. The survey was carried out at a moment when many local governments were still mainly implementing electronic services, without undertaking transformation. In 2008, most municipalities (especially those that took part in the consulting program and subsequently the survey) had not even started their transformational efforts. This likely has its influence on the survey results, which show that very little transformation is taking place. Furthermore, the survey was undertaken during the consulting trajectory. The consultants were found to focus largely on the implementation of technology. This may explain the bias towards the technology that was found, as at that moment in time municipalities were mainly concerned with getting the right technology in place in their organizations.

PVM as an instance of public sector reform presents a third set of limitations. It emerged to overcome some of the problems associated with NPM. Hence, it is at the moment still mainly a theoretical exercise, as few governments around the world can be found to actively pursue PVM. This means that, similar to t-government, few studies exist that have operationalized the notion and tested it empirically. In order for PVM to

be used in studies of t-government more often, it needs to be first properly defined and operationalized based on theory.

The fourth set of limitations is related to the choice for the theoretical perspectives. For the case study analysis, two theoretical perspectives were selected: contingency theory and structuration theory. These perspectives were chosen as they represent two complementary lenses on organizational change and transformation. However, for both theories disadvantages have been identified that have implications for the findings of the empirical work. Contingency theory is seen as a mechanical theory implying 'natural laws' in organizational changes, while it has been often found that organizational change is a tremendously complex undertaking. Furthermore, it is criticized for not taking into account that the contingencies that are identified may also be interrelated or that the relationship with the outcomes of changes is a two-way relationship (Schoonhoven, 1981). This makes the analysis of contingencies much more complex. To also take into account the forces of institutions and human agency structuration theory was used to give additional insights into how change may take place in practice.

Applying structuration theory to the field of IS has made a set of specific assumptions regarding the nature of structure and the possibility of using it for empirical research. Structure, according to Giddens, is something that can only be found in the human mind – and not in the physical world. This makes structural analysis of IT much more difficult. Still, many IS theorists applying construction theory see information technology as an instance of structure. In this study, technology was considered a reflection of the ideas that are found in the human mind. While they may not be embodied in technology, their design, stemming from the human mind, can be, allowing for structural analysis. Furthermore, structure and action are in Giddens' view always mutually influential. Thereby, they can hardly be studied separately, which happens in this study to allow for empirical investigation. And finally, both theoretical perspectives represent meta-theories rather than theories that are readily used in practice. This makes application to empirical research much more difficult. Therefore, an instrument for the empirical work in this study was designed tailored to the phenomenon of IT-induced transformation.

7.6 Recommendations for further research

Partly based on the limitations that were identified in the previous section, recommendations for further research are presented in this section. The recommendations discussed in this section are firstly concerned with further refining the concepts developed for IT-induced 'transformation-as-a-product'. This may lead to an extension or to further details to the model of transformation. Secondly, recommendations are formulated that deepen the understanding of 'transformation-as-a-process' by further developing the combination of theoretical perspectives that was used in this study. Finally, it would also be useful to replicate the study of IT-induced transformation to other case studies or repeat the survey research to find which developments occur over time, especially considering that the research field of PVM is still rather young.

Firstly, the concepts and the model developed in this study should be investigated further in different contexts. While the case studies provide rich material, this study recommends looking at other cases of IT-induced transformation to see if they yield additional insights. Especially the diversity of case studies used in this study should be further explored. At this moment, not many transformational efforts are undertaken in the Netherlands. Therefore, there were not many possible case studies of IT-induced

transformation that could be investigated. When more transformational efforts are undertaken, it would be useful to study these too. Furthermore, this study identified factors that influence the occurrence of IT-induced transformation, such as the role of changes of the law and business process change. The relationship between these factors deserves further research.

Secondly, further research should contribute to theory development in the e-government research field. Although e-government is often seen as to have moved beyond its infancy (Scholl, 2005), it can hardly be recognized as a mature research field yet, in which widely used theories have been developed. This is even more the case for t-government. This means that this explorative study likely adds to the body of literature, but that clear measurements have not yet been set up. This study has established a first basis of conceptualizing IT-induced transformation by developing this the model of IT-induced transformation based on the literature, but further testing – and possibly refining – remains necessary.

The use of the combination of contingency and structuration theory was found to be useful in gaining complementary insights into transformation as a process. To deepen our understanding of IT-induced transformation, the development of perspectives based on organizational and sociological processes was thus found useful and should be continued. New theories from the field of sociology, such as actor-network theory (Latour, 2005), are currently also used in the field of e-government and may enhance the understanding of transformation. Especially since structuration theory is often found to be difficult to apply in empirical studies (see, for example, Stones, 2005), other theories may be looked into to investigate their empirical use in this research field. Therefore, this study recommends both researching further the use of the complementary lenses of contingency and structuration theory as well as consider the use of other theories such as actor-network theory in order to further develop the e-government research field.

Thirdly, for constructing the objectives and mechanisms of IT-induced transformation the state of the art research on public administration is used: public value management. PVM is formulated to overcome some of the disadvantages and limitations of previous public administration agendas. However, translation of PVM to practice has not taken place yet, certainly not among many government organizations. Governments may take different turns, and also through ongoing learning new insights will be generated. This likely affects the objectives for t-government, which should be studied more closely. Furthermore, research on PVM is still ongoing and its impact may be unclear. Therefore, it is useful to investigate how the objectives of public sector reform evolve over time to see how this may influence IT-induced transformation in the future.

8 Epilogue: public service or public value?

The aim of managerial work in the public sector is to create public value just as the aim of managerial work in the private sector is to create private value (Moore, 1995).

IT-induced transformation was found to represent the promise of transformation rather than an actual outcome. Instead of the emergence of a networked organizational structure, the set-up of governance guiding change within networks of public organizations was observed. The main reason for this lack of organizational transformation is that accountability remains organized in a hierarchical manner. But while the organizational structure was not found to transform, other consequences of IT-induced transformation could be observed. One consequence is the change in transformational objectives based on the Public Value Management (PVM) agenda. A second consequence is that t-government efforts strengthen the role of the government more often than that they realize improved service delivery. This chapter discusses the implications of these findings: the persistence of hierarchical accountability, the use of the PVM agenda within t-government efforts, and the strengthened position of the government, resulting in more enforcement and control.

8.1 The persistence of hierarchical accountability

Instead of realizing organizational transformation resulting in a networked structure of government, transformational efforts were found to lead to new stovepipes and the set-up of governance to connect these stovepipes. As soon as change occurred, the vertical stovepipes were moved based on the change in legislation and put in place again. In time, these stovepipes may again become obsolete, starting a new transformation process. However, the promise of transformation has been repeated over and over in the literature on t-government (see, for example, Irani et al., 2007). In fact, this promise was already present when the first information systems were implemented in organizations (see, for example, Leavitt & Whisler, 1958). As this study again finds that transformation has not occurred, the question arises whether it will ever take place and whether it is even possible.

Hierarchical accountability was found to be the main impeding factor for realizing IT-induced transformation. This form of accountability assumes that, by following procedures, public officials are able to account for their actions to their superiors, who, in turn, account for their actions to elected officials (in parliament). Although this form of accountability impedes reform, it remains present for strong reasons. Firstly, it allows for the necessary checks and balances within public decision-making. Secondly, it remains necessary to allow elected officials to control the actions of public administrators. From this perspective, it could even be claimed that public accountability, which is concerned with the achieving the right outcomes of a process, rather than with following the right procedure, is regarded as undesirable as it does not clearly pinpoint responsibility for actions. Thirdly, it creates career structures, giving status and providing public officials with a sense of where they belong within the

organization. While hierarchical accountability may to some extent be conflicting with other forms of accountability, they are used for different purposes. Therefore, hierarchical accountability needs to be complemented with new forms of public accountability in order to achieve the different goals of public administration.

Moreover, this study found a mismatch between the engineered transformational mechanisms, such as business process change, and the objectives of public sector reform, such as realizing public accountability. The operationalization of IT-induced transformation was found useful to study the phenomenon as it shows the complexity of the changes that are undertaken and resembles the way in which governments undertake transformation. But it also shows that there is an inherent conflict. This complexity implies that IT-induced transformation cannot, by nature, be engineered, but that it rather represents a long-term process influenced by the organizational and institutional context and the stakeholders involved. This was confirmed by the case studies and by the findings from the survey. Realizing transformation should thus look at different ways of undertaking change to realize the desired outcomes. Setting up governance governing change in networks of organizations may be one of these.

8.2 The public value management agenda

This study found that Public Value Management (PVM) is useful to derive the transformational objectives. PVM was found to emerge in order to overcome the problems associated with New Public Management (NPM) (Dunleavy et al., 2005). It aims to realize public value to citizens or businesses directly or by strengthening the role of government in society through an ongoing assessment of whether the right actions are performed by government and by public officials. Furthermore, it aims to coordinate the actions of the different organizations within networks of public and private parties. The use of this public reform agenda is likely to have several implications for public administration: for balancing the different and often widely varying public values politicians aim to achieve, for the nature of the workforce and human resources management in government, and for the transparency of government processes.

8.2.1 Balancing public values

Although balancing different public values has always been a core activity of governments – mainly for politicians, PVM provides public officials with an instrument for creating public value for citizens and businesses. “[T]he most important element of [t-government] is the concept of value innovation enabled by constant organizational and behavioral change; restructuring and reshaping of the business processes (front-office along with back-office) should be seen as the means towards modernizing administration and renewing institutions rather than as threats” (Parisopoulos et al., 2009, p. 466). PVM can thus act as an instrument balancing the different values that need to be achieved simultaneously within governments. It is a useful instrument for managing actions between organizations – as it does not matter where benefits are obtained. In this way it can also act as a governance mechanism because using the PVM approach makes it possible to come to agreements over where actions are performed within a network of government organizations. However, it may also result in a deadlock

over which value to create and by whom. In order for it to become an operational approach, these issues need to be solved.

This is especially necessary as public values are plenty. Some authors found over seventy-five public values that may all need to be achieved at the same time (Jorgeson, 2007). Furthermore, the importance attached to certain values changes over time. For example, they may change with every political coalition, or are based on incidents. “[T]hey also reflect the design choices of leading (political) coalitions” (Bekkers & Zouridis, 1999, pp. 186-187). For example, the overview of e-government developments in chapter 1 shows the different values that were aimed for by e-government and t-government over time. In the Netherlands, e-government is strongly connected with administrative burden reduction, as this was an important aim of the political coalition. This was also reflected in the case studies of SBR and the Omgevingsvergunning. In connection to t-government new values are promoted, such as transparency and openness. However, while PVM aims to overcome the promotion of specific values and become a sustainable reform agenda for balancing public values, it does not clearly specify how to do so other than by giving public officials more freedom to determine which value to achieve.

Further development of PVM has two important implications. Firstly, values need to be made explicit and should be assessed continuously to see whether they are still valid in society. Whether some fundamental values, arguably, remain important over time, such as realizing equity and performing services in a cost-effective manner, other values such as administrative burden reduction and open data provisioning, may lose some of their (political) importance over time. Determining the values to be realized remains firmly within the political realm, but it does not mean that public officials can ignore this as they often will have to include additional values to be achieved during a project. And secondly, new ways of working need to be formulated that are able to support the balancing of these values. This requires a different role of the employees and accordingly, management practices, in an organization. However, PVM does not explain clearly how to do so without relinquishing equity.

8.2.2 Professionalization of the workforce

For public value management through the ongoing assessment of the outcomes of the processes of government, balancing process, output and public accountability (Moore, 1995), an increasingly professional workforce was proposed. A different attitude of public officials towards public value creation was assumed to lead to more public value. In the SBR case it was found that the new forms of compliance controls require different professionals that are able to perform these controls. This is necessary for two reasons. Firstly, while the simple tasks are digitized and automated, only the complex tasks are left for the public officials to perform. And secondly, many of the public values are already embedded in the IT and decisions on individual cases are made automatically. Public officials remain necessary to maintain and update these systems and to design their logic. They thereby still have to balance the different public values, but no longer with respect to individual cases but only regarding the design of the information systems.

However, to manage such a workforce, government organizations need to change their accountability structure, up to management levels, and beyond: up to the political level. “In essence, a new view of value needs to be internalized by public administration and adopted by politicians” (Bannister, 2001, p. 73). This has implications for the human

resource management of organizations, which was confirmed by public officials that were interviewed for this study. They said that it will become necessary that public managers allow that their employees use this discretionary room, because this will influence the degree to which they are able to balance the different public values. The main example from the case studies is that the system of horizontal control leads to more decisions being taken on the basis of automatic input and output checks. But public officials remain necessary to design and build the information systems that perform the horizontal control.

Furthermore, also politicians need to remain within in their own realm and not step into the domain of administration. In Weber's original view on government, this was described as the division of the political and the administrative realm. As policy-making became more and more complex, policy-makers stepped into the political domain because they determine more and more details of the policies. From the PVM-perspective, politicians should be concerned with defining general outcomes (public values) that they want to be seen delivered, rather than be concerned with the nitty-gritty of laws. Law-making should thus remain principle-based rather than rule-based and the strict Weberian division between the political and the administrative realm is still relevant.

8.2.3 The role of transparency

As PVM is still a rather novel agenda and it has not yet been operationalized clearly, it is also not yet extensively used in practice. Therefore, it has also not yet run into real issues, but it is already criticized for its lack of equity. Balancing public values may seem very beneficial in serving individual cases, but there is the danger that citizens are not treated equally. Procedure accountability as followed in bureaucracies is traditionally set up to ensure this equal treatment ('rules are rules'). Therefore, new ways of realizing accountability are necessary, ensuring public accountability. Although this was observed not to have been realized yet, it has already given rise to the increased focus on transparency. To overcome the problems associated with realizing effective public accountability, it may need go hand in hand with transparency. Therefore, the objectives of more responsive government and greater transparency are added to the e-government agenda (Gascó, 2003; Kraemer & King, 2006). This is most clearly observed in the UK and the US, where the government has actively pursued opening up it data over the past few years. The open data movement may thus be seen as a first step towards PVM and IT-induced transformation.

This is related to PVM also giving rise to a new role for citizens. Realizing public accountability is only useful if there are citizens willing to use this and hold government organizations accountable. Currently, it is observed that some people are doing this by pursuing transparency by inquiring after data that are not yet public. Realizing public accountability thus also needs citizens that are willing to pursue this accountability by their governments, in a similar way as the media do.

In the cases few evidence was found of a focus on transparency. In order to make the shift to a networked structure, public accountability was expected to become more prominent, for which transparency is a prerequisite. One of the main reasons that was observed for this lack of transparency, was the lack of influence of citizens on the implementation process. Still, the strive for openness may become the next 'administrative burden reduction', in the sense that when it becomes an important public value, it is likely to be taken up by t-government developments. Furthermore, the

compliance controls that are set up in both case studies may be used not only to control whether businesses are compliant, but could also be used to gain insight in the ways governments make decisions on whether businesses are found to be compliant. In this way, the information exchange in both cases may lead to becoming a two-way instrument for creating insight in processes.

8.3 Enhanced enforcement and control by the government

The PVM-perspective used in this study includes public value both by realizing a direct value for citizens and businesses and by strengthening the position of the government. Although the t-government efforts investigated in this study start off mainly aiming for the former, it was found that they end up more often achieving the latter. One reason for this is that the customers of the government – citizens and businesses – are not involved in the implementation of IT-induced transformation. Rather, transformational efforts are developed and implemented by governments themselves. As citizens and businesses have little means in exerting power during the implementation process, it is no surprise that IT-induced transformation mainly strengthens the role of the government, for example by enhancing enforcement and control. Another reason is the need for public administrations to cut costs. These targets have often already been set by the government and need to be met.

The power in promoting the value of government through their e-government and t-government efforts is also observed in the literature. In institutional theory this is depicted as ‘reinforcement of existing structures’ (see, for example, Scott, 1995), which means that instead of changes being accomplished, the existing structures are strengthened. In Information Systems research, there is more evidence that power exerted by public organizations leads to specific outcomes benefiting the government rather than realizing better service delivery. This was incorporated in literature on the ‘automation of bias’ (Kraemer & Dutton, 1982). Still, few studies of t-government take it into account, even though this study finds that it has an impact on the outcomes of IT-induced transformation. Literature on automation of bias does conclude that information systems incorporate the viewpoint of its developers (and their employers), thereby automating their understanding of the world. In the case of IT-induced transformation this bias is strongly towards the use of the systems to benefit the government, rather than citizens or businesses. This implies that a different way of developing information systems for t-government is necessary to capture the desire of citizens and businesses.

This notion of IT having led to a strengthened position of the government, resulting in strengthened control and enforcement was corroborated by the iGovernment (iOverheid) report written by the Scientific Council for Government Policy (WRR, 2011). While this report looked at the transformational developments on the institutional and government-wide level rather than at individual cases, the findings in this study and in the iGovernment report are complementary. The iGovernment report concludes that, partly as a result of function creep of IT-applications that share more and more information and data, a very real and profound change in government has occurred that is not yet grasped fully by government organizations. This is the sharply increased sharing and re-use of information and data of citizens and businesses, spurred by IT.

The result of this development described in the iGovernment report is that information within the government is increasingly shared across organizational borders, without properly addressing issues such as privacy, security and ownership of

information. Through function creep, applications that are created in one context or organization are more often used also in another. As more and more information is known about citizens and businesses, this leads to new opportunities for control and enforcement. But this also means that this information may start to lead a life of its own, with potentially highly undesirable effects for citizens and businesses. When information gathered for one public task is used in another, this may on the one hand provide the opportunity to the government to detect fraud or re-use data in an efficient manner, but on the other hand there is a danger that this information sharing endangers the privacy of citizens.

These findings of the iOverheid report and the findings of this study indicate that as a result of governments mainly automating according to their own objectives, without clearly taking the role of citizens into account, another transformation may take place. Citizens and businesses may no longer be in control of their own data and government organizations may no longer be able to ensure privacy and security of these data. To grasp the complexity of today's society, ever more citizens' data are stored and re-used by government organizations, without clearly indicating the context in which data are captured. This may not only result in the misuse of these data, but also in these data becoming vulnerable to outside attacks in which they may be compromised by parties outside the government. The paradox that may emerge is that by undertaking transformational efforts to realize effective outcomes for citizens, this may in fact endanger the privacy and security of citizens' data in such a way that it effectively undermines their position. IT-induced transformation will need to find ways to ensure that these types of undesired effects are mitigated.

References

- 6, P. (2004) Joined-Up Government in the Western World in Comparative Perspective: A preliminary Literature Review and Exploration. *Journal of Public Administration Research and Theory*, 14(1), 103-138.
- Actieprogramma 'Andere Overheid'. (2003) Retrieved June 1, 2012, from http://www.epractice.eu/files/media/media_298.pdf
- Alford, J., & O'Flynn, J. (2009) Making Sense of Public Value: Concepts, Critiques and Emergent Meanings. *International Journal of Public Administration*, 32(3), 171-191.
- Andersen, K. V., & Henriksen, H. Z. (2006) E-government maturity models: Extension of the Layne and Lee model. *Government Information Quarterly*, 23(2), 236-248.
- Andersen, K. V., & Kraemer, K. L. (1995) Information Technology and Transitions in the Public Service: A Comparison of Scandinavia and the United States. *European Journal of Information Systems*, 4(5), 51-63.
- Ask, A., & Grönlund, A. (2008) *Implementation Challenges: Competing Structures When New Public Management Meets eGovernment*. Paper presented at the Electronic Government: 7th International Conference, EGOV 2008, Turin, Italy.
- Baardwijk, M. v., & Frances, P. H. (2010) *The hemline and the economy: is there any match?* Rotterdam: Econometric Institute, EUR.
- Bannister, F. (2001) Dismantling the silos: extracting new value from IT investments in public administration. *Information Systems Journal*, 11(65-84).
- Bannister, F., & Connolly, R. (2011a) *Transformation and Public Sector Values*. Paper presented at the IFIP EGOV and ePart 2011, Delft, the Netherlands.
- Bannister, F., & Connolly, R. (2011b) *Transformation and Public Sector Values*. Paper presented at the tGov Workshop '11 (tGOV11).
- Bannister, F., & Connolly, R. (2011c) Trust and transformational government: A proposed framework for research. *Government Information Quarterly*, 28, 137-147.
- Barley, S. (1996) Technicians in the workplace: Ethnographic evidence for bringing work into organization studies. *Administrative Science Quarterly*, 41, 404-441.
- Barley, S. R. (1990) The Alignment of Technology and Structure through Roles and Networks. *Administrative Science Quarterly (Special Issue: Technology, Organizations, and Innovation)*, 35(1), 61-103.
- Basettiahalli, R., Kim, H.-W., Lee, H.-L., & Noh, S.-E. (2010) Structural Analysis of e-Government in India. *Asia Pacific Journal of Information Systems*, 20(2), 1-21.
- Baum, C., Di Maio, A., & Caldwell, F. (2000) What is eGovernment? Gartner's definitions. Research note (TU-11-6474).
- Bekkers, V. (2007) The Governance of Back-Office Integration. *Public Management Review*, 9(3), 377-400.
- Bekkers, V., & Zouridis, S. (1999) Electronic service delivery in public administration. *International Review of Administrative Sciences*, 65, 183-195.
- Bellamy, C., & Taylor, J. (1996) New information and communications technologies and institutional change: The case of the UK criminal justice system. *International Journal of Public Sector Management*, 9(4), 51-69.
- Bellamy, C., & Taylor, J. (1998) *Governing in the Information Age*. Buckingham: Open University Press.

- Benbasat, I., Goldstein, D. K., & Mead, M. (1987) The Case Research Strategy in Studies of Information Systems. *MIS Quarterly*, 11(3), 369-386.
- Benington, J. (2009) Creating the Public In Order To Create Public Value? *International Journal of Public Administration*, 32(3), 232-249.
- Bertot, J. C., Jaeger, P. T., & Grimes, J. M. (2010) Using ICTs to create a culture of transparency: E-government and social media as openness and anti-corruption tools for societies. *Government Information Quarterly*, 27, 264-271.
- Beynon-Davies, P. (2007) Models for e-government. *Transforming Government: People, Process and Policy*, 1(1), 7-28.
- Bharosa, N., Wijk, R. v., Janssen, M., & Winne, N. d., (forthcoming) Lean Government: het besturen, inrichten en beheren van publiek-private informatieketens.
- Bogaard, A. v. d., Lintsen, H., Veraart, F., & Wit, O. d. (Eds.). (2008). *De eeuw van de computer. De geschiedenis van de informatietechnologie in Nederland*. Deventer: Kluwer.
- Bourgon, J. (2007) Responsive, responsible and respected government: towards a New Public Administration theory. *International Review of Administrative Sciences*, 73(1), 7-26.
- Bovaird, T., & Löffler, E. (2002) Moving from Excellence Models of Local Service Delivery to Benchmarking 'Good Local Governance'. *International Review of Administrative Sciences*, 68(1), 9-24.
- Bozeman, B., & Bretschneider, S. (1986) Public management information systems: Theory and prescriptions. *Public Administration Review*, 46, 475-489.
- Bruijn, J. A. d., Heuvelhof, E. F. t., & Veld, R. J. i. t. (1998) *Procesmanagement. Over procesontwerp en besluitvorming*. Schoonhoven: Academic service.
- Bruijn, J. d. (2002) Prestatiemeting in de publieke sector - Strategieën om perverse effecten te neutraliseren. *Bestuurswetenschappen* (2), 139-160.
- Brynjolfsson, E., & Hitt, L. M. (2000). Beyond Computation: Information Technology, Organizational Transformation and Business Performance. *Journal of Economic Perspectives*, 14(4), 23-48.
- Cao, G., Wiengarten, F., & Humphreys, P. (2011) Towards a Contingency Resource-Based View of IT Business Value. *Systemic Practice and Action Research*, 24, 85-106.
- Carroll, L. (1865) *Alice in Wonderland*. London: Macmillan.
- Castells, M. (2000) *The Rise of The Network Society, Second Edition*. Cambridge, MA: Blackwell Publishing.
- Caudle, S. L., Gorr, W. L., & Newcomer, K. E. (1991) Key Information Systems Management Issues for the Public Sector. *MIS Quarterly*, 15(2), 171-188.
- CBS. (2009) Overheidsuitgaven Nederland lager dan gemiddeld in de EU. Retrieved March 24, 2011, from <http://www.cbs.nl/nl-NL/menu/themas/macro-economie/publicaties/artikelen/archief/2009/2009-2800-wm.htm>.
- Chae, B., & Poole, M. S. (2005) The surface of emergence in systems development: agency, institutions, and large-scale information systems. *European Journal of Information Systems*, 14, 19-36.
- Chan, Y. E., & Reich, B. H. (2007) IT alignment: what have we learned? *Journal of Information Technology*, 22, 297-315.
- Chatfield, A. T. (2009) Public Service Reform through e-Government: a Case Study of 'e-tax' in Japan. *Electronic Journal of e-Government*, 7(2), 135-146.
- Chen, H. (2002) Digital Government: technologies and practices. *Decision Support Systems*, 34(3), 223-227.

- Chisholm, D. (1989) Coordination without Hierarchy. Informal structures in multi-organizational systems. Berkeley: University of California Press.
- Christensen, T., & Lægreid, P. (2007) The Whole-of-Government Approach to Public Sector Reform. *Public Administration Review*, 1059-1066.
- Chu, C., & Smithson, S. (2007) E-business and organizational change: a structural approach. *Information Systems Journal*, 17, 369-389.
- Clemons, E. K., & Row, M. C. (1992) Information Technology and Industrial Cooperation: The Changing Economics of Coordination and Ownership. *Journal of Management Information Systems*, 9(2), 9-28.
- Coase, R. (1937) The Nature of the Firm. *Economia*, 4, 386-405.
- Cordella, A., & Iannacci, F. (2010) Information systems in the public sector: The e-Government enactment framework. *Journal of Strategic Information Systems*, 19, 52-66.
- Coursey, D., & Norris, D. F. (2008) Models of E-Government: Are They Correct? An Empirical Assessment. *Public Administration Review*, 68(3), 523-536.
- Cresswell, A. M., Burke, G. B., & Pardo, T. A. (2006) *Advancing Return on Investment Analysis for Government IT. A Public Value Framework*. Albany, NY: Center for Technology in Government.
- Croteau, A.-M., & Bergeron, F. (2001) An information technology trilogy: business strategy, technological deployment and organizational performance. *Journal of Strategic Information Systems*, 10, 77-99.
- Crowston, K. G., & Myers, M. D. (2004) Information technology and the transformation of industries: three research perspectives. *Journal of Strategic Information Systems*, 13, 5-28.
- Curtin, G. C., Sommer, M. H., & Vis-Sommer, V. (2004) *The world of e-government*. Binghamton: Haworth Press.
- Danziger, J. N., & Andersen, K. V. (2002) The impacts of information technology on public administration: An analysis of empirical research from the "golden age" of transformation. *International Journal of Public Administration*, 25(5), 591-627.
- Dawes, S. S. (2008) The Evolution and Continuing Challenges of E-Governance. *Public Administration Review* (Special issue on The Quest for High-Performance Administration), 68(4), S86-S102.
- Denhardt, R. B., & Denhardt, J. V. (2000) The New Public Service: Serving Rather than Steering. *Public Administration Review*, 60(6), 549-559.
- DeSanctis, G., & Poole, M. S. (1994) Capturing the Complexity in Advanced Technology Use: Adaptive Structuration Theory. *Organization Science*, 5(2), 121-147.
- Dhillon, G. S., Weerakkody, V., & Dwivedi, Y. K. (2008) Realising transformational stage e-government: a UK local authority perspective. *Electronic Government, An International Journal*, 5(2), 162-180.
- DiMaggio, P. J., & Powell, W. W. (1983) The Iron Cage Revisited: Institutional Isomorphism and Collective Rationality in Organizational Fields. *American Sociological Review*, 48(2), 147-160.
- Doucet, G., Gotze, J., Saha, P., & Bernard, S. (2008) Coherency Management: Using Enterprise Architecture for Alignment, Agility, and Assurance. *Journal of Enterprise Architecture*, 1-12.
- Drazin, R., & Van de Ven, A. H. (1985) Alternative Forms of Fit in Contingency Theory. *Administrative Science Quarterly*, 30(4), 514-539.

- Dunleavy, P., Margetts, H., Bastow, S., & Tinkler, J. (2005) New Public Management Is Dead - Long Live Digital-Era Governance. *Journal of Public Administration Research and Theory*, 16, 467-494.
- Earl, M. J. (1989) Management Strategies for Information Technology. London: Prentice-Hall.
- Ebrahim, Z., & Irani, Z. (2005) E-government adoption: architecture and barriers. *Business Process Management Journal*, 11(5), 589-611.
- Eisenhardt, K. M. (1989) Building Theories from Case Study Research. *Academy of Management Review*, 14(4), 532-550.
- Erakovic, L., & Wilson, M. (2005) Conditions of Radical Transformation in State-Owned Enterprises. *British Journal of Management*, 16, 293-313.
- Esteves, J., & Joseph, R. C. (2008) A comprehensive framework for the assessment of eGovernment projects. *Government Information Quarterly*, 25, 118-132.
- Fernandez, S., & Rainey, H. G. (2006) Managing Successful Organizational Change in the Public Sector. *Public Administration Review*, 66(2), 168-176.
- Foley, P., & Alfonso, X. (2009) eGovernment and the Transformation Agenda. *Public Administration*, 87(2), 371-396.
- Fountain, J. E. (2001a) Building the Virtual State: Information Technology and Institutional Change. Washington, D.C.: Brookings Institution Press.
- Fountain, J. E. (2001b) Paradoxes of Public Sector Customer Service. *Governance: An International Journal of Policy and Administration*, 14(1), 55-73.
- Fountain, J. E. (2001c) The Virtual State: Transforming American Government? *National Civic Review*, 90(3), 241-251.
- Fremantle, P., Weerawarana, S., & Khalaf, R. (2002) Enterprise Services. Examine the Emerging Files of Web Services and How it is Integrated into Existing Enterprise Infrastructures. *Communications of the ACM*, 45(20), 77-82.
- Galbraith, J. (1973) *Designing Complex Organizations*. Reading, MA: Addison-Wesley.
- Gascó, M. (2003) New Technologies and Institutional Change in Public Administration. *Social Science Computer Review*, 24(1), 6-14.
- Giddens, A. (1979) Central Problems in Social Theory. Action, Structure and Contradiction in Social Analysis. Berkeley and Los Angeles, CA: University of California Press.
- Giddens, A. (1984) The constitution of society: Outline of the theory of structuration. Cambridge: Polity.
- Giddens, A., & Pierson, C. (1989) *Conversations with Anthony Giddens*. Cambridge, UK: Polity Press.
- Gil-Garcia, J. R., Canestraro, D., Costello, J., Baker, A., & Werthmuller, D. (2008) Structuration Theory and the Use of XML for Web Site Content Management in Government: Comprehensive Prototyping as an Induced Change Episode. Paper presented at the Proceedings of the American Society for Information Science and Technology.
- Gil-Garcia, J. R., Chengalur-Smith, I., & Duchessi, P. (2007) Collaborative e-Government: impediments and benefits of information-sharing in the public sector. *European Journal of Information Systems*, 16, 121-133.
- Gil-Garcia, J. R., & Pardo, T. A. (2005) E-government success factors: Mapping practical tools to theoretical foundations. *Government Information Quarterly*, 22(2), 187-216.
- Goldfinch, S., & Wallis, J. (2010) Two Myths of Convergence in Public Management Reform. *Public Administration*, 88(4), 1099-1115.

- Gortmaker, J., Janssen, M., & Wagenaar, R. W. (2005) *Accountability of Electronic Cross-Agency Service-Delivery Processes*. Paper presented at the Electronic Government: 4th International Conference, EGOV 2005, Copenhagen, Denmark.
- Greenhalgh, T., & Stones, R. (2010) Theorising big IT programmes in healthcare: Strong structuration theory meets actor-network theory. *Social Science & Medicine*, 70, 1285-1294.
- Gregor, S., Martin, M., Fernandez, W., Stern, S., & Vitale, M. (2006) The transformational dimension in the realization of business value from information technology. *Journal of Strategic Information Systems*, 15, 249-270.
- Gronlund, A., & Andersson, A. (2006) *e-Gov Research Quality Improvements Since 2003: More Rigor, but Research (Perhaps) Redefined*. Paper presented at the Electronic Government: 5th International Conference, EGOV 2006, Krakow, Poland.
- Gronlund, A., & Horan, T. A. (2005) Introducing e-Gov: History, Definition, and Issues. *Communications of the Association for Information Systems*, 15(39), 713-729.
- The Open Group (2009) The Open Group Architecture Framework (TOGAF) Version 9.
- Gupta, M. P., & Jana, D. (2003) E-government evaluation: a framework and case study. *Government Information Quarterly*, 20(4), 365-387.
- Gupta, P. P., Dirsmith, M. W., & Fogarty, T. J. (1994) Coordination and Control in a Government Agency: Contingency and Institutional Theory Perspectives on GAO Audits. *Administrative Science Quarterly*, 39(2), 264-284.
- Hammer, M. (1990) Reengineering Work: Don't Automate, Obliterate. *Harvard Business Review*(4), 104-122.
- Hammer, M., & Champy, J. (1993) *Reengineering the Cooperation: A Manifesto for Business Revolution*. New York: HarperCollins Publishers.
- Haque, M. S. (2000) Significance of Accountability under the New Approach to Public Governance. *International Review of Administrative Sciences*, 66(4), 599-617.
- Haque, M. S. (2001) The Diminishing Publicness of Public Service under the Current Mode of Governance. *Public Administration Review*, 61(1), 65-82.
- Haque, M. S. (2006) Modernising Government: The Way Forward - an analysis. *International Review of Administrative Sciences*, 72(3), 319-325.
- Heeks, R., & Bailur, S. (2007) Analyzing e-government research: Perspectives, philosophies, theories, methods, and practice. *Government Information Quarterly*, 24, 243-265.
- Henderson, J. C., & Venkatraman, N. (1993) Strategic Alignment: Leveraging information technology for transforming organizations. *IBM Systems Journal*, 32(1), 4-16.
- Herrera, L., & Gil-Garcia, J. R. (2010) Structuring Inter-Organizational E-Government: The Enactment of Differentiated Technologies-in-Practice. Paper presented at the IFIP EGOV 2010.
- Heugens, P. (2005) A Neo-Weberian Theory of the Firm. *Organization Studies*, 26(4), 547-567.
- Hiemstra, J. (2003) *Presterende gemeenten. Hoe gemeenten beter kunnen presteren*. Alphen aan de Rijn: Kluwer.
- Hjort-Madsen, K. (2007) Institutional patterns of enterprise architecture adoption in government. *Transforming Government: People, Process and Policy*, 1(4), 333-349.
- Ho, A. T.-K. (2002) Reinventing Local Governments and the E-Government initiative. *Public Administration Review*, 62(4), 434-443.
- Holden, S. H., Norris, D. F., & Fletcher, P. D. (2003) Electronic Government at the Local Level. *Public Performance & Management Review*, 26(4), 325-344.

- Homburg, V. (2009) The Social Shaping of Transformational Government. In V. Weerakkody, M. Janssen & Y. K. Dwivedi (Eds.), *Handbook of Research on ICT-Enabled Transformational Government: A Global Perspective* Hershey, NY: Information Science Reference.
- Hoogwout, M. (2003) Super Pilots, Subsidizing or Self-Organization: Stimulating E-Government Initiatives in Dutch Local Governments. Paper presented at the EGOV 2003 conference, Prague, Czech Republic.
- Huang, R., Zmud, R. W., & Price, R. L. (2010) Influencing the effectiveness of IT governance practices through steering committees and communication policies. *European Journal of Information Systems*, 19, 288-302.
- Hutter, B. M., & Jones, C. J. (2007) From government to governance: External influences on business risk management. *Regulation & Governance*, 1, 27-45.
- Irani, Z., Elliman, T., & Jackson, P. (2007) Electronic transformation of government in the UK: a research agenda. *European Journal of Information Systems*, 16, 327-335.
- Janssen, D., Rotthier, S., & Snijkers, K. (2004) If you measure it they will score: An assessment of international eGovernment benchmarking. *Information Polity*, 9(3), 121-130.
- Janssen, M. (2012) Sociopolitical Aspects of Interoperability and Enterprise Architecture in E-Government. *Social Science Computer Review*, 30(1), 24-36
- Janssen, M., Chun, S. A., & Gil-Garcia, J. R. (2009) Building the Next Generation of Digital Government Infrastructures. *Government Information Quarterly*, 26(2), 233-237.
- Janssen, M., & Cresswell, A. M. (2005) An enterprise application integration methodology for e-government. *The Journal of Enterprise Information Management*, 18(5), 531-547.
- Janssen, M., & Joha, A. (2006) Motives for establishing shared service centers in public administrations. *International Journal of Information Management*, 26 (2), 102-115.
- Janssen, M., & Veenstra, A. F. v. (2005) Stages of Growth in e-Government: An Architectural Approach. *The Electronic Journal of e-Government*, 3(4), 193-200.
- Jarke, M., Loucopoulos, P., Lyytinen, K., Mylopoulos, J., & Robinson, W. (2011) The brave new world of design requirements. *Information Systems*, 36, 992-1008.
- Jessop, B. (2002) The Rise of Governance and the Risks of Failure: The Case of Economic Development. *International Social Science Journal*, 50 (155).
- Jones, M. R., & Karsten, H. (2008) Giddens's Structuration Theory and Information Systems Research. *MIS Quarterly*, 32(1), 127-157.
- Jones, M. R., & Karsten, H. (2009) Divided by a Common Language? A Response to Marshall Scott Poole. *MIS Quarterly*, 33(3), 589-595.
- Jorgesen, T. B. (2007) Public Values: An Inventory. *Administration & Society*, 39(3), 354-381.
- Jorritsma, C. G. D. C. (2005) Publieke dienstverlening, professionele gemeenten: Visie 2015.
- Jos, P. H., & Tompkins, M. E. (2009) Keeping It Public: Defending Service Value in a Customer Service Age. *Public Administration Review*, 26(6), 1077-1086.
- Kamal, M. M., Weerakkody, V., & Jones, S. (2009) The case of EAI in facilitating e-Government services in a Welsh authority *International Journal of Information Management*, 29(2), 161-165.
- Karunasena, K., Deng, H., & Singh, M. (2011) Measuring the public value of e-government: a case study from Sri Lanka. *Transforming Government: People, Process and Policy*, 5(1), 81-99.

- Kernaghan, K. (2005) Moving towards the virtual state: integrating services and service channels for citizen-centred delivery. *International Review of Administrative Sciences*, 71(1), 119-131.
- Kim, H. J., Pan, G., & Pan, S. L. (2007) Managing IT-enabled transformation in the public sector: A case study on e-government in South Korea. *Government Information Quarterly*, 24(2), 338-352.
- Kim, H. M., & Ramkaran, R. (2004) Best practices in e-business process management: Extending a re-engineering framework. *Business Process Management Journal*, 10(1), 27-43.
- Kirlin, J. J. (1996) What Government Must Do Well: Creating Value for Society. *Journal of Public Administration Research of Theory*, 6(1), 161-185.
- Klein, H. K., & Myers, M. (1999) A Set of Principles for Conducting and Evaluating Interpretive Field Studies in Information Systems. *MIS Quarterly*, 23(1), 67-94.
- Klievink, B., & Janssen, M. (2009) Realizing joined-up government - Dynamic capabilities and stage models. *Government Information Quarterly*, 26(2), 275-284.
- Klijin, E.-H. (2008) Governance and Governance Networks in Europe: An assessment of ten years of research on the theme. *Public Management Review*, 10(4), 505-525.
- Koh, C. E., Prybutok, V. R., & Zhang, X. (2008) Measuring e-government readiness. *Information & Management*, 45, 540-546.
- Koppenjan, J. F. M., & Klijin, E.-H. (2004) Managing uncertainty in networks; a network approach to problem solving and decision making. Londen: Routledge.
- Kraemer, K. L., & Dutton, W. H. (1982) The Automation of Bias. In: J. N. Danziger et al. (Eds.), *Computers and Politics* (pp. 170-193). New York: Columbia University Press.
- Kraemer, K. L., & King, J. L. (2006) Information Technology and Administrative Reform: Will e-Government be Different? *International Journal of Electronic Government Research*, 2(1), 1-20.
- Lankhorst, M., & al., e. (2009) Enterprise Architecture at Work: Modelling, Communication and Analysis, Second Edition. Berlin Heidelberg: Springer-Verlag.
- Lawrence, P. R., & Lorsch, J. W. (1967) *Organization and Environment*. Cambridge, MA: Harvard University Press.
- Layne, K., & Lee, J. (2001) Developing fully functional E-government: A four stage model. *Government Information Quarterly*, 18(2), 122-136.
- Leavitt, H., & Whisler, T. L. (1958) Management in the 1980s. *Harvard Business Review*, 36, 41-48.
- Lee, A. S. (1991) Integrating Positivist and Interpretive Approaches to Organizational Research. *Organization Science*, 2(4), 342-365.
- Lee, A. S., & Baskerville, R. L. (2003) Generalizing Generalizability in Information Systems Research. *Information Systems Research*, 14(3), 221-243.
- Lenk, K. (2002) Electronic service delivery - a driver of public sector modernisation. *Information Polity*, 7(2-3), 87-96.
- Liu, S., & Hwang, J. D. (2003) Challenges to transforming IT in the US government. *IT Professional*, 5(3), 10-15.
- Lonsdale, J. (2007) Helping government to be responsive, responsible and respected: a reaction to Jocelyne Bourgon. *International Review of Administrative Sciences*, 73(1), 31-36.
- Lounsbury, M., & Carberry, E. J. (2005) From King to Court Jester? Weber's Fall from Grace in Organizational Theory. *Organization Studies*, 26(4), 501-525.

- Luftman, J. (2004) Assessing Business-IT Alignment Maturity. In W. van Grembergen (Ed.), *Strategies for Information Technology Governance*. Hershey PA: Idea Group Publishing.
- MacKenzie, S. B. (2001) The Dangers of Poor Construct Conceptualization. *Journal of the Academy of Marketing Science*, 31(3), 323-326.
- Maheshwari, D., Veenstra, A. F. v., & Janssen, M. (2011) *Challenges to the Design and Use of Stages-of-Growth Models in E-government* Paper presented at the 11th European Conference on E-Government.
- Malone, T. W. (1999) Is Empowerment Just a Fad? Control, Decision Making, and IT. *BT Technology Journal*, 17(4), 141-144.
- Malone, T. W., Yates, J., & Benjamin, R. I. (1987) Electronic Markets and Electronic Hierarchies. *Communications of the ACM*, 30(6), 484-497.
- Markus, M. L., & Benjamin, R. I. (1997) The Magic Bullet Theory in IT-Enabled Transformation. *Sloan Management Review*, 38(2), 55-68.
- Martin, S. (2003) On Public Management Reform. *British Journal of Management*, 14, S79-S81.
- Mathesen, C. (2009) Understanding the Policy Process: The Work of Henry Mintzberg. *Public Administration Review* (6), 1148-1191.
- McDermott, P. (2010) Building open government. *Government Information Quarterly*, 27, 401-413.
- McNulty, T. (2003) Redesigning Public Services: Challenges of Practice for Policy. *British Journal of Management*, 14, S31-S45.
- Meijer, A. (2009) Understanding modern transparency. *International Review of Administrative Sciences*, 75(2), 255-269.
- Meneklis, V., & Douligieris, C. (2010) Bridging theory and practice in e-government: A set of guidelines for architectural design. *Government Information Quarterly*, 27, 70-81.
- Michels, A., & Meijer, A. (2008) Safeguarding Public Accountability in Horizontal Government. *Public Management Review*, 10(2), 165-173.
- Milward, H. B., & Provan, K. G. (2000) Governing the Hollow State. *Journal of Public Administration Research and Theory*, 10(2), 359-379.
- Milward, H. B., & Provan, K. G. (2003) *Managing Networks Effectively*. Paper presented at the National Public Management Research Conference.
- Mingers, J. (2001) Combining IS Research Methods: Towards a Pluralist Methodology. *Information Systems Research*, 12(3), 240-259.
- Mintzberg, H. (1983) *Structure in Fives: Designing effective organizations*. New Jersey: Prentice Hall Business Publishing.
- Monfardini, P. (2010) Accountability in the new public sector: a comparative case study. *International Journal of Public Sector Management*, 23(7), 632-646.
- Moon, M. J. (2002) The Evolution of E-Government among Municipalities: Rhetoric or Reality? *Public Administration Review*, 62(4), 424-433.
- Moon, M. J., & Norris, D. F. (2005) Does managerial orientation matter? The adoption of reinventing government and e-government at the municipal level. *Information Systems Journal*, 15(1), 43-60.
- Moore, M. H. (1995) *Creating Public Value: Strategic Management in Government*. Cambridge, MA, US: Harvard University Press.
- Morgeson III, F. V., & Mithas, S. (2009) Does E-Government Measure Up to E-Business? Comparing End User Perceptions of U.S. Federal Government and E-Business Web Sites. *Public Administration Review*, 69(4), 740-752.

- Morton, N. A., & Hu, Q. (2008) Implications of the fit between organizational structure and ERP: A structural contingency theory perspective. *International Journal of Information Management*, 28, 391-402.
- Moynihan, D. P., & Landuyt, N. (2009) How Do Public Organizations Learn? Bridging Cultural and Structural Perspectives? *Public Administration Review*(6), 1097-1105.
- Newsted, P. R., Huff, S. L., & Munro, M. C. (1998) Survey Instruments in Information Systems. *MIS Quarterly*.
- North, D. C. (1990) *Institutions, institutional change and economic performance*. Cambridge: Cambridge University Press.
- Nour, M. A., AbdelRahman, A., & Fadlalla, A. (2008) A context-based integrative framework for e-government initiatives. *Government Information Quarterly*, 25, 448-461.
- O'Flynn, J. (2007) From New Public Management to Public Value: Paradigmatic Change and Managerial Implications. *The Australian Journal of Public Administration*, 66(3), 353-366.
- OECD e-Government Studies. (2005) *E-Government for Better Government*. Paris: OECD Publishing.
- Ojo, A., & Janowski, T. (2010) *A Whole-of-Government Approach to Information Technology Strategy Management*. Paper presented at the dg.o 2010 conference.
- Orlikowski, W. J. (1992) The Duality of Technology: Rethinking the Concept of Technology in Organizations. *Organization Science*, 3(3), 398-427.
- Orlikowski, W. J. (2000) Using Technology and Constituting Structures: A Practice Lens for Studying Technology in Organizations. *Organization Science*, 11(4), 404-428.
- Orlikowski, W. J., & Robey, D. (1991) Information Technology and the Structuring of Organizations. *Information Systems Research*, 2(2), 143-169.
- Osborne, D., & Gaebler, T. (1992) *Reinventing Government: How the Entrepreneurial Spirit is Transforming the Public Sector*. Reading, MA: Addison-Wesley.
- Papazoglou, M. P. (2008) *Web Services: Principles and Technology*. Harlow: Pearson Education.
- Parisopoulos, K., Tambouris, E., & Tarabanis, K. (2009) Transformational Government in Europe: A Survey of National Policies. In M. D. L. e. al. (Ed.), *Lecture Notes in Artificial Intelligence 5736* (pp. 462-471). Berlin Heidelberg: Springer.
- Peristeras, V., & Tarabanis, K. (2000) Towards an enterprise architecture for public administration using a top-down approach. *European Journal of Information Systems*, 9(4), 252-260.
- Perrow, C. B. (1967) A framework for the comparative analysis of organizations. *American Sociology Review*, 32, 194-208.
- Pertusa-Ortega, E. M., Molina-Azorin, J. F., & Claver-Cortes, E. (2010) Competitive strategy, structure and firm performance: A comparison of the resource-based view and the contingency approach. *Management Decision*, 48(8), 1282-1303.
- Pfeffer, J., & Leblebici, H. (1977) Information Technology and Organizational Structure. *The Pacific Sociological Review*, 20(2), 241-261.
- Pinsonneault, A., & Kraemer, K. L. (1993) Survey research methodology in management information systems: An assessment. *Journal of Management Information Systems*, 10(2), 75-105.
- Piotrowski, S., & Rosenbloom, D. H. (2002) Nonmission-Based Values in Results-Oriented Public Management: The Case of Freedom of Information. *Public Administration Review*, 62(6), 643-657.

- Pochard, M. (2007) About 'Responsive, responsible and respected government: towards a New Public Administration theory' by Jocelyne Bourgon. *International Review of Administrative Sciences*, 73(1), 27-29.
- Pollitt, C. (2007) 'Towards a New Public Administration theory': some comments on Jocelyne Bourgon's 5th Braibant Lecture. *International Review of Administrative Sciences*, 73(1), 37-41.
- Pollitt, C., & Bouckaert, G. (2004) *Public Management Reform. A Comparative Analysis*. Oxford: Oxford University Press.
- Poole, M. S. (2009) Response to Jones and Karsten, "Giddens's Structuration Theory and Information Systems Research". *MIS Quarterly*, 33(3), 583-587.
- Poole, M. S., & DeSanctis, G. (2004) Structuration Theory in Information Systems Research: Methods and Controversies. In M. E. Whitman & A. B. Wozzczyński (Eds.), *The Handbook for Information Systems Research* (pp. 206-249). Hershey, US: Idea Group Publishing.
- Porter, M. E. (1985) *Competitive Advantage: Creating and Sustaining Superior Performance*. New York, NY, US: The Free Press.
- Poulsen, B. (2009) Competing Traditions of Governance and Dilemmas of Administrative Accountability: the Case of Denmark. *Public Administration*, 87(1), 117-131.
- Powell, W. W. (Ed.). (1991) *Neither Market nor Hierarchy: Network Forms of Organization*. London: Sage Publications.
- Pozzebon, M., & Pinsonneault, A. (2005) Challenges in Conducting Empirical Work Using Structuration Theory: Learning from IT Research. *Organization Studies*, 26(9), 1353-1376.
- Pralahad, C. K., & Hamel, G. (1990) The core competence of the corporation. *Harvard Business Review*, 69(4), 81-93.
- Provan, K. G., & Milward, H. B. (2001) Do Networks Really Work? A Framework for Evaluating Public-Sector Organizational Networks. *Public Administration Review*, 61(4), 414-423.
- Raus, M., Liu, J., & Kipp, A. (2010) Evaluating IT innovations in a business-to-government context: A framework and its applications. *Government Information Quarterly*, 27, 122-133.
- Reddick, C. G. (2009) Factors that Explain the Perceived Effectiveness of E-Government. *International Journal of Electronic Government Research*, 5(2), 1-15.
- Richardson, G. L., Jackson, B. M., & Dickson, G. W. (1990) A Principles-Based Enterprise Architecture: Lessons From Texaco and Star Enterprise. *MIS Quarterly*, 14(4), 385-403.
- Roberts, N. C. (2002) Keeping Public Officials Accountable through Dialogue: Resolving the Accountability Paradox. *Public Administration Review*, 62(6), 658-669.
- Roberts, P. W., & Greenwood, R. (1997) Integrating Transaction Cost Theory and Institutional Theories: Toward a Constrained-Efficiency Framework for Understanding Organizational Design Adoption. *Academy of Management Review*, 22(2), 346-373.
- Robey, D., & Boudreau, M.-C. (1999) Accounting for the Contradictory Organizational Consequences of Information Technology: Theoretical Directions and Methodological Implications. *Information Systems Research*, 10(2), 167-185.
- Rose, J. (1998) *Evaluating the Contribution of Structuration Theory to the Information Systems Development*. Paper presented at the Proceedings of the 6th European Conference on Information Systems.

- Sager, F., & Rosser, C. (2009) Weber, Wilson, and Hegel: Theories of Modern Bureaucracy. *Public Administration Review*, 69(6), 1136-1147.
- Sarker, S., & Lee, A. S. (1999) IT-enabled organizational transformation: a case study of BPR failure at TELECO. *Journal of Strategic Information Systems*, 8, 83-103.
- Schmidt, C., & Buxmann, P. (2011) Outcomes and success factors of enterprise IT architecture management: empirical insight from the international financial services industry. *European Journal of Information Systems*, 20, 169-185.
- Scholl, H. J. (2004) *Current Practices in e-Government-induced Business Process Change (BPC)*. Paper presented at the National Conference on Digital Government Research.
- Scholl, H. J. (2005a) E-Government-Induced Business Process Change (BPC): An Empirical Study of Current Practices. *International Journal of Electronic Government Research*, 1(2), 27-49.
- Scholl, H. J. (2005b) *Organizational Transformation Through E-Government: Myth or Reality*. Paper presented at the Electronic Government: 4th International Conference, EGOV 2008.
- Scholl, H. J. (2007) Central research questions in e-government, or which trajectory should the study domain take? *Transforming Government: People, Process and Policy*, 1(1), 67-88.
- Scholl, H. J. (2009) Electronic Government: A study Domain Past its Infancy. In H. J. Scholl (Ed.), *Electronic Government: Information, Technology and Transformation*. Armonk: M.E. Sharpe.
- Schoonhoven, C. B. (1981) Problems with Contingency Theory: Testion Assumptions Hidden within the Language of Contingency "Theory". *Administrative Science Quarterly*, 26(3), 349-377.
- Schwarz, G. M., & Brock, D. M. (1998) Waving hello or waving good-bye? Organizational change in the information age. *The International Journal of Organizational Analysis*, 6(1), 65-90.
- Schwarz, G. M., & Huber, G. P. (2008) Challenging Organizational Change Research. *British Journal of Management*, 19, S1-S6.
- Scott, W. R. (1995) *Institutions and Organizations*. Thousand Oaks, CA: Sage.
- Smith, G. E., & Huntsman, C. A. (1997) Reframing the Metaphor of the Citizen-Government Relationship: A Value-Centered Perspective. *Public Administration Review*, 57(4), 309-318.
- Smithson, S., & Hirschheim, R. (1998) Analysing information systems evaluation: another look at an old problem. *European Journal of Information Systems*, 7, 158-174.
- Snellen, I. (2002) Electronic Governance: Implications for Citizens, Politicians and Public Servants. *International Review of Administrative Sciences*, 68(2), 183-198.
- Spector, P. E. (2006) Method Variance in Organizational Research: Truth or Urban Legend? *Organizational Research Methods*, 9(2), 221-232.
- Stoker, G. (2006) Public Value Management A New Narrative for Networked Governance? *The American Review of Public Administration*, 36(1), 41-57.
- Stones, R. (2005) *Structuration Theory*. Basingstoke: Palgrave Macmillan.
- Tavakolian, H. (1989) Linking the Information Technology Structure with Organizational Competitive Strategy: A survey. *MIS Quarterly*, 13(3), 309-317.
- Thompson, G. F. (2003) *Between Hierarchies & Markets: The Logic and Limits of Network Forms of Organization*. Oxford: Oxford University Press.
- Thompson, J. D. (1967) *Organizations in Action*. New York: McGraw-Hill.

- Tiwana, A., & Konsynski, B. (2010) Complementarities Between Organizational IT Architecture and Governance Structure. *Information Systems Research*, 21(2), 288-304.
- Tosey, P., & Robinson, G. (2002) When change is no longer enough: what do we mean by "transformation" in organizational change work? *The TQM Magazine*, 14(2), 100-109.
- UNPAN. (2002) Benchmarking e-Government – A Global Perspective. New York: UN.
- UNPAN. (2008) UN e-government survey 2008: From e-government to connected governance. New York, NY: United Nations.
- Veenstra, A. F. v., Agesen, G., Janssen, M., & Krogstie, J. (forthcoming) Infrastructures for public service delivery: Aligning IT governance and architecture in infrastructure development *e-Service Journal*.
- Veenstra, A. F. v., & Janssen, M. (2011) Architectural Principles for Orchestration of Cross-Organizational Service Delivery - Case Studies from the Netherlands. In S. Assar, I. Boughzala & I. Boydens (Eds.), *Practical Studies in e-Government: Best Practices from Around the World* (pp. 167-185). New York: Springer.
- Veenstra, A. F. v., Klievink, B., & Janssen, M. (2011) Barriers and impediments to transformational government: insights from literature and practice. *Electronic Government: An International Journal, Special Issue on: E-Government: Past, Present, and Future*, 8(2/3), 226–241.
- Ven, A. H. v. d., & Poole, M. S. (1995) Explaining Development and Change in Organizational *The Academy of Management Review*, 20(3), 510-540.
- Venkatraman, N. (1994) IT-enabled business transformation: From automation to business scope redefinition. *Sloan Management Review*, 35(2), 73-87.
- VNG. (2010) *Dienstverlening draait om mensen*. Retrieved from http://www.vng.nl/Documenten/Extranet/Gemeentelijke%20dienstverlening/20100310_Dienstverlening_draait_om_mensen%20.pdf.
- Walsham, G. (1995) Interpretive case studies in IS research: nature and method. *European Journal of Information Systems*, 4, 74-81.
- Wamba, S. F., & Chatfield, A. T. (2009) A contingency model for creating value from RFID supply chain network projects in logistics and manufacturing environments. *European Journal of Information Systems*, 18, 615-636.
- Weber, M. (1972 [1920]) *Wirtschaft und Gesellschaft, Grundriss der Verstehende Soziologie*, 5th revised edition. Tübingen: Studienausgabe.
- Weerakkody, V., & Dhillon, G. (2008) Moving from E-Government to T-Government: A Study of Process Reengineering Challenges in a UK Local Authority Context. *International Journal of Electronic Government Research*, 4(4), 1-16.
- Weill, P., & Ross, J. (2005) A matrixed approach to designing IT governance. *MIT Sloan Management Review*, 46, 26-34.
- West, D. M. (2004) E-Government and the Transformation of Service Delivery and Citizen Attitudes. *Public Administration Review*, 64(1), 15-27.
- Williamson, O. E. (1975) *Markets and Hierarchies: Analysis and Antitrust Implications*. New York: Free Press.
- Williamson, O. E. (1985) *The economic institutions of capitalism: Firms, markets, relational contracting*. New York: Free Press.
- Wimmer, M. A. (2002) Integrated service modeling for online one-stop government. *Electronic Markets, special issue on e-Government*, 12(3), 1-8.
- Wise, L. R. (2002) Public Management Reform: Competing Drivers of Change. *Public Administration Review*, 62(5), 555-567.

- Woodward, J. (1965) *Industrial Organization: Theory and Practice*: Oxford University Press.
- WRR. (2011) *iOverheid*. Den Haag: Wetenschappelijke Raad voor het Regeringsbeleid.
- Yildiz, M. (2007) E-government research: Reviewing the literature. limitations, and ways forward. *Government Information Quarterly*, 24, 646-665.
- Yin, R. K. (1989) *Case Study Research: Design and methods*. Newbury Park, California: Sage publications.
- Zachman, J. A. (1987) A Framework for Information Systems Architecture. *IBM Systems Journal*, 26, 276-292.
- Zott, C., & Amit, R. (2008) The Fit Between Product Market Strategy and Business Model: Implications for Firm Performance. *Strategic Management Journal*, 29, 1-26.
- Zuurmond, A. (1994) *De Infocratie Een theoretische en empirische heroriëntatie op Weber's ideaaltype in het informatietijdperk*. Erasmus Universiteit Rotterdam, Rotterdam.

Appendix 1: Documents studied for the case studies

SBR

- Amesz, Hans, 'De alledaagsheid van SBR' *Accountancy Nieuws*, March 26 2010, no. 6, pp. 16-19.
- Belastingdienst 'Horizontaal Toezicht; samenwerking vanuit vertrouwen' http://download.belastingdienst.nl/belastingdienst/docs/horizontaal_toezicht_samenwerken_vertrouwen_dv4031z1ed.pdf, accessed August 19 2010.
- Bottemane, Gerard, 'Verslag bijeenkomst "Kennisplatform Administratieve Software"', 19 februari 2010.
- GBNED, 'Leidraad voor het testen, beoordelen en certificeren van administratieve software, versie 3', juli 2009.
- Heur, Rian van, 'XBRL verplicht bij grote overheidsaanbesteding' *Computable*, March 18 2010.
- Hilvoorde, Marc van, 'XBRL-standaard stabiel, nu de software nog' *Accountancy Nieuws*, September 30 2005, no. 18, pp. 21-22.
- Hilvoorde, Marc van, Frank Koppenjan, 'De Nederlandse taxonomie is van ons allemaal!' *Accountancy Nieuws*, November 25 2005, no. 22, pp. 21-22.
- Full Finance consultants, 'Standard Business Reporting Deel I', February 2010, Full Finance, Apeldoorn.
- Jak, M., 'Autorisatieregister voor Digipoort blijkt onduidelijk' *Computable*, March 10 2010.
- Jonker, F.J., (2009). 'Belastingdienst en banken gaan kwaliteit eisen van kantoren' *Accountancy Nieuws*, June 26 2009.
- 'Meer ruimte voor ondernemers door minder lasten – Van lastenproductie naar lastenreductie', April 8 2004.
- Pasmooij, Jan & Paul Snijders, 'Invoering XBRL staat niet stil', www.accountant.nl, January 15 2008.
- Pasmooij, Jan, 'Het belang van XBRL voor IT-auditors' *De EDP-Auditor*, 2008, no. 2, pp. 18-23.
- Pasmooij, Jan, 'Beschrijving business case XBRL / SBR in de Nederlandse situatie naar de stand medio 2009', August 4 2009.
- Poel, Godert van der, Marc van Hilvoorde, Floris van den Dool, 'XBRL en Audit' *De Accountant*, January 2004, pp. 22-25.
- Persbericht Rapportage Portaal 'Eerste SBR berichten succesvol aangeleverd bij deelnemende banken', 2010, http://www.rapportageportaal.nl/recente_nieuwsberichten.
- Waa, Fred van der, Paul Rothwell, Dick Beekhuizen, 'XBRL: van leuk idee naar praktische toepassing', *Tijdschrift Controlling*, November 2003, no. 11, pp. 52-55.
- Wielaard, Nart, 'XBRL in stroomversnelling' *de Accountant*, February 2006, pp. 28-29.
- Wielaard, Nart, 'XBRL ontwikkeld in sluipgang' *de Accountant*, March 2009, pp. 24-25.
- Wietsma, Jan, 'Gemiste kans' *Accountancy Nieuws*, May 30 2008, pp. 20-21.
- <http://www.sbr-nl.nl/>.
- XBRL International: www.xbrl.org.
- XBRL Netherlands: www.xbrl-nederland.nl.
- <http://www.softwarepakketten.nl/>.

Omgevingsvergunning

- Alders, R., J. Van den Bosch en K. van Walderveen (2009). *Risicoanalyse OLO. Projectrisico's tijdige afronding OmgevingsLoket Online*. Verdonck, Klooster & Associates B.V (VKA).
- Binnenlands Bestuur (2010), 'Eerste Kamer akkoord met Wabo', 23 maart, <http://www.binnenlandsbestuur.nl/vakgebieden/all/eerste-kamer-akkoord-met-wabo.153515.lynkx>.
- Fluitsma, J. (2009). Gemeenten nog lang niet klaar voor Wabo. *Computable*, 6 november 2009, http://www.computable.nl/artikel/ict_topics/overheid/3143874/1277202/gemeenten-nog-lang-niet-klaar-voor-wabo.html.
- Financieel Dagblad (2010). Lagere kosten vergunningen laten weer op zich wachten; ICT frustriert lastenverlichting. *Financieel Dagblad*, 10 maart 2010, <http://www.fd.nl/artikel/14380211/lagere-kosten-vergunningen-laten-weer-zich-wachten>.
- Ministerie van VROM (2009). *Minimale vereisten Wabo voor gemeenten; 'invulling vijf eisen Wabo'*, <http://www.vrom.nl/pagina.html?id=2706&sp=2&dn=9166>.
- Wabowijzer.nl (2007). 'Behandeling Wabo in Tweede Kamer in november 2007', 27 september, http://www.bwtinfo.nl/bwti_com/i672babbc3e980db100994fbf9d21799d.php.
- Warbroek, Boudewijn (2010). 'Klaar voor één vergunning?' Binnenlands Bestuur, 27 september, <http://www.binnenlandsbestuur.nl/vakgebieden/klaar-voor-een-vergunning.305583.lynkx?referer=8e7504be-9ad6-40db-9fc1-2f6684ffb2a4>.
- <http://www.omgevingsvergunning.nl/>.

Appendix 2: Survey

A. Vragenlijst voor de EGEM-i adviseur voorafgaand aan het spel

1. Naam van de gemeente die de ketensimulatie gaat spelen:

Vragen over de transformatie van de front office:

2. Biedt de gemeente diensten samenhangend (rond bepaalde gebeurtenissen zoals verhuizing, werkloosheid, e.d.) aan, of zijn er aparte afdelingen en loketten voor? (1-10, van helemaal losstaand tot alle diensten volledig samenhangend aangeboden / weet niet)
3. Moet een burger voor verschillende diensten verschillende formulieren invullen, of zijn de formulieren geïntegreerd? (1-10, van alles op losstaande formulieren tot alle relevante formulieren geïntegreerd / weet niet)
4. Kan de burger de voortgang van de door hem aangevraagde dienst volgen ("tracking and tracing")? (1-10, van helemaal niet tot voor alle relevante diensten is dit geïmplementeerd / weet niet)
5. Is er een scheiding tussen front office (dienstverlening) en back office (de gegevensopslagen en kernprocessen)? (1-10, van helemaal geen scheiding tot zeer duidelijke scheiding / weet niet)

Vragen over de transformatie van de back office:

6. Wordt de burger proactief door IT ondersteund bij het vinden van al zijn rechten, of moet hij zelf uitzoeken voor welke regelingen en diensten hij in aanmerking komt? (1-10, van voor geen enkele regeling of dienst tot voor alle regelingen en diensten / weet niet)
7. Wordt de burger automatisch benaderd voor een gesprek met een coach/klantmanager, als hij via internet zaken aanvraagt die meer persoonlijke aandacht en tijd vragen? (1-10, van helemaal niets, soms, vaak, altijd / weet niet)
8. Gebruiken afdelingen van de gemeente hun eigen gegevensopslag of maken alle afdelingen gebruik van dezelfde gegevens? (1-10, van elke afdeling gebruikt z'n eigen gegevens tot alle afdelingen maken gebruik van dezelfde gegevens / weet niet)
9. Zijn doublures uit de werkprocessen gehaald zodat handelingen die door meerdere afdelingen moeten worden gedaan, in een keer voor alle afdelingen tegelijk worden uitgevoerd? (1-10, van helemaal niet tot geheel geen doublures in de processen / weet niet)

Vragen over procesautomatisering:

10. Kan het hele proces van dienstverlening (van aanvragen tot verstrekking) online worden doorlopen? (1-10, van voor geen enkele dienst, voor sommige diensten een beetje, voor sommige diensten helemaal, voor bijna alle diensten, voor alle diensten helemaal / weet niet)
11. Worden acties automatisch (met zo min mogelijk tussenkomst van menselijke handelingen) uitgevoerd na de elektronische aanvraag? (1-10, van niet, soms, vaak, altijd / weet niet)

Vragen over transformatie van de infrastructuur:

12. Voor hoeveel diensten kan de burger zich met DigiD legitimeren? (1-10, geen, enkele, veel, alle relevante / weet niet)
13. Worden aanvragen van diensten vooringevuld? (1-10, geen, enkele, alle relevante / weet niet)
14. Kan de burger zijn gegevens (zoals NAW-gegevens) online inzien? (1-10, nee, van sommige, de meeste, alle gegevens / weet niet)
15. Kan de burger zijn gegevens online corrigeren? (1-10, nee, sommige, de meeste, alle / weet niet)

Vragen over case management:

16. Krijgt de burger voor bepaalde diensten een case manager aangewezen? (1-10, niet, soms, vaak, altijd / weet niet)
17. Wordt de desbetreffende burger dan alleen geholpen met gemeentelijke diensten, of ook met de diensten van andere organisaties in de keten? (1-10, van nooit tot altijd / weet niet)

Vragen over architectuur:

18. Heeft de gemeente een systematische architectuur opgesteld? (1-10, van geen architectuur tot zeer systematische architectuur opgesteld)
19. Is het opstellen van de architectuur vanuit de IT of vanuit de business geïnitieerd? (1-10, van vanuit de IT tot vanuit de business)
20. Is de architectuur beschreven en vastgelegd in modellen of documenten? (1-10, van helemaal niet vastgelegd tot geheel vastgelegd in documenten)
21. Wordt de architectuur opgesteld op basis van de werkprocessen? (1-10, van helemaal niet op basis van de werkprocessen tot geheel op basis van de werkprocessen / weet niet)
22. Wordt de architectuur opgesteld op basis van de IT-systemen? (1-10, van helemaal niet tot geheel op basis van de IT-systemen / weet niet)
23. Ondersteunt het MT actief dat de keuzes op IT-gebied binnen architectuurafspraken passen? (1-10, van helemaal geen ondersteuning van MT tot sterke ondersteuning van MT)
24. Wordt in de architectuur rekening gehouden met het opslaan van managementinformatie? (1-10, van helemaal niet tot alles / weet niet)
25. Worden control gegevens opgeslagen voor het afstemmen van processen? (1-10, van helemaal niet tot alles / weet niet)

B. Vragenlijst voor de deelnemers, bij de uitnodiging voor het spel

1. Wat is uw functie?
2. In welke categorie hoort uw functie thuis? (uitvoerend / staf / beleid / ondersteunend / lijnmanagement / bestuurder)
3. Wat is uw leeftijd?
4. Bent u een man of een vrouw? (man/vrouw)
5. Wat is uw hoogst afgeronde opleiding? (voortgezet onderwijs, MBO/MTS, HBO/HTS, WO, postdoctoraal)

Vragen over sturing:

In hoeverre bent u het eens met de volgende stellingen? (1-10, van helemaal mee oneens tot helemaal mee eens / weet niet)

6. De afzonderlijke sectoren/afdelingen van de gemeente zijn nog sterk autonoom.
7. Er is sprake van gemeenschappelijke sturing op de afdelingen van de gemeente.
8. Het management van de gemeente stuurt meer op samenhangende uitvoering van processen, dan op goede afhandeling van taken van afzonderlijke afdelingen.
9. Het dienstverleningsproces is zodanig ingericht dat burgers en bedrijven zo min mogelijk administratieve lasten hebben.
10. Er is een proceseigenaar of er zijn proceseigenaren die overzicht heeft / hebben over het gehele werkproces.
11. De proceseigenaar stuurt / de proceseigenaren sturen samenhangend op het hele werkproces.
12. Medewerkers hebben het gevoel dat ze naar het management moeten stappen als ze merken dat een burger of ondernemer van het kastje naar de muur wordt gestuurd.
13. Er is vanuit het DT/MT veel aandacht voor knelpunten in de uitvoering.
14. Er wordt door het DT/MT structureel tijd vrijgemaakt om naar knelpunten en verbetermogelijkheden te kijken.

Vragen over coördinatie:

In hoeverre bent u het eens met de volgende stellingen? (1-10, van helemaal mee oneens tot helemaal mee eens / weet niet)

15. Afstemming over het werkproces vindt centraal plaats? (1 (van geheel decentraal) tot 10 (geheel centraal))
16. Medewerkers van de gemeente snappen dat ze niet op eilandjes zitten, ze zorgen er voor dat hun handelingen afgestemd zijn met de werkprocessen van collega's van andere gemeentelijke afdelingen.
17. Bij handhaving treden verschillende afdelingen gezamenlijk op. (1 (iedere afdeling voor zich) tot 10 (geheel gezamenlijk))
18. De verschillende afdelingen komen regelmatig samen voor overleg over procedures en de bewaking van de voortgang. (1 (nooit) tot 10 (zeer regelmatig))
19. Er zijn afspraken gemaakt over het dienstenniveau (Service Level Agreements) tussen de verschillende afdelingen.
20. Wanneer medewerkers verschillen tegenkomen, bijvoorbeeld tussen gegevens van hun eigen afdeling en een andere afdeling, worden deze teruggemeld aan de desbetreffende afdeling.
21. Als er iemand nieuw bij de gemeente komt werken, dan wordt alles in één keer geregeld (het contract, de sleutel/toegang tot het gebouw, de pc, de visitekaartjes, het login/password, de kamer, etc.).

Summary

IT-induced public sector transformation

Transformational e-government (t-government) aims to transform public administrations by undertaking *IT-induced transformation*. After e-government gained momentum as a result of the wide-spread use of the internet in the mid-1990s, it was embraced by policy-makers aiming to transform governments and make public administrations more effective. E-government, however, did not realize these changes and t-government emerged. T-government specifically aims at making governments more effective by undertaking organizational change in order to leverage information technology (IT) and realize public sector reform. IT-induced transformation is defined as multi-level (a change on multiple layers, such as the institutional, organizational and technical layers), multi-dimensional (a change into multiple directions) and long-term change of government in order to realize public sector reform.

This study investigates IT-induced transformation by exploring its objectives, mechanisms and outcomes, as well as the factors that influence its outcomes. Transformation can refer to an outcome ('transformation-as-a-product'), but also to a change process ('transformation-as-a-process'). Both aspects are addressed in this research. The central research question of this study is: *How does IT-induced transformation take place?* The goal of this study is to operationalize and elaborate the model of IT-induced transformation that is shown in figure 1.

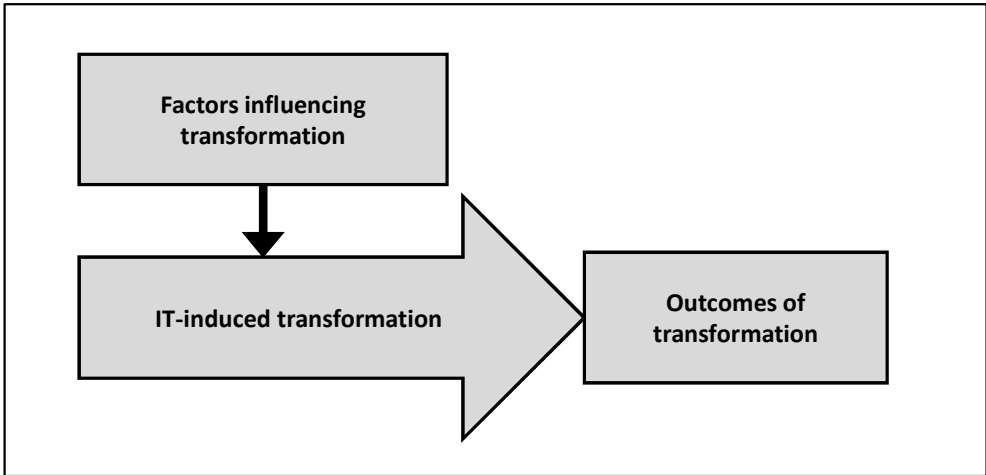

Figure 1: The model of IT-induced transformation.

This study is carried out in three steps, each with its own research question, which are visualized by the three blocks in figure 1. Firstly, the concept of IT-induced transformation is operationalized based on the literature on public sector reform from the field of Public Administration and on the literature on leveraging IT from the field of Information Systems. The first research question is: *What are the objectives and mechanisms of IT-induced transformation?* Using the findings from the literature, the

objectives and mechanisms of IT-induced transformation are identified. Secondly, the outcomes of IT-induced transformation are investigated: *What are the outcomes of IT-induced transformation in practice?* This question is answered by undertaking two case studies of IT-induced transformation, as well as conducting survey research among municipalities. Thirdly, the factors influencing the outcomes of IT-induced transformation are explored: *Which factors influence the occurrence of these outcomes?* For this third part of the investigation, two theoretical perspectives on the transformation process are used, based on contingency theory and structuration theory. These lenses were selected as they are complementary, likely yielding rich insights, and because they are widely used in the Information Systems field.

Although studies into organizational change as a result of governments implementing IT as well as studies of public sector reform are already well-established, the specific topic of IT-induced transformation can be considered new. Only for the past few years governments have actively aimed to transform their organizations undertaking t-government. Therefore, this study is considered explorative in nature aiming at formulating theory on IT-induced transformation. Its contribution to the literature is threefold. Firstly, it aims to define IT-induced transformation. Secondly, it aims to explore its outcomes as well as the factors that influence these outcomes. Thirdly, it develops two theoretical lenses for studying the transformational process to derive factors influencing transformation.

Operationalizing IT-induced transformation

Transformation-as-a-product links transformational mechanisms aiming to improve service delivery and optimizing business processes to the objectives of public sector reform. The objectives of IT-induced transformation are derived by looking at Public Value Management (PVM), which is defined in the Public Administration literature. PVM emerges from the critique on New Public Management (NPM). NPM refers to a paradigm of management reform introduced in the 1980s to overcome the inflexibility and inefficiencies of the traditional bureaucracies as a result of its pre-occupancy with following procedures rather than serving the public. NPM swept through many public administrations around the world. Introducing management practices from the private sector, these governments put executive tasks at a distance. Furthermore, to make public managers accountable for the outputs they achieve, strict targets were introduced. However, NPM is increasingly criticized as it resulted in a fragmentation of government and in a managerial focus on achieving targets rather than serving citizens, sometimes leading to perverse effects of policies.

PVM was defined to overcome some of the negative effects of NPM. Its main objective is a focus on realizing public value either directly for citizens or by strengthening the government. Public value is to be delivered through the continuous evaluation and, where necessary, readjustment of policies to ensure desirable outcomes. But public value is no longer the exclusive domain of governments. Collaboration in networks, in which public and private parties take part, is paramount both for determining which public value will be delivered and for whom, as well as for executing policies accordingly. This collaboration is enabled by the use of IT. Furthermore, PVM aims to realize integrated service delivery, trying to overcome the fragmentation introduced by NPM, and a more publically or socially accountable government through increased transparency. While PVM is often presented as a new ideal type it is more accurate to regard it as a continuation of NPM trying to overcome some of its negative aspects.

Policy makers saw in IT a means of achieving their goals for more efficient, effective and equitable government. As such, t-government is linked to objectives of PVM, just like e-government aims to achieve the objectives of NPM. However, e-government merely created a joined-up front office, with little organizational transformation taking place in the back office. Therefore, t-government emerged aiming to leverage IT in order to achieve public sector reform. Based on the literature on t-government, four commonly used transformational mechanisms of IT-induced transformation were distinguished: governance, service chain formation, business process change, and enterprise architecture. The four objectives of PVM and the four transformational mechanisms form the operationalization of IT-induced transformation (see figure 2).

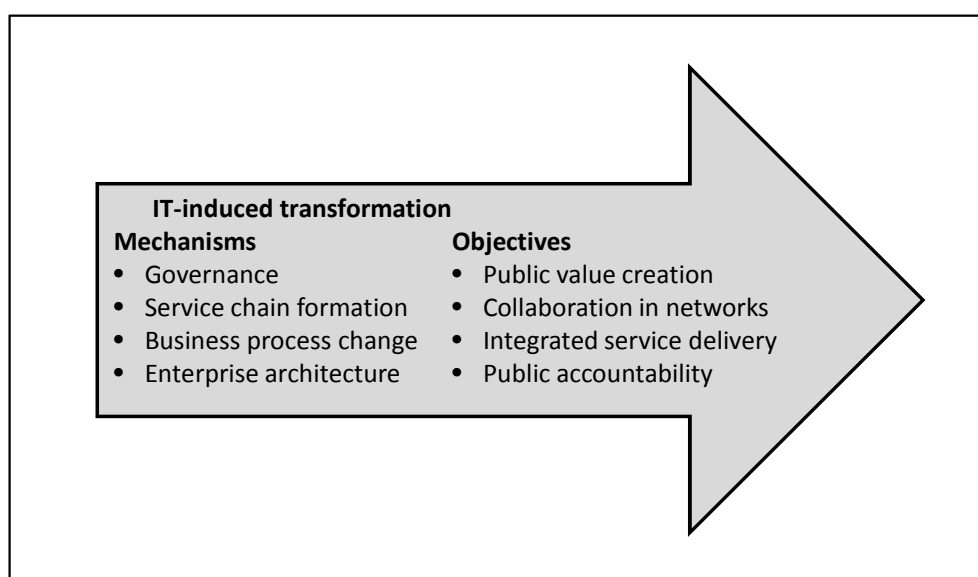

Figure 2: Mechanisms and objectives of IT-induced transformation.

Theoretical perspectives on the transformation process

To understand the process of transformation and derive factors that influence this process, two different theoretical lenses were used: contingency theory and structuration theory. *Contingency theory* is concerned with the organizational changes that take place as a result of a change in the environment. Internal contingencies – factors within the organization – are the type of tasks that are performed and the technology that is deployed. External contingencies are the uncertainty and complexity of the environment. In practice, rather than an endless number of organizational structures, a few organizational configurations are seen to emerge depending on the contingencies. These configurations are characterized by their central coordinating mechanism and by the related characteristics of decentrality of decision-making, and specialization and formalization of activities performed. IT is expected to lead to a networked organizational configuration through a decrease of the transaction costs. Using the contingency perspective, first the organizational changes are investigated, before the factors influencing these changes are explored.

Structuration theory holds that social phenomena are mutually constituted through the social structure (e.g. institutions) and agency. This is seen to happen through norms, interpretative schemes, and resources. Structuration of information systems happens on

the one hand by institutions that become enshrined in the technology that is designed and developed. On the other hand it takes place when actors implement and use the technology according to their own needs and wishes. Structuration is defined by three dimensions: signification, when a meaning is attached to certain practices, domination, when controls are carried out sanctioning different behavior, and appropriation, which deals with (un)faithful adoption and use of technology. Using this theoretical perspective, the process of transformation can be investigated over time by looking at these three dimensions to derive forces that have influenced the outcomes of transformation.

IT-induced transformation in practice

Two cases of IT-induced transformation were investigated. The first is Standard Business Reporting (SBR), aiming to standardize financial reporting of businesses to the Dutch government. Using the international accounting standard XBRL (eXtensible Business Reporting Language), a taxonomy (NT), and a process infrastructure (DigiPoort) SBR includes the reporting processes to the Inland Revenue Service (IRS), the Chambers of Commerce, and the Central Bureau of Statistics (CBS). This program aims to decrease the administrative burden of financial reporting and install better compliance management by creating a uniform process infrastructure using a uniform data standard. The second case study is the Omgevingsvergunning (Wabo) law aiming to join-up twenty-five permit request processes, supported by the introduction of a portal (OLO) that can be used to jointly request these permits. Including permits that are handled by different layers of government (ministries, provinces, and municipalities), this law aims at joining-up government by realizing integrated service delivery and a jointly developed infrastructure.

Both cases have transformational outcomes, including shift towards public value creation, realizing joined-up government and integrated service delivery, and collaboration in networks. However, public accountability, nor the change to a fully networked structure were observed, as hierarchical organizations remain in place. The transformational mechanisms were all deployed in the cases, but they were implemented differently. While both cases deploy governance and enterprise architecture to govern change, they represent different stages of development. While the SBR case is looking at changing business processes, the Omgevingsvergunning is in the phase of service chain formation. Furthermore, transformation was found to not take place without a change in law. Finally, the role of governance was found to play a more significant role than the actual organizational transformation to a networked organization.

Using the contingency perspective for investigating the transformation process and deriving factors influencing transformation, it was confirmed that IT is contingent on transformation. This led to a shift in the coordinating mechanism in the SBR case: from output standardization to standardization of skills. The changes in the related organizational characteristics lead to decentralized decision-making and professionalization of the workforce. Using the structuration perspective it was found that that enactment of the organizations implementing IT drawing upon their own norms and objectives results in differences in IT-implementation across the organizations involved. Furthermore, the appropriation of IT by these organizations often happens unfaithfully through the power exerted by the government. IT-induced transformation was found to be more often used by public administrations to strengthen

their own position – for example by creating better compliance control, rather than to create value for citizens and businesses.

Transformation in municipalities

The second empirical study was a survey conducted among Dutch municipalities. The choice for sending a survey to municipalities was made for three reasons. First of all, it allows for making generalizations for a specific population – local governments, thereby investigating whether transformation really took hold in government. Secondly, municipalities are to become the single point of contact for all contact with the government in the Netherlands, and therefore their performance of public service delivery is especially important. And thirdly, to obtain a large enough sample of comparable cases, as municipalities are the only instance of government organizations of which there are enough to allow for generalization.

Municipalities can be considered undertaking IT-induced transformation as they face subsequent e-government programs aiming to improve service delivery. Over the course of a year ninety municipalities took part in this survey, representing 20% of the total number of municipalities in the Netherlands. The survey included questions on the transformational objectives and mechanisms as well as on the factors that influence IT-induced transformation. Additional indicators from e-government benchmarks were included. The findings show that no real transformation has taken place among municipalities, even though the technical transformational mechanisms (mainly the formation of service chains) were found to correlate with the transformational objectives. Municipalities were found to be mainly concerned with implementing e-government infrastructure building blocks and digitizing current processes rather than with undertaking transformational efforts.

Conclusion

This study finds that IT-induced transformation does not represent ‘transformation-as-a-product’, or ‘transformation-as-a-process’, but rather ‘transformation-as-an-objective’. This means that it aims to transform the public sector, but that organizational transformation was not found in practice. Instead, IT-induced transformation was found to be mostly concerned with setting up governance to govern changes in networks of public organizations. Furthermore, it was found that the use and implementation of IT lead to decentralization of decision-making and professionalization of the workforce. A third finding was that IT-induced transformation is always accompanied by a change in the law, effectively creating new stovepipes. Fourthly, this study found that the implementation of t-government efforts differs across organizations, through the enactment of the technology by the norms and objectives of these organizations.

Contrary to what is found in the literature on t-government, IT-induced transformation more often strengthens the position of the government, for example by setting up compliance controls, than that it improves service delivery to citizens and businesses. This may explain why transparency and public accountability, which would benefit citizens and businesses more than the government, were not observed in this study. Further research should look into how the different factors influencing IT-induced transformation, such as a change in the law and the introduction of new coordinating mechanisms, are related to each other.

Samenvatting

IT-geïnduceerde transformatie van de publieke sector

Transformational e-government (*t-government*) heeft als doel overheden te transformeren middels *IT-geïnduceerde transformatie*. E-government werd onderdeel van het beleid van overheden als gevolg van het wijdverbreide gebruik van het internet vanaf midden jaren '90. Beleidsmakers grepen de implementatie van informatietechnologie (IT) aan om de overheid te hervormen en zo effectiever te maken. E-government bleek deze veranderingen echter onvoldoende te bewerkstelligen. *T-government* is erop gericht om organisatorische veranderingen door te voeren teneinde de doelstellingen van e-government te realiseren. IT-geïnduceerde transformatie, kortweg *transformatie*, is gedefinieerd als een organisatieverandering op meerdere niveaus – zoals institutioneel, organisatorisch, en technisch, in meerdere richtingen – zoals in de informatiesystemen, en in de besluitvorming, en op de lange termijn om de publieke sector te hervormen.

Dit onderzoek gaat over deze transformatie. Hiertoe worden de verschillende onderdelen van transformatie, zoals de doelstellingen, mechanismen, uitkomsten, en factoren die deze uitkomsten beïnvloeden onderzocht. Het begrip transformatie kan verwijzen naar een uitkomst ('transformatie-als-product'), maar ook naar een veranderproces ('transformatie-als-proces'). Dit onderzoek richt zich op beide aspecten. De centrale onderzoeksvraag is: *Hoe vindt IT-geïnduceerde transformatie plaats?* Het doel van dit onderzoek is om de verschillende onderdelen van het model van transformatie, dat is weergegeven in figuur 1, te operationaliseren.

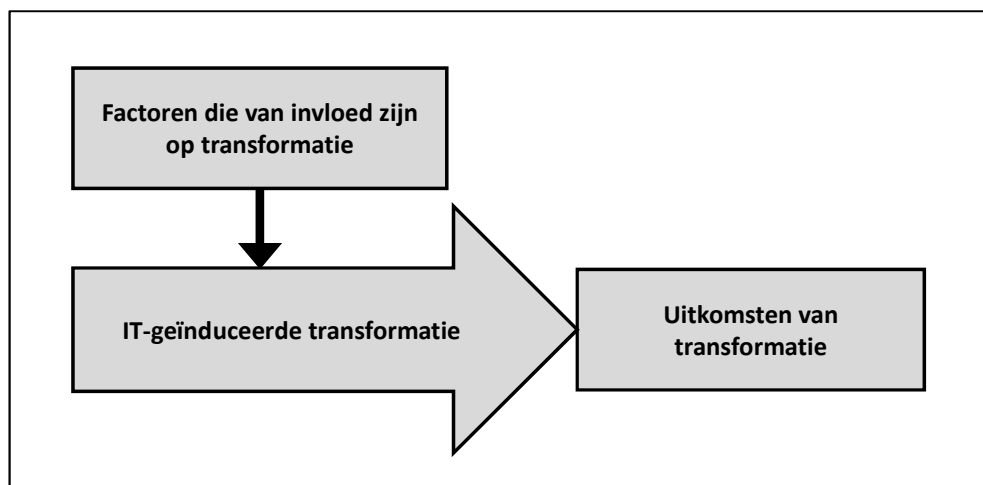

Figuur 1: Model van (IT-geïnduceerde) transformatie.

Dit onderzoek is uitgevoerd in drie stappen, elk met een bijbehorende onderzoeksvraag, weergegeven in de blokken van figuur 1. De eerste stap operationaliseert het concept transformatie op basis van de literatuur: *Wat zijn de doelstellingen en mechanismen van transformatie?* Vanuit de Bestuurskunde literatuur zijn doelstellingen voor

transformatie afgeleid. Literatuur over Informatiesystemen is gebruikt om mechanismen af te leiden die de organisatieveranderingen moeten realiseren. De tweede onderzoeksvraag is: *Wat zijn de uitkomsten van transformatie in de praktijk?* Hiervoor zijn twee cases van transformatie onderzocht en is een kwantitatief onderzoek onder gemeenten gehouden. De derde onderzoeksvraag is: *Welke factoren leiden tot de uitkomsten van transformatie?* Hiervoor wordt gebruik gemaakt van twee theoretische perspectieven op het transformatieproces. Deze zijn afgeleid van contingentietheorie en structuratietheorie. De keuze voor deze perspectieven is gemaakt omdat ze complementair zijn – en ze dus waarschijnlijk tot aanvullende inzichten leiden – en omdat ze veel worden gebruikt in voor studies op het gebied van Informatiesystemen.

Hoewel er al veel onderzoek is gedaan naar organisatieveranderingen als gevolg van het gebruik van IT voor dienstverlening van de overheid, is het onderzoek naar transformatie nieuw. T-government is pas de afgelopen jaren actief nagestreefd door overheden. Daarom is dit een verkennend onderzoek. Dit onderzoek draagt op drie manieren bij aan de literatuur. Als eerste door het definiëren van transformatie. Ondanks dat er, vooral door beleidsmakers, veel wordt gesproken over de transformatie van de overheid, is het begrip nauwelijks geoperationaliseerd – laat staan getest. Als tweede zijn de uitkomsten van transformatie onderzocht en de factoren die de uitkomsten van transformatie bepalen, afgeleid. Als derde zijn twee theoretische perspectieven op het transformatieproces afgeleid die worden gebruikt om factoren die van invloed zijn op transformatie af te leiden.

Transformatie geoperationaliseerd

Transformatie-als-product verbindt verandermechanismen gericht op het verbeteren van dienstverlening met doelstellingen die gaan over de hervorming van de overheid. De doelstellingen van IT-geïnduceerde transformatie zijn afgeleid door naar Public Value Management (PVM) te kijken, dat is opgesteld in de Bestuurskunde literatuur. PVM is een opvolger van het New Public Management (NPM) ideaaltype. NPM kwam op in de jaren '80, toen bureaucratieën steeds vaker geassocieerd werden met een gebrek aan flexibiliteit en efficiëntie als gevolg van de focus op het volgen van procedures. In plaats van de klanten van de overheid (burgers en bedrijven) te bedienen, richten ambtenaren zich op het volgen van de juiste procedures. Daarom werd een hervorming van de publieke sector ingezet gebaseerd op praktijken uit de private sector.

Het gevolg was dat veel publieke taken op afstand werden geplaatst van de centrale overheid, waarbij ze alleen nog gecontroleerd worden op vooraf afgesproken doelen. Hierdoor zouden organisaties efficiënter worden en publieke diensten dus goedkoper. Deze hervormingen kregen echter steeds meer kritiek doordat ze leidden tot fragmentatie van de overheid, waarbij klanten 'van het kastje naar de muur' werden gestuurd. Ook leidde de focus op het behalen van de vooraf afgesproken doelstellingen in sommige gevallen tot perverse effecten – waarbij een andere uitkomst werd behaald dan bedoeld was. Daarom is in de afgelopen jaren PVM opgekomen, dat zich richt op het ongedaan maken van de negatieve effecten van NPM.

De belangrijkste doelstelling van PVM is het creëren van publieke waarde. Dit kan door direct waarde te creëren voor burgers en bedrijven, of door de rol van de overheid te versterken. Bij het uitvoeren van publieke taken wordt voortdurend opnieuw bepaald of de juiste uitkomsten van beleid worden gerealiseerd. Publieke waarden kunnen niet langer door de centrale overheid alleen worden gerealiseerd. Hiervoor is samenwerking in netwerken nodig, waarin publieke en private partijen gezamenlijk optrekken. PVM is erop gericht geïntegreerde dienstverlening te realiseren en zo de fragmentatie van de

overheid op te heffen. Hiervoor is een andere manier van verantwoording afleggen noodzakelijk: publieke verantwoording, waarbij bepaald wordt of de overheid nog wel 'het juiste' doet. Hoewel PVM door sommigen wordt neergezet als een nieuw ideaaltipe, kan het beter beschouwd worden als een continuering van NPM waarbij een aantal negatieve aspecten wordt teruggedraaid.

Beleidsmakers zien sinds de jaren '90 in IT een middel om hun doelstellingen van een efficiëntere en meer klantvriendelijke overheid te bereiken. E-government werd dan ook gezien als een middel om de doelstellingen van NPM te bereiken – vooral betere dienstverlening. Op dezelfde manier wordt t-government gekoppeld aan de doelstellingen van PVM toen bleek dat e-government niet automatisch de gewenste doelstellingen bereikte. Als gevolg werden organisatieveranderingen doorgevoerd die ervoor moeten zorgen dat de doelstellingen van het gebruik van IT worden gerealiseerd. Uit literatuur over t-government kunnen vier verandermechanismen worden afgeleid die veel worden ingezet om de doelstellingen van t-government te bereiken. Deze zijn: governance, de formatie van ketens, verandering van bedrijfsprocessen, en architectuur. De vier doelstellingen van PVM en de vier verandermechanismen vormen samen de operationalisering van transformatie (zie figuur 2).

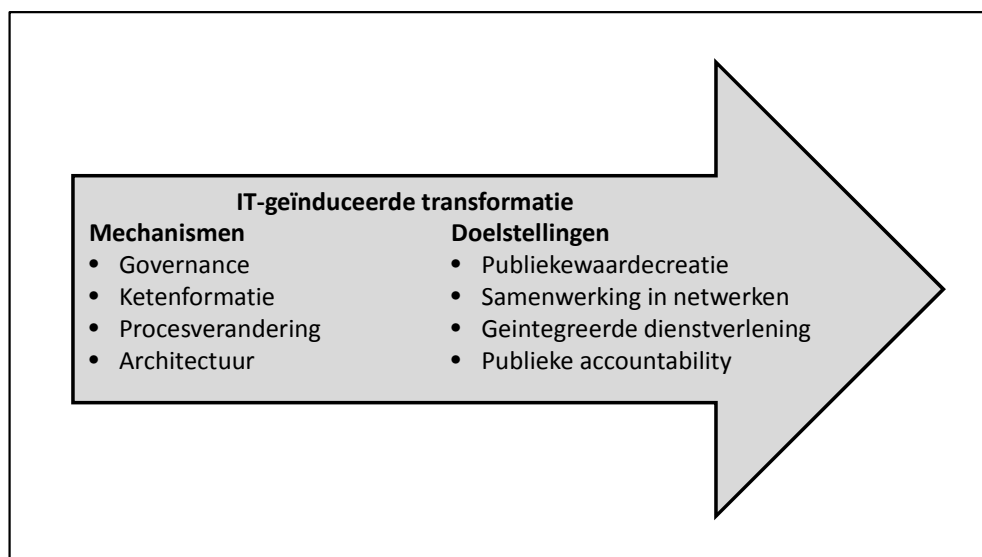

Figuur 2: Mechanismen en doelstellingen van IT-geïnduceerde transformatie.

Theoretische perspectieven op het veranderproces

Om 'transformatie-als-proces' te onderzoeken, worden twee perspectieven ontwikkeld op basis van theorieën over verandering: contingentietheorie en structuratietheorie. *Contingentietheorie* ziet organisatieveranderingen als het gevolg van veranderingen in de omgeving. Doordat organisaties altijd zullen streven naar de optimale vorm om de beste prestatie te leveren, treden veranderingen in de structuur op. De factoren in de omgeving die leiden tot verandering in de organisatie worden contingenties genoemd. Interne contingenties zijn het type taken dat wordt uitgevoerd in een organisatie en de technologie die wordt gebruikt bij de uitvoering van deze taken. Externe contingenties zijn de onzekerheid en complexiteit van de omgeving.

In de praktijk leveren de contingenties niet een oneindig aantal verschillende organisaties op, maar ontstaat er een aantal vaste configuraties. Deze configuraties

worden gekenmerkt door hun centrale coördinatiemechanisme. Zo wordt het gebruik van informatietechnologie gezien als contingent op het ontstaan van een netwerk – één van de configuraties. Het perspectief voor transformatie vanuit contingentietheorie brengt dan ook eerst de veranderingen in de organisatie in kaart voordat er wordt gekeken welke factoren tot deze veranderingen hebben geleid.

Structuratietheorie gaat er vanuit dat zaken voortkomen uit de wederzijdse beïnvloeding van structuur en mensen. Dit wil zeggen dat de wederzijdse beïnvloeding van bestaande praktijken en ideeën ('instituties') en menselijk ingrijpen leidt tot bepaalde uitkomsten. Deze wederzijdse beïnvloeding wordt inzichtelijk gemaakt aan de hand van normen, interpretatieve schema's en bronnen. Structuratie via IT gebeurt aan de ene kant doordat bestaande instituties ingebakken worden in de technologie tijdens de fasen van ontwerp en ontwikkeling. Aan de andere kant beïnvloedt het gebruik van de technologie door mensen ook de uitkomsten van het gebruik. Structuratie vindt plaats via drie dimensies: significantie, wanneer betekenis wordt gegeven aan een bepaalde praktijk, dominantie, wanneer controles worden uitgevoerd die afwijkend gedrag bestraffen, en appropriatie, dat inzicht geeft in het waarheidsgetrouwe gebruik van technologie. Deze drie dimensies worden gebruikt om gedurende het transformatieproces te bepalen welke krachten van invloed zijn geweest op de uitkomsten van dit proces.

Transformatie in de praktijk: SBR en Omgevingsvergunning cases

Om transformatie te onderzoeken in de praktijk is gebruik gemaakt van twee cases. De eerste is Standard Business Reporting (SBR), dat financiële rapportages van bedrijven aan de overheid standaardiseert. Deze standaardisatie vindt plaats via de invoering van een gegevensstandaard (eXtensible Business Reporting Language, XBRL), een taxonomie (NT) en een procesinfrastructuur (DigiPoort). Vanuit de overheid zijn de Belastingdienst, de Kamers van Koophandel, en het Centraal Bureau voor de Statistiek (CBS) betrokken. SBR beoogt de administratieve lasten van bedrijven te verlagen en de controle van overheden op de financiële rapportages te verbeteren door informatiestromen binnen de keten te standaardiseren. De tweede casus is de Omgevingsvergunning. Dit is een overkoepelende vergunning waarin vijftientig vergunningen voor de gebouwde omgeving zijn verenigd. Deze kunnen in een keer worden aangevraagd via een portal (de OLO), ook al worden de vergunningaanvragen behandeld bij verschillende overheden (gemeenten, provincies en het Ministerie van I&M). Beide cases hebben als doel transformatie te realiseren.

In beide cases worden uitkomsten gerealiseerd die gericht zijn op het creëren van publieke waarde, geïntegreerde dienstverlening, en samenwerking in netwerken. Eén doelstelling van transformatie wordt echter niet behaald: publieke verantwoording. Daarnaast kan ook niet worden geconcludeerd dat er sprake is van daadwerkelijke transformatie richting een netwerkstructuur van de overheid, omdat de verantwoordingsstromen nog steeds resulteren in een hiërarchische organisatiestructuur. De transformatiemechanismen worden in beide cases ingezet, maar leiden tot verschillende uitkomsten. Hoewel er in beide cases gebruik wordt gemaakt van governance en van architectuur om coördinatie van activiteiten te realiseren, zijn de cases in twee verschillende fasen van transformatie. In het SBR programma is er sprake van het herontwerpen van bedrijfsprocessen, terwijl de Omgevingsvergunning zich bezig houdt met het formeren van dienstverleningsketens.

Uit de cases bleek verder dat transformatie niet plaatsvindt zonder wetswijzigingen. Vanwege de veranderingen die nodig zijn in verticale processen, is het noodzakelijk dat

deze worden aangepast. Ten slotte is gevonden dat de rol van governance centraal staat in de transformatie. De invoering van governance die veranderingen in de samenwerking tussen organisaties bewerkstelligt, is belangrijker dan de realisatie van echte transformatie richting een netwerkorganisatie. Hoewel er dus geen echte transformatie wordt gevonden in de cases, wordt de aanzet ervan wel gezien in de SBR casus, maar niet in de Omgevingsvergunning.

Door gebruik te maken van het perspectief gebaseerd op contingentietheorie, wordt bevestigd dat IT contingent is op de organisatiestructuur, en dus op de transformatie die plaatsvindt. Deze verandering leidt tot een verandering in het centrale coördinatiemechanisme in de SBR casus: van standaardisatie van uitkomsten naar standaardisatie van vaardigheden. Daardoor veranderen ook andere aspecten van de organisatie, zoals de invoering van decentrale besluitvorming en de professionalisering van ambtenaren.

Door gebruik te maken van het perspectief gebaseerd op structuratietheorie kan worden geconcludeerd dat het gebruik van technologie verschilt tussen organisaties. Dit komt doordat het wordt beïnvloed door de normen en doelstellingen van een organisatie. Wanneer deze verschillen, leidt dit ook tot verschillen in het gebruik van IT. Daarnaast vindt door de macht die de overheid tijdens het transformatieproces uitvoert een toenemende focus op controle plaats. In plaats van dat transformatie ten goede komt aan de dienstverlening voor burgers en bedrijven, gebruiken overheden transformatie vaak om hun eigen rol te versterken en nieuwe controlemechanismen in te voeren die ervoor moeten zorgen dat de handhaving verbetert. Dit kan worden gezien als oneigenlijke appropriatie van de technologie.

Transformatie in de praktijk: Nederlandse gemeenten

Om te onderzoeken of transformatie daadwerkelijk plaatsvindt op een bredere schaal binnen de Nederlandse overheid, is een tweede empirisch onderzoek uitgevoerd naar de stand van elektronische dienstverlening en transformatie bij Nederlandse gemeenten. De keuze voor gemeenten is om drie redenen gemaakt. Ten eerste worden gemeenten gezien als minder innovatieve organisaties. Als veranderingen hebben plaatsgevonden in gemeenten, dan geeft dit goed inzicht in of transformatie daadwerkelijk plaatsvindt in de publieke sector. Ten tweede zijn gemeenten aangewezen als 'one-stop-shop' voor alle dienstverlening van de overheid. Ten derde is het nodig voor het maken van generalisaties dat een steekproef wordt gedaan die groot genoeg is voor een kwantitatieve analyse. Aangezien er niet veel soorten overheidsorganisaties zijn waarvan er zoveel zijn, ligt de keuze voor gemeenten voor de hand. De afgelopen jaren is een groot aantal verschillende e-government ontwikkelingen op gemeenten afgekomen die als doel hebben betere dienstverlening te realiseren. Daarom kan worden geconstateerd dat gemeenten transformatie nastreven teneinde al deze ontwikkelingen te implementeren.

Negentig gemeenten zijn bevestigd door per gemeente een aantal betrokkenen een vragenlijst te sturen met daarin vragen over de stand van elektronische dienstverlening en de veranderingen in de organisatie. De vragenlijst gaat over de doelstellingen van transformatie en over de verandermechanismen. Ook is een aantal vragen opgenomen dat gaat over mogelijke factoren die transformatie beïnvloeden. Deze vragen zijn gesteld aan medewerkers van de gemeenten, en aan een consultant die is ingehuurd door de gemeenten (betaald door de centrale overheid) om ze te helpen met de ontwikkeling en implementatie van elektronische dienstverlening. Daarnaast zijn ook de scores van twee nationale e-government benchmarks meegenomen.

Op basis van de kwantitatieve analyses die zijn gedaan op de gegevens die zijn verzameld met behulp van de vragenlijst, kan niet worden geconcludeerd dat er transformatie plaatsvindt. Wel werden correlaties gevonden tussen de technische en procesmatige verandermechanismen (met name de formatie van ketens) en scores van dienstverlening. Dit geeft aan dat hoewel gemeenten transformatie als doelstelling hebben, ze nog vooral bezig lijken te zijn met de invoering van de technische mogelijkheden. Ze zijn dus nog voornamelijk bezig met het implementeren van de infrastructuur en het digitaliseren van de huidige bedrijfsprocessen.

Conclusies

Dit onderzoek concludeert dat transformatie niet gaat over 'transformatie-als-product' of 'transformatie-als-proces', maar over 'transformatie-als-doelstelling'. Transformatie leidt dus niet daadwerkelijk tot een andere organisatiestructuur, maar er sprake is van de doelstelling tot transformatie, die zorgt voor verandering in de publieke sector. Daarnaast gaat transformatie over het inrichten van een nieuwe manier van samenwerking tussen organisaties binnen netwerken. Het gaat dus over het inrichten van governance. Daarbij leidt transformatie tot het inrichten van decentrale besluitvorming en toenemende professionalisering van ambtenaren. Hoewel de mechanische veranderingen dus niet leiden tot een herinrichting van de publieke sector – zoals werd verwacht, leiden ze wel tot een andere inrichting van coördinatie van processen binnen de overheid.

Een derde bevinding is dat transformatie altijd gepaard gaat met een wetswijziging. Zonder wetswijziging geen transformatie, maar deze zorgt er ook voor dat er nieuwe verkokering ontstaat. Een vierde conclusie is dat de invoering van t-government sterk verschilt tussen organisaties. Dit is het gevolg van het gebruik van informatietechnologie op een manier die past bij de normen en doelstellingen in de verschillende organisaties. Ten slotte is gevonden dat hoewel t-government doorgaans als doel heeft de dienstverlening aan burgers en bedrijven te verbeteren, IT-geïnduceerde transformatie in de praktijk juist de positie van de overheid versterkt, bijvoorbeeld door betere handhaving te realiseren. Vervolgonderzoek zou zich moeten richten op hoe de verschillende uitkomsten van dit onderzoek zich tot elkaar verhouden, zoals de invloed van wetswijzigingen en de veranderingen in het centrale coördinatiemechanisme.

Publications by the author

2012

Veenstra, A.F. van, Aagesen, G., Janssen, M. and Krogstie, J. (2012) "Infrastructures for public service delivery: Aligning IT governance and architecture in infrastructure development", *e-Service Journal*, forthcoming.

Veenstra, A.F. van, and Janssen, M. (2012) "Policy Implications of Top-down and Bottom-up Patterns of E-Government Infrastructure Development". In: Egyedi T.M. and Mehos, D.C. (eds.) *Inverse Infrastructures: Disrupting Networks from Below*, Cheltenham, UK: Edward Elger, pp. 223-236.

2011

Veenstra, A.F. van, and Janssen, M. (2011) "Architectural principles for orchestration of cross-organizational service delivery". In: Assar, S., Boughzala, I., and Boydens, I. (eds.) *Practical Studies in e-Government: Best Practices from Around the World*, New York: Springer, pp. 167-185.

Veenstra, A.F. van, Klievink, B. and Janssen, M. (2011) "Barriers and Impediments to Transformational Government: Insights from literature and practice", *Electronic Government, An International Journal*, vol. 8, nos. 2/3, pp. 226-241.

Veenstra, A.F. van, and Janssen, M. (2011) "Migration Strategies for Multi-channel Service Provisioning in Public Agencies", In: Worrall, L. (ed.) *Leading Issues in e-Government Research*, Reading, UK: Academic Publishing International, pp. 123-146.

Aagesen, G., Veenstra, A.F. van, Janssen, M. and Krogstie, J. (2011) "The Entanglement of Enterprise Architecture and IT-Governance: The Cases of Norway and the Netherlands". In: *Proceedings of the 44th Hawaii International Conference on System Sciences (HICSS-44)*, 4-7 January, Kauai, Hawaii.

Veenstra, A.F. van, and Ramilli, M. (2011) "Exploring Information Security Issues in Public Sector Inter-Organizational Collaboration". In: Janssen, M., Scholl, H.J., Wimmer, M.A. and Tan, Y.-H. (eds.), *LNCS 6846 10th IFIP WG 8.5 International Conference, EGOV 2011*, Heidelberg: Springer, pp. 355-366.

Veenstra, A.F. van, Janssen, M., and Boon, A. (2011) "Measure to Improve: a Study of eParticipation in Frontrunner Dutch Municipalities". In: Tambouris, E., Macintosh, A. and Bruijn, J.A. de (eds.), *LNCS 6847 3rd IFIP WG 8.5 International Conference, EPart 2011*, Heidelberg: Springer, pp. 157-168.

Janssen, M., Winne, N. de, Wijk, R. van, Voort, H. van der, Veenstra, A.F.E. van, Hulstijn, J., and Bharosa, N. (2011) "Exploring Public-Private Information Exchange: An XBRL-based Infrastructure for the Exchange of Financial Information". In: *Proceedings of the Transforming Government Workshop (tGov 2011)*, 17-18 March, London, UK.

Maheshwari, D., Veenstra, A.F. van, and Janssen, M. (2011) "Challenges to the Design and Use of Stages-of-Growth Models in E-government", paper presented at the *11th European Conference on E-Government*, Faculty of Administration, University of Ljubljana, Slovenia, 16-17 June.

Maheshwari, D., Veenstra, A.F. van, and Janssen, M. (2011) "Developing Measures for Benchmarking the Interoperability of Public Organizations", paper presented at the *11th European Conference on E-Government*, Faculty of Administration, University of Ljubljana, Slovenia, 16-17 June.

Maheshwari, D., Janssen, M. and Veenstra, A.F. van (2001) "A Multi-level Framework for Measuring and Benchmarking Public Service Organizations: Connecting Stages-of-growth Models and Enterprise Architecture", paper presented at the *5th International Conference on Theory and Practice of Electronic Governance (ICEGOV2011)*, Tallinn, Estonia, 26-28 September.

2010

Veenstra, A.F. van, and Janssen, M. (2010) "Migration Strategies for Multi-channel Service Provisioning in Public Agencies", *The Electronic Journal of e-Government*, vol. 8, no. 2, pp. 215-226.

Veenstra, A.F. van, Janssen, M. and Tan, Y.-H. (2010) "Towards an Understanding of E-Government Induced Change – Drawing on Organization and Structuration Theories". In: Wimmer, M.A., Chappelet, J.-L., Janssen, M. and Scholl, H.J. (eds.), *LNCS 6228, 9th IFIP WG 8.5 International Conference, EGOV 2010*, Heidelberg: Springer, pp. 1-12. (Nominated for best paper award.)

Bharosa, N., Janssen, M., Klievink, B., Veenstra, A.F. van, and Overbeek, S. (2010) "Guiding integrated service delivery: synthesizing and embedding principles using role-playing games", *The Electronic Journal of e-Government*, vol. 8, no. 2, pp. 83-92.

Hennigsson, S. and Veenstra, A.F. van (2010) "Barriers to IT-driven transformation", paper presented at *The 18th European Conference of Information Systems*, Pretoria, South Africa, 6-9 June.

Veenstra, A.F. van, and Janssen, M. (2010) "Strategies for Migration to Multi-channel Service Provisioning in Public Agencies", paper presented at the *10th European Conference on E-Government*, National Centre for Taxation Studies, University of Limerick, Ireland, 17-18 June.

Bajnath, S.S., Janssen, M., Bharosa, N., Both, C., Klievink, B., Overbeek, S. and Veenstra, A.F. van (2010) "Service Delivery Principles: Deriving Principles Using a Role-Playing Game", paper presented at the *10th European Conference on E-Government*, National Centre for Taxation Studies, University of Limerick, Ireland, 17-18 June.

Veenstra, A.F. van, en Janssen, M. (2010) "Door orkestratie minder administratieve lasten" *Proces en Document*, no. 2, p. 45.

2009

Veenstra, A.F. van, Janssen M. and Klievink, B. (2009) "Strategies for Orchestrating and Managing Supply Chains in Public Service Networks", *The Electronic Journal of e-Government*, vol. 7, no. 4, pp. 425-42.

Veenstra, A.F. van, and Zuurmond, A. (2009) "Opening the Black Box: Exploring the Effect of Transformation on Online Service Delivery in Local Governments". In: M.A. Wimmer et al. (eds.), *LNCS 5693, 8th International Conference EGOV 2009*, Springer, Berlin/Heidelberg, pp. 234-244.

Veenstra, A.F. van, Klievink, B. and Janssen, M. (2009) "Barriers for Transformation: Impediments for Transforming the Public Sector Through e-Government", paper presented at *The 17th European Conference of Information Systems*, Verona, Italy, 8-10 June.

Veenstra, A.F. van, Janssen, M. and Klievink, B. (2009) "Strategies for Integrated Service Delivery and Supply Chain Management", paper presented at the *9th European Conference on E-Government*, Westminster Business School, University of Westminster, London, UK, 29-30 June.

Klievink, B., Veenstra, A.F. van, and Janssen, M. (2009) "Failure to transform: the gap in e-government stage models", paper presented at the *9th European Conference on E-Government*, Westminster Business School, University of Westminster, London, UK, 29-30 June.

2005-2008

Veenstra, A.F. van, Janssen, M. and Zuurmond, A. (2008) "Realizing Transformation in Municipalities: Factors Influencing Success", In: E. Ferro et al. (eds.) *7th International Conference EGOV 2008*, Trauner Verlag 27, Linz, Austria, pp. 3-9.

Janssen, M., Kars, M. and Veenstra, A.F. van (2007) "Integrating information architecture and process management: experiences from the development of a digital safe by the Dutch Inland Revenue Service", *International Journal of Technology, Policy and Management*, vol. 7, no. 4, pp. 378-395.

Janssen, M. and Veenstra, A.F. van (2005) "Stages of Growth in e-Government: An Architectural Approach", *The Electronic Journal of e-Government*, vol. 3, no. 4, pp. 193-200.

Janssen, M. and Veenstra, A.F. van (2005) "Towards Integrated Government: A five stage architecture model", paper presented at the *5th European Conference on E-Government*, University of Antwerp, Belgium, 16-17 June.

Research reports

Veenstra, A.F. van, en Janssen, M. (2012) "Publieke waarde van keteninformatisering". *Ministerie van Binnenlandse Zaken en Koninkrijksrelaties*, Den Haag.

Janssen, M., Veenstra, A.F. van, Groenleer, M., Voort, H. van der, Bruijn, J.A. de, en Bastiaanse, C. (2010) "*Uit het zicht: Beleidsmaatregelen voor het versnellen van het gebruik van ICT-toepassingen voor administratieve lastenverlichting*". *Adviescollege Toetsing Administratieve Lasten*, Den Haag.

Veenstra, A.F. van, en Zuurmond, A. (2010) "Transformatie van gemeenten: een kwantitatief onderzoek rondom de Ketensimulaties". *Alliantie Vitaal Bestuur*, Den Haag.

Veenstra, A.F. van, en Janssen, M. (2009) "Migratiestrategieën voor multi-kanalen strategie". *Novay*, Enschede.

Veenstra, A.F. van, en Janssen, M. (2009) "Orchestratie van Ketens: Techniek, bestuur en organisatie". *Alliantie Vitaal Bestuur*, Den Haag.

Curriculum Vitae

Anne Fleur van Veenstra was born on July 15, 1981 in Haarlem. After she obtained her gymnasium diploma from the Revius Lyceum in Doorn in 1999 she studied Systems Engineering, Policy Analysis and Management at Delft University of Technology. During her studies she spent a semester at the Politecnico di Milano in Milan, Italy, studying Management Engineering. She interned at Indutech, an IT consultancy in Stellenbosch, South Africa and was invited for the IBM Top EMEA Student Recognition Event in La Gaude (Nice), France, in 2004. She graduated in 2005, having written a Masters' thesis on the introduction of a personalized citizens' portal for tax declaration during an internship at *De Belastingdienst* (Inland Revenue). In 2006 she obtained a Masters in International Relations at the University of Amsterdam, graduating cum laude. Subsequently, she was a participant in the Japan Prizewinners Program 2006-2007. This program consists of a six-month full-time course of Japanese language and culture at Leiden University and the Japan-Nederland Institute, and an internship in a Japanese organization. For five months she interned at the Institute of Energy Economics Japan (IEEJ) in Tokyo.

Anne Fleur became associated researcher at the ICT section of the Technology, Policy and Management department of Delft University of Technology in 2007. Besides working on her dissertation, she carried out several research projects on governmental IT-projects, including a study into the acceleration of the administrative burden reduction of IT-projects for Actal, the Dutch board for administrative burden reduction, a quantitative study into electronic services delivery in Dutch Municipalities, and a study into measuring the public value of chains of information systems for the Ministry of the Interior. She published over twenty-five scientific papers, supervised several Master thesis projects and taught on evaluation and benchmarking of Enterprise Architecture. In 2010 she acted as junior faculty of the iGov research institute. Besides working as a researcher, Anne Fleur also worked as a freelance journalist since 2005, writing about IT-projects in government organizations for Computable. Since 2012 she works as a researcher and consultant at TNO on projects in the field of privacy, e-government and open data. She is an alumnus and former board member of the Route66 trainee program of D66.