

Document Version

Final published version

Licence

CC BY

Citation (APA)

Gutiérrez Martínez, J., Bezner, M., Molenkamp, A., van den Bos, J., Hofland, B., Leblanc, P., Rella, A., Rosenberg, Y., & Sella, I. (2023). Physical Evaluation Of The Hydrodynamic Stability Of An Eco-engineered Armouring Unit. In D. Cox (Ed.), *Coastal Engineering 2022: Proceedings of 37th International Conference* (Vol. 37). (Proceedings of the Coastal Engineering Conference; No. 37). American Society of Civil Engineers (ASCE).
<https://doi.org/10.9753/icce.v37.papers.35>

Important note

To cite this publication, please use the final published version (if applicable).
Please check the document version above.

Copyright

In case the licence states “Dutch Copyright Act (Article 25fa)”, this publication was made available Green Open Access via the TU Delft Institutional Repository pursuant to Dutch Copyright Act (Article 25fa, the Taverne amendment). This provision does not affect copyright ownership.
Unless copyright is transferred by contract or statute, it remains with the copyright holder.

Sharing and reuse

Other than for strictly personal use, it is not permitted to download, forward or distribute the text or part of it, without the consent of the author(s) and/or copyright holder(s), unless the work is under an open content license such as Creative Commons.

Takedown policy

Please contact us and provide details if you believe this document breaches copyrights.
We will remove access to the work immediately and investigate your claim.

PHYSICAL EVALUATION OF THE HYDRODYNAMIC STABILITY OF AN ECO-ENGINEERED ARMOURING UNIT

Jorge Gutiérrez Martínez¹, Maor Bezner¹, Auke Molenkamp², Jeroen v.d. Bos^{2,3}, Bas Hofland², Philippe Leblanc¹, Andrew Rella¹, Yaeli Rosenberg¹, Ido Sella¹

ECONcrete®'s Coastalock is an ecologically designed armour unit, providing an alternative and/or a complement to traditional armour layers with ecologically enhanced armouring that provides shoreline stabilization, while also creating well-defined local ecosystems that mimic natural rock pools. The 2D physical model tests performed at TU Delft focused on the stability, reflection and overtopping of a slope with regularly placed single layer Coastalock armour. The 2V:3H slope had an impermeable core, no wave breaking on the foreshore and no rock toe. The stability was seen to double, with stability number N_s ($N_s = H_s/\Delta D_{n50}$) increasing from roughly 2 to 4 and above, by increasing the porosity between the blocks from spacing the units from 0% to 25%. So less concrete use led to more stability. The mean overtopping discharge could be characterized by a roughness factor of $\gamma_f = 0.610$ (for 25% spacing). A key goal of the Coastalock development is to demonstrate that with the use of innovative eco-engineered armour unit design it is now possible to add ecological considerations into the design process to promote biodiversity and provide ecosystem services, achieving both structural and ecological goals.

Keywords: Nature Inclusive Design (NID), biodiversity, marine habitat, ecological engineering, coastal protection, bioenhancing concrete, single layer armour unit, physical modelling

INTRODUCTION

With the increase in population in coastal areas and climate change, the degree of armoring and hard solutions is on the rise and is expected to continue to increase as a result of expanding coastal populations and growing threats from climate change, storm surges, and sea level rise (Creel, 2003). Coastal and marine infrastructures (CMI) should be designed in such a way as to prevent and minimize the consequences due to global warming and sea level rise. Similarly, such infrastructures should also be designed following criteria that help to address Blue Economy priorities to improve water quality, promote biodiversity, and protect and restore local marine ecosystems. Biodiversity is fundamental for well-functioning marine ecosystems that provide essential services and benefits to human societies. In recent years, there has been a growing interest by diverse stakeholders to integrate nature-based structural solutions into the designs of CMI projects (De Vriend et al., 2014; King et al., 2021; Sella et al., 2022). By implementing science based, cost effective and scalable design enhancements that are in accordance with the principles of ecological engineering it is possible to modify the design of CMI to encourage the increased growth of native organisms, as well as greater species richness (Perkol-Finkel and Sella, 2014). These ecologically engineering design approaches and the use of innovative technologies and materials have been proven not only to provide significant ecological advantages over traditionally engineered CMI, but also valuable structural advantages, contributing to a structure's strength, stability, and lifespan (Perkol-Finkel and Sella, 2015).

ECOLOGICAL ENGINEERING DESIGN

The Coastalock is the first fully structural and ecologically engineered armour unit for coastal protection designed to offer an alternative and/or to complement traditional armour layers with limited value to marine ecosystems. The Coastalock comprehensive ecologically engineering design was a result of the work of a multidisciplinary team of marine biologists, industrial designers, and coastal engineers, which materialized into an interlocking, multidirectional, water retaining single layer armour concrete unit with regular ordered placement, (Figure 1) whose inaugural installation took place at the Port of San Diego (PoSD), USA in spring of 2021 (Figure 2).

The primary objective of the Coastalock design was to offer an ecologically enhanced armouring unit which can simultaneously provide shoreline stabilization, while also creating well-defined local ecosystems that mimic natural rock pools and other important ecological niches.

¹ ECONcrete Tech LTD, 8 Tversky St, Tel Aviv, 67210, Israel

² Hydraulic Engineering laboratory, TU Delft, Stevinweg 1, 2628 CN, Delft, The Netherlands

³ Royal Boskalis Westminster N.V., TU Delft, Gantelweg 10, 3356 LA, Papendrecht, The Netherlands



Figure 1. Coastallock Nature Inclusive Design



Figure 2. Inaugural deployment of Coastallock unit at the Port of San Diego (PoSD)

Each Coastallock armour unit is manufactured using bio-enhancing technologies which were developed and scientifically validated through multiple applied research projects by ECONcrete (Perkol-Finkel and Sella, 2014, 2015). The core elements of the technology are a suite of science-based bio-enhancing concrete admixtures, complex surface textures, and nature-inclusive designs that act in synergy to increase the ecological value and reduce the environmental footprint of coastal and marine infrastructure. The combination of these three core elements has proved to achieve optimal results when applied to fully structural solutions (Perkol-Finkel and Sella, 2015). In addition, the adherence of marine organisms generates an extra layer of protection to the concrete, called bio-protection, which helps to protect and increase the longevity of the structures (Coombes et al., 2017, Sella and Perkol-Finkel, 2015). The result is the enhancement of CMI by encouraging the development of healthy marine ecosystems, while preserving all functional and structural properties.



Figure 3. Graphic representation of multiple orientations of the Coastallock unit to optimize ecological functionality

PHYSICAL MODEL TESTS

Within the development of the Coastalock armour unit, 2D physical model tests were performed with the aim of investigating the stability potential of the Coastalock units on sloping structures when applied as single layer armour protection. A test programme was executed in the Hydraulic Engineering Laboratory at TU Delft to evaluate the performance of the Coastalock units against different wave action and define the hydraulic stability parameters for optimization and future specification. The testing program included constructing and analyzing the hydraulic stability of different armour layer configurations, with varying unit orientations, on a sloped structure exposed to irregular wave action while observing the associated overtopping and reflection.

Model Composition

The tests were performed with a constant water depth of 0.60m in a 42m long wave flume. A straight section of a sloped structure was placed at 23.25m distance from the wave generator. Considering the maximum producible wave height $H_s=18\text{cm}$ and the aim to assess damages at the structure, the model was scaled at 1/37.5. The slope was built with a standard 2V:3H steepness with an impermeable core and in deep water conditions (no toe protection was built nor assessed). A wooden structure was used to build the slope on top of which small gravel ($d=2\text{mm}$) was glued to provide roughness to prevent sliding down of the underlayer. The wooden structure finished at the lower extent of the armour with a step to hold the under layer and armour layer in place.

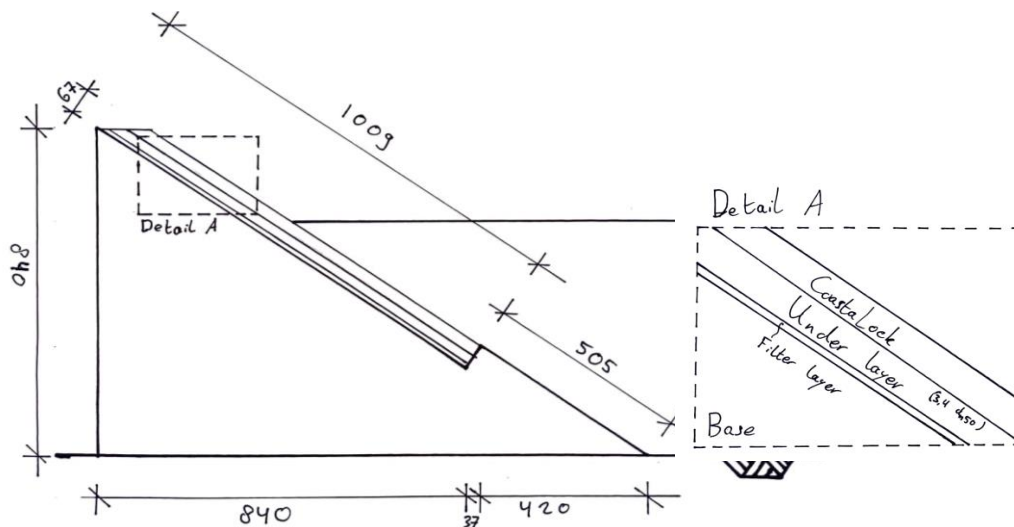

Figure 4. Cross section of the tested slope. Dimensions in mm (Molenkamp 2022)

A single layer of Coastalock armour units was placed in a regular placement pattern on top of the 8.34 mm gravel underlayer. A total of approximately 900 Coastalock armour units (3cm height) were locally produced for the construction of the armour layer. Since the model tests were run using fresh water, the units were produced with a cement paste with some additions of steel to achieve the correct density. The resulting density of the model units was $2,299.44 \text{ kg/m}^3$ with a relative density, Δ of 1.30. This resulted in a 2.25% lower relative density than the ideal relative density of $\Delta=1.33$ (concrete density of $2,400 \text{ kg/m}^3$ and seawater density of $1,030 \text{ kg/m}^3$ considered), providing a slightly conservative approach. The bottom level of the armour layer was placed at $2 H_{s,\text{max}}$ below the water level because the maximum wave attack vertical line was determined at $2 H_{s,\text{max}}$ below and above the water line at large water depth conditions (Schierck and Verhagen 2019). The crest level was placed at $1.5 H_s$ to simulate a realistic application of the armour units. The coastal layer simply was placed up to the required crest level. Behind this the first under layer material was shaped to form a horizontal crest that connected well to the units. To measure the waves and assess the results of the tests, two arrays with three wave gauges were placed along the flume; one in offshore conditions, one in front of the structure, and one additional gauge was placed at the back of the structure inside a bucket that collected the overtopped water to measure the water level of the overtopping. For visual assessment, apart from the visual observations during the tests series, two photo/video cameras were placed; one looking down at the structure and another one at the side of the structure.

Placement of the armour layer

The Coastallock armour units are designed to be placed in multiple orientations to provide several ecological niches and a favorable environment in which marine flora and fauna communities can thrive, increasing biodiversity. When the cavity is facing forwards/upwards a water-retaining element is created, when the cavity is facing sideways a cave is created, and when the cavity is facing downwards an overhang is created (Figure 5). Therefore, several configurations of armour layer could be produced for the physical evaluation.

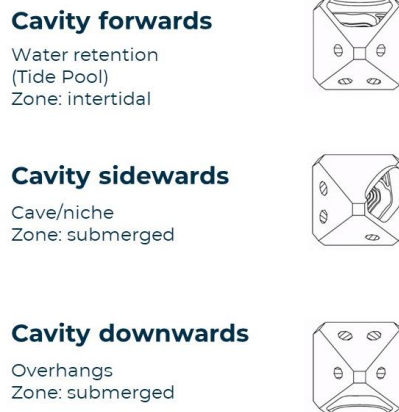

Figure 5. Coastallock orientations and associated areas of application on the slope for habitat creation

Based on ecological and operational reasons as well as the lessons learned from the pilot project at the PoSD three different Coastallock armour configurations were selected (Figure 6). These resulting configurations were named: San Diego (SD), Cavity forwards(CF) and Cavity sideways(CS). Cavity downwards might decrease stability if filled with air, so it was not preferred.

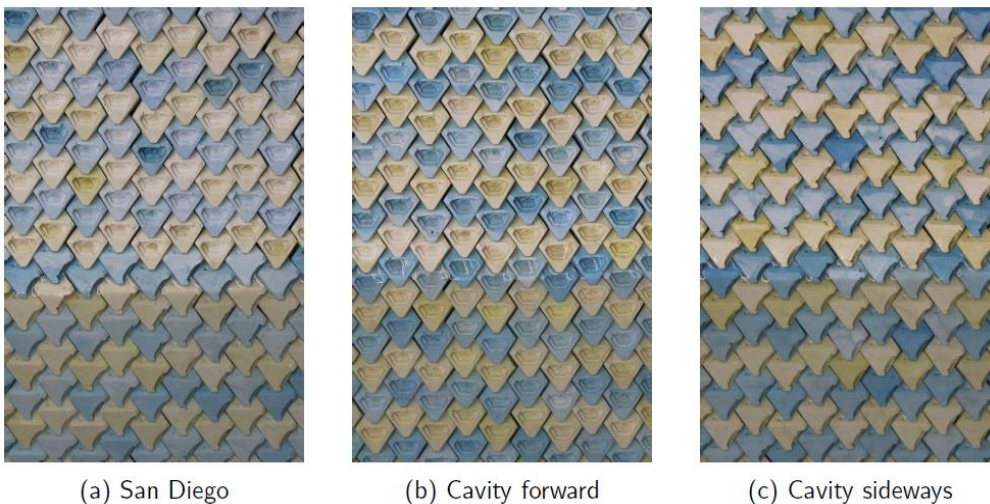

Figure 6. Configurations of the Coastallock armour layer used in the tests with multiple orientations of the units (Molenkamp 2022)

The standard configuration (SD) consisted of a combination of orientations in which the units below the water line are placed with the cavity sideways and the units above the water level are placed with the cavity forwards (Figure 7). In prototype, the units with the cavity forward are placed at the intertidal area to retain water at low tide, creating tidepools and the units with the cavity sideways are placed at the submerged area to create caves.

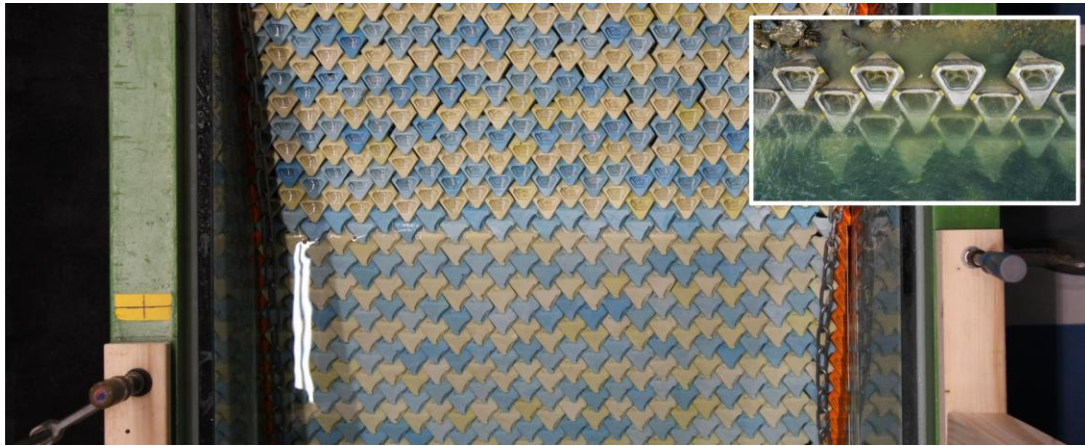

Figure 7. Standard Configuration (SD) (Molenkamp 2022) and, top right, the prototype installation in PoSD

In the standard placement (SD) all the units are placed tightly packed. During the tests, to assess the influence of the porosity of the armour on the hydraulic stability, reflection and overtopping, all the configurations were evaluated by increasing horizontally the distances between the units (Figure 8).

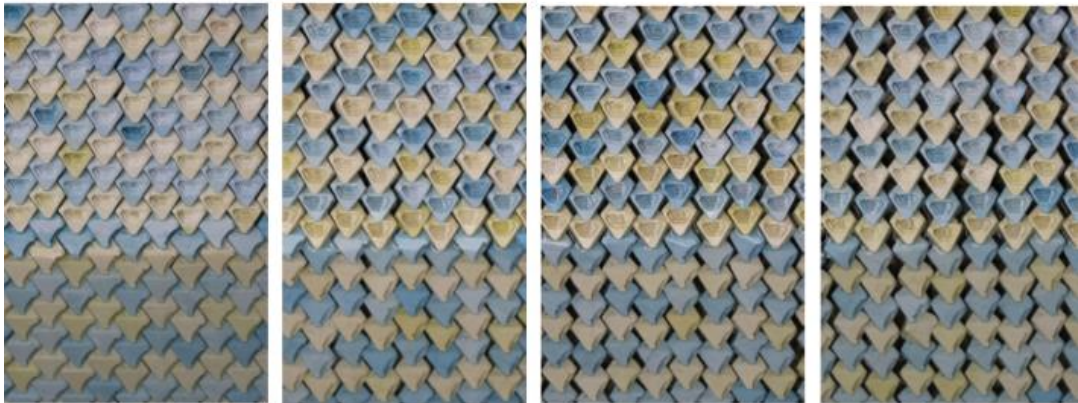

Figure 8. Increased spacing between the units used in the tests. From left to right: 0% spacing, 10% spacing, 15% spacing and 20% spacing (Molenkamp 2022)

Tests

The tests performed consisted of testing the three different Coastalock configurations with a total of 24 test series (Table 1) with multiple runs of perpendicular wave attack with irregular waves. A total of 1,200 waves were produced per test run, except for the first run of each series that consisted of 500 waves to settle the armour layer. The varying tests runs were produced at 60%, 80%, 100% and 120% of the design H_s . The wave spectrum chosen for the tests was JONSWAP with a peak enhancement factor γ of 3.3. The design H_s was selected at 10cm based on an initial estimate of the stability number of $H_s/\Delta D_{n50} = 2.6$, the depth of the flume, the maximum wave height that can be produced and the aim of assessing damage on the armour layer. The parameters that were changed during the test series were the wave steepness (varying it from $s_{op} = 2\%$ to 6% with increments of 1%), the underlayer thickness (varying the underlayer from $3D_{n50}$ to $2D_{n50}$), and the spacings between the armour units (porosity). The spacings between the units were obtained by increasing the horizontal distance between the units. Each of the afore described configurations of armour layer were submitted to test series, starting with the SD configuration. As per the results obtained with this configuration, the remaining test series were adapted to the other two configurations to limit the time required for performing the tests.

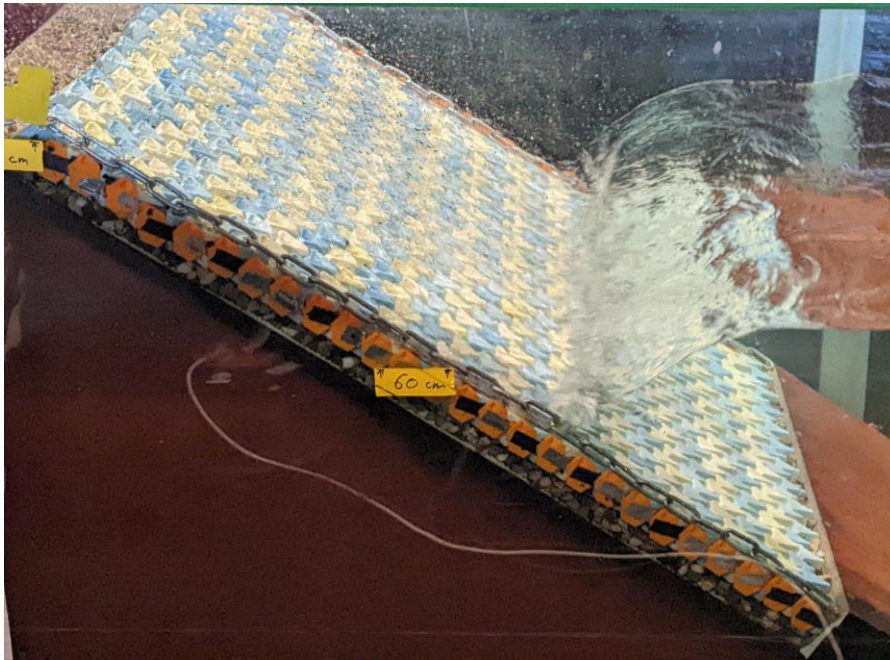

Figure 9. Side view during one of the test runs performed on a Coastallock armour slope at TU Delft

Test series	Description	Wave steepness $S_{op}[-]$	Spacing $S[A_{slope}]$	Orientation	Underlayer thickness $D_{under} [D_{n50, under}]$
1	Extra thick underlayer	0.04	0.00	San Diego	3.4
2	Extra thick underlayer	0.04	0.00	San Diego	3.4
3	No underlayer	0.04	0.00	San Diego	0
4	No underlayer	0.04	0.00	San Diego	0
5	Baseline test	0.04	0.00	San Diego	2
6	Baseline test	0.04	0.00	San Diego	2
7	Short waves	0.06	0.00	San Diego	2
8	Short waves	0.06	0.00	San Diego	2
9	Long waves	0.02	0.00	San Diego	2
10	5% spacing	0.04	0.05	San Diego	2
11	10% spacing	0.04	0.10	San Diego	2
12	10% spacing	0.04	0.10	San Diego	2
13	15% spacing	0.04	0.15	San Diego	2
14	20% spacing	0.04	0.20	San Diego	2
15	25% spacing	0.04	0.25	San Diego	2
16	Validate baseline	0.04	0.00	San Diego	2
17	Cavity sideways	0.04	0.00	Cavity sideways (right)	2
18	Sideways, 20% spacing	0.04	0.20	Cavity sideways (right)	2
19	7.5% spacing	0.04	0.075	San Diego	2
20	Cavity forwards	0.04	0.00	Cavity forwards	2
21	Forwards, 10% spacing	0.04	0.10	Cavity forwards	2
22	Medium-long waves	0.03	0.00	San Diego	2
23	Long waves, 10% spacing	0.02	0.10	San Diego	2
24	Medium-short waves	0.05	0.00	San Diego	2

Breathing and porosity of the armour

Under tight placement (below 10% spacing), a so-called breathing mechanism occurred at rather low wave heights. The mechanism is characterized by the movement of the armour layer perpendicular to the slope and the deformation of the underlayer below the armour units producing an S-concave shape. This was previously defined for a different regularly placed unit type as a failure mechanism (Van der Berg et al. 2020). This is a mechanism also seen across placed block revetments systems with low permeable cover layer. The breathing mechanism ultimately led to the extraction of the armour units, and failure of the armour once the deformation becomes too large (Figure 10).

Breathing is thought to induce the motion of underlayer material from the top of the slope to the bottom of the slope. In Figure 11 an elevation scan of the armour surface is shown. It can be seen that a permanent upward deformation of the armour layer below the water line increases after each test step. This underlayer irregularities caused by the mechanism, as previously described by v.d. Berg et al. 2020, have an important effect on the interlocking between the blocks.



Figure 10. Effect of breathing on the armour (Molenkamp 2022)

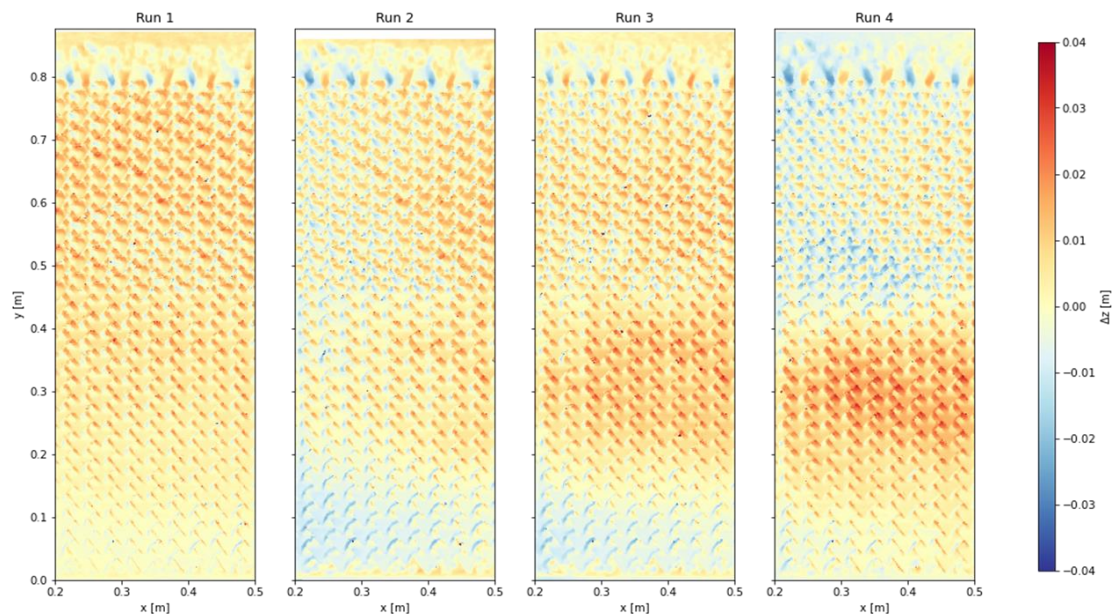

Figure 11. 3D elevation model showing the effect of "breathing" of the armour (Molenkamp 2022)

The solution identified to mitigate this mechanism that led to the failure of the armouring was to reduce the leakage length of the armour, with increasing of the porosity of the armour layer. A low permeable armour layer with tight placement increases the leakage length, being this parameter defined as the most important for the definition of the uplift pressure (Pilarczyk, 2003). The increment of porosity was made through distancing more the units, center to center of the unit, along the horizontal axis (spacing). The increase of spacing between the units, increases of porosity of the armour, resulting

in an increase of stability. Additional to that effect, it also caused a reduction of the reflection and a reduction of the overtopping rates.

Results

Regarding the hydraulic stability, the tests showed that a lower placement density provided a more stable armour layer. This was applicable to all the different armour layer configurations that were tested. Furthermore, the orientation of the units resulted in minor or no influence on the hydraulic stability of the armouring. The tests indicated that there is an impact on hydraulic stability when spacing the units 10% or above, with the stability number N_s ($N_s = H_s / \Delta D_{n50}$) increasing from roughly 2 to 4 and above. Under tight placement (below 10% spacing), the breathing mechanism occurred already around $N_s = 2$. This led to the extraction of the armour units afterwards.

With spacings between the units higher than 10%, the failure of the structure could not be reached for the maximum wave heights ($H_s = 18\text{cm}$) that could be produced in the flume.

The results showed that the stability slightly increases with the increase of the wave steepness. The two different underlayer thicknesses tested did not affect the hydraulic stability of the armour layer assuming there was one underlayer.

Regarding reflection, higher porosity resulted in less reflection and the different configurations produced slightly different results. The tests additionally showed that reflection decreases with the increase of wave steepness. The CS configuration produced slightly less reflection than the CF or the SD configuration. The different underlayer thicknesses showed minor or no influence on the reflection.

Regarding the overtopping, the different configurations produced very small differences, with the different underlayer thickness not making a recordable impact. For the configurations with spacings below 10%, the volume collected was too small to reach a conclusion. For spacings above 10% the overtopping discharges were reduced while increasing the porosity. A roughness factor of $\gamma_f, CL = 0.610$ was obtained (EurOtop 2018) for 25% spacing.

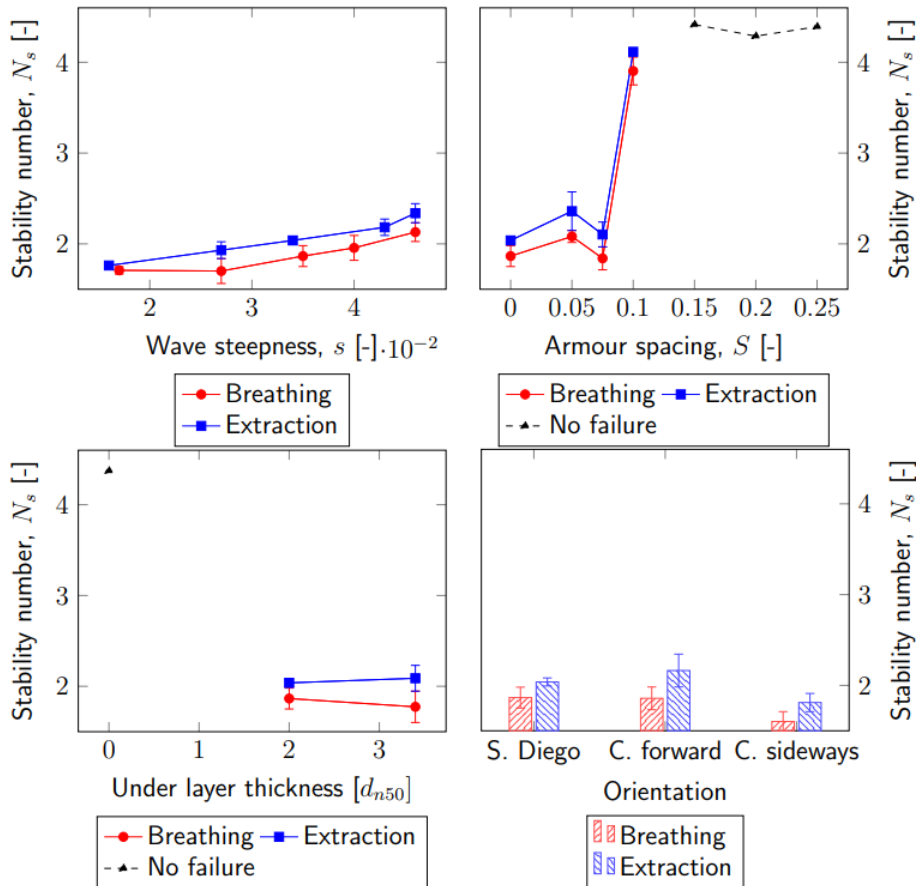

Figure 12 –Results of the hydraulic stability with (unless stated otherwise) 0% spacing, $s=0.035$ underlayer thickness $2D_{n50}$ and SD configuration. The dashed line labeled as “No failure” was limited by the maximum wave height H_s achieved in the flume (Molenkamp 2022)

PILOT PROJECT

As part of the development of the Coastalock to fully validate the operational and ecological application of the innovative armouring Coastalock units at a full scale, EConcrete in partnership with the PoSD developed a full-scale pilot project under the PoSD Blue Incubator Program. The main objective of the pilot project, was to provide an ecologically improved armour unit for shoreline stabilization and to encourage the development of local ecosystems by imitating the natural rock pools that are so often seen on the coastline.

The existing revetment protection at PoSD was built in the 1950's and information on its design and construction was limited. From the available information, it was possible to obtain that the design included a riprap armour protection of mixed material with approximate sizes of 60-300kg (and smaller), and a filter layer of crushed rock of approximately 10kg on a core of finer materials. The slope of the existing revetment is between 1V to 1.2H-1.5H. The crest is located approximately at +4.70m NGVD88 and the depth at the toe of the structure is located at around -1.21m NGVD88. The maximum tidal range is around 1.74m.

The pilot project is composed of seventy-four Coastalock units of 3.4 tons each, across two sheltered locations of the riprap armouring protecting Harbour Island adjacent to the San Diego International Airport. Thirty-seven Coastalock units were installed at each site between February and March 2021, with water borne equipment, by means of a barge with "spuds" equipped with a large crawler crane. Replacing the existing armour rock revetment, the installation was made in four rows, where units in the upper three rows were placed as water-retaining elements to mimic natural tidepools, and the units in the lower row were rotated sideways to generate cave-like habitats (Figure 13)



Figure 13. Installation of the Coastalock armour at PoSD, California, USA

Comprehensive structural and biological monitoring was scheduled to take place for two years to compare the performance to that of the adjacent rock sections at the project site.

Biological Monitoring

Monitoring protocol was designed to compare between the Coastalock units and the control rip-rap rocks of the existing revetment. To sample the control rocks, a rope was used to mark the outer parameter of one Coastalock unit, then place the resulting circular rope on the control rocks and sample everything that falls inside the circle. In November 2021, eight months post-deployment (8MPD) the first monitoring survey was conducted. During the survey, twenty-nine invertebrates, thirteen algae species, and four fish species inhabiting the area were identified. The sessile invertebrate community was comprised of different species of bryozoans, sponges, tunicates, polychaetes, mollusks, and cnidarians, while the mobile invertebrate community was comprised of decapods and mollusks.

The Coastalock units were found to inhabit a larger number of species than the control rocks with thirty-one sessile species and ten mobile invertebrates compared to twenty-two sessile and five motile, respectively. In addition, bivalves, decapods, nudibranchs, and the gastropod *Aplysia californica* were noticed on and within the Coastalock units only. Furthermore, when examining the algal community, the control rocks, highly dominated by a red invasive alga, the *Asparagopsis armata*, inhabiting eight other algae species, and the Coastalock units presented thirteen different algae species including green, red, brown.

To date the results from the biological monitoring program of the Coastalock pilot project at the PoSD showed significant development towards a richer and more diverse community of marine organisms, compared to adjacent control rocks.

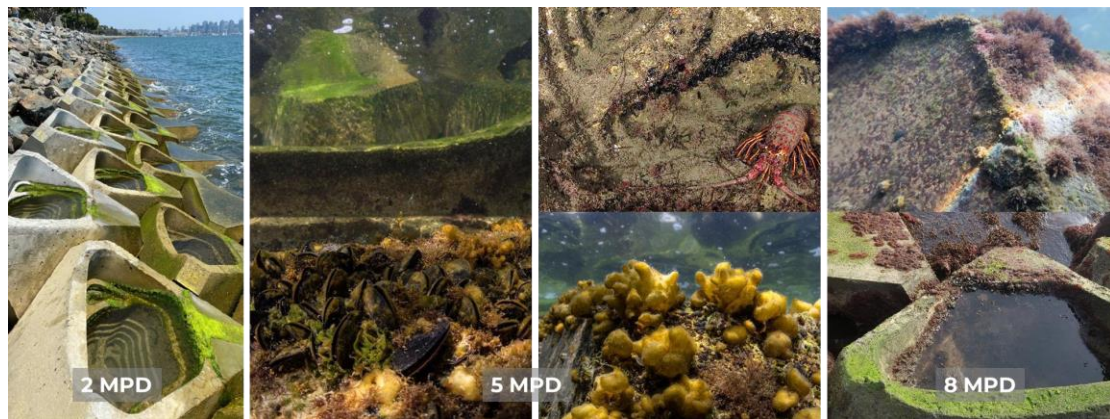

Figure 14. Biological build up on the Coastallock units at 2MPD(left) , 5MPD(center) and 8MPD (right)

FURTHER PROGRESS

The placement and or higher resolution design of the Coastallock units is to be further evaluated to achieve a higher porosity that will lead to a higher hydraulic stability. Additional 2D physical model tests are being scheduled to be performed to assess the stability of a Coastallock armour layer with a toe protection, on a permeable slope and with different underlayer gradings and slope steepness. 3D model tests are also needed for the Coastallock armour layer aimed to be placed at close bends and/or at the roundheads of sloped structures.

Biological monitoring is to be completed with the additional monitoring campaigns up to two years post deployment at PoSD. A full dedicated paper on the biological results will be published separately.

The results of the biological monitoring will also be included on evaluation of the Coastallock units regarding the placement orientations of the units on the slope, the biological growth and the porosity of the armour.

CONCLUSIONS

The physical model tests of the Coastallock aimed to provide the first results of the hydraulic performance of an armour layer entirely made of an ecologically designed armour unit. As the main parameter of influence, porosity is key to achieve optimal stability of a Coastallock armour layer as uplift pressures could lead to instability. For spacings above 10% the stability number obtained was $N_s > 4$. For spacings of 25% the calculated roughness factor was $\gamma_{f,CL} = 0.610$. A more porous armour layer will result in benefits such as a higher hydraulic stability, a reduced reflection and an improved constructability (reduced use of materials and reduced construction times: production and placement).

The continued trend of shoreline armoring over generations has led to the hardening of coastlines across the world (Airoldi et al., 2005; Nordstrom, 2014), specifically along urban coasts (Gittman et al., 2015). Artificial structures have different physical, chemical, and biological characteristics than the natural habitats they replace, often resulting in a reduction, or complete removal of intertidal and shallow subtidal ecosystems (Connell, 2000; Glasby et al., 2007).

Traditionally, hydraulic stability and structural performance have been the main drivers in the design of coastal sloped structures (Scaravaglione et al. 2022). Coastal engineers are exploring how natural processes and ecologically engineered technology can be integrated into the traditional coastal protections and designs.

The Coastallock development is aimed to provide design solutions to address not only the structural and coastal engineering requirements for shoreline protection and stabilization, but also the need to promote native marine habitats, increase biodiversity and restore local coastal ecosystems.

A key goal of the Coastallock pilot project and physical modelling is to demonstrate that with the use of innovative eco-engineered armour unit design it is now possible to add ecological considerations into the design process to promote biodiversity and provide ecosystem services, achieving both structural and ecological goals.

ACKNOWLEDGMENTS

We would like to thank EConcrete co-Founder Dr. Shimrit Perkol-Finkel (1975-2021) for her perseverance, vision, and guidance.

REFERENCES

- Airoldi et al. 2005. An ecological perspective on the deployment and design of low-crested and other hard coastal defence structures. *Coastal Engineering*, Elsevier Volume 52, 1073-1087
- Connell, S. 2000. Floating pontoons create novel habitats for subtidal epibiota, *Journal of Experimental Marine Biology and Ecology*, Volume 247, Issue 2,
- Coombes, M. et al. 2017. Cool barnacles: Do common biogenic structures enhance or retard rates of deterioration of intertidal rocks and concrete? *Science of the Total Environment*, Elsevier 580 1034-1045.
- Creel, L. 2003. Ripple effects: Population and Coastal regions. Population Reference Bureau. MEASURE Communication
- De Vriend et al. 2014. Building with nature: the new Dutch approach to coastal and river works *ICE Proceedings*. Volume 167 Issue 1, pp. 18-24;
- EurOtop (2018). Manual on wave overtopping of sea defences and related structures. An overtopping manual largely based on European research, but for worldwide application. V.d. Meer, J.W.; Allsop, N.W.H.; Bruce, T.; De Rouck, J.; Kortenhaus, A.; Pullen, T.; Schüttrumpf, H.; Troch, P. and Zanuttigh, B
- Gittman, R.K. et al. 2015. Engineering away our natural defenses: an analysis of shoreline hardening in the US. *Frontiers in Ecology and the Environment*, 13: 301-307.
- Glasby, T.M., et al. 2007. Nonindigenous biota on artificial structures: could habitat creation facilitate biological invasions?. *Marine Biology* 151, 887–895.
- King et al. 2021. Engineering with Nature: Supporting Mission Resilience and Infrastructure Value at Department of Defense Installations. ERDC.
- Molenkamp, A.. 2022. Hydraulic performance of CoastaLock armour units. MSc Thesis TU Delft..
- Nordstrom, K. 2014. Living with shore protection structures: A review, *Estuarine, Coastal and Shelf Science*. Elsevier. Volume 150, Part A, 11-23.
- Perkol-Finkel, S., Sella, I. 2014. Ecologically active concrete for coastal and marine infrastructure: innovative matrices and designs. ICE Publishing, pp.1139– 1149.
- Pilarczyk, K. 2003. Design of revetments. Technical report, Rijkswaterstaat, DienstWeg- en Waterbouwkunde.
- Scaravaglione et al. 2022. Historical overview of the structural integrity of Concrete Armour Units. *Coastal and Offshore Science and Engineering*. P.68-98.
- Schierck and Verhagen. 2019. Introduction to bed, bank and shore protection. Delft Academic Press VSSD.
- Sella, I., Perkol-Finkel, S. 2015. Blue is the new green—Ecological enhancement of concrete based coastal and marine infrastructure. *Ecological Engineering* 84:260-272.
- Sella, I. et al. 2022. Design, production, and validation of the biological and structural performance of an ecologically engineered concrete block mattress: A Nature-Inclusive Design for shoreline and offshore construction. *Integrated environmental assessment and management* 18.1: 148-162. 2022
- Van der Berg et al. 2020. Influence of irregularities in the rock underlayer on the stability of XblocPlus. *Coastal Engineering*, 157