

Energy-based system architecture design - environmental control system

Joksimović, Aleksandar; Carbonneau, Xavier; Brazier, Frances; Vingerhoeds, Rob

Publication date

2022

Document Version

Final published version

Published in

33rd Congress of the International Council of the Aeronautical Sciences, ICAS 2022

Citation (APA)

Joksimović, A., Carbonneau, X., Brazier, F., & Vingerhoeds, R. (2022). Energy-based system architecture design - environmental control system. In *33rd Congress of the International Council of the Aeronautical Sciences, ICAS 2022* (pp. 5942-5955). (33rd Congress of the International Council of the Aeronautical Sciences, ICAS 2022; Vol. 8). International Council of the Aeronautical Sciences.

Important note

To cite this publication, please use the final published version (if applicable).
Please check the document version above.

Copyright

Other than for strictly personal use, it is not permitted to download, forward or distribute the text or part of it, without the consent of the author(s) and/or copyright holder(s), unless the work is under an open content license such as Creative Commons.

Takedown policy

Please contact us and provide details if you believe this document breaches copyrights.
We will remove access to the work immediately and investigate your claim.

ENERGY-BASED SYSTEM ARCHITECTURE DESIGN - ENVIRONMENTAL CONTROL SYSTEM

Aleksandar Joksimović¹, Xavier Carbonneau¹, Frances Brazier² & Rob Vingerhoeds¹

¹ISAE-SUPAERO, Université de Toulouse, France

²Faculty of Technology, Policy and Management, Delft University of Technology, The Netherlands

Abstract

A prominent pathway for the aeronautical industry to meet contemporary challenges is to explore overall vehicular efficiency gains enabled by various functional and structural distributions and/or synergies between onboard systems. To that end, this paper combines analytical first-principle-based methods and principles of systems engineering and focuses on the Environmental Control System (ECS). The objective is to develop means for simple blank-sheet design of complete system architectures, which would help unlock potentially obscured parts of the system design space. Basic thermodynamics is employed, complemented with "Function-Behaviour-Structure-Experience" systems engineering framework. The method presented in the paper enables users to initialise the design from a primitive abstract system architecture described by elementary physical processes, and then carry out a sequence of decisions and design material systems architecture, i.e. concepts that respond to the system requirements. The preliminary results present development of architectures representative both of traditional pneumatic and innovative electrical ECS concepts. Energy consumption figures of merit (thermodynamic efficiency, exergy destruction rate) are used as guidelines during the design i.e. for a given flight condition, the designer can assess the influence of each choice on the overall system energy consumption. Trade-offs between architectural design choices and figures of merit are thus rendered transparent in preliminary architecture design. In this paper the figures of merit are based on thermodynamic energy efficiency; in perspectives the method can include other constraints such as e.g. weight, volume, cost, or other, with long-term objective of enabling a comprehensive multi-disciplinary multi-system aeroplane architecture design scheme.

Keywords: Aeroplane Energy, Environmental Control System, Thermodynamic Cycles, System Architectures.

1. Introduction

Opposing forces of incentives for industry growth and desire for environmental sustainability result in emergence of often contradictory challenges for civil aeronautics. While possible ways to meet the challenge of overcoming these constraints can be found in all the branches of the airline industry (operations, manufacturing, etc.), new technological concepts arguably lie at the center of it all. One notable trend in technological innovation is the so-called "More Electric Aircraft" (MEA), described by progressive increase of electrification of non-propulsive and propulsive on-board systems. [1] Their aim is to increase energy efficiency of different systems to reduce the need for using hydrocarbon fuel as primary energy source, as well as to leverage the operational flexibility and fast response times characteristic for electric systems. [1] A notable in-service representative of MEA is the Boeing 787 *Dreamliner*, which features a fully electric Environmental Control System (ECS). [2] In the presented context, this paper focuses on ECS architecture preliminary design.

1.1 ECS Electrification State of the Art

The theoretical promise of ECS electrification in terms of aeroplane-level energy efficiency is not a new discovery [3]. The fact that it is still in the domain of unknown is a testimony to the immaturity of the electric technologies to reach sufficient power densities to enable aircraft-level benefit of the electrification. [4] However, the numerous works that employ fundamental thermodynamics and the so-called “exergy analysis” methods have consistently been showing that the engine bleed and numerous cross-flow heat exchanges in the ECS air-conditioning pack present a major source of entropy generation, i.e. thermodynamic losses. [5, 6, 7, 8] To illustrate this, three different ECS architectures are presented in Figure 1 from work developed by Parilla [9]; three zones of each schematic depict:

- The engine (pink), where the bleed air is conventionally taken from compressor and the mechanical shaft power is produced;
- The air managements system (yellow), which regulates the state of the air before it enters the air-conditioning pack;
- The air-conditioning pack (grey), where the air is brought to the desired state (pressure, temperature and humidity conditions) in order to be delivered to the cabin.

The electrification mostly concerns the processes and subsystems upstream of the air-conditioning pack (Fig. 1-2) which itself remains relatively unchanged between the different architectures. It could be inferred from this that a lot of ground remains to be gained in terms of the whole-system level thermodynamic efficiency of the ECS. Moreover, while the benefits in terms engine thermodynamic

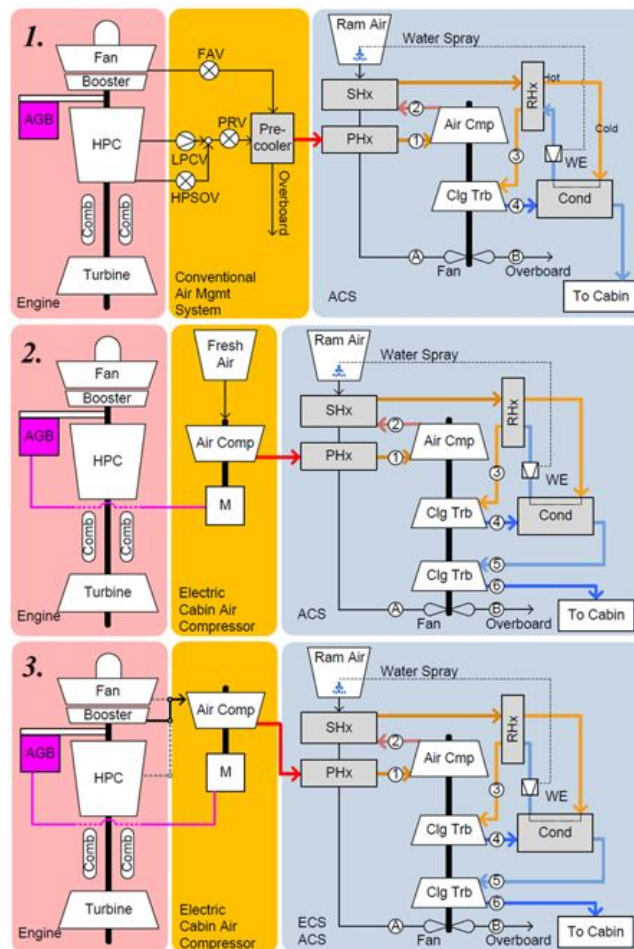

Figure 1 – ECS architectures: Conventional pneumatic (1); A hybrid-electric option (2); All-electric (3). Illustration by Parilla [9].

efficiency resulting from removal of the ECS air bleed from the engine core are evident, the associated increase in mechanical power offtake for electricity generation poses potential problems for the engine operability (engine compressor surge), which must be taken into account in the early engine design. [10, 11]

In order to leverage the potential of engine efficiency increase and gain in operational benefits of the ECS, Parilla [9] studied a hybrid architecture (Fig. 1-3). A concept was outlined where the air would be taken from the low pressure compressor, and additionally compressed electrically when necessary. In this work, the system was sized only at a single operating point, which provides a very limited insight into the true improvement potential of this architecture. Employing a coupled engine-ECS model, the results in terms of overall performance were promising. Another such work is presented by Lents et al. [12], who found that the overall benefit is higher for ECS that operate with low-pressure bleed air, then for all-electric systems with no bleed. Again, a more encompassing, mission-level analysis would be necessary in order to ascertain the full viability of such solutions. This is all the more true since other recent works still do not show coherent trends in terms of various impacts of this architectural change. For example, Ozcan et al. [10] state that the engine fuel consumption improvements from the ECS electrification are mainly offset by the added system weight and the added drag from the external air intakes. More recent work done by Shi et al. [13, 14, 15] on joint engine and ECS modelling indicates that conventional engine bleed losses associated to ECS are so excessive that the aircraft-level benefits from bleed removal outweigh penalties resulting from an electric ECS retrofit and the resulting added weight and drag.

1.2 Knowledge Gap and Objectives

The extensive body of work found in the literature reveals the complex nature of innovation in aeronautical systems, characterised by often contradictory multi-disciplinary constraints across a broad range of operating scenarios, especially if the surrounding systems architectures and the overall aeroplane architecture are assumed to be fixed. This makes the scope for possible changes very narrow, and arguably does not allow for reaching out for all theoretically possible functional and structural synergies in order to attain higher aeroplane-level energy efficiency. Ongoing work by the authors [16] correlates function-to-form mapping with aeroplane energy efficiency. Evaluation and quantification of such correlations requires a top-down first-principles based methodology for aeroplane system architecture design from blank sheet which does not resort to any hard constraints imposed by the existing solutions. Such method has not been identified in the literature so far by the authors.

Therefore, the work described in this paper proposes a new approach to system architectures preliminary design, based on first principles of thermodynamics and principles of systems engineering. The system of interest - Environmental Control System (ECS) - was selected in the first place to constrain the initial methodological development to a single on-board system which carries out an important function on a civil aeroplane. Secondly, the ECS was chosen because it is traditionally tightly coupled to several major systems (engine, cabin, ice protection, etc.), and has been identified historically as the biggest non-propulsive energy consumer. Since the motivation behind this work is to devise a method that renders trade-offs between architecture design choices and energy consumption transparent, ECS was deemed to be a relevant test case. Finally, the ECS architecture has been locked in a certain concept for many decades. The challenge therefore lies in finding a way to look at architectural choices made at the most fundamental level to see if truly different concepts could emerge while respecting the whole-aeroplane level requirements and constraints which have kept the ECS architecture constrained for so long.

To that end, the following objectives are defined for this paper:

1. Present a modelling framework based on principles of systems engineering and thermodynamics, adapted to civil aeroplane air-conditioning (AC) thermodynamic cycles.
 - (a) Employ the framework to define the functional "abstract" architecture of the system which operates at the minimal energy level prescribed by first principles of physics.
2. Develop a decision making process enabling the designer to design a system architecture component by component while evaluating the energy efficiency impact of each individual choice.

- (a) Employ the process to design different material ECS architectures from the same abstract baseline and estimate their energy performance.

2. Systems Engineering Principles

As the core of the paper lies in designing system architectures, the systems engineering definitions that are employed or used to guide the intuitions behind this work are firstly presented. The framework for describing requirements and constraints used in this work is based on the *Function-Behaviour-Structure (FBS)* ontology formulated by Gero and Kannengiesser [17]. This formalism has been extended subsequently by Brazier et al. [18] with the *Experiential (E)* category, and the resulting FBSE framework is employed in this paper. The respective definitions are the following: *F* - required function, *B* - behaviour measure, *S* - how the given requirements are materialised, *E* - required user experience. The architecture design then represents a progressive conversion of the entire initial set of FBSE requirements and constraints into a set of purely structural (*S*) requirements, which represents a solution.

Furthermore, the presented work discusses system architecture, function and form using definitions provided by Crawley et al. [19] In summary, the cited authors elaborate that:

- Form is the physical or informational embodiment of a system;
- Function of a designed system is the actions for which the system exists;
- System architecture is the embodiment of concept, the allocation of physical/informational function to the elements of form, and the definition of relationships among the elements and with the surrounding context.
- Function-to-form mapping, an expression of architecture design, thus describes how many distinct functions are carried out by a single component or system.

Notions of abstract and material systems used in this paper are correlated to the above definitions following the formalism initially presented by Paynter [20]:

- Abstract system is a system constituted of generic physical processes which represent elementary functions in the system. This is analogous to conventional systems engineering notion of functional architecture.
- Material system is a system of physical components whose aggregate effect is enabling of the system-level functions identified in the abstract architecture. This represents the previously defined form of the system, i.e. the solution specified by a set of purely structural requirements.

The example of the classic Joule-Brayton thermodynamic power cycle and a gas turbine engine can be used to illustrate the above duality, as illustrated in Figure 2. In this key, the Joule-Brayton cycle represents the abstract architecture of a system conceived to carry out the function of producing useful mechanical power. The abstract architecture consists of a succession of analytically expressed functions: compression, heat exchange, expansion, and a virtual heat exchange, all of which can be interpreted as individual elementary functions that all contribute to the system-level useful power production function.

In turn, the compression function can be carried out by various types of compressors or by ram effect for flights at high speed, the heat exchange function can be materialised by different types of heat exchangers, or by a combustion chamber - all of which can represent different structural solutions that enable the required functions. Therefore, a material architecture corresponding to the abstract architecture that is the simple Joule-Brayton cycle can thus be represented by an abundance of material solutions: a single-spool gas turbine, a triple spool gas turbine, a gas turbine with an electrically driven compressor, either one employing axial or radial turbomachinery or different types of combustion chambers. While the number of solutions is abundant, every single concept is derived from the same underlying abstract theoretically represented system. How the designer converges

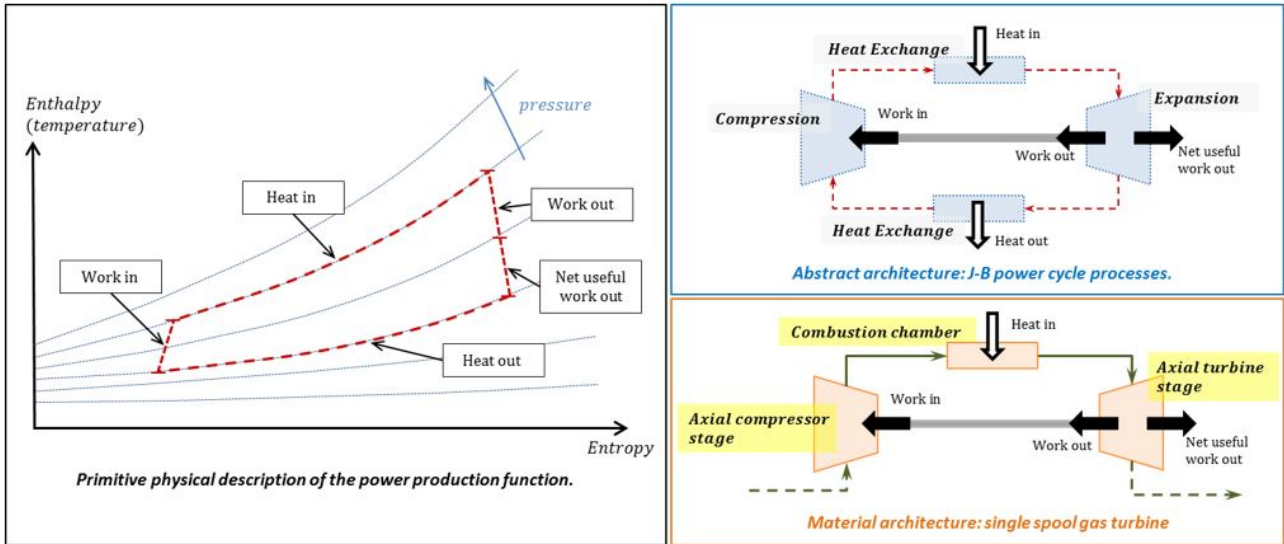

Figure 2 – Representing mechanical power production function as classical first-principle model (left), the associated abstract (upper right) and one possible material architecture (lower right) deriving from it.

to one or the other solutions depends on the (FBSE) requirements and constraints stipulated by the stakeholders in the system design process, which is what this work attempts to formalise for the ECS application case.

3. Thermodynamic Modelling of the ECS

This chapter presents the previously enunciated ECS architecture design process. Before proceeding to the development at hand, the first two sections will briefly lay out the baseline cases which serve as a backdrop for the custom ECS cycles (analogous to ECS architectures) designed in this work. On the one end of the comparison, the well-known existing cycles representative of material ECS architectures will be outlined (Section 3.1). On the other end, primitive abstract cycles will be presented (Section 3.2), to serve as theoretical minimum performance starting points for ECS architecture design (Section 3.3).

The operating scenario for all of the cases presented subsequently is generic short-medium range aeroplane (e.g. representative of Airbus A320 or Boeing 737) standard-day cruise condition. The representative heat loads for the representative fuselage geometry and number of cabin occupants (Table 1) are estimated using in-house models; the corresponding cabin requirements in terms of the air temperature, pressure and volumetric flow per passenger are taken from EASA CS-25 airworthiness specifications [21], and are used as reference in all the presented cases (Table 2).

Fuselage length [m]	Fuselage diameter [m]	No. Pax	No. Crew
44	4.14	200	6

Table 1 – Typical short-medium range aeroplane and cabin characteristics.

T_{cabin} [°C]	p_{cabin} [kPa]	$V_{air}/pax/min$ [$\frac{m^3}{min \cdot pax}$]
24	≥ 80	0.3

Table 2 – Objective cabin conditions representative of typical cruise of a short-medium range civil aeroplane, conforming to CS-25 airworthiness specifications. [21]

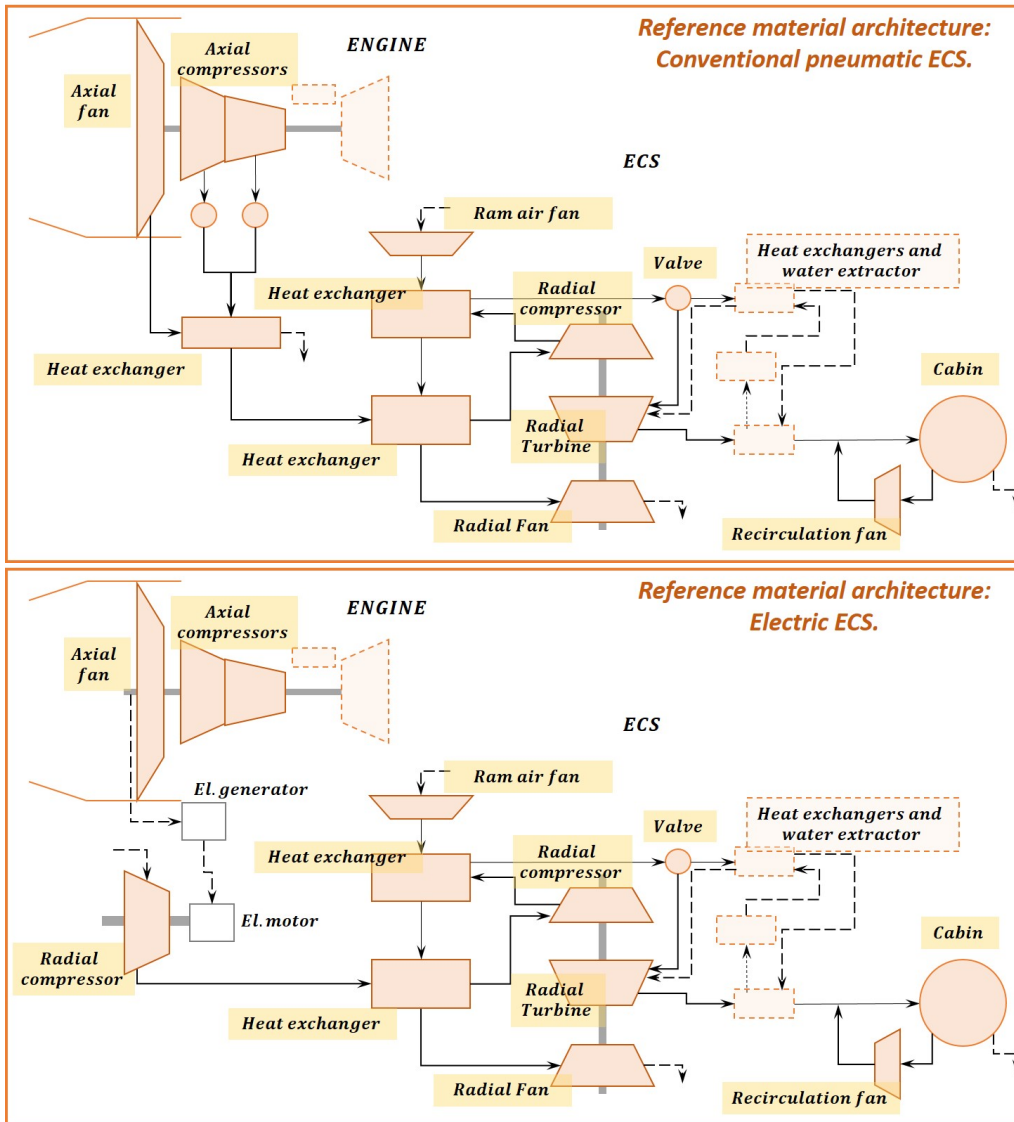

Figure 3 – Reference pneumatic (above) and electric (below) ECS architectures with the respective components modelled for the two cases. Hyphenated contours indicate components not included in the model either because they are out of scope (engine components) or for simplicity reasons (water extraction subsystem).

3.1 Conventional ECS Cycles and System Architectures

3.1.1 Pneumatic ECS

A 0D thermodynamic model of a pneumatic ECS is developed conforming to conventional architectural specifications for ECS found on contemporary civil aeroplanes [22, 23], and tuned to match a generic short-medium range aeroplane application case. The model comprises the engine pre-compression subsystem (inlet and compressor stages upstream of the bleed stations), the ECS pre-cooler, the ECS pack and the re-circulation module which mixes the fresh air with a part of recirculated cabin air prior to final injection of the breathable air mixture into the cabin. The modelled architecture, along with calculated component-level performance is illustrated schematically in Fig.3 (above). The resulting thermodynamic cycle performance results are provided alongside the other designed cycles in Subsection 3.3.2.

3.1.2 Electric ECS

An electric ECS model is also developed, with architectural description typical of what is described in the literature [2, 9], with properties tuned to match a generic short-medium range application analogously to the previously described pneumatic case. Such all-electric systems have no link to the

upstream engine compression stages; only mechanical power can be drawn from the engine shaft to run the dedicated compressor, but this effect is not modelled in the current case. The model comprises a dedicated air inlet with an electrical pre-compression subsystem driven by an electric motor; downstream subsystems are then equivalent to the conventional pneumatic case, consisting of the pre-cooler, the ECS pack and the re-circulation module. The modelled architecture, along with calculated component-level performance is illustrated schematically in Fig.3 (below). The resulting thermodynamic cycle performance results are provided alongside the other designed cycles in Subsection 3.3.2.

3.2 Underlying Primitive Air-Conditioning Cycle

This section presents the underlying primitive refrigeration thermodynamic cycle that responds to the aeroplane need for an air-breathing system that leads the ambient air to the cabin, conditioned to appropriate pressure and temperature conditions at any flight level. This cycle represents the abstract system architecture composed of a minimum amount of elementary processes necessary to enable the air conditioning function.

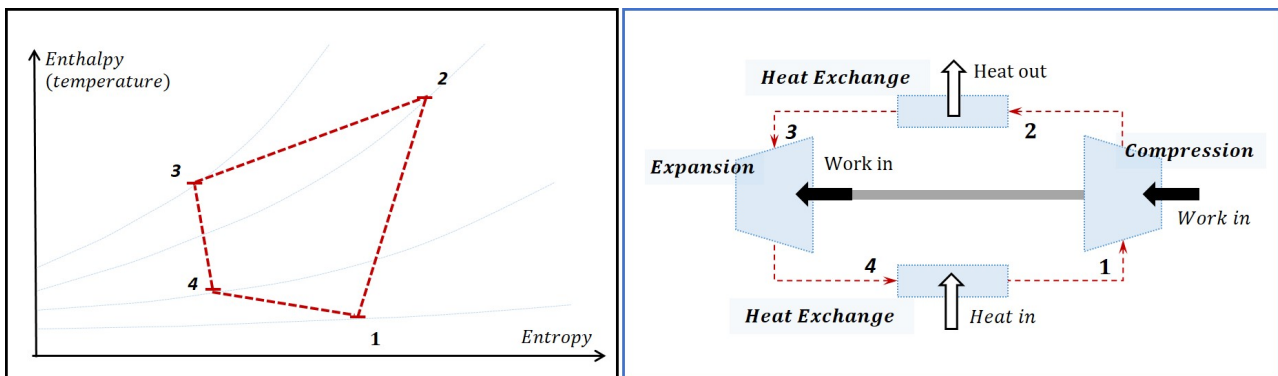

Figure 4 – Primitive thermodynamic cycle enabling the air conditioning function (left) and the equivalent abstract architecture consisting of elementary processes that enable the function; cruise altitude.

In the most fundamental configuration the abstract ECS architecture (Figure 4) will consist of:

- A compression process,
- A heat exchange process,
- An expansion process.

For a given flight altitude and process efficiency values fixed by the designer, this cycle will be characterised by certain energy performance. The following figures of merit [24] are introduced to characterise it:

- Coefficient of performance, which represents energy efficiency of refrigeration cycle,
- Exergy destruction rate, which represents destruction rate of the potential to extract useful work from the system.

Figure 5 presents a parametrisation of the design space of the abstract architecture defined in this study as a function of two parameters: compression pressure ratio and the temperature at the end of the heat exchange process (heat removal in this case). Access to this information allows to extract sensitivities of the objective functions of interest to different cycle parameters, i.e. it enables optimisation. Figure 6 presents two such optimised examples for a cruise altitude scenario, one optimised for maximum exergy destruction rate, and the other for maximum coefficient of performance. It is instructive to observe that although they start at the same starting point, the two solutions do not represent the same abstract architectures, meaning that even this primitive starting point for the system design - the theoretical baseline - is not necessarily unique. Taking into consideration that

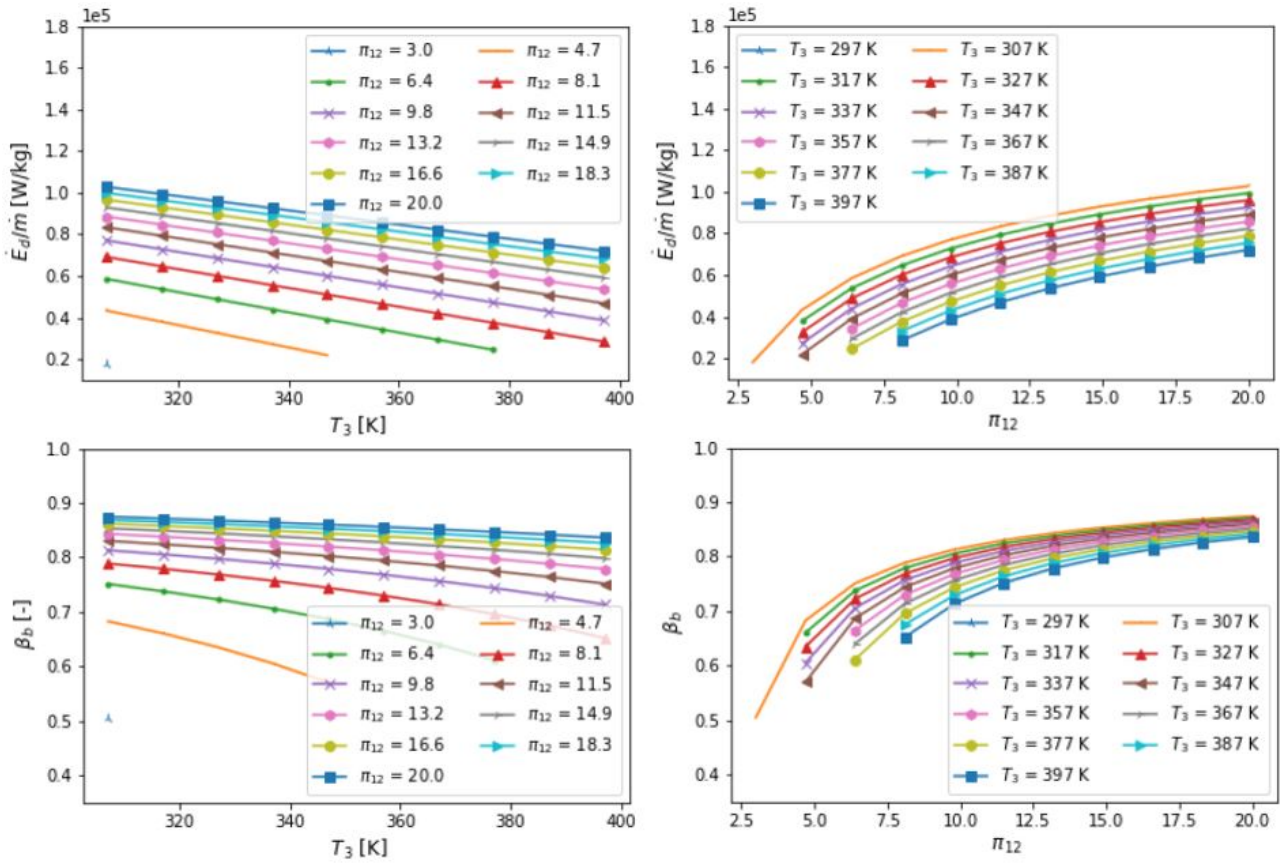

Figure 5 – Exergy destruction rate (above) and Coefficient of performance (below) as a function of two primitive cycle parameters; cruise altitude.

(as argued at the end of Chapter 2) an abundance of material architectures can be designed starting from a unique abstract architecture - multiplying the number of abstract architectures for a given set of top-level system requirements implies that the potential design space size could be even bigger than what is normally considered.

3.3 Material ECS Architecture Design

3.3.1 Methodology

The developed system architecture design tool contains a set of simple component descriptions which can be appended to the system starting from the initial state - in this case the state of the

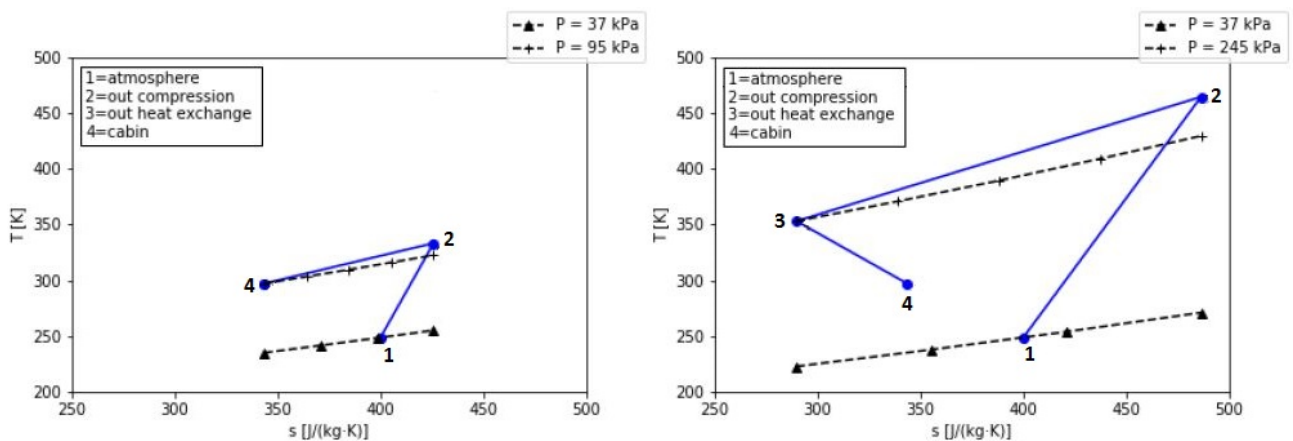

Figure 6 – Two optimised scenarios for the primitive cycle: left - cycle optimised for minimum exergy destruction; right - cycle optimised for best coefficient of performance; standard-day cruise altitude.

ambient air at a given flight altitude - and the final state - described by the cabin habitability requirements. At this stage, the components available to the user are: compressor, heat exchanger, turbine and pressure regulating valve. The components are described by first-order thermodynamic equations. As such they do not differ fundamentally from the abstract processes discussed previously, but there is little practical difference to the designer at this stage where low fidelity models are commonly employed to model such components even when the final architecture layout is well-known.

The free parameters available to the designer concerning the different components are the following:

- Compressor: pressure ratio and efficiency.
- Heat exchanger: temperature drop.
- Turbine: outlet pressure and efficiency.
- Pressure regulating valve: outlet pressure and outlet temperature.

3.3.2 Case Studies

ECS cycle plots grouped in Figure 7 illustrate four different material architecture design scenarios performed in the preliminary studies. The presented studies were performed for a single operating point representative of cruise conditions at 35000 ft altitude, ISA conditions. Each of the respective custom designed cycles (drawn in purple) is plotted against the backdrop of two abstract architecture cycles optimised for two different objective functions (Fig.6) and the two references cases discussed in Section 3.1 - a pneumatic case and an electric case. Naturally, the starting and ending points of the plotted cycles coincide, since they are all designed to fulfil the same functional and behavioural requirements - providing air flow at pressure and temperature levels characteristic of the operating condition under consideration.

The four plot groups are defined according to the type of architecture designed:

1. Pneumatic (Fig.7-1), where first compression stages of the cycle are carried out by engine compressors. (a conventional civil architecture, cf. Subsection 3.1.1)
2. Electric (Fig.7-2), where the air is taken directly from the exterior, and compressed by means of a dedicated (electrical) compressor. (an architecture equivalent to Boeing 787 ECS, cf. Subsection 3.1.2)
3. Electric without recirculation (Fig.7-3), equivalent to the second architecture, without the recirculating air subsystem upstream of the cabin. (a hypothetical architecture)
4. A simple architecture consisting of an unconventional process chain (Fig.7-4). (a hypothetical architecture)

The last of the four architectures is designed to firstly cool down the exterior air only to be followed by a compression to reach the required conditions. Such chain of processes is theoretically feasible, but materially not feasible for an isolated architecture, that is an architecture which does not contain any heat sinks at lower temperature than the ambient air. Therefore, this purely theoretical option was included in the presentation only to showcase the capability of the developed tool to enable exploration of "out of the box" solutions once the surrounding aeroplane systems are brought into the picture at a subsequent phase. The ongoing work aims at introducing constraints to the developed design method in order to prevent solutions that are unfeasible in a given system environment from being rendered accessible to the designer.

The plots in Figure 7 are representative of different whole-system energy levels: the more narrow-spanning a cycle plot is i.e. the fewer processes it consists of (cf. the abstract architectures in green and black) the less entropy is generated and less energy is wasted for the same outcome. The same is observed for the material architectures, the more components the architecture consists of, the more energy is expended for its operation (cf. the reference pneumatic cycle plotted in blue). The conclusion in itself does not necessarily contribute any fundamentally new knowledge. The contribution lies in the presented capability to use the theoretical minima and existing cycles as

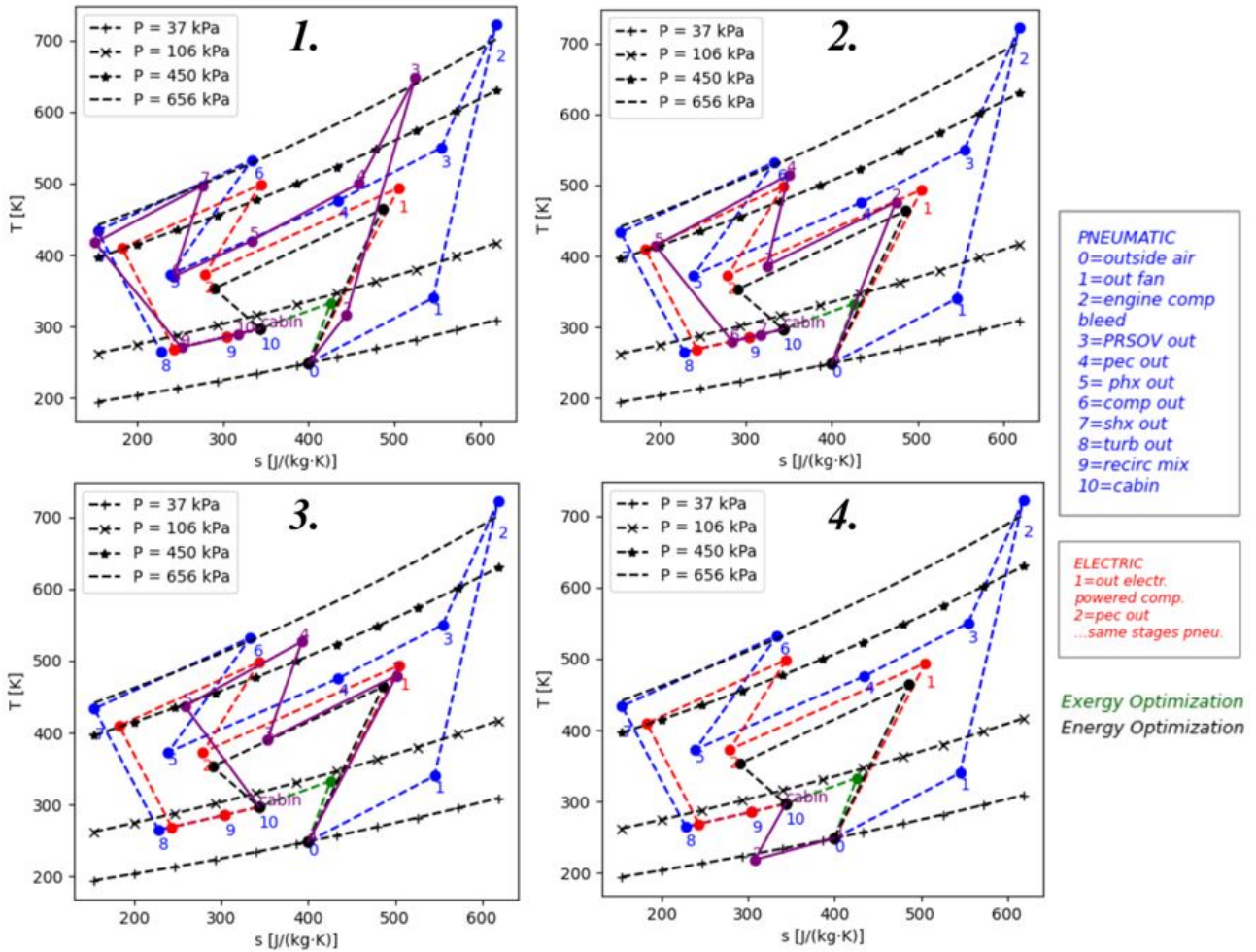

Figure 7 – Four different material architecture designs (purple) plotted against the common background of two different optimised abstract architectures (black and green) and the reference pneumatic and electric material architectures (red and blue); standard-day cruise conditions.

boundaries of sorts for system architecture design, which can be used to assess every step of the design-making process along the way, and re-evaluate alternative choices once a whole architecture has been designed. The calculated performance expressed in the previously outlined thermodynamic figures of merit is summarised in Figure 8 for all the different architecture designs plotted in Fig.7.

4. Discussion

The presented cases give insight into the developed approach for an isolated subsystem of a fictitious whole aeroplane system not modelled at this time. While the employed simplifications and hypotheses could render some of the obtained results questionable in this first analysis, the general framework for physics-based decision making is capable of providing the designer a clean-sheet first-principle based architecture design tool where each decision can be evaluated against a figure of merit of interest. The presented case of isolated environmental control system is evaluated in a conventional i.e. strictly disciplinary (thermodynamics-based) manner and in a setting that excludes any system environment. (Fig.9) As such, the repercussions on the adjacent subsystems of even the most unusual decisions are nor visible nor relevant in such simplified context. This includes practically any potential impact of the decisions made in the ECS subsystem architecture design:

- **In-operation aeroplane-level:** whole-aircraft weight, drag, available volume, heating properties of adjacent onboard systems, etc.
- **ECS and/or aeroplane life-cycle performance:** maintainability, cash operating cost, etc.

ENERGY-BASED SYSTEM ARCHITECTURE DESIGN - ENVIRONMENTAL CONTROL SYSTEM

Architecture	<i>Abstract</i>	<i>Abstract</i>	<i>Material</i>	<i>Material</i>	<i>Material</i>
	Minimal Exergy Destruction	Maximal Energy Efficiency	Pneumatic Reference	Electric Reference	Designed
Case:	1. Pneumatic-like ECS material architecture design.				
Work [<i>kW</i>]	109.52	206.93	327.36	170.53	279.94
Heat [<i>kW</i>]	-46.79	-144.20	-178.76	-135.73	-136.06
Energetic efficiency [-]	0,43	0.78	0.55	0.80	0.49
Exergy destruction [<i>kW</i>]	14.79	52.03	200.91	66.70	165.65
Case:	2. Electric-like ECS material architecture design.				
Work [<i>kW</i>]	109.52	206.93	327.36	170.53	165.53
Heat [<i>kW</i>]	-46.79	-144.20	-178.76	-135.73	-123.10
Energetic efficiency [-]	0,43	0.78	0.55	0.80	0.74
Exergy destruction [<i>kW</i>]	14.79	52.03	200.91	66.70	56.17
Case:	3. Electric-like (no recirculation) ECS material architecture design.				
Work [<i>kW</i>]	109.52	206.93	327.36	170.53	165.53
Heat [<i>kW</i>]	-46.79	-144.20	-178.76	-135.73	-123.10
Energetic efficiency [-]	0,43	0.78	0.55	0.80	0.74
Exergy destruction [<i>kW</i>]	14.79	52.03	200.91	66.70	56.17
Case:	4. Alternative ECS material architecture design.				
Work [<i>kW</i>]	109.52	206.93	327.36	170.53	101.60
Heat [<i>kW</i>]	-46.79	-144.20	-178.76	-135.73	-38.87
Energetic efficiency [-]	0,43	0.78	0.55	0.80	0.38
Exergy destruction [<i>kW</i>]	14.79	52.03	200.91	66.70	18.27

Figure 8 – Summary of the thermodynamic performance results of the different designed ECS architectures, each compared to the different abstract and material architecture baselines.

This reasoning can be generalised for any other system of interest.

For this reason, defining a framework for application of the presented *FBSE* (Chapter 2) requirements and constraints is included in the ongoing developments of the presented work. The civil aviation industry is famously conservative, which is reflected in arguably very high inertia to even minor modifications to the whole system and subsystem architectures. Many parts of the possible design space have been revealed by the research community throughout the decades. The challenge in rendering the innovative concepts practically feasible requires a demonstration of their compliance with requirements and constraints related to safety, environmental impact and economic performance.

Figure 9 presents the developed methodology where the high-level abstract architecture and various material system architectures are found the opposite sides of the spectrum quantified by a single figure of merit: energy performance. The rest of the design space between these extremes is populated by potentially infinitely many solutions, many of which remain inaccessible to the designer by pre-mature locking in of architectural solutions into the known concepts, defining their structure rather than focusing on the required functions. For instance, a hypothetical pneumatic-resembling ECS intermediate solution where the first compression is left as abstract process, i.e. no material components are defined there, would be an example of such intermediary solution. Application of the *FBSE* framework correlated to analytically defined metrics - currently thermodynamic energy; subsequently weight, environmental impact, operating cost, and other - would allow for fully transparent and rigorous system architecture design, be it full blank sheet or tightly constrained by the legacy concepts. This is emphasised all the more in light of the fact that on traditionally highly constrained systems such as civil aeroplanes (e.g. constrained in weight, volume, development cost) system synergies are often sought in order to leverage maximum functionality for a given amount of available space, weight, or other. This tendency is especially visible in the innovative aeroplane concepts,

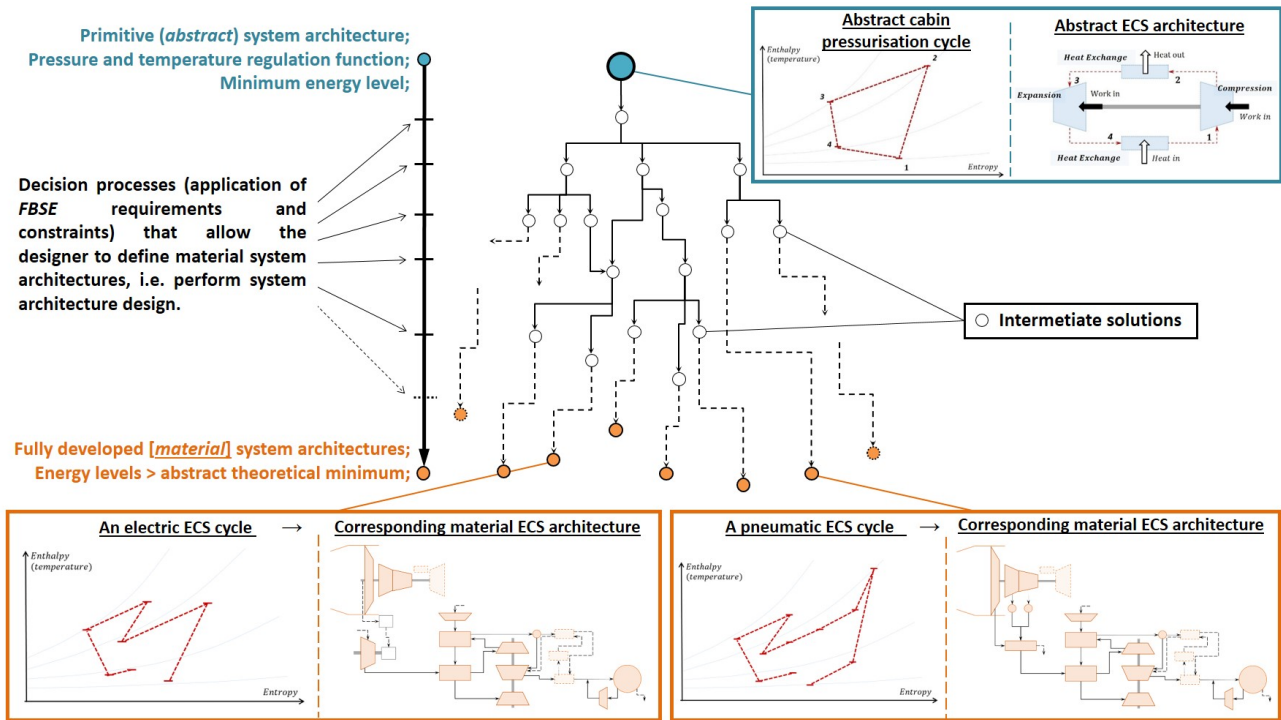

Figure 9 – Schematic overview of the proposed architecture design process spanning the fundamental abstract description on the one end and a variety of possible material architectures on the other.

and has been previously presented by the authors as correlation between function to form mapping and energy efficiency of the system. [16] Searching for yet unexplored system-level multi-disciplinary synergies on civil aeroplanes while respecting various disciplinary and proprietary/stakeholder requirements and constraints could arguably be enabled by the presented methodology.

5. Conclusion and Perspectives

The paper presents a method for blank sheet system architecture design, applied to a civil aeroplane Environmental Control System test case. The presented model was developed as a theoretical case of completely isolated ECS. The approach enabled by the presented work is summarised as a sequential decision making process initiated by defining a primitive physics-based *abstract* architecture of interest. The abstract architecture is characterised by a minimal energy performance at a given flight condition, which is predicted using first-principle thermodynamics models. The decision-making process is then initialised; it leverages a number of pre-defined elementary thermodynamic processes that represent individual components added by the designer. A chain of components that fulfils the function of bringing the ambient air to the temperature and pressure required in the cabin at a satisfactory energy performance is the designed material ECS architecture. This process can lead to a virtual infinity of architectural possibilities, constrained only by the energy performance described by energy levels and process efficiency parameters transparent to the user at each decision level. The identified added value to the system architecture designer is:

1. Possibility to perform blank-sheet system architecture design with no exposure to constraints of the existing concepts;
2. Possibility to assess design choices impact on a figure of merit of interest (in this case energy performance) at every step of the design;
3. Possibility to postpone component selection decisions as far as possible into the design process, which can lead to more flexible decision making, which will in turn be of crucial importance when functional synergies and trade-offs with other aeroplane systems enter the picture.

Perspectives for the work presented in this paper include:

1. Modelling of parallel system branches, as for the moment the modelled architectures are strictly serial;
2. Including representative figures of merit other than the thermodynamic criteria, e.g. weight, volume, aerodynamics, cost, to enable applying the *FBSE* requirement and constraint framework in a scope broader than simple thermodynamic performance.
3. Modelling of other aeroplane systems, in order to obtain the whole aeroplane-level picture and enable full exploration of function-to-form mapping in that context, as discussed in [16].
4. Performing architecture design for a mission profile broader than individual operating points.

Acknowledgements

The authors wish to acknowledge the significant contribution of Gonzalo Garcia de Fernando Alvarez to development of the physical models presented in this paper, which he carried out in the framework of his master's thesis.

Contact Author Email Address

mailto:aleksandar.joksimovic@isae-supero.fr

Copyright Statement

The authors confirm that they, and/or their company or organization, hold copyright on all of the original material included in this paper. The authors also confirm that they have obtained permission, from the copyright holder of any third party material included in this paper, to publish it as part of their paper. The authors confirm that they give permission, or have obtained permission from the copyright holder of this paper, for the publication and distribution of this paper as part of the ICAS proceedings or as individual off-prints from the proceedings.

References

- [1] Whurr, J. and Beecroft, P., "Rolls-Royce's Long Term Civil Aircraft Propulsion System Concept and Technology Strategy," p. 19, 2017.
- [2] Sinnett, M., "787 No-Bleed Systems: Saving Fuel and Enhancing Operational Efficiencies," *Boeing AERO Magazine*, no. 28, pp. 6–11, 2007.
- [3] Cronin, M. J., "All-electric vs conventional aircraft - The production/operational aspects," *Journal of Aircraft*, vol. 20, pp. 481–486, June 1983.
- [4] Schäfer, A. W., Barrett, S. R., Doyme, K., Dray, Y. M., Gnad, A. R., Self, R., O'Sullivan, A., Synodinos, A. P., and Torija, A. J., "Technological, economic and environmental prospects of all-electric aircraft | Nature Energy," *Nature Energy*, vol. 4, pp. 160–166, Feb. 2019.
- [5] Vargas, J. V. and Bejan, A., "Integrative thermodynamic optimization of the environmental control system of an aircraft," *International Journal of Heat and Mass Transfer*, vol. 44, pp. 3907–3917, Oct. 2001.
- [6] Leo, T. J. and Pérez-Grande, I., "A thermoeconomic analysis of a commercial aircraft environmental control system," *Applied Thermal Engineering*, vol. 25, pp. 309–325, Feb. 2005.
- [7] Pérez-Grande, I. and Leo, T. J., "Optimization of a commercial aircraft environmental control system," *Applied Thermal Engineering*, vol. 22, pp. 1885–1904, Dec. 2002.
- [8] Pellegrini, L. F., Gandolfi, R., Silva, G., and de Oliveira Jr., S., "Exergy Analysis as a Tool to Decision Making in Aircraft Design," in *45th AIAA Aerospace Sciences Meeting and Exhibit*, (Reno, Nevada), American Institute of Aeronautics and Astronautics, Jan. 2007.
- [9] Parrilla, J. A., *Hybrid Environmental Control System Integrated Modeling Trade Study Analysis for Commercial Aviation*. PhD, Sept. 2014.
- [10] Ozcan, M. F., Chakraborty, I., and Mavris, D. N., "Impact of Subsystem Secondary Power Requirements on Gas Turbine Sizing and Performance," in *16th AIAA Aviation Technology, Integration, and Operations Conference*, (Washington, D.C.), American Institute of Aeronautics and Astronautics, June 2016.

- [11] Kloos, V., Speak, T. H., Sellick, R. J., and Jeschke, P., "Dual Drive Booster for a Two-Spool Turbofan: High Shaft Power Offtake Capability for MEA and Hybrid Aircraft Concepts," in *Volume 1: Aircraft Engine; Fans and Blowers; Marine*, (Oslo, Norway), p. V001T01A007, American Society of Mechanical Engineers, June 2018.
- [12] Lents, C. E. and Baig, Z., "Parallel Hybrid Propulsion & Secondary Power System Architecture Exploration and Evaluation," in *AIAA Propulsion and Energy 2020 Forum*, (VIRTUAL EVENT), American Institute of Aeronautics and Astronautics, Aug. 2020.
- [13] Shi, M., Chakraborty, I., Tai, J. C., and Mavris, D. N., "Integrated Gas Turbine and Environmental Control System Pack Sizing and Analysis," in *2018 AIAA Aerospace Sciences Meeting*, (Kissimmee, Florida), American Institute of Aeronautics and Astronautics, Jan. 2018.
- [14] Shi, M., Chakraborty, I., Cai, Y., Tai, J. C., and Mavris, D. N., "Mission-Level Study of Integrated Gas Turbine and Environmental Control System Architectures," in *2018 AIAA Aerospace Sciences Meeting*, (Kissimmee, Florida), American Institute of Aeronautics and Astronautics, Jan. 2018.
- [15] Shi, M., Cai, Y., Gladin, J. C., and Mavris, D. N., "A Multi-Design Point Sizing Methodology for Environmental Control Systems," in *AIAA Scitech 2020 Forum*, (Orlando, FL), American Institute of Aeronautics and Astronautics, Jan. 2020.
- [16] Joksimović, A., Brazier, F., Vingerhoeds, R., and Carbonneau, X., "Function to Form Mapping and Search for Civil Aeroplane Energy Efficiency," in *2021 IEEE International Symposium on Systems Engineering (ISSE)*, (Vienna, Austria), pp. 1–8, IEEE, Sept. 2021.
- [17] Gero, J. S. and Kannengiesser, U., "The situated function–behaviour–structure framework," *Design Studies*, vol. 25, pp. 373–391, July 2004.
- [18] Brazier, F., van Langen, P., Lukosch, S., and Vingerhoeds, R., *Complex Systems: Design, engineering, governance*, pp. 35–60. NAP, 2018.
- [19] Crawley, E., Cameron, B., and Selva, D., *System Architecture: Strategy and Product Development for Complex Systems*. Pearson, 1st ed., Apr. 2015.
- [20] Paynter, H. M., *Analysis and Design of Engineering Systems : Class Notes for M.I.T. Course*. MIT Press, 1961.
- [21] Agency, E. U. A. S., "Certification Specifications and Acceptable Means of Compliance for Large Aeroplanes (CS-25)," Nov. 2021.
- [22] Moir, I. and Seabridge, A. G., *Aircraft Systems: Mechanical, Electrical, and Avionics Subsystems Integration*. Aerospace series, Chichester, West Sussex, England: John Wiley & Sons, Ltd, third edition, reprinted with corrections ed., 2009.
- [23] U.S. Department of Transportation FEDERAL AVIATION ADMINISTRATION Flight Standards Service,, "Aviation Maintenance Technician Handbook – Airframe, vol.2," 2012.
- [24] Moran, M. J., Shapiro, H. N., Boettner, D. D., and Bailey, M. B., *Fundamentals of Engineering Thermodynamics*. John Wiley & Sons, Inc., 8th ed., 2014.