



# *Theatrics*

*Where theatre begins before the performance.*

# Act I

## *Setting the Scene*





01.

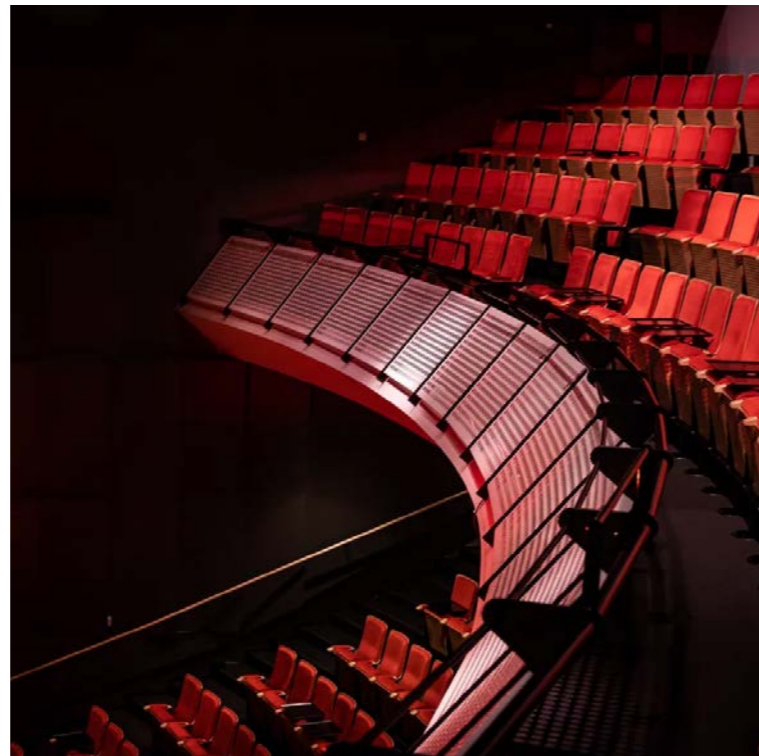

02.

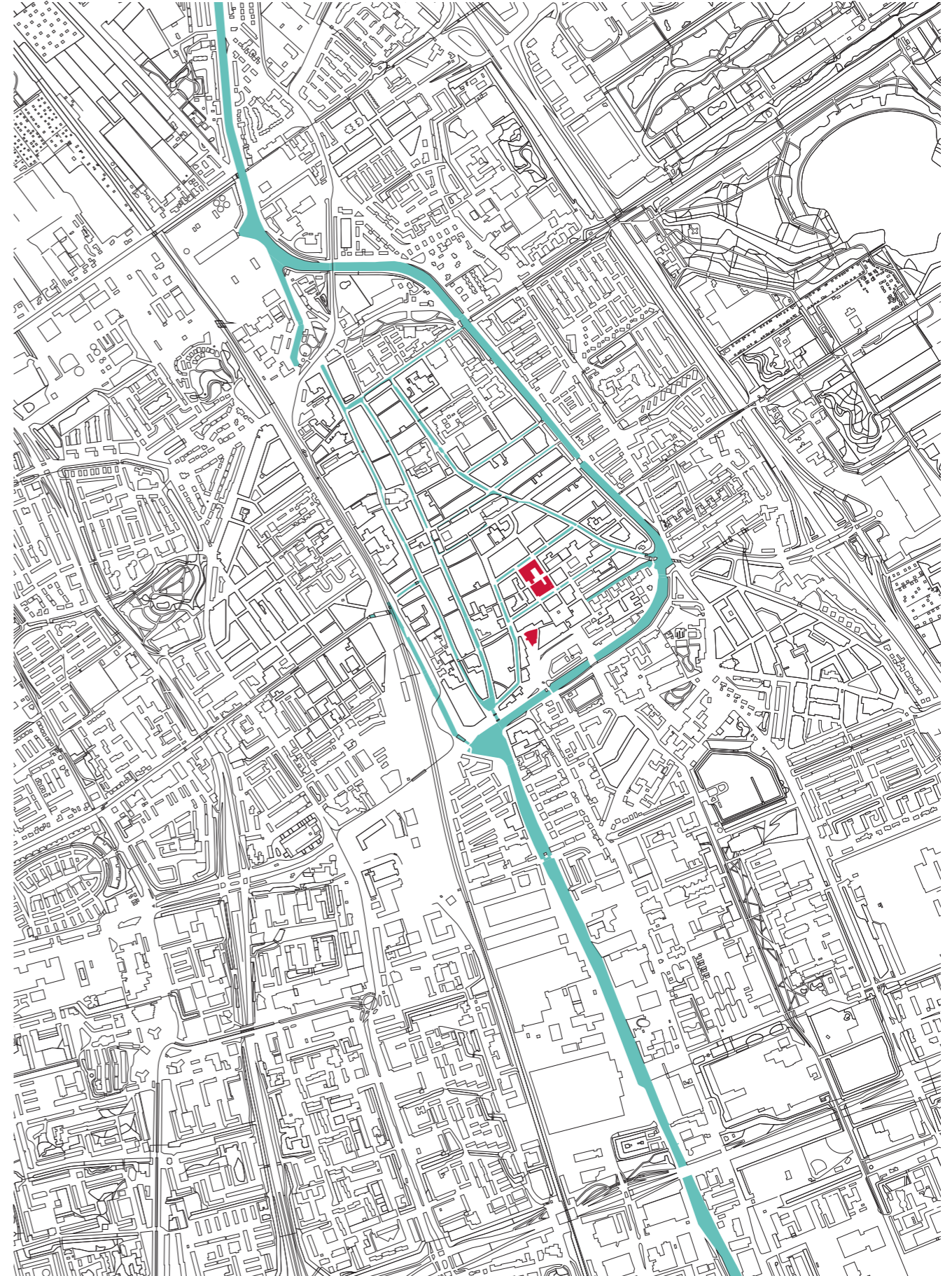

03.



01 inDelft n.d.

02 Theater De Veste 2024

03 dexter scholten may. 2026

**DE VESTE brief**m<sup>2</sup>

|                                    |             |
|------------------------------------|-------------|
| <b>Main Auditorium</b>             | <b>1747</b> |
| 1.1 Auditorium                     | 420         |
| 1.2 Balcony                        | 210         |
| 1.3 Stage                          | 759         |
| 1.4 Proscenium                     | 20          |
| 1.5 Orchestra Pit                  | 50          |
| 1.6 Chair Storage                  | 15          |
| 1.7 Technical Office               | 15          |
| 1.8 Loading/Unloading              | 28          |
| 1.9 Parking 2 trucks               | 144         |
| 1.10 Stage Storage                 | 70          |
| 1.11 Technical Workshop            | 12          |
| 1.12 Workshop Cupboard             | 4           |
| <b>Small Auditorium</b>            | <b>484</b>  |
| 2.1 Auditorium                     | 300         |
| 2.2 Fixed Bars                     | 16          |
| 2.3 Balconies                      | 60          |
| 2.4 Sound/light console            | 4           |
| 2.5 Parking 1 truck                | 40          |
| 2.6 Storage                        | 60          |
| 2.7 Tool Storage                   | 4           |
| <b>Public Facilities</b>           | <b>680</b>  |
| 3.1 Entrance Hall                  | 25          |
| 3.2 Additional Foyer functions     | 200         |
| 3.3 Bar(s) main hall               | 20          |
| 3.4 Ticket office/information desk | 30          |
| 3.5 Bar(s) Small hall              | 10          |
| 3.6 Cloakroom                      | 53          |
| 3.7 Reception areas                | 90          |
| 3.8 Kitchen                        | 25          |
| 3.9 Washing-up area                | 15          |
| 3.10 Catering Storage              | 40          |
| 3.11 Foyer storage                 | 50          |
| 3.12 Facilities workshop           | 12          |
| 3.13 Toilets                       | 90          |
| 3.14 Disabled toilet               | 10          |
| 3.15 First aid/restroom            | 10          |

**DE VESTE brief .2**m<sup>2</sup>

|                               |             |
|-------------------------------|-------------|
| <b>Staff Facilities</b>       | <b>234</b>  |
| 4.1 Restaurant                | 120         |
| 4.2 Toilets                   | 12          |
| 4.3 Kitchen                   | 25          |
| 4.4 Washing Room              | 15          |
| 4.5 Cooling Room              | 20          |
| 4.6 Storage                   | 20          |
| 4.7 Catering Office           | 10          |
| 4.8 Staff dressing room       | 10          |
| 4.9 utility closet            | 2           |
| <b>Staff Working</b>          | <b>277</b>  |
| 4.10 Office                   | 230         |
| 4.11 Staff Room               | 35          |
| 4.12 Toilets                  | 12          |
| <b>Artist Facilities</b>      | <b>301</b>  |
| 5.1 4 person dressing room    | 75          |
| 5.2 6 person dressing room    | 64          |
| 5.3 15 person dressing room   | 75          |
| 5.4 Showers                   | 12          |
| 5.5 Artist's foyer/green room | 75          |
| <b>Total Base Function</b>    | <b>3723</b> |

04.

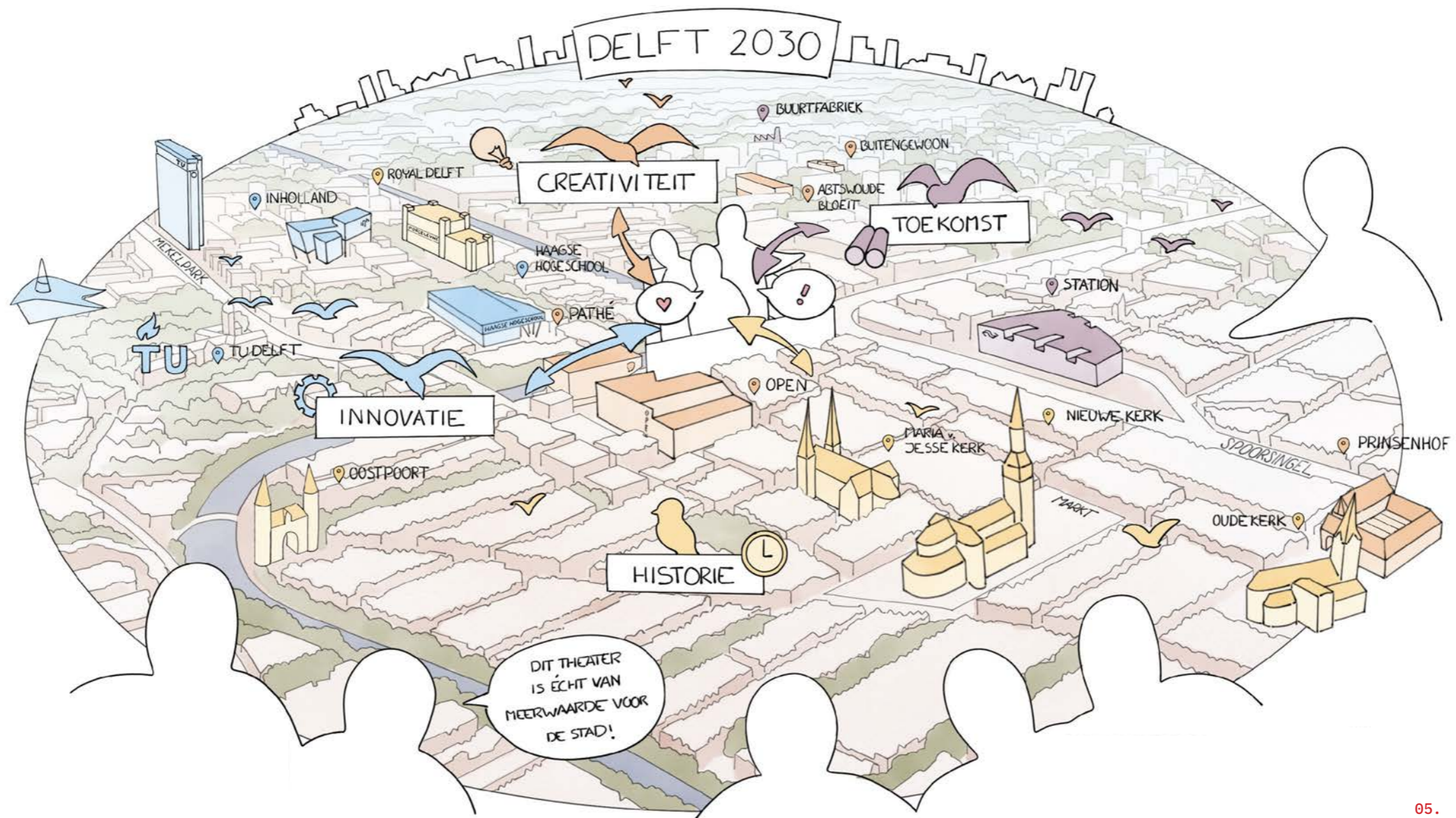

05.

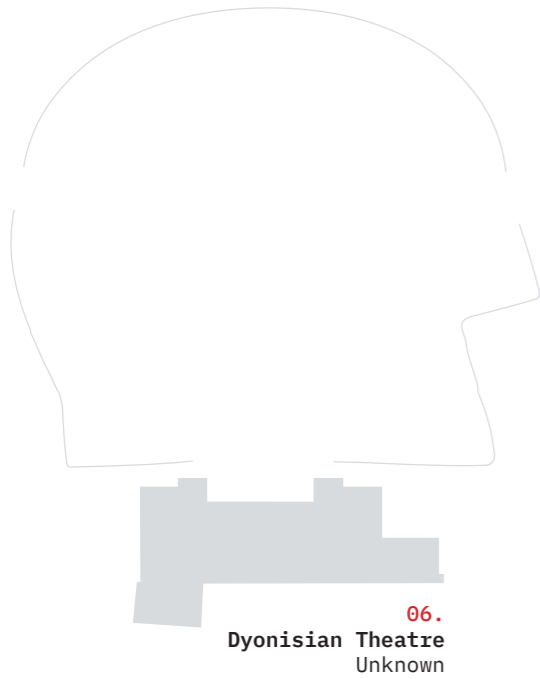

06.  
Dyonisian Theatre  
Unknown



07.  
Teatro Olimpico  
Andrea Palladio



08.  
Teatro Olimpico  
Cuthbert &  
Ricard Burbage



09.  
Opera Garnier  
Charles Garnier



10.  
Bayreuth Festspielhaus  
Otto Bruckwald



11.  
London Coliseum  
Frank Matcham



12.  
De Meerpaal  
Frank van Klingeren



13.  
The National Theatre  
Danys Lasdun



14.  
Half Moon Theatre  
Florian Beigel

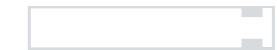

15.  
Teatro Oficina  
Lina Bo Bardi

06 Daniel Robertson, Suus Konings *dec. 2025*  
07 Jade Melis, Matthias Hellriegel *dec. 2025*  
08 Guusje Witte, O Zeng *dec. 2025*

09 Chantal Booi, Floyd Shazly *dec. 2025*  
10 Annemijn Bruins Slot, Dexter Scholten *dec. 2025*  
11 Lilly Aeverbeck, Nils Ewen *dec. 2025*

12 Emina Šehmehmedović, Max Wijnschenk *dec. 2025*  
13 Igor Sztormowski, Miriam Barnett *dec. 2025*  
14 Carla Zurlino, Casper van Tilburg *dec. 2025*

15 Eva Lücking, Marko Stevanov *dec. 2025*

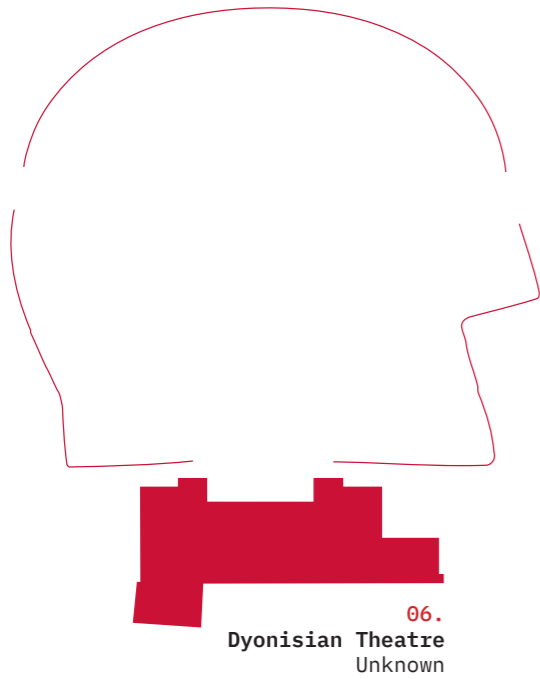

06.  
Dyonisian Theatre  
Unknown



07.  
Teatro Olimpico  
Andrea Palladio



08.  
Teatro Olimpico  
Cuthbert &  
Ricard Burbage



09.  
Opera Garnier  
Charles Garnier

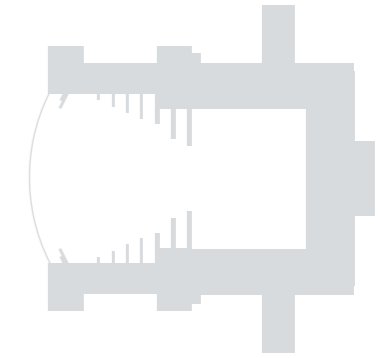

10.  
Bayreuth Festspielhaus  
Otto Bruckwald



11.  
London Coliseum  
Frank Matcham

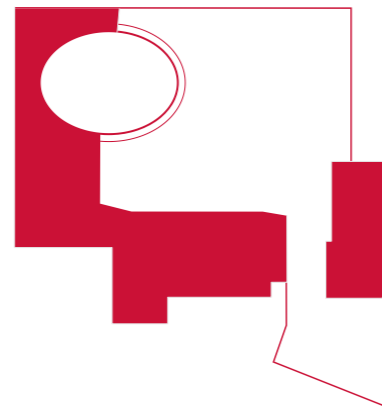

12.  
De Meerpaal  
Frank van Klingeren



13.  
The National Theatre  
Danys Lasdun



14.  
Half Moon Theatre  
Florian Beigel

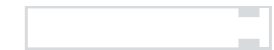

15.  
Teatro Oficina  
Lina Bo Bardi

06 Daniel Robertson, Suus Konings *dec. 2025*  
07 Jade Melis, Matthias Hellriegel *dec. 2025*  
08 Guusje Witte, O Zeng *dec. 2025*

09 Chantal Booi, Floyd Shazly *dec. 2025*  
10 Annemijn Bruins Slot, Dexter Scholten *dec. 2025*  
11 Lilly Aeverbeck, Nils Ewen *dec. 2025*

12 Emina Šehmehmedović, Max Wijschenk *dec. 2025*  
13 Igor Sztormowski, Miriam Barnett *dec. 2025*  
14 Carla Zurlino, Casper van Tilburg *dec. 2025*

15 Eva Lücking, Marko Stevanov *dec. 2025*

16.



16 Stichting Geschiedschrijving *n.d.*

17.

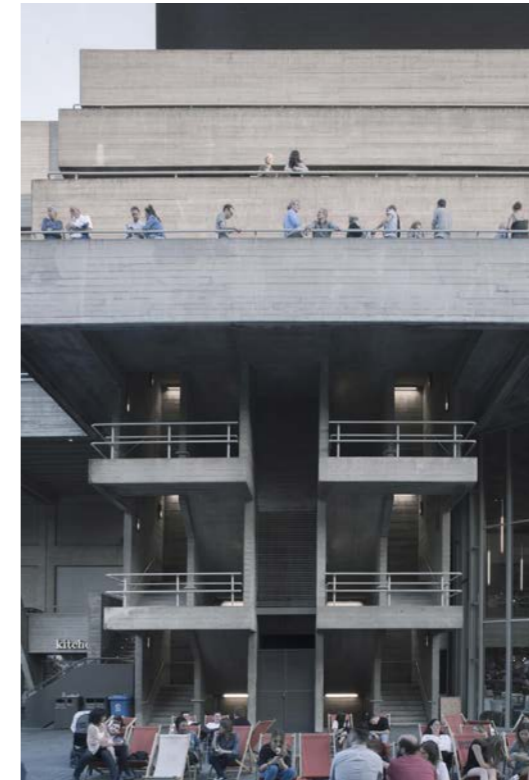

17 Lorenzo Zandri *jun. 2020*



18.



19.



20.



21.



22.



23.

16 delamar *n.d.*  
17, 19 Dexter Scholten *dec. 2025*  
18 Nationaal Opera en Ballet *n.d.*

20 Dexter Scholten *jan. 2025*  
21 Dexter Scholten *mar. 2025*



16.



18.



17.



19.



20.



21.

16 delamar *n.d.*  
17, 19 Dexter Scholten *dec. 2025*  
18 Nationaal Opera en Ballet *n.d.*

20 Dexter Scholten *jan. 2026*  
21 Dexter Scholten *mar. 2026*

# Act II

## *The Theatre Lands*



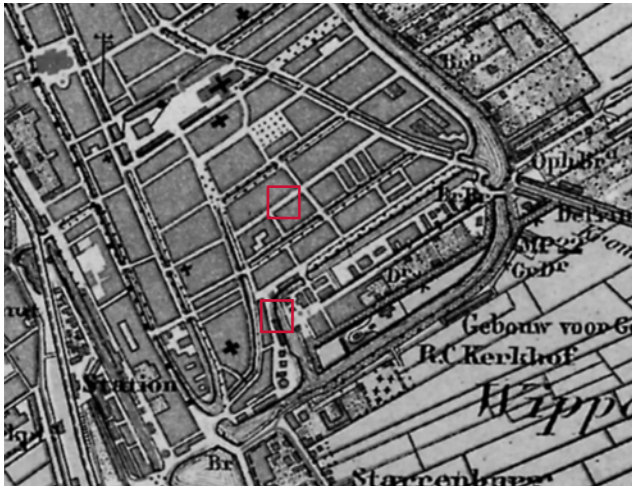

23. ca. 1890



24. 1940



25. 1963



26. 1981

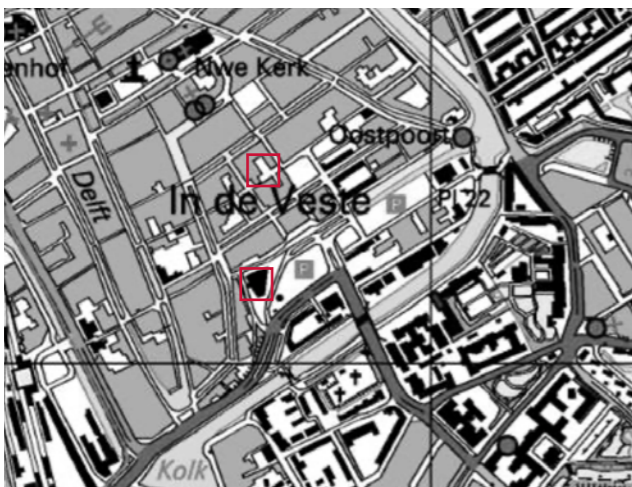

27. 2000

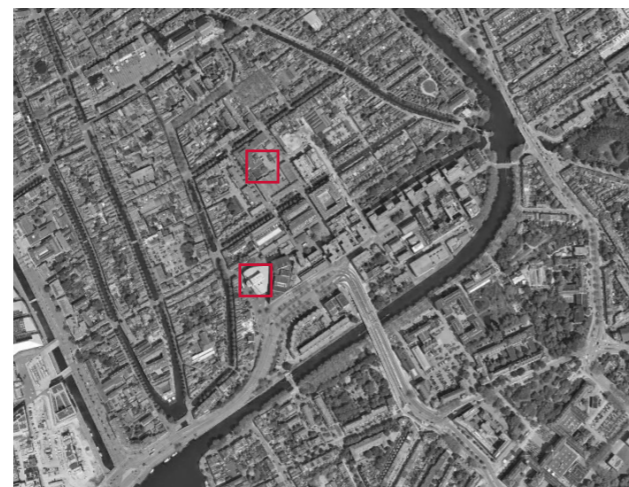

28. 2026

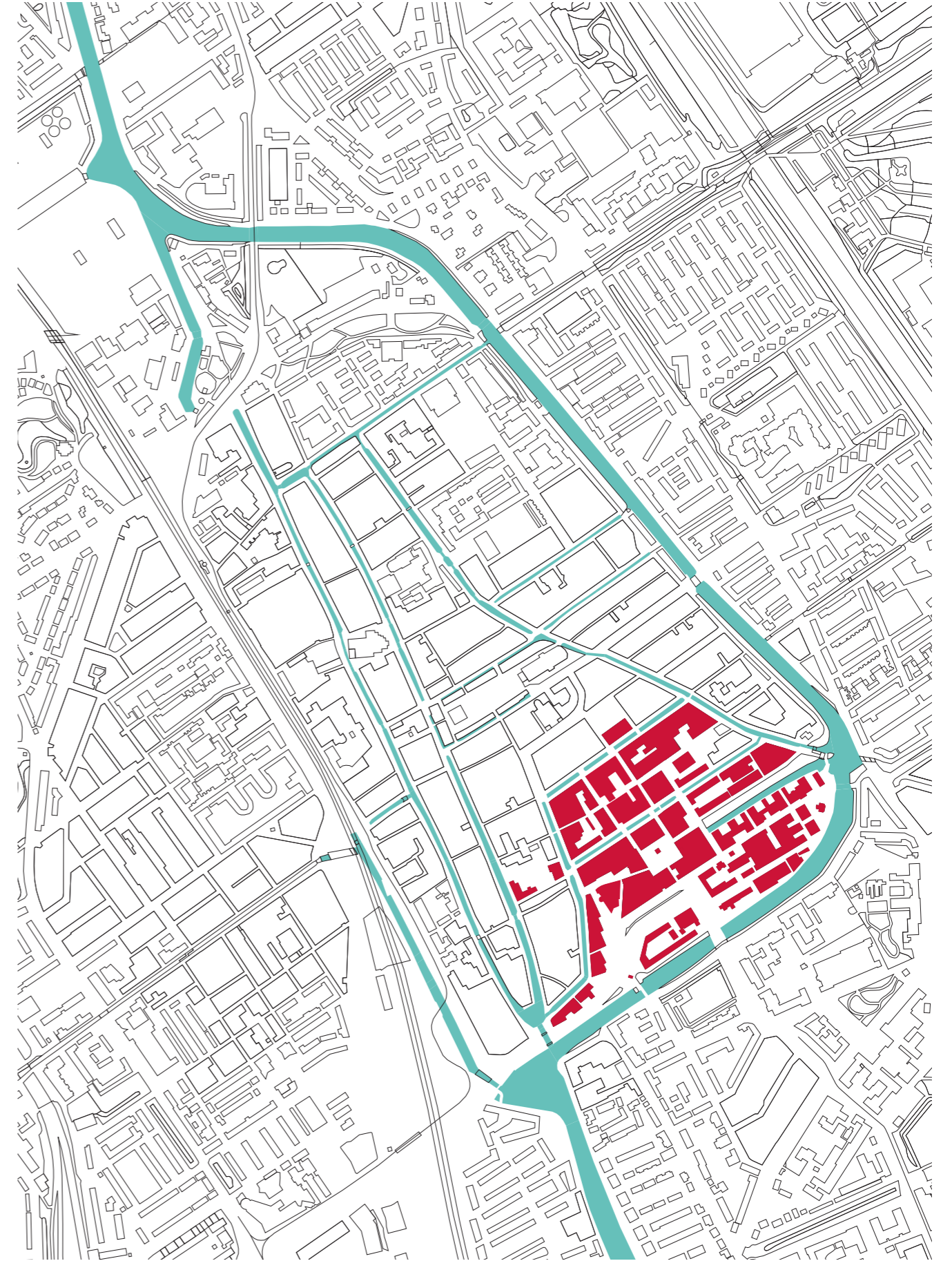

29.



23,24,25,26,27 Topotijdreis may. 2026

28 Google Earth may. 2026

29 Dexter Scholten may. 2026



30 Erfgoed Delft *n.d.*



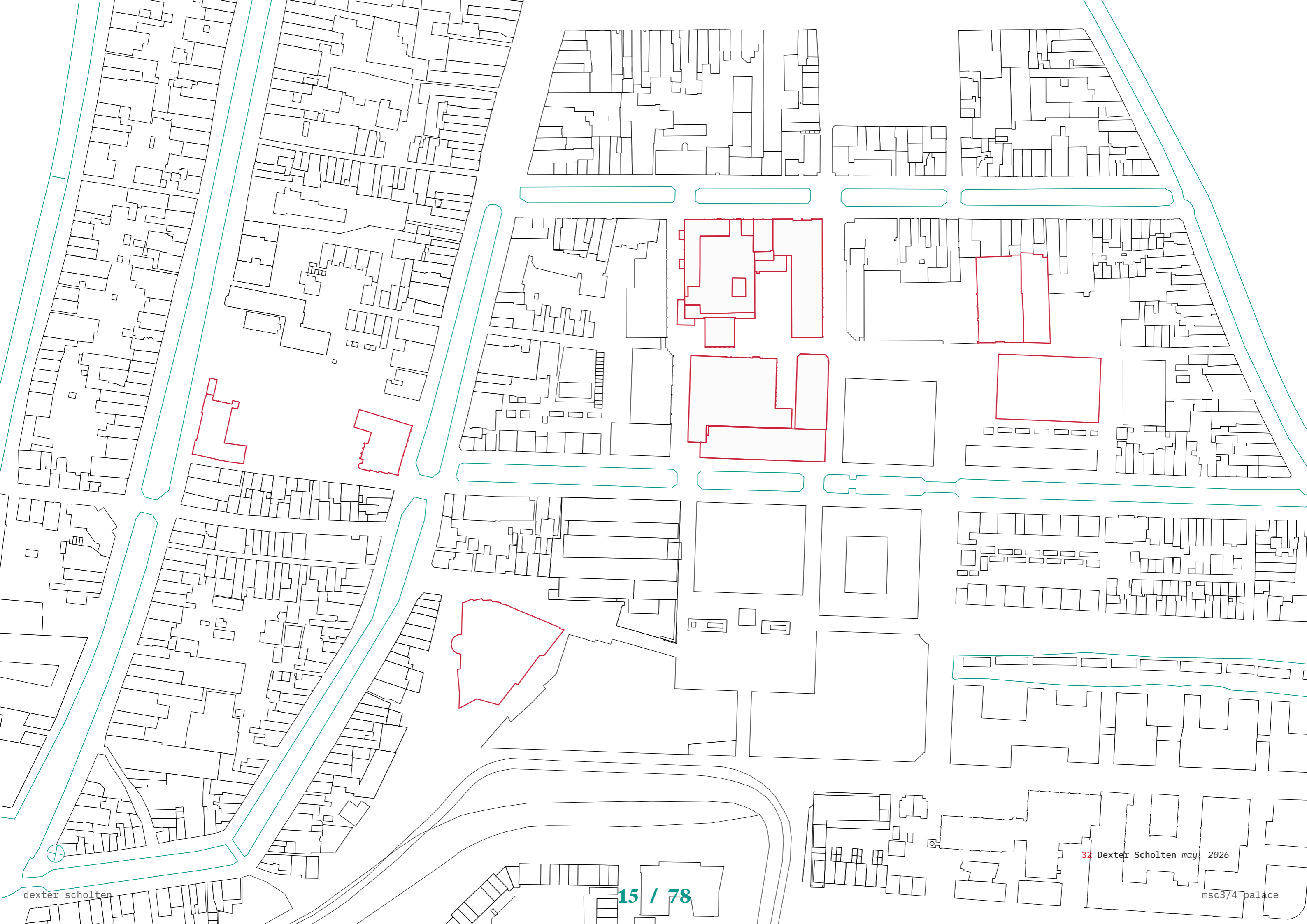

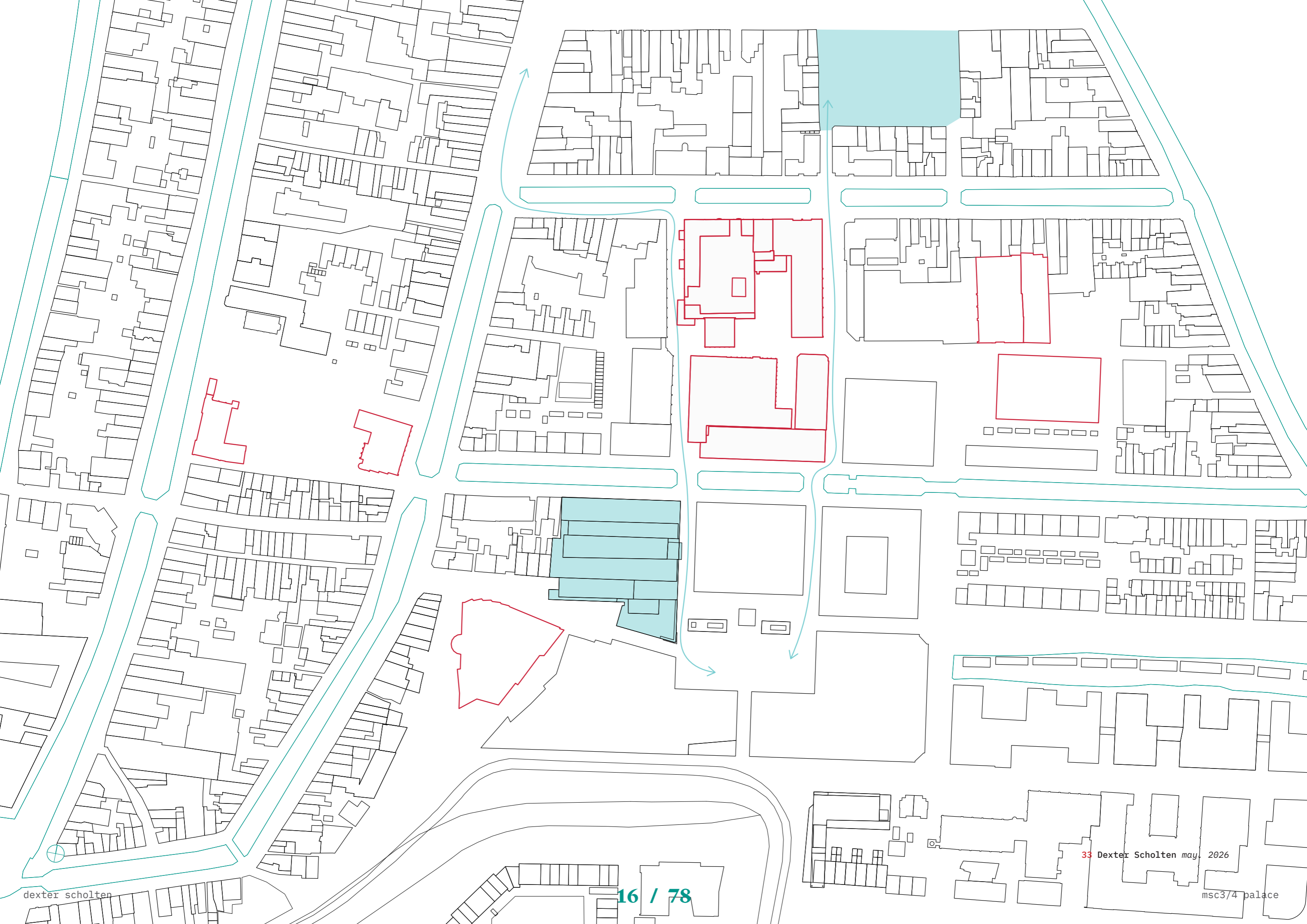

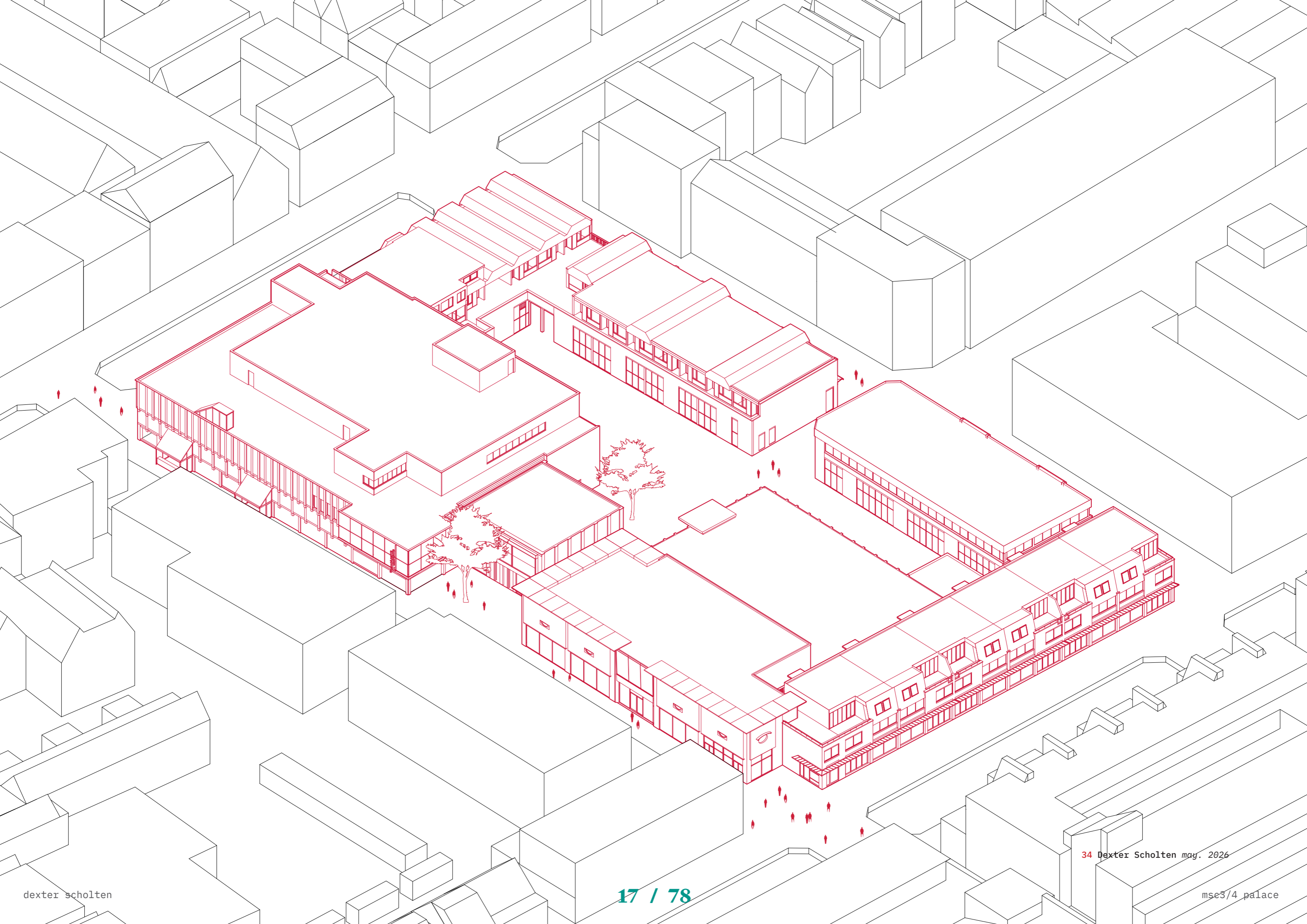

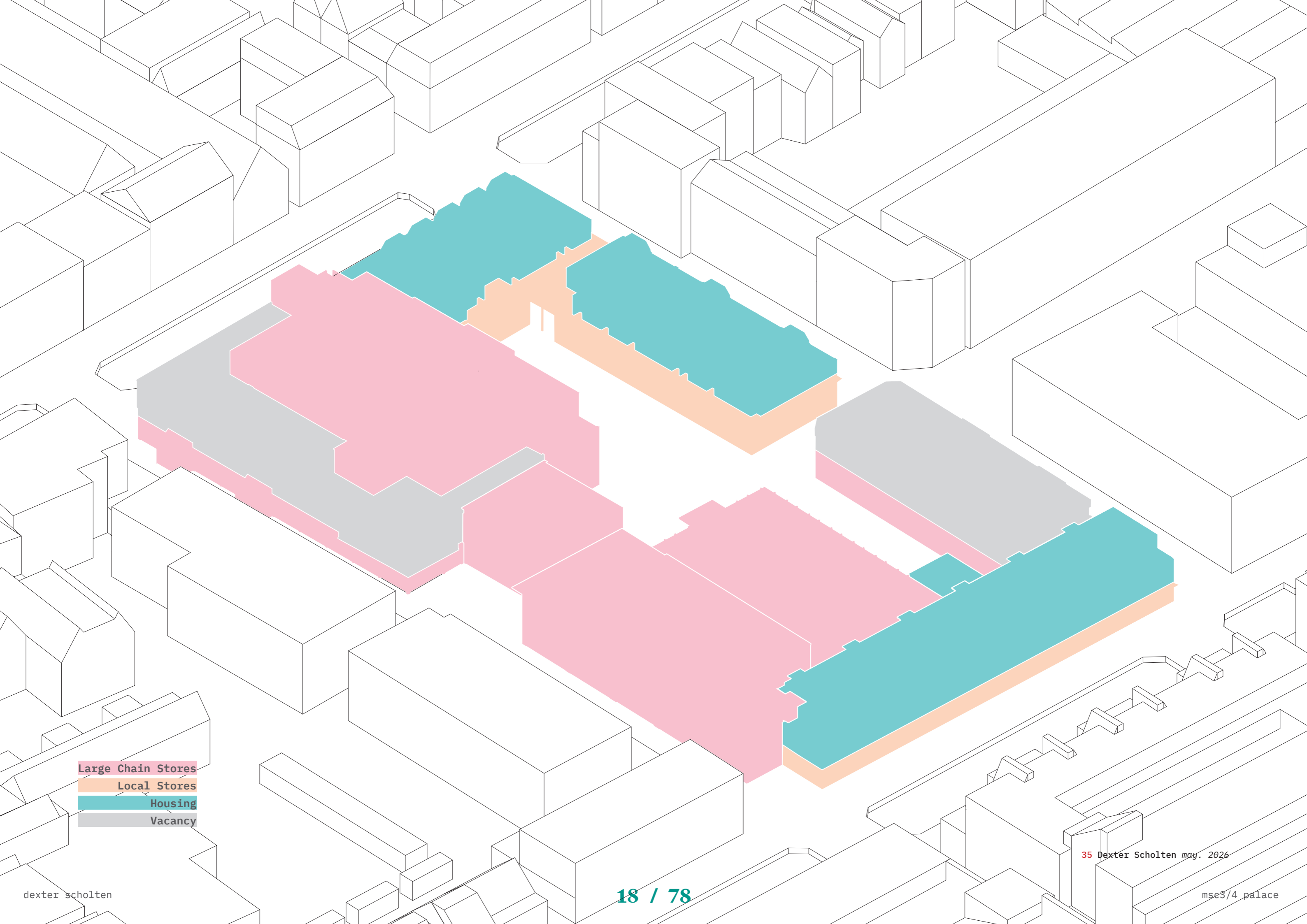

- Large Chain Stores
- Local Stores
- Housing
- Vacancy

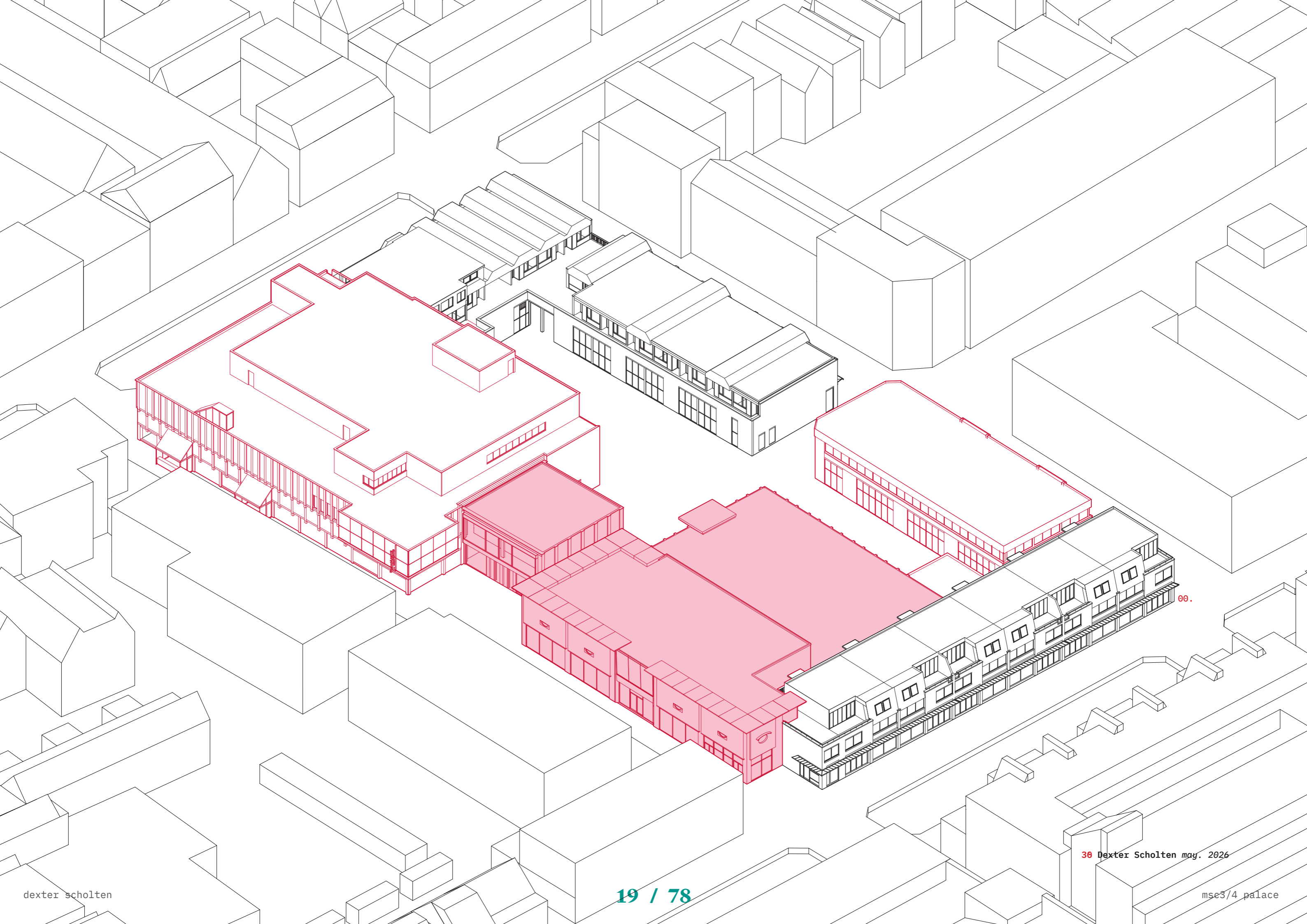

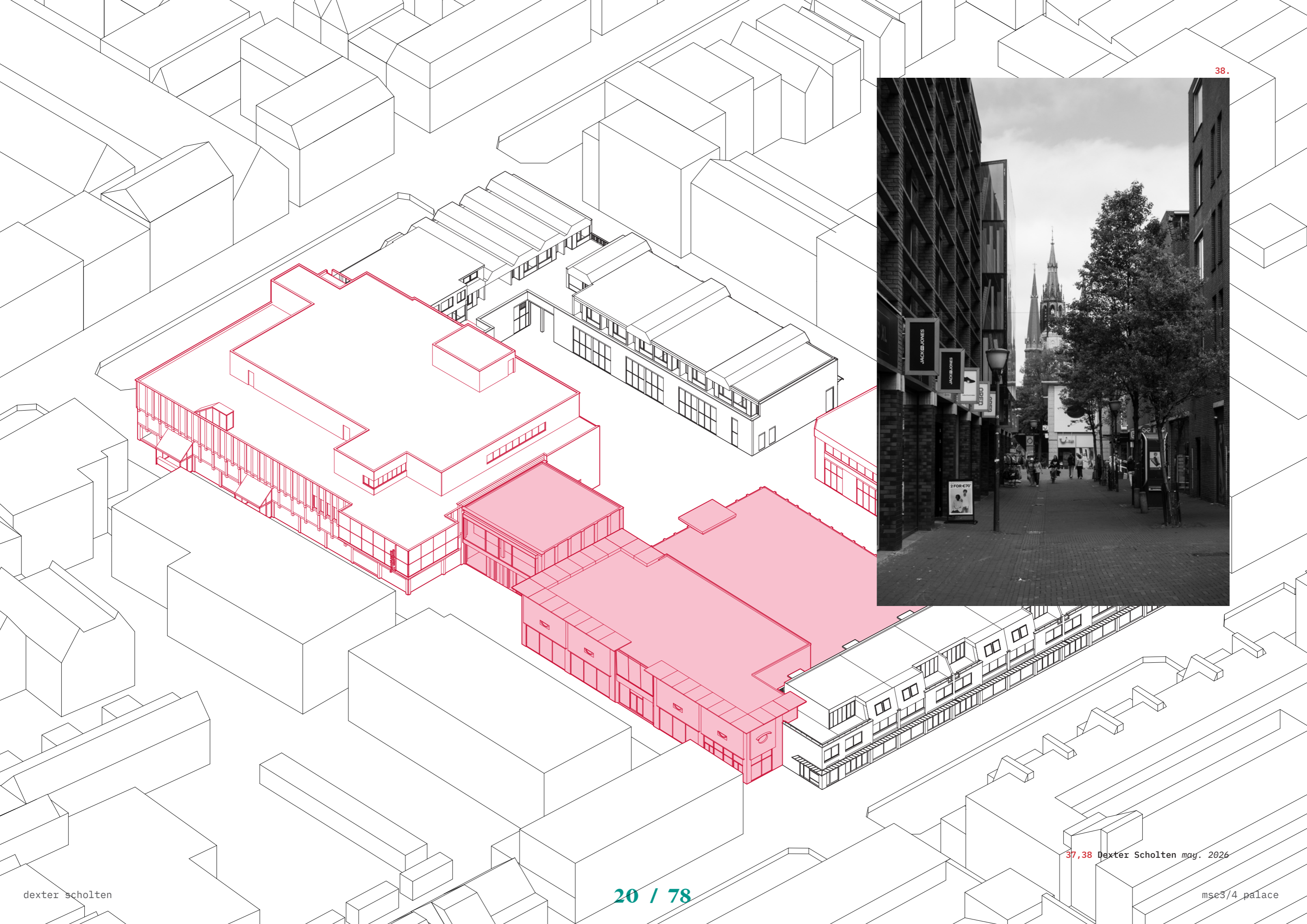

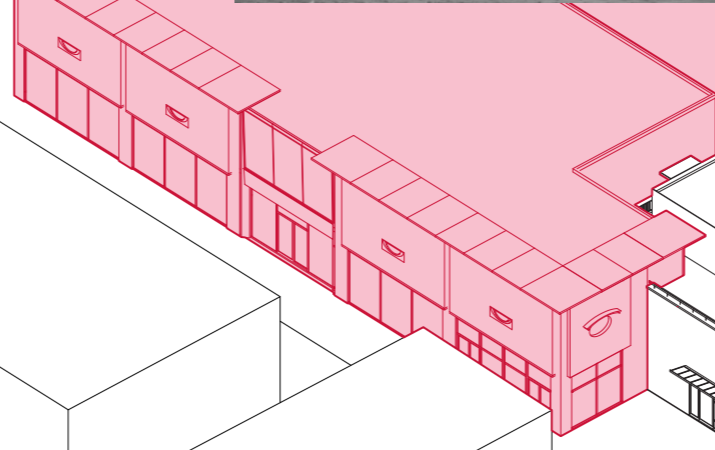
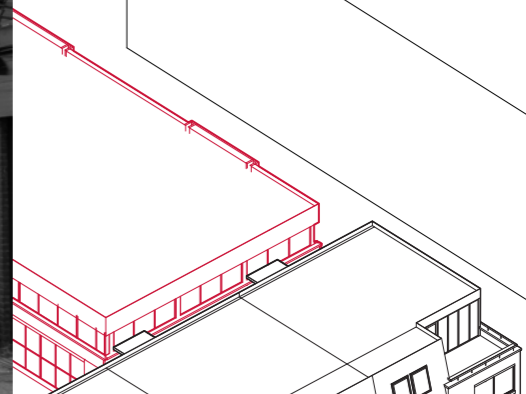
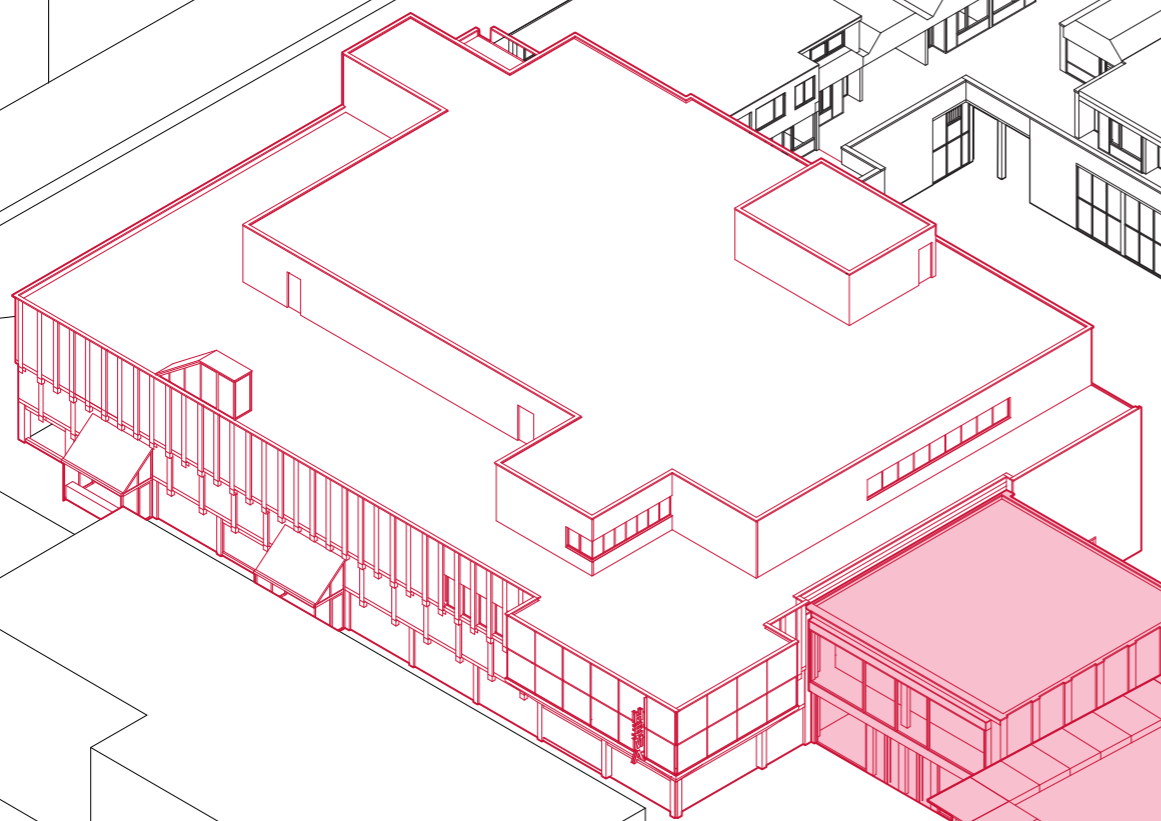

42.

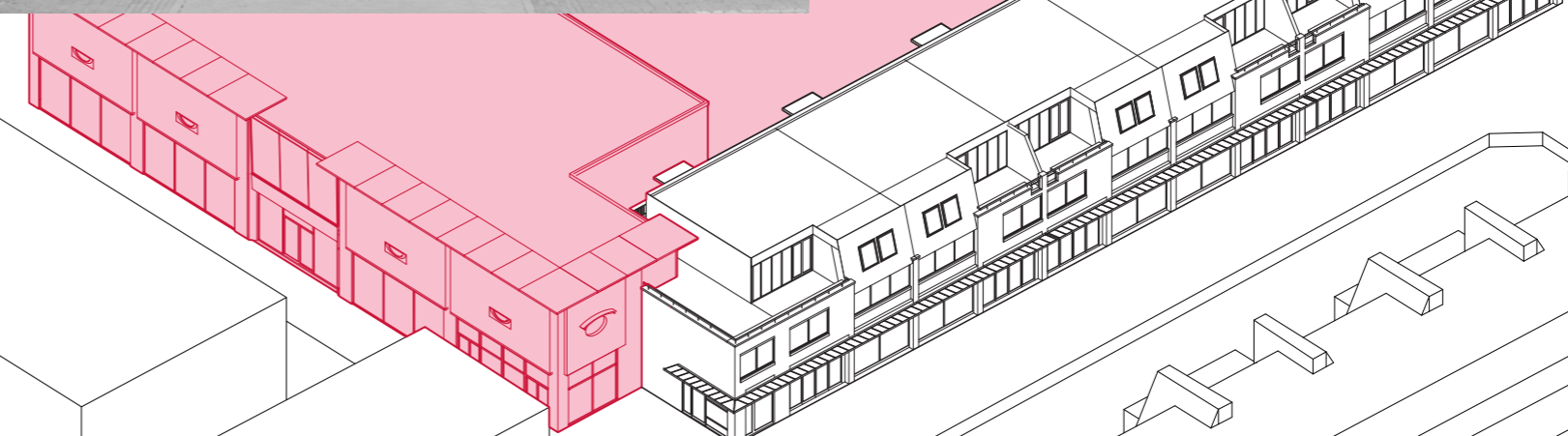
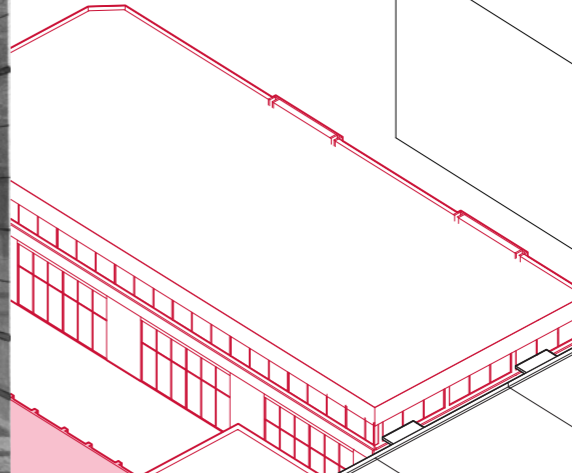
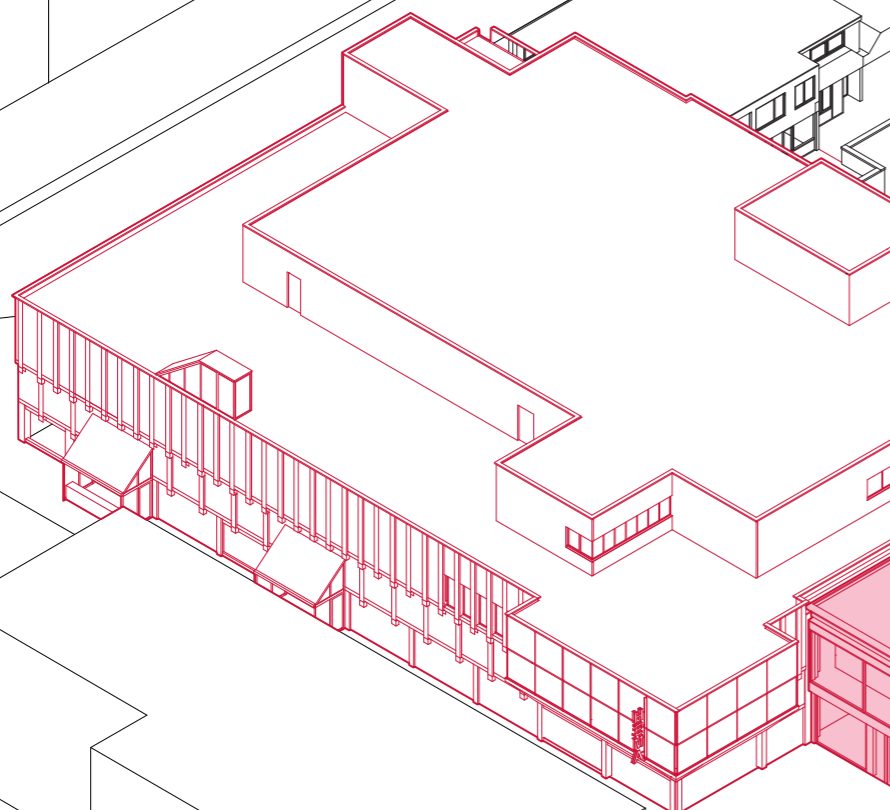

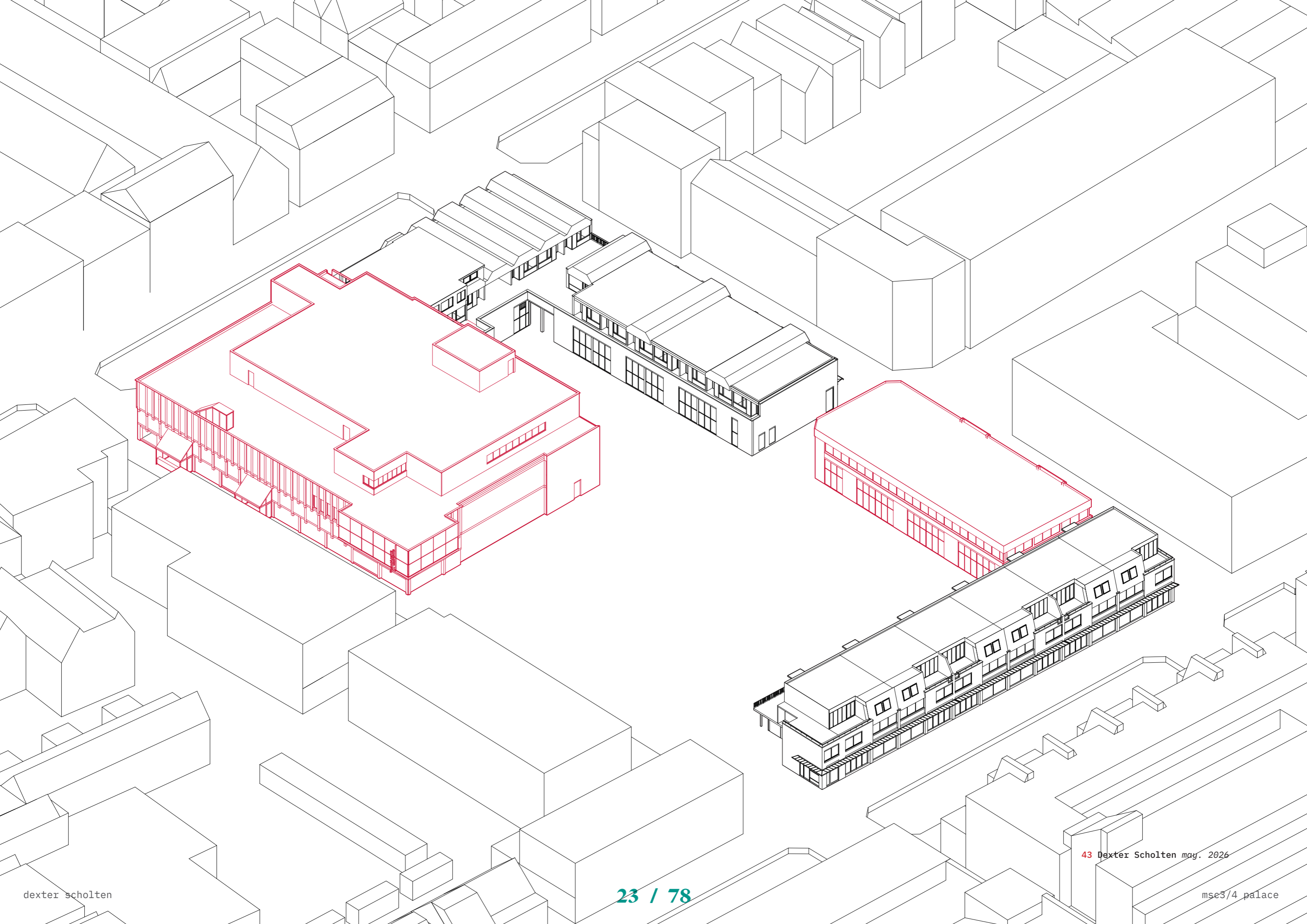

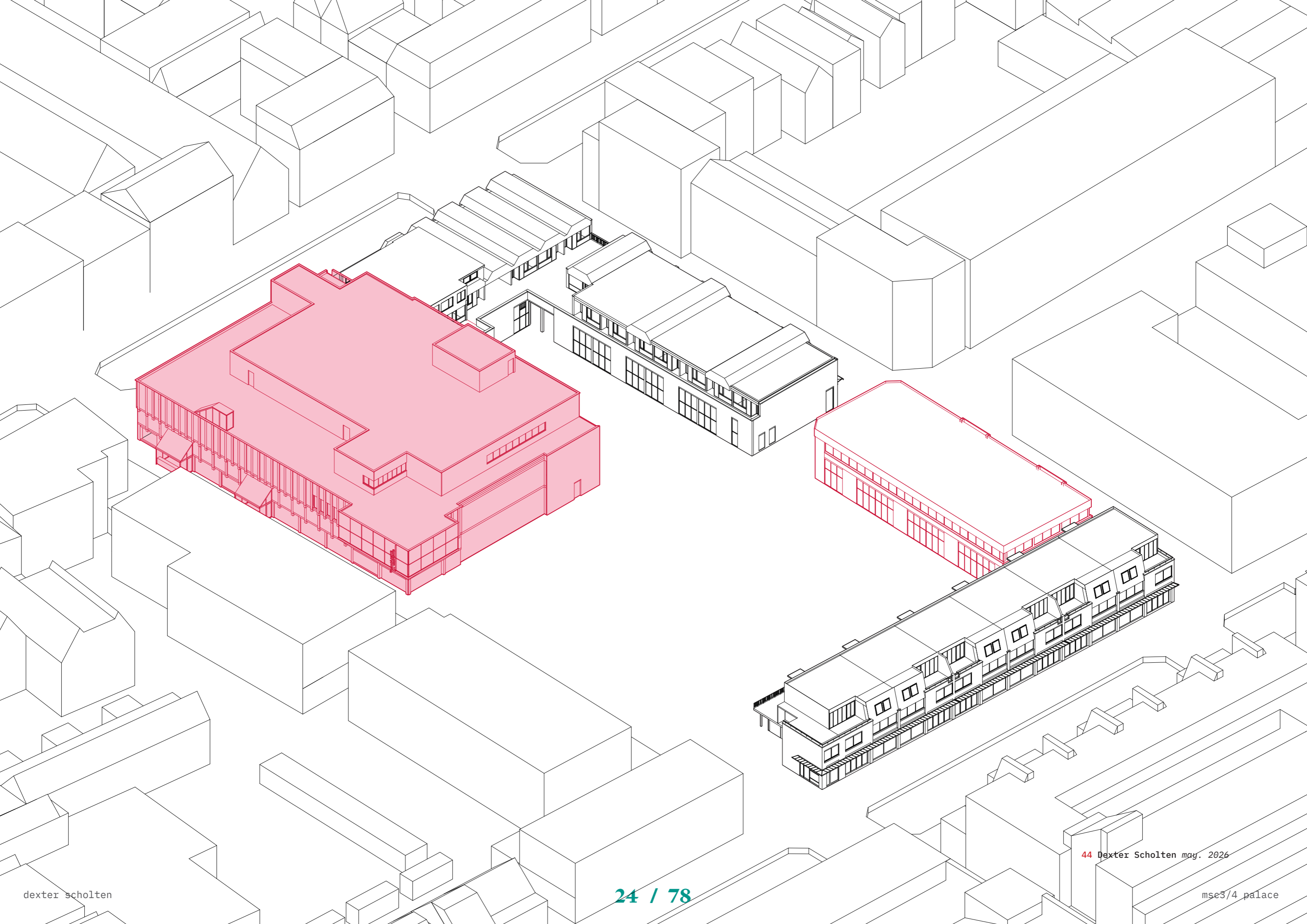

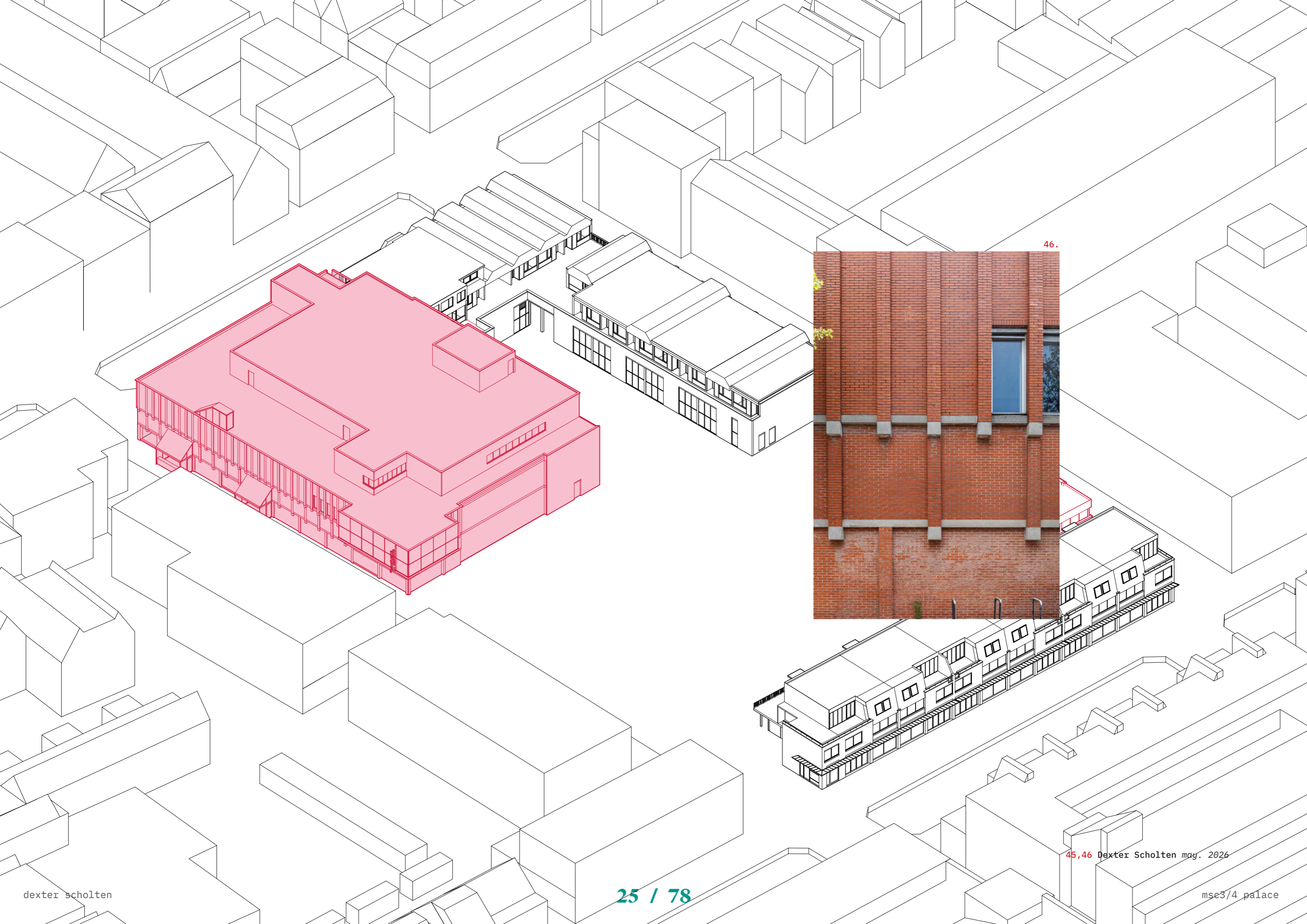

46.

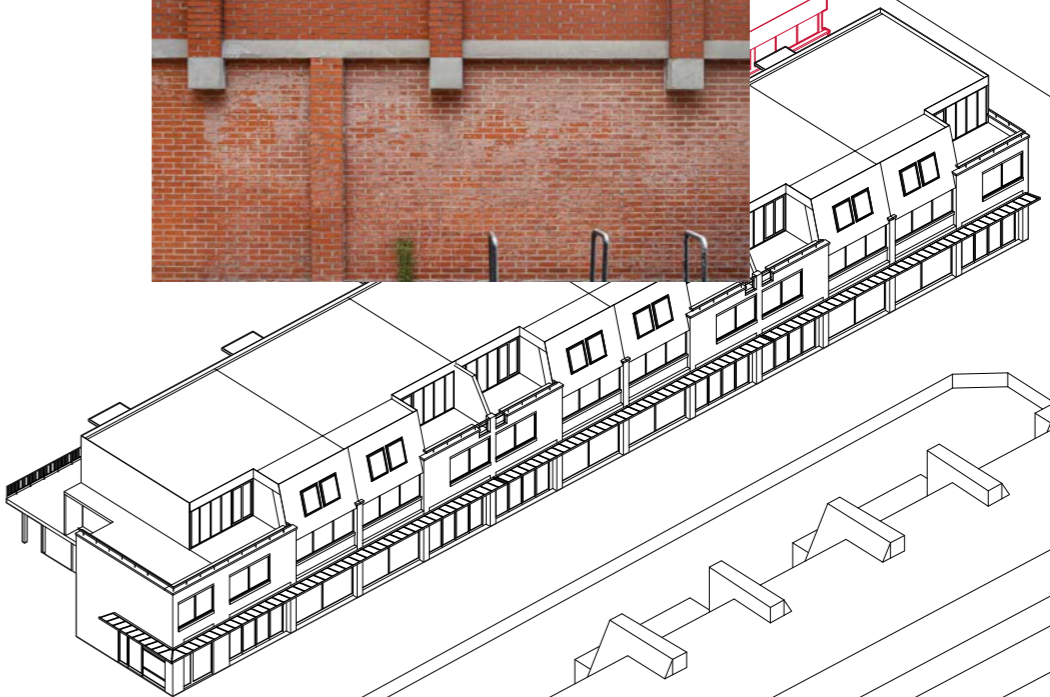
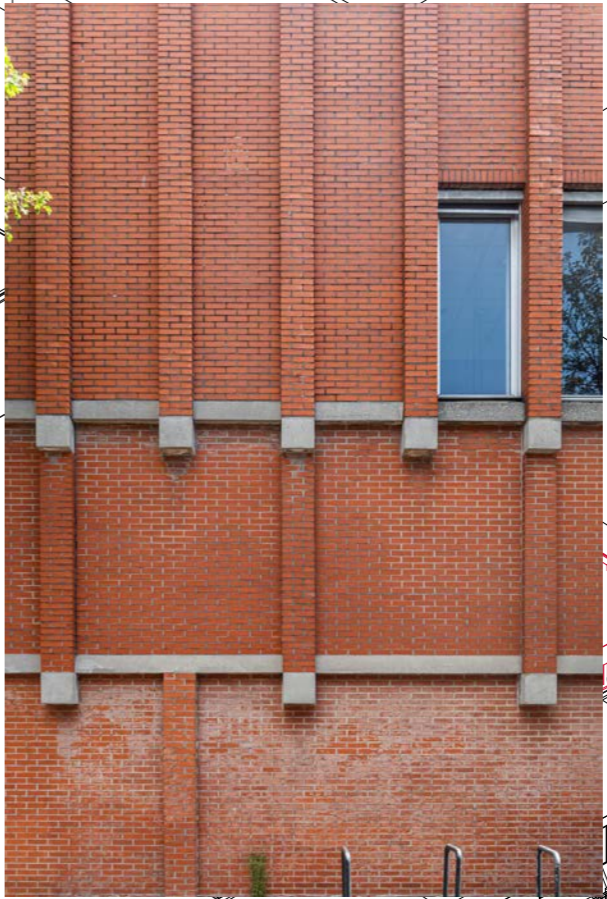

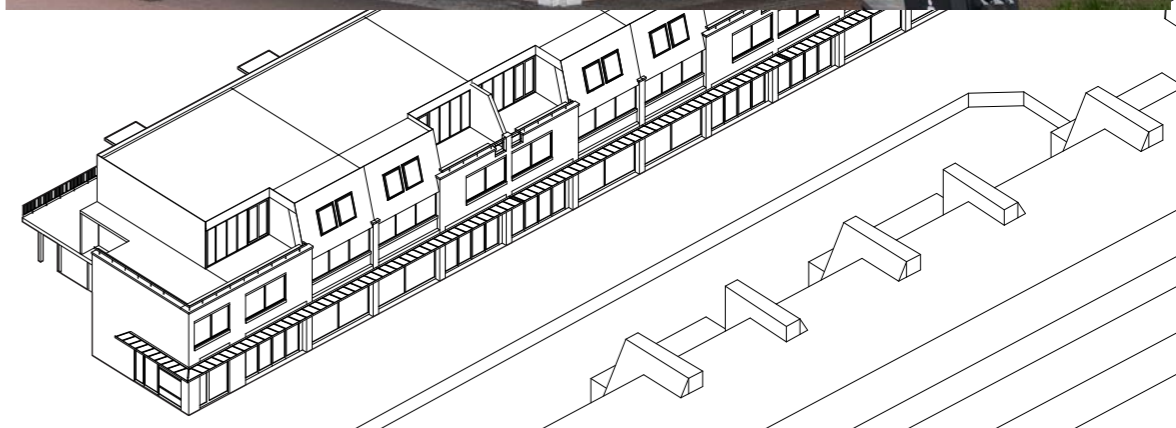
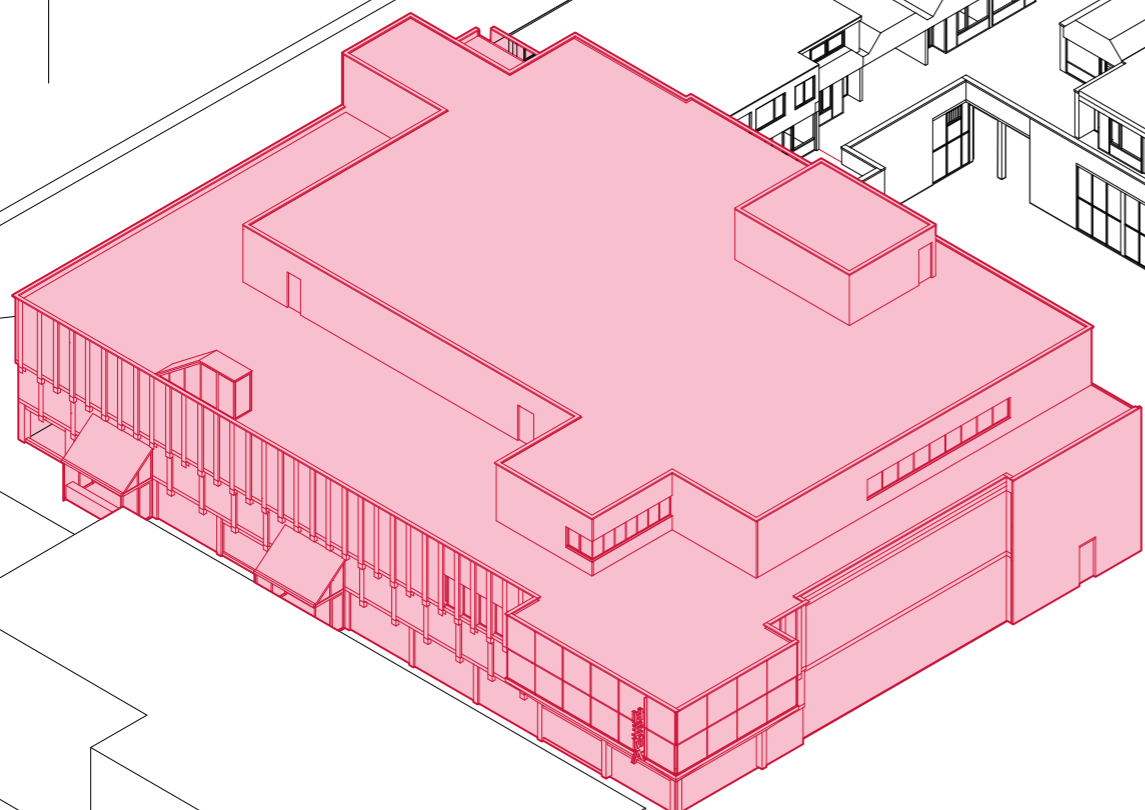

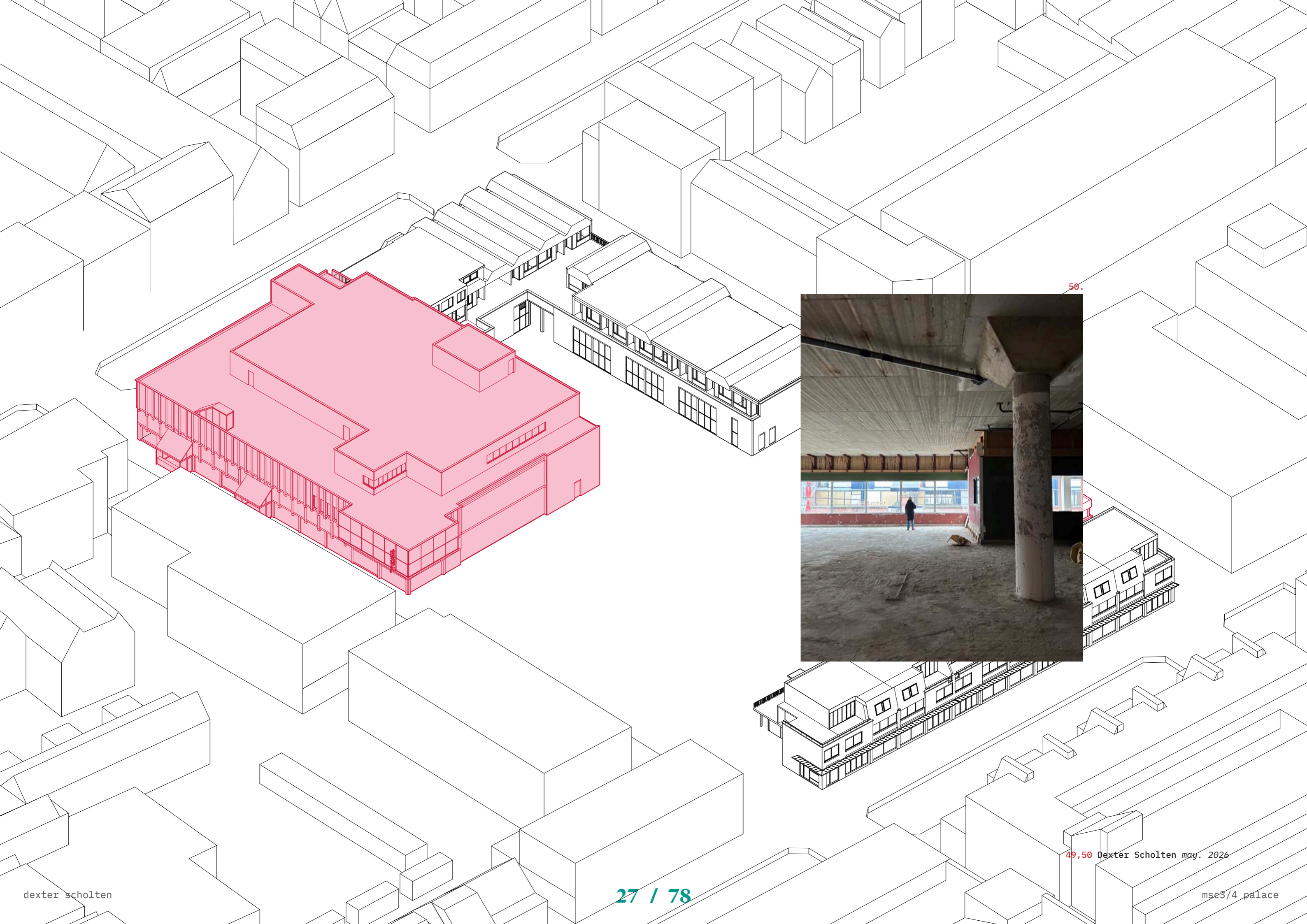

50.



49,50 Dexter Scholten may. 2026

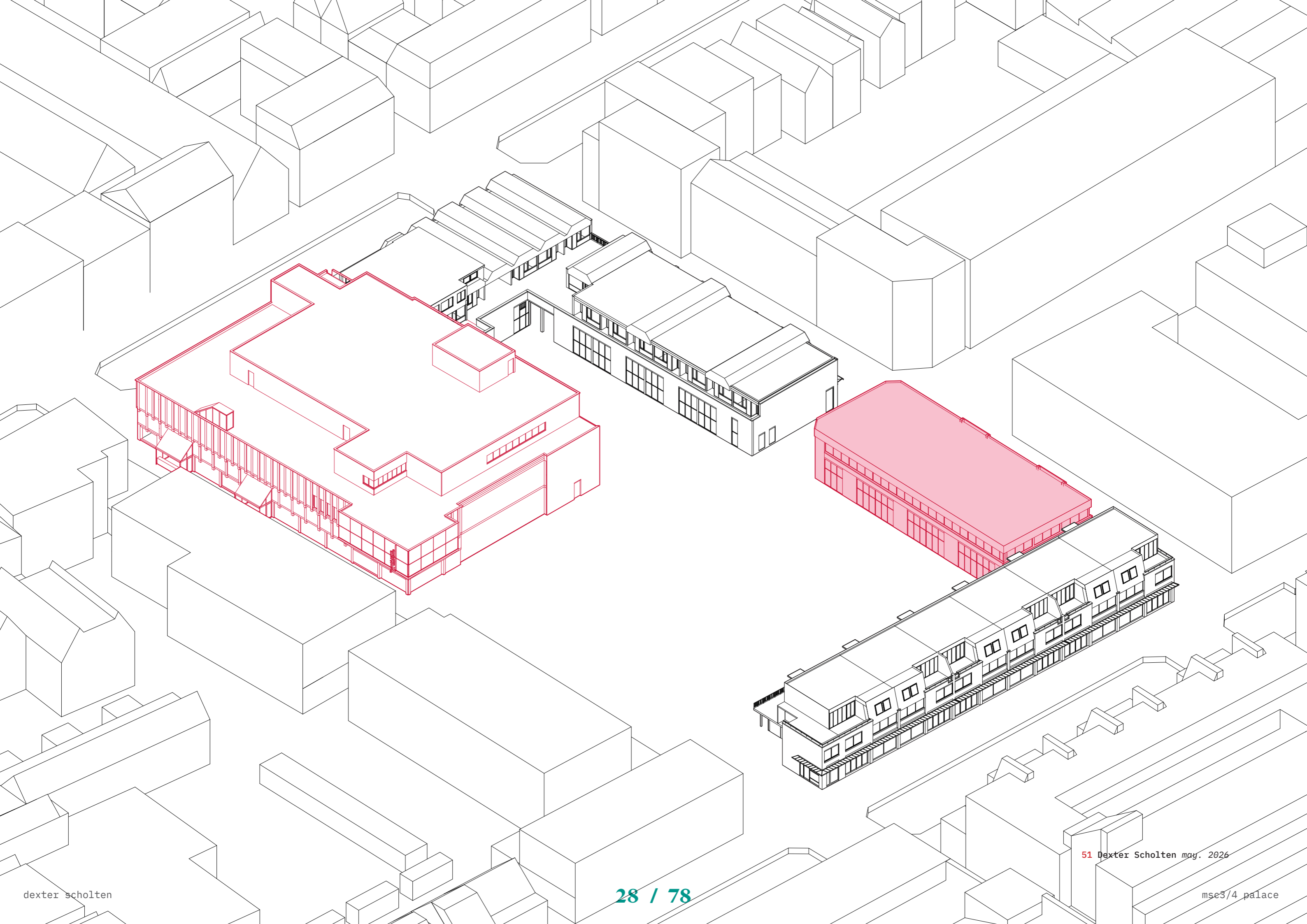



53.

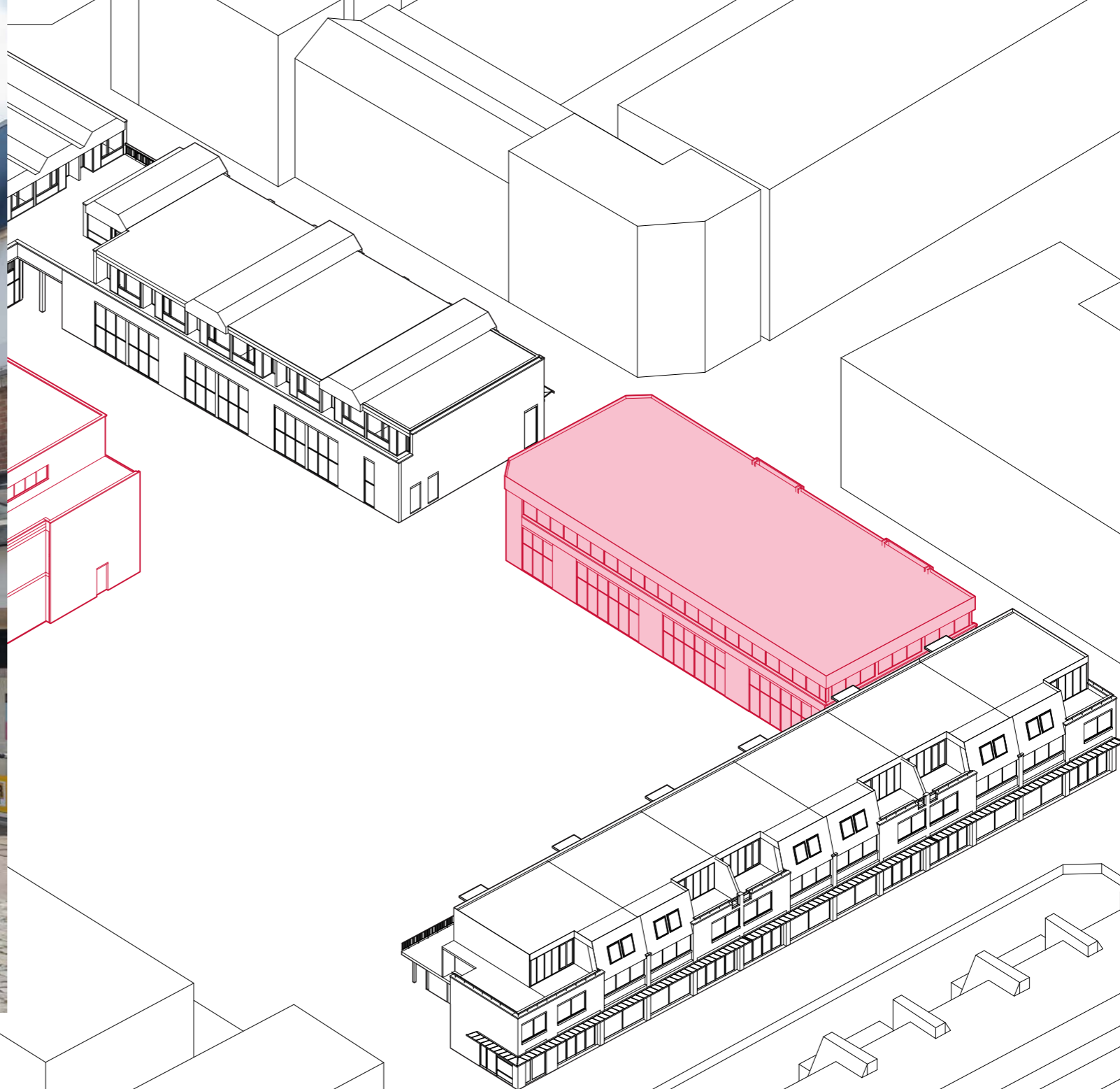

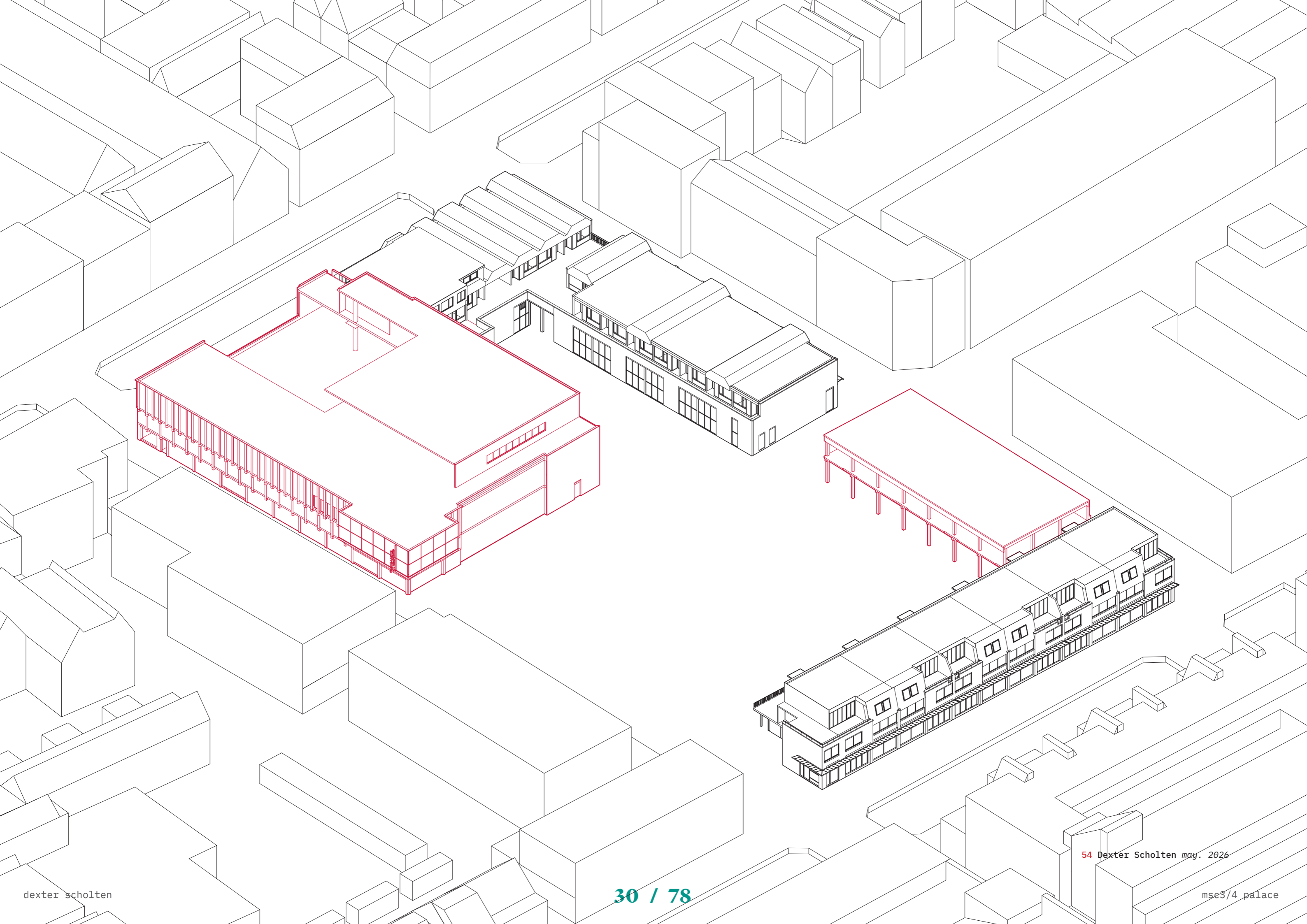

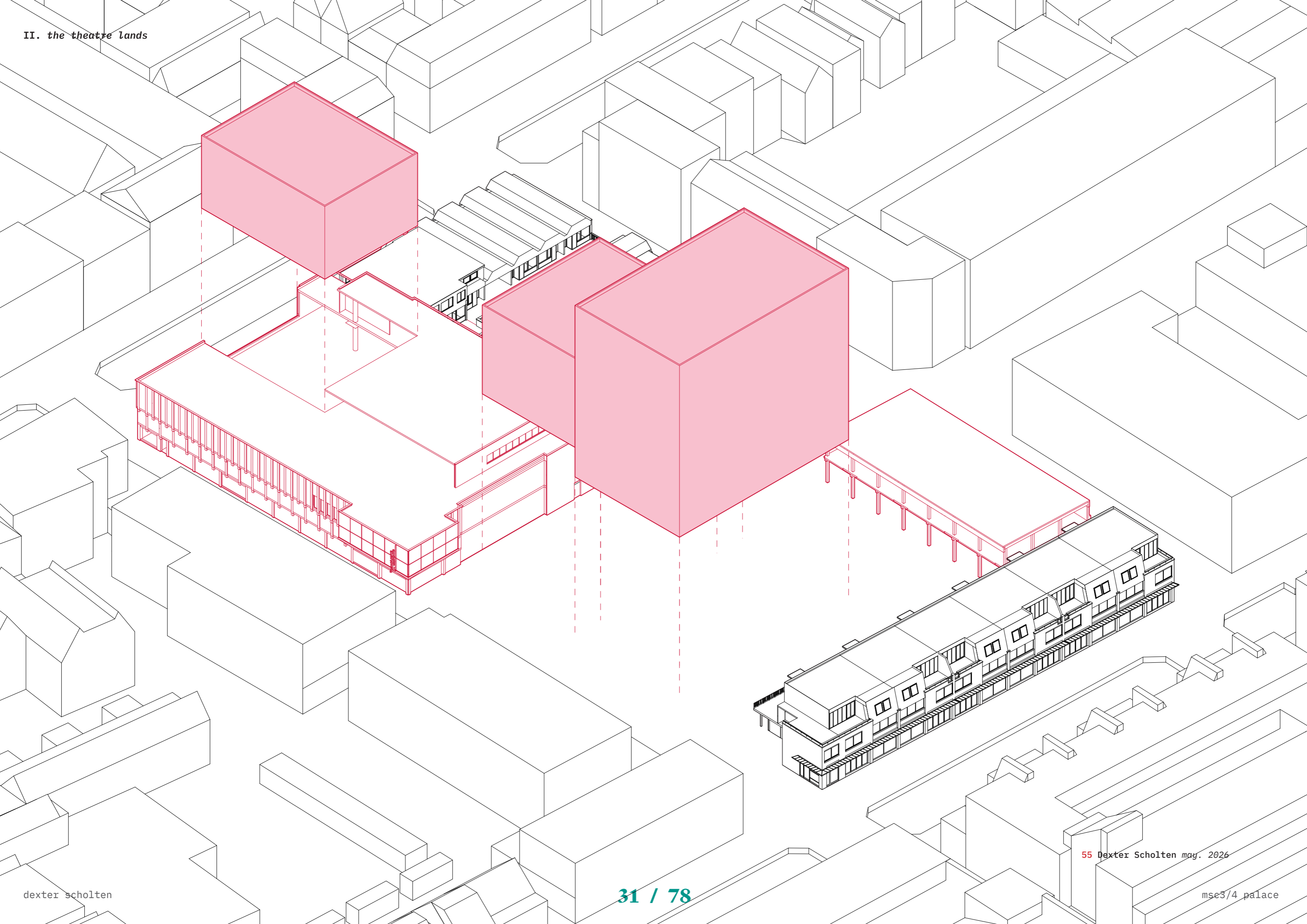

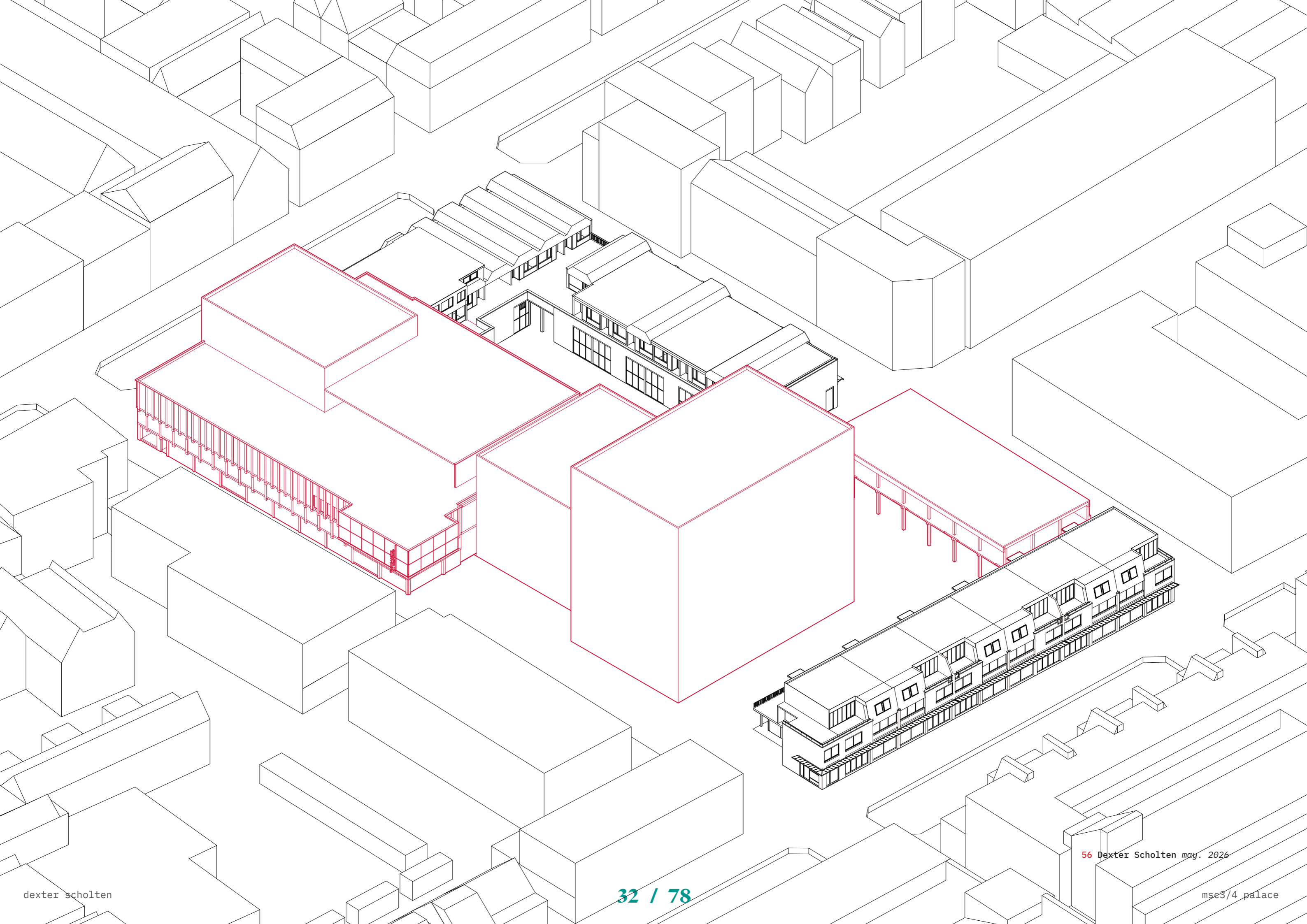

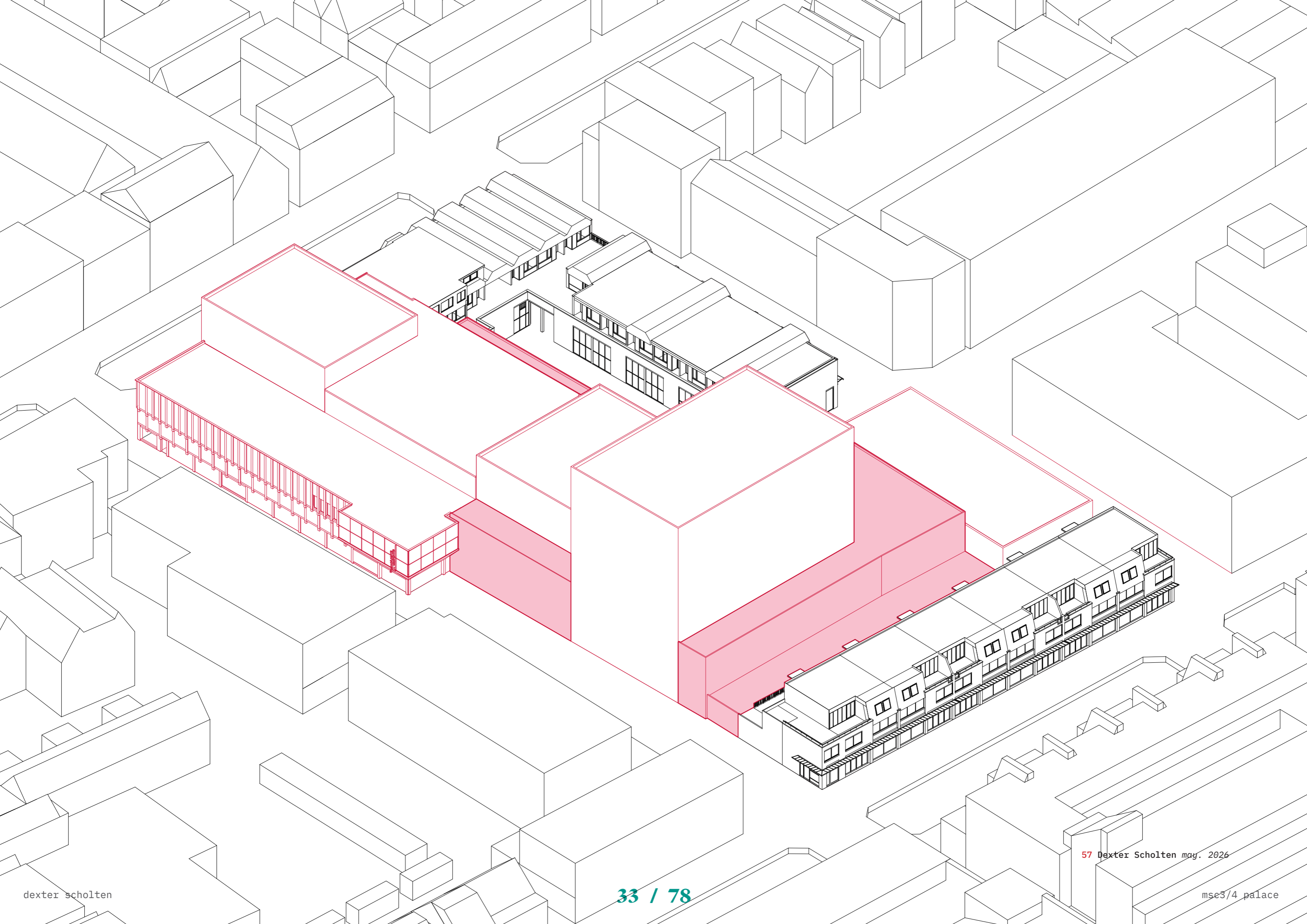

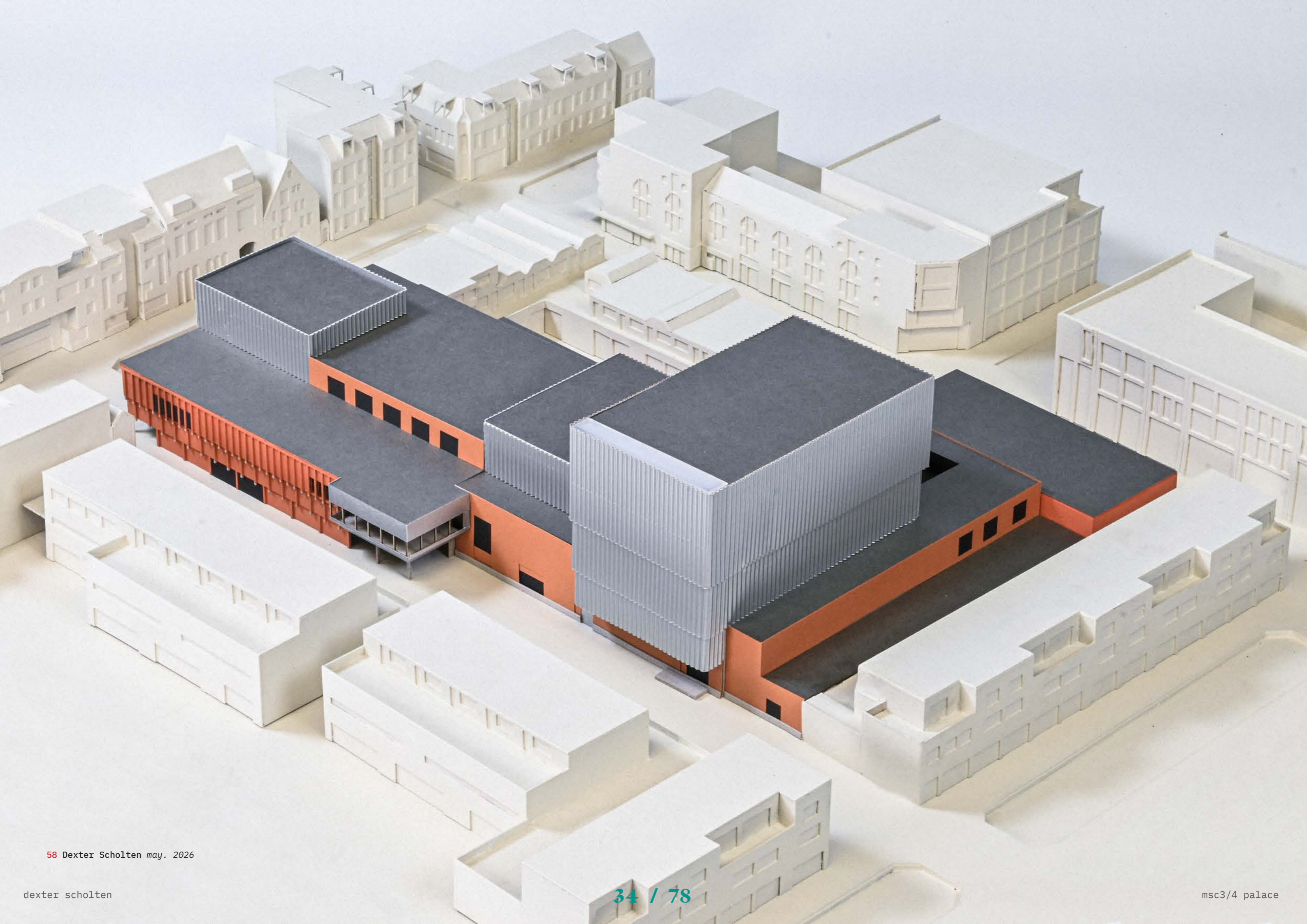

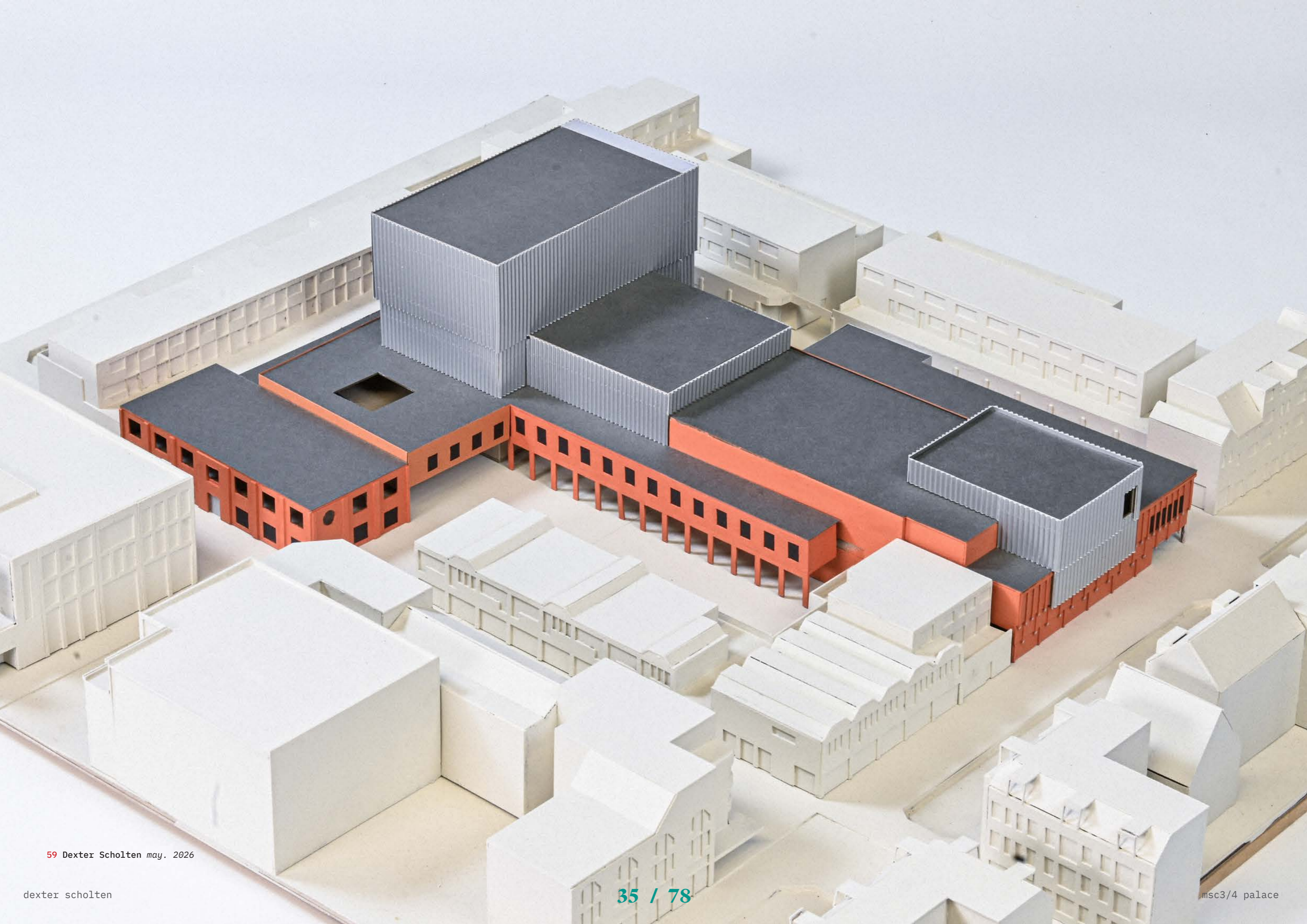

**Act III**  
*The Visitor Arrives*



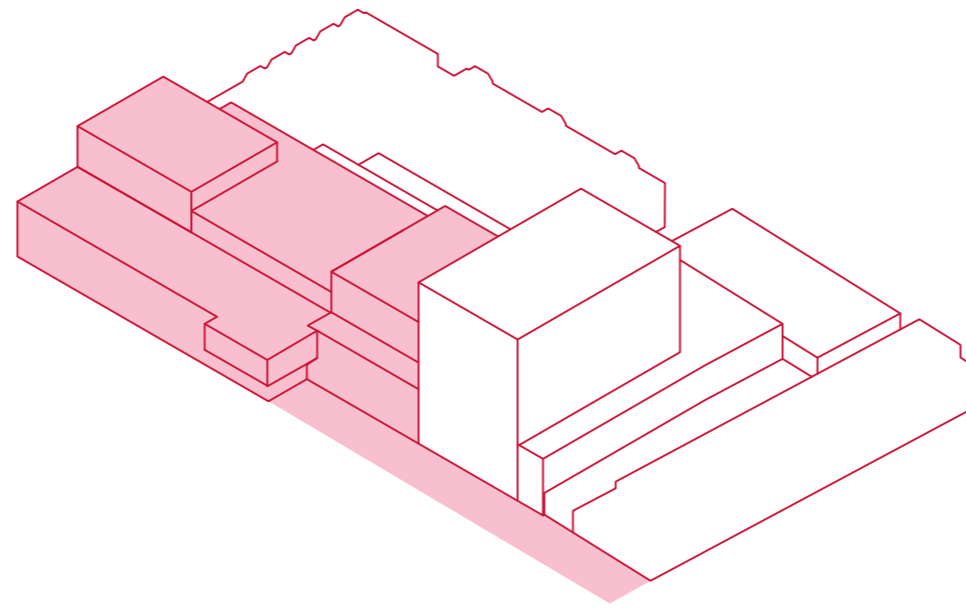

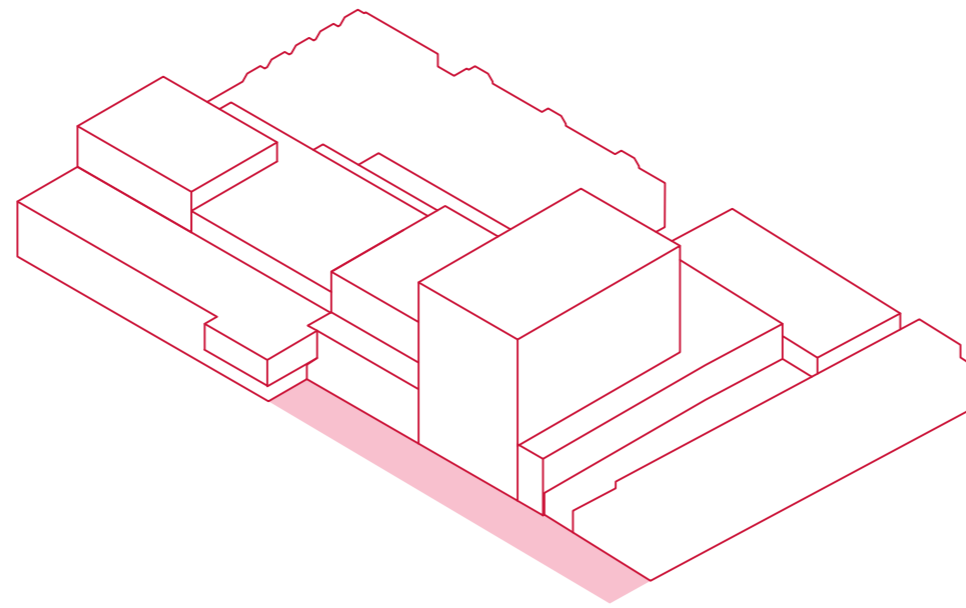

III. a first acquaintance

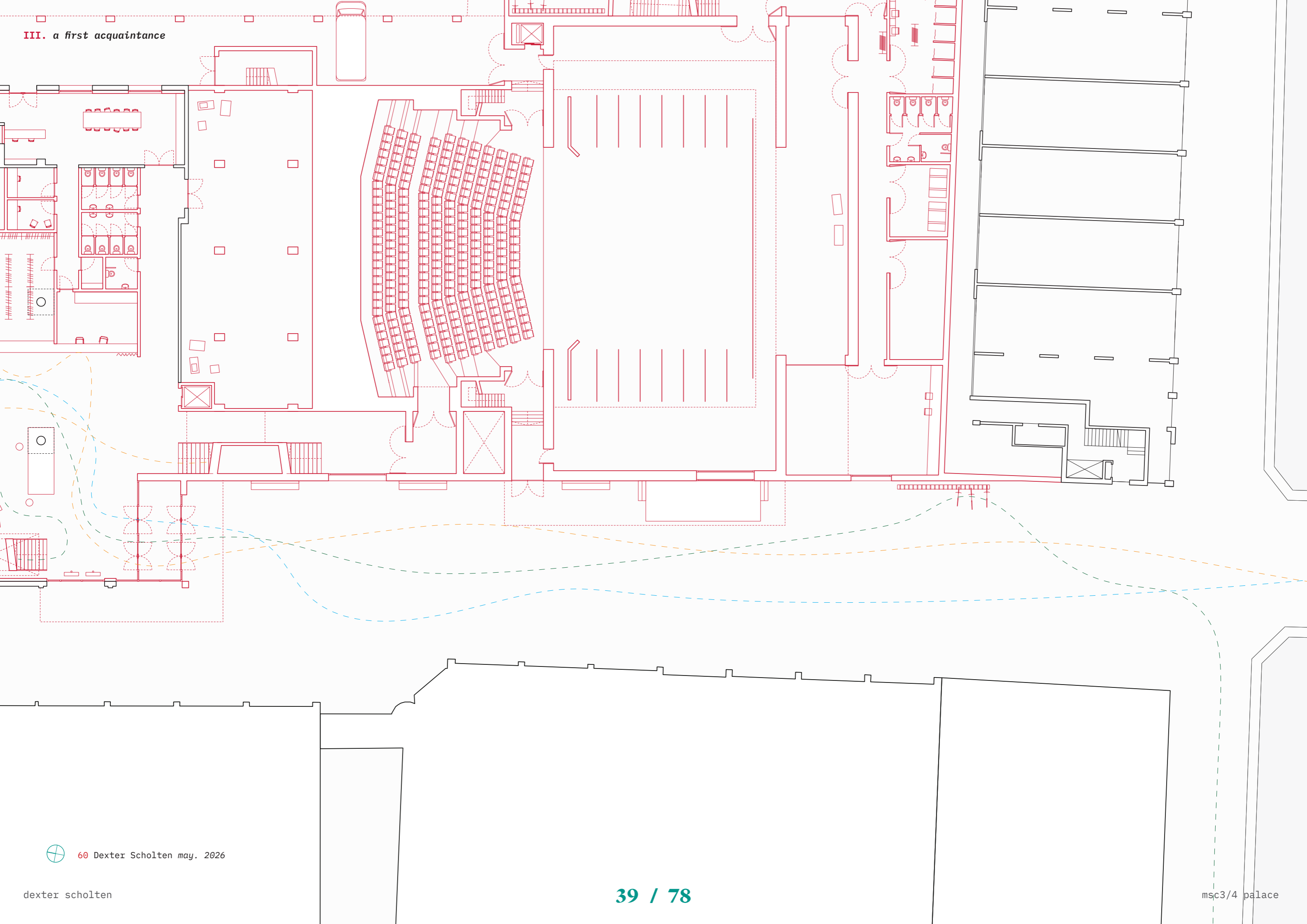



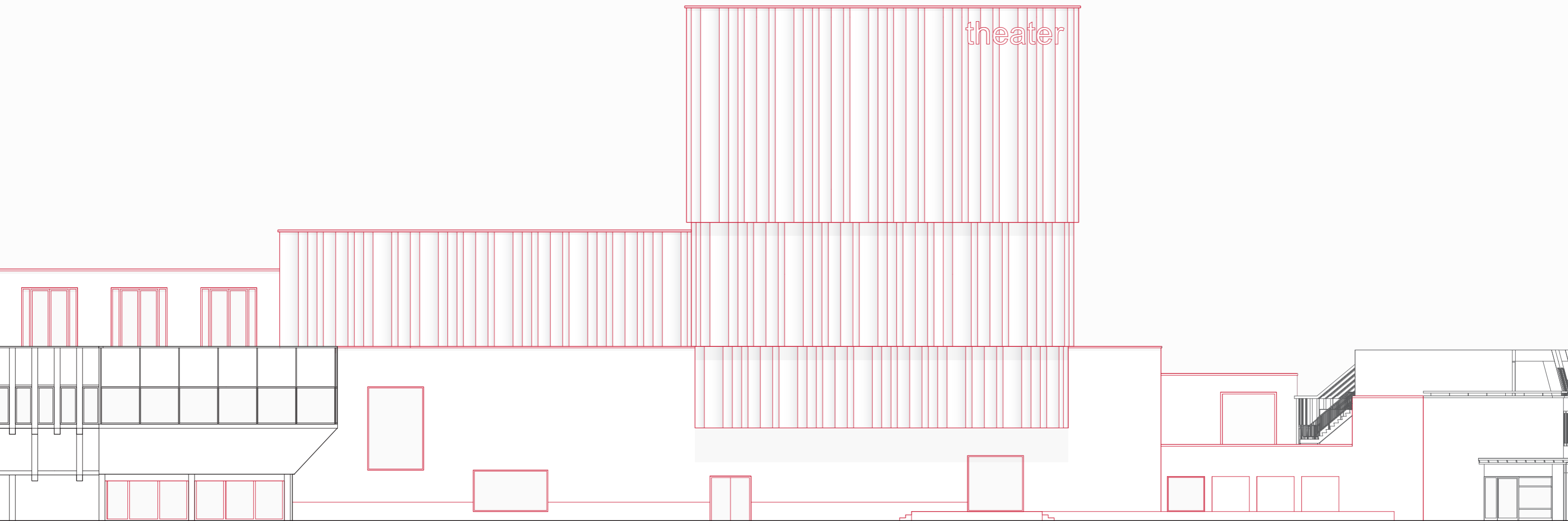

theater

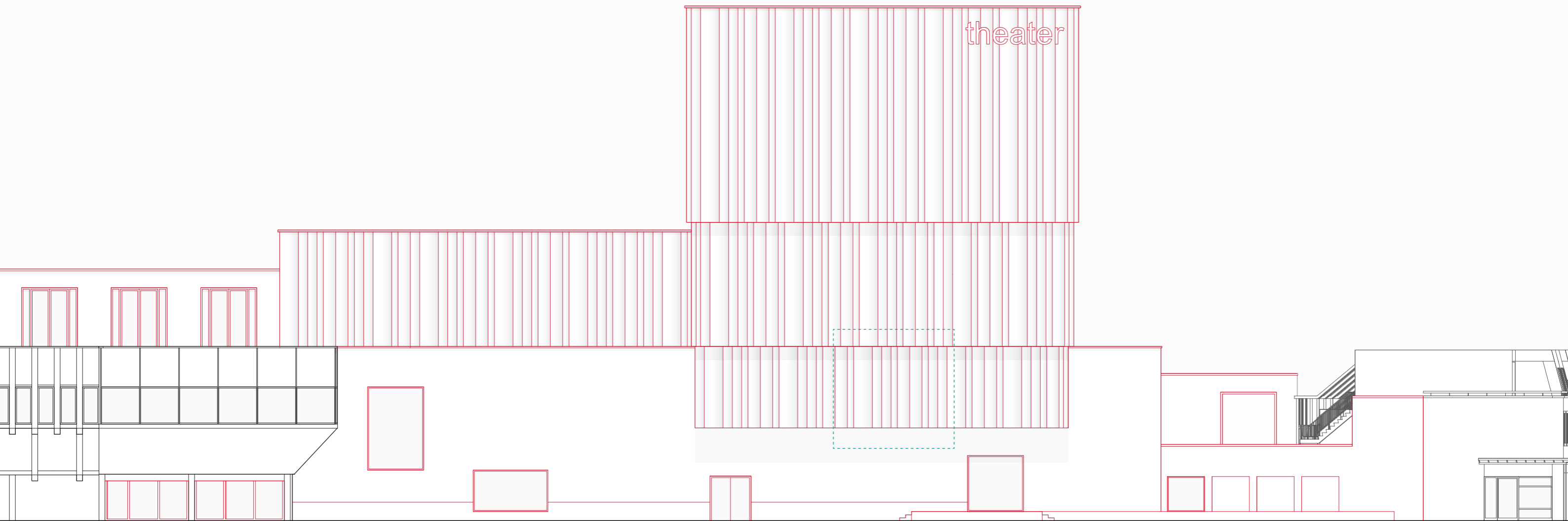

theater

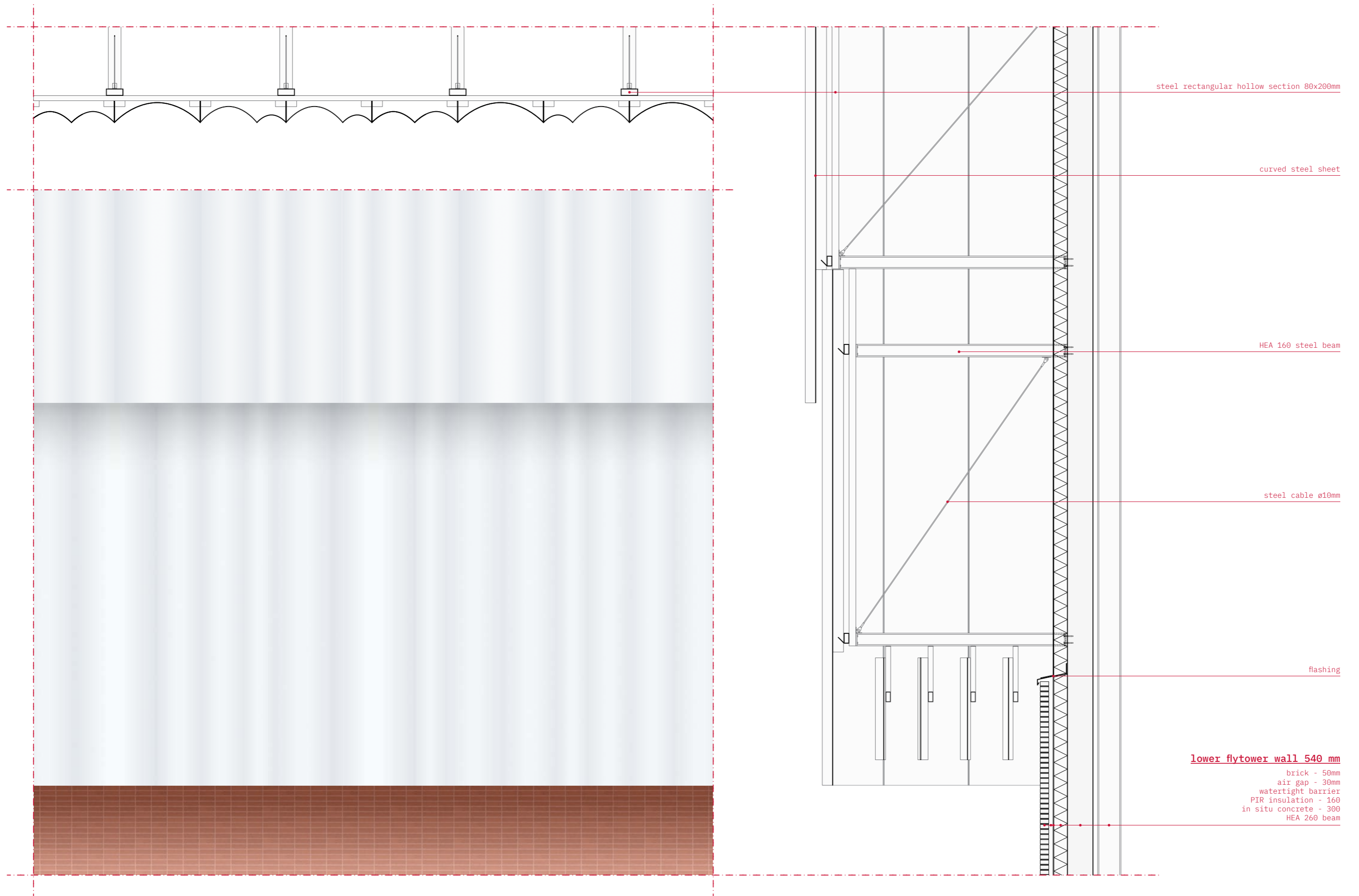

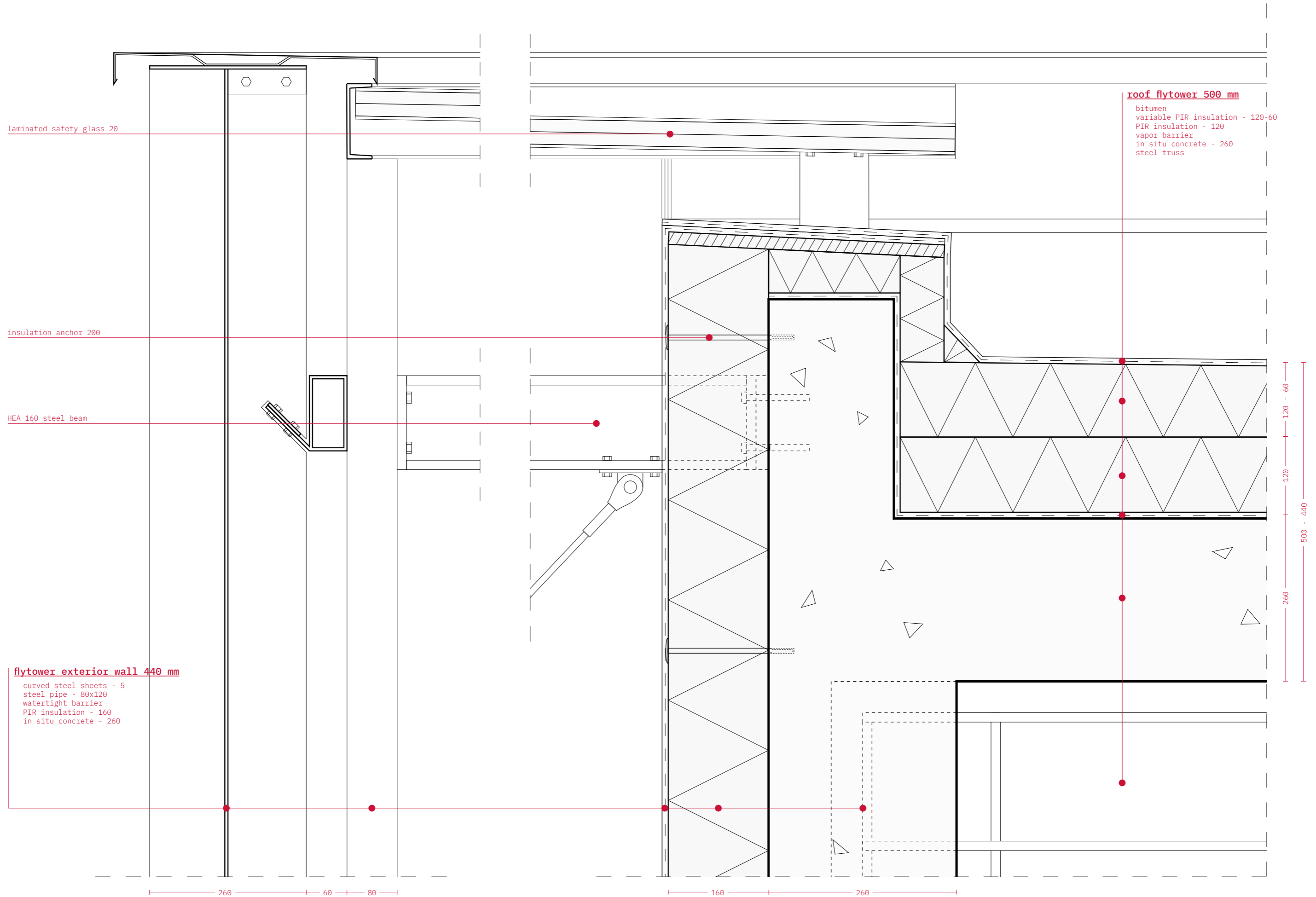

laminated safety glass 20

insulation anchor 200

HEA 160 steel beam

flytower exterior wall 440 mm

curved steel sheets - 5  
 steel pipe - 80x120  
 watertight barrier  
 PIR insulation - 160  
 in situ concrete - 260

roof flytower 500 mm

bitumen  
 variable PIR insulation - 120-60  
 PIR insulation - 120  
 vapor barrier  
 in situ concrete - 260  
 steel truss

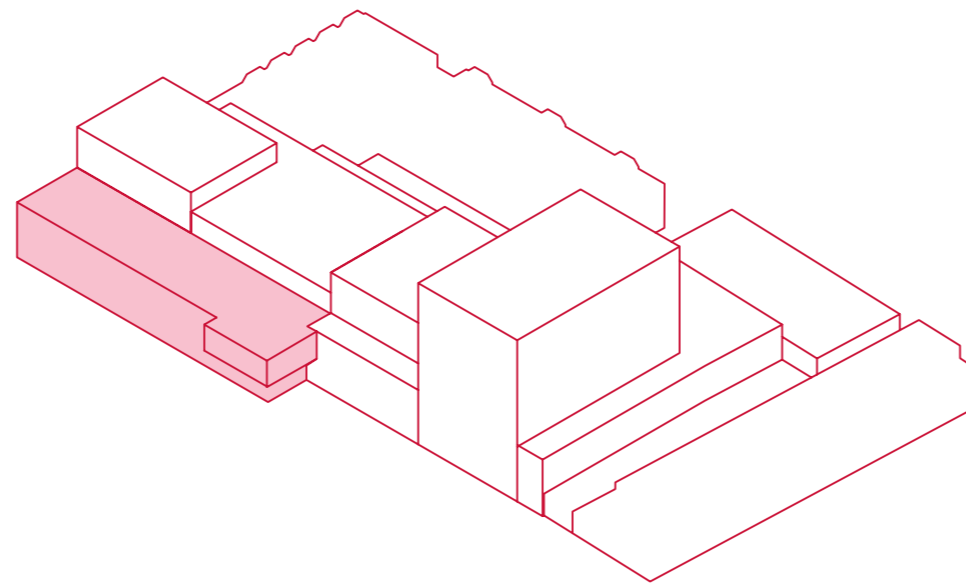

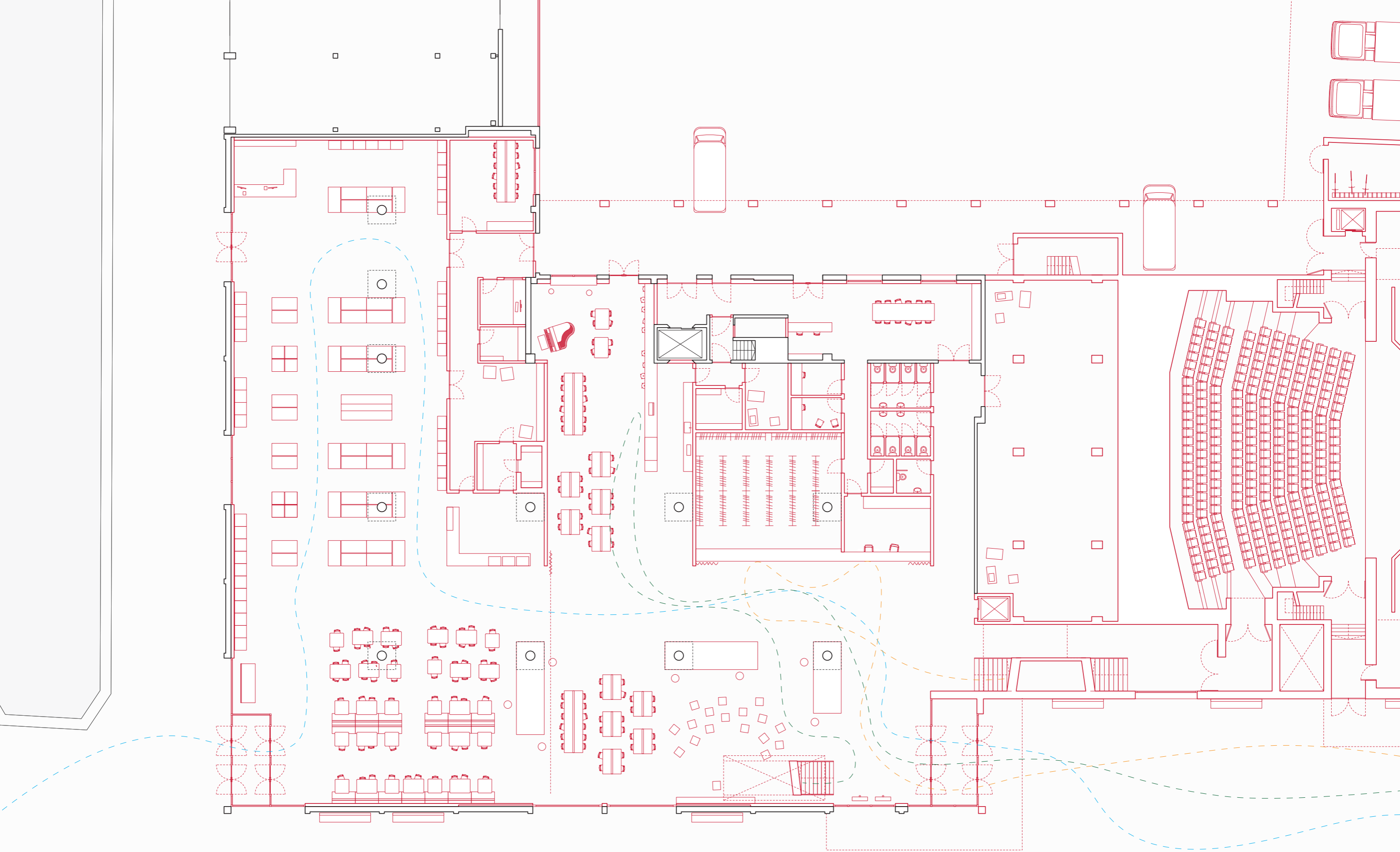

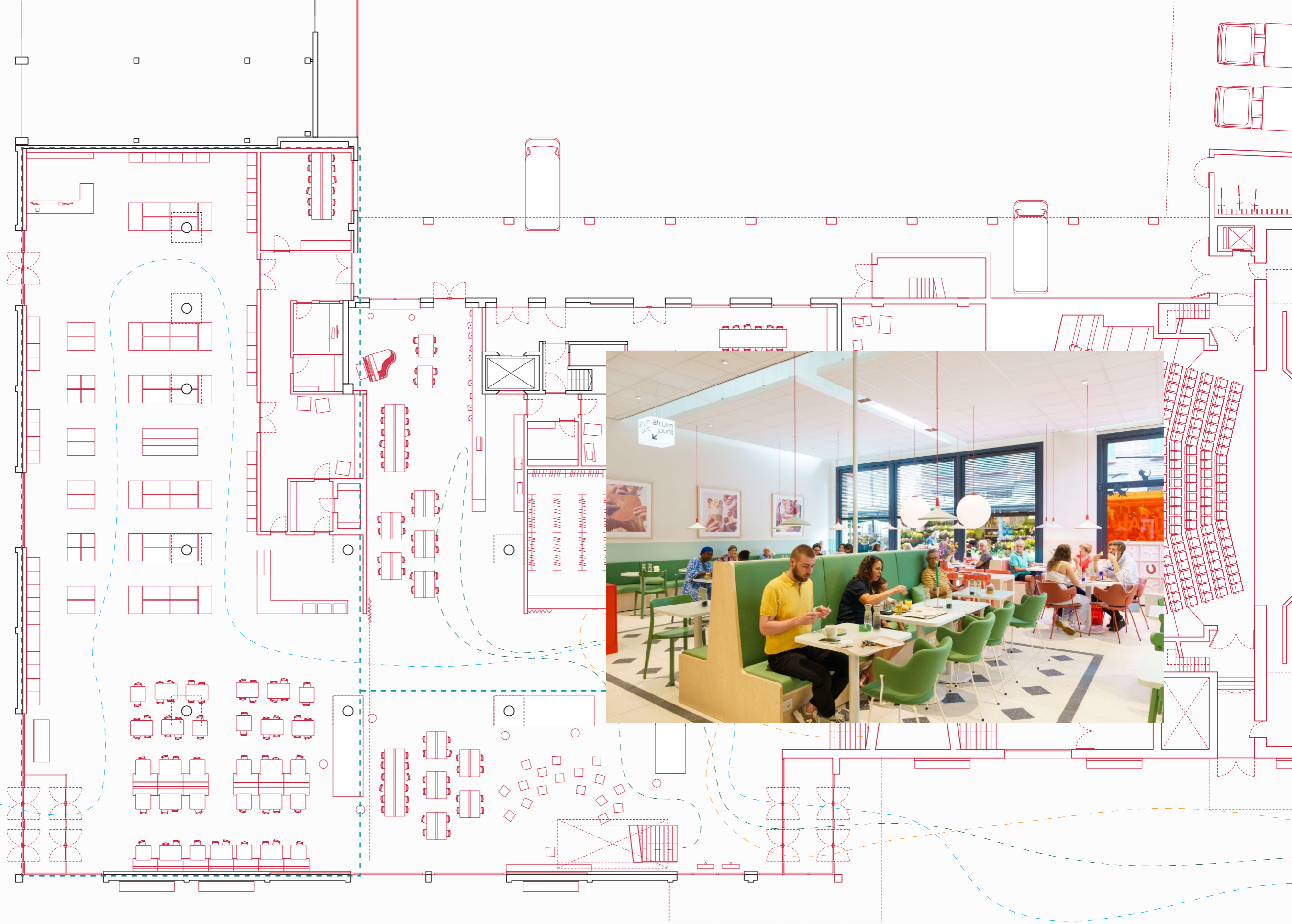

66 Dexter Scholten may. 2026

67 HEMA n.d.

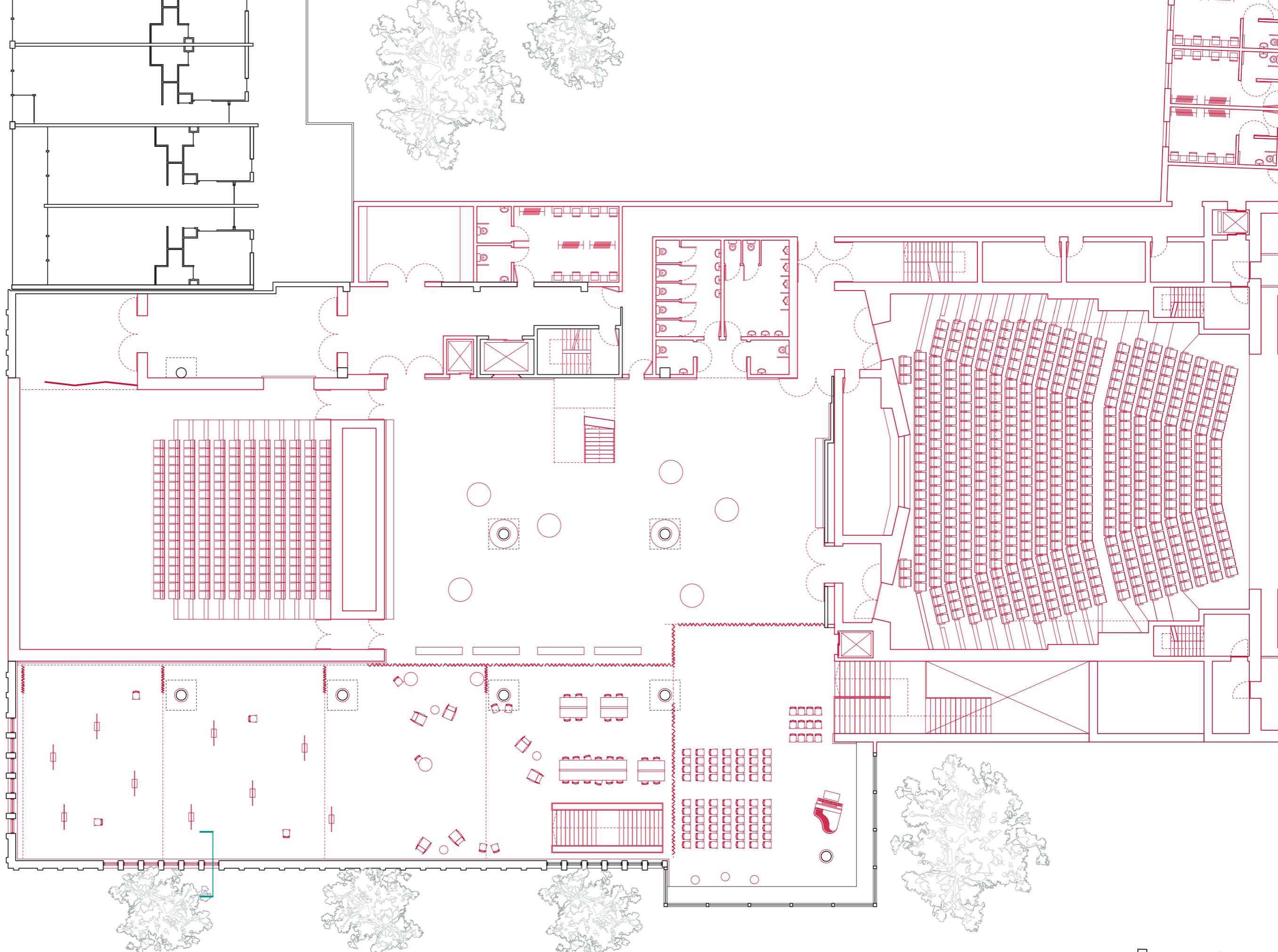

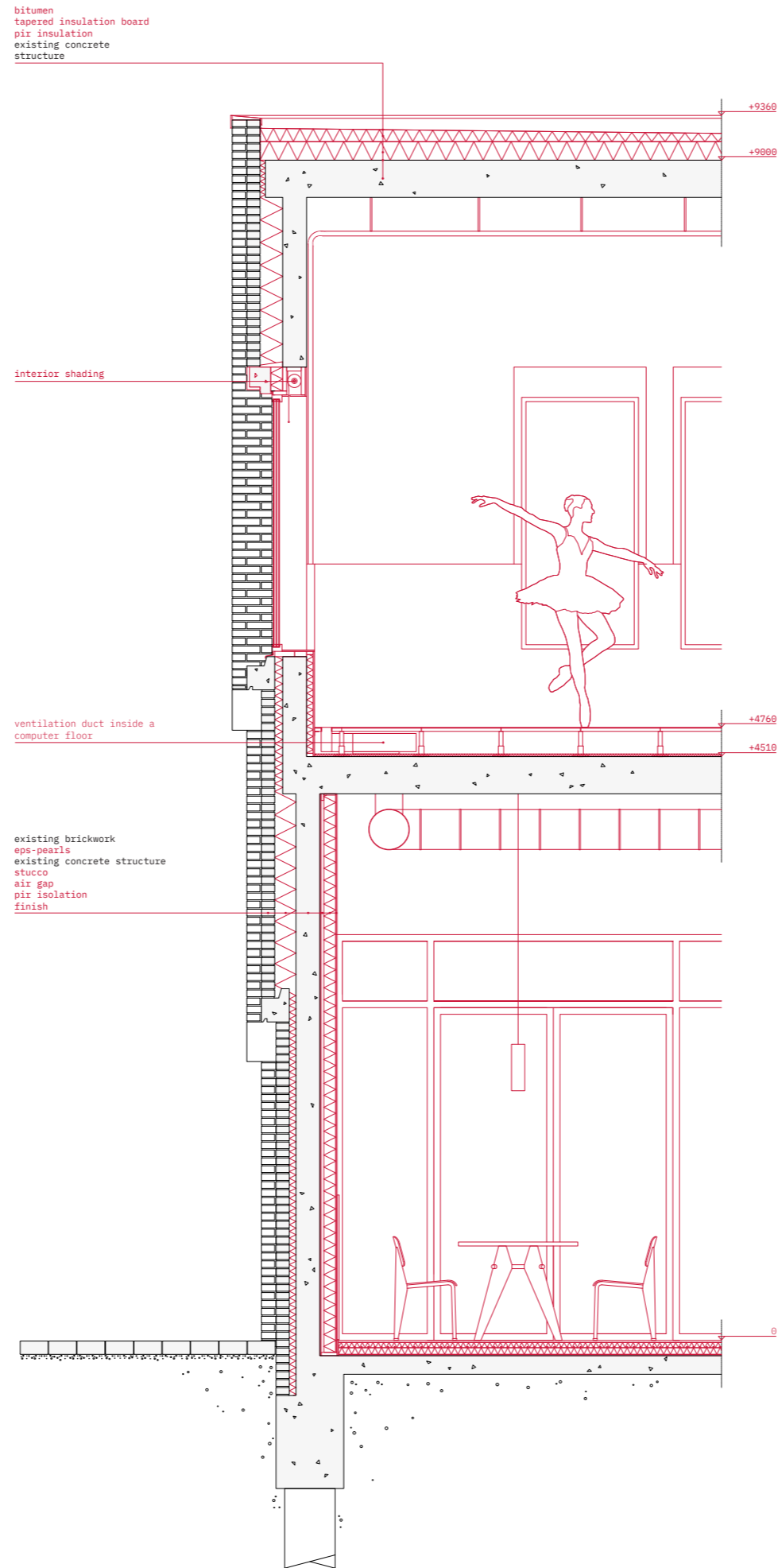

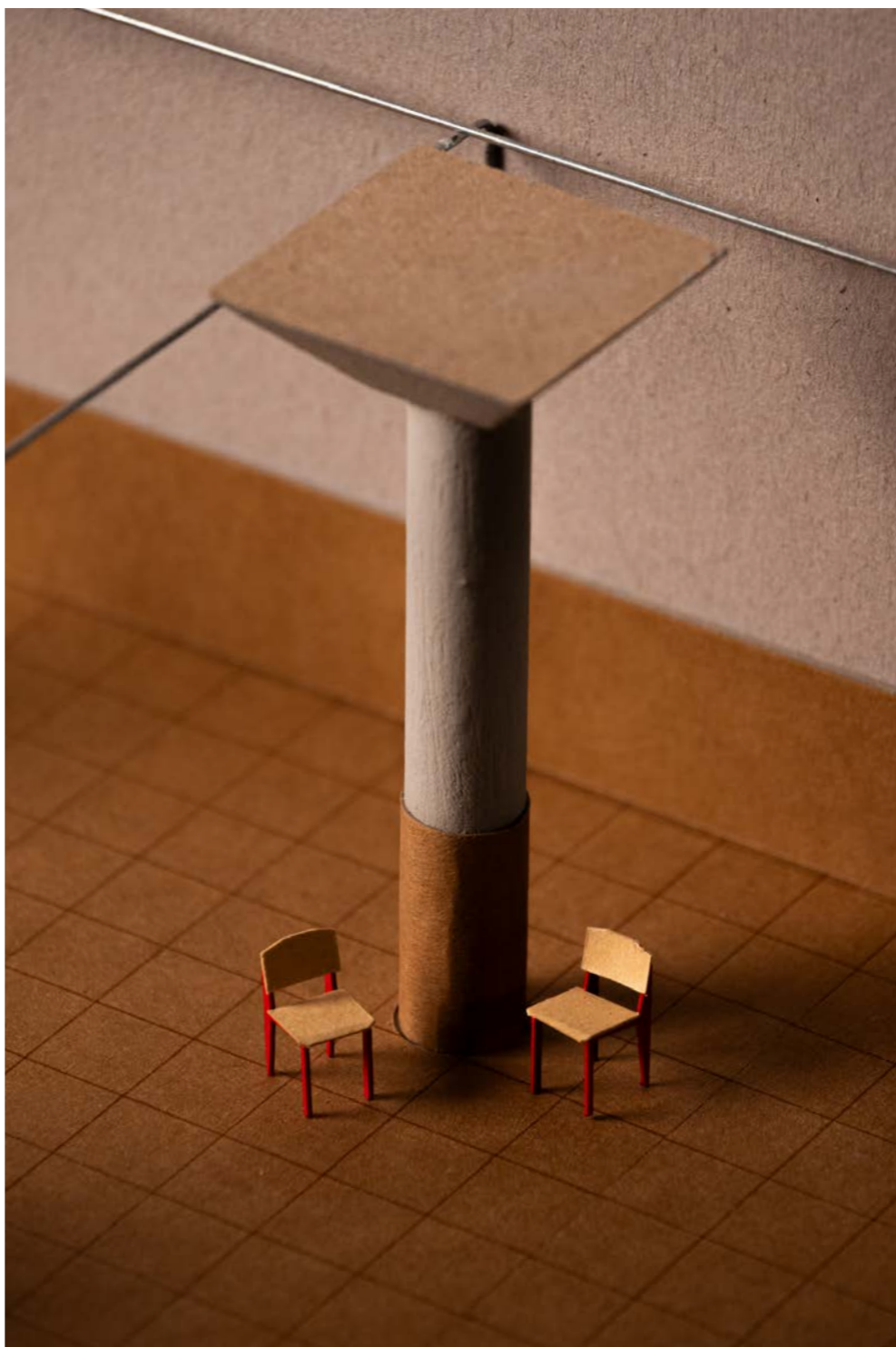



71 Superstudio ca. 1971

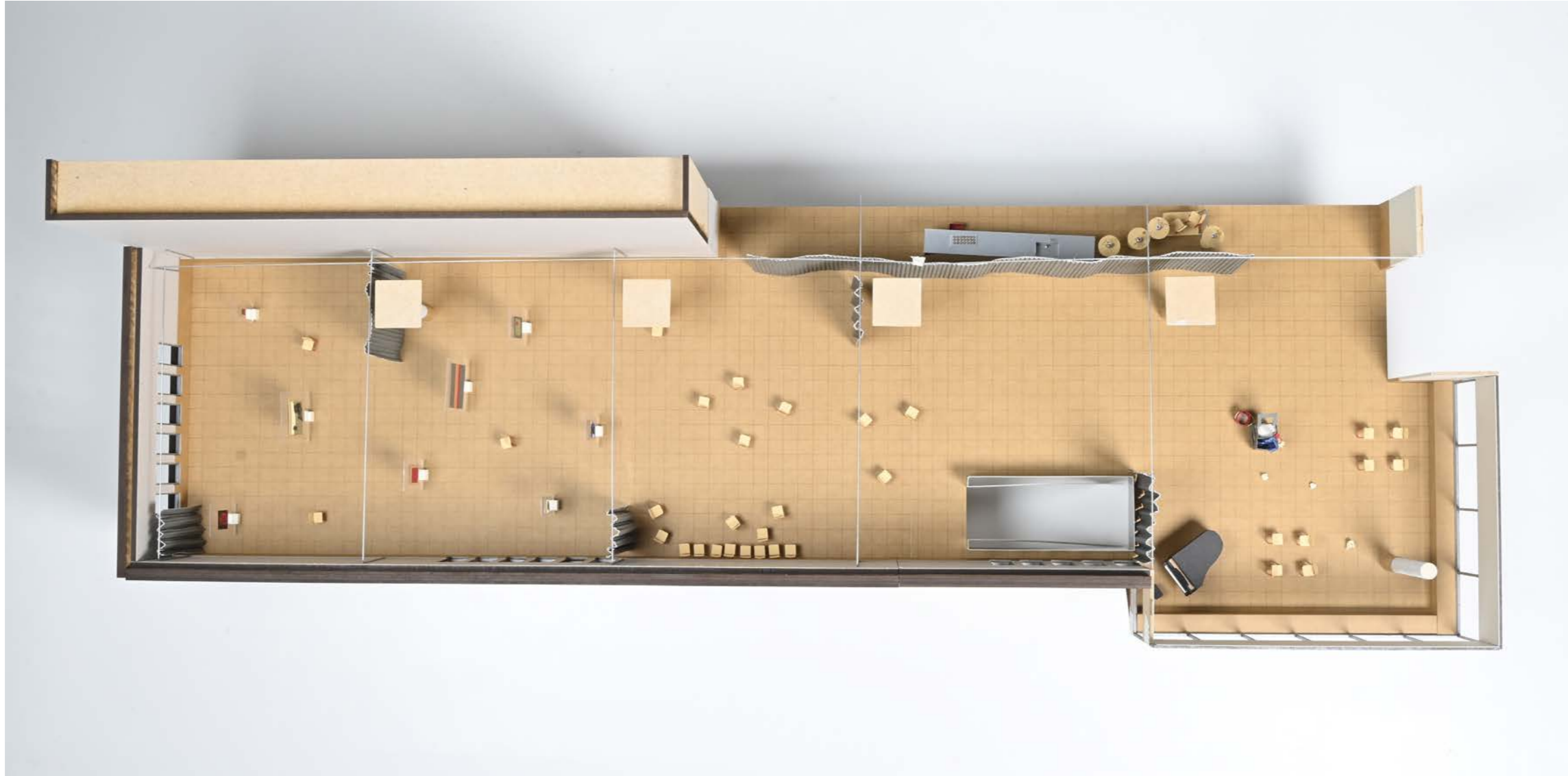

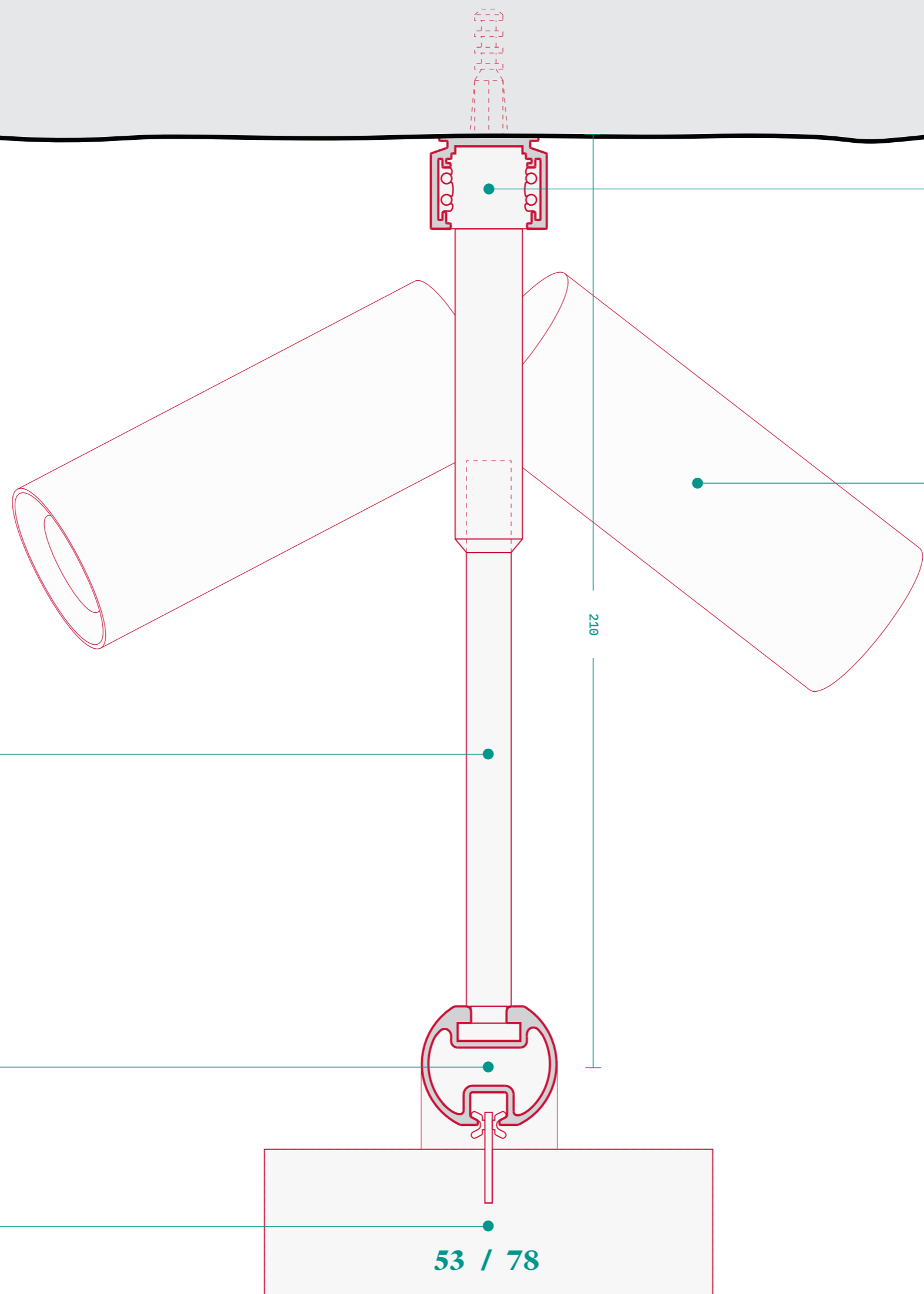

Kuro Lighting Rail Silver

Kuro SPRINT Evo 40 Track Spot Silver

SilentGliss Pendel SG6190 Silver

SilentGliss Curtain Rail SG1003p Silver

SilentGliss Wave Curtain Dark Grey

53 / 78



74 Dexter Scholten feb. 2026







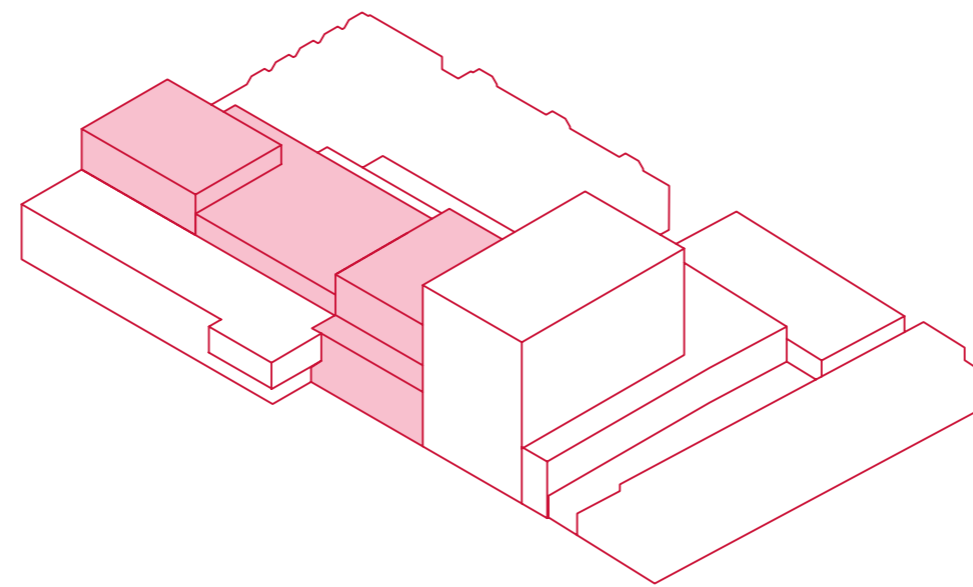

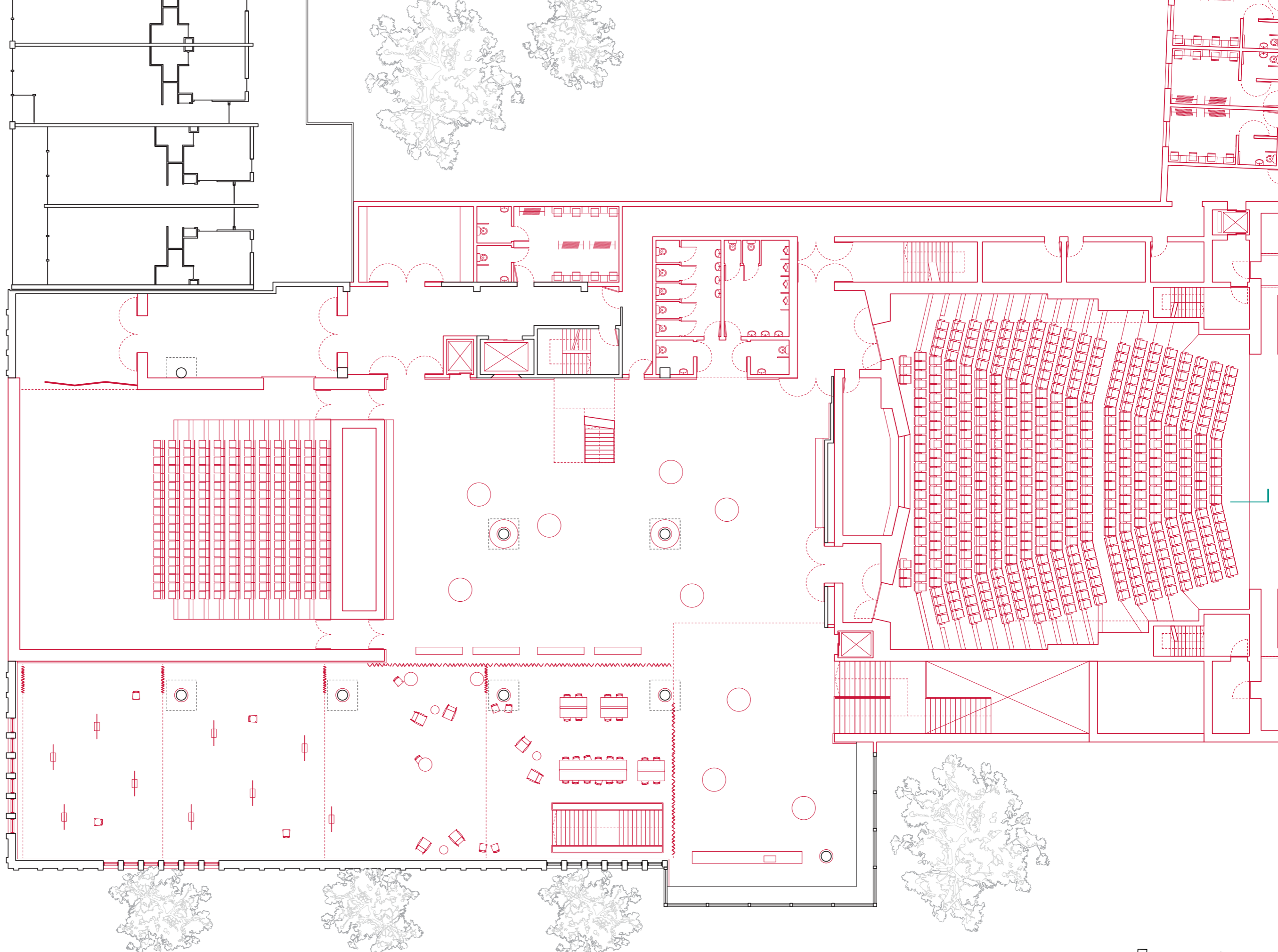

78 Dexter Scholten may. 2026

dexter scholten

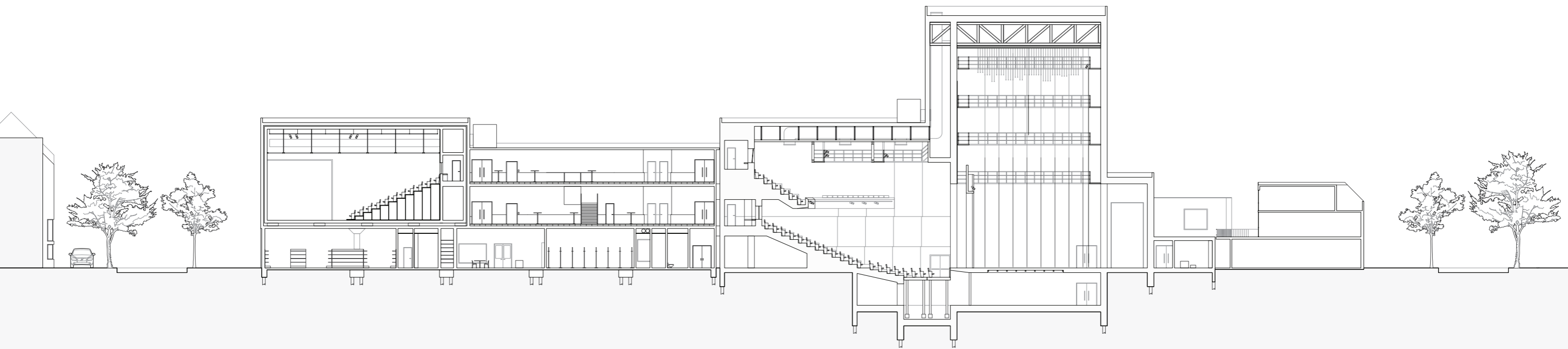

concrete box in box construction

concrete shell with internal steel structure

steel structure

existing concrete structure

existing concrete structure

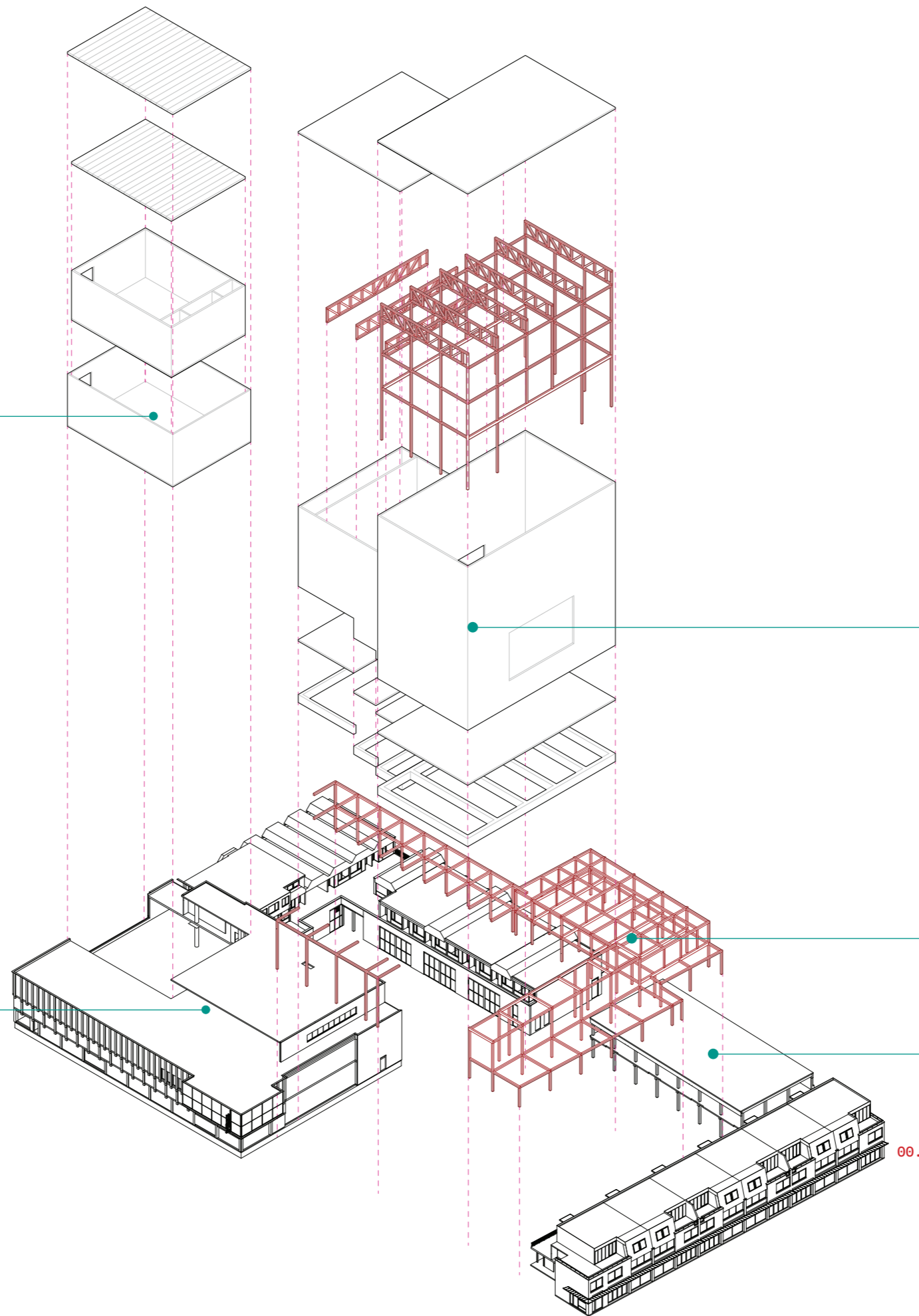

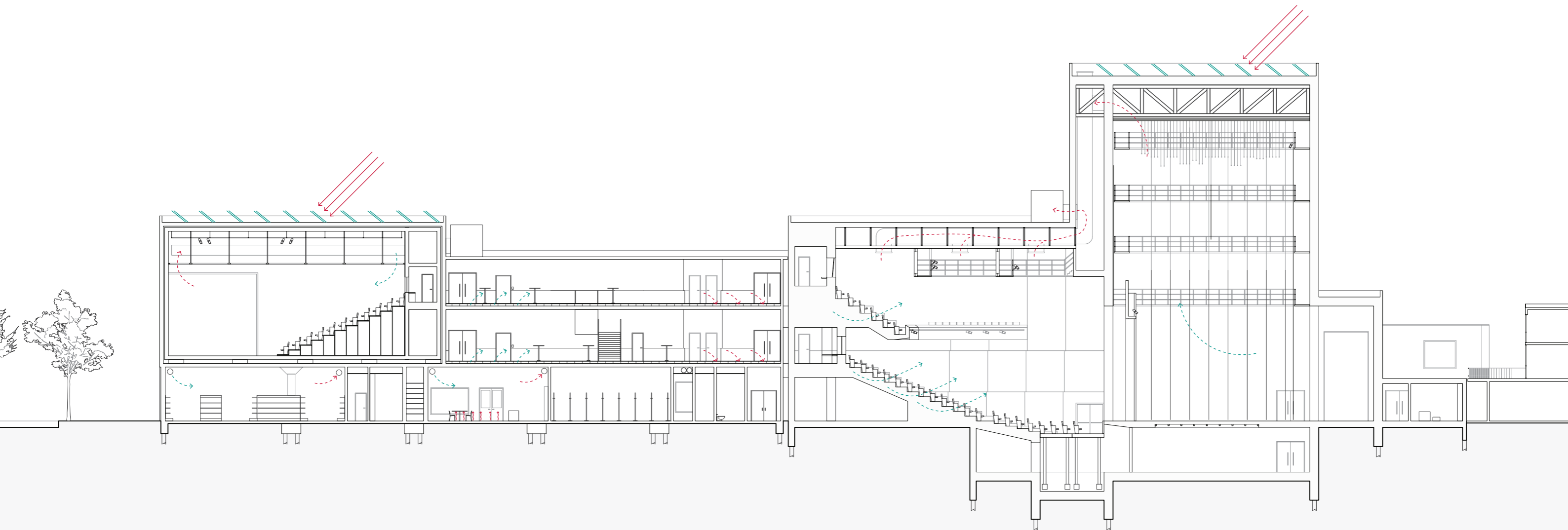

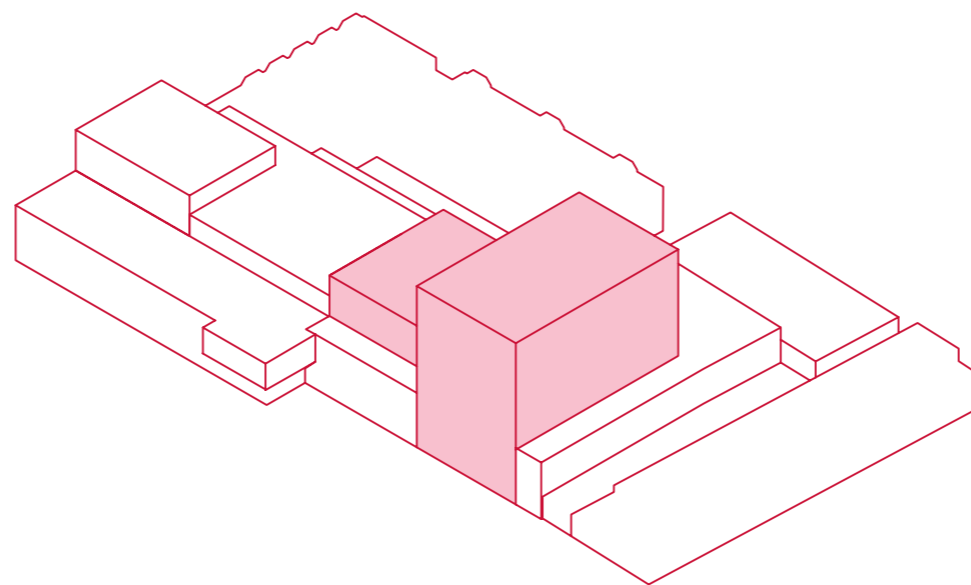

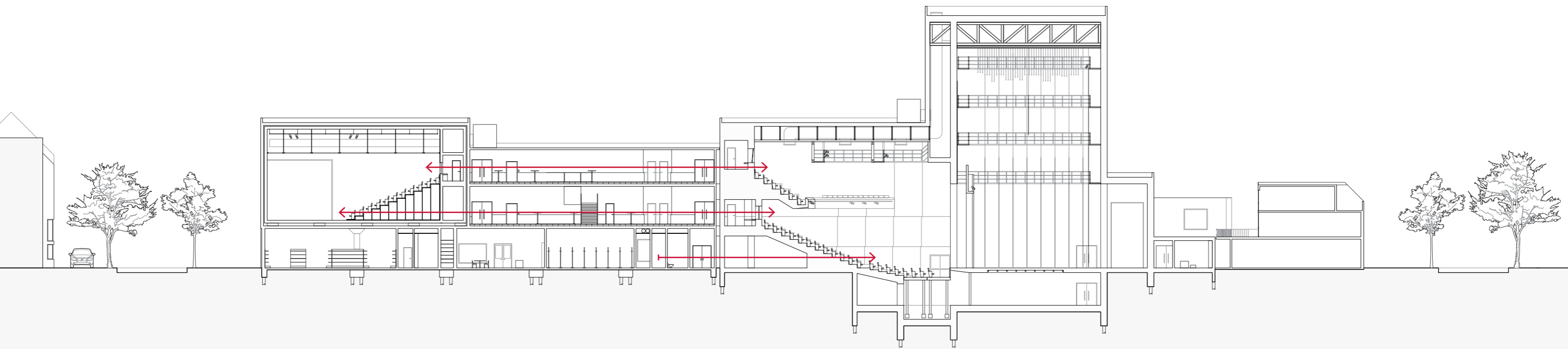

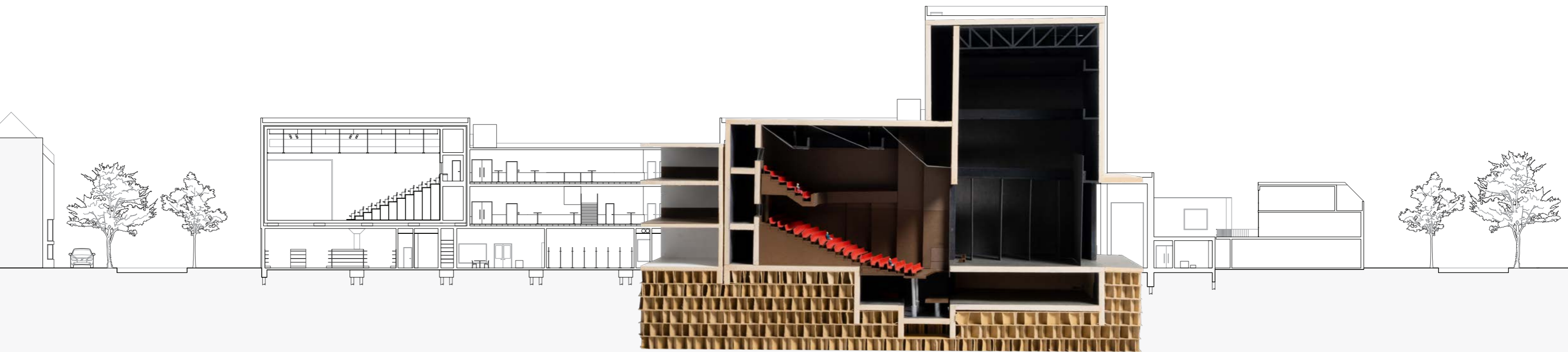



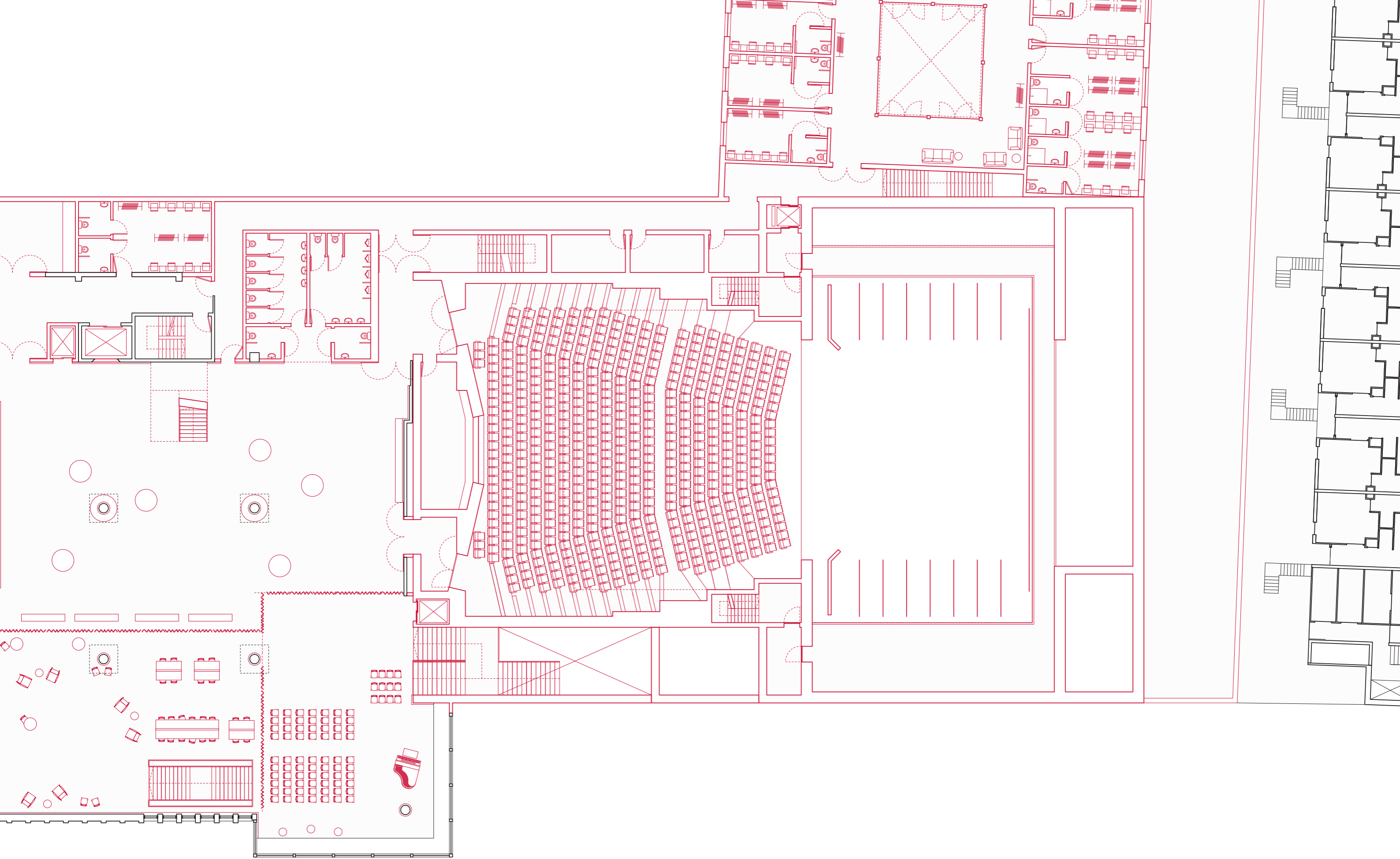

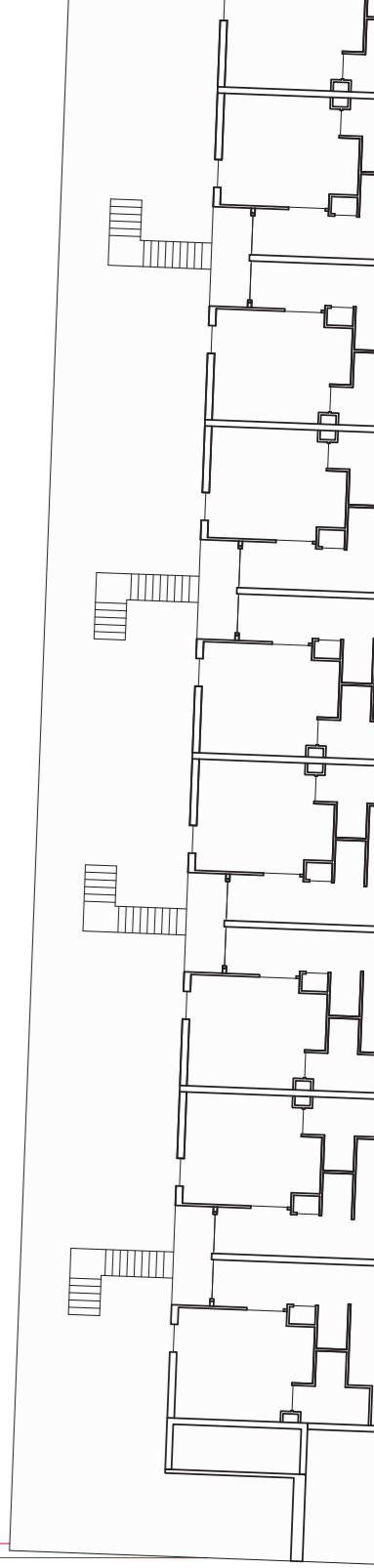
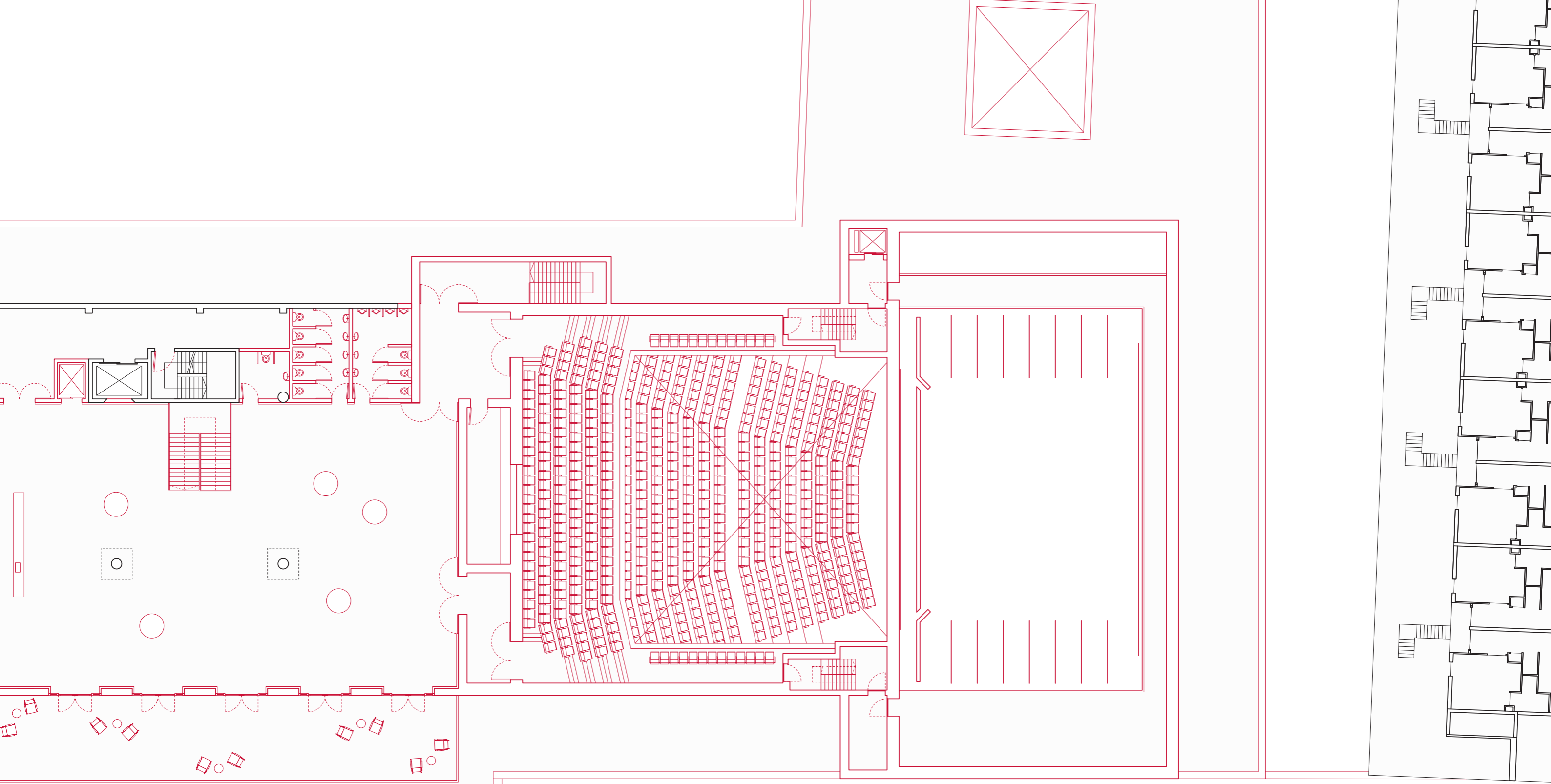

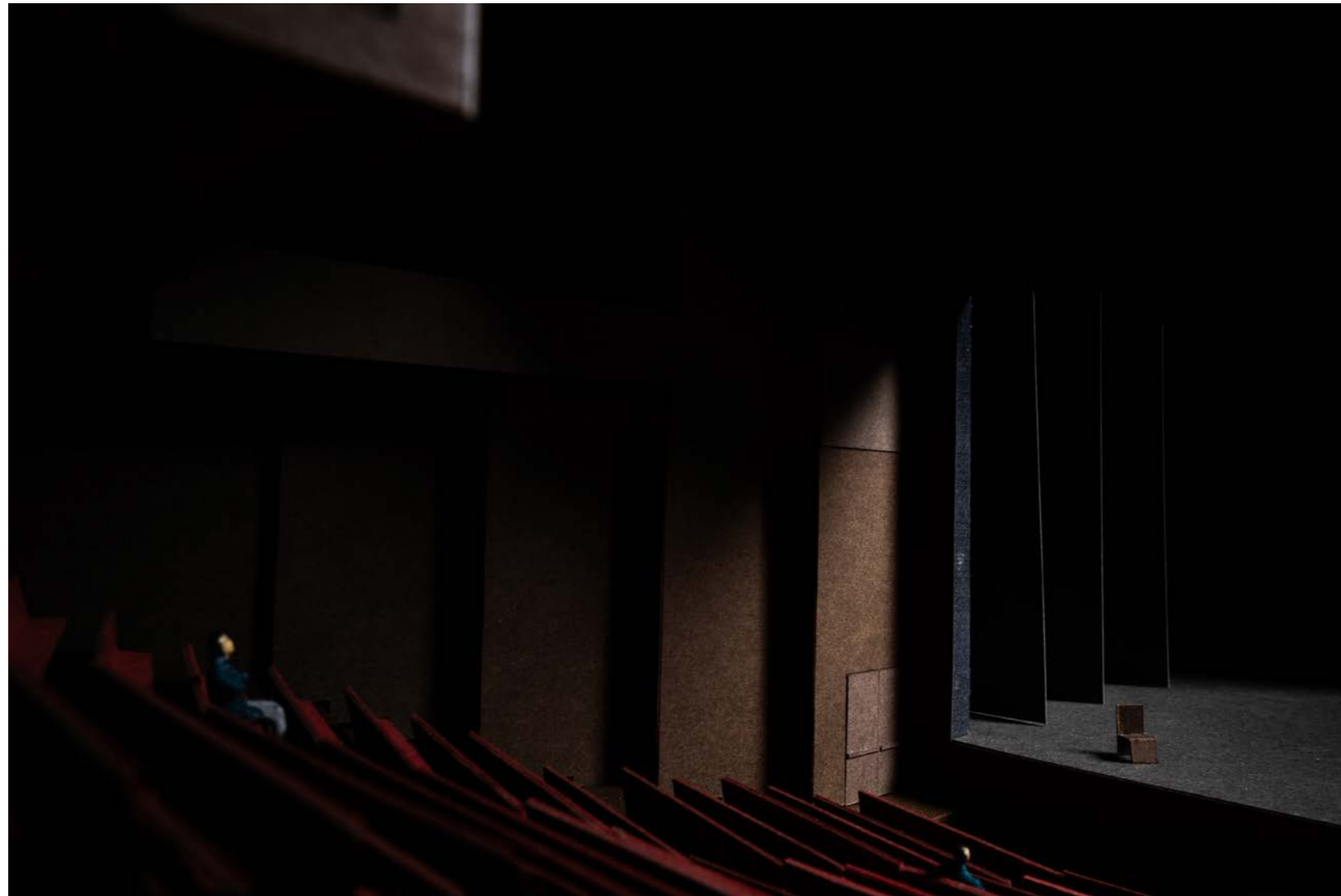

# Act IV

## *The Worker and the Performer*



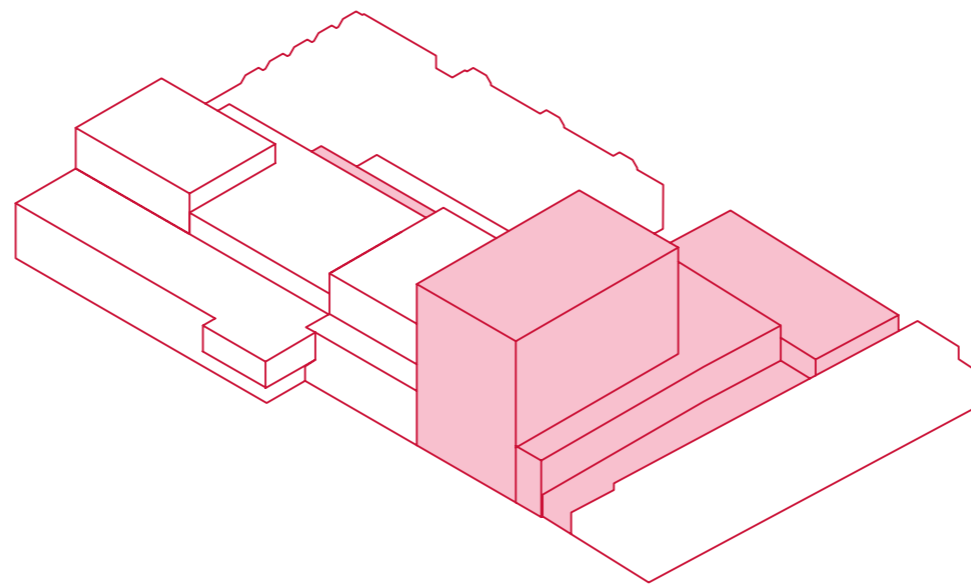

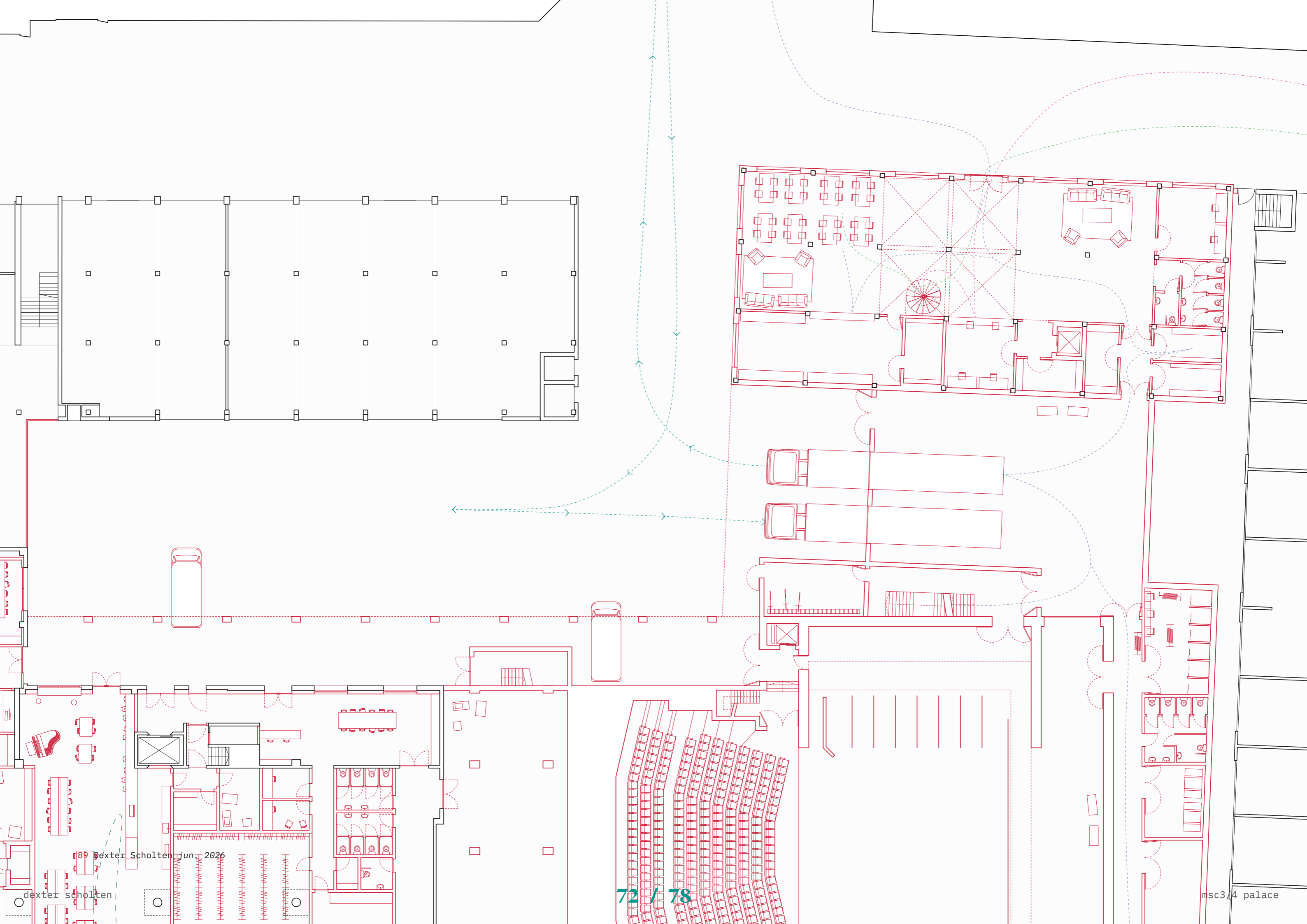

89 Dexter Scholten jun. 2026

dexter scholten

72 / 78

msc3/4 palace

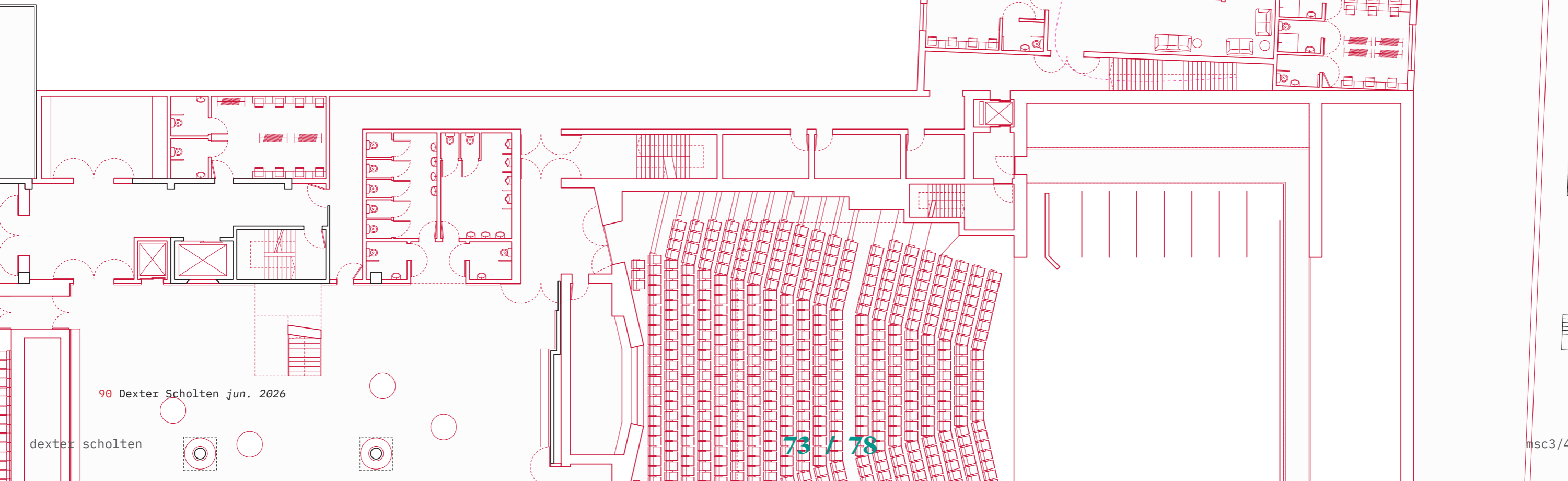
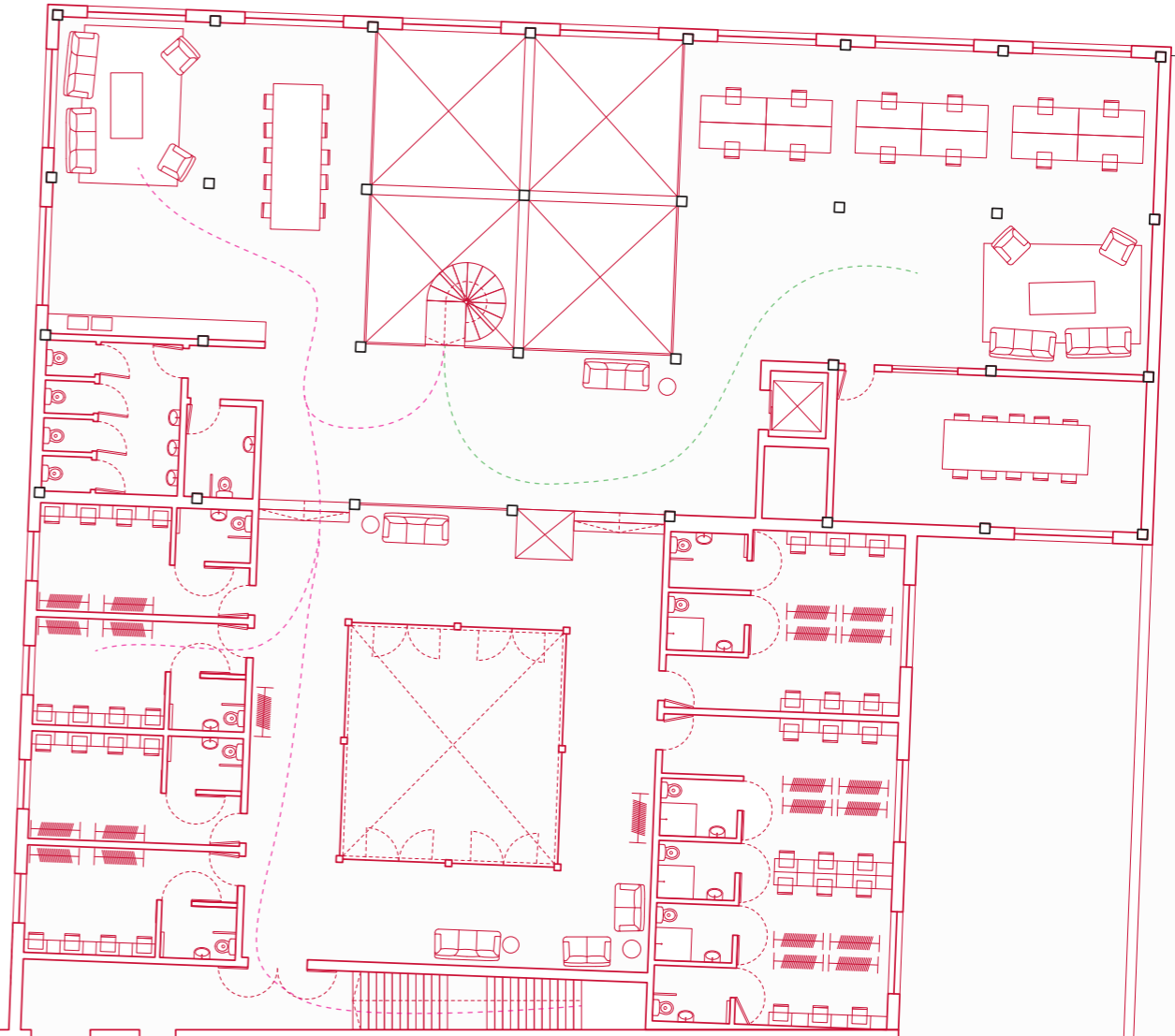
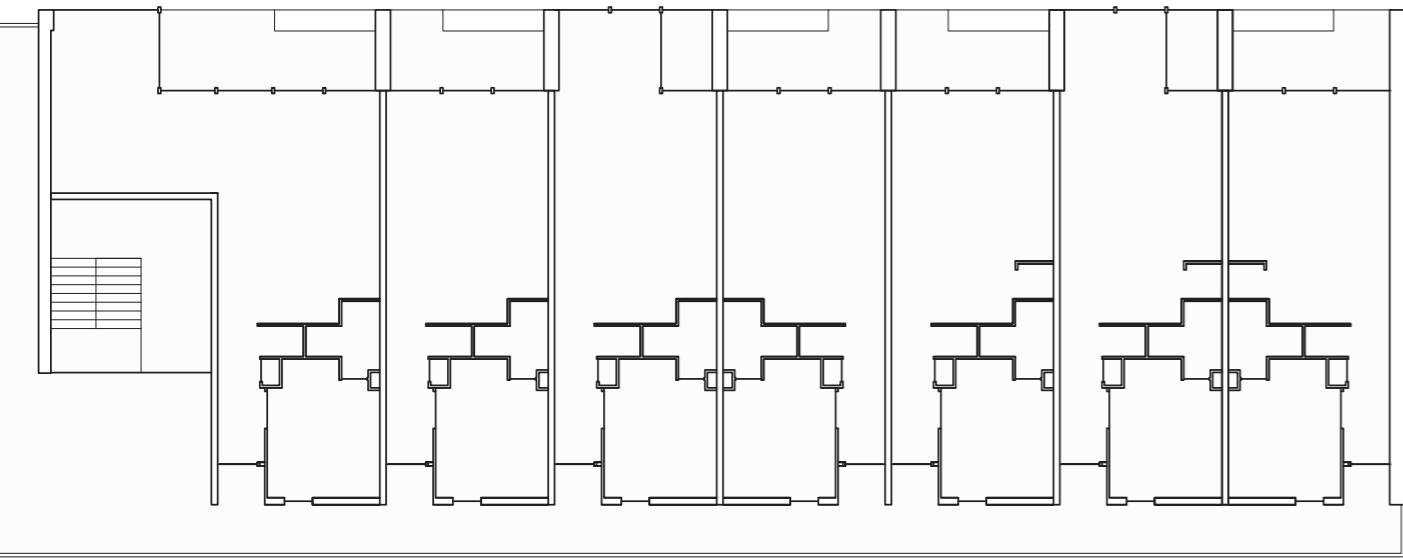

90 Dexter Scholten jun. 2026

dexter scholten

73 / 78

msc3/4 palace

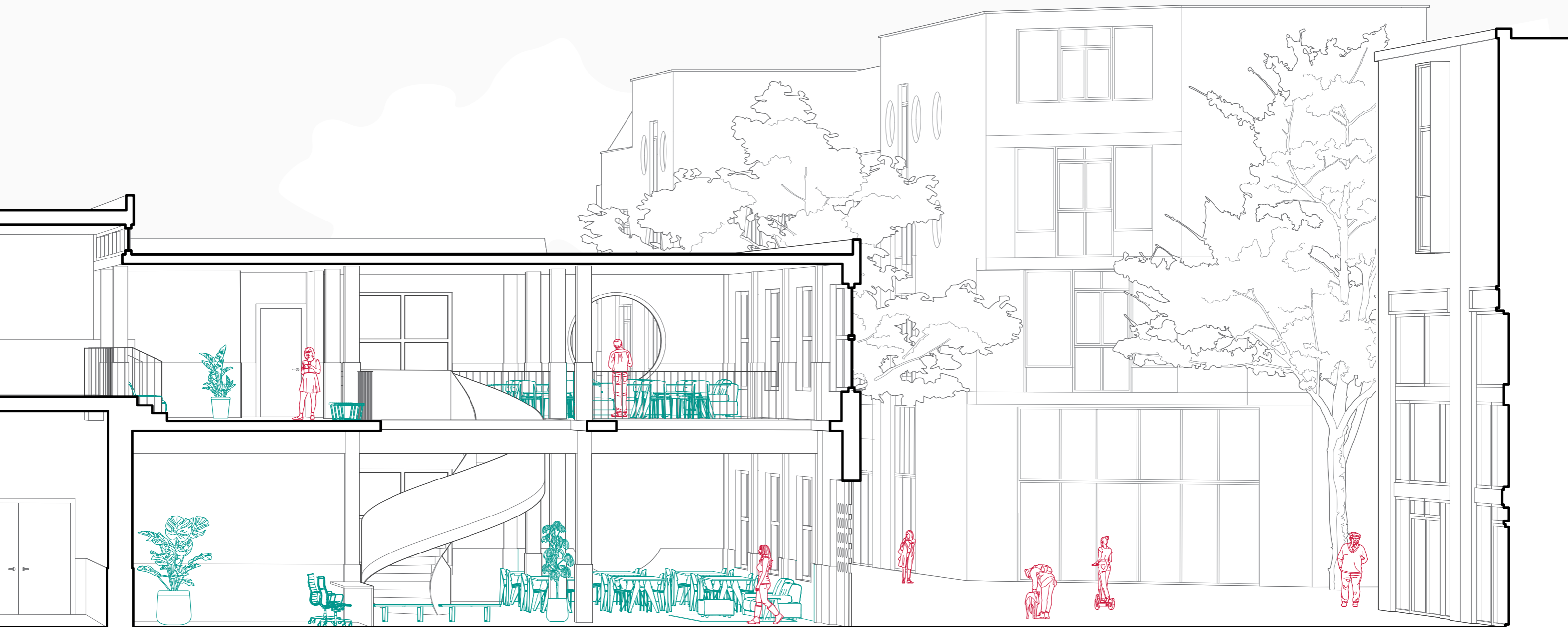



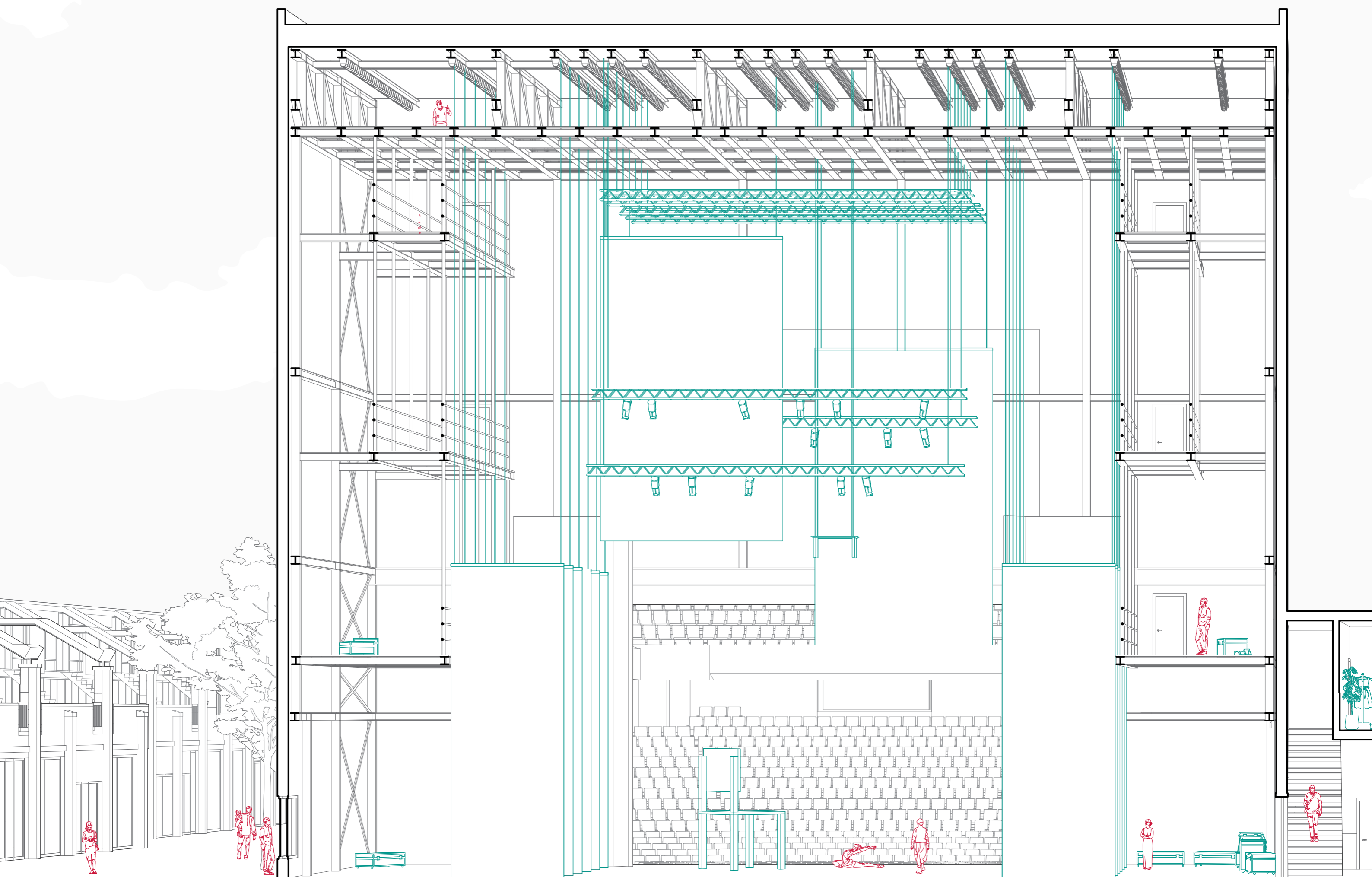

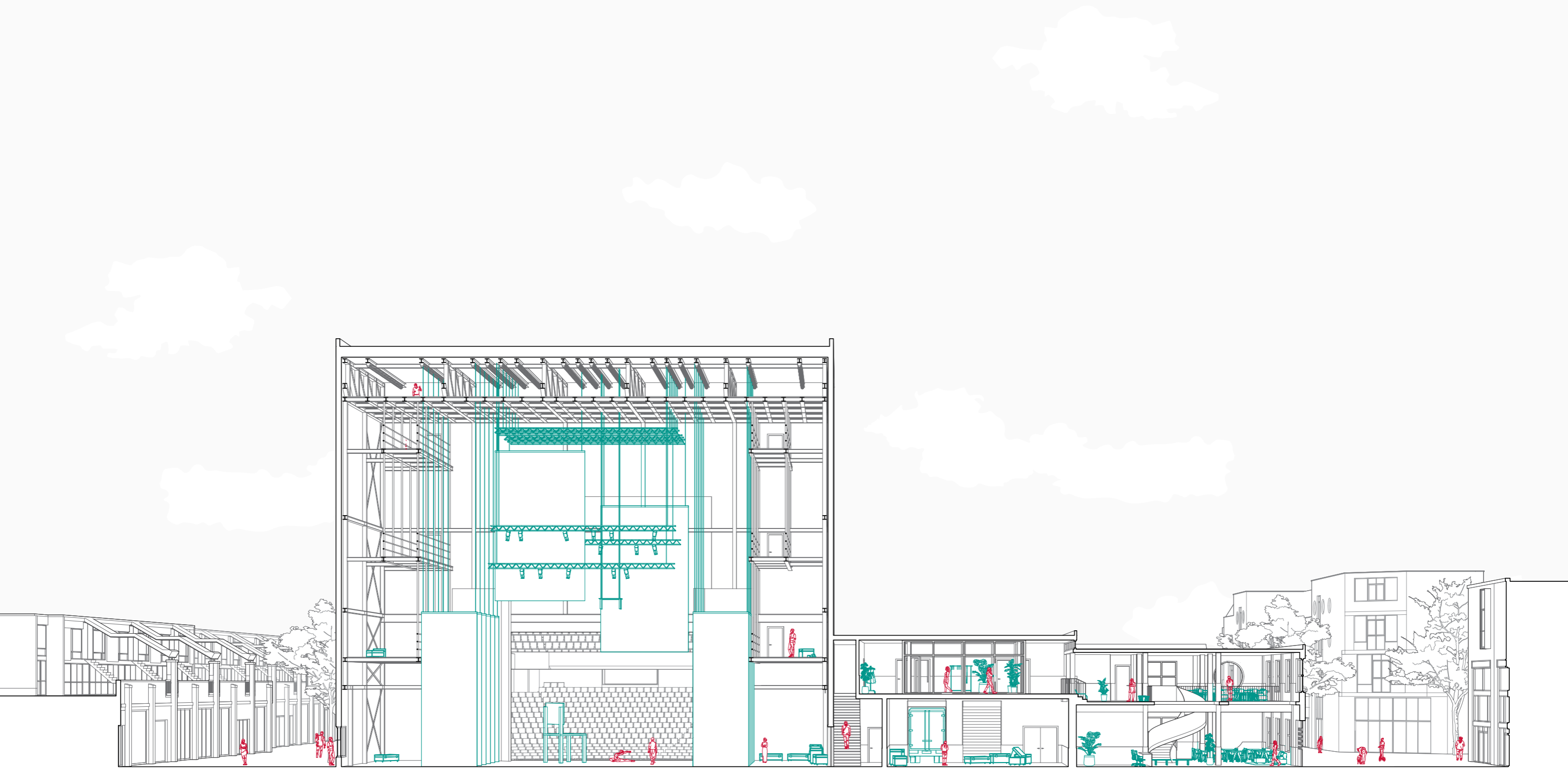

*Thank you.*

