

The Development of an Energy Efficient Electric Mitad for Baking Injeras in Ethiopia

Jones, Robin ; Diehl, Jan-Carel; Simons, Leon ; Verwaal, Martin

DOI

[10.23919/DUE.2017.7931827](https://doi.org/10.23919/DUE.2017.7931827)

Publication date

2017

Published in

Proceedings of the 25th Domestic Use of Energy Conference

Citation (APA)

Jones, R., Diehl, J.-C., Simons, L., & Verwaal, M. (2017). The Development of an Energy Efficient Electric Mitad for Baking Injeras in Ethiopia. In *Proceedings of the 25th Domestic Use of Energy Conference: Towards Sustainable Energy Solutions for the Developing World* (pp. 75-82). Cape Peninsula University of Technology. <https://doi.org/10.23919/DUE.2017.7931827>

Important note

To cite this publication, please use the final published version (if applicable). Please check the document version above.

Copyright

Other than for strictly personal use, it is not permitted to download, forward or distribute the text or part of it, without the consent of the author(s) and/or copyright holder(s), unless the work is under an open content license such as Creative Commons.

Takedown policy

Please contact us and provide details if you believe this document breaches copyrights. We will remove access to the work immediately and investigate your claim.

The Development of an Energy Efficient Electric Mitad for Baking Injeras in Ethiopia

Robin Jones, Jan Carel Diehl, Leon Simons and Martin Verwaal

Abstract— Preparation of Injera, the cultural staple bread food item in Ethiopia, is known for its intensive energy consuming cooking. Baking this food item in the traditional three stone stoves, with an efficiency of 5-15%, consumes huge amounts of firewood and causes consequent problems like deforestation, global warming and household air pollution. Electrical injera stoves (mitads) are a sound alternative in Ethiopia because of the relatively wide availability of electricity (hydropower). However, these electrical Mitad have designs dating back to the 1960's and are highly inefficient as well and are overloading the electricity grid. Consequently, a research and design project called 'Magic Mitad' was initiated to develop an energy-efficient electric injera mitad. Starting with the introduction of a new type of fuel-efficient baking plate a range of research and design experiments were initiated to further optimize the energy-efficiency as well as the baking quality of the Magic Mitad. In the first experiment the 'start-up energy' of different baking plates was tested in order to identify and select the most energy efficient one. During the next experiment, the chosen type of baking plate was used for baking injeras to study the heat distribution. A uniform heat distribution is key to produce high quality injeras. From the result obtained it was concluded that a different type of heating element was needed. Ten types of alternative heating elements were selected of which four were tested in a lab-setting. Ribbon wire heating element was selected, and optimized in its lay-out. Finally, the prototypes were tested in Addis Ababa on quality performance and energy-efficiency compared to electrical clay mitads. The outcomes were successful in the sense of quality and increased efficiency by 30%.

Index Terms— Clean Cooking, Ethiopia, Heat Distribution, Energy Efficiency, Injera, Kitchen Environment

1 INTRODUCTION

Injera is the cultural staple bread food item in Ethiopia and made from indigenous grain called 'teff'. Traditionally, this 60 cm diameter sourdough pancake is baked on a 20–30 mm thick clay griddle, called 'mitad', placed on three stones above open fire [1, 2]. Fermented dough is poured on a hot clay pan and stays until the boiling temperature is reached; consequently bubbles from the boiling water escape forming thousands of tiny craters (eyes) that give the peculiar injera texture (see Fig. 1) [2].



Fig. 1. Injeras and their peculiar texture.

Preparation of injera is known for its intensive energy and time consuming cooking. Baking this food item in the traditional three stone stoves consumes huge amounts of firewood (95% of the population of Ethiopia still relies on traditional biomass fuels for cooking) and this leads in different localities to alarming deforestation of trees, and exposing the environment to global warming due to its inefficiency [3-5]. In addition, the kitchen environment is highly polluted with soot and smoke that affect the health of household inhabitants [6].

Over 90% of energy consumed in household level in Ethiopia is for cooking and from this injera baking accounts for 50-75% [3, 7]. Both traditional and newly developed biomass injera stoves are energy inefficient [6]. Some researchers indicated that the traditional clay stoves have an estimated efficiency of 5-15% [2, 8-10]. Others show that improved biomass stoves, have registered efficiencies in the range of 25-35% [2, 11].

To mitigate the above challenges, different scholars have attempted to design and develop injera baking alternatives like for example stoves based on biogas, solar power, and electricity [2, 4, 7, 12]. Because of the relative wide availability of electricity in Ethiopia (hydropower), electricity based mitads are a sound alternative and have become a popular alternative especially in the urban areas.

There are currently an estimated 530.000 injera electric baking stoves, or alternatively called 'electric mitads' in use in Ethiopia [13]. It is estimated that the power consumed by existing electric mitads (3.5-6 kW per cooker) consume approximately 60–70% of the Ethiopian hydro-based grid-power. The daily baking's power load becomes coincident with peak load requirements, thereby overloading the electricity distribution system [13, 14]. The impact is especially severe on week days, given the timing of Mitad use—mid morning and mid noon-[14]. Consequently, the current electric mitads in use solve part of the problem, but meanwhile create new ones as well.

The mitad design, in current use, dates back to 1960's when electric baking of Injera started with high-income groups in cities[13]. However, since then, almost no design improvements have taken place and are highly energy inefficient, given poor design and use practices [14].

This work was supported in part by the Climate KIC.

R. Jones, Delft University of Technology, Landbergstraat 15, Delft, The Netherlands (robinjones01@gmail.com).

J.C. Diehl, Delft University of Technology, Landbergstraat 15, Delft, The Netherlands (j.c.diehl@tudelft.nl).

L. Simons, Magic Ventures, Meentweg 115, 3755 PD Eemnes, The Netherlands (leon.simons@magicmitad.org).

M. Verwaal, Delft University of Technology, Landbergstraat 15, Delft, The Netherlands (m.verwaal@tudelft.nl).

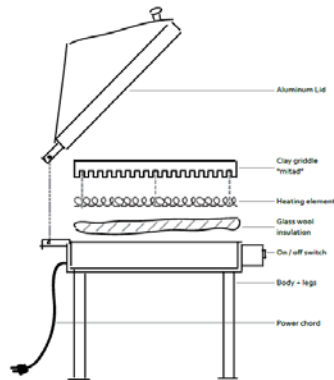

Fig. 2. Schematic overview of the components of an electric mitad [15].

Sood [14] summarizes the main shortfalls of existing designs of electric mitads as:

- i. The high resistance, inadequately sized electric wiring, and incorrectly adjusted heating element;
- ii. Use of poor construction materials;
- iii. Poor insulation: dissipation of energy during the baking session is said to roughly range from 40 to 50 percent;
- iv. Lack of temperature control device such as a thermostat, encouraging loss of heat; and
- v. Overall, sub-optimal/poor and inefficient design and workmanship.

All facts mentioned above in this introduction have been motivations to start our research by design project initiated by the start-up company Magic Ventures with the aim to develop a more energy efficient electric mitad.

2 RESEARCH & DESIGN CHALLENGE

2.1 Magic Mitad

Magic Ventures is a Dutch Start-up which develops products and services that utilise (western) developed technology to create energy-efficient products with high quality and performance for developing areas. At the start of this research project, the company was working on a proof of concept of a new electric mitad to reduce energy needs of baking injera, by introducing a fuel-efficient baking plate. This was done under the project name "Magic Mitad". The aim was to further improve the energy-efficiency of this new type of electric mitads while keeping the quality of the baked injeras equal to traditional biomass fuelled stoves.

Current electric mitads use a traditional clay baking plate, but with grooves cut in the underside, in which the heating element is embedded. As heating element, a coil-shaped resistance wire in a lay-out consisting of concentric rings is used. The first prototype at the start of the Magic Mitad project used the same type of heating element but placed a few centimetres underneath a glass sheet (instead of embedded in a clay plate) (See Fig. 3). Prior research and field tests by the company showed the energy saving potential of glass compared to the traditional clay mitads. Within this paper we further refer to this new type of baking plate as 'MM-plate' (referring to Magic Mitad).



Fig. 3. Electrical mitad with clay plate (left) and electric mitad with MM-plate (right).

Typical positive characteristics of the first prototypes were shorter heating time, reduction of the required baking temperature while retaining the baking time of 3 minutes (and shorter reheat time). There were however problems with (consistently) baking high quality injeras on the magic mitad plate: slight differences were formed on the eyes (holes) on the injera's surface. This was due to a non-uniform distribution of heat throughout the baking pan.

2.2 Research and Design Brief

Hence this project aimed to design, optimize and configure an electrical injera backing stove to enhance its performance. The gap observed in the previous designs was; heat transfer and uniform heat distribution through the stove, as well as quality performance. At the start both the energy efficiency of an electric mitad as well as the quality parameters of an injera were defined.

2.3 Energy Efficiency

The efficiency of an electric mitad is measured by the energy [kWh] used per injera in a baking session. This has been defined with the following formula:

$$E_{injera} = (P * t) + \left(\frac{E_{startup}}{N} \right)$$

$$E_{injera} = \text{Energy per injera [kWh]}$$

$$P = \text{Mitad Power [kW]}$$

$$t = \text{baking cycle time per injera [h]}$$

$$E_{startup} = \text{Start up energy [kWh]}$$

$$N = \text{Amount of injeras baked during session}$$

2.4 Quality of injera

It is essential for the user acceptance of a new energy efficient electric mitad that the injeras are of the same quality as those baked on the traditional clay mitads. Based on literature and observations in the field, it was determined that the following characteristics define a good quality injera:

Subjective:

- "Eyes" on top side
- Smooth underside
- Thin, crispy edges

Objective: (averages, as baked in Addis Ababa)

- Diameter: 56 cm
- Thickness: 3-5 mm
- Weight: 330 g

2.5 Research & Design Experiment Cycles

Since the project did have technical challenges (energy efficiency) as well as user acceptance challenges (injera

quality) it was decided to combine technical lab experiments with design experiments in the field (Ethiopia). The project existed of in total six sequential experiment cycles which will be described the following sections.

3 RESEARCH & DESIGN EXPERIMENTS

3.1 Experiment 1 Efficiency: Start-up Energy

The start-up energy is one part of the efficiency formula (see 2.3) which could already be tested in a lab setting at Delft University of Technology. Start-up energy is used to heat up the mitad, as a preparation for baking the injera. The heat contained by the mitad is usually lost to the surroundings at the end of the baking session. The start-up time is also an indicator for the reheat time in between the baking of each injera (especially relevant in bakeries).

To quantify the start-up energy a heating-up test was conducted, the expected results were temperature curves (over time) of MM baking plates and clay baking plates. The results of this experiment indicated to what extent the start-up energy of a mitad has an influence on the overall baking efficiency.

$$E_{injera} = (P * t) + \left(\frac{E_{startup}}{N} \right)$$

The start-up energy is divided over the total amount of injeras baked in a session. If proven to be significant, the start-up energy is especially important when few injeras are baked in a session, as is the case for households. Since the start-up energy is also an indicator for the reheat energy (in between baking each injera), it is also an indicator for the overall efficiency of large sessions, as is the case for B2B scenarios (i.e. injera bakeries).

Methods

To quantify the ‘start-up energy’ of a mitad with MM plate compared to one with a clay plate, a heating-up test was conducted. This test consisted of measuring the required amounts of time and energy to heat up the clay and MM baking plates to baking temperature (250°C). A MM baking plate and a traditional clay baking plate were mounted on the same heating element and heated up. Temperature was measured with both a thermal imaging camera and an IR thermometer. Power and energy consumption were measured with a power and energy meter, which also functioned as a timer (see Fig. 4).

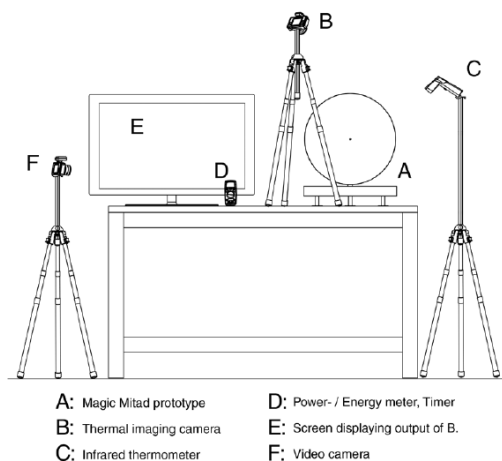

Fig. 4. Schematic overview of the experiment setup.

Results

The horizontal axis in Fig 5 shows the time while the vertical axis shows the temperature. The X marks the time at which the power was switched off for each test. The MM baking plate reaches 250°C after eight and a half minutes, while the clay baking plate takes 35 and a half minutes.

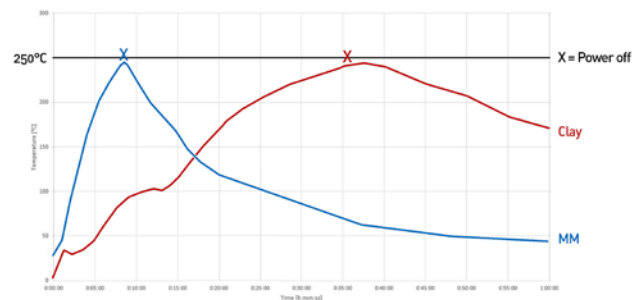

Fig. 5. Mitad heat up characterization: Temperature [°C] over time [h:mm:ss]

The power for both tests was the same (2,55 kW). As such the ‘start-up energy’ indicated in kWh is determined by the heating up time. The start-up energy for the MM plate was 0,35 kWh versus 1,48 kWh for the clay plate.

Conclusions

The MM plate has a significantly shorter start-up time and therefore requires less start-up energy compared to the traditional clay baking plate. This indicates that the reheat time in between the baking of each injera will also be shorter for MM compared to clay. The results of this experiment support the earlier findings which indicated that the MM plate may have a significantly higher energy efficiency than clay. This led to the decision to continue the further development with the MM plate.

3.2 Experiment 2 Quality: Baking tests

Even though the MM plate proved to be a promising direction for energy efficiency compared to the clay plate, it was not yet possible to bake injeras with consistent quality on the MM plate. It was suspected that a non-uniform heat distribution might be the cause of the baking quality problems. In order to investigate the non-uniformity of heat distribution baking tests were performed to validate this assumption as well as to discover other potential causes of baking problems.

Some of the thermal properties of glass (MM plate), like specific heat capacity, are similar to those of Ethiopian clay (See Table 1). Other properties like thermal conductivity are different, which have an influence on the heat distribution. The low thermal conductivity and thickness of the clay plate make it in fact an insulator, allowing the heat to evenly spread across the baking surface. The MM plate is thinner and transfers the heat faster, causing an unevenly heated baking surface.

Table I: Specific material characteristics of Ethiopian clay and glass.

Property	Ethiopian Clay	Glass
Thermal Conductivity [W/mK]	0,34	1-1,4
Specific Heat Capacity [kJ/kgK]	0,83	0,84

Methods

Two professional Eritrean chefs prepared teff-based injera dough (as used in Ethiopia). Six injeras were baked on the Magic Mitad V1 prototype. The test consisted of the following quality evaluation steps:

- Subjective evaluation of baking quality (by professional chefs);
- Measurement of the heat distribution on the mm baking plate (without injera).

The heat distribution was measured with a SP Thermoview 8300+ infrared thermal imaging camera with a 480 x 640 resolution micro-bolometer.

Results

The tests led to the following two main results:

- It was not possible to achieve satisfactory baking quality. The injeras did not have a smooth underside since they kept sticking or burning to the mitad. The professional chefs evaluated the baking quality as being unsatisfactory.
- Heat distribution measurements: the Magic Mitad prototype recorded temperature differences of over 40°C (see Fig. 7). The heat distribution was non-uniform.

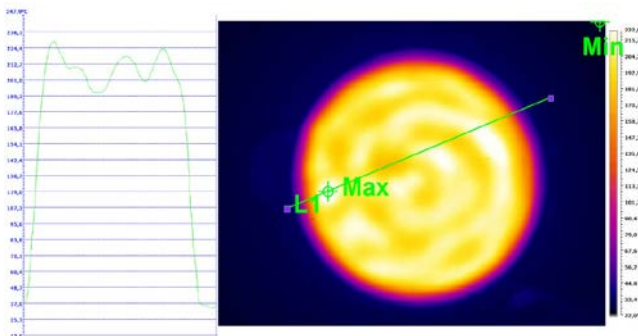

Fig. 7. MM mitad with coil wire element: temperature differences >40°C. The graph shows temperature (vertical axis) along section line L1 (horizontal axis).

Conclusions

It was determined that the unsatisfactory baking results of the Magic Mitad are strongly related to:

- Uneven heat distribution;
- Incorrect baking temperature / heat transfer.

To form a smooth under layer, it is essential that the mitad reaches the right temperatures and that the proper amount of energy is transferred throughout the baking process. The heat distribution is directly related to this. A non-uniform heat distribution means that some places of the baking surface will have an incorrect temperature and energy supply. The temperature differences of >40°C are the

presumed cause of the injera burning and sticking to the mitad. A different type of heating element is required to achieve a satisfactory heat distribution.

The Magic Mitad V1 prototype has a power rating of about 2,55 kW. The baking test showed that this is too much, the baking plate often became too hot, causing the injera to burn. To gain more control over temperature and heat transfer, a power control unit was installed, allowing any power level between 0 and full power. By baking at various temperatures and power settings, ideal values can be determined for baking on the MM baking plate.

3.3 Experiment 3 Efficiency: Heating element

In order to overcome the non-uniform heat distribution, alternative heating elements were being explored. After an initial exploration ten types of heating elements were further evaluated and a selection was made based on criteria such as power per area, energy efficiency and price (see Fig. 8).

These heating element were evaluated on a number of criteria, which are based on the preliminary requirements. For the first set of criteria the alternatives were evaluated on a pass or fail basis:

- Able to reach and maintain a temperature of at least 220°C.
- Acceptable heat distribution (less than 20°C temperature differences across the baking area).
- The output power should be close to 1,2W/cm².

For a second set of criteria the alternatives were judged on their performance relative to the other alternatives:

- Price.
- Efficiency (also: conduction versus radiation and convection).
- Possibility of local production.

This resulted in four remaining types of heating elements, which could be suitable for the Magic Mitad. This included the original coil wire, which might still give satisfactory results when placed in a different layout or when installed in an altered way. In addition the ribbon wire, silicon heater, and micanite heater were selected.

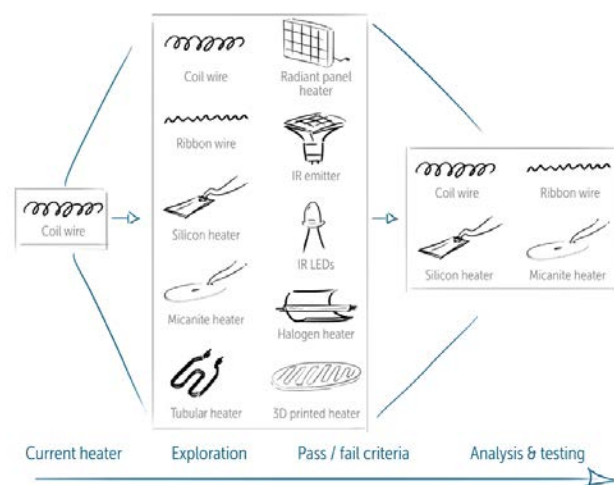

Fig. 8. Exploration, evaluation and selection of alternative heating elements [15].

Methods

The test setup for Experiment 3 was the same as for Experiment 1. For each test one of the four selected heating elements was mounted underneath the MM plate of the Magic Mitad prototype. The measurements during each test include heat distribution and start-up time.

The first two tests were done with ready-made heating elements:

- *Silicon heater* (resistance wires insulated by silicon);
- *Micanite heater* (resistance wires insulated by micanite).

The last two tests were with two resistance wires, without a layout, only a single wire:



- *Coil wire* (as used in current electrical mitads and in the Magic Mitad V1 prototype);
- *Ribbon wire* (as used in modern electrical cooking stove tops).

Results

The *silicone heating element* provides a relatively even heat distribution on the MM baking plate (see Table II). It does have a relative long start-up time: 12 minutes to reach 162°C. The element has a relatively high efficiency because of direct conduction to the mm plate (instead of radiation and convection), however the power per area remains too low.

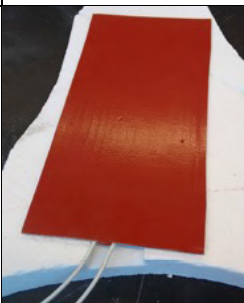
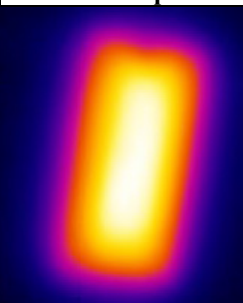

During heating up, the *micanite heating element* deformed significantly and started to touch the MM plate at some places, which caused local hotspots (see Table II). Besides these hotspots, the element caused a major cold spot above the hole in the centre of the element. The micanite heating element did have a fast start-up time: 1 minute to reach 173°C.

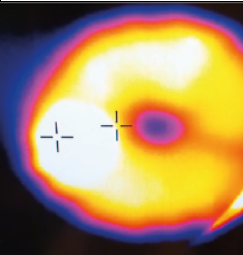
Table II: The silicon and micanite heating elements and their respective heat distribution as recorded by the IR camera.

Heat element type	Element	Heat distribution with MM plate
Silicon		
Micanite		

Isolated sections of the *ribbon* and *coil wire* were compared to each other as well. The ribbon wire shows a faster start-up time and a greater and more even heat distribution compared to the coil wire (see Table III).

Table III. The coil and ribbon wire and their respective heat distribution as recorded by the IR camera.

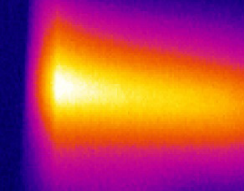
Wire type	Wire	Heat distribution with MM plate
Coil wire		
Ribbon wire		

The graph below in Fig. 9 shows the heat distribution across Line 1 for both the coil wire (blue) and ribbon wire (red) after ten minutes of heating. The graph shows that across the same distance, the ribbon wire has a more distributed curve. Also, within the same time it heats faster, and it has a higher power density.

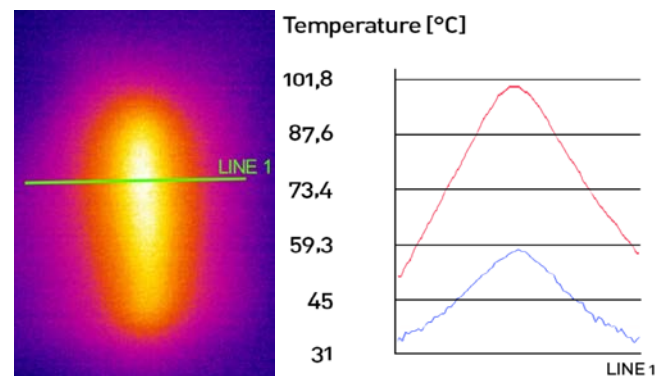

Fig. 9. Thermal imageGraph with heat distribution across Line 1: coil wire (blue) and ribbon wire (red).

Conclusions

The start-up time of the silicon heating element is too long and its power per area too low. Perceived advantages such as more direct energy transfer through conduction proved to be insufficient.

After contacting several manufacturers, it became clear that the micanite element will always have unheated parts on its surface. This will cause major temperature differences which also makes it unsuitable for the Magic Mitad.

The ribbon wire showed better results compared to the coil wire in terms of heat distribution and start-up time and was therefore selected for further development. The better heat distribution can probably be explained by the more vertical geometry of the ribbon wire compared to the coil wire. The surface area of the coil wire is at a 90° angle with the surface of the mm plate, therefore it is likely to spread the heat further than the coil wire.

In terms of production, the ribbon wire can be placed much more precisely on the element bed than a coil wire. More accurate wire placement will be beneficial to the overall uniformity of the heat distribution.

The next step is to develop a wire layout which provides a satisfactory heat distribution.

3.4 Experiment 4 Quality: Wire layout optimization

As an alternative for the coil wire, the more suitable ribbon wire was identified with a more uniform heat distribution and faster start-up time. Part of the problem with the old element was the wire layout. The new ribbon wire allows more accurate placement, by which it should be possible to achieve a uniform heat distribution with an optimized layout. Several layout concepts have been evaluated with quick simulations. The best layout concept has been further developed by prototyping and further optimization with computer simulations.

Methods

Several wire layouts were explored. They were evaluated using three methods:

- Simulation with Adobe Photoshop “glow effect” function;
- Making a physical prototype and measuring heat distribution with thermal camera;
- Simulation with SolidWorks thermal simulation.

The first method was used to quickly evaluate different layout concepts. The second method was used to more accurately evaluate different iterations of the chosen layout. The third method was used as an optimization step to eliminate hot and cold spots in the centre.

Results

Method 1:

A line was drawn in Photoshop, to which the “Outer Glow” effect was applied (see Fig. 10). The contour of the glow was chosen to match the heat distribution graph of the ribbon wire in Experiment 3. Three layout concepts were made in this way. Whenever a line has a sharp bend, a hotspot appears.



Fig. 10. Three layout concepts: the spiral concept shows the most uniform heat distribution without hotspots.

The spiral shape layout (right) was selected from three different concepts. The selection was made based on the amount and size of hotspots:

- The first concept (left) has 8 hotspots and several coldspots along the side.
- The second concept (middle) has 6 hotspots and 4 coldspots.
- The third concept (right) has no hotspots, only two coldspots. It is suspected that the layout in the center can be optimized to remove the coldspot in the center.

The third concept (right) has the lowest amount and size of hot-and coldspots (and consequently the most uniform heat distribution) and was therefore selected.

Method 2:

To validate and improve the spiral layout concept, in iterations, nine prototypes were made using a ribbon wire from a kitchen stove element. First a prototype was made without the use of any template. In case the results proved unsatisfactory, first a hand-cut cardboard template was used to position the wire. For even more accurate wire placement a laser-cut MDF template was used for the 7th iteration. A double spiral design was implemented so that the wire would start and end at the edge of the element (instead of ending in the centre), a requirement for production (see Fig. 11).

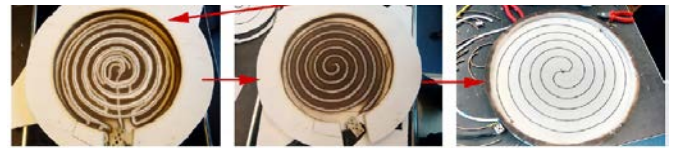

Fig. 11. Several prototype iterations of the chosen spiral concept.

Method 3:

The double spiral prototype still had two cold spots in the centre. Another prototype was made (8th iteration) with less space between the wires in the centre, but the problems remained. A SolidWorks simulation was performed to optimize the centre of the layout without having to prototype each iteration (see Fig. 12).

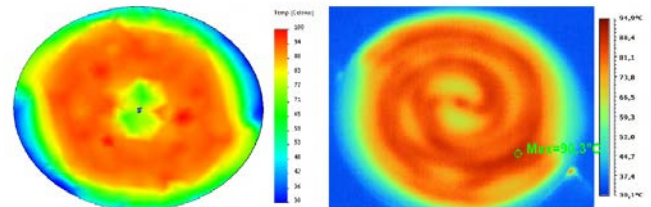

Fig. 12. A SolidWorks simulation result of the 8th layout iteration (left) compared to a thermal image of the physical prototype of the 8th layout iteration (right).

After optimization in SolidWorks, a 9th and last prototype iteration was made. This prototype provided satisfactory results in terms of heat distribution. Apart from the edges, temperature differences are <math><20^{\circ}\text{C}</math> (see Fig. 13).

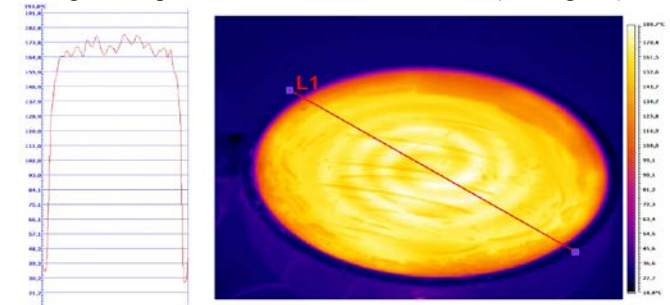

Fig. 13. Temperature distribution of the Magic Mitad prototype with enhanced ribbon wire heating element with optimized layout. The graph shows temperature (vertical axis) along section line L1 (horizontal axis).

Conclusions

After exploring three different layout concepts, the spiral layout was selected and further optimized. Challenges with the spiral layout include the edges and the centre. After nine iterations, a layout was conceived with an acceptable uniform heat distribution. The new heating element was evaluated with another baking test, which showed very promising results. The next step was to validate the improved design with field tests.

3.5 Experiment 5 Quality: Baking test in the field.

After selecting the proper heating element as well as optimizing the layout of the heating element it was time to go to Ethiopia to test in the field the energy efficiency and baking performance of the improved Magic Mitad.

Methods

Based on the Controlled Cooking Test [16], the mitad efficiencies were evaluated by measuring the energy consumption per kilogram of cooked food. At the test site, Addis Ababa University Bakery, about 150 injeras are baked each day, seven days per week. Baking in such large quantities made it possible to more accurately evaluate efficiency and other aspects such as usability.

- i. First the quality of the injeras baked on the Magic Mitad were evaluated in two ways. First by comparing them to the injeras baked on clay mitads and evaluating the desired injera properties as stated in section 2.4. Secondly the injeras were subjectively evaluated by interviews with professional injera bakers (working at bakeries), chefs and other locals. The injeras, which were baked that same day were shown to the interviewees. Questions asked included: “What is your opinion of the quality of these injeras?”.
- ii. Next the energy efficiency of current electrical clay mitads as well as of the new improved Magic Mitad was measured. The efficiency was calculated using the formula as presented in 2.3. For this purpose the following measurements were made:
 - *Power* was recorded with a power- and energy meter. This device measures the amount of power [kW] drawn by the mitad, this amount is relatively stable over the duration of the baking session.
 - *Baking cycle time* was recorded with a timer / stopwatch device.
 - *Startup energy* was recorded with a power- and energy meter. This device measures the energy consumption [kWh] during the heating up process.
 - (amount of injera’s baked during a session)

Results

The results show that the Magic Mitad configuration has a higher efficiency than the clay mitads. The ‘magic mitad’ showed the highest efficiency: up to 30% energy savings compared to the current electrical clay mitads.

Table IV: Baking time, energy consumption, and energy savings.

Mitad type	Baking cycle time (m:ss)	Energy per kg injera	Energy savings
Traditional clay mitad	4:15	658 Wh	-
Improved Magic Mitad	3:00	460 Wh	30%

Concerning injera quality: both the objective and subjective evaluations were mostly positive, the Magic Mitad injeras were almost indistinguishable from clay mitad injeras in terms of thickness, “eyes” on the top side and a smooth under layer. The main point of improvement concerned the edges, which were not thin and crispy like on the clay mitad injeras.

Conclusions

The combination of the new heating element with the MM baking plate can result into 30% energy savings.

Injera quality was positively evaluated by experts, except for the edges. It is assumed that the edge problem can be solved by changing the geometry of the MM baking plate.

3.6 Experiment 6 Quality: Power settings

The currently used electrical clay mitads only have two power setting: on and off. During baking the power is always on, the power level is chosen in a way that enough energy is supplied during the baking process. The power level is also one of the determinants of the baking cycle time: how long it takes to reheat between baking of injeras. The purpose of this experiment is to determine this power level for the Magic Mitad, to allow continuous baking without having to adjust the power.

Methods

During baking, the power level was adjusted to several different levels with a power control unit, ranging from 2000-2600W, in order to compare baking quality.

The baking temperature was determined by the experienced professional chef. When the chef deemed the temperature to be correct, she poured the dough onto the mitad. Methods for evaluating temperature (by the chefs) include:

- Spreading ground up oily seeds (mushit) on the baking area and evaluating the colour change (from brown-yellowish to dark brown) and smoke;
- Pouring a few drops of dough onto the baking area and judging by visual and audible feedback.

Results

The highest quality baking results were achieved with a continuous power level of 2000W on a 48,5cm diameter baking area (1,09W/cm²).

Conclusions

After further optimization the baking area was increased to 54cm diameter, which corresponds to a power setting of 2500W (1,09W/cm²).

4 CONCLUSIONS AND DISCUSSION

Electricity based mitads are a sound alternative for the energy inefficient traditional three stone fire mitad ovens. However, also their energy efficiency has to be improved drastically in order to prevent an overload on the electricity grid.

The Magic Mitad project as discussed in this paper has resulted through a range of research and design experiments in a new type of electrical Mitad. The most recent version of the Magic Mitad prototype has some significant advantages as well as disadvantages compared to the electrical clay mitads. The energy efficiency of the Magic Mitad is significantly higher compared to the electrical clay mitads (up to 45% higher). The quality of the injeras baked on the Magic Mitad was perceived by experts as very high, comparable to the quality of injeras baked on clay mitads. Good uniform heat distribution has proven to be the key to a quality injera and as such key to user acceptance.

A disadvantage of the Magic Mitad is the expected retail price, which is higher than for a clay mitad. This makes the Magic Mitad unaffordable for low-income households, since energy savings (in the context of Ethiopia) do not compensate for the high initial investment. In the setting of a bakery with up to 16 hours of baking each day, electricity costs do become very significant. Savings on electricity could compensate for the initial investment of purchase within a few months. Also, since the baking time is up to 37% faster, this means that fewer mitads are required to bake the same amount of injeras each day.

The Magic Mitad is in ongoing development, with the aim to find a balance between efficiency, baking quality and cost price. Other factors such as local production and durability also play an important part.

REFERENCES

- [1] Putz, K. and J. Muller, Development of a Multi Fuel Mitad as Stove Extension for Injera Baking in Ethiopia, in Development on the margin. 2011: Bonn.
- [2] Tesfay, A.H., M.B. Kahsay, and O.J. Nydal, Solar Powered Heat Storage for Injera Baking in Ethiopia. *Energy Procedia*, 2014. **57**: p. 1603-1612.
- [3] Mulugeta, B., S.W. Demissie, and D.T. Nega, Design, Optimization and CFD Simulation of Improved Biogas Burner for 'Injera' Baking in Ethiopia. *International Journal of Engineering Research & Technology*, 2017. **6**(1).
- [4] Fekadu, G., Review of Forest loss and climate change in Ethiopia. *Research Journal of Agriculture and Environmental Management*, 2015. **4**(5): p. 216-224.
- [5] Mengistu, M.G., et al., Factors affecting households' decisions in biogas technology adoption, the case of Ofla and Mecha Districts, northern Ethiopia. *Renewable Energy*, 2016. **93**: p. 215-227.
- [6] Tesfay, A.H., M.B. Kahsay, and O.J. Nydal, Design and Development of Solar Thermal Injera Baking: Steam Based Direct Baking. *Energy Procedia*, 2014. **57**: p. 2946-2955.
- [7] Kebede, D. and A. Kiflu, Design of Biogas Stove For Injera Baking Application. *International Journal of Novel Research in Engineering and Science*, 2014. **1**(1): p. 6-21.
- [8] Van Buskirk, R., H. T., and E. N., The effect of clay and iron cooking plates on mogogo efficiency and energy use: experimental results. *Eritrean Studies Review* 1999. **3**(1): p. 105-125.
- [9] Gebreegziabher, Z., et al., Urban energy transition and technology adoption: The case of Tigray, northern Ethiopia. *Energy Economics*, 2012. **34**: p. 410-418.
- [10] Alem, Y., S. Hassen, and G. Köhlin, Adoption and disadoption of electric cookstoves in urban Ethiopia: Evidence from panel data. *Resource and Energy Economics*, 2014. **38**: p. 110-124.
- [11] Gebreegziabher, Z., Household fuel consumption and resource use in rural-urban Ethiopia, in *Agricultural Economics and Rural Policy Group*. 2007, Wageningen University: Wageningen.

- [12] Tafere, A.T., Experimental investigation on performance characteristics and efficiency of electric injera baking pans ('Mitad'), in *Energy Technology*. 2011, Addis Ababa University: Addis Ababa.
- [13] DANAS, Project Document on Electric Injera Mitad: Energy Efficiency Standards & Labeling. 2015.
- [14] Sood, D., Injera Electric Baking: Energy Use Impacts In Addis Ababa Ethiopia, W.B.A. Region, Editor. 2010, World Bank Africa Region: Washington.
- [15] Jones, R., Magic Mitad: Development of Energy Efficient Injera Stove for the Ethiopian Market, in *Industrial Design Engineering*. 2015, Delft University of Technology: Delft.
- [16] Bailis, R., Controlled Cooking Test (CCT). 2004, Shell Foundation.

AUTHORS BIOS AND PHOTOGRAPHS



Robin Jones received his MSc degree in Integrated Product Design from Delft University of Technology in 2015. At Delft University of Technology he took an interest in sustainable design as well as medical design. Currently pursuing entrepreneurial ventures with a start-up in the YES!Delft tech incubator focussing on 3D scanning and printing for customized orthotics..



Jan Carel Diehl received his MSc and PhD degrees in Industrial Design Engineering from Delft University of Technology. In his present position, he is assistant professor for the Design for Sustainability (DfS) research program and senior researcher within the Delft Global Initiative and the LDE Center for Frugal Innovation in Africa.

Presenting author: The paper will be presented by Jan Carel Diehl