

Teaching buckling of cylindrical shells through an effective laboratory demonstration

Gavioli, Marta; Bisagni, Chiara

DOI

[10.1080/15376494.2021.1913269](https://doi.org/10.1080/15376494.2021.1913269)

Publication date

2021

Document Version

Final published version

Published in

Mechanics of Advanced Materials and Structures

Citation (APA)

Gavioli, M., & Bisagni, C. (2021). Teaching buckling of cylindrical shells through an effective laboratory demonstration. *Mechanics of Advanced Materials and Structures*, 29(25), 3911-3923.
<https://doi.org/10.1080/15376494.2021.1913269>

Important note

To cite this publication, please use the final published version (if applicable).
Please check the document version above.

Copyright

Other than for strictly personal use, it is not permitted to download, forward or distribute the text or part of it, without the consent of the author(s) and/or copyright holder(s), unless the work is under an open content license such as Creative Commons.

Takedown policy

Please contact us and provide details if you believe this document breaches copyrights.
We will remove access to the work immediately and investigate your claim.



Teaching buckling of cylindrical shells through an effective laboratory demonstration

Marta Gavioli & Chiara Bisagni

To cite this article: Marta Gavioli & Chiara Bisagni (2021): Teaching buckling of cylindrical shells through an effective laboratory demonstration, Mechanics of Advanced Materials and Structures, DOI: [10.1080/15376494.2021.1913269](https://doi.org/10.1080/15376494.2021.1913269)

To link to this article: <https://doi.org/10.1080/15376494.2021.1913269>



© 2021 The Author(s). Published with license by Taylor and Francis Group, LLC



Published online: 16 Apr 2021.



Submit your article to this journal [↗](#)



Article views: 230





View related articles [↗](#)



View Crossmark data [↗](#)

Teaching buckling of cylindrical shells through an effective laboratory demonstration

Marta Gavioli  and Chiara Bisagni 

Faculty of Aerospace Engineering, Delft University of Technology, Delft, The Netherlands

ABSTRACT

A laboratory demonstration for a Stability of Structures course is presented, consisting in the buckling test of two cylindrical shells: a 3D-printed and a composite cylinder. The learning outcomes have been formulated by comparing what can be learnt from theoretical lessons and buckling tests. The activity follows the Interactive Lecture Demonstration approach. Main results show that the activity helped students' understanding of shell buckling and it increased their enthusiasm for the topic. This demonstration is easily implementable, and the presented step-by-step development methodology provides guidelines to develop similar activities for different engineering subjects.

ARTICLE HISTORY

Received 31 March 2021
Accepted 1 April 2021

KEYWORDS

Shell buckling; structural stability; intended learning outcomes; pedagogical affordance; engineering education

1. Introduction

Stability of Structures is a fundamental master-level course in several engineering curricula, such as Aerospace, Civil and Mechanical Engineering. The objective of the discipline is to develop methods for the analysis of the structural stability under different set of loadings, to be used in the design of structural elements [1]. Within the context of Aerospace Engineering, master courses of Stability of Structures present the phenomenon of buckling in common aerospace structural elements, such as beams, plates, and shells [2]. During the normal lectures, students are introduced to the analytical derivation of the equations governing buckling of each of these structural elements. These mathematical representations summarize and organize quantitative information about the phenomenon, such as crucial relations between variables.

However, analytical derivations present a high level of mathematical formalism, abstraction, and complexity [3]. As a result, lectures often focus on the mathematical procedures instead of the physical phenomenon they represent. Moreover, the equations do not provide a full picture of the physical phenomenon to students who never experienced buckling before [4]. Hence, students often struggle at linking mathematical representations to the real-world scenarios and understanding the buckling behavior of structural elements [3].

To overcome these limitations, buckling test demonstrations could be implemented as complementary activities to normal instruction. In fact, laboratory tests reproduce physical phenomena [5] and so provide a context for students where directly experience buckling of structures and interact with different representations than the analytical models. Therefore, the aim of the current work is to provide a proof of principle

that laboratory demonstrations can promote master students' understanding of the buckling phenomenon.

The demonstration presented in this paper focuses on buckling and post-buckling behavior of thin-walled cylindrical shells. Cylindrical shells are widely used in the aerospace sector, for example in the fuselage of aircrafts and rockets components. Buckling is a driving aspect in the design of cylindrical shells, because these structural components can deform in buckling before than in yielding, and because their load-carrying capacity drops off dramatically after buckling [2]. Moreover, since shell buckling is a highly imperfection-sensitive phenomenon, the analytical predictions are usually higher than the experimental buckling load [6]. For this reason, structural testing is essential for accurately characterizing the buckling behavior of cylindrical shells. The experimental outcomes are used to formulate assumptions and approximation in the development of analytical and numerical methods, as well as provide evidence to validate those methods [2]. For these reasons, it is important for students to reach a good level of understanding of the shell buckling phenomenon and of the experimental techniques.

Other engineering subjects normally include laboratory practice in the lecture curricula. In these cases, instructors already have available a wide range of standard instructional laboratory activities that can be implemented. However, this is not the case for Stability of Structures, which is usually taught in an expository lecture style. As a consequence, the development and implementation of laboratory demonstrations can feel daunting for lecturers, due to a lack of time, resources, and a formal design process.

Subsequently, this paper presents the design and implementation of the laboratory demonstration and an

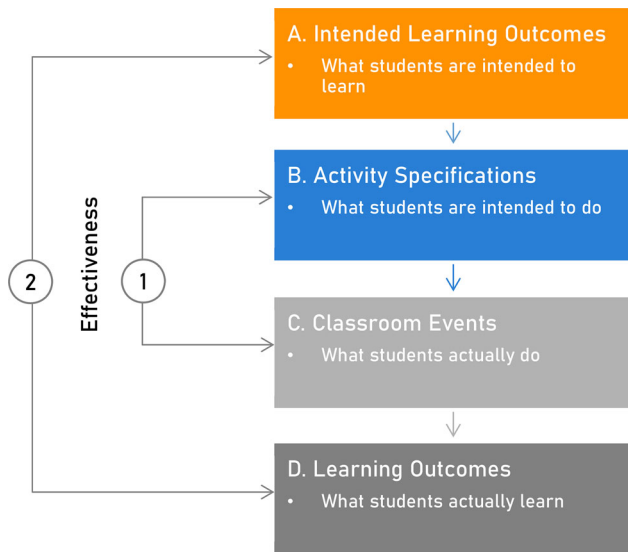

Figure 1. Steps in the development and evaluation of an instructional laboratory activity in relation to the term ‘effectiveness’.

investigation of its effectiveness in promoting master students’ understanding of buckling of cylindrical shells. First, the steps that have been followed in the design process and the methods for the analyses of the effectiveness of the activity are summarized. The intended learning outcomes for the laboratory demonstration are defined by analyzing the representations usually used in *Stability of Structures*. Consecutively, the additional insights on the buckling phenomenon that the demonstration could provide are outlined. Next, the activity specifications are described, presenting the buckling test set-up and specimens for the demonstration, as well as the instructional material to guide student attention during the activity. Finally, the implementation of the laboratory demonstration in a master lecture is assessed. Students were asked to complete written tasks and fill in a short survey. Response rate, survey results and the effectiveness of the activity are discussed.

2. Methodology for the design of the laboratory demonstration

The main design requirement for the laboratory demonstration is to be effective at helping students better understand the phenomenon of shell buckling. Millar’s model of effectiveness [7] of practical work, developed within the European Labwork in Science Education project [8], provides a useful tool in this regard. The model, shown in Figure 1, makes explicit the relationship between the usual steps that instructors undergo in the development and implementation of a practical instructional activity and the effectiveness of the intervention.

The starting point (step A) is the definition of the Intended Learning Outcomes (ILOs). These constitute the aims and intentions of the instructor and specify the insights and skills that students are expected to learn from the activity. Step B is for the instructor to design or choose a specific instructional activity that has the potential to enable students to achieve the desired ILOs.

Once the laboratory activity is designed and implemented in practice, it is possible to assess what students actually do

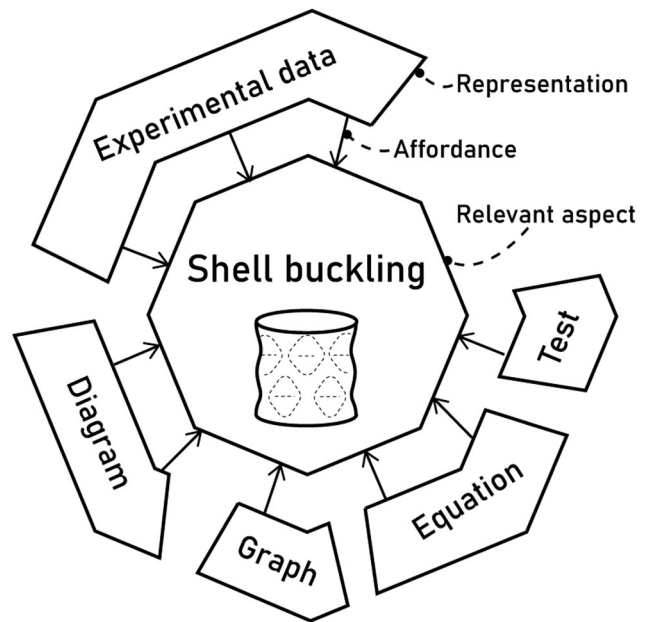

Figure 2. Phenomenon, disciplinary representations and affordances.

as they undertake the activity (step C). In fact, students might not do exactly what was planned; for example, students might not understand the demands or decide not to follow them. The final stage (step D) is concerned with the evaluation of the actual learning outcomes, that is what students actually learn because of undertaking the activity.

From this model, the term “effectiveness” can have two meanings [7]. “Effectiveness 1” is the extent to which the activity guided students in doing what they were intended. This is about the relationship between step C and step B. “Effectiveness 2” is the extent to which the activity enabled students to learn what they were expected. This is about the relationship between step D and step A.

In the following sections, following the steps of Millar’s model of effectiveness (Figure 1), the development, implementation, and assessment of the laboratory demonstration is presented.

3. Intended learning outcomes

The first step in the design of the laboratory demonstration is the detailed definition of the ILOs. Core constructs, such as the pedagogical affordances of disciplinary representations, are introduced and then used to analyze the theory of shell buckling. The additional insights on the buckling phenomenon that the demonstration could provide are highlighted. Finally, the ILOs of the laboratory demonstration are defined in alignment with the pedagogical affordances of the buckling tests.

3.1. Disciplinary representations and pedagogical affordances

According to the perspective of Fredlund, Linder and Airey [9] on university physics education, a discipline consists of a coherent system of ideas and concepts for thinking about

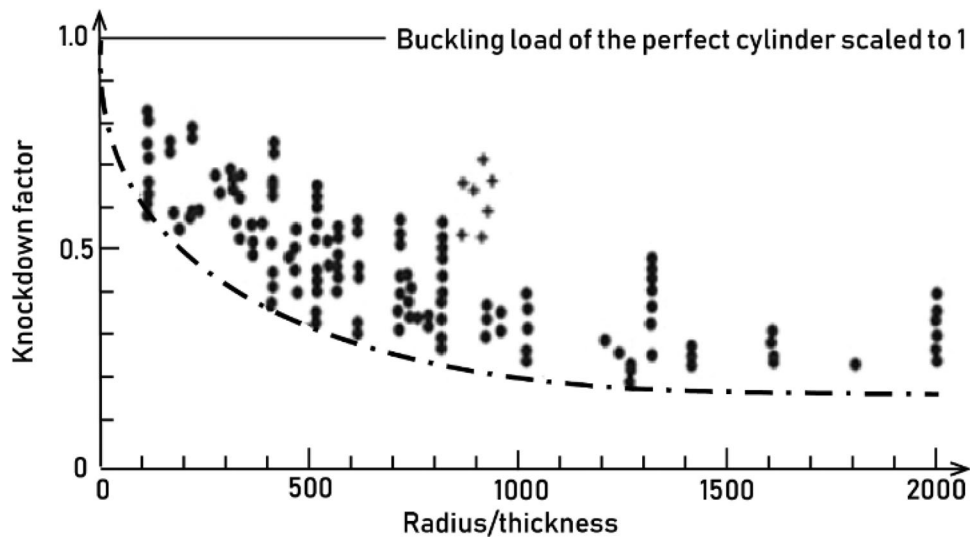

Figure 3. Buckling knockdown factor diagram [14].

objects and phenomena. Within the community of experts of a discipline, ideas are developed and communicated using disciplinary representations, such as technical written and spoken language, mathematical formulas, equations, graphs, diagrams, physical tools, and experimental work. These representations together form the ‘language’ of the discipline [10].

Because phenomena are complex events with multiple relevant aspects to be considered, many representations are needed to fully represent them. This point is schematically shown by Airey and Linder in [4], and applied to the specific case of shell buckling in Figure 2. The phenomenon under study is represented as a polygon, whose sides symbolize the relevant aspects to be considered. Every disciplinary representation affords access to only some of the relevant aspects, namely the disciplinary affordances of the representation. Therefore, many disciplinary representations are needed to fully represent a phenomenon.

Students are novices in the discipline; thus, they often do not use the disciplinary representations in the ways experts do, they struggle at seeing the relevant aspects that the disciplinary representations afford. For this reason, when designing an instructional activity to explain a specific concept or phenomenon, Airey & Linder advice instructors to reflect not only on what disciplinary representations to include, but also on their pedagogical affordances [10], i.e. “the usefulness of a representation for teaching some particular educational content”. In other words, the pedagogical affordances of a disciplinary representation consist of all the aspect of the phenomenon that a novice can potentially learn from that representation. This construct makes explicit that some representations may be better than others to help students discover new aspects of the phenomenon under study.

It is possible to distinguish different types of disciplinary representations based upon the different ways they convey information [11]. Specifically, during theoretical lessons students are normally introduced to symbolic-mathematical representations such as equations and formulas, which afford a quantitative description of the relations between variables. On the other hand, laboratory demonstrations can

be seen as actional-operational representations, which reproduce physical phenomena, and they convey information in the form of physical objects, events, and their observable properties, such as geometry, materials, relative location, and motion [12]. Furthermore, during a demonstration activity, students are usually presented with additional visual-graphical representations [11], such as schemes of the experimental set up, diagrams of the experimental procedures, as well as graphs and plots of the experimental results. Visual-graphical representations allow students to interpret experimental data and visualize relationships between variables.

In instructional activities which integrate multiple representations, the pedagogical affordances of the representations, the intended learning outcomes and the tasks students are asked to perform should be aligned [11]. For this reason, in the following sections the pedagogical affordances of the disciplinary representations of Stability of Structures and the ILOs of the demonstration activity are outlined.

3.2. Theory of buckling of cylindrical shells

During Stability of Structures theoretical lessons on buckling of cylindrical shells, the main topic discussed is how to predict the buckling load and the post buckling behavior of thin-walled shells under axial compression. First, the analytical derivations are introduced [2]. Cylindrical shells are usually discussed considering isotropic materials. From the equilibrium equations is possible to derive, after several and complex mathematical manipulations [13], a simplified formula to compute the critical buckling stress, represented in (1):

$$\sigma_C = \frac{E(t/R)}{\sqrt{3(1-\nu^2)}} \quad (1)$$

This equation links the critical buckling stress to the geometrical (thickness t , radius R) and material properties (Elastic modulus E ; Poisson’s ratio ν) of the structure. To compute the theoretical buckling load in the case of a thin

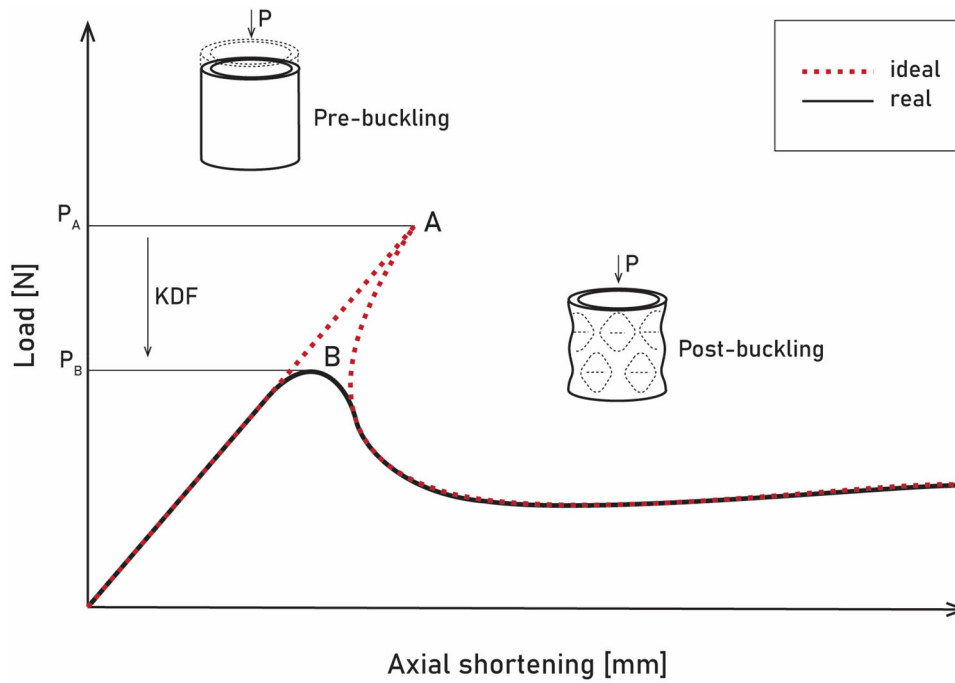

Figure 4. Typical load-shortening curves of a cylindrical shell under axial compression.

cylindrical shell, (1) is multiplied with the surface area on which the load is applied:

$$P_{Buckling} = \sigma_c(2\pi Rt) = \frac{2\pi Et^2}{\sqrt{3(1-\nu^2)}} \quad (2)$$

Eq. (2) assumes an ideal cylinder and ideal loading conditions, thus overpredicting the load at which real structures buckle, as shell buckling phenomenon is extremely imperfection sensitive: because of minor imperfections, the experimentally measured buckling loads are far lower and scattered than the theoretically predicted value [2]. For these reasons, the presence and influence of unavoidable imperfections due to manufacturing, boundary, and loading conditions is an important concept that students must learn.

To account for the effect of imperfections during preliminary design, the theoretical buckling load is multiplied by an empirical design factor, known as buckling knockdown factor (KDF). Diagram of NASA document SP-8007 [14], presented in Figure 3, is the most widely used source of KDFs for cylindrical shells.

This diagram summarizes experimental results of several structural tests, defining the lower-bound as conservative factor to be used in the design of cylindrical shells, depending on the radius over thickness ratio.

The pre- and post-buckling behavior of cylindrical shells is also described to students. To illustrate this concept, the characteristic load-axial shortening curves are reported in Figure 4.

The dotted curve describes the behavior of a perfect shell in an ideal loading condition [2]. In this case, the load-displacement relation is linear until point A is reached. This portion of the graph illustrates the pre-buckling behavior, where the shell shows only an axial shortening. At point A buckling occurs. The load at this point (P_A) is predicted

with the eq.2. The second part of the graph illustrates the post-buckling behavior. Here, the structural element assumes a buckled shape with out-of-plane displacement, which is much larger than the axial shortening, and the load-carrying capacity of the shell decreases sharply. This second portion of the graph shows a nonlinear relation between the load and displacement.

Because the phenomenon of shell buckling is very sensitive to geometrical, material and loading imperfections, in most cases it is necessary to perform a structural test to better characterize the imperfections of the structure, and to measure the buckling load. The solid line reports the behavior of an imperfect shell [6]. In this case, the load-displacement relation is nonlinear from an earlier stage of loading and buckling occurs less sharply at a lower load P_B . The relationship between P_A and point P_B is known as Knock-Down Factor (KDF) as previously described in Figure 3. The solid line describes the typical behavior observed during buckling tests of real structures [2].

3.3. Shell buckling representations and their pedagogical affordances

Important disciplinary representations emerged by analyzing the theory of cylindrical shell buckling. These are: the buckling load equation, the knock-down factor diagram, and the load-axial shortening curve. Their pedagogical affordances, i.e. what students can potentially learn from each disciplinary representation, have been discussed in detail in the previous section and they are summarized in Table 1.

While these representations provide several insights on the buckling phenomenon, they do not provide a full picture to students who never experienced buckling before. Hence, additional disciplinary representations, proper of the

Table 1. The representations of the theoretical lessons and their pedagogical affordance.

	Disciplinary representation	Type*	Pedagogical affordances: "with this representation, students can ..."
Theoretical lessons	Equations of buckling load and stress.	SM	Quantitatively describe the relationships between the buckling load and the geometrical and material properties of the cylindrical shell.
	Knock-down factor diagram.	VG	Compute /predict the buckling load in the ideal case (no imperfections). Estimate the influence of imperfections on buckling behavior based on the radius over thickness ratio.
	Predicted load-axial shortening curve.	VG	Compare the pre- and post-buckling behavior without and with imperfections.

*Types of disciplinary representations [11]: SM = symbolic-mathematical; VG = visual-graphical; AO = actional-operational.

laboratory environment, have been chosen to be the focus of the demonstration activity. These are: the test equipment, the demonstration of the phenomenon, and the plots of the experimental results. Their pedagogical affordances are presented in Table 2.

3.4. Outline of the intended learning outcomes

The ILOs represent a detailed list of what students are intended to learn from the learning activity. For the shell buckling laboratory demonstration, the ILOs are defined in alignment with the pedagogical affordances of Stability of Structures representations. The ILOs formulated following Bloom's taxonomy [15] are presented in Figure 5:

ILO1 implies that students will be introduced to new disciplinary representation proper of laboratory practice. Indeed, students are expected to learn how buckling tests are performed, in terms of needed equipment and procedures. ILO2 deals with the pedagogical affordances of the new representations, students are expected to discover new aspects of the buckling phenomenon, which are presented in Table 2. ILO3 is concerned with grounding theory in the physical world, students are expected to link the experimental findings to the theory of shell buckling.

4. Activity specifications

The activity specifications define the tasks students are expected to perform during the laboratory demonstration, in order to achieve the ILOs. First, the Interactive Lecture Demonstration (ILDs) approach [5], which informed the development of the activity specification, is presented. Then, the two cylindrical shells used in the buckling demonstration and the performed buckling tests are described. The following sections introduce the instructional material, developed to guide students' attention in the activity.

4.1. Interactive lecture demonstrations (ILDs) approach

The Interactive Lecture Demonstrations (ILDs) approach is an active learning strategy developed by Sokoloff, and Thornton [5]. It aims at supporting students' engagement in the learning process and help increase their understanding of physical phenomena [16]. ILD approach recommends structuring the activity on three tasks: predicting, observing, and reflecting on the demonstration results.

The Science Education Resource Center at Carleton College [17] offers guidelines for the design of ILDs, the main points have been summarized in Table 3.

The prediction phase supports students' engagement in the learning activity and guides students focus on main concepts to be learned. Studies on the efficacy of laboratory demonstration [16] showed that students tend to correctly report observations if asked to predict the phenomenon beforehand. In the observation phase, students experience the phenomenon in a real-world context. The reflection phase helps students abstract from the specific situation and link theory with their observations.

4.2. Demonstration: buckling tests of cylindrical shells

To perform the shell buckling demonstration, a common set-up for testing cylindrical shells in axial compression [6] is used, as reported in Figure 6.

The cylindrical shell is positioned between the two end plates of a testing machine. During this step, special precautions are necessary to assure a uniform loading of the structure. For example, often end tabs are added to the cylindrical shell to increase the loading surface.

The structural tests have to be displacement controlled. The distance between the end plates is decreased and the axial load is measured. The measured load increases until the structure buckles. At buckling, the load drops and the shell snaps into the typical diamond pattern deformed shape. Moreover, buckling does not always imply material failure. If the buckling load happens before yielding, the structure remains in the elastic regime and the deformation is not permanent, hence the buckling phenomenon can be repeated several times.

In the laboratory demonstration, the data acquired are the buckling load, the axial shortening, strains, and out-of-plane displacements. The measurement equipment used is the loadcells and axial displacements sensors of the testing machine. In addition a Digital Image Correlation (DIC) system can be used to capture the strains and out-of-plane displacements.

4.3. Demonstration: cylindrical shells

Two cylindrical shells, differing in material and dimensions, have been chosen as specimens for the laboratory demonstration. The demonstration consists in testing both shells to obtain the experimental buckling load and to observe buckling behavior. The specimens are presented in Figure 7.

Table 2. The representations of the laboratory demonstration and their pedagogical affordance.

	Disciplinary representation	Type*	Pedagogical affordances: “with this representation, students can ...”
Laboratory demonstration	Selection of test equipment and instrumentation.	AO	Design and conduct investigations on the buckling behavior of cylindrical shells, focusing on boundary conditions, loading mechanism, data acquisition systems.
	Demonstration of the phenomenon.	AO	Experience buckling of cylindrical shells in a real-world context and notice contextual elements as imperfections and buckling shape.
	Experimental measurements and plots.	VG	Interpret data about buckling behavior of cylindrical shells, such as load, displacements, and strain distributions. Visualize relationships between variables, such as buckling load and axial shortening.

*Types of disciplinary representations [11]: SM = symbolic-mathematical; VG = visual-graphical; AO = actional-operational

A. Intended learning outcomes
What students are intended to learn:

- IL01: students are able to explain how the phenomena is studied in an experimental setting, with a particular focus to the tools needed and strategies to deal with imperfections.
- IL02: students are able to describe additional aspects of the shell buckling phenomenon (for the complete list: Table 2).
- IL03: students are able to relate the experimental outcomes to theory.

Figure 5. Intended Learning Outcomes (ILOs) for the laboratory demonstration.**Table 3.** Main goals and design guidelines for each phase of ILD.

	Main goal	Guidelines
Predict	Engage students in the learning activity Guide students focus on main concept to be learned. Connect the demonstration with the students' prior experience.	Clearly indicate what will take place in the demonstration without revealing the outcome. Elicit students' prior knowledge or experience on the topic. Ask students to predict the outcome of the experiment. Ask students to explicitly document their thinking in writing. Do not push student formulate right or wrong prediction, but help them focus on the main concepts.
Observe	Let students observe the phenomenon. Guide students focus on main aspects to be noticed.	Run the demonstration. Ask students to note differences and similarities between their predictions and the demonstration outcomes.
Reflect	Increase new knowledge retention. Abstract from the specific situation. Highlight general applicability and support transfer.	Ask students to consider the ways in which the demonstration challenged their prior beliefs (or not). Ask students to think explicitly about what they have learned, making connections to what they knew before, and identifying what specifically has changed in their thinking. Help students transfer their learning to new situations for which the concept applies.

The first specimen is a 3D-printed cylindrical shell manufactured using commercially available Creality Ender 3D-printer with a 0.5 mm nozzle and polylactide (PLA) filament. The shell has a height of 170 mm, an inner diameter of 150 mm and a radius over thickness ratio of 150. More information about this shell structure can be found in [18]. Reinforcement tabs made of 6 mm fiberboard are added on both ends to strengthen the specimen and to be able to apply the compression load. The buckling load in the ideal

case, computed with the Eq. (2) is equal to 2180 N. The knock down factor recommended for this shell is 0.56; thus, the buckling load in case of imperfection is expected to be around 1243 N.

The 3D-printed shell has been chosen for two main reasons. First, the material can be considered homogeneous, so students can directly use the formula taught in class to calculate the theoretical buckling load. The second reason is that, thanks to the affordable material and the small

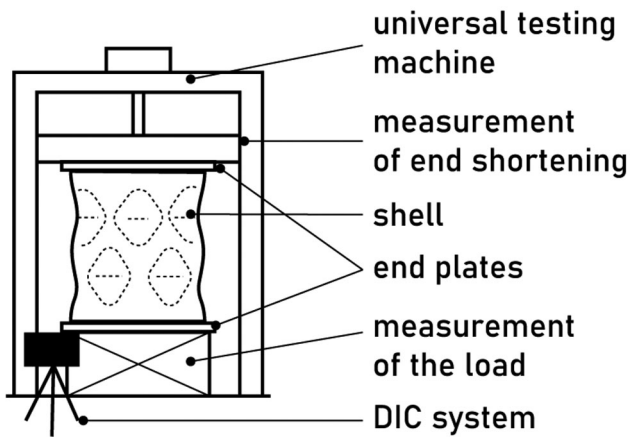

Figure 6. Schematic view of the axial compression testing set-up for the laboratory demonstration.

dimensions of the specimen, this demonstration requires only conventional laboratory equipment and, therefore, it is easily implementable.

The second specimen is a large cylindrical shell made of composite material. The shell has a height of 790 mm, an inner diameter of 600 mm and a thickness of 1.45 mm. The shell is made of 8 layers of AS4/8552 carbon fiber reinforced polymer (CFRP). The composite shell was readily available in the laboratory due to a previously conducted research project [19].

The composite shell has been chosen for the demonstration because it represents an example of a real aerospace structural element and because it differs from the previous specimen both in dimensions and in material. Therefore, the structural test of this shell provides students with additional insights on the buckling phenomenon.

4.4. Instructional material

The instructional material has been developed to guide students in the activity. It includes a demonstration worksheet, a short survey and an open question. The structure of the activity and of the instructional material is presented in Figure 8.

The blue boxes represent the demonstration worksheet. The worksheet contains technical questions on the laboratory demonstration, pertaining the predict and reflect phases of the Interactive Lecture Demonstration (ILDs) approach [5]. The short survey and an open question, reported in the gray boxes of Figure 8, assess students perceived learning outcomes.

The worksheet presents 33 tasks, 27 of which were closed-ended questions and 6 were open-ended. The first page of the worksheet introduces students to the scope of the tests, which is describing the buckling behavior of two different cylindrical shells. Students are also provided with the specimen data, as in Figure 7. The second page of the worksheet helps students in the Predict 1 phase, with 11 questions focusing on the 3D-printed cylindrical shell. Students are not expected to formulate right prediction to successfully complete the activity, the questions are meant to direct students' attention to important aspects of the buckling phenomenon. Prior knowledge of the

theory of buckling is elicited, asking students to apply the analytical formula and the knock-down factor and to compute the buckling load to be used in the design of the structural element. Based on that, students have to state if they expect the buckling load measured during the test to be higher or lower than what they computed and if they think that the specimen is going to break. Afterwards, three multiple choice questions required students to formulate predictions about other aspects of the buckling phenomenon, such as the order of magnitude of the in- and out-of- plane displacements, the buckling shape and the experimental set-up needed. Examples of these questions can be found in Figure 9.

The following 8 questions of the worksheet guide students in the Reflect 1 part. Students must report the data measured during the test and confront them with their predictions. Irrespective of whether the prediction was right or wrong, students are asked to comment on it using their theoretical knowledge.

The same predict and reflect steps are repeated for the test of the second specimen. 6 similar questions guide students in the Predict 2 phase for the composite cylindrical shell, with the difference that students are not asked to predict the buckling load, but instead to reflect on the applicability of the formula to composite materials [20]. In the Reflect 2 part, 8 questions ask students to report their observations. This time, students are invited also to reflect on the non-linear aspects of the phenomenon.

4.5. Outline of the activity specifications

What students are expected to do while undertaking the activity has been summarized in Figure 10:

Because the questions of the worksheet have been designed in alignment with the ILOs, by performing the activity students are expected to gain insights on how the phenomenon is studied in an experimental setting, reflect on relevant aspects of shell buckling phenomenon, and to relate the experimental outcomes theory.

5. Classroom events

The laboratory demonstration was implemented in the Stability of Structures course at Delft University of Technology (the Netherlands). Stability of Structures is taught during the first year of the Aerospace Structure Master program, with a lecture groups of typically 25 to 50 students each year. For the case presented in this paper, 28 students cohort participated in the activity. The laboratory demonstration was run two days after the theoretical lesson on shell buckling. Students were asked to fill in the Predict 1 part of the worksheet while being in class, the rest of the activity took place in the Aerospace Structure and Materials Laboratory.

During the tests, the loading-displacement data were shown to students in real time. Digital Image Correlation (DIC) results, such as the strain distribution and the out-of-plane displacement, were shown to students at the end of both tests. Students attentively observed both structural tests and asked several questions to the instructor. Students were

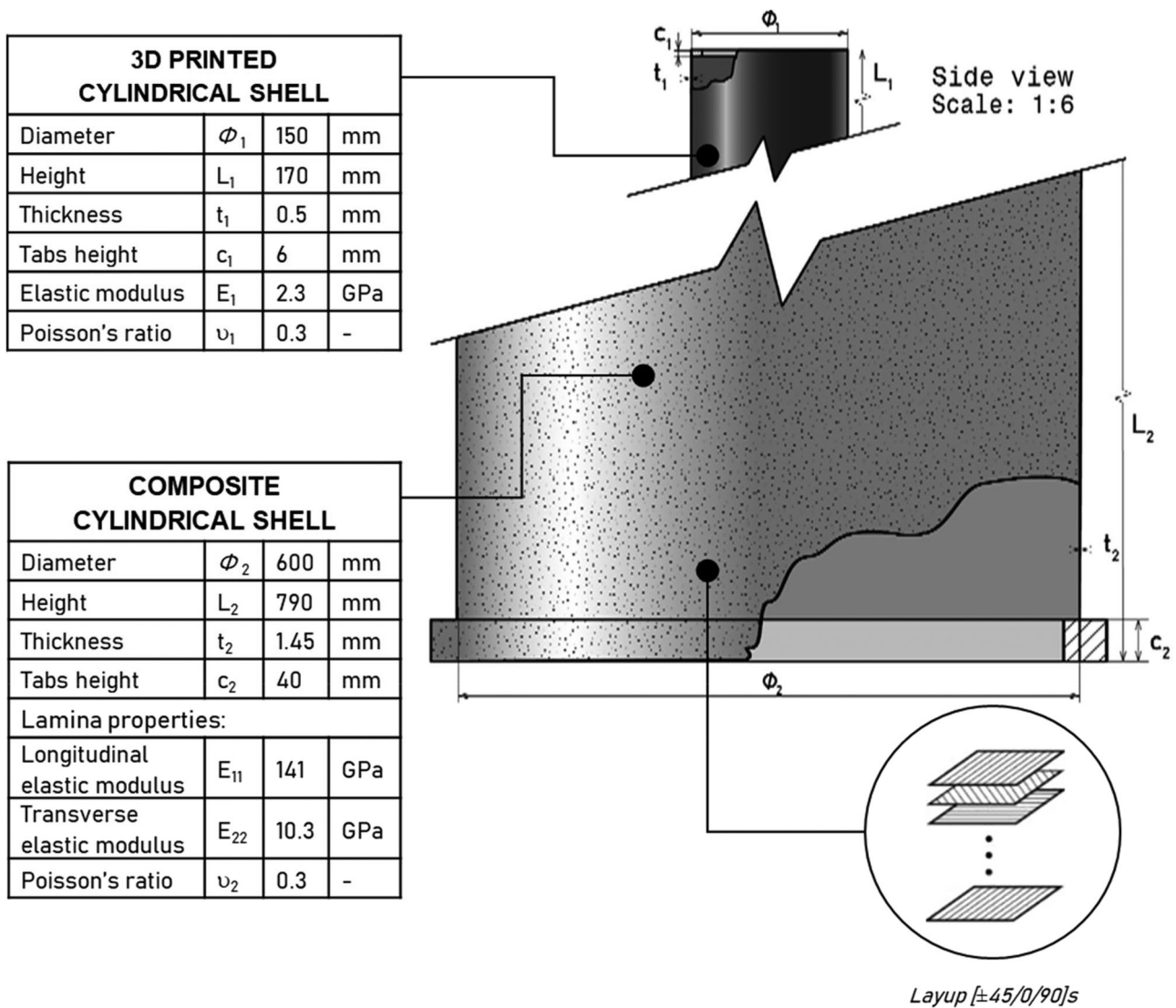

Figure 7. Specifications of the two cylindrical shells.

allowed to get closer the machines and closely observe the specimens twice: after the structure buckled and after the load had been release. Figure 11 shows students in the laboratory, completing the Reflect 1 section of the worksheet.

5.1. Buckling tests results

The 3D-printed shell has been tested in compression on Zwick Z20 mechanical test machine with 20 kN load capacity. The shell was painted with contrasting dotted pattern to allow better surface tracking by DIC system. The shell was supported by two parallel steel plates and compressed in displacement-controlled test with the loading rate of 0.5 mm/min. The shell buckled at 1250 N. At this value, the shortening was 0.6 mm while the maximum out of plane displacement was 4 mm. After reaching the buckling load, the shell quickly lost load carrying capacity and adopted a post-buckling shape with two rows of uniform diamonds around the circumference, as shown in DIC plot in Figure 12. The shell did not break and, once the load was released, it returned to the initial condition.

The composite shell was tested on the MTS 3500 servo hydraulic test machine with 3.5 MN load capacity due to its bigger dimensions and higher buckling load. The loading rate of the displacement-controlled test was 0.25 mm/min. The cylinder was loaded until reaching the buckling load, and then gradually unloaded.

This specimen buckled at 3000 kN with a sudden and loud shot noise, a shortening of 2 mm and a maximum out of plane displacement of 13 mm. The cylinder snapped immediately into a pattern of two-row diamonds, as shown in Figure 13. The structure remained in the elastic regime, when the structure was unloaded, it returned to its original undeformed shape.

6. Effectiveness and learning outcomes

The last step in the development of the laboratory activity is the evaluation of the learning outcomes and effectiveness.

6.1. Worksheet and effectiveness 1

The demonstration activity has been developed with the aim of guiding students in performing three tasks (Figure 10):

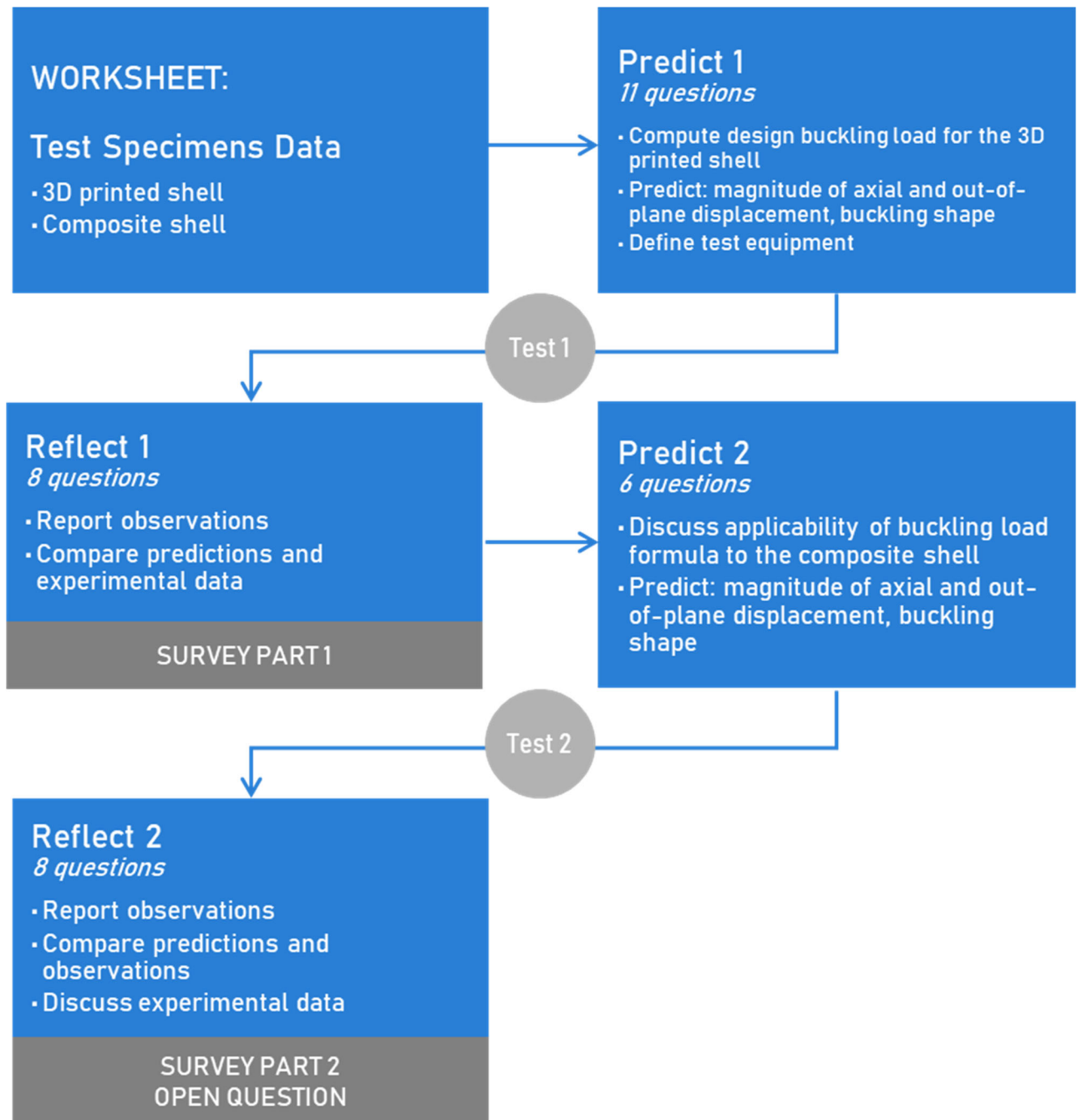

Figure 8. Structure of the instructional material and phases of the laboratory demonstration activity.

observe the axial compression tests of the two cylindrical shells, answer to the questions of the worksheet (predict and reflect) and correctly report the experimental outcomes. During the classroom events, students attentively observed both axial compression tests. Students have been told that the completion of the worksheet was optional, anonymous, and not graded, yet the response rate was 87% on average. Specifically, response rate to close-ended questions was 90% on average and to open-ended question was 78%. Finally, students reported the correct experimental outcome 97% of the times on average. These results provide compelling evidence that students engaged in the activity and that the activity was effective in sense 1.

Although the results are positive, some small improvements could be implemented. A possible improvement would be to

elicit students' prior knowledge with a home assignment, saving time in class for the actual demonstration.

6.2. Survey, open question, and effectiveness 2

The survey and the open questions were included in the instructional material students were given at the beginning of the demonstration (Figure 8). The survey comprises of two identical parts, to be filled in at the end of each of the two Reflect phases. The items of the survey are reported in full in Table 4.

In both parts, using a 5-point Likert scale ranging from 1 (strongly disagree) to 5 (strongly agree), students evaluated their level of agreement to four statements. Statements a.; b.;

1.6. All bets are on! Do you think the 3D-printed cylindrical shell is going to break at the buckling load? yes no

1.7. Can you briefly explain your answer?

1.10. What buckling shape do you expect to see during the test?

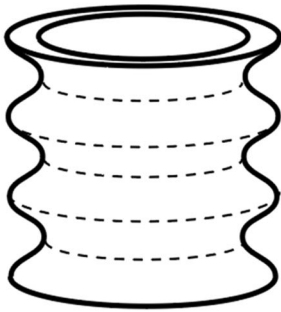

axial symmetrical waves



small half-waves

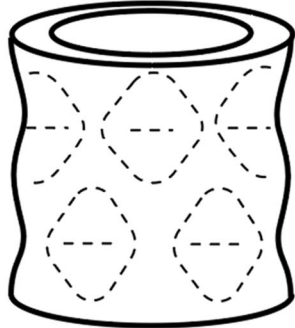

diamond waves

Figure 9. Examples of questions from the demonstration worksheet.

B. Activity specifications

What students are intended to do:

- observe the axial compression tests of the two cylindrical shells
- answer to the questions of the worksheet (predict and reflect)
- correctly report the experimental outcomes

Figure 10. What students are intended to do during the activity.

and c. measure the perceived achievement of ILO 1 (students are able to explain how the phenomena is studied in an experimental setting); of ILO 3 (students are able to relate the experimental outcomes to theory); and of ILO 2 (students are able to describe additional aspects of the shell buckling phenomenon), respectively. Last item (d.) checked if the laboratory activity increased students' interest in the topic.

28 students were present during the laboratory demonstration. The completion of the survey was voluntary and anonymous, students could leave blank any question they did not want to answer. 23 students out of 28 decided to fill in the first part of survey. 27 students out of 28 decided to fill in the second part of the survey. Student responses are reported in Figure 14.

An average of 78% of the students agree or strongly agree that the intended learning outcomes have been met after the first buckling test. For the second test, the result was of

80%. The demonstration particularly helped students better understand the physical phenomenon, with item c. receiving the highest agreement score in both cases. The item 2b. (*the test of the composite shell helped me relate theory to experimental practice*) received the highest disagreement. This is probably due to the fact that students could not apply the formula learnt in class to this case, being composite a not isotropic material. The item 1a. (*the test of the 3D-printed shell helped me better understand the experimental testing procedures*) received a lower agreement than the rest. A possible explanation is that the procedure followed in the first test had been already presented in detail during the theoretical lessons.

In answering the last item of the survey, students stated that the demonstration increased their interest and enthusiasm for shell buckling, with 91% of positive responses regarding the first test and 93% in the second. Remarkably, students' appreciation of the two tests is not very different.



Figure 11. Students completing part of the worksheet in the Delft Aerospace Structure and Materials Laboratory.

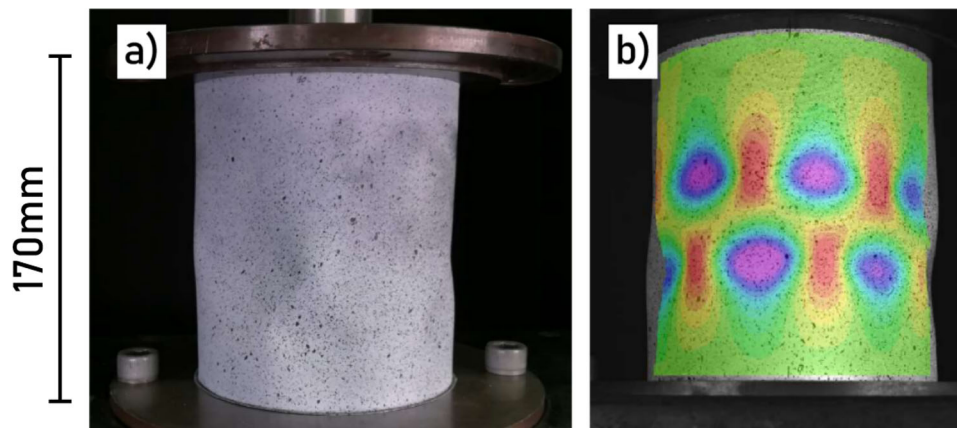

Figure 12. 3D-printed shell: a) experimental post-buckling shape; b) DIC results.

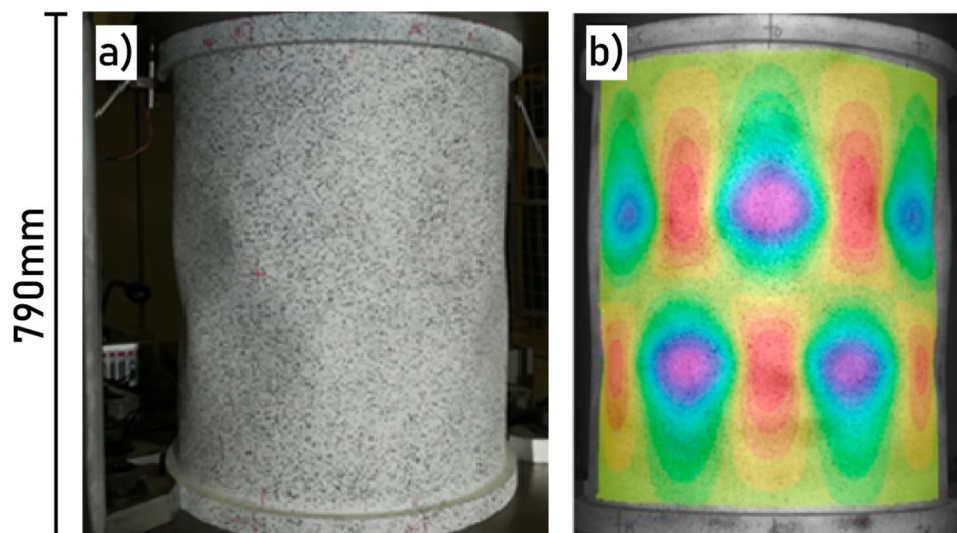

Figure 13. Composite shell: a) experimental post-buckling shape; b) DIC results.

The effectiveness of the test of 3D-printed shell is an encouraging result, since this test is easily implementable, both in terms of costs and set-up needed.

At the end of the activity, students were asked to answer to the following open question: “Can you name two of the most important things you learnt today, if any?”

Table 4. Survey items to evaluate the perceived learning outcomes.

How much do you agree or disagree with the following statements? This buckling test...	strongly disagree	disagree	agree nor disagree	agree	strongly agree
a. Helped me better understand the experimental testing procedures					
b. Helped me relate theory to experimental practice					
c. Helped me better understand the physical phenomena					
d. Increased my interest and enthusiasm for the topic					

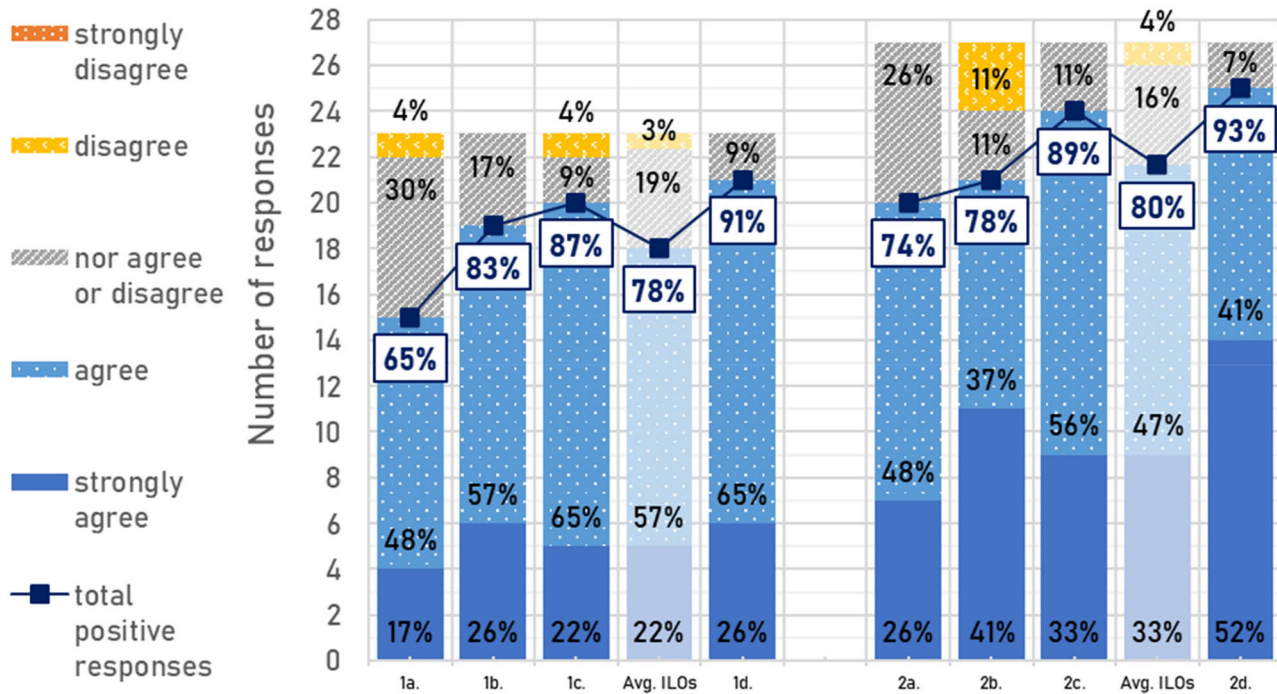
**Figure 14.** Students' responses to the survey on their perceived understanding of the topic.**Table 5.** Students' responses to the open question.

Can you name two of the most important things you learnt today, if any?

1. Capability of composites to withstand compression and those deformations.
2. Buckling in an elastic behavior & the shell recovers its deformed shape.
3. Buckling is an elastic procedure; you observe diamond patterns in the geometry once you achieve buckling.
4. Buckling shapes, experimental set up.
5. Composite did not break.
6. Difficult to apply load on thin geometries; predicted vs actual value with knock down are quite close.
7. How buckling shape looks like, the amount of noise buckling makes.
8. I did not understand the deformability of a shell and now I do, also I did not know everything could happen in linear-elastic regime.
9. If the test setup is not perfect, buckling will not be homogenous; I understood the theory better.
10. In the buckling shape the inward halfwaves have larger displacement because it takes less energy. Buckling of composite shells is noisy.
11. Shell buckling, even for composites, can be linear elastic.
12. That plastics and composites buckle differently and that composites are super resistant to buckling.
13. The 3D-printing quality which is available.
14. The sound of the test buckling; how buckled shells look in real life.
15. Understood theory better, influence of imperfection.
16. Buckling shapes of PLA and CFRP.
17. How shapes differ. The order of magnitude of force/displacement.
18. Shape of the buckling cylinder = sharper radius is observed inside due to lower energy; energy released as sound was a new learning.
19. Typical modes

The aim of this question was to investigate what new aspects of the buckling phenomenon students discovered thanks to the activity, and better characterize the learning

process occurring. For the data analyses, students' answers are quoted and discussed.

19 students out of 28 answered to the open question. Students' responses are reported in full in Table 5.

Students answers to the open questions provide additional insights on the achievement of the intended learning outcomes. Students appreciated new aspects of the phenomenon, ("you observe diamond patterns in the geometry once you achieve buckling"), new insights on the experimental procedure ("It is difficult to apply load on thin geometries") and they related the experimental outcomes to theory ("Buckling is an elastic procedure; predicted vs actual value with knock down are quite close"). Based on the survey results and on the open question responses, the activity has been effective also in sense 2, i.e. students learnt what they were intended to.

7. Conclusions

The presented study provides a proof of principle that it is possible to promote master students' understanding of buckling of cylindrical shells with a laboratory demonstration activity. In particular, the findings show that the activity was effective at engaging students in the learning process and increasing their understanding of the phenomenon. This was achieved with a novel approach to the design of laboratory demonstrations.

To develop the laboratory demonstration, the present study followed Millar's et al. model of the processes involved in designing and evaluating a practical task. First, an in-depth analysis of the theory of shell buckling was performed. Disciplinary representations of Stability of Structures, as well as their pedagogical affordances were identified. This analysis led to the definition of three intended learning outcomes for the activity: introduce students to new disciplinary representation and tools proper of laboratory practice, use the pedagogical affordances of these representations to support students' discovery of new aspects of the phenomenon, and help them link the experimental findings to the theory of shell buckling. The design of the activity followed the Interactive Lecture Demonstrations approach. A worksheet was developed to guide students in predicting, observing, and reflecting on the experimental results.

To evaluate the effectiveness of the activity, students' engagement with a worksheet questions and the perceived learning outcomes have been analyzed. The demonstration worksheet effectively guided students in completing the required tasks. Overall, the activity improved students understanding of the phenomenon and afforded the appreciation of new aspects, such as the buckled shape, the order of magnitude of the variables involved, the elasticity of the phenomenon. The global trend of the results showed that students did and learnt what they were intended to, hence the effectiveness of the activity has been proven.

In the light of the complexity of the mathematical derivations of the theory of shell buckling, the findings of this study suggest that instructional laboratory activities should be included as part of Stability of Structures curriculum where possible. In this regard, the test of the 3D-printed cylindrical shell provides a particularly affordable example of laboratory demonstration. At the same time, the presented step-by-step development methodology provides solid guidelines to develop similar activities for different engineering subjects.

Acknowledgements

The authors would like to thank Edgars Labans for the technical support in the experimental activities, Aldert Kamp, Perry den Brok and Renate Klaassen for their insightful feedback on the pedagogical theories, and Ines Uriol Balbin for the fruitful discussion on shell buckling.

Funding

The first author gratefully acknowledges the full financial support to her PhD project provided by 4TU Center of Engineering Education of Delft University of Technology.

ORCID

Marta Gavioli  <http://orcid.org/0000-0003-1690-8235>
Chiara Bisagni  <http://orcid.org/0000-0002-8713-9763>

References

- [1] T.H.G. Megson, *Aircraft Structures for Engineering Students*, 4th ed., Butterworth-Heinemann Elsevier Ltd., Oxford, United Kingdom, 2007.
- [2] R.M. Jones, *Buckling of Bars, Plates, and Shells*, Bull Ridge Publishing, Blacksburg, VA, 2006.
- [3] K.-E. Kurrer, *The History of the Theory of Structures*, Wilhelm Ernst & Sohn, Weinheim, Germany, 2018. DOI: [10.1002/9783433609163](https://doi.org/10.1002/9783433609163).
- [4] J. Airey and C. Linder, A disciplinary discourse perspective on university science learning: achieving fluency in a critical constellation of modes, *J. Res. Sci. Teach.*, vol. 46, no. 1, pp. 27–49, 2009. DOI: [10.1002/tea.20265](https://doi.org/10.1002/tea.20265).
- [5] D.R. Sokoloff and R.K. Thornton, Using interactive lecture demonstrations to create an active learning environment, *Phys. Teach.*, vol. 35, no. 6, pp. 340–347, 1997. DOI: [10.1119/1.2344715](https://doi.org/10.1119/1.2344715).
- [6] J. Singer, J. Arbocz, and T. Weller, *Buckling Experiments: Experimental Methods in Buckling of Thin-Walled Structures. Built-Up Structures, Composites and Additional Topics, Vol. 2*, John Wiley & Sons, Inc, New York, 2002.
- [7] R. Millar, *Analysing Practical Science Activities to Assess and Improve Their Effectiveness*, Association for Science Education, Hatfield, 2010. (Getting practical).
- [8] R. Millar, A. Tiberghien, and J.-F. Le Maréchal, Varieties of labwork: a way of profiling labwork tasks. In: Psillos D, Niedderer H, editors. *Teaching and Learning in the Science Laboratory*, Dordrecht, Kluwer, 2002. pp. 9–20. DOI: [10.1007/0-306-48196-0](https://doi.org/10.1007/0-306-48196-0).
- [9] T. Fredlund, C. Linder, and J. Airey, A social semiotic approach to identifying critical aspects, *Int. J. Lesson Learn Stud.*, vol. 4, no. 3, pp. 302–316, 2015. DOI: [10.1108/IJLLS-01-2015-0005](https://doi.org/10.1108/IJLLS-01-2015-0005).
- [10] J. Airey and C. Linder, Social semiotics in university physics education. In: Treagust DF, Duit R, Fischer HE, editors. *Multiple Representations in Physics Education*, Springer International Publishing, Cham, Switzerland, 2017. pp. 95–122. DOI: [10.1007/978-3-319-58914-5](https://doi.org/10.1007/978-3-319-58914-5).
- [11] H.-K. Wu and S. Puntambekar, Pedagogical Affordances of Multiple External Representations in Scientific Processes, *J. Sci. Educ. Technol.*, vol. 21, no. 6, pp. 754–767, 2012. DOI: [10.1007/s10956-011-9363-7](https://doi.org/10.1007/s10956-011-9363-7).
- [12] C.-Y. Tsui, *Teaching and learning genetics with multiple representations*, Doctoral Dissertation, Curtin University of Technology, Perth, Australia, 2003.
- [13] S. Timoshenko and J.M. Gere, *Theory of Elastic Stability*, 2nd ed., Dover Publications, New York, 2009.
- [14] NASA SP-8007. *Buckling of Thin-Walled Circular Cylinders*, 1968.
- [15] Anderson, L.W. Krathwohl Dr, *A Taxonomy for Learning, Teaching, and Assessing. A Revision of Bloom's Taxonomy of Educational Objectives*, New York: Addison Wesley Longman, 2001.
- [16] C. Crouch, A.P. Fagen, J.P. Callan, and E. Mazur, Classroom demonstrations: learning tools or entertainment?, *Am. J. Phys.*, vol. 72, no. 6, pp. 835–838, 2004. DOI: [10.1119/1.1707018](https://doi.org/10.1119/1.1707018).
- [17] D. Merritts, et al., *Interactive Lecture Demonstrations*, [Internet]. Science Education Resource Center, Carleton College, Northfield (MN); [updated, 2019. Aug 21; 2019 accessed 2021 Jan 9]. Available from: <http://serc.carleton.edu/introgeo/demonstrations/index.html>.
- [18] E. Labans and C. Bisagni, Buckling of 3D-printed cylindrical shells with corrugated surface, In: AIAA Scitech 2020 Forum, 2020 Jan 6–10; Orlando, FL. Paper 1925. DOI: [10.2514/6.2020-1925](https://doi.org/10.2514/6.2020-1925).
- [19] E. Labans and C. Bisagni, Buckling and free vibration study of variable and constant-stiffness cylindrical shells, *Compos. Struct.*, vol. 210, pp. 446–457, 2019. DOI: [10.1016/j.compstruct.2018.11.061](https://doi.org/10.1016/j.compstruct.2018.11.061).
- [20] J.N. Reddy, *Mechanics of Laminated Composite Plates and Shells: theory and Analysis*, 2nd ed., CRC Press, Boca Raton, FL, 2004.