

The modular post-earthquake shell

A multi-objective parametric structural design approach

Joanne Jimmink

INTRODUCTION





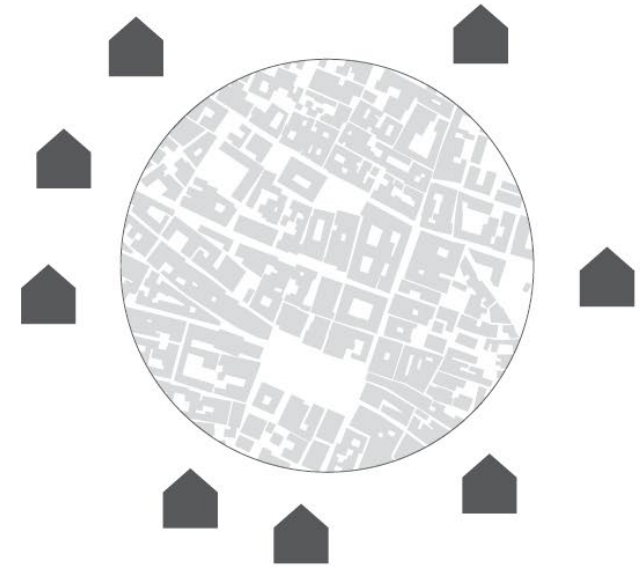
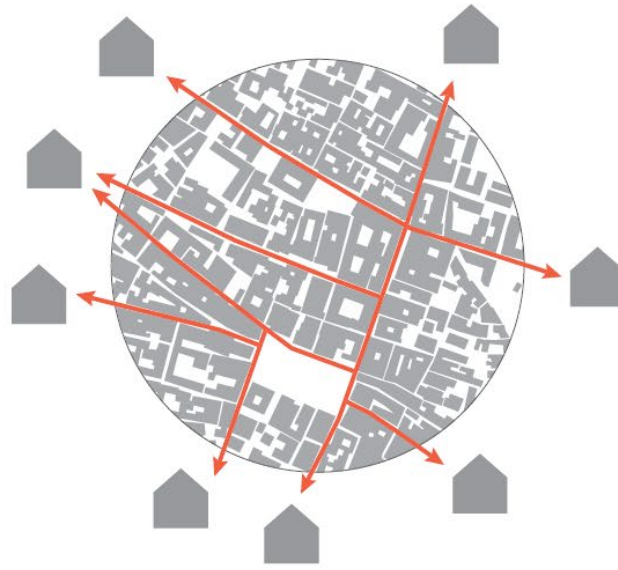

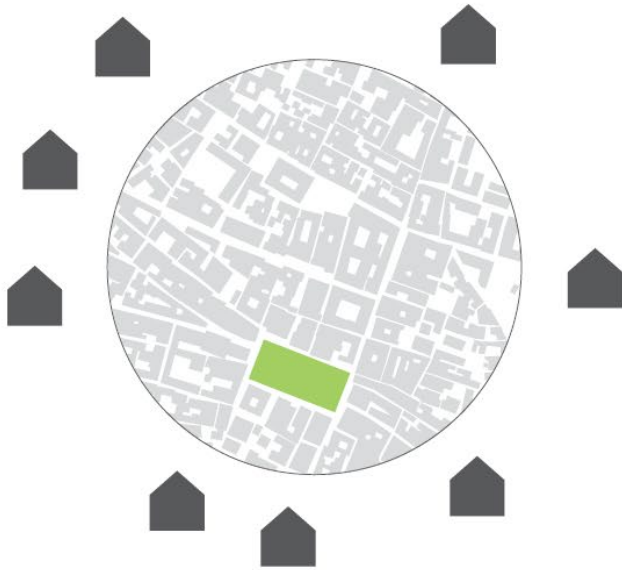
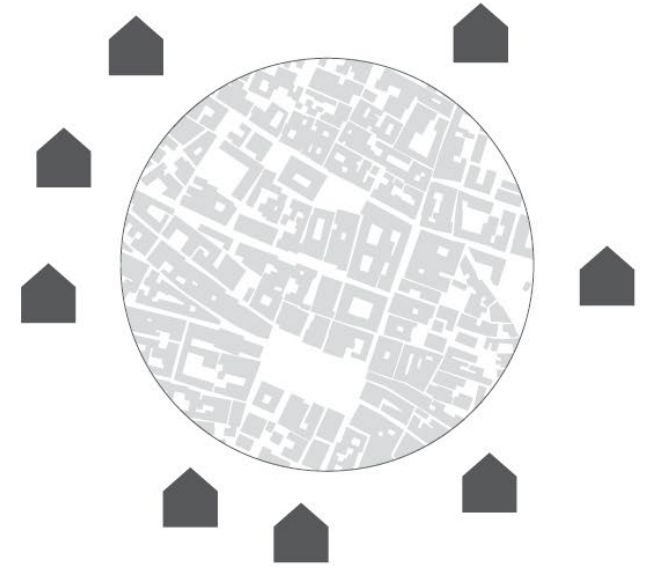
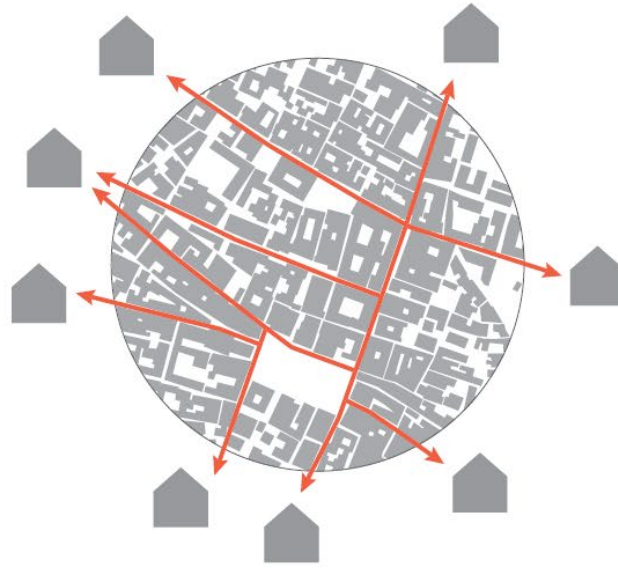



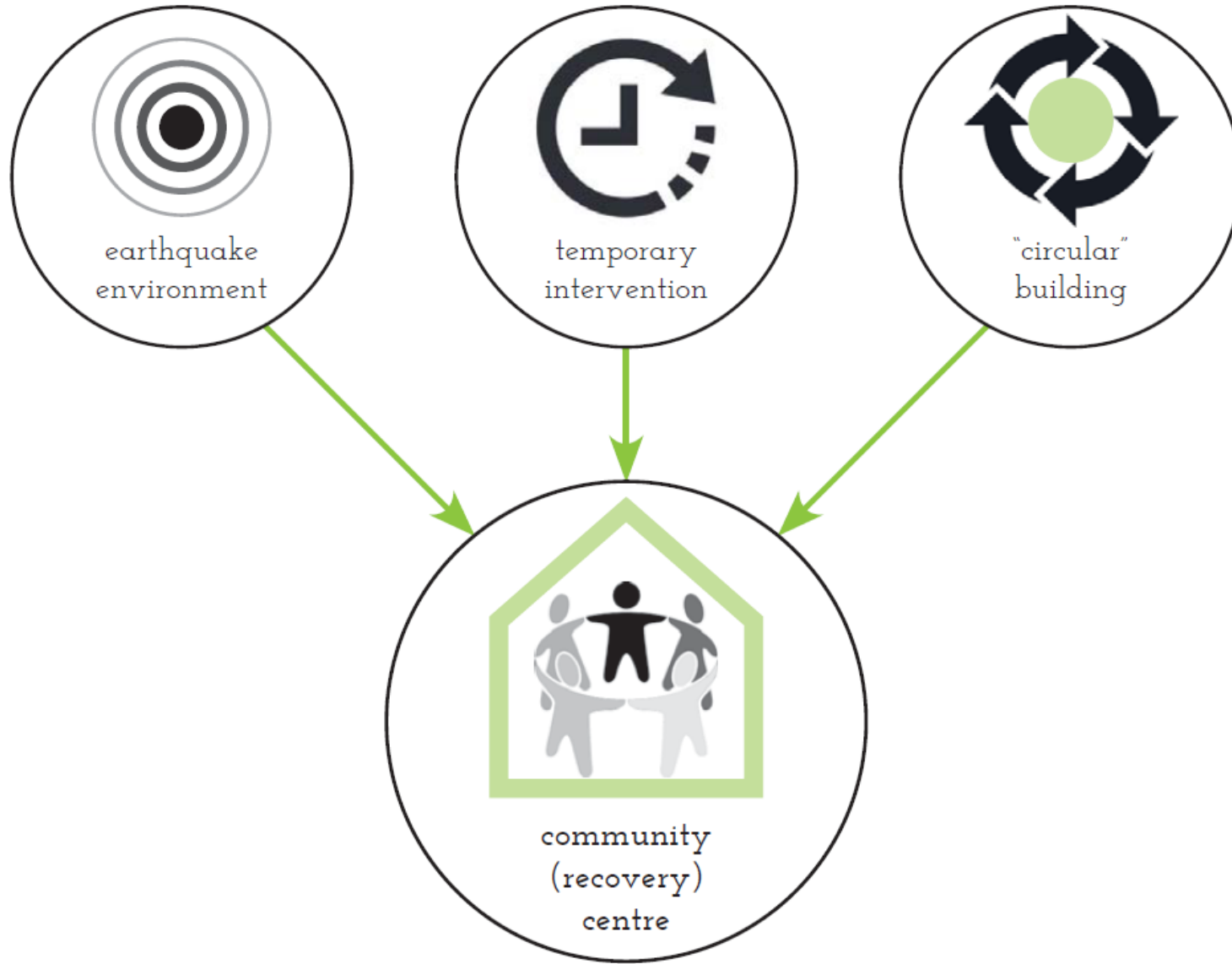



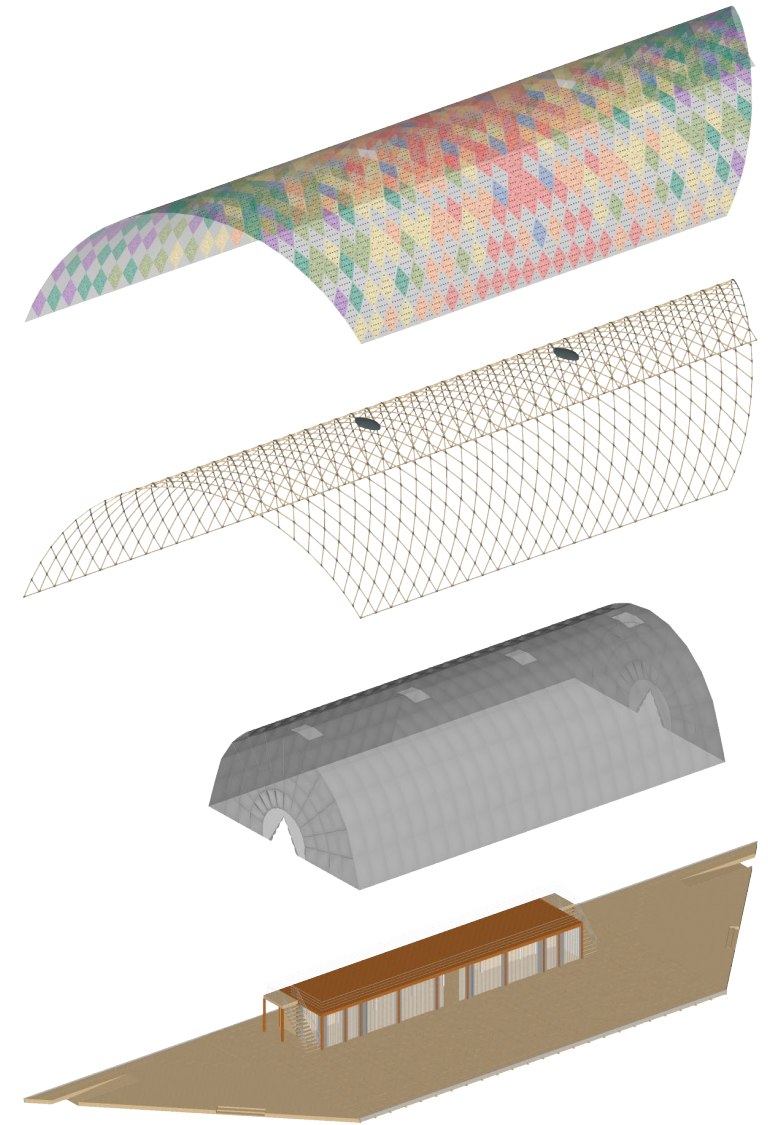
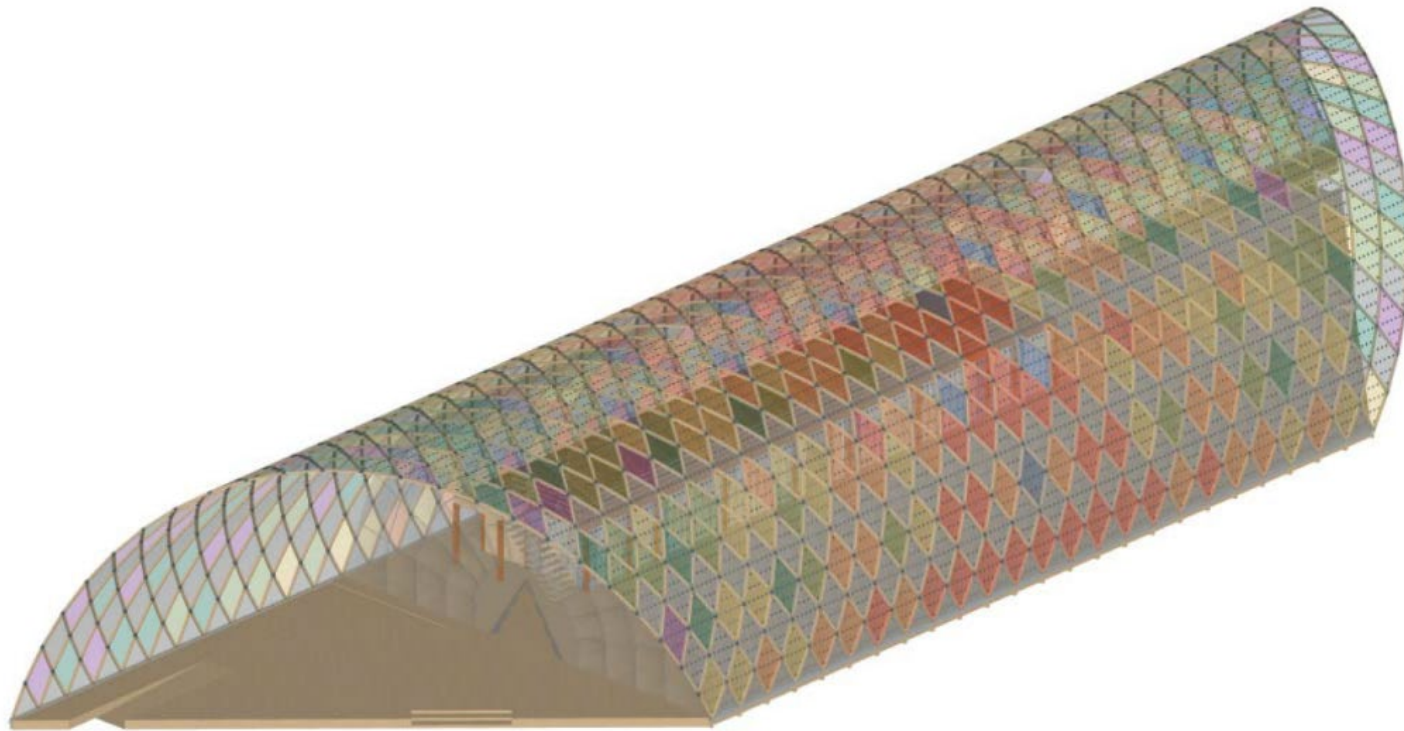

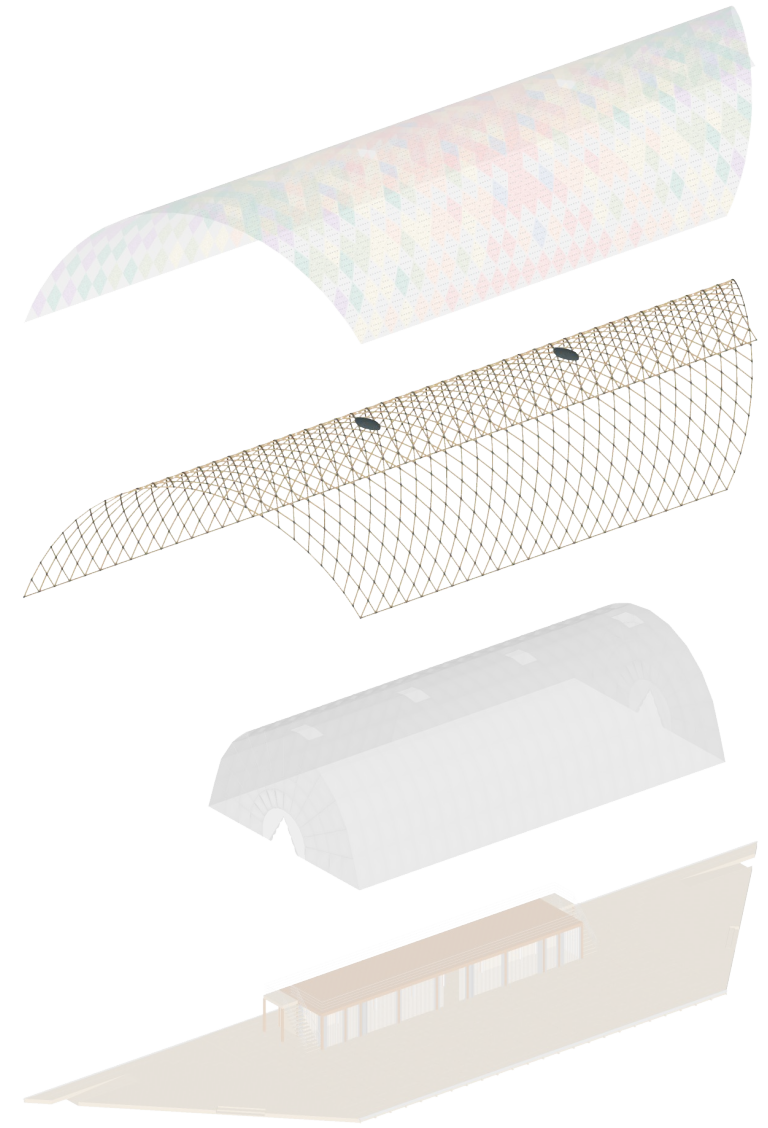
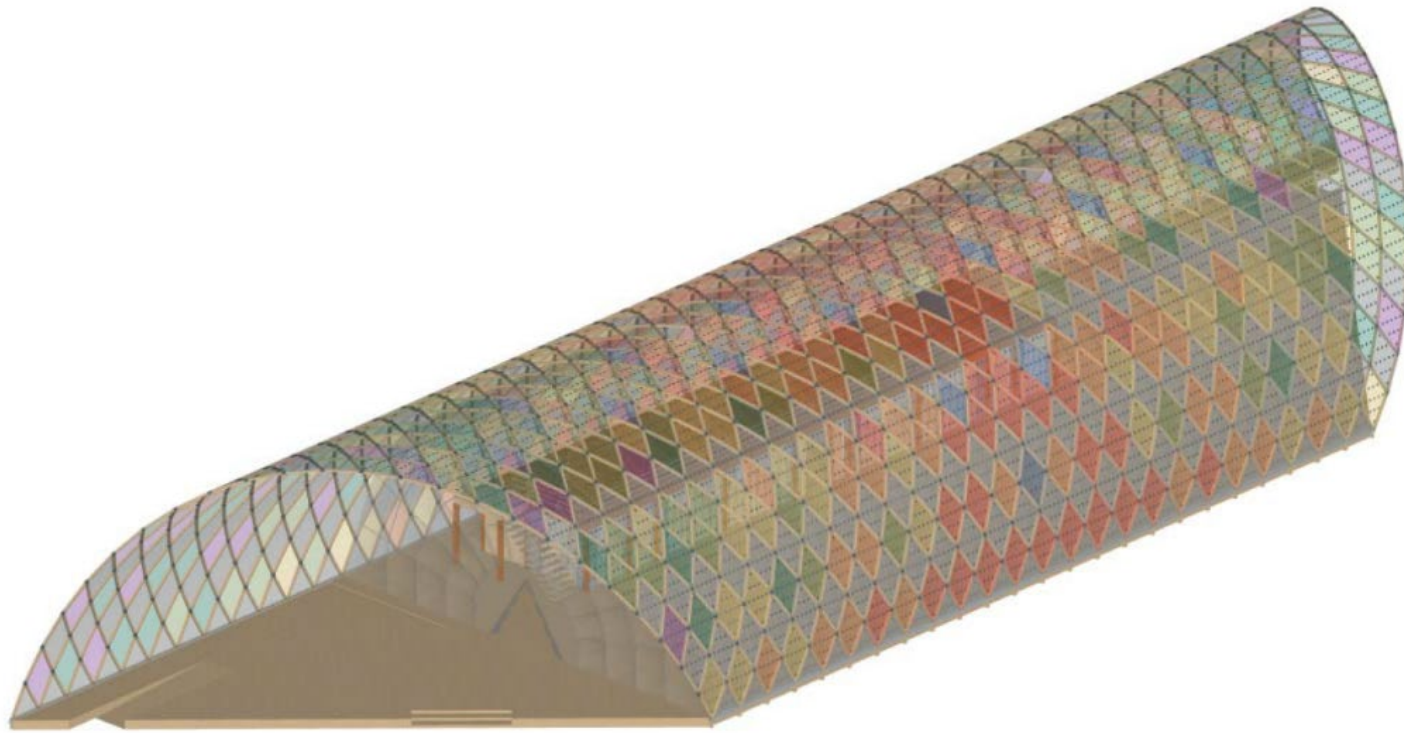

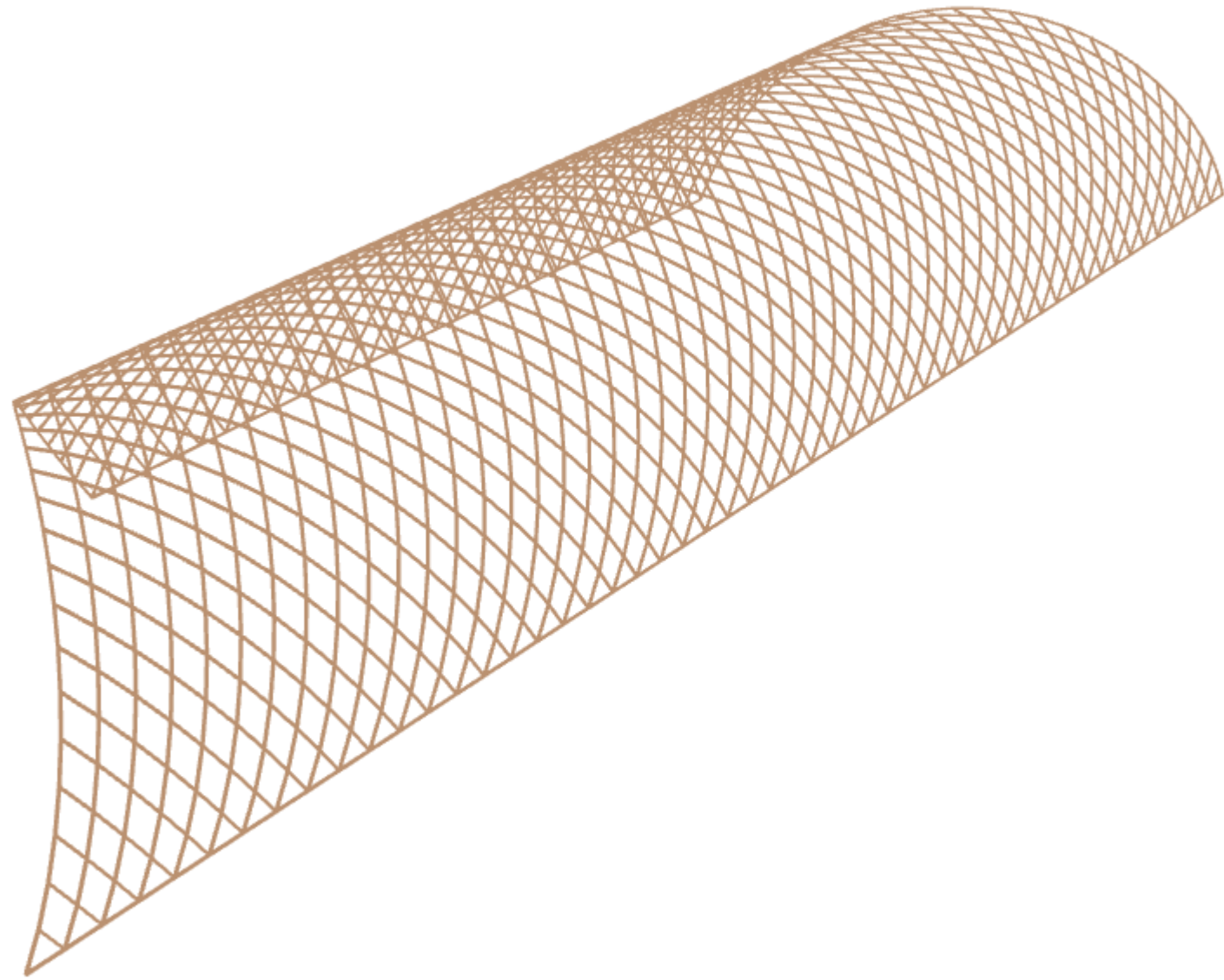

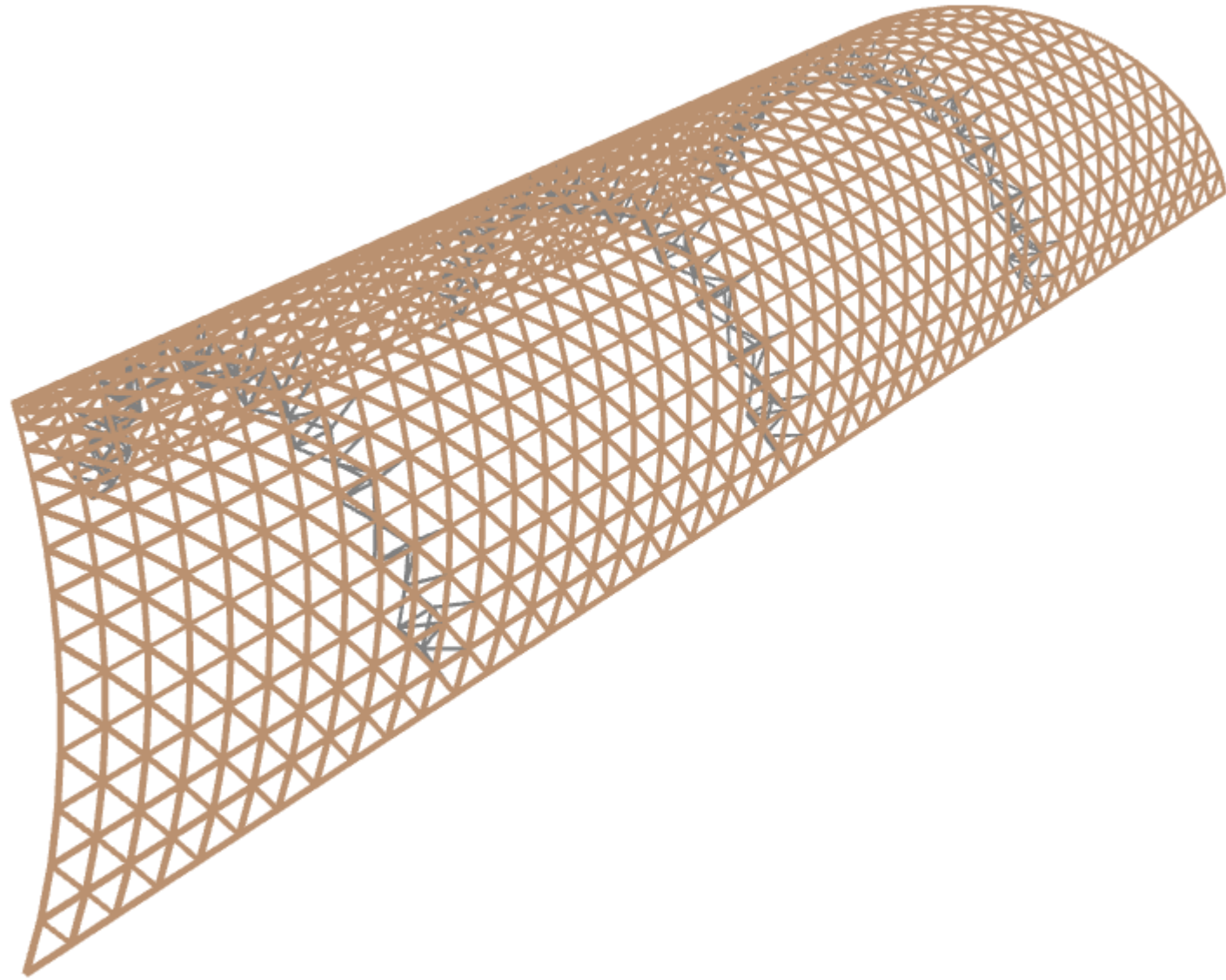

PROJECT



structural
validity



sustainability



aesthetics



constructability

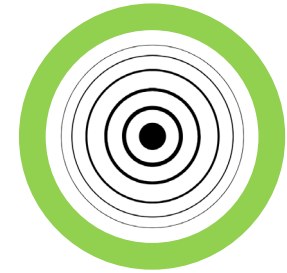

seismic
resistance



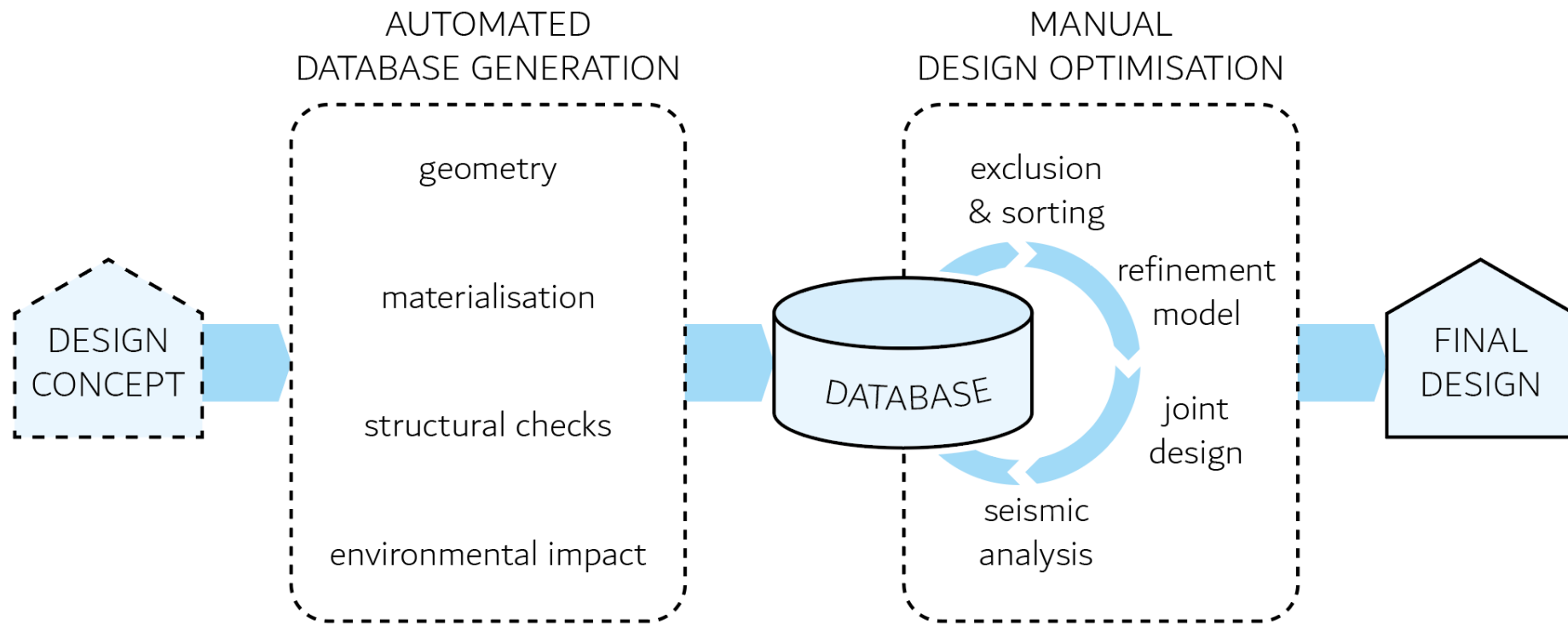



AUTOMATED DATABASE GENERATION

DESIGN CONCEPT

- geometry
- materialisation
- structural checks
- environmental impact

MANUAL DESIGN OPTIMISATION

DATABASE

- exclusion & sorting
- refinement model
- joint design
- seismic analysis

FINAL DESIGN

EXAMPLE

| | | |
|------------|-----------|----------|
| | steel | |
| 4 columns | concrete | 2 floors |
| 6 columns | timber | 3 floors |
| 8 columns | glass | 4 floors |
| 10 columns | masonry | 5 floors |
| | aluminium | |

MANUAL MODELLING

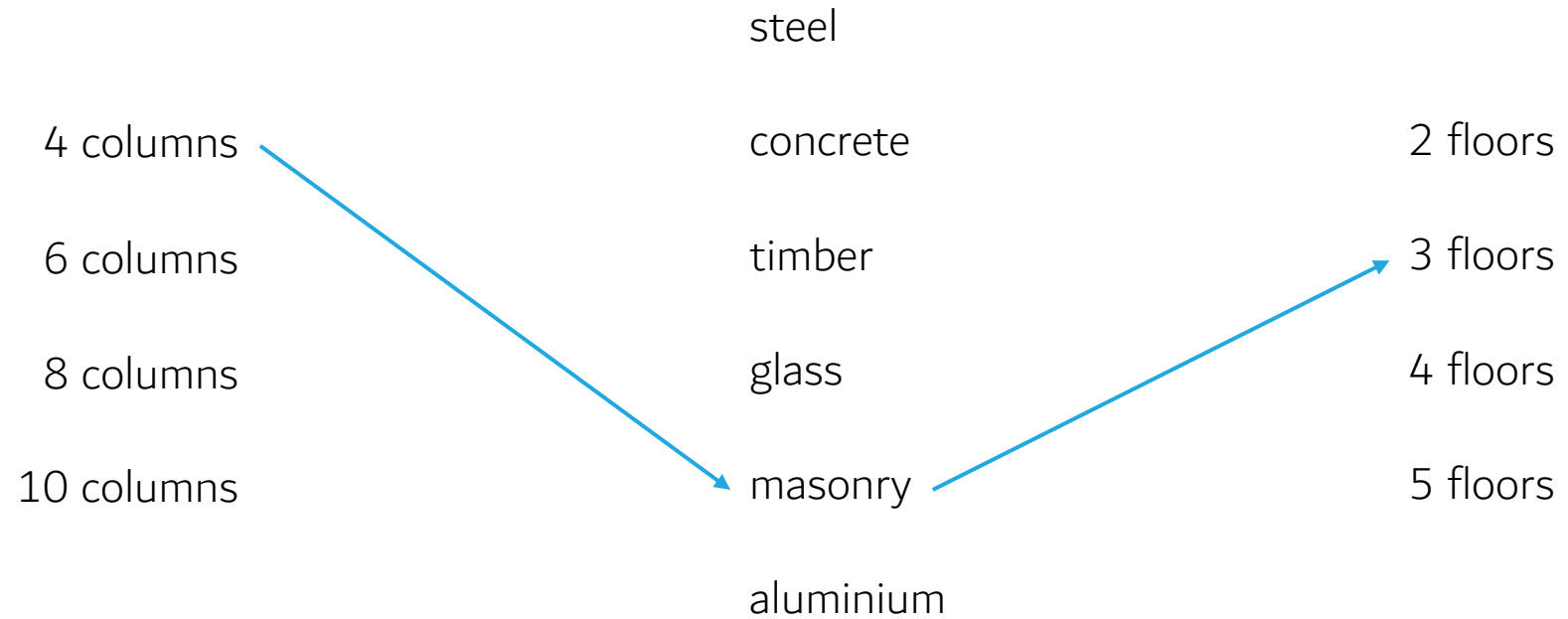

AUTOMATED MODELLING

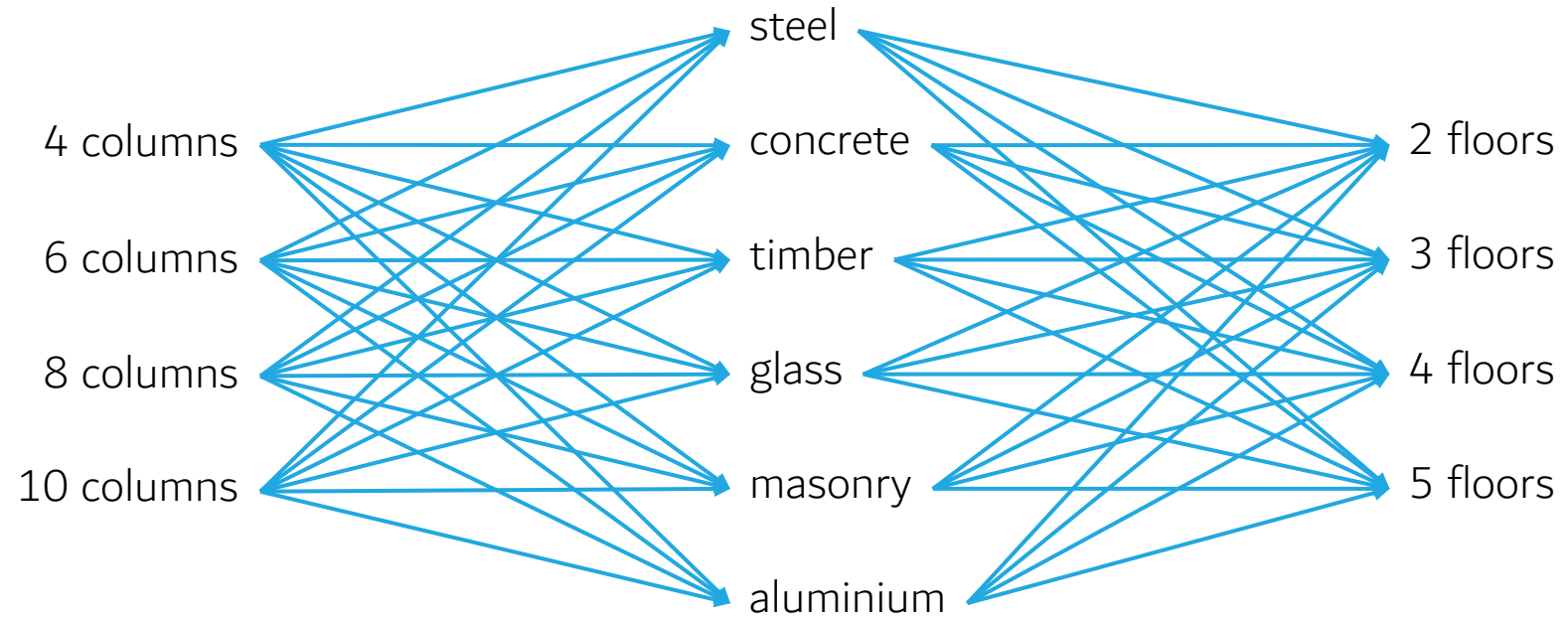

AUTOMATED DATABASE GENERATION

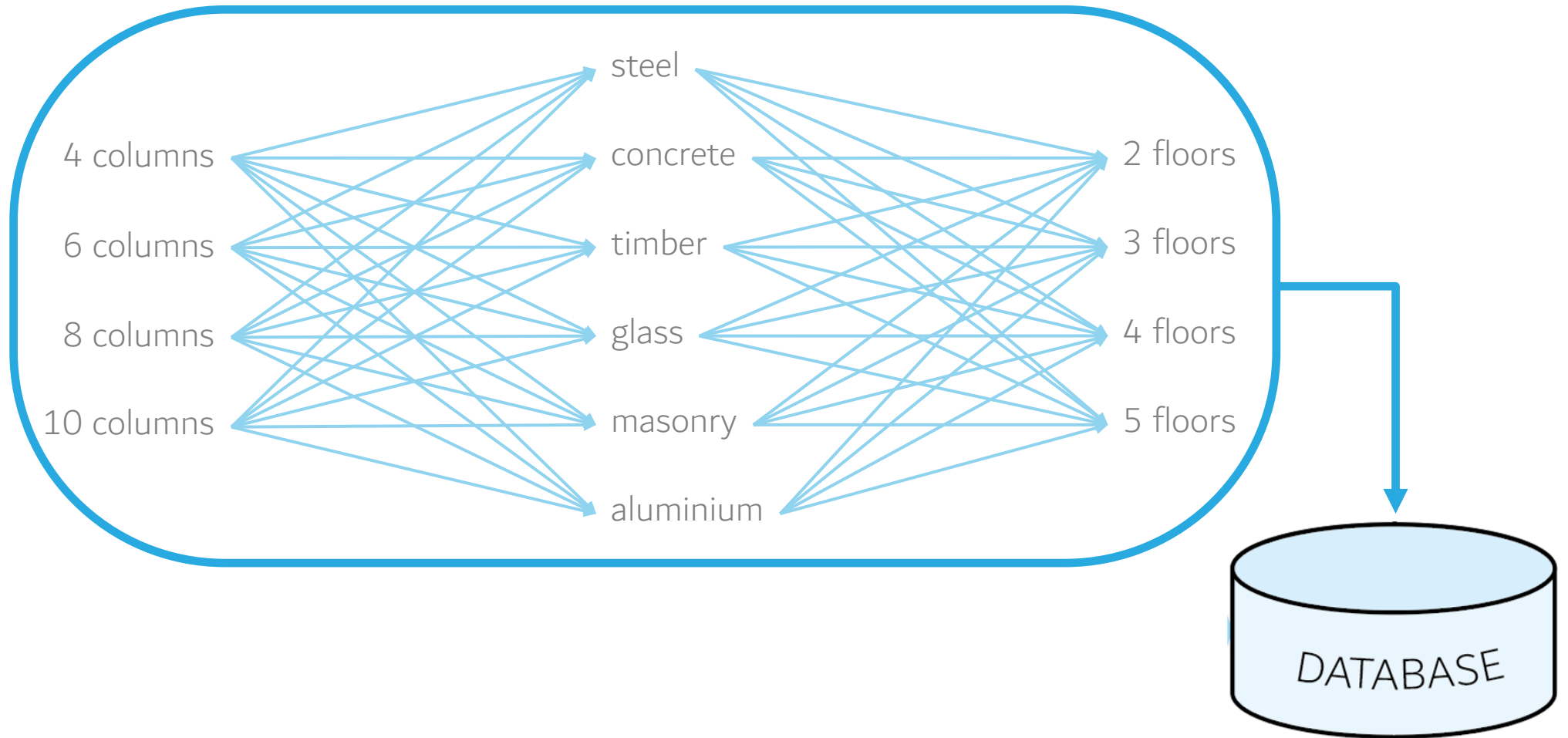

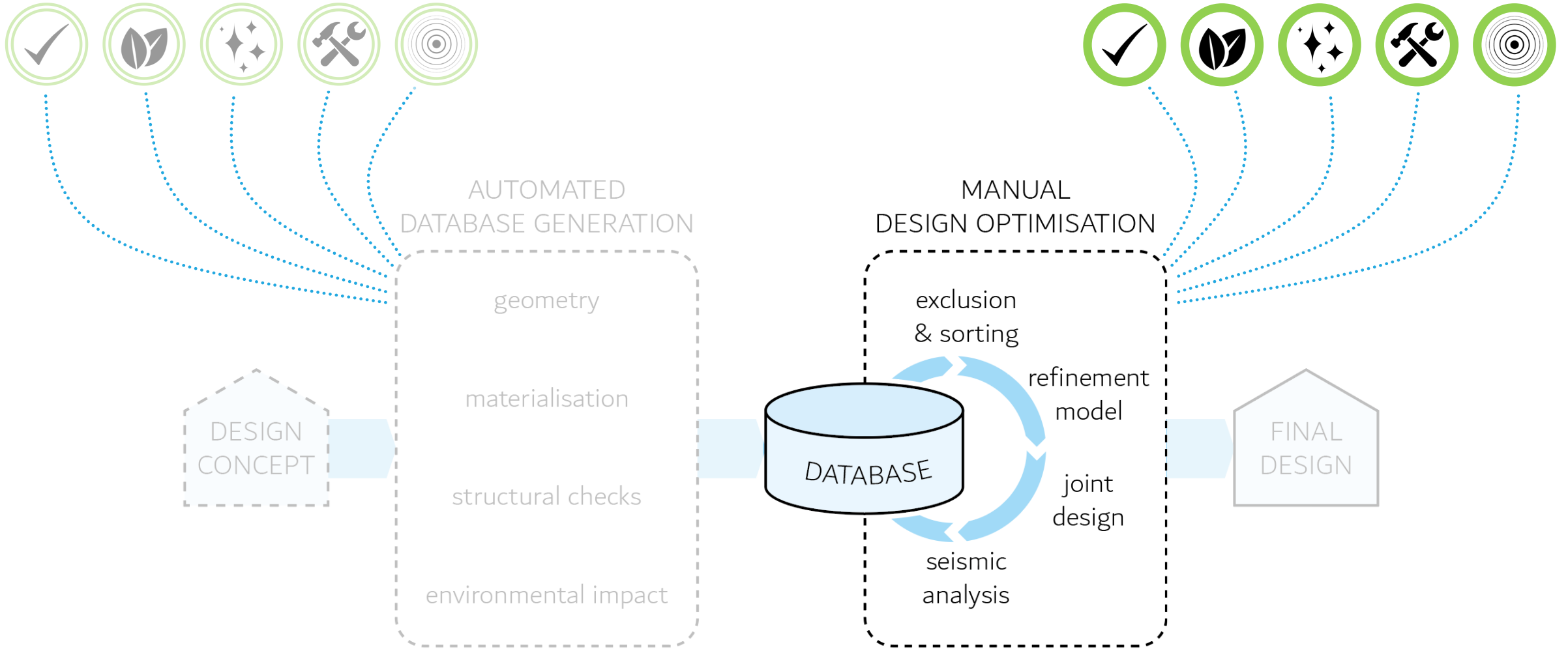

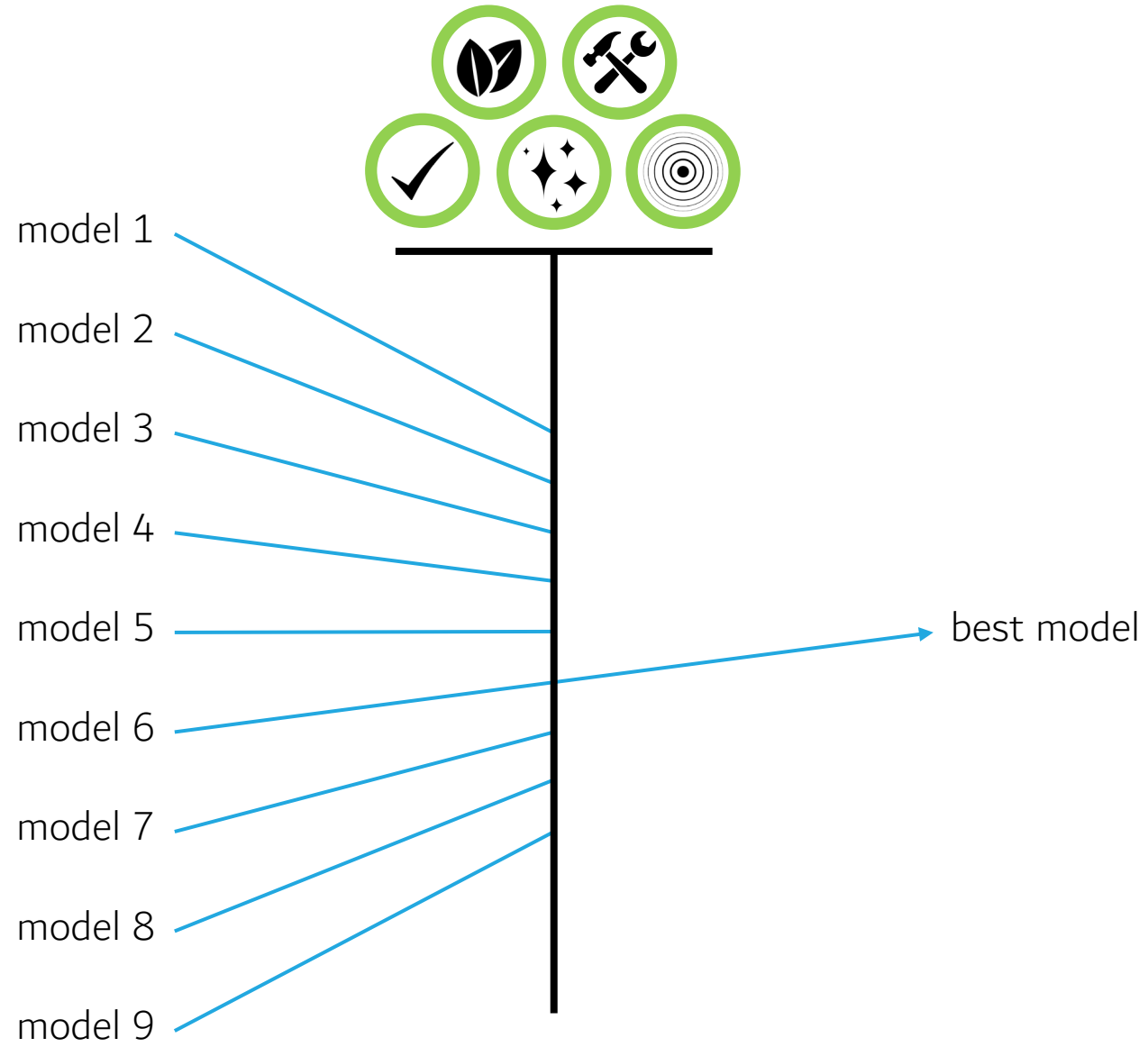

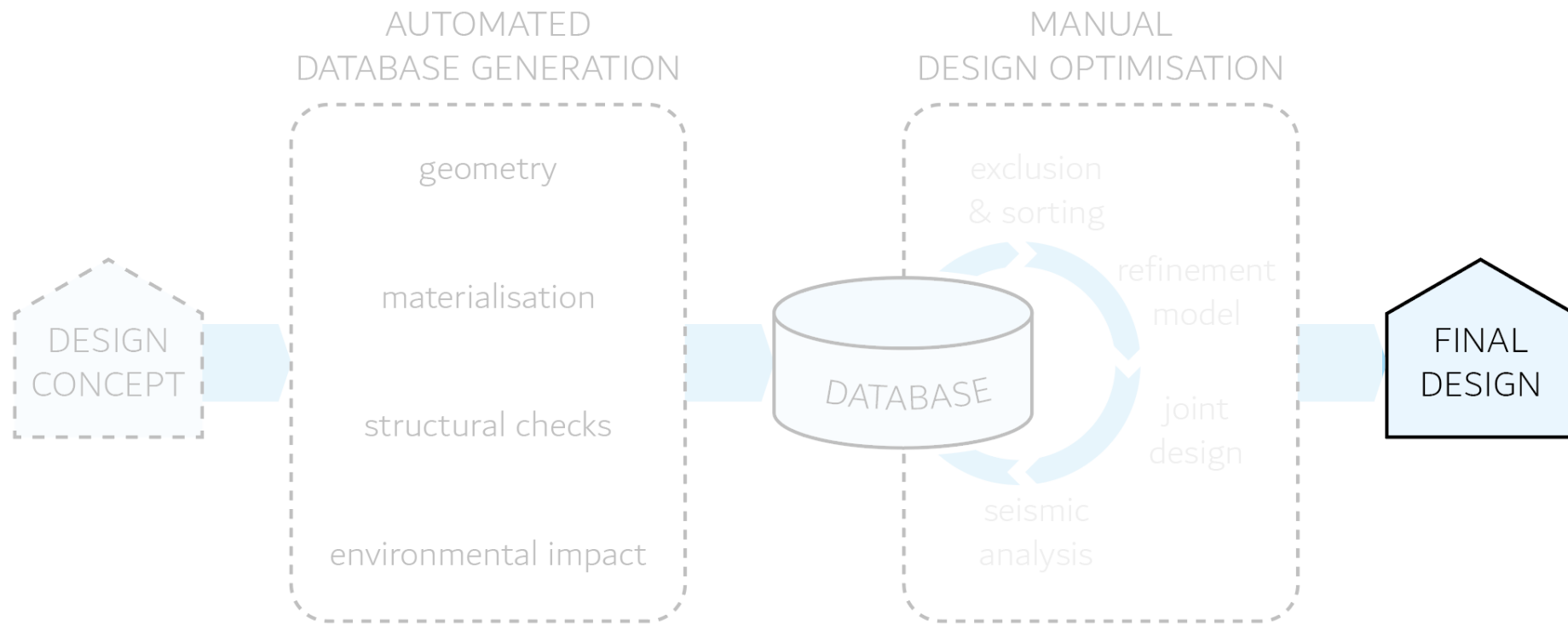

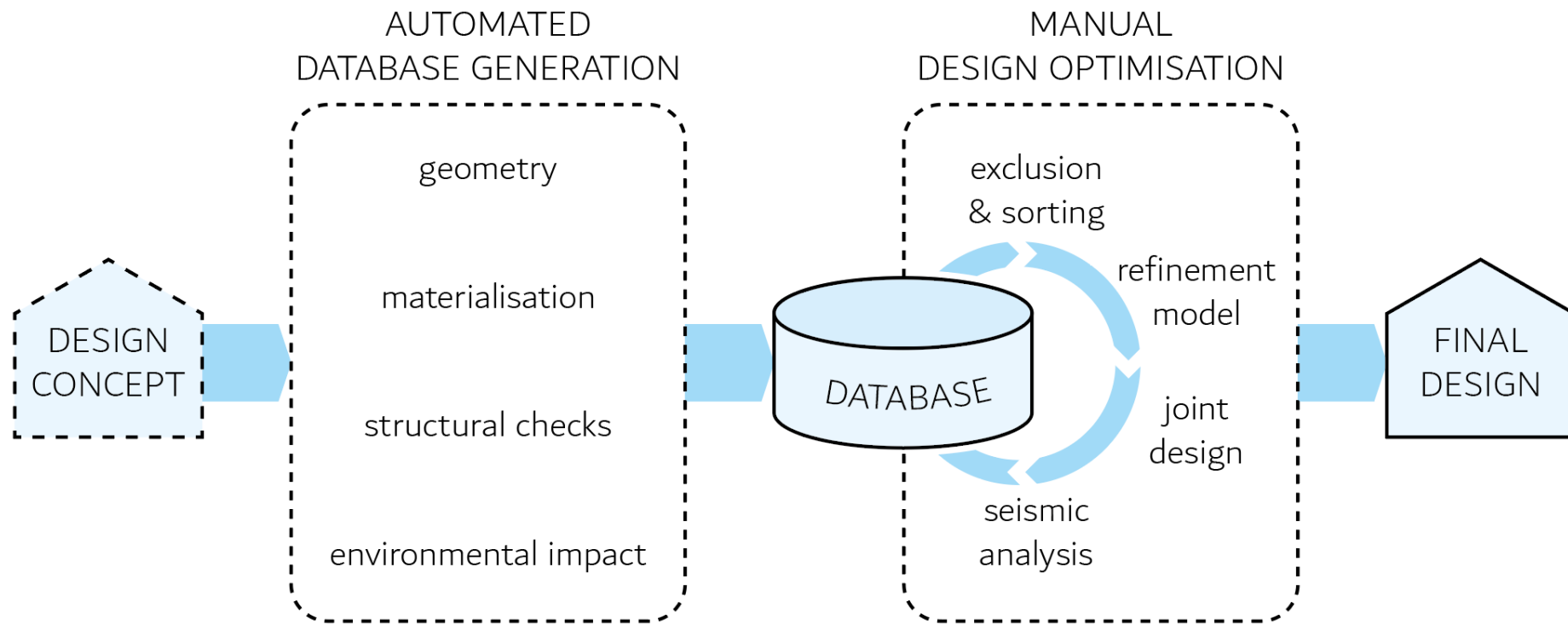

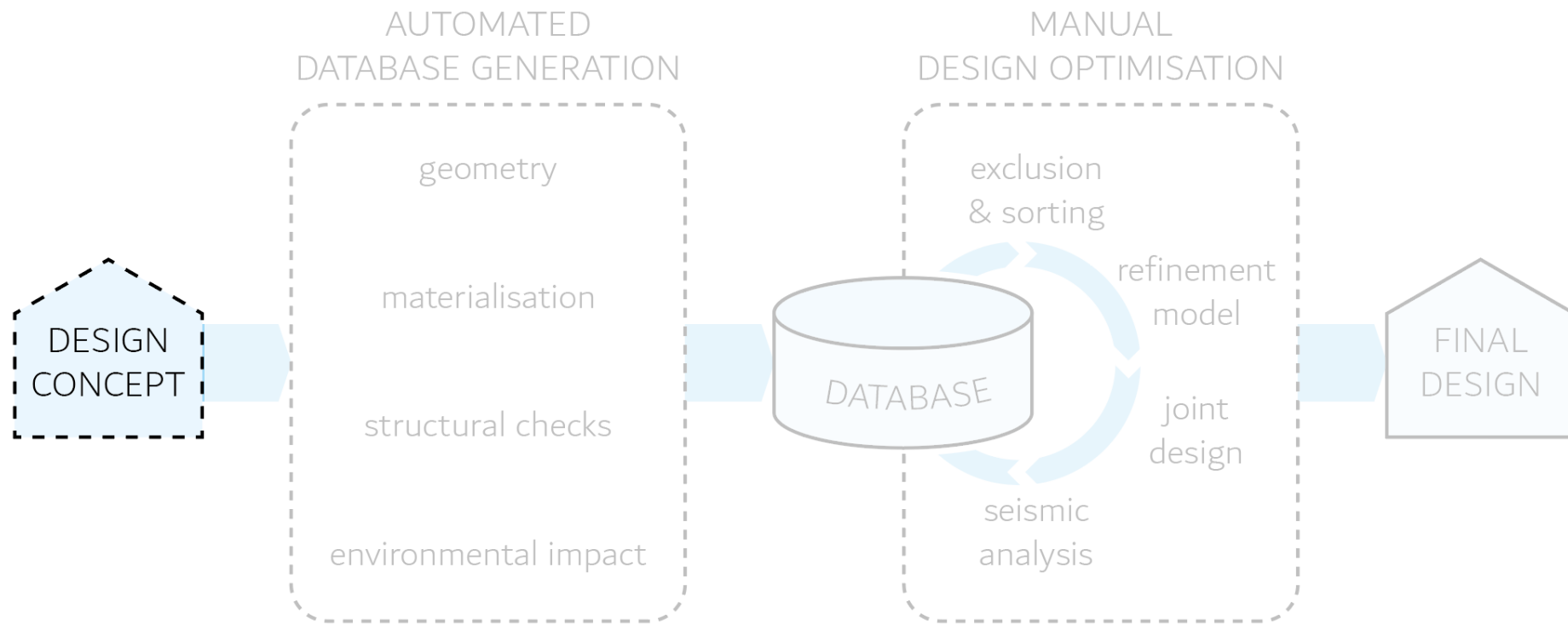

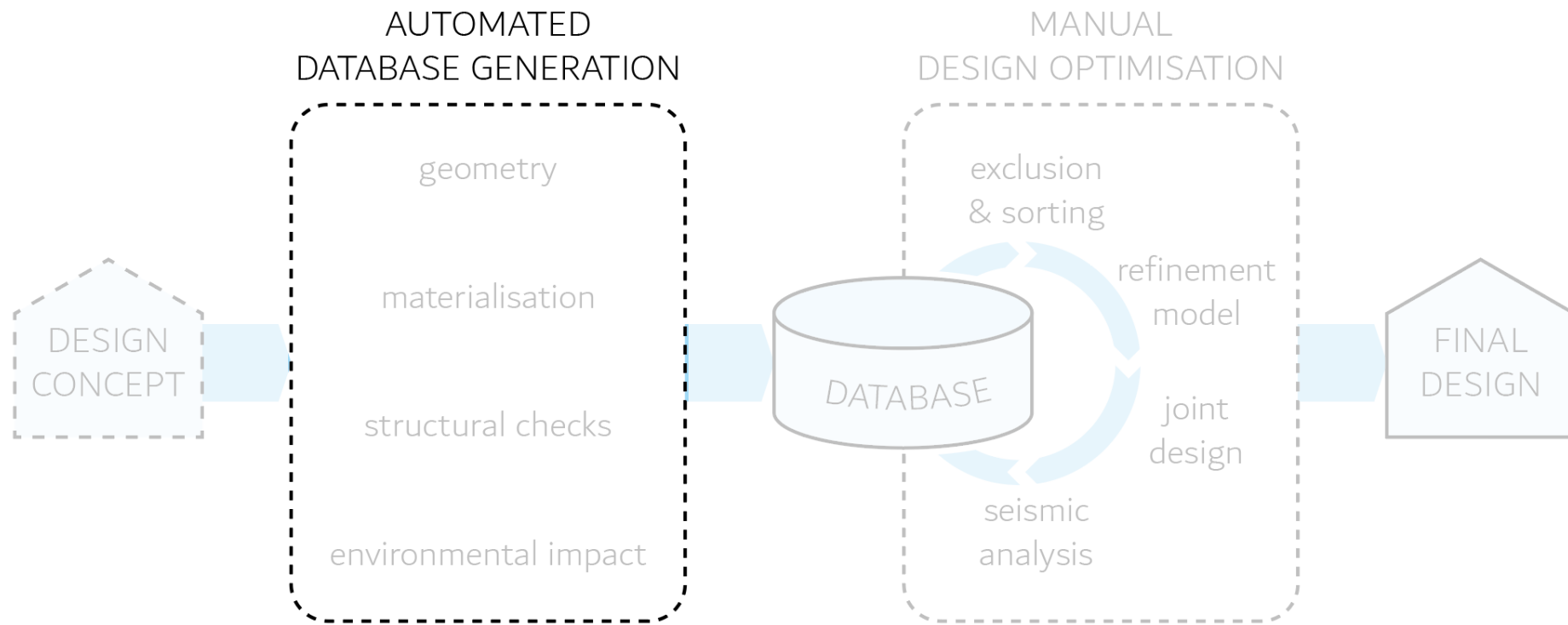

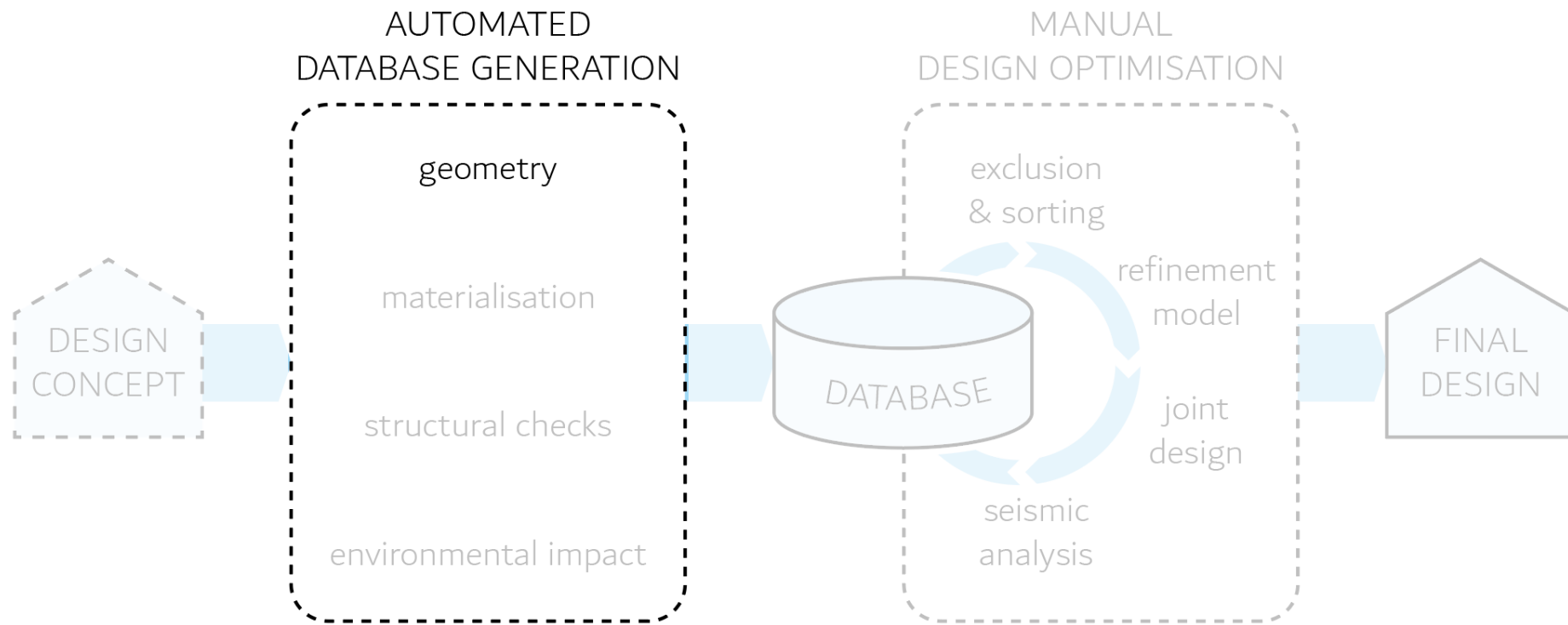

GRID SIZE

7x

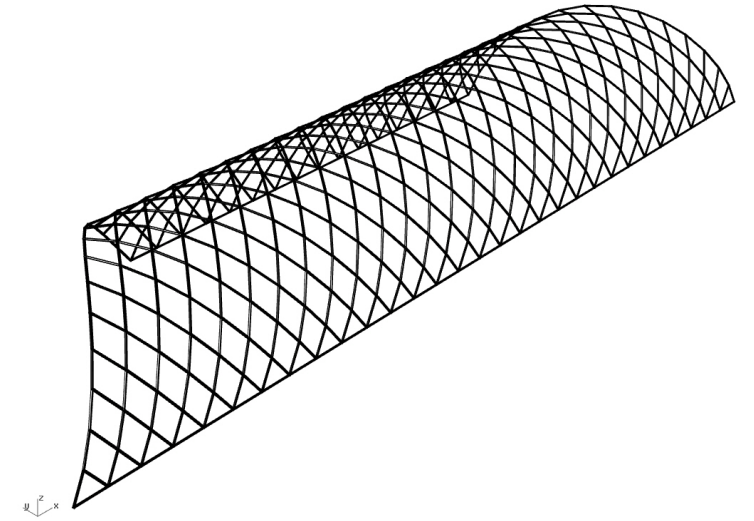
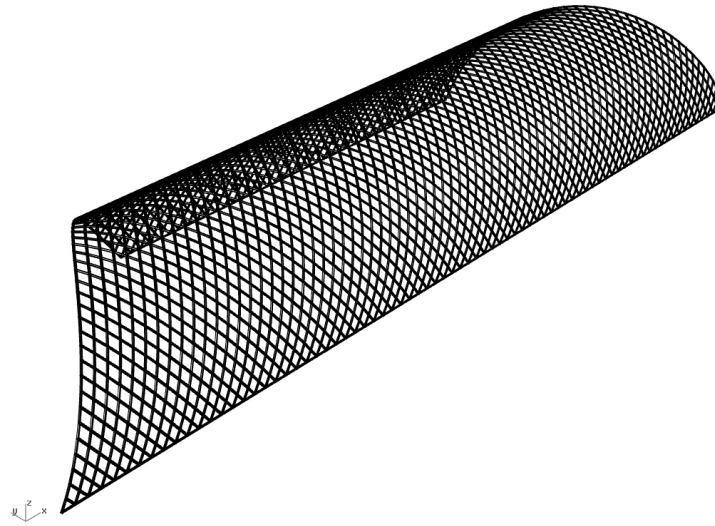

CONNECTIONS

2x

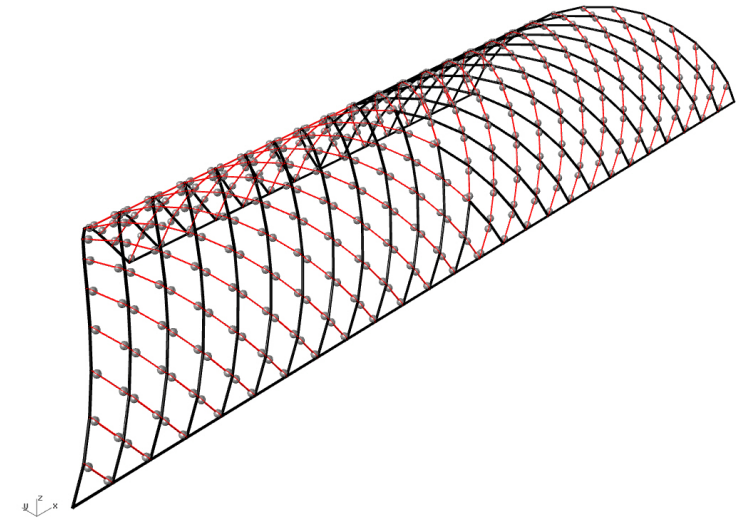
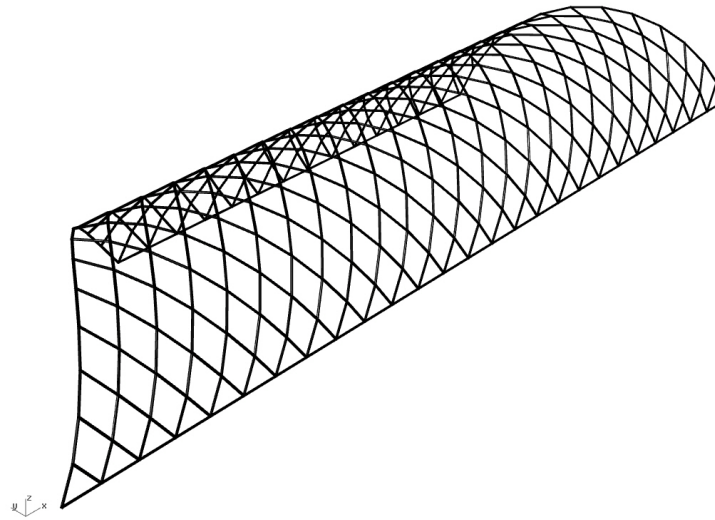

IN-PLANE

3x

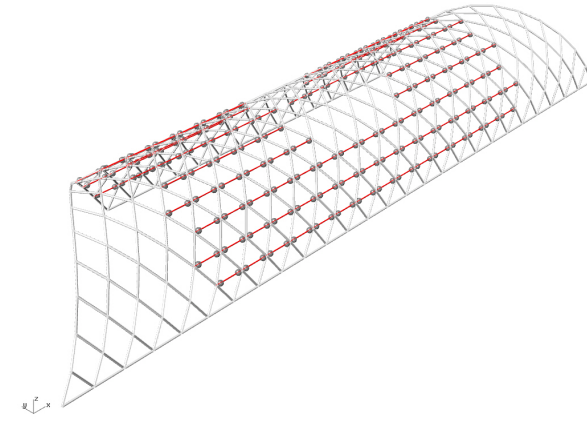
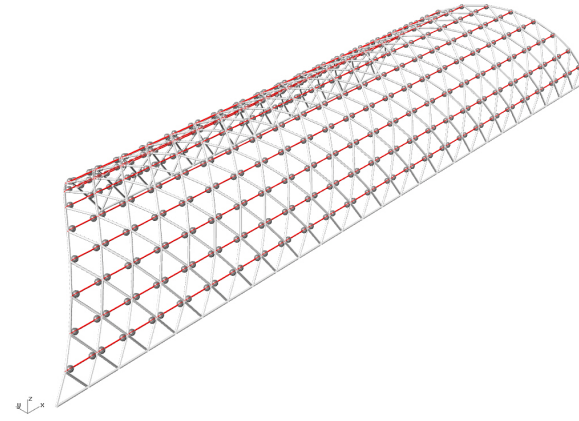
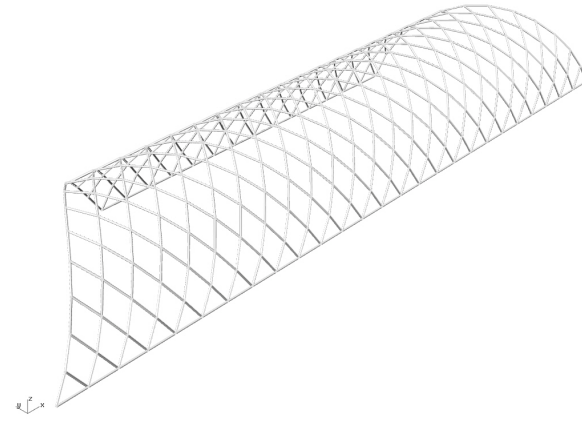

GEOMETRY

OUT-OF-PLANE

3x

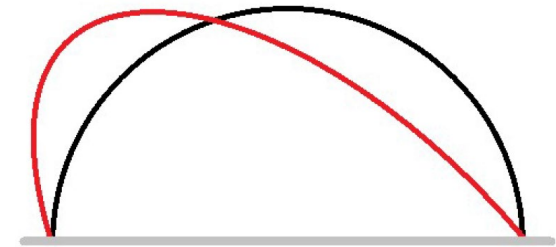
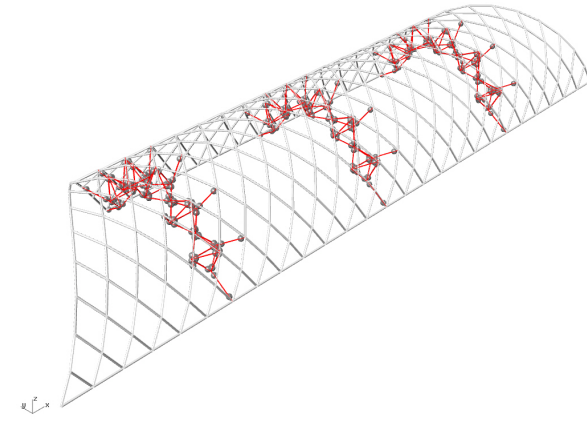
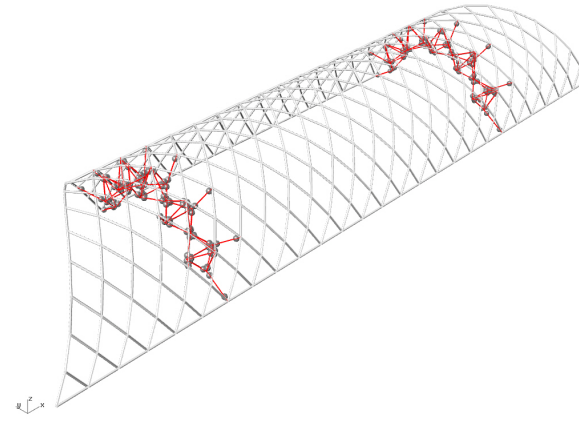
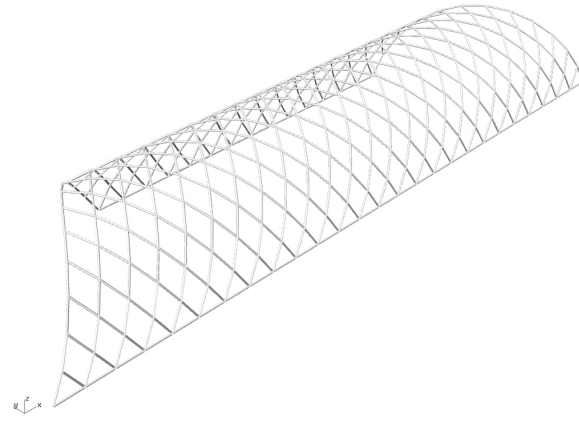

126 variations



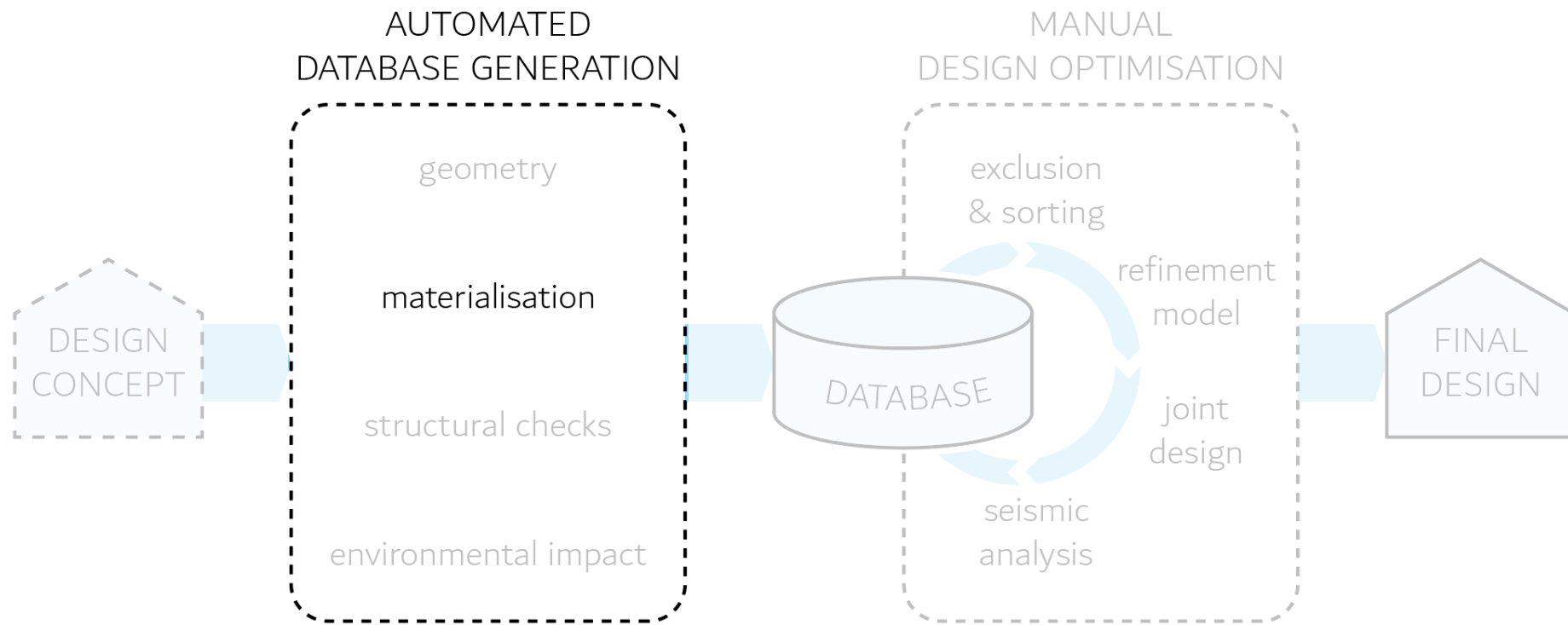

ELEMENTS

| | | |
|--------|----------------------------|-------------|
| STEEL | Lower strength | $I7 \times$ |
| | Higher strength | $2I \times$ |
| TIMBER | Lower strength (local) | $I6 \times$ |
| | Higher strength (imported) | $I6 \times$ |

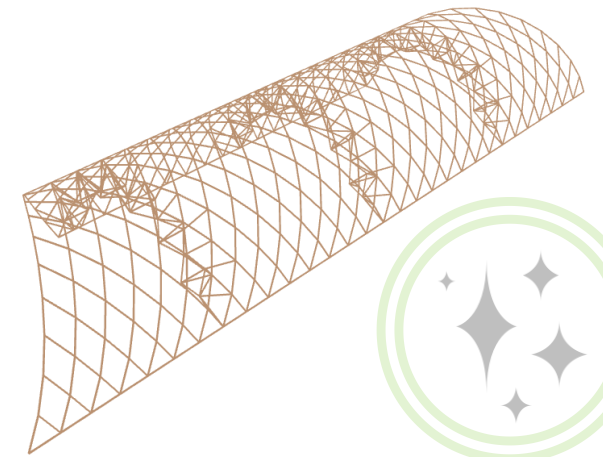
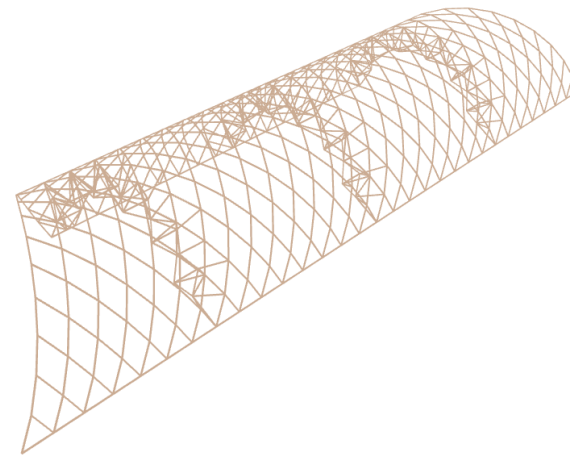
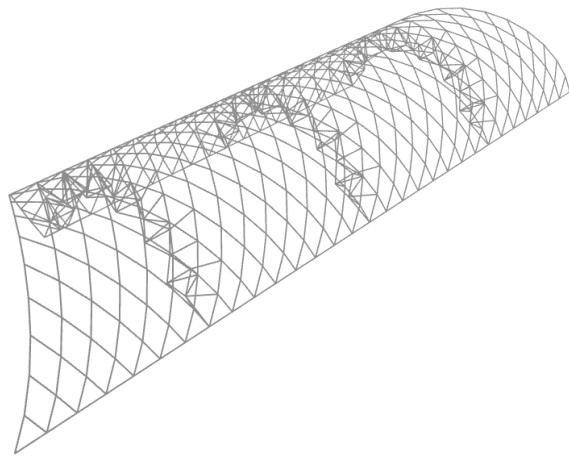
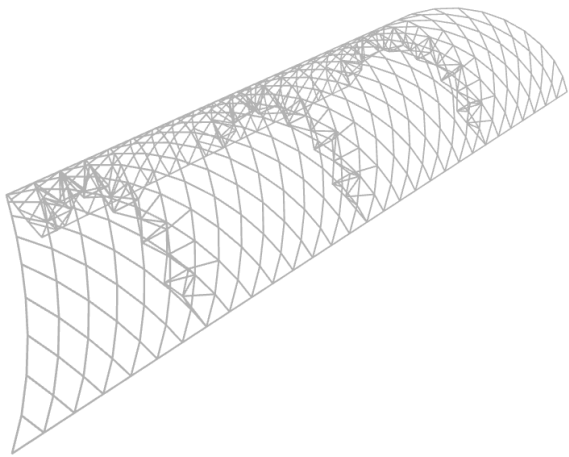

STEEL TRUSS

in timber structure

3 ×

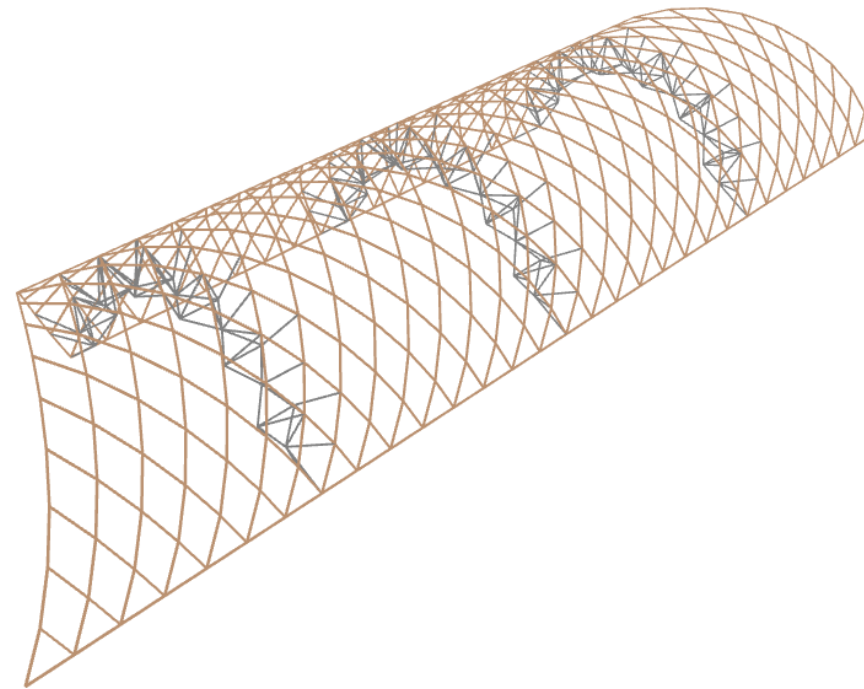

16 884
variations



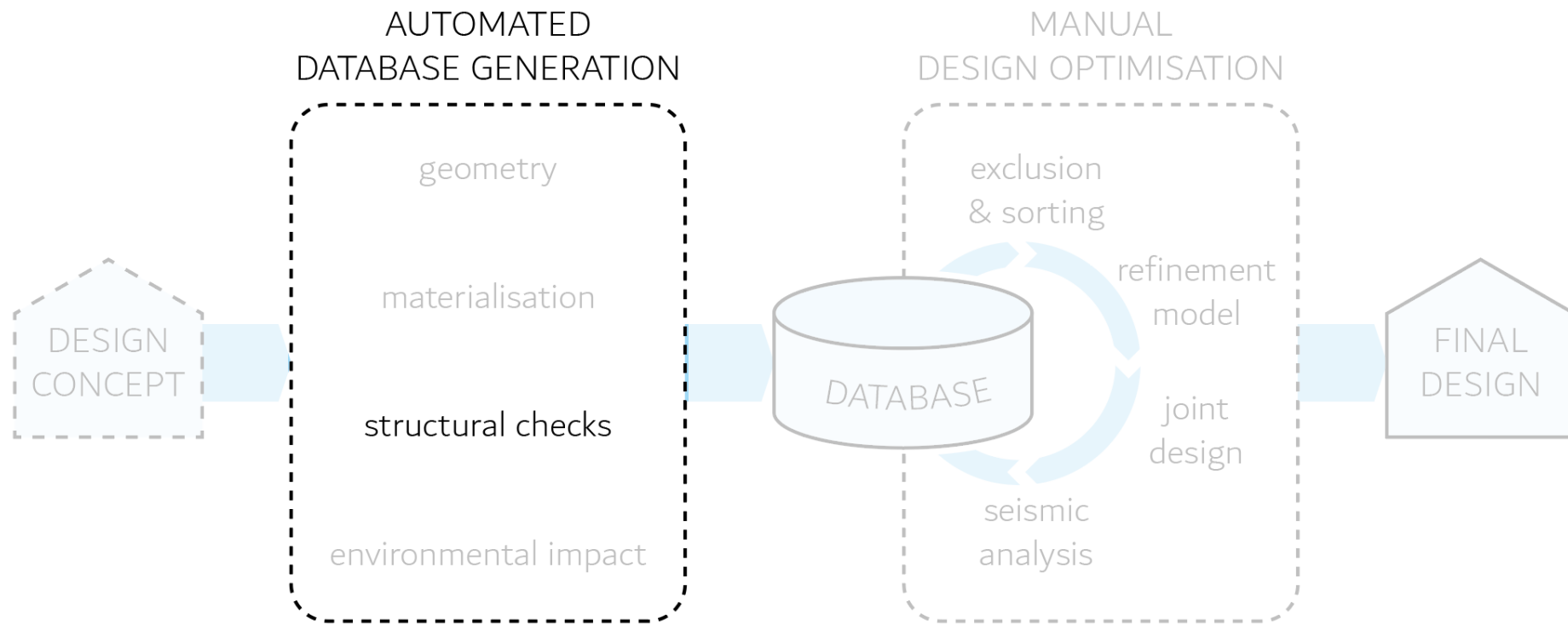

PERMANENT

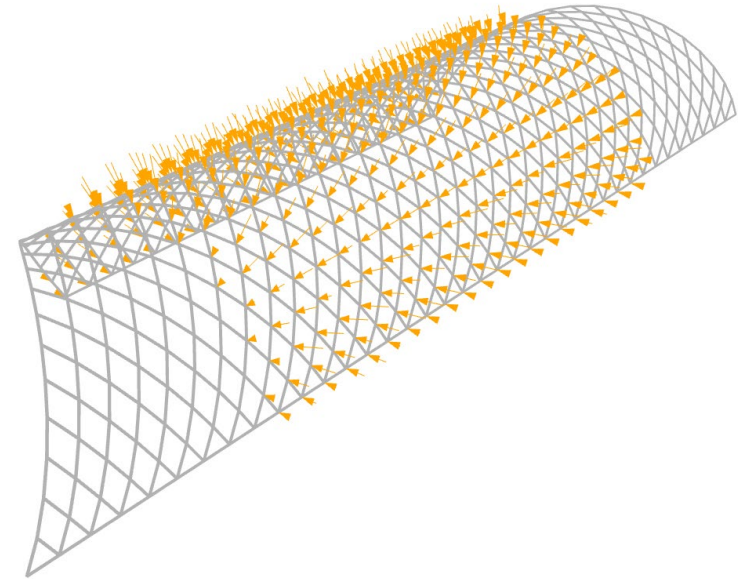
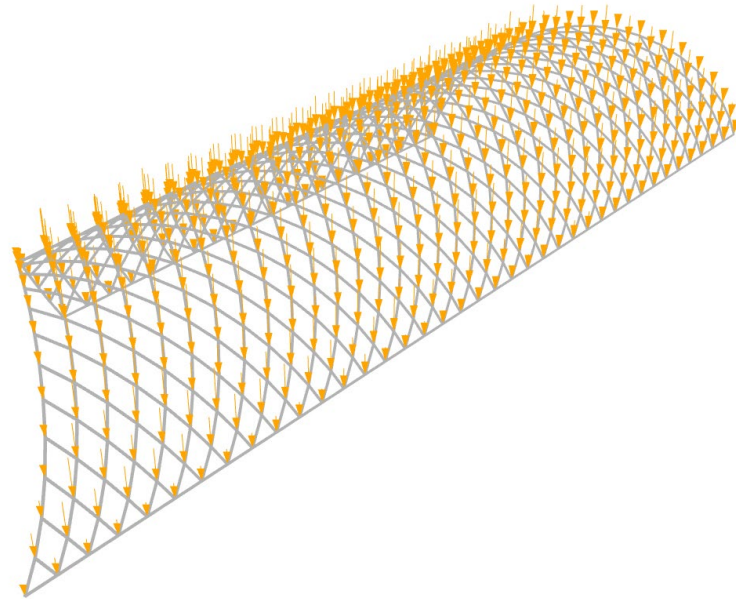

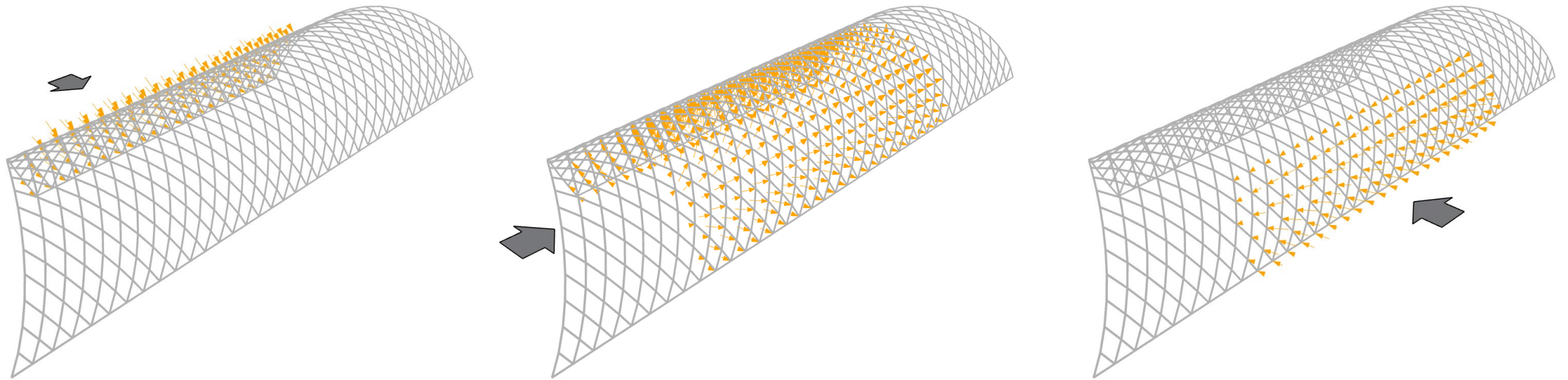

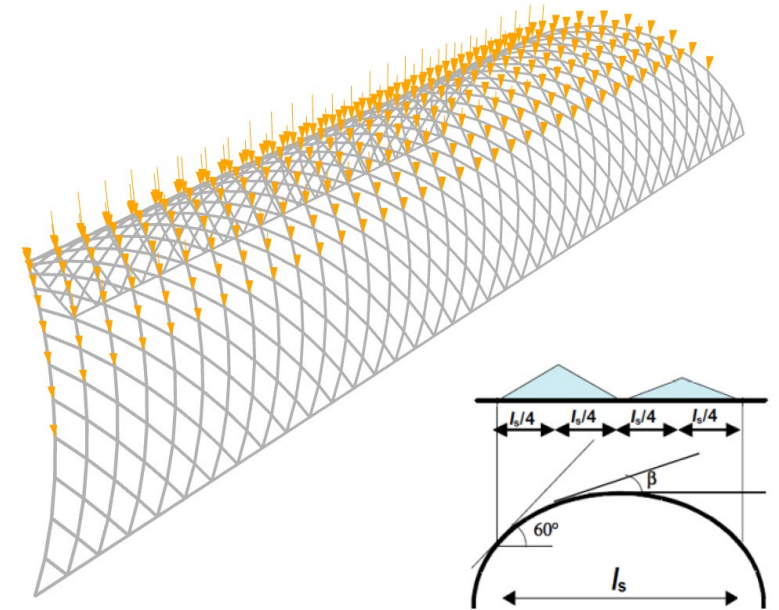
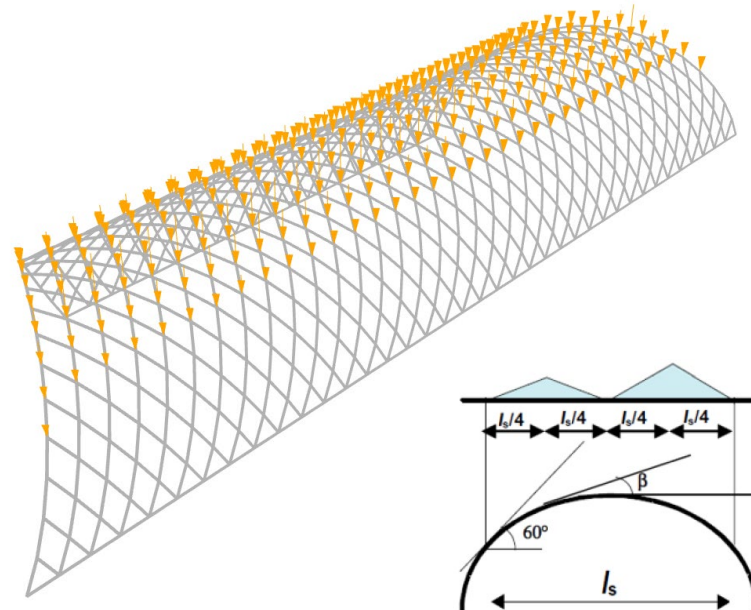
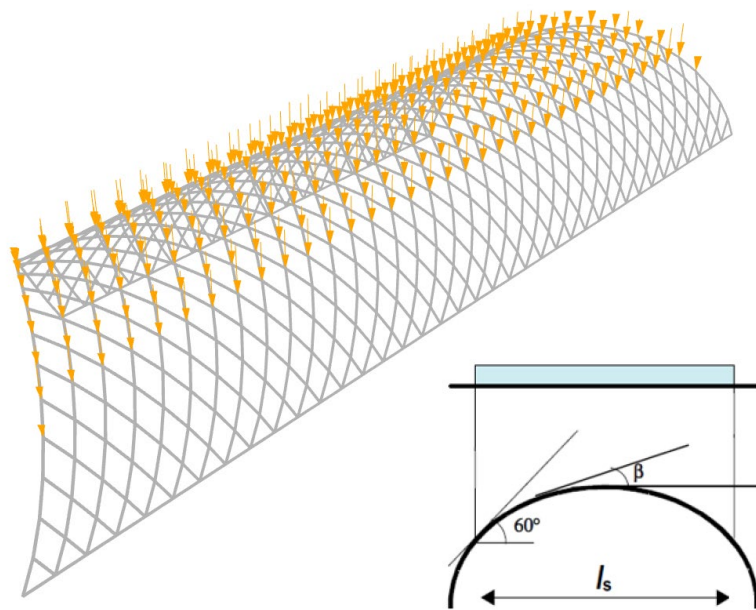

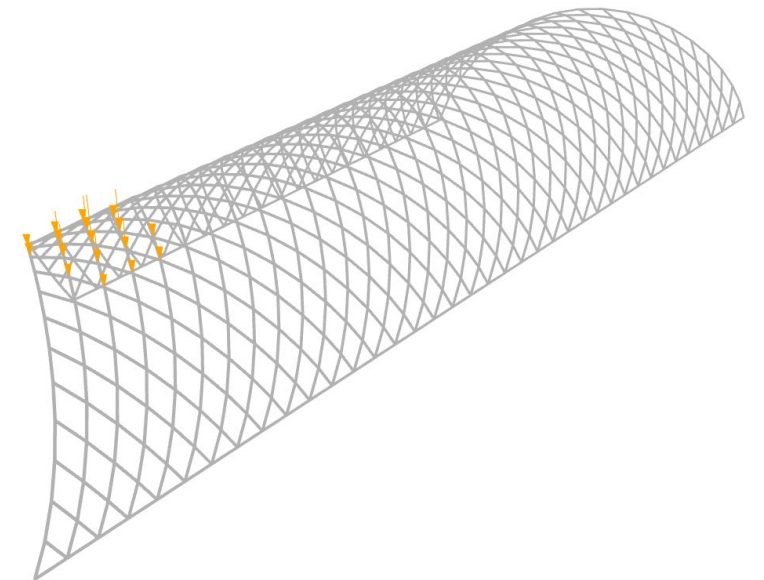
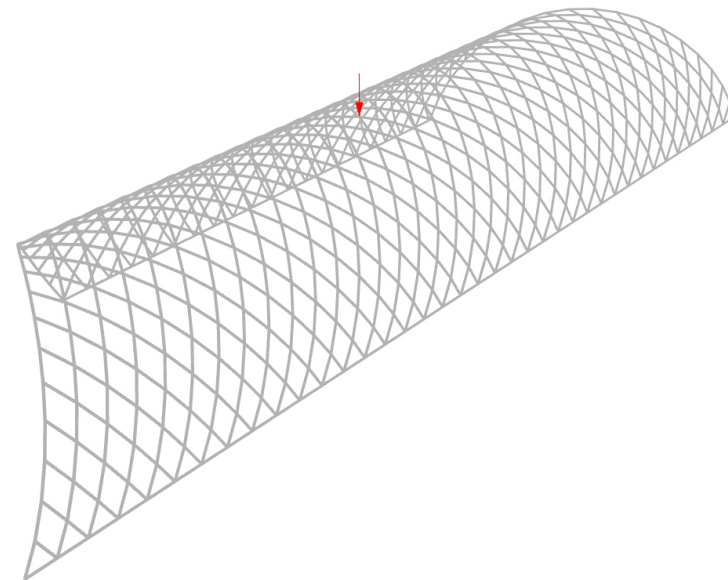

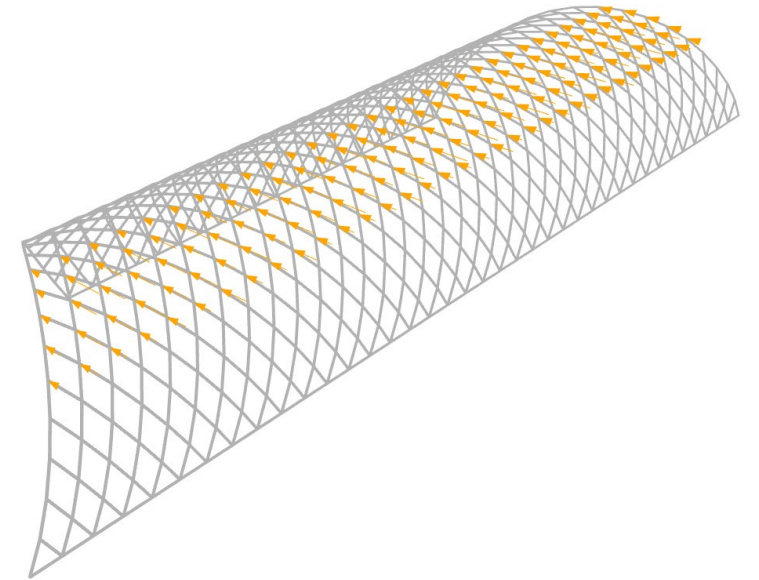
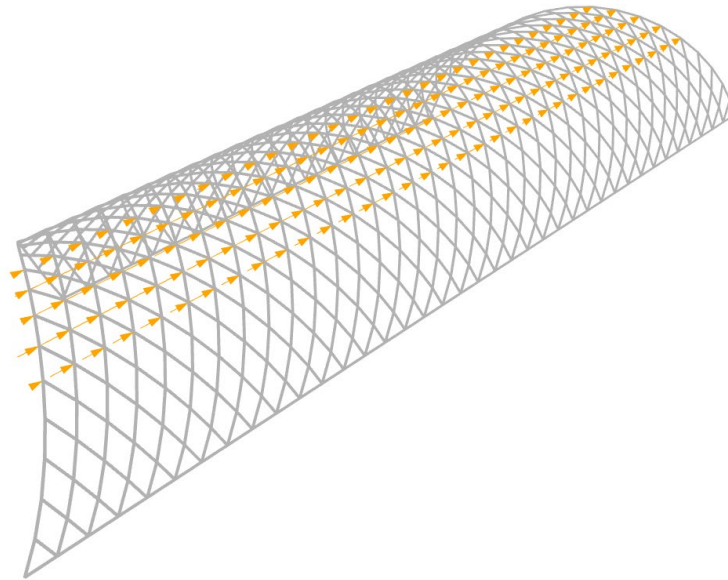



STRENGTH vs. LOADS

Is the design strong enough?

$$\frac{\tau_d}{f_{v,d}} \leq 1$$

$$\frac{\sigma_{t,0,d}}{f_{t,0,d}} + \frac{\sigma_{m,y,d}}{f_{m,y,d}} + k_m \cdot \frac{\sigma_{m,z,d}}{f_{m,z,d}} \leq 1$$

$$\frac{\sigma_{t,0,d}}{f_{t,0,d}} + k_m \cdot \frac{\sigma_{m,y,d}}{f_{m,y,d}} + \frac{\sigma_{m,z,d}}{f_{m,z,d}} \leq 1$$

$$\left(\frac{\sigma_{c,0,d}}{f_{c,0,d}}\right)^2 + \frac{\sigma_{m,y,d}}{f_{m,y,d}} + k_m \cdot \frac{\sigma_{m,z,d}}{f_{m,z,d}} \leq 1$$

$$\left(\frac{\sigma_{c,0,d}}{f_{c,0,d}}\right)^2 + k_m \cdot \frac{\sigma_{m,y,d}}{f_{m,y,d}} + \frac{\sigma_{m,z,d}}{f_{m,z,d}} \leq 1$$

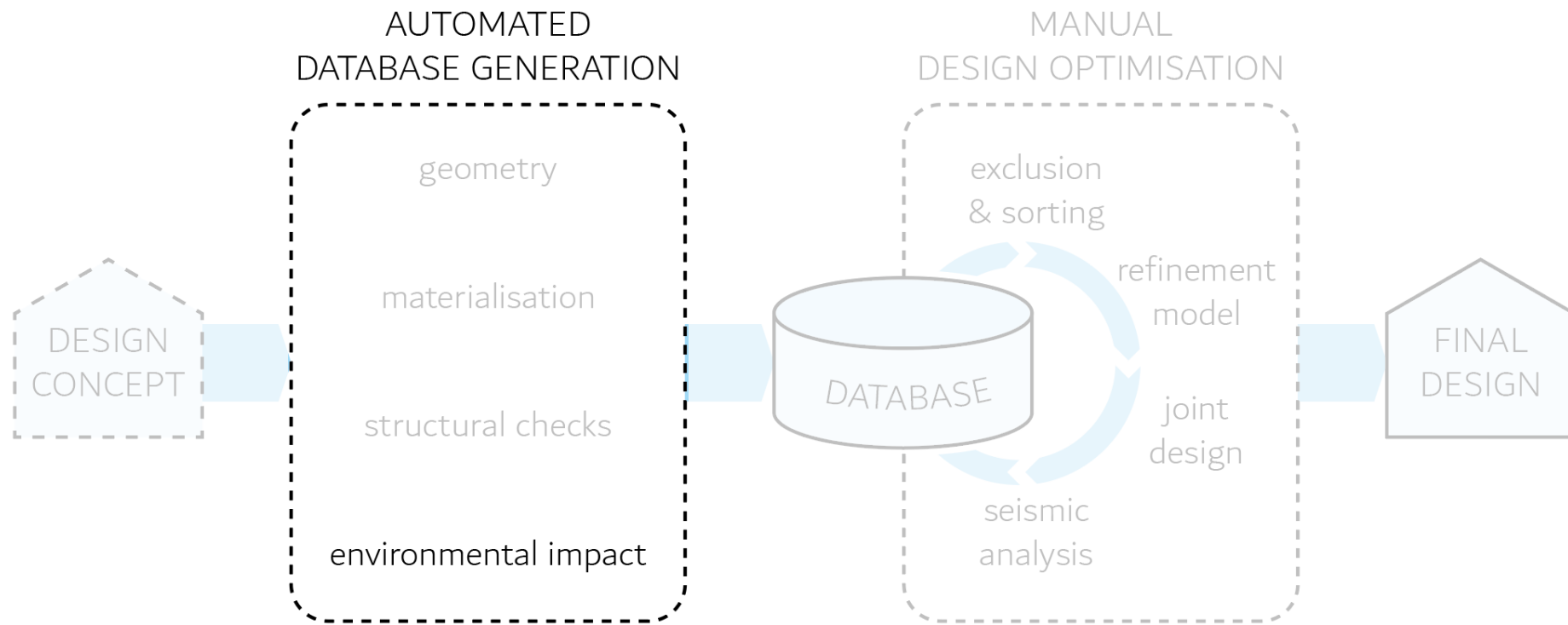

ENVIRONMENTAL IMPACT

Environmental impact per kg structure

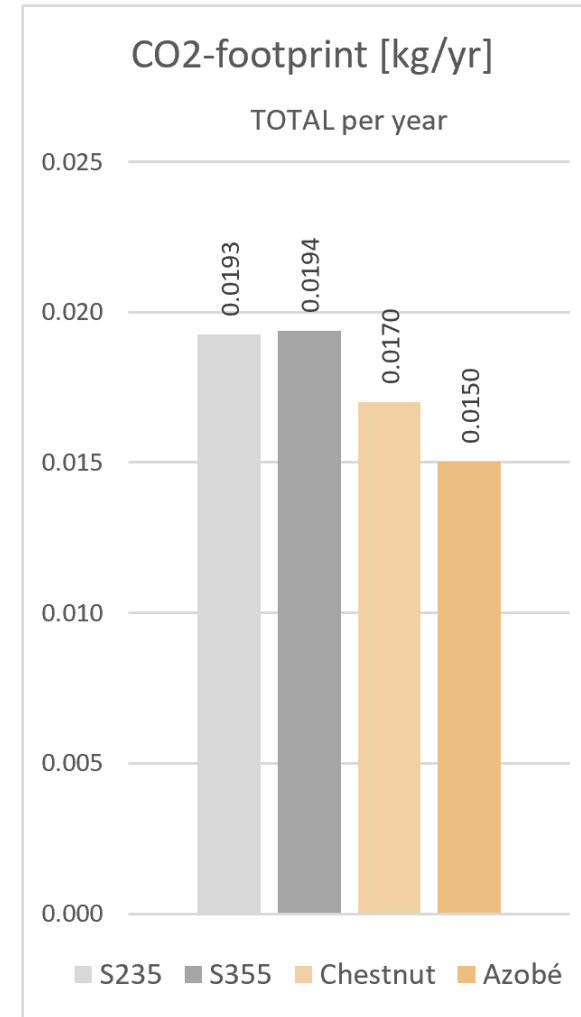
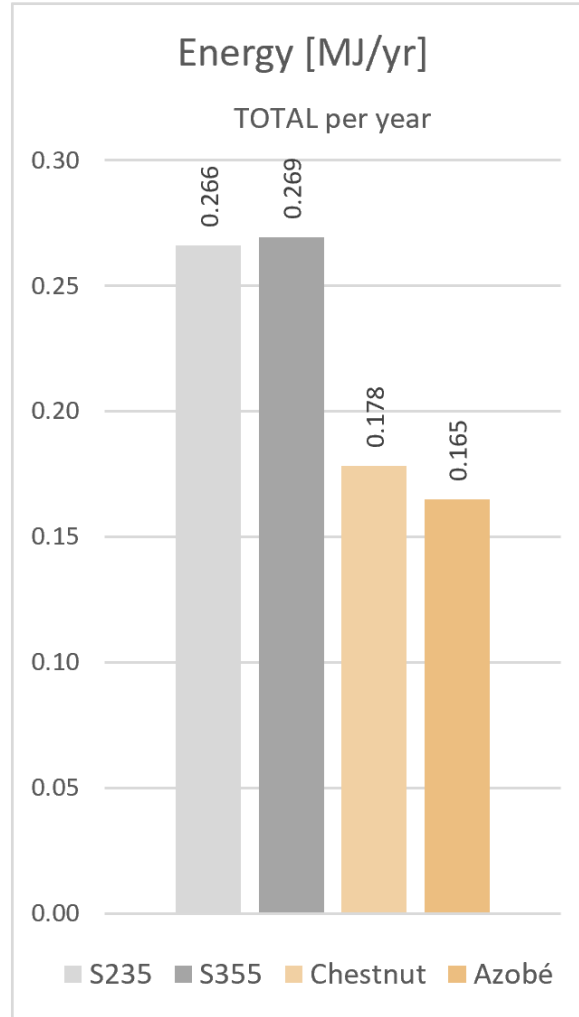

Exclusion:
Chestnut

10 836
variations

JOINT

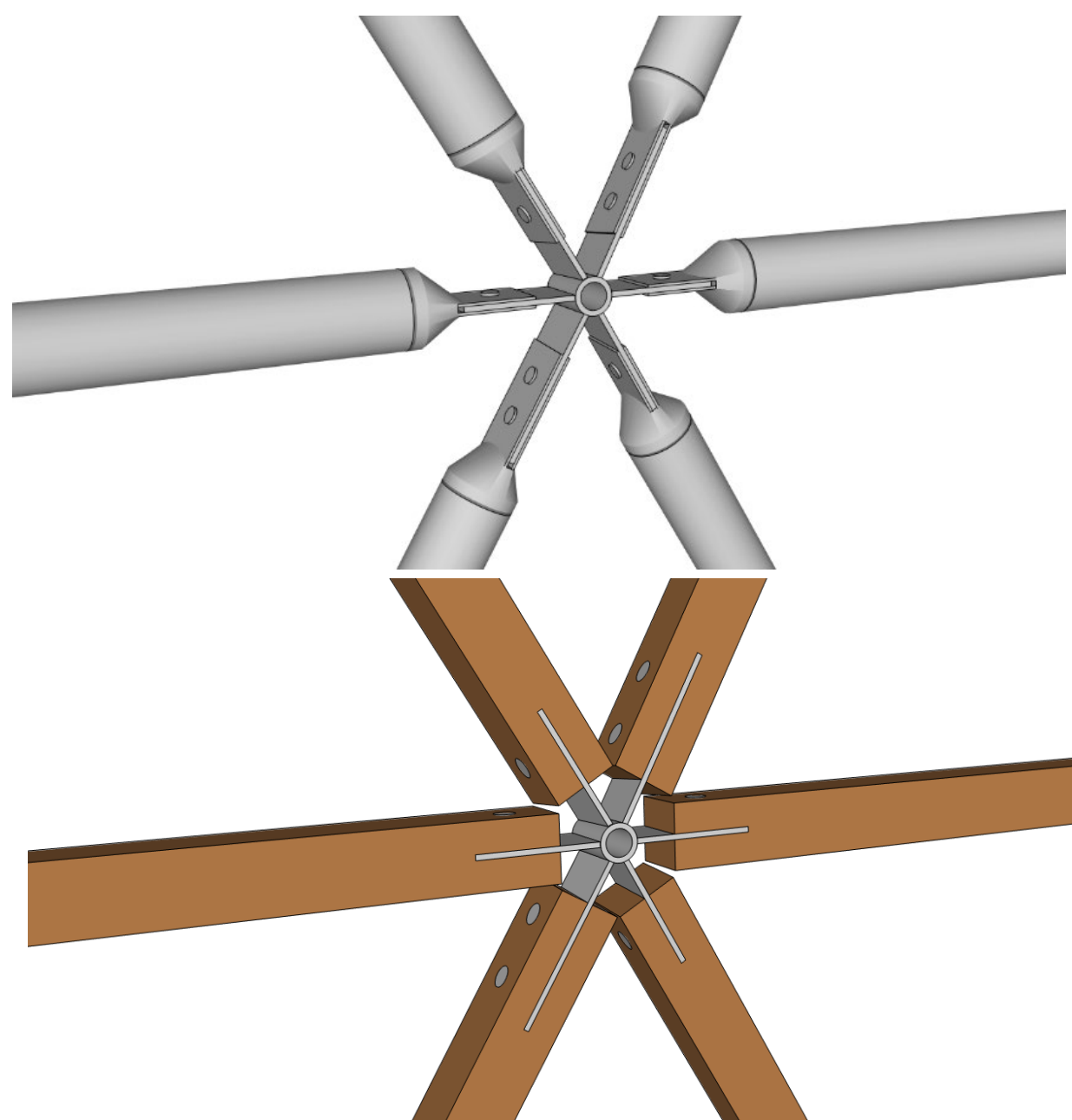

ENVIRONMENTAL IMPACT

Environmental impact per joint

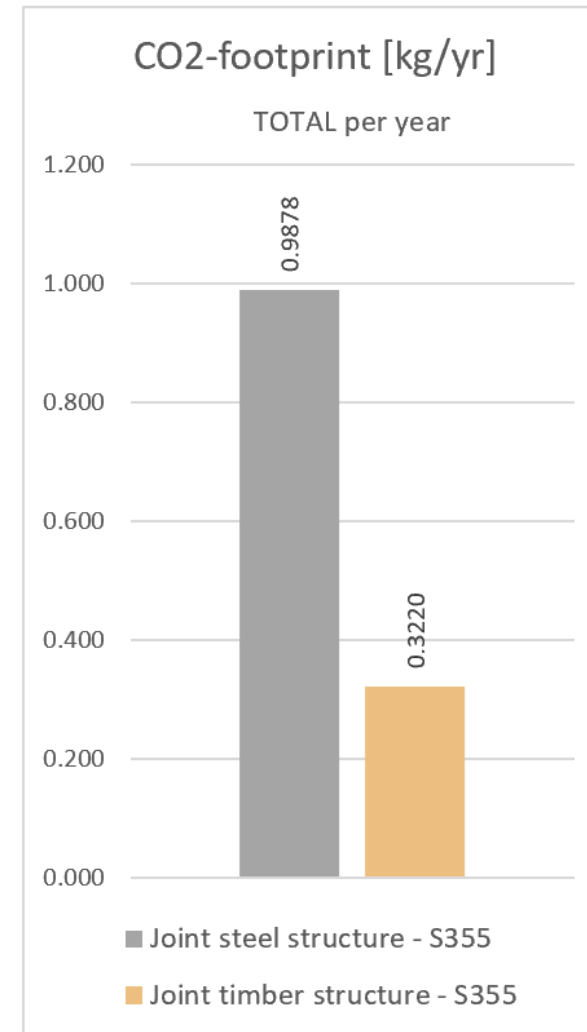
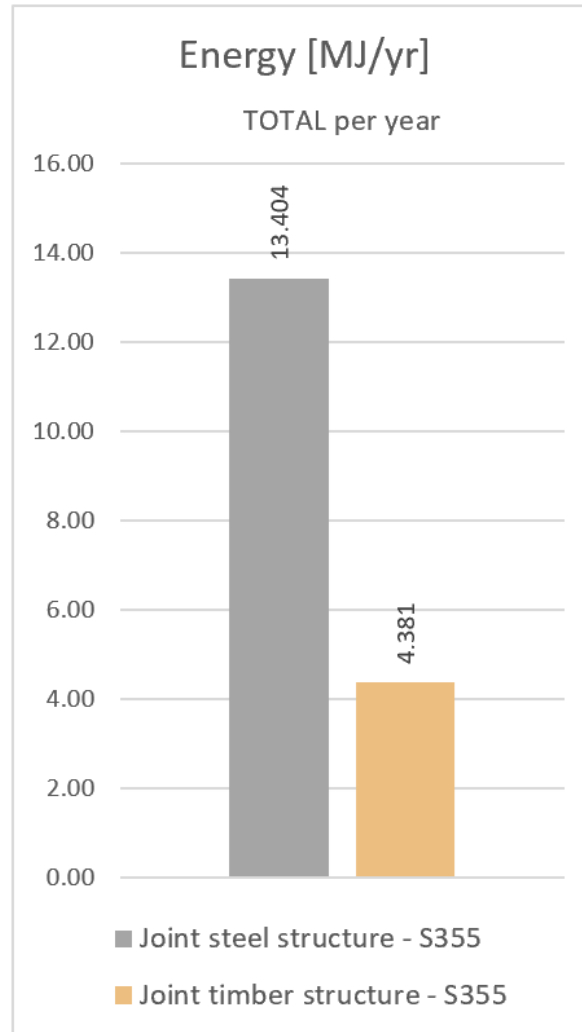

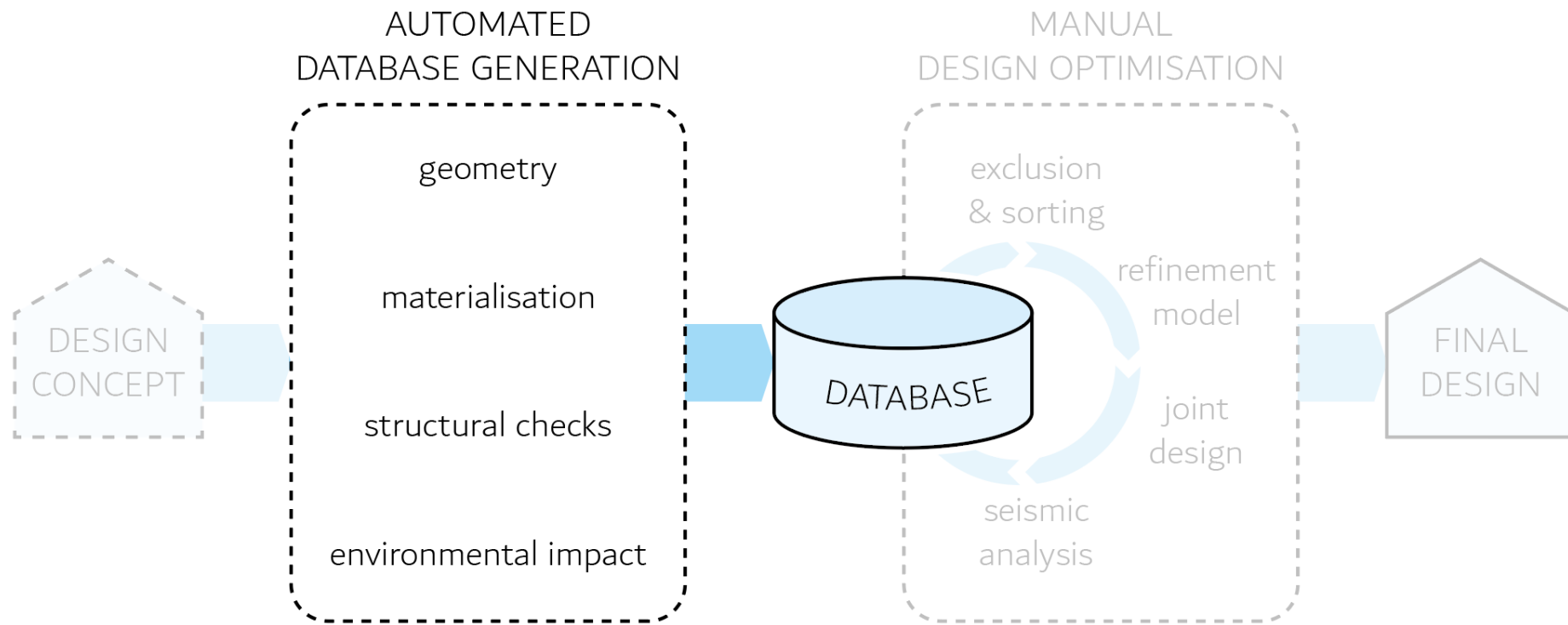

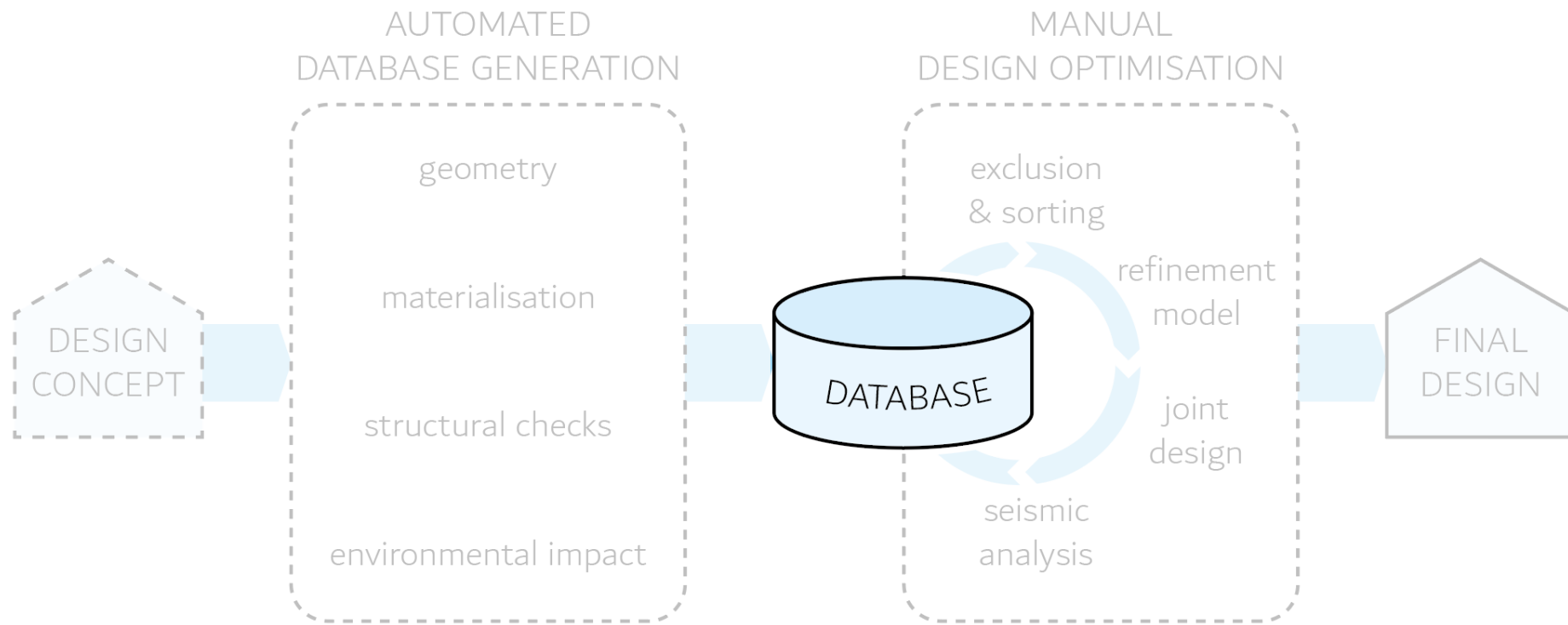

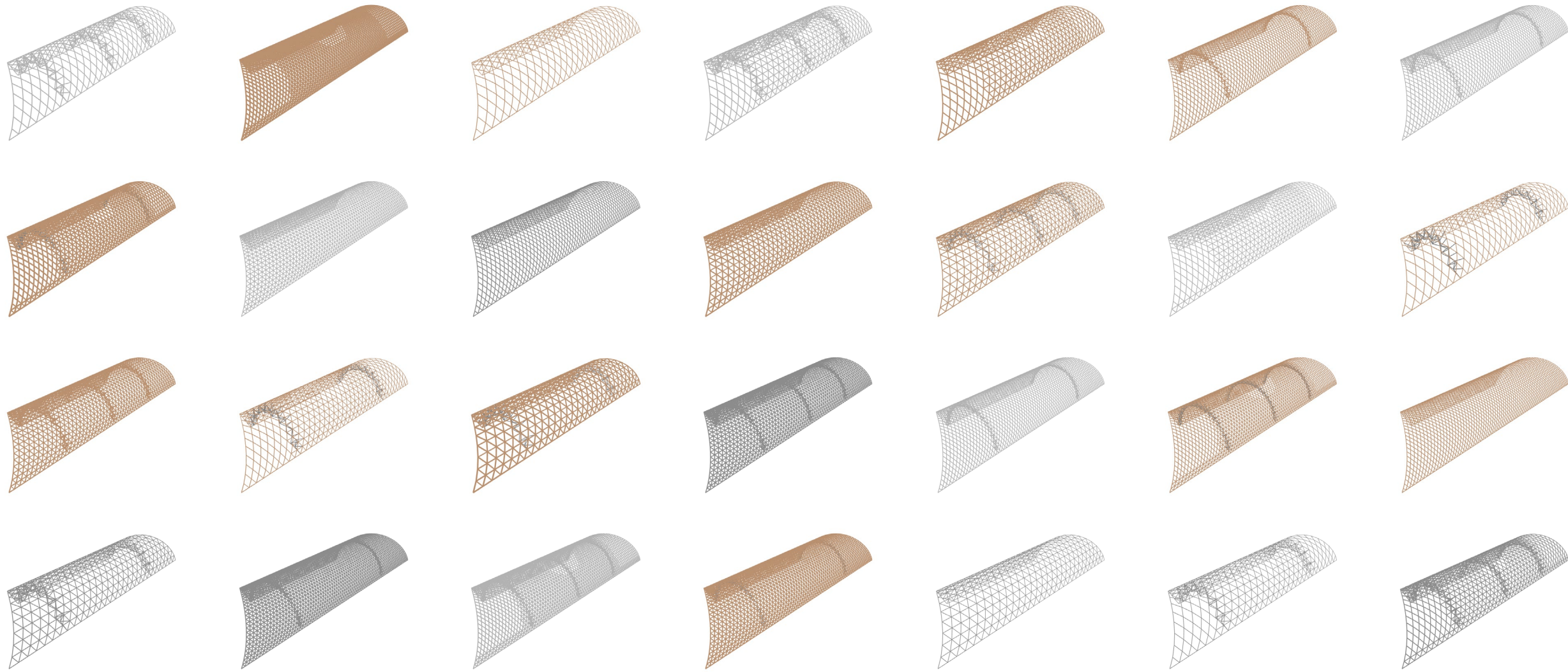

10 836
variations

ALL MODELS

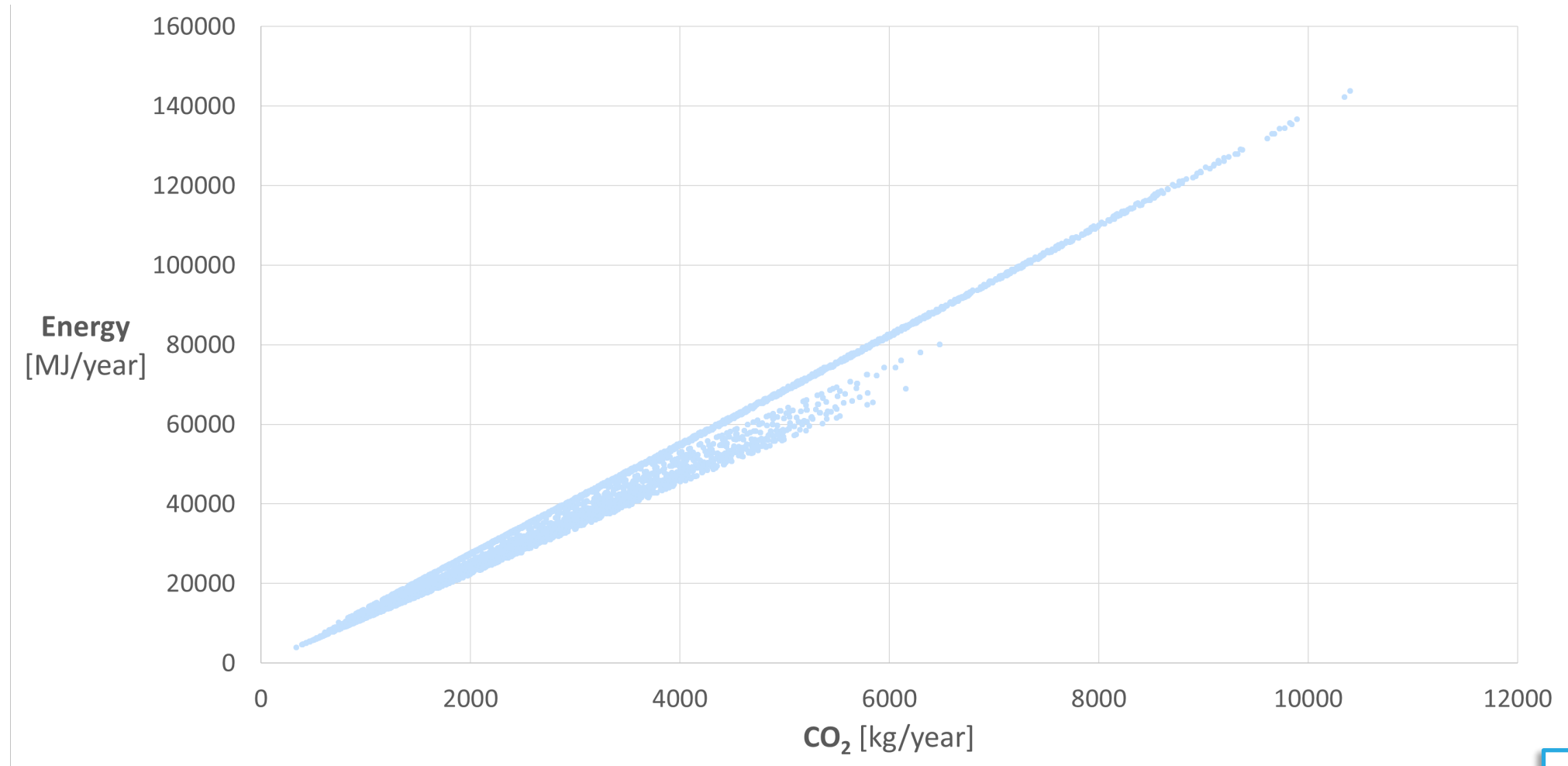

10 836
variations

STEEL

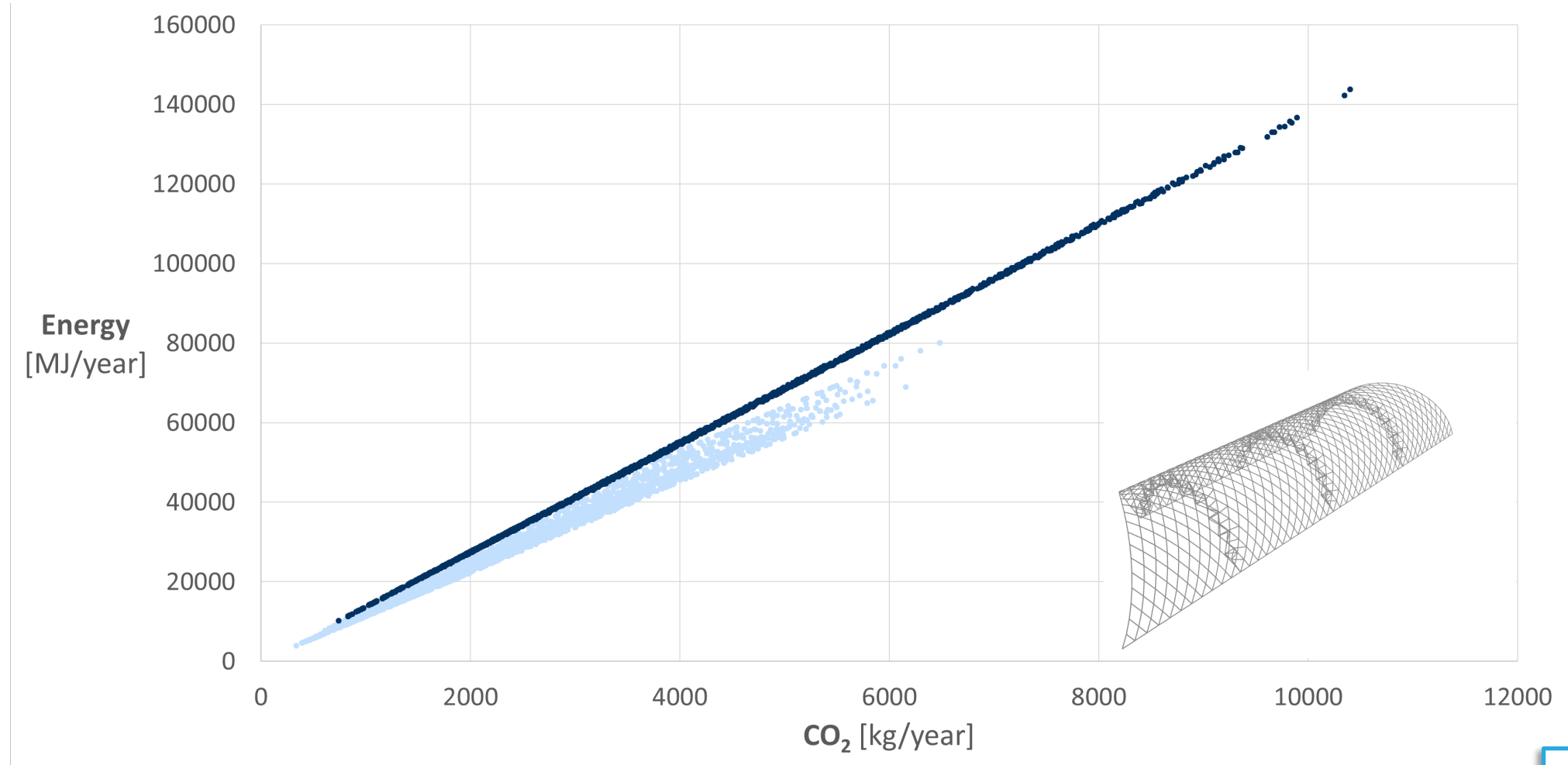

4 788
variations

TIMBER

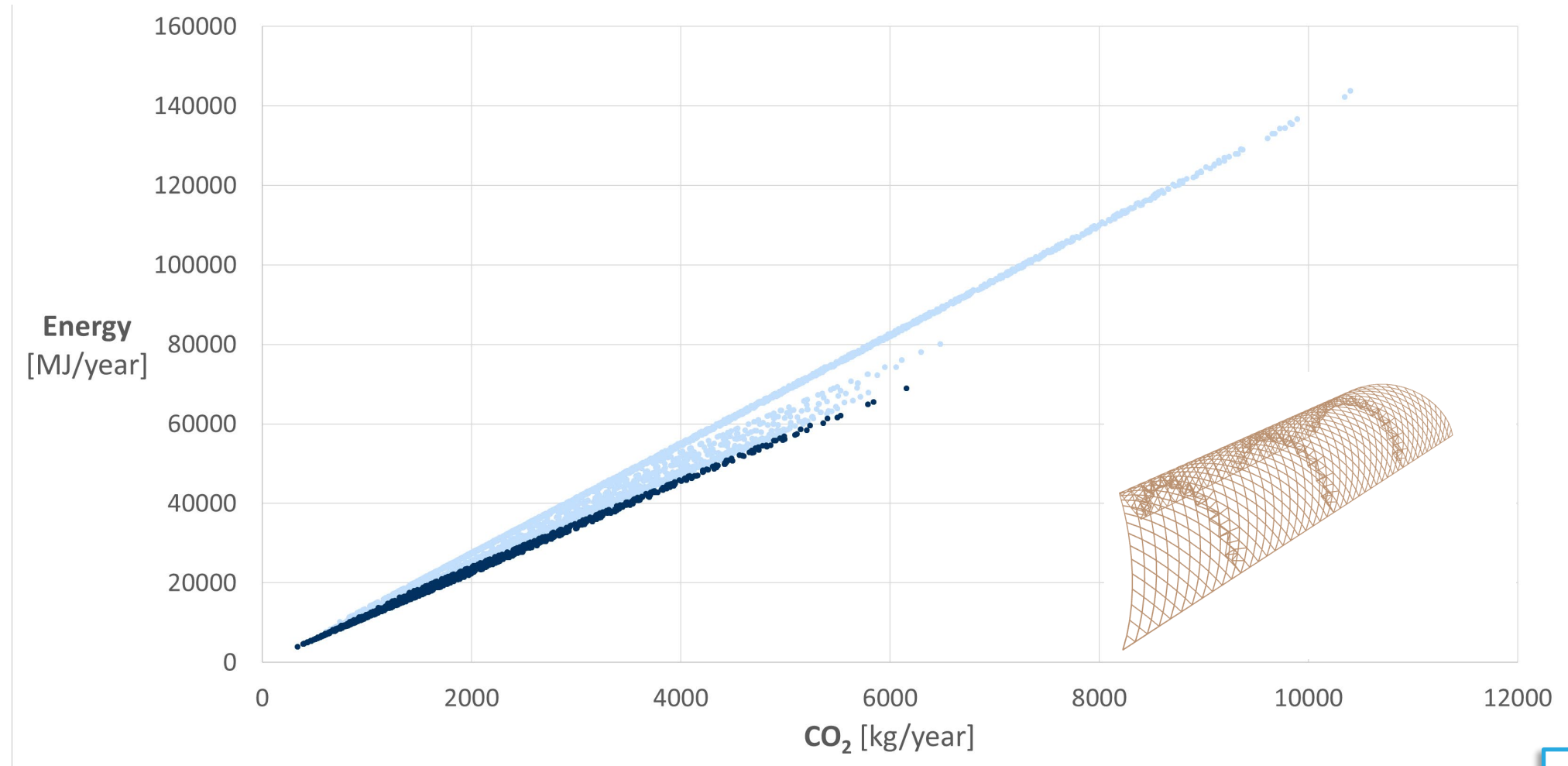

2 016
variations

TIMBER & STEEL

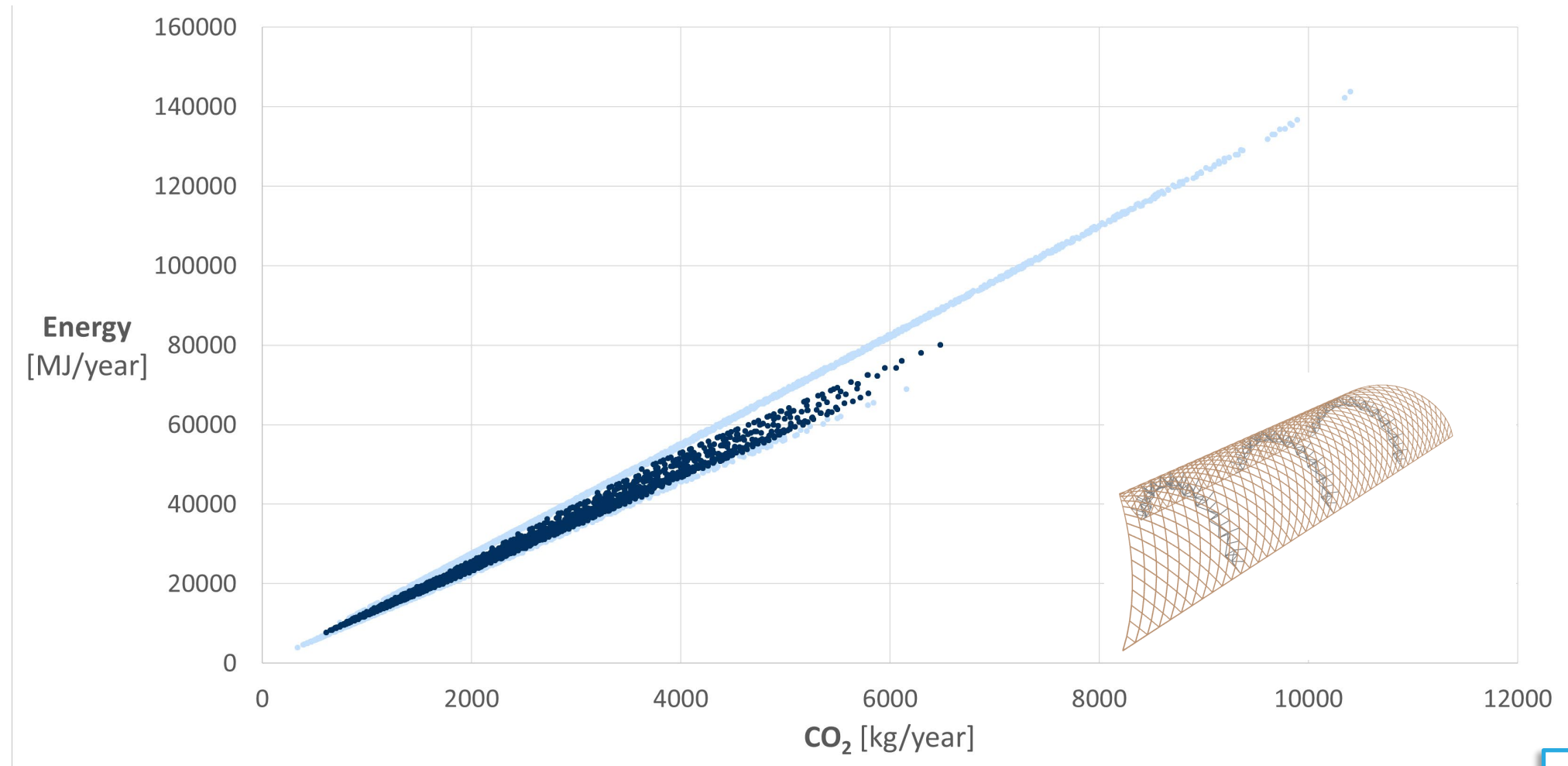

4 032
variations

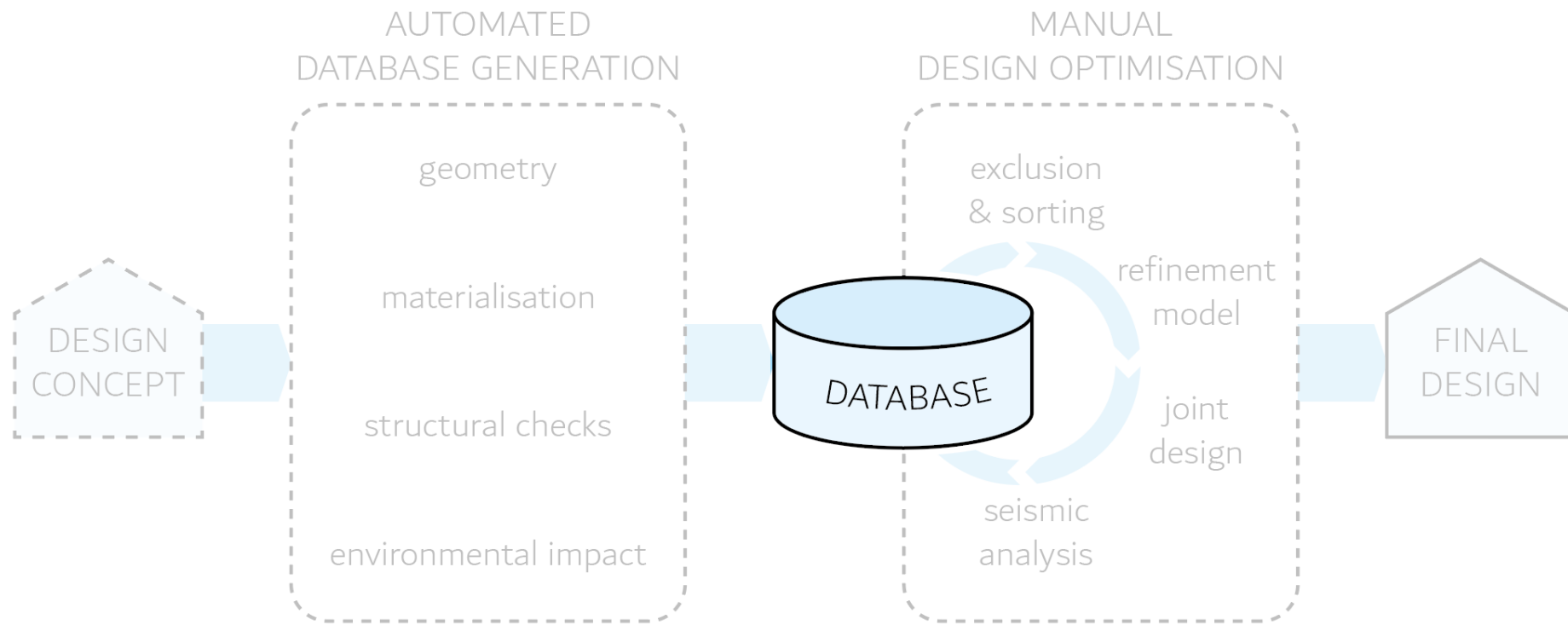

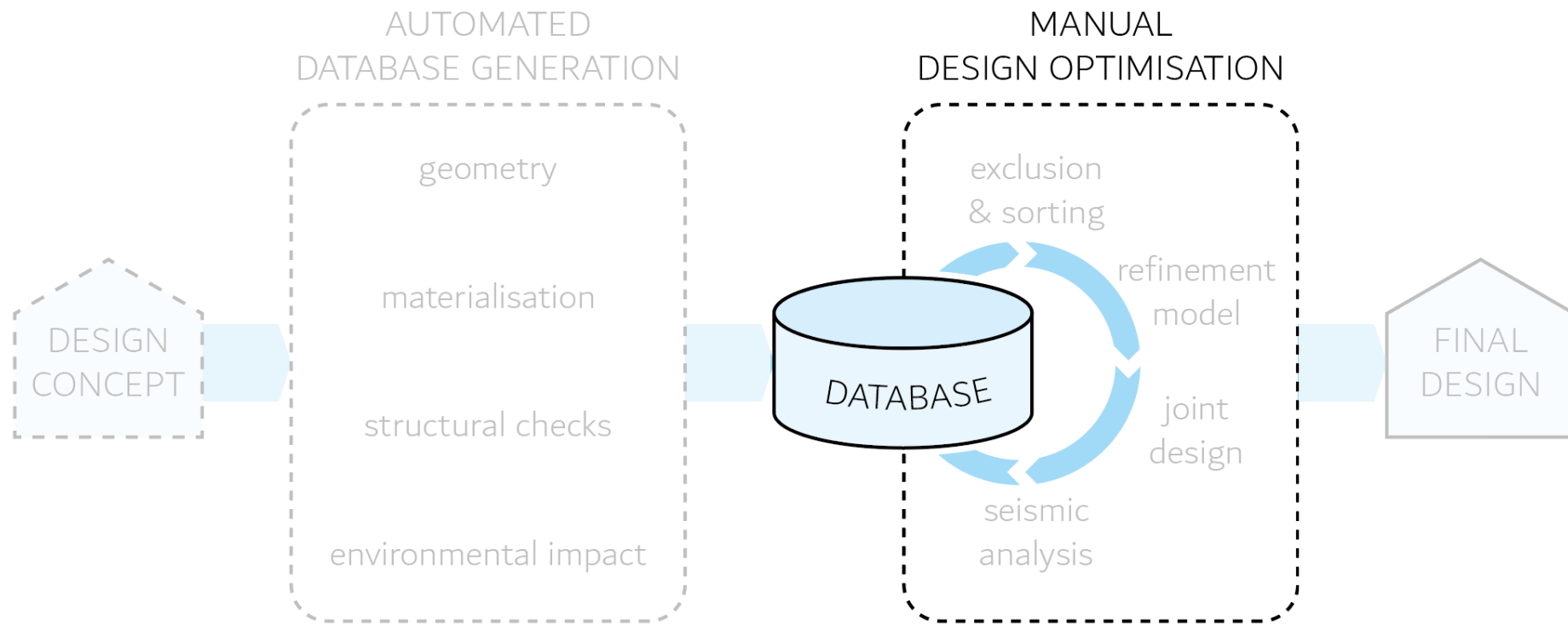

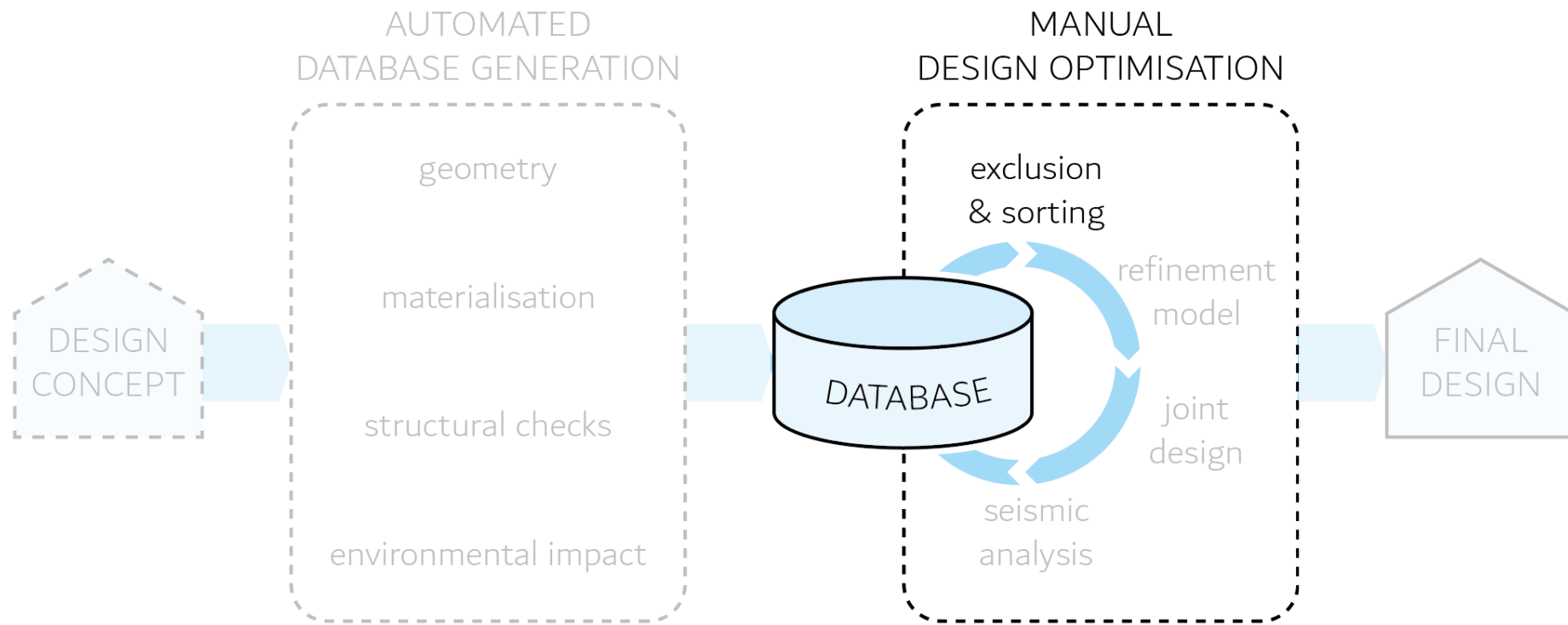

structural checks
O.K.



ALL MODELS

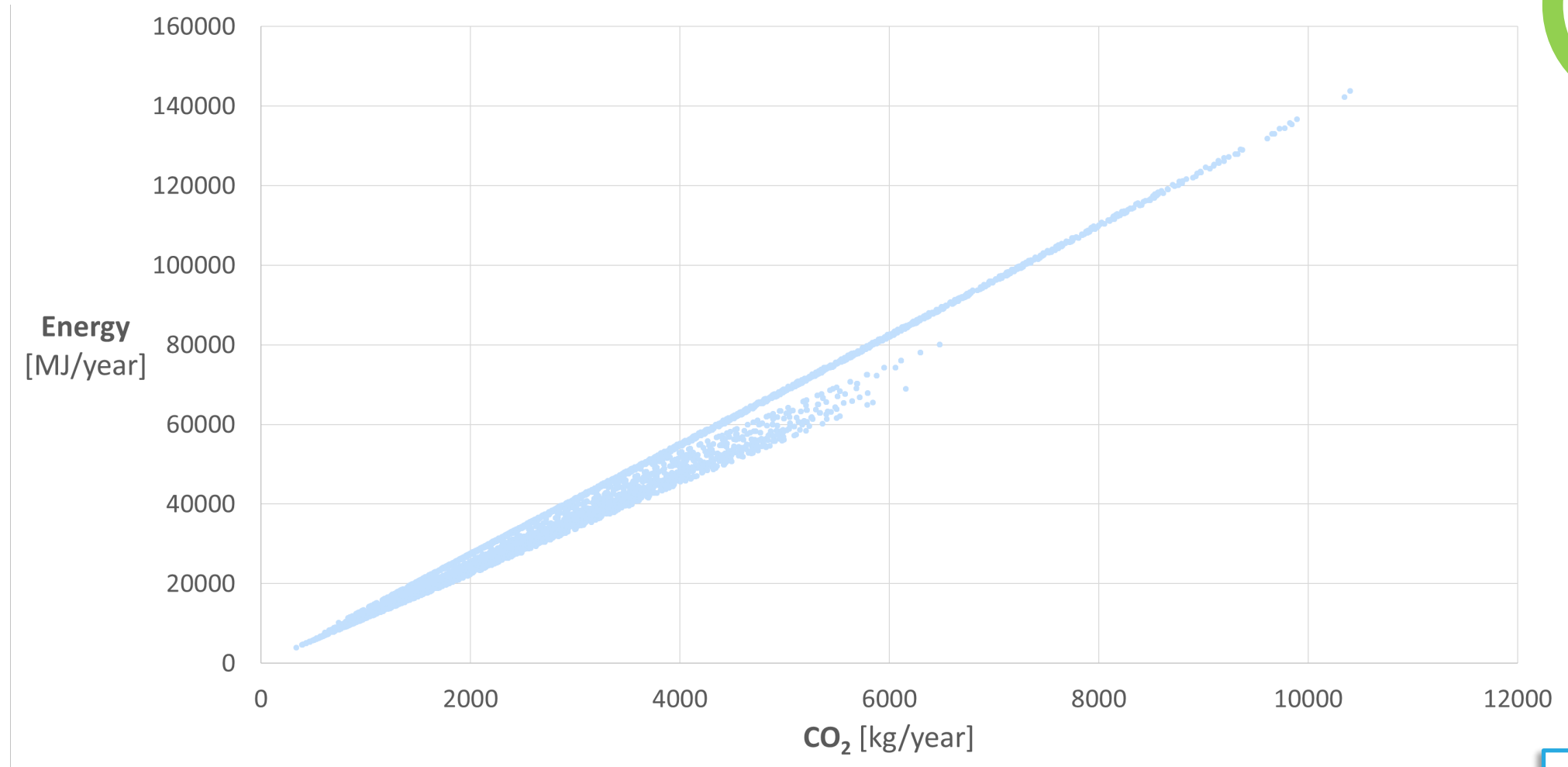

10 836
variations

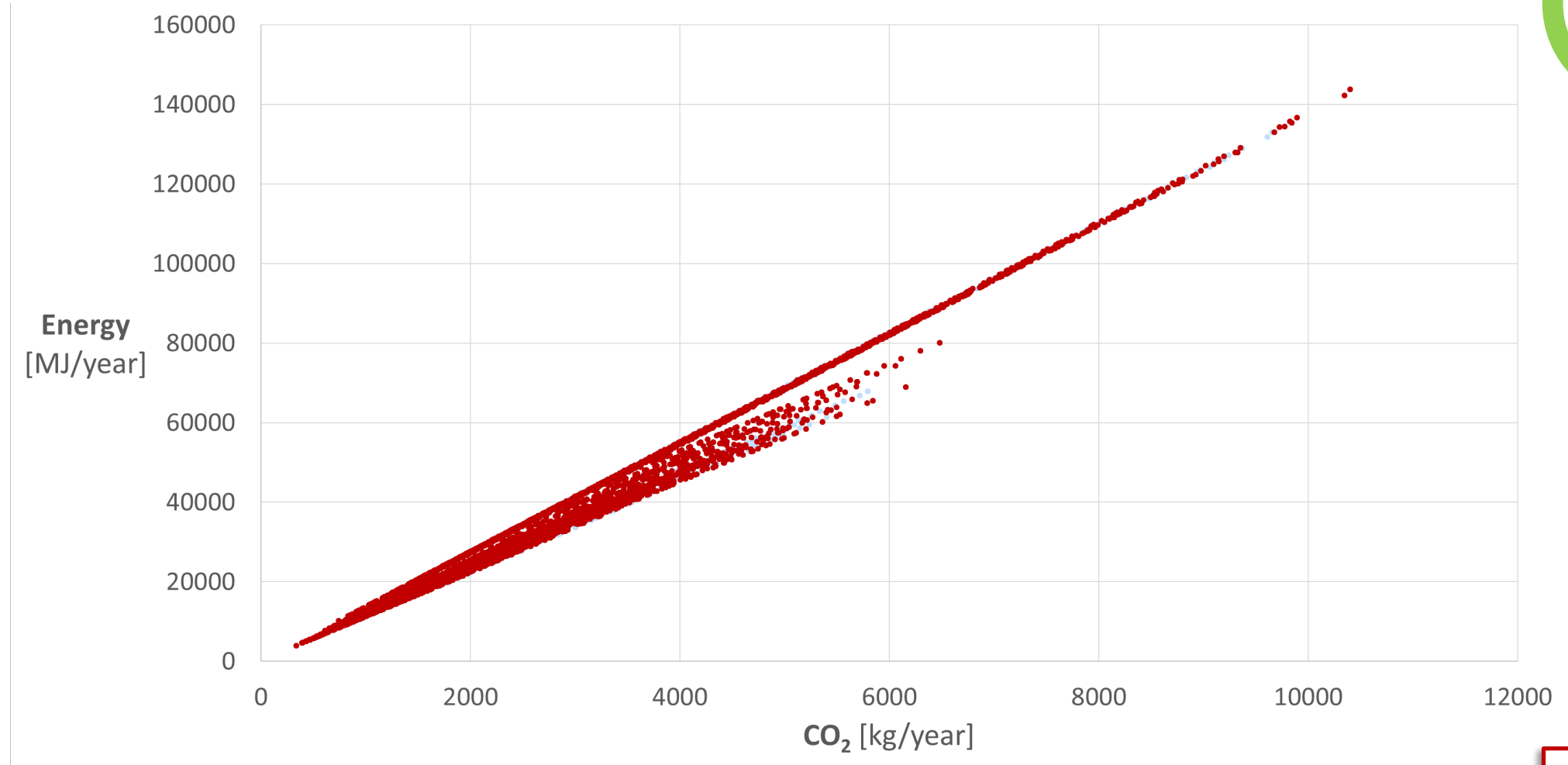

9 335 variations

STRUCTURAL CHECKS

O.K.

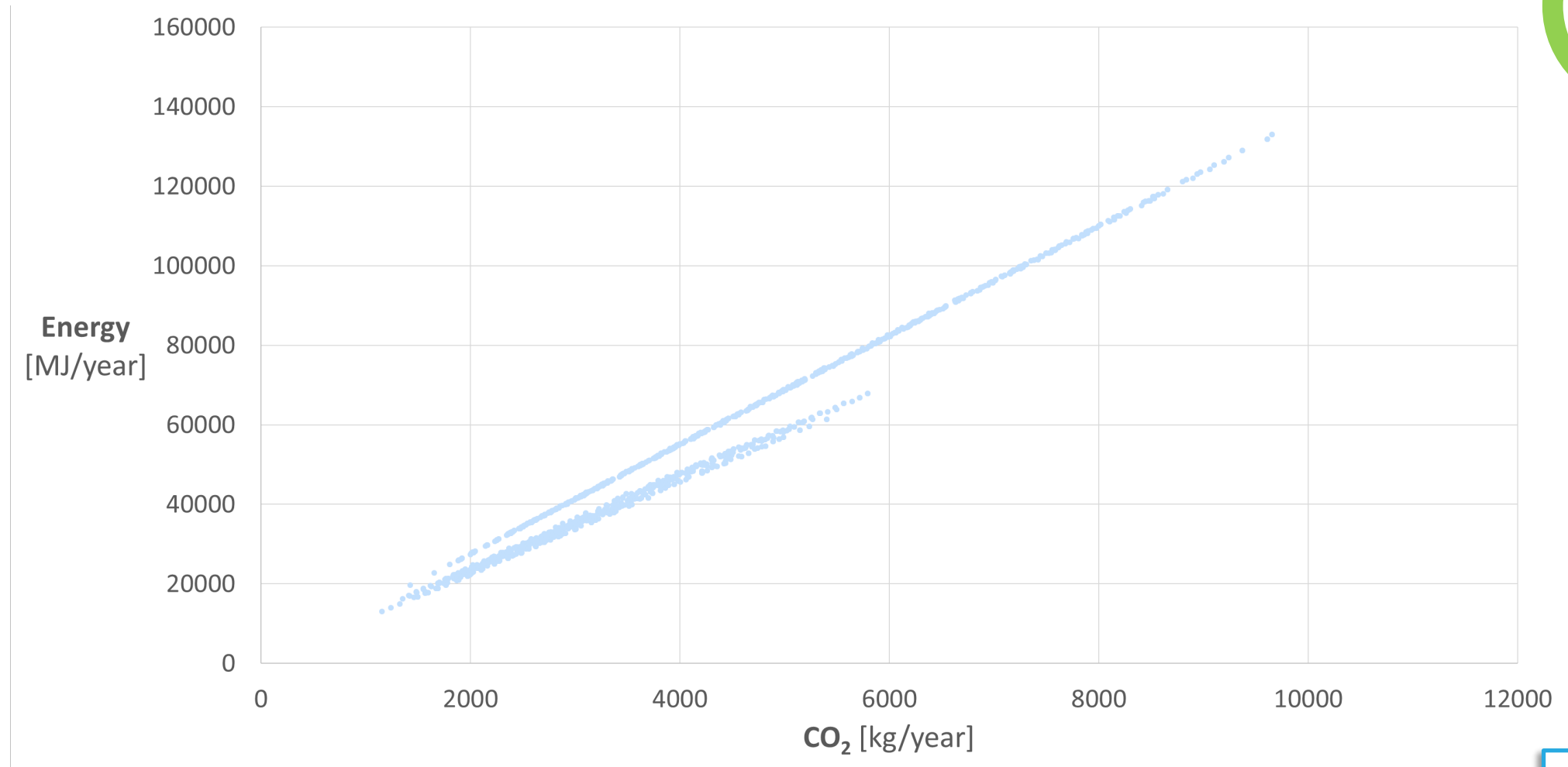

1 501 variations

element weight
< 40 kg



REMAINING MODELS

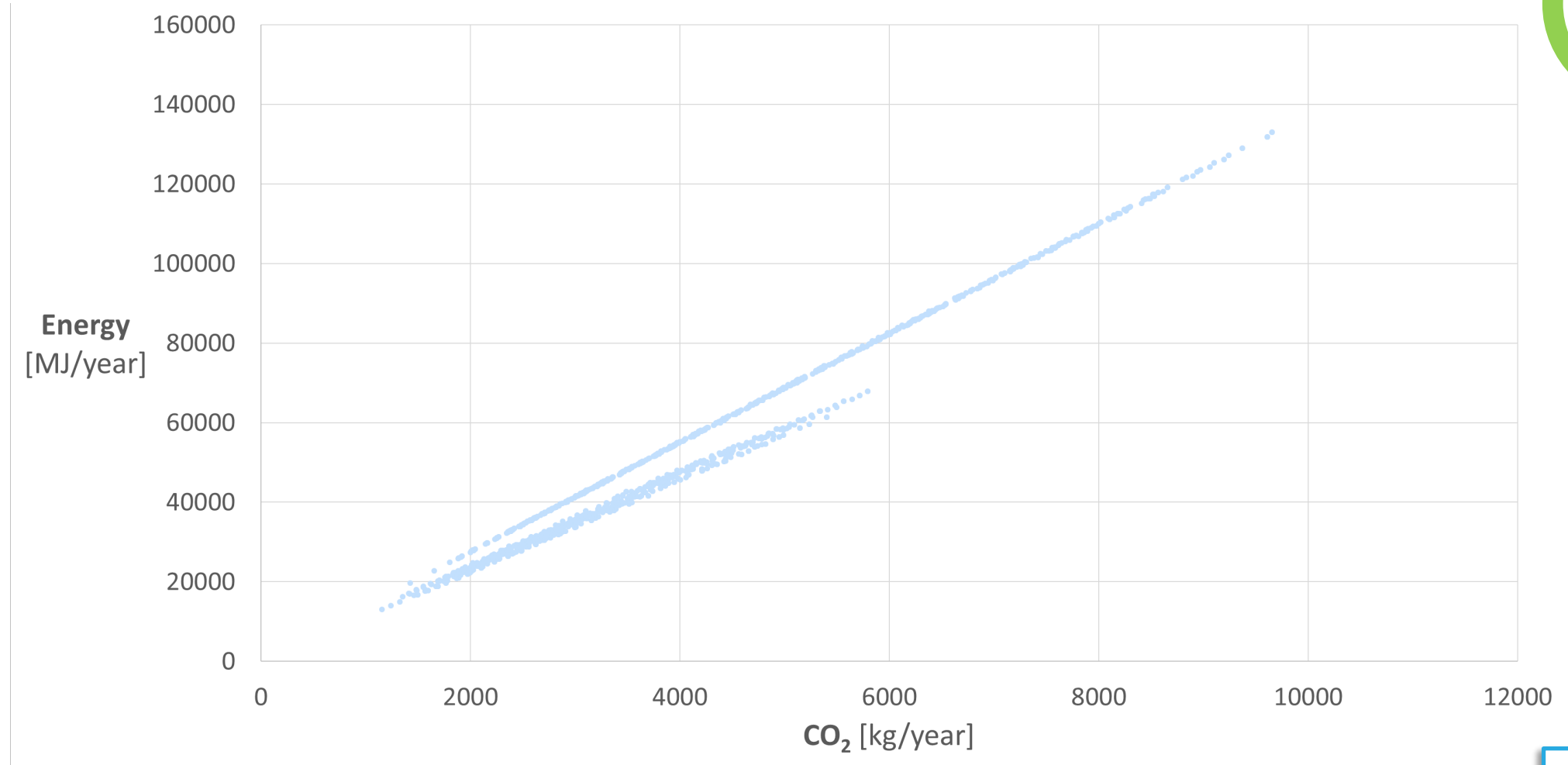

1 501
variations

ELEMENT WEIGHT

>40 kg

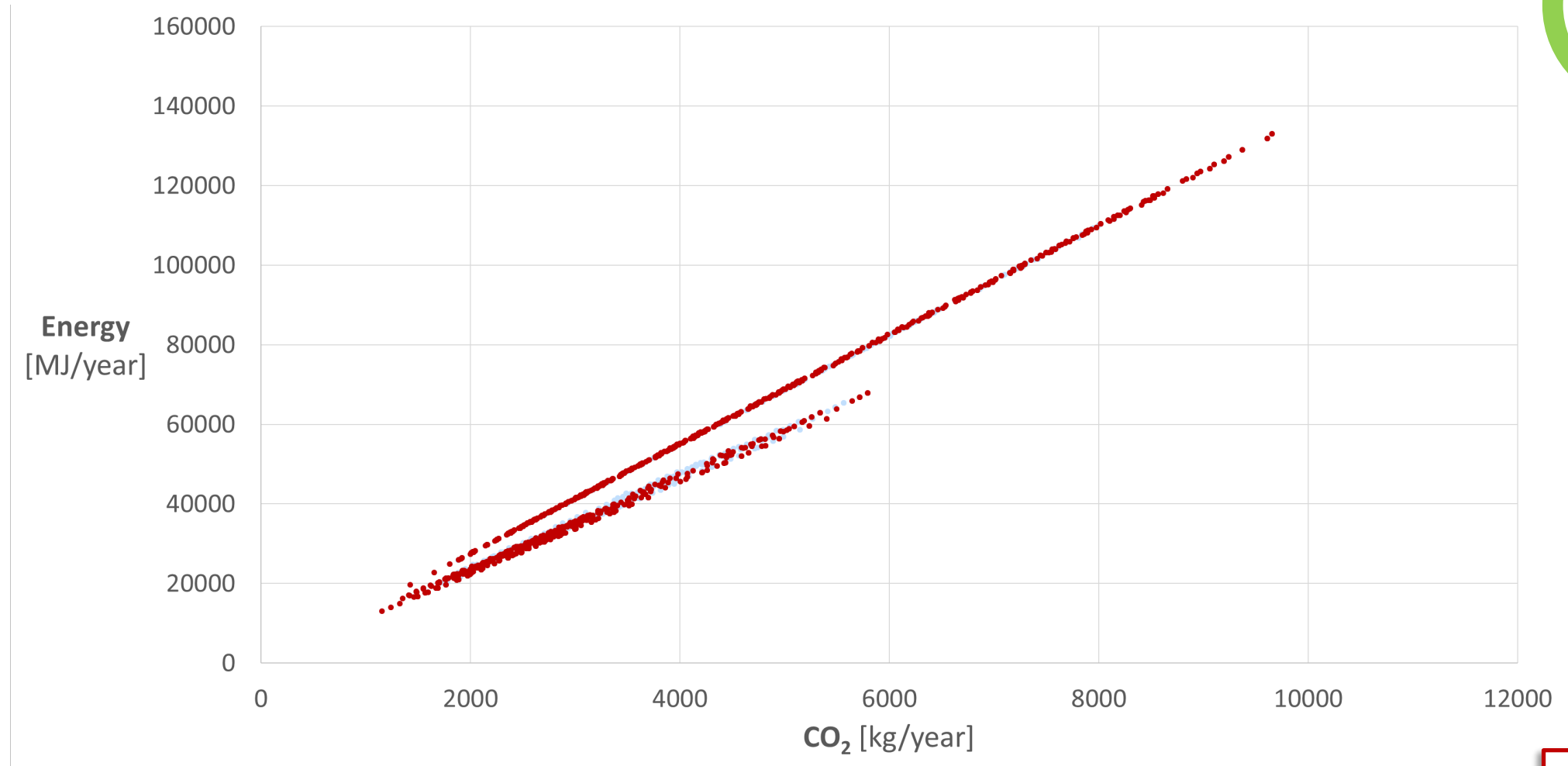

1 124 variations

ELEMENT WEIGHT

<40 kg

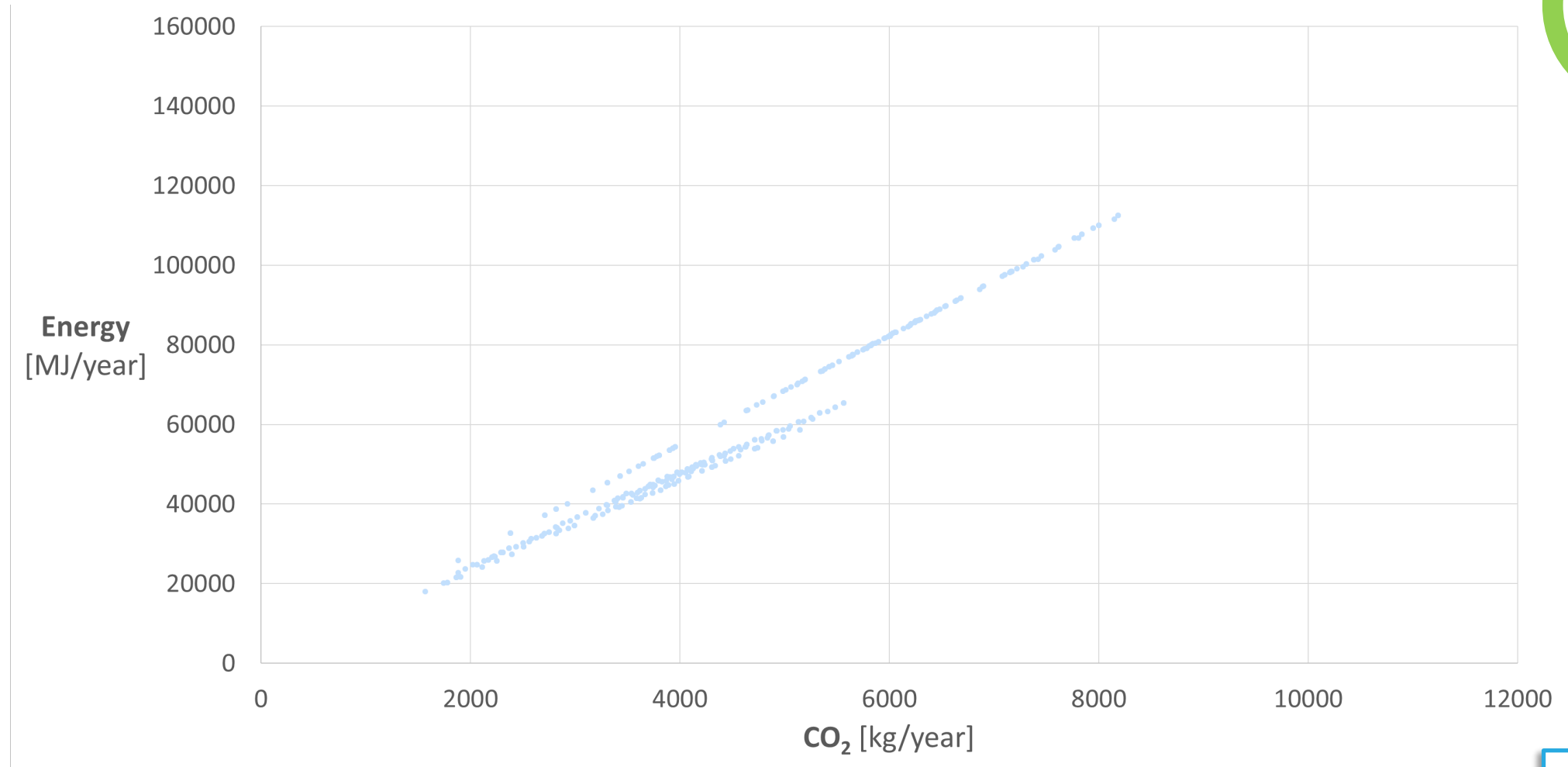

377 variations

environmentally friendly
top 5%



REMAINING MODELS

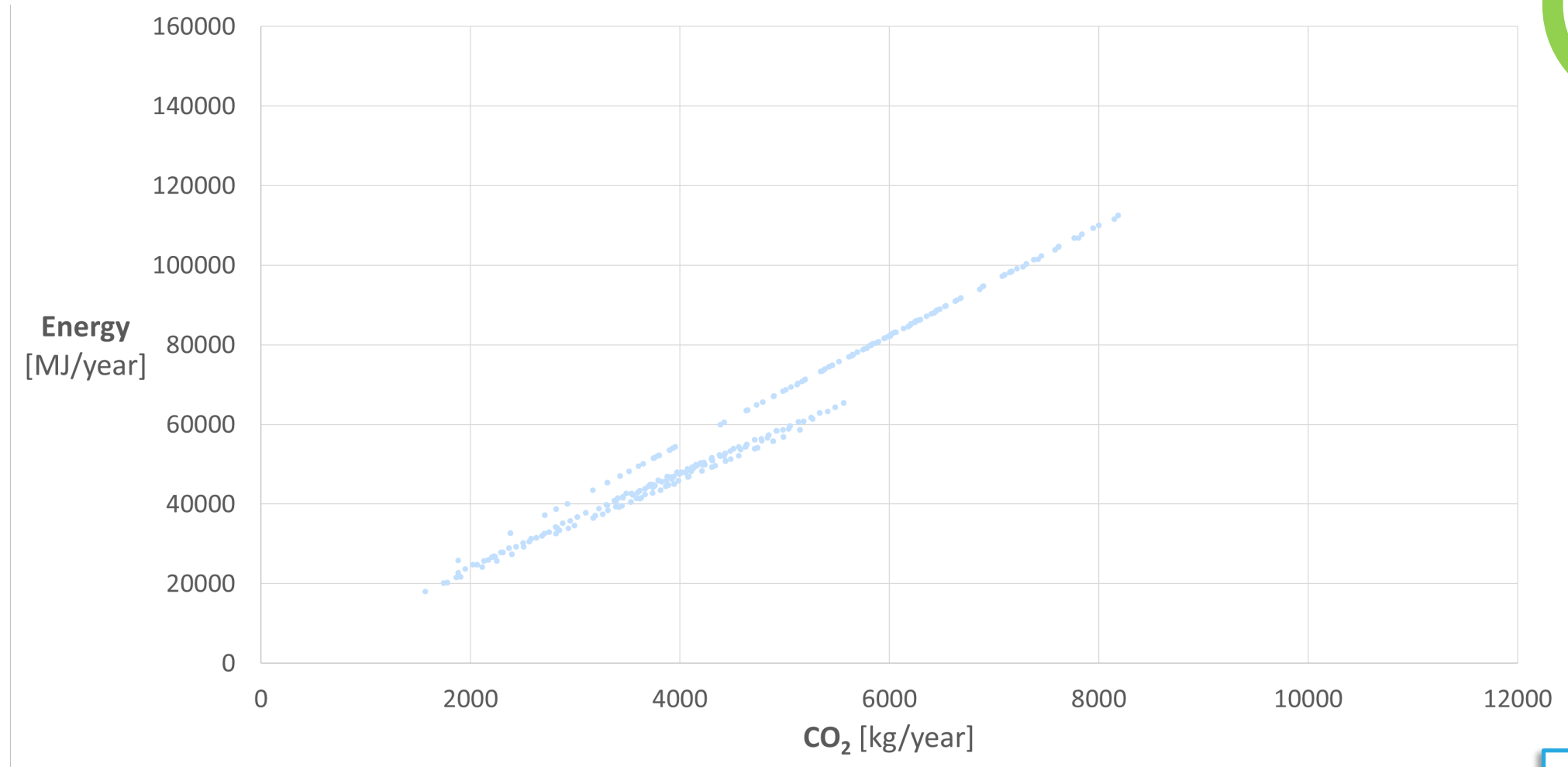

377
variations

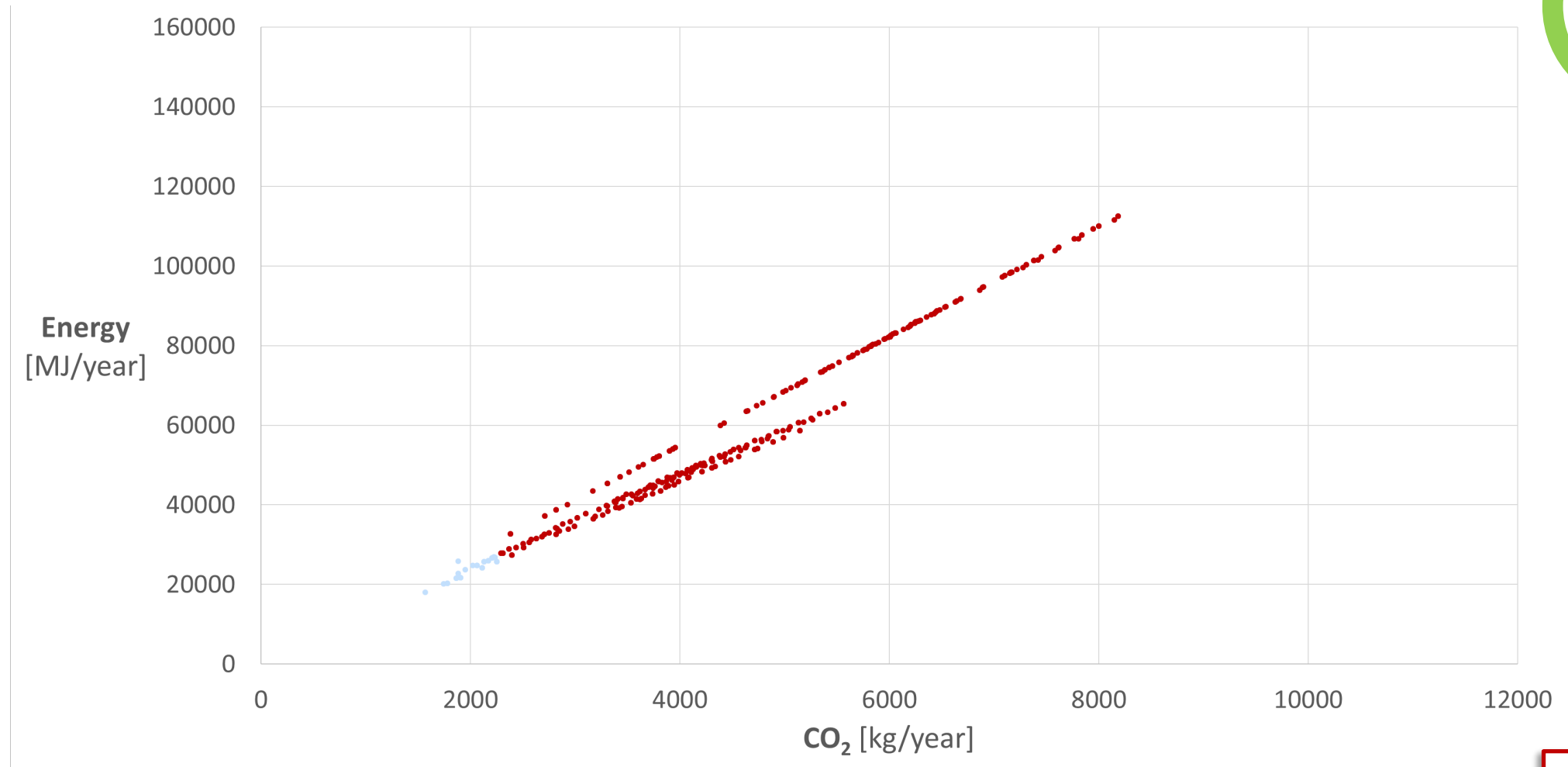

349 variations

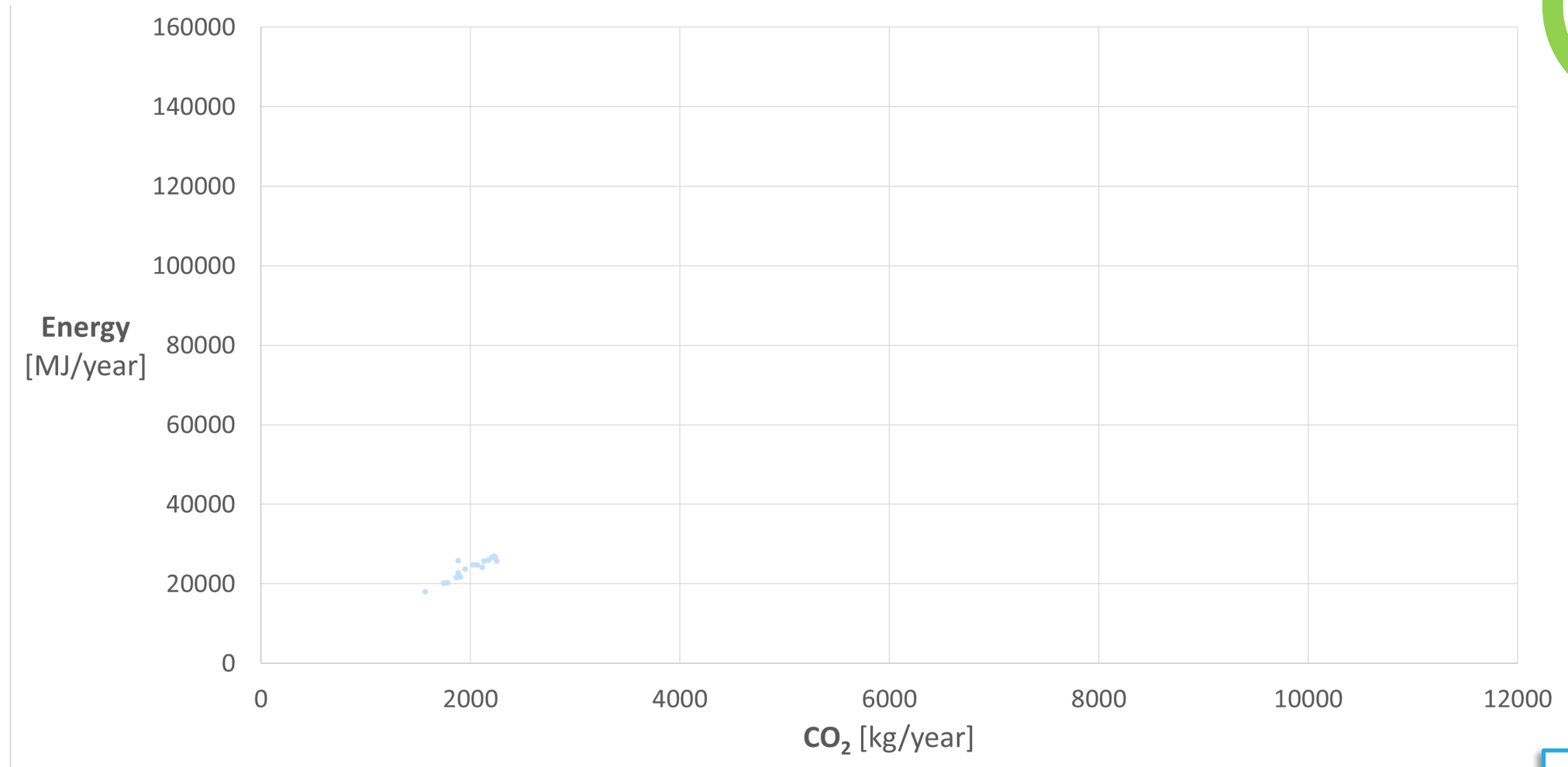

28 variations

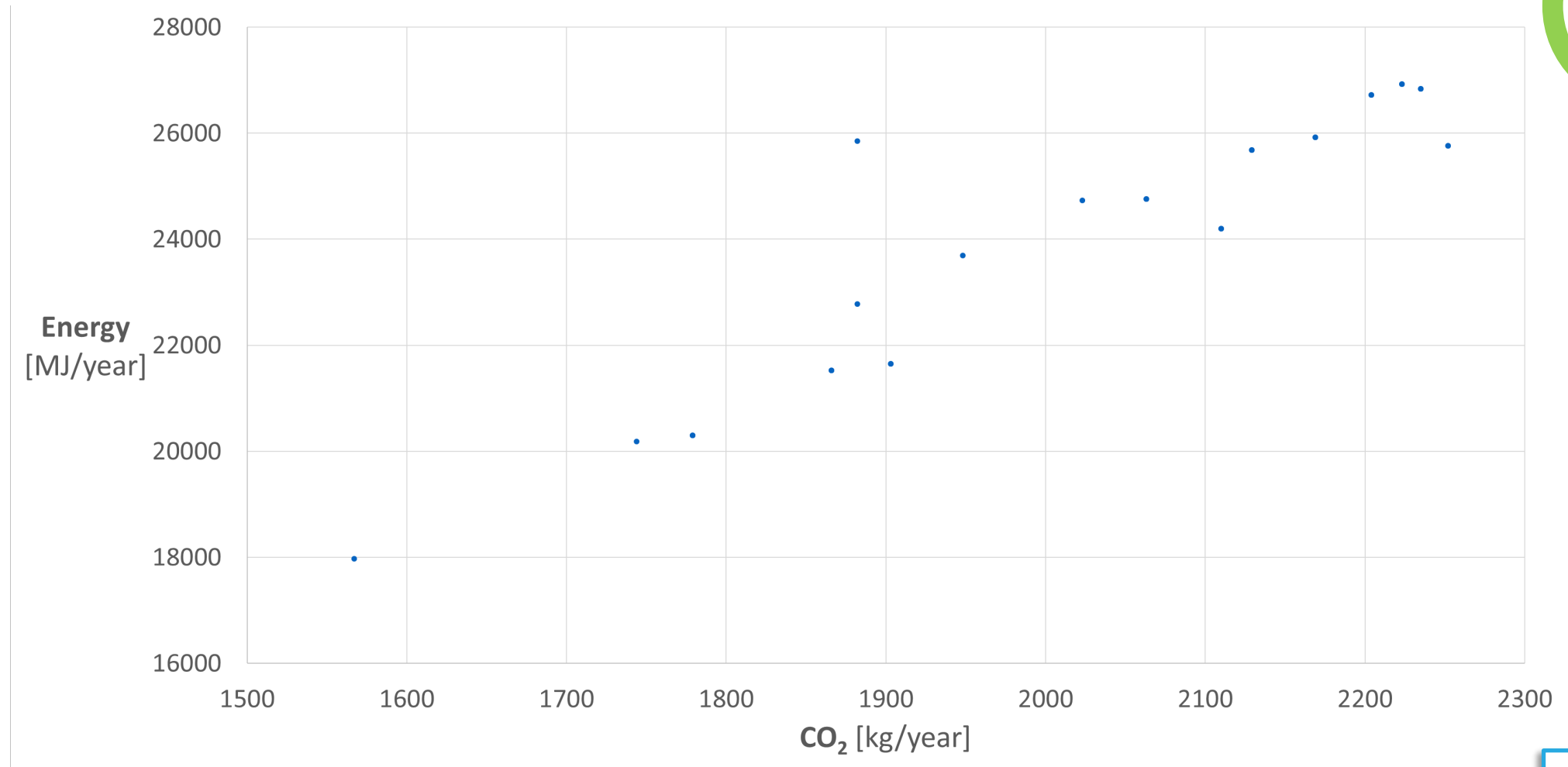

28 variations

aesthetical value
ranking



RANKING

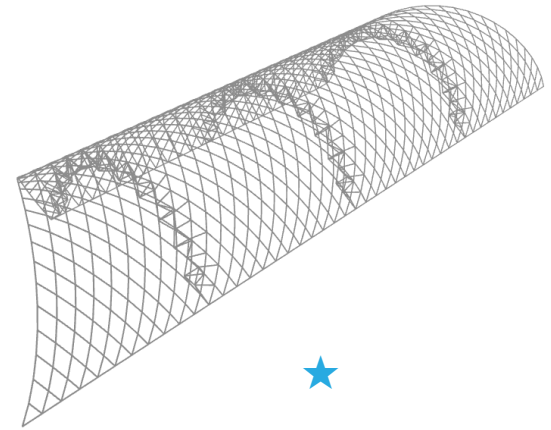
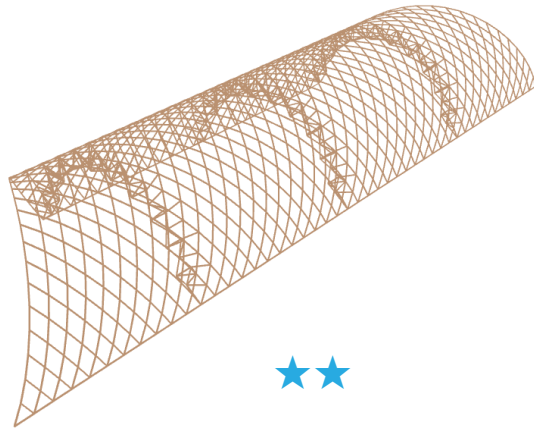
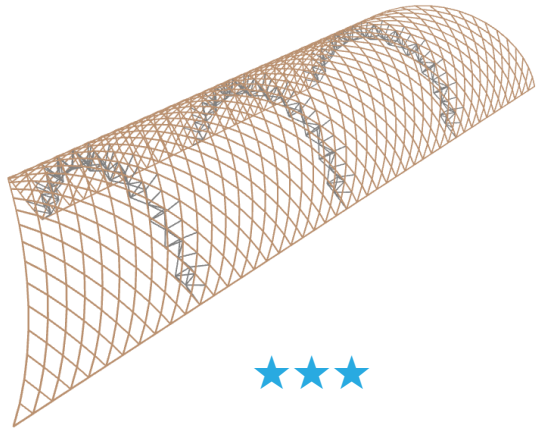
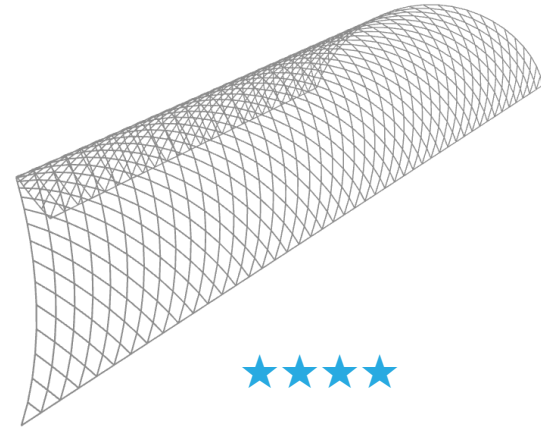
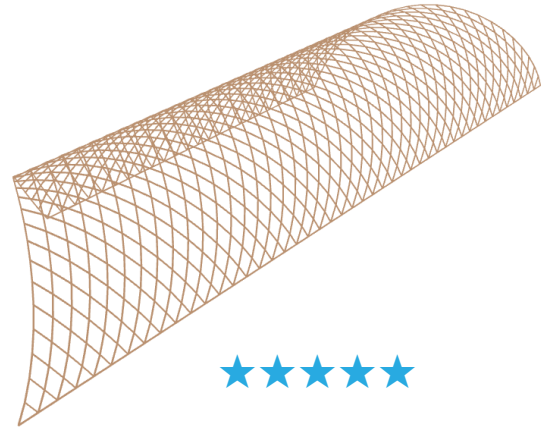

RANKING

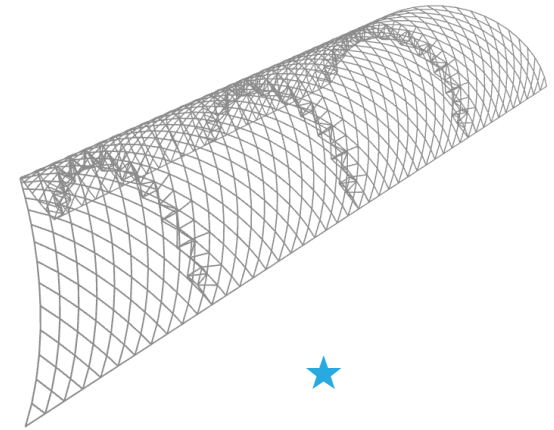
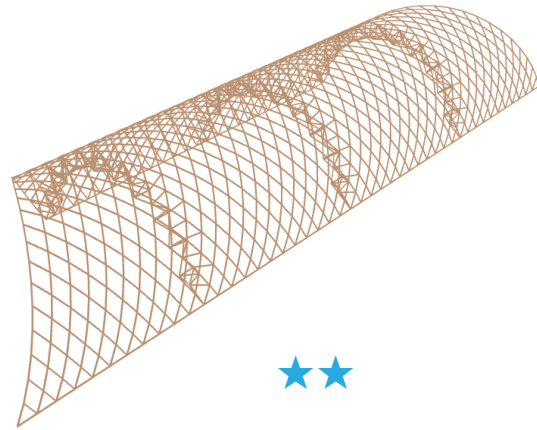
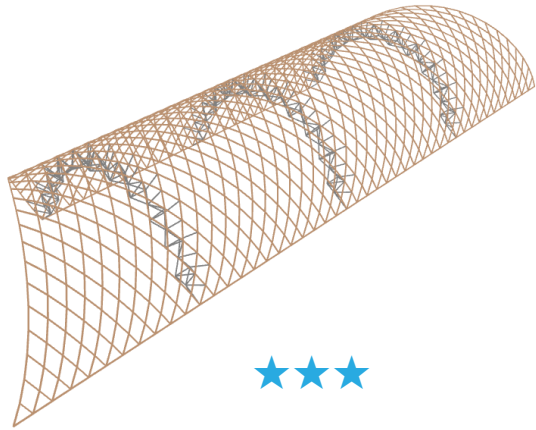
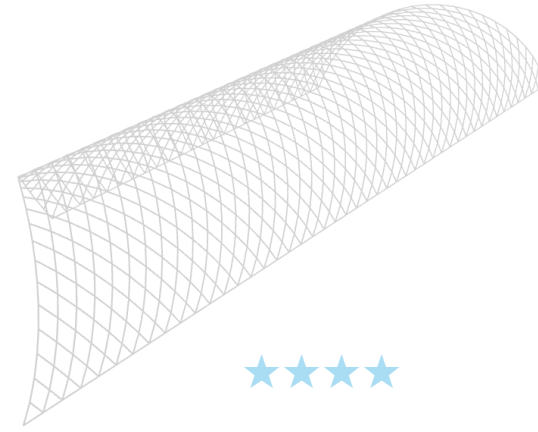
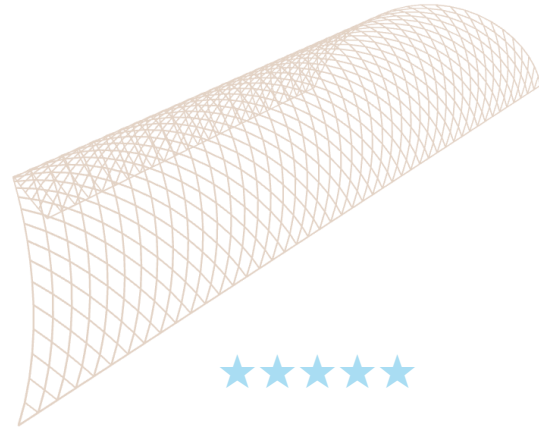

RANKING

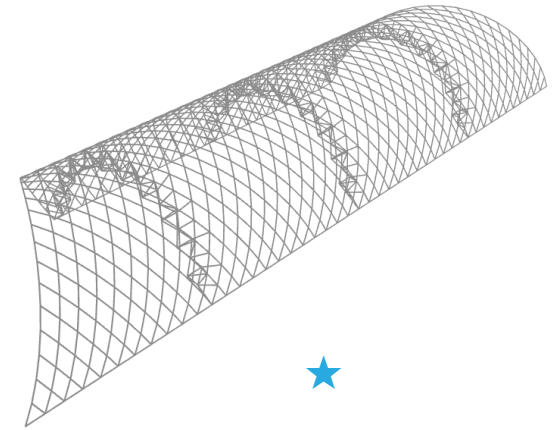
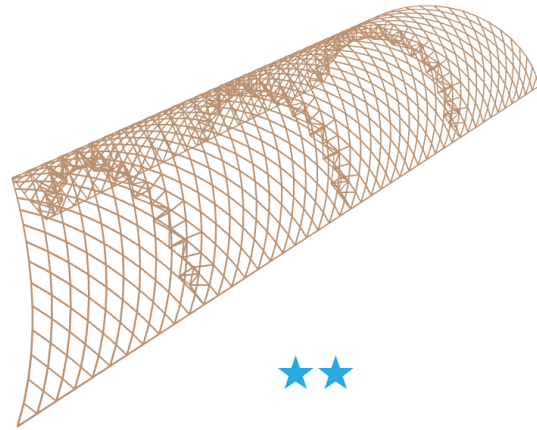
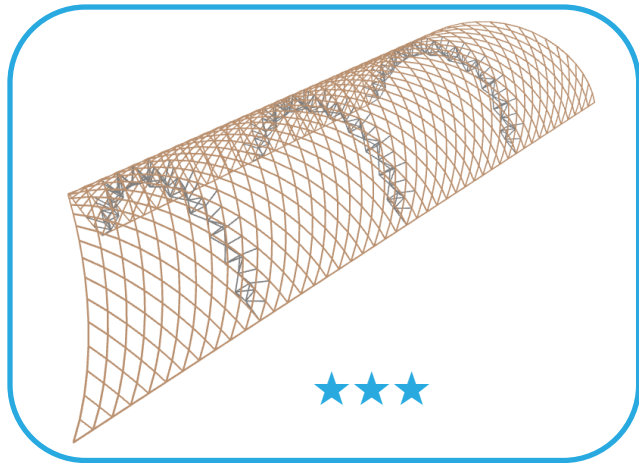
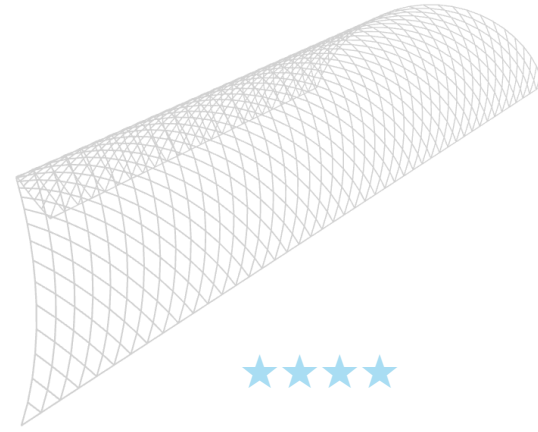
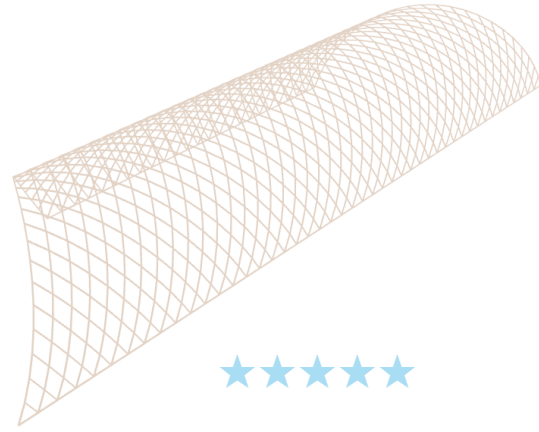

REMAINING MODELS

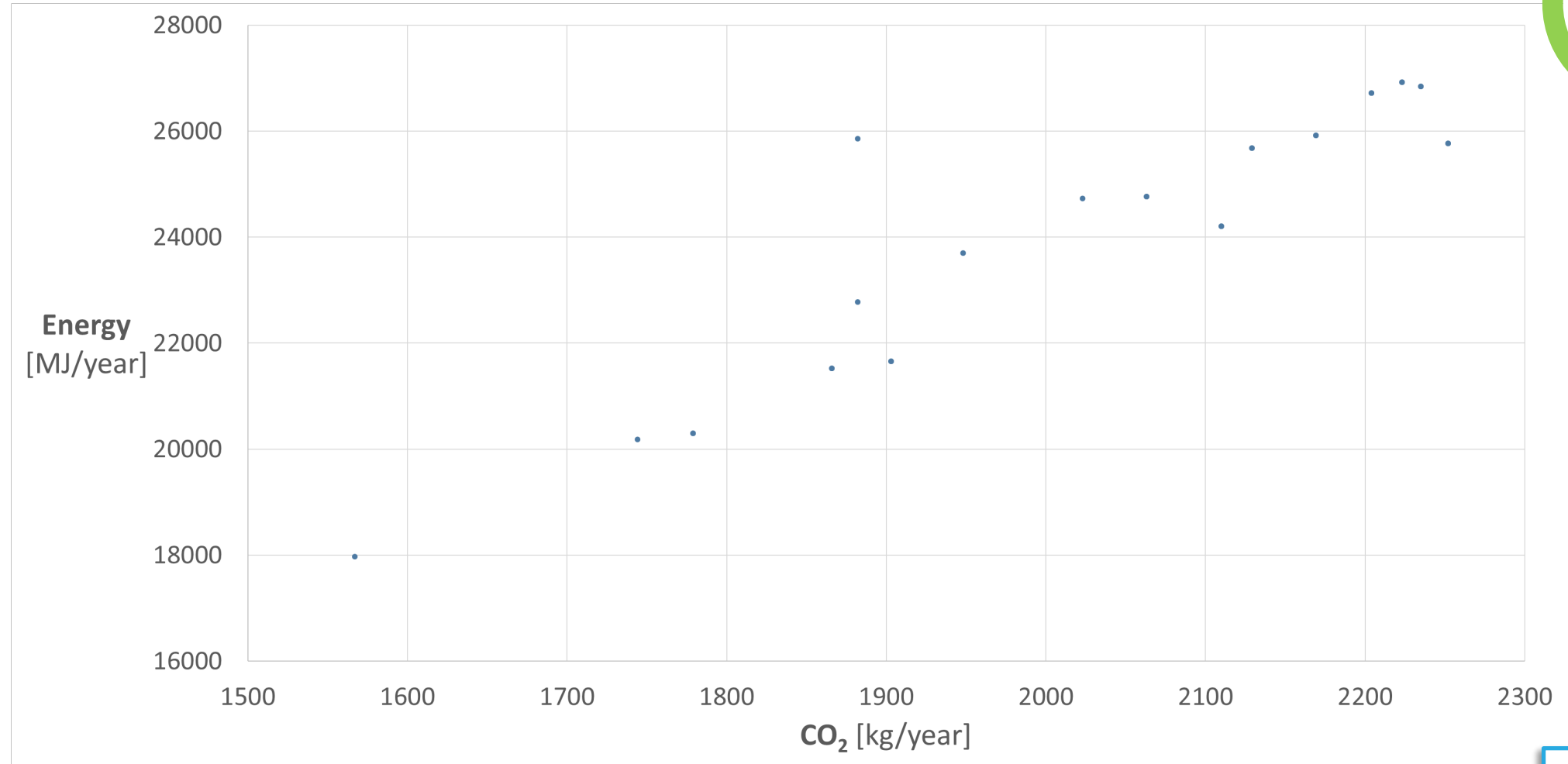

28 variations

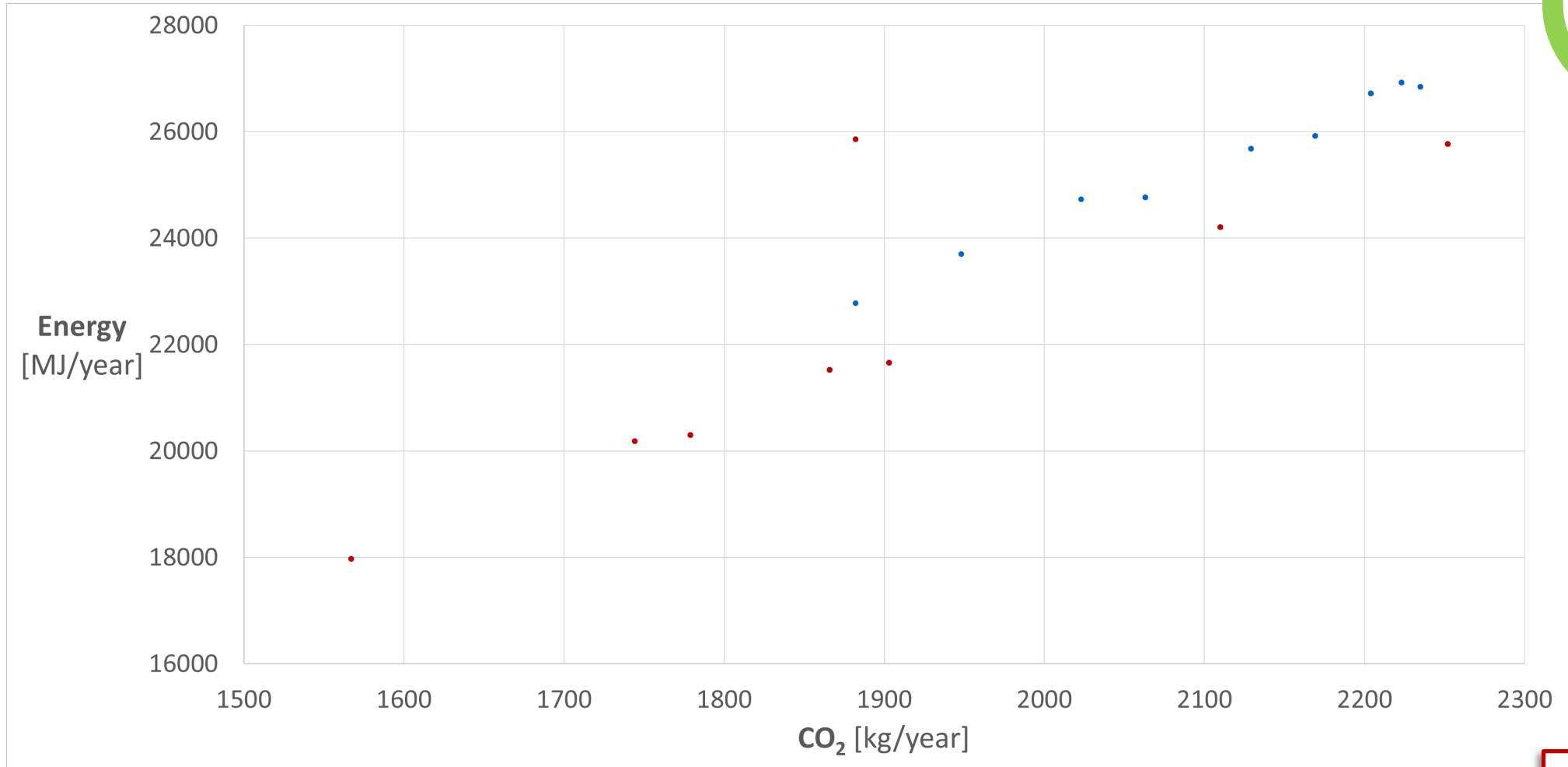

13 variations

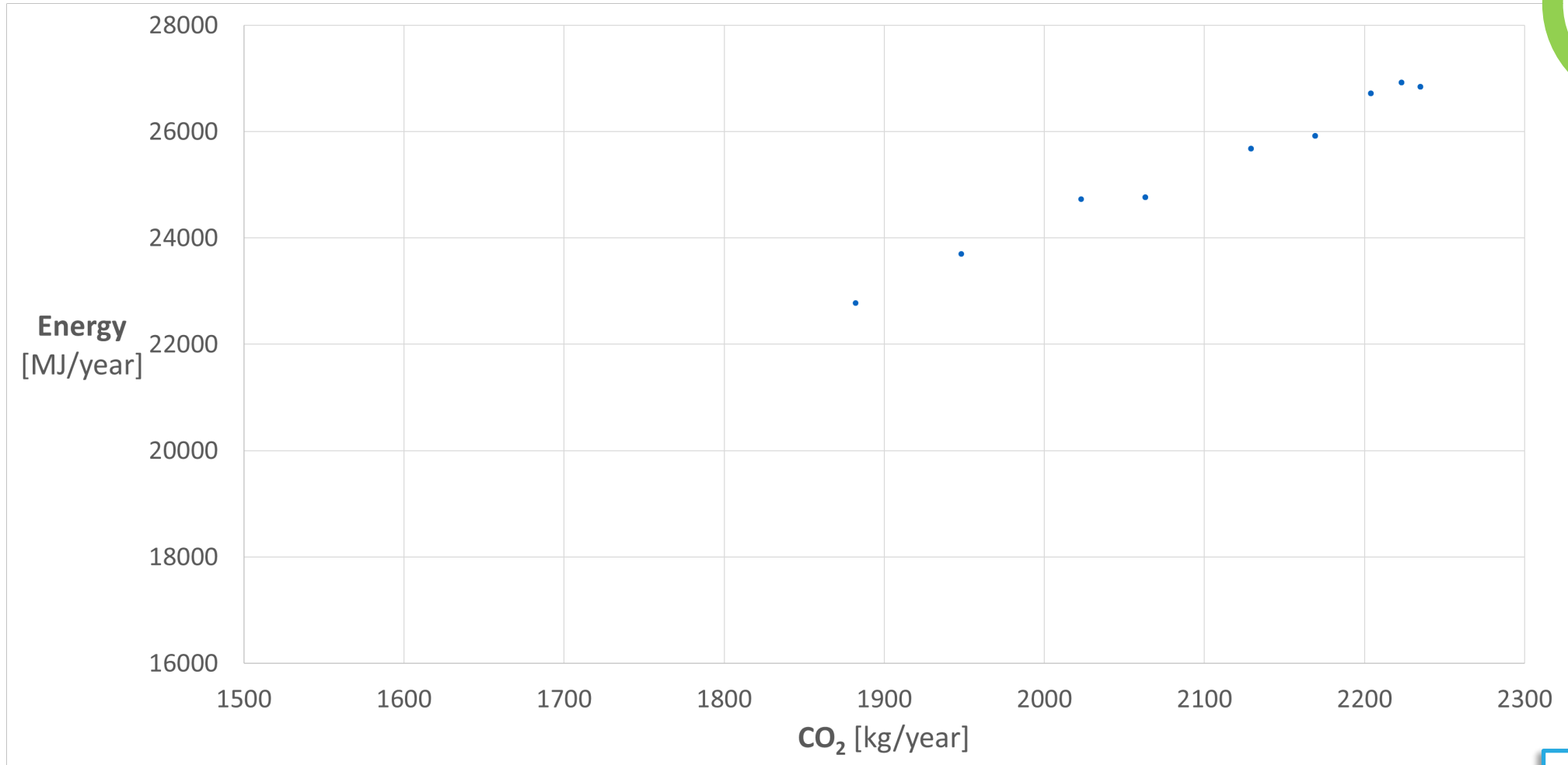

15 variations

REMAINING MODELS

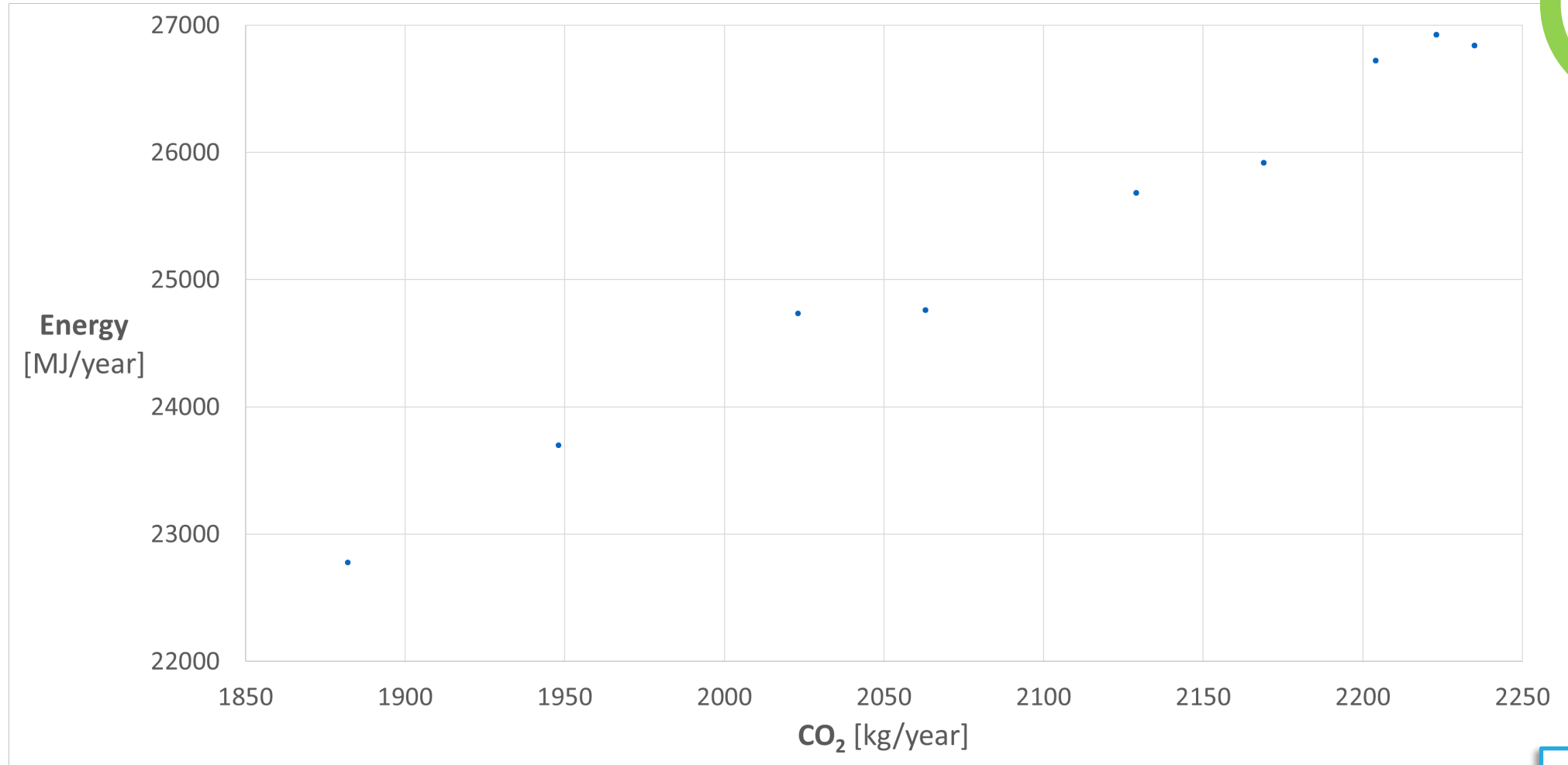

15 variations

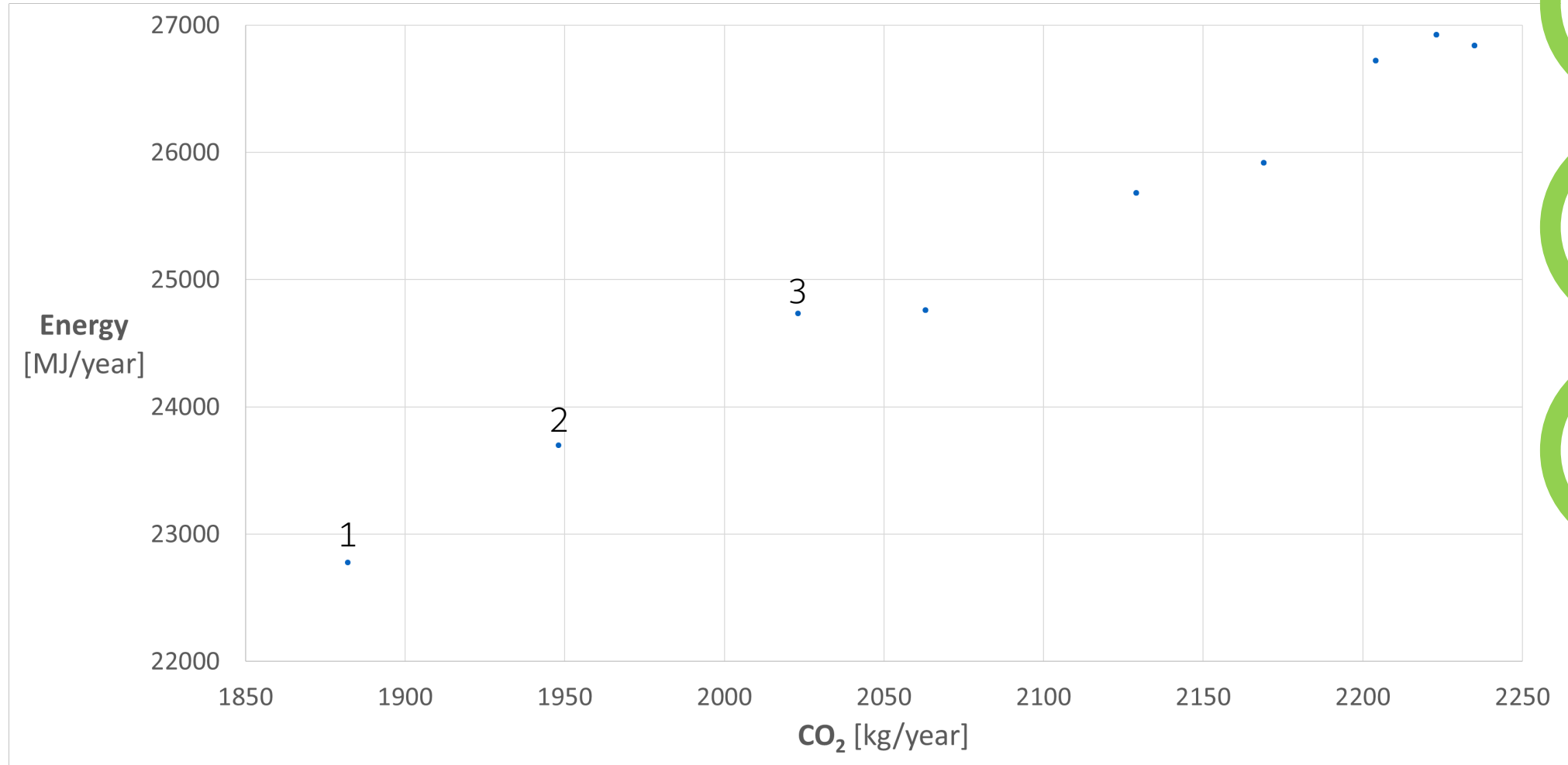

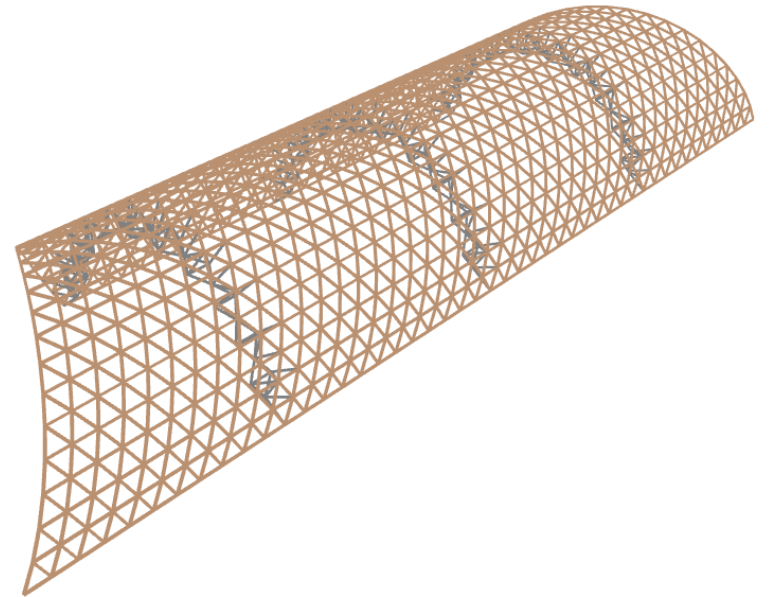
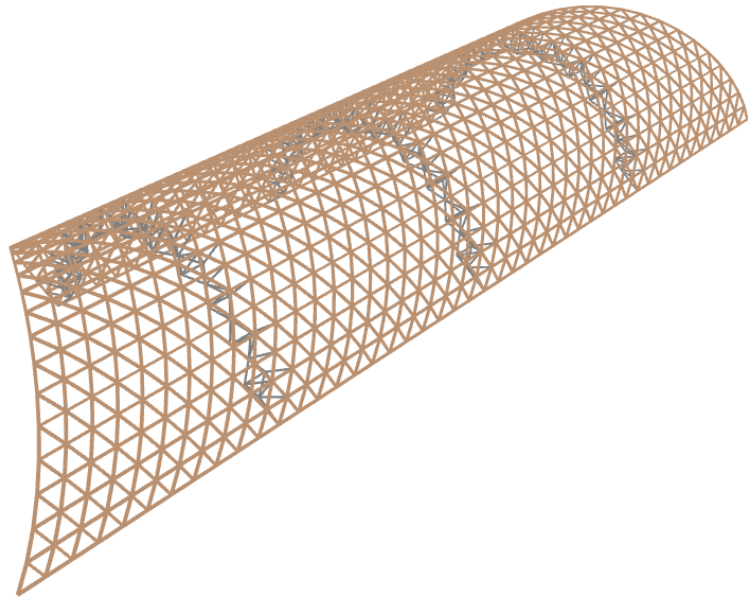
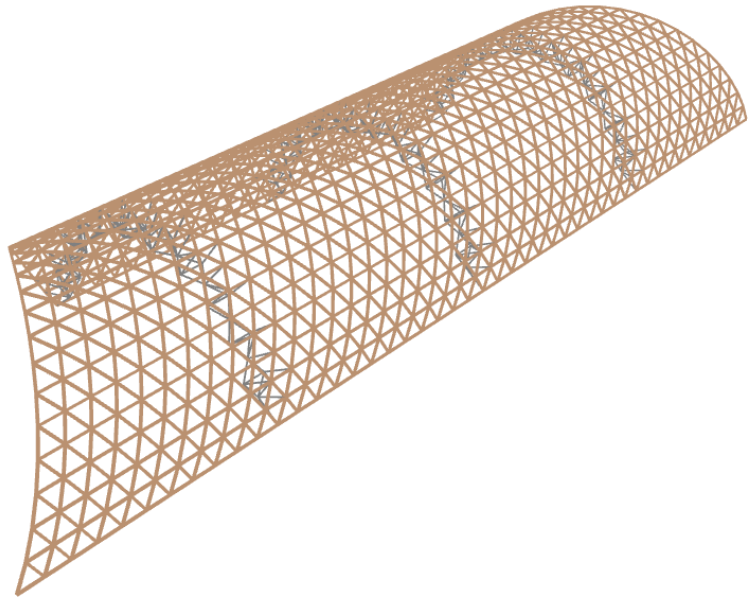

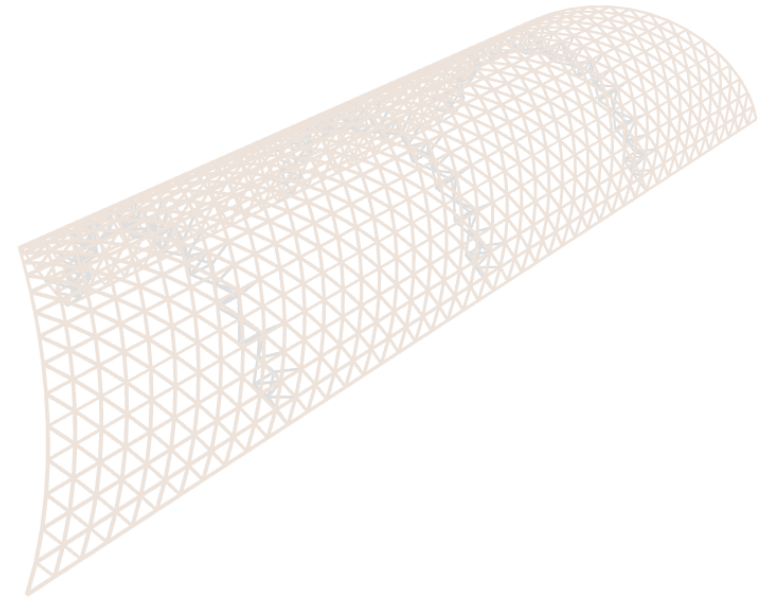
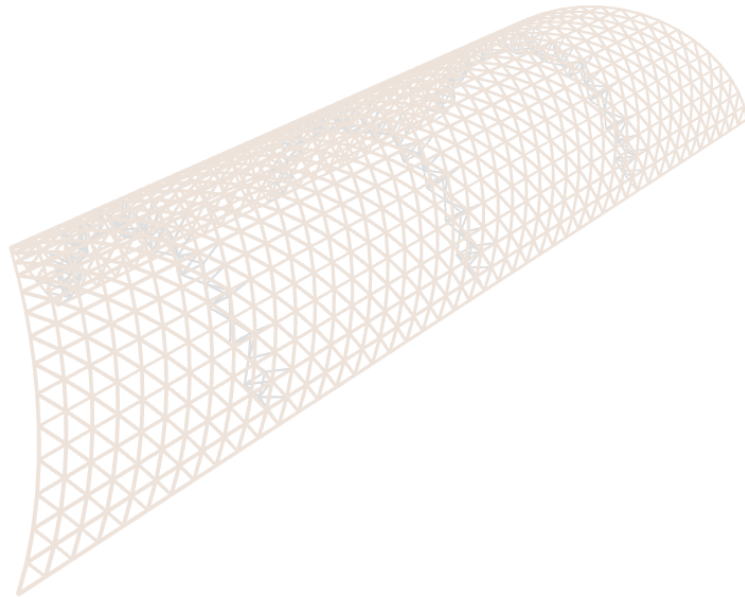
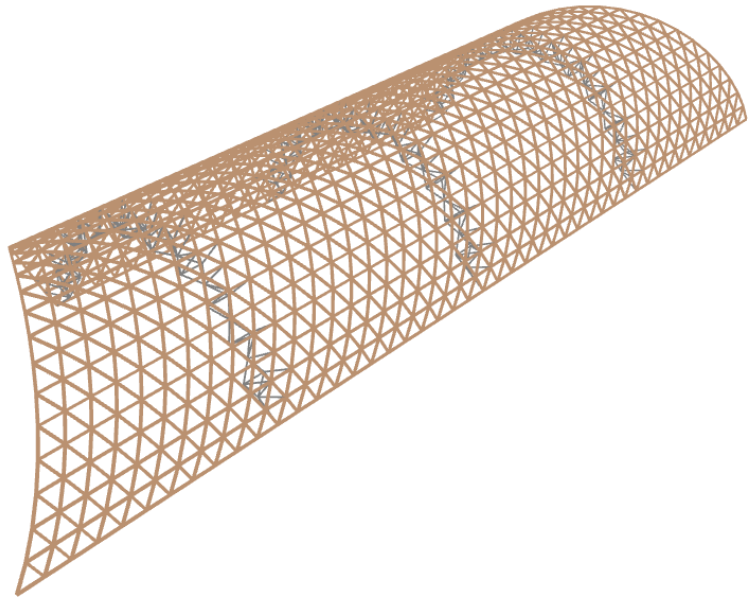

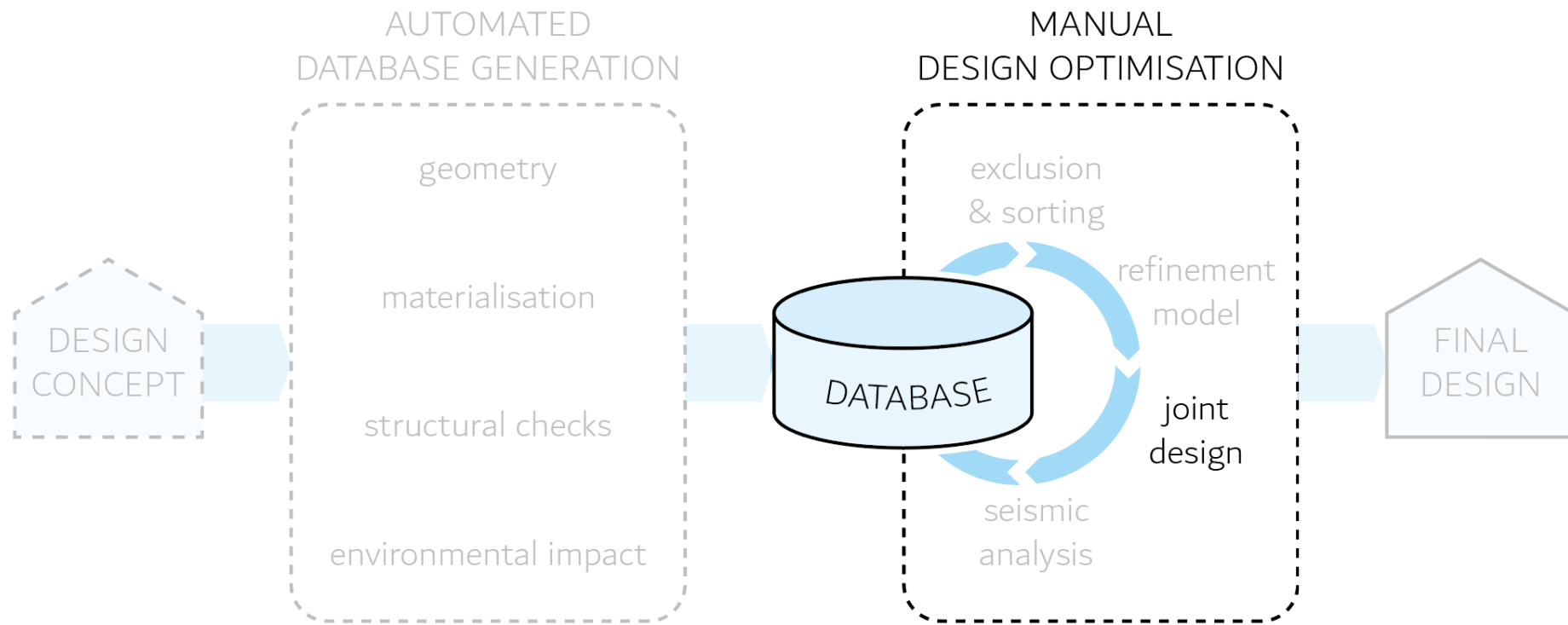

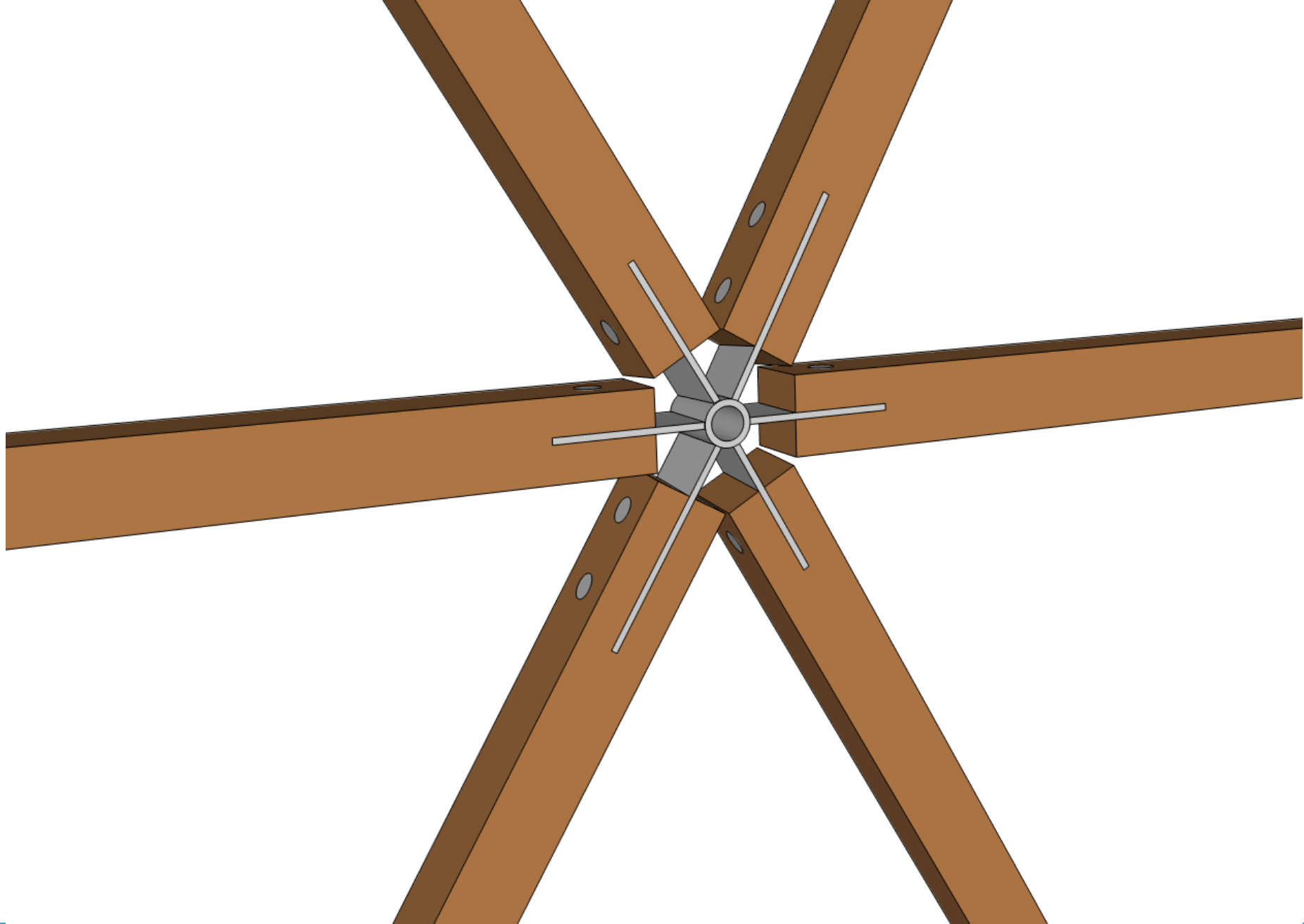

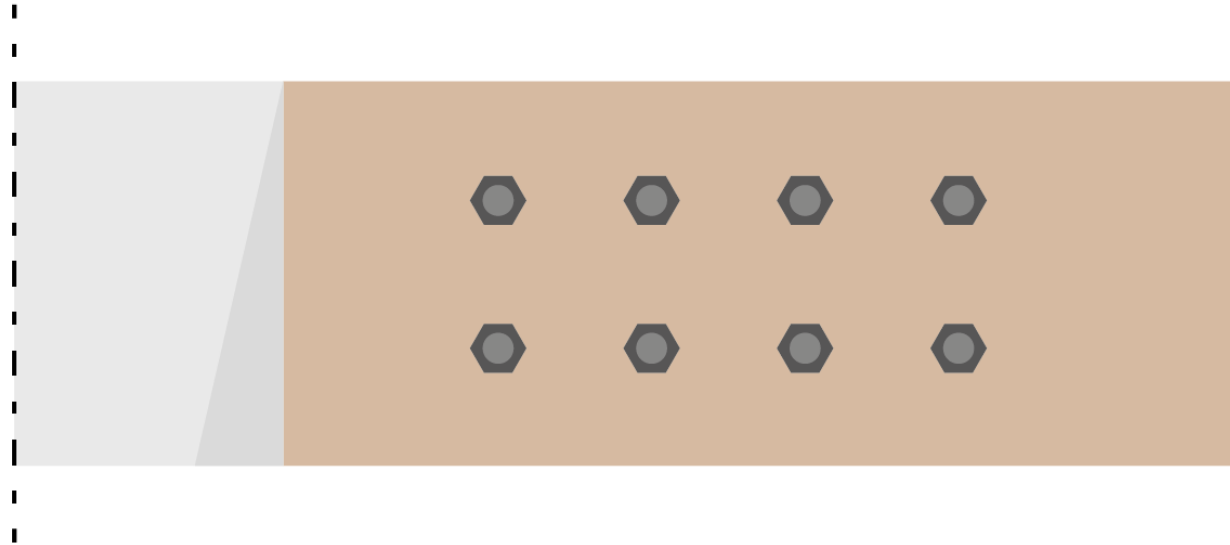

JOINT CHECKS

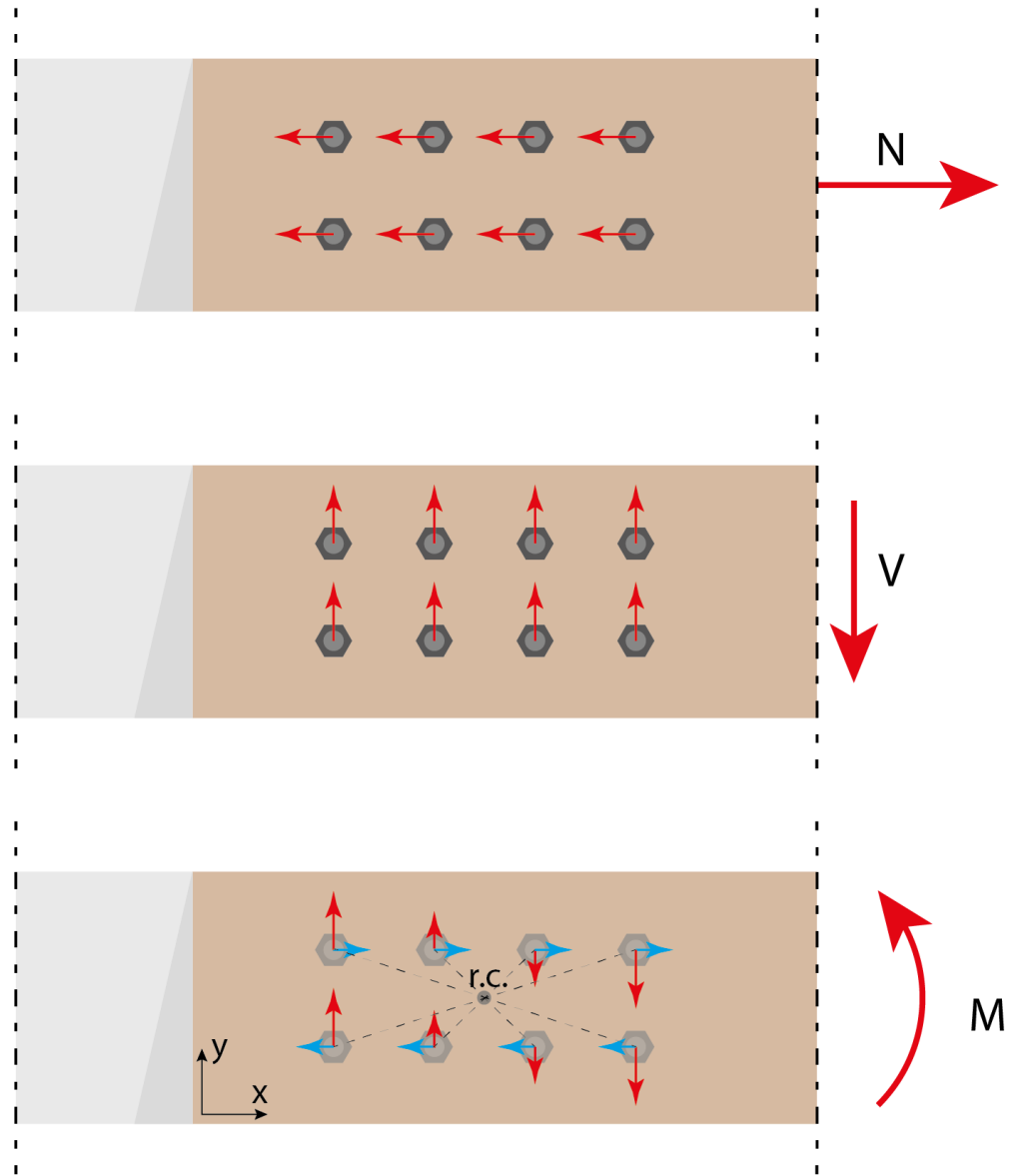

TOP 1

O.K.

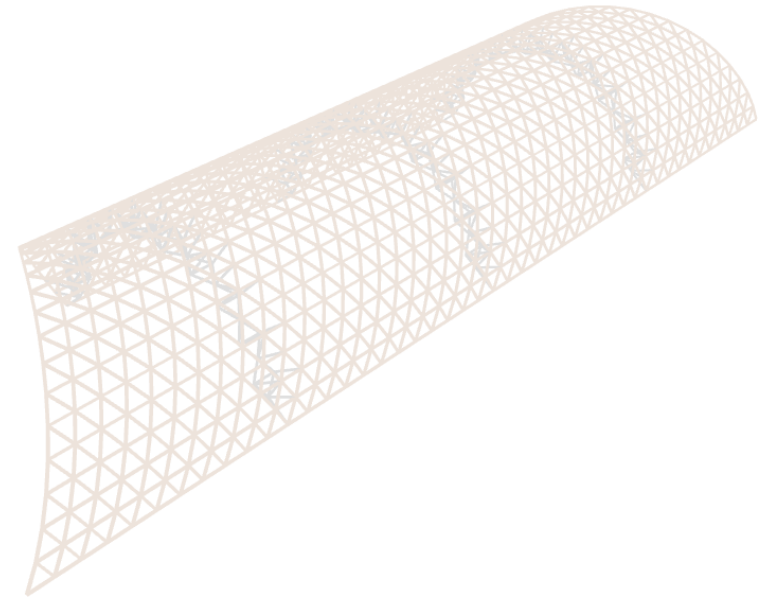
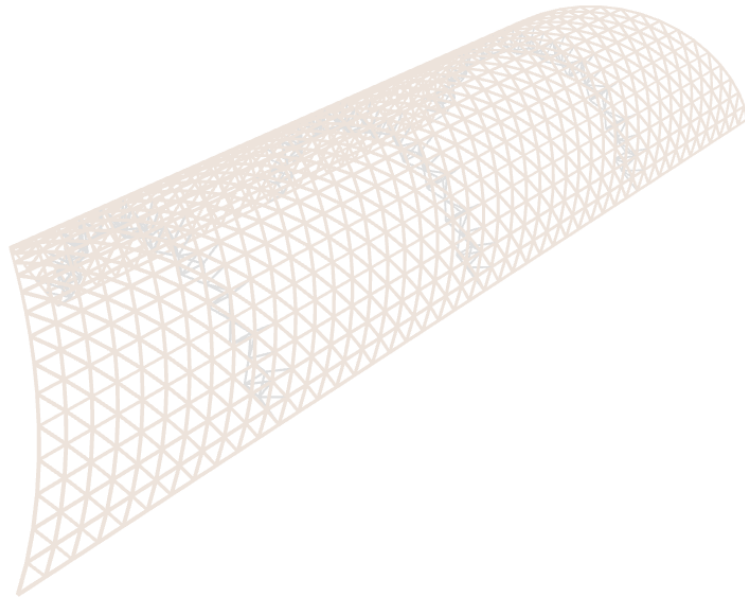
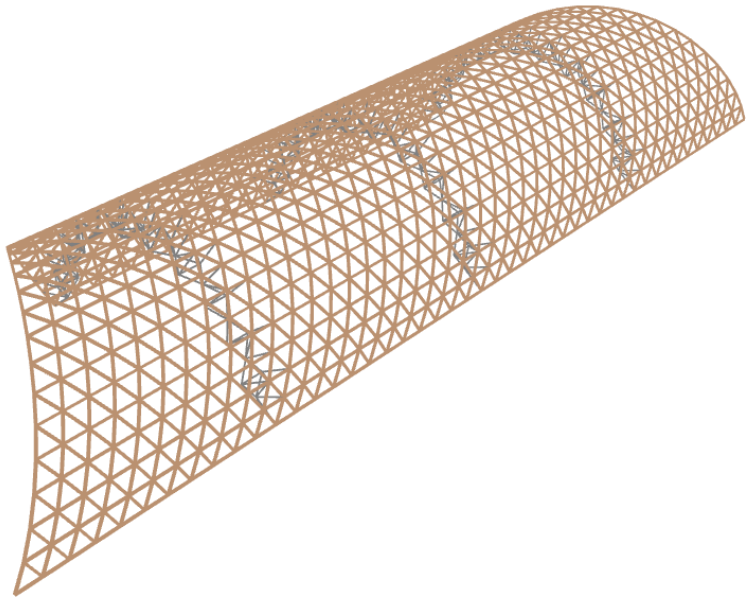

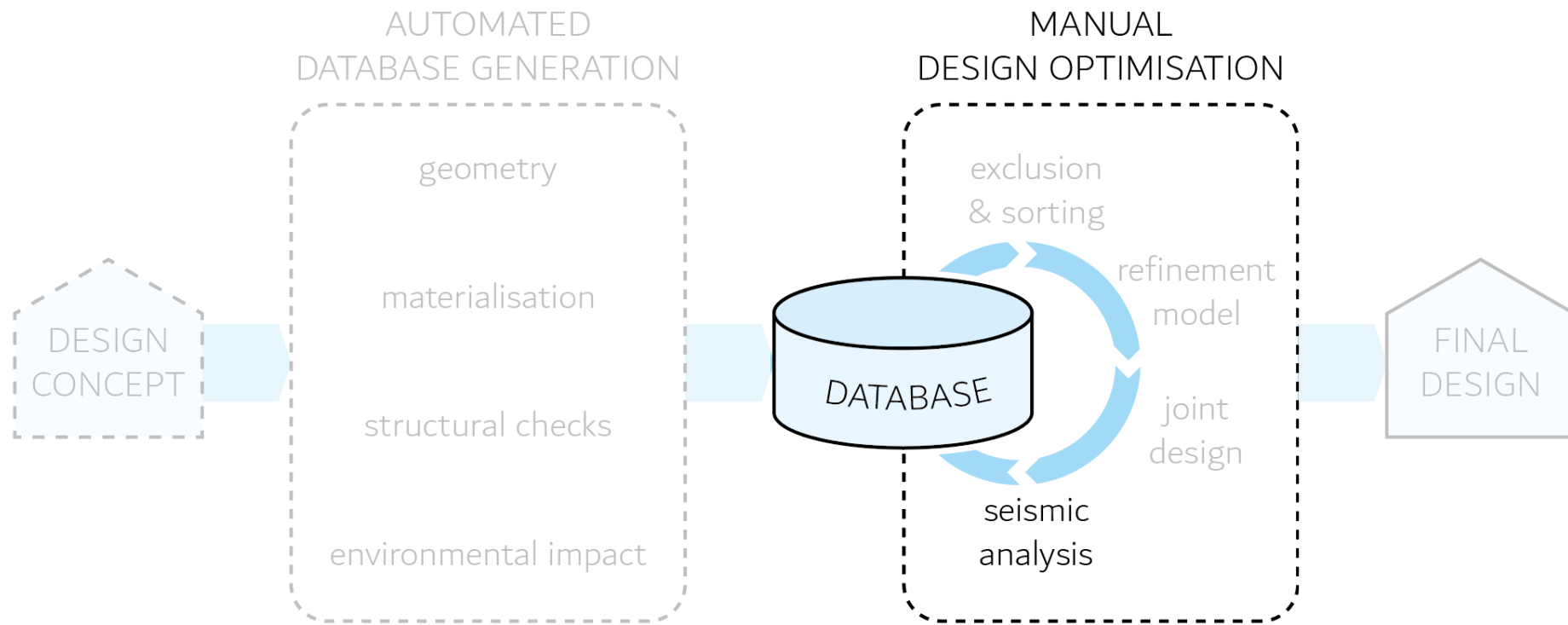



$$F = m \cdot a$$

force = mass · acceleration

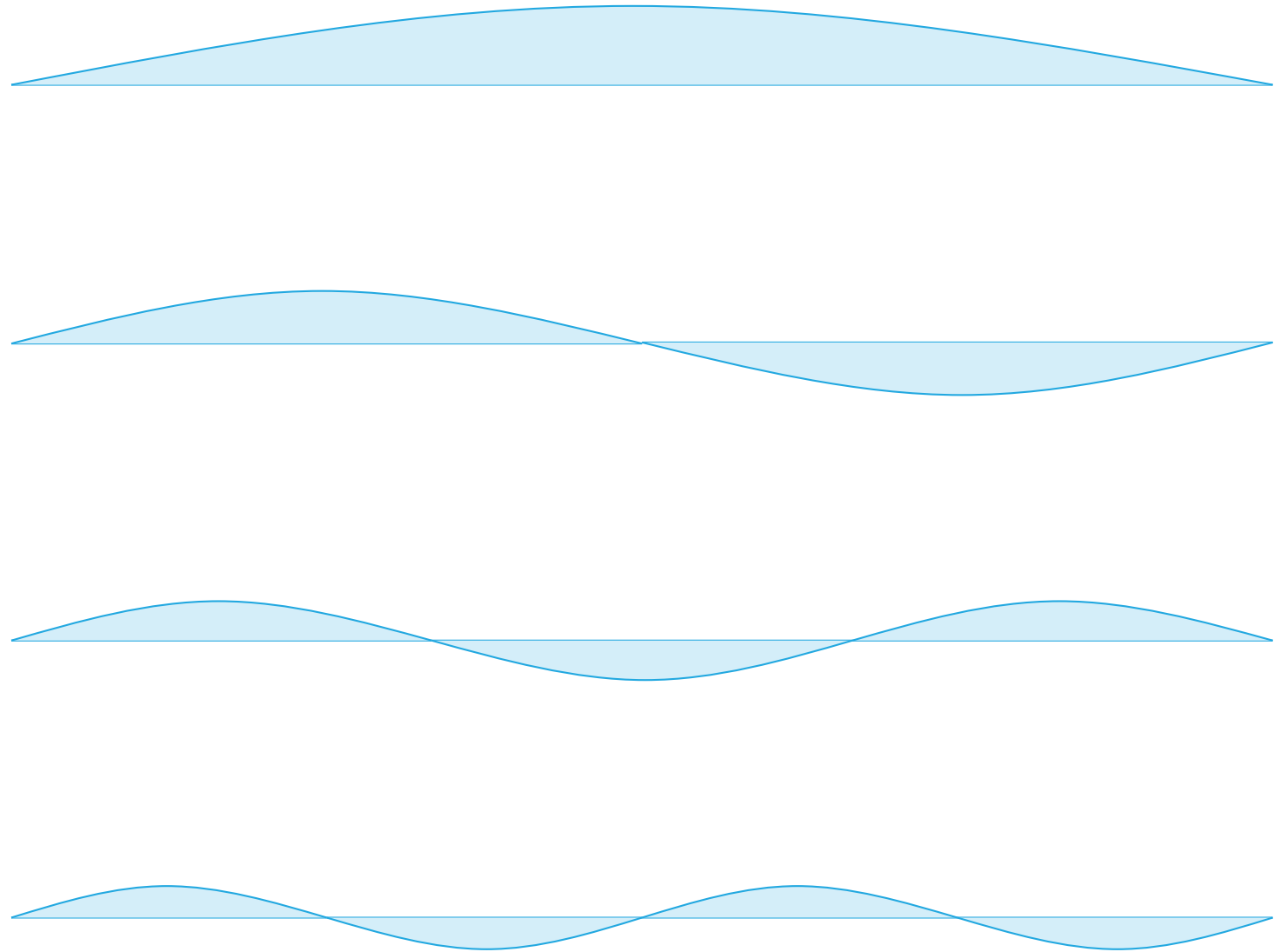

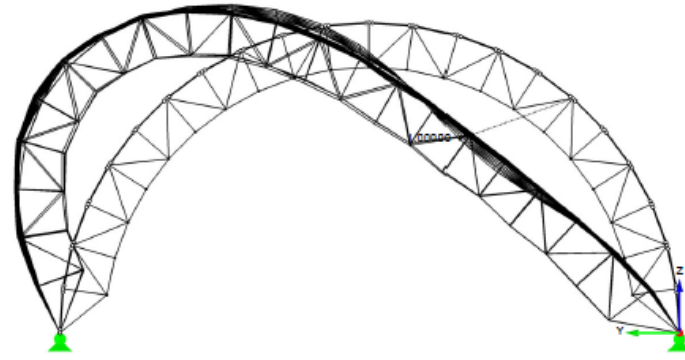

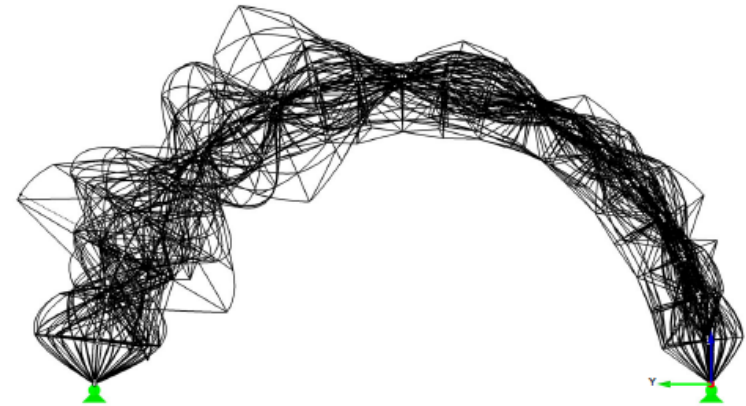
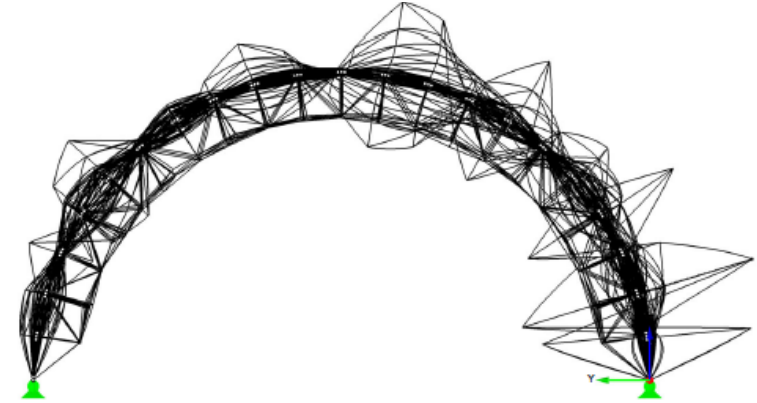
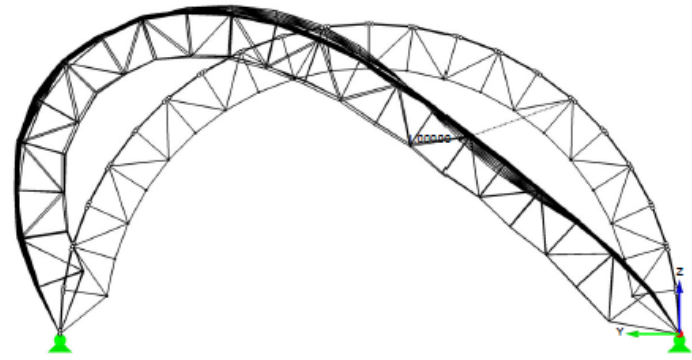



$$F = m \cdot a$$

force = mass · acceleration

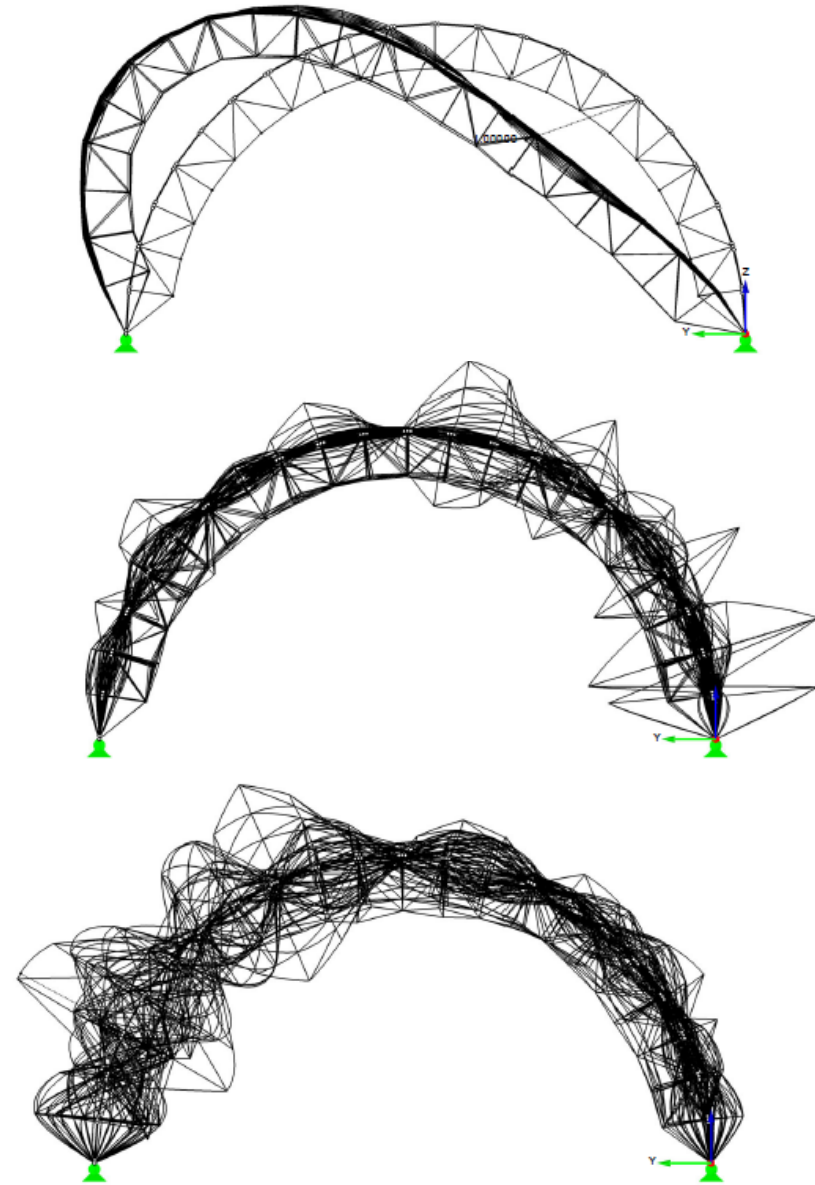
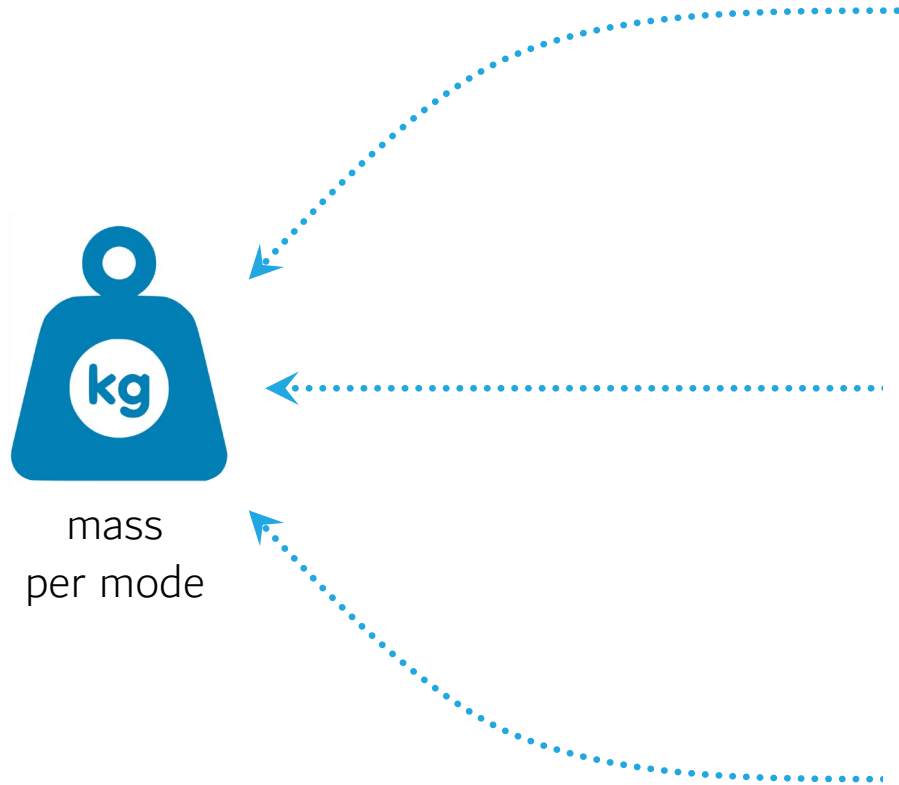



$$F = m \cdot a$$

force = mass · acceleration

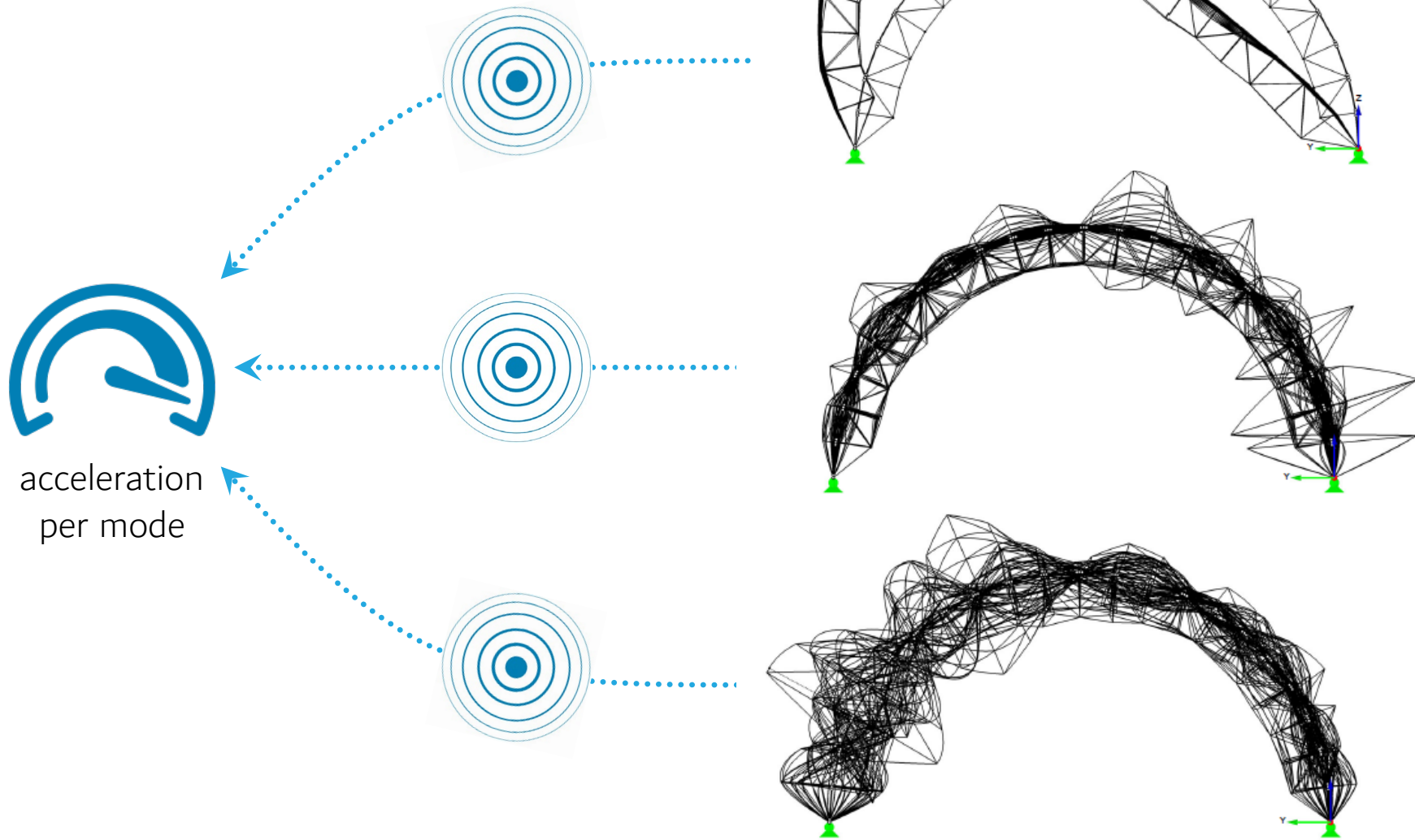



$$F = m \cdot a$$

force = mass · acceleration

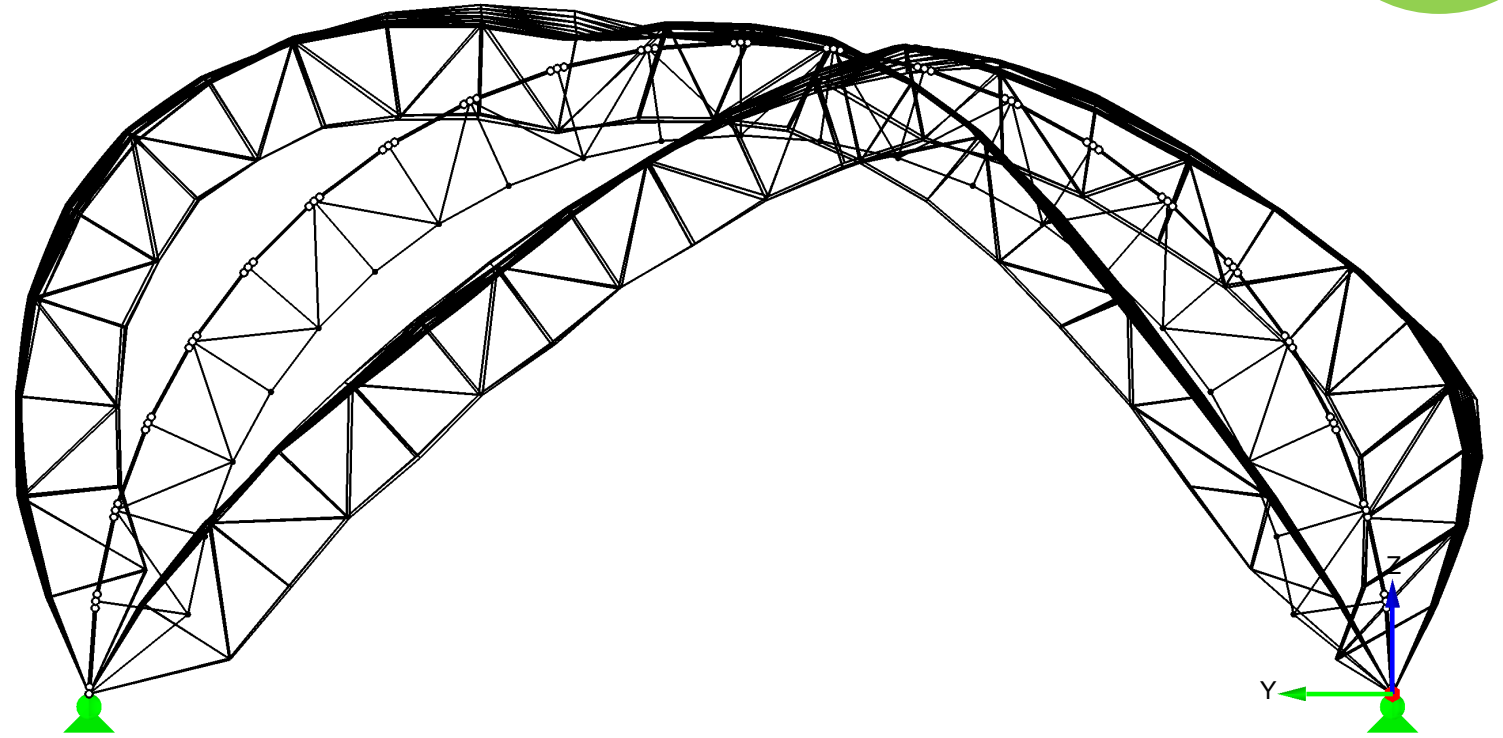

TOP 1

O.K.

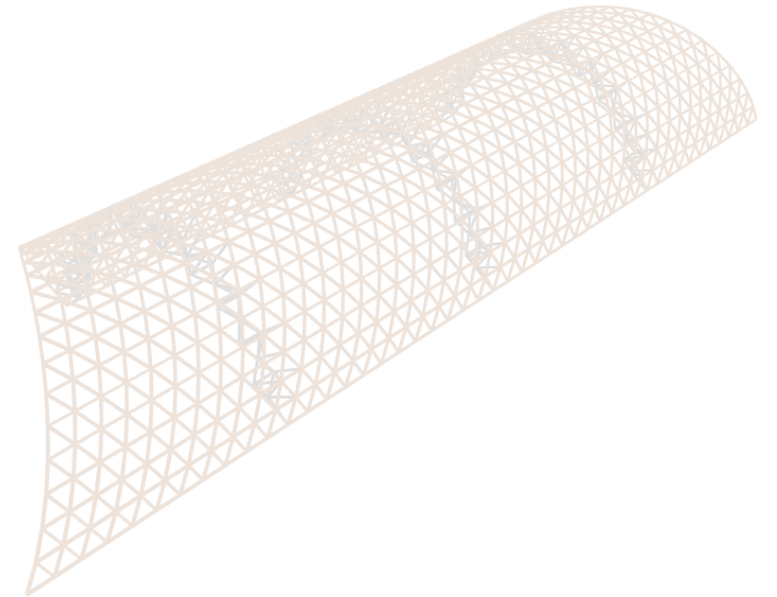
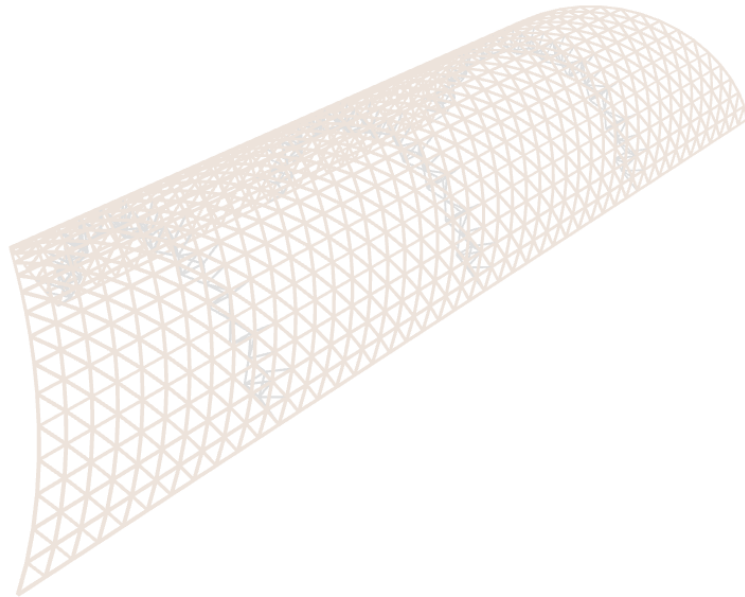
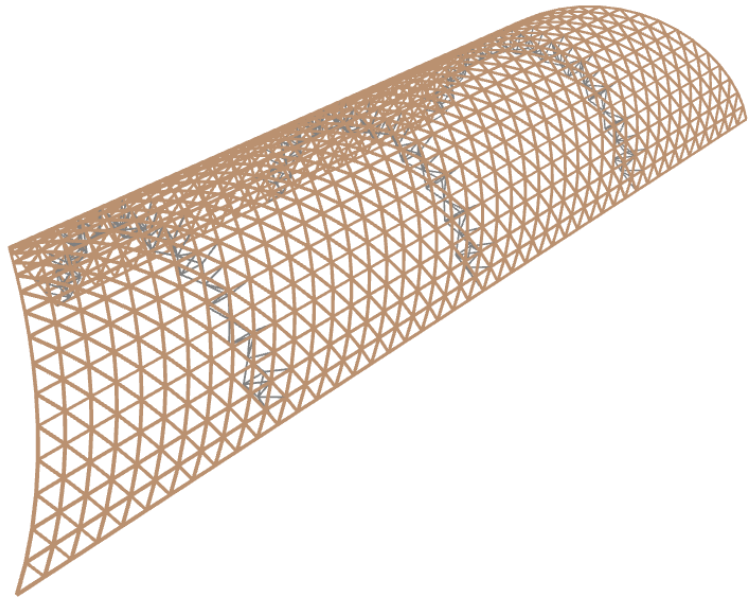

CONCLUSION

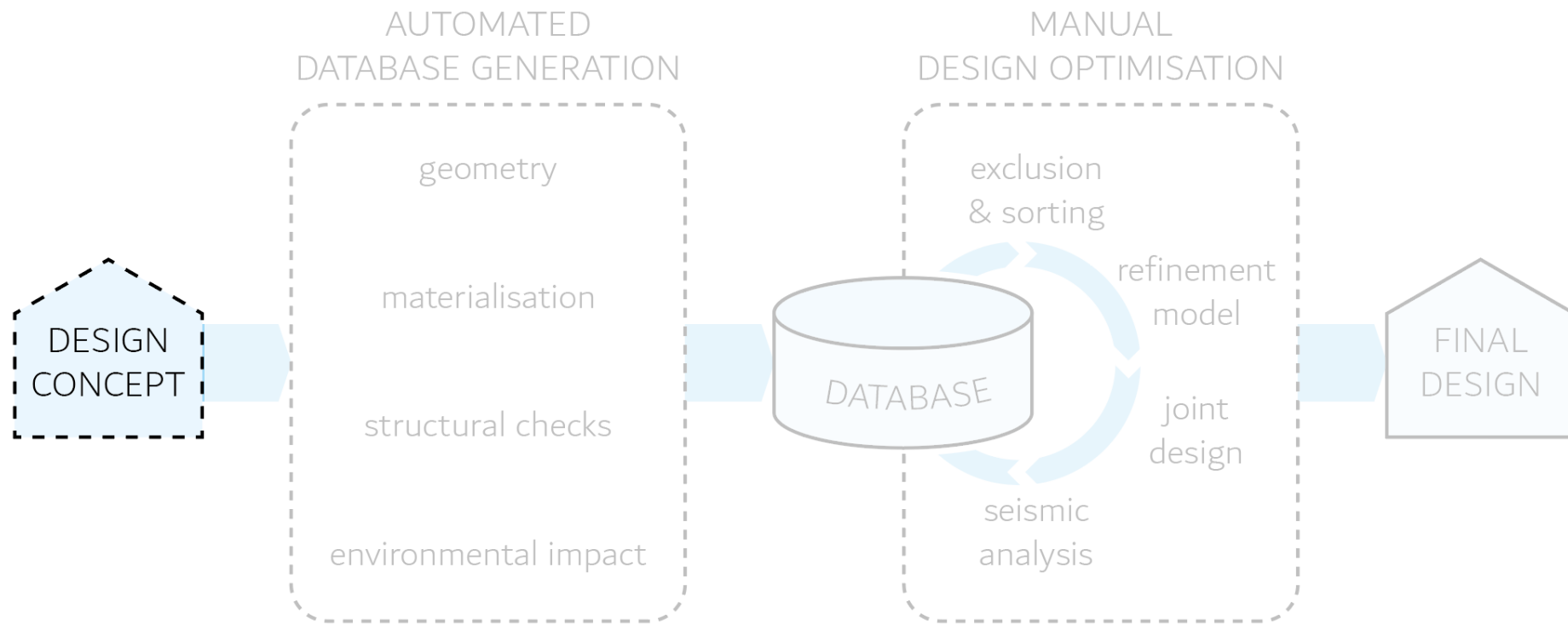

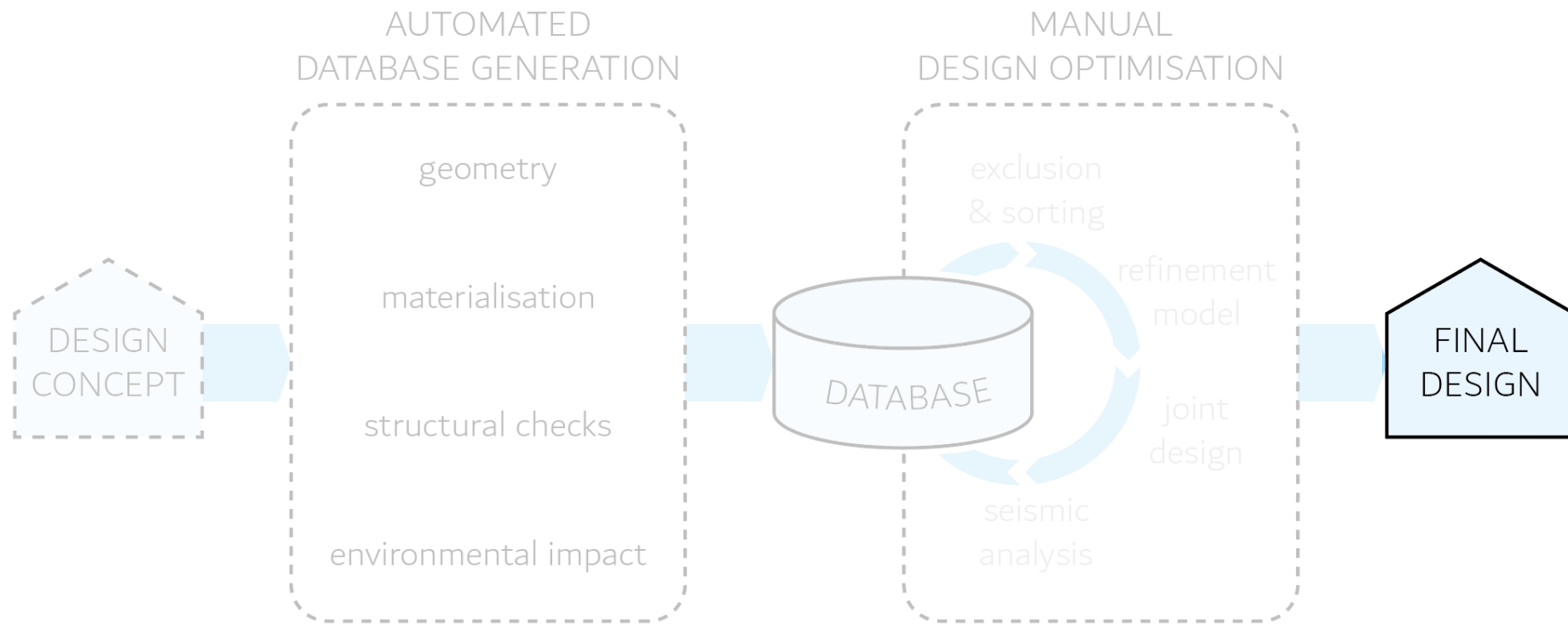

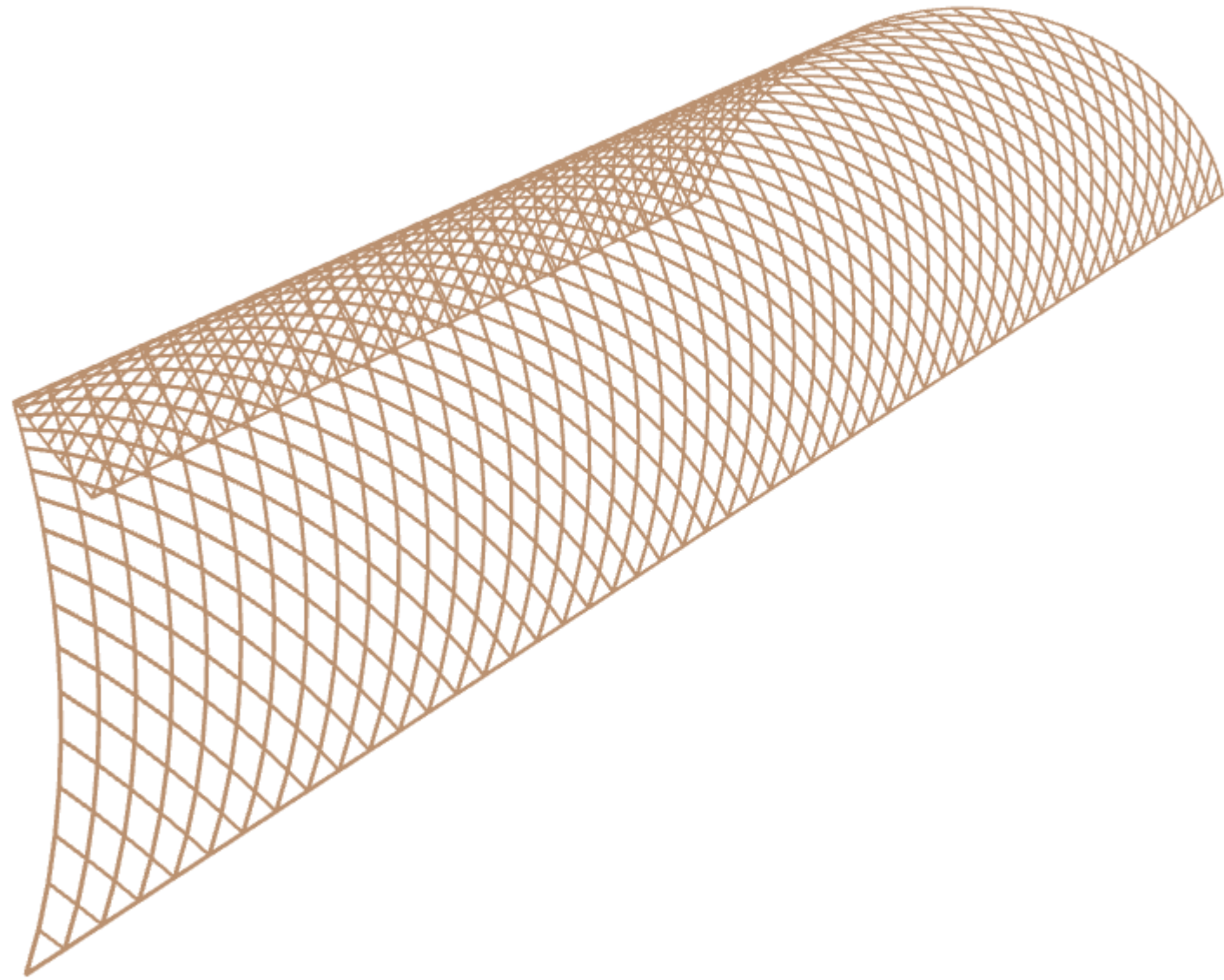

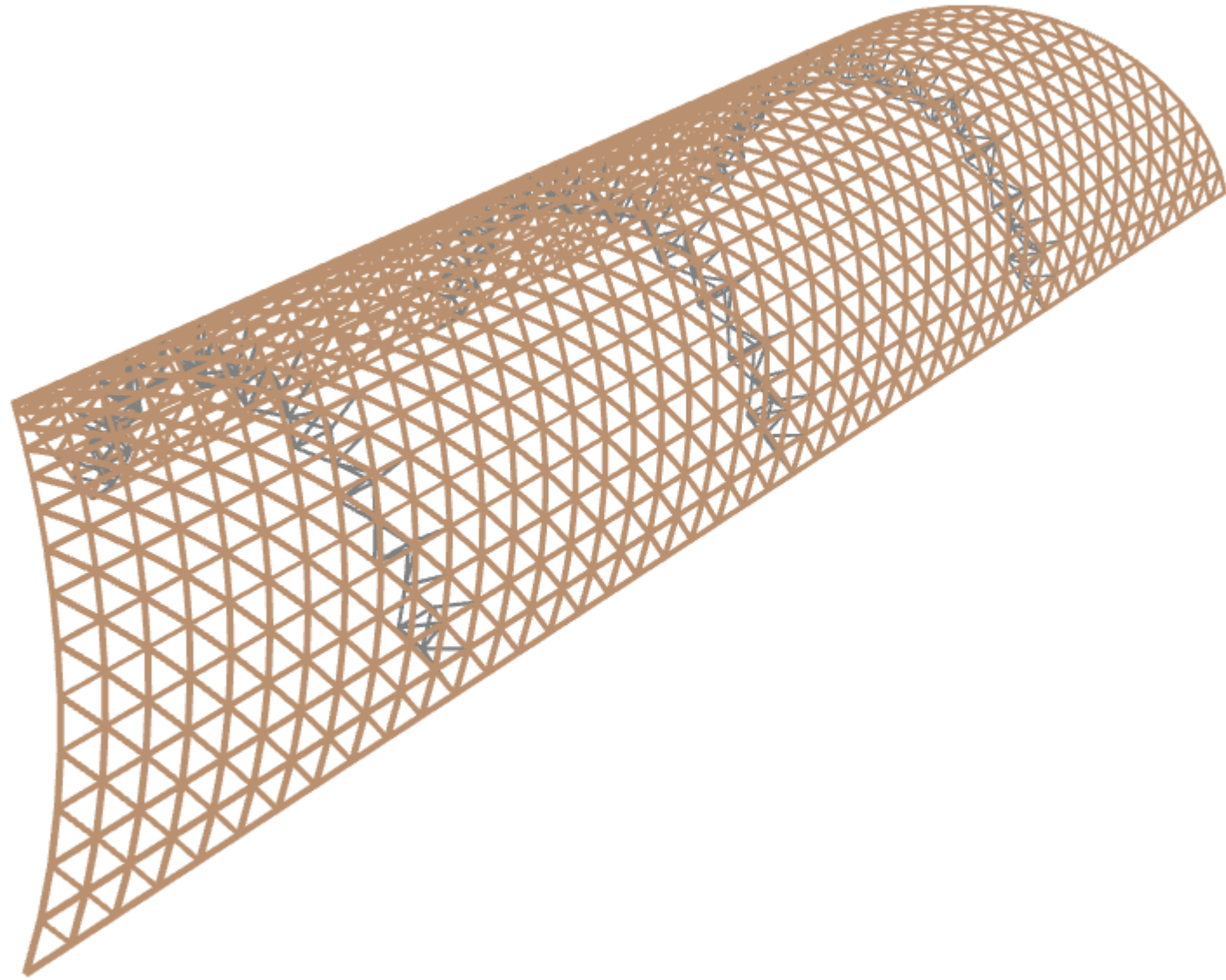

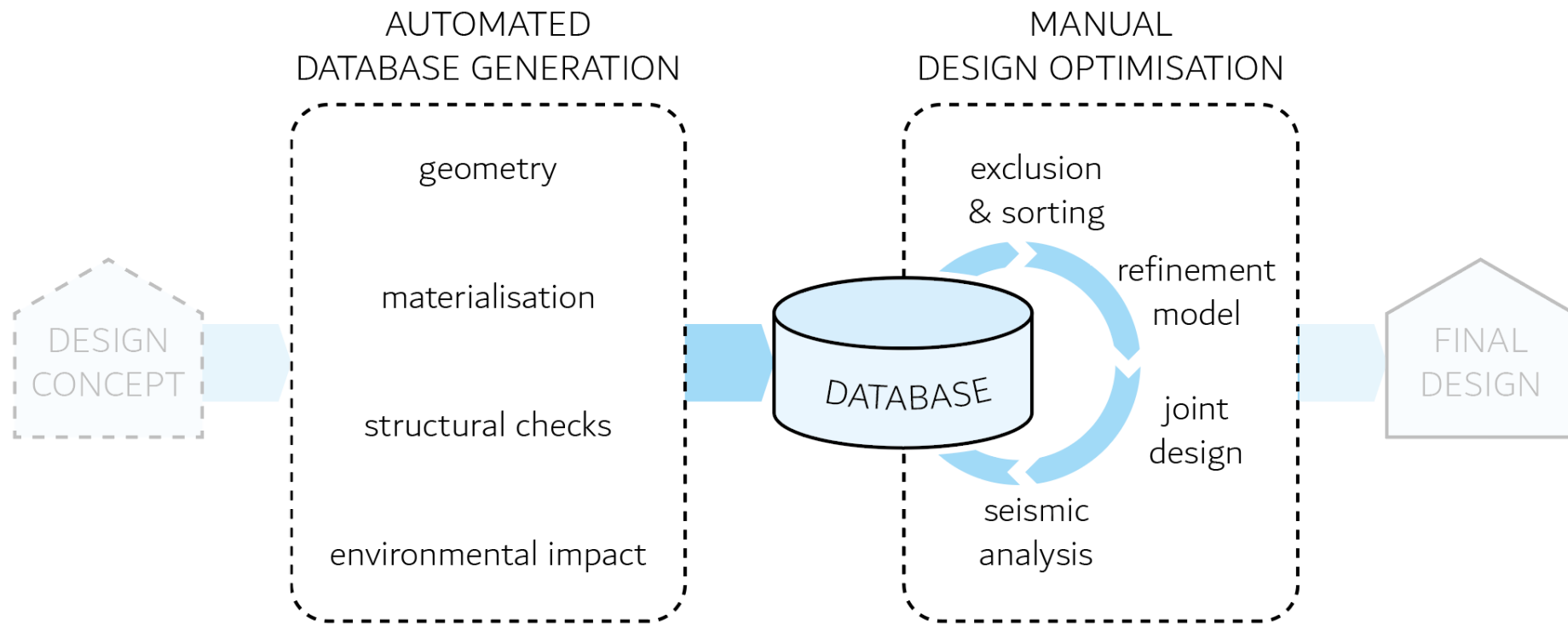

structural
validity



sustainability



aesthetics



constructability



seismic
resistance

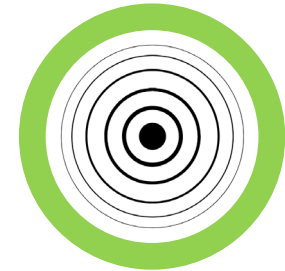

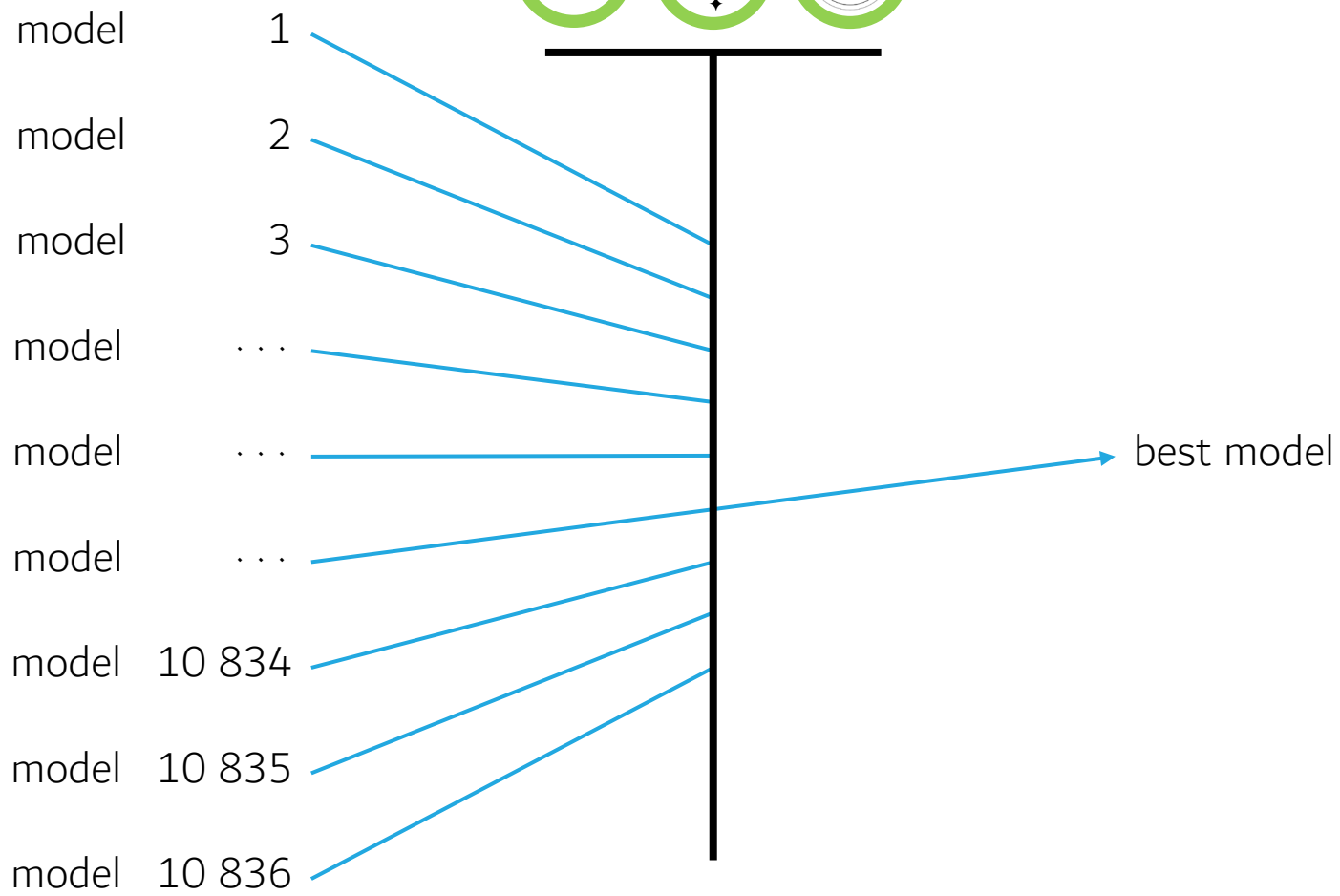

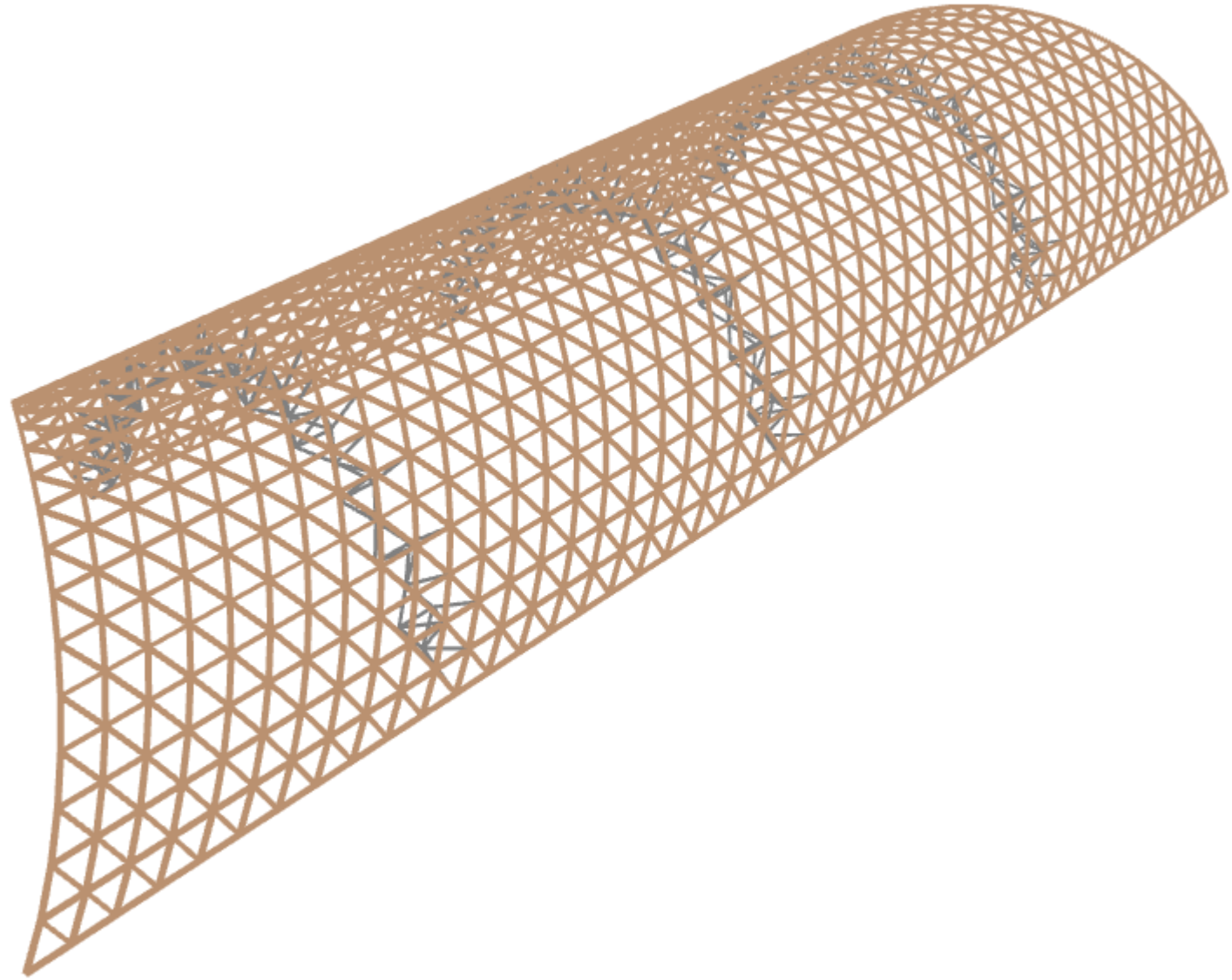

THE END