



NEW CENTRALITIES IN POST-SOCIALIST VILNIUS

MSC THESIS, P4 report

SUPERVISORS:

Prof. Rients Dijkstra | Design of the Urban Fabric
part-time tutor-researcher. Lidewij Tummers, Ir. L.C. | Spatial Planning and Strategy

AUTHOR:

Algimantas Varpučanskis
Student number: 4515986
avarpučanskis@gmail.com

DELFT UNIVERSITY OF TECHNOLOGY
Faculty of Architecture
MSc Architecture, Urbanism and Building Sciences
Master Track: Urbanism
May 2017

TABLE OF CONTENTS

1. INTRODUCTION
 2. METHODOLOGY
 3. THEORETICAL FRAMEWORK
 4. THESIS PLAN
 5. FRAMING CASE STUDY OF VILNIUS
 - 5.1 ECONOMICAL INDICATORS
 - 5.2 PHYSICAL FEATURES
 6. HOUSING TYPOLOGIES AND FACILITY DISTRIBUTION
 - 6.1 CONCLUSIONS
 7. ENVIRONMENTAL CONDITION
 - 7.1 POLLUTION
 - 7.2 NOISE
 - 7.3 CONCLUSIONS
 8. MOBILITY
 - 8.1 REMOVING FREEWAYS
 - 8.2 CASE OF STOCKHOLM
 - 8.3 CONCLUSIONS
 9. URBAN ENCLAVES – RISK AREAS OF EXTREME GENTRIFICATION
 10. SAFETY
 11. SEGREGATION AND INEQUALITY
 12. CONCLUSIONS
 13. PROBLEM FIELD - RESEARCH QUESTION
 14. STRATEGY
 15. ANALYTICAL PLANNING MODEL
 - 15.1 IDEAL MODEL
 - 15.2 GUIDELINES
 16. SUSPENDING GROWTH OF SUB-URBS
 17. DOWNTOWN FOR ALL
 - 17.1 IMPLEMENTATION
 - 17.2 INDICATORS
 18. UPGRADING URBAN ENCLAVES
 - 18.1 IMPLEMENTATION
 - 18.2 TEST SITE
 19. URBAN RENEWAL IN VILKPĖDĖ
 - 19.1 IMPLEMENTATION
 20. RETROFITTING INDUSTRIAL SITES
 - 20.1 IMPLEMENTATION
 21. DIVERSIFYING COMMERCIAL DISTRICTS
 22. PUBLIC REALM
 - 22.1 PUBLIC SPACE DEVELOPMENT MODELS
 - 22.2 IMPLEMENTATION
 - 22.3 CONCLUSIONS
 23. REFLECTION
 - 23.1 SUGGESTIONS FOR FURTHER ACADEMIC RESEARCH
 - 23.2 PROJECT LIMITATIONS
 - 23.3 CONCLUSIONS
- BIBLIOGRAPHY

1. INTRODUCTION

After collapse of Soviet Union and extreme shift from planned economy to market economy, Lithuania is facing increasing inequality and social segregation. Vilnius, which is a capital city, is chosen as a case study for this research because issue of social segregation is especially strong due to influence of globalization and foreign investment. Uneven distribution of wealth is reflected not only in statistical data but has strong spatial outcomes. Particular locations become sites for extreme redevelopment violently evicting residents. There are numbers of neighborhoods with low quality housing, which due to low real estate price concentrates marginalized social groups, people with low income. Increasing social stratification instigate reconsideration of safety issue within separate neighborhoods and entire city.

This paper examines the causes of the social stratification within city of Vilnius, Lithuania, as a result of privatization of housing market and gentrification. In many cases, gentrification in Vilnius embodies negative effects, such as displacing existing communities, abuse of purchasing power and homogenizing diverse neighborhoods. At the same time, there are models of gentrification that are able to retain local communities, improve safety of the district and increase the opportunities for jobs and investment in an incremental manner.

2. METHODOLOGY

Research was carried out by collecting and comparing spatial and statistical data of Vilnius. Analysis was conducted by observing and clustering major trends related with gentrification and social stratification trends in Vilnius. Cloud of statistical data was linked with different spatial features trying to find correlation between socioeconomic processes and geographical location. Since some of detailed geographical data does not exist, part of the analysis was based on other academic research papers and surveys, conducted in case of Vilnius. In order to grasp relevant trends research was supported with existing literature on urban sociology, criminology and economy.

3. THEORETICAL FRAMEWORK

Despite the fact that theories of Henri Lefebvre, Hannah Arendt and Richard Sennett does not play a major role in this research, works such as *The production of space* (Lefebvre, 1991), *Writings on cities* (Lefebvre et al., 1996), *The human condition* (Arendt, 1998), *The open city* (Sennett, 2006) were crucial in taking a direction for thesis project. *The production of space* (Lefebvre, 1991) is a key work in critique of current development trends, which cause a complete loss of social practice aspect in built environment. *Writings on cities* (Lefebvre et al., 1996) was outset for grasping negative aspects of increasing space commodification processes in Vilnius and loss of a use value. Book *The Human condition* (Arendt, 1998) was used as a basis for understanding the relevance of public space and consequences of individualization (in spatial terms - sub-urbanization, appearance of gated communities) and shift from *Res-publica* to society. There is a major input of Richard Sennett and his essay "The open city" (2006), which helped to understand vulnerabilities and inability to accommodate changes within Soviet city in transition.

Research part was mainly based on theories of Jane Jacobs, Christopher Alexander, Jan Gehl, John F. C. Turner and Richard Sennett. Work of John F. C. Turner "Housing by people" (1977) helps to understand and explain housing as a vehicle for the fulfillment of their users' lives and hopes. Together with work of Jane Jacobs - "The death and life of great American cities" (1961), it helps to build up arguments for city space, which open for production and self employment. The work of Jane Jacobs is also a key theory in order to understand relevance of social and economic diversity and what are the conditions for it to take place. Christopher's Alexander's "Patterns language" (Alexander et al., 1977) is a basis for spatial analysis, which helps to assess current physical situation in Vilnius, form a critical approach towards mass production of urban environment and assists in new patterns formulation for gradual city development in the future. Ideas of Jan Gehl, from his book "Cities for people" (2011), helps to build up arguments against city development indulging car driving. Lecture of Richard Sennett "interiors and interiorities" (2016) helps to understand more complex relations between public and private realms, connect spatial aspects with ideas of public space from Hannah Arendt.

4. THESIS PLAN

	sub research questions	Methods	Location/scale	Final product
Problem statement				
Social analysis, finding trends and phenomena	what is the social composition of Vilnius? What are differences in different parts of the city? How does it relate with physical features?	this section will be carried out mainly by studying other academic researches, collecting statistical data and using literature. Some information might be obtained by carrying out interviews	Vilnius, Lithuania	Graphs, maps reflecting certain composition, Text, aprx. 600
demography / social composition	what is actual social composition in Vilnius?		City scale; district scale	
stratification	Does particular city parts tend to cluster homogenous social groups?		City scale; neighborhood scale	
gentrification	Does gentrification exist in Vilnius? If so what is the nature of current gentrification processes?		City scale; neighborhood scale	
apollitical standpoint	What is widespread political standpoint of mainstream society (or particular groups)? Is collaboration between politicians and residents is plausible?		National scale; city scale	
individualism/participation	Does individuals within community (neighborhood, city, country) are willing to participate in common activities? To what extent activism is prevalent?		Nation scale; City scale; neighborhood scale; community scale	
DIY culture	Does DIY culture still prevalent among younger generation? Is it possible to implement design proposals with help of community (residents)?		Neighborhood scale; household scale	
Current development trends	What are current development trends?	this section will be carried out mainly by collecting statistical data and monitoring daily telegraph for news on housing market.	Vilnius, Lithuania	Map indicating locations (city scale), axonometric schemes, Text, aprx. 600
actual products on the market	What are the limitations of current products on the market?		City scale - geographic locations; features of selected products	
principles of operation	How and why these products appear on the market?		City scale; district scale; neighborhood scale; one project unit; household	
impact on the city	How these products influence overall operation of the city?		City scale - district scale	
users	What are the end users? Income, occupation, age etc.		City scale (In comparison with nation scale) - household	
prices	What are the actual real estate prices? What are the real estate prices in comparison with other expenditures of the end user?		City scale - prices in relation with geographic location; Project unit scale; household	
spatial analysis	What are the main spatial features of the city? What are the problematic points?		this section will be carried out mainly by selecting and displaying important physical features of the city, linking it with various types of data	
prevalent urban typologies in particular parts of the city	Can some of urban typologies be identified as problematic?	City scale; district scale; Dwelling unit features		
correlation between facility distribution and physical features	is there a correlation between physical features and facility distribution? Is some of the city parts are more favorable for particular establishments?	City scale; district scale		
Traffic flow in relation to city functions	How traffic flow is influenced by facility distribution?	City scale; district scale		
environmental condition, pollution	What are the main factors influencing environmental condition in Vilnius?	Global scale - environmental condition in comparison with other countries; city scale, household scale - habits		
landscape and geological features	What are the main natural features in Vilnius influencing urban development and recreational usage?	City scale; district scale		
Theory paper	Does gentrification actually exist in Vilnius? What are the main influencing factors for social stratification? What are the risks of continuing current trends?	collecting and comparing spatial and statistical data; observing and clustering major trends related with gentrification and social stratification; linking statistical data with different spatial features; finding correlation between socioeconomic processes and geographical location		Global scale - comparison with other countries; city scale; district scale
Field trip to Seestadt Aspern		conducting open interviews with residents, observing environment - taking pictures	Vienna, Austria	Visual observations - pictures
indicating problematic city areas	Which city areas can be identified as problematic? What is the reason for some parts to become nonfunctional?	linking and extrapolating results of analysis and research	City scale; district scale; neighborhood scale	map (city scale). Text, aprx. 300
city development strategy	What changes needs to be done in order to avoid risks created by current development direction?	using references and information collected from precedent cases, analyzing origins of the problem, studying existing literature	Vilnius, Lithuania	strategic map (city scale). Might be supported by several secondary maps. Text, aprx. 500
strategy map text			City scale Nation scale; city scale	
choosing design intervention site	What is the most crucial intervention site? Where it is necessary to take action in order to avoid complications?	by extrapolating results of analysis and research parts indicating crucial points (several points) of intervention	Neighborhood scale	Maps - city scale, neighborhood scale, text, aprx. 300
Analogs	Are there an analogous cases? How comparable problems were solved in other cases?	browsing architectural/urban web pages, magazines, studying existing research	architectural/urban web pages, magazines, books with project collections and descriptions	Reference pictures, descriptions
international practice local precedents				
Field trip to Tubingen		conducting open interviews with residents, conducting interviews with municipality officials using prepared questionnaires, observing environment - taking pictures	Tubingen, Germany	List of basic features; summary of interviews; Visual observations - pictures; booklet or essay on collective housing (optional)
Analysis of Lithuanian legal framework	How does the existing legal framework influence current development trends?	studying Lithuanian set of laws for building and planning	Online database for Technical construction regulation	Text indicating, aprx 400 words
indicating sections causing increasing problems / risks	Can existing legal framework be indicated as one of the reasons for urban environment flaws in Vilnius (Lithuania)?			
indicating parts incompatible with proposals / sustainable development	What parts of existing legal framework are incompatible with proposed problem solutions? How legal framework could be improved in order to make development more sustainable?			
Field trip to Vilnius		conducting open interviews with residents (find out if noise of airport is perceived as an irritation), conducting interviews with municipality officials using prepared questionnaires, observing environment - taking pictures	Vilnius, Lithuania	summary of interviews; Visual observations - pictures
Design	What is the spatial answer to existing urban problems / shortcomings of current development trends?		Vilnius, Lithuania	
defining further city development pattern			Nation scale; city scale; district neighborhood scale; dwelling unit	Maps - city and district scale, drawings - neighborhood scale; axonometries - dwelling unit scale
testing proposed patterns in chosen design site			City scale; district scale; neighborhood scale	Schemes - city scale; drawings 1:1000 - 1:10000, sections - 1:1000 - 1:250 (optional), implementation principles depicted with axonometries, model 1:5000 - 1:1000 (optional)
crucial intervention parts in detail			Neighborhood scale; Dwelling unit scale	Drawings 1:1000 - 1:500, sections and elevations - 1:500 - 1:250, renderings, implementation principles depicted with axonometries; model - 1:1000 - 1:500 (optional)
Implementation strategy	How spatial problem solutions can be implemented within current political/economical/social medium?	checking design solutions against existing legal framework, applying practice from precedent cases	Nation scale; city scale; district scale; neighborhood scale, community scale	Text, aprx 500 words, supporting visuals - axonometries, drawings
Defining target groups	What are the social groups potentially suitable to be involved in project implementation?			Text, aprx 300 words
Assessment criteria for project implementation and monitoring		applying information about implementation process obtained in fieldtrips (mainly in Tubingen)		Text, aprx 400 words
Conclusions / suggestions	What are the blindspots, shortcomings of thesis work? What are the possible positions/directions of future academic work in this field?			Text, aprx 500 words

Parts crucial for project integrity
 Parts which has important input on project quality
 Optional project parts

5. FRAMING CASE STUDY OF VILNIUS

5.1 Economical indicators

Vilnius is a capital city with ~536.000 inhabitants, which is almost half of all urban population in Lithuania, and it becomes a major economical, cultural and scientific center in Lithuania. 52% of all specialists with higher education reside in Vilnius (SOURCE: <https://www.vilnius.lt/vaktai2011/DefaultLite.aspx?Id=3&DocId=30243678>). General prosperity indicators in the country were always on the rise since the crisis in 2008. GDP grew 2.9% in 2016, it was one of the fastest growing countries in Europe. Also every year there is growing number of foreign investments, in Vilnius these investments are significantly higher than in the rest of the country:

Lithuania - €4 673 per resident

Vilnius - €16 729 per resident

SOURCE: <http://osp.stat.gov.lt/web/guest/statistiniu-rodikliu-analize?portletformname=vizualizacija&hash=a44bbf1a-010e-4fab-b5e9-271d7f0709e0>

In 2016 IBM announced Lithuania as 10th best country to invest by average job value of investment projects. (Fig. 1)

Recently Vilnius accommodated international companies such as IKEA, BARCLAYS, IBM, Western Union etc. Increasing globalization along with its benefits brought many new challenges. While free flow of money in many cases increased business opportunities, made trade between different countries less complicated, it also increased exploitation and became one of the main driving factors for increasing inequality (Piketty, 2014). Problem of inequality in Lithuania was present from the very early stages of independence in 1992. Unfortunately this topic is very sensitive and has very little attention because redistribution of wealth connotes with communism - time when a lot of people experienced terrific atrocities of the state. Since country became part of EU in 2004 situation has barely changed - according to Eurostat (Fig. 2) rates of inequality in Lithuania is one of the highest in Europe. Country by large is based on large scale industry, which becomes a fertile ground for inequality to rise.

For instance 40% of food market is under control of one company "MAXIMA LT"(SOURCE: <http://www.lpia.lt/>). Even though this company is one of the most profitable in the state, shop assistant in super market earns ~380 euros per month.

Small scale, local economies does not exist, or they exist in an informal level (Williams and Horodnic, 2015). While in rural areas local trade is still prevalent and widely accepted, in urban areas it is marginalized and related with low income. While small scale economy might be a tool to reduce inequality and become an alternative for exploitation in big companies, this topic hardly ever reach political level. On the contrary – general indicators such as GDP, foreign investment, average salary is always on the agenda.

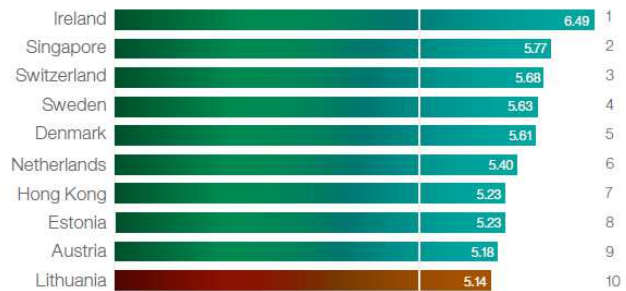

FIGURE 1. TOP-RANKING DESTINATION COUNTRIES BY AVERAGE JOB VALUE OF INVESTMENT PROJECTS – 2015 (2014).
SOURCE: IBM-PLI GLOBAL LOCATION TRENDS DATABASE AND ANALYSIS. 2016.

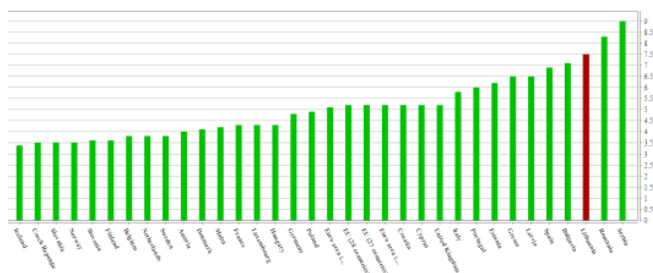
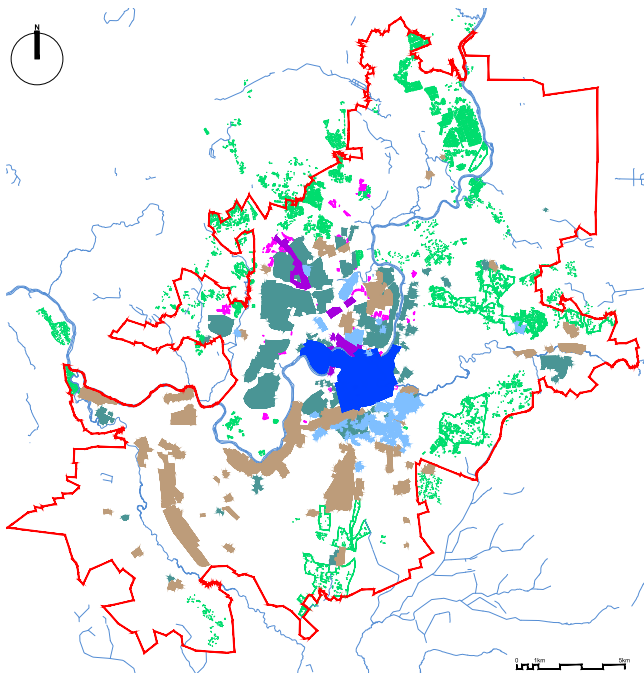

FIGURE 2. THE RATIO OF TOTAL INCOME RECEIVED BY THE 20 % OF THE POPULATION WITH THE HIGHEST INCOME (TOP QUINTILE) TO THAT RECEIVED BY THE 20 % OF THE POPULATION WITH THE LOWEST INCOME (LOWEST QUINTILE). INCOME MUST BE UNDERSTOOD AS EQUIVALISED DISPOSABLE INCOME.
SOURCE: [HTTP://EC.EUROPA.EU/EUROSTAT/TGM/GRAPH.DO?TAB=GRAPH&PLUGIN=1&LANGUAGE=EN&PCODE=TESS180&TOOLBOX=TYPE](http://ec.europa.eu/eurostat/tgm/graph.do?tab=graph&plugin=1&language=en&pcode=TESS180&toolbox=type)

5.2 Physical features

One of the main features of Vilnius is extreme difference between separate parts of the city, which forms a big patchwork of margin physical features concentrated in big clusters.

Since city is highly affected by soviet city planning - functional zoning is highly visible. City can be divided into 7 distinct zones.



Mass housing areas

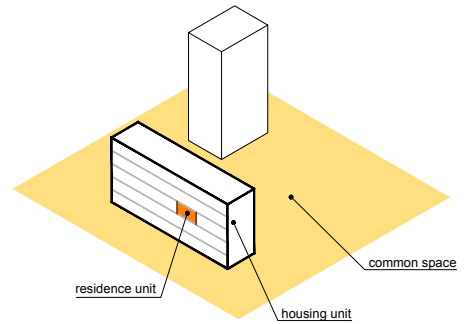

Speculative developments

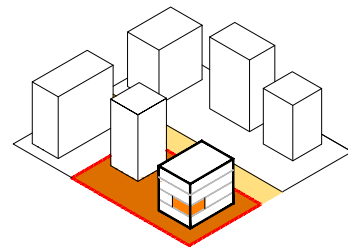

Commercial districts

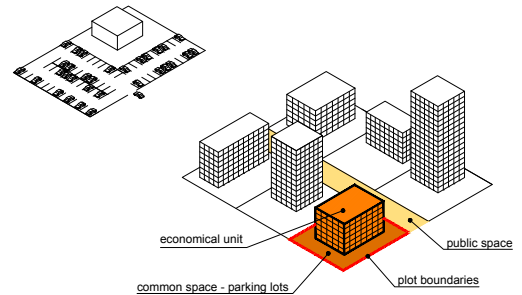

Industrial areas

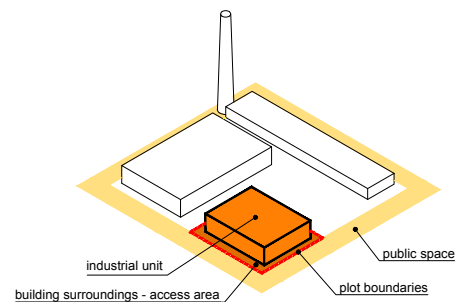

City center

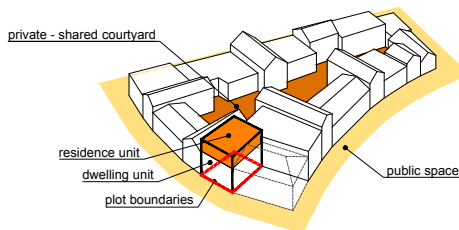

Vernacular urban enclaves

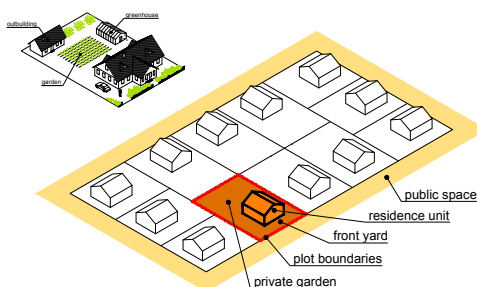

Sub-urbs

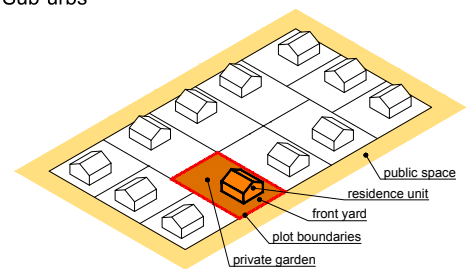

6. HOUSING TYPOLOGIES AND FACILITY DISTRIBUTION

Besides clearly visible physical difference between housing typologies one of the main features which affects everyday life of people residing in each of these types is facility and workplace distribution.

- **Mixed use districts** is a prevalent facet of old town. Basically it contains all necessary facilities inside, so theoretically resident of old town can meet its everyday needs, find cultural activities and meeting places or reach working place within walking distance.

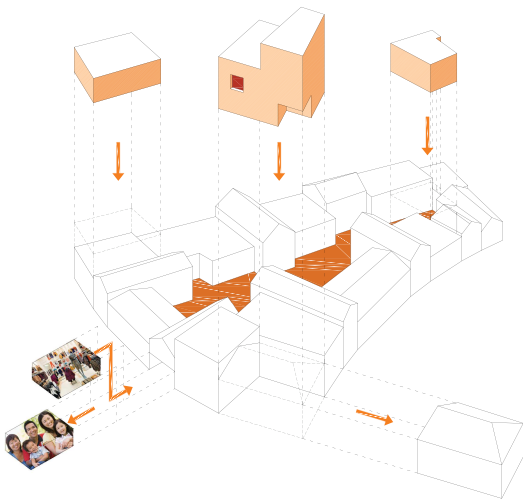

- **Mass housing areas** – contains high number of primary facilities such as schools, kindergartens, clinics, shopping facilities. However it was planned according to strict zoning rules, therefore residential part of neighborhood is strictly separated from any other function. Even though some of the facilities can be reached within walking distance, pedestrian paths do not offer attractive activities along the route, which makes them unpleasant to walk (Gehl, 2011). Functional zoning also clearly defined locations of all the facilities, which works as nodes for traffic destination and cause traffic jams. Relatively high population density allows developing a good public transport network, so these areas are well connected. However number of people using public transport goes along with overcrowding during the rush hours.

Despite few exceptions there are basically no cultural facilities or meeting places, which means that most of the residents are forced to commute in order to enjoy cultural life of Vilnius.

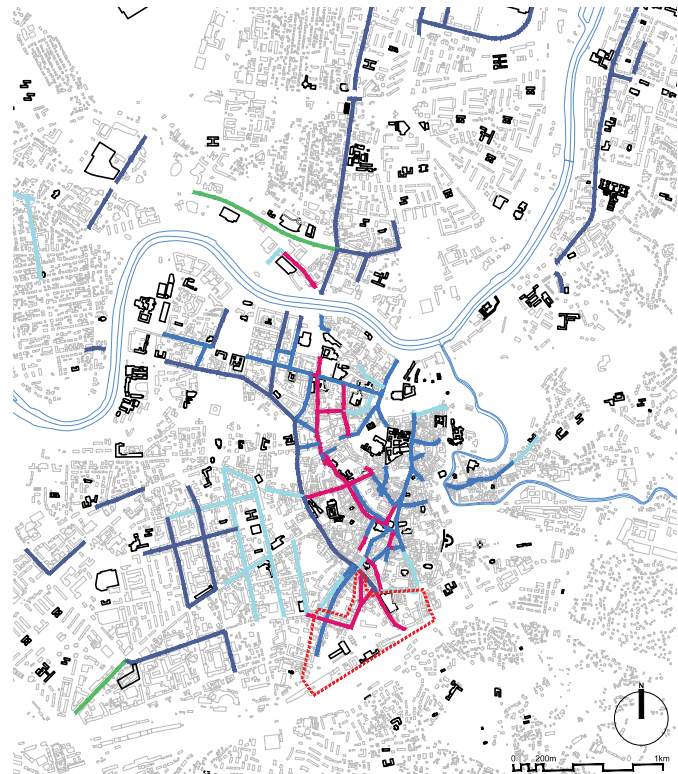

- active only during the work day 8:00-17:00, mainly shops and offices
- active during and after the work day, great variety of functions
- active till late night, many bars and night clubs
- diversity of facilities, but not active at any time mainly due to intense traffic
- diversity of facilities, but human scale is completely lost

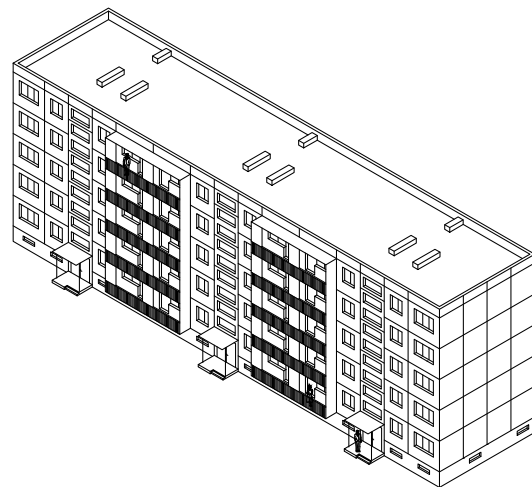

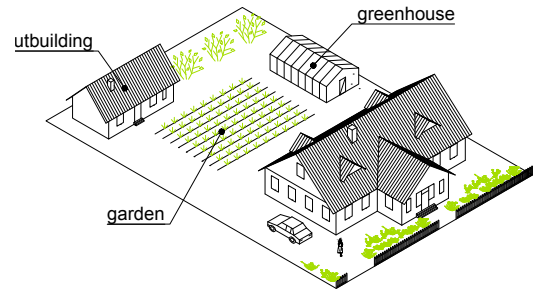
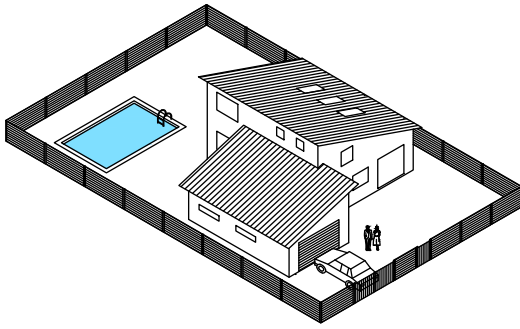

- **Sub-urbs** – in most cases these areas lack even most basic facilities such as schools, shops. It is based on everyday car usage, because working places, educational and health care institutions, leisure activities are based far away from these areas. Since driving is an inseparable part of these neighborhoods the main threat remains aging society and what happens when residents are no longer able to drive.

In addition to that it is also hardly accessible by public transport, due to low density expanding public transport network to these areas is inefficient.

- **Vernacular villas** - this type of housing is often assimilated with sub-urban villas, however in its functional operation it is completely different. Many households still practice small scale farming, there are many cases of self employment. Despite the fact that public facilities are usually missing as it is in case of Vilnius sub-urbs, the fact that people practice small local businesses, it causes less traffic than in case of periphery.

6.1 Conclusions

Considering facility distribution Vilnius housing types form 3 different regions:

- Downtown - all necessary facilities**
- Mass housing areas - primary facilities**
- Sub-urban - no facilities**

These differences in function distribution clearly correlate with real estate prices.



City center ~50m²	€130.000
Housing areas ~70m²	€80.000
House in sub-urbs ~100m²	€90.000
Land price. City center	€180.000/are
Land price. Outskirts	€2.000/are

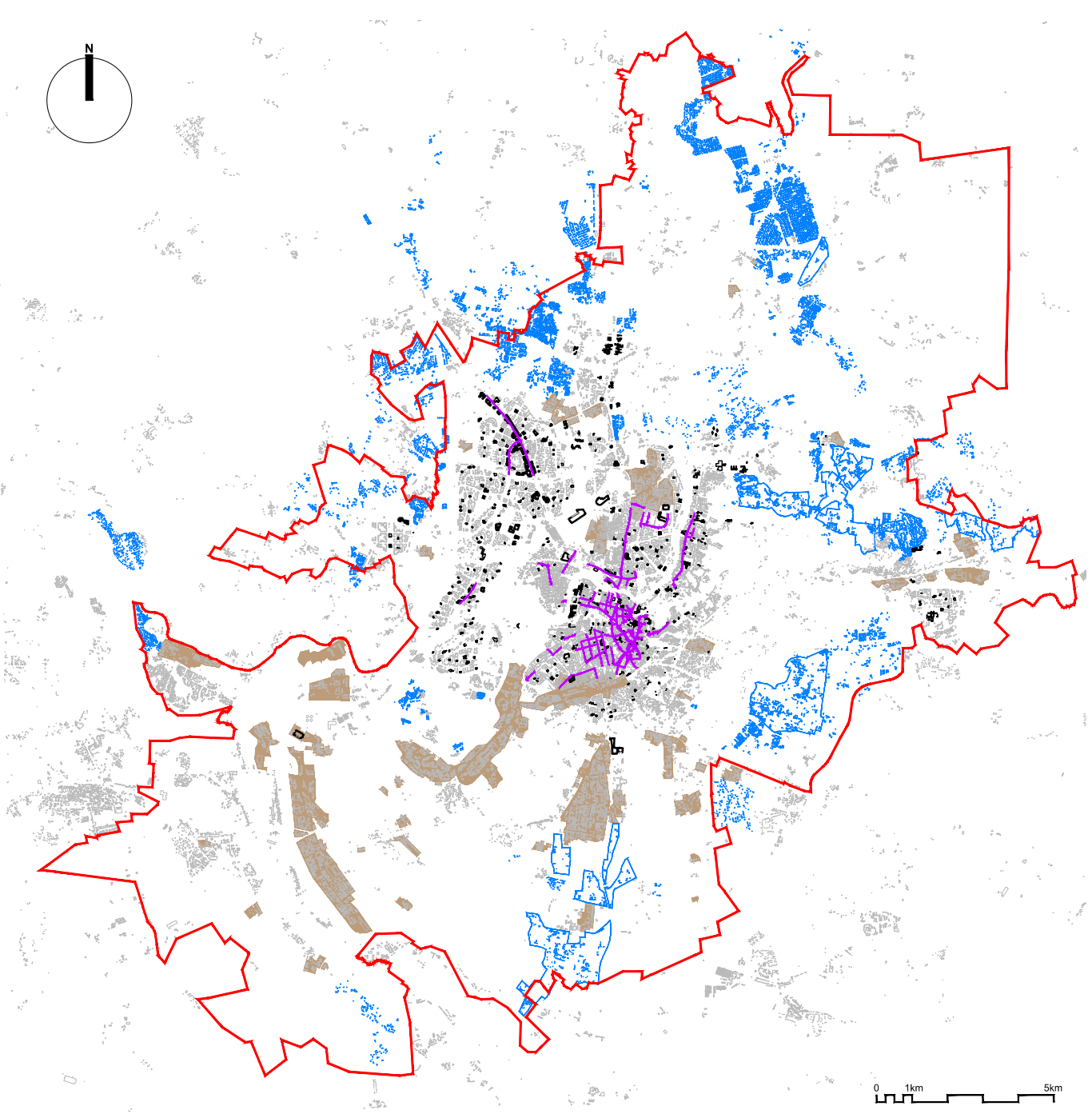
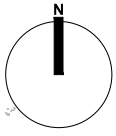

- **Speculative housing** - Some researchers (Čiupailaitė, 2012) compare it with mass socialist housing and claim that it is a continuation of the same mass production patterns. From the point of view of facility distribution it can be compared with sub-urban developments - facilities are not taken into consideration neither while planning nor building. Therefore these developments come with an inevitable need of commuting. Physical distances to everyday facilities are slightly shorter compared with sub-urban developments, because usually speculative developments are located closer to the city center, therefore people can use existing infrastructure.

While variety itself is a positive feature, one type of housing, assembled in one neighborhood, tends to concentrate a homogenous social group. In addition to that - each "patch" goes along with a different level of accessibility to social services, education, leisure, social or cultural activities. Large distances to reach particular activities on a daily basis might cause a great time loss, increase travelling expenses, influence way of commuting or define whether a particular facility will be used in general. Research conducted by Artūras Tereškinas and Apolonijus Žilys (Tereškinas et al., 2013) indicates that absence of social services in sub-urban areas does not play a major role since attendance of cultural activities is highest among people living in sub-urbs. Because public transport connection is poor - it suggests that most of residents are using cars on a daily basis. On the other hand - absence of cultural facilities in old mass housing projects might be a reason resulting in lower rates of attending cultural activities. Since the population has higher numbers of elderly and people with low education levels they are less likely to commute long distances for secondary activities.



-  Specialized facilities. Schools, shopping malls, hospitals etc. Mostly single use buildings
-  Streets accommodating various functions, which forms continuous stripes of facilities
-  Sub-urbs

7. ENVIRONMENTAL CONDITION

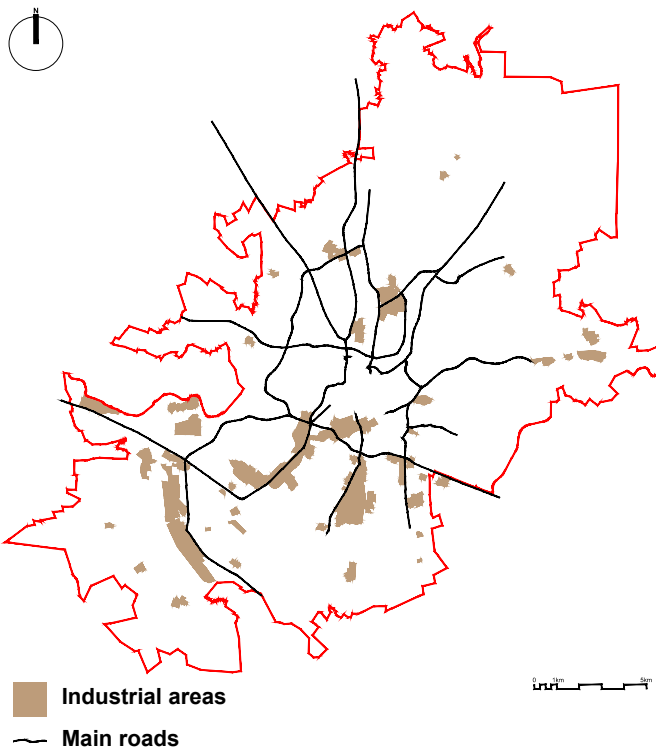

Considering trend that all new developments comes without basic facilities, one of the key issues to be considered is traffic and need for everyday commuting. Therefore this chapter will examine current environmental situation in Vilnius and impact of commuting.

Compared with other cities Vilnius has very high number of cars. For instance in Amsterdam there is twice as less vehicles per 1000 residents compared with Vilnius

Vilnius	515 per 1000 inhabitants
Berlin	327 per 1000 inhabitants
Amsterdam	274 per 1000 inhabitants
Vienna	380 per 1000 inhabitants

7.1 Pollution

Considering soviet planning practice and how industrialization shaped city of Vilnius it is clearly visible that main source of pollution was considered to be industry. Production areas were concentrated in huge clusters, away from residential areas in order to prevent harmful pollution reaching populated parts (Vanagas 2008). Well connected by transport lines while prioritizing public transport it was considered to be a sustainable model for city development. However political shift in 1992 marked an end in priority of public transport. Increasing individualization and accessibility to purchase a car (during soviet era chance of obtaining a car was limited) came along with sharp increase of traffic. Following maps illustrate that industry which once was considered to be main source of pollution now is replaced by traffic.

Almost all most polluted areas within city of Vilnius clearly coincide with busiest streets/highways/roads within Vilnius. Exceptions are:

- Combined Heat and Power Plant (TEC-3), which becomes the main source of sulfur dioxide during heating season
- Individual houses producing carbon monoxide during heating season. (Amount of carbon monoxide produced by individual houses is still quite low compared with motorized vehicles). Therefore it is clear that in order to reduce levels of pollution within the city it is crucial to address traffic problems.

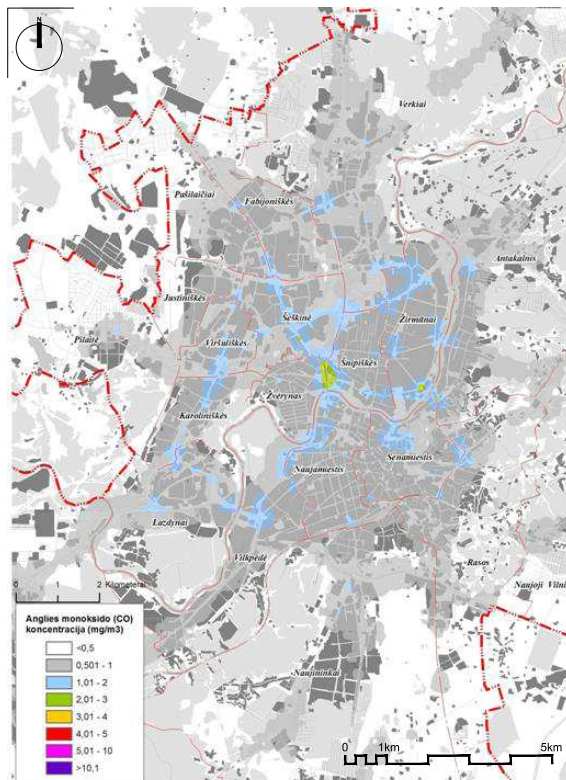

FIGURE 3. CONCENTRATION OF SULFUR DIOXIDE DURING WARM PERIOD OF THE YEAR.

SOURCE: [HTTPS://WWW.VILNIUS.LT/VAKTAI2011/DEFAULTLITE.ASPX?ID=3&DOCID=30213328](https://www.vilnius.lt/vaktai2011/defaultlite.aspx?id=3&docid=30213328)

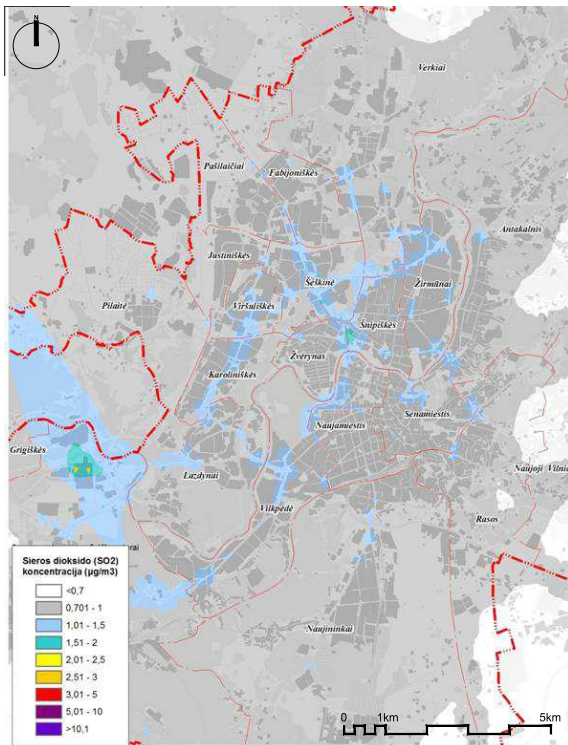

FIGURE 4. CONCENTRATION OF SULFUR DIOXIDE DURING COLD PERIOD OF THE YEAR.
SOURCE: [HTTPS://WWW.VILNIUS.LT/VAKTA12011/DEFAULTLITE.ASPX?ID=3&DOCID=30213328](https://www.vilnius.lt/vakta12011/defaultlite.aspx?id=3&docid=30213328)

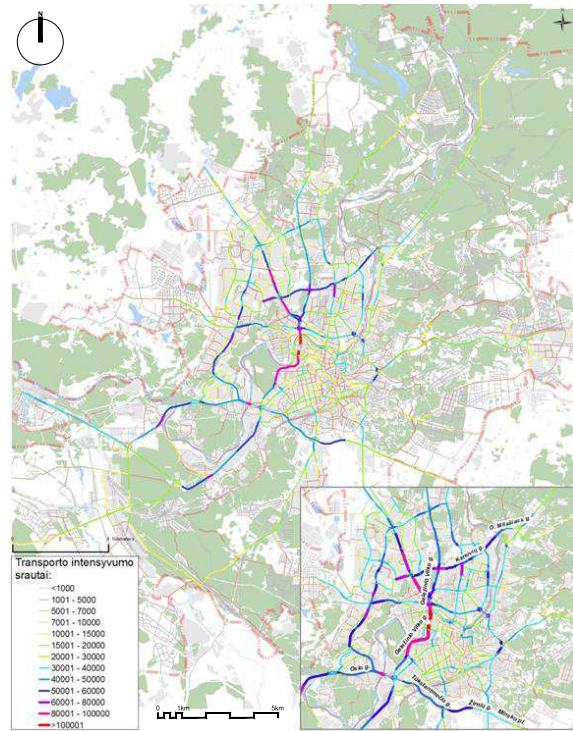

FIGURE 6. BUSIEST HIGHWAYS/ROADS IN VILNIUS. SOME OF BUSIEST SECTIONS HAS TRAFFIC FLOW OF AROUND 100 THOUSAND VEHICLES PER DAY.
SOURCE: [HTTPS://WWW.VILNIUS.LT/VAKTA12011/DEFAULTLITE.ASPX?ID=3&DOCID=30213328](https://www.vilnius.lt/vakta12011/defaultlite.aspx?id=3&docid=30213328)

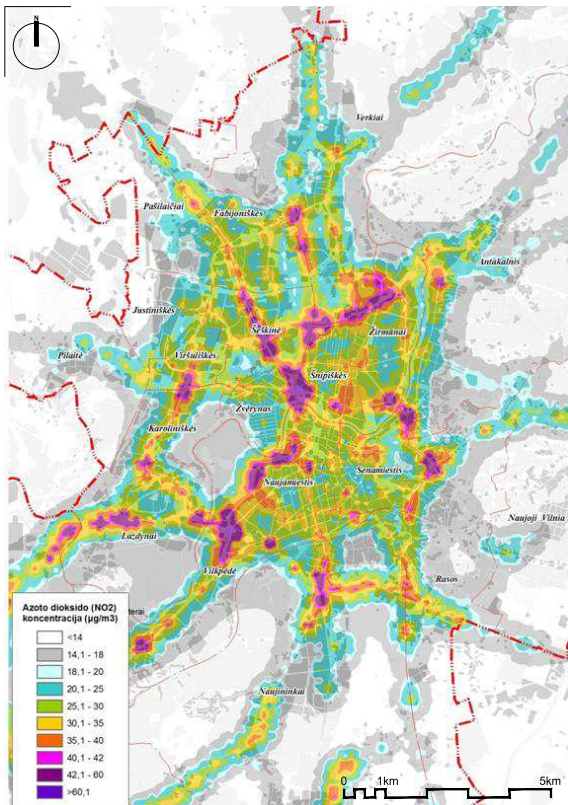

FIGURE 5. CONCENTRATION OF NITROGEN DIOXIDE. 2007 - 2011.
SOURCE: [HTTPS://WWW.VILNIUS.LT/VAKTA12011/DEFAULTLITE.ASPX?ID=3&DOCID=30213328](https://www.vilnius.lt/vakta12011/defaultlite.aspx?id=3&docid=30213328)

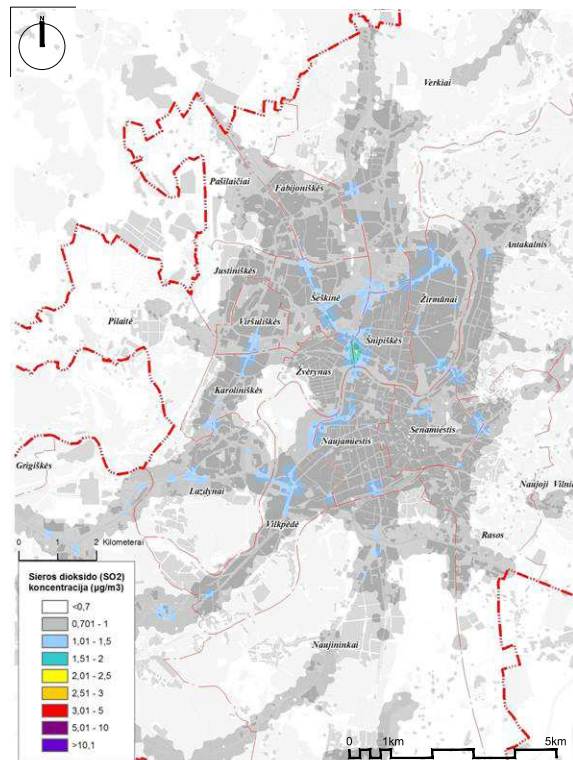

FIGURE 7. CONCENTRATION OF CARBON MONOXIDE.
SOURCE: [HTTPS://WWW.VILNIUS.LT/VAKTA12011/DEFAULTLITE.ASPX?ID=3&DOCID=30213328](https://www.vilnius.lt/vakta12011/defaultlite.aspx?id=3&docid=30213328)

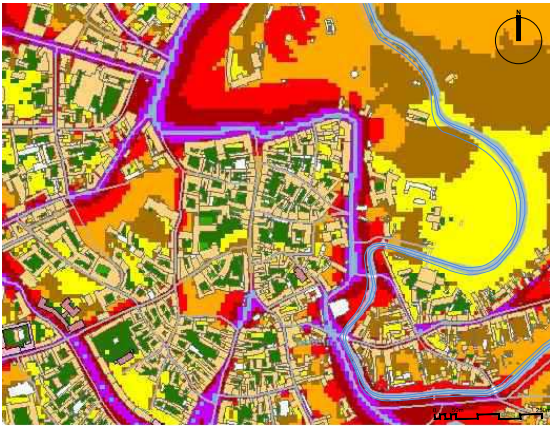

FIGURE 8. THIS FRAGMENT INDICATES THAT BUILDINGS CAN REDUCE FRAGMENT FROM MAP OF NOISE LEVELS PRODUCED BY TRAFFIC. GREEN COLOUR INDICATES THE QUIET AREAS FROM 35DBA, GREY AND BLUE OVER 80DBA. THIS FRAGMENT CLEARLY INDICATES THAT BUILDINGS WORKS PRETTY WELL AS SOUND BARRIERS. NOISE LEVELS OF 75-79 DBA ARE REDUCED TO 40-44 DBA WITHIN ~25M 2011.
SOURCE: [HTTP://APLINKA.VILNIUS.LT/LT/INDEX.PHP/APLINKOS-KOKYBE/TRIUKSMAS/TRIUKSMO-ZEMELAPIA/](http://aplinka.vilnius.lt/lt/index.php/aplinkos-kokybe/triuksmas/triuksmo-zemelapiai/)

7.2 Noise

Another very important aspect defining a decent quality of living environment in Vilnius is noise.

Following maps indicate noise levels produced by different kind of human activities – rail traffic, motorized transport, air transport and industry.

Analysis of different sources of noise in Vilnius indicates several trends. Considering overall amount of noise that is being produced, the biggest impact is made by motorized traffic. Most of the noise producing industry is located in south west of the city. This trend is self evident since most of the industry is located in this part of the city. However, having in mind that industrial zones in Vilnius consists of numerous industrial units - number of noise producing is very low, which is 35 (including rail stations and airport). This helps to draw a conclusion that most of the industry is no longer noisy. Railroad also mostly affects southern part of the city, air traffic – south east.

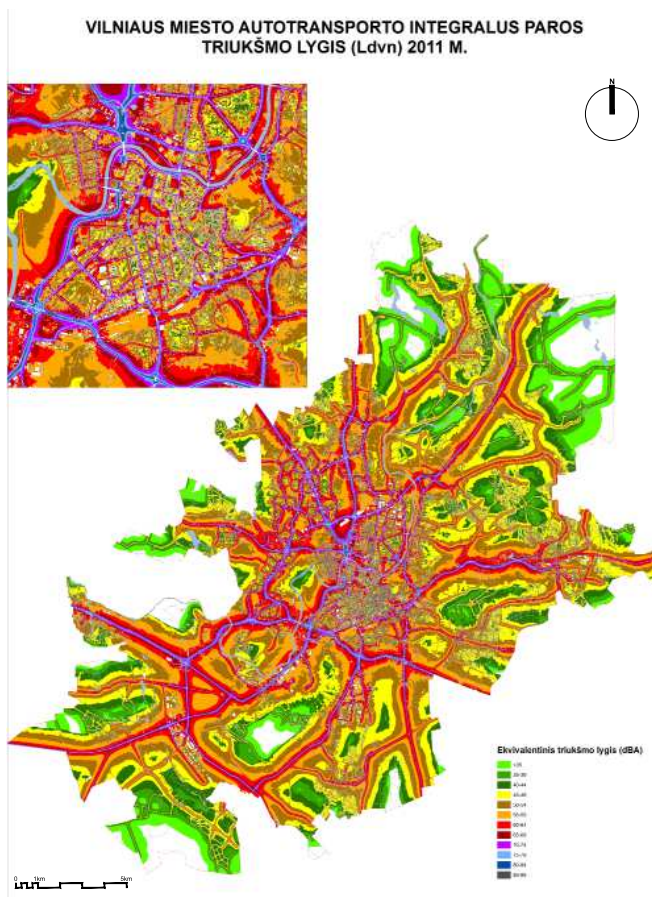

FIGURE 9. NOISE LEVELS PRODUCED BY MOTORIZED TRAFFIC. GREEN COLOUR INDICATES THE QUIET AREAS FROM 35DBA, GREY AND BLUE OVER 80DBA. 2011.
SOURCE: [HTTP://APLINKA.VILNIUS.LT/LT/INDEX.PHP/APLINKOS-KOKYBE/TRIUKSMAS/TRIUKSMO-ZEMELAPIA/](http://aplinka.vilnius.lt/lt/index.php/aplinkos-kokybe/triuksmas/triuksmo-zemelapiai/)

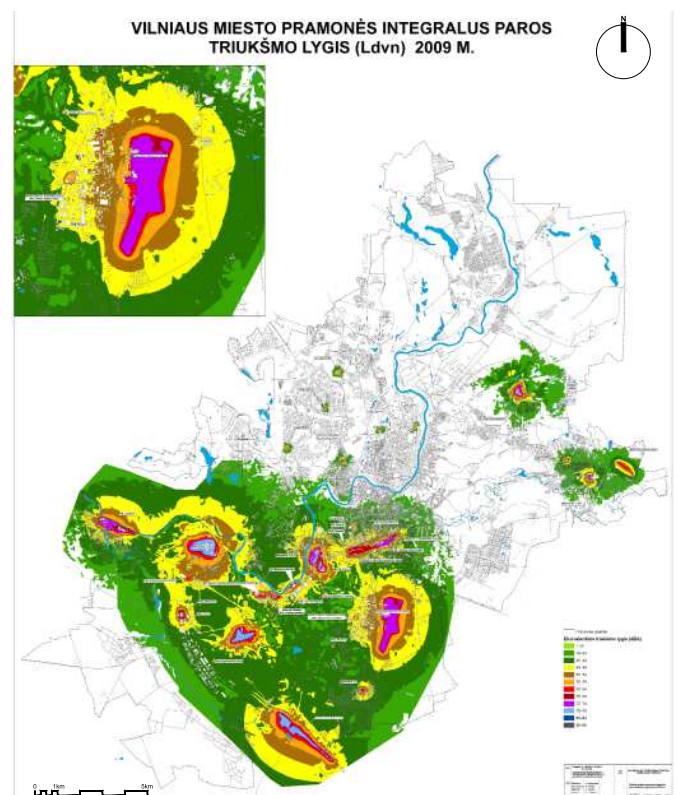

FIGURE 10. NOISE LEVELS PRODUCED BY INDUSTRIAL ACTIVITIES WITHIN CITY OF VILNIUS. THERE ARE 35 INDUSTRIAL UNITS (INCLUDING TRAIN STATIONS AND AIRPORT) WHICH WERE INDICATED AS NOISE PRODUCING NODES. GREEN COLOUR INDICATES THE QUIET AREAS FROM 35DBA, GREY AND BLUE OVER 80DBA. 2009.
SOURCE: [HTTP://APLINKA.VILNIUS.LT/LT/INDEX.PHP/APLINKOS-KOKYBE/TRIUKSMAS/TRIUKSMO-ZEMELAPIA/](http://aplinka.vilnius.lt/lt/index.php/aplinkos-kokybe/triuksmas/triuksmo-zemelapiai/)

Since levels of noise produced by motorized traffic is more or less evenly distributed throughout the city all 4 maps combined offers a conclusion that southern part of the city is affected the most by different kinds of noise sources.

However the most important factor defining sound levels and how far it spreads is whether area is built up.

This trend is only present in closed courtyards where buildings are aligned with street and form closed perimeter. Any gap within the perimeter effects higher noise levels within courtyard. The same trend can be noticed with all four sources of noise except air traffic.

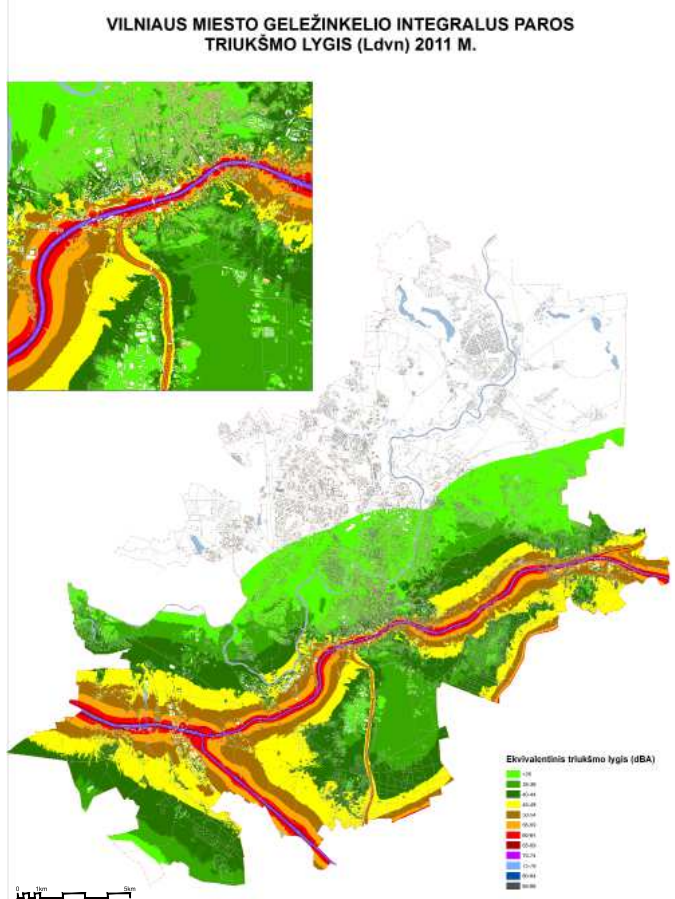
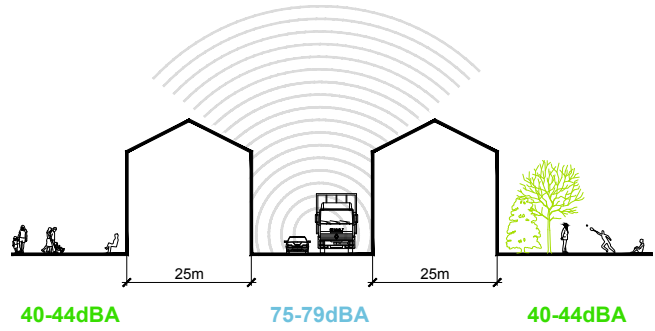

FIGURE 11. NOISE LEVELS PRODUCED BY RAIL TRAFFIC. GREEN COLOUR INDICATES THE QUIET AREAS FROM 35DBA, GREY AND BLUE OVER 80DBA. 2011.
SOURCE: [HTTP://APLINKA.VILNIUS.LT/LT/INDEX.PHP/APLINKOS-KOKYBE/TRIUKSMAS/TRIUKSMO-ZEMELAPIAI/](http://aplinka.vilnius.lt/lt/index.php/aplinkos-kokybe/triuksmas/triuksmo-zemelapiai/)

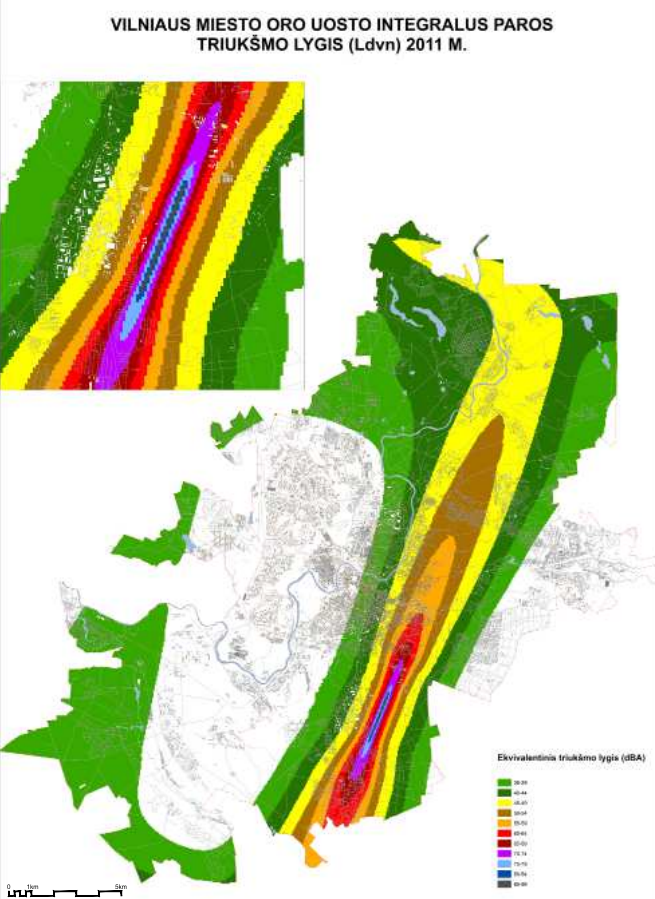

FIGURE 12. NOISE LEVELS PRODUCED BY AIR TRAFFIC. GREEN COLOUR INDICATES THE QUIET AREAS FROM 35DBA, GREY AND BLUE OVER 80DBA. 2011.
SOURCE: [HTTP://APLINKA.VILNIUS.LT/LT/INDEX.PHP/APLINKOS-KOKYBE/TRIUKSMAS/TRIUKSMO-ZEMELAPIAI/](http://aplinka.vilnius.lt/lt/index.php/aplinkos-kokybe/triuksmas/triuksmo-zemelapiai/)

7.3 Conclusions

Concluding analysis of noise and pollution in Vilnius the number and intensity of car usage is the main influencing factor considering environmental condition.

There are three trends (Bearing in mind previously conducted research on accessibility) influencing intensity and high number of cars in Vilnius:

- Expansion of sub-urbs - residential areas without any facilities/activities
- Functional zoning, which ends up with working places separated from residential areas
- Priority of car in legal framework. All necessary infrastructure provided for car drivers invites to own a car and move to live further from daily needs (Cervero, 2009).

Despite negative impact on the city caused by traffic - accessibility for cars is still considered to be

inevitability in urban planning level. Priority of car together with workplace separation from residential areas (fig. 66) - creates self-feeding model, where demand for car infrastructure is always on the rise.

However, according to urban researchers such as Jan Gehl (2011), Jane Jacobs (1961) or Robert Cervero (2009) city development based on priority of car driving is not sustainable. Only focus on mixed use development, attractive design and population/work place density can solve mobility problems within city. Accessibility for cars is not sustainable (considering it's operation in time). Any infrastructure provided for SOV (single owner vehicles) only induce the traffic. In other words - solving congestion with more infrastructure is a short term solution, because it encourage further urban sprawl (Jacobs, 1962; Cervero, 2009).



FIGURE 13. DUE TO INTENSE TRAFFIC, OLD HOUSE MAIN ENTRANCE, WHICH USED TO BE A REPRESENTATIVE PART OF BUILDING, COVERED WITH BLANK WALL.
SOURCE: GOOGLE STREET VIEW

8. MOBILITY

As identified earlier, congestion in Vilnius is one of the main existing city problems, causing pollution, noise, time losses, imposing high fiscal and social costs. For a number of years, mobility problems were tried to be solved by providing more infrastructure for SOV (single occupant vehicles), which became dominant mode of commuting. Today it became clear that current methods does not bring desired results neither from technical point of view nor from socio-economical. While urban mobility is a crucial part of everyday life in the city, recent studies shows that improving transportation in expense of other aspects of urban life can actually decrease global competitiveness of the city and have other negative effects.

Despite arguments that **1)high density, 2) mixed land use, 3)investment in public transport and 4)place making** helps to solve mobility problems in contemporary city (Cervero, 2003, 2009, Jacobs 1961, Gehl 2011, Pivo, et al., 1994, Rode P. et al., 2015) - separating different uses, providing all necessary infrastructure for SOV is pretty much a dominant approach in Vilnius and entire country. Planing department of Vilnius is drifting with ever increasing demand for SOV infrastructure, without even questioning the results. Considering long term implications of such approach - promoting SOV as the main mode of mobility is simply un-sustainable, because it encourage further sprawl of the city, (even without growing population), additional sprawl again comes with increased demand for road capacity.

additional road capacity quickly gets consumed by newly generated traffic, what is called "induced traffic" (Cervero, 2003, p. 214).

According to Cervero (2009) mixed land use (diversity), pedestrian/bicycle friendly environment (attractive design) and density - are the main factors having negative impact on number of single owner vehicles.

Research conducted by Cervero (2003, 2009) and Rode P. et al., (2015) criticize traditional way of "predict and provide" method of dealing with mobility issues. That is to say - extrapolating numbers of continuously growing SOV and providing missing infrastructure can be misleading (fig. 14). In many cases increase of private vehicles was slowed down or even reversed by place making, introducing smart technologies, improvement of public transport, taxation etc. However these changes always demands a deliberate and conscious intervention, pushing towards desired result.

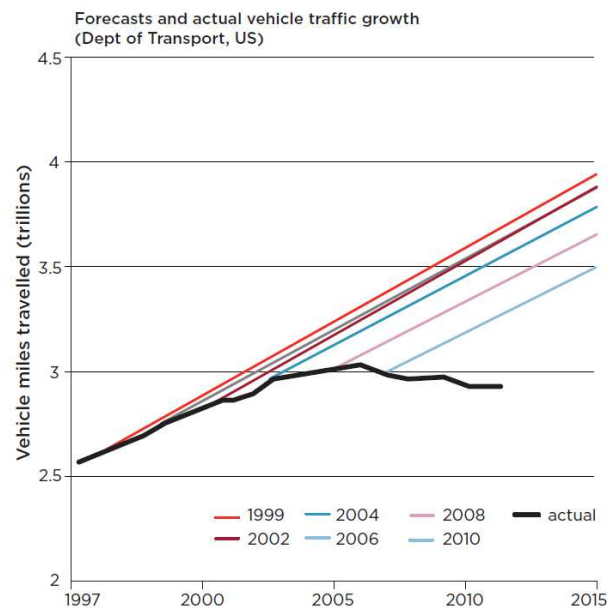
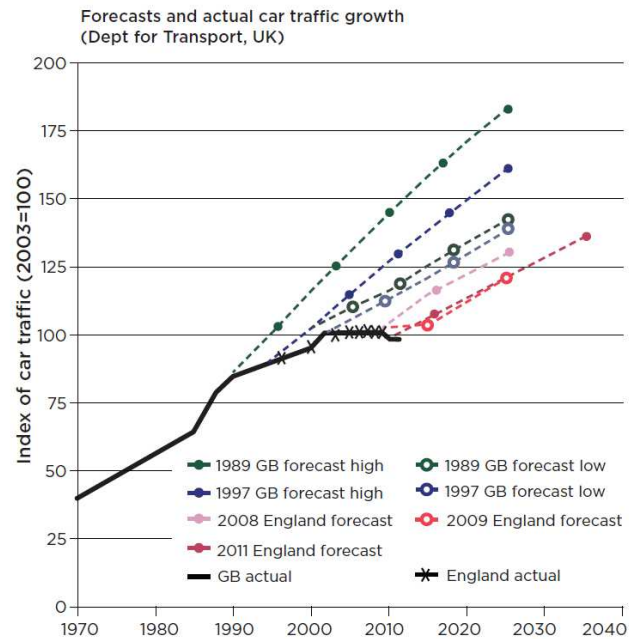

FIGURE 14.
FALSE PROJECTIONS OF CAR TRAFFIC GROWTH
SOURCE: GOODWIN 2012A (TOP) AND WILLIAMS-DERRY 2013 (BOTTOM)



FIGURE 15.
REMOVAL OF CHEONG GYE CHEONG DOUBLE DECK
FREEWAY.
FREEWAY BEFORE(A) AND AFTER(B). REMOVAL WORKS
TOOK 3 YEARS BETWEEN 2003 AND 2005.
SOURCE: CERVERO 2009



FIGURE 16.
CURRENT SITUATION OF CHEONG GYE CHEONG FREEWAY.
SOURCE: [HTTP://WWW.PANORAMIO.COM/PHOTO/12155043](http://www.panoramio.com/photo/12155043)

Evidence also shows that transportation problems cannot be approached purely from an engineering perspective. Research conducted in Bogota and Guangzhou (Cervero et al., 2009) highlights the importance of attractive design. Despite the fact that BRT (bus rapid transit) lines in Bogota were aiming for equity, they were approached mainly from an engineering perspective. BRT improved connectivity and was implemented with a relatively low budget, however it still had a negative impact on the surrounding urban environment, because the space created by bus highways did not offer attractive places. While at the same time the BRT concept applied in Guangzhou was more successful in place making because a lot of attention was paid on making surrounding areas attractive and connected with the BRT system.

8.1 Removing freeways

Quite controversial findings provided by Cervero (2009) point out that space dedicated for intense traffic (double-deck highways, multi-layer intersections, wide roads, parking lots, etc.) can bring more revenue for the urban region if replaced with attractive public space and mixed land use. Evidence shows that removing the Cheong Gye Cheong freeway in Seoul (fig. 15-18) had a positive impact on real estate value in surrounding areas, attracted more creative industries and increased global city competitiveness. Seoul is just one of many examples where excessive road infrastructure was removed. More than thirty years ago, residents of Portland, Oregon, voted to bulldoze the Harbor Drive freeway and replace it with a thirty-seven-acre waterfront park on the edge of downtown. Following the 1989 Loma Prieta earthquake, San Francisco razed double-deck freeways along its waterfront and several miles inland in favor of attractively landscaped, multiway boulevards. Milwaukee recently tore down its Park East Freeway, opting to use the vacated land for housing, shops, and offices. The most notorious freeway demolition project is Boston's Big Dig. Freeway demolition is currently being planned in a number of cities, including the Inner Loop in Rochester, New York; Route 29 in Trenton, New Jersey; and the Whitehurst freeway in Washington, D.C. Serious discussions are under way to remove the Jones Falls Expressway in Baltimore, Seattle's Alaska Way Viaduct, Buffalo's Skyway, the Sheridan Expressway in the Bronx, Robert Moses Parkway in Niagara Falls, sections of Interstate 5 in Portland, and segments of Paris's Pompidou Expressway.

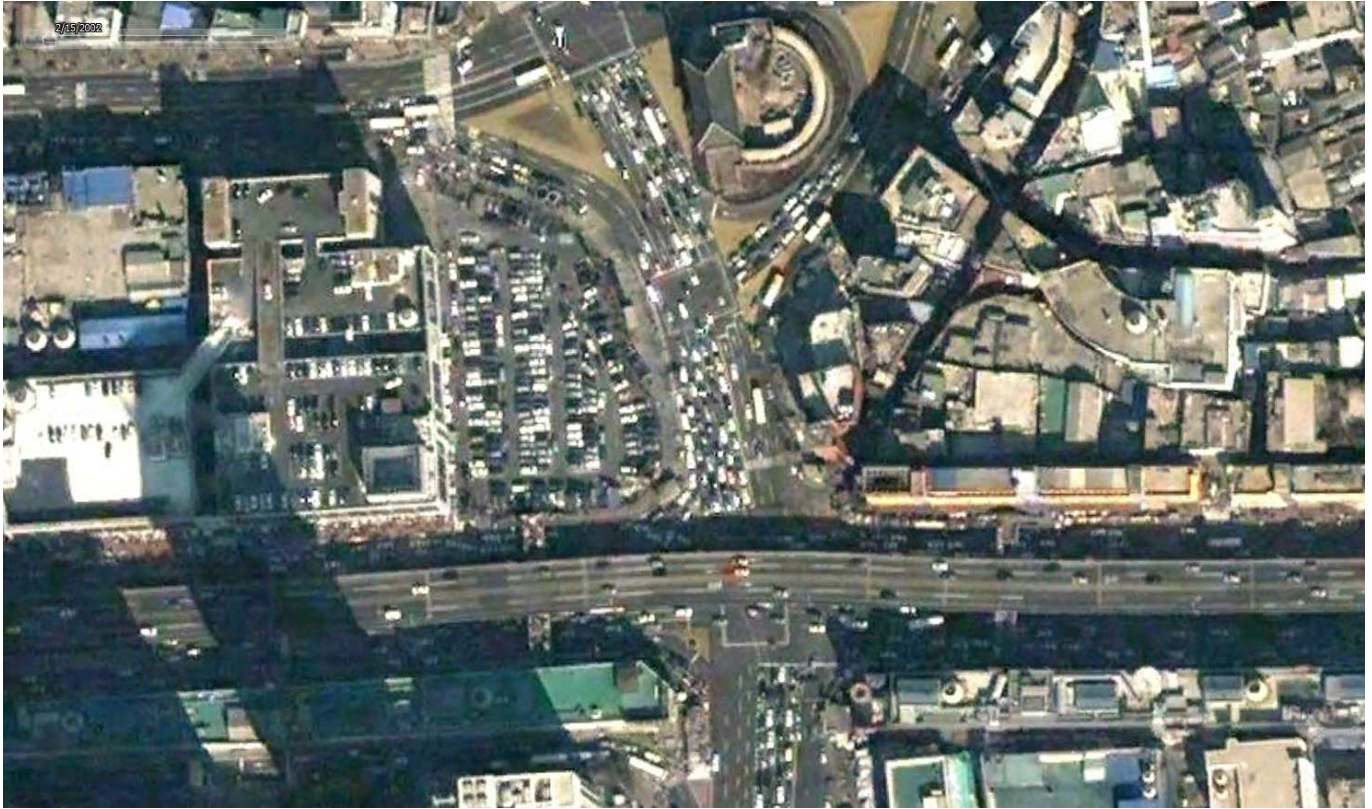

FIGURE 17.
CHEONG GYE CHEONG DOUBLE DECK FREEWAY BEFORE REMOVAL (2002).
SOURCE: GOOGLE EARTH

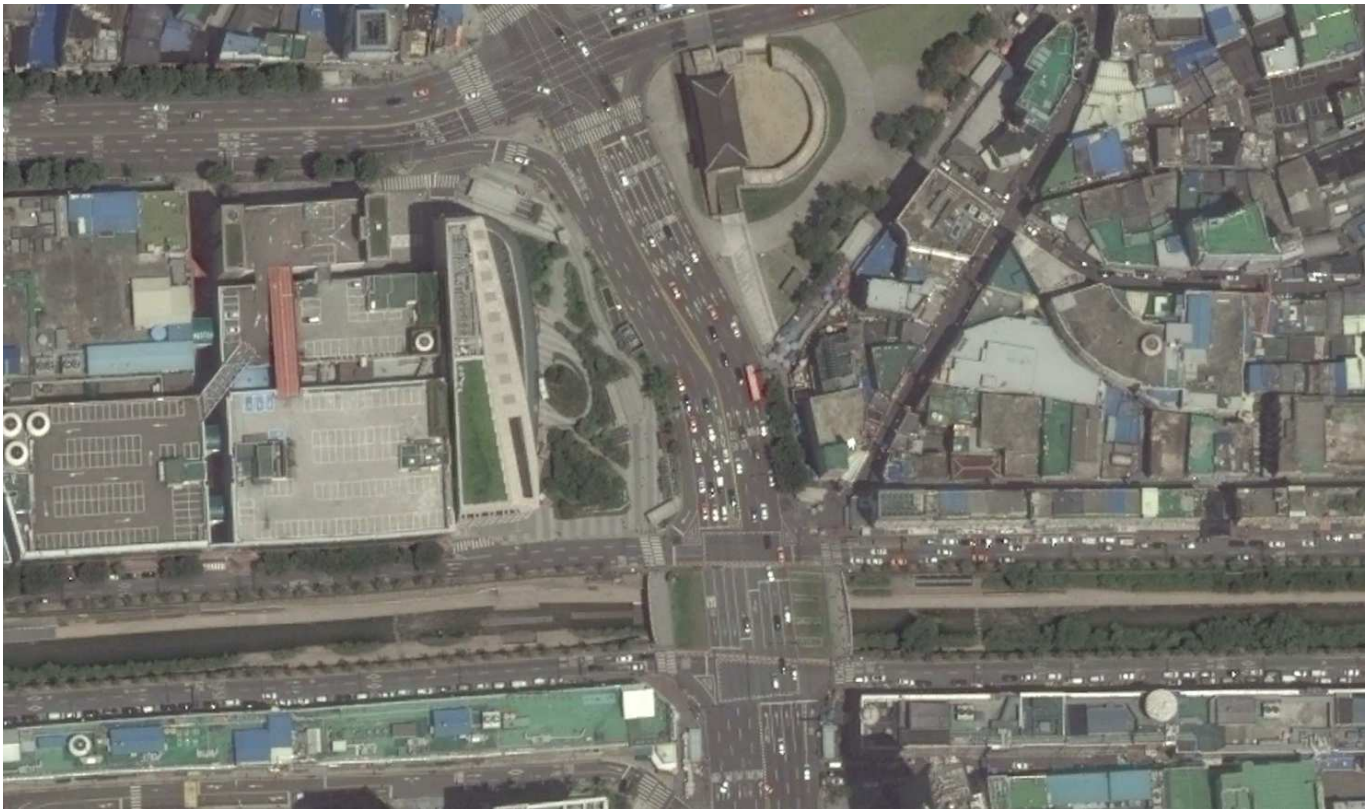

FIGURE 18.
CHEONG GYE CHEONG AFTER REMOVAL (2016).
SOURCE: GOOGLE EARTH

8.2 Case of Stockholm

Another interesting case can be found in Stockholm, where after introduction of congestion charge city drastically decreased problem of traffic jams (fig. 19). This imposed charge helped to reduce car numbers entering the city center by 20%, which may not seem much, however even this slight decrease reduced traveling time by one third in the morning peak and by half in the evening peak (Eliasson, 2009). Stockholm case gives a hint that solving congestion problems does not necessarily require drastic reduction in numbers of SOV - even slight decrease can have significant results. In

other words - relation between number of SOV and congestion is not direct. After certain point, linear increase in numbers of SOV cause geometrical progression in congestion. Stockholm example might become a basis to question current legacy in Vilnius, because increasing road capacity is simply unsustainable - doubling the number of lanes does not necessarily accommodate double the amount of cars. As a result providing infrastructure for SOV might become more and more expensive if not impossible to afford.



FIGURE 19. PICTURES SHOWS DRASTICALLY DECREASED CONGESTION IN ONE OF THE MAIN ROADS GOING TO CITY CENTER OF STOCKHOLM AFTER INTRODUCING CONGESTION CHARGE. ACTUAL DECREASE IN NUMBER OF VEHICLES WAS ONLY 20%.
SOURCE: SCREENSHOT FROM JONAS ELIASSON TED TALK

8.3 Conclusions

This chapter does not argue that mobility infrastructure within the city is irrelevant, on the contrary - it does have a significant and positive impact on GDP. However fiscal revenue of mobility is lower compared with revenue created by place making. Transit area itself is not valuable, it is a way to reach the place which creates fiscal and social value (Cervero 2009). In other words - road infrastructure should be understood as an addition to place making. Whenever mobility is improved in the expense of economically active space - it becomes damaging for city operation.

At the same time, some researchers claim that traveling modes are also defined by personal preferences and cannot be solved only through taxation, planning and regulations (Rode P. et al., 2015). Research carried out in Berlin and London shows that preferred mode of commuting often becomes an incitement while choosing a residence location and type of living place. For instance people who prefer driving a car often chose to live in a countryside, outside the city in private villas (Rode P. et al., 2015). In these cases regulations often does not have any significant effect because drivers are ready to pay the price. However the fact that these cases exist is not a problem by itself. Real trouble arise with large number of such households. These numbers can be kept under control deliberately making city inconvenient for SOV or integrating single family houses into urban fabric.

Last century of city planning is marked by mass standardised production. Fordism ideals applied to city planning created vast amount of dull (Jacobs, 1961, Gehl 2011) non operational "lost space". While some forward looking cities are already turning back to Fordism ideals - Vilnius is continuously drowning itself in traffic (fig. 21-23). In addition to the fact that SOV cannot solve mobility problems within the city, priority of SOV infrastructure also brings a sharp division within society. It is divided into those who can own (or drive) a car and those who cannot. City is full of four line streets with no pedestrian paths (or ridiculously narrow pedestrian paths), where as a pedestrian person simply feels unwelcome or ridiculed.

For instance during the winter carriageway is always cleaned first, whereas pedestrian paths sometimes are not cleaned for the entire winter (fig. 20). Walking on such path while having cars passing by on perfectly clean road can be extremely demoralizing. Findings displayed in this chapter should become an alternative for current solutions of mobility problems in Vilnius.

Infrastructure expansion, which is usually based on meticulous traffic flow calculations and simulations, fail to take into account all the complexity of urban life. As a result, there is not even a single example of new street constructed, which would include utilized public space. In order to change current situation, it is crucial to get rid of technocratic, market based approach in city planning. As an example of different stance could be election of Antanas Mockus as a mayor of Bogota, who in tandem with Enrique Peñalosa managed to bring biggest reforms in the history of Colombian capital city only in few tenures. Mainly these reforms were brought through performance, arts, education and aim for equity. It would be useful to remember one phrase of Enrique Peñalosa while solving mobility problems in Vilnius. *"Urban transport is a political and not a technical issue"*



FIGURE 20. EXAMPLE OF SIDEWALK COVERED WITH SNOW, WHILE CARRIAGEWAY BEING IMMEDIATELY CLEANED.
SOURCE: <http://kaunas.kasvyksta.lt>



FIGURE 21. TRAFFIC JAM IN KALVARIJŲ st. FROM CITY CENTER TOWARDS SUB-URBS. LINE GOES UP TO 1.2km, (TILL THE PREVIOUS CROSS), BUT USUALLY THE LINE GOES BEYOND PREVIOUS CROSS. THEREFORE IT MIGHT REACH 1.5 - 2km. 17:00 (AFTER WORKING HOURS)



FIGURES 22-23. TRAFFIC JAM IN KALVARIJŲ st. FROM SUB-URBS TOWARDS CITY CENTER. IN THIS PARTICULAR CROSS, LINE OF CARS GOES UP TO 1.5km, BUT IT IS ONLY ONE OF NUMEROUS CROSSES THAT CREATES TRAFFIC JAMS GOING FROM "BALSAI" SUB-URB. 7:40 (BEFORE WORKING HOURS)

9. URBAN ENCLAVES – RISK AREAS OF EXTREME GENTRIFICATION

Most well known example of successful gentrification in Vilnius is Užupis. This area was not included to Unesco heritage preservation program, therefore after 1992, while the rest of the city center was refurbished after Soviet times, it became left over district with a bad reputation. After group of young artists from arts academy moved in and squatted an abandoned building (Aidukaite, 2016), Užupis slowly changed its face. Squatted building became a local cultural center for residents of Užupis, which formed a sense of community and slowly rehabilitated the bad name of district. Squatters were not evicted because of strong support from residents. Gradually former squat became an informal art gallery with cheap working space for artists.

However besides soft gentrification there are also extreme examples. Most well known case is district of Šnipiškės, which became a target of big investors before crisis in 2008. It is an urban enclave located in the city center, mainly built up with old wooden houses. Since southern part of the neighborhood was devoted for redevelopment in 2000 - it opened a “Pandora’s box” of developers trying to obtain land plots from current residents and use them for high revenue commercial projects. This was the time of deep uncertainty for local residents (Aglinskas, 2014), people were waiting either for an offer to sell or a threat. During the period of 2000-2007 many houses were burned down in order to make space for development. It was quiet for a while after real estate market was hit hard in 2008. However in 2015 another house was burned down in Rinktinės st.

The former owner - Vacys Butrimas, who refused to move out, was found dead inside the ruins (15min. It, 2015). For the moment the same site is being developed as luxurious apartment complex by one of the biggest real estate development company “Merko statyba” (fig. 25).



FIGURE 24.
HOUSE FIRE IN RINKTINĖS st., 2015
SOURCE: 15min



FIGURE 25.



FIGURE 26.
PROJECT CURRENTLY BEING IN
SOURCE: www.rinktinesurban.lt

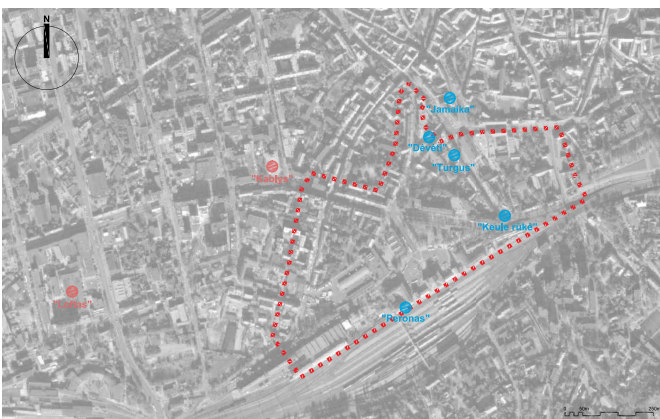
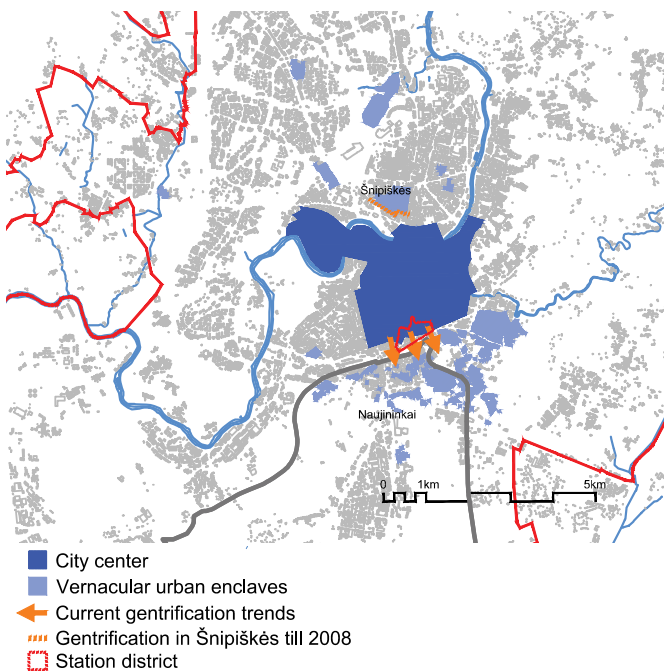

FIGURE 27. FEW DECADES AGO GENTRIFICATION FRONTIERS WERE ARTISTS (CASE OF “REPUBLIC OF UŽUPIS”), THEN THEY WERE REPLACED BY ANARCHISTS (CASE OF “KABLYS”, “GREEN CLUB”, “LOFTAS”), FOR THE MOMENT MAIN INDICATOR OF GENTRIFICATION BECAME TRENDY HIPSTER BARS. CURRENTLY THERE ARE 5 NEW BARS OPENED IN STATION DISTRICT, WHERE RENT PRICES DOUBLED IN THREE MONTHS.

Physical features of Šnipiškės might resemble current sub-urban sprawl (Cirtautas, 2015), however these houses have far reaching history, strong communal bonds and usually goes together with informal economy (Aglinskas, 2014). It is a remaining example of vibrant community where neighbors still know each other, recognize strangers on the street, take after each other’s children, practice small scale urban gardening etc. Šnipiškės is not the only remaining enclave of this kind. Towards south-east from the city center concentration of this kind of neighborhoods is even higher. Having in mind that gentrification in station district is rapidly taking place, risk of violent land acquisition and evictions in Naujininkai is ever increasing. In order to prevent such processes it is important to understand the very nature of gentrification that takes place in Šnipiškės. Land acquisition in forced way is only possible in neighborhood where one land plot is owned by one owner. For instance this kind of eviction would not be possible in Užupis, where one plot of land and one building has multiple owners. Considering Lithuanian property rights evicting or even buying this kind of property becomes extremely difficult. However neighborhoods such as Naujininkai (Urbonaitė-Barkauskienė, 2014) and Rasos is in a very similar situation as Šnipiškės in the year 2000:

- **It is located within close proximity with a city center**
- **Neighborhoods are deprived, therefore land prices are low**

These three properties very much increase probability of investment targeting land in these neighborhoods. Furthermore, station district (district located next to Naujininkai), which was considered to be deprived area, now is rapidly gentrified. Since property in Naujininkai is relatively cheap (it is possible to buy a private house for €43,000), after selling their property, people without extra money, can only afford living place in cheapest parts of mass housing areas, previously mentioned as areas increasingly concentrating poor and uneducated people.

10. SAFETY

Since Lithuania has a very high levels of crime (for instance homicide rate is highest in Europe) it is important to address safety issue in Vilnius and how it might be related with increasing social segregation.

According to various reports on safety in Vilnius city center is indicated as area with highest crime rates. However V. Ceccato, and N. Lukyte (Ceccato and Lukyte, 2011) claims that these reports does not reflect actual sense of safety. Survey conducted on citizen’s perception whether area where they live is safe, indicates that city center is the safest place in Vilnius. According to Bernd Belina (2012) police reports does not represent real crime situation in Vilnius, because there is higher concentration of police forces within city center. Another reason might be that people in particular areas do not report criminal activities:

If social cohesion is poor, residents will not bother to make a call.(Ceccato and Lukyte, 2011, p.89)

Social researchers such as Kornhauser (Kornhauser, 1978); Sampson (Sampson et al., 1997), Shaw & McKay (Shaw and McKay, 1942), suggests that one of the main reasons for geographical distribution of crime is poverty and exclusion in a particular geographical location. As indicated in the following map (Fig. 32) felling of exclusion may already be present, since unemployment rates correlates with concentration of ethnic minorities within particular neighborhood.

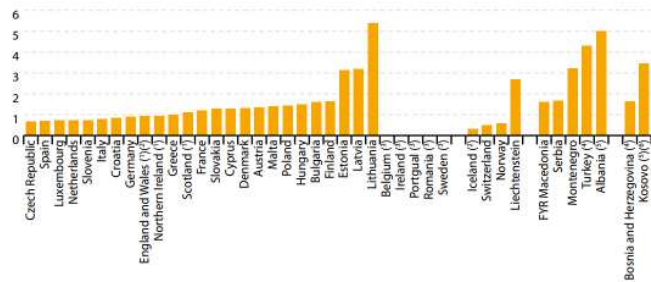

FIGURE 28. HOMICIDE RATE IN LITHUANIA IS HIGHEST IN EUROPE – 5.4 HOMICIDES PER 100 THOUSAND INHABITANTS. **SOURCE:** [HTTP://EC.EUROPA.EU/EUROSTAT/DOCUMENTS/3217494/7745644/KS-02-16-996-EN-N.PDF/EAE6B7F9-D06C-4C83-B16F-C72B0779AD03](http://ec.europa.eu/eurostat/documents/3217494/7745644/KS-02-16-996-EN-N.PDF/EAE6B7F9-D06C-4C83-B16F-C72B0779AD03)

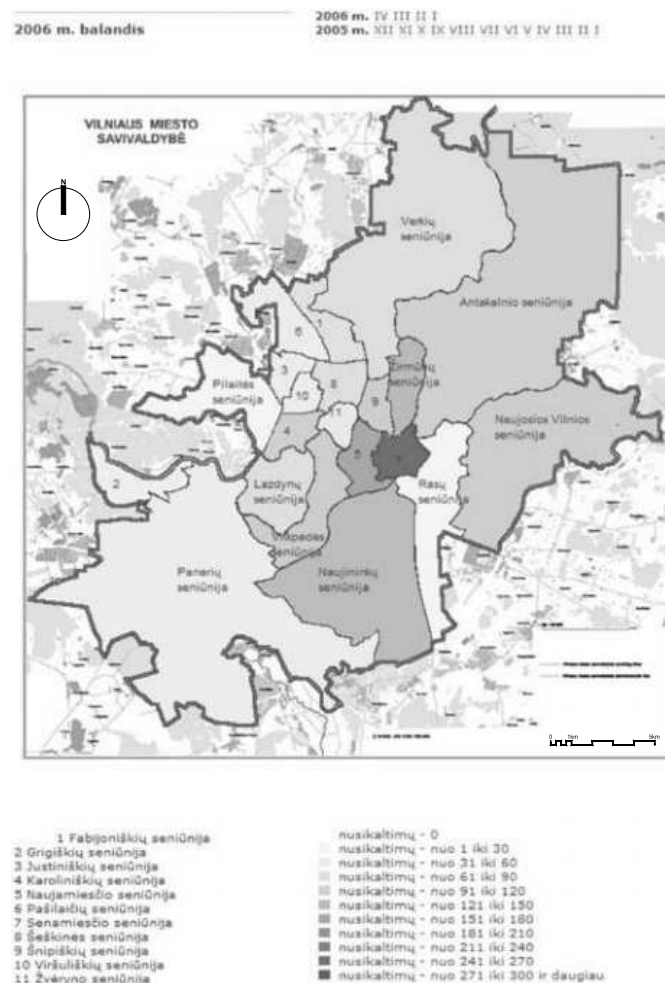

FIGURE 29. DARKER COLOUR ON THE MAP INDICATES HIGHER NUMBER OF POLICE REGISTERED CRIMES. 2005-2006 SOURCE: [HTTP://WWW.VILNIUS.LT/NEWVILNIUSWEB/INDEX.PHP/46/](http://www.vilnius.lt/newvilniusweb/index.php/46/)

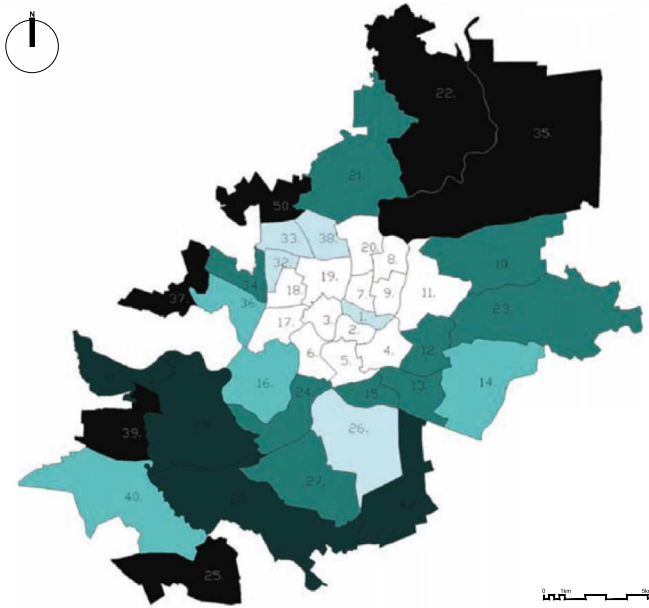

FIGURE 30. VILNIUS KEY PROBLEM-AREAS ACCORDING TO THE CITIZEN'S PERCEPTION, 2005. DARKER SHADES INDICATES MORE PROBLEMS WITHIN PARTICULAR AREA. **SOURCE:** BARDAUSKIENE (2007).

Other urban researchers claim that safety is directly related with physical features of space.(Gehl, 2011, Jacobs, 1961). For instance that spaces with more economical or leisure activity tends to be safer, because it goes along with more presence of other people. According to Jacobs (1961) potential criminals rather chose remote areas far from presence of other people. Another physical aspect mentioned by Jacobs is clear separation between public and private. Freely standing buildings tends to create perfect conditions for gang formation, because boundary between public and private is blurred (Jacobs, 1961). In Lithuanian case both of these aspects - confusion between public and private and absence of economical activities can be found in mass housing areas.

Considering spatial features of space urban theories of Gehl (2011) and Jacobs (1961), suggests that city center of Vilnius must be one of the safest places in Vilnius. This idea also coincides with resident's opinion about safety of their own environment (Figure 30). However Data on thefts and robberies indicates that city center is one of the most popular areas among criminals (Fig. 31. sections b,d). Research conducted by V. Ceccato, N. and Lukyte, (2011) suggests that it is more important to look beyond actual crime geographies, but rather look at everyday life, habits and background of particular criminal.

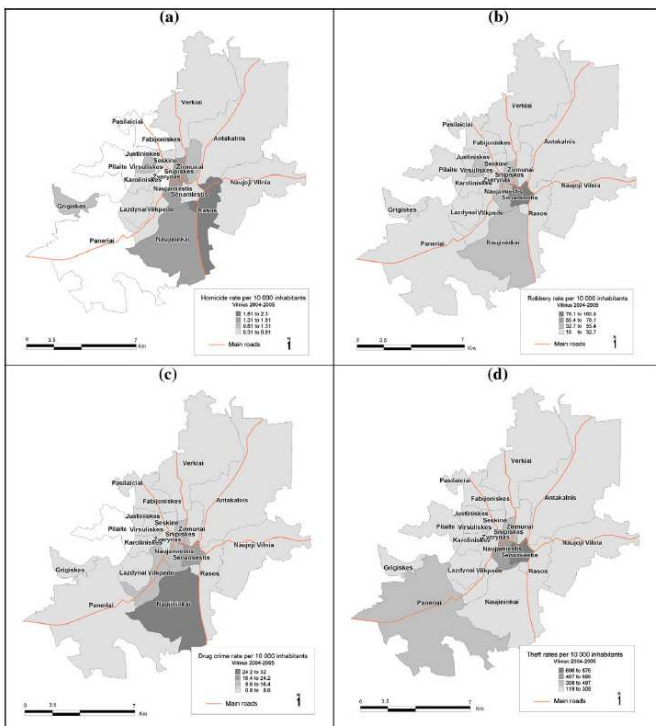

FIGURE 31. OFFENCE RATES PER 10,000 INHABITANTS IN VILNIUS 2004–2005, (A) HOMICIDE, (B) ROBBERY, DRUG-RELATED CRIMES AND (D) THEFTS. **SOURCE:** V. CECCATO, N. LUKYTE, 2011.

Despite the fact that particular area can have all the physical and social features of being safe it might become unsafe because of deprived area located within close proximity. In other words criminals such as thieves might travel outside deprived area in order to find rich victims. As mentioned before, most of thefts and robberies in 2004-2005 were registered in city center, which is considered to be one of the safest district, homicides (Figure 31. Section a) seems to coincide with deprived areas of the city. Most of homicides in Lithuania are committed while using alcohol, during domestic conflicts, which in most cases happens in a place of residence.

Survey in 2010 showed that thirteen out of fifty-three (around 25%) newly built neighbourhoods with detached or semi-detached houses in Vilnius region were gated and guarded (KRUPICKAITĖ et al., 2014) Some social researchers claim that security for one social group sometimes is achieved in expense of other social groups.

This emerging new pattern of individuals' movements in Vilnius constitutes a direct challenge to the ideal of social sustainability, since the sense of urbis as a place of co-existence in space is threatened by people's fear of crime and their selective access to security commodities. (Ceccato and Lukyte, 2011, p.90)

This suggests that increasing number of gated communities (KRUPICKAITĖ et al., 2014) and social stratification (Tereškinas et al., 2013) might have a significant effect on safety, since it increase the feeling of seclusion for deprived social groups. While at the same time, advocates of social mixture (Jacobs, 1970, Sampson et al., 1997) claim that integration between different social groups have economical and social benefits for both – socially secure and less socially secure people. Low income people can provide with labor and services, Higher income people provide with employment and capital.

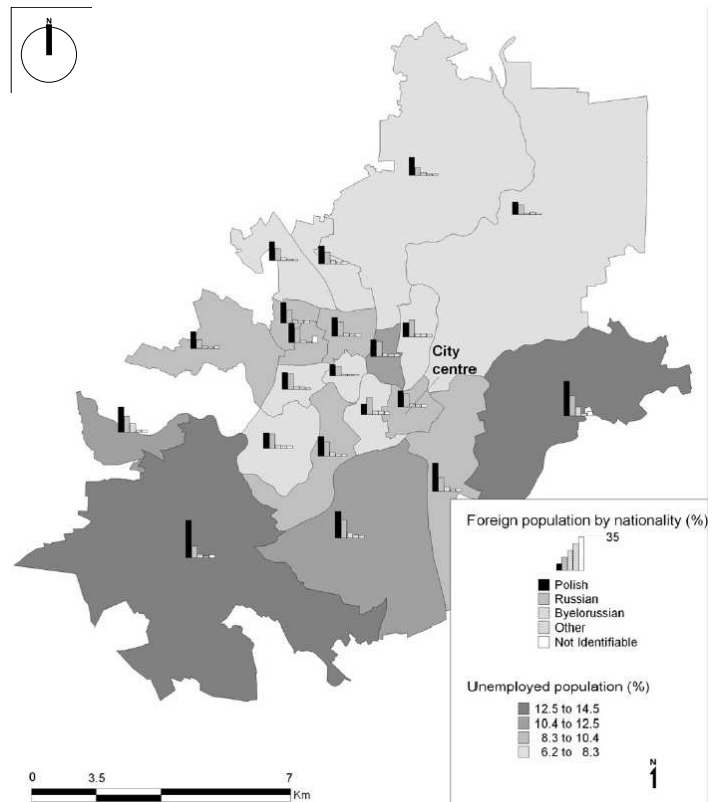

FIGURE 32. POPULATION BY NATIONALITY (%) AND UNEMPLOYED (%), FROM 15 TO 65 OF AGE, VILNIUS 2001.
SOURCE: OSP, OFICIALIOSIOS STATISTIKOS PORTALAS

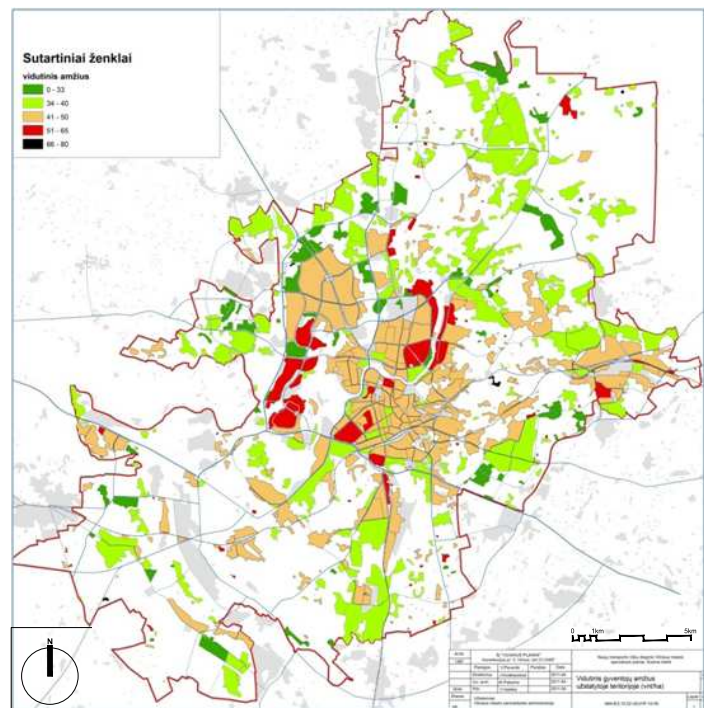
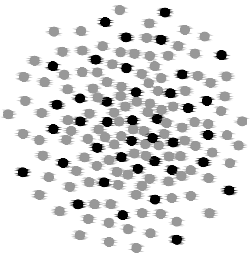

FIGURE 33. AVERAGE AGE OF POPULATION IN DIFFERENT PARTS OF THE CITY. DARK GREEN REPRESENTS AREAS POPULATED MAINLY BY YOUNG PEOPLE.
SOURCE: [HTTPS://WWW.VILNIUS.LT/VAKTAI2011/DEFAULTLITE.ASPX?ID=3&DOCID=30243678](https://www.vilnius.lt/vaktai2011/defaultlite.aspx?id=3&docid=30243678)

11. SEGREGATION AND INEQUALITY

There are 4 major types/levels of segregation found while conducting this research:



1. Differences are equally spread

Ex.: Gender, Hair/eye colour, age etc.
(of course there can be cases when these features can be segregated)

Differences exist, but they are not perceived

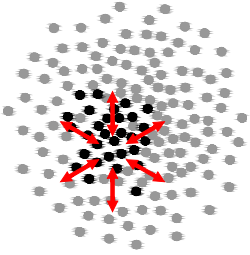

2. Natural concentration of particular social groups

Ex.: Chinatowns; different dialect; migrant areas etc.

Differences are perceived, but interaction remains as self evident action, without any effect of conflict. It is perceived as positive/attractive diversity.

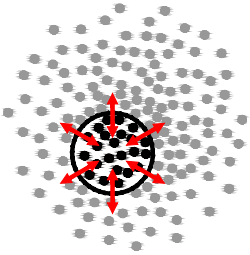

3. Self isolation (usually conscious act)

Ex.: Gipsy settlements; Christiania; Zapatista uprising

Differences are perceived. External actors are usually willing to integrate excluded part, but strong resistance within self-excluded group allows to operate (partly) independently. Usually excluded group is easy to integrate in case commitment of self-exclusion weakens in time

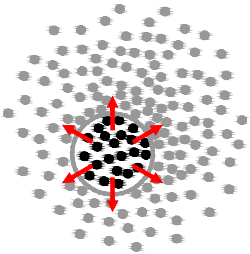

4. Rejection (isolation caused by external forces)

Ghettos; prisons; Indian reserves;

Interaction in most cases becomes limited and unilateral. Isolated group is still dependent on external resources/capital/jobs/regulations. Technically these groups are usually difficult to integrate.

Most of the problems arise when conditions of isolated group becomes visibly worse - in that case it can lead to social unrest.

Levels of segregation in European cities are still modest in comparison with American or African cities, however disparities are rapidly growing. City of Vilnius is not an exception, according to research conducted by Szymon Marcińczak, Sako Musterd, Maarten van Ham, Tiit Tammaru (2016) social segregation is on the rise. Having in mind that inequality by income in Lithuania is one of the highest in Europe, rising levels of spatial segregation is likely to create serious social problems in the future.

While many researchers still do not agree if segregation can lead to social unrest, in 2007 Tallinn, ethnic Russians clashed with police because of soviet monument that was about to be removed.

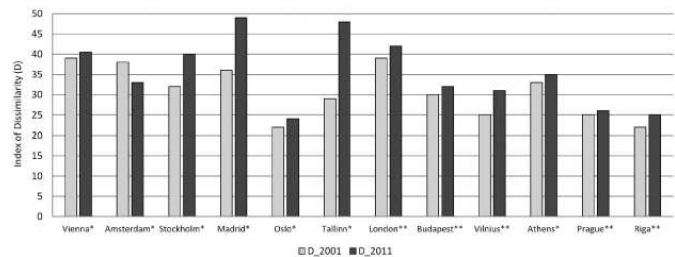

FIGURE 34. COMPARISON OF WEALTH DISSIMILARITIES IN DIFFERENT EUROPEAN CAPITAL CITIES IN THE YEAR 2001 AND 2011
SOURCE: MARCIŃCZAK (2016).



FIGURE 35.
SCENE FROM 2007 RIOTS IN TALLINN
SOURCE: ETV

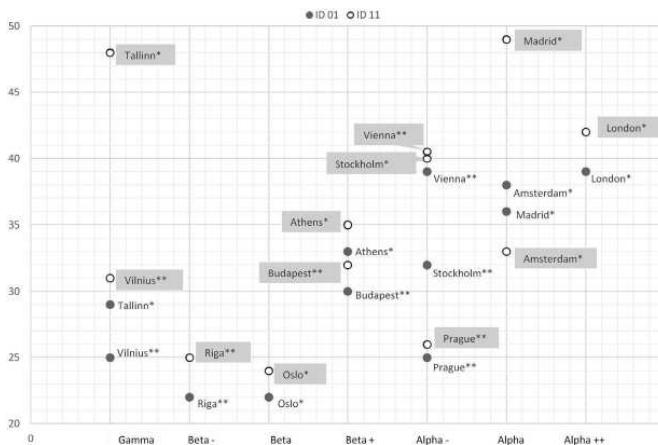

FIGURE 36.
CORRELATION BETWEEN GLOBAL CITY STATUS AND RESIDENTIAL SEGREGATION BETWEEN TOP AND BOTTOM SOCIAL GROUPS IN SELECTED EUROPEAN CITIES. DATA INDICATES FLUCTUATIONS BETWEEN THE YEAR 2001 AND 2011.
SOURCE: MARCIŃCZAK (2016).

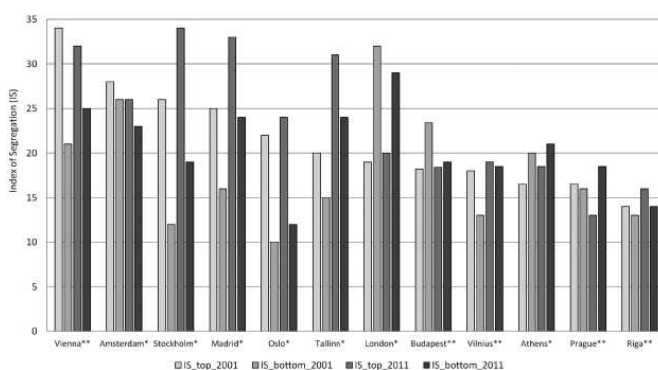

FIGURE 37.
COMPARISON OF SPATIAL SEGREGATION FOR TOP AND BOTTOM SOCIAL CATEGORIES IN DIFFERENT EUROPEAN CAPITAL CITIES. DATA INDICATES FLUCTUATIONS BETWEEN THE YEAR 2001 AND 2011.
SOURCE: MARCIŃCZAK (2016).

It is worth mentioning that social segregation and wealth dissimilarities in Tallinn was rising rapidly between 2001 and 2011 and is one of the highest among European capital cities. While cause of riots could be explained by intentions to remove the monument, high levels of spatial segregation partly explains why ethnic Russians still does not feel to be part of Estonia.

According to Saskia Sassen (1991) truly globalized cities tend to concentrate more well paid jobs in service sector as well as low paid jobs associated with serving the better-off. City developed in this way inevitably will be polarised. In most of the cases cities had to be transformed from low skilled manufacturing - to knowledge intensive service sector. Exactly the same processes are taking place in Vilnius at the present day. In figure 32 we see higher rates of unemployment in southern part of the city, predominantly oriented towards traditional industry, which currently is rapidly declining. While at the same time we can see high concentration of working places in the city center (fig. 66), which is oriented to knowledge intensive service sector.

There are several factors which could be distinguished as main causes of social segregation in European cities (Szymon Marcińczak, 2016):

- Neo-liberal housing regimes. Accessibility to housing is defined by market forces.
- Short-term economic, financial or housing crises
- Globalisation - shift from traditional industry to knowledge intensive service sector.
- Physical urban fabric. Some areas tend to concentrate particular social groups.

All of these factors can be found in Vilnius. For the moment most segregated social group in Vilnius is the high class (Szymon Marcińczak, 2016), however bottom class is becoming increasingly segregated compared with the year 2001. From all data collected there are 5 characters of segregation that can be observed in Vilnius:

- **Ethnicity** (fig. 32)
- **Income** (Tereškinas et al., 2013)
- **Age** (fig. 33)
- **Type of employment** (Szymon Marcińczak, 2016)
- **Education level/type** (Tereškinas et al., 2013)

The fact that differences between distinct areas in Vilnius are already visible and they are on the rise is a worrying trend. While some of segregation characters are self conscious, others are caused by external forces and social groups are being rejected. Presence of this type of segregation is especially alarming condition. Issue of segregation cannot be solved by planning alone, but it has to take its share and contribute to reduction of social/economical disparities.

12. CONCLUSIONS

While processes of gentrification and social stratification itself can be harmful (as it happened in case of Šnipiškės), it is also important to look beyond single acts of brutal displacement. It is crucial to understand damage made by displacement since it tends to enforce concentration of poverty in one or several particular localities, where real estate is cheap enough for displaced people. According to Sampson, R. (1997) poverty and social exclusion might become one of the main reasons for sense of insecurity and distribution of crimes in urban areas. Furthermore it tends to isolate residents from key resources, therefore once particular area become problematic – situation tends to get worse by itself. Having in mind that in case of Vilnius, urban enclaves such as Šnipiškės has its own informal economies, disassembling such processes can be especially damaging for people for whom it is the only source of income. It is important to mention that informal economy in these urban enclaves is entirely dependent on communal bonds and local trade. Once community is displaced for most of the people it is extremely hard, or even impossible to tie new communal bonds (Jacobs, 1961). Even more extreme examples in Europe shows that concentrating and isolating vulnerable parts of society might lead to massive eruption of violence as it happened in France 2004, United Kingdom 2011, Stockholm 2013 or 2007 in Tallinn, Estonia. All of these cases indicate that eruption of violence is closely related with socio-economic segregation. In all case preconditions for violence were:

- Secluded social group founds itself in worse condition in comparison with the rest of the society
- There is always a triggering action, such as abuse of power; unacceptable political decision; or similar

While on the other hand there are successful examples of gentrification and integration as it happened Užupis. Learning from these practices can help to improve situation in neighborhoods, such as Vilkipėdė or Šnipiškės before existing qualities are completely destroyed. Injecting cultural activities and engaging local residents can improve social cohesion as well as add culturally rich space, which would be beneficial for the city as a whole. It is important to mention that not even a single culturally active space in Vilnius has been created by speculative investment (Čiupailaitė, 2012). Therefore attention for existing grass-root activities should be brought to a political level.

13.

PROBLEM FIELD

In this research issue of social segregation, increasing concern about safety, pollution were used as indicators about existing spatial differentiation, which is mainly caused by lack of economically and culturally rich urban space in particular parts of the city. In other words - lack of urbanity. The need for everyday commuting to urban areas and high real estate prices in central districts indicates that there is a huge demand for such spaces. However supply of such environment does not exist. Limited amount of such space created huge economical pressure on centralities, therefore it only became available for very few who can afford such convenience. The rest of the city has to live with a consolation that city is somewhere near by and it is possible to travel there. Considering possibility to create more urban space in Vilnius it is crucial to understand that urbanity cannot be created only by introducing mixed use in legal framework. Real urbanity, which creates sense of place and forms communal bonds requires social mixture (Jacobs, 1961), otherwise urban activities cannot survive. But since after collapse of Soviet Union state completely withdraw from housing provision policy and market forces overtook a power of decision who can live in a particular place, possibility to create such place seems to be less and less plausible. Therefore speculation became main driving force in housing market, leading to continuously homogenized built environment. In order to create new urban environments in Vilnius there is an urgent need to rethink relations between public institutions and private dwellers.

RESEARCH QUESTION

How better integration between public and private domains can help to create new urban environments in post-Soviet Vilnius?

- How co-creation can become a way to generate well functioning, vibrant public space?
- How public-private integration can create better legal and spatial conditions for self-employment? How self-employment can improve economical environment and make city more resilient for economical shifts?
- How co-operation between public institutions and local communities can lead Vilnius towards more sustainable development?
- How government should assist self-helped initiatives in order to provide Vilnius with affordable housing? What is the relevance of integrating poor into a city development?

14. STRATEGY

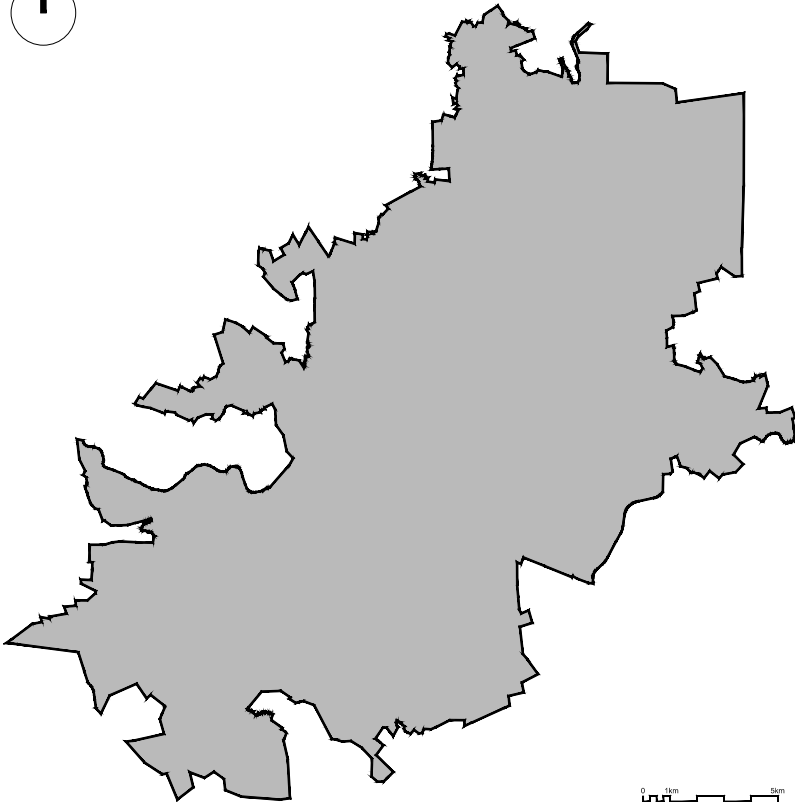

- Power supply
- Water supply
- Pipelines
- Streets
- Sewerage
- Maintenance of infrastructure

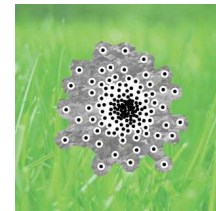
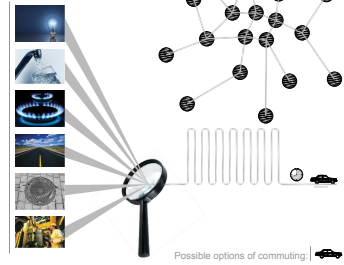

Average population density in Vilnius is 13.7 residents/ha. That is extremely low number compared with other European cities. For instance in Vienna, which covers approximately the same area as Vilnius (Vilnius - 40100 ha; Vienna - 41500 ha), population density is 42 residents per 1 ha. That is 3 times more than population density in Vilnius. Such scattered city goes along with several side effects - because of extremely long distances to be covered in order to reach, private car became the most popular way of commuting (there are 515 registered cars per 1000 inhabitants, which is twice as high comparing with Amsterdam). Other side effect is that city cannot provide sufficient infrastructure for many of the residents, as an example - there are approximately 500km of unpaved streets in city of Vilnius. These numbers gives us a glimpse that maintaining such a vast amount of space is extremely inefficient and this actually reflected in city financial situation - annual city budget in the year 2017 is €510.500.000. And while being the capital city, the most important financial hub in Lithuania, with a lot of foreign investment - city is in debt of €300.000.000. Despite the fact that part of this debt could be related with corruption, it is clear that city simply cannot sustain itself under current development strategy and it needs serious reforms.

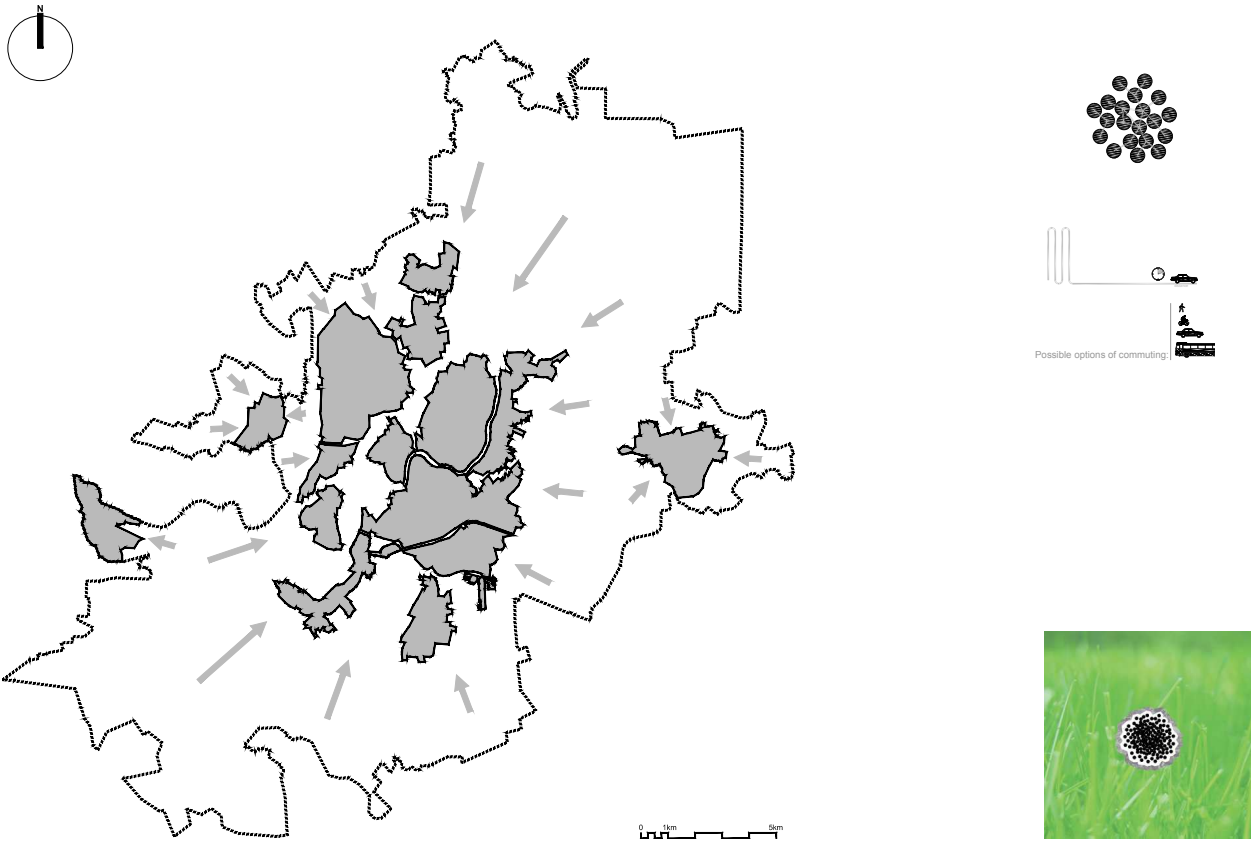

As one of the first steps towards change of development strategy should be city densification. Despite the fact that Vilnius is one of the few cities, which are still growing in terms of population number, it is not realistic to densify entire city area. Therefore the main focus should be allocated on already urbanized areas, where most of the infrastructure is already in place. While at the same time halting any kind of new construction on the outskirts, where infrastructure is not provided.

City area can be reduced to 73km² (18% of current area). Entire population accommodated within this area would create density of 79 residents per 1ha. This part of strategy does not necessarily have to change official city boundaries (it would be extremely difficult in bureaucratic terms), it could simply limit construction outside the development zone. This would reduce city footprint and damage to the nature, lower costs of city maintenance and reduce daily travelling distances in the future.

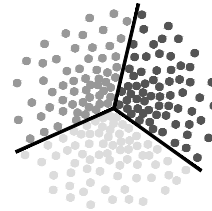
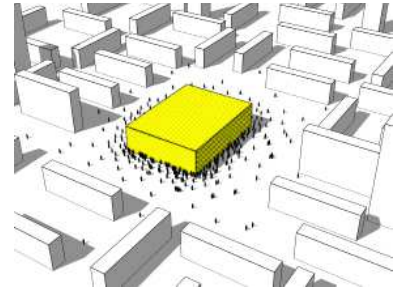

While some of the problems can be solved by densification, existing situation requires that this strategy would be directed in a particular way. City of Vilnius consists of 6 clearly distinguishable patches with distinct urban fabric.

- Historical city center
- Vernacular urban enclaves
- Mass housing areas
- Commercial districts
- Industrial sites
- Sub-urbs

All of these parts contains completely different urban qualities, therefore they require completely different approach while implementing densification strategy. Further this project will be separated into 6 different proposals for each of these parts. While dealing with some parts there can be more concrete actions taken in the near future, therefore it will suggest specific solutions, other parts are just describing possible risks in the future and providing conceptual guidelines for possible solutions.

Overall aim of this strategy is to diminish existing spatial differences and uneven facility distribution. Reason behind is that particular city parts tend to concentrate socially insecure residents and because of inaccessibility to key resources - these neighborhoods tend to get worse during the time (Sampson, R., 1997). If we look closely to the analysis part we can see clearly that deprived city neighborhoods have poor access to some of the amenities (such as cultural facilities - theaters, cinemas or simply public events), therefore levels of usage are significantly lower (Tereškinas et al., 2013). Economic activities are based on large scale industry/commerce, where residents play a role of a "guest" instead of having a status of stakeholder. Therefore, in case gentrification processes takes place - occupants of such neighborhoods are extremely vulnerable, because they are simply moved out from one deprived neighborhood to the other. This principle creates no condition whatsoever for socially insecure people to improve their status in time.



This part of strategy could be described as homogenization through diversification. It should **not** be understood as a strategy that aims city to fatten all differences between separate parts of the city, on the contrary - different characters are more than welcome. It means that each of the existing patches should include equal opportunities in comparison with each other, at the same time it would accommodate range of social groups and different activities within itself. Homogenization would mean that people from particular location should be able to access job market, create their own businesses, have social and cultural activities within the neighborhood, have equal access to educational/health care facilities etc.

Aim of this strategy is to reduce negative aspects of gentrification. In case residents of particular area would be replaced - it would not necessarily lead to negative impact, because they would find the same quality of life anywhere else. At the same time driving forces of harmful gentrification would be dispersed. If urban qualities would be the same across the city focus of investors would be removed from one (or several) particular spots. In that sense market forces could be turned into catalyst instead of being threat for some residents. In order to achieve that - investors also should change their attitude - instead of one large scale investment, they should be convinced to have several small scale sites incorporated into diverse urban fabric. Dispersed market pressure would ensure more secure ownership rights for all residents. If enterprise interest is focused on particular location/group - this group cannot influence political decisions due to small number of residents. While dispersed investment focus in principle would turn all of the residents into targets. This would create a critical mass of residents requesting more state protection. Simply because of sheer number of voters - government would be pushed towards favorable decision.

15. ANALYTICAL PLANNING MODEL

This analytical model was made in order to explain spatial planning methods chosen for distinct parts of the city. This diagram briefly indicates how particular spatial features influence urban processes and how spatial features can be used in order to shape these processes differently. It will help easier understand design methods chosen in each of the design site. It is important to stress that this diagram is not a design tool kit - but a visual information to understand logic behind ideal city model.

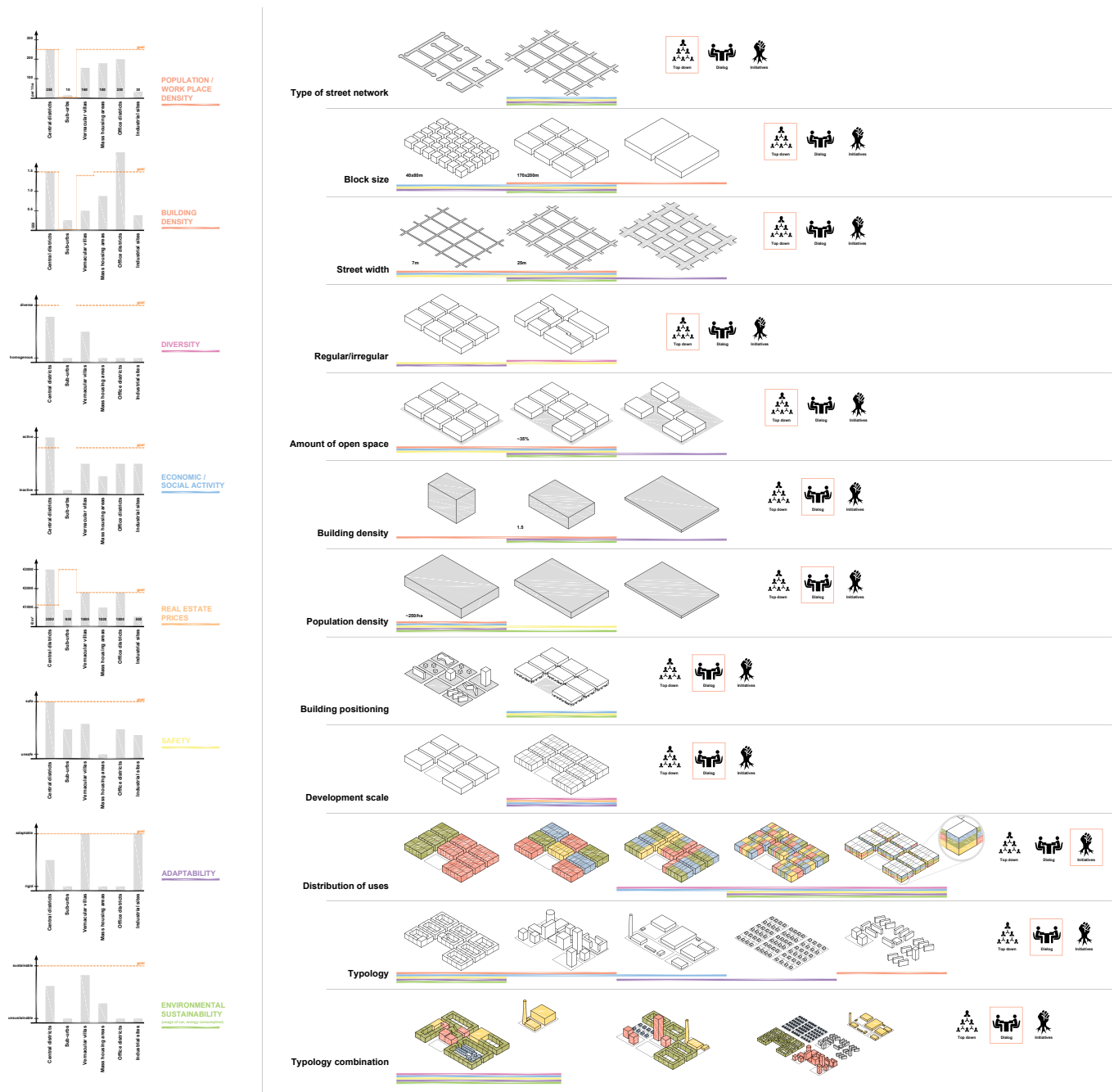

15.1 Ideal model

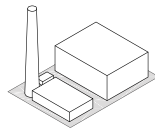
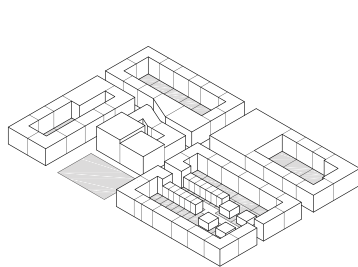

Integration of different uses:

- Residential
- Commercial / public facilities
- Industrial
- Flexible spaces

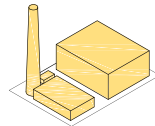
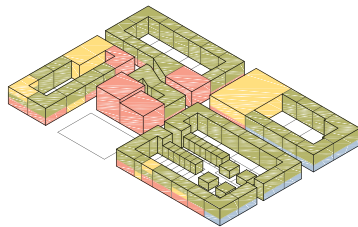

Integration of different typologies:

- Apartment buildings
- Industrial buildings
- Office buildings
- Villas / row houses

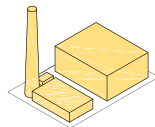
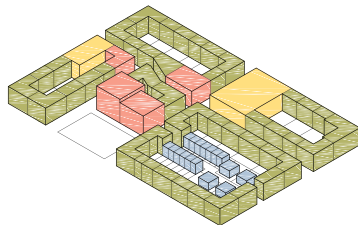

Integration of different income groups:

- High income
- Middle income
- Low income
- Owned by high income residents
- Owned by middle income residents

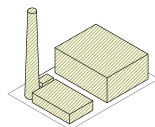
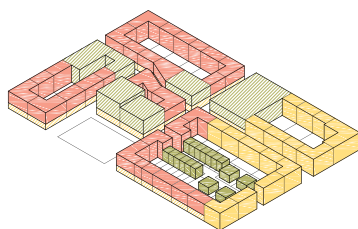

- Different typologies combined together. It has to accommodate apartments, town houses (row houses), detached houses, commercial buildings, public buildings, industrial buildings combined together in a way that it forms a coherent and continuous urban fabric.
- Urban fabric has to be able to accommodate different uses. Instead of using clustering method - functions have to be dispersed and mixed in building and street scales. Residential, commercial, cultural, industrial activities has to overlap. This helps to create lively space 24/7.
- Street scale has to vary from 6m to 15m for local importance streets, 20 - 25m for city transport corridors. There has to be a great attention devoted to create narrow streets, because at the moment this scale is completely missing in new developments. (for the moment streets usually are being overscaled due to fire, traffic and car parking regulations)
- Building height should not exceed 5 storeys (in exceptional cases it can go up to 6 storeys using penthouse storey) in order to keep relation with the street.
- There has to be a significant focus on forming street plinths. This is the most important step in order to make attractive public space (street has to be understood as most commonly used public space).
- In order to make formation of street plinth possible - buildings have to be aligned with the street. This creates a direct access from the street, which is crucial for retail to exist.
- City has to consist of a small grain. In order to avoid long monotonous facades - plot edge facing the street cannot exceed 35m (preferably it has to be smaller). This is another precondition in order to have a successful plinth strategy. Long, monotonous facades, with only few entrances, accommodating single use - tends to be unattractive and boring. In exceptional cases when there is a need for large office or industrial building - it has to accommodate different uses on the ground floor.
- All Streets have to be pedestrian friendly, no matter what other modes of traffic it accommodates in addition.
- Real estate market has to be socially just It cannot be conditioned only in terms of neo-liberal principles. People with low income, who contribute to the urban life culturally/socially/academically/etc. has to have full accessibility to housing market.
- There has to be directive policies towards more sustainable life style in urban areas. (like CO2 tax)

15.2 Guidelines

1. Designing for self-employment

Each neighborhood has to create certain number of working places in relation how many working age people live in a city. Obviously numbers of working places cannot match 100% with demand because central locations tends to concentrate more, but there has to be an attempt to satisfy existing need within each neighborhood.

Understanding of commercial function within the city has to be changed. Instead of designating commercial areas - it has to be changed into flexible spaces within any kind of building. In other words grain of one commercial unit has to be drastically reduced (from commercial districts designated by master plan - to small shops, offices or workshops integrated into residential buildings). Previously conducted analysis has proven that city parts including clear block system built up on the perimeter with small building units along the street - are more favorable for commercial activities. It is clearly visible in map of workplace distribution - city parts with block system accommodates ~40% of all workplaces in Vilnius. Also there has to be a shift in definition how commercial activities are functioning within the building. Instead of strict division - commercial and residential spaces can be merged together. (for instance – space can become an office from 8:00 to 17:00, and be a living room for the rest of the day). Activities additional to living should be regulated from the point of whether they have any negative impact on neighbor living condition.

In order to avoid residential areas being overtaken by successful businesses certain limits has to be set for amount of space used for commercial purposes. Every residential unit has to have a right to create its own income source, but preferably it has to be located next to living space. Amount of remotely owned commercial space has to be less than 50% of actual area and less than 50% of property units within one urban block. In that sense original residents would always have more power in decision making. Newly developed (or redeveloped) areas has to begin by implementing streets devoted for mixed use, constantly checking the number of working places created. Whenever the required amount is reached the rest of the streets can be developed as residential if there is a demand.

2. Environmental sustainability

People should be motivated to live closer to their working places by introducing CO2 emission fees for those who live further than walking distance. There has to be more effective resident registration procedure, because for the moment most of the people are registered in other places than they actually live (without more effective registration system CO2 tax would not work). Since most of the production is not polluting anymore it can be included to residential areas. Main reason of doing so is to reduce daily traffic flows towards working places within industrial areas.

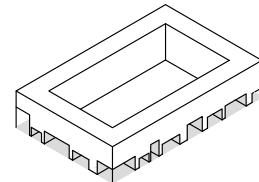
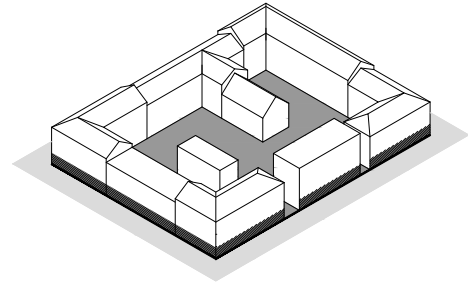
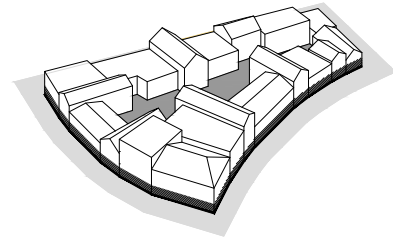

Public space could be extended using private court yards as a space for various business purposes (for instance restaurant)

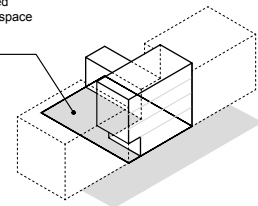

9:00 - 22:00

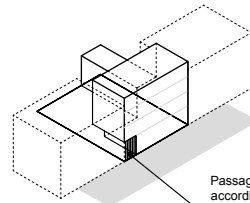

Passageway could be closed and opened according to business type and particular needs of residents

22:00 - 9:00

3. Density

In order to be functional city has to contain certain population density, otherwise facilities and infrastructure becomes too expensive to maintain. Long distances make traveling more expensive and time consuming. High density also means that city have a smaller footprint and cause less damage for nature. However the same density used in different configuration can have completely different effect. It can increase or diminish quality of life; improve interaction between different entities or make it impossible etc. Free standing buildings usually has better insolation, they are easier to implement using repetitive projects or prefabricated building materials. While buildings aligned along public space (street) are more suitable for commercial activities, create sense of place and safety, better and more efficient climate control.

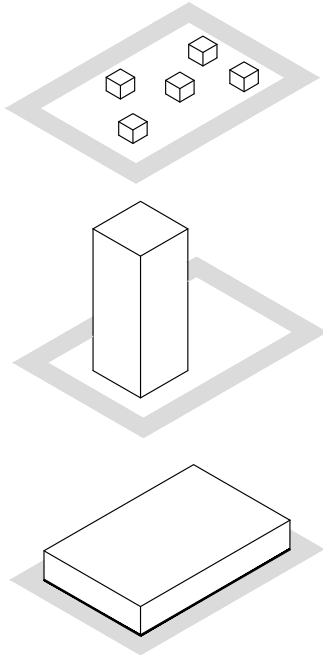

4. Diversity

Concentration of vulnerable social groups in certain locations has to be stopped. In order to achieve that - municipality has to take active role in housing provision policy. But instead of creating social housing, which expose resident incapacities and deepens marginalization, people with low income have to be provided with living place, which becomes a tool to earn a better living. Instead of focusing exclusively on housing, problem has to be understood with all its complexity – housing in relation with employment, production, culture etc.

One of the main leverage to create different kind of housing is publicly owned land. It can be either land which is already owned by municipality, or land which potentially can be obtained from private owners (for instance acquiring abandoned industrial areas for relatively low price). Part of this land, preferably within areas already provided with infrastructure, has to be devoted for new developments. In order to include people with low income land has to be taken out from the market, where under normal market conditions it would be sold for highest price. Instead - prices have to be fixed. In order to obtain land plot - people have to bid with their ideas. Bidding process would be proceeded as a competition, where main criteria to chose the best idea would be a contribution to a common good.

Property obtained through this competition, cannot be used as a speculative commodity and resold for higher price for at least 5 years. Owner obtains its full rights to land ownership only after the project fully developed and ready for implementation. In this case both sides would be motivated to finish project as soon as possible. In case owner is not able to develop original idea or project turns out to be not feasible - municipality can take the land back.

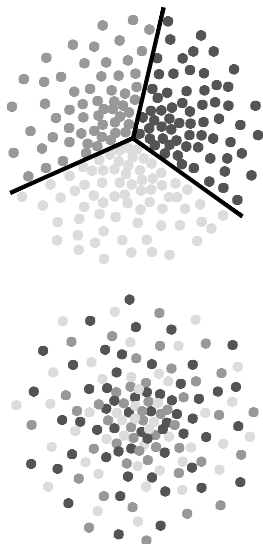

5. Urban fabric adaptability

Reducing development scale. History has proven that large scale developments are much more brittle (in terms of economical operation, ability to accommodate spatial changes, etc.) than small scale dwellings. In case of residential buildings main problem usually is multiple owners who are very difficult to negotiate if there is a need for spatial modifications (extensions in case of family increase, introducing different functions, subdivision, etc.).

Extended families (common spaces).

6. Safety

Along with better integration of marginal groups there has to be spatial implications which would improve safety measures in Vilnius. Open space has to be clearly defined by multiple buildings aligned along the streets, around squares and parks. Buildings have to have direct connection with public space – there can be no blank walls or parking garages facing public space. Elevation difference between ground floor and street level cannot be more than 0.5m. There can be no ambiguous land patches – it must be owned and maintained privately (including collective ownership) or publicly.

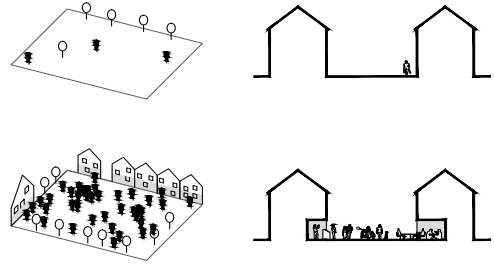

7. Requirements for design

Reduce development scale. Block, street, neighborhood, district should not be understood as one design or project, but rather a collection of projects, which altogether functions as part of the city. At the same time there has to be a detain of district growth which exist with the expense of other city parts. Assignations of city budget has to be distributed according to population density within particular neighborhood.

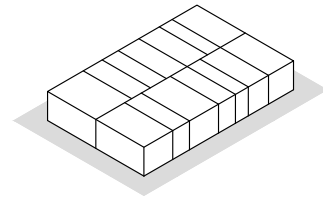

Design should be divided into 3 major steps:

1 step - block division.

This step has to be implemented in district scale.

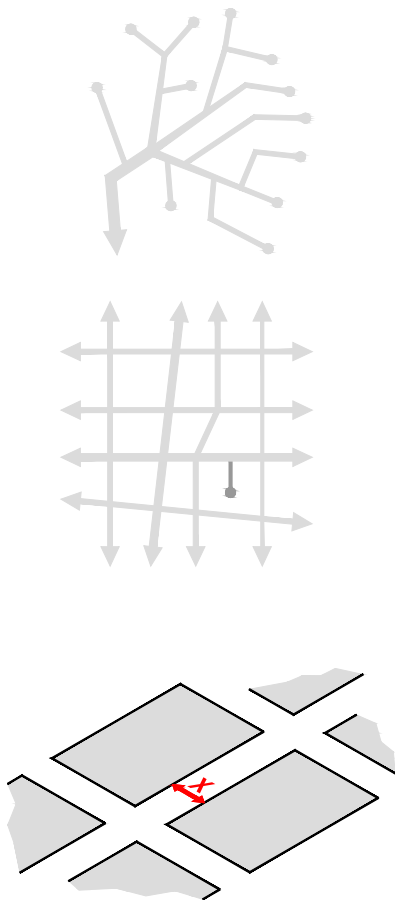

- Defining relation between amount of public and private land. Public land ~ 35%; Private land/land devoted for building (including public buildings) ~ 65%
- Defining block size/street length. Distance between two intersections cannot not exceed 200m
- Block has to be big enough to accommodate at least 4 plots suitable for apartment houses. minimum size of the block - 40x40m
- Street network. Streets have to be designed as network. Cul-de-sac still can be used but only in specific locations and in small scale Street with dead end cannot be longer than 100m and can be used only as an addition to grid street network, for instance as an entrance to plot(s) inside the urban block, which does not face the street; or in a very specific landscape situation; (main disadvantages of cul-de-sacs:
 - not suitable for commercial activities.
 - tend to concentrate intense traffic flow in “collector” streets)

Streets have to accommodate multiple modes of transportation

- Defining street types (use intensity – whether it include commercial activities or not; building typologies – multiple apartment, row house, villas etc.) typology on both sides of the street has to match (this rule is not applicable for commercial, industrial or public buildings)
- Defining street scale (street width **X** has to be understood as distance between two urban blocks; building heights regulated in storey – not in meters). Street cannot exceed the ratio between building height and street width of 1:6. Street network has to offer variety of street widths, from 5m to 20m. Since most of the existing streets within recently planned neighborhoods are extremely wide, there has to be exceptional attention to create more narrow streets where possible.
- Defining locations for industrial or commercial units
- Defining locations for public buildings

2 step - plot division.

Has to be implemented considering typology along the street – plot size and configuration depends on typology indicated in block division plan (step1). Instead of free standing buildings - wide usage of firewall and buildings blocked together has to be reintroduced. Plot division is the main tool to define building typology.

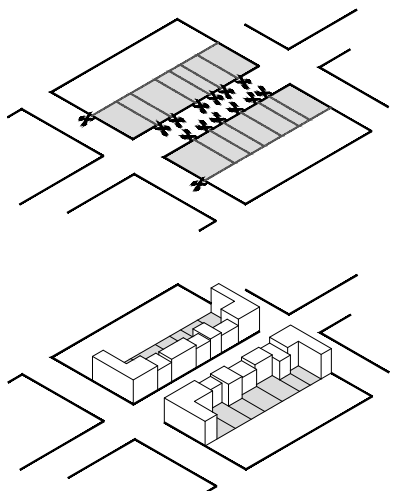

- One urban block cannot be formed with less than 4 plots
- one owner cannot own two adjacent plots,
- One plot cannot occupy more than 25% of entire block
- Block corners cannot be devoted for villas or row houses
- Two large scale plots suitable for industrial, commercial or public use cannot be placed next to each other
- Plot side facing the street cannot be longer than 35m. This rule is not applicable for industrial and public buildings

3step - building.

- Monitoring of implementation of mixed use (residential ~78%; commercial ~22%), if there is one purely residential street, other streets has to include more commercial space. Overall each neighborhood has to meet this relation 78% - 22% and 10% of industrial land
- each building has to be aligned with the street unless setback is allowed in block division plan (max 2.5m for row houses and 3m for villas). This rule is not applicable when plot is not facing the street.
- each building has to be placed in between two other buildings using firewalls. Blocked buildings has to form street front. Only villas can keep the distance from neighboring buildings. This rule is not applicable for public buildings or in cases when plot is not facing the street.
- Number of free standing villas has to be limited according to current percentage and demand of private developments which is 8%, having in mind that this number has to be reduced in future. Therefore typology transformation from private villas to row houses, or multiple apartment houses has to be encouraged, but not vice versa.
- commercial buildings always has to have a direct entrance to the building,
- if activities dominating commercial building are exclusive (for instance offices), first floor has to offer other activities attracting frequent users (restaurants, bars, shops etc.)
- Parking lots have to be designed within boundaries of private plot (several housing units can design shared parking spaces in order to reduce space devoted for cars). Car parking on public land can be designed only aligning cars parallel to the street and buildings, perpendicular car parking should be allowed only in exceptional cases (perpendicular car parking has strong spatial impact and often becomes a barrier). In all cases of parallel car parking there should be no parking lot marking in order to encourage people to own smaller cars (or other types of vehicles) which takes less space.
- Inside the plot owner can use any configuration without restriction. This would allow evolution of different typologies. The only condition should be that each owner get the agreement from adjacent plot neighbors. Building along the street is allowed by default (width is defined by building typology) there is no need for agreement.

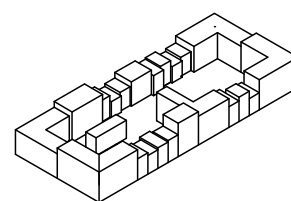
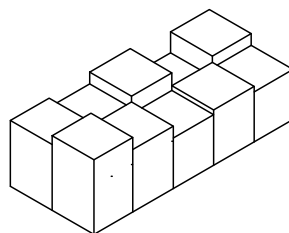
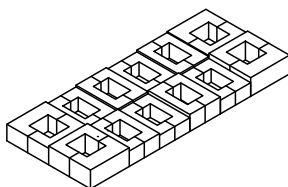
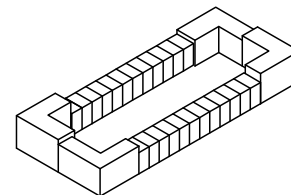
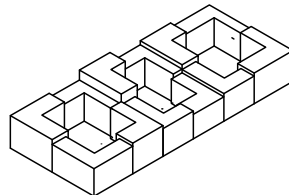
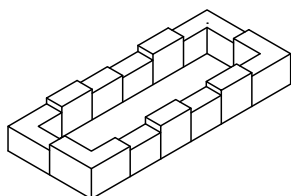
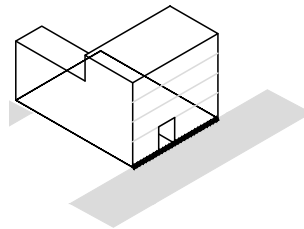
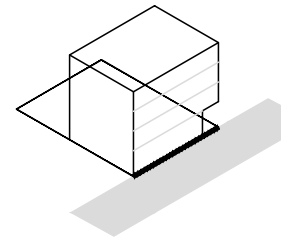
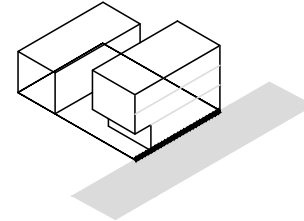
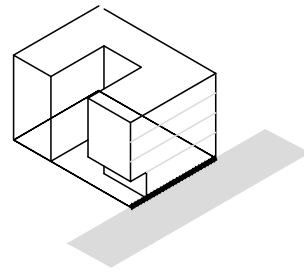

Building height should not be fixed in order to allow future densification. Height of particular building should be decided taking into account surrounding context of well operating part of the city. For the moment prevalent building height in city center is 4-5 storey in dense areas. This height should be used as an outset for new developments. In long term, after city center gets entirely filled up height limit can be raised up to 6 storey, then to 7 using penthouse type or rooftop, with setback from facades. 7 storey height should be a limit, because higher buildings completely lose the connection with the street.

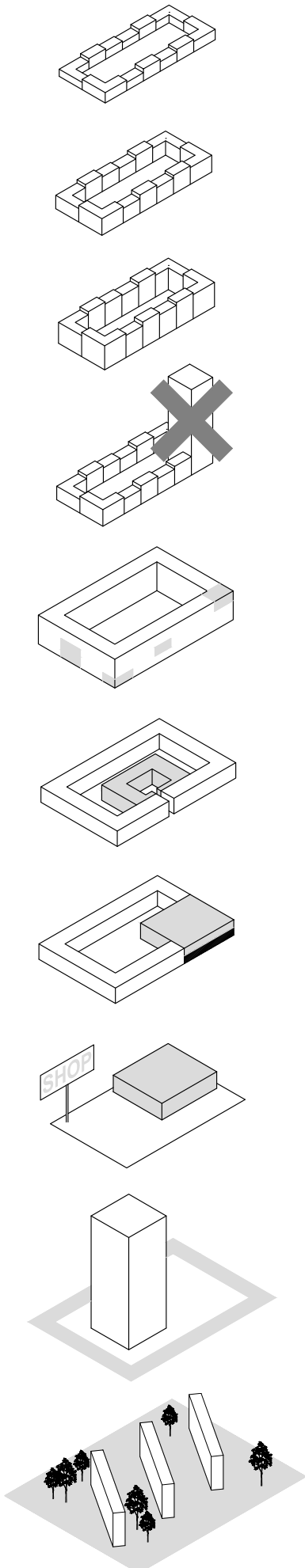

Types of industry to be placed in the city, has to be checked against measures:

- possible accidents (such as explosions)
- noise
- pollution
- flow of supplies (what time of the day, frequency and noise levels produced by delivery)

In order to avoid effect of dead streets new industrial units has to be incorporated into urban fabric in a way that does not have negative effect on a public space:

- It cannot occupy entire block
- blank walls cannot face the street (façade has to remain interactive)

Concept of freestanding buildings has to be abolished because of:

- ambiguous space
- hardly possible functional differentiation
- energy loss (during heating season)
- lack of safety
- lack of social interaction

These rules should be applied to each existing and newly planned city part. Most of the existing urban fabric falls out of this criteria, therefore whenever there is an initiative for new development (or redevelopment) in existing areas - it has to fit these rules.

16. SUSPENDING GROWTH OF SUB-URBS



Aims:

- Prevent further growth of sub-urban areas

Stakeholders:

- Municipality
- Current residents

Finance:

- In general program can be implemented without major costs

Methods:

- Launching a program for plot swap
- Costs of infrastructure provision has to be transferred to private developer
- Introducing CO2 emission fee
- Budget allocations has to be calculated according to population density within particular area (district scale)
- Introducing more effective land and real estate ownership taxation

Benefits:

- City management becomes more efficient
- Reduced city footprint/damaging impact on the nature
- Reduced levels of pollution
- Reduced levels of noise
- Wealthy part of the population would be re-incorporated in the city, therefore it could improve situation of social segregation
- End result contributes to proposed strategy - people are motivated to live in densely built environment.

Risks:

- Lack of political will to initiate participatory planning process
- Corruption

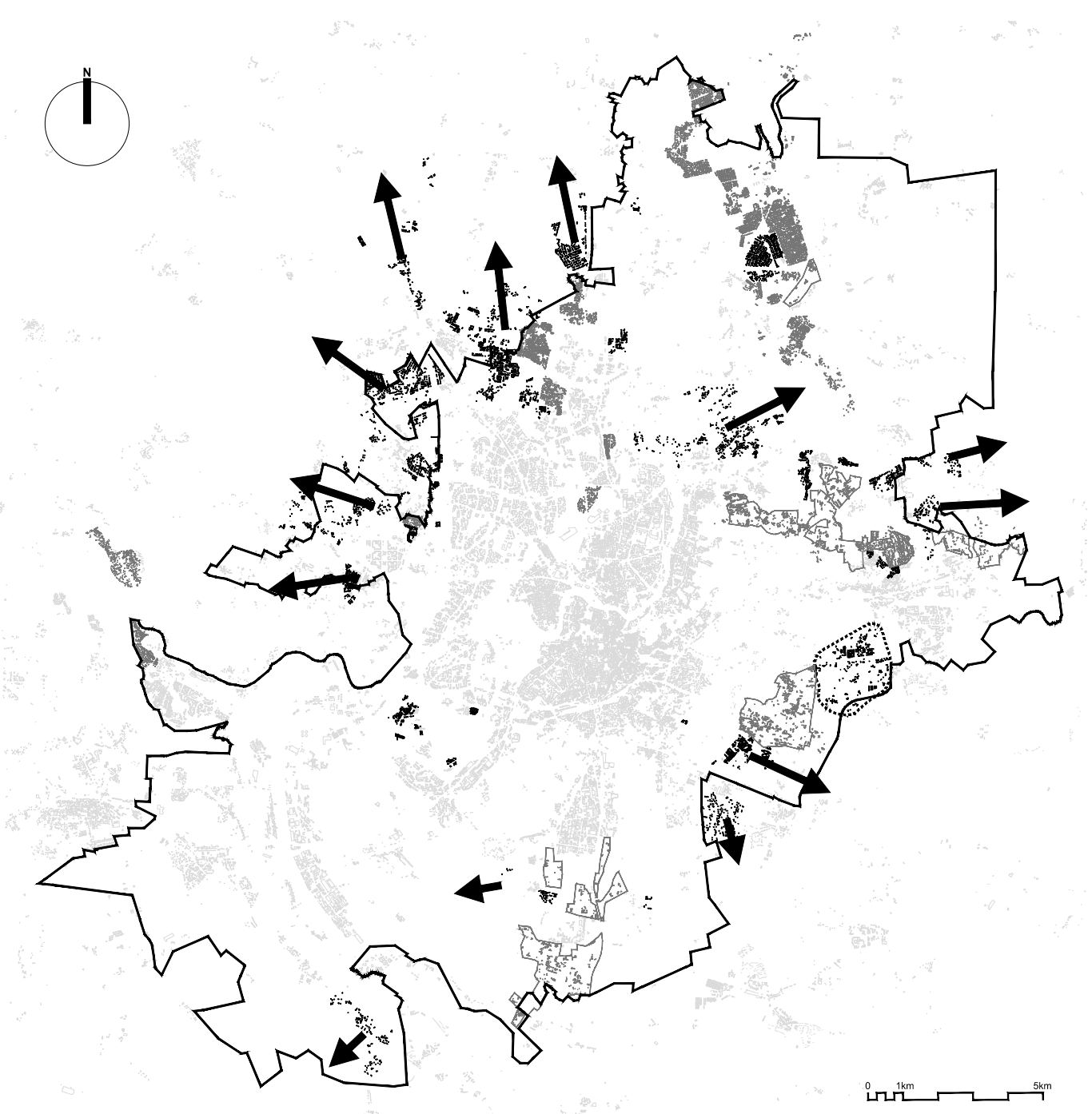

- Sub-urban developments after 90's
- Summer house conversion

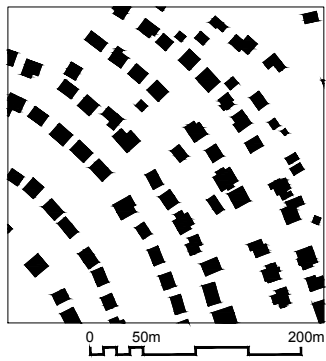

Public land - 18%
Gross space index (GSI) - 0.3
Population/ha - 14
Workplaces/ha - 2

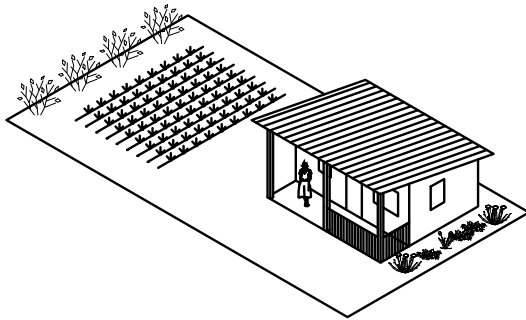

Summerhouses practiced during soviet era

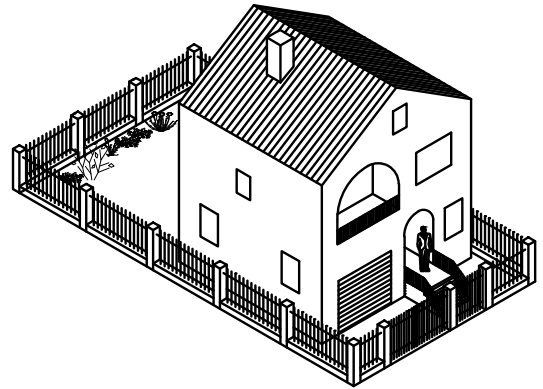

Summerhouse conversions turning them into regular house (in most cases illegal)

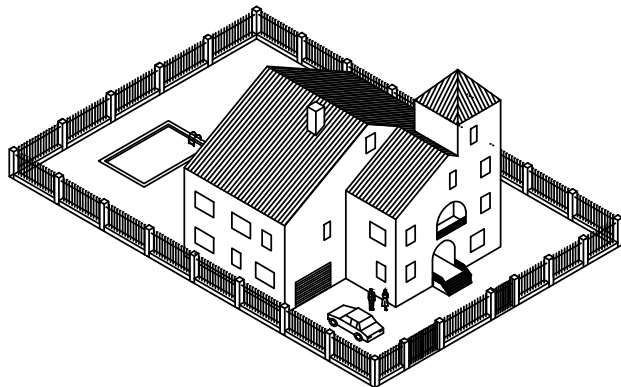

Extremely large individual houses widely practiced in 90's

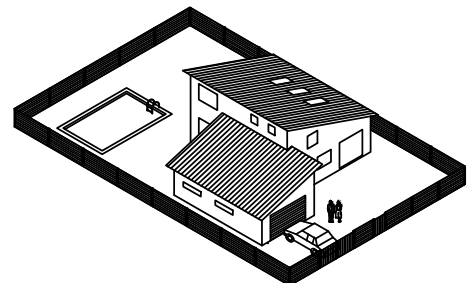

Current sub-urban houses

Basically all Lithuanian cities shares the same feature of extremely low density (fig. 40). Even though Vilnius is inhabited by 570 thousand people, only few geographical spots contains density higher than 100 residents per 1ha. It is hard to speculate what are the real driving factors of people moving to live out of the city - whether it is cultural, economical reasons, or disappointment in urban environment in general, but as we can see in figure 39, construction of individual houses continued even after the crisis in 2008. Furthermore, as we can see in figure 41-42. mainly this construction took place on the outskirts of the city where usually there is no infrastructure. This trend is harmful not only from ecological point of view as cities expand in expense of nature, according to Madanipour, A. (2013) sub-urbanisation also has a negative impact on our public space:

Public spaces are closely associated with the degree of urbanization in a city, and when urbanization suffers through suburbanization and individualization, public spaces also suffer from neglect and loss of meaning. (Madanipour, A. 2013, p.241)

While figures of building individual houses are on the rise - there is no positive input on the entire city observed while studying sub-urban developments in Vilnius. In other words - residents living in sub-urbs are completely dependent on economically, socially and culturally active parts of the city, but sub-urbs does not offer anything in return for the rest of the city. On the contrary - people from sub-urbs usually are driving through densely populated areas everyday, creating high levels of pollution where otherwise there would be no intense traffic. In addition to that - due to low density - amount of taxes collected in these areas is much smaller compared with densely populated neighborhoods. At the same time demand for infrastructure is the same. In some parts of the city residents have no other choice other than living in that particular place (as in case of Vilkpėdė) - while for people moving to live in sub-urbs it is a matter of choice. As we can see from population age maps - it usually accommodates young families, and according to research conducted by Artūras Tereškinas, Apolonijus Žilys, Rasa Indriūnaitė (2013) these are usually socially and economically secure families. In that sense sub-urban developments exist in expense of people with lower income who live in densely populated city areas. It is also important to mention that there is no effective real estate taxation system - real estate tax is applied only for exceptional cases when value is extremely high (vast majority of sub-urban developments fall out of this category). At the same time land taxation is applied according to land value.



FIGURE 38. EXAMPLE OF UNCONTROLLED CITY EXPANSION IN VILNIUS BETWEEN THE YEAR 2002 AND 2015. **SOURCE:** GOOGLE EARTH

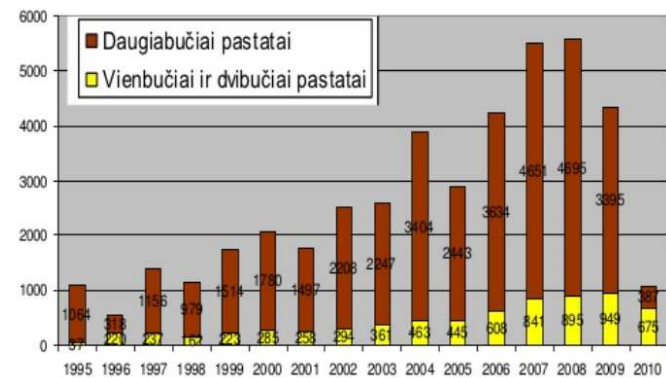

FIGURE 39. NUMBER OF HOUSES CONSTRUCTED BETWEEN THE YEAR 1995 AND 2010. BROWN COLOR REPRESENT NUMBER OF APARTMENTS, YELLOW - NUMBER OF DETACHED HOUSES. THIS GRAPH INDICATES THAT CONSTRUCTION OF DETACHED HOUSES WAS HARDLY AFFECTED BY REAL ESTATE CRISIS IN 2008 **SOURCE:** "VILNIAUS PLANAS"

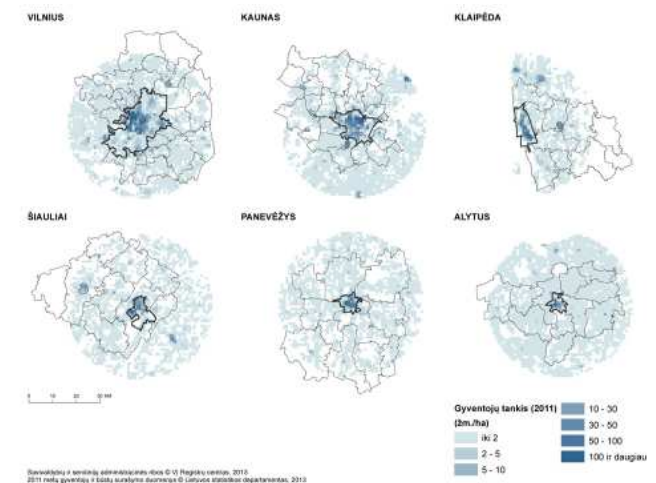

FIGURE 40. POPULATION DENSITY OF SIX MAJOR CITIES OF LITHUANIA. DARK BLUE COLOR REPRESENTS POPULATION DENSITY OVER 100 RESIDENTS PER 1ha. **SOURCE:** LIETUVOS STATISTIKOS DEPARTAMENTAS

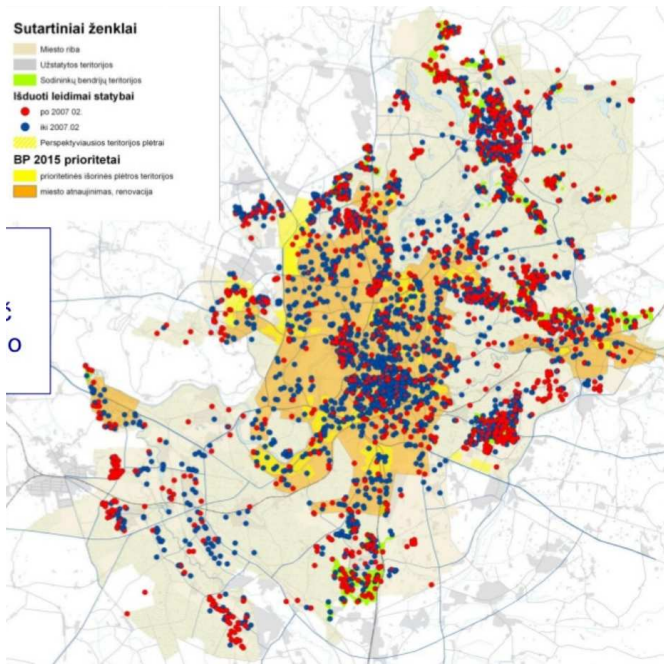

FIGURE 41. BUILDING PERMISSIONS BEFORE AND AFTER 2007. BLUE DOTS REPRESENT BUILDING PERMISSIONS ISSUED BEFORE 2007, RED DOTS REPRESENT BUILDING PERMISSIONS ISSUED AFTER 2007. GREEN COLOR - SUMMER HOUSE AREAS. THERE IS A VISIBLE TREND THAT AFTER 2007 NUMBER OF BUILDING PERMISSIONS ISSUED OUTSIDE URBANIZED CITY PART - INCREASED.
SOURCE: "VILNIAUS PLANAS"

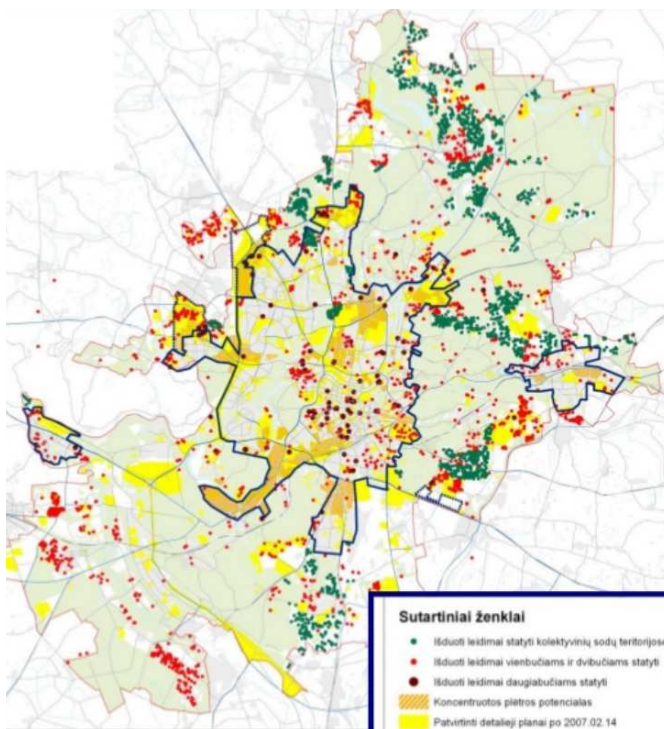

FIGURE 42. TYPE OF BUILDING PERMISSIONS. GREEN DOTS REPRESENT BUILDING IN SUMMER HOUSE AREAS, RED DOTS REPRESENT BUILDING PERMISSIONS FOR DETACHED HOUSES. DARK RED DOTS - APARTMENT BUILDINGS.
SOURCE: "VILNIAUS PLANAS"

Because land value is significantly lower in outskirts - owner of average plot have to pay approximately €20 per year.

Another important discrepancy with regards to sub-urban development is aging. The fact that residents in such areas are 100% dependent on driving - makes it extremely vulnerable against the factor of getting old. In that sense this model is completely not sustainable not only from the point of view of the entire city, but also from individual perspective.

There can be no effective strategy launched retrieving people who already moved to live outside the city other than waiting. However policy preventing more people from living in sub-urbs is quite feasible. In order to stop this trend there should be a program launched for a land swap. Owners who obtained land in undeveloped outskirts of the city, should be offered with a possibility to swap the land into equivalent plot within developed part of the city. Size of the plot should be equivalent to the land value. There should be a condition that land was obtained before this program was launched (in order to avoid speculation of obtaining expensive land in more central locations). Also there should be no buildings on currently owned plot (owner is free to demolish its own house if he wants to swap the land). Plots offered for exchange can have slightly higher value, but should not be smaller than 6mx12m (plot suitable for town house). Locations for land swap should be differentiated according to real estate value - more valuable locations would offer smaller plots. Current owners should be free to chose the location from the municipality list of available land. Several participants could swap the land into a plot suitable for housing collective. Land in the outskirts that municipality would obtain should be prevented from any kind of development and turned back into agricultural use or left for natural vegetation.

This program most likely would become a target for corruption, therefore there has to be a lot of safeguards in place before it is launched.

It is important to mention that program should not become a rejection of detached house as a typology, but rather incorporation of villa into overall urban fabric. Main goal is to find space for people with various housing needs in locations with access to all of the facilities, and no need to cover long commuting distances. However in long term the sheer amount of private villas should be reduced, simply because it occupies large amount of space in comparison with other typologies. Therefore people should be encouraged to choose town houses (row houses) instead of detached villas.

17. DOWNTOWN FOR ALL



Aims:

- Reduce the number of working places located in the city center (from 540 per 1ha to ~160)
- Increase population density (from 70 residents per 1ha to ~250 residents per 1ha)
- Create models for affordable housing (reduce current price of €3000 per 1m²)
- Create space for small scale industry
- Indicate underused spaces - propose additional/alternative programs

Stakeholders:

- Municipality
- Future residents
- Banks

Finance:

- Collective loan from bank
- Private investment (savings)

Methods:

- **Introducing collective building models - eliminating real estate developer**
- **Making Use of state owned land**
- **Introducing tighter regulations for increase of commercial space in the city center, increase taxation**

Benefits:

- Environmental consciousness becomes self evident in community led projects. People tend to include various environmentally friendly solutions without any legal requirement to do so.
- Since real estate developer is eliminated - the end price can be significantly reduced. In case of Tübingen - cost was reduced up to 25%.
- Neighborhoods built through *building groups* shares a very strong sense of community, not only among members of one *building group*, but within entire neighborhood.
- Neighborhoods designed through joint building venture usually happen to be very safe, especially for children.
- Each project is unique, therefore environment does not become homogenous and repetitive as it is usually the case in speculative developments.
- Since people are designing and building for themselves - the end result can be of a higher quality.
- It creates economically active space - conditions for production, self-employment.
- This model of development represents a truly democratic way of city development, where everyone who is determined has a chance to contribute. Sometimes the fact that people have possibility to make decisions together, has greater value than the physical outcome itself, because it gives a feeling of true citizenship and understanding that city is a result of collective action.
- The remarkable characteristic of this community led development model is the possibility of infinite variations, therefore it can evolve and improve in time.
- End result contributes to proposed strategy - people are motivated to live in densely built environment; development is likely to result as functionally, demographically diverse environment.

Risks:

- Possible disagreements in collective design process
- Lack of political will to initiate participatory planning process
- Bank mistrust in collective loans

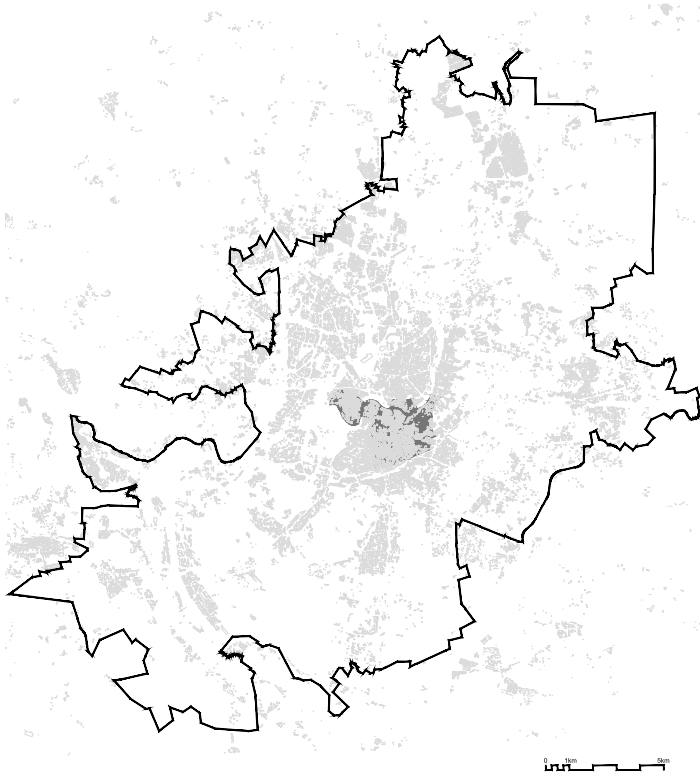

Public land - 35%
Gross space index (GSI) - 1.5
Population/ha - 70
Workplaces/ha - 540

■ Typology prevalence in the city

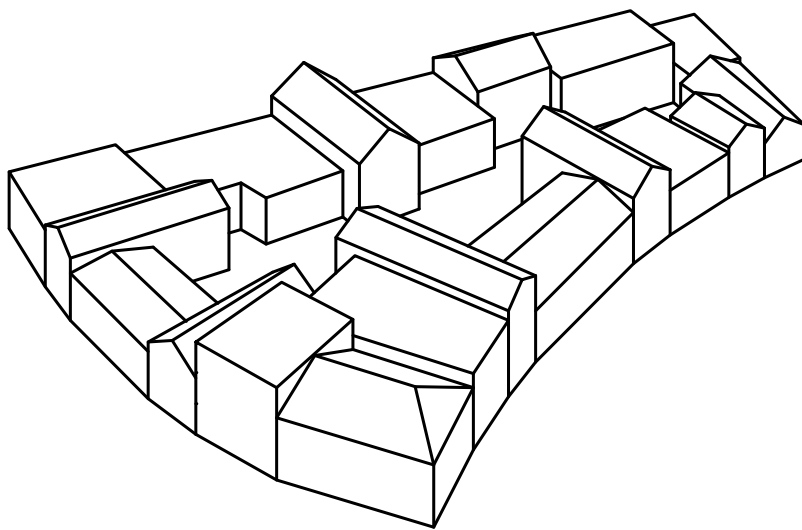



Because some of the problems (such as high real estate price) cannot be solved while using conventional development models, this design proposal should be implemented using method of joint building venture (community led development). Development using this model has to start in central locations, because success of the project is more secure. In order to carry out a collective project - there are few preconditions to be met in a political level:

- Planning department with a capacity and willingness to pursue the process
- Bank which has an interest to lend money for joint building venture
- Trust between all parties - municipality, participants, bank, architects/managers
-

17.1 Implementation

1. Municipality has to initiate a preparation of masterplan for underused spaces in city center of Vilnius. Because this land (almost in all cases) belongs to the state - there is no need for expropriation. Municipality has to undertake provision of all necessary infrastructure - water supply, electricity, gas, street pavement etc. In most of the cases infrastructure is already there, just it needs to be adjusted according to new urban plans. Densification of the city center should not reduce the amount of public space to less than 35%. Logic behind city center densification has to be - completing urban blocks. Not every empty lot has to be built up - only those, which creates ambiguous, underused spaces.

2. Contrary to the regular development (where land is sold for highest possible price) plots have to be distributed through a competition where everybody is free to bid with an idea for particular plot and get it for the fixed price. Price doesn't have to be extremely low, because in that case it would increase the risk of corruption (money received for the land should cover all the costs for infrastructure provision). Main purpose of this competition is to involve end user in the design process and prevent short term, low quality speculative investment. This type of investment usually ends up with products built for the lowest possible price (using cheapest materials) and sold for highest possible price. It is not that real estate speculators would be excluded using legal barriers - but long process of participation usually is not attractive for people who are only looking for fast profit.

After competition is launched, interested people form groups of particular interest (it can be group of friends) and make concise proposals together with the architect. Participation of architect in the stage of

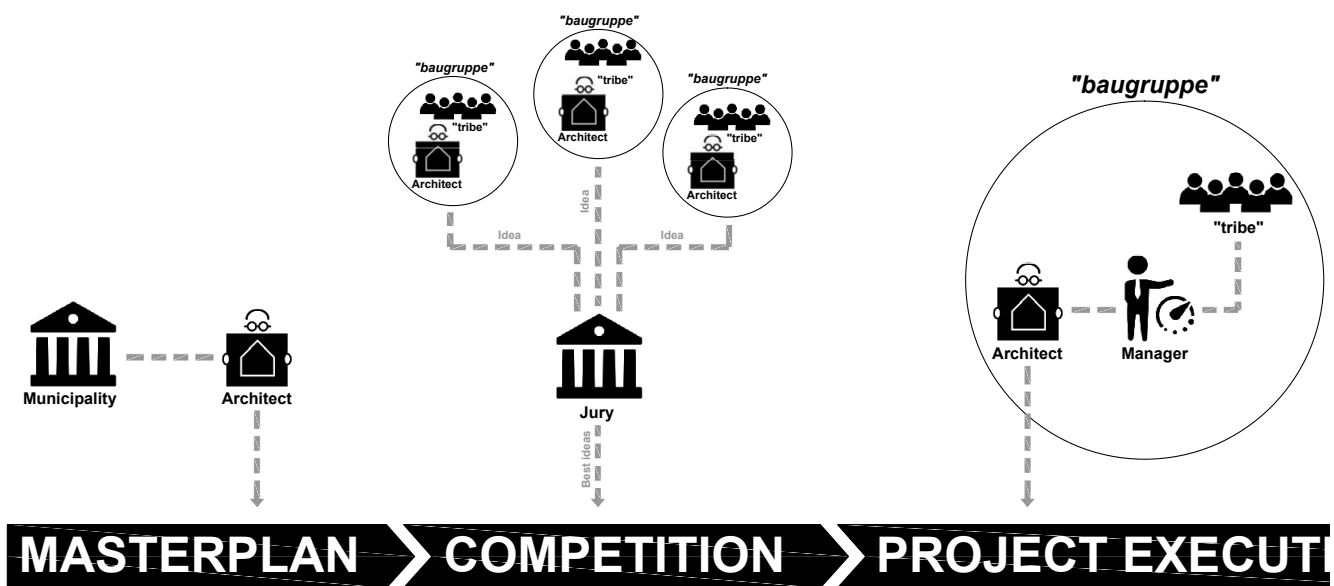

proposals is not crucial (in legal terms), but it would make proposal more feasible, therefore more chances to win. But people who are able to make proposals on their own - should be able to do so.

3. Ideas submitted for competition have to be assessed by jury appointed by municipality. Main criteria to select the best idea has to be a contribution to a public realm and common good of the city. Group with the best idea gets the right to implement their idea on particular land plot, but full ownership is transmitted only when the project is ready to implement - when municipality issues a building permission.

4. Further owners of the winning idea has to prepare a technical project. In order to make this process more organized, *building group* should be led by particular type of project manager who specializes in joint building venture projects (this specialization is yet to come in Lithuania). This project manager is a mediator between members of one building group and architect preparing the project. It is better when the architects and managers belong to different offices.

In this way the monitoring of the budget is ensured. 10-20 people (families/housing units) is the optimal number of people to form one *building group*. More people involved makes design process inefficient, While at the same time less people increase the project price per household. In order to join particular *building group* people have to pay entrance fee of approximately €200. Every meeting has to be paid, that prevents design process to go on for ever. The price of paying an architect for large number of hours spent on meetings does not really increase the price of investment because of ratio between the price of the building and amount of people in *building group*.

5. Construction process is quite similar to the regular housing project. Group of people hire a construction company which delivers the end result. Main difference is that there is no developer overcharge as there is in speculative development. Price of individual flat is a matter of agreement among participants within particular building group. It may depend on numerous factors - size, materials, configuration, floor, orientation (south or north), etc. Each of these points have to be discussed and among members and the leading architect in the design stage. This process takes most of the time, since usually there are many different needs, opinions and financial capacities. It is inevitable that some of the groups will simply fall apart because of disagreements and will not reach the stage of construction. Therefore it is always important to form the group of people who goes along with each other.

In order to prevent speculation it should not be allowed to sell property for 10 years

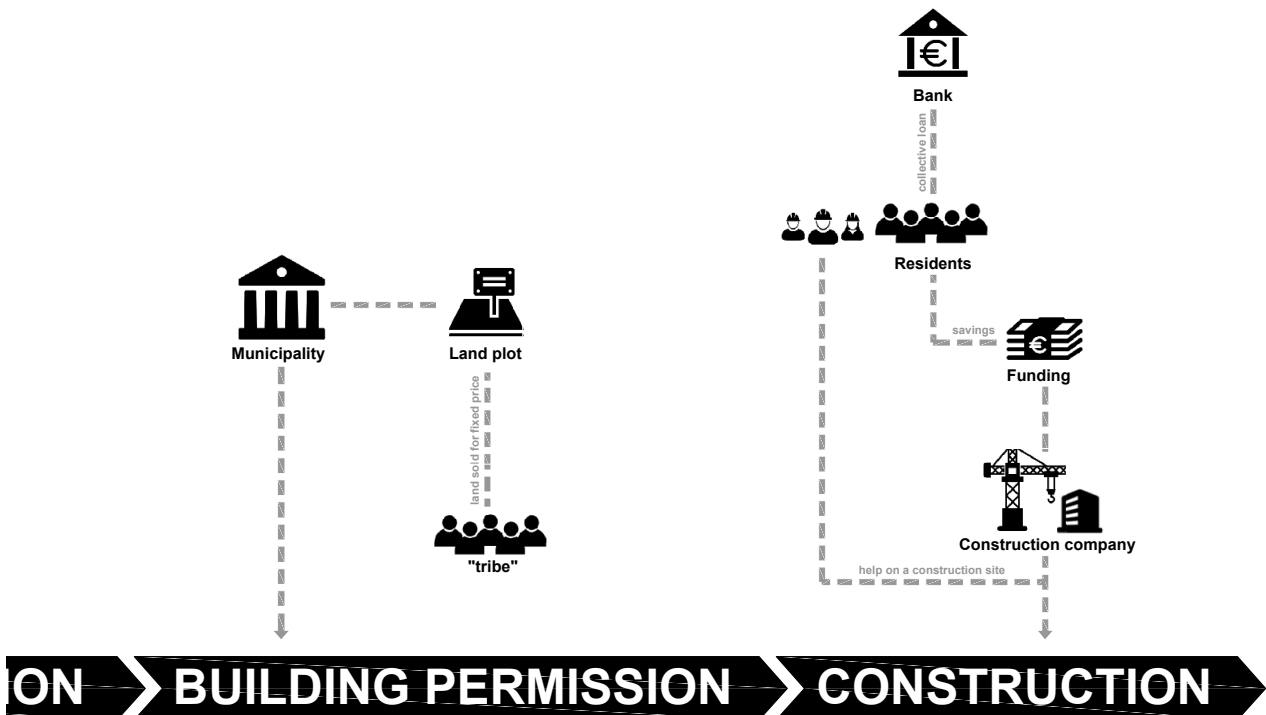

There are many benefits of development through joint building ventures:

- Environmental consciousness becomes self evident. People tend to include various environmentally friendly solutions without any legal requirement to do so. (Tummers, 2011)
- Since real estate developer is eliminated - the end cost can be significantly reduced. In case of Tübingen price was reduced up to 25%.
- Neighborhoods built through *building groups* shares a very strong sense of community, not only among members of one *building group*, but within entire neighborhood.
- Neighborhoods designed through joint building venture usually happen to be very safe, especially for children.
- Each project is unique, therefore environment does not become homogenous and repetitive as it is usually the case in speculative developments.
- Since people are designing and building for themselves - the end result can be of a higher quality.
- It creates economically active space - conditions for production, self-employment.
- This model of development represents a truly democratic way of city development, where everyone who is determined has a chance to contribute. Sometimes the fact that people have possibility to make decisions together, has greater value than the physical outcome itself, because it gives a feeling of true citizenship and understanding that city is a result of collective action.
- The remarkable characteristic of this collective city development model is the possibility of infinite variations, therefore it can evolve and improve in time.

“True benefit of collaborative building is not ‘communalism’ but quality of urbanism, where true community is created in everyday public spaces of interaction” -

17.2 Indicators

This design site is important for the rest of the project, because indicators for other design locations were mainly extracted using historical urban fabric. The reason behind using downtown as a test site - are the results of analysis part. In most of the cases historical city center outstrip other city parts in fields such as: ability to accommodate high numbers of working places, social and cultural activities, at the same time being the most attractive place to live (real estate prices are highest in the city center). Capacity to accommodate both - working places and residential use - makes it the most sustainable city part, because of walkability on everyday basis. According to survey conducted on peoples perception on safety (Bardauskienė, 2007) - city center was indicated as safest place.

Indicators of public land vs. private land were calculated covering entire downtown area, assuming that empty plots in future will be built up according to proposed strategy. GSI, unbuilt private land, number of residents, number of working places, residential units, population density, actual area - were calculated in case study are of 10.9ha. Most of the precise data does not exist, therefore it was calculated combining various sources.

According to population density data in this area (Vilnius masterplan 2015) and calculated number of residential units actual residential space is only 18000m² (16%), the rest of the space suitable for residential purpose was turned into office or commercial space.

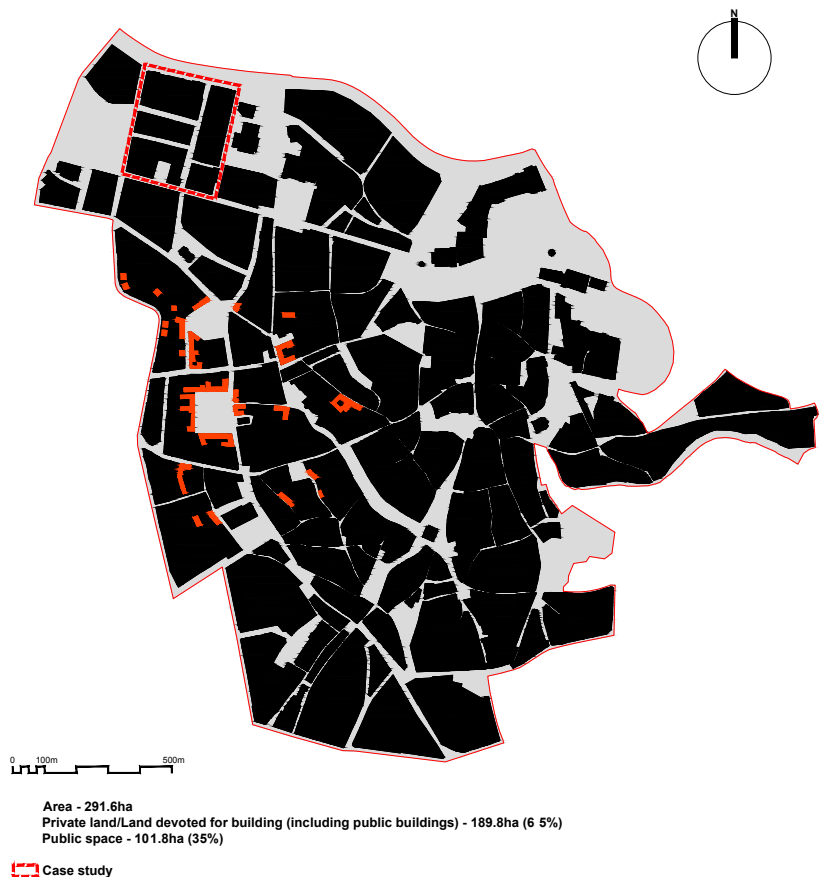

So in total there is 97000m² of non residential space (commercial, public institution, public facilities) which is more than 84% of all actual space available in this area.

Even with assumption that all residents live in flats average 100m² (which in this district would be considered extremely luxurious) residential area still would amount only to less than 30%

Amount of space also approximately match with the relation between number of residents and number of working places in this case study area if it is calculated with average amount of residential space per resident in entire city of Vilnius.

Relation between number of residents and number of working places is 11 : 89

In newly planned districts relation between working places and residents should be calculated in relation with latest demographic statistics. For instance now 64% of Vilnius population is working age people (36% of non working age people). Therefore relation between number of people and created working places within each neighborhood should be as close as possible to this ratio.

Currently there are ~18.6km² of industrial areas in Vilnius. It covers 23% of densely built up area within the city (4.6% of entire city area). In order to include industry as it is now in newly developed areas almost 1/4 of land should be devoted for industrial areas. However it is important to point out the fact that currently industrial land is used extremely inefficiently - gross space index does not exceed 0.4. A lot of space is devoted for car parking, most of the buildings are only one story high, some of the plots are abandoned. In some parts of the city (for instance in Naujamiestis, which is closer to the city center and land value is higher) gross space index (GSI) of industrial areas in some parts goes up to 1.6 - 2.5. These indicators gives a hint that some of the industry could be consolidated and use less space. Having in mind that some of the industry still cannot be included into populated areas because of noise and pollution, devoting up to 10% of land could include most of harmless industry into urban areas without having negative effect on urban qualities. ~20% of work places in Vilnius are located in industrial areas.

These numbers were not used as a concrete goal, but rather as a base point for orientation - if design is going to the right direction.

	city center	Šnipiškės	Krasnūcha	Industrial
Area (ha)	10.9ha	35.0ha	48.8ha	24.6ha
Public land (current)		35% 10.4ha (30%)	30.7ha (63%)	6.4ha (26%)
Public land (desired)		35% 7.3ha (21%)	15.9ha (33%)	8.8ha (35%)
Private land/Land devoted for building (including public buildings) (current)		65% 24.6ha (70%)	18.1ha (37%)	18.3ha (74%)
Private land/Land devoted for building (including public buildings) (desired)		65% 28.0ha (79%)	32.9ha (67%)	15.9ha (65%)
Unbuilt private land	30985m ²			
Gross space index (current)		1.5	0.4	
Gross space index (desired)		1.5	1.4	1.5
Current real estate price				
Number of residents (current)		763	6000	8800
Number of residents (desired)		2700	9300	11300
Number of work places (current)		5900	Self employment (not registered); official <1000	1500
Number of work places (desired)		1700	5950	7200
Residential units (current)		341		15
Residential units (desired)		1200	4200	5100
Population density (inhabitants per 1ha) (current)		70	170	180
Population density (inhabitants per 1ha) (desired)		250	270	230
Actual area (current)	115000m ²	91000m ² (15m ² per resident)	242900m ²	76000m ²
Actual area (desired)	115000m ²	380000m ²	485000m ²	240000m ²
prevalent building height	4-5	3	4-5	4-5

18. UPGRADING URBAN ENCLAVES



Aims:

- Legitimize informal economy
- Create conditions for new and diverse industries in the neighborhood
- Provide neighborhood with basic infrastructure
- Creating finance models for wooden house repair/expansion (increasing residential space to ~30m² per resident)
- Enhance integrity of urban structure

Stakeholders:

- Municipality
- Current residents
- External investors

Finance:

- External investments
- Private investment (savings)
- Self-help working groups
- EU funds

Methods:

- Secure ownership rights of current residents
- Recognizing existing human capital
- Attracting new residents willing to invest while keeping existing urban qualities
- Allow expansion of existing structures (buildings)

Benefits:

- It creates economically active space - conditions for production, self-employment.
- End result is compatible with proposed strategy - people are motivated to live in densely built environment; development is likely to result as functionally, demographically diverse environment.

Risks:

- Possible disagreements in collective design process
- Resident mistrust or passivity upon proposed redevelopment schemes
- Attraction of damaging speculative forces

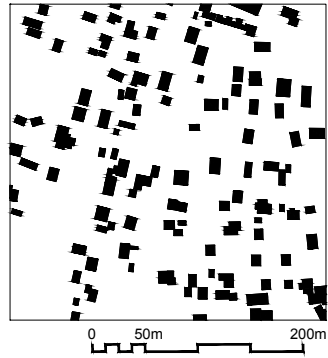
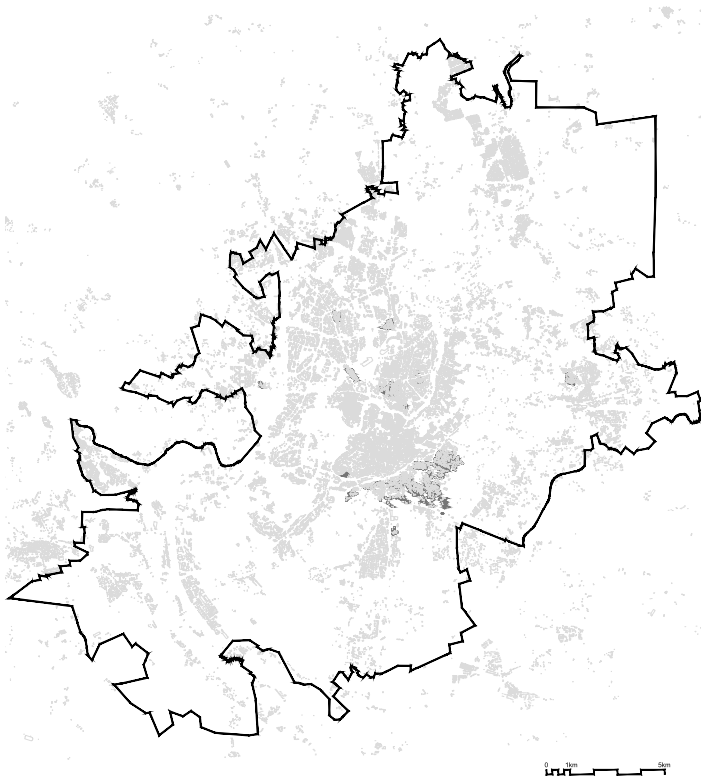

Public land - 30%
Gross space index (GSI) - 0.4
Population/ha - 170
Workplaces/ha - unknown

■ Typology prevalence in the city

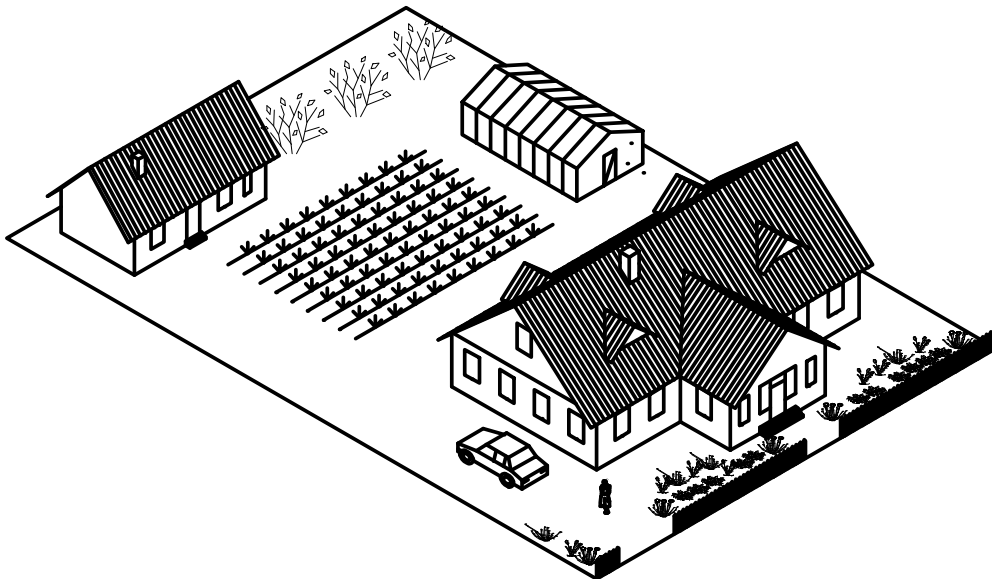

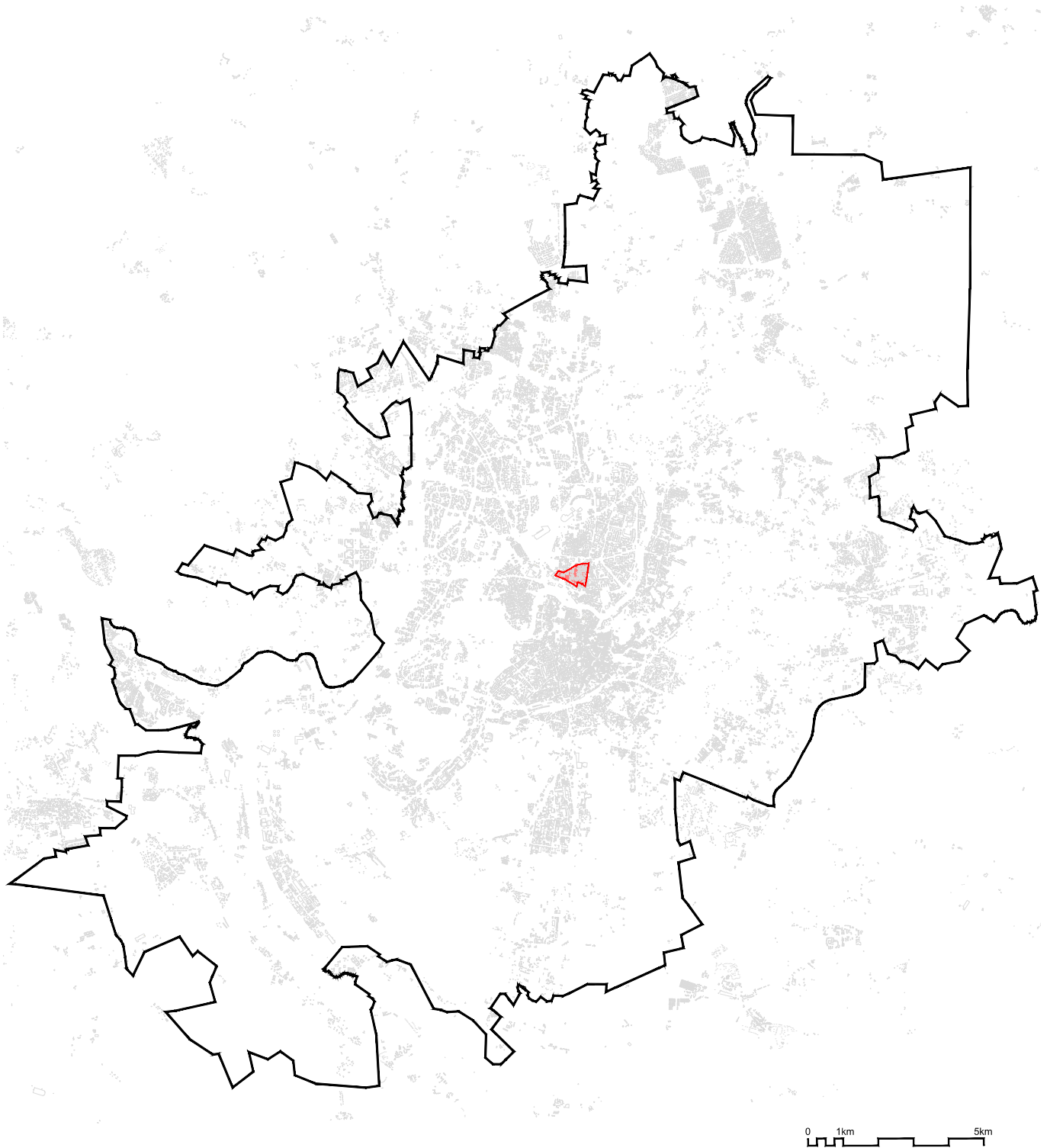

 Design site



2002



2015

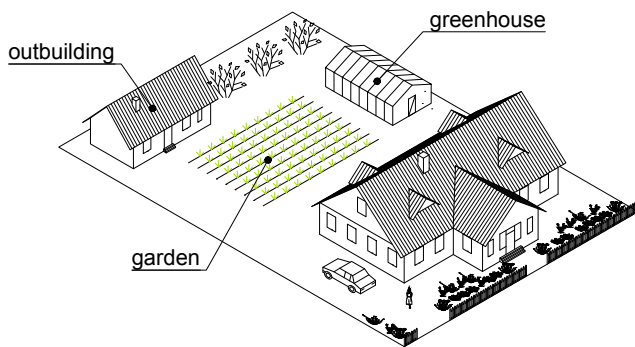

The worst scenario for the city is to be frozen in time. In that case it begins slow process of decay. That is exactly the case in Šnipiškės. This site is well known as a slum area in the very city center of Vilnius. Before 2008 it was an example of extreme gentrification, when people were evicted from their houses in order to obtain expensive land plots. Difficult situation in Šnipiškės could be improved by turning it into a site for investment - attracting external resources to mobilize local potential. Program should be launched as an **opportunity** investment - recognizing and mobilizing existing qualities.

Possible return for investor:

- Co-ownership of high value land
- Ownership of built space - living space, space for rent, space for production. For instance: extra created space could be used as a living space for rent. Rent prices of average living place in Šnipiškės for the moment is ~€350 for a small flat.
- Part of production revenue (investor can rise the quality of existing activities and hold a share of increased revenue)

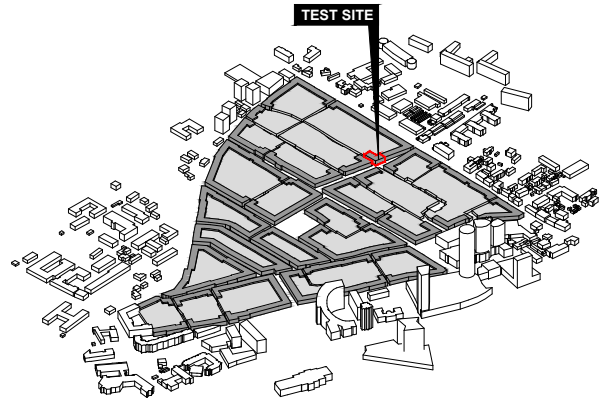
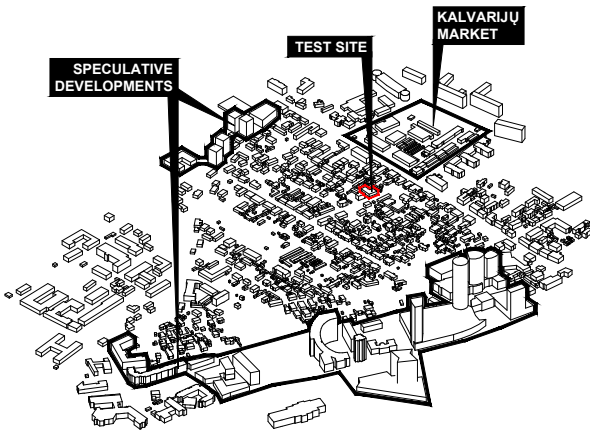

■ 3 storey
■ 2 storey

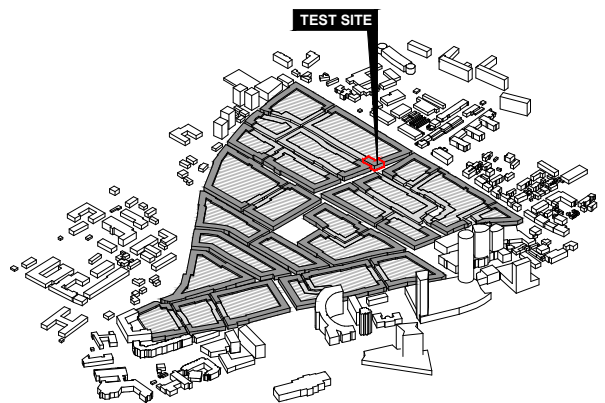
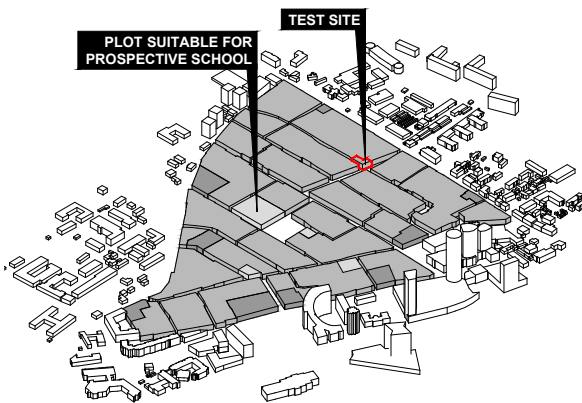

- Land plots which potentially could be used for industrial activities
- Land plots which potentially could accommodate public or commercial activities

- Buildings aligned with the street and blocked together with neighboring buildings (forming street front/active plinth)
- 3m setback is allowed, street front can be disrupted
- ▨ Space can be built up only partly 30-60%, depending on plot size

* These locations indicated only as one of the multiple possibilities, it is not directive. Purpose is to show that site is actually capable to accommodate this kind of activities. Placement of industrial or commercial activities has to be ensured/prevented by constantly monitoring development. In case there is lack/surplus particular use - new developments has to be directed towards needed use by using leverage of taxation; provision/halt of building permission; creating favorable/unfavorable conditions for change of use. Distribution of use has to be perceived not as a fixed document but rather as continuous process.

* Street type can be changed if majority of residents from particular street insists to do so. However neighborhood has to contain both types, (street type cannot be changed in case if there is a risk that all the streets will become only residential or vice versa)

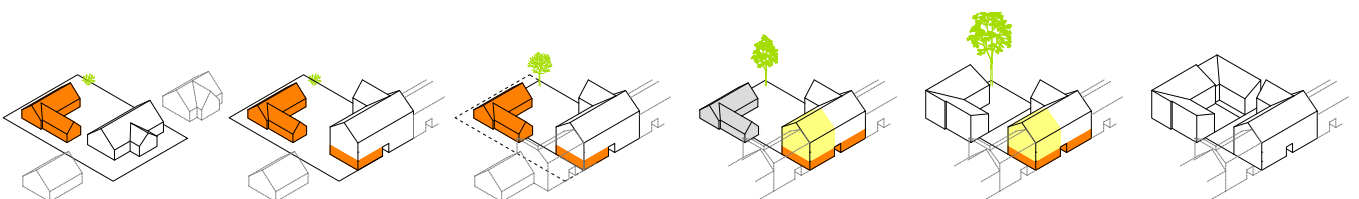

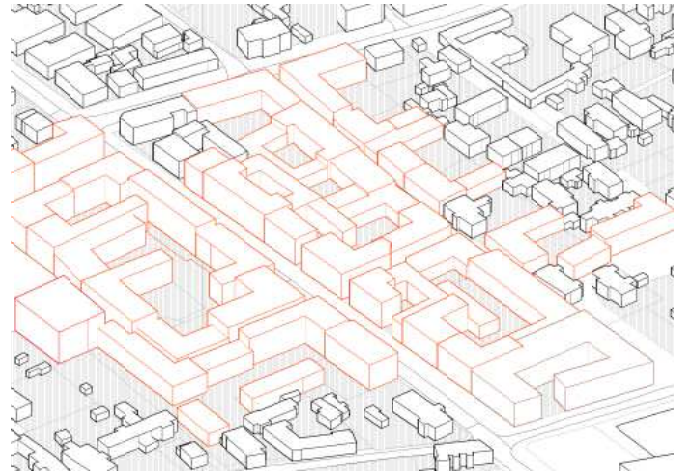
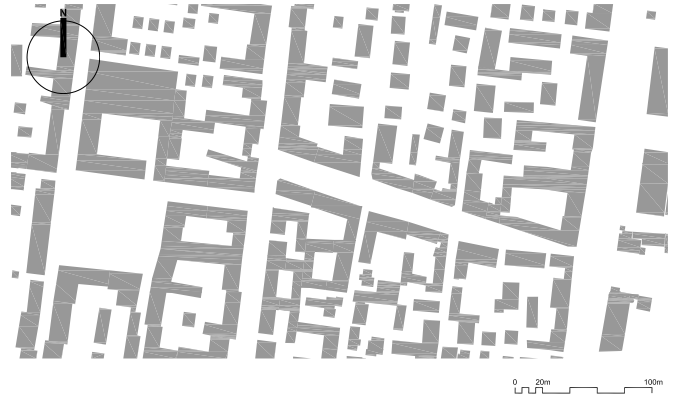
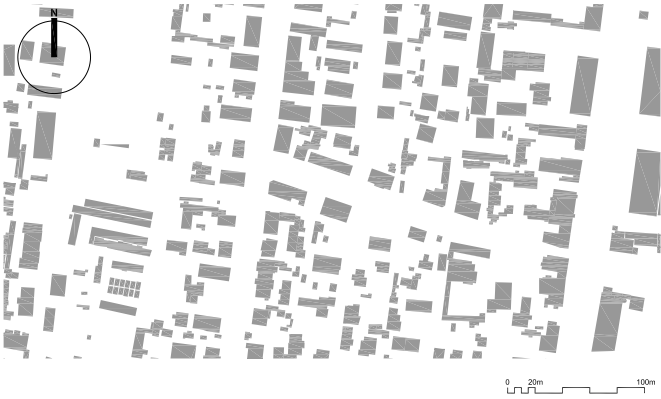

EXISTING URBAN FABRIC

PROSPECTIVE URBAN FABRIC TRANSFORMATION

This urban fabric sample is not a concrete proposal, but rather one of the possibilities how existing urban fabric could evolve while developing under proposed guide lines.



Area - 35.0ha
Private land/Land devoted for building (including public buildings) - 24.62ha (70%)
Public space - 10.35ha (30%)

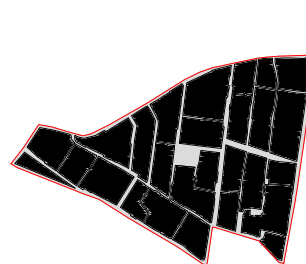

Area - 35.0ha
Private land/Land devoted for building (including public buildings) - 28.0ha (79%)
Public space - 7.34ha (21%)

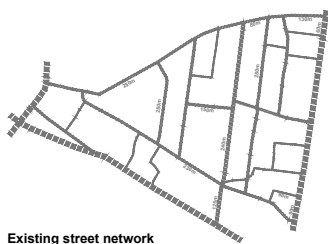

Existing street network

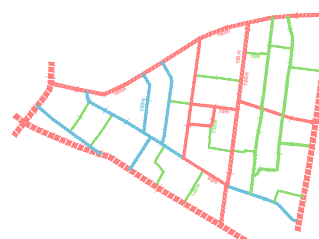

— Streets serving intense economic and social uses (along residential use)
— Streets potentially serving economic and social uses (flexible ground floor use)
— Residential streets

In order to implement proposed design methods current plot configuration should be modified as indicated in the following drawing:

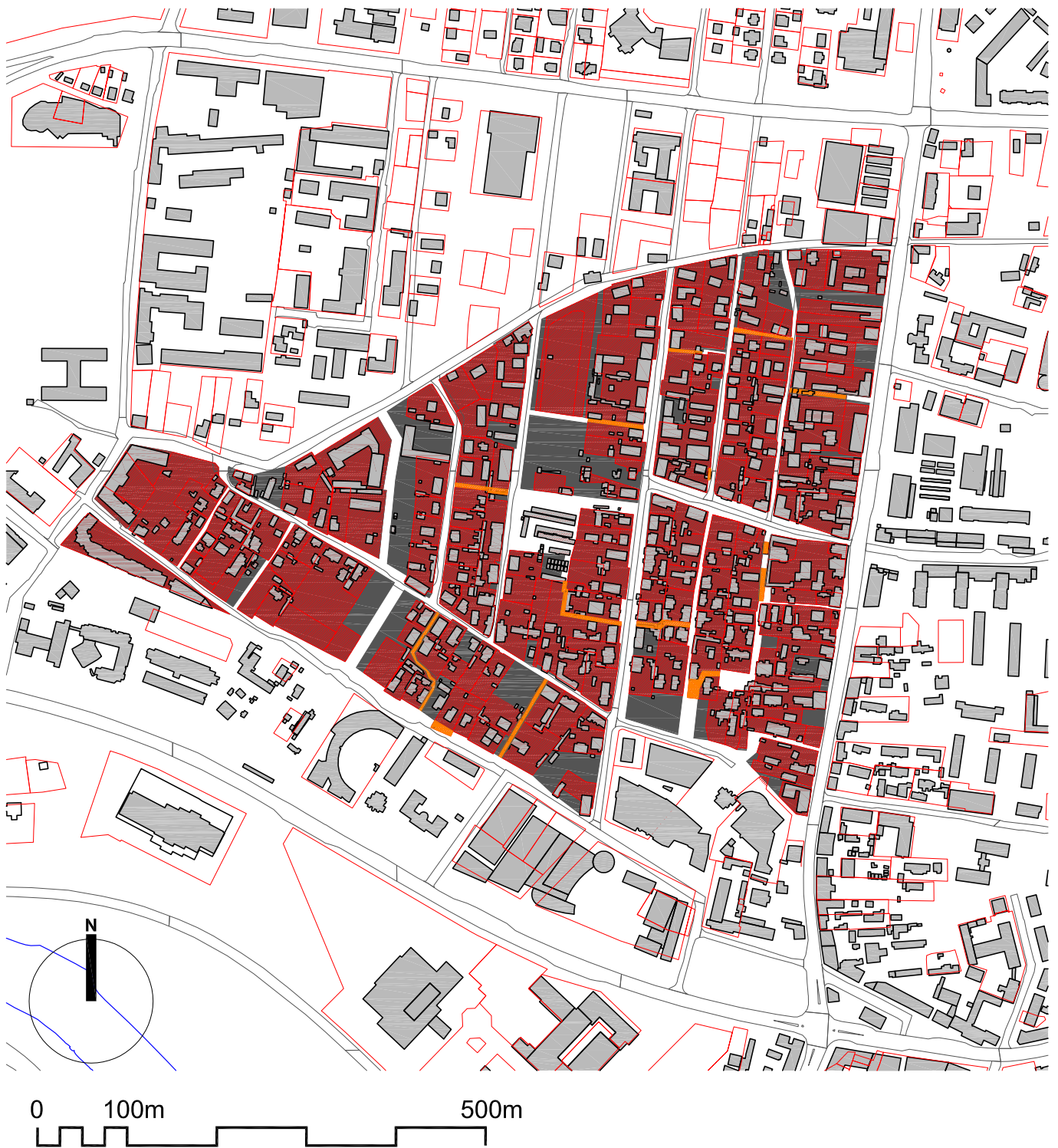

- **Proposed configuration of private land/Land devoted for building** (including public buildings)
- ▨ **Existing private land/Land devoted for building** (including public buildings)
- **Expropriated land**

18.1 Implementation:

Municipality (platform can be also prepared by resident initiative) prepares an interactive platform where each resident can display their property availability, current activities and human resources. Each household (or housing collective) would have a slot where they would display following information:

- Size of land plot which they are willing to share (one slot in this platform preferably should be defined by plot - this would make legal procedures easier).
- Number and size of households existing on a plot (including GSI and FSI)
- Existing activities being practiced by occupants. It can also be particular skills or other potentials that needs investment in order to be fully realized.
- Possible contribution in implementation (financial, labour, etc.)
- "Wish-list" for the investor who wants to invest in their property (for instance create more living space for current residents, install sewage treatment plant, make a water well etc.). As a basis for understanding investment size should be: 1)land price; 2)how many owners there are currently and what size of ownership will belong to new shareholder; 3)how much new space (value) it is possible to create within existing property boundaries according to new indicators for Šnipiškės.

Platform would be also open for people willing to invest. They could propose their ideas for the area and residents could join for development of particular idea.

- Describing investment format
- Proposed legal relations between investor and current residents
- Investment size (capital and/or human resource value)

People have to be able to join and leave the platform freely.

After residents finds and settles with the investor - they have to make a legal document out of their "wish-list". It becomes a contract between residents and investor indicating points that needs to be fulfilled in order investor to get collective (or partial) property rights. After this contract is signed there is green light for investment process to start. The point if investment was fulfilled has to be assessed by external independent municipality official or community.

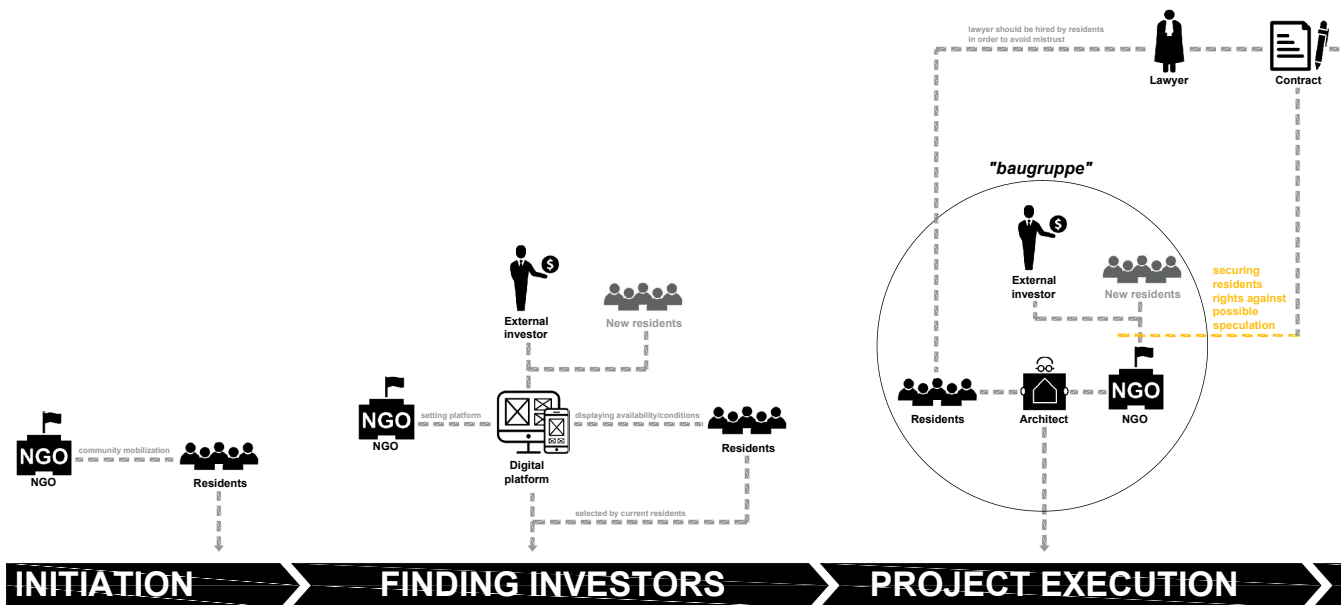

This is necessary because there is a risk that resident will demand more than it is stated in the contract, while at the same time investor might tend to cut off the budget during the implementation period. There has to be clear deadlines for investment to be finished. There has to be a possibility to extend, but only for limited period. Contract has to state clearly that unfulfilled demands for the investor will prevent property rights to be transferred (money spent on unfinished product will be lost). At the same time resident contribution (if there is such) has to be turned into numeric value. In case resident breaks its promises (for instance help in the construction site) he faces the risk to get reduced proportion of created real estate product, or reduced amount of revenue created in new enterprises. In case investment fails because of resident fault investor also can take back material goods already installed during unfinished process. However measuring risks and paying for failure has to be a responsibility of investor, who has to measure and evaluate possible risks before coming.

After fulfilment of investment is confirmed by external official - co-ownership (or ownership) rights has to be transferred to the investor.

- Residents can also express their collective willingness to participate in larger investment (for instance small industrial site).
- One household can become a site for multiple investors.
- Property cannot be sold for the next 10 years

Most likely investors will try to benefit by speculating with real estate value, which is extremely high in this area. Therefore main focus has to be safeguarding property rights of current residents and creating all necessary legal conditions for them to stay.

Predicting which street will be serving economic activities in this neighborhood is impossible, therefore map of street types is rather indicating which streets are more suitable for economic activities spatially and geographically. In case if residents do not agree of proposed configuration it can be changed if all residents within particular street agree of doing so.

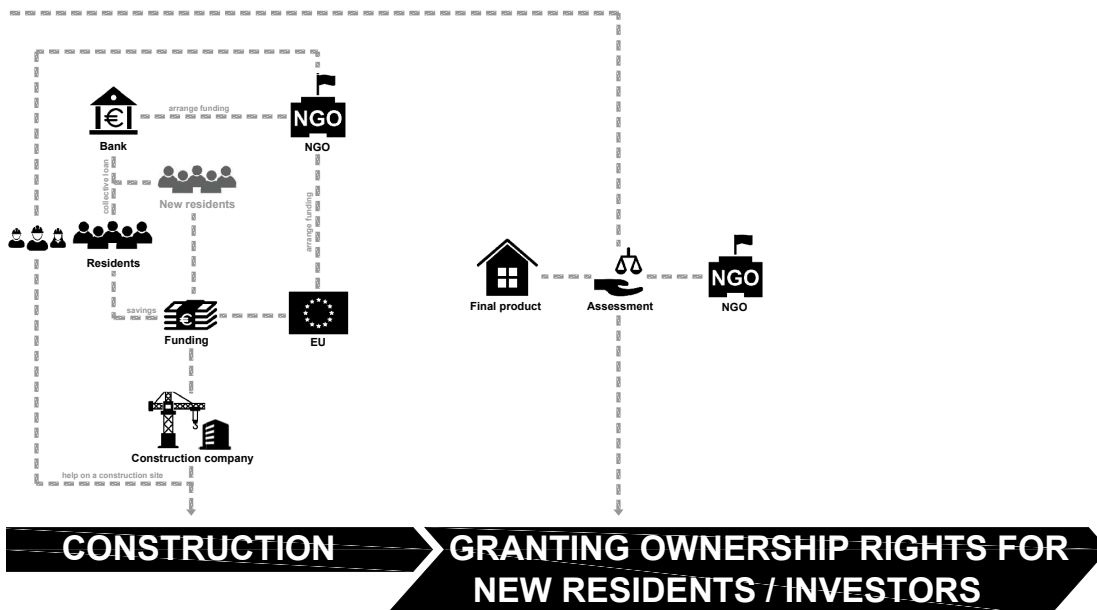

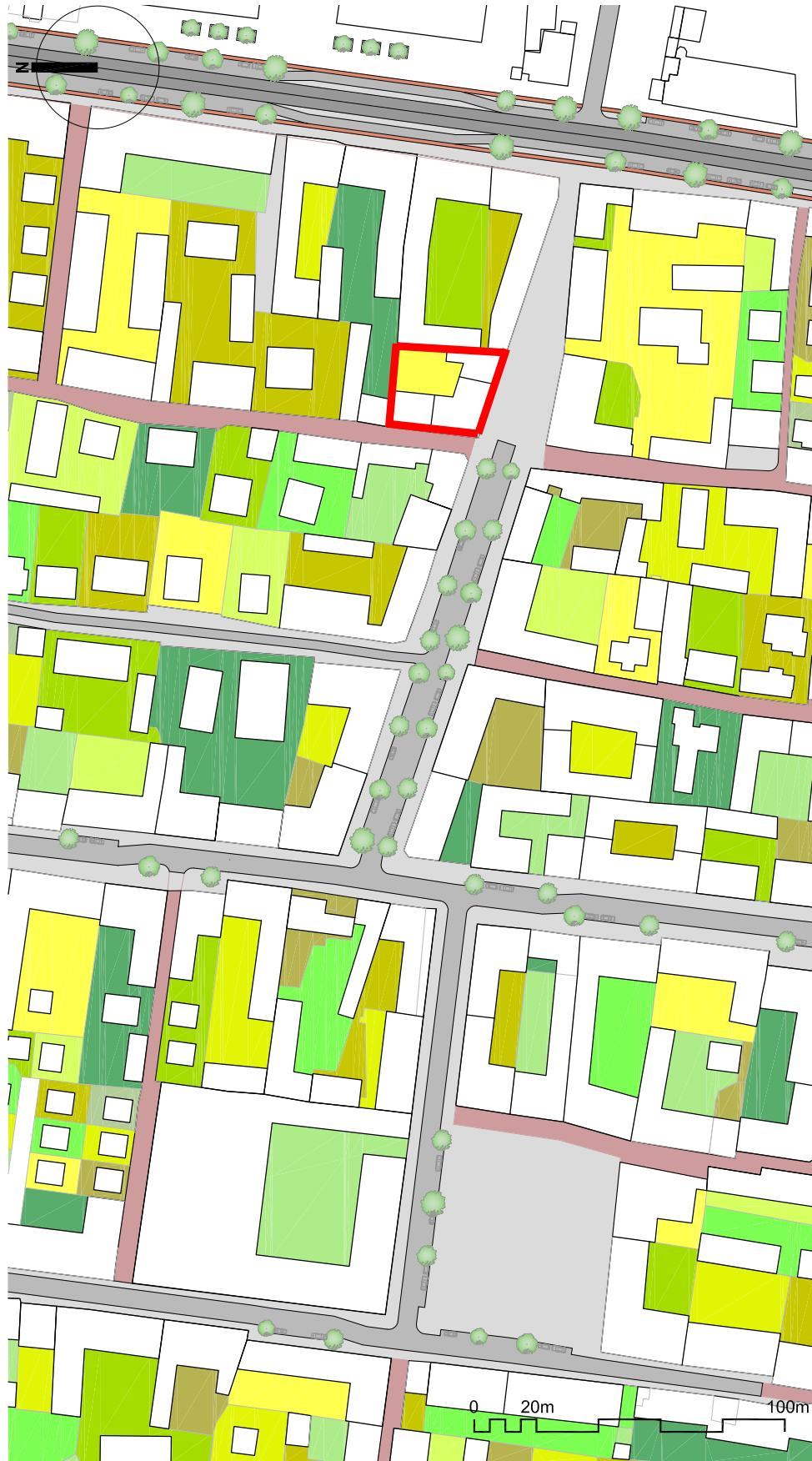

- Pedestrian paths**
- Streets**
- Shared space** (all modes of traffic share the same space)
- Bicycle paths** (1.2m)
- Dedicated bus lines** (3.5m)
- Plots owned by multiple land owners**
- Buildings**

18.2 Test site



For the moment this particular house accommodates 10 families (10 distinct residence units). Actual area of this dwelling is ~330m². Considering number of residents living in this house (22 residents) each dweller poses less than 15m² of actual space.

According to local residents story - after soviet occupation this building was recognized as unsafe to live because of its poor condition. But during the period of rapid housing shortage it was painted and declared as suitable to live. Most of the houses in this area does not have sewage or water supply. But two households in this dwelling brought water supply using their own savings. There is no sewage therefore residents use outdoor toilet. Despite poor living conditions residents like this place because of good relations with neighbors. Possibility to have a garden and grow their own vegetables was referred as a great advantage of this area.



POSSIBILITY TO HAVE INTERACTION BETWEEN PRIVATE AND PUBLIC REALMS HAVE TO BE TAKEN FOR GRANTED. IT HAS TO BE UNDERSTOOD NOT AS A DECORATION FOR PUBLIC SPACE REVITALISATION, BUT RATHER A SPACE WHICH CAN GENERATE INCOME FOR RESIDENTS.

Assumed conditions for investor:

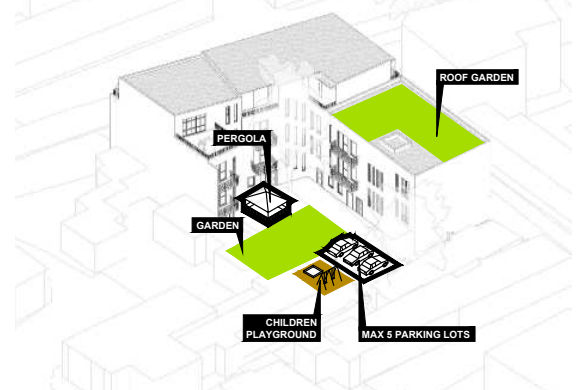
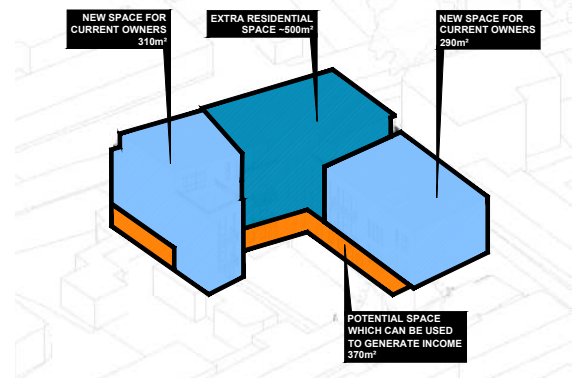
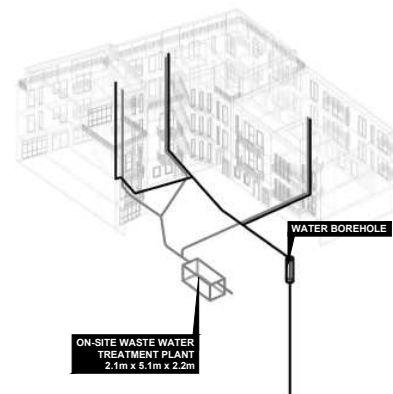
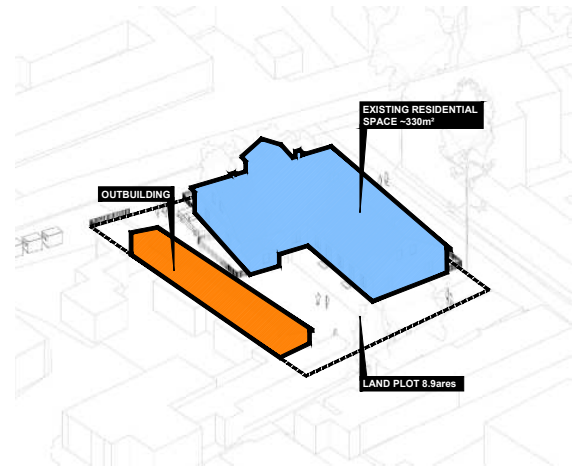

Since most of the houses in Šnipiškės does not possess sewage and water supply, providing residents with these amenities is one of the main assignments for designers working in this area.

Promises of municipality to provide basic infrastructure is frozen for years. Therefore further counting on municipality can be very delaying and give no results in the end.

World wide examples shows that sewage and water can be successfully provided without centralised systems. While water boreholes are widely practiced in Lithuania - off-the-grid sewage systems are almost unknown. Reviewing current autonomous sewage systems on the market allows to make an assumption that Šnipiškės could rely on such plants in the future. It does not require much space - waste water treatment plant for this test site would take space of 2,1m x 5,1m x 2,2m, which can be easily installed inside this plot.

Despite the fact that semi-centralised system could be more effective, pilot projects should not rely on such model since it may fail if residents refuse to co-operate in the process. After first on-site waste water treatment system would be installed it could be used as a successful example to convince remaining residents co-opertae in building semi-centralised systems.



FIGURE 44.
BIO WASTEWATER TREATMENT PLANT FOR 100 PERSONS.
SOURCE: <http://www.wte-ltd.co.uk>



FIGURE 45.
BIO WASTEWATER TREATMENT PLANT FOR 300 PERSONS.
SOURCE: <http://www.wte-ltd.co.uk>

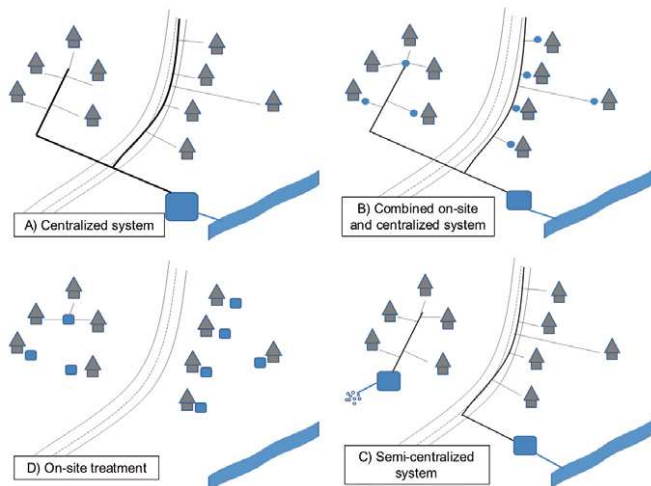
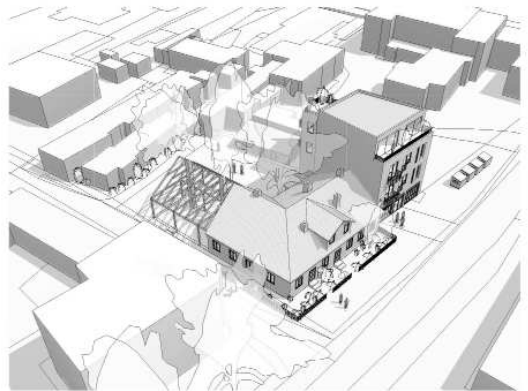
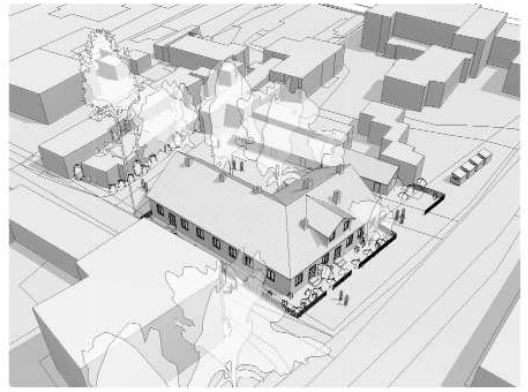
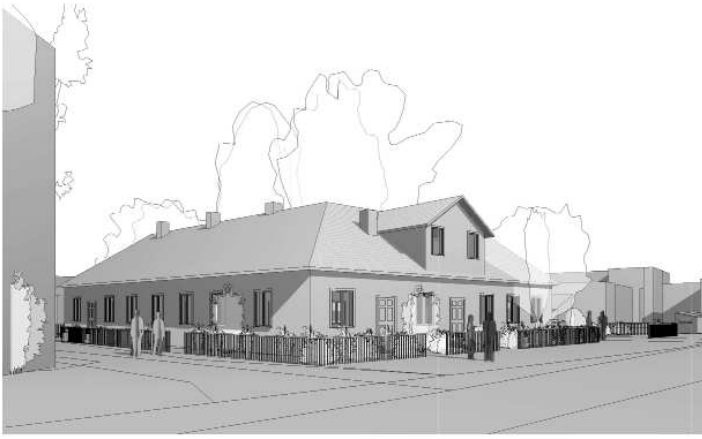

FIGURE 43.
WASTEWATER TREATMENT PLANT OPTIONS.
SOURCE: WECF, Women in Europe for a Common Future



FIGURE 46.
HALF OF THE HOUSE BEING REBUILD. NAUJININKAI, VILNIUS.
STRUCTURE OF OLD WOODEN LITHUANIAN HOUSES ALLOWS PARTIAL DEMOLITION IF IT IS **NOT** DEMOLISHED LENGTHWISE.
SOURCE: GOOGLE STREET VIEW.



19. URBAN RENEWAL IN VILKPEDE



Aims:

- Introduce functional mixture within most of the buildings
- Increase social diversity - attract socially secure groups
- Reduce the amount of public space (from 63% to ~35%)
- Increase density (from 180 residents per ha to ~230 residents per ha)
- Improve means of safety
- Increase the amount of residential space per inhabitant (from 18m² to 30m²)
- Improve building quality
- Reduce dwelling unit scale

Stakeholders:

- Municipality
- Current residents
- Banks

Finance:

- Collective bank loan
- Private investment (resident savings)
- Self-help working groups
- State support
- Speculation with extra space

Benefits:

- Currently deprived neighborhood would attract more socially secure people
- Possibility to speculate with real estate would engage residents to city economy
- End result is compatible with proposed strategy - people are motivated to live in densely built environment; development is likely to result as functionally, demographically diverse environment.

Risks:

- Possible disagreements in collective design process
- Residents refuse to co-operate
- Lack of political will to initiate participatory planning process
- Bank mistrust in collective loans

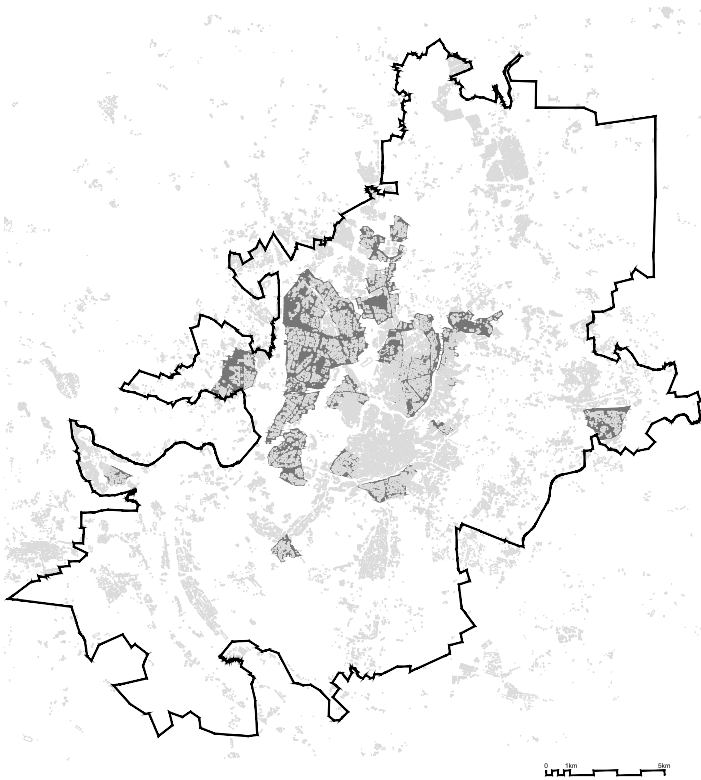

■ Typology prevalence in the city

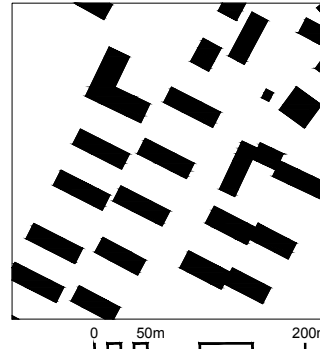
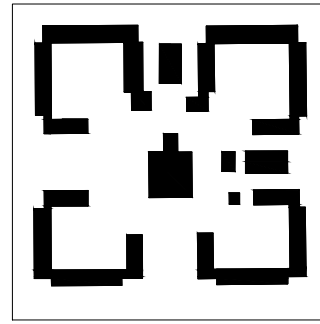

Public land - 63%
Gross space index (GSI) - 1.7
Population/ha - 180
Workplaces/ha - 30

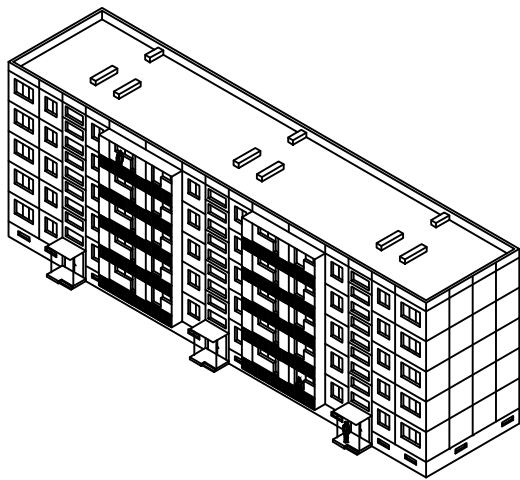

Soviet mass housing

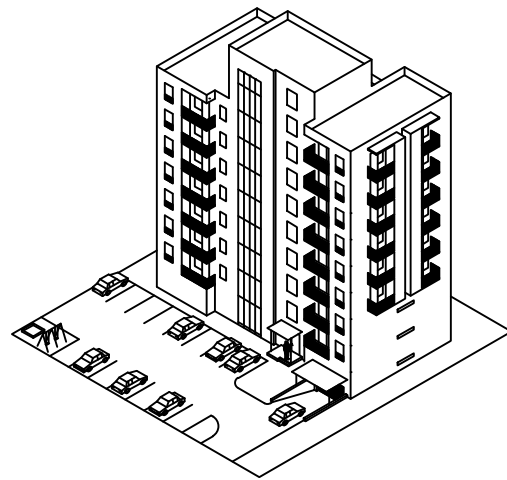

Current speculative developments
By spatial configuration and social composition very similar to soviet mass housing (Čiupailaitė, 2012)

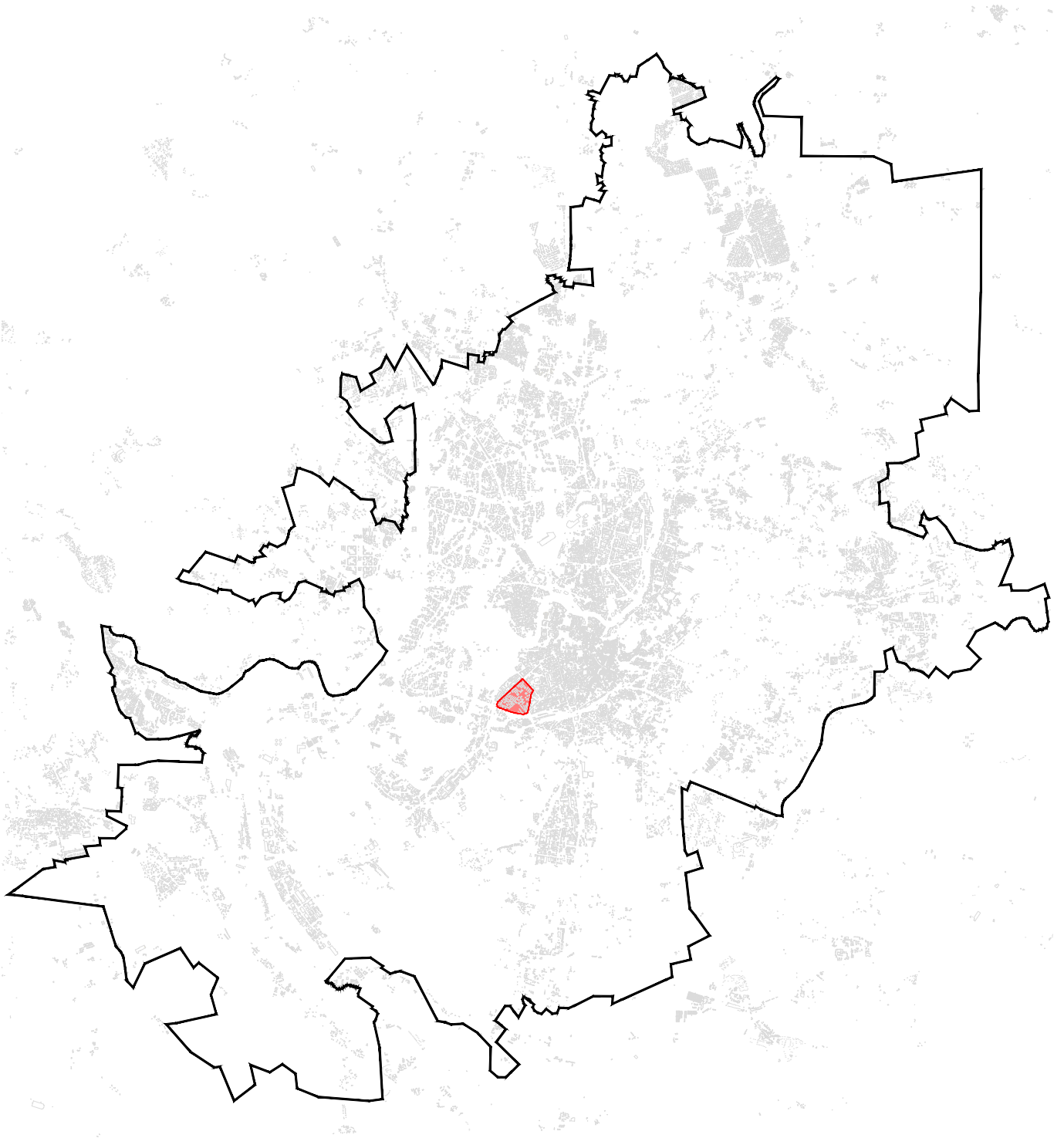

 Design site

It is one of the most deprived neighborhoods within city of Vilnius. Current condition of social housing estates within Vilkipėdė is very poor. Flats are extremely small and inconvenient. Buildings lack any kind of heat insulation, therefore energy losses during heating season are immense. Because most of the residents would not be able to pay enormous heating bills - government is compensating expenses which goes above 20% of family monthly consumption expenditures. Due to large numbers of socialist housing estates country waste tremendous amount of energy and capital resources. As a response to that there is an ongoing renovation program launched in order to reduce energy losses in mass housing areas, where government compensates 40% of construction expenses. Despite many problems present in these neighborhoods renovation program is limited only by putting insulation layer. In many cases the layer of insulation and new windows are more expensive than the building itself.

Using this agenda as a pretext there could be an initiative to launch comprehensive urban renewal dealing with all of the problems within these neighborhoods.

In order to avoid mistakes done in the past new there are several moves to be avoided:

- There can be no forced renewal - government should offer attractive conditions so that residents would participate by their own will
- There can be no displacement
- Renewal cannot be implemented in large scale - it has to take place by incremental steps
- Decisions cannot be made behind closed doors - residents have to be involved all the time.



19.1 Implementation

People would be offered with an option to rebuild their house in the same neighborhood. They would be granted with land plot (land is owned by state, so it should be free for current residents). Because state or municipality cannot afford to cover all of the building expenses, it would be implemented by creating and selling extra residential or renting commercial space. First residents from one of the buildings has to agree to rebuild their house in newly formed neighboring plot. Participants would be provided with a loan from a bank consisting several parts:

- Part of loan would be covered by state/municipality (approximately the same amount that would be spent on insulation of old house)
- Part of loan would have to be covered by residents (monthly installment for a bank should be smaller than they would spend on paying full heating bills)
- Part of the loan would be covered by creating and selling extra residential and renting commercial space
- As an option to reduce the costs - residents should be able to help in construction site, they would be paid salaries which would be lower than average. People would be selected by construction company (check if they are motivated, have skills and if they are fit). Company would be motivated to hire because of low salary, residents would be motivated to work because they would build their own houses and they can inspect work quality.

Loan size depends on size of the flat rebuilding the same amount of space should not cost anything, if family decides to increase their residential space to 30m² per family member they receive preferential conditions for loan. If they want to go beyond 30m² per resident - they have to cover the difference by themselves, speculate with extra space or help in construction site. Creating commercial space on the ground floor should not be mandatory (especially in first renewal steps), but ground floor should be constructed in a way that residential use could be easily turned into commercial space.

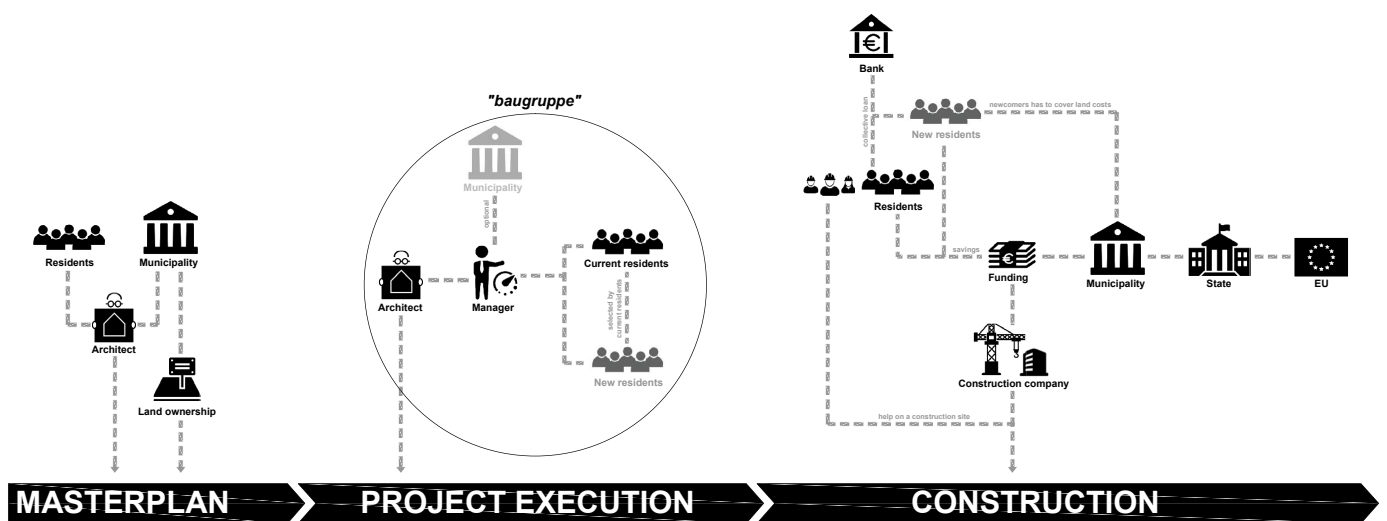

Pilot project:

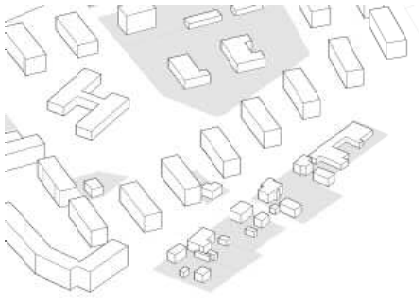

Current situation.

Site accommodates 7 dwelling units. In total there is 9100m² of residential space.

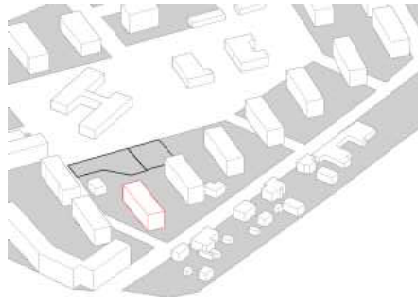

1 step

Selecting first dwelling for demolition. (Residential space 1300m²) and forming plots for new buildings. Rebuilding in this way gives certain level of freedom - residents can rebuild their living space as one or more buildings, it depends on how they are able to deal among themselves.

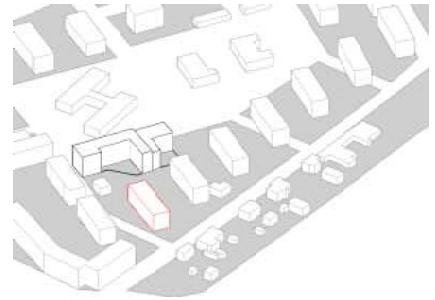

2 step

Constructing new dwellings.

Possible indicators of new dwellings:

Actual area - 3500m²

Possible commercial area - 760m²

Extra residential space - 580m²

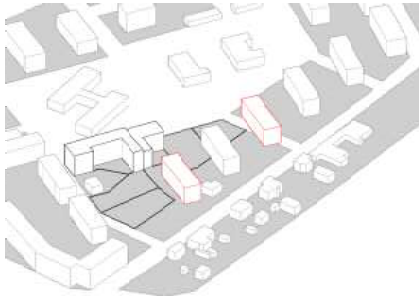

3 step

Demolishing first dwelling.

If program proves to be effective it can be continued further. There can be several dwellings selected for rebuilding at once if spatial configuration allows that.

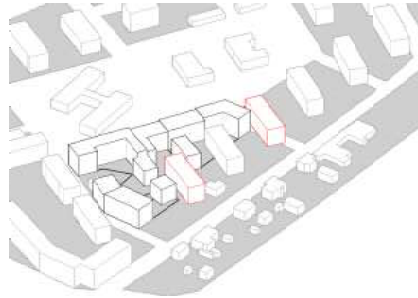

4 step

Possible indicators of new dwellings:

Actual area 6300m².

Possible commercial area - 1400m²

Extra residential area - 600m²

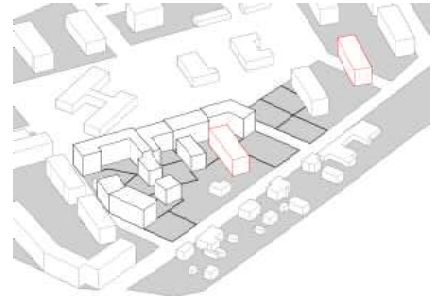

5 step

Demolishing following two soviet dwellings.

Selecting buildings for further renewal.

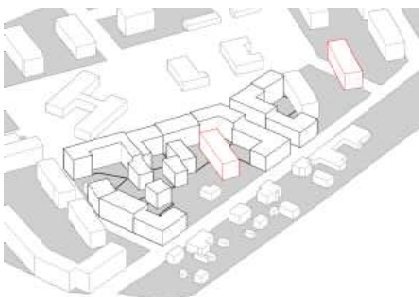

6 step

Possible indicators of new dwellings:

Actual area 6700m².

Possible commercial area - 1500m²

Extra residential area - 900m²

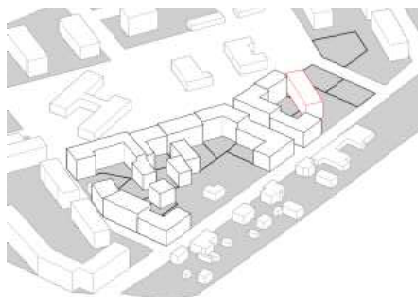

7 step

Demolishing following two soviet dwellings.

Selecting building for further renewal.

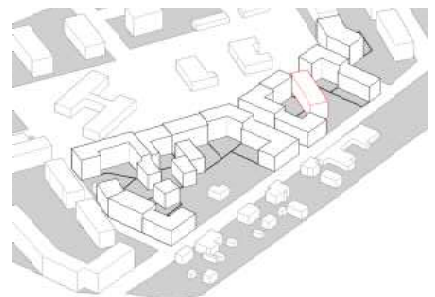

8 step

Possible indicators of new dwellings:

Actual area 3900m².

Possible commercial area - 850m²

Extra residential area - 900m²

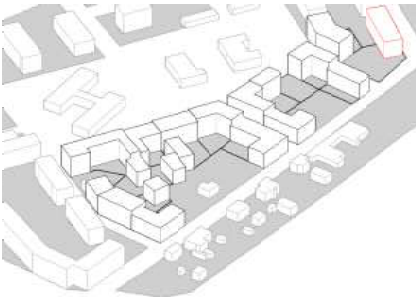

9 step
Demolishing following soviet dwelling.
Selecting building for further renewal.

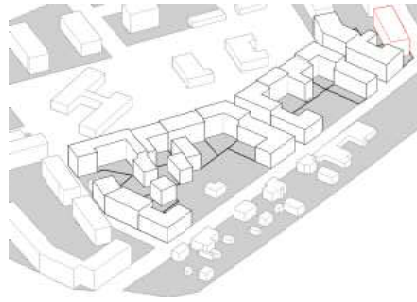

10 step
Possible indicators of new dwellings:
Actual area 3200m².
Possible commercial area - 700m²
Extra residential area - 350m²

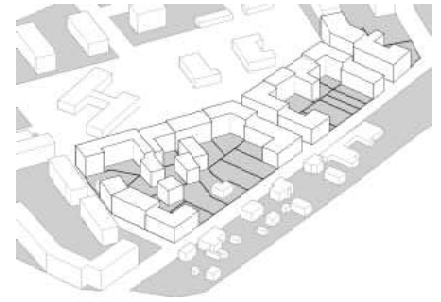

11 step
Remaining land would be subdivided into smaller plots suitable for villas and row houses and sold on the market. Money received for the land would be distributed to all of the residents to cover part of their loans

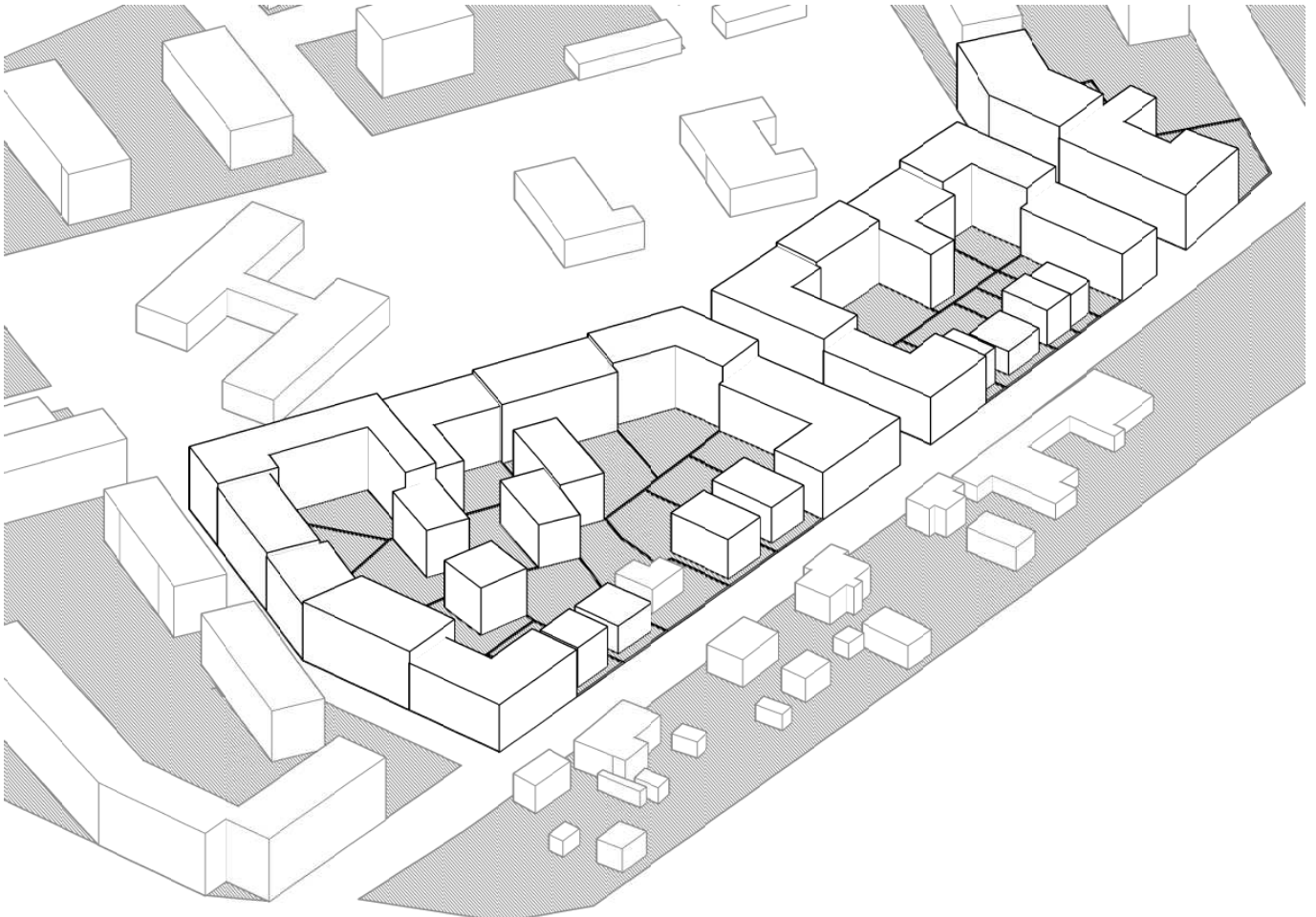

12 step
New residents also have to build according to the existing rules. In final stage neighborhood should consist of completed urban blocks, built up on the perimeter. This would clearly define street space and create favorable conditions for retail.

Building in this manner it is possible to reach 23500m² of actual space rebuilt by co-operating with local residents. Of which 5000m² could be devoted for commercial activities. In theory this amount of space could provide all local residents with working space. If neighborhood would be built using principles listed in planning stage, it would significantly increase the possibility that commercial activities would have a success. In addition to that it is possible to create extra 3200m² of residential space and sell it on the market. Revenue received for this space could be used to cover part of re-building expenses.

According to current Lithuanian building prices construction of new dwellings would cost around 19 million euros. Selling extra residential space and land on the market would return around 6 million euros. Considering the fact that government is devoting money for renovation where they cover 40% of construction costs of insulating old houses, for this area they should devote ~1 million euros. In the end prime cost per 1 household for rebuilding would be 50 thousand euros. Taking loan of this size from a bank would require 210 euro monthly installment. Renting out 5000m² of commercial space in this area would bring each household minimum €220 per month, which is enough to cover entire monthly installment of bank loan.

This is just a principal calculation showing that rebuilding in combination with extra space could actually cover the costs. In reality these numbers could change in various ways - some would build more of extra residential space, others could start their own businesses using created commercial space, others would save money by building smaller apartments etc. However it is just an example how local residents could be motivated to densify their own environment and become developers themselves. In this case high real estate prices in Vilnius could help to improve living conditions of most vulnerable social groups. At the same time it would attract more socially secure residents into deprived areas without the risk of pushing out the poor.

Different variations:

- Commercial use first can be implemented as flexible residential space which later on can be turned into commercial.
- Additional created space can be put on the market as a residential space for rent.
- Part of the risk can be taken over by municipality - building costs could be covered by municipality, but then extra space would belong to the city and then it can be used as catalyst of the neighborhood - creating affordable spaces for artists, organizing events, or other used for other cultural activities, which would regenerate this neighborhood.



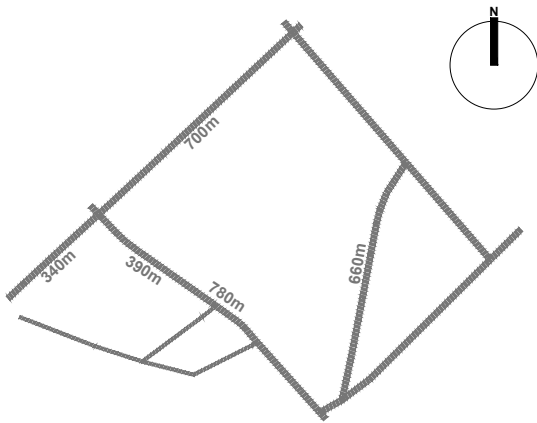

Existing street network

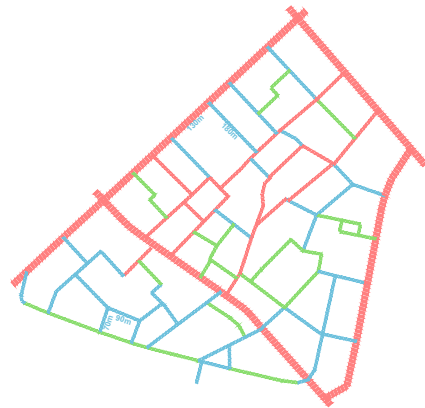

- Streets serving intense economic and social uses (along residential use)
- Streets potentially serving economic and social uses (flexible ground floor use)
- Residential streets



Area - 48,8ha
 Public land - 30,7ha (63%)
 Private land, land devoted for buildings (including public buildings - 18,1ha (37%))



Area - 48,8ha
 Public land - 15,9ha (33%)
 Private land, land devoted for buildings (including public buildings - 32,9ha (67%))

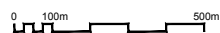

In order to implement proposed design methods current plot configuration should be modified as indicated in the following drawing:

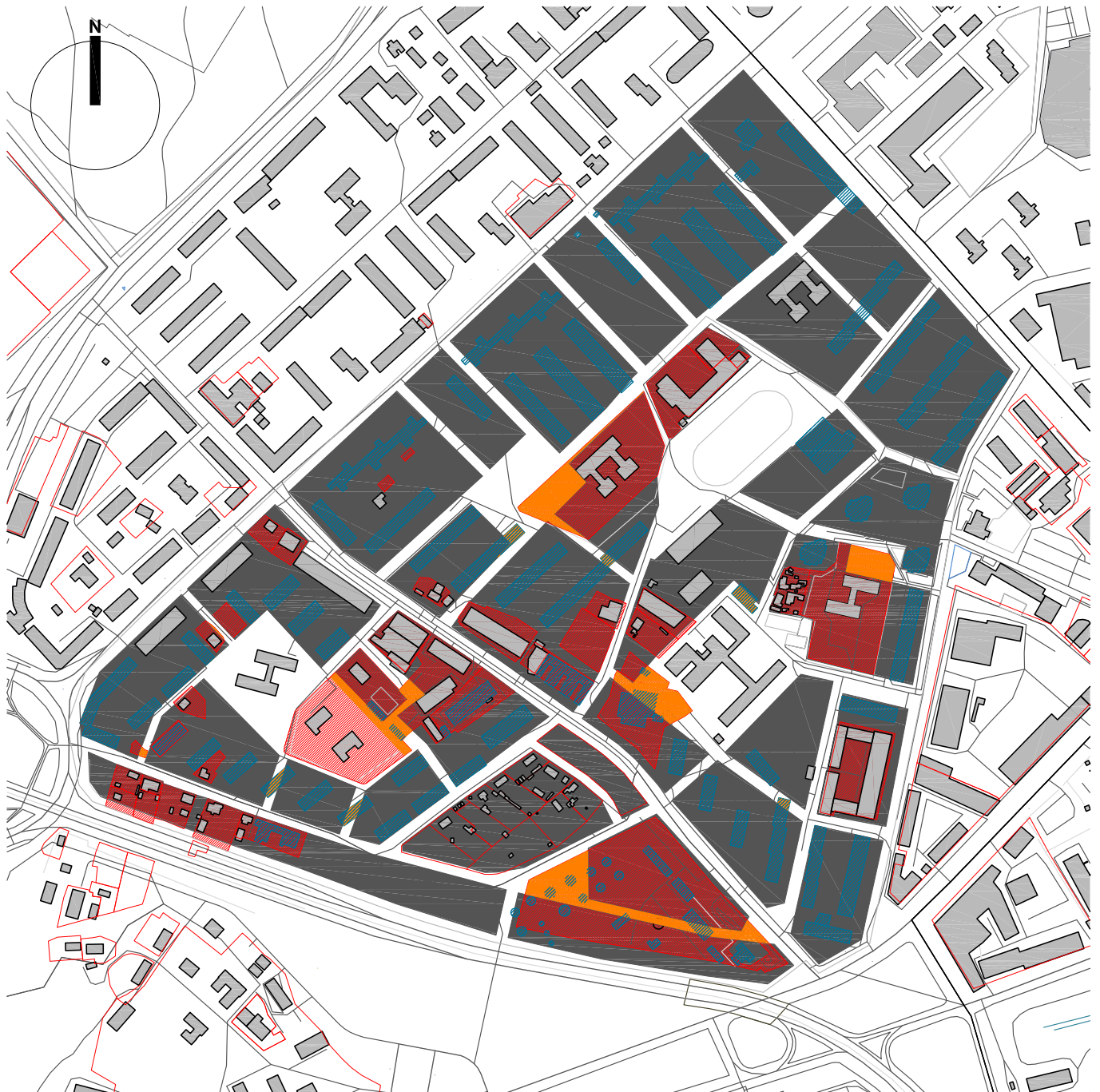

- **Proposed configuration of private land/Land devoted for building** (including public buildings)
- **Existing private land/Land devoted for building** (including public buildings)
- **Expropriated land**
- **Malfunctioning buildings, need for redevelopment/demolition**

20. RETROFITTING INDUSTRIAL SITES



Aims:

- Integrate industrial sites into the city
- Create and utilize public space (preferably ~35% of land has to be public)
- Introduce residential use (~230 resident per 1ha)
- Diversify economical activities - commercial activities has to exist along with industry
- Reduce development scale

Stakeholders:

- Municipality
- Current owners (in case of disagreement to sell the land)
- Future residents
- Banks

Finance:

- Collective bank loan
- Private investment (savings)

Methods:

- Involving municipality into development process
- Offering attractive conditions for current owner in redevelopment scheme or expropriating abandoned industrial sites through municipality
- Actively involving new parties in development process
- Introducing collective housing models

Benefits:

- Currently homogenous and barely functional industrial sited can be turned into vibrant and economically active urban environment
- End result is compatible with proposed strategy - people are motivated to live in densely built environment; development is likely to result as functionally, demographically diverse environment.

Risks:

- Possible disagreements in collective design process
- Lack of political will to initiate participatory planning process
- Bank mistrust in collective loans
- Current owner refuse to co-operate

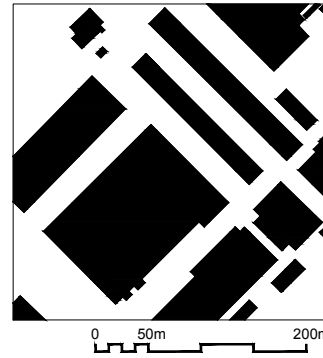
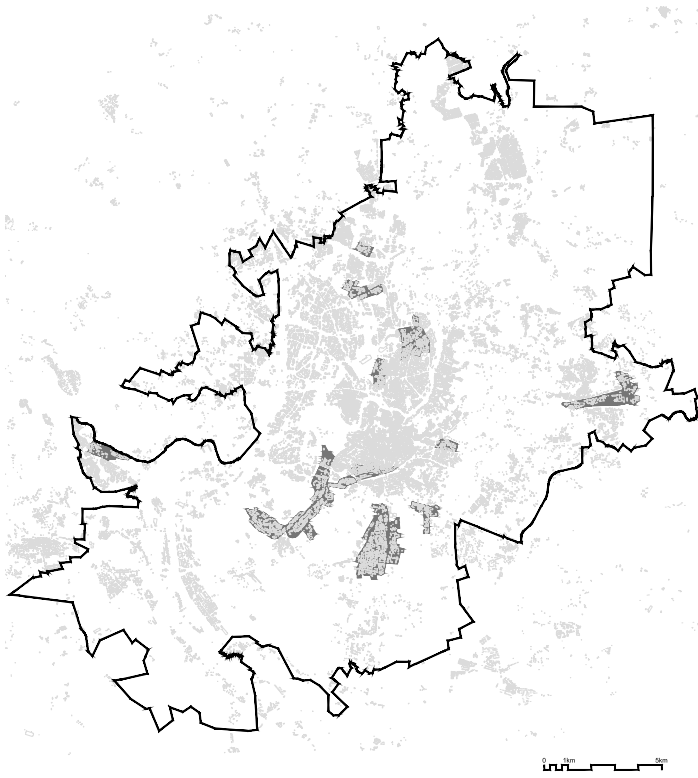

Public land - 26%
Gross space index (GSI) - 0.4
Population/ha - 0
Workplaces/ha - 70

■ Typology prevalence in the city

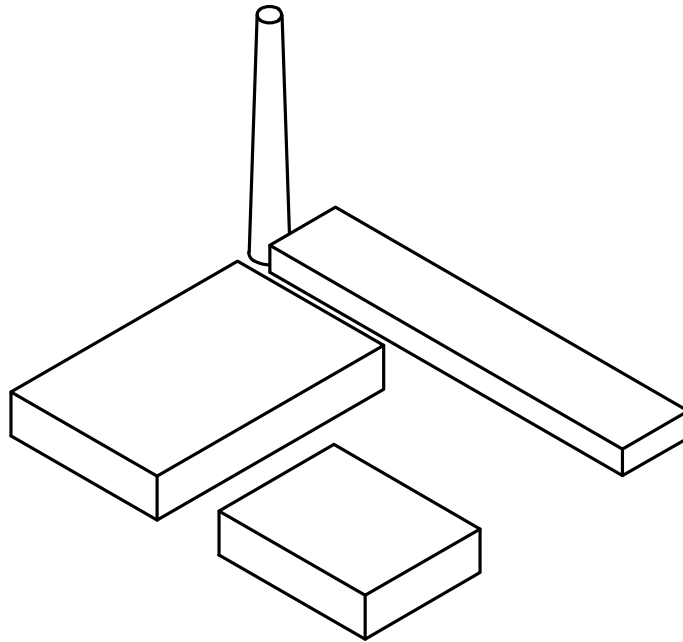

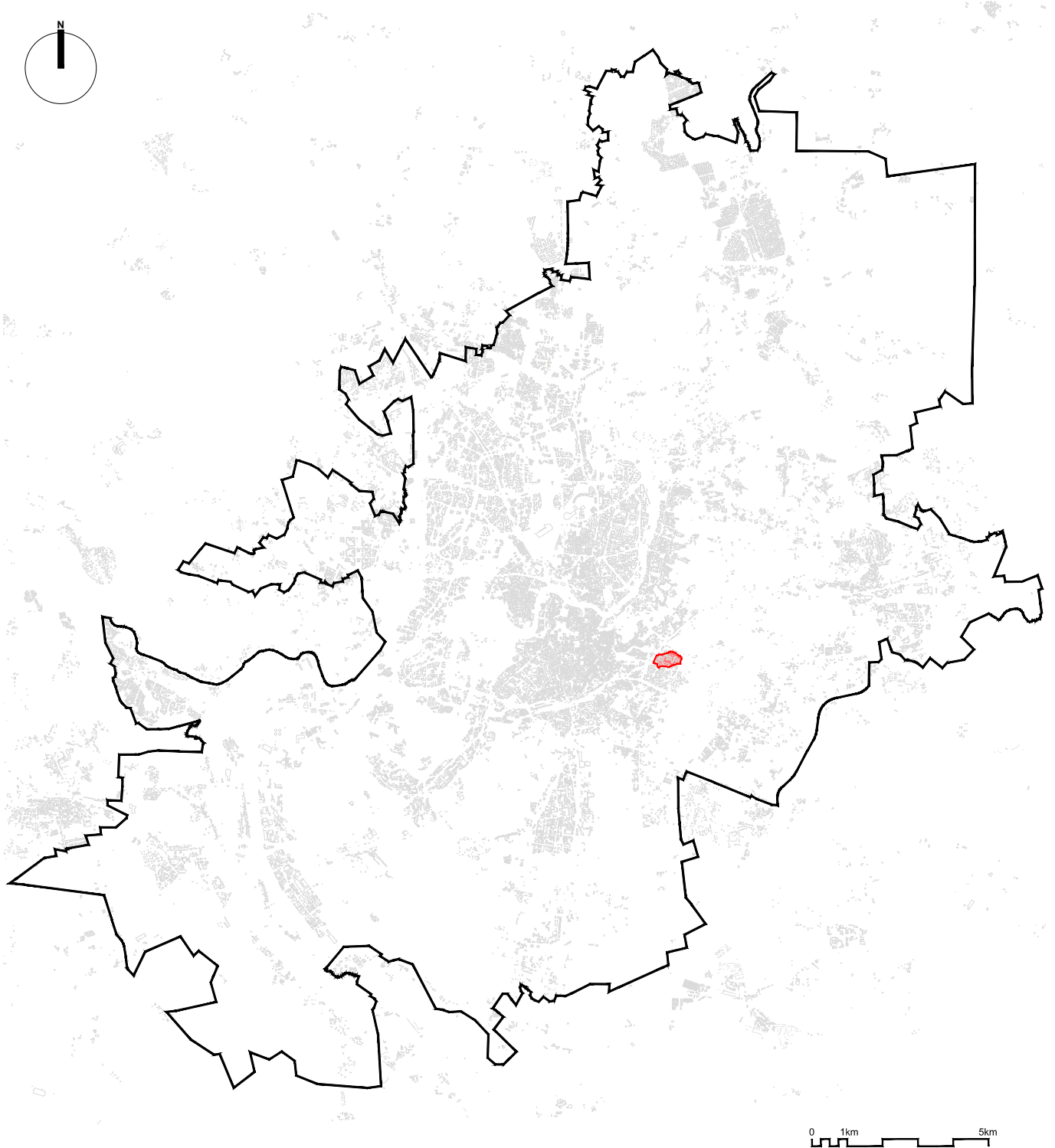

 Design site

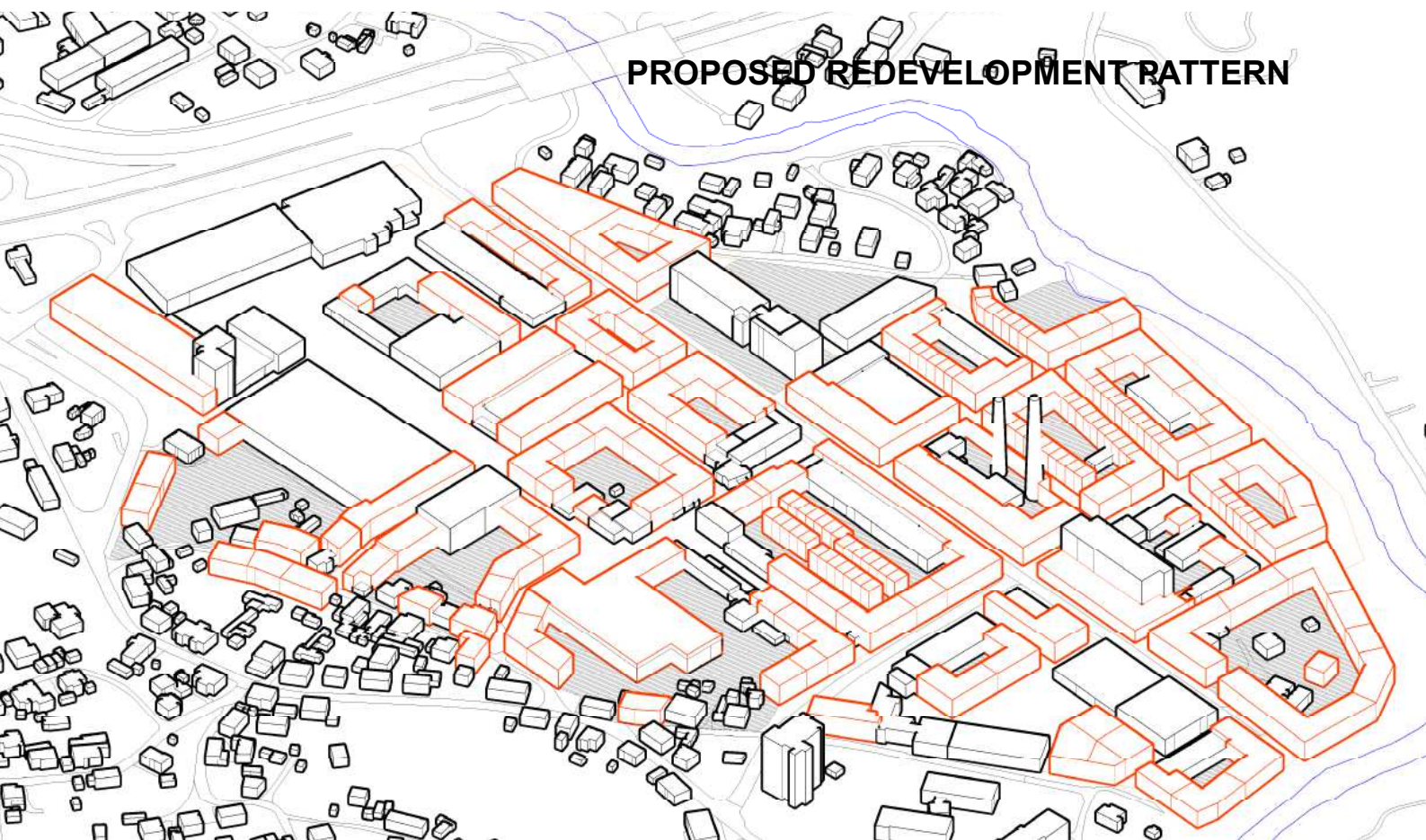
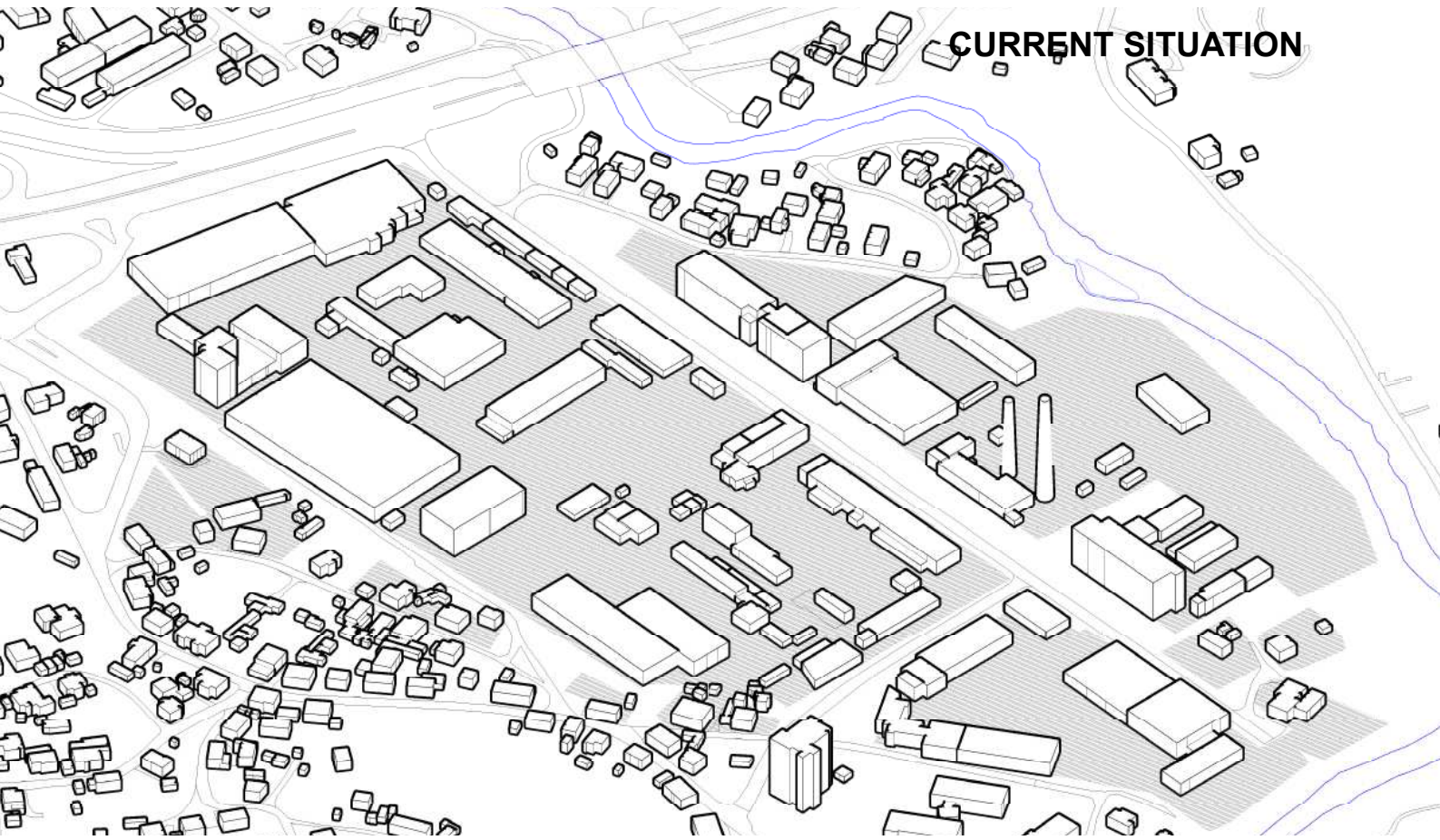

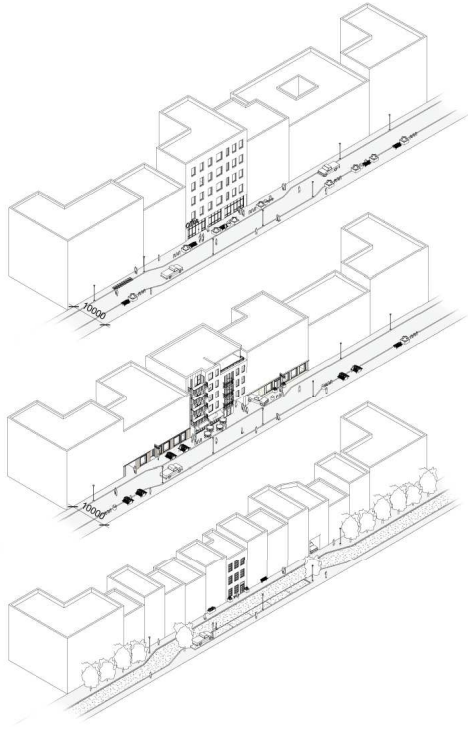

FIGURE 47.
WIDTH - 6.5m
NIEUWE LEIDEN.
SOURCE: GOOGLE STREET VIEW.

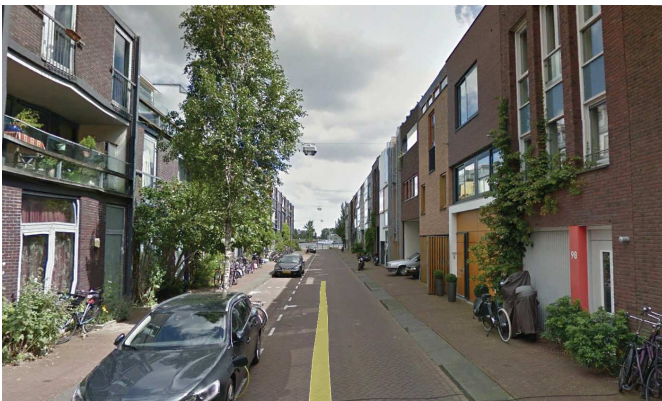

FIGURE 48.
WIDTH - 11m
SCHEEPSTIMMERMANSTRAAT, AMSTERDAM.



FIGURE 49.
WIDTH - 15m
GÖLZSTRASSE, TÜBINGEN.



FIGURE 50.
WIDTH - 23m
AIXER STR, TÜBINGEN.



FIGURE 51.
WIDTH - 17m
FRANZÖSISCHE ALLEE, TÜBINGEN.

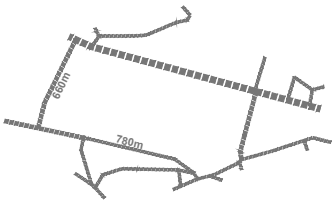
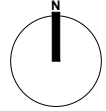

Existing street network

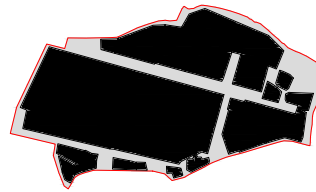

Area - 24.6ha
Private land/Land devoted for building (including public buildings) - 18.3ha (74 %)
Public space - 6.4ha (26%)

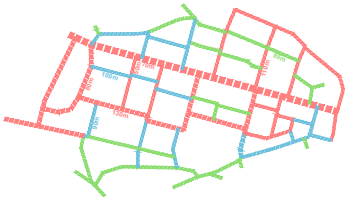

— Streets serving intense economic and social uses (along residential use)
— Streets potentially serving economic and social uses (flexible ground floor use)
— Residential streets



Area - 24.6ha
Private land/Land devoted for building (including public buildings) - 15.9ha (65 %)
Public space - 8.8ha (35%)

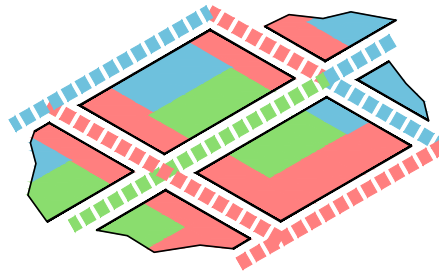
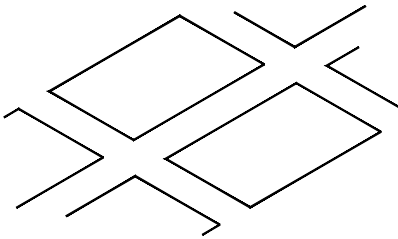
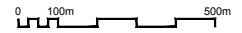

- Building typology is defined by type of the street
- In case corner defined by two different street types - typology is assigned according to preceding street type (if intersection is defined by 2'd and 3'd street type - corner is going to be 2'd)

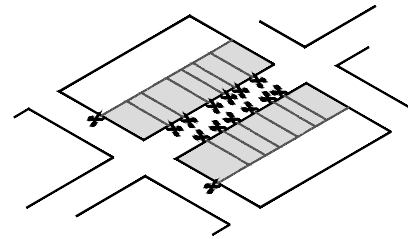

- Plot size depends on assigned typology
- Typologies has to be assigned streetwise (not blockwise)
- One owner cannot own two adjacent plots

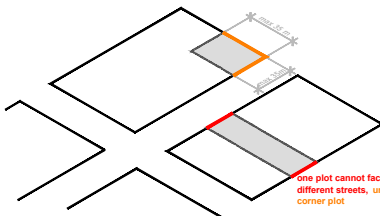

one plot cannot face two different streets, unless it is a corner plot

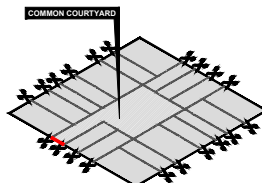

- All block edges have to be aligned with privately (or collectively) owned plots. In case there is a common courtyard - it cannot face the street with the edge which is longer than 4m.

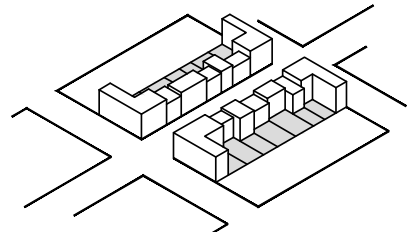

- Whenever possible - development has to begin streetwise

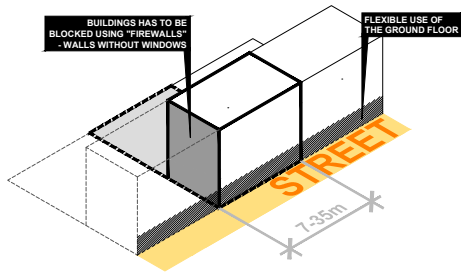

- Only this type can be used to form block corners

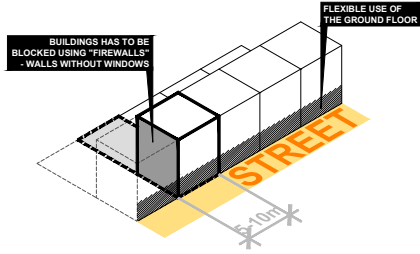

- Depending on the use of ground floor, this typology can belong to both - economically active streets (1th) and residential streets (3rd).
- If it accommodates activities other than living - it does not have to be included into number of solely residential households which cannot exceed 8%.

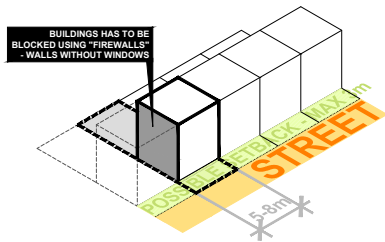

- These typologies cannot exceed 8% of housing supply (meaning housing units) in area that they are being planned. If there is no clear planning boundaries, or planned area is too small (smaller than 3ha) than amount has to be calculated within radius of 100m. In case there is no developments yet according to which this number can be calculated, this type cannot be used. (this rule has to be applied in order to avoid further growth of sub-urbs)

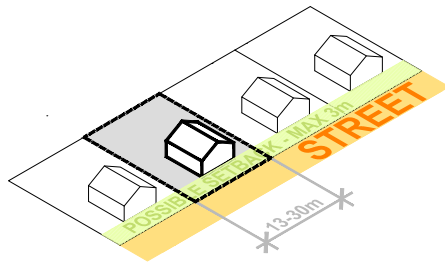

Local importance street profiles

Street profiles used for city transport corridors

- This type of street cannot continue for more than 200m - it has to start and end by intersecting 1th or 2^d type of the street
- It can be used as inner block street network, which is not larger than 200m x 200m
- It can end with cul-de-sac (max length of such street - 100m)

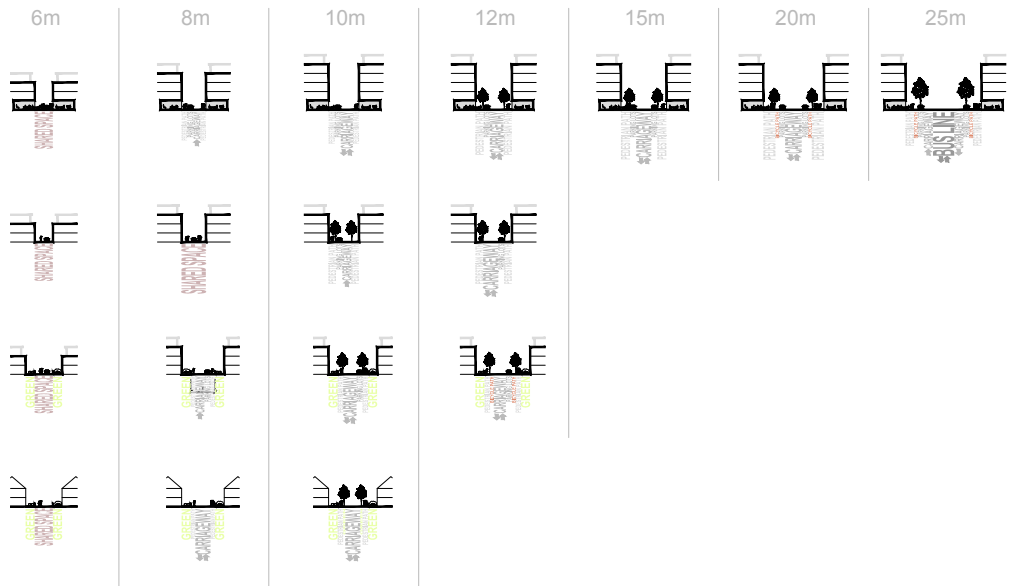

Buildings blocked together using "firewalls"
Buildings does not necessarily have to be blocked together



- | | |
|--|--|
| <ul style="list-style-type: none"> Pedestrian paths Unpaved pedestrian paths Streets Shared space (all modes of traffic share the same space) Bicycle paths (1.2m) | <ul style="list-style-type: none"> Existing buildings Newly planned buildings Individual plot ownership Lawn River Vilnelė |
|--|--|

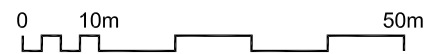

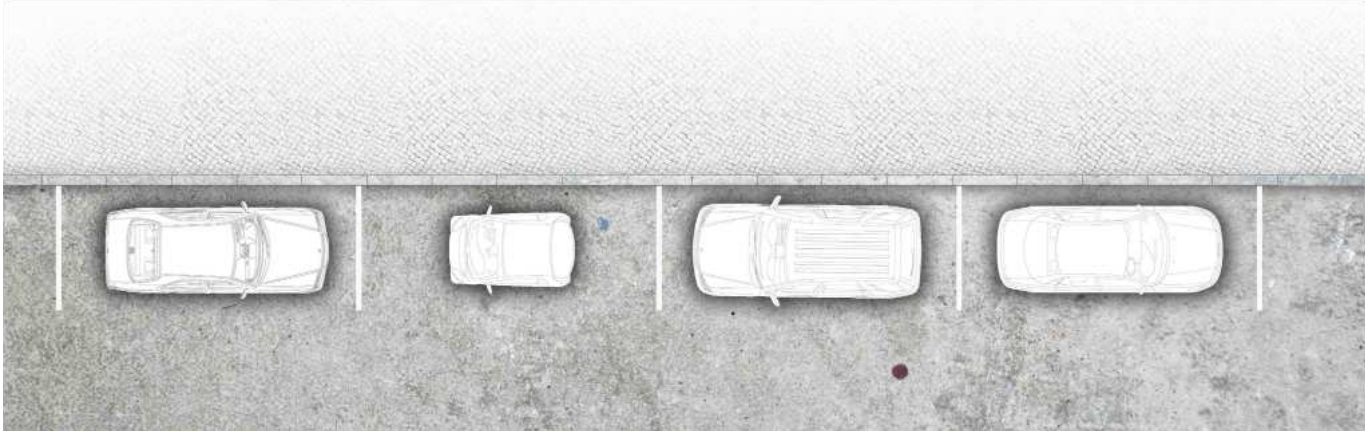

MARKED PARKING LOTS.

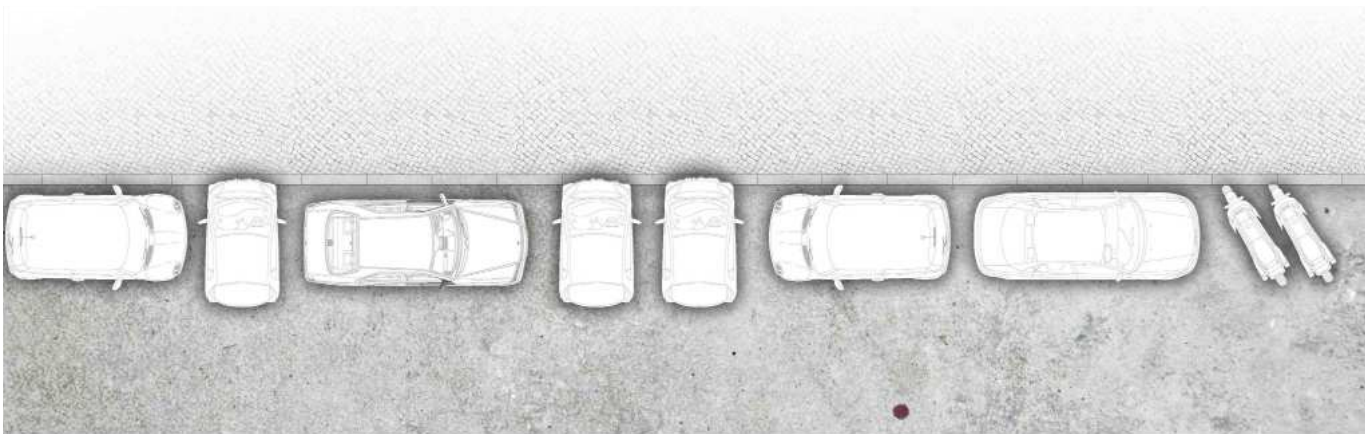

UNMARKED PARKING LOTS. UNMARKED PARKING LOTS CAN BE LOT MORE EFFICIENT IN TERMS OF FITTING LARGER NUMBER OF CARS AND MOTIVATE PEOPLE TO OWN SMALLER VEHICLES.

In order to implement proposed design methods current plot configuration should be modified as indicated in the following drawing:

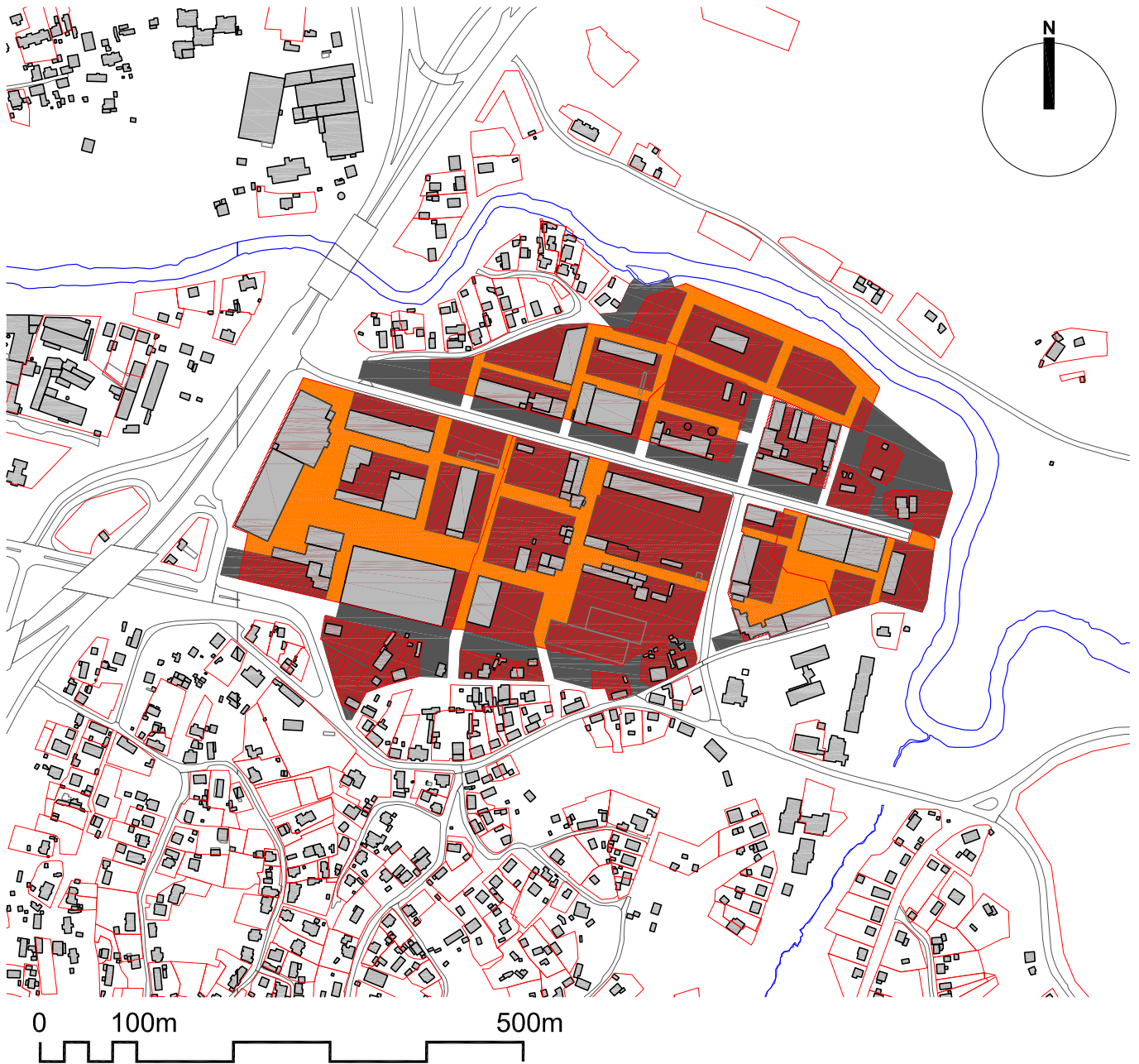

- Proposed configuration of private land/Land devoted for building (including public buildings)
- ▨ Existing private land/Land devoted for building (including public buildings)
- Expropriated land

Redevelopment of industrial sites could be implemented in two different ways:

1. Municipality expropriates the land. In that case land should be subdivided into smaller urban blocks (according to earlier mentioned urban rules), then subdivided into smaller plots (also according to earlier mentioned urban rules) and retrofitted from purely industrial to more economically diverse neighborhoods including residential use. In this case land should be developed using the same steps described in first scenario - "downtown for all".

2. Current owners involved in new development models. Because density in current industrial sited is relatively low - increased density could provide extra space while keeping current activities in the same site (there might be a need to change the way how some of the enterprises are operating at the moment - noise, safety, pollution etc.). Because of increased density - property value would also go up. Therefore current owners should be willing to participate in the program.

There has to be fair evaluation of current building and land value - it has to be carried out by independent real estate agency. Then it has to be turned into value of potential space and collectively owned land value. This potential value has to add extra value for original owner (otherwise nobody is going to participate in these projects)

Municipality commit to provide necessary infrastructure in return that part of the land will be turned into public space (~35% of land has to be public).

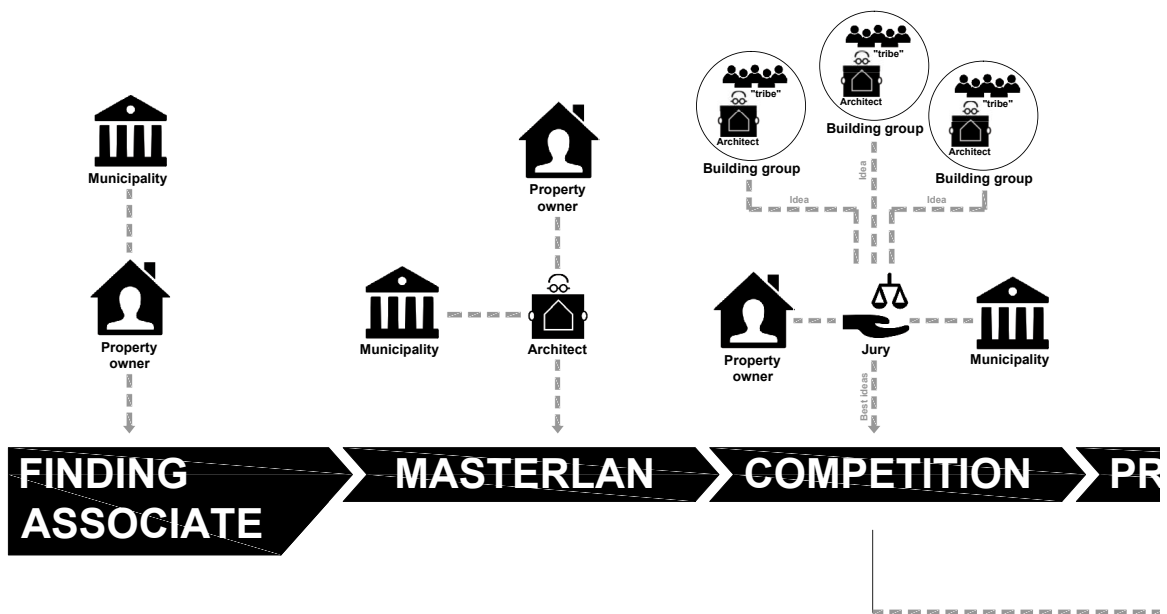

20.1 Implementation

- Preparing master plan for the area which defines urban block division, configuration, amount of public land densities and program (approximate). This document does not change status of ownership - just defines development steps. This plan is crucial for making further process more fluent since development has to be gradual - as main development unit using street. Part of land can be sold out as small plots suitable for villas or row houses after collective project is finished. Location of these plots has to be indicated in the masterplan.
- Selecting first street to develop. After selection, municipality and current owner signs a contract that change the status of ownership within one (or several) street(s) - from private to shared ownership. After this step is made indicators in the masterplan becomes valid for particular street (not for entire area). Contract has to indicate the maximum amount of space that can be created and owned by current owner. The rest as potentially possible to create belongs to municipality.
- Potential space has to be distributed by putting a fixed price and announcing public competition for the best idea. Authors of the best idea further develop their project together with the original owner. From this point there are three parties in this project - Original owner, authors of winning project (*building group*) and municipality. Here municipality plays a role of referee in case there are disagreements during design process between original owner and building group. If design process fails - competition can be either repeated or cancelled. In case of cancelation ownership rights are given back for the original owner.
- After design is finished and municipality issues building permission - building group is granted with ownership rights. From this point building group can apply for loan and start building process.

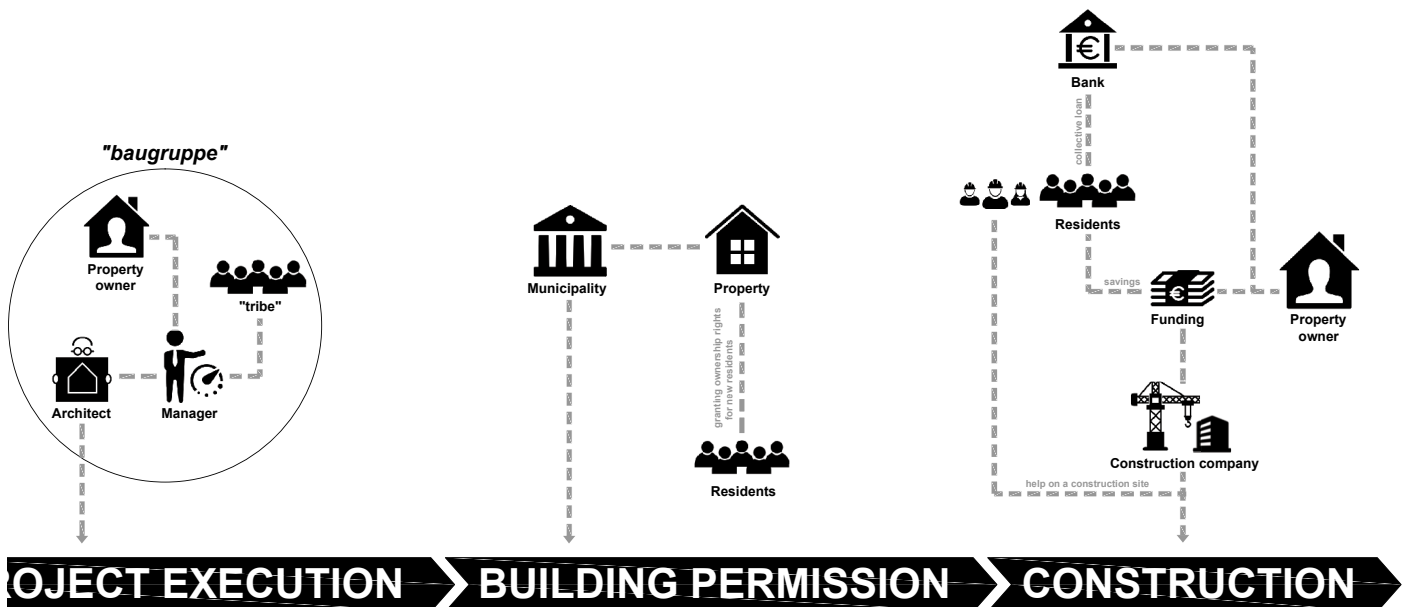

period when municipality temporarily becomes shareholder

21. DIVERSIFYING COMMERCIAL DISTRICTS



Aims:

- Reduce concentration of working places in particular locations
- Reduce the need for commuting
- Make commercial activities more resilient against changes in the future
- Make commercial activities more accessible for everybody
- Reduce energy demand for commercial buildings

Stakeholders:

- Municipality
- Future residents
- Banks

Methods:

- **Reducing the scale of development**
- **Diversifying single use**

Benefits:

- possible result would contribute to proposed strategy - people would be motivated to live in densely built environment; development would likely to result as more functionally, demographically diverse environment.

Risks:

- Current trends of concentrated/large scale commercial activities will remain in place - intensifying existing problems

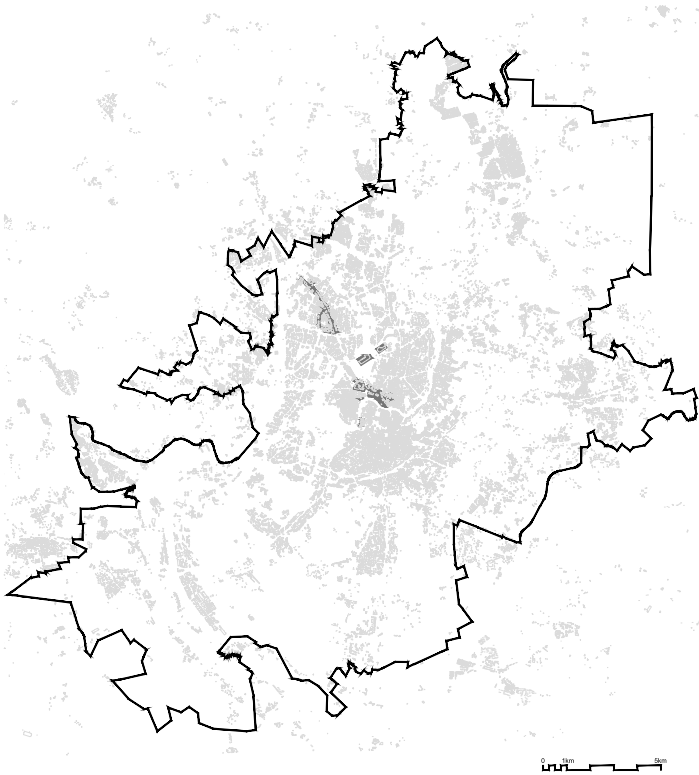

■ Typology prevalence in the city



Public land - 34%
Gross space index (GSI) - 2.5-18
Population/ha - 0
Workplaces/ha - 200

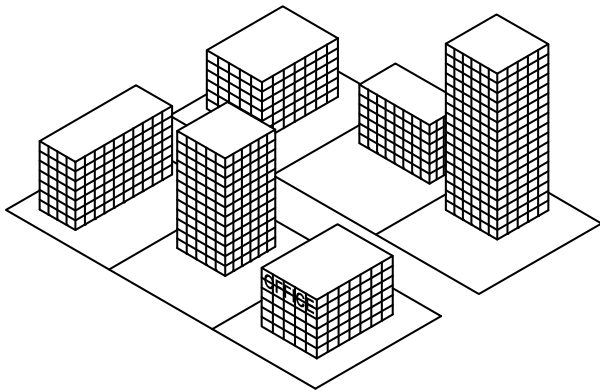

Office districts

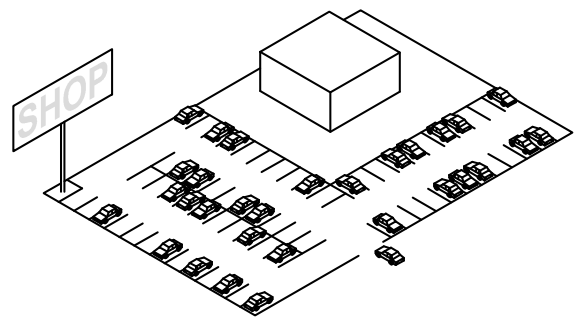

Shopping malls



FIGURE 52.
 ABANDONED SHOPPING MALL IN AKRON, OHIO, USA.
SOURCE: BUSINESSINSIDER, IMAGE AUTHOR - JOHNNY JOO

Attracting foreign companies such as “Barclays” (even if it is attracted under exceptional conditions with low taxes, while discriminating local companies) creates an image of Vilnius as growing important commercial hub. But it does not make the fact of 500km of unpaved streets to go away. One can speculate that attracting capital (and making space to invest it) is important step while mobilizing local potential, but so far this approach fails to give any results. On the contrary - most deprived areas in Vilnius seems to be frozen in time for years and give no sign of recover, unless local residents are simply removed elsewhere. While at the same time commercial areas are booming, without no sign that capital accumulated within shiny skyscrapers gives any positive input to the rest of the city.

Economist Robert Shiller claims that economy is closely related with made up viral stories/narratives - a shared optimistic opinion can push people to invest or spend more. Quite often economy becomes an end in itself, rather than a tool to solve real problem. And because solving problems is not a focus of economy - naturally it creates more. Crisis of 2008 is one of the examples. Urban theorists such as David Harvey claims that origins of recent economic crisis lays deep in real estate market. This question is raised not because of attempt to find a right answers, but rather to start a debate - if economy is something that even the most recognized economists describe as a wide spread of narrative - why it is so important to upkeep these narratives? At the same time leaving behind real problems such as: poverty, lack of basic infrastructure, social segregation, sky high rates of homicides etc.

Even though current development direction failed to address these problems - it is still continued by offering “more of the same” and expecting different result. Figure 53. is a map from current masterplan, which indicates areas where supposedly should be created more jobs. Red contour with purple fill represents new areas designated for commercial or industrial activities only, which basically will result in offices and shopping malls. One of these zones is envisioned in mass housing area, where at the moment there is highest concentration of shopping malls already. The contradiction here is that these areas already have oversupply of shopping. Intention to create more jobs is of course good. But nature of shopping mall is that one shopping mall can serve large numbers of people. In other words - shopping mall is very efficient - few employees can serve many customers. Therefore creating more malls in that area can hardly change situation of employment, because more likely it will result in other malls shutting down.

On the other hand offices creates large numbers of jobs, but the question is - why all these offices are located next to each other. Usually presence of one office is completely irrelevant for other office. Most of the customers comes from elsewhere. But the very fact that working places are created by separate building - causes need for commuting.

Other part of the problem is the scale of development. Any area designated for commercial activities only inevitably ends up as a site for big investors. Therefore it creates no chance for local residents to start their own businesses. End result of these plans in mass housing area will create few low paid jobs, which in general will only contribute to rising inequality levels. While if there will be any offices, it will create jobs for people with higher income who usually lives in sub-urbs. This is one of the examples how planning contributes to current problems.

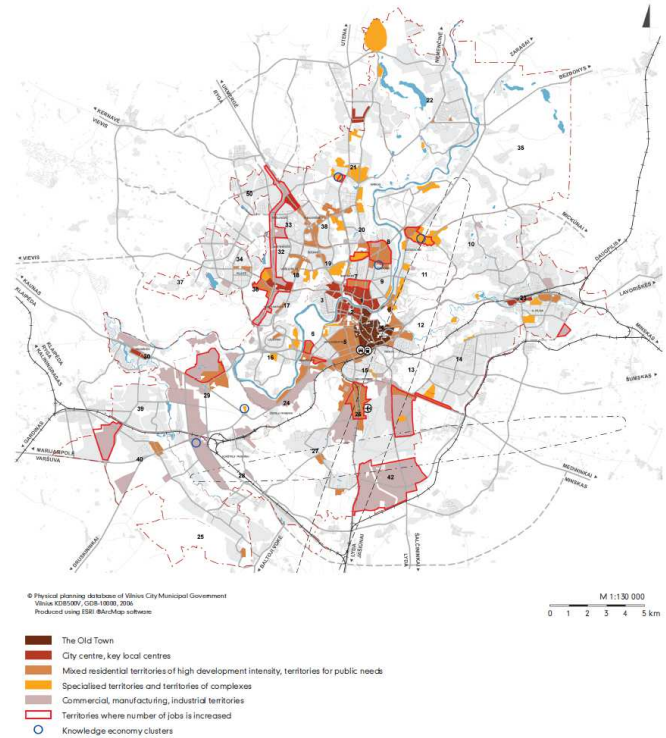
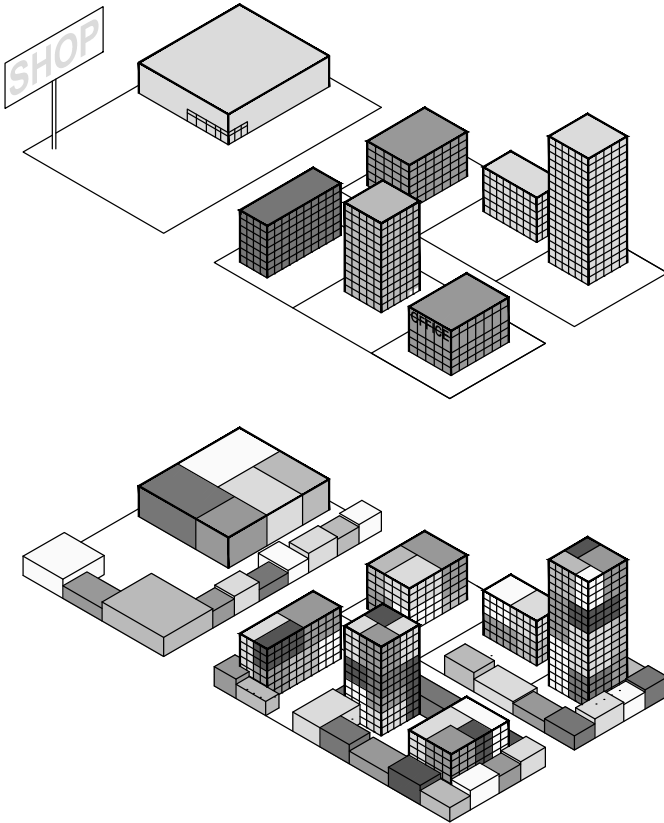

FIGURE 53.
THIS MAP REPRESENTS INTENTIONS TO CREATE MORE JOBS IN PARTICULAR CITY AREAS.
SOURCE: VILNIUS MASTERPLAN 2015



Other issue is sustainability. As a built structure commercial buildings tend to accommodate one particular use, and when it comes to a point of changing the purpose - usually it faces major difficulties. It is naive to expect that the use assigned from the very beginning of building operation will last forever. In fact US practice shows that shopping malls, which was perceived as a major ingredient of "the american dream" - are rapidly dying out. Fig. 52. Phenomenon of dead malls in Europe have not yet got the momentum, but it is likely that it will come here sooner or later.

Because of these issues mentioned, in the future development of exclusively commercial districts should be revised. Preferably development of such districts should be given away. It should **not** be about rejecting commercial building as such. But instead of creating vast commercial districts - commercial buildings should be incorporated into more diverse urban fabric and become part of neighborhood life. However question remains what should be done with existing structures, which most likely will face vacancy and need of reuse in the future. When this issue will arise - there should be a major focus on how to diversify these functions, reduce the investment scale and therefore make them more accessible for local residents. Some structures inevitably will have to be demolished. Others (in case structure allows to do so) should be diversified in uses, preferably including residential use.

This part of thesis does not have strong theoretical or fact based support. Development of commercial districts still have a very strong grip in Lithuanian planning system, thus expecting drastic change in the near future would be naive. The aim is just starting the discussion - where does further commercialization lead our cities, what and how should be changed in the very nature of commercial activities and their spatial expression. It is not something that can be changed overnight, it simply comes together with growing consciousness. But creating conditions for community initiatives can certainly accelerate the shift.

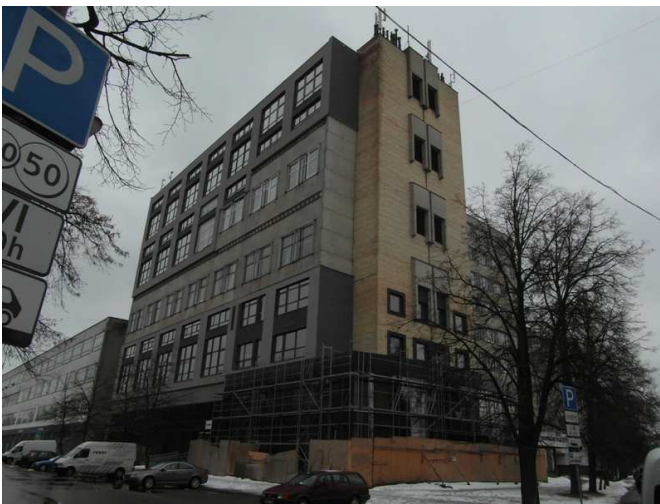

FIGURE 54. RESIDENTIAL LOFTS IN a FACTORY BUILDING. PART OF THE BUILDING IS STILL OPERATING AS A SEWING FACTORY. RESIDENTIAL USE AND PRODUCTION EXISTS ALONG EACH OTHER.



22. PUBLIC REALM

IMAGE SOURCE: LAIMIKIS.LT

Political philosopher Hannah Arendt (1998) claimed that main feature which makes human being different from an animal is that humans lives two different lives - private, where home (*oikiri*) and family plays the center role. And direct opposition of private life is his political life (*bios politikos*). While private realm was described as space for contemplation also where one is dealing with biological urgencies of life (food, breeding etc.) - public realm was described as place for action, where man leaves all its personal needs behind and works for a common good. It was described as a place for human excellence, great deeds, but also requires for courage to step in an take action. Taking action was pictured as a focal point - prerogative of human being, even gods in Greek mythology had to become half man if they wanted to intervene. Hannah Arendt criticized modern man of giving away this prerogative and retreating to *society*, where all responsibilities of taking action are granted to one man (or small number of representatives), by providing him with power to act upon the others. *Society*, according to Arendt, became a place of conformism, where strength one common interest is enforced by sheer number of supporters, normalizing individuals and leaving no place for spontaneity. Society inevitably comes with immense bureaucracy, which eventually becomes a no mans rule.

Dealing with urban environment requires to add another layer to a debate about public and private realms - man made structures. Built environment cannot be oversimplified down to interior which is private and exterior which is public. Richard Sennett (2016) argues that interior can actually be public, at the same time person can distance himself from others and retreat to its personal space while being in public. The exclusive attribute about public space is the possibility to chose the level of interaction. While at the same time interior (home) usually expose person to family structures and hierarchies, which can be difficult to avoid. So instead of equalizing **public / private** realms with **exteriors / interiors**, Richard Sennett superimposed **public / private** with **interaction / subjectivity**. This superimposition helps to link the notion of public / private with built environment and creates a basis for discussion of much more complex relation between these entities.

Despite the fact that Hannah's Arendt's and Richard's Sennett's approaches are purely theoretical, it actually match with conclusions made by Ali Madanipour (2013), who summarized multiple researches conducted on resident participation practice in making of public spaces. He concluded that public space is an integral part of the city, can enhance and help to build new forms of democracy. At the same time he emphasized the fact that today public space is deteriorating and is being engulfed by private interests.

The decline of public space reflects a breakdown in social and spatial linkages and a deterioration of the city as a whole...

...Public spaces that once were meaningful places are becoming a mere part of a transportation network dominated by cars. They are also at risk of being taken over by minority interests, being privatized in the name of safety or exclusivity, further fragmenting the urban society and space. (Madanipour, 2013 p.238)

As a way out of current public space decline he suggests to invent models of resident involvement into processes of public space production. Leaving responsibility only to governmental institutions creates a risk that solutions will never be implemented due to lack of funding or political willingness to act. Situation in Vilnius is a good example of that, there is approximately 500km of unpaved streets. Expecting that this situation will change in any time soon, while practicing current legacy, would be simply unrealistic. Even if governmental institutions take action, often it ends up striving for quantity, rather than quality, because with limited amount of resources municipality always tries to provide for as much potential voters as possible (fig. 55,56).



FIGURE 55.
EXAMPLE OF RIDICULOUS BICYCLE PATH DESIGN SOLUTIONS IN
KLAIPĖDA, H. MANTO st.
SOURCE: VAKARŲ EKSPRESAS

The opposite example of institutions taking care of public realm - solving individual problems in isolation - can also be counterproductive (fig. 57). In many cases individual issues can be solved much more effectively while acting in co-operation with other citizens dealing with the same issue (for instance mobility). In some cases ones problem can be opportunity for others (for instance: if there is lack of parking - some people accommodate others cars in their private space and earn money). Success of many collective practices across the world (Madanipour, 2013) suggests that participation models should be also on the agenda in case of Vilnius.

What is very important in case of Vilnius that co-operative public space development can also be a push towards more sustainable modes of transportation. At the moment government is able to pursue big SOV infrastructure projects with the argument that everybody is using car. Most of the people who might have disadvantages imposed by SOV infrastructure projects - are using cars, therefore it is fair that they have to contribute while creating good road infrastructure. This statement can be turned the other way around if majority of residents within particular neighborhood decides to use other modes of transportation (for instance bicycle or public transport). In that case they have strong argument on their side - if people do not use SOV - they should not be forced to pay the price for other people who are using private vehicles on a daily basis.



FIGURE 57. EXAMPLE OF DISINTEGRATED BICYCLE PATH DESIGN IN KLAIPĖDA, TAIKOS pr. BICYCLE PATH ENDS ALONGSIDE PROPERTY BOUNDARIES WHERE "RIMI HYPER MARKET" WAS OBLIGED TO PROVIDE BICYCLE AND PEDESTRIAN PATHS. BICYCLE PATH STARTS AGAIN ALONG PROPERTY BOUNDARIES OF "NESTE" GAS STATION, BUT ON THE OPPOSITE SIDE OF THE SIDEWALK.
SOURCE: SUMODELIUOK LIETUVĄ



FIGURE 56. EXAMPLE OF DISINTEGRATED BICYCLE PATH DESIGN IN KLAIPĖDA, TAIKOS pr.
SOURCE: VAKARŲ EKSPRESAS



FIGURE 58. RECENT DEVELOPMENTS IN ŠIAURĖS MIESTELIS, VILNIUS. RED COLOR INDICATES AMOUNT OF SPACE DEDICATED FOR CAR PARKING.
SOURCE: GOOGLE EARTH

22.1 public space development models:

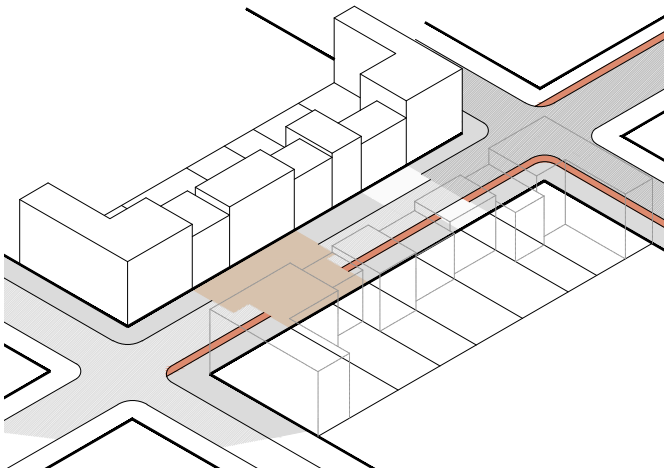

FIGURE 59.

Individually developed public space (by obligation or self initiative) falls under the risk that solutions, which require city scale coordination, will never be realized or realized with serious flaws (fig. 57) creating unutilized, disruptive infrastructure. From maintenance point of view this model works quite well, because people who develop the space usually takes care of it afterwards.

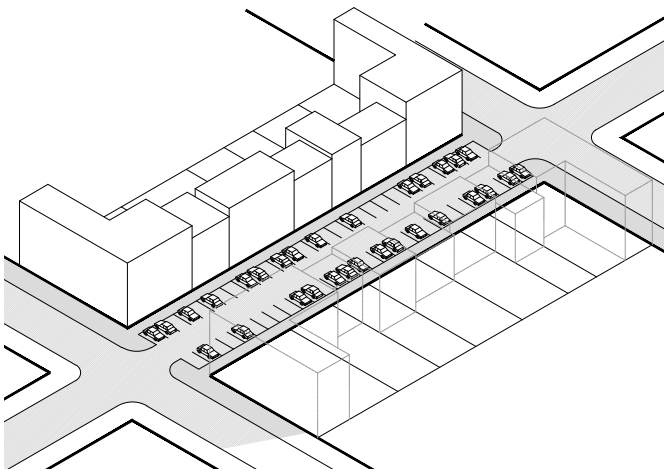

FIGURE 60.

“Top down” model. It is very “convenient” while implementing larger visions for the city. However public space provided by state or municipal institutions usually contain very generic solutions, lacks sensitivity for the place, in many cases do not match with needs of the residents. In case of Lithuania usually it goes along with vast amount of space dedicated for private cars (fig. 58).

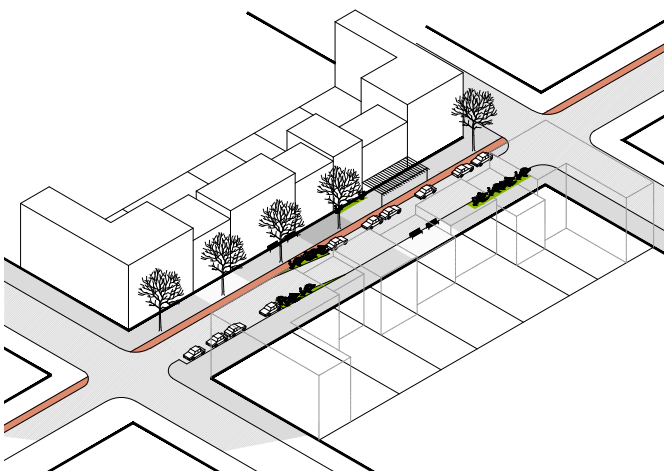

FIGURE 61.

Collective development model is a combination of two prior examples. It includes coordination at various levels, therefore it can be used to implement larger infrastructure visions. At the same time it can accommodate needs of local residents and create unique character.

In order to make collective development successful it is important to understand several characteristics and pitfalls of such processes:

- Co-creation / co-production is not be about compromising integrity or individuality, but rather taking the best out of both approaches, and linking them in a way that public realm gets integrated where it needs the most (for instance continuity of bicycle paths) without losing identity and character of particular place. One of the crucial points in process of public space design is to understand limitations and capacities of each actor. It is crucial to give away responsibilities where one is not able to resolve a task with all its particularities. At the same time there has to be a firm stance when it comes to space integrity, feasibility, facilitation etc. (aspects which cannot be resolved by individuals having separate visions/needs). An exemplar model of such approach could be a *Politique de la Ville* - a national framework supporting local processes (Michialino, 2013).
- Participatory process should be focused on co-production in order not to become a public consultancy. It can cause serious dissatisfaction among citizens if their proposals are not taken into account after they invested time and effort in co-creation.
- It is important to understand that collective public space making cannot be carried out according to a rigid set of rules. In most of the cases sharing out responsibilities or setting action plan (sequence) can be completely different. Therefore it requires active involvement, commitment and owning responsibilities from all parties. It should be quite the opposite what is being practiced at the moment by Lithuanian institutions, where everything is being carried out according to rigid set of rules and in case of failure - rules are to blame. In other words - nobody owns the responsibility. Participatory line of thinking requires more commitment and dedication, therefore evoking motivation and choosing right people to work with is one of the main tasks. But despite the complexities, this way of public space production would allow quick "on site" solutions and would prevent drowning of responsibility in nowadays bureaucratic protocols.
- It is very important to set clear legal boundaries between public and private property. It is not that this boundary cannot be crossed or has to be demarcated by any physical structures. It is about keeping the private interests from overcoming public space. For instance: if there is a square which is used by community - individual community member has to respect these boundaries. Any intentions of privatization should be stopped.

- Collectively created space most likely will end up being managed collectively. The reason is that government may not want to take responsibility for others creation. At the same time residents may not trust other organizations entirely taking care of their creation. Therefore it cannot be applied anywhere - if residents are not willing to engage, most likely collaboration will fail at some point. Participants have to be educated about successful public space management. Some cases indicates that people tend to put too much restrictions on public space, which creates an idea of privatization as it happened in a park within settlement of Colonia Revolución, Mexico. *The playground used to be full of children, but now not many people come to the park because we threw them out so many times.* (Bonilla, 2013, p.206) People should not forget that the space is public and that public interests has to come before private interests (Bonilla, 2013).
- *The principle by which the claims are evaluated and the character of public spaces examined should be the principle of equality.* (Madanipour, 2013 p.242)
- There should be no illusion that people will achieve everything by themselves - Designers (architects, planners) are present in the process. Success by large part is also dependent on close collaboration and support from government. All cases discussed in "Whose public space?" (Madanipour, 2013) indicates that close collaboration between residents and institutions played an important role. Therefore collective design should not be understood as autonomy or independence, but rather as more integrity among all parties.
- Participatory design is not a panacea. It is important to understand limitations and indicate cases where soft collective interventions cannot solve the problem. One of the main ingredients of successful public space is permanent program placed along/around/inside public space. Relying only on periodic activities: recreation, children playgrounds, sports etc., will never create facilitated public space. This kind of space will always require artificial effort in order to keep it lively. While on the other hand - simply placing daily activities around public space creates permanent presence of other people. In addition to that - owners of such activities usually take care of the space, because attractive places also increase success of their businesses (Jacobs 1961). At this point creation of successful public space comes back to built environment and program accommodated within. If built environment is not able to create sense of place - possibility of urban infill, change of property configuration or even demolition should always be on the table as possible solution.

22.2 Implementation

First step in participatory process organization should be setting up a platform for discussion and decision making, which later on can become a basis for work group formation, dealing with different aspects of public realm through representatives.

Entire process have to be subdivided into separate fields (scales) of operation, each dealing with different aspects of public space:

City level

- Lines of public transport
- Coordinating separate projects together - matching bicycle paths or transport corridors among different neighborhoods

Neighborhood level

- Setting priorities of mobility (public transport, bicycle, cars...?)
- Organizing mobility - deciding which streets will include bicycle paths, which streets will serve as more intense traffic corridors, placing speed bumps etc.
- Choosing locations for economic activities

Street level

- Type of pavement (materials)
- street furniture
- Planting
- Locating streets, pedestrian paths, bicycle paths (for instance place of carriageway can be shifted within the street, keeping dimensions (width) decided in a neighborhood level, (fig. 62)

Household level

- There has to be a space for exceptions (for instance placing plants in front of the building, using different pavement pattern, placing street furniture etc.), if they do not go against overall vision.

Each of these fields has to be actively coordinated among each other through representatives.

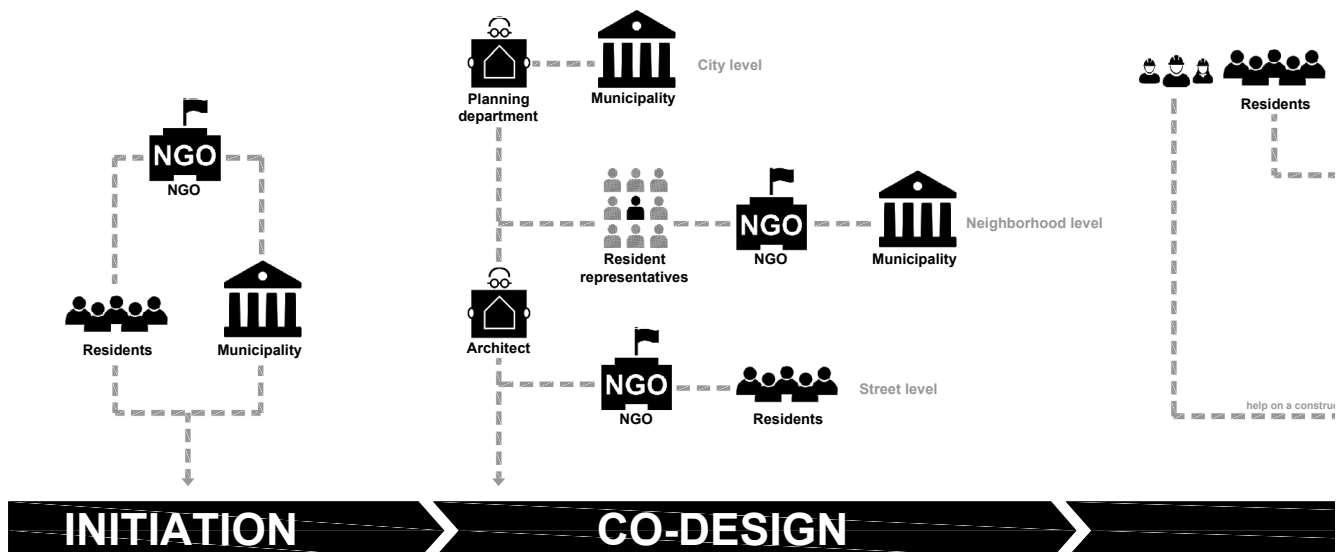

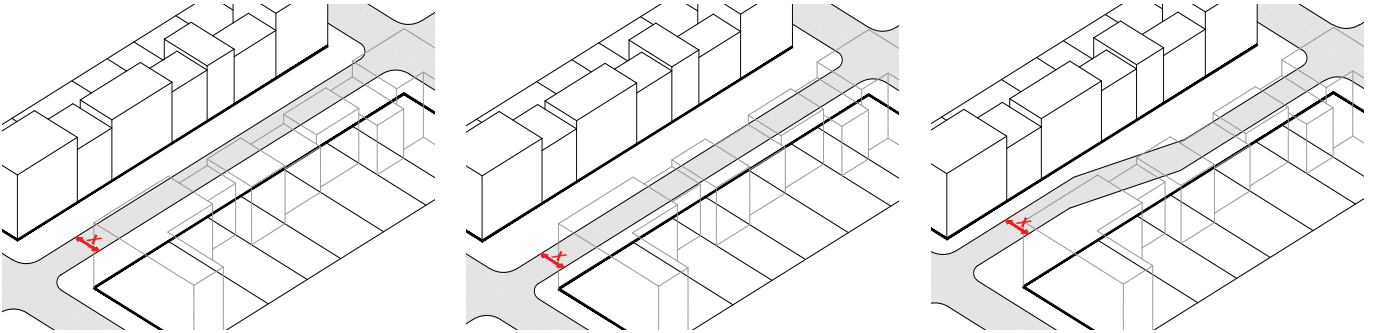
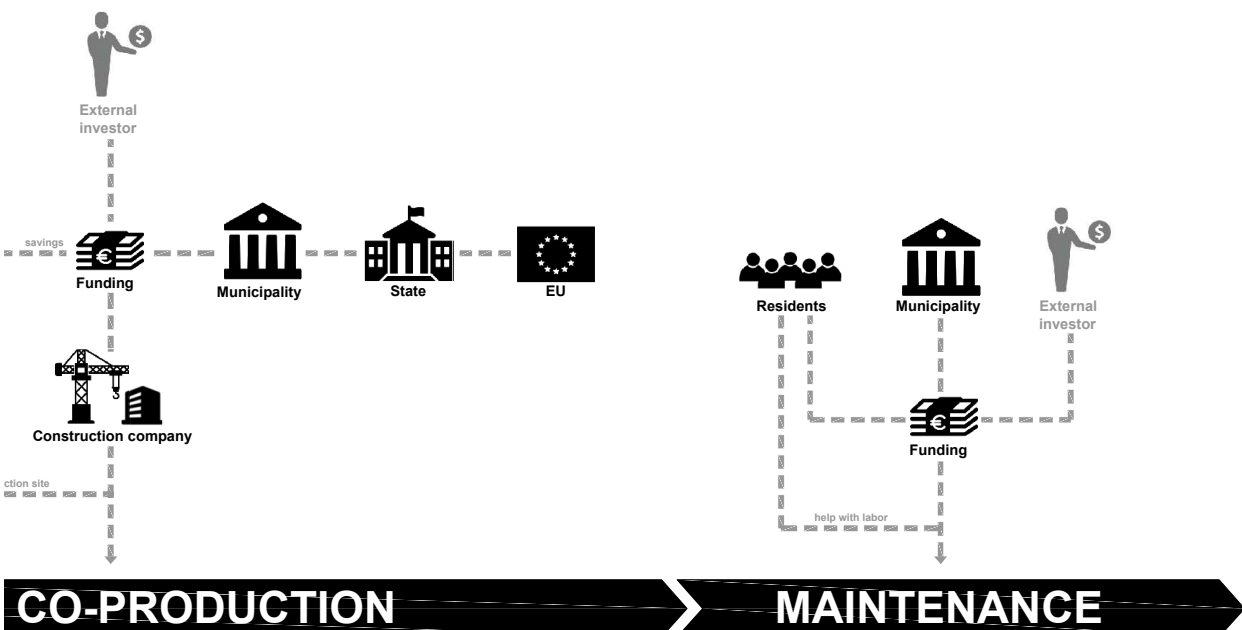

FIGURE 62. CONFIGURATION OF STREET ELEMENTS SHOULD BE DECIDED AT STREET LEVEL BY LOCAL RESIDENTS COLLECTIVELY. THE CONDITION SHOULD BE THAT SOLUTIONS SHOULD NOT GO AGAINST OVERALL VISION OF NEIGHBORHOOD OR ENTIRE CITY. (FOR INSTANCE: IF OVERALL VISION INDICATES THAT CARRIAGEWAY WAY WITH IS X METERS, THE INDICATION HAS TO BE RESPECTED. BUT LOCATION OF CARRIAGEWAY CAN BE ADJUSTED ACCORDING TO RESIDENTS NEEDS, AS LONG IT DOES NOT CRIPPLE OVERALL OPERATION OF STREET NETWORK).

It is crucial to coordinate actions with local government (municipality), taking into account city scale projects and visions. Collective initiatives does not necessarily have to follow solutions imposed by planning department (in case they go against resident well-being, initiatives should keep the right and power to oppose), however keeping the dialog helps to earn trust and can help to get additional (financial) support at some point. Successful coordination with government can become a foundation for further collaboration, where government would perceive communities as a tool for successful city development.

Possible funding sources:

- Private savings (capital, help with labor, materials)
- External private investors, who might have benefits from attractive public space
- Future residents. As one of the conditions coming to live (for instance in Šnipiškės), could be a certain amount of money invested to public space.
- Municipality
- State funds
- EU funds



22.3 Conclusions.

Any of possible public space facilitation models could not be referred as “the right” or “the best” model, rather it depends on a social context. Recent research shows that existing grassroots initiatives in Vilnius were more effective in stopping (undesired) projects in the vicinity rather than creating something on their own. Also environment for organization of such initiatives is not favorable - usually government meets them with alienation or confrontation (Aidukaitė, 2013). Therefore leaning on collective production of space in Vilnius would be quite unreliable. If people refuse or fail to co-operate - “top down” provision model could still be the best solution. Knowing that municipality of Vilnius financially is not capable to develop all public space needed - in some cases individual initiatives may be better than nothing, even though that sometimes it leads to ridiculous outcomes. In addition to that - individual initiatives is the sign of willingness to engage, therefore these initiatives should be recognized as a basis to act, involve more actors and start community organization process. As a way to develop public space municipalities tried to obligate every private owner to form and maintain public space around private property. Unfortunately this approach failed, due to lack of communication among different owners it resulted in comic outcomes (fig. 57). However if there is a possibility to chose between different development models - co-creation and co-production of public space should be prioritized. This way of development is an effective urban catalyst, helps to build consciousness among residents about their environment, can help to create strong communal bonds, make inclusive physical space and uplift integrity of the city as a whole (Madanipour, 2013).

22.4 Public space and mobility

Very important aftermath of current traffic engineering agenda is the amount of space consumed by end products - freeways and junctions. In this particular case (fig. 64) one junction takes 15ha. In theory it could accommodate ~3800 residents. It is a matter of speculation how much value it would add to the city if it would be turned into vibrant and attractive neighborhood such as Užupis. No matter how crazy it could sound today, many examples worldwide shows that such places actually can be replaced and rise quality of living.

Offering these kind of solutions today would

be too radical. However in the far future, if current city development would be shifted from monocentric to polycentric, and designers would recover ability to create lively urban environment - these kind of spaces inevitably will have to be questioned. As indicated earlier in this chapter, well crafted urban space is much more beneficial for the city than monofunctional transit corridors (it can be argued if such place have function in general, because it is used only for passing by). Vilnius possess great amount of lost space, which possibly hides great potential.

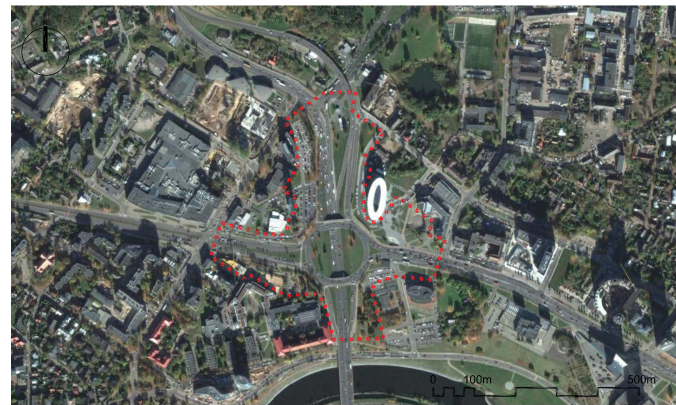
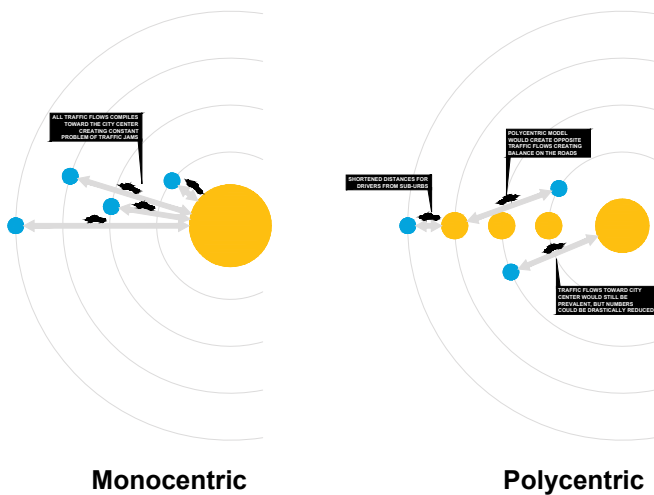

FIGURE 64.

FIGURE 63. SCHEME OF TWO POSSIBLE CITY DEVELOPMENT PATTERNS, WHICH DEFINE TRANSPORTATION PRINCIPLES (COLOR CODE RELATED WITH FIG. 66) WHILE MONOCENTRIC PATTERN INEVITABLY CREATES CONGESTION, POLYCENTRIC PATTERN HELPS TO BALANCE FLOWS DISTRIBUTING THEM ON BOTH DIRECTIONS - FROM CITY CENTER AND TOWARDS CITY CENTER. POLYCENTRIC PATTERN IS ALSO MORE EFFICIENT FROM PUBLIC TRANSPORT POINT OF VIEW. IT IS LESS LIKELY TO BE OVERCROWDED DURING RUSH HOURS, BECAUSE:

- PEOPLE GOING BOTH DIRECTIONS,
- MOST LIKELY TRAVELING DISTANCE IS GOING TO BE SHORTER
- IT IS MORE LIKELY THAT EACH COMMUTER IS GOING TO HAVE DIFFERENT DESTINATION.

AT THE SAME TIME MONOCENTRIC PATTERN CREATES ONE DESTINATION FOR EVERYBODY, SO PUBLIC TRANSPORT GETS CRAMMED WHILE GETTING CLOSER TO THE CENTER. IT ALSO DETERMINES THAT DURING RUSH HOURS PUBLIC TRANSPORT IS FULL ONLY GOING TO ONE DIRECTION (IN THE MORNING TOWARDS CITY CENTER, IN THE EVENING - FROM CITY CENTER). THIS CAUSES HIGHER PRICE OR REDUCE FREQUENCY, BECAUSE ONE WAY TRAVEL HAS TO COVER RETURN COSTS OF EMPTY BUS (TROLLEYBUS). ONE OF THE EXAMPLES OF CITY BEING TURNED FROM MONOCENTRIC TO POLYCENTRIC IS PORTLAND, OREGON, US.

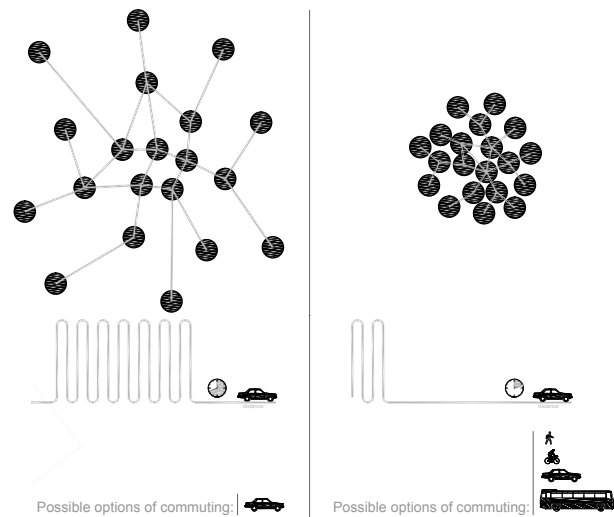

FIGURE 65. ONE OF THE MOST IMPORTANT CONDITION FOR EFFICIENT MOBILITY IS DENSITY, WHICH DEFINES PHYSICAL DISTANCES, TIME AND MONEY SPENT ON TRAVELING, POSSIBILITY TO CHOSE BETWEEN DIFFERENT MODES OF COMMUTING.

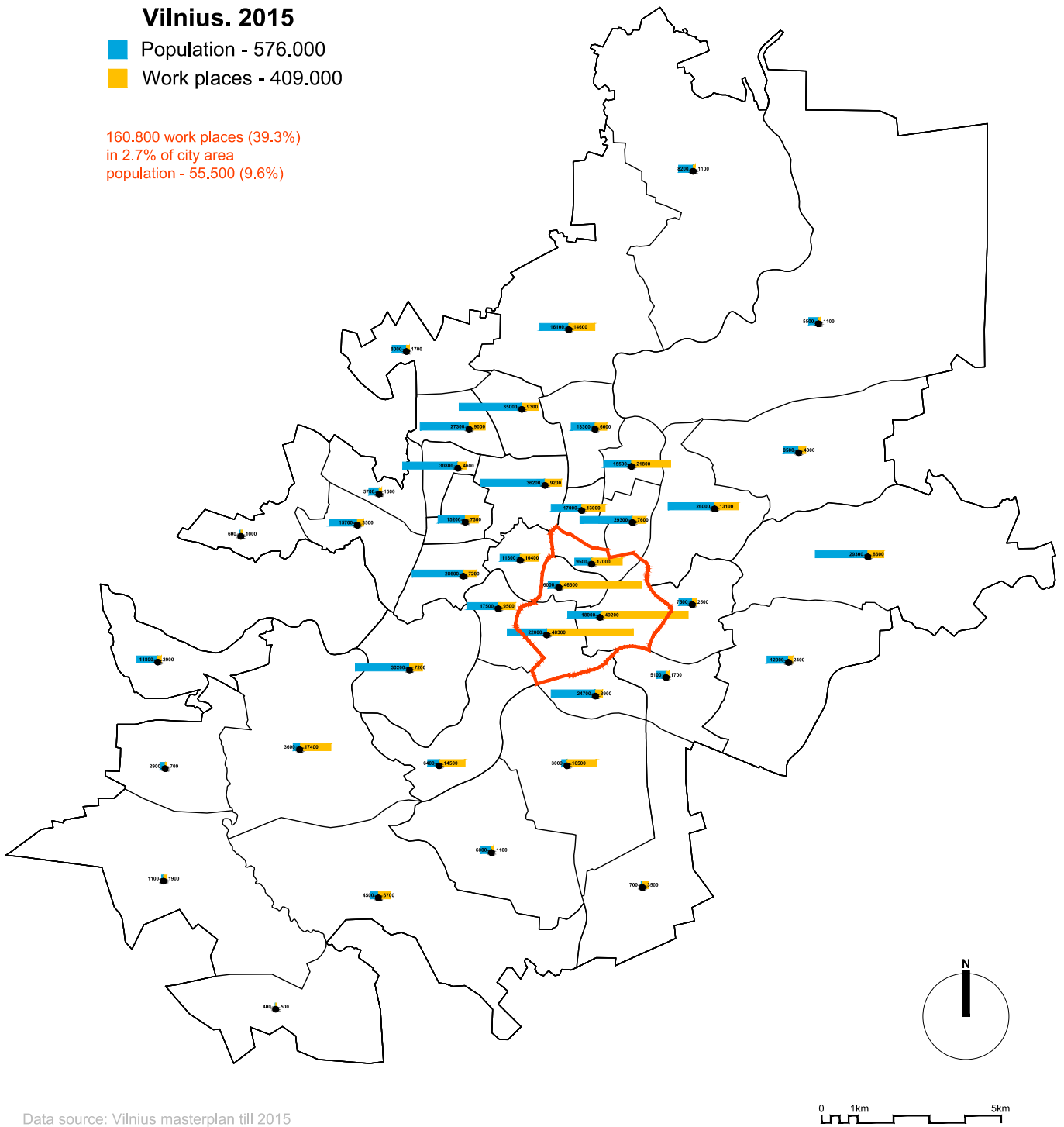
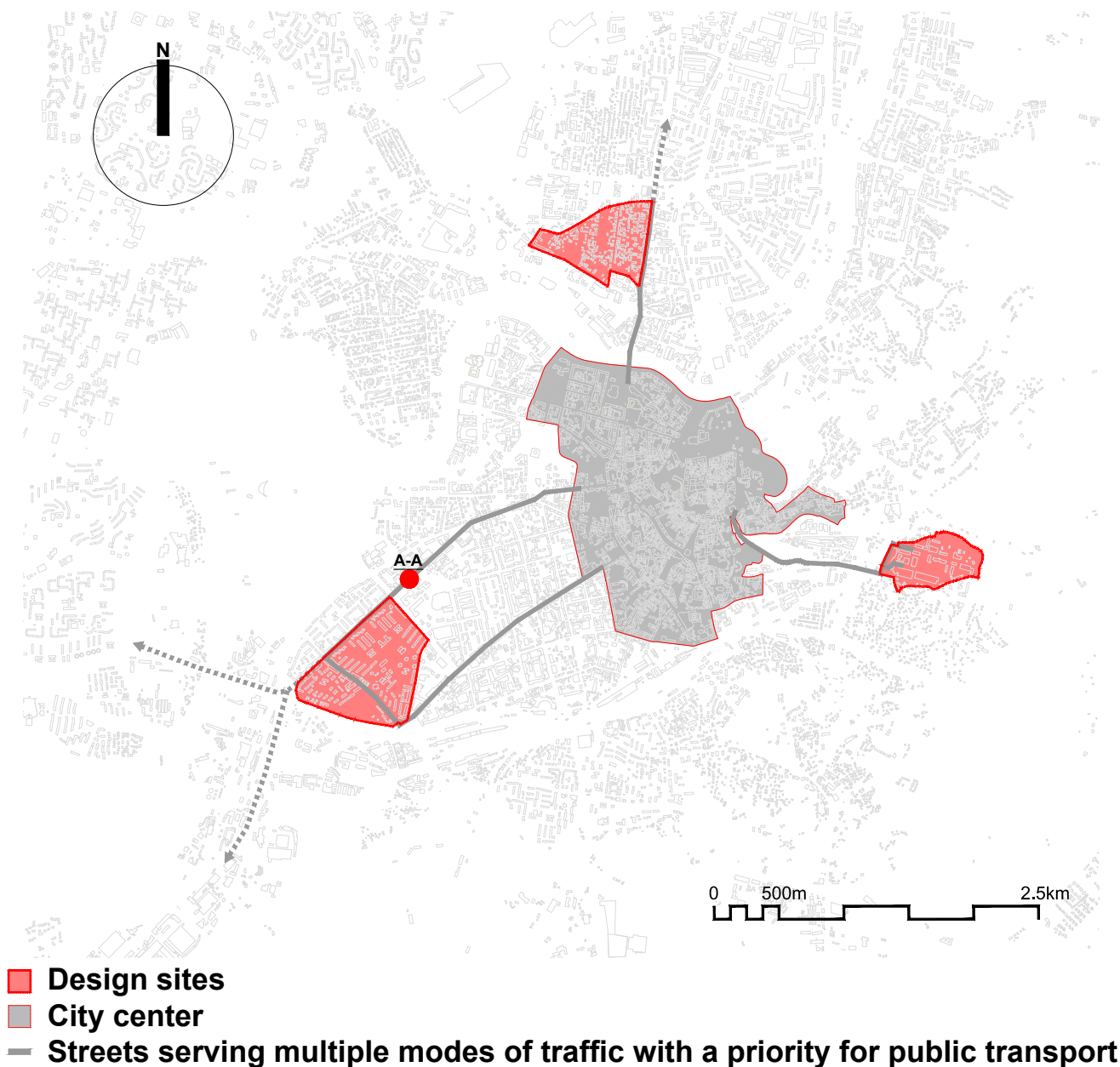

FIGURE 66. POPULATION AND WORKPLACE DISTRIBUTION IN DIFFERENT PARTS OF THE CITY. IT IS CLEARLY DISTINGUISHABLE THAT MOST OF WORKING PLACES ARE CONCENTRATED IN CENTRAL PART OF THE CITY, WHICH PORTRAYS VILNIUS AS MONOCENTRIC CITY (FIG. 63).
SOURCE: VILNIUS MASTERPLAN 2015.

Even keeping current transport corridors, without major re-configuration of urban fabric, could be re-arranged by setting different priorities. Examples all over the world show that walkability, cycling and good quality of urban transport is much more effective and socially just than SOV. Current trends across the world shows that car does no longer define social status and there is a decrease in single owner vehicle numbers in many leading cities across the world (Claris, 2016). Research conducted by Susan Claris and Demetrio Scopelliti (2016) indicates numerous benefits which can be brought by making cities more walkable: reducing road mortalities, improving safety condition, enhancing interaction between people, improving health condition, reducing costs, enhancing local

economy, attracting creative class, increasing tourism, optimizing land use, reducing energy consumption, reducing noise and pollution etc. While having positive evidence about walkability across the world, continuing Fordism ideas in Vilnius is simply outdated. On the basis of provided facts - design sites should be connected with the city center by using multifunctional streets. Keeping in mind worldwide trends - newcomers most likely will be young people, who will not be 100% dependent on SOV anymore. Therefore walkability, cycling, and public transport should be among the priorities. Compared with SOV infrastructure proposed model is rather cheap, does not demand any serious reconstruction and would be more effective in moving urban population around the city.



Current situation



Proposed profile



Section A-A

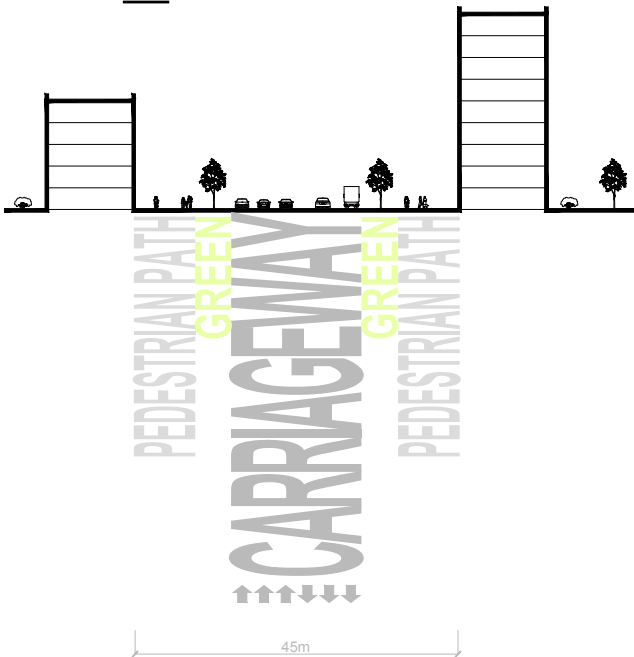

Section A-A

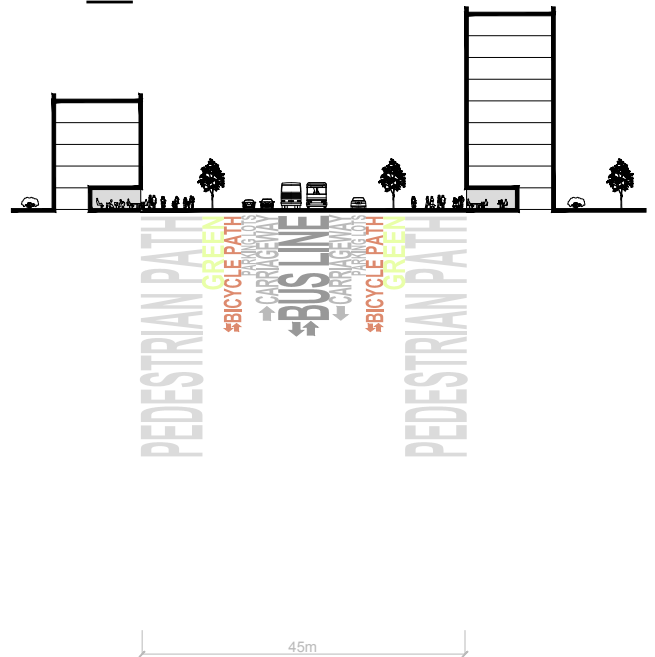

Currently bus lines are placed on sides of the street, which makes it very difficult to take the left turn. Not only that they have to cross 4 lines going from other directions, but also because they have to take a turn from the same line with cars. It also means that there are many cars crossing bus lines, entering the road from secondary streets. Another obstruction is the fact that buses go under the same traffic light with cars, so most of the time buses are stuck in the same traffic jams.

Placing bus lines in the middle of the street makes public transport much more effective. It eliminates unnecessary interruptions by cars and improves movement through junctions. Buses are able to stop without taking a turn, but that also means bus stops are placed in the middle of the street. Bus stops have to be elevated to the height of bus floor, that makes entering the bus much quicker and reduce stop time. Combined with distinct traffic lights and complete separation from car traffic - public transport can come up with significant improvement. Success of such principle can be found all over the world. One of the most well known example is in Bogota, Colombia. However there BRT system was implemented with additional feature - buses are entered from opposite side. This makes easier to switch between the lines, but it also makes implementation more expensive, because city would have to replace or modify all current buses.

23. REFLECTIONS AND CONCLUSIONS

Despite the fact that project by large part was dealing with implementation strategy - main goal was to design livable built environment. However as a main obstacle to create engaging urban tissue I indicated restrictions created by bureaucracy and current economical trends. Avoiding confrontation with these barriers and working only within existing framework creates a risk that existing problems will never be resolved and will continue worsening until the point when it will cause serious social unrest. It is not only necessary to change existing design criteria, but also create conditions that well designed built environment would be accessible for those who needs it the most. Accessibility (affordability) is one of the main urban challenge in Lithuania today.

23.1 Suggestions for further academic research

Current development trends (function wise) can be summarized in figure 68. Working places are strictly separated from residential areas. The same trend is also visible in figure 67, which represents actual relation between work and living place distribution. This way of development fits in current planning requirements (for instance: zoning regulations) and serves needs of real estate developer, (space can be produced efficiently and cheaply in large quantities). Unfortunately this model not only creates homogenous urban environment (which was tried to oppose with this thesis project), but comes along with immense need of commuting, therefore need for expensive road infrastructure.

Issue of commuting was partially addressed in this thesis while trying to propose models, which would create mixed use / vibrant neighborhoods and therefore reduce the need of commuting. However investigating the topic of mobility, demand of infrastructure and impact that it has on life quality in the city can be a research topic on itself. According to urban theorists such as Jane Jacobs (1961) or Jan Gehl (2011) – increasing accessibility for cars only diminishes urban qualities and can cause serious urban degeneration. This topic is absolutely crucial in order to build a coherent academic database and develop new Lithuanian planning system. Current urban mobility agenda, which is mainly focused on car priority - is doubtful (Cervero 2009). Despite that fact - road infrastructure is being increasingly expanded in expense of urban qualities. This is a big academic gap which still needs to be filled. In combination with new models of housing (mixed use) it could become a strong antidote for existing, out-dated planning policies.

23.2 Project limitations

An overall proposed strategy was to reduce uncontrolled growth of city and expansion of sub-urbs. However this part may be difficult to implement because of human factor. In many cases people first start to build and only after they finish construction - try to legalize their settlements by obtaining building permission. This can easily be stopped by tightening delivery of building permission. However tightening might be difficult on itself.

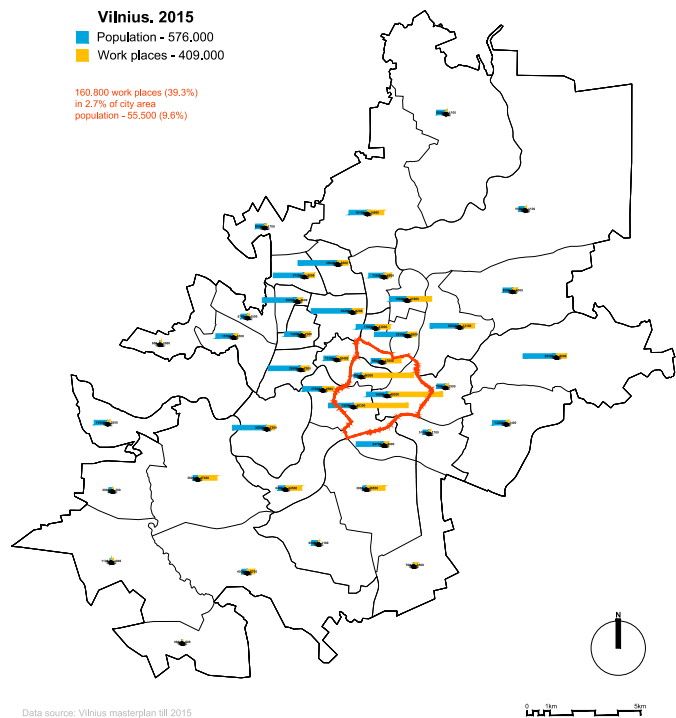

FIGURE 67. POPULATION AND WORKPLACE DISTRIBUTION IN DIFFERENT PARTS OF THE CITY. SOURCE: VILNIUS MASTERPLAN TILL 2015.

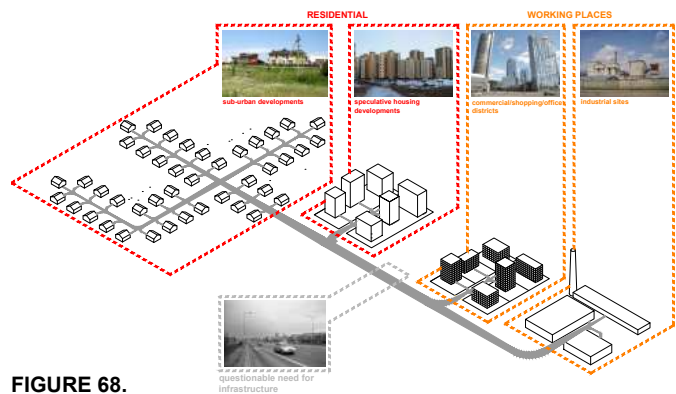

FIGURE 68.

- First it might fail because of simple human compassion - there are many people trying to legalize sub-urban houses in undeveloped areas, including people working in municipality, who can also have the same problems. This factor can make civil servants more indulgent of issuing building permission.

- Another very important factor is possibility to bribe. Those who have more money can simply buy their way out to get a building permission (fig. 69). These possible flaws can make the strategy of city densification softer and create preconditions and justification for other people to ask the same rights to obtain building permissions in undeveloped land.

However preventing city to grow outwards does not solve all the existing problems - it would just make the city of Vilnius more efficient in terms of maintenance. Problems such as lack of safety, pollution, social segregation, lack of public facilities or poor living conditions in particular city parts can only be solved by directing densification in a right way. However channeling densification might be even more difficult task. Justifying right to build in particular city parts, (which currently are unbuilt, or contains only low density) may open a Pandora's box of developers trying to profit. Also, if densification policy would be launched without right regulation in place - most likely it would result in even more generic and monotonous environment, without public facilities, social, cultural activities etc. It is likely to happen because of existing rules and



FIGURE 69. EXAMPLE OF BUILDING IN LAND PLOT ON THE BANK OF GULBINŲ LAKE. THIS AREA WAS DEVOTED FOR RECREATIONAL USE AND MEANT TO BE ACCESSIBLE TO PUBLIC. HOWEVER IT RESULTED IN HIGHLY SECURED, FENCED-OFF RESIDENTIAL DISTRICT FOR THE RICHEST. THIS IS ONLY ONE OF MULTIPLE EXAMPLES, WHERE BUILDINGS ARE BEING CONSTRUCTED WHILE GOING COMPLETELY AGAINST EXISTING PLANNING DOCUMENTS, YET BEING PERFECTLY LEGAL.

SOURCE: DELFI.LT

regulations:

Zoning. Keeping distinct functions separated increases need for commuting; land for distinct uses becomes more expensive; development scale (building size) for particular use increase, therefore it becomes inaccessible for people with low income (for instance: only reasonably wealthy person can afford to buy commercial plot and build shop). While at the same allowing mixed use would reduce the scale of possible commercial space (instead of having separate building as shop individual would be able to devote small space in its own house and generate income, that would become a small step helping vulnerable social groups). It would keep separate uses close to each other. (close proximity would reduce the need of commuting, reduced commuting on itself would reduce levels of pollution and noise).

- **Priority of car.** Requirements to provide 1 parking lot per 1 household usually results in vast open spaces around residential buildings, which cannot accommodate any other purpose; Integrated parking garages usually creates blank ground floors resulting in dead public space around the building. Requirements for immense street widths and huge turning radius, transforms streets into roads, which are unable to create pedestrian friendly, attractive space. In combination with zoning any kind of retail becomes simply impossible
- **Various security zones.** Regulations of keeping certain rooms / buildings / facilities away from certain infrastructure / other functions / or just away from each other. (for instance: children playground and car parking lots cannot be placed closer than 15m to the windows of residential space, windows of neighboring houses cannot be placed next to each other closer than 6m, etc.). These excess regulations often prevent to build tighter in places where it is most necessary. While at the same time wide use of "firewalls" (blocking buildings together) would allow to build tighter and create well defined urban space. Blocking buildings together could improve means of safety, create favorable conditions for retail.
- **Neo-liberal real estate regime.** Accessibility to real estate defined only by means of capital possession is the main driving factor for rising social segregation in Vilnius.
- **Planning process completely secluded from public.** Using generic models, top down planning is creating conditions for core investment. This approach completely ignores voice of residents and existing potential, which could result in more diverse environment.

Replacing these regulations (and many more) might be extremely difficult, because of inertia acting under existing order. Even though implementation part took much of the focus in this thesis - convincing government and planning department to change their approach might still be a major obstacle in order to take action or change a direction of current planning agenda. Pursuing densification strategy under current legal framework is extremely dangerous, because there is a risk that only some parts of entire proposal will be taken for granted, leaving other parts behind (parts which require more serious reform inside planning department and legal basis). Consequences of partially implemented strategy can be disastrous.

For instance neighborhoods with low density, high property value and low income owners - would become targets for real estate developers, and that may cause increasing numbers of brutal eviction. Partially this risk could be eliminated bypassing legal institutions and working directly with existing vulnerable communities. By empowering residents to take action in city formation, vulnerable social groups could uplift their status and get the right arguments of city planning on their side. As a result, planning department would not be able to launch damaging redevelopment strategies (in this case "unfinished" densification strategy). Successful community mobilization projects can make vulnerable neighborhoods more resilient against brutal real estate development schemes and improve existing social and spatial condition. In case the strategy for Šnipiškės would be successfully implemented - bottom up approach could become exemplary, enter another stage and become a basis to start urban renewal in mass housing areas (preferably starting with most secluded area such as Vilkpėdė).

Mass housing renewal strategy is almost impossible without close co-operation with municipality. Risk that municipality (planning department) will refuse to co-operate - is the main weak point of this proposal. The fact that Lithuanian government have inherited a lot of characteristics from former soviet way of ruling, allows making an assumption that integrating participatory practices in the planning agenda might be difficult.

Slovakia's practice shows that most of people initiatives were implemented with minimal help from municipalities, especially in the initial stage

(Marcinčzak, S., 2016). According to the research conducted on social innovations in Slovakia – officials perceive themselves as a rulers rather than servants. In that case participative practices, local initiatives and collective planning are perceived as a burden. Since political situation in Lithuania is pretty much comparable with Slovakia, it is likely that proposed concepts will be met with the same attitude. Therefore, success in Šnipiškės is especially important, because could become a leverage to pursue legal institutions to support bottom up initiatives. In case municipality refuses to co-operate - it may lead to public perception that it is better to develop city without planning department rather than with it. In other words - favorable outcome in Šnipiškės might impel impression that planning department is a redundant institution, and that is

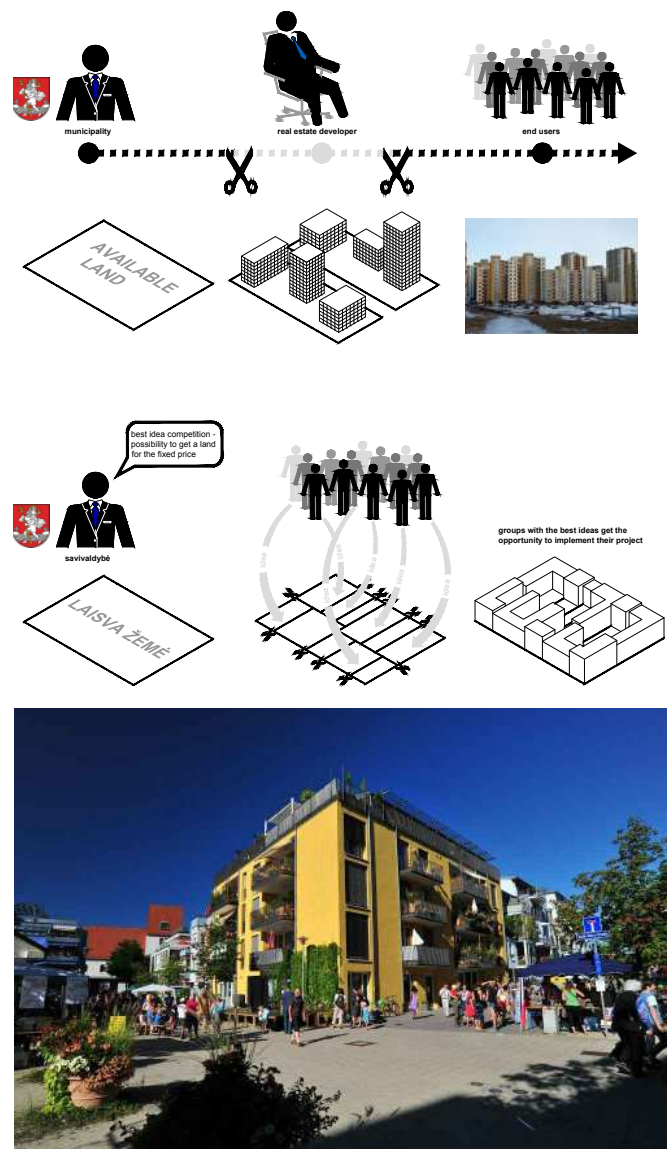

FIGURE 70.
LORETTO VIERTEL, TÜBINGEN, GERMANY.
IMAGE SOURCE: MAPIO.NET

definitely not the image that these civil servants want to have. After planning department would be “forced” to co-operate with local residents it would be easier to pursue development models similar to “Baugruppen”. Therefore strategy for Šnipiškės is a focal point for the rest of the project.

However bottom-up approach also has its own peculiar traverses. For instance in case of Šnipiškės, which experienced extreme cases of eviction between the year 2002 and 2008, it might be extremely difficult to convince local residents to participate in any redevelopment scheme offered by outsider. The fact that residents in this neighborhood were facing real threat imposed by economical forces, any external financing model proposed by stranger - most likely will be met with a deep suspicion. Therefore earning trust of local residents

can be very difficult. Fortunately there are already community mobilization projects in Šnipiškės, which could make first step a bit easier. Examples all over the world shows that community mobilization is possible and in fact can be very fruitful compared with conventional top-down models.

Another goal of proposed city development strategy is to reduce increasing socio-economic segregation. Existing inequalities can be reduced by invoking a method of collective development. Collective development models already applied in Germany or France usually results in accommodating people with middle income levels and higher education. In order to avoid the same effect - models of collective housing were modified in case of Šnipiškės and Vilkipėdė by turning most vulnerable people into main stakeholders. The goal is to make secluded neighborhoods attractive enough for people with higher income. Models provide newcomers with opportunity to invest in redevelopment schemes and create their own living space together with local residents. Driving factors to invest in such projects would be:

- Lower price
- Close proximity to daily facilities
- Strong sense of community
- Possibility to live in eco friendly environment
- Possibility to adapt living space according to individual needs
- House could generate income in combination with other uses
- Possibility to be less dependent on “top-down” decisions

Ideally it would result in mixed income neighborhood, where both sides can benefit from each other - lower class would provide with labor/skills/services - higher class would mobilize this potential by infusing capital. However, as it was mentioned before - proposed re-development schemes might have no or very little interest among local residents. It might require additional economic support for “pioneers”, which could be provided by state government, municipality or applying for EU funds, however success of getting this kind of funding is rather vague. In general - proposals are not capable to eliminate existing differences entirely, but it might contribute to a concept of more just city in combination with other (legal) actions, which falls out from the scope of urbanism field, so it was not tackled in this work.

DEVELOPMENT METHODS:

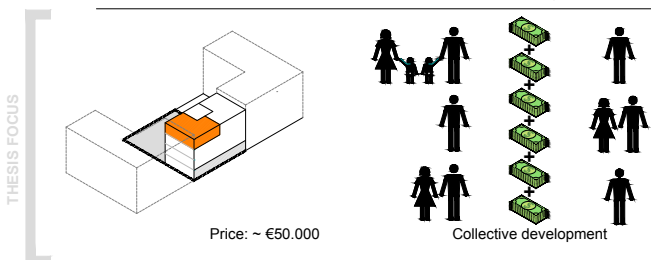
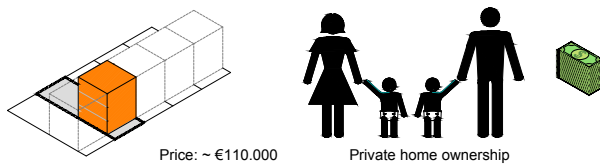
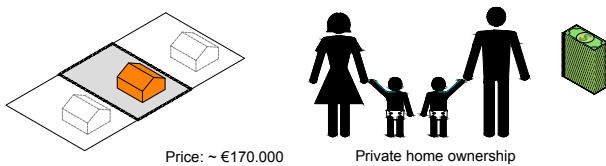
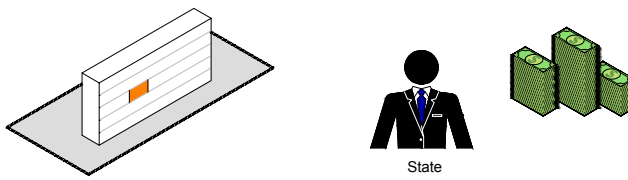
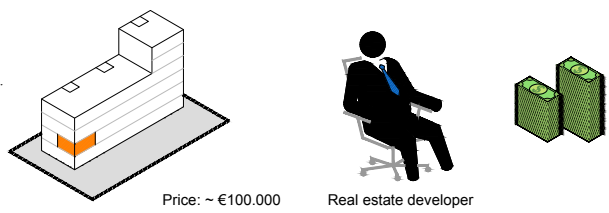

23.3 Conclusions

This thesis project mainly was dealing with absence of lively urban space in Vilnius. Collective housing was proposed as one of the possible ways to get out of current urban deadlock, where conventional models repetitively produce dead, sub-urban space. This proposal naturally comes up with a question: is it possible to achieve the same results by using conventional development models and placing particular regulations? Theoretically it should be possible. However even in case if the outcome of such policy would be successful - it would require constant and active government efforts to upkeep such development. Any shift in authority (elections) would undermine continuation of such strategies. The reason why conventional models can hardly become permanent generator of civic life - is that motivation for main stakeholder is based on short term profit or asset acquisition.

Conventional model:

- *Governmental institution (objective - economical indicators)*
- *Designers/builders (objective - assignments - profit)*
- *Developer (objective - profit) main stakeholder*
- *End users (objective - obtaining living/commercial space)*

Within conventional model lively space at best is understood as a mix of functions and interactive facade.

While this part is of course important, it is by far not enough to meet these parameters. Furthermore - even if regulations for such parameters are in place - in most cases they are implemented only cosmetically (fig. 71). This happens because lively space does not bring any additional profit for conventional developer (situation could change if developer would be turned into a shareholder throughout product (building) operation time, but this automatically becomes a collective development model). There is no intention to deny possibility of creating vibrant space with a help of real estate developer, however aim of this project is to make production of lively urban space a self evident goal. Therefore collective development is introduced as sustainable and continuous in time. After this model would be successfully adopted in practice - pull-back would unlikely to happen.

Collective development:

- *Governmental institution (objective - indicators of sustainability and space integrity)*
- *Designer (objective - assignment - profit, reputation)*
- *Builders/managers (objective - assignment - profit)*
- *End users/developers (objective - creating living space, participation in civic life) main stakeholder*



FIGURE 71. EXAMPLE OF DEVELOPMENT IN ŠIAURĖS MIESTELIS DISTRICT. EVEN THOUGH IT INCLUDES INTERACTIVE FACADE FACING THE STREET - IT FAILS TO GENERATE ATTRACTIVE SOCIAL/CULTURAL SPACE. THE FACT THAT TYPE OF ACTIVITIES AND POSSIBILITY TO PURCHASE THE LIVING SPACE IS DEFINED BY ABILITY TO PAY THE HIGHEST PRICE, CREATES CONDITIONS FOR HOMOGENOUS SOCIAL COMPOSITION AND VERY SPECIFIC ACTIVITIES, WHICH FAILS TO CREATE CONSTANT PRESENCE OF THE PEOPLE IN PUBLIC SPACE (JACOBS 1961).

IMAGE SOURCE: <http://www.vestus.lt>

To sum up - this project widened my scope of using different tools for spatial design, but also and more importantly helped me to understand limitations of design and importance to go beyond spatial simulations. This work gave basics to understand significance of collective initiatives, collective design and collective financing models. Learning more about these methods enabled me to enter completely new field with seemingly infinite possibilities. Various interviews conducted during field trips, while visiting collective housing projects in Delft, Netherlands; Tübingen, Germany; Vienna, Austria, gave a better understanding of specificity of such design approach. First the complexities and risks that designer have to face in these diverse projects. And finally the appropriation of space and sense of community after design is implemented (according to some interviewees - these are ever ongoing projects with no end). At the same time such advantages can be hardly found in regular real estate investment projects. Already existing examples shows that community led projects tend to outpace mainstream investment models led by developer in numerous aspects such as:

- Building up environmental consciousness
- Lowering building costs
- Creating better quality of urban environment
- Building a sense of community
- Creating socially/economically/culturally active/inclusive places
- Creating functional diversity

And yet, while being successful example of comprehensive city development, it has relatively little attention in academic debate.

BIBLIOGRAPHY:

- AGLINSKAS, V. 2014. Caught in the waiting game: community, creativity and everyday life in Šnipiškės. *Coactivity: Philosophy, Communication/Santalka: Filosofija, Komunikacija*, 22, 77-86.
- AIDUKAITE, J. (2013). Community mobilizations around housing and local environment: Insights into the case of Vilnius. *Sociologija: Mintis ir Veiksmas*, 32(1), 136.
- AIDUKAITE, J. 2014. Housing Policy Regime in Lithuania: towards liberalization and marketization. *GeoJournal*, 79, 421-432.
- AIDUKAITE, J. 2016. Post-Sovjet Vilnius: Giving meaning to abandoned buildings. *Baltic Worlds*, 9, 68-79.
- ALEXANDER, C., ISHIKAWA, S. & SILVERSTEIN, M. 1977. *A pattern language : towns, buildings, construction*, New York, Oxford University Press.
- ARENDT, H. 1998. *The human condition*, Chicago, University of Chicago Press.
- BERNARD RUDOFISKY. 1964. *Architecture without architects a short introduction to non-pedigreed architecture*, Museum of modern art, New York.
- CAMAGNI, R., GIBELLI, M. C., & RIGAMONTI, P. 2002. Urban mobility and urban form: the social and environmental costs of different patterns of urban expansion. *Ecological economics*, 40(2), 199-216.
- CECCATO, V. & LUKYTE, N. 2011. Safety and sustainability in a city in transition: the case of Vilnius, Lithuania. *Cities*, 28, 83-94.
- CERVERO, R. 2009. Transport infrastructure and global competitiveness: Balancing mobility and livability. *The ANNALS of the American Academy of Political and Social Science*, 626(1), 210-225.
- CERVERO, R., SARMIENTO, O. L., JACOBY, E., GOMEZ, L. F., & NEIMAN, A. 2009. Influences of built environments on walking and cycling: lessons from Bogotá. *International Journal of Sustainable Transportation*, 3(4), 203-226.
- CIRTAUTAS, M. 2015. Changing periphery of the Baltic cities: Lithuanian case. *Journal of Architecture and Urbanism*, 39, 56-69.
- ČIUPAILAITĖ, D. 2012. Sociologinė naujųjų būsto projektų posocialistiniame Vilniuje refleksija. *Sociologija. Mintis ir veiksmas*, 2, 1392-3358.
- CLARIS, S., & SCOPELLITI, D. 2016. *Cities alive: towards a walking world*.
- ELIASSON, J., HULTKRANTZ, L., NERHAGEN, L., & ROSQVIST, L. S. 2009. The Stockholm congestion-charging trial 2006: Overview of effects. *Transportation Research Part A: Policy and Practice*, 43(3), 240-250.
- FRANK, L. D., & PIVO, G. 1994. Impacts of mixed use and density on utilization of three modes of travel: single-occupant vehicle, transit, and walking. *Transportation research record*, 1466, 44-52.
- GEHL, J. 2011. *Cities for People*. *Landscape Architecture Magazine*, 101, 136-136.
- JACOBS, J. 1961. *The death and life of great American cities*, Vintage.
- JACOBS, J. 1970. *The economy of cities. The economy of cities*.
- JOHN F.C. TURNER, 1977, *Housing by People: Towards autonomy in building environments*, Pantheon books, New York.
- KORNHAUSER, R. R. 1978. *Social sources of delinquency: An appraisal of analytic models*, University of Chicago Press Chicago.
- KRUPICKAITĖ, D., POCIŪTĖ, G. & PEČIUKONYTĖ, L. 2014. In the middle of nowhere: Gated neighbourhoods in Vilnius region as a new lifestyle? *Hungarian Geographical Bulletin*, 63.
- LEFEBVRE, H. 1991. *The production of space*, Oxford, OX, UK ; Cambridge, Mass., USA, Blackwell.
- LEFEBVRE, H., KOFMAN, E. & LEBAS, E. 1996. *Writings on cities*, Oxford ; Cambridge, Mass, Blackwell.
- LIDEWIJ TUMMERS. The re-emergence of self-managed co-housing in Europe: A critical review of co-housing research. *Urban Studies* August 2016 53: 2023-2040, first published on May 22, 2015, SAGE Journals. P. 1-18
- MADANIPOUR, A. (Ed.). 2013. *Whose public space?: International case studies in urban design and development*. Routledge.
- MARCIŃCZAK, S., MUSTERD, S., VAN HAM, M., & TAMMARU, T. 2016. *Inequality and rising levels of socio-economic segregation: Lessons from a pan-European comparative study*. Taylor & Francis.
- NEMEC, J., MERICKOVA, B. M., & SVIDRONOVA, M. 2015. *Social Innovations in Public Services: Co-creation in Slovakia*. In *Proceedings of the 19th International Conference "Current Trends in Public Sector Research"*. Brno: Masaryk University (pp. 273-281).
- PIKETTY, T. 2014. *Capital in the twenty-first century: a multidimensional approach to the history of capital and social classes*.
- RODE, P., HOFFMANN, C., KANDT, J., GRAFF, A., & SMITH, D. 2015. *Towards new urban mobility: the case of London and Berlin*.
- SAMPSON, R. J., RAUDENBUSH, S. W. & EARLS, F. 1997. Neighborhoods and violent crime: A multilevel study of collective efficacy. *Science*, 277, 918-924.
- SASSEN, S. 1991, *The global city: New York, London, Tokyo*, Princeton, NJ, Princeton University Press.
- SENNETT, R. 2006. *The open city*. *Urban Age*, 1-5.
- SHAW, C. R. & MCKAY, H. D. 1942. *Juvenile delinquency and urban areas*. Chicago, Ill.

TEREŠKINAS, A., ŽILYS, A. & INDRILIŪNAITĖ, R. 2013. Pilietiškumas ir tapatumas šiuolaikinėje visuomenėje: socialinė atskirtis ir socialinė segregacija Lietuvos didmiesčiuose.

URBONAITĖ-BARKAUSKIENĖ, V. 2014. „Vilniaus graffiti žemėlapis kaip socialinės miesto kaitos indikatorius: Naujininkų rajono atvejis“. Santalka: filosofija, komunikacija, 22, 53-68.

WENDLAND C., ALBOLD A. 2010. Sustainable and cost-effective wastewater systems. WECF, Women in Europe for a Common Future.

WILLIAMS, C. C. & HORODNIC, I. A. 2015. Explaining The Prevalence Of The Informal Economy In The Baltics: An Institutional Asymmetry Perspective¹. European Spatial Research and Policy, 22, 127-145.

News article about burned house in Šnipiškės.

Original source: BNS, 02-09-2015

<http://www.15min.lt/naujiena/aktualu/nusikaltimaiirnelaimes/rinktines-gatveje-vilniuje-uzsidege-negyvenamas-namas-gesinant-gaisra-rastas-smarkiai-apdegusio-zmogaus-kunas-59-525514>

News article about soviet monument removal in Tallinn:

Original source: Reuters

<http://www.spiegel.de/international/europe/deadly-riots-in-tallinn-soviet-monument-causes-rift-between-estonia-and-russia-a-479809.html>

Public lecture (2012) in Vilnius, National gallery of art. Given by German geographer BERND BELINA. On crime geography in urban areas and police discrimination. <http://www.archfondas.lt/lt/pokalbiu/irasas/ar-architektura-gali-kovoti-sunusikalstamumu>

Lecture “Interiors and interiorities” in Harvard university (2016) by Richard Sennett.

<https://www.youtube.com/watch?v=hVPjQhfJfKo>

News report of 2007 riots in Tallin:

<https://www.youtube.com/watch?v=Sg8329uIKcw>

Movie “Cities on speed: Bogota”

commissioned by The Danish Film Institute and the national broadcaster DR. Directed by Andreas Dalsgaard.