

Permanent International Association
of Navigation Congresses

~~Association~~ ^{Delft} Internationale Permanente
des Congrès de Navigation



XXIIIrd International Navigation Congress

XXIII^e Congrès International de Navigation

OTTAWA
1973

M. J. J. J. J.

Section II

OCEAN NAVIGATION

NAVIGATION MARITIME

Subject 1 - Sujet 1

Engineering and economic aspects of
fixed or floating offshore structures in
deep water :

- sea protection works;
- installations for unloading and storing goods;
- installations for the discovery and exploitation of underground resources;
- installations for the display of navigational aids.

Aspects techniques et économiques des
ouvrages fixes ou flottants en pleine mer
et en eau profonde :

- ouvrages de protection contre la mer;
- installations pour le déchargement et le stockage des marchandises;
- installations pour la recherche et l'exploitation des ressources du sous-sol;
- installations de signalisation maritime.

PAPER

by

Ir. J. van DIXHOORN, Ir. L.A. KOELE, Dr. J.P. HOOFT (Netherlands)

General Secretariat of P.I.A.N.C. - Secrétariat Général de l'A.I.P.C.N.

Résidence Palace, Quartier Jordaens (Rez-de-chaussée)

Rue de la Loi 155

1040 Brussels (Belgium) - 1040 Bruxelles (Belgique)

S. II - 1

PAPER

by

ir. J. van DIXHOORN

Rijkswaterstaat, Directorate Lower Reaches of the Rhine,
Hook of Holland,

ir. L.A. KOELE,

Rijkswaterstaat, Directorate for Water Management
and Hydraulic Research, Wageningen,

Dr. J.P. HOOFT

National Shipping Laboratory, Wageningen.

FEASIBILITY AND PROFIT OF NAVIGATION INFORMATION AND NAVIGATIONAL AIDS OFFSHORE.

I. INTRODUCTION.

General consideration.

With the advent of VLCC's an increasing number of situations have arisen whereby the approaches to existing harbours which are situated in relatively shallow coastal areas offer insufficient depth of water for the passage of these vessels.

In some cases such means as artificially increased waterdepths which are maintained at a predetermined depth and width by means of dredgers, are resorted to, as for instance in the case of the approaches to Hook of Holland/Europoort.

Entering a harbour through a channel poses serious problems with regards to navigation since external factors as currents, waves and wind must be taken into account while the vessel is already sailing in a restricted fairway.

Passage through a channel may be simplified by the installation of additional navigational aids, the use of which results in the passage being executed with greater precision. This is in turn beneficial as far as the costs of laying and maintaining the channel, exploitation of ship and harbour and the prevention of pollution are concerned.

The approaches to the harbour and such navigational aids as are present together influence the impression gained by the captains and crews of vessels which make use of them and therefore should be presented undoubtedly to them.

To the mariner the entrance to the harbour and its facilities should be such that an easy and safe passage is assured, to the shipowner turn around time in a port, harbour dues and safety are of importance while for the harbour authorities the entrance and its facilities must also form a sound investment.

Technical and economical aspects.

In order to realize the aims outlined above, a study of the technical aspects of the problems must be carried out first. In the case of VLCC's the technical aspects are both of a physical — technical as of a human — technical nature. At this stage the technical aspects of pollution must also be taken into consideration. A technical approach to a problem will lead to a solution which is both technically feasible and a technical optimum, the question as to whether the solution is also economically sound requires an economic study which not only takes into account the costs of realization but also of exploitation and maintenance.

For the project as a whole to be economically feasible the sum of these costs must be minimal.

Evaluation of the technical and economical aspects of the project at a number of stages during its development will lead to technically and economically feasible results. The above mentioned evaluation can be carried out during the design phase, construction phase, exploitation phase and during the subsequent stages of evolution. The combined technical and economical evaluation is modified in each following phase of the project and finally leads to an integrally feasible project. It may for instance be preferable, with regards to future development of the project, to accept relatively high maintenance costs rather than a high prime investment.

In the same way a high level of the cost of exploitation of a system of navigational aids may be preferable to a wider approach channel which is not equipped with these aids. It may be necessary, with regards to an efficient running of the approach channel to refrain from reserving a particular lane for a certain class of ships.

If at this stage of its development the project is still not feasible that class of vessels which is deemed to be a governing factor in the project must be taken into account in the evaluation.

By including the class of vessels in the total evaluation it is possible, in principle, to develop the combined project of ship/harbour. In this respect a study has been carried out in the Netherlands of the combination of the so called Restricted Draught Tanker of approx. 500,000 dwt and Hook of Holland/Europoort. (see ref. [1]).

Technical and economical aspects of navigation information and navigational aids as part of a project.

It is against the back-ground of the project as a whole that a technical and economical appraisal of additional navigational aids must be made. In many instances the comparison between the alternatives for such devices from a technical and economical point of view will be completely overshadowed by the feasibility bestowed on them as a part of the whole project and by the consequences of these facilities on the realization of the whole project. After a technical and economical evaluation of the total project has

been made, it can be determined to which degree and with which accuracy a technical and economical evaluation of a given part of the project is to be carried out.

In this paper the influence of such facilities as hydrometric and meteorological information given to mariners and additional navigational aids on the feasibility, use and future development of a project such as the approaches and entrance to Hook of Holland/Europoort will be discussed. The purpose of a meteo-hydro system for a harbour is to supply mariners with information concerning the sea condition in the area of the coastal channel on a "real time" basis. This information may apply to the waterdepth, waves, current, wind and visibility and is based on measurements carried out in the area concerned. The measuring instruments are located either on the sea-floor or on floating bodies or on structures placed on the bed. In order that the information can be supplied on a real time basis, the measurements are transmitted by radio to a shore-based central control station where, if necessary, additional processing may be carried out on-line.

Normal ship to shore communication systems are then used to relay the information to pilots and captains. The information is also communicated to the harbour authority and, if requested, to the ship owner.

Through the information supplied by a meteo-hydro system it will be possible that :

- a. the efficiency of the marine activities from a point of view of both economy and safety of operation can be increased;
- b. from a point of view of the vessel, captain and pilot, the number of uncertain factors can be reduced so that instead of merely correcting for errors as they occur, a more rational approach, based on anticipation of the occurrence of errors, may be applied.

On the basis of this information it is possible to :

- judge the keel clearance of the vessel with regards to waves, waterdepth and ships speed;
- carry out manœuvres which are adapted in a more rational way to the restricted width and waterdepth in the channel with due regard to the currents, visibility, tracking etc.

Additional navigational aids are defined to be electronic aids such as Radar and radiolocation which complete the traditional systems such as leading lines of lights and beaconing by buoys.

An additional navigational aid can be required when it is decided that ships have to enter the harbour for all weather conditions even under such conditions (for instance, bad visibility) in which the traditional navigational aids fail. When however an additional navigational aid once has been put in operation it also can be used continuously to improve the navigation of the ships in the coastal zone and inside the harbour. This improvement can be used for an increased safety of the navigation traffic but also for a more economic use of the harbour or for a more economic design of the harbour.

Once an additional navigational aid is installed it also can be extended to a primary navigational aid for those areas in the coastal zone which the shore based leading line of lights can not be used anymore.

Through the information supplied by additional navigational aids it thus will be possible that:

- a. the harbour will be open during bad visibility conditions;
- b. the dimensions of harbour can be adapted to a cheaper design;
- c. the traffic can be controlled in a safer and more economic way.

II. METEO-HYDRO SYSTEM IN RELATION TO THE DEPTH OF THE CHANNEL AND ACCESSIBILITY OF THE HARBOUR

Ports which are situated in shallow coastal areas can be made accessible to VLCC's by dredging a suitable channel.

While sailing in such an artificial undeep channel a certain amount of keel clearance is necessary as in an undeep natural fairway, for instance for the increase in draught (see ref. [2]), due to the ships speed, commonly termed squat.

In determining the amount of keel clearance required in a given channel the following factors must also be taken into account.

- Size and loading condition of vessel plying the harbour.
- Variation in waterlevel due to tides, wind etc.
- The occurrence of waves which induce ships' motions leading to a momentary increase in draught.

Increasing the accessibility of the harbour to as great a value as is possible may result in a channel of which the depth is large, relative to the draught of the vessels sailing through it. From a point of view of dredging operations, an increase in the depth of the channel is of greater consequence than an increase in the width.

The capital investment involved with the creation of a deep channel is only permissible if the accessibility of the harbour and its consequences with regards to the economics of transport in general and the safety of operations are detrimentally affected when a smaller depth is chosen.

In viewing those factors which influence the choice of the depth of the channel it is seen that a number of them are of a stochastic nature. This is particularly true in the case of the environmental conditions.

It is also seen that a number of these factors are more or less independent of each other.

At the design stage usually very little information about the factors which determine the depth of the channel is available. Due to this there is a very real danger of the effect of these factors being accounted for by ever accumulating coefficients of safety. The final depth of the channel may be arrived at by implementing the project in stages. As each stage is completed, the behaviour of the vessels in the channel is measured, analysed, and related to the channel dimensions as they are at that stage.

In this way the necessary basic information for determining the ultimate depth of the channel is also gathered in stages. The observations and measurements may be carried out by means of a meteo-hydro system which itself may also be set up in several stages. In this way the captains and pilots of VLCC's can be supplied with relevant information on a real time basis from the onset of the project.

In the following a number of the factors which are of importance from the point of view of the depth of an approach channel will be discussed. Since the relative importance of these factors depends to a large degree on local conditions this discussion will not be generally applicable.

Draught of ships.

Usually the largest vessel in terms of draught and tonnage which is permitted to enter a given port is determined from discussions between port authorities and the users of the port. The maximum allowable draught which may be designated by the design draught T_0 is one of the criteria upon which the choice of the depth of the channel will be based.

If the value of T_0 is large in relation to existing tonnage it may be expected that when the channel is completed, a significant number of vessels with draught T such that

$$T_0 > T > T_n$$

where T_n is the maximum allowable draught outside the channel, will be making use of the port in question. It may be that the number of these vessels is far greater than the number of vessels with design draught T_0 . In any case there will be a distribution of the number of vessels plying the port as a function of the draught. Figure 1a (see also figure 11).

This distribution is liable to modification as the project is completed. A similar development as shown in figure 1a and figure 11 will occur if, due to a continued increase in the size of tankers, the maximum permissible draught in the channel T_0 is increased to a greater

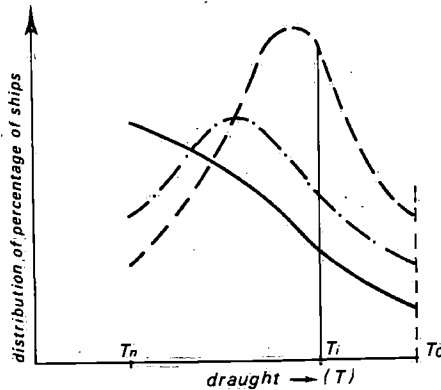

Fig. 1a. Distribution of percentage of ships as a function of draught for a given design draught T_0 (schematically)

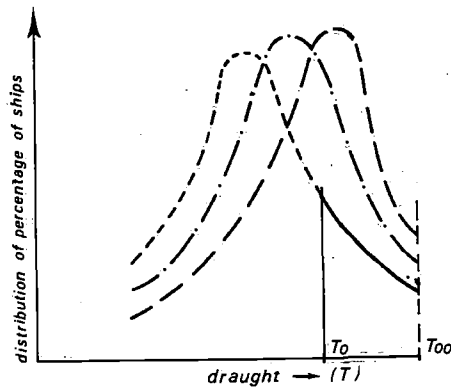

Fig. 1b. Distribution of percentage of ships as a function of draught for a change in design draught from T_0 to T_{00} (schematically)

- 1 year after opening channel
- - 2 years after opening channel
- — 3 years after opening channel

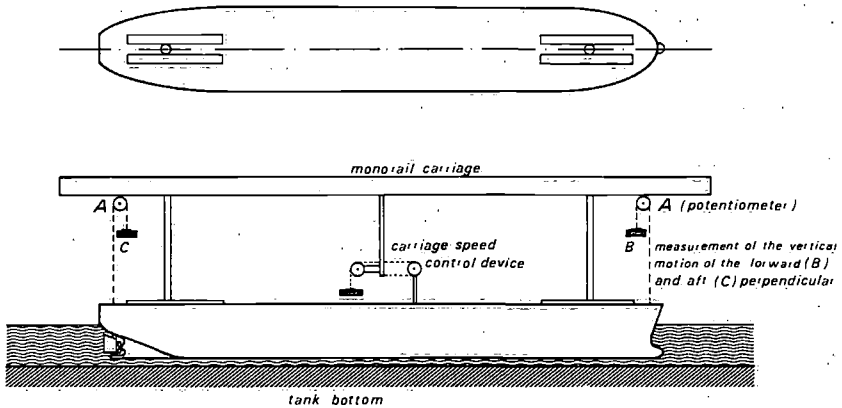

Fig. 2. — Test arrangement for squat measurements.

value T_{00} at a later stage. The effect of this on the distribution of the number of vessels over the draught is shown in figure 1b.

This aspect of the project puts the design draught T_0 as a measure by which the depth of the channel is determined into its true perspective with regards to the question as to whether or not dredging of a deep channel forms a sound economic investment; since the probability of a relatively small number of VLCC's with draught T_0 meeting with unfavourable sea conditions on arrival at the mouth of the channel is significantly less than would be the case with a larger number of vessels whose draught T_1 is somewhat less than T_0 .

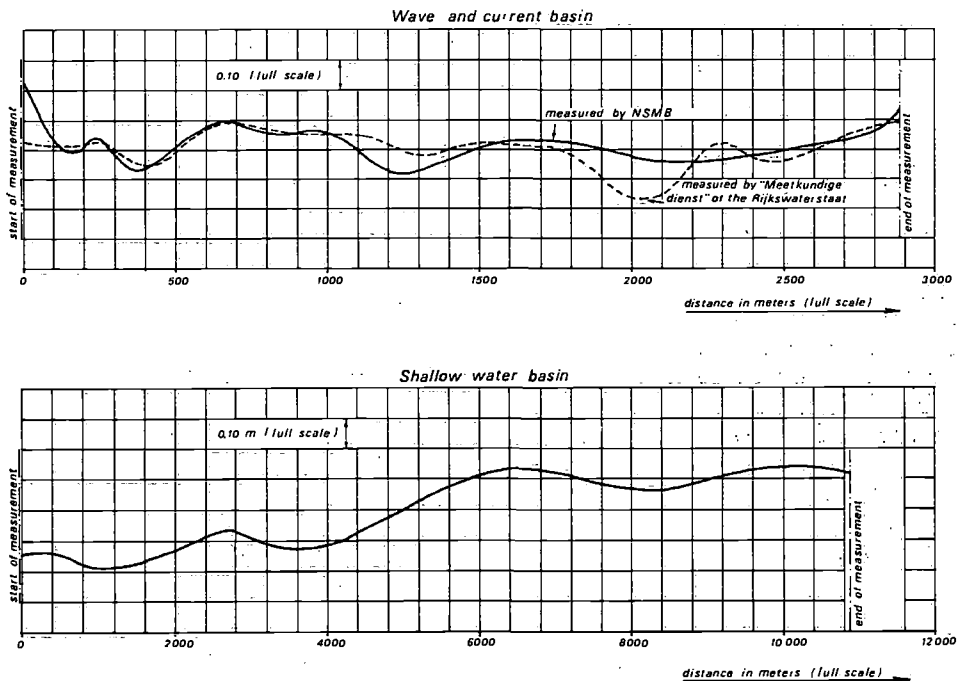

Fig. 3. — Distance between carriage and still water level.

Selection of T_1 as design draught infers that the largest vessels would be traversing the channel with somewhat less keel clearance.

By supplying these vessels (with $T > T_1$) with accurate and relevant information concerning the ambient conditions in the channel, an economic and safe traversal of the channel can be sought after.

If we assume for instance a value of 72 feet for T_0 and the depth of the channel is based on vessels with draught T_1 equal to 69 feet and a keel clearance of 20 % of the draught, then the depth of the channel will be approximately 1 metre less than when the draught T_0 had been applied. With a depth of channel which is 1 metre less than when T_0 had been applied, VLCC's with a draught equal to T_0 will traverse the channel with a minimum keel clearance equal to 15 % of the draught.

Naturally the same reasoning to that given above applies to draughts of T_0 equal to 60 feet and T_1 equal to 50 feet.

Shipspeed.

The shipspeed is one of the factors which require the vessel to have a certain amount of keel clearance while sailing in the channel. In this respect tests were carried out with the model of a 425,000 dwt tanker in the Shallow Water Basin and the Wave and Current Basin of the Netherlands Ship Model Basin in Wageningen. The object of the tests was to determine the increase in the ships draught, known as squat, as a function of the shipspeed and the waterdepth. The squat consists of the mean sinkage and change of trim of the vessel relative to the equilibrium position at zero speed. During the squat tests which were carried out in still water, the vertical motions of the fore and aft perpendicular of the vessel were measured relative to an overhead carriage which was running at the same speed as the self propelled model (See fig. 2).

Since the vertical motions were measured relative to the carriage it was necessary to determine the vertical position of the carriage relative to the still water surface as a function of their longitudinal position in the basin. In figure 3 a plot of the variations in the vertical distance between carriage and still water level is given for the wave and current basin as well for the shallow water basin. From these results the true value of the squat of the vessel could be determined. In figure 4 some of the results of these tests are given.

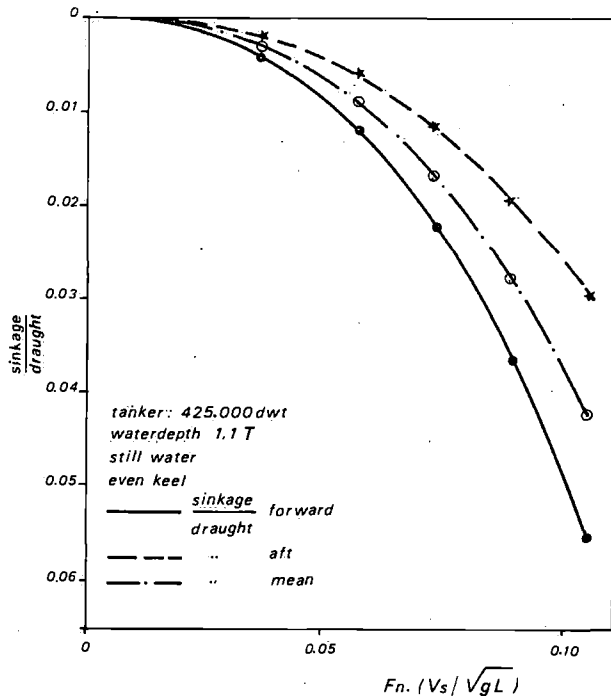

Fig. 4. — Results of squat measurements.

In general it appeared that the mean sinkage of the vessel was proportional to the square of the speed which is in agreement with theoretical results given by Tuck [3]. From this it follows that the keel clearance necessary to allow for the squat of VLCC's depends to a large extent on the speed at which they will be sailing in the channel.

This can be determined by observation of the speed of the ships approaching the harbour entrance. As the channel is dredged, the speed of the vessels may be modified by the changes in the approaches. The results of such measurements may be plotted in the form of the number of vessels to a base of the shipspeed as was done in figure 12.

The fact that the squat is dependent on the shipspeed affords the captain and pilot the opportunity of adapting the shipspeed to the waterdepth of the channel. This adaptation is only possible within a limited speedrange since the maximum speed is restricted by the power available on board the ship while a minimum speed exists at which the ship still can be kept under control or which is needed to pass the approach channel within a limited time.

Waterlevel.

The variation in the waterlevel is also a factor which must be taken into account when determining the depth to which the channel is to be dredged and when making decisions concerning the feasibility of transversing the channel at any time.

If in a coastal area there are variations in the waterlevel due to tides, then dependent on the type and number of vessels and the time needed to traverse the channel, the depth of the channel will be chosen so that the vessels with the greatest draught will be sailing in it about the time of high water.

Ships with a draught less than this can make use of the channel at other times during the tidal cycle. An important aspect of this problem is the correct phasing of marine activities. The distribution of the number of vessels over the draught as given in figure 1 gives basic information in this respect.

If the channel is of great length the time to traverse it will also be considerable so that the depth of water available will vary while the vessel is in the channel. Due to for instance wind, distortion of the tidal wave in coastal areas and the coriolis acceleration, the variation in the water level over the length of the channel may also be considerable.

The effects of these phenomena can be included in the channel-depth insofar that these variations in waterlevel are of a more or less static nature or that they are closely related to measurable quantities.

In many cases the differences in the water levels will be the result of a process of a dynamic nature which is influenced by a large number of factors.

When observed during longer periods of time these processes may show themselves to be of a stochastic nature.

As far as the actual business of sailing is concerned these differences in the water level, which are of the order of magnitude of one or two feet, constitute a factor of uncertainty to the captain and pilot with regard to the actual waterdepth in the channel.

During storm with high wind velocities, the water level may rise considerably more than given above.

If this is the case then it is to the benefit of the vessel since its motions — and following from this the requirement of additional keel clearance — may be wholly met. In other cases storm may cause a large drop in the water level and so seriously disrupt traffic in the channel. If direct information is not available the effect of these large differences in the water level on the depth of the channel may be taken into account by statistical methods (See ref. [4]).

If a permanent system to monitor the water level is in function then effects which occur frequently may be taken into account directly in the depth of the channel. Phenomena which occur less frequently may be monitored and shipping can be informed on a real time basis. The latter method of approach is of importance since the probability of unfavourable conditions occurring while a VLCC is travelling through the channel is very small. This certainly holds true for the largest VLCC's with draughts equal to T_0 .

Waves.

A last aspect to be discussed here is the relationship between the depth of the channel and the waves which occur in that area.

From model tests undertaken at the N.S.M.B. and from full scale measurements it has been shown that the response of VLCC's to the relatively short wind waves is negligible. This is not the case when wave frequencies occur which are in the vicinity of the natural periods of the ship motion. In terms of wave periods this occurs at periods of approximately 10 seconds and more. The vertical ship motions of heave, roll and pitch cause periodical increases in the draught of the vessel. This dynamic phenomenon is, for a given ship, dependent on the wave frequency, direction of the waves relative to the vessel, waterdepth and to some extent also on the shipspeed. Just as the wave height, the increase in the draught due to the vertical motions is a stochastic phenomenon.

The response of the ship to irregular waves of the type that occur in the channel area can be determined by means of model tests.

Once these quantities are known the extra underkeel clearance required can be calculated statistically. In principle a rational choice of the value of the underkeel clearance to give absolute safety cannot be made in areas where the frequencies of the waves are such that they are, for a significant percentage of the time, in the vicinity of the vessel's natural periods.

In figure 5 an example is given of the influence of the wave height, wave frequency and wave direction on the ship motions.

These results have been taken from tests in regular waves undertaken with the model of a 425,000 dwt tanker of the N.S.M.B. (see ref. [1]).

In the example given here the tanker has a draught of 72 feet, a speed of 8 km and the waterdepth is equal to 1.2 times the draught.

For three wave conditions with respect to the wave period defined by

$$T_m = 2\pi \sqrt{\frac{m_2}{m_0}} \quad (\text{see ref. [5]}),$$

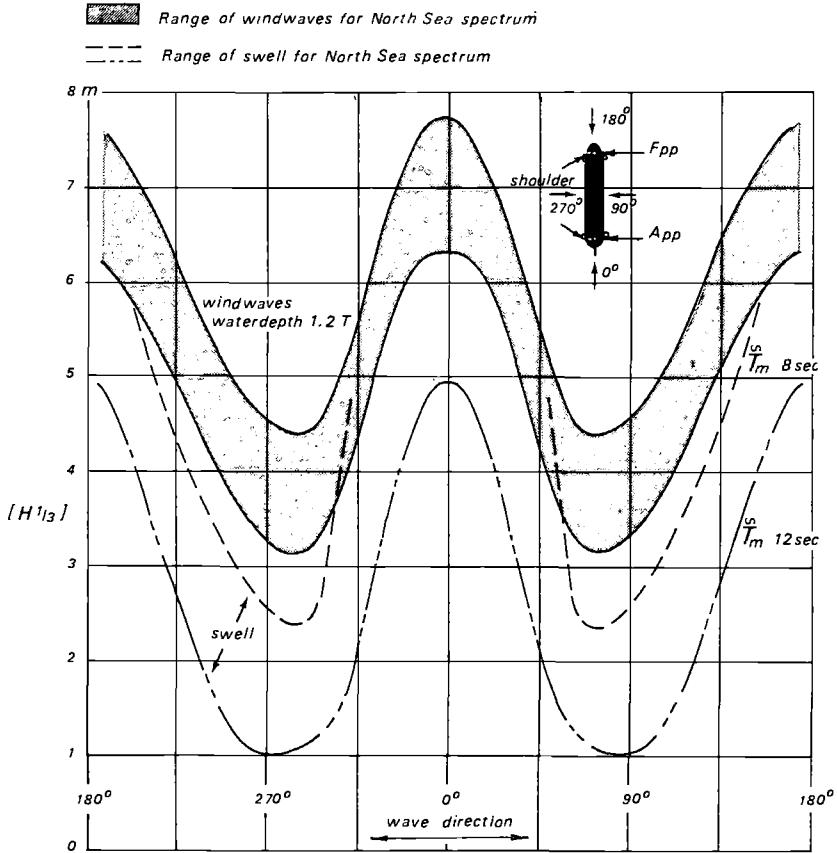

Fig. 5. — Critical waveheight $[H 1/3]$ at which 425,000 dwt R-D tanker hits bottom when sailing with approximate speed of 8 knots. (for 0° this means F_{pp} hits bottom, for all other directions forward shoulder hits bottom).

the significant wave height $\tilde{H}_{1/3} = 4 \sqrt{m_0}$, has been determined at which, on an average, the vessel will strike the bottom once in 1,000 oscillations for a number of wave directions.

In choosing the depth of the channel care will be taken to ensure that in a given sea-state the probability of the vessel striking the bottom is as small as possible.

The fact remains however that it is extremely difficult for captains and pilots to estimate the amplitude of ship motions and to judge from this the safety aspect of sailing in the channel. In this respect neither the pilot on the vessel nor a shore based control station are able to give advice which is of absolute validity.

By giving real time information concerning the wave heights occurring in the channel area based on measurements, the problem is somewhat reduced since at least some of the uncertain factors can be judged in the clearer light cast on them. See for instance figure 5 in which the relatively great influence of wave direction and wave period on the ship motion is shown.

As is the case with variations in the water level, a part of the effect of waves on the draught of the vessel can be taken into account in the depth of the channel. A permanent system to monitor the wave height in the channel area can furnish the information necessary to captains and pilots in order to be able to make decisions concerning current sea conditions.

III. NAVIGATIONAL AIDS IN RELATION TO THE WIDTH OF THE APPROACH CHANNEL

The way in which a ship is handled when approaching a harbour depends to a large extent on the interpretation of the ship's characteristics and harbour layout including navigational aids by the responsible navigator.

In other words the presentation of the harbour to the man on the bridge is of prime importance (see ref. [6]).

One of the means to facilitate navigation during the approach to a harbour is the use of additional navigational aids.

These navigational aids have to be designed mainly on the criterion that the VLCC's using the approach route can be kept under control during their entering manœuvres. The type of vessel and the ambient environmental conditions during the approach manœuver play an important part in the behaviour of the ship. The controlability of such vessels is to a large extent dependent on human capabilities. Knowledge of human perception and reaction is of vital importance when designing the afore mentioned navigational aids.

Besides general knowledge about human behaviour and capabilities more precise information regarding the behaviour of the combination human operator-VLCC is needed. To this end the Dutch Ministry of Transport and "Waterstaat" has carried out investigations on the ship manœuvring simulator of the Netherland Ship Model Basin in Wageningen (see ref. [7]) in co-operation with the Dutch Institute of Physiological Perception I.Z.F.-R.V.O.-T.N.O.

The operation of the ship manœuvring simulator was based on the manœuvring characteristics of a VLCC. These characteristics were programmed in the hybrid computer of the simulator. In a mock-up of a ship's bridge, the wheel compass and several other navigational aids are at the disposal of the person in command of the vessel. An important feature of the simulator is the visual display system which presents an image of the sea and coastline including the leading line of the channel or harbour in which the ship is sailing, see figure 6.

A display of electronic aids such as radar, hyperbolic systems such as radiolocation etc. are also simulated. As is the case in reality, the navigator gives manœuvring orders such as speed, angle of helm and course. The responses to these orders are fed into the computer through the wheel and engine room telegraph settings.

The results of subsequent computations are fed back to adjust the visual display. The simulation is in real time and continuous records are made of the track of the vessel, engine speed, rudder movements, heading angle etc.

The results of simulator studies (see ref. [8]) which will be discussed here as examples of human engineering have been compared with full scale observations.

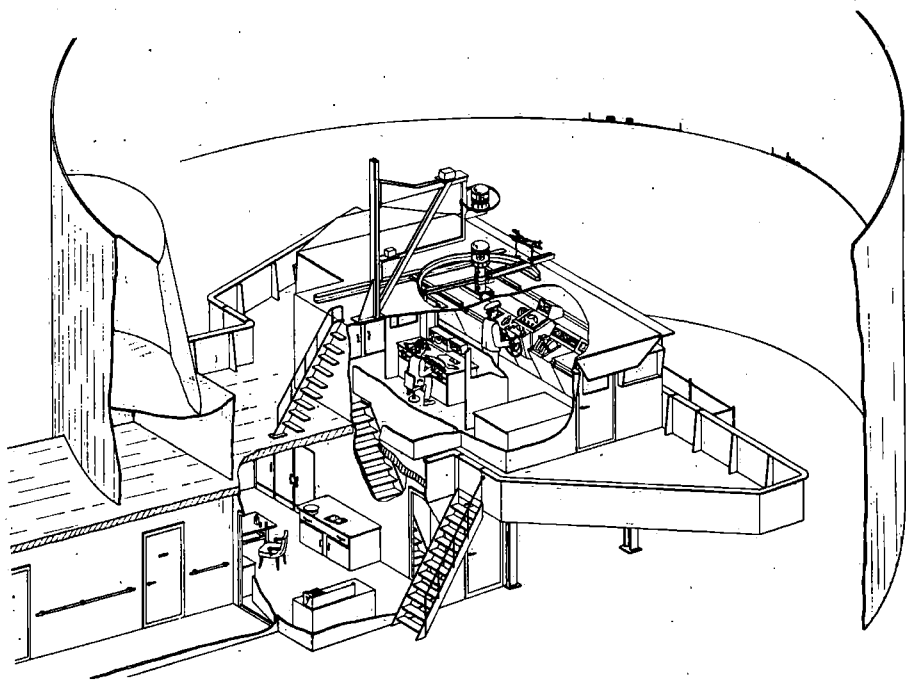

Fig. 6. — Sectional perspective drawing of the simulator.

Influence of the method of presentation of information on human behaviour.

During most simulation studies it was found that the efficiency in the use of a new navigation device depended to a large extent on the navigators (either pilots or captains) getting used to the new system. The effect of training is of great importance with regards to conclusions concerning the choice of a new system.

When a navigator has acquainted himself with a new system through training he is still likely to use the capabilities of the system incorrectly. One frequently recurring pattern of behaviour is that the navigators tend to spend too much effort in obtaining information given by the system. One of the reasons for this is that the motions of a VLCC are so slow that as time passes, the navigator becomes uncertain as to the validity of the latest information given by the system and in order to reassure himself he will again look at the instruments.

However, since the response of the vessel is so slow no new information will be given. Another reason lies in the fact the human capacity for accumulating information during the process is limited, which means that a navigator is checking earlier given information only to refresh his memory.

When the information given by the system is less precise (for instance : a distance is given in tens of metres instead of to one metre), the navigator will be more relaxed and therefore safer, while the area needed for the passage of the vessel will not increase and may even decrease in some cases.

It is not necessary that the information has to be given continuously. The optimum frequency at which new information is provided is dependent on the velocity of the ship.

The external disturbances which are of importance from a point of view of human behaviour can be divided into the following classes:

1. Static disturbances which are such that the navigator must take action if the ship is to be kept on the required track.
2. Dynamic disturbances of an oscillatory nature which shift the vessel away from its track and back again periodically. In such cases it may be preferable to refrain from taking action.

It has been found that due to the nature of the dynamic disturbances, the navigator is able to some extent to differentiate between the errors given by the position indicating system which are due to these dynamic disturbances and the error in position which is a result of his own incorrect action.

An improved system for the determination and presentation of the ships position does not guarantee that the navigation of the vessel will be optimal.

From the simulator studies and from full scale measurements it was found that in some cases ships could be manoeuvred within an area which was less than one third of the average area required during all other manoeuvres in which the same navigational aid was used.

From such examples it can be concluded that there are other factors, as yet unknown, which play an important part in the efficient use of a navigation aid by mariners.

Influence of external conditions on human behaviour.

With decreasing time constants P (for instance due to an increase in the velocity of the vessel) the frequency of rudder actions increases.

Sometimes this increase is independent of the ship's reaction to the rudder action. In this case the time constant P is defined to be the time elapsed between the rudder action and the time that the ship motion has reached a value which is 95 % of the steady state value according to the constant rudder angle.

A bend in a shipping lane will result in an increase in the space needed for the passage of the ship. This will continue to increase with the magnitude of the change of direction of the lane in the bend. The space required while passing a bend is independent of the ship's speed since at low speeds the navigator tends to turn the vessel too soon while at higher speeds he tends to order insufficient helm which results in a large overshoot in the bend. Both reactions of the navigator show the limited capacity of a human being to anticipate which measures must be taken to make the ship manoeuvre correctly.

Ambient wind and current conditions influence to an important extent the space required for the passage of a ship. The space required will increase rapidly as less is known about these environmental conditions. For example, if the navigator is not aware of ambient conditions with respect to current and wind, it has been found that more manoeuvring space is required when sailing in still water than in current if the navigator is used to spending most of his time sailing in current.

The space needed for the passage of a ship ("width of lane") decrease at increasing ships speed. This is only true for the speed range in which large vessels can sail.

External disturbances of a static nature influence to a considerable extent the space needed for the passage of a ship.

The additional space required due to such a disturbance increases when the controllability of the vessel has been decreased (for instance due to reduced ship's speed) or in case the accuracy of the position information has been reduced.

Consequences of the results of the simulator experiments on the width of an approach channel.

From the afore mentioned examples of the factors influencing the width of lane for the passage of a ship, it will be clear that for the determination of the width of an approach channel analogous considerations can be given as for the determination of the depth of the channel as discussed in section II.

Namely that a reduction of the costs in the investment and the maintenance of the channel can be obtained by the capital investment in and exploitation of installations for navigational aids.

For example the influence of the following factors on the width of lane will be given. It will be obvious that the width of lane directly determines the width of the channel.

In these examples the width of lane is indicated by an average value of the width (see fig. 7).

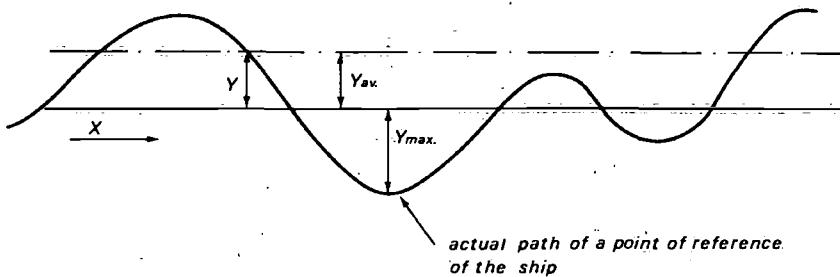

$$\bar{y}_{av} = \text{average width of lane} = \frac{1}{L^*} \int_0^L |Y| dX$$

L = distance travelled along the X-axis

y_{max} = maximum of the absolute value of the ship of the centre of the channel

Fig. 7. — Definition of average width of lane

Accuracy of Information : When the position of the ship is given each 80 seconds then generally speaking the average width of lane y_{av} will be about 28 m in stead of 23 m when continuous information is given. This gain of 5 m in the average value will correspond to a decrease of 5 a.m. (a being some factor) in the maximum distance from the centreline of an average path of the ship sailing the channel. The maximum departure off the centreline for a particular manoeuvre of the ship then will differ 5.a.b. m (b being some factor) between the two systems of information presentation. This means that at a given chance of safety the lane of the ship will be 10.a.b. m greater for the one system as compared to the other. The factors a and b to be determined from full scale and simulator experiments.

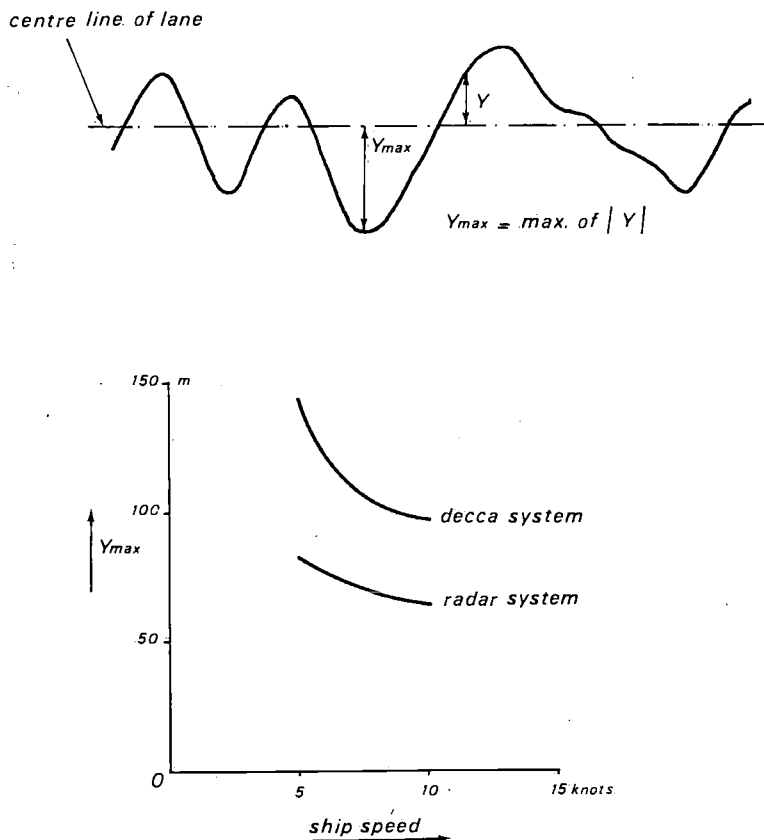

Fig. 8. — Influence of ship speed to the average of the maximum values Y_{max} .

Shipspeed. When the position of the ship is given each 10 seconds then the average width of lane y_{av} will be about 30 m at a speed of 6 knots in stead of about 22 m at a speed of 10 knots.

When speaking in terms of max. shift y_{max} of the ship's position off the centre of the lane the influence of the shipspeed can be seen from figure 8.

Environmental Conditions. The influence of the current speed can be seen from figure 9 in where the average value from several repeated manoeuvres of the maximum shift of the ship's position off the centreline is plotted as a function of the speed of current.

IV. EVALUATION OF THE INSTALLATIONS FOR NAVIGATIONAL AIDS FOR THE HOOK OF HOLLAND/EUROPOORT PROJECT

With respect to depth.

The harbour of Rotterdam-Europoort is at present accessible to tankers with a draught of 57 feet (T_n) to 65 feet (T_o), via an outer channel (direction $82^\circ 30'$) and inner channel (direction 112°) see figure 10 (see also ref. [9]).

The distribution of the number of vessels entering this harbour over the draught for 1969, 1970 and 1971 is given in figure 11.

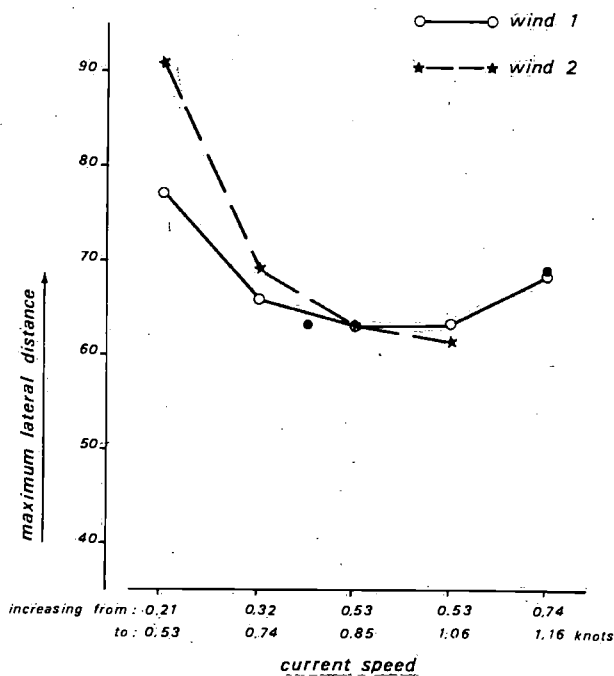

Fig. 9. — Maximum lateral distance as function of the disturbance.

The wind force is simulated by a certain rudder angle necessary to compensate the wind at 6 knots sailing speed.

The length of the outer channel is approximately 30 km and the length of the inner channel approximately 14 km. The average time taken by a VLCC to travel the total length of the approach channels is approximately 2.6 hours with a maximum of approx. 4 hours and a minimum of approx. 1.8 hours dependent on the shipspeed. The distribution of the shipspeed is given in figure 12.

The mean tidal amplitude is in the order of magnitude of 1.5 metres.

The depth of the channel is such that at present the minimum available waterdepth is equal to 1.2 times the draught in the outer channel and 1.15 times the draught in the inner channel.

Due to these criteria the VLCC's with a draught equal to 65 feet sail through the channel around the time of high water in that area.

Taking into consideration the duration of the trip through the channel and the variation in water level during this time, VLCC's with a draught of 62 feet, are at present able to use the channel at almost all stages of the tidal cycle.

In the sea area of the Hook of Holland waves which induce relatively large motions of the VLCC's can be expected to occur a number of times a year. These waves which are of low frequency (see ref. [10]) arise from severe local storms with wind from the West and North or as swell coming from distant storm centres in the Northern part of the North Sea, Northern Icesea or the Eastern part of the Atlantic Ocean entering the area of the Hook of Holland from a northerly direction. Besides observations made on board of tankers entering the Hook of Holland, information has since January 1970 been collected by means of a limited meteo-hydro system see figure 13. At this moment the Europort was made accessible for 65 feet draught tankers while accessibility for 62 feet draught tankers was attained in December 1969. This accessibility of 65 feet draught tankers in June 1971 was reached by steadily progressing dredging work after December 1969. A provisional system is in 1972 in the stage of construction.

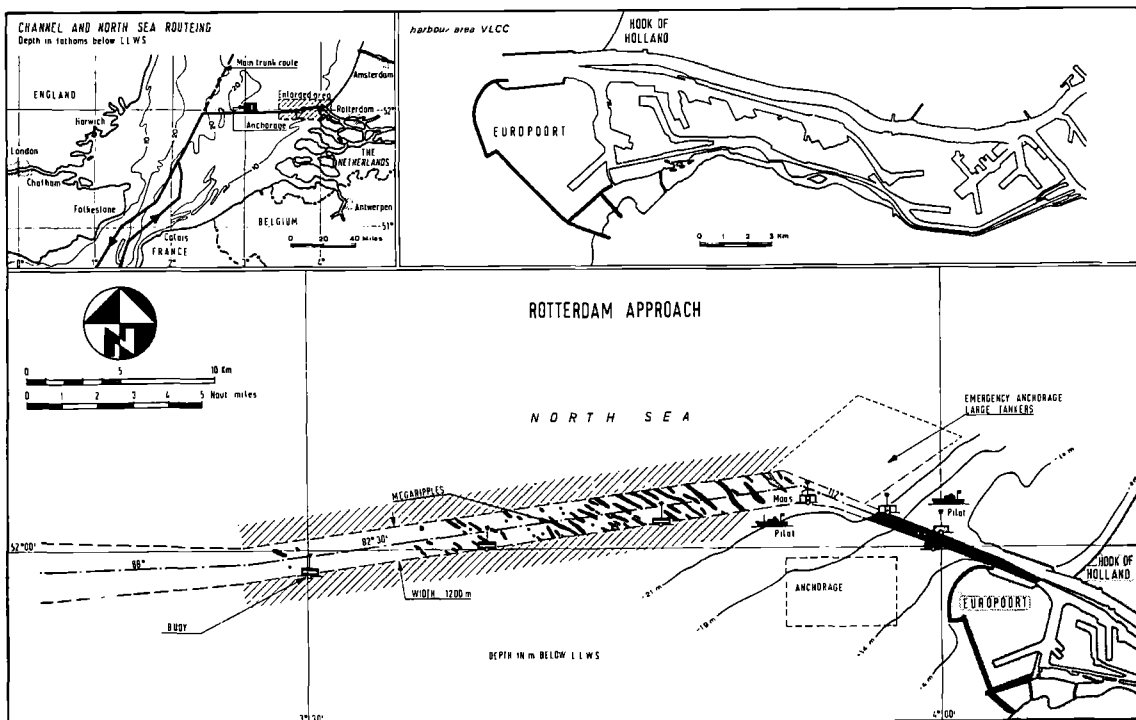

Fig. 10. — Entrance and approach channels to Europoort.

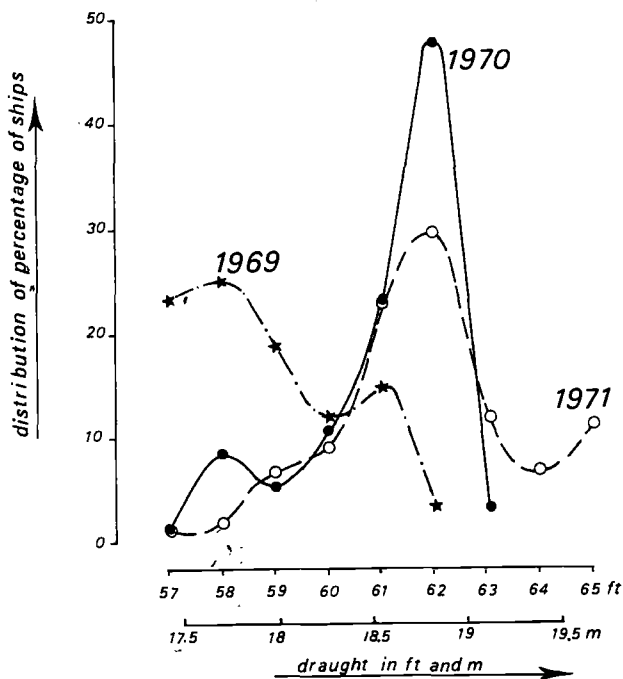

Fig. 11. — Distribution of the percentage of vessels as a function of draught (T); Europoort approach channel.

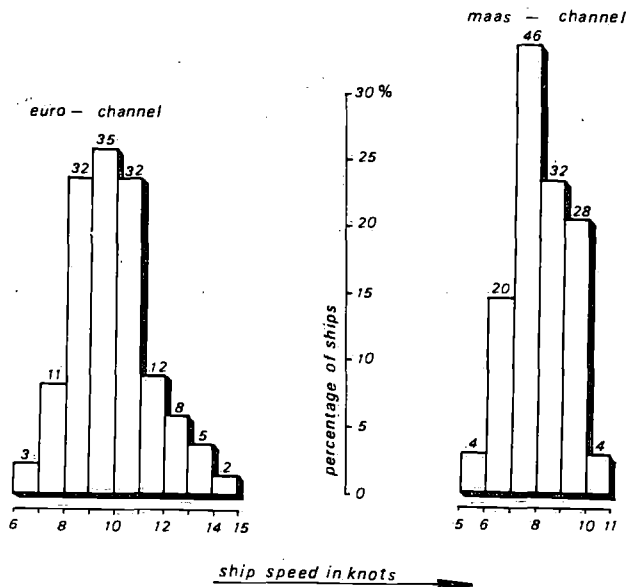
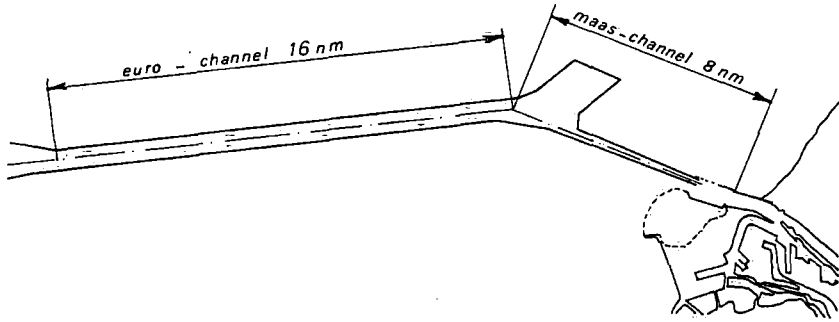

Fig. 12. — Distribution of percentage of ships over shipspeed.

The measurements carried out by this system have up to now been concerned with waves, waterlevel and wind. Further processing of the results takes place in the central control center in the Hook of Holland (see fig. 14) where gathered field data among which the energy distribution of the waves are calculated on line by computer. The information about several aspects calculated in this way are analysed and integrated together. This observation system is linked up with a forecasting system which is also directed at waves, waterlevel and wind. The forecasts are made by the KNMI* in de Bilt and are based on measurements made over the whole of the North Sea and the Atlantic Ocean. (See ref. [11]). After comparison of the results of field measurements and of the forecast, information is

* Royal Dutch Meteorological Institute.

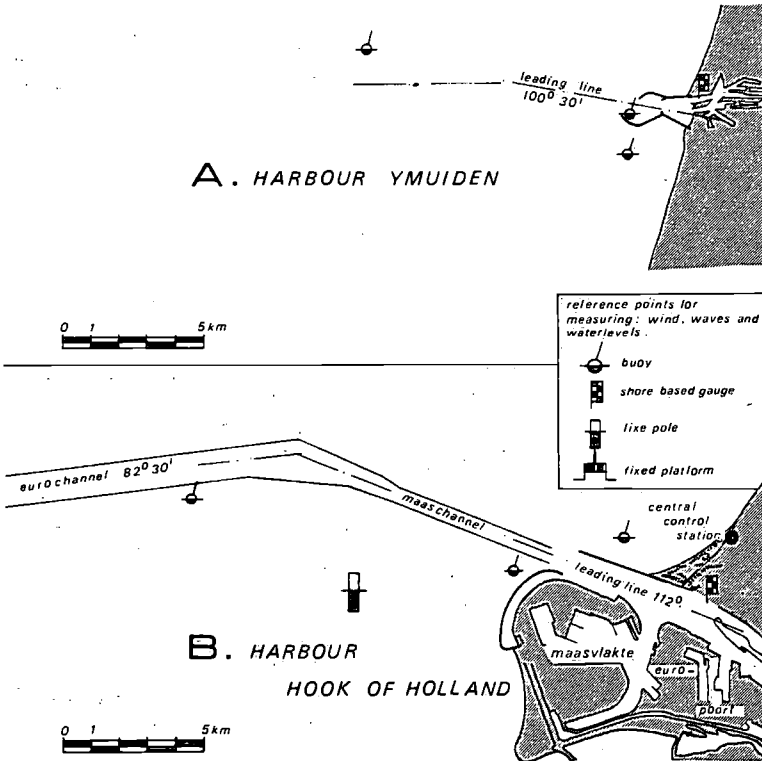
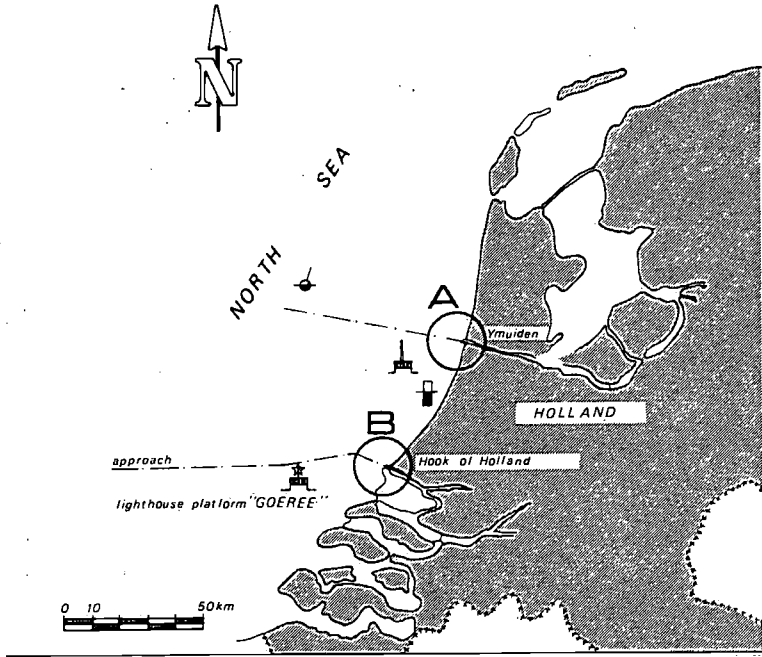

Fig. 13. — Meteo-hydro system.

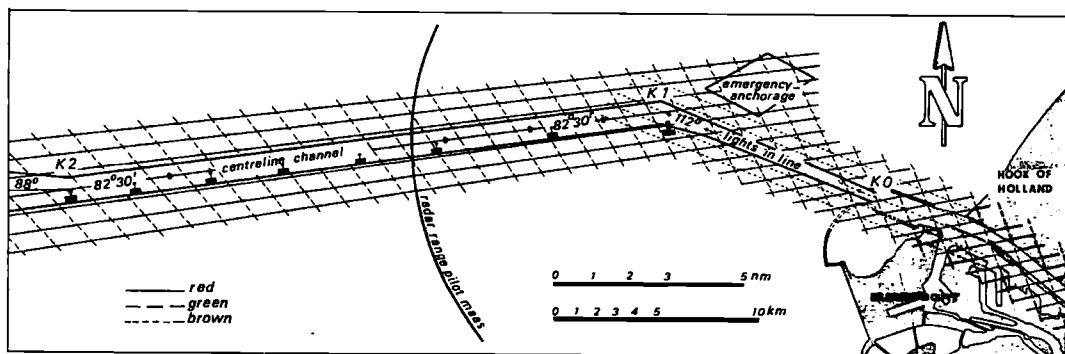

Fig. 14. — Central control Hook of Holland.

produced by the Dutch Ministry of Transport and "Waterstaat" at Hook of Holland for shipping and other interested parties by the central control station at the Hook of Holland and issued by the Governmental Harbour master of Hook of Holland entrance. Both the results of forecasting and measurement are included in this information.

The costs of the present operational provisional system are approximately 1 milj. guilders, while for each foot of extra depth an amount of 5 milj. guilders for the initial dredging and an amount of 1/2 milj. guilders/year for maintenance (longer channel in a sloping coast) is needed. In spite of occasional occurrence of low frequency waves and large variations in the water level at the same time while a VLCC was sailing in the channel, none of the 256 tankers (28 having a draught of 65 feet) which entered the harbour during 1971 experienced any difficulties or incurred a loss of time.

With respect to width.

The width of the approach channel (see ref. [12]) at present amounts to :

1200 m	for the outer channel;
600 m - 400 m	for the inner channel;
350 m	for the harbour entrance.

That navigational equipment for the approach of Hook of Holland/Europoort consists of a combination of systems of buoyancy and leading lines of lights and additional of a shore based radar and a Decca Navigator (see ref. [13]). The situation of mid 1972 is as follows :

The South side of the outer channel is marked by conventional light buoys equipped with radar reflectors, their relative distance being approximately 2 miles. Manœuvring a deep draught vessel through the channel is a high tide operation and consequently the ship will always manœuvre downstream of the buoys. The centre line of the inner channel is indicated by a leading line of lights. To assist navigation in reduced visibility a shore based radar system has been in operation for several years. The outer station of the radar chain along the Nieuwe Rotterdamse Waterweg is sited at the Hook of Holland signal tower. The coverage of this station in the seaward direction did not, however meet the previously mentioned requirements. For this reason a new, so called product radar, system was

installed in 1969 while a completely new radar chain using secondary radar techniques for identification and traffic control and extending further sea-ward is being designed at present.

Meanwhile a Decca Navigator chain was set up for radio position fixing in the Southern part of the North Sea of which the siting of the transmitter stations is indicated in reference [12].

The combination of a Master and a Slave station in a hyperbolic electronic position fixing system radiates a pattern of hyperbolic position lines, the perpendicular bisector of the base line connecting the Master and Slave stations being a straight line. In this case the transmitter stations have been sited so that the perpendicular bisector of the red base line coincides with the centre line of the outer channel, which is therefore marked by an electronic leading line. In a Decca system, since all Slave transmissions are phase-synchronized with the Master transmission, any two Slave stations are phase-synchronized and thus also radiate a pattern of hyperbolic position lines. By siting the Green transmitter in such a position that the perpendicular bisector of the Red/Green base line coincides with the centre-line of the inner channel, this can also be marked by an electronic leading line. However, since it is not possible to observe the hyperbolic pattern radiated by the slave stations on the standard Decca receiver, a special attachment to the standard Mark 12 receiver has been designed for the purpose. This is commonly known as the "Brown box" since the Slave-Slave hyperbolic pattern is printed in brown on the chart. The brown box incorporates three decometers, one each for the red, green and brown patterns.

Using a secondary pattern for the inner channel still there is a perpendicular bisector of a primary pattern available for further development of the system of electronic leading lights.

The system is very simple in use and the pilot, making use of a helicopter or pilot cutter equipped with the same decca system, brings the relatively small box on board with him. It is connected to the Mark 12 receiver with a long lead which enables the pilot to carry the box with him to a convenient position on the bridge. (See figure 15.) By keeping the red indicator on pre-determined reading he can follow the centre-line of the 82°30' channel. When at a certain distance, point KI, course has to be altered to 112°, the pilot keeps his brown indicator on another pre-determined reading in order to follow the centre-line of the 112° channel. Distances along the two centre-lines are indicated by the green pattern.

The system came in use on the 3rd Juli 1972 and was introduced to the Shipping and other interested parties by a Notice to Mariners:

The above-named new Decca Chain is now operating officially and covers the sea area within a radius of approximately 60 nautical miles of the Maas-Center light and whistle buoy, (52°01' 10" N, 3°53' 35" E. approx.). The appropriate Admiralty Charts will be latticed in due course; in the meantime mariners are referred to charts published by the Netherlands Hydrographer.

Special features of this Chain include the provision of two electronic leading lines for use in the approaches to Europoort. The perpendicular bisector of the Red baseline coincides with the centre line of the 082 ½° outer approach channel, Eurogeul. A Brown difference pattern providing finer position lines is derived from the Red and Green patterns; the perpendicular bisector of the Brown baseline marks the centre line of the 112° entrance



Fig. 15. — Pilot operating with brown-box and VHF.

channel, Maasgeul. Additional equipment carried by the Pilot is necessary to display the Brown readout.

The present operational system of Decca Navigator System has cost about 10 milj. guilders, (the whole project will cost about 1,300 milj. guilders), while each 50 meters of extra width of the outer channel which is 30 km long will cost about 3 milj. guilders for the initial dredging and about 0.1 milj. guilders/year for maintenance. In this context it should be noted that due to the presence of the Decca Navigator the original width of the outer channel (being 1,800 m for the 62 feet draught vessels) could be reduced to 1,200 metres for even 65 feet draught vessels. By the realization of the Decca Navigator System also the width of the inner channel could have been reduced when this had been desired.

IV. CONCLUSION

Additional means such as navigation information and additional navigational aids affect the navigation and its safety in a favourable way from a point of view of nautical use and of the economics of the harbour. Moreover, these additional means influence the dimensions and thus the costs of parts of the harbour design as for instance an approach channel while the costs of these additional means as a part of a whole project are negligible in comparison to the costs of the whole project.

The costs of the additional means are also small relative to the costs of the extras for e.g. an approach channel, which are needed when the additional means would not have been placed:

- a. The extra waterdepth, needed as a consequence of the ship motions due to the environmental conditions and the ship's speed, can be restricted when the environmental conditions and the consequences on the ship motions can be known in an accurate way.
- b. The extra width of the approach channel, as a consequence of the positioning information system, the environmental conditions (e.g. sky wave effects) and the ship speed, can be restricted when the environmental conditions can be predicted accurately and when the accuracy of the positioning information can be raised.

During the evaluation of the Hook of Holland/Europoort project the saving in costs due to these limitations of the depth and width of the approach channels turned out to be an enormous amount of money.

From the research on the additional navigation aids it can be concluded that the effect of the human being on the navigation is of utmost importance. It therefore will be clear that during the design of for instance a harbour entrance one should take into account not only the physical engineering aspects but also the human engineering aspects. This will be even more so when the relation is investigated between the dimensions of the harbour design and the additional navigational aids.

REFERENCES.

- [1] *Symposium on the Development of a 425,000 DWT Tanker with Restricted Draught.* Sponsored by the Municipal Port Management of Rotterdam. September 9-10, 1971.
- [2] KOELE, L.A.: *Behaviour of large tankers in shallow water in relation to the dimensions of an Approach Channel.* Symposium on «Offshore Hydrodynamics». Publication no. 375 of the Netherlands Ship Model Basin, Wageningen, 1971.
- [3] TUCK, E.O. and TAYLOR, R.J.: *Shallow water problems in ship hydrodynamics.* 8th Symposium on Naval Hydrodynamics, Pasadena, August, 1970.
- [4] SVASEK, J.N.: *Contribution in Dutch paper on XXIste International Navigation Congresses.* Stockholm, 1965. Section 112.
- [5] CARTWRIGHT, D.E. and LOUGUET-HIGGINS, M.S.: *The statistical distribution of the maxima of a random function.* Proc. Royal Soc of London. Ser. A237. No. 1203, page 212-232 (1956).
- [6] DIXHOORN, J. van: *The constraints of Traffic Flow imposed by the terminal.* Symposium on Marine Traffic Engineering held at the National Physical Laboratory Teddington, 1972.
- [7] HOOFT, J.P. and OLDENKAMP, I.: *Construction, operation and capabilities of the N.S.M.B. Ship Manoeuvring Simulator.* Publication No. 382 of the Netherlands Ship Model Basin, Wageningen.
- [8] OLDENKAMP, I. and HOOFT, J.P.: *On the use of a manoeuvring simulator.* Schiff und Hafen, August, 1972.
- [9] *Dutch papers at XXIst and XXIInd International Navigation Congresses.* Stockholm, 1965, Section 112 and Paris, 1969, Section 113.
- [10] KOELE, L.A. and KRUSEMAN, P.: *On the occurrence and behaviour of low frequency waves in the Southern part of the North Sea.* 1971, Rijkswaterstaat report n.h.o. 71.4.2, nr. 12. Dutch Ministry of Transport and «Waterstaat». (Dutch text, report not published).

- [11] KRUSEMAN, P.: *The forecast of swell in the sea area before Hook of Holland-Europoort* (in Dutch). De Zee. No. 170, Nov./Dec. 1971.
- [12] KOELE, L.A. and DON, C.: *Manœuvring large tankers in the Approach Channels to Europoort*. The Journal of the Institute of Navigation, vol. 24, No. 3, 1971.
- [13] SCHIMMEL, N.: *The New Radarsystem for Rotterdam, the New Rotterdam Waterweg and Europoort*. Paper on AISM-IALA Congress, Stockholm, 1970.

RESUME.

Le déplacement des pétroliers géants dans un chenal d'accès peut être influencé favorablement par des nouvelles méthodes telles que la transmission instantanée des renseignements concernant les circonstances affectant la navigation.

Le rapport passe en revue quelques aspects de ce problème. Il mentionne entre autre que les nouvelles méthodes permettent d'adapter plus rationnellement les dimensions de chenaux au comportement des navires et du trafic maritime. C'est ainsi que l'installation d'un système « métro-hydro » et d'un système de détermination de lieu peuvent favoriser l'accessibilité et l'économie du port.

Dans certains cas les dimensions du chenal pourront être réduites, réalisant ainsi une économie appréciable, alors que le coût de ces nouveaux aides à la navigation est une quantité négligeable dans l'ensemble du projet.

Les considérations émises dans le rapport sont appuyées par des expériences pratiques réalisées à l'Europoort.
