

# Biological drinking water treatment of anaerobic groundwater in trickling filters

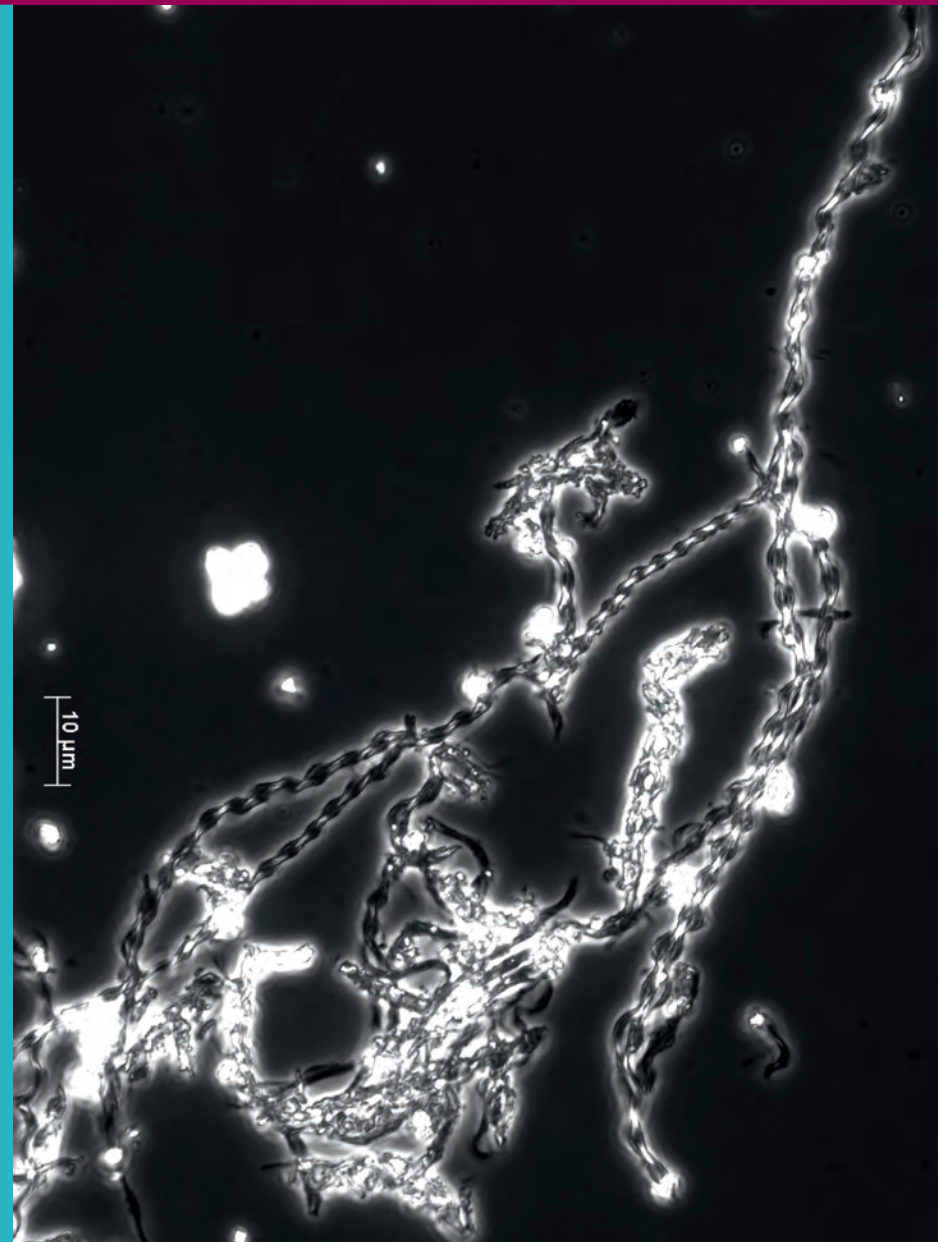

Biological drinking water treatment of anaerobic groundwater in trickling filters Weren de Vet



Weren de Vet

**Uitnodiging**  
Voor het bijwonen van de  
openbare verdediging van  
het proefschrift

**“Biological Drinking  
Water Treatment of  
Anaerobic Groundwater  
in Trickleing Filters”**

door  
Weren de Vet

De promotie zal plaatsvinden  
op dinsdag 14 juni 2011  
om 15:00 uur in het  
Science Center Delft,  
Mijnbouwstraat 120, Delft.

De verdediging wordt  
voorafgegaan door een  
lekenpraatje om 14:30 uur.

Aansluitend op de promotie  
is er een receptie.

Weren  
weren.de.vet@oasen.nl

Paranimfen:  
Doris van Halem  
DvanHalem@tudelft.nl

Dirk van der Woerdt  
d.vd.woerdt@waterbedrijfgroningen.nl

# Stellingen

behorend bij het proefschrift

*“Biological drinking water treatment of anaerobic groundwater in trickling filters”*

door W.W.J.M. de Vet

Delft, 14 juni 2011

1. Natuurlijke selectie vertaalt zich voor microbiologische populaties in grondwaterfilters onder meer in de competitie om schaarse voedingsstoffen zoals fosfaat. Ammoniakoxideerders leggen het af in deze strijd (van Droogenbroeck en Laudelout, 1967 en dit proefschrift).
2. Droogfilters zijn de meest efficiënte systemen om methaan, ijzer, ammonium en mangaan uit anaeroob grondwater te verwijderen (dit proefschrift).
3. Niet een lage zuurstofspanning (Emerson en Revsbech, 1994), maar de gelijktijdige aanwezigheid van ferro-ijzer en zuurstof is de belangrijkste voorwaarde voor de groei van *Gallionella* bacteriën (Hanert, 2006 en dit proefschrift).
4. Door toepassing van kwantitatieve moleculaire technieken kan het belang van biologische t.o.v. chemische ijzeroxidatie worden bepaald (dit proefschrift).
5. Ondanks vermelding in de oorspronkelijke literatuur over *in situ* ontijzering (Hallberg en Martinell, 1976) wordt bij de huidige analyse van het proces (Appelo, 1999) ten onrechte een verwaarloosbare rol toegeschreven aan de ijzermicrobiologie, die de kinetiek en efficiëntie van het proces kan bepalen.
6. Volledige biologische omzetting en nitrificatie tijdens de zuivering is de beste manier om biologische instabiliteit en nitrificatie tijdens drinkwaterdistributie te voorkomen.
7. De toepassing van chloraminering als secundaire desinfectie en fosfaatdosering als corrosiebescherming (Zhang, 2008) vormt een explosieve nutriëntencocktail voor (micro)biologische nagroei tijdens de drinkwaterdistributie.
8. Wetenschappelijke speculaties over de miljarden jaren toekomst van het heelal zijn prikkelend (Brian Cox), een hypotheek nemen op honderdduizenden jaren toekomst met afval van kernenergie is overmoedig en ondoordacht.
9. Exploitatie van natuurlijke processen - naast waterkracht, wind-, zonne- en getijdenenergie, nieuwe ontwikkelingen zoals *blue energy* en biobrandstoffen - maakt een omschakeling naar een duurzame maatschappij nu al mogelijk.
10. Intuïtie sleept je voort en gedachten houden een mens tegen (Arthur Japin, 10-3-2009). Desondanks is de grootste uitdaging voor een wetenschapper om systematische en zorgvuldige waarneming te laten prevaleren boven intuïtie en gewoonte.
11. Goede technologie onderscheidt zich van slechte door natuurlijke evenwichten te verleggen in plaats van te verstoren.
12. Het is opmerkelijk dat de tucht van de markt nog steeds geen korte metten heeft gemaakt met de ontwrichtende hebzucht van enkelen.

*Deze stellingen worden opponeerbaar en verdedigbaar geacht en zijn als zodanig goedgekeurd door de promotoren prof. dr. dr. h.c. ir. M.C.M. van Loosdrecht en prof. dr. ir. L.C. Rietveld.*

# Propositions

Accompanying the thesis

*“Biological drinking water treatment of anaerobic groundwater in trickling filters”*

by W.W.J.M. de Vet

Delft, June 14, 2011

1. In groundwater trickling filters, the natural selection of microbial populations is, among other things, determined by the competition for scarce nutrients such as phosphate. Ammonia-oxidizers get the worst of this battle (van Droogenbroeck en Laudelout, 1967 and this thesis).
2. Trickling filters are the most efficient systems to remove methane, iron, ammonium and manganese from anaerobic groundwater (this thesis).
3. Not a low oxygen pressure (Emerson en Revsbeck, 1994), but the concurrent presence of ferrous iron and oxygen is the principal prerequisite for the growth of *Gallionella* bacteria (Hanert, 2006 and this thesis).
4. The application of quantitative molecular tools may determine the relevance of biological compared to chemical iron oxidation (this thesis).
5. Despite notification in the early literature on *in situ* iron removal (Hallberg en Martinell, 1976), the current analysis of this process (Appelo, 1999) unjustly ignores the role of microbial iron oxidation that may determine the kinetics and efficiency of the process.
6. The best way to prevent biological instability and nitrification during drinking water distribution is to have full biological conversion and nitrification during drinking water treatment.
7. The combined application of chloramination as secondary disinfection and phosphate dosage as anti-corrosion measure (Zhang, 2008) results in an explosive nutrient cocktail for (micro)biological growth during drinking water distribution.
8. Scientific speculations about billions of years in the future of the universe are exciting (Brian Cox), mortgaging hundreds of thousands of years of future with nuclear waste is presumptuous and reckless.
9. Exploiting natural processes - besides waterpower, wind, solar and tidal energy, new developments such as *blue energy* and biofuels - enable a conversion to a sustainable society right now.
10. Intuition drags one along and thoughts slow a man down (Arthur Japin, March 10, 2009). Despite this, the greatest challenge for a scientist is to let systematic and cautious observation prevail over intuition and convention.
11. Good technology distinguishes itself from bad technology by shifting instead of disturbing natural equilibria.
12. It is remarkable that the market discipline still has not made short work of the paralyzing greed of a few.

*These propositions are regarded as opposable and defendable, and have been approved as such by the supervisors prof. dr. dr. h.c. ir. M.C.M. van Loosdrecht en prof. dr. ir. L.C. Rietveld.*

# Biological drinking water treatment of anaerobic groundwater in trickling filters

## Proefschrift

ter verkrijging van de graad van doctor  
aan de Technische Universiteit Delft;  
op gezag van de Rector Magnificus prof. ir. K.C.A.M. Luyben,  
voorzitter van het College voor Promoties  
in het openbaar te verdedigen  
op dinsdag 14 juni 2011 om 15:00 uur

door

Werenfried Wilhelmus Josephus Maria DE VET

civiel ingenieur  
geboren te 's Hertogenbosch.



Dit proefschrift is goedgekeurd door de promotoren:

Prof. dr. dr. h.c. ir. M.C.M. van Loosdrecht

Prof. dr. ir. L.C. Rietveld

Samenstelling promotiecommissie:

Rector Magnificus

Technische Universiteit Delft, voorzitter

Prof. dr. dr. h.c. ir. M.C.M. van Loosdrecht

Technische Universiteit Delft, promotor

Prof. dr. ir. L.C. Rietveld

Technische Universiteit Delft, promotor

Prof. ir. J.C. van Dijk

Technische Universiteit Delft

Prof. Dr. H. Horn

Technische Universität München

Prof. dr. H.J. Laanbroek

Universiteit Utrecht / NIOO-KNAW

Prof. dr. W.H. van Riemsdijk

Wageningen Universiteit

Prof. Dr.-Ing. W. Uhl

Technische Universität Dresden

Prof. dr. J.T. Pronk

Technische Universiteit Delft, reservelid

© W.W.J.M. de Vet

Biological drinking water treatment of anaerobic groundwater in trickling filters

This research was supported by Oasen drinking water company, the Netherlands.

Photos front cover and p. 88, 156, 248, 256: © Bart Benschop ([www.bartbenschop.com](http://www.bartbenschop.com))

Design and layout of cover and chapter title pages: Esther Teunissen ([www.textcetera.nl](http://www.textcetera.nl))

Printed by Gildeprint Enschede, the Netherlands

ISBN: 978-90-8957-000-0

Het is moeilijk iets zinnigs te zeggen over iets onbekends

Wouter (± 2007)



## Table of contents

1. <i>General Introduction</i>	1
2. <i>Water quality and treatment of river bank filtrate</i>	17
3. <i>Influence of iron on nitrification in full-scale drinking water trickling filters</i>	41
4. <i>Molecular characterization of microbial populations in groundwater sources and sand filters for drinking water production</i>	61
5. <i>Biological iron oxidation by Gallionella spp. in drinking water production under oxygen saturated conditions</i>	89
6. <i>Gallionella spp. in trickling filtration of subsurface aerated and natural groundwater</i>	119
7. <i>Filter coatings in groundwater trickling filters for drinking water production</i>	139
8. <i>Assessment of nitrification in groundwater filters for drinking water production by qPCR and activity measurement</i>	157
9. <i>Phosphorus limitation in nitrifying groundwater filters</i>	185
10. <i>Concluding remarks</i>	205
<i>Annexes</i>	223
<i>Summary</i>	237
<i>Samenvatting</i>	243
<i>Dankwoord – Acknowledgements</i>	249
<i>Over Weren</i>	256
<i>List op publications</i>	257
<i>Legends for photos</i>	261





# CHAPTER 1

1

## General introduction

## 1.1 Anaerobic groundwater as source for drinking water production

Groundwater is used worldwide for drinking water production. In Europe about 75% of the drinking water originates from groundwater (Jørgensen and Stockmarr, 2009). The groundwater composition varies enormously and is influenced by a complex of factors such as the quality of the infiltrating water, the interaction with the percolated soil layers, redox conditions, temperature and microbial activity. Natural groundwater is generally considered to be of constant quality and hygienically safe.

In phreatic groundwater, the presence of nitrate, nitrite and ammonia is generally regarded as an indicator of possible sewage and animal waste pollution (WHO, 2008). In anaerobic groundwater, however, inorganic compounds are generally related to the decomposition of natural organic matter (NOM). The oxidative decay of organic matter 'enriches' the groundwater with ammonium but also with other inorganic compounds, such as iron, manganese and trace metals from the reductive dissolution of soil minerals. The oxidation of NOM is paired with, in typical order, the reduction of oxygen, nitrate, and sulfate and fermentation alongside with reductive dissolution of iron and manganese, acidification, dissolution of calcium carbonate and mineralization of ammonium (Stuyfzand, 1989). A strong decrease in oxidation reduction potential (ORP) during infiltration is observed in river delta, wetland and polder areas, where nutrients and plant growth have resulted in highly reductive, organically loaded soils. In the western parts of the Netherlands, the groundwater is recharged by the river Rhine and by percolation of rain water through peat and clay layers in the polders. It contains high concentrations of methane, iron, ammonium and manganese (see Chapter 2). As an example, Figure 1 shows the ammonium concentration in all Dutch well fields for drinking water production (Registratie Waterkwaliteitsgegevens Bedrijven (REWAB), 2003). 62 % contains more than  $0.2 \text{ mg L}^{-1}$  and 15 % more than  $1.0 \text{ mg L}^{-1}$  of ammonium.

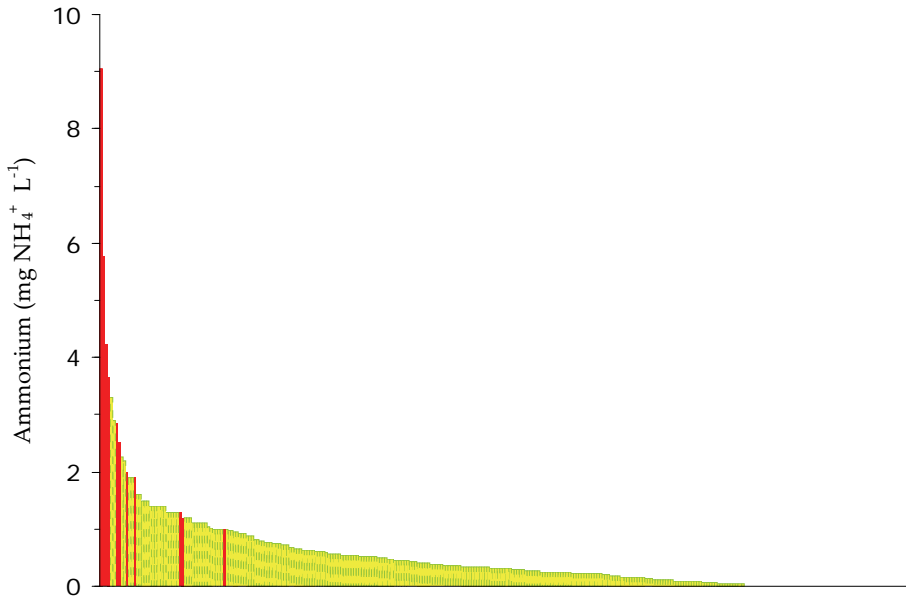

Figure 1: Average ammonium concentration in all groundwater well fields for drinking water production in the Netherlands (REWAB, 2003); the red bars indicate the well fields of Oasen Drinking Water Company, operating in the western polder area of the Netherlands (see Section 1.3.1)

Methane only poses a risk (from accumulation and explosion) during groundwater extraction, but is easily removed by aeration and aerobic biological processes. When properly removed, methane does not pose a problem for drinking water quality and no drinking water standards for methane exist. Iron and ammonium do not form a health threat in the concentrations present in anaerobic groundwater and manganese only at levels over  $0.4 \text{ mg L}^{-1}$ . The strict drinking water standards for these compounds are based on operational, organoleptic or esthetical reasons. Iron and manganese are restricted in drinking water because of discoloration of laundry and sanitary equipment, ammonium because of the possibility of microbial regrowth and of nitrite formation as a result of nitrification during the drinking water distribution. The backgrounds and levels of national and international standards for inorganic compounds are given in Annex A. The inorganic compounds can be removed from groundwater by different chemical and physical treatment techniques, but also by (micro-)biological processes (see Table 1 in Chapter 2).



## 1.2 Biological trickling filtration of anaerobic groundwater

The first reported application of fixed film biological water treatment dates back to 1865 and concerned sewage treatment with trickling filtration in Germany (Peters and Alleman, 1982). Biological treatment processes, such as nitrification, still form the pivot of wastewater purification. In drinking water treatment, the notion of microbiology and biological action has long been restricted to pathogens and their removal (Smit, 1948). Only in the last decades, a more positive attitude towards biological processes evolves in drinking water treatment and new applications are investigated and developed (Brown et al., 2003; Kasuga et al., 2007; Upadhyaya et al., 2010).

For the treatment of anaerobic groundwater, filtration on granular media is the general technique and the filters are biologically active when no pre-chlorination is used. In the 1980s, the focus of research and engineering shifted from conventional (interpreted as chemical) towards biological processes for iron and manganese removal in Germany (Czekalla et al., 1985) and France (Mouchet, 1992). Biological iron removal from groundwater has since been implemented full-scale in many parts of Europe (Frischherz et al., 1985; Czekalla and Kotulla, 1990; Bourguine et al., 1994; Søggaard et al., 2001; Katsoyiannis and Zouboulis, 2004), and worldwide like in Togo, Africa (Badjo and Mouchet, 1989), Canada (Brian Gage et al., 2001) and China (Li et al., 2005). The essential process of iron oxidation may be chemical or microbial in nature, depending on the water quality and operating conditions (see Annex B, Chapter 5 and 10).

Nitrification also occurs in these filters when treating ammonium-containing anaerobic groundwater. Nitrification is an essential process in the natural nitrogen cycle. For drinking water treatment, nitrification is widely applied but has also been often contested and the literature on it was scarce until recently (Olańczuk-Neyman and Bray, 2000; Andersson et al., 2001; van der Aa et al., 2002; Kihn et al., 2002; Laurent et al., 2003).

Ammonium ( $\text{NH}_4^+$ ) is in pH-dependent equilibrium with ammonia ( $\text{NH}_3$ ) as shown in Equation 1. During nitrification, ammonia is converted in two steps to nitrite and nitrate according to the Equations 2 and 3 (Fiencke et al., 2005).

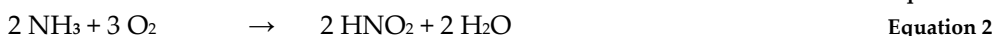

Conversion of ammonium to nitrite is usually the rate limiting step of nitrification under moderate to low temperature conditions (Wijffels et al., 1995). Under neutral conditions, ammonium is the main species in water, but Suzuki et al. (1974)

demonstrated that ammonia is the main substrate for ammonia-oxidizing bacteria (AOB). The ammonia oxidation in AOB is catalyzed by two enzymes (Prosser, 1989), the ammonia monooxygenase (amo) enzyme for the oxidation of  $\text{NH}_3$  (ammonia) to  $\text{NH}_2\text{OH}$  (hydroxylamine) and the hydroxylamine oxidoreductase (hao) enzyme for the oxidation of  $\text{NH}_2\text{OH}$  to  $\text{HNO}_2$  (nitrite).

The combined removal of iron, manganese and ammonium by biological processes has long been considered impossible, because of the incompatibility of the required ORP (Mouchet, 1992). Currently, nitrification during drinking water treatment attracts increasing attention in literature, both as separate process or in combination with iron and manganese removal (Štembal et al., 2005; Lytle et al., 2007; Tränckner et al., 2008; Tekerlekopoulou et al., 2010).

### 1.3 Background of the thesis

#### 1.3.1 Nitrification problems in trickling filters

This thesis was initiated by the Drinking Water Company Oasen in the Netherlands, which faced a reoccurring problem in its nitrifying groundwater filters. Oasen exploits most of the Water Treatment Plants (WTPs) with high concentrations of ammonium in the groundwater in the Netherlands (see red bars in Figure 1). Good nitrification is possible in the groundwater filters but it sometimes fails. Nitrification starts up almost completely in the trickling filters during the first half year after renewal or intensive washing of the filter sand. After this period, the nitrification activity typically relapses (see Figure 2A). The most effective way for Oasen to counteract this problem is the application of subsurface aeration (see Figure 2B and next section).

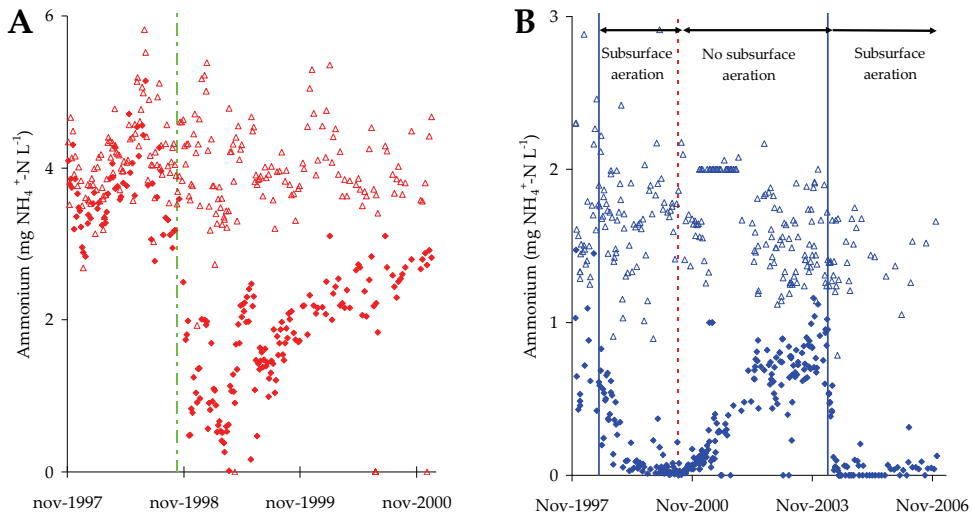

**Figure 2: Ammonium in influent ( $\Delta$ ) en effluent ( $\blacklozenge$ ) of two Oasen groundwater trickling filters; graph A shows typical nitrification problem: starting with incomplete nitrification, almost complete nitrification after replacement of filter bed by new filter sand in October 1998 (stripe-dotted line) and gradual relapse; graph B shows effect of application of subsurface aeration (firm line: start, dotted line: stop of subsurface aeration)**

Several possible causes for incomplete nitrification in the filters were identified: (1) anoxic conditions; (2) unfavorable pH or temperature; (3) variable ammonium load with insufficient growth rate to counteract its increase; (4) inhibition by toxic compounds; (5) net loss of active microbes by desorption and washout, death or limited inoculation; (6) mass transfer limitation by filter clogging or iron adsorption; (7) limitation of growth by other essential nutrients than ammonium.

In the literature, nitrification problems during drinking water production are usually related to low temperatures in surface water treatment (Andersson et al., 2001) or biomass loss by desorption or predation (Tränckner et al., 2008). Incomplete ammonium removal during cold periods is caused by the combination of increasing ammonium concentrations in the surface water and the reduced activity and growth rate of nitrifying microorganisms (Uhl and Gimbel, 2000). This discrepancy is sometimes intensified by the limitation of trace elements, like at the Amsterdam Water Works in the winter of 1995-1996 (Kors et al., 1998; van der Aa et al., 2002). Phosphorus has been shown to be limiting for microbial growth in other drinking water production systems as well, depending on the groundwater quality and the applied treatment processes (Lehtola et al., 2002).

Causes 1 to 4 are not obvious for the Oasen groundwater filters. The trickling filters are well ventilated with air and oxygen depletion does not occur. Low pH, seasonal variations of temperatures or ammonium load are not likely to cause the nitrification problems at Oasen either, because the groundwater has a constant temperature of 12-13 °C, a constant pH between 7.1 and 7.3 and relatively constant

ammonium concentration. The almost complete nitrification in the first period after the startup with new filter material (Figure 2A) suggests the absence of inhibiting toxic compounds in the groundwater. The causes 5 to 7 may be relevant for the Oasen trickling filters and have been evaluated in this thesis (see section 1.5 for hypotheses).

### 1.3.2 The effect of subsurface aeration on nitrification

Subsurface aeration is a very limited form of *in situ* iron removal (Appelo et al., 1999). *In situ* treatment is applied for the removal of many compounds such as iron, manganese and nitrate (Braester and Martinell, 1988), organic pollutants (Madsen et al., 1991), and arsenic (van Halem et al., 2010) from groundwater. So far, research into subsurface aeration has mainly been approached from a geochemical perspective and the microbiological references for such systems are still scarce (Sutton et al., 2009). The concept of subsurface aeration was introduced by Oasen to emphasize the difference with the original de-ironing process. In both techniques, oxygen is introduced into an anaerobic ferrous-iron containing aquifer, resulting in oxidation and precipitation of the iron. Unlike *in situ* iron removal, the aim of subsurface aeration is not the total removal of iron in the aquifer, but the observed stimulation of nitrification (see Figure 2B) in the WTP. Because it was unclear, how the *in situ* process, being separated in time and place from the groundwater filters, could influence the biological nitrification, this phenomenon was called the Miracle of (Wonder van) Nieuw Lekkerland, named after the village where it was first identified at an Oasen WTP.

### 1.3.3 The need for alternative techniques for durable nitrification

The application of *in situ* iron removal is challenged by some serious drawbacks. First of all, it is an indirect, poorly controllable and badly understood technique. Secondly, the deposition of iron oxyhydroxides in the aquifer may be coupled with coprecipitation and adsorption of heavy metals (such as arsenic and nickel) present in the groundwater. Although their concentrations are relatively low ( $< 10 \mu\text{g L}^{-1}$ ) in the groundwater, the possible accumulation of these metals in the aquifer incites strict regulatory enforcement by the licensing authorities. For these reasons, research into the mechanism and development of alternative (not *in situ*) techniques was started. Previous PhD-research focused on the geochemical aspects (Wolthoorn, 2003). Wolthoorn found that subsurface aeration not only led to iron precipitation on the soil particles, but also stimulated the formation of complex, mobile iron(oxy)hydroxides (Wolthoorn et al., 2004a; Wolthoorn et al., 2004c). She was able to produce synthetic counterparts of these colloids, which stimulated the removal of ammonium in lab scale column experiments (Wolthoorn et al., 2004b). These results have not yet been applied to full-scale systems, because of



insufficient understanding of the defining processes in full-scale groundwater filtration. To reduce this knowledge gap, the research continued in 2006, now focusing on the biological and chemical processes in the trickling filtration. This thesis presents the outcome of these investigations, with a general focus on the diversity, activity and interaction of the microbial populations in the groundwater filters. The ground-breaking development of new molecular tools for the characterization of microbial populations has given a strong impulse in this field.

#### 1.4 The revolution of the molecular tools

The tools for identification of the genetic make-up of organisms were first developed in the nineteen eighties in medical research for diagnostics purposes (Saiki et al., 1985) and opened up new possibilities in other fields such as forensics (DNA finger printing). They soon revolutionized the possibilities to analyze the (microbial) populations in known and unknown habitats. These techniques generally work by direct marking with radioactive or fluorescent probes or amplification (Saiki et al., 1988) of parts of the DNA. The amplification of DNA by the polymerase chain reaction (PCR; Mullis et al., 1986) allows the detection of very low numbers or even single cells in complex (natural) samples and makes these techniques supersensitive. Because of the sensitive nature of molecular techniques, the identification of species can also be used in a reverse way to demonstrate even low active metabolic processes, which cannot be detected by chemical measurements, but may be essential in the functioning of natural and engineered ecosystems. The discovery and possibilities of the new molecular techniques is an exciting story in itself (Mullis, 1990), but lies beyond the scope of this thesis. Muyzer and Ramsing (1995) give an overview of the early tools that are still widely used in ecological molecular research. Nowadays, molecular tools are still developing rapidly and allow the determination, quantification, activity measurement of individual species in complex populations, their interdependency and much more. New tools, including Terminal Restriction Fragment Length Polymorphism (TRFLP; Liu et al., 1997), genomic or clone libraries, and direct sequencing techniques tools, such as pyrosequencing (Ronaghi et al., 1998), quickly gain relevance and expand the possibilities of the molecular determination, while reducing the costs.

Quick screening techniques, such as denaturing gradient gel electrophoresis (DGGE, Muyzer et al., 1993), have revealed the population composition in many natural and engineered systems. Molecular characterization of unknown habitats are abundant in different environments, such as estuaries (Sahan and Muyzer, 2008), wetlands (Wang et al., 2009), arsenic contaminated aquifers (Sutton et al., 2009) and oilfields (van der Kraan et al., 2009).

In drinking water research, molecular techniques have taken off both to explore the microbial populations in bioreactors (Fonseca et al., 2001; Li et al., 2011) and distribution systems (Martiny et al., 2005; Eichler et al., 2006; Li et al., 2010). Other researchers focused on the application of molecular techniques on specific processes or aspects, such as nitrification problems in distribution systems (Regan et al., 2003; Lipponen et al., 2004; Hoefel et al., 2005), pathogens (Wullings and Van Der Kooij, 2006) and manganese-oxidizing bacteria (Burger et al., 2008).

This thesis confines to two important biological processes in the treatment of anaerobic groundwater, iron-oxidation and nitrification, and their interaction in trickling groundwater filters. The main groups of neutrophilic iron-oxidizing bacteria and the nitrifying prokaryotes are presented with major references in Annex C.

## 1.5 Aim and overview of this thesis

The aim of this thesis is, firstly, to get a better understanding of the role of iron conversion in relation to the failure of nitrification in groundwater trickling filters and, secondly, to find alternative techniques for subsurface aeration as remediation for the nitrification problem. With a focus on the interaction of iron oxidation and nitrification, we tested the following hypotheses:

- a) Biological iron oxidation outcompetes chemical iron oxidation in trickling filtration of natural groundwater;
- b) Nitrification problems are caused by poor attachment and extensive washout of ammonia-oxidizing microorganisms; subsurface aeration results in a more favorable filter coating for the attachment and growth of these microorganisms;
- c) Incomplete nitrification is caused by mass transfer limitation as a result of filter clogging or impermeable iron deposits;
- d) Incomplete nitrification is caused by the limitation of an essential nutrient as a result of the growth of competing microorganisms.

The thesis is structured as follows. Chapter 2 and 3 introduce the full-scale Oasen groundwater and treatment systems. Chapter 2 provides a systematic overview of the quality and treatment of riverbank groundwater. Some of the main hydrological and geochemical factors determining the quality are discussed. Via systematic analysis of historical data of full-scale groundwater trickling filters, biases in general accepted theories in drinking water sciences are commented on.

Chapter 3 presents the specific ageing problem in nitrifying filters at Oasen and evaluates proven full-scale techniques to enhance nitrification by influencing the iron removal process, thus stating a chemical hypothesis for the nitrification problems.

For the rest of the thesis, two types of full-scale trickling groundwater filters were systematically compared. One of the filter types was fed by subsurface aerated groundwater and had full nitrification; the other type treated normal, non-subsurface aerated groundwater and had incomplete nitrification.

Chapters 4 to 6 and 8 elaborate on the biological populations in subsurface and non-subsurface aerated groundwater and groundwater filters. Different molecular techniques have been used for their characterization and quantification and specific activity and growth conditions were further evaluated in complementary lab-scale experiments. In Chapter 4, the bacterial and archaeal populations in the groundwater and trickling filters were identified using PCR and DGGE with both general and specific primers. Chapter 5 presents the assessments of the growth of *Gallionella* spp. through quantitative PCR under neutral and oxygen saturated conditions in full-scale trickling filters and lab-scale reactors and filters. This chapter also evaluates the effect of pH on the heterogeneous chemical iron oxidation and growth of *Gallionella* in complex natural water and examines hypothesis a. Chapter 6 shows the application of the quantitative PCR approach to evaluate the role of iron-oxidizing *Gallionella* bacteria in the two types of groundwater and full-scale trickling filters; clone libraries were made to distinguish the specialization of different *Gallionella* subspecies in the various niches of these systems.

Chapters 7 to 9 focus on the three hypothesized causes for the nitrification problems in the Oasen groundwater trickling filters. Chapter 7 evaluates some major biological and chemical characteristics of the iron coated filter materials in Oasen groundwater filters the results of which are used in the test of hypothesis b. Chapter 8 focuses on the ammonia-oxidizing prokaryotes and evaluates hypotheses for the nitrification problems by comparing the two full-scale filters through quantitative PCR and activity measurements. The cell specific activities calculated from the combination of these two methods are used to test the hypotheses b and c.

In Chapter 9, a bioassay method based on Lehtola et al. (1999) was developed to determine the microbially available phosphorus and to test for phosphorus limitation during nitrification in groundwater filters. The addition of phosphate during lab-scale experiments is presented as a solution for incomplete nitrification in full-scale filtrate.

In Chapter 10, the main implications of this research are discussed and suggestions are made for further research and alternative techniques to enhance nitrification in groundwater trickling filters.

## References

- Andersson, A., Laurent, P., Kihn, A., Prévost, M. and Servais, P. (2001) Impact of temperature on nitrification in biological activated carbon (BAC) filters used for drinking water treatment. *Water Research* 35(12), 2923-2934.
- Appelo, C.A.J., Drijver, B., Hekkenberg, R. and Jonge, M. (1999) Modeling *In Situ* Iron Removal from Ground Water. *Ground Water* 37(6), 811-817.
- Badjo, Y. and Mouchet, P. (1989) Appropriate technologies - example of a large biological iron removal plant in Togo. *Aqua* 38(3), 197-206.
- Bourguine, F.P., Gennery, M., Chapman, J.I., Kerai, H., Green, J.G., Rap, R.J., Ellis, S. and Gaumard, C. (1994) Biological processes at Saints Hill water-treatment plant, Kent. *Journal of the Institution of Water and Environmental Management* 8(4), 379-392.
- Braester, C. and Martinell, R. (1988) The vyredox and nitredox methods of *in situ* treatment of groundwater. *Water Science and Technology* 20(3), 149-163.
- Brian Gage, A.T.S.I., Dr. Dennis H. O'Dowd, B.C. and Paul Williams, O.D.L. (2001) Biological iron and manganese removal, pilot and full scale applications, Ontario Water Works Association conference, Ontario
- Brown, J.C., Snoeyink, V.L., Raskin, L. and Lin, R. (2003) The sensitivity of fixed-bed biological perchlorate removal to changes in operating conditions and water quality characteristics. *Water Research* 37(1), 206-214.
- Burger, M.S., Krentz, C.A., Mercer, S.S. and Gagnon, G.A. (2008) Manganese removal and occurrence of manganese oxidizing bacteria in full-scale biofilters. *Journal of Water Supply: Research and Technology - AQUA* 57(5), 351-359.
- Czekalla, C. and Kotulla, H. (1990) The conversion of the waterworks Westerbeck of the city of Wolfsburg to aerobic biological contact filtration. *Die Umstellung des Wasserwerkes Westerbeck der Stadtwerke Wolfsburg AG auf aerobe biologische Kontaktenteisung* 131(3, Mar., 1990), 126-132.
- Czekalla, C., Mevius, W. and Hanert, H. (1985) Quantitative removal of iron and manganese by microorganisms in rapid sand filters (*in situ* investigations). *Water Supply* 3(1), 111-123.
- Eichler, S., Christen, R., Höltje, C., Westphal, P., Bötel, J., Brettar, I., Mehling, A. and Höfle, M.G. (2006) Composition and dynamics of bacterial communities of a drinking water supply system as assessed by RNA- and DNA-based 16S rRNA gene fingerprinting. *Applied and Environmental Microbiology* 72(3), 1858-1872.
- Fiencke, C., Spieck, E. and Bock, E. (2005) *Nitrifying Bacteria*  
Springer Netherlands.
- Fonseca, A.C., Scott Summers, R. and Hernandez, M.T. (2001) Comparative measurements of microbial activity in drinking water biofilters. *Water Research* 35(16), 3817-3824.

Frischherz, H., Zibuschka, F., Jung, H. and Zerobin, W. (1985) Biological elimination of iron and manganese. *Water Supply* 3(1), 125-136.

Hoefel, D., Monis, P.T., Grooby, W.L., Andrews, S. and Saint, C.P. (2005) Culture-independent techniques for rapid detection of bacteria associated with loss of chloramine residual in a drinking water system. *Applied and Environmental Microbiology* 71(11), 6479-6488.

Jørgensen, L. and Stockmarr, J. (2009) Groundwater monitoring in Denmark: characteristics, perspectives and comparison with other countries. *Hydrogeology Journal* 17(4), 827-842.

Kasuga, I., Shimazaki, D. and Kunikane, S. (2007) Influence of backwashing on the microbial community in a biofilm developed on biological activated carbon used in a drinking water treatment plant, pp. 173-180.

Katsoyiannis, I.A. and Zouboulis, A.I. (2004) Biological treatment of Mn(II) and Fe(II) containing groundwater: Kinetic considerations and product characterization. *Water Research* 38(7), 1922-1932.

Kihn, A., Andersson, A., Laurent, P., Servais, P. and Prévost, M. (2002) Impact of filtration material on nitrification in biological filters used in drinking water production. *Journal of Water Supply: Research and Technology - AQUA* 51(1), 35-46.

Kors, L.J., Moorman, J.H.N., Wind, A.P.M. and Van Der Hoek, J.P. (1998) Nitrification and low temperature in a raw water reservoir and rapid sand filters. *Water Science and Technology* 37(2), 169-176.

Laurent, P., Kihn, A., Andersson, A. and Servais, P. (2003) Impact of backwashing on nitrification in the biological activated carbon filters used in drinking water treatment. *Environmental Technology* 24(3), 277-287.

Li, D., Li, Z., Yu, J., Cao, N., Liu, R. and Yang, M. (2010) Characterization of Bacterial Community Structure in a Drinking Water Distribution System during an Occurrence of Red Water. *Appl. Environ. Microbiol.* 76(21), 7171-7180.

Li, D., Zhang, J., Wang, H., Yang, H. and Wang, B. (2005) Operational performance of biological treatment plant for iron and manganese removal. *Journal of Water Supply: Research and Technology - AQUA* 54(1), 15-24.

Li, X., Upadhyaya, G., Yuen, W., Brown, J., Morgenroth, E. and Raskin, L. (2011) Changes in the structure and function of microbial communities in drinking water treatment bioreactors upon addition of phosphorus. *Applied and Environmental Microbiology* 76(22), 7473-7481.

Lipponen, M.T.T., Martikainen, P.J., Vasara, R.E., Servomaa, K., Zacheus, O. and Kontro, M.H. (2004) Occurrence of nitrifiers and diversity of ammonia-oxidizing bacteria in developing drinking water biofilms. *Water Research* 38(20), 4424-4434.

Liu, W.T., Marsh, T.L., Cheng, H. and Forney, L.J. (1997) Characterization of microbial diversity by determining terminal restriction fragment length polymorphisms of genes encoding 16S rRNA. *Applied and Environmental Microbiology* 63(11), 4516-4522.

Lytle, D.A., Sorg, T.J., Wang, L., Muhlen, C., Rahrig, M. and French, K. (2007) Biological nitrification in a full-scale and pilot-scale iron removal drinking water treatment plant. *Journal of Water Supply: Research and Technology - AQUA* 56(2), 125-136.

Madsen, E.L., Sinclair, J.L. and Ghiorse, W.C. (1991) *In situ* biodegradation: Microbiological patterns in a contaminated aquifer. *Science* 252(5007), 830-833.

Martiny, A.C., Albrechtsen, H.-J., Arvin, E. and Molin, S. (2005) Identification of Bacteria in Biofilm and Bulk Water Samples from a Nonchlorinated Model Drinking Water Distribution System: Detection of a Large Nitrite-Oxidizing Population Associated with *Nitrospira* spp, pp. 8611-8617.

Mouchet, P. (1992) From conventional to biological removal of iron and manganese in France. *Journal / American Water Works Association* 84(4), 158-167.

Mullis, K., Faloona, F. and Scharf, S. (1986) Specific enzymatic amplification of DNA in vitro: The polymerase chain reaction. *Cold Spring Harbor Symposia on Quantitative Biology* 51(1), 263-273.

Mullis, K.B. (1990) The unusual origin of the polymerase chain reaction. *Scientific American* 262(4), 56-65.

Muyzer, G., De Waal, E.C. and Uitterlinden, A.G. (1993) Profiling of complex microbial populations by denaturing gradient gel electrophoresis analysis of polymerase chain reaction-amplified genes coding for 16S rRNA. *Applied and Environmental Microbiology* 59(3), 695-700.

Muyzer, G. and Ramsing, N.B. (1995) Molecular methods to study the organization of microbial communities, pp. 1-9.

Olańczuk-Neyman, K. and Bray, R. (2000) The Role of Physico-Chemical and Biological Processes in Manganese and Ammonia Nitrogen Removal from Groundwater. *Polish Journal of Environmental Studies* 9(2), 91-96.

Peters, R.W. and Alleman, J.E. (1982) History of fixed-film wastewater treatment systems, *Proceedings: 1st International Conference on Fixed-Film Biological Processes*. King Island, OH, USA.

Prosser, J.I. (1989) Autotrophic Nitrification in Bacteria. *Advances in microbial physiology* 30, 125-181.

Regan, J.M., Harrington, G.W., Baribeau, H., Leon, R.D. and Noguera, D.R. (2003) Diversity of nitrifying bacteria in full-scale chloraminated distribution systems. *Water Research* 37(1), 197-205.

Ronaghi, M., Uhlén, M. and Nyérén, P. (1998) A sequencing method based on real-time pyrophosphate. *Science* 281(5375), 363-365.

Sahan, E. and Muyzer, G. (2008) Diversity and spatio-temporal distribution of ammonia-oxidizing Archaea and Bacteria in sediments of the Westerschelde estuary. *FEMS Microbiology Ecology* 64(2), 175-186.

Saiki, R.K., Gelfand, D.H., Stoffel, S., Scharf, S.J., Higuchi, R., Horn, G.T., Mullis, K.B. and Erlich, H.A. (1988) Primer-directed enzymatic amplification of DNA with a thermostable DNA polymerase. *Science* 239(4839), 487-491.

Saiki, R.K., Scharf, S. and Faloona, F. (1985) Enzymatic amplification of  $\beta$ -globin genomic sequences and restriction site analysis for diagnosis of sickle cell anemia. *Science* 230(4732), 1350-1354.

Smit, J. (1948) Microbiology of Drinking Water and Sewage. *Annual Review of Microbiology* 2(1), 435-452.

Søgaard, E.G., Aruna, R., Abraham-Peskir, J. and Bender Koch, C. (2001) Conditions for biological precipitation of iron by *Gallionella ferruginea* in a slightly polluted ground water. *Applied Geochemistry* 16(9-10), 1129-1137.

Štembal, T., Markić, M., Ribičić, N., Briški, F. and Sipoš, L. (2005) Removal of ammonia, iron and manganese from groundwaters of northern Croatia - Pilot plant studies. *Process Biochemistry* 40(1), 327-335.

Stuyfzand, P.J. (1989) Hydrology and water quality aspects of Rhine bank groundwater in the Netherlands. *Journal of Hydrology* 106(3-4), 341-363.

Sutton, N.B., van der Kraan, G.M., van Loosdrecht, M.C.M., Muyzer, G., Bruining, J. and Schotting, R.J. (2009) Characterization of geochemical constituents and bacterial populations associated with As mobilization in deep and shallow tube wells in Bangladesh. *Water Research* 43(6), 1720-1730.

Suzuki, I., Dular, U. and Kwok, S.C. (1974) Ammonia or Ammonium Ion as Substrate for Oxidation by *Nitrosomonas europaea* Cells and Extracts. *J. Bacteriol.* 120(1), 556-558.

Tekerlekopoulou, A.G., Papazafiris, P.G.D. and Vayenas, D.V. (2010) A full-scale trickling filter for the simultaneous removal of ammonium, iron and manganese from potable water. *Journal of Chemical Technology & Biotechnology* 85(7), 1023-1026.

Tränckner, J., Wricke, B. and Krebs, P. (2008) Estimating nitrifying biomass in drinking water filters for surface water treatment. *Water Research* 42(10-11), 2574-2584.

Uhl, W. and Gimbel, R. (2000) Dynamic modeling of ammonia removal at low temperatures in drinking water rapid filters. *Water Science and Technology* 41(4-5), 199-206.

Upadhyaya, G., Jackson, J., Clancy, T.M., Hyun, S.P., Brown, J., Hayes, K.F. and Raskin, L. (2010) Simultaneous removal of nitrate and arsenic from drinking water sources utilizing a fixed-bed bioreactor system. *Water Research* 44(17), 4958-4969.

van der Aa, L.T.J., Kors, L.J., Wind, A.P.M., Hofman, J.A.M.H. and Rietveld, L.C. (2002) Nitrification in rapid sand filter: Phosphate limitation at low temperatures. *Water Science and Technology: Water Supply* 2(1), 37-46.

van der Kraan, G.M., Bruining, J., Lomans, B.P., Van Loosdrecht, M.C.M. and Muyzer, G. (2009) Microbial diversity of an oil-water processing site and its associated oil field: The possible role of microorganisms as information carriers from oil-associated environments. *FEMS Microbiology Ecology* 71(3), 428-443.

van Halem, D., Olivero, S., de Vet, W.W.J.M., Verberk, J.Q.J.C., Amy, G.L. and van Dijk, J.C. (2010) Subsurface iron and arsenic removal for shallow tube well drinking water supply in rural Bangladesh. *Water Research* 44(19), 5761-5769.

Wang, J., Muyzer, G., Bodelier, P.L.E. and Laanbroek, H.J. (2009) Diversity of iron oxidizers in wetland soils revealed by novel 16S rRNA primers targeting Gallionella-related bacteria. *ISME Journal* 3(6), 715-725.

WHO (2008) *Guidelines for Drinking-water Quality*, 3-rd edition, Geneva.

Wijffels, R.H., Englund, G., Hunik, J.H., Leenen, E.J.T.M., Bakketun, A., Gunther, A., Obon de Castro, J.M. and Tramper, J. (1995) Effects of diffusion limitation on immobilized nitrifying microorganisms at low temperatures. *Biotechnology and Bioengineering* 45(1), 1-9.

Wolthoorn, A. (2003) *Subsurface aeration of anaerobic groundwater. Iron colloid formation and the nitrification process*. PhD-thesis, Wageningen University.

Wolthoorn, A., Temminghoff, E.J.M. and Van Riemsdijk, W.H. (2004a) Colloid formation in groundwater by subsurface aeration: Characterisation of the geo-colloids and their counterparts. *Applied Geochemistry* 19(9), 1391-1402.

Wolthoorn, A., Temminghoff, E.J.M. and Van Riemsdijk, W.H. (2004b) Effect of synthetic iron colloids on the microbiological NH<sub>4</sub><sup>+</sup> removal process during groundwater purification. *Water Research* 38(7), 1884-1892.

Wolthoorn, A., Temminghoff, E.J.M., Weng, L. and Van Riemsdijk, W.H. (2004c) Colloid formation in groundwater: Effect of phosphate, manganese, silicate and dissolved organic matter on the dynamic heterogeneous oxidation of ferrous iron. *Applied Geochemistry* 19(4), 611-622.

Wullings, B.A. and Van Der Kooij, D. (2006) Occurrence and genetic diversity of uncultured *Legionella* spp. in drinking water treated at temperatures below 15°C. *Applied and Environmental Microbiology* 72(1), 157-166.





# CHAPTER 2

---

## Water quality and treatment of river bank filtrate

2

**Published as:**  
de Vet, W.W.J.M., van Genuchten, C.C.A.,  
van Loosdrecht, M.C.M. and van Dijk, J.C. (2010)  
Water quality and treatment of river bank filtrate.  
Drink. Water Eng. Sci. 3(1), 79-90.

## **Abstract**

In drinking water production, river bank filtration has the advantages of dampening peak concentrations of many dissolved components, substantially removing many micropollutants and removing, virtually completely, the pathogens and suspended solids. The production aquifer is not only fed by the river bank infiltrate but also by water percolating through covering layers. In the polder areas, these top layers consist of peat and deposits from river sediments and sea intrusions.

This paper discusses the origin and fate of macro components in river bank filtrate, based on extensive full-scale measurements in well fields and treatment systems of the Drinking Water Company Oasen in the Netherlands. First, it clarifies and illustrates redox reactions and the mixing of river bank filtrate and PW as the dominant processes determining the raw water quality for drinking water production. Next, full-scale results are elaborated on to evaluate trickling filtration as an efficient and proven one-step process to remove methane, iron, ammonium and manganese. The interaction of methane and manganese removal with nitrification in these systems is further analyzed. Methane is mostly stripped during trickling filtration and its removal hardly interferes with nitrification. Under specific conditions, microbial manganese removal may play a dominant role.

## **Keywords**

Ammonium, groundwater, manganese, methane, redox conditions, river bank filtration, sulfate, trickling filtration

## **Abbreviations and Notations**

PW	=	Polder water
RBf	=	River bank filtration
WTP	=	Water treatment plant

## 2.1. Introduction

Although the role of surface water as a source for drinking water is gradually increasing, in the Netherlands still over 60% is produced from groundwater (VEWIN, 2008). Groundwater generally has the advantage of a good hygienic and consistent quality compared to surface water. Groundwater abstraction may, however, be restricted especially in areas with desiccation or sea water intrusion. In these cases natural or artificial recharge of the groundwater with surface water may provide a solution, like with dune infiltration and river bank filtration (RBF). Based on the definition of at least 10% infiltrated surface water, the share of river groundwater in the Netherlands in 2007 was 62 millions m<sup>3</sup>, 5 % of the total abstracted amount for drinking water production (VEWIN, 2008). Depending on the hydrological situation, the river may infiltrate or drain the surrounding land. In all cases, abstraction of river bank filtrate enhances the infiltration of river water compared to the natural situation.

Although water from a properly designed RBF plant has the general advantages of groundwater, there are some drawbacks. First of all, persistent micropollutants present in the river water will eventually reach the production wells, although high concentrations are effectively reduced by adsorption, biological breakdown and residence time variation (Sontheimer, 1991). The latter applies to *peak* concentrations in the river water, which are reduced in the well by blending with earlier and later infiltrated water containing lower micro pollutant concentrations. These remaining substances will have to be removed by specific techniques in the treatment plant. In the Netherlands, all treatment plants for river bank filtrate include advanced oxidation, adsorption and/or membrane filtration steps, which will not be discussed in this paper.

Infiltration implies aquifer passage, resulting in water quality changes. In most cases, the raw groundwater consists of a mix of river bank filtrate and locally infiltrated polder water (PW). This article describes the origin of the concentrations of methane, ammonium, iron, manganese, phosphate and sulfate in the raw water at the Oasen Drinking Water Company in the Netherlands (Oasen). Differences in concentration between individual wells can be explained by the ratio of PW compared to river bank filtrate and by redox processes during transport. Changes in river water composition over the last 50 years also play a role.

Dutch standards for sulfate are so high that removal is not necessary, but results are presented in the hydrology section of this article because it is a good indicator for the changes in redox potential) during aquifer passage. The hardness of the water may increase during RBF due to the dissolution of alkaline minerals. Calcium and bicarbonate are not removed by conventional filtration techniques but



are reduced efficiently by supplemental techniques such as pellet softening (van Dijk and Wilms, 1991). That, however, will not be discussed in this article.

In the section about treatment, this article focuses on the applied trickling filtration, also known as dry (bio)filtration, as an effective combined treatment step for methane, iron, ammonium and manganese. As part of the joint Oasen-TU Delft PhD-project “Nitrification in trickling filters for drinking water production”, this article further elaborates on possible interactions between the removal processes in a filter. This article focuses further on methane and manganese removal mechanisms and their possible adverse effects on nitrification. Although most analyses presented in this paper were performed according to standard methods in accredited drinking water laboratories, this article is not a research article *sensu proprio*, lacking the strictly defined structure with Materials and Methods and Results sections. It presents a general approach to evaluate the functioning of defined parts of the geohydrological and treatment system of Water Treatment Plants. By comparing the extended but still scarcely analyzed datasets from full-scale systems, that are available in many Drinking Water Companies with the appropriate theoretical concepts, interesting deviations and focus points for further research have been formulated.

## **2.2. Bank filtration in Oasen polders, the Netherlands**

### **2.2.1. Oasen groundwater quality**

The Water Treatment Plant (WTP) Reijerwaard uses river bank filtrate as a source for drinking water production. The groundwater is abstracted with vertical wells in a semi-confined aquifer of unconsolidated sandy sediments along the river Nieuwe Maas, which is a branch of the river Rhine. A 10 m thick Holocene layer of clay and peat sediment lies over the aquifer. The area is a polder below river water level, with a dense network of ditches.

#### *Hydrology*

The abstracted groundwater consists of a mixture of two anoxic water types with different origins (Figure 1), compositions and redox states:

- River bank filtrate. Rhine water infiltrating through the river bottom and flowing horizontally through Pleistocene sand deposits to the wells. Subsurface residence times range from 3 to 50 years. This water type accounts for approximately 70% of the abstracted water.
- PW. Water abstracted from shallow groundwater and ditches through the clay and peat layer. Residence times range from a year to several decades. The shortest residence time of one year for polder water is a conservative approach. Actually the uncertainty in this travel time is very large. The

groundwater model calculates travel times starting from 5 years (in the middle of the well field, with the largest drawdown in piezometric height and a downward flux a little over 2 mm/day). However, we expect the heterogeneity of the top layer to result in some flow paths with significantly smaller travel times. We have no information on whether this is really one year (or three years or half a year). This water type accounts for approximately 30% of the total.

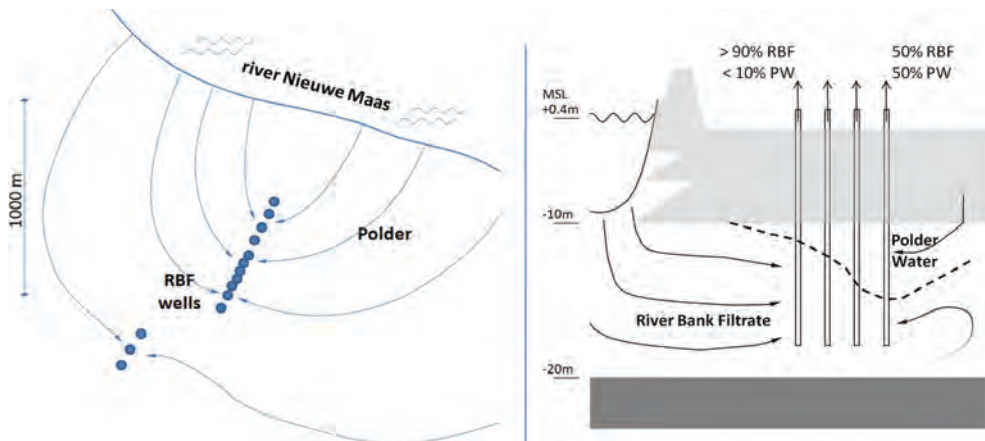

Figure 1: Layout of the Reijerwaard RBF site (51° 52' N, 4° 35' E, left) and cross-section of the abstraction of river bank filtrate and PW (right); wells were placed perpendicular to the river to create a larger attenuation (more variation in travel times)

As shown in Figure 1, the hydrologic setting of RBF well fields is such that the wells near the river abstract mainly river bank filtrate, while the share of PW increases with distance from the river. This increase is caused by the longer flow paths for the filtrate – as a function of distance, but even more as a function of time – combined with the increasing drawdown in hydraulic head by the abstraction, causing a larger aquifer recharge with PW. The mixing of river bank filtrate and PW occurs mainly within the wells; in an aquifer, mixing is generally limited.

#### *Redox processes*

Redox processes are the crucial initiator of changes in composition for both the river bank filtrate and the PW. In general, it can be stated that when organic matter is sufficiently available, it is oxidized by a sequence of redox processes (from Stuyfzand, 1988):

- aerobic respiration
- denitrification
- reduction of manganese and iron
- reduction of sulfate
- methanogenesis

Methanogenesis will generally only occur after all sulfates have been reduced, so methane will only be present simultaneously with sulfate as a result of mixing (Stuyfzand et al., 1994).

For the Reijerwaard well field, Figure 2 presents hydrological characteristics of the individual production wells from a detailed groundwater model and compares these with measured concentrations in the wells. It shows signs of a lowering redox level with increasing distance and travel time from the river, which is a logical consequence of the increasing share of PW with deep redox conditions.

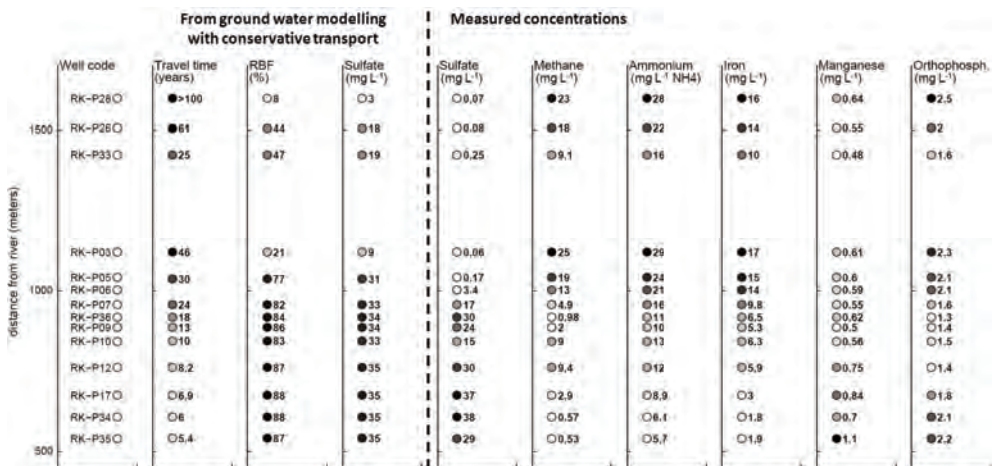

Figure 2: Hydrological characteristics and concentrations in raw water of individual production wells at Oasen WTP Reijerwaard; concentrations are averages for 2005-2009

### Redox parameters sulfate and methane

In the river water, the annual averages of sulfate concentration have varied between 50 and 80 mg L<sup>-1</sup> over the last 30 years. The river bank filtrate reaches the redox level of sulfate reduction while passing the deposits on the river bottom and remnants of the Holocene layers that the river intersects, resulting in sulfate concentrations of one half that of the river water. The PW passes the Holocene clay and peat layer and reaches an even lower redox level, with methanogenesis. Since methane and sulfate do not occur simultaneously, the methane and sulfate concentrations were used as indicators for estimating the water fractions derived from both origins. PW is identified by the presence of methane and river bank filtrate by the presence of sulfate. Since the ratio of PW to river bank filtrate determines the methane and sulfate concentrations of individual wells, the concentrations show a negative correlation (Figure 3). Corresponding to the hydrology, wells near the river abstract mostly river bank filtrate and therefore have low methane and high sulfate concentrations (e.g. wells RK-P12, 17, 34 and

35), while wells at the other side of the well field abstract mostly PW and have high methane and low sulfate concentrations.

Figure 2 compares the measured sulfate concentrations with concentrations based on the calculated mixing ratio of PW and river bank filtrate, where PW contains no sulfate and river bank filtrate contains an assumed concentration of  $40 \text{ mg L}^{-1}$  after passing the river deposits. For the wells close to the river the calculated and measured concentrations correspond well, showing the dominant effect of the mixing process of PW and river bank filtrate on the resulting sulfate concentration. With travel times longer than 10 to 20 years, the measured sulfate concentrations, however, are lower than ones the calculated from the share of river bank filtrate. This suggests a process that needs longer travel times to contribute significantly: the reduction of sulfate by the small amounts of organic matter present within the aquifer.

The wells at largest distance from the river will experience another minor influence on sulfate concentrations. These wells partly abstract river bank filtrate over 50 to 70 years of age, originating from a period that Rhine water was less polluted and contained lower sulfate concentrations, contributing to a lower sulfate concentration in the abstracted groundwater.

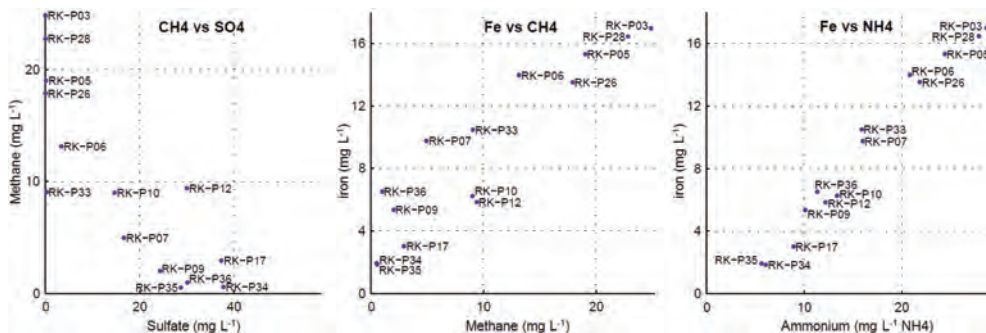

Figure 3: Water qualities of individual wells at the Oasen WTP Reijerwaard; relationship between sulfate and methane; methane and iron; ammonium and iron; averages for 2005-2009

### *Origin of the macro components iron, ammonium, manganese and phosphate*

#### *Origin of iron and ammonium*

For ammonium, an obvious source is the oxidation of nitrogenous (N-containing) organic matter in the confining clay and peat layer, in the river bottom, and to a lesser extent in the aquifer itself. In this process, iron and manganese oxides act as oxidizing agents and dissolve. In river bank filtrate, the iron concentrations are limited because of precipitation as iron sulfides with  $\text{HS}^-$  resulting from subsequent sulfate reduction (Stuyfzand, 1985). This iron sulfide precipitation leaves only very low hydrogen sulfide concentrations in the groundwater. Although mostly below the detection limit, the highest measured concentration of hydrogen sulfides in raw groundwater of another, yet comparable Oasen WTP was



0.03 mg L<sup>-1</sup>. In the PW, all sulfate has been reduced – even methanogenesis occurs – and iron is introduced from the dissolution of minerals like siderite (FeCO<sub>3</sub>) and vivianite (Fe<sub>3</sub>(PO<sub>4</sub>)<sub>2</sub>·8(H<sub>2</sub>O)) that are common in areas with peat. A further increase in iron concentrations in the aquifer can occur due to the reductive dissolution of iron oxides. The positive relationship between the redox indicator, methane, and iron is illustrated in Figure 3. This figure also shows a strong positive correlation between iron and ammonium, indicating that a relevant contributing process may be the release of adsorbed or organically bound ammonium during the reductive dissolution of iron oxides.

Compared to river water, ammonium concentrations in river bank filtrate and PW are very high. In the river Rhine, ammonium was present at yearly averaged concentrations over 0.5 mg L<sup>-1</sup> N before 1990, which has decreased to less than 0.1 mg L<sup>-1</sup> N in the last decade. In the river water, the ammonium concentration is generally five times higher in winter than in summer; in river bank filtrate, however, no seasonal variation has been observed due to attenuation.

#### Origin of manganese

Manganese concentrations are known to rise to a high level during infiltration from the river. At WTP Reijerwaard, and in the nearby Opperduit test location, studied by Stuyfzand and Lüers (1996), concentrations are found of 1.4 and 1.5 mg L<sup>-1</sup>, in observation wells at several tens of meters after infiltration into the aquifer. Stuyfzand (1985) assumed that manganese mainly originates from the reductive dissolution of manganese oxides and observed that the river bank filtrate is in equilibrium with MnCO<sub>3</sub> precipitate which may be a source, but also a limit, for the manganese concentration.

The high concentration of manganese in the river bank filtrate decreases with travelling time and distance after infiltration. This decrease is visible in the raw water concentrations of the first five wells shown in Figure 2 and is also found in a row of observation wells perpendicular to the river at Opperduit (Stuyfzand and Lüers, 1996). At the far half of the well field, away from the river, the manganese concentration in the river bank filtrate has decreased to a low level, and PW contributes predominantly to the concentrations that are found in the wells. Here, the highest concentrations are found in the wells with the highest share of PW.

#### Origin of Orthophosphate

Orthophosphate originates from the dissimilation of organic matter and the dissolution of phosphate minerals, with vivianite as the most important one. From Figure 2 it can be concluded that both the river bank filtrate and PW contain high concentrations. In the river bank filtrate, however, a decrease in the orthophosphate concentration is observed with increasing distance from the river, probably as a consequence of adsorption on iron (oxy)hydroxides present in the aquifer.

### *Geochemistry of aquifer sediments*

The availability of iron and manganese oxides is, of course, a condition for their reductive dissolution. Samples of the aquifer sediment on a nearby well field (WTP Lekkerkerk) confirm their presence in large quantities. Analysis showed 1000 to 3000 mg kg<sup>-1</sup> by dry weight of amorphous iron (oxy)hydroxides in the sediment (extractable with oxalic acid), whereas a similar amount was found in the form of ferrous iron precipitates as iron sulfides, like pyrite, and in the form of crystalline iron oxides (extractable with aqua regia). For manganese, the samples showed concentrations of 30 to 60 mg kg<sup>-1</sup> of dry weight of easily soluble manganese oxides, manganese carbonate (rhodochrosite) and reduced species mainly adsorbed to iron (oxy)hydroxides. A similar amount of manganese was found in more persistent manganese containing minerals. These iron and manganese precipitates might be source or sink for dissolved iron and manganese species.

### **2.2.2. Oasen groundwater treatment**

The complex mixture of river bank filtrate and PW in the groundwater poses a number of challenges in the treatment process. Before discussing some of these issues based on long-term observations in existing, full-scale filters systems, the next paragraph provides an overview of existing treatment processes for the removal of the relevant macro components.

### *Removal processes for macro components*

The presence of the macro components methane, iron, ammonium and manganese is unwanted in the drinking water for several reasons and, therefore, is severely restricted by drinking water standards. The compounds can be removed from the groundwater by a wide array of physical, chemical and microbiological processes, or combinations of them. All four compounds can be removed by oxidation with oxygen or a chemical oxidizing agent like ozone, permanganate or peroxide. In all cases, the oxidation can be biologically catalyzed, or indeed sometimes is strictly biological, like for methane, ammonium and manganese under neutral conditions with oxygen as the only oxidizing agent. In the bacterial processes, the (catabolic) oxidation reaction is used for energy generation and growth of the bacteria. Non-oxidative removal processes range from membrane filtration through flocculation, sedimentation and filtration to adsorption or gas stripping. The membrane filtration techniques of reverse osmosis and nanofiltration, although rather effective for removal of iron and manganese, are generally not applied for the removal of only inorganic macro components. An overview of applicable removal processes is given in Table 1.

**Table 1: Removal processes for groundwater macro components**

		Microbial	Physical-chemical
Component	Reduction-oxidation reaction (with O <sub>2</sub> )	Microorganisms (Madigan and Martinko, 2005)	Oxidation context Alternative processes (de Moel et al. (eds), 2006)
Methane	CH <sub>4</sub> + 2 O <sub>2</sub> → CO <sub>2</sub> + 2 H <sub>2</sub> O	Methylophilus spp., Methylobacter spp., (de Vet et al. 2009a)	Stripping
Iron	Fe <sup>2+</sup> + ¼ O <sub>2</sub> + 1½ H <sub>2</sub> O → FeOOH + 2H <sup>+</sup>	Gallionella ferruginea, Leptothrix ochracea., Sphaerotilus natans, Toxothrix Trichogenes (Czekalla et al., 1985; Emerson and Moyer, 1997)	Adsorptive oxidation (Sharma et al., 2001) Homogenous oxidation Flocculation, settling, floc or flocking filtration
Ammonium	2 NH <sub>4</sub> <sup>+</sup> + 3 O <sub>2</sub> → 2 NO <sub>2</sub> <sup>-</sup> + 4 H <sup>+</sup> + 2 H <sub>2</sub> O 2 NO <sub>2</sub> <sup>-</sup> + O <sub>2</sub> → 2 NO <sub>3</sub> <sup>-</sup>	Nitrosomonas spp., (Nitrosospira spp., Nitrosolobus spp.), Ammonia-oxidizing Archaea Nitrospira spp., (Nitrobacter spp.) (de Vet et al. 2009a)	(Breakpoint chlorination) (not applied in the Netherlands) Stripping of ammonia (high pH), Adsorption on zeolites (reverse osmosis)
Manganese	2 Mn <sup>2+</sup> + ½O <sub>2</sub> + 2H <sub>2</sub> O → Mn <sub>2</sub> O <sub>3</sub> + 4H <sup>+</sup>	Manganese-oxidizing bacteria like Leptothrix spp., Metallogenium spp., Hyphomicrobium spp., Siderocapsa spp., Siderocystis spp. (Czekalla et al., 1985)	Autocatalytic oxidation Homogeneous oxidation with strong oxidants like permanganate (Reverse osmosis, nanofiltration) Flocculation, settling, floc or flocking filtration

*Oasen groundwater treatment systems*

In groundwater treatment in the Netherlands, only oxygen from the air and no chemical agents are used for oxidation purposes. The central process for treatment of river bank filtrate/PW groundwater is filtration over a granular medium, in most cases single layer silica sand, but other bed configurations (dual layer) and materials (e.g. anthracite, expanded clay pellets) are increasingly used. Because of the oxygen demand of the macro component removal processes, the anoxic groundwater requires aeration before or during filtration. In some cases a simple spraying directly on top of the filter bed may suffice, but in most cases there is a specialized gas exchange process step before filtration. Such a gas exchange step will also strip oversaturated gases like methane and carbon dioxide from the groundwater. Removal of the latter increases the pH of the water, which in turn may stimulate the oxidation of iron, ammonium and manganese, the rates of which are proportionate to OH<sup>-</sup> concentrations squared in circumneutral circumstances. The scheme of typical Dutch groundwater treatment is shown in Figure 4.

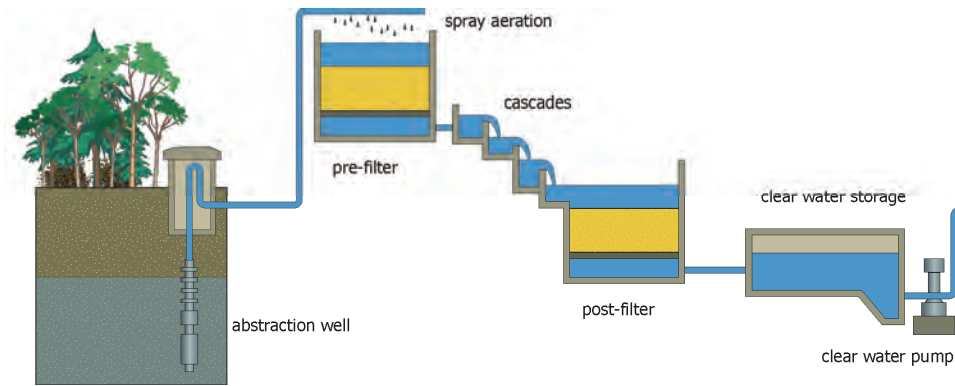

**Figure 4: Artist impression of a conventional groundwater treatment system in the Netherlands with submerged sand filters**

Due to the high oxygen consumption of ammonia oxidation ( $4.6 \text{ mg O}_2$  per  $\text{mg NH}_4\text{-N}$ , as follows from the stoichiometry in Table 1), trickling filtration (also called dry biofiltration) is applied in cases of high ammonium content in the groundwater, like at several Oasen WTPs. As an alternative, submerged (also called wet) filtration with the injection of pure oxygen might be considered in these situations.

Of the four groundwater components considered, only ammonium and manganese removal pose regular problems for Oasen. The nitrification problems have previously been described by de Vet et al. (2009b). Iron removal in itself is never problematic for Oasen but some of its possible interactions with nitrification were discussed in that earlier paper. It also contained a number of the many relevant references about the interaction of iron, manganese and ammonium in groundwater filters (Mouchet (1992); Vandenabeele et al. (1995); Štembal et al. (2005); Tekerlekopoulou et al. (2006). The role of microbial iron oxidation, although possibly of importance in the Oasen trickling filters, will not be discussed here. For methane and manganese, different removal mechanisms and their interactions with nitrification are discussed in the next two sections.

#### *Methane removal and its effect on nitrification*

Methane removal can be achieved physically by stripping, or biologically by methane-oxidizing bacteria. Biological degradation is characterized by a relatively high biomass over substrate yield (19 to 70% of the substrate carbon is incorporated into cell material; Leak and Dalton, 1986), and may lead to the clogging of filter material by production of extracellular polymeric substances (Streese and Stegmann, 2003). Therefore, because biological methane oxidation may interfere with other filtration processes, it is generally not chosen.

Several systems for intensive gas transfer, such as cascades, tower and plate aerators and high pressure spraying, are effectively applied in full-scale plants for this purpose. A vacuum stripper is applied in situations where aeration is unwanted,

as is the case in front of trickling filtration, to avoid clogging the distribution spraying with oxidation products. The stripping efficiency for dissolved gases is determined by gas properties, especially the water/air distribution (or Henry) coefficient, and system characteristics for the equilibrium state (determined by the air-to-water ratio, RQ), and kinetics (described by the transfer coefficient). The distribution coefficients in Table 2 show methane's lower affinity for water compared to that of carbon dioxide, implying a better removal of the former under the same system characteristics. Oxygen and methane are comparable in this respect. The constant temperature of the Oasen groundwater means fixed equilibria for the gas distribution, unlike for surface water and river bank filtrate with short travel times, where a rise in water temperature results in lower water solubility of the gases and an increased driving force for stripping.

**Table 2: Molecular weight (MW; g mol<sup>-1</sup>) and distribution coefficients (mass in water/mass in air) for methane, oxygen and carbon dioxide (de Moel et al. (Eds.,) 2006)**

		MW	0°C	10°C	20°C
Methane	CH <sub>4</sub>	16.0	0.0556	0.0433	0.0335
Oxygen	O <sub>2</sub>	32.0	0.0493	0.0398	0.0337
Carbon dioxide	CO <sub>2</sub>	44.0	1.71	1.23	0.942

The difference in removal efficiencies for methane and carbon dioxide is illustrated in Table 3 for the full-scale gas transfer systems at two Oasen WTPs. The vacuum stripper had distinctly lower gas removal efficiency for carbon dioxide than the cascade did. For methane, the difference was less pronounced, and both systems achieved over 90 % efficiency.

**Table 3: Methane and carbon dioxide in- and outgoing concentrations and stripping efficiency for two Oasen full-scale gas exchange systems**

		WTP Reijerwaard Cascades *		WTP Lekkerkerk Vacuum stripper **	
Driving force AVG (MIN)		RQ = 24 (5.4)		P = 6 kPa	
Hydraulic load AVG (MAX)		37 (165) m <sup>3</sup> m <sup>-1</sup>		50 (90) m <sup>3</sup> h <sup>-1</sup> m <sup>2</sup>	
		CH <sub>4</sub>	CO <sub>2</sub>	CH <sub>4</sub>	CO <sub>2</sub>
IN	(mg L <sup>-1</sup> )	7.2 ± 1.7	103 ± 36	0.93 ± 0.31	32.6 ± 4.4
OUT	(mg L <sup>-1</sup> )	0.28 ± 0.08	23.7 ± 3.4	0.08 ± 0.03	25.5 ± 3.6
Efficiency	%	95.7 ± 1.7	72.3 ± 9.0	90.8 ± 2.6	21.9 ± 5.0

Efficiency = (C<sub>in</sub> - C<sub>out</sub>)/C<sub>in</sub>; RQ = air to water ratio v/v

\* values for 1995–2004

\*\* values for Jan–Nov 1998

Methane will be completely removed by trickling filtration. Although methane is not measured above the detection limit in the trickling filter effluent, no direct assessment can be made of the role of physical and biological methane removal. However, from the removal efficiency for carbon dioxide, it can be concluded that the air stripping of the trickling filters performed much better than the vacuum stripper at Oasen WTP Lekkerkerk (Figure 5). The trickling filter contained coarse filter sand (1.7-2.5 mm), was concurrently ventilated with an RQ of 10 and had an average filtration rate of  $2.2 \text{ m h}^{-1}$ .

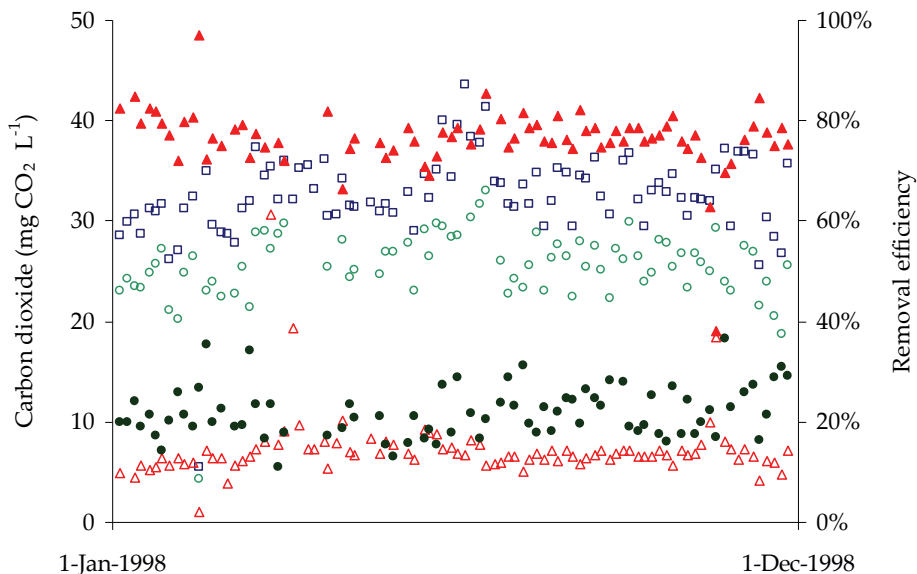

**Figure 5:** Carbon dioxide concentrations and removal efficiencies for vacuum stripper and trickling filtration at Oasen WTP Lekkerkerk, period January till November 1998; open symbols, concentrations: □ raw water; ○ effluent vacuum stripper; △ effluent trickling filter; solid symbols removal efficiencies: ● vacuum stripper; ▲ trickling filter

The removal efficiency for carbon dioxide was over 75% for the trickling filter, which is comparable to the removal efficiency of cascade aeration (see Table 3). Before the startup of the acidifying nitrification and manganese removal, the carbon dioxide stripping efficiency in the trickling filter was even higher than 90%. The supposed predominance of physical over biological methane removal was confirmed by two more direct methods. First, when balancing the fluxes of methane entering (by water) and leaving (by water and air) the filter, the average and standard deviation for the physical removal efficiency in six trickling filters at several Oasen WTPs was  $84 \% \pm 12 \%$ . Differences before and after backwash were found to be within the boundaries of uncertainty. Secondly, the methane-oxidizing activity measured in batch experiments varied only slightly between sand samples

taken from trickling filters at Oasen WTP Lekkerkerk with and without pretreatment by vacuum stripping.

Figure 6 shows that pretreatment of the groundwater by vacuum stripping had no clear effect on the nitrification in the trickling filters.

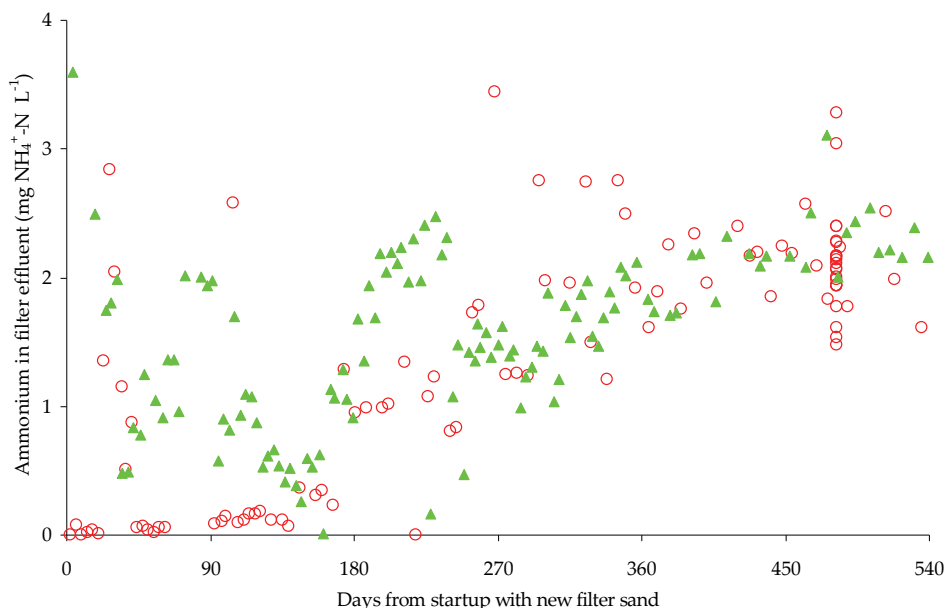
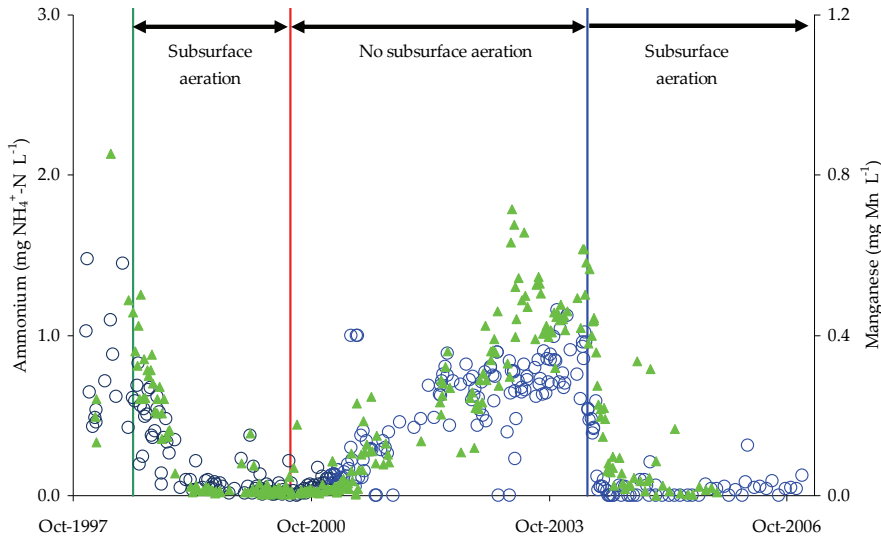

Figure 6: Ammonium concentrations in the effluents of trickling filters at Oasen WTP Lekkerkerk; ▲ PLTOFF08 with pretreatment by vacuum stripping (October 1998 to April 2000), ○ PLTOFF05 without pretreatment by vacuum stripping (March 1999 to September 2000); the low concentrations during the first months in the effluent of PLTOFF05 were caused by a reduced raw water flow

#### Manganese removal and its effect on nitrification

Without strong oxidizing chemicals, manganese oxidation under circumneutral circumstances may occur chemically (Graveland and Heertjes, 1975) and biologically (Czekalla et al., 1985). A comparison of full-scale trickling filters at Oasen WTP Lekkerkerk shows some interesting differences in manganese removal and its occurrence in combination with nitrification problems. At this WTP, groundwater from two separated well fields (Schuwacht and Tiendweg) is also treated with separated double trickling filters. In the Schuwacht well field, subsurface aeration (Appelo et al., 1999) – a very mild form of *in situ* iron removal – is applied for the enhancement of nitrification. Figure 7 shows that the enhancement of subsurface aeration worked for manganese removal as it did for nitrification and the interruption of the technique resulted in a similar relapse for both processes.



**Figure 7: Ammonium (○) and manganese (▲) concentrations in the trickling filter effluent in periods with and without subsurface aeration in the Oasen WTP Lekkerkerk's Schuwacht well field**

Incomplete nitrification, however, does not always coincide with incomplete manganese removal. Figure 8 shows that, despite incomplete nitrification, manganese removal was not severely reduced in another full-scale trickling filter, which treated normal, non-subsurface aerated groundwater from the Tiendweg well field.

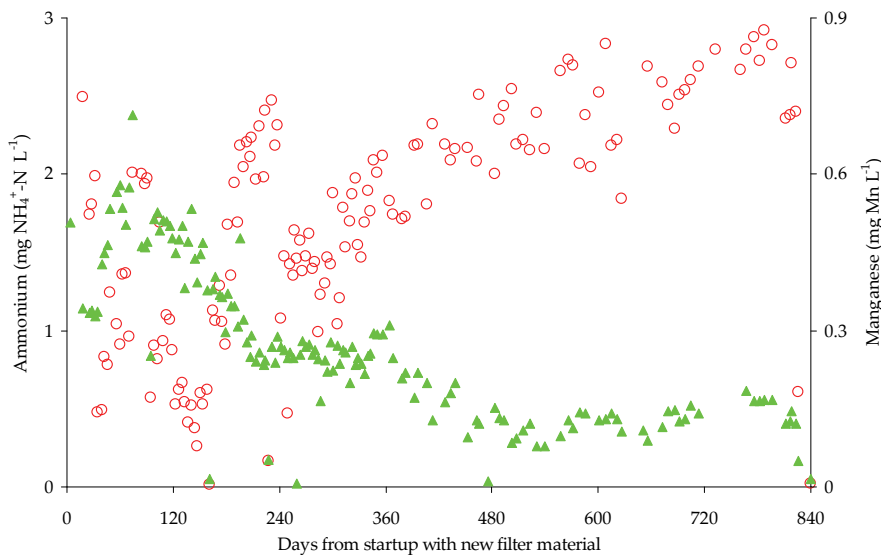

**Figure 8: Ammonium (○) and manganese (▲) concentrations in the trickling filter effluent treating normal non-subsurface aerated groundwater from the Oasen WTP Lekkerkerk's Tiendweg well field**



Remarkable differences were also observed in the second trickling filter of the double filter sets during startup with fresh filter sand only in the first trickling filter (Figure 9). Each first filter was directly coupled to its own second filter, making the effluent of the former the influent of the latter. From the startup with new filter material in the first filter, the manganese removal was almost complete in the second filter of the non-subsurface aerated double filter set. In the subsurface aerated double filter set, both the first and second filter required a startup period of over a month for manganese removal.

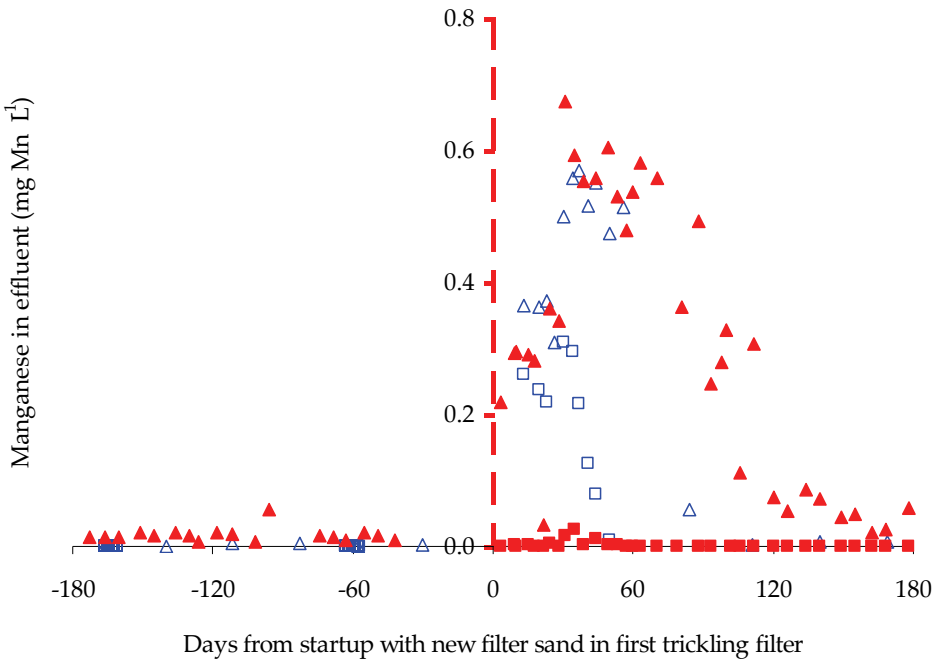

Figure 9: Manganese concentrations in the effluent of the first and second filter of double trickling filter sets at the Oasen WTP Lekkerkerk around the startup with fresh filter sand in the first trickling filter;  $\Delta$  and  $\square$  effluent of first and second subsurface aerated filter,  $\blacktriangle$  and  $\blacksquare$  effluent of first and second non-subsurface aerated filter

The backwash water from a non-subsurface aerated first trickling filter contained more biological formed iron (oxi)hydroxide deposits, resembling those of the *Leptothrix ochracea* (Czekalla et al., 1985), iron- and possibly manganese-oxidizing bacteria (Figure 10).

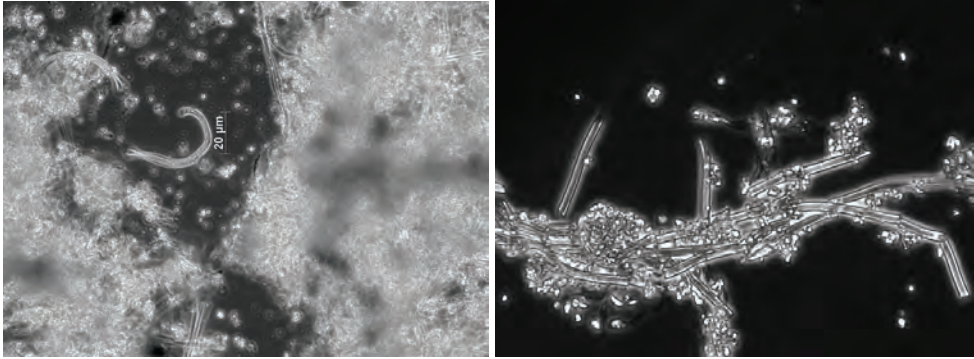

Figure 10: Phase-contrast pictures of backwash water from first trickling filters at Oasen WTP Lekkerkerk; mainly inorganic flocs in backwash water from a subsurface aerated filter (left, 630X), mainly biological deposits from a non-subsurface aerated filter (right, 1000X)

## 2.3. Discussion

### 2.3.1. Origin of macro components

When abstracting river bank filtrate, it is nearly inevitable that PW is also attracted and abstracted. The abstraction, therefore, results in a raw water mix of both water types, of which the origins are illustrated in Figure 11, together with their macro component contributions of interest. The figure shows that PW accounts for the methane and high loads of iron and ammonium, which are relevant for the filtration steps. River bank filtrate and PW contribute an approximately equal load of manganese to the total raw water.

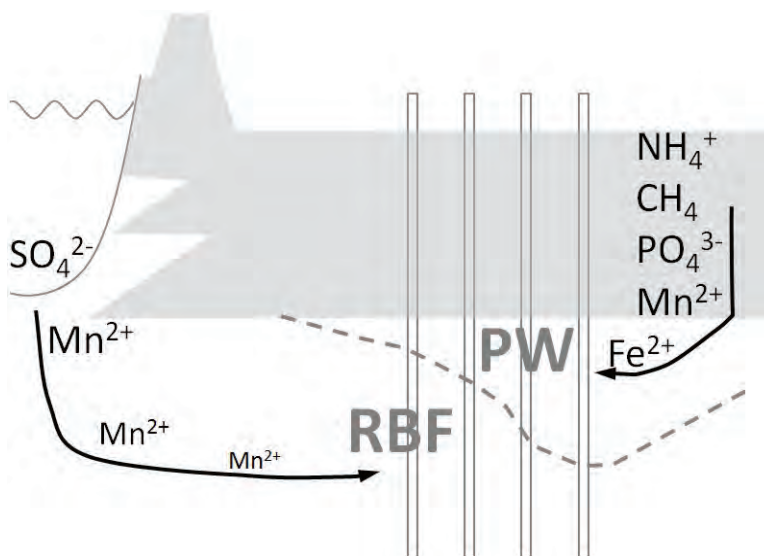

Figure 11: Schematic presentation of the origin of discussed parameters

*Influencing the ratio of PW to river bank filtrate*

River bank filtrate offers a better source for producing drinking water than PW, considering ammonium and iron concentrations. So, with the operation and the design of well fields, it is favorable to maximize the share of river bank filtrate. The percentage of river bank filtrate can be influenced by changing the location of a well field relative to the river or by choosing a location with favorable hydrological conditions. For example, a location close to the river in a polder far below river level will result in a relatively high share (%) of river bank filtrate. But moving well fields is generally not realistic, and other factors, such as spatial-planning-conflicts and adverse effects of a new abstraction (especially land subsidence), will be more important than these aspects of water quality.

For existing well fields, it is a technically challenging idea to separately abstract (and treat) PW and river bank filtrate. Considering the distribution of the PW and river bank filtrate both in the horizontal plane and in depth, as shown in Figure 11, a technical solution would be to equip each well with two separate screens and pumps. Well screen depth and pump capacity are designed so that the deep screen abstracts only river bank filtrate, while the shallower screen abstracts only PW. As both screens are in the same aquifer, separate abstraction should be achieved by finding the right balance in abstraction rate between the shallow and the deep screen.

**2.3.2. Pretreatment or direct trickling filtration for methane stripping**

Full-scale trickling filters at Oasen are versatile removal systems, in optimal conditions capable of removing over 1 g of methane, 10 g of iron, 8 g of ammonium and 1 g of manganese per hour and m<sup>3</sup> of filter bed almost completely. Physical, chemical and biological processes occur simultaneously. Methane is predominantly removed by stripping and the remaining microbial methane-oxidizing activity in Oasen trickling filters was, at most, about 0.7 g methane per hour and m<sup>3</sup> of filter bed only in the upper layer of the filter bed. This is moderate compared to the maximum methane-oxidizing activity measured at a landfill gas treatment filter (63 g methane per hour and m<sup>3</sup> of filter bed; Streese and Stegmann, 2003). In the Oasen trickling filters, ammonia-oxidizing microorganisms may even account for part of the methane-oxidation. Pretreatment by vacuum stripping for methane removal had no effect on the nitrification in the trickling filters. Thus, in well-ventilated trickling filters, biological methane oxidation is limited and does not compete with nitrification. Proper assessment of the physical methane removal capabilities of the trickling filter is recommended to prevent building a costly, but ineffective, extra pretreatment step preceding trickling filtration.

### 2.3.3. Manganese removal mechanism and problems

Like in iron oxidation (Sharma et al., 2005), the role of microorganisms in manganese oxidation is being debated. Although no conclusions about the steady state can be drawn, manganese-oxidizing bacteria have been shown to play an important role in the startup of the process (Burger et al., 2008). Observations of the full-scale filters at Oasen WTP Lekkerkerk suggest that the role of bacteria in manganese oxidation may be distinctly different under deviating conditions. Thermodynamically, ammonia and nitrite oxidation precede manganese oxidation and the inhibitory effects of incomplete nitrification on manganese removal have been reported by Vandenaabeele et al. (1995). With this in mind, we anticipated the results of the subsurface aerated first trickling filter, where incomplete manganese removal accompanied the nitrification problems. The combination of severely inhibited nitrification without similar manganese removal problems in the non-subsurface aerated filter can not be explained in this manner.

The immediate and almost complete manganese removal in the second filter of the non-subsurface aerated filter set after startup in the first filter is remarkable as well. According to Graveland and Heertjes (1975), the autocatalysis of manganese only occurs with unstable manganese oxides like  $Mn_3O_4$ . These transform over time into more oxidized and stable phases like  $MnO_2$ , losing their catalytic capacity, requiring a constant regeneration of the deposition by freshly formed manganese oxides. Therefore, it should be expected that filter material in the second filters does not contain the unstable, catalyzing manganese coating after more than half a year without a supply of manganese in the filter influent. Finally, the microscopic pictures from the backwash water show microbially formed deposits by iron- or manganese-oxidizing bacteria. From this we hypothesize that manganese (and iron) oxidation is predominantly bacteriological in Oasen trickling filters treating normal groundwater. We further hypothesize that subsurface aeration enhances the chemical removal of manganese (and iron), thus limiting the growth of these bacteria. Finally, we hypothesize that the growth of competing iron- and manganese-oxidizing bacteria in trickling filters leads to the inhibiting of nitrifying microorganisms.

### 2.4. Future Research questions

- What processes control manganese concentrations in groundwater, and can they be influenced underground?
- How can PW and river bank filtrate be abstracted separately? Is separate abstraction of river bank filtrate and PW feasible? And how much mixing is inevitable?
- What are optimal / fitting treatment schemes for both separated water types?

- Under what conditions does microbial iron and manganese oxidation occur?
- Does increased growth of iron- and manganese-oxidizing bacteria result in nutrient limitation for ammonia-oxidizing bacteria?
- Does subsurface aeration inhibit growth of iron- and manganese-oxidizing bacteria?

## 2.5. Conclusions

- The raw water at the OASEN consists of a mixture of two water types, polder water and river bank filtrate, which have distinct differences in composition, related to their redox levels;
- Polder water has the lowest redox level and accounts for the larger part of the macro components methane, ammonium and iron, while river bank filtrate contributes most to the manganese content of raw water;
- Trickling filtration can be a highly efficient and versatile removal system for macro components in polder river bank filtrate including stripping of methane;
- Manganese oxidation is probably predominantly microbial in trickling filtration of polder river bank filtrate;
- Coincidence of incomplete manganese removal and nitrification may indicate competition for phosphate or essential trace substrates in biological processes.

## Acknowledgements

We would like to acknowledge Wilfred Burger (formerly Oasen, currently Logisticon Water Treatment), Jan-Dik Verdel (Royal Haskoning), Dirk van der Woerdt (formerly Oasen, currently Groningen Water Company), and Anke Wolthoorn (formerly Wageningen University, currently Paques BV) for their contributions to the research on methane removal.

## References

- Appelo, C.A.J., Drijver, B., Hekkenberg, R. and Jonge, M. (1999) Modeling *In Situ* Iron Removal from Ground Water. *Ground Water* 37(6), 811-817.
- Burger, M.S., Krentz, C.A., Mercer, S.S. and Gagnon, G.A. (2008) Manganese removal and occurrence of manganese oxidizing bacteria in full-scale biofilters. *J Water Supply Res T* 57(5), 351-359.

Czekalla, C., Mevius, W. and Hanert, H. (1985) Quantitative removal of iron and manganese by microorganisms in rapid sand filters (*in situ* investigations). *Water Supply* 3(1), 111-123.

de Moel, P.J., Verberk, J.Q.J.C. and van Dijk, J.C. (eds) (2006) *Drinking water : principles and practice*, Singapore : World Scientific.

de Vet, W.W.J.M., Dinkla, I.J.T., Muyzer, G., Rietveld, L.C. and van Loosdrecht, M.C.M. (2009a) Molecular characterization of microbial populations in groundwater sources and sand filters for drinking water production. *Water Research* 43(1), 182-194.

de Vet, W.W.J.M., Rietveld, L.C. and van Loosdrecht, M.C.M. (2009b) Influence of iron on nitrification in full-scale drinking water trickling filters; *J Water Supply Res T* 58(4) 247–256 doi:10.2166/aqua.2009.115.

Emerson, D. and Moyer, C. (1997) Isolation and characterization of novel iron-oxidizing bacteria that grow at circumneutral pH. *Appl Environ Microb* 63(12), 4784-4792.

Graveland, A. and Heertjes, P.M. (1975) Removal of manganese from ground water by heterogeneous autocatalytic oxidation. *Trans. Inst. Chem. Eng.* 53, 154-164.

Leak, D.J. and Dalton, H. (1986) Growth yields of methanotrophs. I. Effect of copper on the energetics of methane oxidation. *Appl Microbiol Biot* 23(6), 470-476.

Madigan, M. T., Martinko, J. M.: *Brock Biology of Microorganisms*, Upper Saddle River (New Jersey), Prentice-Hall, ed. 11, 2005.

Mouchet, P. (1992) From conventional to biological removal of iron and manganese in France. *Journal / American Water Works Association* 84(4), 158-167.

Sharma, S.K., Kappelhof, J., Groenendijk, M. and Schippers, J.C. (2001) Comparison of physicochemical iron removal mechanisms in filters. *J Water Supply Res T* 50(4), 187-198.

Sharma, S.K., Petrushevski, B. and Schippers, J.C. (2005) Biological iron removal from groundwater: A review. *J Water Supply Res T* 54(4), 239-247.

Sontheimer, H. (1991) *Trinkwasser aus dem Rhein? Bericht über ein vom Bundesminister für Forschung und Technologie gefördertes Verbundforschungsvorhaben zur Sicherheit der Trinkwassergewinnung aus Rheinuferfiltrat bei Stossbelastungen*, Academia Verlag, Sankt Augustin, Germany.

Štembal, T., Markić, M., Ribičić, N., Briški, F. and Sipos, L. (2005) Removal of ammonia, iron and manganese from groundwaters of northern Croatia - Pilot plant studies. *Process Biochemistry* 40(1), 327-335.

Streese, J. and Stegmann, R. (2003) Microbial oxidation of methane from old landfills in biofilters. *Waste Manage* 23(7), 573-580.

Stuyfzand, P.J. 1985, *KIWA mededeling 89 Drinkwater uit oevergrondwater, Anorganische bestanddelen*.

Stuyfzand, P.J. 1988. De alkaliteit, het redoxniveau en de verontreinigingsindex als parameters en keuzemogelijkheden in een hydrochemische classificatie van watertypen. *H2O* 21 640-643.

Stuyfzand, P.J., F. Lüers & G.K. Reijnen, 1994. Geochemische aspecten van methaan in grondwater in Nederland. *H2O* 27, 500-510.

Stuyfzand, P.J. & F. Lüers, 1996. KIWA mededeling 125. Gedrag van milieugevaarlijke stoffen bij oeverinfiltratie en kunstmatige infiltratie.

Tekerlekopoulou, A.G., Vasiliadou, I.A. and Vayenas, D.V. (2006) Physico-chemical and biological iron removal from potable water. *Biochemical Engineering Journal* 31(1), 74-83.

van Dijk, J.C. and Wilms, D.A. (1991) Water treatment without waste material. Fundamentals and state of the art of pellet softening. *Aqua London* 40(5), 263-280.

Vandenabeele, J., Vande Woestyne, M., Houwen, F., Germonpre, R., Vandesande, D. and Verstraete, W. (1995) Role of autotrophic nitrifiers in biological manganese removal from groundwater containing manganese and ammonium. *Microb Ecol* 29(1), 83-98.

VEWIN, Geudens P. J. J. G. (2008) Waterleidingstatistiek 2007, Vewin nr. 2008/82/6259, <http://www.vewin.nl/Publicaties/Drinkwaterstatistieken/Pages/default.aspx>, 2008.







# CHAPTER 3

---

## Influence of iron on nitrification in full-scale drinking water trickling filters

3

**Published as:**  
de Vet, W.W.J.M., Rietveld, L.C. and van Loosdrecht, M.C.M. (2009)  
Influence of iron on nitrification in full-scale drinking water filters.  
Journal of Water Supply: Research and  
Technology-AQUA 58(4), 247-256.

## **Abstract**

In the production of drinking water from groundwater, iron removal in filters may interfere with nitrification. Microbial nitrification might decline because of irreversible accumulation of iron deposits in pores and on filter material. This paper shows the successful application of two experimental techniques applied at a full-scale water treatment plant in the Netherlands to maintain sustainable nitrification. Filter performances were evaluated by measurements of ammonium in the filter effluent, accumulation of deposits and their removal during backwash, development of the mainly inorganic filter coating, and media expansion curves. The application of dual media drinking water trickling filters, in combination with filter backwash with media expansion, minimizes the irreversible accumulation of iron deposits in the filter. Subsurface aeration results in a lower iron content of the filter coating.

## **Keywords**

Backwash, drinking water, dual media filter, trickling filter, iron removal, nitrification; subsurface aeration

### 3.1. Introduction

In the Netherlands and Flanders, the production of drinking water from groundwater containing ammonium usually comprises nitrification in rapid sand filters by immobilized microorganisms attached to the sand. No oxidizing chemicals are applied. Incomplete nitrification may lead to regrowth in the (non-chlorinated) drinking water distribution systems since ammonium is a nutrient for many microorganisms (Chu, et al. 2005). Both the presence of ammonium itself and the biological instability resulting from it may deteriorate water quality and lead to health risks. Therefore, strict standards for ammonium are applied (0.20 and 0.10 mg L<sup>-1</sup> for the Dutch and the company's standards, respectively); research focuses on maintaining sufficient nitrification capacity by optimizing the process design and/or its operation and maintenance. In a rapid sand filter system, a sufficient surface for the attachment of microorganisms exists, hydraulic conditions are such that contact time is sufficient, and short-circuit flows do not occur. The nitrifying population adapts to the local ammonium supply and, in standard downward flow filters, activity is highest at the top of the filter bed. During the startup period of 1 to 5 months with new filter material, nitrifying microorganisms have to multiply first to form sufficiently large populations. Seeding is not mandatory for the startup, so it must be concluded that nitrifying microorganisms are sufficiently present in the raw water, ventilation air or filter material for inoculation. Trickling filters in full-scale water treatment plants (WTP) at Oasen Drinking Water Company (Oasen) in the province of South Holland, the Netherlands, show an efficient nitrification directly after the startup period. In many cases, however, this is not a sustainable situation and the ammonium concentration in the filter effluent starts to rise after some years or even months of production. Figure 1 shows a typical pattern for ammonium removal in an Oasen drinking water (DW) trickling filter. Iron removal is always nearly complete in this filter (>98%).

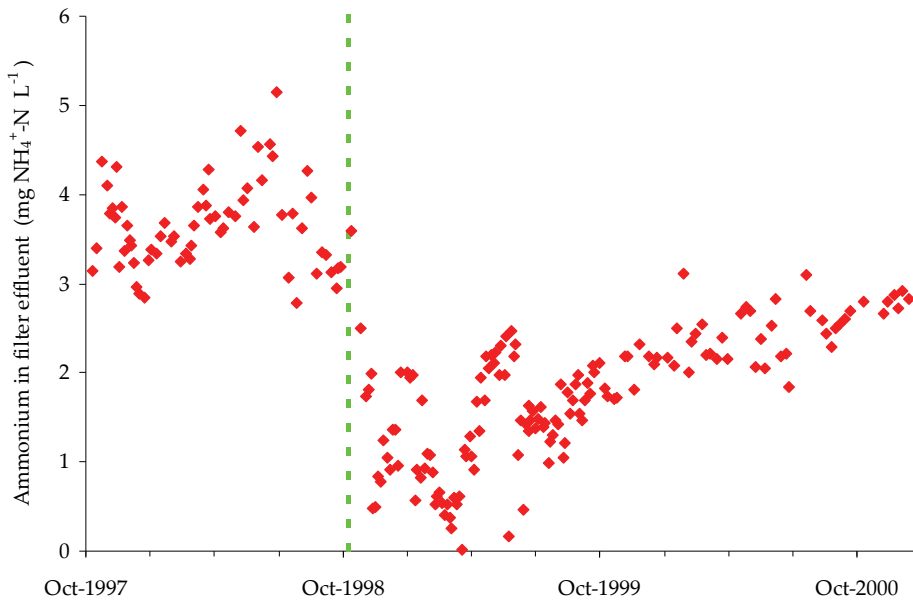

Figure 1: Typical startup and fallback pattern for ammonium removal in an Oasen single medium DW trickling filter; the filter was filled with fresh filter material (sand 1.7-2.5 mm, bed height 2 m) on October 15, 1998; average NH<sub>4</sub> in raw groundwater was 5.3 mg L<sup>-1</sup>; fluctuations before October 15, 1998 were caused by fluctuations in raw water quality

In the first period after startup, there is almost full ammonium removal and about 90% of NH<sub>4</sub>-N is converted to NO<sub>3</sub>-N. After approximately 6 months, the nitrifying activity slowly declines, resulting in increasing ammonium levels in the filter effluent (Figure 1). The remaining ammonium is always converted in a subsequent DW trickling filter.

Nitrification in the DW trickling filters is not limited by oxygen, due to an intensive gas exchange by forced ventilation with air through the filter bed, resulting in oxygen concentrations always over 8 mg L<sup>-1</sup> in the filtrate. The filter ventilation also removes methane very efficiently (de Vet, et al. 2002), preventing the extensive growth of methane-oxidizing bacteria in the filter. The same can be assumed for hydrogen sulfide in the raw water. Biological degradation of dissolved organic matter (DOC) is not likely to be the cause of the relapse in nitrification. In the two sequential filters, only 0.4 mg L<sup>-1</sup> DOC is removed from the the raw water (containing 2.5 to 2.8 mg L<sup>-1</sup> C). Even in the worst case, where no adsorbed DOC is flush out during backwash and all is being converted in the filters, the oxygen demand for it is marginal compared to that for oxidation of over 5 mg L<sup>-1</sup> of ammonium. Since full nitrification can occur, it is hypothesized that the decline in nitrifying activity is caused by interference with deposits built up during the ageing of the filter.



Anaerobic groundwater usually contains ammonium, iron and manganese (and sometimes methane). Information on the interaction between ammonium, iron and manganese removal in drinking water filters is still limited. Most references on combined iron, manganese and ammonium removal in drinking water filters focus on the biological processes. In pilot research on biological groundwater treatment in northern Croatia, Štembal, et al. (2005) found increased removal at higher flow rates for all three removal processes, and therefore concluded that processes are mass transfer- rather than reaction-limited. Different flow-rate dependencies of the removal efficiency for the three compounds require optimization of the filter design and operational actions depending on the raw water quality. Some authors elaborate on biological iron and manganese removal in filters without nitrification (Mouchet 1992; Li, et al. 2005). Others deal with the influence of nitrification on biological manganese removal. Vandenabeele, et al. (1995b) demonstrated a stimulating effect of *Nitrosomonas europaea* and *Nitrobacter winogradskyi* on biological manganese removal, compared to inhibition of biological manganese oxidation and even the reduction of  $\text{MnO}_2$  by nitrite. Vandenabeele, et al. (1995a) found nitrate having a stabilizing effect on the removal of manganese by preventing the microbial reduction of  $\text{MnO}_2$  to  $\text{Mn}^{2+}$ . Bray & Olańczuk-Neyman (2001) studied the combined ammonium and manganese removal in drinking water production from groundwater in Poland in full- and pilot-scale long-term experiments of over half a year. They found a negative impact of long-lasting low oxygen concentrations on manganese removal, but did not find any interaction between nitrification and manganese removal. Adverse effects from manganese removal on nitrification are not reported in the literature. References concerning the combination of nitrification and biological iron oxidation in drinking water filters are scarce. Štembal, et al. (2005) found bacteria of the Genus *Siderocapsa* present in comparable cell counts as nitrifying bacteria and suggest its role in iron and manganese oxidation. Their research did not focus on possible interactions between the removal processes. Other studies emphasize the inhibiting effect of ammonium on biological iron removal (e.g. Twort, et al. 2000). Tekerlekopoulou, et al. (2006) report on biological and physico-chemical iron oxidation in combination with nitrification in a pilot-scale trickling filter for drinking water production during a test period of eight months. High raw water concentrations (up to  $4 \text{ mg L}^{-1}$ ) of iron and ammonium reduced removal efficiency significantly for iron, but not for ammonium.

None of the references demonstrates a direct adversarial effect of iron removal on nitrification in drinking water filters. Iron accumulation, however, influences nitrification in at least one indirect way: filter clogging as a result of iron accumulation requires frequent backwashing of the filter, which might result in detachment of the (nitrifying) biomass. References on this subject show a broad array of impacts because of variations in filter materials, water quality and backwash procedures (Laurent, et al. 2003; Miltner, et al. 1995).

This paper focuses on the interference of iron removal with the nitrifying bacteria in trickling filters for drinking water production, resulting in decreased nitrifying activity. Two distinct techniques are presented in long-duration experiments in a full-scale WTP to prevent the negative impact of iron removal and maintain sustainable nitrification in the DW trickling filters.

### 3.2. Materials and methods

#### 3.2.1. Description of WTP Lekkerkerk (Oasen)

The source for the drinking water production for Oasen is riverbank infiltrate from the river Lek into fenland soils, resulting in concentrations of methane, iron, ammonium and manganese in the raw water well above drinking water standards. In the Oasen WTP, methane is effectively stripped before or during trickling filtration by forced aeration. The other compounds, however, are deposited or converted in the DW trickling filters.

Two separate long-term experiments took place at Oasen WTP Lekkerkerk. The WTP comprises two comparable but separate DW trickling filtration systems for two separate well fields. The treatment process consists of additional steps, but this paper focuses on the first DW trickling filters only. To prevent interference, each of the full-scale experiments took place in a different treatment system. More details of the two experimental setups, dual media DW trickling filtration with backwash in expansion mode and subsurface aeration, will be given further down in this paragraph. Raw and filtrate water quality parameters for both full-scale systems during the experimental periods are summarized in Table 1.

**Table 1: Raw and filtrate water qualities for both experimental full-scale DW trickling filter systems**

		Dual media filter with		Subsurface aeration <sup>b</sup>	
		Influent	Effluent	Influent	Effluent
Ammonium	mg NH <sub>4</sub> <sup>+</sup> -N L <sup>-1</sup>	4.5	0.41	1.7	0.05
Nitrite	mg NO <sub>2</sub> <sup>-</sup> -N L <sup>-1</sup>	<0.002	0.02	<0.002	0.01
Nitrate	mg NO <sub>3</sub> <sup>-</sup> -N L <sup>-1</sup>	<0.1	n.a.	<0.1	n.a.
Iron	mg Fe <sup>2+</sup> L <sup>-1</sup>	5.4	0.01	3.6	0.02
Manganese	mg Mn <sup>2+</sup> L <sup>-1</sup>	0.54	0.02	0.95	0.07
Methane	mg CH <sub>4</sub> L <sup>-1</sup>	1.1 <sup>c</sup>	n.a.	0.59	n.a.
Bicarbonate	mg HCO <sub>3</sub> <sup>-</sup> L <sup>-1</sup>	229	n.a.	229	n.a.
TOC	mg C L <sup>-1</sup>	2.7	n.a.	2.2	n.a.
Temperature	°C	12	12	12	13
pH at 20°C	pH	7.24	7.41	7.33	7.75

n.a. = not analyzed.

<sup>a</sup> average September 2004-2006

<sup>b</sup> average September 2005-2006

<sup>c</sup> average 2003-2006

In both systems, each DW trickling filter has a bed area of 18 m<sup>2</sup> and a bed depth of 2 m. The average superficial water velocity is 2.2 m h<sup>-1</sup>. Figure 2 shows Oasen DW trickling filters with spraying of the raw water onto the dry filter bed. The second filter is being backwashed.



Figure 2: Oasen DW trickling filters in production (front) and during backwash (background)

*Experiment 1: dual media DW trickling filtration with backwash in expansion mode*

The application of dual media DW trickling filters is rare. Dual media filters consist of a layer of coarse material with lower density on top of a finer material with a higher density. With down flow filtration the coarse material on top guarantees a large storage volume for suspended matter such as iron flocs, while the fine bottom layer supplies a good effluent water quality. The fractions of both materials are chosen such that the expansion during backwashing for the top layer is slightly larger than for the bottom layer. In the full-scale experiment, a combination of anthracite (1.4-2.5 mm, dry density 700 kg m<sup>-3</sup>) on top of normal filter sand (0.8-1.25 mm, dry density 1600 kg m<sup>-3</sup>) has been used. Each layer was 1 m in height (de Vet & Burger 2006).



*Experiment 2: subsurface aeration*

Another way for Oasen to maintain sound nitrification is by subsurface aeration, a mild form of *in situ* iron removal (Appelo, et al. 1999). In this technique, limited amounts of tap water (oxygen content  $> 8 \text{ mg L}^{-1}$ ) are periodically injected over two days into one of the six wells on average used in the well field for extraction of groundwater, followed by 40 days of extraction from the same well. Because of this, the total amount of injection water is only 1% of the total extracted raw water. Subsurface aeration has a limited effect on the total iron concentrations in the raw water and only at the beginning of the extraction period. During subsurface aeration, mobile iron colloids are formed in the aquifer (Appelo & de Vet 2003; Wolthoorn, et al. 2004a). Former research on subsurface aeration proved that these colloids are extracted with the raw water (Wolthoorn, et al. 2004a). In lab-scale filtration experiments, Wolthoorn, et al. (2004b) demonstrated that synthetically formed analogues of these natural colloids do enhance nitrification. The filter material in the DW trickling filter on which the subsurface aerated groundwater is treated is coarse river sand (fraction 1.7-2.5 mm).

### **3.2.2. Measurements**

Ammonium has been determined by colorimetric measurement. The method used has a detection limit of 0.03 and an accuracy of 0.019 at  $0.16 \text{ mg L}^{-1} \text{ NH}_4^+\text{-N}$ . Nitrification capacity was calculated at every data point from the measured ammonium concentrations in the filter influent and effluent, and the water flow through the filter divided by the fixed gross volume of the filter bed.

Separate column experiments with samples from the full-scale filter as shown in Figure 3 have been used to directly measure the expansion curves for the dual media materials used. The measurements were performed twice: once with new filter material and once with coated materials from the full-scale DW trickling filter after more than a year of production. Measurements took place at  $20 \pm 2 \text{ }^\circ\text{C}$ . Expansion was expressed as expanded bed height divided by bed height without expansion in the test column.

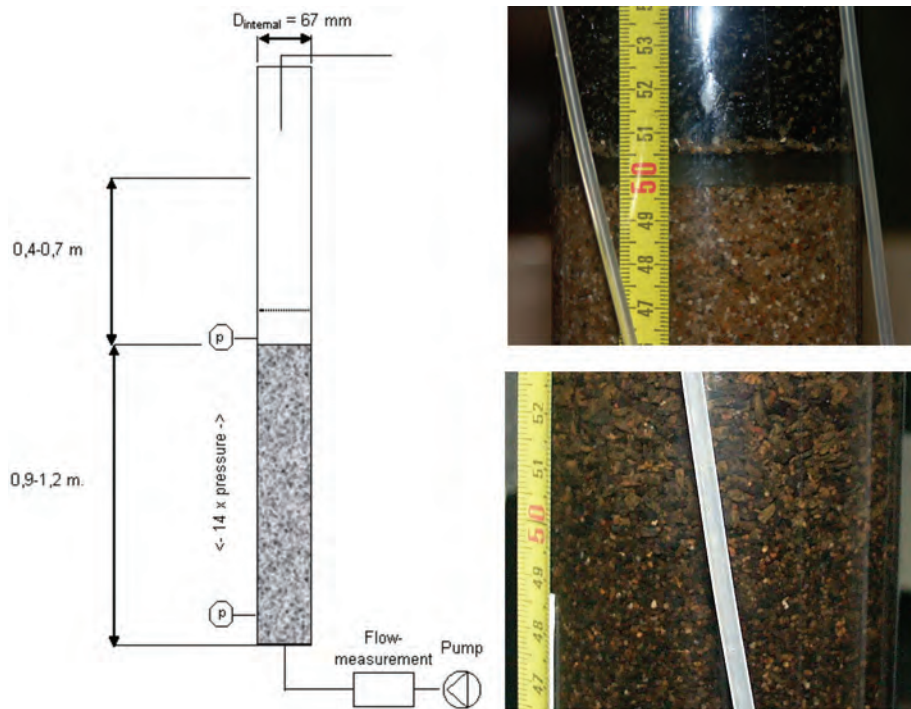

Figure 3: Diagram (left) and photos (fresh materials top right and coated materials bottom right) of experimental setup for media expansion measurements

In order to determine the amount of deposits accumulated, 20 mL of filter material was flushed four times with 100 mL of demineralized water and the wash water was filtered over a glass fiber filter ( $\varnothing$  90 mm, DoubleWeigh, F93490mm-X, T.J. Environmental) each time. The deposits' content was then calculated by measuring the dry weight of the clean filter and the filter with the deposits. The deposits' content is expressed in  $\text{g L}^{-1}$ .

The composition of the coatings was determined in two ways. For most experiments, the washed, coated material was first dried after removing the deposits (see method for deposits' content). Next, all the coating of 4 g of dried filter material was dissolved in 100 mL 4M hydrochloric acid with  $2 \text{ g L}^{-1}$  oxalic acid. The total coating weight was determined by measuring the dry weight before and after acidification and is expressed as mass-% of the dried, uncoated filter material. The calcium, iron, magnesium and manganese concentrations in the decanted acid solution were measured by ICP-MS. Only for the comparison of the coatings on subsurface aerated and non-subsurface aerated filter materials was Scanning Electron Microscopy combined with X-Ray Micro-Analysis (SEM/XRMA) used.

### 3.3. Results

#### 3.3.1. Existing single media filters without subsurface aeration as pre-treatment

The full-scale DW trickling filters removed virtually all iron, ammonium and manganese during the first period after startup. The calculated average nitrifying capacity for a whole filter reached values of over 6 g NH<sub>4</sub> per h per m<sup>3</sup> of filter material. Long-term measurements of the filter material from a full-scale DW trickling filter demonstrate that increased inorganic deposits on the filter material accompany the decline of nitrifying activity. Examination of the top one meter depth of the filter shows a decrease of nitrifying capacity and a growing coating of mainly iron deposits over time (Figure 4).

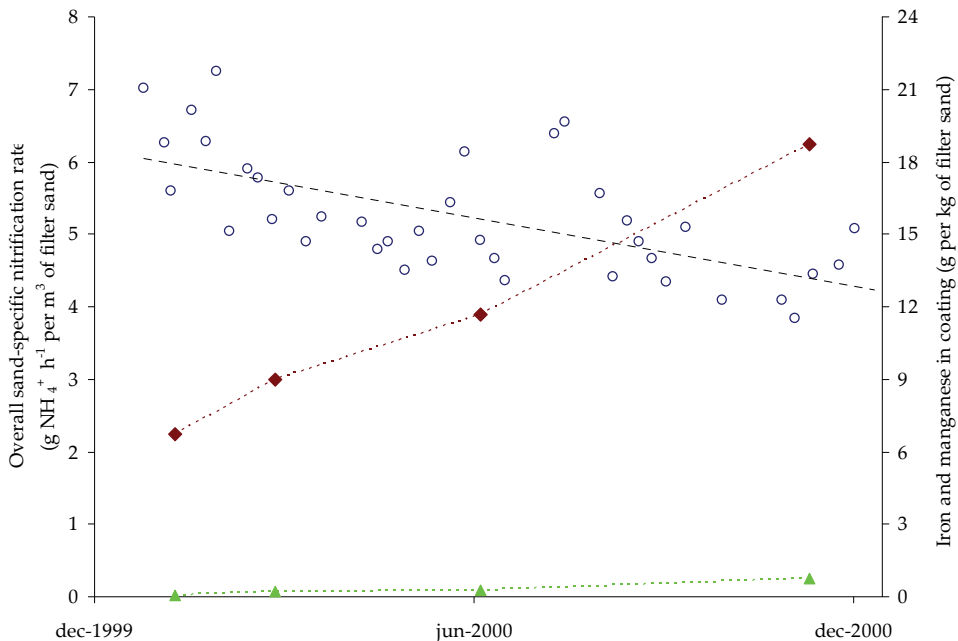
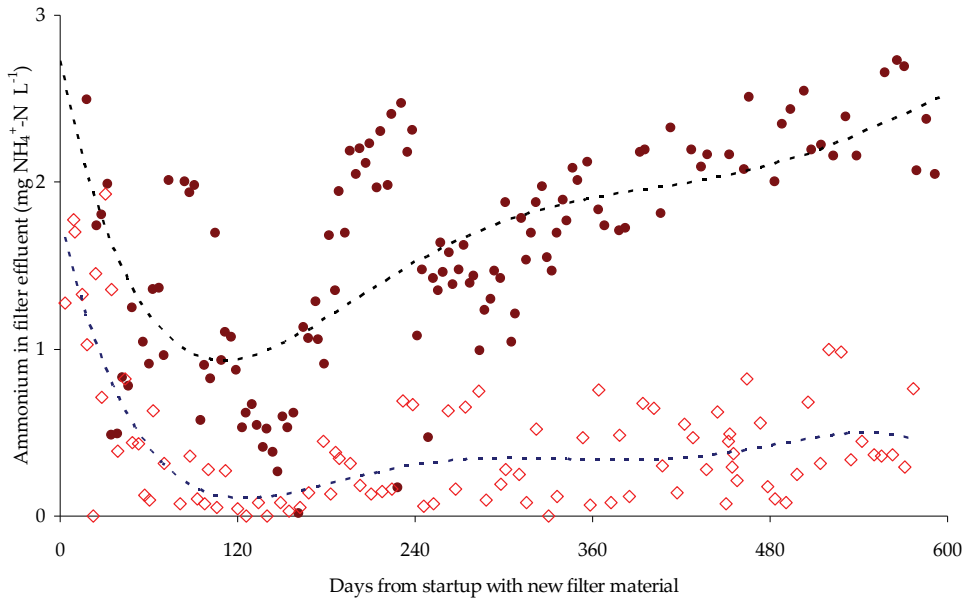

Figure 4: Change in overall sand-specific nitrification rate (○) and amount of iron (◆) and manganese (▲) coating in a single medium, DW trickling filter over time

#### 3.3.2. Dual media DW trickling filtration with backwash in expansion

One way of delaying the deterioration of nitrification might be by reducing iron deposition on the filter material by improving backwashing. In the same treatment system, a dual media filter with bed expansion during backwash was compared with a single medium filter (coarse sand 1.7-2.5 mm) without bed expansion during backwash. For expansion of the reference single medium filter material, a

much higher superficial backwash velocity of over  $90 \text{ m h}^{-1}$  is required, which is physically impossible in the full-scale filters. To enhance deposit removal, a long backwash period with a water flow of  $4 \text{ m h}^{-1}$  and air scour was applied. Figure 5 shows that nitrification remained significantly better in the filter with backwash under bed expansion as compared to filter backwash without expansion over a period of almost two years' time. Run time for the dual media filter was 96 hours. For the single medium filter, the run time was only 48 hours due to clogging.



**Figure 5: Ammonium in the effluent of a filter with backwashing without expansion (●) and a filter with backwashing with bed expansion (◊)**

For efficient deposit removal during backwash, a minimum of preferably 10 % expansion of the filter bed is required. Measured expansions of the filter materials used are shown in Figure 6. Bed expansion (measured in the laboratory at  $20 \pm 2 \text{ }^\circ\text{C}$ ) increases during production, probably due to low density or the higher drag coefficient of the coating. In the full-scale filters, bed expansion will be even higher as a result of the higher water viscosity at the lower water temperature ( $12\text{-}13 \text{ }^\circ\text{C}$ ).

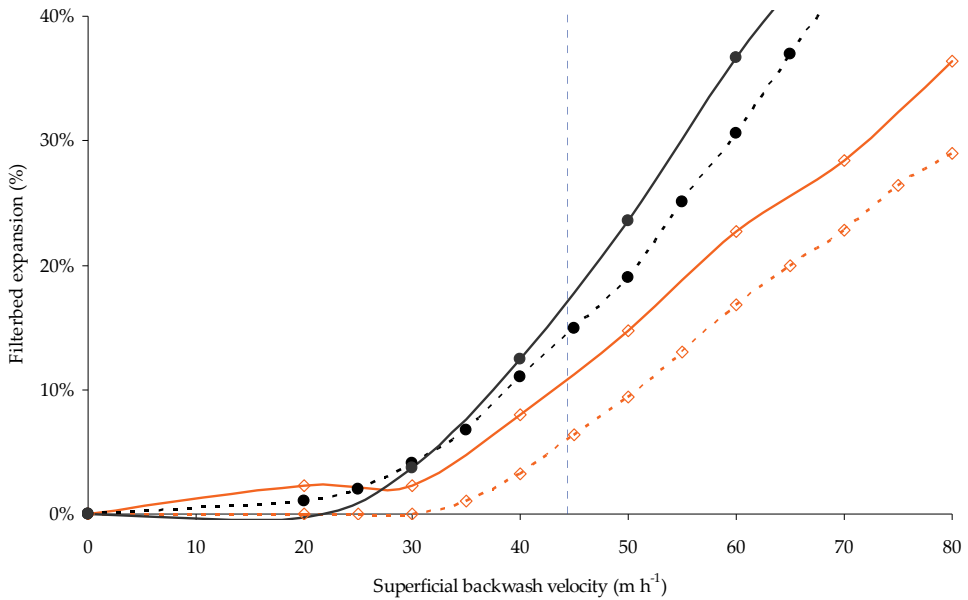

Figure 6: Filter bed expansion for anthracite (●) and sand (◊) filter medium as a function of backwash velocity; dotted lines are for fresh medium, solid lines for media after 13 months of operation; actual backwash velocity at full-scale filter 44 m h<sup>-1</sup>

In order to assess the efficiency of deposit removal during backwash, the deposits' content was determined by sampling at three depths in the filter bed. The removed deposits mainly consisted of iron (hydr)oxides (data not shown). Figure 7 illustrates the removal of deposits during backwash in the first year of production. The data points shown for depth are the averages of 50 cm depths of the filter bed, so the 25 cm depth point is the value determined from samples over depths ranging from 0-50 cm, etc. Deposit removal after 12 months of production appears to become less efficient, and more deposits seem to accumulate in the lower sand layer. The coating on the filter material also increases disproportionately in this period (Figure 8). However, the growth of the coating is overall much greater in the top anthracite layer.

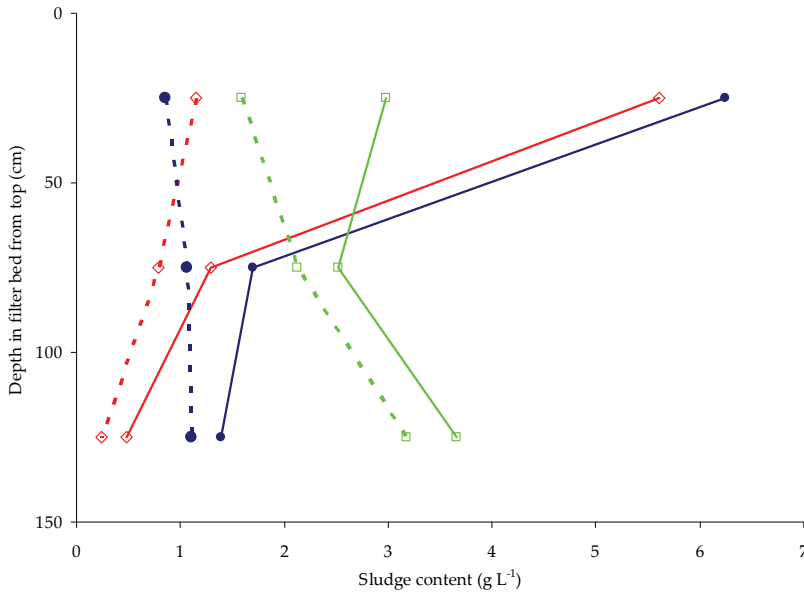

Figure 7: Accumulated sludge concentrations in the dual media filter just before (solid lines) and after (dotted lines) backwashing; operational times after filling with new filter medium were 3 months ( $\diamond$ ), 6 months ( $\bullet$ ) and 12 months ( $\square$ )

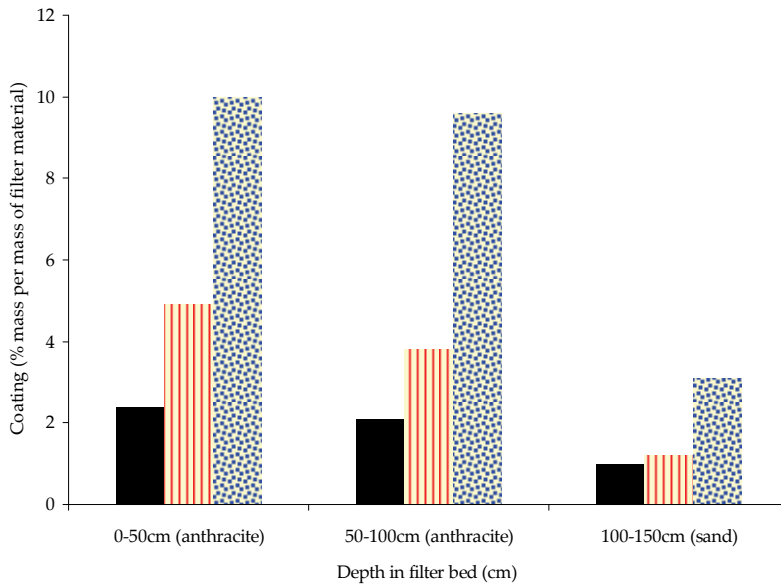
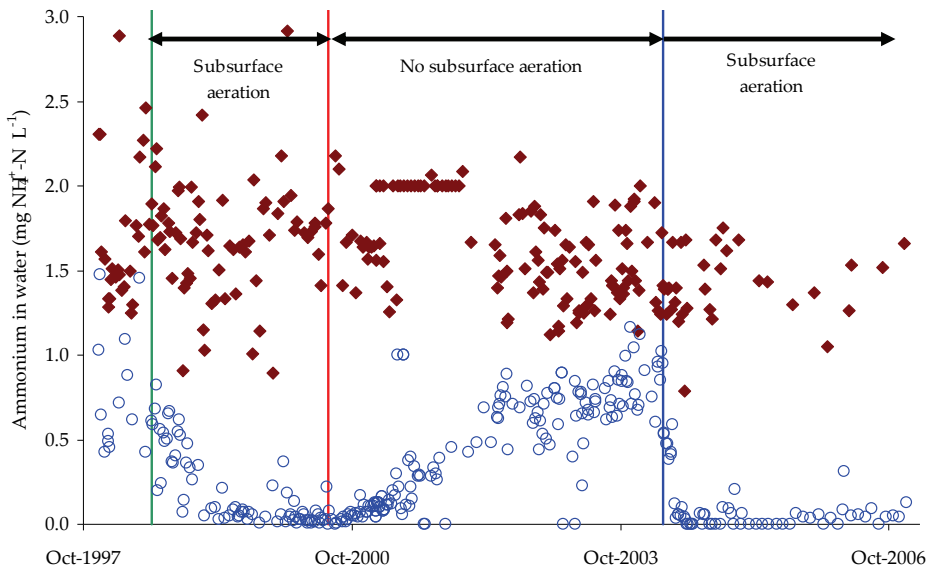

Figure 8: Formation of mainly inorganic coating in three layers of the dual media filter over time. Operational times after filling with new filter medium were 3 months (solid bars), 6 months (striped bars) and 12 months (dotted bars).

**3.3.3. Influencing the iron removal mechanisms by subsurface aeration**

Coating of the filter material does not lead, per se, to nitrification problems. In full-scale filters, a comparable fraction, between 31 and 34 %, of iron from the raw water was deposited as filter coating in both a subsurface aerated filter and a filter without subsurface aeration after a production period of 2.5 years. Figure 9 illustrates both the beneficial effect of subsurface aeration on nitrification in a single medium DW trickling filter as well as the autonomous deterioration during a moratorium without subsurface aeration. This major improvement of the nitrification by subsurface aeration has been reproduced in over 10 DW trickling filters at three full-scale Oasen WTPs during the last decade. It is emphasized that the effect is not caused by subsurface removal of iron or ammonium. Only 2-3 % of the iron and no ammonium are removed in the aquifer due to subsurface aeration (data not shown).



**Figure 9: Ammonium concentration in the influent (♦) and effluent (○) of a full-scale groundwater trickling filter during periods with and without subsurface aeration**

The exact mechanism by which iron deposits influence nitrifying microorganisms is yet unknown. However, it is assumed that the characteristics of the filter coating play a determining role as the major attachment sites for nitrifying microorganisms. The composition of the main elements in the coatings of filter sand from a subsurface aerated and a non-subsurface aerated filter at Oasen is shown in Figure 10. In the subsurface aerated filter, the iron content is lower and the manganese content higher than in the non-subsurface aerated filter.

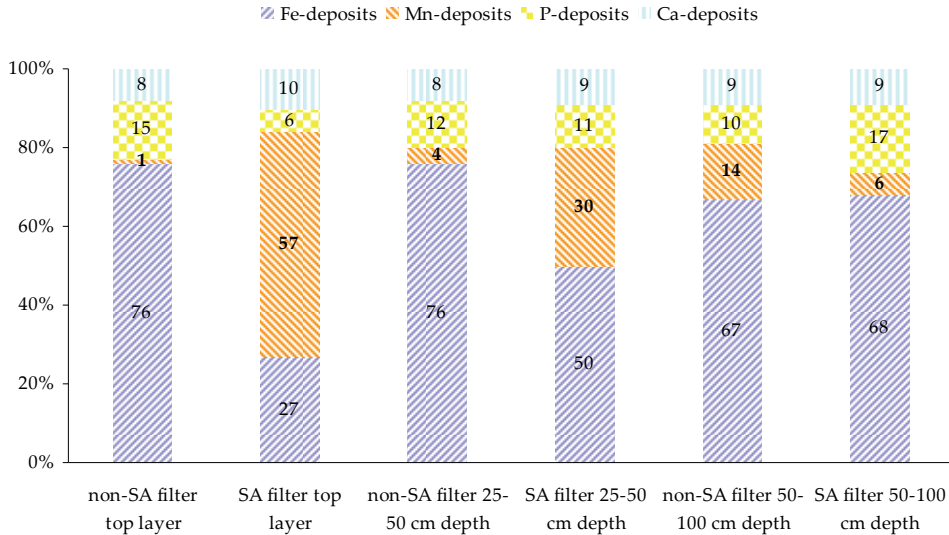

**Figure 10: Mass distribution of the major components in the coatings in a subsurface aerated and a non-subsurface aerated filter as determined by X-Ray Micro-Analysis**

### 3.4. Discussion

The decline of nitrifying activity in full-scale groundwater trickling filters can effectively be prevented by the application of dual media filters backwashed with expansion or by the application of subsurface aeration. The observations presented throw some light upon the possible mechanisms for the improved nitrification. The binding element appears to be iron deposition, iron being the quantitatively most important substance in these filters. All the iron (oxy)hydroxides formed will consist of the unstable, low-crystalline ferrihydrite as a result of the rapid oxidation (in fact: hydrolysis) process.

Ferrihydrite – generally, but wrongly, called “amorphous iron oxide” - exists in different grades of crystallinity, ranging from two to eight peaks or lines in X-ray diffraction (XRD). The poorest crystalline ferrihydrite is formed at the highest rate of hydrolysis. Only the 2-line ferrihydrite may transform into higher crystalline phases like goethite. Ferrihydrite has a larger surface area compared to the crystal forms that lack internal surfaces (Schwertmann & Cornell 2000). Using XRD, Sharma, et al. (2002) found in all but one case only low-crystalline phases of iron (oxy)hydroxides in full-scale filter samples in the Netherlands, but the crystalline gradation is not shown in that paper.

In DW trickling filters, reduced iron from groundwater is removed by a combination of two mechanisms, floc filtration and adsorptive oxidation. During the rapid hydrolysis in the water phase, primary ferrihydrite oxidation products of



the lowest crystallinity are formed, which polymerize into agglomerations of voluminous, hydrated flocs during flocculation. In the adsorptive oxidation removal process, iron (oxy)hydroxides grow by consecutive adsorption and oxidation, are therefore more compact, and possibly more crystalline. In DW trickling filters, adsorptive oxidation will prevail due to short pre-oxidation time, but both iron removal mechanisms will occur. During an effective backwash, the flocs formed by oxidation in the water phase are mostly flushed out of the filter bed. Without expansion, the removal is incomplete; flocs stay trapped in the filter bed and the iron may then be transformed on the surfaces of the filter grains. Pedersen, et al. (2005) demonstrated that in the presence of  $Fe^{2+}$ , ferrihydrite is transformed within days into stable iron oxides such as lepidocrocite and goethite. The combination of both forms of iron is available in DW trickling filters. The standard backwash frequency for iron removing filters is once every 1 to 4 days, so in case of an ineffective backwash, the transformation of flocs may occur. On the one hand, this rapid transformation of ferrihydrite from the flocs into stable iron oxides on the filter coating might lower the porosity and permeability of the filter coating significantly. Direct growth of a ferrihydrite coating by adsorption and oxidation, on the other hand, will occur more gradually and result in a stable coating with larger pore area. An increase in the coating surface area by adsorptive oxidation was also found by Sharma, et al. (2002).

When subsurface aeration is applied, nitrification remains good despite the presence of the coating. The composition and structure of the coating can be influenced by changing the oxidation regime of iron. One hypothesis based on research by Wolthoorn (2003) is that complex colloids formed by subsurface aeration might change the iron removal mechanism in the filters. The colloids might alter the ratio of iron removed by floc formation to adsorption by changing the homogeneous oxidation rate of iron or directly change the coating by attachment. The higher manganese content of the coating of subsurface aerated filters might be an indication of a larger surface area.

Further research into the effect of components other than iron in the filter coating (especially manganese) on nitrification is still necessary.

High porosity of the filter coating might alter the availability of, for example, substrates or trace elements or the attachment of microorganisms.

### **3.5. Conclusions**

Nitrification problems in trickling sand filters for the production of drinking water from iron-containing groundwater usually occur through ageing of the filter bed. The accumulation of iron (oxy)hydroxide deposits between the filter material and the growth of mainly iron-based coatings on the filter material coincide with these problems and are their probable cause. Two full-scale techniques have proven

successful in the long term to prevent the negative impact of iron removal on nitrification in the DW trickling filters. On the one hand, the irreversible accumulation of removed iron deposits can be prevented by using dual media filtration in combination with backwashing with adequate filter bed expansion. On the other hand, the iron content of the coating can be reduced by changing the iron oxidation process through subsurface aeration. Both techniques maintain sound and almost complete nitrification in the first filtration step, thus contributing to the biological stability of the drinking water leaving the WTP.

## References

- Appelo, CAJ & de Vet, WWJM 2003 Modeling *in situ* iron removal from groundwater with trace elements such as As. Kluwer Academic, Boston.
- Appelo, CAJ, Drijver, B, Hekkenberg, R & Jonge, M 1999 Modeling *In Situ* Iron Removal from Ground Water. *Ground Water* 37(6), 811-817.
- Bray, R & Olańczuk-Neyman, K 2001 The influence of changes in groundwater composition on the efficiency of manganese and ammonia nitrogen removal on mature quartz sand filtering beds. *Water Science and Technology: Water Supply* 1(2), 91-98.
- Chu, C, Lu, C & Lee, C 2005 Effects of inorganic nutrients on the regrowth of heterotrophic bacteria in drinking water distribution systems. *Journal of Environmental Management* 74(3), 255-263.
- de Vet, WWJM & Burger, W 2006 Duurzame nitrificatie door dubbellaags droogfiltratie. *H2O: tijdschrift voor watervoorziening en waterbeheer* 39(22), 39-42.
- de Vet, WWJM, Burger, W & van der Woerdt, D 2002 Methaanbelasting irrelevant voor filterwerking. *H2O: tijdschrift voor watervoorziening en waterbeheer* 35(1), 26-29.
- Laurent, P, Kihn, A, Andersson, A & Servais, P 2003 Impact of backwashing on nitrification in the biological activated carbon filters used in drinking water treatment. *Environmental Technology* 24(3), 277-287.
- Li, D, Zhang, J, Wang, H, Yang, H & Wang, B 2005 Operational performance of biological treatment plant for iron and manganese removal. *Journal of Water Supply: Research and Technology - AQUA* 54(1), 15-24.
- Miltner, RJ, Summers, RS & Wang, JZ 1995 Biofiltration performance: part 2, effect of backwashing. *Journal / American Water Works Association* 87(12).
- Mouchet, P 1992 From conventional to biological removal of iron and manganese in France. *Journal / American Water Works Association* 84(4), 158-167.
- Pedersen, HD, Postma, D, Jakobsen, R & Larsen, O 2005 Fast transformation of iron oxyhydroxides by the catalytic action of aqueous Fe(II). *Geochimica et Cosmochimica Acta* 69(16), 3967-3977.

Schwertmann, U & Cornell, RM 2000 Iron Oxides in the Laboratory - Preparation and Characterization. Wiley-VCH Verlag, Weinheim.

Sharma, SK, Petrusevski, B & Schippers, JC 2002 Characterisation of coated sand from iron removal plants. *Water Science and Technology: Water Supply* 2(2), 247-257.

Štembal, T, Markic, M, Ribičić, N, Briški, F & Sipos, L 2005 Removal of ammonia, iron and manganese from groundwaters of northern Croatia - Pilot plant studies. *Process Biochemistry* 40(1), 327-335.

Tekerlekopoulou, AG, Vasiliadou, IA & Vayenas, DV 2006 Physico-chemical and biological iron removal from potable water. *Biochemical Engineering Journal* 31(1), 74-83.

Twort, AC, Ratnayaka, DD & Brandt, MJ 2000 *Water supply*. Arnold, London

Vandenabeele, J, De Beer, D, Germonpre, R, Van de Sande, R & Verstraete, W 1995a Influence of nitrate on manganese removing microbial consortia from sand filters. *Water Research* 29(2), 579-587.

Vandenabeele, J, Vande Woestyne, M, Houwen, F, Germonpre, R, Vandesande, D & Verstraete, W 1995b Role of autotrophic nitrifiers in biological manganese removal from groundwater containing manganese and ammonium. *Microbial Ecology* 29(1), 83-98.

Wolthoorn, A 2003 Subsurface aeration of anaerobic groundwater. Iron colloid formation and the nitrification process. PhD-thesis, Wageningen University.

Wolthoorn, A, Temminghoff, EJM & Van Riemsdijk, WH 2004a Colloid formation in groundwater by subsurface aeration: Characterisation of the geocolloids and their counterparts. *Applied Geochemistry* 19(9), 1391-1402.

Wolthoorn, A, Temminghoff, EJM & Van Riemsdijk, WH 2004b Effect of synthetic iron colloids on the microbiological NH<sub>4</sub><sup>+</sup> removal process during groundwater purification. *Water Research* 38(7), 1884-1892.



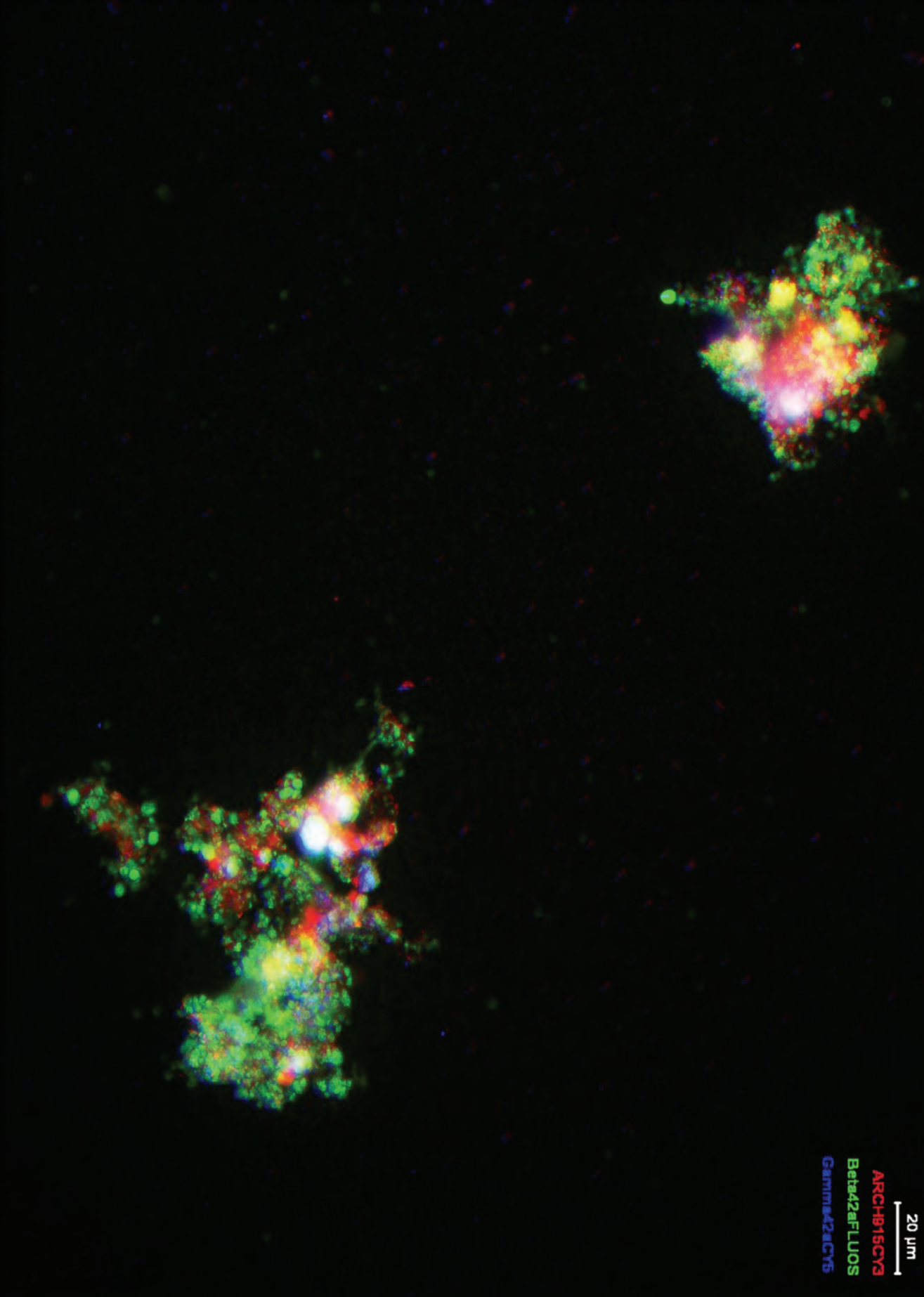

20  $\mu$ m

ARCH915CY3

Beta42aFLUOS

Gamma42aCT6

# CHAPTER 4

---

## Molecular characterization of microbial populations in groundwater sources and sand filters for drinking water production

4

**Published as:**  
de Vet, W.W.J.M., Dinkla, I.J.T., Muyzer, G., Rietveld, L.C.  
and van Loosdrecht, M.C.M. (2009)  
Molecular characterization of microbial populations in groundwater  
sources and sand filters for drinking water production.  
Water Research 43(1), 182-194.

## Abstract

In full-scale drinking water production from groundwater, subsurface aeration is an effective means of enhancing the often troublesome process of nitrification. Until now the exact mechanism is however unknown. By studying the microbial population we can improve the understanding of this process. Denaturing gradient gel electrophoresis of PCR-amplified 16S rRNA gene fragments of Bacteria, Archaea and ammonia-oxidizing bacteria was used to characterize the microbial populations in raw groundwater and trickling filters of an active nitrifying subsurface aerated system and an inactive non-subsurface aerated system. Only in the active filter were nitrifying microorganisms found above the detection limit of the method. In ammonium oxidation in this groundwater filter both Bacteria and Archaea played a role, while members belonging to the genus *Nitrospira* were the only nitrite-oxidizing species found. The subsurface aerated groundwater didn't contain any of the nitrifying organisms active in the filter above the detection limit, but did contain *Gallionella* species that might play a major role in iron oxidation in the filter.

## Keywords

Archaea, DGGE, drinking water production, *Gallionella*, groundwater, nitrification, *Nitrosopumilus*, subsurface aeration

## Abbreviations and Notations

AOA	=	Ammonia-oxidizing archaea
AOB	=	Ammonia-oxidizing bacteria
NOB	=	Nitrite-oxidizing bacteria
MTB	=	Magnetotactic bacteria
PCR	=	Polymerase Chain Reaction
DGGE	=	Denaturing Gradient Gel Electrophoresis
WTP	=	Water Treatment Plant

#### 4.1. Introduction

In the Netherlands the production of drinking water from anaerobic groundwater usually comprises ammonium to nitrate conversion in rapid sand filters by immobilized microorganisms attached to the sand. Nitrification occurs spontaneously in drinking water filters like in many other natural and industrial processes where ammonium is present under aerobic conditions. The Oasen Drinking Water Company (Oasen) in the province of South Holland in the Netherlands is being continually challenged, however, by the untimely and irreversible loss of nitrifying activity in its sand filters. Ammonium removal typically starts to decline after a short period of almost complete nitrification with new filter sand. A practical approach used by Oasen to maintain sound nitrification in the filters is the application of subsurface aeration, a mild form of *in situ* iron removal (Appelo et al., 1999), as pretreatment. By periodical injection of aerated water in a well during 5% of the operational time, mobile iron colloids are formed in the aquifer (Appelo and de Vet, 2003)). Previous research on subsurface aeration at Oasen proved that these colloids are extracted with the raw groundwater and may enhance nitrification in the production filters (Wolthoorn et al., 2004). Both the autonomous relapse in ammonium removal and the beneficial effect of subsurface aeration on it in full-scale filters are reported elsewhere (De Vet et al., 2008, accepted after revision).

The observed loss in nitrifying activity poses the question of whether this is caused by the loss of nitrifying microorganisms in the filters or by the inhibition of their activity. In order to distinguish between these effects, more insight into the microbial population in the system is required.

Nitrification comprises two consecutive and distinct steps by different species of microorganisms. Until 2005 nitrification was considered to be an exclusively Bacterial process. An overview of nitrifying Bacteria is given by Belser (1979). In 2005 the first ammonia-oxidizing Crenarchaeota was isolated from a marine aquarium by Könneke et al. (2005) and was named *Candidatus "Nitrosopumilus maritimus"*. Ammonia-oxidizing archaea (AOA) have since been reported in several soil (Leininger et al., 2006) and wastewater systems (Park et al., 2006). Publications on characterization of the microbial composition in drinking water treatment processes or nitrifying trickling filters are still scarce (Qin et al., 2007, Lydmark et al., 2006). These references have been limited to the Bacterial domain.

The main aim of this work was to test two hypotheses in relation to nitrification problems in drinking water filters and the beneficial effect of subsurface aeration, using Denaturing Gradient Gel Electrophoresis (DGGE) analysis of PCR-amplified 16S rRNA gene fragments of Bacteria and Archaea. The first hypothesis, stating that the loss in nitrification activity is caused by the absence of nitrifying



microorganisms, was evaluated by establishing the differences in microbial populations between a properly nitrifying filter treating subsurface aerated groundwater and an inactive filter fed with non-subsurface aerated groundwater. The second hypothesis tested states that the growth of microorganisms in the subsurface aerated aquifer plays an important role in the beneficial effect of subsurface aeration on nitrification in the drinking water filter. The performance of the sand filters may be influenced by the chemical composition of the groundwater, but also by differences in the microbial community in the groundwater as a result of subsurface aeration. The community may then influence the performance by either acting as a specific inoculum for the filters or by carrying out specific conversions resulting in a change in the chemical composition of the raw water. To test this hypothesis for both possible processes, the composition of the microbial community in the groundwater of the subsurface and non-subsurface aerated well was also studied by DGGE analysis and compared to that in the corresponding filters.

## 4.2. Methods and materials

### 4.2.1. WTP Lekkerkerk raw water and filter samples

Oasen Water Treatment Plant (WTP) Lekkerkerk (51°53'N, 4°38'E) comprises two separate treatment systems with their own well fields. The Schuwacht field lies near the WTP and close to the river Lek (51°53'N, 4°38'E), and the Tiendweg field is situated 0.8 to 1.7 km further into the Krimpenerwaard polder (51°54'N, 4°39'E). Subsurface aeration is only applied to one well in the Schuwacht field. The other wells in both fields extract groundwater that is not influenced by subsurface aeration and one of them serves as a reference in this paper. The subsurface aeration regimen applied is not as intensive as for *in situ* iron removal, so that ammonium and manganese are not significantly lowered in the mixed raw water, and iron and methane are reduced by less than 5%. The location of all sampling points is shown schematically in Figure 1. Water quality and filtration parameters are reported under Operational Aspects in the Results section.

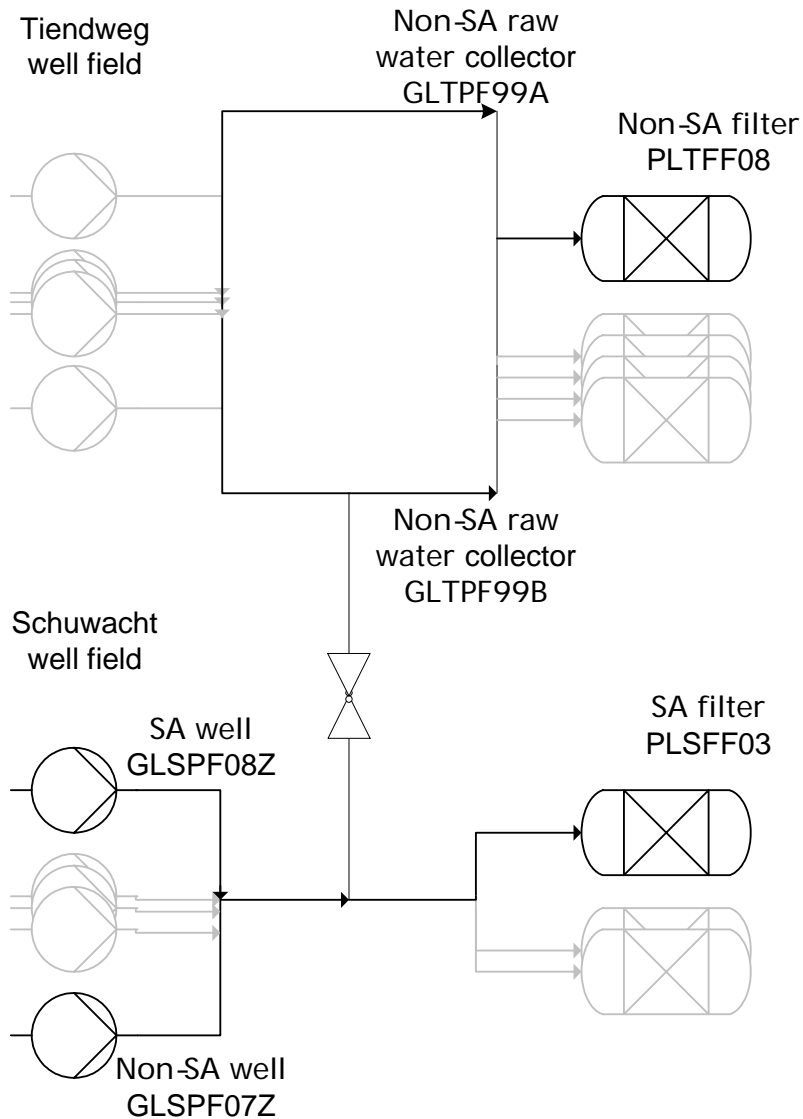

Figure 1: Scheme of sampling points for groundwater and filter samples

In the Schuwacht field, samples were collected from the subsurface aerated well GLSPF08Z at the end of the extraction phase of the subsurface aeration cycle and from the reference well GLSPF07Z abstracting original Schuwacht groundwater. Two samples from Tiendweg's raw water were taken from the two collectors

entering the WTP, coded GLTPE99A and GLTPE99B. The volume of each groundwater sample was 1100 mL. All water samples were taken on December 15, 2006, and kept cool after sampling until DNA extraction. Filter samples were taken on August 23, 2006, from the subsurface aerated filter (Schuwacht PLSFF03) and the non-subsurface aerated filter (Tiendweg PLTFF08). In both filters, sand was collected at three depths (0-10 cm, 25-50 cm and 50-100 cm depth). At each depth, mixed samples were formed by sampling four different places over the filter bed area. The resulting 100 mL samples were preserved immediately after sampling by adding 40 mL 96% ethanol, 2.5 mL 0.1 M sodium-citrate buffer solution, and 20 mL demi water until DNA extraction. An overview of all samples is given in Table 1.

**Table 1: Overview of groundwater and sand filter samples**

Sample	Sample type	Sample date	Sample information	Amount used for extraction	Lane number in DGGE-gels
GLTPE99A-20061215	Groundwater	15-12-2006	Non-subsurface aerated well Tiendweg	1100 mL	1
GLTPE99B-20061215	Groundwater	15-12-2006	Non-subsurface aerated well Tiendweg	1100 mL	2
GLSPF07Z-20061215	Groundwater	15-12-2006	Non-subsurface aerated well Schuwacht	1100 mL	3
GLSPF08Z-20061215	Groundwater	15-12-2006	Subsurface aerated well Schuwacht	1100 mL	4
PLTO-FF08-20060823-0/10cm	Filter sand	23-08-2006	Non-subsurface aerated filter Tiendweg	2.79 g	5
PLTO-FF08-20060823-25/50cm	Filter sand	23-08-2006	Non-subsurface aerated filter Tiendweg	1.96 g	6
PLTO-FF08-20060823-50/100cm	Filter sand	23-08-2006	Non-subsurface aerated filter Tiendweg	2.22 g	7
PLSO-FF03-20060823-0/10cm	Filter sand	23-08-2006	Subsurface aerated filter Schuwacht	2.54 g	8
PLSO-FF03-20060823-25/50cm	Filter sand	23-08-2006	Subsurface aerated filter Schuwacht	1.78 g	9
PLSO-FF03-20060823-50/100cm	Filter sand	23-08-2006	Subsurface aerated filter Schuwacht	1.81 g	10

#### 4.2.2. Sand-specific nitrification rate

In order to quantify the nitrifying activity of the filter samples, the sand-specific nitrification rate was measured at Vitens Laboratorium Utrecht based on the method proposed by Kihn et al. (2000). Instead of a synthetic medium, tap water was used. This water is a natural bicarbonate buffer and contains all required macro and trace elements for nitrification, except for ammonium. At  $t = 0:00$  min, 200 mL of the tap water was added to 100 g of filter material in order to reach N-equilibrium in the liquid phase before the measurements started. At  $t = 5:00$  min, a concentrated  $\text{NH}_4\text{Cl}$  solution in tap water was added up to a concentration of 7.8

mg/l  $\text{NH}_4^+\text{-N}$  (10 mg/l  $\text{NH}_4^+$ ). At  $t = 5:30, 10:00, 20:00$  and  $35:00$  min, samples were taken to analyze ammonium, nitrite and nitrate. The temperature during all measurements was  $21 \pm 1$  °C; the pH  $8.15 \pm 0.15$ . Aeration and mixing were guaranteed by air bubbling and shaking. All samples were kept in a dark room at  $4 \pm 3$  °C for at least 16 hours before analysis. Both ammonium and nitrite were determined by colorimetric measurement. Nitrate was measured by conductivity in accordance with *NEN-EN-ISO 10304-1 and 10304-2*. The sand-specific nitrification rate was calculated from the linear trend in time for the sum of  $\text{NO}_2\text{-N}$  and  $\text{NO}_3\text{-N}$  concentrations and expressed as mg ( $\text{NO}_2\text{-N} + \text{NO}_3\text{-N}$ ) per hour and kg of filter sand.

#### 4.2.3. DNA extraction

Groundwater samples were filtered over  $0.2 \mu\text{m}$  polycarbonate membranes to concentrate the cells prior to DNA extraction. DNA was extracted from the total volume of 1100 mL per groundwater sample taken on December 15, 2006. Due to the presence of large fragments of inorganic material from the filtercoating, sand filter samples were pretreated before extracting biomass. Samples of approximately 10 grams were added to 3.5 mL phosphate buffer containing 0.1 M sodium citrate, and vigorously vortexed for 1.5 minutes. One mL of the liquid phase was subsequently subjected to DNA extraction by bead beating. The DNA was purified using a silica-based column and eluted in 100  $\mu\text{l}$  TE.

#### 4.2.4. PCR-amplification of Bacteria, Archaea, and ammonia-oxidizing bacteria (AOB)

Prior to DGGE analysis, the 16S rRNA gene of Bacteria and Archaea was amplified using modified primers (EUB0999F-GC and EUB1416R, and ARC0915F-GC and ARC1380-1R). For amplification of the 16S rRNA gene of AOB belonging to the *Betasubdivision* of the *Proteobacteria*, previously described primers CTO0189-1F-GC, CTO0189-2F-GC, and CTO0654R were used (Kowalchuk et al. (1997)). Amplification was performed by initial denaturation for 3 min at 94°C, followed by 35 cycles of amplification (30 s denaturation at 94°C; 30 s annealing at 58°C; 30 s elongation at 72°C), and 5 min at 72°C to complete elongation. Detailed protocols and primer sequences are available at Bioclear, on request.

#### *PCR-amplification of Nitrobacter*

Because of the explicit claim in textbooks that *Nitrobacter* spp. are the exclusive species of nitrite-oxidizing bacteria (NOB) in drinking water treatment (see discussion), a specific PCR was developed for *Nitrobacter* spp. PCR primers were developed for the detection of the 16S rRNA gene from *Nitrobacter* spp. Two forward primers, NTB0676-1F 5'-TGAGGATCTTGAGTTCGGGAGA-3' and NTB0676-2F 5'-TGAAGGTCTTGAGTTCGGGAGA-3', and one reverse primer,

NTB1031-LNA0-R 5'-GCAGCA CCTGTGCTCCA+T-3' containing an Locked nucleic acid (LNA) base located on the 3'-end to improve selectivity, were designed. Amplification was performed by initial denaturation for 3 min at 94°C, followed by 35 cycles of amplification (30 s denaturation at: 94°C; 30 s annealing at 62°C; 30 s elongation at 72°C), and 5 min at 72°C to complete elongation.

#### **4.2.5. DGGE analysis of PCR-amplified gene fragments**

Separation of amplification products by DGGE was performed on a device manufactured by Ingeny International bv (Goes, the Netherlands). Gels were made of 9% polyacrylamide containing a 30-70% gradient of urea (7.3 M) and formamide (42% (v/v)). Samples were run for 16 h at a temperature of 60 °C and a constant voltage of 110 V. The gels were silver stained and digitally photographed.

#### **4.2.6. Sequencing of PCR products**

Small amounts of acrylamide material containing the fragment of interest were taken from the gel using a sterile needle/scalpel, and added to 25 µl of PCR mix. The fragment was subsequently re-amplified using the same primers and conditions as described in 2.3. The amplified product was purified using the Zymo DNA Clean & Concentrator kit (Zymo Research, USA) and sent to Baseclear bv (Leiden, the Netherlands) for sequencing.

#### **4.2.7. Comparative sequence analysis**

The sequences were first compared to sequences stored in GenBank using the BLAST algorithm (<http://www.ncbi.nlm.nih.gov/BLAST>). Subsequently, the sequences were imported into the ARB software program (Ludwig et al., 2004), automatically aligned, and added to a phylogenetic tree using the Quick-add tool. A phylogenetic tree was build from a number of selected sequences using the Neighbor-Joining algorithm with automation correction. The sequences obtained with the CTO-specific primers were added to this tree without disturbing the topology of the tree, because of lack of overlap between the sequences of the DNA fragments obtained with the general Bacterial and the CTO-specific primers. The final tree for the Archaeal 16S rRNA gene sequences was built using the Neighbor-Joining algorithm with automatic correction setting. Sequences were deposited in GenBank under the accession numbers EU314588 - EU314615.

### 4.3. Results

#### 4.3.1. Operational aspects

The water quality of both well fields Schuwacht and Tiendweg is highly comparable. In both fields fresh anaerobic groundwater is extracted from the first aquifer at a depth between 15 and 30 m below ground level. Both fields are located in a fenland polder and, as a consequence, the infiltration water from the Lek River serves as the main source for the first aquifer. The groundwater is further recharged by downward percolation through peat layers. Average values for different chemical parameters in the groundwater of both fields are shown in Table 2. The temperature of the groundwater is constant at 12°C throughout the year. Differences between both fields result from the differences in the travel distance from the river Lek.

**Table 2: Groundwater quality parameters for the Schuwacht and Tiendweg well fields at the Oasen WTP Lekkerkerk**

		Raw water Schuwacht	Raw water Tiendweg
Ammonium	mg L <sup>-1</sup> NH <sub>4</sub> <sup>+</sup> -N	1.7	4.4
Nitrite	mg L <sup>-1</sup> NO <sub>2</sub> <sup>-</sup> -N	<0.002	<0.002
Nitrate	mg L <sup>-1</sup> NO <sub>3</sub> <sup>-</sup> -N	<0.1	<0.1
Calcium	mg L <sup>-1</sup> Ca <sup>2+</sup>	80.0	81.5
Chloride	mg L <sup>-1</sup> Cl <sup>-</sup>	99.5	122
Iron	mg L <sup>-1</sup> Fe <sup>2+</sup>	3.7	5.6
Potassium	mg L <sup>-1</sup> K <sup>+</sup>	4.5	2.7
Magnesium	mg L <sup>-1</sup> Mg <sup>2+</sup>	11.0	10.7
Manganese	mg L <sup>-1</sup> Mn <sup>2+</sup>	0.94	0.61
Methane	mg L <sup>-1</sup> CH <sub>4</sub>	0.516	1.075
Sodium	mg L <sup>-1</sup> Na <sup>+</sup>	57.1	61.5
Sulfate	mg L <sup>-1</sup> SO <sub>4</sub> <sup>2+</sup>	50.6	45.7
Bicarbonate	mg L <sup>-1</sup> HCO <sub>3</sub> <sup>-</sup>	230	228
TOC	mg L <sup>-1</sup> C	2.2	2.6
EC at 20°C	mS/m	69.9	75.0
Temperature	°C	12	12
pH at 20°C	pH	7.33	7.22

\* Average values over the period from April 2004 [start of subsurface aeration] to the end of 2006.

\*\* Average values over the period from 2003 to the end of 2006.

Averages for ammonium, iron and manganese for Schuwacht are based on 12 samples per year and for Tiendweg on 36 to 46 samples per year. Other parameters were sampled less frequently (2 to 6 times per year).

The groundwater of both fields is treated separately on trickling sand filters with a filter bed height of 2 m and an average superficial velocity of 2.2 m/h. The trickling filters have forced ventilation with an average RQ (air to water ratio) of 10, resulting in nearly complete saturation of oxygen in the water and stripping of methane from the water. Average values for the influent and effluent concentrations of the primary removed substances in both filters are shown in Table 3.

**Table 3: Average influent and effluent concentrations for the subsurface and non-subsurface aerated filter**

		Subsurface Influent*	aerated Effluent**	filter Influent*	Non-subsurface Effluent**
Ammonium	mg/l N-NH <sub>4</sub> <sup>+</sup>	1.7	< 0.03	4.4	2.7
Nitrite	mg/l N-NO <sub>2</sub> <sup>-</sup>	<0.002	<0.002	<0.002	0.022
Nitrate	mg/l N-NO <sub>3</sub> <sup>-</sup>	<0.1	n.a.	<0.1	n.a.
Iron	mg/l Fe <sup>2+</sup>	3.7	0.007	5.6	0.009
Manganese	mg/l Mn <sup>2+</sup>	0.94	0.002	0.61	0.047
Methane	mg/l CH <sub>4</sub>	0.516	<0.010	1.075	<0.010

n.a. = not analysed.

\* Averages for the influent were taken from Table 2.

\*\* Averages for filter effluents were determined over a three months period around the sampling date (July-September 2006) because of the dynamic character of filter removal efficiency. Filter effluent was sampled on a weekly basis.

**4.3.2. Sand-specific nitrification rate**

Sand-specific nitrification rates over the filter bed height are shown for both filters in Figure 2.

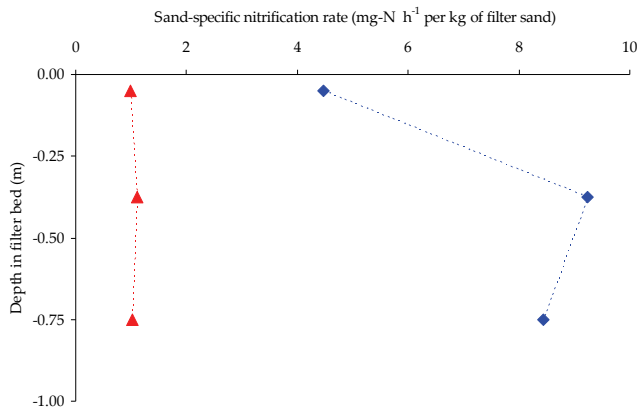

**Figure 2: Sand-specific nitrification rates over the filter bed height of the subsurface aerated filter (◆) and of the non-subsurface aerated filter (▲)**

The nitrification rate in the top layer of the subsurface aerated filter is, despite receiving the highest load of ammonium, lower than in the deeper layers. This finding coincides with an absence of nitrifying species found by DGGE in the top layer. The nitrification rates for the non-subsurface aerated filter are significantly lower than for the subsurface aerated filter. The molecular tools used did not show the presence of AOB, AOA and NOB, in this non-subsurface aerated filter. The nitrification rate is more or less constant over the filter bed height.

#### 4.3.3. DGGE analysis of groundwater samples

DGGE analysis of PCR-amplified 16S rRNA gene fragments of Bacteria (Figure 3, BAC lanes) and Archaea (Figure 3, ARC lanes) was used to study the microbial communities present in the subsurface aerated and non-subsurface aerated wells. In addition, an attempt was made to determine the diversity of AOB using the CTO primers (see Figure 3, CTO lanes). In all groundwater samples, Bacteria (6 bands in total), as well as Archaea (10 bands in total) were observed. No PCR product was obtained with the CTO primers, suggesting that the AOB of this group were below the detection limit or absent from the groundwater samples. A total of 12 bands (see Figure 3, bands 1 to 12) were selected for sequencing, either because they represented a dominant band, or because they were found to be significantly different in the subsurface aerated well sample compared to the other groundwater samples.



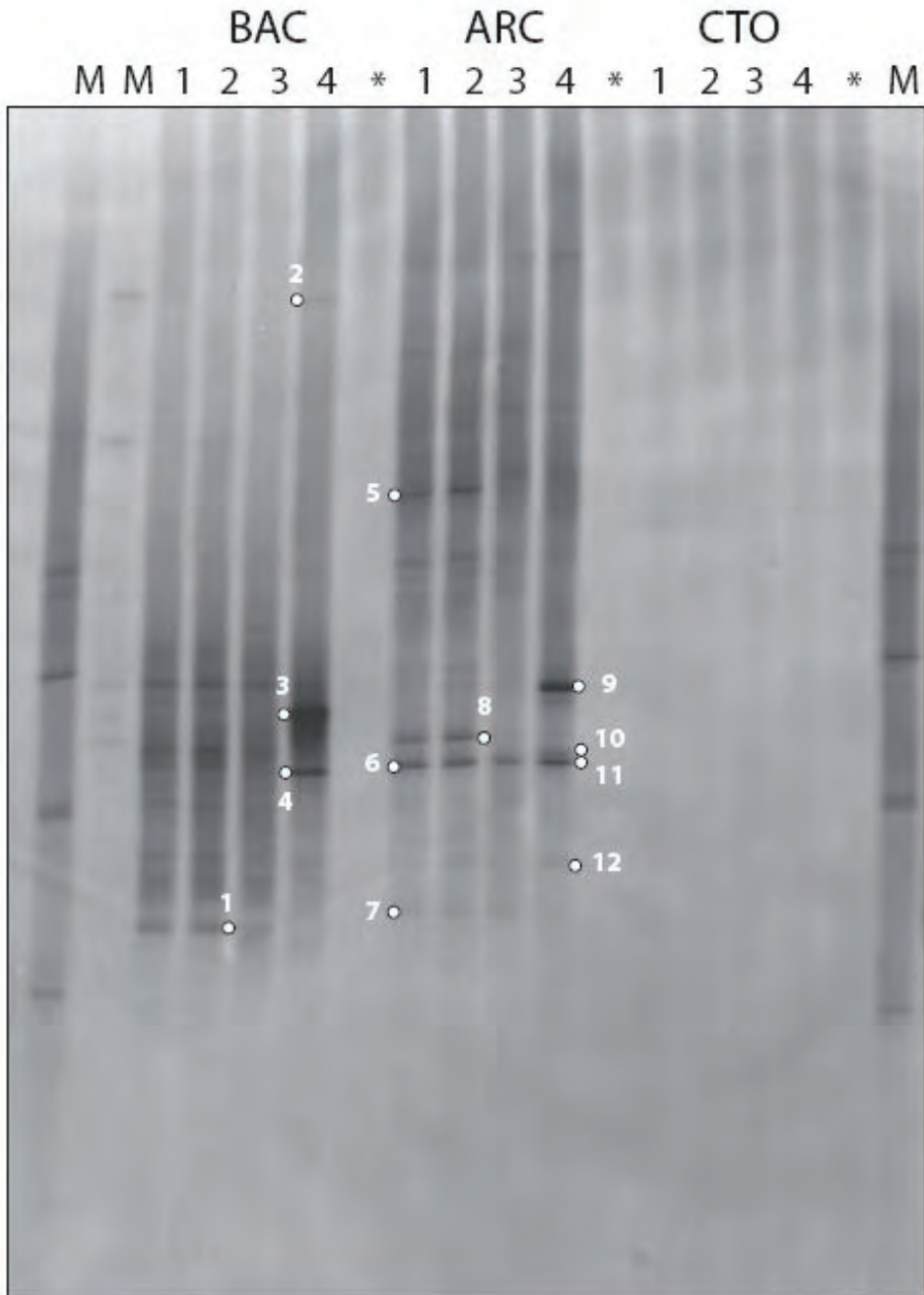

Figure 3: DGGE analysis of 16S rRNA gene fragments amplified from DNA extracts from different raw water samples. Lane 1 and 2, from non-subsurface aerated Tiendweg raw water headers; lane 3, from a non-subsurface aerated Schuwacht well; lane 4, from the subsurface aerated Schuwacht well.

Similar DGGE profiles were found for the samples of the non-subsurface aerated Tiendweg field (Figure 3, lanes 1 and 2) and the non-subsurface aerated reference sample from the Schuwacht field (Figure 3, lane 3). The groundwater sample of the subsurface aerated well from the Schuwacht field (GLSP08Z, lane 4) contained several additional bands (e.g., 2, 3, 4, 9, 10, and 12), which were not found in the non-subsurface aerated wells, while others were found with a much lower intensity in the subsurface aerated well (e.g., 1, 5, 7, and 8). Bands 6 and 11 were found in both the subsurface aerated as well as the non-subsurface aerated wells, with a similar intensity.

#### 4.3.4. DGGE analysis of sand filter samples

The DGGE profiles in Figure 4 represent PCR-amplified 16S rRNA gene fragments of Bacterial (BAC, lanes 5 to 10) and Archaeal (ARC, lanes 5 to 10) populations that were present in the sand filter samples. Additionally, 16S rRNA genes of a group of well-described AOB were amplified using the CTO primers and subjected to DGGE analysis (CTO, lanes 5 to 10). The Bacterial and Archaeal profiles reveal a large number of minor and several more dominant bands. Additionally, several bands were found in the PCR product that was amplified by the CTO primers. Lane numbers 5 to 7 represent samples taken from different depths in the non-subsurface aerated Tiendweg filter, while lane numbers 8 to 10 represent samples taken from different depths in the subsurface aerated Schuwacht filter. A total of 29 bands were selected for sequencing because they represented a dominant band, because they were found to be significantly different in the subsurface aerated filter sample compared to the other filter samples, or because they were amplified using the CTO primers. Nineteen sequences were useful for further identification, representing the numbered bands (13 to 31) in the gel. The other bands could not be read due to contamination with unknown sequences.

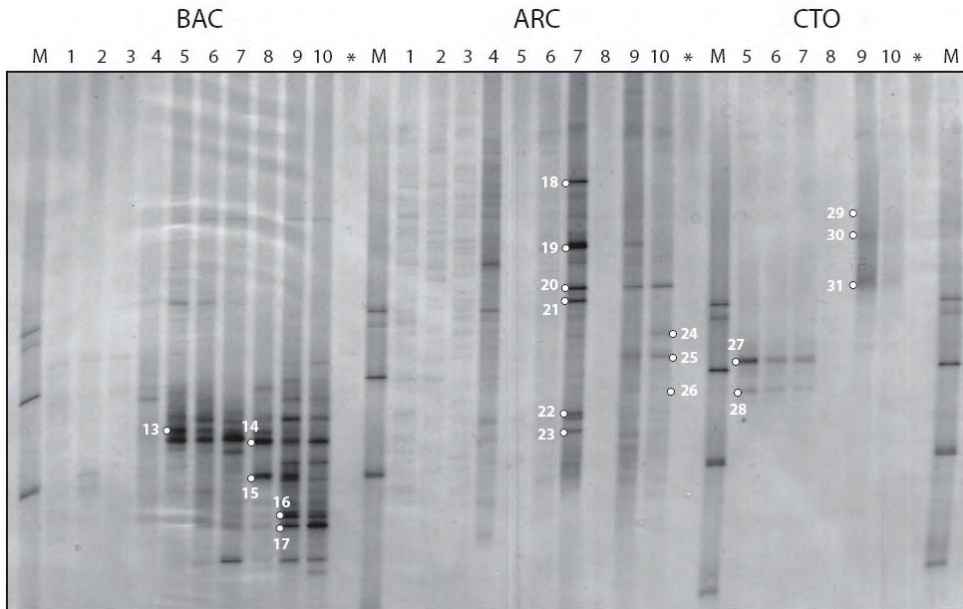

Figure 4: DGGE analysis of 16S rRNA gene fragments amplified from DNA extracts from different drinking water filters samples. Lane 1 to 4, identical raw water samples to those in Figure 3, the small volume samples used here contained insufficient 16S rRNA genes for DGGE analysis (see Discussion); lane 5, non-subsurface aerated Tiendweg filter, depth 0/10cm; lane 6, non-subsurface aerated Tiendweg filter, depth 25/50cm; lane 7, non-subsurface aerated Tiendweg filter, depth 50/100cm, lane 8, subsurface aerated Schuwacht filter, depth 0/10cm; lane 9, subsurface aerated Schuwacht filter, depth 25/50cm; lane 10, subsurface aerated Schuwacht filter, depth 50/100cm

#### 4.3.5. Comparative sequence analysis of groundwater samples

The phylogenetic affiliation of the Bacterial 16S rRNA gene sequences (BAC) that were amplified from the groundwater samples is shown in Figure 5, while the Archaeal 16S rRNA gene sequences are shown in Figure 6.

The Bacteria that were detected as dominant DGGE bands in the Schuwacht subsurface aerated well sample are closely affiliated with the iron-oxidizing bacterium *Gallionella ferruginea* in the case of bands 2 and 3, and with the ammonium-oxidizing *Nitrosovibrio tenuis* and *Nitrosospira briensis* strains in the case of band 4. The Archaeal sequences that were found specifically in the subsurface aerated well include organisms that were distantly related to methanogenic *Methanosaeta* species (band 10) or to uncharacterized clones (bands 9 and 12). The sequences of bands 6 and 11 were identical to the *Methanosaeta*-like sequence found in band 10, showing that this organism was present in both subsurface aerated as well as non-subsurface aerated wells. The bands that were found to be more dominant in the groundwater of the non-subsurface aerated wells compared to the subsurface aerated well included sequences that were related to a

*Magnetobacterium bavaricum* (band 1), and to uncharacterized (bands 5, and 8) or *Methanosaeta*-like archaea.

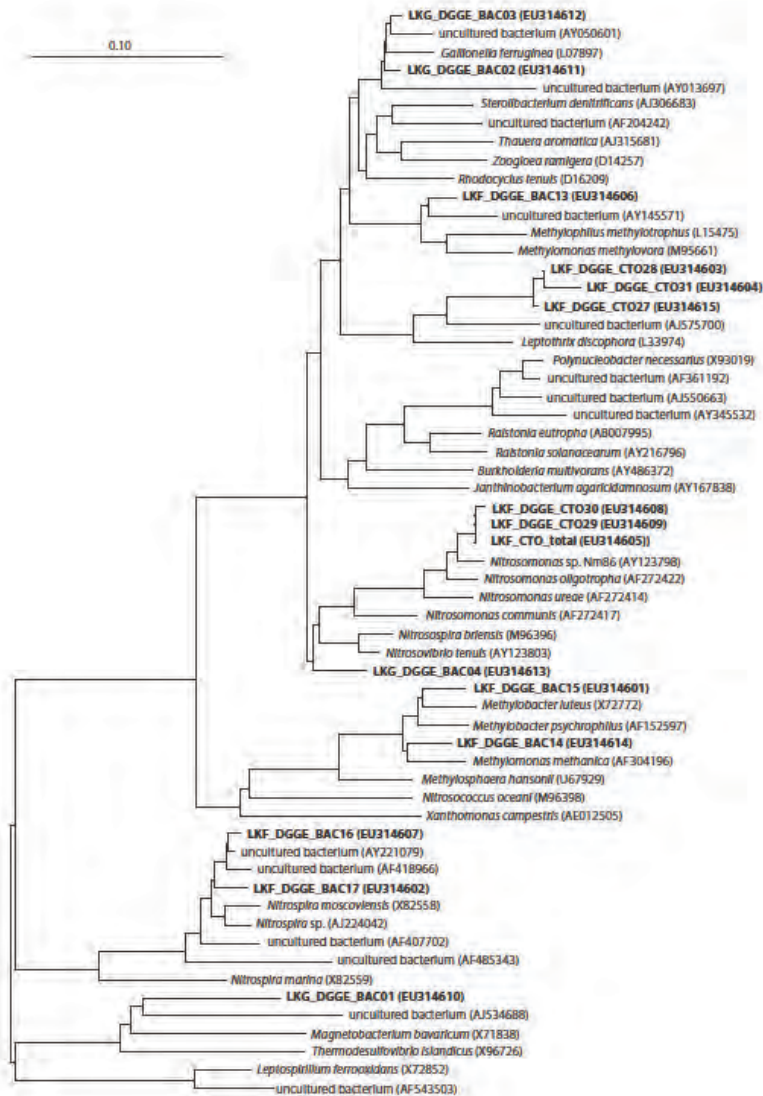

Figure 5: Phylogenetic affiliation of the Bacterial 16S rRNA gene sequences from DGGE profiles of the different groundwater (LKG) and (LKF) filter samples

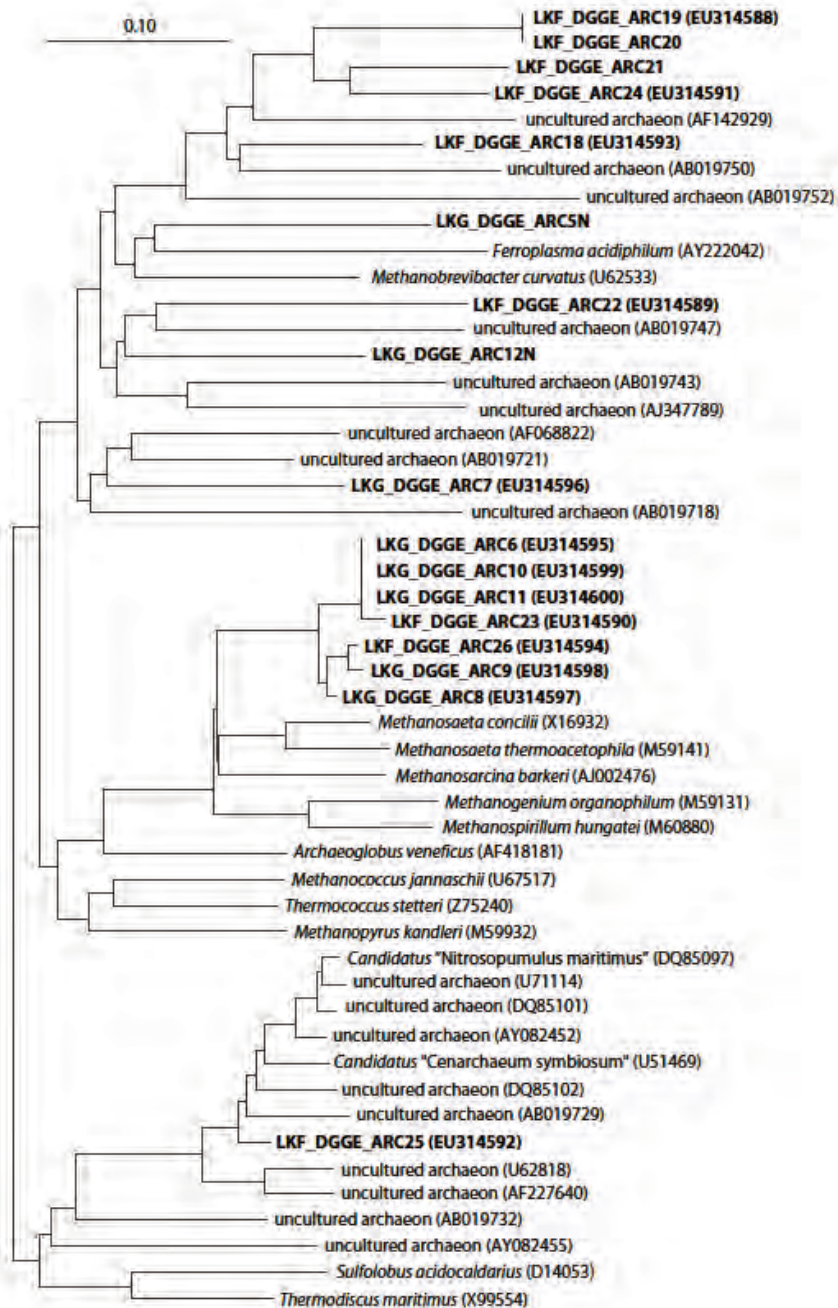

Figure 6: Phylogenetic affiliation of the Archaeal 16S rRNA gene sequences from DGGE profiles of the different groundwater (LKG) and filter (LKF) samples

#### 4.3.6. Comparative sequence analysis of sand filter samples

The phylogenetic affiliation of the Bacterial 16S rRNA gene sequences (BAC and CTO) that were amplified from the filter samples is shown in Figure 5, while the Archaeal 16S rRNA gene sequences are shown in Figure 6. The Bacterial profile revealed a sequence related to the methylotroph *Methylomonas methylovora* that was found as a dominant DGGE band in the non-subsurface aerated sample (band 13), while sequences from two bands, 14 and 15, that were found specifically in the subsurface aerated filters were also related to the methylotrophs, *Methylomonas methanica* and *Methylobacter luteus*, respectively. Two bands that were predominantly found in the lower depths of the subsurface aerated filter (band 16 and 17) were closely affiliated with the nitrite-oxidizing *Nitrospira* species, supporting evidence of the conversion of nitrite by NOB species in these filters. The Archaeal profile suggests that most of the Archaea are found in the lower depths of the non-subsurface aerated (ARC, lane 7) and subsurface aerated filters (ARC, lanes 9 and 10). Sequences retrieved from bands 18-21 (dominant in the non-subsurface aerated filter), and band 24 (dominant in the subsurface aerated filter) were found to be most closely related to uncultured archaea (bands 18-21), making any correlation to possible physiological functions impossible. ARC amplified bands 23 and 26 were found to be closely related to each other and to the sequences 6, 8, 10, and 11 found in the groundwater samples. These sequences were all very closely related to the methanogenic group of *Methanosaeta*. Although most closely related to an uncultured Archaeon, the sequence of band 25 that was found in the subsurface aerated Schuwacht filter is related to strains named *Candidatus* "Cenarchaeum symbiosum" and *Candidatus* "Nitrosopumulus maritimus", organisms that have been described as potential ammonium oxidizers (Hallam et al. (2006) and Könneke et al. (2005) respectively). The PCR products obtained with the CTO PCR in the subsurface aerated filters suggest the presence of the well-described ammonium oxidizer *Nitrosomonas* as the sequences of bands 29 and 30 are closely related to this species. Direct sequencing of the CTO PCR product ("LKF\_CTO\_total" in the Bacterial tree) resulted in the same identification, suggesting that *Nitrosomonas* are the dominant species found by amplification with the CTO primers. The absence of *Nitrosomonas*-related sequences in the Tiendweg non-subsurface aerated filter suggests that the presence of this organism is indeed correlated to the conversion of ammonium in the Schuwacht subsurface aerated filters. Finally, three sequences (CTO 27, 28 and 31) distinctly related to *Leptothrix discophora* were found mainly in the top layers of the non-subsurface aerated filter, but to a lesser extent also in the 25-50 cm depth of the subsurface aerated filter.

#### Detection of *Nitrobacter*

Despite the general claim in textbooks, no *Nitrobacter* spp. were found in any of the raw water and filter samples. This suggests that this organism is absent in these samples or is present at numbers below the detection limit of the method.

### 4.4. Discussion

#### 4.4.1. Molecular characterization of populations in groundwater treatment for drinking water production

Both groundwater and drinking water filters contain diverse populations of Bacterial and Archaeal microorganisms. The three target-based 16S rRNA gene DGGE approach (Bacteria, Archaea and CTO) provides a good overview of and adequately focused information for the most relevant microbial species present. The inclusion of Archaea in this analysis is relevant as will be further explained in the next section. Combining the search for the Bacterial composition of the samples with a specific search for AOB results in a balanced insight into the organisms that can be responsible for the differences in the nitrification rates that are observed in the filters. *Nitrosomonas* was identified in the subsurface aerated filter sample after amplification with the CTO primerset, but not when general Bacterial primers were used. This suggests that *Nitrosomonas* is a dominant AOB, but not one of the dominant species in the general Bacterial population. A similar observation was made by Qin et al. (2007) for drinking water filters treating surface water.

The identification of sequences related to *Leptothrix discophora*, that like AOB belongs to the *Betaproteobacteria*, after amplification with the CTO primers, shows that these primers are not exclusively targeting AOB. Identification of species closely related to the AOB after CTO-amplification was previously also reported by Ikenaga et al. (2003). In contrast, in the subsurface aerated groundwater *Nitrosospira* spp. were only determined after amplification with the general Bacterial and not with the CTO-amplification as could be expected. This limitation of the CTO primers for some *Nitrosospira* spp. was reported before by Mahmood et al. (2006).

#### 4.4.2. Nitrifying Archaea in groundwater treatment for drinking water production

The results of this study show the insufficiency of the accepted view presented in textbooks on nitrification in drinking water filters: AOB are only represented by *Nitrosomonas* and NOB only by the *Nitrobacter* genera. (Degrémont, 2007; de Moel et al., 2006). Although *Nitrosomonas* indeed turned out to be a relevant AOB, the only NOB found in the drinking water filter belonged to *Nitrospirae*; *Nitrobacter* was not found. Blackburne et al. (2007) demonstrated that *Nitrospira*, rather than



*Nitrobacter*, dominate nitrite oxidation under conditions with low ammonium and nitrite concentrations because *Nitrospira* has a higher affinity for ammonium and a higher growth yield. The Bacterial nitrifying population found in this study corresponds to populations described in recent studies on drinking water treatment. Qin et al. (2007) found that *Nitrosomonas* spp. dominate over *Nitrospira* in an aerated submerged biofilm reactor for drinking water pretreatment in Shanghai. Lipponen et al. (2004) found *Nitrosomonas* dominant in newly formed biofilms in drinking water distribution systems. Martiny et al. (2005) found *Nitrospirae* spp. to be the dominant NOB in drinking water produced from aerated and filtered anaerobic groundwater in Denmark.

This study shows that Archaea might play a role in drinking water nitrification in addition to the well-known *Proteobacteria*. Sequences closely related to the ammonium-oxidizing *Candidati* "Cenarchaeum symbiosum" and "Nitrosopumilus maritimus" were found to represent a significant part of the Archaeal population in the active nitrifying drinking water trickling filter. Their relative importance in the nitrification process in drinking water filters is unknown at this time. Recent studies, however, showed that Archaea might play a significant role in ammonium oxidation in other systems, such as marine water columns and sediments (Francis et al., 2005) and Wastewater Treatment Plant Bioreactors (Park et al., 2006). Wuchter et al. (2006) found that the concentration of Archaeal *amoA* was significantly higher than that of Bacterial *amoA* in both the natural and enriched North Sea waters. The dominant Archaeal *amoA* gene they found was closely related to the *Candidatus* "Nitrosopumilus maritimus". Leininger et al. (2006) demonstrated that Archaea are far more important than Bacteria for nitrification in different soils and suggest that they are the major ammonia-oxidizing microorganisms in soil ecosystems around the world. There is a larger degree of variety within Archaeal *amoA* encoding sequences as compared to the variety within Bacterial *amoA* genes (Francis et al., 2005), which predicts the discovery of new AOA species in near future. The Archaea found in the Oasen subsurface aerated groundwater filter may also belong to this group.

Current research in which molecular techniques are used to obtain more insight in the nitrification in drinking water treatment, the role of Archaea is still ignored (Lytle et al., 2007; Qin et al., 2007). This study and the evidence described above show that Archaea should not be omitted in molecular surveys on nitrification in drinking water treatment. Because of their possible relative importance over Bacterial nitrifiers, it is mandatory to include Archaea in the quantitative molecular techniques for the assessment of drinking water systems in the near future.



#### 4.4.3. Microbial populations in subsurface and non-subsurface aerated groundwater

Subsurface aeration leads to some interesting shifts in Bacterial populations in the groundwater. The Archaeal population in the groundwater is not significantly influenced by subsurface aeration, although some shifts in *Methanosaeta* spp. can be observed. Minor changes also appear within the Archaea that are related to uncultured species. Since their physiology is unknown, their role in the process can't be assessed. Two groups of Bacteria are clearly stimulated by subsurface aeration, the iron-oxidizing bacterium *Gallionella ferruginea* and the AOB related to the species of *Nitrosovibrio tenuis* and *Nitrosospira briensis*. As both may play a role in the impact of subsurface aeration on nitrification in drinking water filters, their presence is discussed in more detail in the section entitled "Impact of subsurface aeration on nitrification in trickling filters" below.

One species of Bacteria appears to be oppressed in the subsurface aerated groundwater. *Magnetobacterium bavaricum* is found only in the non-subsurface aerated groundwater from the Tiendweg well field. Although not the most abundant type of Magnetotactic bacteria (MTB) in nature, *Magnetobacterium bavaricum* is regularly observed in natural samples. Spring et al. (1993) found that the natural habitat for *Magnetobacterium bavaricum* is the micro-aerobic, hydrogen sulfide containing zone. The researchers suggest an iron-dependent way of energy conservation with redox reactions between iron and sulfide at the centre in their catabolism. The ability of the *Magnetobacterium bavaricum* to use iron can make this organism relevant to the effects of subsurface aeration. Its absence in the non-subsurface aerated groundwater well of the Schuwacht field suggests, however, that its role in the decrease of nitrification is not crucial. Non-subsurface aerated Schuwacht groundwater contains more sulfate than Tiendweg, indicating less reduction of sulfate to sulfide which results in less favorable circumstances for MTB.

#### 4.4.4. Microbial populations in active and inactive nitrifying drinking water filters

The molecular characterization of populations in the active and poorly active nitrifying filter confirms the first hypothesis: the low nitrifying activity is caused by the absence of nitrifying microorganisms rather than by the inhibition of their activity. In the subsurface aerated filter, both Bacterial and Archaeal nitrifying species are present in all but the top layer.

In addition to this general observation, the characterization provides more detailed information. Significant differences in the Archaeal populations are found between the filters with and without subsurface aeration. Especially in the deeper layer of the non-subsurface aerated filter, several bands linked to yet unidentified species are found.

Species related to *Leptothrix discophora* are more frequently found in the non-subsurface aerated filter than in the subsurface aerated filter. *Leptothrix discophora* is the only species that is capable of enzymatically catalyzing both iron- and manganese-oxidation (Corstjens et al., 1992). Their presence suggests that biological processes play a role in manganese removal in the Oasen groundwater trickling filters.

For non-subsurface aerated systems, nitrification in the full-scale filter and sand-specific nitrification rates in the batch experiments are low, but not insignificant. The residual activity could be explained by the presence of AOB or AOA below the threshold of the applied PCR/DGGE methods. Alternatively, residual nitrification may be performed by methane oxidizers, such as the *Betaproteobacteria Methylophilus* and the *Gammaproteobacteria Methylobacter* that were found. These are closely related to nitrifying *Proteobacteria* and capable of ammonium oxidation because of the close resemblance of the methane and ammonium-oxidizing enzymes (Holmes et al., 1995). Residual nitrite oxidation is also observed, suggesting that NOB, being the only known nitrite oxidizers so far, are present in the filter in low numbers.

#### 4.4.5. Impact of subsurface aeration on nitrification in trickling filters

The second hypothesis in this study, which states that the enhancement of nitrification is caused by the effect of microbial growth in the aquifer due to subsurface aeration, is also evaluated using molecular characterization. This effect might work through direct inoculation of the filters with nitrifying microorganisms or by changing the raw water composition. As for the first mechanism, the characterizations reveal that the only *Nitrosovibrio*- or *Nitrospira*-like sequence found in the subsurface aerated groundwater bears little resemblance to the nitrifiers found in the subsurface aerated filter, which were characterized as *Nitrosomonas*. This suggests that inoculation of the filters with nitrifiers from subsurface aerated groundwater does not play a direct role in promoting nitrifying activity in subsurface aerated filters. Although *Nitrospira* could not be identified in the filter samples by the DGGE methods applied, we cannot exclude they were still there. The presence of *Nitrospira* in the subsurface aerated water but the lack of this species in the filters corresponds to observations that *Nitrospira* are generally found more abundantly in soils, but are often outpaced by the more rapid-growing *Nitrosomonas* (Belser, 1979)).

The fact that *Nitrosomonas* was found in the filter but not in the groundwater may be caused by restrictions of the applied PCR/DGGE method. *Nitrosomonas* might still be inoculated continuously in low numbers that are under the detection limit of this method. The biomass concentration in the tested groundwaters is very low. Repetition of groundwater sampling was necessary before sufficient DNA for PCR-amplification was collected. Raw water sampling in August 2006 of only small

volumes (i.e., 30 mL per sample) resulted in insufficient PCR products for identification. In December 2006, raw water sampling was successfully repeated with much larger volumes (i.e., 1100 mL per sample). With the detection limit of the method being 100 cells, 10% extraction yield and an assay volume of 1/50, the overall detection limit for each analysis becomes  $5 \times 10^4$  cells for the total sample volume. Based on this detection limit and the observation of organisms in the DGGE-gel in the 1100 mL but not in the 30 mL samples, the cell numbers for each species in the groundwater samples, including *Nitrospira*, is calculated between  $4.5 \times 10^1$  and  $2 \times 10^3$  cells mL<sup>-1</sup> of groundwater. *Nitrosomonas* and AOA were not detected in the large groundwater sample, suggesting that the cell concentration for each species was less than  $4.5 \times 10^1$  cells mL<sup>-1</sup> of groundwater. Comparing these numbers to the estimated total number of  $10^{15}$  nitrifying cells present in the filter places the role of inoculation of nitrifying microorganisms in perspective. During one filter run of two days (with  $Q = 40$  m<sup>3</sup>/h, 20% from subsurface aerated well) an approximate maximum of  $2 \times 10^{10}$  *Nitrosomonas* and AOA cells and  $8 \times 10^{11}$  *Nitrospira* cells may be inoculated, while in the same period the population in the filter may have doubled by growth. Although this suggests at most a minor role for inoculation as a result of subsurface aeration, further research is required to test the inoculation hypothesis. The subsurface aerated groundwater has so far been sampled only once at the end of a subsurface aeration cycle. Future experiments will focus on the quantification of dominant species during the entire subsurface aeration cycle in both the groundwater and the filters samples by using Q-PCR.

There are several species other than nitrifiers in the groundwater that might be of relevance to the enhancement of nitrification in filters. The acetotrophic and methanogenic euryarchaeal species of *Methanosaeta* were present in all groundwater and filter samples tested. They are, therefore, continuously inoculated by the raw groundwater in the filters and are able to survive there. The presence of these methanogens in all types of groundwater at Lekkerkerk is to be expected considering the significant levels of methane (Nicol et al., 2003). *Methanosaeta* spp. are strictly anaerobic (Patel and Sprott, 1990), so that growth in the trickling filters will be marginal, unless large anaerobic pockets occur. So far, no indications of this have been found and their presence in the filters can be attributed to the continuous inoculation from the raw groundwater.

The role of *Gallionella ferruginea* in the process, however, may be significant. This iron-oxidizing bacterium, although continuously inoculated from the subsurface aerated groundwater, is absent or present in very low numbers in the subsurface aerated filter. Biological iron oxidation is expected to be of minor importance in the trickling filter because of the unfavorable circumstances in the filter, like high pH and oxygen concentrations and the inhibitory effect of ammonium (Sharma et al., 2005). The presence of *Gallionella ferruginea* in the raw water of a filter may, however, still have a major impact on the physical-chemical oxidation of iron.

Their oxidation products or even their cells might be part of the mobile iron colloids related to the enhanced nitrification in the production filters, as proposed by Wolthoorn et al. (2004). For this reason additional studies into the role of *Gallionella ferruginea* in the enhancement of nitrification by subsurface aeration will be performed.

#### 4.5. Conclusions

- With DGGE of 16S rRNA genes and a set of Bacterial, Archaeal and CTO primers, a characterization of the microbial population in groundwater and drinking water filters was established.
- The data suggest that ammonia-oxidizing archaea, similar to *Candidati "Cenarchaeum symbiosum"* or "*Nitrosopumilus maritimus*" are found in significantly amounts in nitrifying drinking water filters. They may therefore play a role in nitrification in drinking water production. For this reason, Archaea should be included in molecular surveys on nitrifying microorganisms in drinking water systems.
- For the particular case study of subsurface aeration, this approach proves that loss of nitrifying capacity of a filter is caused by the absence of nitrifying organisms.
- The presence of the iron-oxidizing bacteria *Gallionella ferruginea* in subsurface aerated groundwater only, might influence the iron oxidation and thereby enhance nitrification in drinking water filters.

## References

Appelo, C.A.J. and de Vet, W.W.J.M. (2003) Arsenic in groundwater; A.H. Welch and K.G. Stollenwerk, e. (Ed), pp. 381-401, Kluwer Academic, Boston.

Appelo, C.A.J., Drijver, B., Hekkenberg, R. and Jonge, M. (1999) Modeling In Situ Iron Removal from Ground Water. *Ground Water* 37(6), 811-817.

Belser, L.W. (1979) Population ecology of nitrifying bacteria. *Annual Review of Microbiology* 33, 309-333.

Blackburne, R., Vadivelu, V.M., Yuan, Z. and Keller, J. (2007) Kinetic characterisation of an enriched *Nitrospira* culture with comparison to *Nitrobacter*. *Water Research* 41(14), 3033-3042.

Corstjens, P.L.A.M., De Vrind, J.P.M., Westbroek, P. and De Vrind-De Jong, E.W. (1992) Enzymatic iron oxidation by *Leptothrix discophora*: Identification of an iron-oxidizing protein. *Applied and Environmental Microbiology* 58(2), 450-454.

de Moel, P.J., Verberk, J.Q.J.C. and van Dijk, J.C. (Eds) (2006) *Drinking water : principles and practice*, Singapore : World Scientific.

De Vet, W.W.J.M., Rietveld, L.C. and Van Loosdrecht, M.C.M. (2007) Influence of iron on nitrification in full-scale drinking water filters.

Degrémont (Ed) (2007) *Water Treatment Handbook*, Lavoisier SAS.

Francis, C.A., Roberts, K.J., Beman, J.M., Santoro, A.E. and Oakley, B.B. (2005) Ubiquity and diversity of ammonia-oxidizing archaea in water columns and sediments of the ocean. *Proceedings of the National Academy of Sciences of the United States of America* 102(41), 14683-14688.

Hallam, S.J., Mincer, T.J., Schleper, C., Preston, C.M., Roberts, K., Richardson, P.M. and DeLong, E.F. (2006) Pathways of carbon assimilation and ammonia oxidation suggested by environmental genomic analyses of marine Crenarchaeota. *PLoS biology* 4(4).

Holmes, A.J., Costello, A., Lidstrom, M.E. and Murrell, J.C. (1995) Evidence that particulate methane monooxygenase and ammonia monooxygenase may be evolutionarily related. *FEMS Microbiology Letters* 132(3), 203-208.

Ikenaga, M., Asakawa, S., Muraoka, Y. and Kimura, M. (2003) Phylogenetic study on CTO primer-amplified ammonia-oxidizing bacteria and *Betaproteobacteria* associated with rice roots grown in a flooded paddy soil. *Soil Science and Plant Nutrition* 49(5), 719-727.

Kihn, A., Laurent, P. and Servais, P. (2000) Measurement of potential activity of fixed nitrifying bacteria in biological filters used in drinking water production. *Journal of Industrial Microbiology and Biotechnology* 24(3), 161-166.

Könneke, M., Bernhard, A.E., De La Torre, J.R., Walker, C.B., Waterbury, J.B. and Stahl, D.A. (2005) Isolation of an autotrophic ammonia-oxidizing marine archaeon. *Nature* 437(7058), 543-546.

Kowalchuk, G.A., Stephen, J.R., De Boer, W., Prosser, J.I., Embley, T.M. and Woldendorp, J.W. (1997) Analysis of ammonia-oxidizing bacteria of the b subdivision of the class Proteobacteria in coastal sand dunes by denaturing gradient gel electrophoresis and sequencing of PCR-amplified 16S ribosomal DNA fragments. *Applied and Environmental Microbiology* 63(4), 1489-1497.

Leininger, S., Urich, T., Schloter, M., Schwark, L., Qi, J., Nicol, G.W., Prosser, J.I., Schuster, S.C. and Schleper, C. (2006) Archaea predominate among ammonia-oxidizing prokaryotes in soils. *Nature* 442(7104), 806-809.

Lipponen, M.T.T., Martikainen, P.J., Vasara, R.E., Servomaa, K., Zacheus, O. and Kontro, M.H. (2004) Occurrence of nitrifiers and diversity of ammonia-oxidizing bacteria in developing drinking water biofilms. *Water Research* 38(20), 4424-4434.

Ludwig, W., Strunk, O., Westram, R., Richter, L., Meier, H., Yadhukumar, A., Buchner, A., Lai, T., Steppi, S., Jacob, G., Förster, W., Brettske, I., Gerber, S., Ginhart, A.W., Gross, O., Grumann, S., Hermann, S., Jost, R., König, A., Liss, T., Lüßmann, R., May, M., Nonhoff, B., Reichel, B., Strehlow, R., Stamatakis, A., Stuckmann, N., Vilbig, A., Lenke, M., Ludwig, T., Bode, A. and Schleifer, K.H. (2004) ARB: A software environment for sequence data. *Nucleic Acids Research* 32(4), 1363-1371.

Lydmark, P., Lind, M., Sörensson, F. and Hermansson, M. (2006) Vertical distribution of nitrifying populations in bacterial biofilms from a full-scale nitrifying trickling filter. *Environmental Microbiology* 8(11), 2036-2049.

Lytle, D.A., Sorg, T.J., Wang, L., Muhlen, C., Rahrig, M. and French, K. (2007) Biological nitrification in a full-scale and pilot-scale iron removal drinking water treatment plant. *Journal of Water Supply: Research and Technology - AQUA* 56(2), 125-136.

Mahmood, S., Freitag, T.E. and Prosser, J.I. (2006) Comparison of PCR primer-based strategies for characterization of ammonia oxidizer communities in environmental samples, pp. 482-493.

Martiny, A.C., Albrechtsen, H.-J., Arvin, E. and Molin, S. (2005) Identification of Bacteria in Biofilm and Bulk Water Samples from a Nonchlorinated Model Drinking Water Distribution System: Detection of a Large Nitrite-Oxidizing Population Associated with *Nitrospira* spp, pp. 8611-8617.

Nicol, G.W., Glover, L.A. and Prosser, J.I. (2003) Molecular analysis of methanogenic archaeal communities in managed and natural upland pasture soils. *Global Change Biology* 9(10), 1451-1457.

Park, H.D., Wells, G.F., Bae, H., Griddle, C.S. and Francis, C.A. (2006) Occurrence of ammonia-oxidizing archaea in wastewater treatment plant bioreactors. *Applied and Environmental Microbiology* 72(8), 5643-5647.

Patel, G.B. and Sprott, G.D. (1990) *Methanosaeta concilii* gen. nov., sp. nov. ('*Methanothrix concilii*') and *Methanosaeta thermoacetophila* nom. rev., comb. nov. *International Journal of Systematic Bacteriology* 40(1), 79-82.

Qin, Y.Y., Li, D.T. and Yang, H. (2007) Investigation of total bacterial and ammonia-oxidizing bacterial community composition in a full-scale aerated submerged biofilm reactor for drinking water pretreatment in China. *FEMS Microbiology Letters* 268(1), 126-134.

Sharma, S.K., Petrushevski, B. and Schippers, J.C. (2005) Biological iron removal from groundwater: A review. *Journal of Water Supply: Research and Technology - AQUA* 54(4), 239-247.

Spring, S., Amann, R., Ludwig, W., Schleifer, K.H., Van Gernerden, H. and Petersen, N. (1993) Dominating role of an unusual magnetotactic bacterium in the microaerobic zone of a freshwater sediment. *Applied and Environmental Microbiology* 59(8), 2397-2403.

Wolthoorn, A., Temminghoff, E.J.M. and Van Riemsdijk, W.H. (2004) Effect of synthetic iron colloids on the microbiological  $\text{NH}_4^+$  removal process during groundwater purification. *Water Research* 38(7), 1884-1892.

Wuchter, C., Abbas, B., Coolen, M.J.L., Herfort, L., Van Bleijswijk, J., Timmers, P., Strous, M., Teira, E., Herndl, G.J., Middelburg, J.J., Schouten, S. and Damste, J.S.S. (2006) Archaeal nitrification in the ocean. *Proceedings of the National Academy of Sciences of the United States of America* 103(33), 12317-12322.





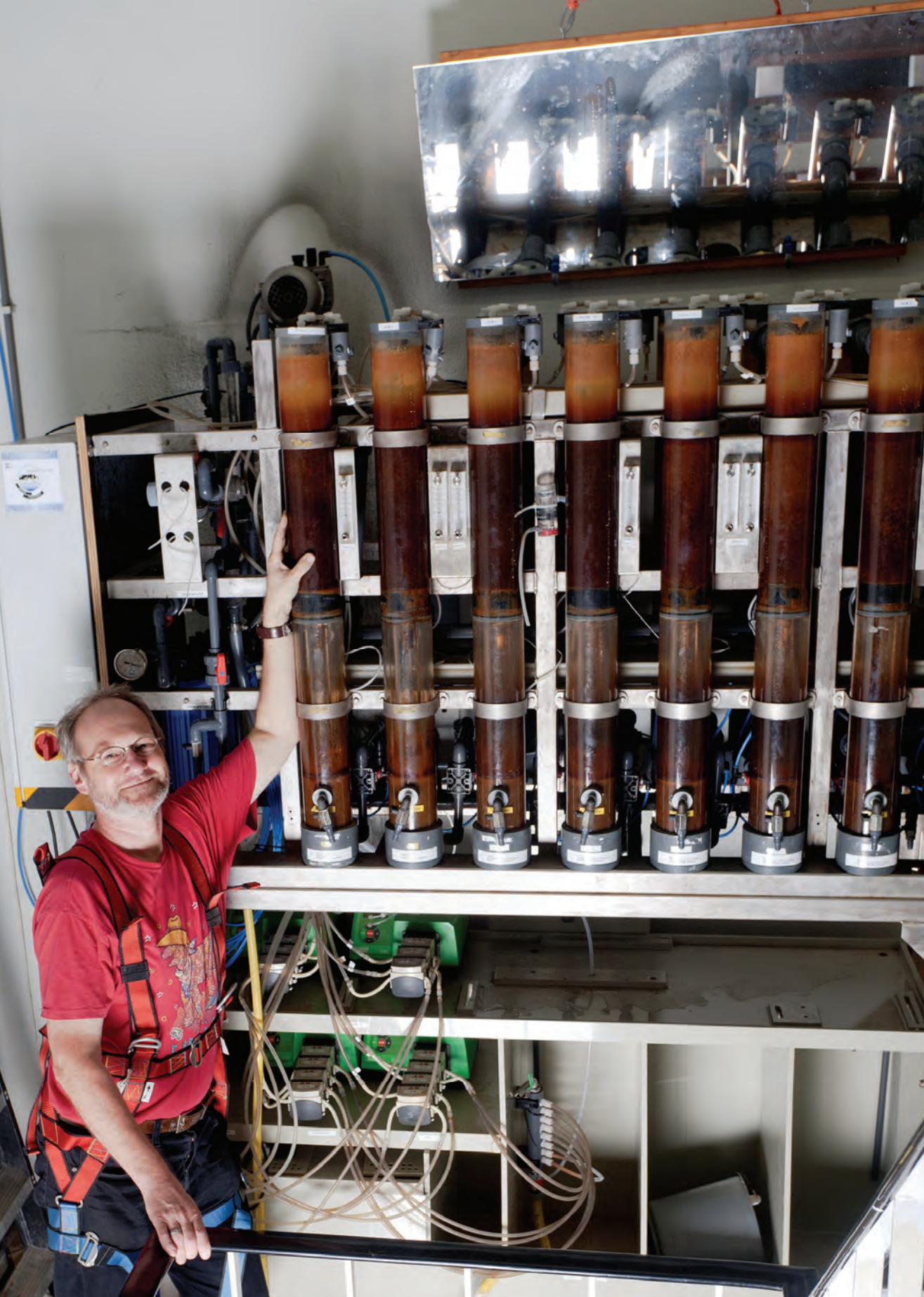

# CHAPTER 5

---

## Biological iron oxidation by *Gallionella* spp. in drinking water production under oxygen saturated conditions

5

**Submitted as:**  
de Vet, W.W.J.M., Dinkla, I.J.T., Rietveld, L.C.  
and van Loosdrecht, M.C.M.  
Biological iron oxidation by *Gallionella* spp. in drinking  
water production under oxygen saturated conditions.

## Abstract

Iron oxidation under neutral conditions (pH 6.5 to 8) may be a homo- or heterogeneous chemically- or a biologically-mediated process. The chemical oxidation is supposed to outpace the biological process under slightly alkaline conditions (pH 7 to 8). The iron oxidation kinetics and growth of *Gallionella* spp. – obligatory chemolithotrophic iron oxidizers – were assessed in natural, organic carbon-containing water, in continuous lab-scale reactors and full-scale groundwater trickling filters in the Netherlands. From *Gallionella* cell numbers determined by qPCR, balances were made for all systems. The homogeneous chemical iron oxidation occurred in accordance with the literature, but was retarded by a low water temperature (13 °C). The contribution of the heterogeneous chemical oxidation was, despite the presence of freshly formed iron oxyhydroxides, much lower than in previous studies in ultrapure water. This could be caused by the adsorption of natural organic matter (NOM) on the iron oxide surfaces. In the oxygen saturated natural water with a pH ranging from 6.5 to 7.7, *Gallionella* spp. grew uninhibited and biological iron oxidation was an important, and probably the dominant, process. *Gallionella* growth was not even inhibited in a full-scale filter after plate aeration. From this we conclude that *Gallionella* spp. can grow under neutral pH and oxygen- saturated conditions when the chemical iron oxidation is retarded by low water temperature and inhibition of the autocatalytic iron oxidation.

## Keywords

qPCR, *Gallionella* spp., groundwater trickling filtration, biological and chemical iron oxidation

## Abbreviations and Notations

IOB	=	iron-oxidizing bacteria
NOM	=	natural organic matter
qPCR	=	(quantitative) real-time polymerase chain reaction
WTP	=	water treatment plant

## 5.1. Introduction

The existence and relevance of iron-oxidizing bacteria (IOB) in drinking water treatment has been well established from the very beginning of central water supply. Berger and Berger (1928) mentioned that only five years after start-up, all Berlin Water Works were forced to switch from groundwater to surface water in 1882 due to a so-called 'Eisenkalamität' (iron calamity). Biological essays demonstrated that *Crenothrix polyspora* and probably also *Leptothrix ochracea* caused pollution of the unfiltered, distributed water with 'ocher-yellow, dirty brownish up to coffee brown flocky deposits' (Ibid.). Similar problems with iron-containing groundwater occurred in Rotterdam, the Netherlands (de Vries, 1890). Iron-containing groundwater could only be used for drinking water production once properly working de-ironing filters were developed.

Since the establishment of de-ironing filters, there has been an ongoing discussion with regard to the importance of chemical versus biological iron oxidation (Czekalla et al., 1985; Sharma et al., 2005, and references therein). In drinking water filters in northern Germany, at least four species of IOB have been reported (*Gallionella* sp., *Leptothrix ochracea*, *Toxothrix trichogenes* and an unknown bacterium), next to five species of manganese-oxidizing bacteria. From these observations it was concluded that iron and manganese removal was a bacterial process (Czekalla et al., 1985). Søgaard et al. (2000) studied precipitates from backwash sludge from three water treatment plants (WTP) in Denmark. They suggested low oxygen content of the raw water, poor aeration and relatively low pH as the determining prerequisites for biological iron oxidation; however, they did not provide consistent data from the WTPs to substantiate these presumptions. The presence of ferrous iron in combination with low dissolved oxygen and/or slightly acidic pH is also regarded by other researchers as prerequisites for growth of IOB (Hallbeck and Pedersen, 1990; Emerson and Floyd, 2005).

The distinction between heterogeneous chemical and biological iron oxidation is, however, hard to make (Sharma et al., 2005; Tekerlekopoulou and Vayenas, 2008). Only in some cases, the distinguishable characteristic forms of iron deposits – like the twisted stalks formed by *Gallionella* spp. - indicate biological action, but in many other cases, particulate amorphous iron oxyhydroxides, very similar to chemical precipitates, are shown to be of biological origin as well (Emerson and Weiss, 2004).

In recent studies the catalysis of iron oxidation by excreted RedOx-enzymes like flavins (Degrémont, 2007) or exopolymers (Søgaard et al., 2000) has been reported, however this chemical process does not yield energy for bacterial growth. The chemo-lithotrophy of some IOB is still under dispute (Spring and Kämpfer, 2005).

*Gallionella* spp. are, however, generally regarded as strictly lithotrophic, unable to catabolize organic matter (Lütters-Czekalla, 1990), so the growth of *Gallionella* spp. can be seen as direct proof of biological iron oxidation. For this reason, this paper focuses on *Gallionella* spp., even though other IOB such as *Leptothrix* spp. were found to be growing in the studied systems as well (data not shown).

New molecular techniques provide powerful tools to assess and quantify the role of IOB in full-scale treatment systems. For this paper, the kinetics of iron oxidation and the growth of the iron-oxidizing *Gallionella* bacteria were assessed in continuous lab- and full-scale reactors and trickling filters. The results of these studies were used to discuss the competition of biological iron oxidation with chemical iron oxidation at different pH's in groundwater filtration. We hypothesize that *Gallionella* spp. can also grow under oxygen-saturated and slightly alkaline pH conditions when chemical iron oxidation is retarded.

## 5.2. Methods and materials

### 5.2.1. Lab-scale experiments

The oxidation and removal of iron was investigated in two lab-scale setups at WTP *Lekkerkerk* of the Oasen drinking water company in the Netherlands. The lab-scale research consisted of oxidation column and filtration column experiments, which are described separately in the next two sections. Both experimental setups were fed with drinking water locally produced from riverbank groundwater. This water is moderately hard ( $\text{Ca}^{2+} \sim 2 \text{ mM}$ ), well buffered ( $\text{HCO}_3^- \sim 3.0 \text{ mM}$ ), has a constant temperature of  $13 \text{ }^\circ\text{C}$ , a pH of  $7.8 \pm 0.1$  and is almost saturated with oxygen ( $\text{O}_2 \sim 10 \text{ mg L}^{-1}$ ). Ferrous iron ( $\text{FeSO}_4 \cdot 7\text{H}_2\text{O}$ , Merck 103965 5000) was added to the feed water of all but the reference filter columns in a concentration of  $3.3 \text{ mg L}^{-1} \text{ Fe}$ , resembling the groundwater quality at WTP *Lekkerkerk*. A nutrient solution, containing phosphorus ( $0.6 \text{ } \mu\text{M PO}_4\text{-P}$ ), nitrogen ( $3.8 \text{ } \mu\text{M NH}_4\text{-N}$ ) and trace elements (Zn, Co, Cu and Mo), was added to prevent bacterial growth limitation. All water and chemical flows were controlled by tube pumps and all flow rates were checked weekly by mass measurements. All columns had an internal diameter of  $0.089 \text{ m}$  resulting in a water velocity of about  $2.2 \text{ m h}^{-1}$ , similar to the full-scale filters. While the desired flow rate was  $14.0 \text{ L h}^{-1}$ , the realized flow rates for the oxidation and filter columns were  $13.9 \pm 0.4$  and  $13.5 \pm 0.8 \text{ L h}^{-1}$ , respectively. The flow direction was upwards for the oxidation columns and downwards for the filter columns.

### *Oxidation columns' setup*

The chemical iron oxidation strongly depends on pH (Sung, 1980; Tamura et al., 1976), it is therefore supposed that, with a decreasing pH, biological oxidation might outcompete chemical oxidation processes. In order to determine which rates of chemical oxidation still allow simultaneous biological oxidation by *Gallionella* spp., different pH conditions allowing different rates of chemical oxidation were applied. The influence of feed water pH on the oxidation rate of the ferrous iron and the growth of *Gallionella* spp. in the natural water of WTP *Lekkerkerk* was studied in six oxidation columns. With an overflow level of 0.58 m, the residence time calculated from mass balances was 16 min. Determination of the residence time by NaCl spiking and corresponding conductivity measurements (not presented) showed no short-circuiting, indicating mainly plug flow conditions in the oxidation columns.

To set the pH, HCl or NaOH was added to the column influent. The required doses of HCl and NaOH were determined in triplicate by titration of the feeding drinking water and checked by offline pH measurement in conformity with NEN 6411 of the columns' influent, also in triplicate (Figure A.1 of Supplementary Material A). Although the titrations and control measurements were executed at 20 °C, operational pH values at 13 °C will not have differed much because of the good buffering of the feed water. The deviation of the control measurements at the more extreme pH values was probably caused by gas exchange during sampling and off-line measurements and calcium carbonate precipitation during storage. As the values determined by the titrations best represented the actual system during the experiments, these pH values will be used in the results section, with the uncertainty range calculated from mass measurements of the acid and base dosing. The realized iron dose determined by mass balances and ICP-MS was  $3.3 \pm 0.7$  mg L<sup>-1</sup> Fe and is shown per column in Figure A.2 of the Supplementary Material A. In total,  $58 \pm 4$  g Fe was dosed over 7 weeks.

The oxidation columns were run for seven weeks from July 8 to August 26, 2009. The concentrations of ferrous and ferric iron in the column effluents were determined weekly. The *Gallionella* spp. cell numbers were determined after three and seven weeks in the column influents and effluents and after seven weeks in the accumulated sludge in the oxidation columns. A picture of the oxidation columns' setup at the end of the experiment is given in the Supplementary Material B.

### *Filter columns' setup*

To model groundwater trickling filtration, iron removal was studied in a lab-scale filter columns' setup, consisting of seven sets of trickling filter columns, in duplicate, filled with standard filter sand (1.7-2.5 mm). The pH of the feed water was lowered by HCl to resemble the groundwater before filtration ( $7.25 \pm 0.15$ ). One duplicate column set was used as a reference with no iron removal. In three sets of duplicate columns, ferrous iron was dosed just before the filter top, in three



sets of duplicates ferrous iron passed a pre-oxidation column before filtration. These columns are referred to as “without pre-oxidation” and “with pre-oxidation”, respectively. The scheme of the setup is given in Figure 1. All trickling filter columns had forced ventilation which raised the pH in the filter effluents to  $7.67 \pm 0.07$ . Each filter column was automatically backwashed with a fixed volume of 30 L drinking water and filter bed expansion every 24 hours. Additional information on the columns’ setup, including an extended scheme and picture, is given in the Supplementary Material B. A detailed description of the materials and methods used for the filtration column experiments can be found in de Vet et al. (2008).

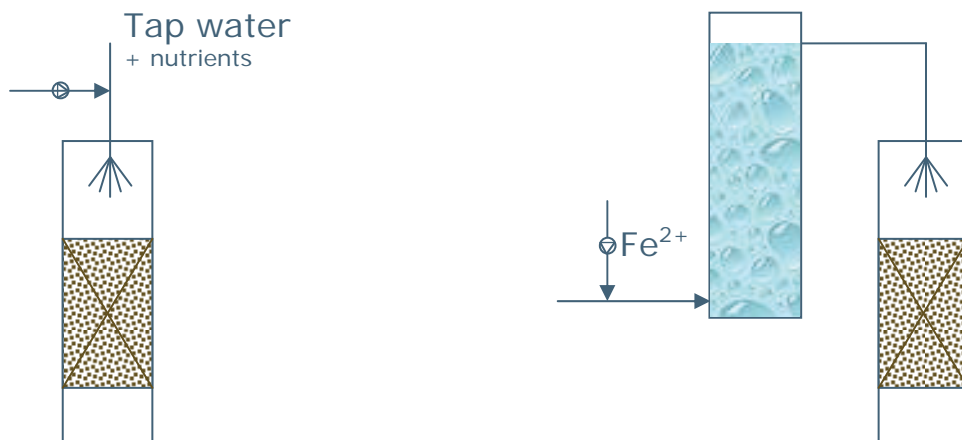

Figure 1: Scheme of oxidation and filter columns’ setup

The filtration columns were run for six months from April 2 to October 8, 2008. The *Gallionella* spp. cell numbers were determined after six months in the influents and effluents, the backwash water and the filter material of seven columns (one of each duplicate).

### 5.2.2. Full-scale groundwater trickling filters

The growth of *Gallionella* spp. and their role in iron oxidation was verified in three full-scale trickling filters at two Oasen WTPs. All three full-scale filters treated moderately hard and well-buffered anoxic groundwater. The filters were backwashed automatically after a filter runtime of 48 hours, to prevent clogging by removal of inorganic precipitates and excess biomass. At WTP *Lekkerkerk*, the filter material of one trickling filter was externally washed and the filter performance and growth of *Gallionella* spp. were monitored extensively for nine months after restart of the filters from December 12, 2007 to September 19, 2008. At WTP *De Hooge Boom*, the growth of *Gallionella* spp. in two groundwater trickling filters was assessed in a quick scan on March 1, 2010. In one of these filters, the anoxic

groundwater was sprayed directly on the trickling filter, while in the other the groundwater was intensively aerated on a plate aerator prior to spraying on top of the trickling filter. Both plate aeration and trickling filtration raised the dissolved oxygen content to nearly a saturated level and the pH by the stripping of carbon dioxide (see Table 1). All iron present in the groundwater was virtually completely removed in the filters (> 95%). Table 1 gives an overview of the groundwater and filtrate qualities as well as the characteristics of the three studied filters.

**Table 1: Groundwater and filtrate quality and filter characteristics of the full-scale trickling filters at the Oasen WTPs**

		WTP <i>Lekkerkerk</i>		WTP <i>De Hooge Boom</i>	
		Direct trickling filtration		Direct trickling filtration	Plate aeration and trickling filtration
Filter sand d10-d90	mm	1.7-2.5		2.0-3.15	
Filter bed area	m <sup>2</sup>	18.0		28.0	
Average production flow	m <sup>3</sup> h <sup>-1</sup>	37		64	
Filter runtime	h	48		48	
Groundwater quality		Average ± St.Dev. Jan. - Sept. 2008		Average ± St.Dev. Jan. 2008 – Mar. 2010	
Temperature	°C	11.6 ± 0.3		11.5 ± 0.2	
pH	-	7.33 ± 0.04		7.10 ± 0.05	
HCO <sub>3</sub> <sup>-</sup>	mg L <sup>-1</sup>	216 ± 7		387 ± 12	
Total iron	mg L <sup>-1</sup>	5.5 ± 0.6		8.5 ± 0.8	
TOC	mg L <sup>-1</sup> C	2.2 ± 0.1		8.3 ± 0.2	
Effluent plate aerator					
pH	-	-	-	-	7.7*
O <sub>2</sub>	mg L <sup>-1</sup>	-	-	-	10.1*
Filtrate quality					
pH	-	7.69 ± 0.10		7.8*	7.80 ± 0.03
O <sub>2</sub>	mg L <sup>-1</sup>	9.7 ± 0.6		9.7*	10.2 ± 0.4
Total iron removed per filter runtime	kg Fe	9.6 ± 1.1		26.1 ± 2.3	

\* indicative local measurement on March 1, 2010

### 5.2.3. DNA extraction

Samples for detection and identification of *Gallionella* spp. were taken in sterilized glass bottles at different points in the Oasen WTP *Lekkerkerk*. All samples were stored at 4°C. *Gallionella* spp. cell numbers were determined by qPCR.

Groundwater, influent and effluent water and backwash water samples were filtered over 0.2 µm polycarbonate membranes to concentrate the cells prior to DNA extraction. DNA was extracted from a volume of 100-150 ml water per sample. The filter was subsequently subjected to DNA extraction by bead beating.



The DNA was purified using a silica-based column and eluted in 100 µl TE. DNA from approximately 10 g of filter sand was extracted as described by de Vet et al. (2009). In all cases, an internal control was used to determine the extraction efficiency. DNA from the gradient tube samples was extracted by bead beating in an Ultraclean™ Microbial DNA isolation kit after centrifuging.

#### 5.2.4. Quantification of *Gallionella* spp.

In order to quantify the amount of *Gallionella* spp. cells in the systems, a specific PCR was developed to detect these bacteria, including the *Gallionella* spp. sequence that was previously found in the drinking water filters (Ibid.). PCR primers were developed for the detection of the 16S rRNA gene from *Gallionella* spp. using ARB software. One forward primer, GALFER0218-F 5'-GCTTTCGGAGTGGCCGATA-3', and one reverse primer, GALFER1408-R 5'- CAGATTCCTCCATGGTG -3' were designed. Amplification was performed by initial denaturation for 3 min. at 94°C, followed by 35 cycles of amplification (30 s denaturation at 94°C; 30 s annealing at 62°C; 1 min. elongation at 72°C), and 5 min. at 72°C to complete elongation. Quantification was based on a comparison of the sample Ct value to the Ct value of a calibration curve using standard amounts of 16S rDNA of *Gallionella*. An internal control was added to all samples to correct for the efficiency of the PCR reaction. The specificity of the qPCR method was checked through the construction and sequencing of four clone libraries of the PCR products (de Vet et al., submitted).

From the qPCR enumeration results, balances for the lab-scale columns and the full-scale filters were calculated. To assess the role of biological iron oxidation, the following assumption was made: When disregarding the decay and accumulation of biomass in the system, during one filter run, the cumulative (outflow – inflow) equals the growth of *Gallionella* cells. For every water flow entering or leaving a system, the totalized values for the cell numbers were calculated by multiplying the measured concentration with the flow rate and duration of the phase. For the full-scale filter at WTP *Lekkerkerk*, the groundwater was sampled in duplicate; the filtrate in duplicate in five and nine months after external washing with four samples per filter runtime of 48 hours; the backwash water was sampled three, six and nine months after external washing; control backwash samples were taken in quintuplet 15 to 16 months after external washing.

At WTP *De Hooge Boom*, the influent and backwash water of each filter and the effluent of the plate aerator were sampled once; the filtrate water of each filter was sampled twice, at the beginning and at the end of the filter runtime of 48 hours.

The filtrate of the filter columns was sampled two hours after backwash. Filter column sand samples were taken from the top half of the bed during expansion backwashing.

### 5.2.5. Iron analyses

Samples for iron analysis were taken directly into acid containing bottles to set the pH below 2. Nitric and hydrochloric acid were used to stabilize the samples for total and ferrous iron analysis, respectively. All samples were stored cool and analyzed within 24 hours after sampling. Total iron in water samples was determined by ICP-MS. Ferrous iron was determined by the 1,10-phenanthroline method according to the Dutch NEN 6482 protocol, based on Standard methods (1975). The iron concentration in the sludge was measured by AES after sample destruction in a microwave. The mass of the filter coating was determined by measurements of the dry mass before and after acidification with 4M hydrochloric acid and oxalic acid. The iron concentration in the decanted acid solution was measured by ICP-MS.

### 5.3. Results

#### 5.3.1. pH effect on growth of *Gallionella* and iron oxidation rate in oxidation columns

The pH dependency of *Gallionella* growth and iron oxidation was examined in six lab-scale oxidation columns.

During the first week after start-up of the experiment, the degree of oxidation was lower than the average for the following six weeks for all oxidation columns except the one with pH 8.25 (Figure 2). Apart from the first week, the oxidation degree of iron in the columns' effluent - calculated from the ferrous iron concentrations in filter effluent (by 1,10-phenanthroline method; Figure A.3 of Supplementary Material A) and added iron concentrations (from mass balances) - was constant in time. During the first week after start-up, virtually no iron oxyhydroxides or IOB had formed in the columns yet, and the measured iron oxidation was accounted for mainly by the homogeneous chemical process. After the start-up period, both iron oxyhydroxides and IOB accumulated in the columns and influenced the oxidation kinetics.

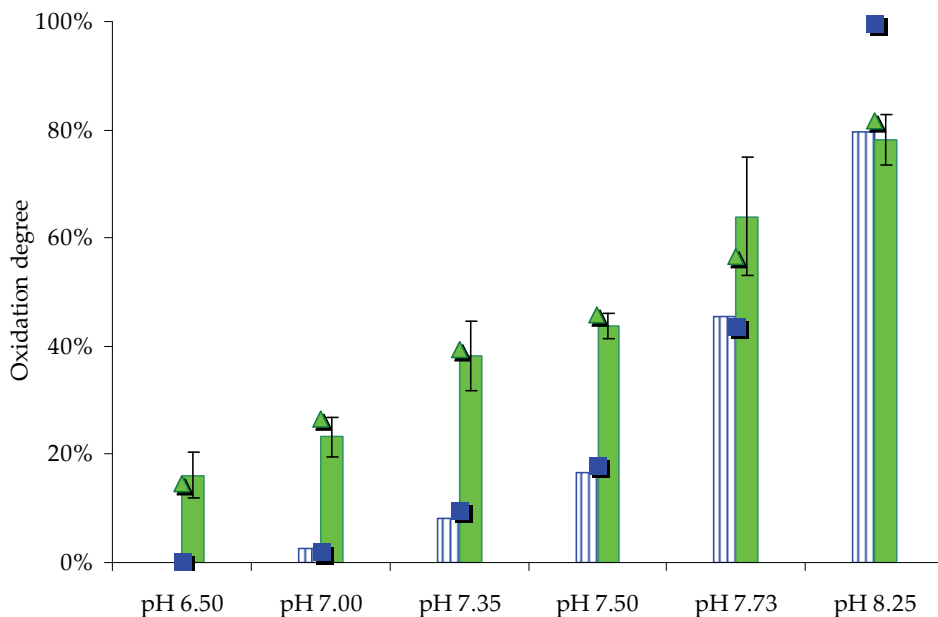

Figure 2: Oxidation degree of iron after 16 minutes' passage through oxidation columns; green solid bars, averages and standard deviations for 6 to 7 data points for whole period except first week after start-up, calculated from the ferrous iron concentrations in filter effluent (by 1,10-phenanthroline method) and total iron concentrations (from mass balances); blue striped bars, oxidation degree of iron during first week after start-up; ▲ calculated with [OH]<sup>-</sup>0.6, ■ calculated with [OH]<sup>-</sup>2 (see Discussion section for explanation)

The concentration of *Gallionella* cells determined by qPCR in the influents and effluents of the columns after 3 and 7 weeks and the total iron and *Gallionella* cell numbers accumulated as sludge in the oxidation columns after 7 weeks are shown in Figure 3.

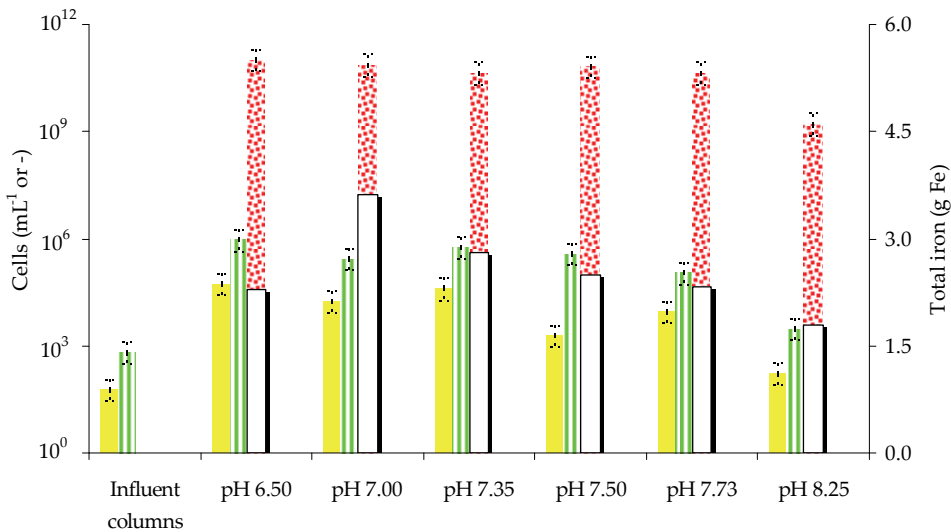

Figure 3: *Gallionella* spp. concentrations (left axis, in cells mL<sup>-1</sup>) in the influent and the effluents of the oxidation columns operated at different pH values after 3 weeks (yellow solid bars) and after 7 weeks (green striped bars); total *Gallionella* spp. numbers (red dotted bars on left axis, in cells) and total iron (white bars on right axis, in g Fe) accumulated in the oxidation column after 7 weeks; error bars show uncertainty of qPCR method (between 0.5\*N and 2\*N)

The cell concentrations in the influent, effluent and sludge show that *Gallionella* grew and accumulated in all oxidation columns. Statistical analysis (Supplementary Material D) shows that *Gallionella* grew equally fast in all columns with a pH between 7.0 and 7.73, and slightly (but not significantly) faster at pH 6.5. The increasing rate of chemical iron oxidation did not inhibit the growth of *Gallionella* up to a pH of 7.73. Only in the column with pH 8.25 was *Gallionella* growth significantly slower. The total iron accumulated in the oxidation columns had a maximum at pH 7.00, and was for all columns between 1.8 and 3.6 g (3 to 6 × 10<sup>-2</sup> mol). This was between 3 and 6 % of the iron loading. The majority of the iron, therefore, was present in the effluent of the columns in dissolved ferrous or colloidal ferric form.

Growth of *Gallionella* spp. was confirmed based on the morphology of the deposits. Figure 4 shows a phase contrast picture of deposits in the oxidation column with pH 7.73.

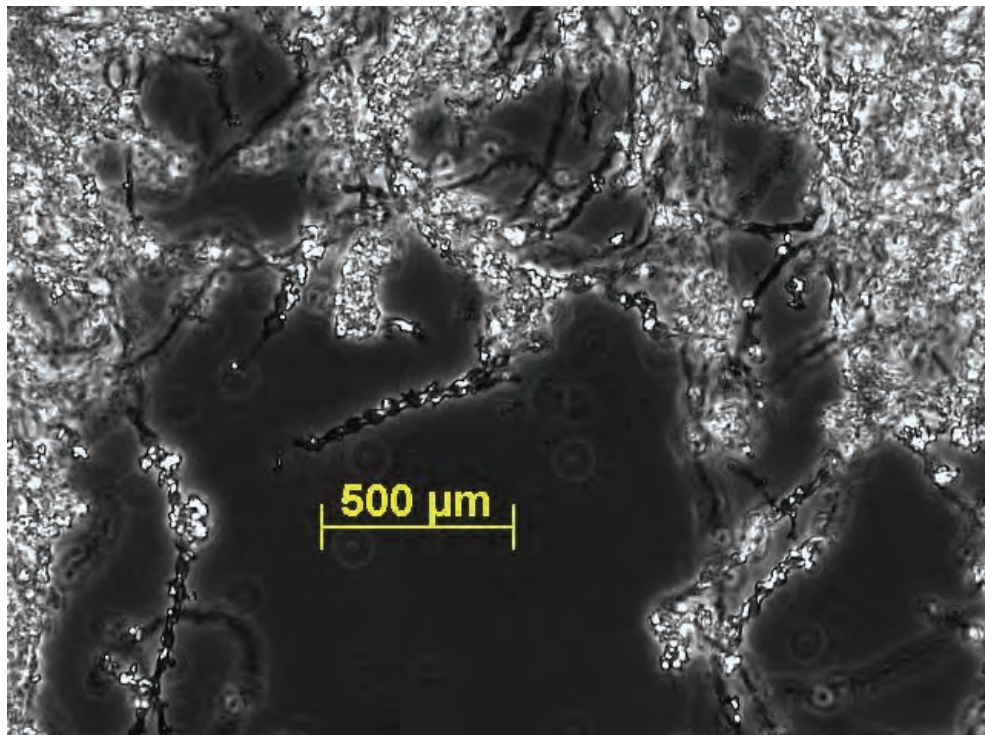

Figure 4: Phase contrast microscopic picture (400x magnification) of a sludge sample from the bottom of the oxidation column with pH set to 7.73 after three weeks of operation

In the oxidation columns experiment, the specific growth rate  $\mu$  of *Gallionella* spp. can be approached by Equation 1.

$$(\Delta t \downarrow 0) \quad \mu = \frac{\ln \left[ \frac{\{X_{t,\text{column}} + Q \cdot \Delta t \cdot [x]_{t,\text{effluent}}\}}{X_{t,\text{column}}} \right]}{\Delta t} \quad \text{Equation 1}$$

Where

$X_{t,\text{column}}$  = total cells in column (cells)

$Q$  = flow rate ( $\text{m}^3 \text{h}^{-1}$ )

$[x]_{t,\text{effluent}}$  = cell concentration washed out of column ( $\text{cells m}^{-3}$ )

$t$  = experimental time (h)

At the end of the oxidation columns experiment,  $\mu$  was  $0.08 \pm 0.06 \text{ h}^{-1}$ , corresponding to a doubling time of 8.4 h on average. Hallbeck and Pedersen (1990) found a generation time of 8.3 h *in vitro* at the optimal temperature of 20 °C. This is comparable to the growth rate observed in our experiments at 13 °C, which suggests slightly more favorable growth conditions *in situ*.

### 5.3.2. Effect of pre-oxidation on *Gallionella* growth in trickling filters

In order to determine whether pre-oxidation had an effect on the amount of *Gallionella* spp. in the filter systems, their growth was examined in six duplicate lab-scale trickling filtration columns with and without pre-oxidation of the iron in the oxidation columns and one set of duplicate reference columns without iron removal. The pre-oxidation caused an oxidation degree of  $29 \pm 6$  % before the water entered the trickling filters. At the applied pH ( $7.25 \pm 0.15$ ) this corresponded with the oxidation degree measured in the oxidation column experiments (Figure 2). The total numbers of *Gallionella* spp. for the water flows cumulated over one filter runtime (24 hours) and for the filter beds at the end of the test period of 6 months are shown in Figure 5. This figure clearly shows growth of *Gallionella* spp. in all filter columns spiked with ferrous iron, but none in the reference column. No significant difference was found in the water samples from filter columns without and with pre-oxidation and only marginally more *Gallionella* spp. in the filter samples from filter columns without pre-oxidation (shown in Supplementary Material D).

Figure 5 also shows iron deposition in the filter coating. After 91 days, the amount of iron deposited in the filter coatings was comparable regardless of pre-oxidation or not, and on average 60 % of the loaded iron (Supplemental Material C) was encapsulated in the filter coating. After 187 days, however, the amount of iron in the filter coatings of columns with pre-oxidation had not increased, while it had in the columns without pre-oxidation. This suggests that the growth of attached IOB in the filters may enhance the formation of iron coating.

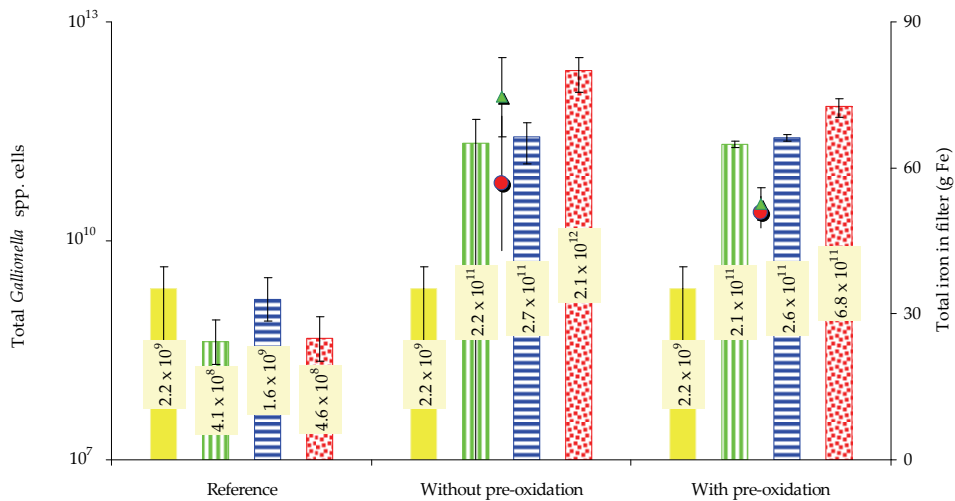

Figure 5: Iron deposition in filter coating and cumulative numbers of *Gallionella* spp. by qPCR determined for a reference column, three columns without and three with pre-oxidation in the filter columns' setup at the end of 6-months' trial; numbers in water flows (solid and striped bars) cumulated over one filter run of 24 hours, yellow solid bar in feed water, green vertically striped bar in filtrate water; and blue horizontally striped bars backwash water; total present in filter material (dotted bars); iron deposition in filter coating (● after 91 days, ▲ after 187 days, on the right axis); error bars show uncertainty of qPCR method for the outflow measurements of the reference and standard deviation for the other measurements

In the filter column experiments, the absence of pre-oxidation resulted, on average, in slightly higher cell numbers attached to the filter material, but due to error margins it is not possible to judge if this is significant. Although this is consistent with the higher ferrous iron loading, there was no significant difference in *Gallionella* spp. numbers in the water flows from columns with and without pre-oxidation. With the approach according to Equation 1,  $\mu$  was calculated as  $0.01 \pm 0.005$  and  $0.03 \pm 0.01 \text{ h}^{-1}$  for the filter columns without and with pre-oxidation, respectively (with equal distribution of the cells washed-out during backwash periods over the filter runtime). This suggests that the *Gallionella* cells in the columns without pre-oxidation were better attached, more encapsulated in the iron oxyhydroxide filter coating, and less active than in the columns with pre-oxidation.

### 5.3.3. Full-scale groundwater trickling filters

In order to determine the potential role of biological oxidation in the groundwater trickling filters, the abundance and growth of the iron-oxidizing *Gallionella* species were assessed in the three full-scale filters by qPCR. The balances for *Gallionella* spp. in duplicate calculated over one filter run of 48 hours from the qPCR cell numbers, water flows, and time are shown in Figure 6.

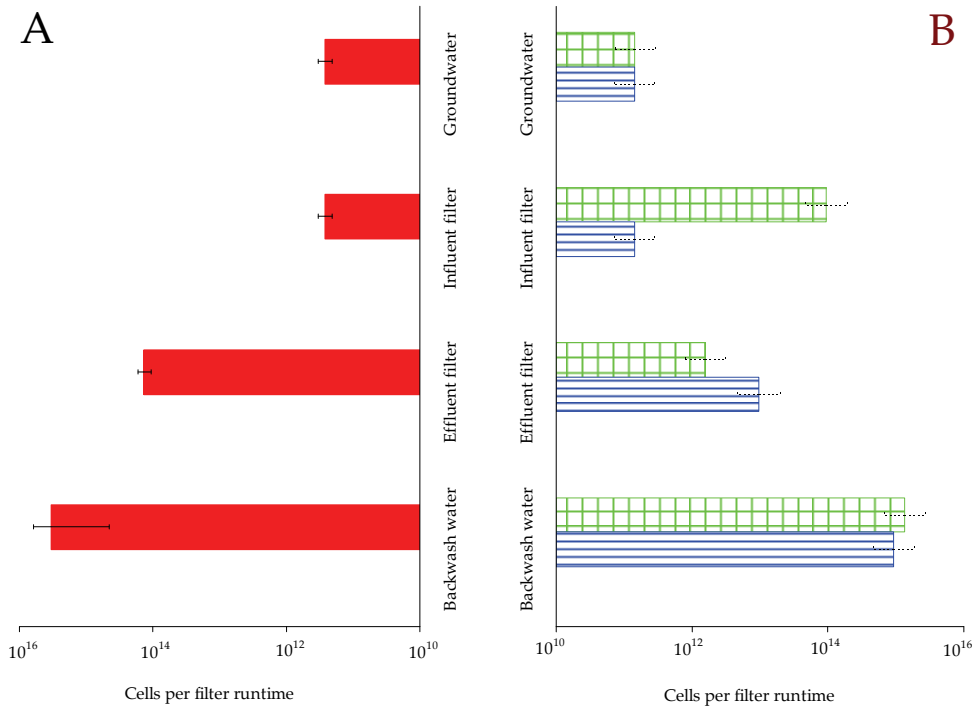

Figure 6: *Gallionella* spp. balances for the WTP Lekkerkerk trickling filter (multiple measurements, graph A, red solid bars) and for the WTP De Hooge Boom trickling filters (singular measurements, graph B, green square bars, trickling filtration after plate aeration; blue line bars, direct trickling filtration); cumulative cell numbers inoculated directly from groundwater or via plate aerator, washed out to effluent and to backwash are calculated for one filter runtime of 48 hours; Influent filter values are for effluent plate aerator if present and equal to ground water for the other filters; error bars show standard deviation (graph A) and uncertainty of qPCR method (graph B, between  $0.5 \cdot N$  en  $2 \cdot N$ )

The measurements show that significant amounts of *Gallionella* cells were found in all three full-scale filters despite the fact that these filters were very well aerated and the oxygen content of the filtrate water was close to saturation level. This condition is usually associated with chemical iron oxidation (Sharma et al., 2005). The cell numbers leaving the filter through the filtrate and backwash water were much higher than in the groundwater feeding the filter. This indicates a strong growth of *Gallionella* spp. in these full-scale trickling filters. The plate aeration prior to the filtration at WTP De Hooge Boom did not inhibit the growth of *Gallionella* spp. in the filter, despite the oxygen saturation and elevated pH of the effluent water. *Gallionella* spp. started to grow in the plate aerator, were filtered off in the trickling filter and continued growing there.



## 5.4. Discussion

### 5.4.1. Chemical versus bacteriological iron oxidation in groundwater filtration

Iron oxidation under aerobic, neutral pH conditions may be homogeneous, heterogeneous or biologically mediated. At the start of the oxidation column experiment, a negligible amount of iron oxyhydroxides and IOB was present, and the iron oxidation was predominantly homogeneous. The general kinetic equation for homogeneous iron oxidation is given by Equation 2:

$$-dFe/dt = k * [OH^-]^n * P_{O_2} * [Fe^{2+}]^m \quad \text{Equation 2}$$

Where  $m = 1$  and  $n = 2$ , as found by Sung (1980); only for the first week measurements did the model reasonably match the measured data (blue squares in Figure 2; 13 °C, ionic strength 0.01 M) with a rate constant of  $k = 4 \cdot 10^{12} \text{ M}^{-2} \text{ atm}^{-1} \text{ min}^{-1}$ . This is approximately 10 times lower than the rate reported by Sung (Ibid.) in water with similar salinity but at 25 °C. The temperature difference between 25 °C and 13 °C, explains this difference for the larger part. The lower temperature reduces the rate constant by a factor of 7, not because of changes in the activation energy (almost zero), but by the decline in  $K_w$  and thus  $[OH^-]$  activity (Stumm and Lee, 1961). This strongly indicates that the iron oxidation was mostly a homogeneous chemical reaction in the first week of the oxidation column experiment.

The measurements during the rest of the experimental period can only be fitted to the model by reducing the order of  $[OH^-]$ ,  $n$ , to 0.6 (green triangles in Figure 2). Tamura et al. (1976) found that rate of heterogeneous chemical iron oxygenation was proportional to the first order of the reciprocal  $[H^+]$ . The general kinetic equation for heterogeneous chemical iron oxidation is given by Equation 3:

$$-dFe/dt = (k_1 + k_2 * [Fe^{3+}]) * [Fe^{2+}] \quad \text{Equation 3 (Ibid.)}$$

Where

$$k_1 = k_{\text{hom}} * [OH^-]^2 * P_{O_2} \quad \text{Homogeneous oxidation rate constant, Equation 3a}$$

$$k_2 = k_{s,o} * [O_2] * K * [H^+]^{-1} \quad \text{Heterogeneous oxidation rate constant, Equation 3b}$$

$$k_{s,o} = 4380 \text{ M}^{-1} \text{ min}^{-1} \quad \text{Surface rate, Equation 3c}$$

$$K = 10^{-4.85} \quad \text{Adsorption constant of } Fe^{2+} \text{ on } FeOOH, \text{ Equation 3d}$$

The iron sludge that accumulated at the end of the experimental period of seven

weeks in the oxidation columns was assumed to be equally distributed in the oxidation columns, leading to a ferric iron concentration of 9 to 18 mM (see Figure 3; sludge volume per column was  $4.0 \pm 0.1$  L). Under these conditions, the heterogeneous oxidation rate constant  $k_2\text{Fe}^{3+}$  according to Equation 3 would be in the range 1 to  $35 \text{ min}^{-1}$  (for pH 6.5 up to 8.25, respectively). As this means an oxidation half-life ( $t_{1/2}$ ) of less than one minute, it would implicate a nearly complete chemical oxidation of iron after the average residence time of 16 minutes in all the oxidation columns, which was not the case in our experiments.

The reason for this reduced heterogeneous oxidation rate cannot be deduced from our experiments, but is probably related to the composition of the natural water. In many studies on chemical iron oxidation (Stumm and Lee, 1961; Sung, 1980; Tamura et al., 1976) the oxidation rates were determined with ultrapure water. Some studies determined the effects of natural organic matter (NOM) on the chemical iron oxidation. Davison and Seed (1983) and Liang et al. (1993) found that the rate constant for homogeneous iron oxidation in natural freshwater under oxygen saturated conditions was comparable to the one in synthetic water, as we did. Other researchers found a significant effect of NOM complexation on iron removal and oxidation, but that effect could be either accelerating (Ninh Pham et al., 2004) or inhibiting (Theis and Singer, 1974). All these studies were confined to homogeneous chemical iron oxidation.

Sung (1980) stated that catalytic iron oxidation was only noticeable at pH 7 and above because of the slow surface formation at a lower pH. Our research with natural water indicates that the heterogeneous iron oxidation rate was strongly reduced even at a higher pH. This reduced heterogeneous chemical iron oxidation rate may be caused by surface complexation of inorganic and (natural) organic compounds in water. Complexation of inorganic ions had little influence on the adsorption capacity of ferrous iron (Sharma, 2001, Chapter 3). Tipping (1981) showed that the surface charge and adsorption capacity of iron oxyhydroxides could be influenced by the complexation of humic substances. *Gallionella* growth may have contributed to this complexation by the excretion of EPS-like compounds.

Analysis of the growth of *Gallionella* spp. by qPCR demonstrates the significance of bacterial iron oxidation in the full-scale filter and laboratory filter columns. The direct enumeration of *Gallionella* spp. by this method combined with the biomass yield on iron oxidation makes it possible to quantify the share of biological iron oxidation. The maximum biomass yield reported in the literature is low ( $0.006 \text{ g DW g}^{-1} \text{ Fe oxidized}$  (Lütters and Hanert, 1989) and  $0.013 \text{ g DW g}^{-1} \text{ Fe oxidized}$  (Neubauer et al., 2002). Thermodynamically, a maximum theoretical yield of  $0.05 \text{ g DW g}^{-1} \text{ Fe}$  can be expected, based on the anabolic reaction energy of  $3500 \text{ kJ C mol}^{-1}$  biomass (Heijnen and Van Dijken, 1992) and the catabolic reaction energy (Hanselmann, 1991):  $\text{Fe}^{2+} + \frac{1}{4} \text{ O}_2 + \frac{1}{2} \text{ H}_2\text{O} \rightarrow \text{FeOOH} + 2\text{H}^+$  with  $\Delta G_r = -83.8 \text{ kJ mol}^{-1} \text{ Fe}$  at pH 7.73 and  $1 \text{ mM Fe}^{2+}$ ).

During one filter runtime, 0.9 g of iron was removed in the laboratory filter system (Supplementary Material C) and  $9.6 \pm 1.1$  kg in the full-scale filter at WTP Lekkerkerk. During one runtime, in total  $4.7 \pm 2.9 \times 10^{11}$  and  $3.4 \pm 2.9 \times 10^{15}$  *Gallionella* cells were washed out of these filters, respectively. When biomass accumulation, maintenance and decay were not considered, the observed yield was  $5.1 \pm 3.3 \times 10^{11}$  and  $3.6 \pm 3.4 \times 10^{11}$  *Gallionella* cells  $\text{g}^{-1}$  Fe oxidized, respectively. This assumes that the iron oxidation was completely biological and exclusively by *Gallionella* spp.. These maximum *Gallionella* cell yields can be related to dry weight (DW) by using the cell dimensions (mean volume of  $0.4 \mu\text{m}^3$ ) determined by Hallbeck and Pedersen (1991). With a specific cell DW of  $1.2 \times 10^{-13}$  g, the yield equals  $0.062 \pm 0.040$  and  $0.043 \pm 0.041$  g DW  $\text{g}^{-1}$  Fe oxidized, for the filter columns and the full-scale filter, respectively (Table 2).

**Table 2: Overview of iron conversion, net *Gallionella* cells washout and calculated yield for filter column experiment and full-scale trickling filter at WTP Lekkerkerk**

Parameters	Unit	Filter columns	Full-scale trickling filter
Iron removed per filter runtime	g Fe	$0.92 \pm 0.04$	$9.6 \pm 1.1 \times 10^3$
<i>Gallionella</i> cells washed out per filter runtime	cells	$4.7 \pm 2.9 \times 10^{11}$	$3.4 \pm 2.9 \times 10^{15}$
Cell yield	cells $\text{g}^{-1}$ Fe	$5.1 \pm 3.3 \times 10^{11}$	$3.6 \pm 3.4 \times 10^{11}$
Biomass yield*	gDW $\text{g}^{-1}$ Fe	$0.062 \pm 0.040$	$0.043 \pm 0.041$

\* calculated with  $1.2 \times 10^{-13}$  g DW  $\text{cell}^{-1}$ , mean cell volume  $0.4 \mu\text{m}^3$ , Hallbeck and Pedersen (1991)

Although the standard deviations are large, the average yield was higher than reported in the literature and close to the theoretical maximum. The high cell yields found suggest that biological iron oxidation by *Gallionella* spp. played a dominant role in both the full-scale filter and in the filter columns.

#### 5.4.2. Growth conditions of *Gallionella* spp.

The results reported in this manuscript show that *Gallionella* spp. may grow under broader conditions than generally assumed. No growth inhibition was found in the natural water under nearly oxygen-saturated conditions and at a pH ranging from 6.5 to 7.73. This finding contrasts with the general perception of *Gallionella* being strictly micro-aerophilic (Emerson, 2000). According to Degrémont (2007), biological iron oxidation will only prevail under conditions where physico-chemical iron oxidation is not possible: oxygen concentration between 0.2 and 0.5  $\text{mg L}^{-1}$ , pH 6.3, ORP +100 mV and  $r\text{H}_2$  between 14 and 20 (whereas  $r\text{H}_2 = -\log(\text{pH}_2) = E_h/0.0296\text{V} + 2\text{pH}$ ). Under  $r\text{H}_2$  of 14, the biological oxidation should be inhibited, while over 20, the bacteria would lose the competition with the physico-chemical iron precipitation. At pH 7.73, the upper limit of  $r\text{H}_2$  indicates a maximum redox potential of 135 mV and an oxidation degree of less than 98%.

It was stated that the boundaries are not strictly defined and can shift f.i. by chelation. Hanert (2006) listed the broad array of the environments where *Gallionella* spp. have been found and concluded that the stability of ferrous iron in combination with oxygen is crucial for their existence, more than mere pH or Eh. This paper substantiates this claim by showing the growth of *Gallionella* spp. on ferrous iron under oxygen-saturated and slightly alkaline circumstances, when the chemical iron oxidation is slow.

In the oxidation column experiment with a fixed pH ranging from 6.5 to 7.73 and oxygen-saturated natural water, the initial iron oxidation was homogeneous with rates consistent with the literature. After the start-up period, IOB and iron oxyhydroxydes accumulated in the columns but the oxidation rate increased less than theoretically expected from heterogeneous chemical oxidation. Heterogeneous chemical iron oxidation may be seriously hampered in natural water compared to synthetic water by complexation of natural organic matter on iron oxyhydroxide surfaces. The specific growth of *Gallionella* spp. was in accordance with the values found in culture experiments. The comparable *Gallionella* cell growth and the increase in iron oxidation degree indicate that, for pH ranging from 6.5 to 7.73, the increased iron oxidation rate had to be attributed to the growth and activity of IOB, rather than to chemical catalysis. Yield calculations for the biological iron oxidation by *Gallionella* spp. in lab- and full-scale trickling filters, indicate that the dominant iron oxidation mechanism in groundwater filtration is biological under wider process conditions (pH and oxygen content) than previously thought.

## 5.5. Conclusions

- The quantitative PCR approach targeting the 16S rRNA of *Gallionella* spp. was successfully used to determine the significance of biological versus chemical oxidation in full-scale groundwater trickling filters and lab-scale column experiments.
- *Gallionella* spp. grew in full-scale groundwater trickling filters and lab-scale oxidation vessels and trickling filters at oxygen saturation, neutral pH (up to pH 7.7) and at a moderate temperature of 13 °C.
- Biological oxidation by *Gallionella* spp. was the dominant process for iron oxidation in this type of groundwater, and heterogeneous chemical iron oxidation in natural water was substantially reduced, compared to experimental results from the literature for synthetic water.

## Acknowledgements

The authors gratefully acknowledge the contribution of Peter Dijkstra for assistance in the full-scale research, Petra Lafeber for support in the columns experiments and Sabine Doddema and Paul van der Wielen for the DNA-isolation for the qPCR.

## Supporting Information Available

- Supplementary Material A, schema and picture of the columns' setup;
- Supplementary Material B, set points and control measurements for pH and ferrous iron dosing in the oxidation column experiment;
- Supplementary Material C, cumulative iron loading and iron bleeding in the filtrate in the filter column experiment; and,
- Supplementary Material D, Ftest on significance of differences in *Gallionella* growth per oxidation column.

## References

- Berger, H. and Berger, E. (1928) *Biologie der Trink- und Brauchwasseranlagen*, Jena : Verlag von Gustav Fischer, Berlin-Dahlem, Germany.
- Czekalla, C., Mevius, W. and Hanert, H. (1985) Quantitative removal of iron and manganese by microorganisms in rapid sand filters (in situ investigations). *Water Supply* 3(1), 111-123.
- Davison, W. and Seed, G. (1983) The kinetics of the oxidation of ferrous iron in synthetic and natural waters. *Geochimica et Cosmochimica Acta* 47(1), 67-79.
- de Vet, W.W.J.M., Dinkla, I.J.T., Muyzer, G., Rietveld, L.C. and van Loosdrecht, M.C.M. (2009) Molecular characterization of microbial populations in groundwater sources and sand filters for drinking water production. *Water Research* 43(1), 182-194.
- de Vet, W.W.J.M., Rietveld, L.C. and van Loosdrecht, M.C.M. (2008) Iron coatings in pilot dry groundwater biofilters, *Water Quality Technology Conference & Exposition 2008*, Cincinnati, Ohio (USA)
- de Vet W.W.J.M., Kleerebezem R., van der Wielen P.W.J.J., Rietveld L.C., van Loosdrecht M.C.M.; Abundance and activity of ammonia-oxidizing prokaryotes in groundwater filters for drinking water production; submitted)
- de Vries, H. (1890) *Die Pflanzen und Thiere in den dunklen Räumen der Rotterdamer Wasserleitung; Bericht über die biologischen Untersuchungen der*

Crenothrix-Commission zu Rotterdam, vom Jahre 1887, Jena : Verlag von Gustav Fischer.

Degrémont (ed) (2007) Water Treatment Handbook, Lavoisier SAS.

Emerson, D. (2000) Environmental microbe-metal interactions. Lovley, D.R. (ed), pp. 31-52, ASM, 2000, Washington.

Emerson, D. and Floyd, M.M. (2005) Enrichment and isolation of iron-oxidizing bacteria at neutral pH. *Methods in Enzymology* 397, 112-123.

Emerson, D. and Weiss, J.V. (2004) Bacterial iron oxidation in circumneutral freshwater habitats: Findings from the field and the laboratory. *Geomicrobiology Journal* 21(6), 405-414.

Hallbeck, L. and Pedersen, K. (1990) Culture parameters regulating stalk formation and growth rate of *Gallionella ferruginea*. *Journal of General Microbiology* 136(9), 1675-1680.

Hallbeck, L. and Pedersen, K. (1991) Autotrophic and mixotrophic growth of *Gallionella ferruginea*. *Journal of General Microbiology* 137(11), 2657-2661.

Hanert, H.H. (2006) *The Prokaryotes, A Handbook on the Biology of Bacteria*, pp. 990-995, Springer.

Hanselmann, K.W. (1991) Microbial energetics applied to waste repositories. *Experientia* 47(7), 645-687.

Heijnen, J.J. and Van Dijken, J.P. (1992) In search of thermodynamic description of biomass yields for the chemotrophic growth of microorganisms. *Biotechnology and Bioengineering* 39(8), 833-858.

Liang, L., Andrew McNabb, J., Paulk, J.M., Gu, B. and McCarthy, J.F. (1993) Kinetics of Fe(II) oxygenation at low partial pressure of oxygen in the presence of natural organic matter. *Environmental Science and Technology* 27(9), 1864-1870.

Lütters-Czekalla, S. (1990) Lithoautotrophic growth of the iron bacterium *Gallionella ferruginea* with thiosulfate or sulfide as energy source. *Archives of Microbiology* 154(5), 417-421.

Lütters, S. and Hanert, H.H. (1989) The ultrastructure of chemolithoautotrophic *Gallionella ferruginea* and *Thiobacillus ferrooxidans* as revealed by chemical fixation and freeze-etching. *Archives of Microbiology* 151(3), 245-251.

Neubauer, S.C., Emerson, D. and Megonigal, J.P. (2002) Life at the energetic edge: Kinetics of circumneutral iron oxidation by lithotrophic iron-oxidizing bacteria isolated from the wetland-plant rhizosphere. *Applied and Environmental Microbiology* 68(8), 3988-3995.

Ninh Pham, A., Rose, A.L., Feitz, A.J. and Waite, T.D. (2004) The effect of dissolved natural organic matter on the rate of removal of ferrous iron in fresh waters, pp. 213-219.

Sharma, S.K. (2001) Adsorptive iron removal from groundwater, Wageningen University / International Institute for Infrastructural, Hydraulic and Environmental Engineering, Delft.

Sharma, S.K., Petrusevski, B. and Schippers, J.C. (2005) Biological iron removal from groundwater: A review. *Journal of Water Supply: Research and Technology - AQUA* 54(4), 239-247.

Søgaard, E.G., Medenwaldt, R. and Abraham-Peskir, J.V. (2000) Conditions and rates of biotic and abiotic iron precipitation in selected Danish freshwater plants and microscopic analysis of precipitate morphology. *Water Research* 34(10), 2675-2682.

Spring, S. and Kämpfer, P. (2005) *Bergey's Manual® of Systematic Bacteriology*, pp. 740-746.

Standard methods for the Examination of Water and Waste Water, 14th ed. (1975), American Public Health Association, Washington, p. 208-213.

Stumm, W. and Lee, G.F. (1961) *Oxygenation of Ferrous Iron*, pp. 143-146.

Sung, W. (1980) Kinetics and product of ferrous iron oxygenation in aqueous systems. *Environmental Science and Technology* 14(5), 561-568.

Tamura, H., Goto, K. and Nagayama, M. (1976) Effect of ferric hydroxide on the oxygenation of ferrous ions in neutral solutions. *Corrosion Science* 16(4), 197-207.

Tekerlekopoulou, A.G. and Vayenas, D.V. (2008) Simultaneous biological removal of ammonia, iron and manganese from potable water using a trickling filter. *Biochemical Engineering Journal* 39(1), 215-220.

Theis, T.L. and Singer, P.C. (1974) Complexation of iron(II) by organic matter and its effect on iron(II) oxygenation. *Environmental Science and Technology* 8(6), 569-573.

Tipping, E. (1981) The adsorption of aquatic humic substances by iron oxides. *Geochimica et Cosmochimica Acta* 45(2), 191-199.

## Supporting information paragraph

## Supplementary Material A

Set points and control measurements for pH and ferrous iron dosing in the oxidation column experiments are shown in Figures A.1 and A.2 below.

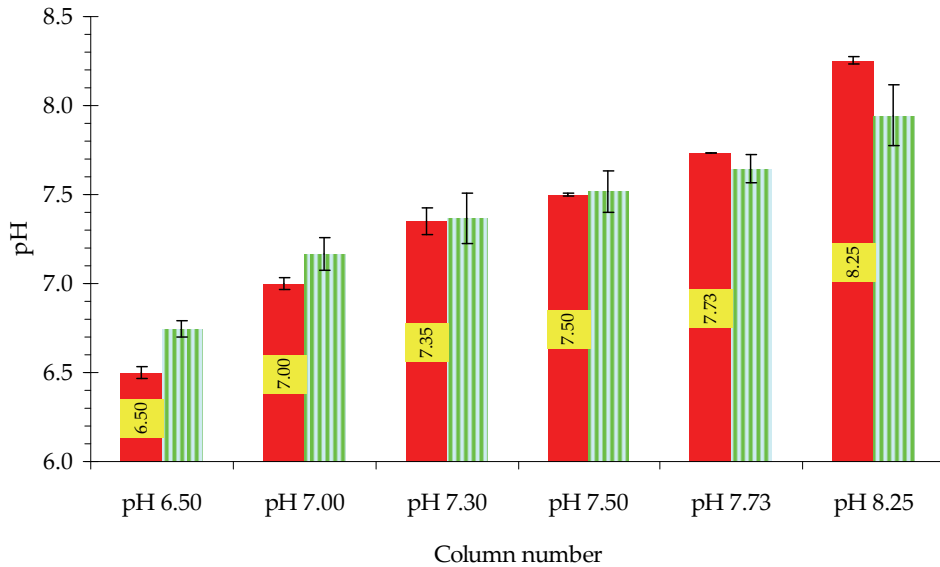

Figure A.1: Set points (solid bars) and control measurements in columns' influent (18 samples, striped bars) of the pH in the oxidation columns; error bars for the set points calculated from standard deviation of mass measurements of HCl and NaOH-dosings

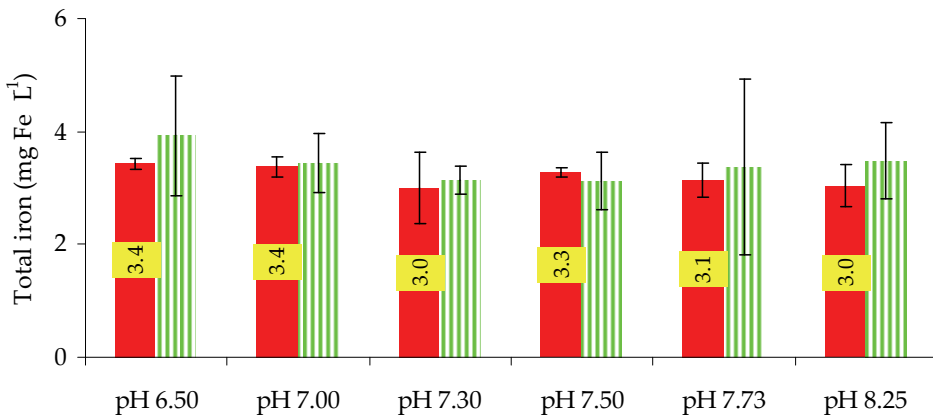

Figure A.2: Total iron concentration, calculated from mass balance (48 datapoints, solid bars) and measured by ICP-MS (51 samples, striped bars)



During the first week, the oxidation degree in the oxidation columns changed in time (Figure A.3). The sample points at pH 7.35 and 8.25 after 33 days from start-up were deleted from the analysis due to a dosing problem during the previous week. At pH 7.00 no sample was taken after 26 days from start-up.

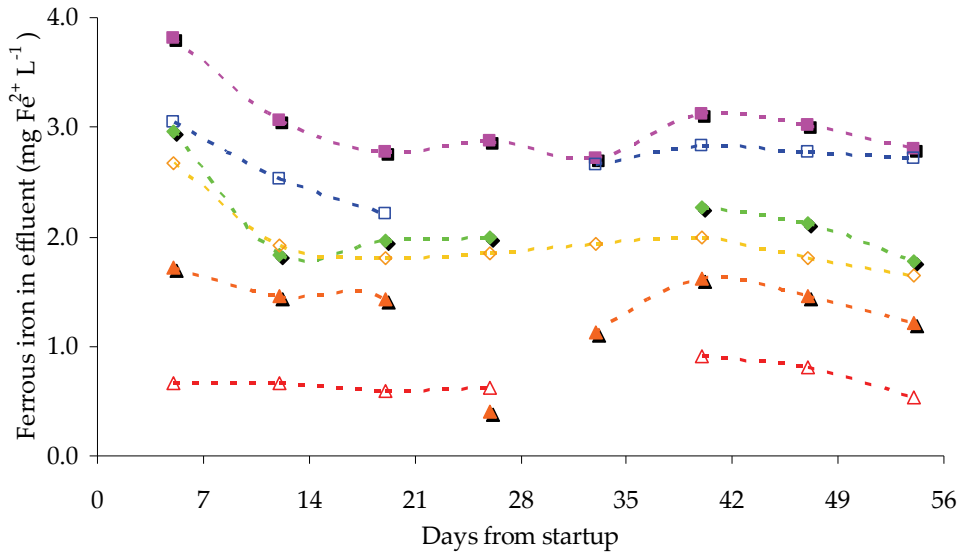

Figure A.3: Ferrous iron in effluent of oxidation columns, indicated by their set pH; ■ pH 6.50, □ pH 7.00, ◆ pH 7.35, ◇ pH 7.50, ▲ pH 7.73, △ pH 8.25

### Supplementary Material B

#### *Oxidation columns' setup*

Figure B.1 shows a picture of the oxidation columns' setup at the end of the seven weeks' experimental period.

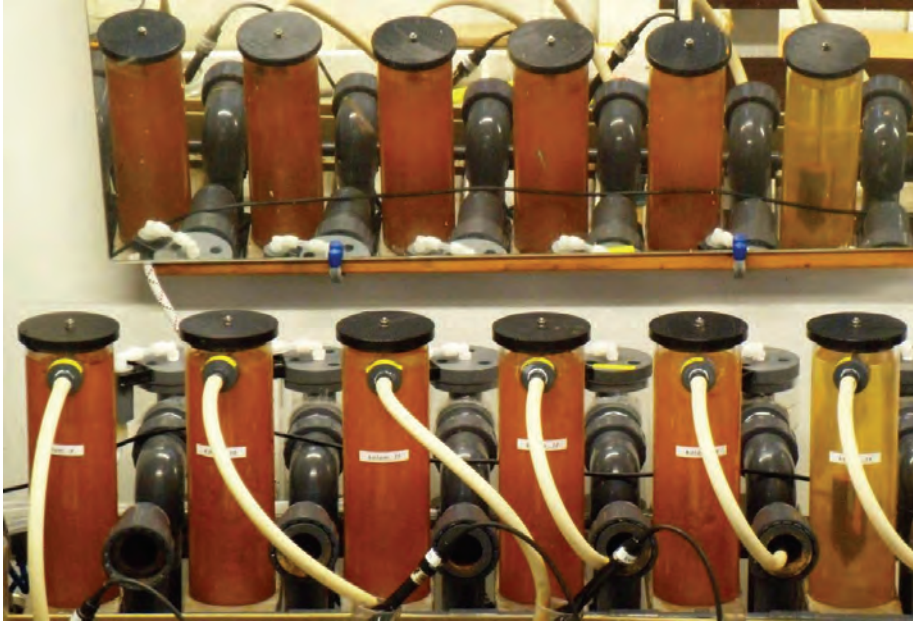

Figure B.1: Picture of the oxidation columns' setup after seven weeks; left to right: pH of the influent 6.5 to 8.25

#### *Filter columns' setup*

The filter columns' setup consisted of 7 duplicate columns. The feed water for all filter columns was spiked with  $\text{NH}_4\text{Cl}$  ( $\text{NH}_4\text{Cl}$  Merck 101141 5000) and the pH was lowered by HCl to resemble the groundwater before filtration ( $7.25 \pm 0.15$ ). In each set of successive columns, the primary had an odd number and the duplicate an even number. One duplicate column set (numbers 1 and 2) was used as a reference for nitrification only. In three sets of duplicate columns (number 3 up to 8 inclusive), ferrous iron was dosed just before the filter top, in three sets of duplicates (number 9 up to 14 inclusive), ferrous iron passed a pre-oxidation column before filtration. Further variations between the columns included the addition of manganese or reduced ventilation flow ( $\text{RQ}=1$ ). Figures B.2 and B.3 show the schema and picture of the filter columns' setup. The reduced ventilation flow raised the pH to  $7.31 \pm 0.01$  in the filter effluents instead of  $7.67 \pm 0.07$  in the filter columns with high ventilation flow ( $\text{RQ}=10$ ). Manganese addition and reduced ventilation flow did not result in significant differences and are not discussed in this paper.

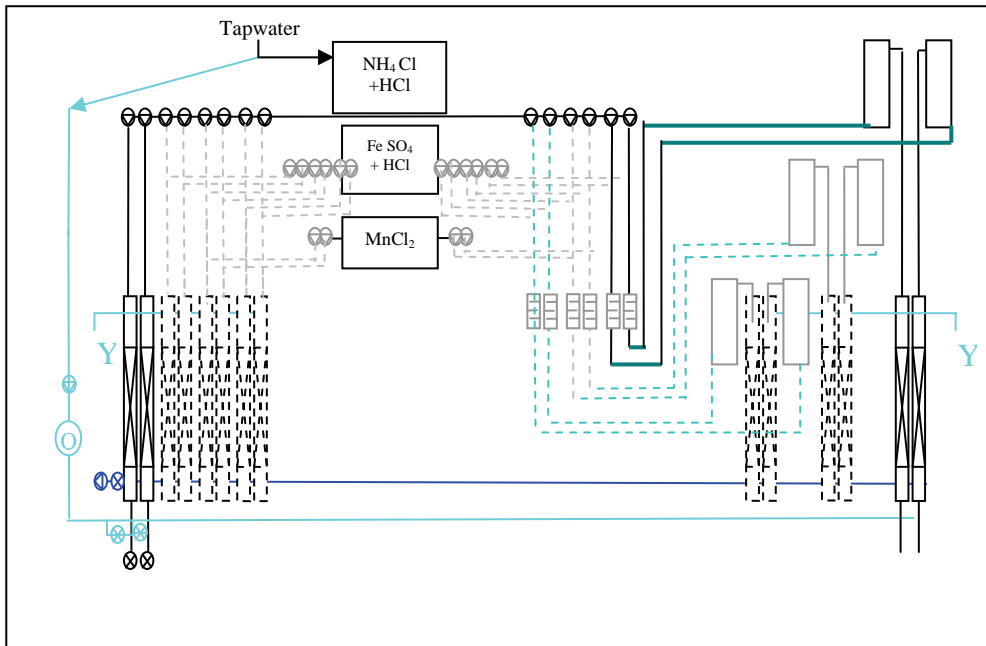

Figure B.2: Scheme of the filter columns' setup

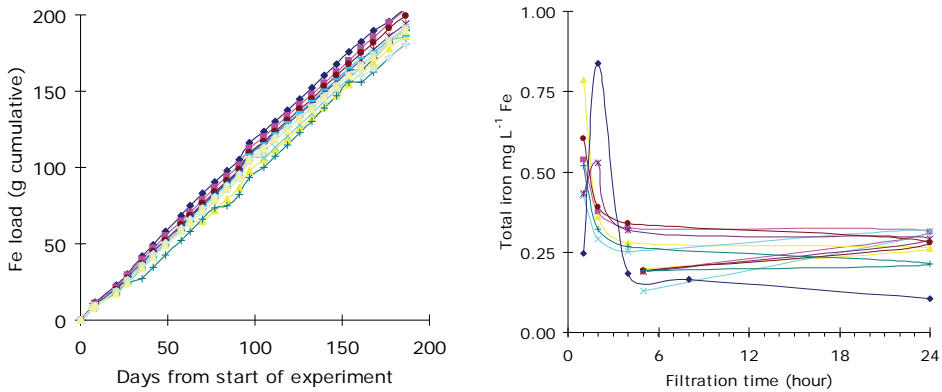

Figure B.3: Picture of the filter columns' setup

### Supplementary Material C

#### Filter columns

The cumulative iron loading and iron bleeding in the filtrate are shown in Figure C.1. The total load of Fe in the test period of six months was  $191 \pm 8$  g per filter column; see Figure C.1 (left). After the first month, iron removal was almost complete in all columns (Fe-total in filtrate after initial peak  $<0.3$  mg L<sup>-1</sup>), as is illustrated by the measurements over the filter runtime after 3 months of the experiment; see Figure C.1 (right). After the start-up period, 90% of the dosed iron or  $3.2 \pm 0.1$  mg L<sup>-1</sup> was removed, corresponding to  $0.92 \pm 0.04$  g Fe oxidized per column over each filter runtime of 24 hours.



**Figure C.1: Cumulative iron loading per filter column (left) and total iron concentration in filtrate during one filter runtime after 3 months of the experiment (right)**

## **Supplementary Material D**

### *Oxidation columns*

A Ftest was used to evaluate whether the variance per column of the *Gallionella* cell concentrations deviated significantly from the median of all columns for three data series (concentrations in effluent after 3 weeks, in effluent after 7 weeks and in columns after 7 weeks). *Gallionella* growth in all oxidation columns except the ones with a pH of 6.5 and 8.25 was highly comparable, with Ftest results of  $\geq 72$  % for all results and  $\geq 82$  % for the results after 7 weeks. For the column with pH 6.5, all values were slightly above the median of the other columns, and Ftest results were 43 % and 61 % for all results and results after 7 weeks only, respectively. For the columns with pH 8.25, the Ftest results were 0.2% and 3.8 % for these sets, indicating significantly lower growth of *Gallionella* compared to the other columns.

### *Filter columns*

A student's t-Test (with two-tailed distribution and two-sample unequal variance) was used to evaluate whether *Gallionella* spp. cell concentrations in the samples from the filter columns without pre-oxidation were likely to have come from the same underlying population with the same mean as the filter columns with pre-oxidation. This evaluation gave a probability of 96%, 96% and 19% for the filtrate, backwash water and filter samples, respectively, indicating a difference only for the filter material, namely marginally higher *Gallionella* spp. cell numbers in the columns without pre-oxidation.





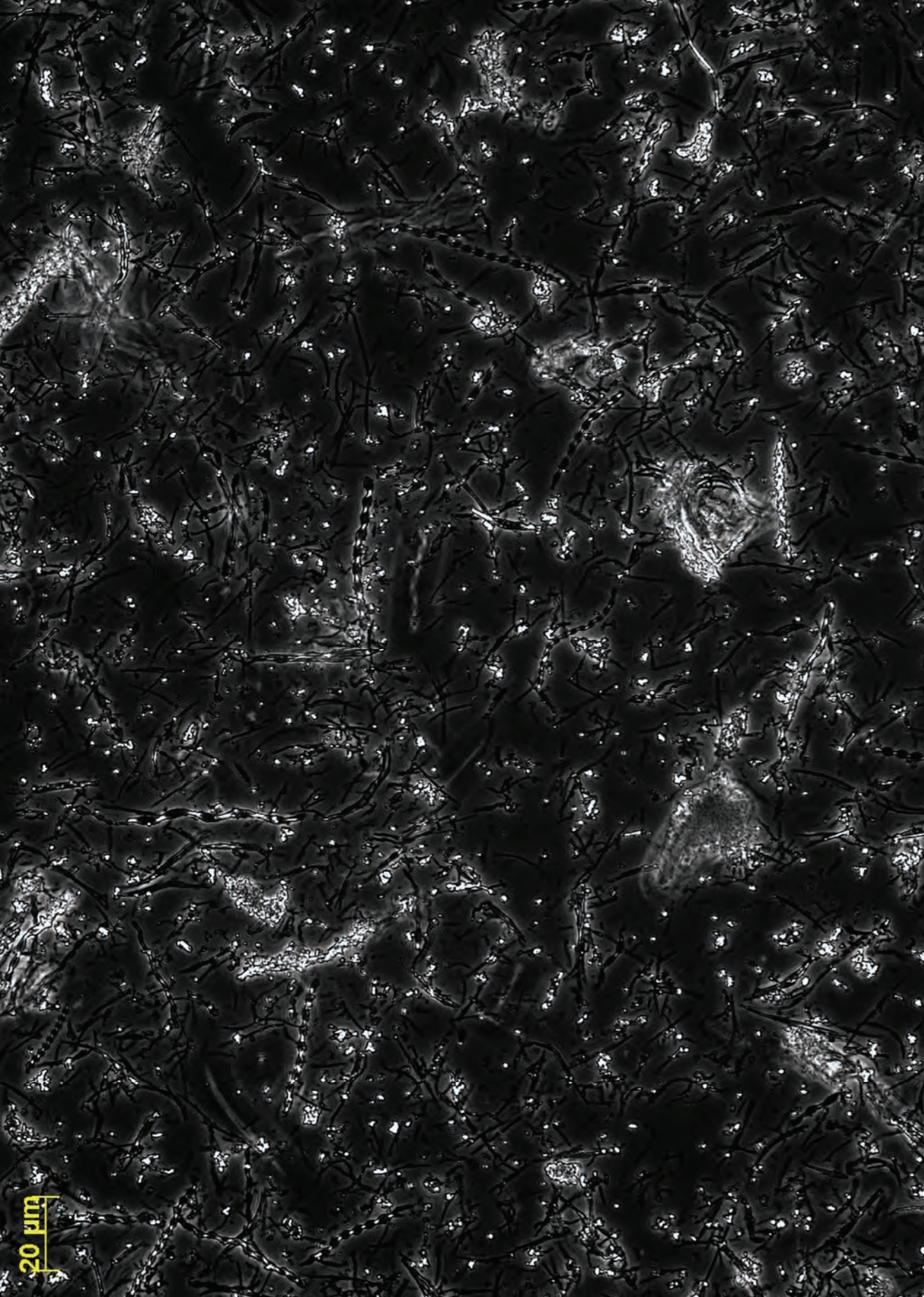

20  $\mu\text{m}$

# CHAPTER 6

---

## *Gallionella* spp. in trickling filtration of subsurface aerated and natural groundwater

**Submitted as:**  
de Vet, W.W.J.M., Dinkla, I.J.T., Abbas, B.A.,  
Rietveld, L.C. and van Loosdrecht, M.C.M.  
*Gallionella* spp. in trickling filtration  
of subsurface aerated and natural groundwater.



## Abstract

The growth of iron-oxidizing bacteria, generally regarded as obligate micro-aerophilic at neutral pH conditions, has been reported in a wide range of environments, including engineered systems for drinking water production. This research focused on intensively aerated trickling filters treating deep anaerobic and subsurface aerated groundwater. The two systems, each comprising groundwater abstraction and trickling filtration, were monitored over a period of nine months. *Gallionella* spp. were quantified by qPCR with specifically designed 16S-rRNA primers and identified directly in the environmental samples using clone libraries with the same primers. In addition, enrichments in gradient tubes were evaluated after DGGE separation with general bacterial primers. No other iron-oxidizing bacteria than *Gallionella* spp. were found in the gradient tubes. qPCR provided an effective method to evaluate the growth of *Gallionella* spp. in these filter systems. The growth of *Gallionella* spp. was stimulated by subsurface aeration, but hardly continued in the trickling filter. In the uninfluenced anaerobic groundwater, *Gallionella* spp. were only present in low numbers, but they grew extensively in the trickling filter. Identification revealed that *Gallionella* spp. growing in the trickling filter were phylogenetically distinct from the species found growing during subsurface aeration, indicating that the different conditions in both systems selected for niche organisms, while inhibiting other groups. The results suggest a minor direct significance for inoculation of *Gallionella* spp. during filtration of subsurface aerated groundwater.

## Keywords

Clone libraries, DGGE, *Gallionella* spp., groundwater trickling filtration, qPCR, subsurface aeration

## Abbreviations and Notations

16S rD/RNA	=	16 S ribosomal DNA or reverse transcribed RNA
DGGE	=	denaturing gradient gel electrophoresis
DO	=	dissolved oxygen
FeOB	=	iron-oxidizing bacteria
qPCR	=	(quantitative) real-time polymerase chain reaction
TE	=	Tris and EDTA buffer
WTP	=	water treatment plant

## 6.1. Introduction

### 6.1.1. Biological iron oxidation by *Gallionella* spp.

Iron-oxidizing prokaryotes are widely found under acidic conditions (Emerson and Floyd, 2005), but at circumneutral pH only limited species are reported. These belong to the  $\beta$ -*Proteobacteria* like *Gallionella*, *Sphaerotilus/Leptothrix* and *Rhodocyclus* spp., or to only some genera in the  $\alpha$ - and  $\gamma$ -*Proteobacteria* (Emerson et al., 2010, and references therein). As opposed to most other iron-oxidizing bacteria (FeOB), *Gallionella* spp. are generally regarded as strictly chemolithotrophic, i.e., unable to catabolize organic matter with reduced iron or a sulfurous compound as their sole electron donor (Lütters-Czekalla, 1990). In the absence of reduced sulfurous compounds, the growth of *Gallionella* spp. can be seen as direct proof of biological iron oxidation. For this reason, this paper focuses on *Gallionella* spp., even though other FeOB like *Leptothrix* spp. were found to be growing in the studied systems as well (data not shown). In these studied systems, *Leptothrix* spp. were never observed in the absence of *Gallionella* spp. that were the dominant FeOB.

The presence of ferrous iron in combination with low dissolved oxygen and/or slightly acidic pH is regarded as a prerequisite for the growth of FeOB (Hallbeck and Pedersen, 1990; Sobolev and Roden, 2004; Emerson and Floyd, 2005). For this reason, most references describe the natural environments for FeOB and their primary cultivation methods as systems with opposing gradients of  $\text{Fe}^{2+}$  and  $\text{O}_2$ . Under neutral conditions, iron oxidation may be a chemical or a biologically mediated process. Only in some cases, the distinguishable characteristic forms of iron deposits – like the twisted stalks formed by *Gallionella* spp. - indicate biological action, but in other cases, particulate amorphous iron oxyhydroxides, very similar to chemical precipitates, are shown to be of a biological origin as well (Emerson and Weiss, 2004). New molecular techniques provide powerful tools to assess and quantify the role of FeOB in full-scale treatment systems.

### 6.1.2. Engineered groundwater systems for drinking water production

#### *Subsurface aeration*

Subsurface aeration is a mild form of *in situ* iron removal (Braester and Martinell, 1988). The Drinking Water Company Oasen in the Netherlands applies this technique not for the purpose of *in situ* iron removal, but for the enhancement of nitrification in the water treatment plant (WTP; de Vet et al., 2009a). In this technique, limited amounts of well-aerated tap water are periodically injected back into the anaerobic groundwater aquifer, which contains ferrous iron, in between longer periods of groundwater abstraction. Because of the intermittent operation, dissolved ferrous iron and oxygen are not concurrently present in the aquifer

during the subsurface aeration, apart from dispersion in the boundary and porous layers, and diffusion into stagnant zones. Despite this, almost all the oxygen is reduced and the iron in the groundwater is reduced stoichiometrically. Most of the iron is retained in the aquifer and precipitated within the soil matrix (van Halem et al., in press), but mobile iron colloids are also formed in the aquifer (Appelo and de Vet, 2003) and extracted with the raw groundwater onto the trickling filters (Wolthoorn et al., 2004a). In the literature, it has been proposed that the dominant mechanism in subsurface iron removal is a chemical surface complexation and oxidation process (Appelo et al., 1999; Hiemstra and van Riemsdijk, 2007), but the role of bacterial iron oxidation in these systems is still relatively unexplored.

#### *Groundwater trickling filtration*

In many parts of Europe, the use of disinfecting or strong oxidizing chemicals in drinking water production is minimal (Smeets et al., 2009) and biological filtration is generally applied in groundwater treatment (Czekalla et al., 1985; Mouchet, 1992; Tekerlekopoulou and Vayenas, 2008). Such biofilters are filled with fine to coarse carrier material, mostly sand, but materials like anthracite and expanded clay granules are also used. Trickling filtration with forced ventilation is applied with elevated ammonium levels in the groundwater. These biofilters may completely remove iron and ammonium present in the anaerobic groundwater in concentrations of more than 10 mg L<sup>-1</sup> (de Vet et al., 2010).

At the Oasen WTP Lekkerkerk, *Gallionella* spp. were found by DGGE in the subsurface aerated but not in the natural groundwater, nor in the filters treating both groundwater types (de Vet et al., 2009b). In this paper we investigated the niche differentiation of *Gallionella* spp. in groundwater-based drinking water systems and evaluated the potential of using qPCR as a methodology to verify conversions and mass balances in such filtration systems.

## **6.2. Methods and materials**

### **6.2.1. WTP Lekkerkerk groundwater, filter and water samples**

#### *Subsurface aerated and reference groundwater samples*

The natural groundwater at the WTP Lekkerkerk, situated in a peat polder area, is anaerobic. There are two distinct well fields with separate filtration systems. The technique of subsurface aeration is applied in one well of one well field; the other wells in both well fields are not influenced by it. At WTP Lekkerkerk, one subsurface aeration cycle consists of two days of fully aerated tap water injection in one groundwater well, followed by 40 days of extraction from the same well. During one cycle, 105 kg Fe is oxidized *in situ* (see Supplementary Material A).

All groundwater types were sampled in duplicate during April-May and July-September 2008; For the subsurface aerated filter, samples were taken from the subsurface aerated well and another representative well in the well field. The subsurface aerated well was sampled five or six times per abstraction cycle of 40 days. For the non-subsurface aerated filter, the mixed raw water from all wells was sampled. For more details of both well fields and filter systems we refer to de Vet et al. (2009b).

#### *Full-scale groundwater trickling filter samples*

The filter material from two full-scale trickling filters at WTP Lekkerkerk, the Netherlands, was externally washed and the filter performances were monitored for nine months after restart of the filters. The raw and effluent water qualities and specifications of the two filters have been previously reported (Ibid.). Both filters treated well-buffered ( $\text{HCO}_3^- \sim 3.8 \text{ mM}$ ) anaerobic groundwater, with an average pH of  $7.35 \pm 0.06$  and a temperature of  $11.6 \pm 0.3 \text{ }^\circ\text{C}$ . Due to forced ventilation in the trickling filter, the pH was raised to  $7.67 \pm 0.13$  and the dissolved oxygen (DO) was close to saturation in the filter effluents of both filters. One filter treated natural groundwater and will be indicated further as non-subsurface aerated filter. The filter being referred to as the subsurface aerated filter treated partially subsurface aerated groundwater. It was not only fed by the subsurface aerated well, but also by other wells in the well field. The filters were backwashed automatically after a filter runtime of 48 hours to prevent clogging by removal of inorganic precipitates and excess biomass. During one filter run,  $9.6 \pm 1.1$  and  $7.1 \pm 1.0 \text{ kg Fe}$  were removed by the non-subsurface aerated filter and the subsurface aerated filter, respectively (see Supplementary Material A).

The filtrate was sampled in duplicate in May and September 2008 with four samples per filter runtime. Backwash water was sampled three, six and nine months after external washing. Control backwash samples were taken 15 to 16 months after external washing, in duplicate, for the subsurface aerated filter and in quintuplet for the non-subsurface aerated filter.

#### **6.2.2. Gradient tube enrichment**

Gradient tubes are generally applied for the culturing of microorganisms that prefer growth at an oxic-anoxic interface, like *Gallionella* spp.. The gradient tubes were prepared according to the protocol of Emerson and Floyd (2005) with slight modifications. The gradient tubes consisted of a 1% high melting agarose bottom layer with freshly prepared FeS and a 0.15% low melting agarose top layer with 5mM sodium bicarbonate. Both layers contained Modified Wolfe's Minimal Medium and the headspace contained sterilized air. A sterile vitamin and trace element solution was added after autoclaving. The gradient tubes were inoculated

aseptically, in duplicate per sample, and stored at room temperature in the dark. After three weeks, biomass from one tube per sample was transferred aseptically into the new gradient tubes in triplicate. One of these three tubes was autoclaved and used as a negative control. This enrichment was repeated twice.

### 6.2.3. DNA extraction

Samples for detection and identification of *Gallionella* spp. were taken in sterilized glass bottles at different points in the Oasen WTP Lekkerkerk. All samples were stored at 4°C. Groundwater, influent and effluent water and backwash water samples were filtered over 0.2 µm polycarbonate membranes to concentrate the cells prior to DNA extraction. DNA was extracted from a volume of 100-150 ml water per sample. The filter was subsequently subjected to DNA extraction by bead beating. The DNA was purified using a silica-based column and eluted in 100 µl TE. DNA from approximately 10 g of filter sand was extracted as described by de Vet et al. (2009b). In all cases an internal control was used to determine the extraction efficiency. DNA from the gradient tube samples was extracted by bead beating using an Ultraclean™ Microbial DNA isolation kit after centrifuging.

### 6.2.4. Quantification of *Gallionella* spp.

In order to quantify the number of *Gallionella* spp. cells in the systems, a specific PCR was developed to detect these bacteria, including the *Gallionella* spp. sequence that was previously found in the drinking water filters (Ibid.). PCR primers were developed for the detection of the 16S rRNA gene from *Gallionella* spp. using ARB software. One forward primer, GALFER0218-F 5'-GCTTTCGGAGTGGCCGATA-3', and one reverse primer, GALFER1408-R 5'-CAGATTCCACTCCCATGGTG -3' were designed. Amplification was performed by initial denaturation for 3 min at 94°C, followed by 35 cycles of amplification (30 s denaturation at 94°C; 30 s annealing at 62°C; 1 min. elongation at 72°C), and 5 min at 72°C to complete elongation. Quantification was based on a comparison of the sample Ct value to the Ct value of a calibration curve using standard amounts of 16S rDNA of *Gallionella*. An internal control was added to all samples to correct for the efficiency of the PCR reaction.

From the qPCR enumeration results, balances for both full-scale filters were calculated. For every water flow entering or leaving the filter, the total values for the cell numbers were calculated by multiplying the measured concentration with the flow rate and duration of the phase. A weighted average was used in this calculation when the cell numbers were measured at different times during a phase. For a scheme of the balancing method and details of the filter operation and sampling, we refer to de Vet et al. (submitted, Water Research). To assess the role

of biological iron oxidation, the following assumption was made: When disregarding the decay and accumulation of biomass in the system, the cumulative outflow – inflow equals the growth of *Gallionella* cells during one filter run. To relate *Gallionella* cell yield to dry weight (DW), the cell dimensions for *G. ferruginea* determined by Hallbeck and Pedersen (1991) were used: mean volume  $0.4 \mu\text{m}^3$ ; DW  $1.2 \times 10^{-13} \text{ g cell}^{-1}$ .

#### 6.2.5. Identification and phylogenetic affiliation of *Gallionella* spp.

Identification of *Gallionella* spp. was done through the construction and sequencing of four clone libraries of PCR products amplified with the 16S-rRNA forward and reverse primers identical to those used in the qPCR. Clone libraries were constructed using PCR products that were amplified directly from the DNA extracts of four filter-related samples.

Additionally, *Gallionella* spp. were identified through direct sequencing of PCR products derived from the gradient tubes after DGGE separation. The 16S rRNA bacterial genes were amplified using general bacterial 16S-rRNA primers (Bac341f+GC and Bac907rM (rA+rC); Schäfer and Muyzer, 2001 and references therein). Amplification was performed by initial denaturation for 5 min at  $94^\circ\text{C}$ , followed by 30 cycles of amplification (30 s denaturation at  $95^\circ\text{C}$ ; 40 s annealing at  $57^\circ\text{C}$ ; 40 s elongation at  $72^\circ\text{C}$ ), and 30 min at  $72^\circ\text{C}$  to complete elongation. The DGGE was performed according to Schäfer and Muyzer (Ibid.) using a 20%-70% gradient of urea and formamide. An overview of samples and methods used for identification is given in Table 1. All sequencing was performed at Macrogen (South Korea).

Sequence data from four clone libraries (a total of 92 clones) were compiled using ARB software (Ludwig et al., 2004) and aligned with complete length sequences of their closest relatives, obtained from The 'All-Species Living Tree' (Release LTP\_s100) database (ARB Silva database project: <http://www.arb-silva.de>) using the ARB FastAligner utility. Matrices of similarity distance and phylogenetically corrected distance values were generated using the neighbor-joining option in ARB. In total 515 bp were used for calculation and a filter (taking into account only the positions present in the species *Gallionella ferruginea* with accession no. L07897) was used to remove any irregularities. Sequences (535 bp) from 20 lanes on the DGGE gel and from a relevant reference (Li et al., 2010) were also filtered and added separately using the maximum parsimony option in ARB. Clusters have been made according to valid taxonomic affiliation.

### 6.3. Results

#### 6.3.1. *In situ* growth of *Gallionella* spp. in subsurface aerated groundwater well

The *Gallionella* cell numbers in the subsurface aerated groundwater are shown in Figure 2. The two curves were determined during the abstraction phase of two distinct subsurface aeration cycles (May-June and July-September 2008). The figure also shows the reference values during the same periods for *Gallionella* spp. in groundwater that was not influenced by subsurface aeration.

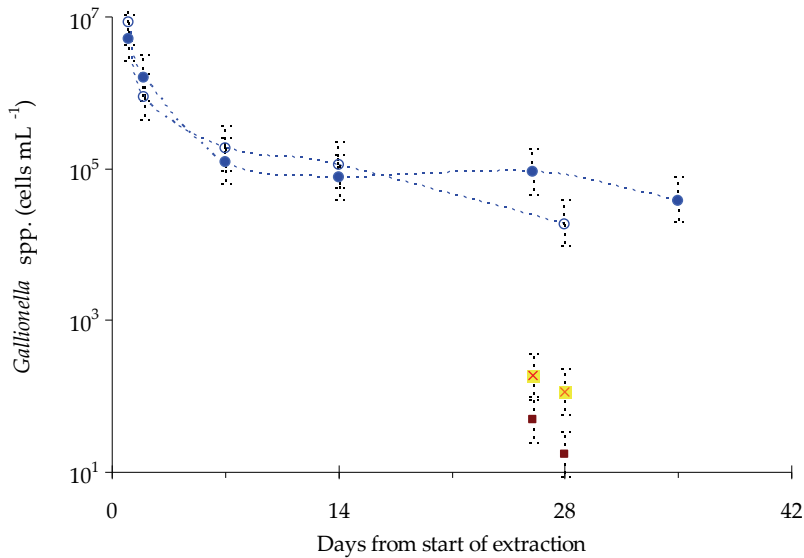

Figure 1: *Gallionella* spp. cell numbers in subsurface aerated and natural groundwater during two abstraction cycles; dotted lines with symbols duplicate measurement during the 40-day extraction phase of the subsurface aerated well (● April-May 2008 and ○ July-September 2008), ■ reference well in same well field; ■ raw water header with non-subsurface aerated groundwater; results under detection limit of the method (<35 mL<sup>-1</sup>) are depicted as 17.5 (half of detection limit); error bars show the uncertainty of qPCR method (between 0.5\*N en 2\*N)

*Gallionella* spp. were close to or below the detection limit of the qPCR method in the natural, anaerobic non-subsurface aerated groundwater. Samples from the raw water header contained slightly higher numbers than from the reference well. Subsurface aeration, however, led to a substantial increase in *Gallionella* cell numbers in the groundwater. Subsurface aeration raised the number of *Gallionella* spp. in the groundwater by a factor >10<sup>3</sup> compared to the non-subsurface aerated groundwater, resulting in a continuous inoculation of the subsurface aerated filter. The high cell numbers at the start of the abstraction period may be caused by growth, but also by detachment caused by increased shear forces from the pump

switch between injection and abstraction. The long tail in elevated *Gallionella* numbers may likewise indicate a prolonged growth or continued detachment and washout. For the *Gallionella* balance over the trickling filter described in the next section, the average cell concentration over the abstraction period was used.

### 6.3.2. Balancing *Gallionella* spp. with iron conversion in full-scale groundwater trickling filters

In order to determine the role of biological iron oxidation in the two groundwater trickling filters, the abundance and growth of the iron-oxidizing *Gallionella* spp. were assessed by qPCR. The balances for *Gallionella* spp. calculated over one filter run of 48 hours from the qPCR cell numbers, water flows, and time are shown in Figure 2 for both filters.

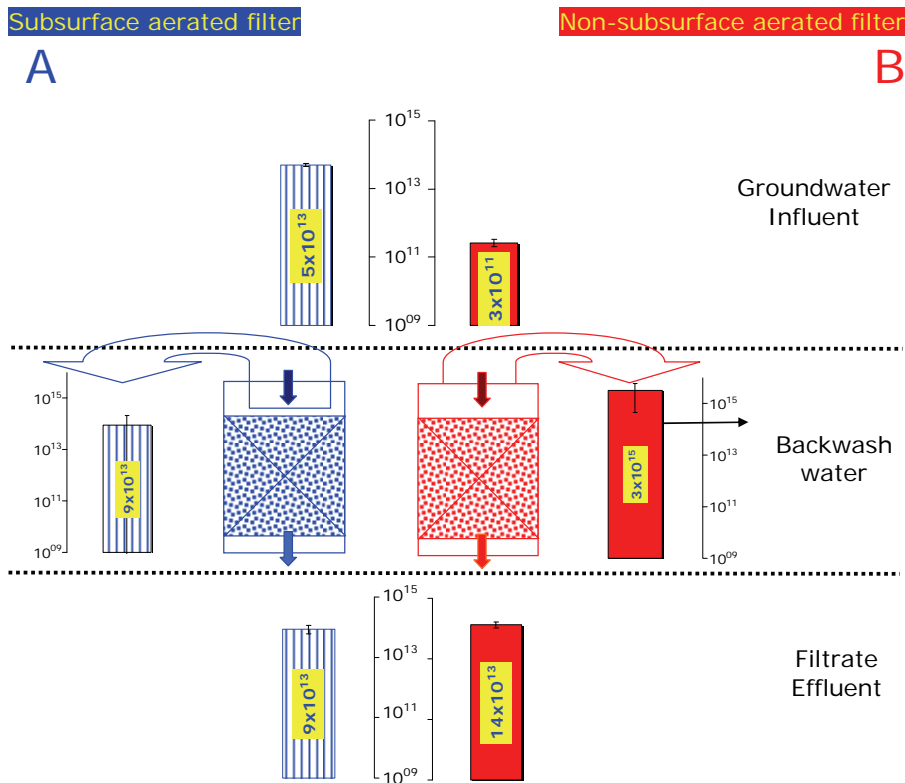

Figure 2: *Gallionella* spp. balances for the subsurface aerated filter (left graph) and non-subsurface aerated filter (right graph); total cell numbers inoculated from groundwater, washed out to backwash and to filtrate are calculated for one filter runtime of 48 hours. Center graphs present the cumulative cell numbers in influent (top) and effluent (bottom); middle left and right graphs present cumulative cell numbers in backwash water; error bars show standard deviations



The measurements show that a significant number of *Gallionella* cells were found in both filters despite the fact that these filters were very well aerated and the oxygen content of the filtrate water was close to saturation level. This condition is usually assumed to be associated with chemical iron oxidation (Sharma et al., 2005). Despite the continuous inoculation from the subsurface aerated well, the cell numbers leaving the subsurface aerated filter through the filtrate and backwash water were in the same order of magnitude as the inflowing cell numbers. In the non-subsurface aerated filter the cell numbers leaving the filter through the filtrate and backwash water were over 10 times higher than for the subsurface aerated filter and  $10^4$  times higher than in the groundwater feeding that filter. This indicates a strong growth of *Gallionella* spp. in the non-subsurface aerated filter, and a small or absence of growth in the subsurface aerated filter.

### 6.3.3. Identification of *Gallionella* subspecies in different niches in subsurface aerated groundwater and trickling filters

In order to get more insight into the role and diversity of *Gallionella* spp. in the groundwater and filters and to confirm the accuracy of the qPCR method, the PCR products obtained from the different samples in the processes were sequenced. Samples were selected from groundwater, filtrate, and backwash water from both filters and from gradient tube studies (see Table 1).

**Table 1: Overview of samples and methods used for identification of *Gallionella* spp. ([non-]SA = [non-]subsurface aerated); samples codes based on de Vet et al. (2009b)**

Code	Sample description	Sample date	<i>Gallionella</i> spp. (cells mL <sup>-1</sup> )*	Method
LKG-A1-clonelib	SA groundwater, (24 hours after extraction started)	31-Jul-08	$8.4 \times 10^6$	2
LKG-B-DGGE-EUB	SA groundwater, (8 hours after extraction started) after partial enrichment in gradient tubes	22-Apr-09	$3.1 \times 10^4$	3
LKG-C-DGGE-EUB	SA groundwater, (24 hours after extraction started) after partial enrichment in gradient tubes	23-Apr-09	$1.4 \times 10^4$	3
LKF-D-clonelib	Backwash water, SA filter	23-Apr-08	$6.5 \times 10^5$	2
LKF-E-clonelib	Filtrate water non-SA filter (end of filter run)	19-sep-08	$8.5 \times 10^4$	2
LKF-F-clonelib	Backwash water, non-SA filter	18-Jun-08	$2.4 \times 10^6$	2
LKF-G-DGGE-EUB	Backwash water, non-SA filter after partial enrichment in gradient tubes	06-Apr-09	$1.9 \times 10^8$	3
LKF-H-DGGE-EUB	External wash water**, non-SA filter after partial enrichment in gradient tubes	06-Apr-09	$1.8 \times 10^7$	3

Gradient tubes were used to enrich for FeOB from groundwater and filter wash water to check for other culturable FeOB than *Gallionella* spp. in the original samples. The growth of FeOB in the inoculated tubes is visible from the formation of a sharp band (Figure 3).

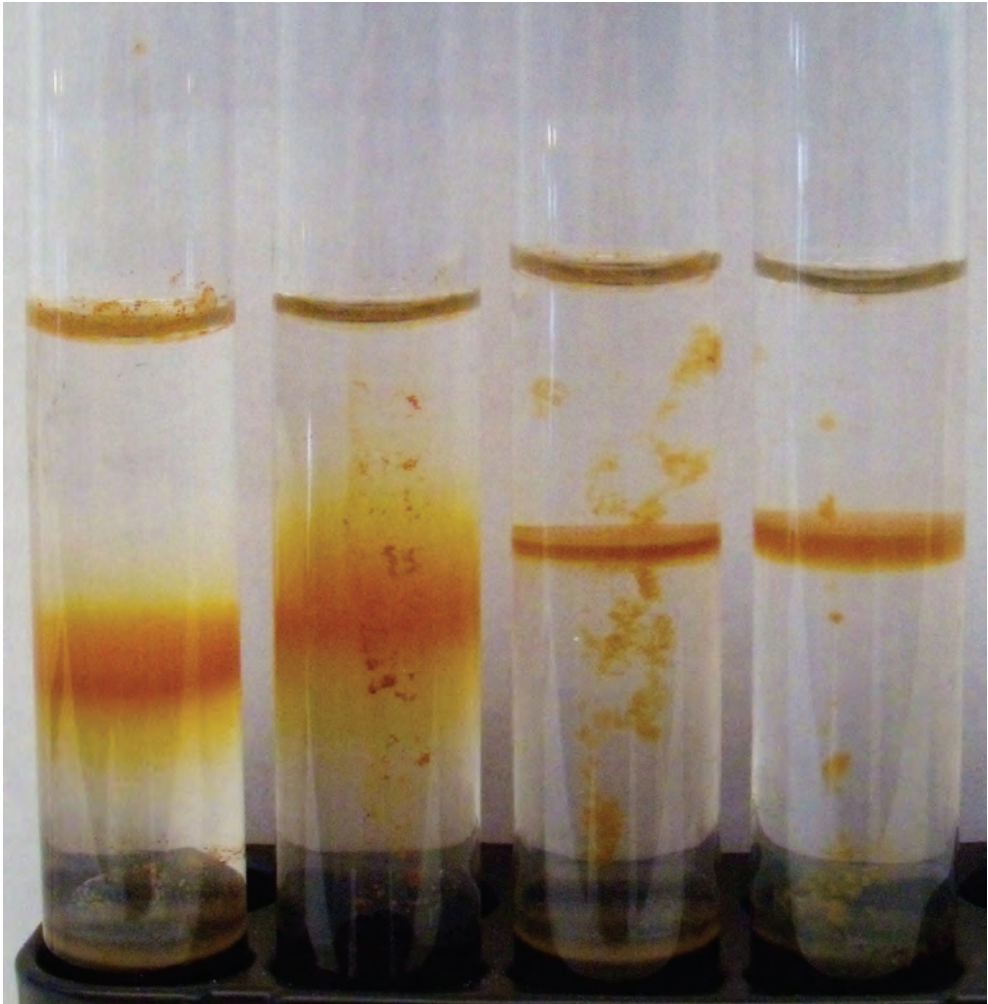

Figure 3: Gradient tubes with FeS at the bottom and oxygen at the top; left to right: blank (no bacterial cells), negative control (autoclaved), inoculated with subsurface aerated groundwater (sampled 24 hours after start of extraction) in duplicate

The sequences from DGGE and clone libraries were calculated into a phylogenetic tree, with existing *Gallionella* sequences from pure cultures and environmental samples (see Figure 4).

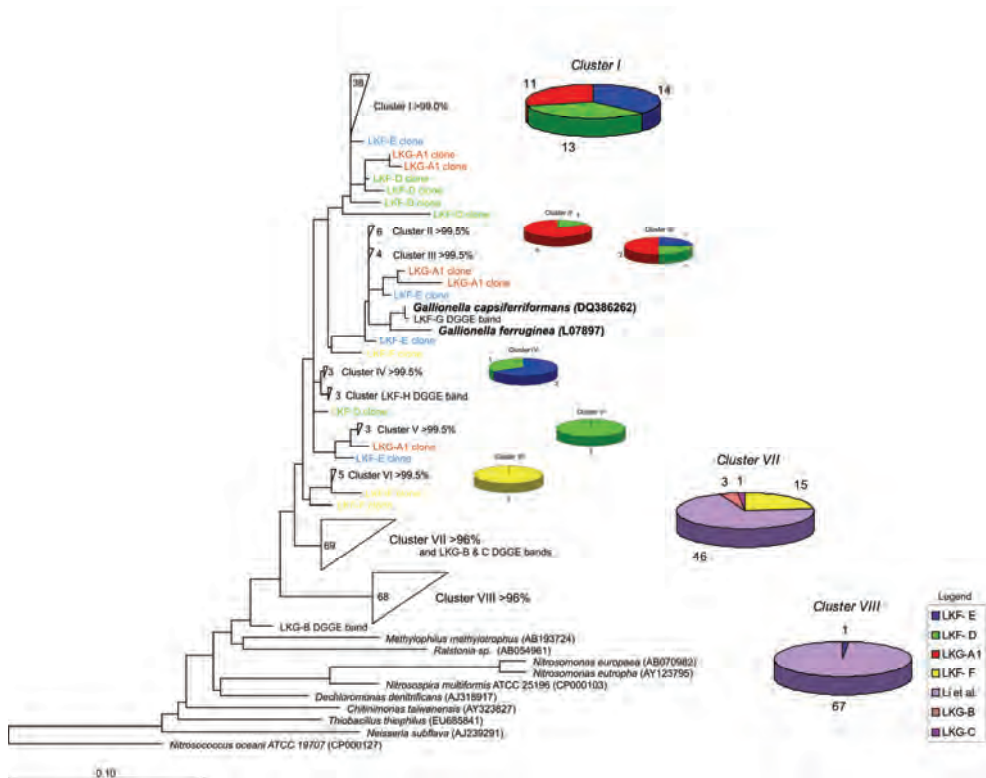

Figure 4: Phylogenetic representation of the *Gallionella* 16S rRNA gene sequences originating from groundwater, filters, and enrichments (for description see Table 1): SA groundwater (LKG-codes, red pink and dark red), backwash water SA filter (LKF-D, green), backwash water non-SA filter (LKF-F, yellow; LKF-G and H, black), filtrate water non-SA filter (LKF-E, blue); sequences from Li et al. (2010) purple

All sequences found in the clone libraries were related to *Gallionella*, showing that the qPCR method was indeed selective for these organisms only. The phylogenetic analysis showed that different subspecies of *Gallionella* were present within and between the samples supporting the presence of different niche conditions in these samples. Similar sequences of *Gallionella* (clusters I, II and III) were found in the SA treated groundwater (red sequences) and SA backwash water (green sequences) showing that *Gallionella* species inoculated from the groundwater also establish themselves within the SA filter. Similar *Gallionella* sequences were also found in the filtrate (blue sequences) but not in the backwash water (yellow sequences) of the non-SA filters. Instead, the backwash water of these non-SA filters contained two significantly different clusters of sequences (yellow sequences, clusters VI and VII) suggesting that the (micro)conditions on the filter material in the non-SA filter allowed different *Gallionella* subspecies to attach and grow.

This shows that *Gallionella* cells that attach to the filter material in the non-SA filters are different from *Gallionella* cells in the SA filters, probably as the result of

selective enrichment due to minor differences in the filter and feed water conditions. The sequences from the gradient tubes show that it was possible to enrich *Gallionella* cells from the different starting samples. No sequences of FeOB were found other than those related to *Gallionella*. The resulting sequences were dissimilar to the sequences found in the original start material, showing that the conditions in the enrichment were different from the original conditions and are therefore unsuitable for obtaining large numbers of the most relevant clones. However, sequences from the gradient tubes clustered differently according to their origin.

## 6.4. Discussion

### 6.4.1. Growth of *Gallionella* spp. in subsurface aerated groundwater and groundwater filters

The results described in this manuscript show that *Gallionella* spp. may grow under broader conditions than generally assumed. Subsurface aeration enhanced the growth of *Gallionella* spp. *in situ*. In total  $8 \times 10^{15}$  cells (see Figure 2) or  $1 \times 10^3$  gDW of *Gallionella* spp. grew during one abstraction phase on the oxidation of 105 kg of ferrous iron in total. The *Gallionella* yield of  $8 \times 10^{10}$  cells or  $0.01 \text{ gDW g}^{-1}$  Fe oxidized is comparable to values in the literature (Hanert, 2006; Neubauer et al., 2002), suggesting that biological iron oxidation plays a major role in *in situ* iron removal systems. *Gallionella* spp. did not grow further in the subsurface aerated trickling filter. This appears to be consistent with the general perception of *Gallionella* being strictly micro-aerophilic.

In the non-subsurface aerated filter, however, inoculation of *Gallionella* spp. cells from the groundwater was marginal, but the growth in the filter important. Yield calculations confirm that biological iron oxidation by *Gallionella* spp. played a dominant role in the non-subsurface aerated full-scale filter (de Vet et al., submitted). The growth of *Gallionella* spp. in groundwater and drinking water under fully aerated conditions at neutral pH (up to 7.7) was found in other full- and lab-scale filters and reactors as well (Ibid.). Growth of *Gallionella* spp. under comparable redox conditions has also been observed by other researchers in a well-fed surface water (James and Ferris, 2004) and in drinking water distribution (Li et al., 2010).

In view of the general growth of *Gallionella* spp. in the Oasen treatment systems, the non-subsurface aerated filter formed an exception. In the subsurface aerated full-scale filter, *Gallionella* spp. grew much less than in the non-subsurface aerated filter. The continuous inoculation of *Gallionella* cells from the subsurface aerated

well did not result in enhanced growth in the trickling filter. A yield of  $1.8 \pm 2.4 \times 10^{10}$  *Gallionella* cells, or  $0.002 \pm 0.003$  g DW,  $\text{g}^{-1}$  Fe oxidized was found.

Because no other explanation was evident, subsurface aeration appeared to be preventing the growth of *Gallionella* spp. in the trickling filter. The reason for this inhibition cannot be deduced from our experiments, but at least one hypothesis has emerged. During subsurface aeration, not only iron-oxidizing bacteria are stimulated, but also complex iron oxyhydroxides colloids are formed (Wolthoorn et al., 2004b). These catalytic particles are removed by the filter and may enhance the heterogeneous chemical iron oxidation, thus outpacing the bacterial process.

#### **6.4.2. Selection of dominant *Gallionella* spp. in subsurface aerated groundwater and groundwater filters**

In the groundwater and filter systems presented in this paper, we found two differentiated environments for the growth of *Gallionella* spp.: a subsurface aerated groundwater well and a trickling filter treating non-subsurface aerated groundwater. As discussed in the previous section, *Gallionella* spp. grew in the subsurface aerated well and were continuously inoculated on a trickling filter, but in that filter, *Gallionella* cell numbers hardly increased further. In the non-subsurface aerated filter, however, *Gallionella* cell numbers were low in the groundwater but increased vigorously. The clone libraries showed that the *Gallionella* spp. growing in these two environments belonged to different clusters. This distinction raises the question whether the selection is caused by specific circumstances in the respective niches. Niche differentiation, especially along gradients (such as for substrate, pH, DO or temperatures), has been recognized as an important mechanism for selection of genotypes (Kassen and Rainey, 2004). The subsurface aerated well niche can be characterized by the successive availability of the two catabolic substrates, ferrous iron and oxygen. Apparently, the *Gallionella* are able to use the ferrous iron that was adsorbed on iron oxyhydroxides or biogenic depositions during the previous abstraction phase. In the trickling filter, ferrous iron and oxygen are both constantly available. *Gallionella* grows continuously and the population reaches equilibrium.

The subspecies growing in the fully aerated Dutch trickling filter clustered with the sequences found in a well-aerated Chinese drinking water distribution system (Li et al., 2010; see Figure 4), but deviated from the subsurface aerated groundwater. The distinct conditions in the two niches have selected for different clusters of *Gallionella* spp., with their own specific physiological characteristics such as oxygen tolerance, nutrient demands, specific growth rate and excretion of ligands.

## 6.5. Conclusions

- Different clusters of *Gallionella* spp. in a subsurface aeration well and a trickling filter for drinking water production were quantified by qPCR and identified by clone libraries.
- Subsurface aeration stimulated the *in situ* growth of *Gallionella* spp. in the groundwater, but prevented growth in the coupled trickling filter, despite continuous inoculation;
- Growth of *Gallionella* spp. occurred in another trickling filter treating non-subsurface aerated groundwater;
- Different conditions in the subsurface aerated groundwater and the non-subsurface aerated trickling filter selected for different clusters of *Gallionella* spp. in each niche

## Acknowledgements

The authors gratefully acknowledge the contribution of Florence Marty and Mark Hanemaaijer for their work with the gradient tubes enrichment, Peter Dijkstra for assistance with the filter operation, and Sabine Doddema and Paul van der Wielen for the DNA-isolation for the qPCR.

## Supporting Information Available

- Supplementary Material A, Iron oxidation in subsurface aeration and trickling filters at Oasen WTP Lekkerkerk

## References

- Appelo CAJ, de Vet WWJM. 2003. Modeling *in situ* iron removal from groundwater with trace elements such as As. In: A.H. Welch and K.G. Stollenwerk (Eds.). Arsenic in groundwater. Kluwer Academic, Boston. p 381-401.
- Appelo CAJ, Drijver B, Hekkenberg R, Jonge M. 1999. Modeling In Situ Iron Removal from Ground Water. *Ground Water* 37(6):811-817.
- Braester C, Martinell R. 1988. The vyredox and nitredox methods of *in situ* treatment of groundwater. *Water Science and Technology* 20(3):149-163.

Czekalla C, Mevius W, Hanert H. 1985. Quantitative removal of iron and manganese by microorganisms in rapid sand filters (*in situ* investigations). *Water Supply* 3(1):111-123.

de Vet WWJM, Rietveld LC, van Loosdrecht MCM. 2009a. Influence of iron on nitrification in full-scale drinking water filters. *Journal of Water Supply: Research and Technology-AQUA* 58(4):247-256.

de Vet WWJM, Dinkla IJT, Muyzer G, Rietveld LC, van Loosdrecht MCM. 2009b. Molecular characterization of microbial populations in groundwater sources and sand filters for drinking water production. *Water Research* 43(1):182-194.

de Vet WWJM, van Genuchten CCA, van Loosdrecht MCM, van Dijk JC. 2010. Water quality and treatment of river bank filtrate. *Drink. Water Eng. Sci.* 3(1):79-90.

de Vet W.W.J.M., Kleerebezem R., van der Wielen P.W.J.J., Rietveld L.C., van Loosdrecht M. C. M.. Abundance and activity of ammonia-oxidizing prokaryotes in groundwater filters for drinking water production. Submitted November 8, 2010)

Emerson D, Fleming EJ, McBeth JM. 2010. Iron-Oxidizing Bacteria: An Environmental and Genomic Perspective. *Annual Review of Microbiology* 64(1):561-583.

Emerson D, Floyd MM. 2005. Enrichment and isolation of iron-oxidizing bacteria at neutral pH. *Methods in Enzymology* 397:112-123.

Emerson D, Weiss JV. 2004. Bacterial iron oxidation in circumneutral freshwater habitats: Findings from the field and the laboratory. *Geomicrobiology Journal* 21(6):405-414.

Hallbeck L, Pedersen K. 1990. Culture parameters regulating stalk formation and growth rate of *Gallionella ferruginea*. *Journal of General Microbiology* 136(9):1675-1680.

Hallbeck L, Pedersen K. 1991. Autotrophic and mixotrophic growth of *Gallionella ferruginea*. *Journal of General Microbiology* 137(11):2657-2661.

Hanert HH. 2006. The Genus *Gallionella*. *The Prokaryotes, A Handbook on the Biology of Bacteria*. Third Edition ed: Springer. p 990-995.

Hiemstra T, van Riemsdijk WH. 2007. Adsorption and surface oxidation of Fe(II) on metal (hydr)oxides. *Geochimica et Cosmochimica Acta* 71(24):5913-5933.

James RE, Ferris FG. 2004. Evidence for microbial-mediated iron oxidation at a neutrophilic groundwater spring. *Chemical Geology* 212(3-4 SPEC.ISS.):301-311.

Kassen R, Rainey PB. 2004. The ecology and genetics of microbial diversity. *Annual Review of Microbiology* 58:207-231.

Li D, Li Z, Yu J, Cao N, Liu R, Yang M. 2010. Characterization of Bacterial Community Structure in a Drinking Water Distribution System during an Occurrence of Red Water. *Appl. Environ. Microbiol.* 76(21):7171-7180.

Ludwig W, Strunk O, Westram R, Richter L, Meier H, Yadhukumar A, Buchner A, Lai T, Steppi S, Jacob G and others. 2004. ARB: A software environment for sequence data. *Nucleic Acids Research* 32(4):1363-1371.

Lütters-Czekalla S. 1990. Lithoautotrophic growth of the iron bacterium *Gallionella ferruginea* with thiosulfate or sulfide as energy source. Archives of Microbiology 154(5):417-421.

Mouchet P. 1992. From conventional to biological removal of iron and manganese in France. Journal / American Water Works Association 84(4):158-167.

Neubauer SC, Emerson D, Megonigal JP. 2002. Life at the energetic edge: Kinetics of circumneutral iron oxidation by lithotrophic iron-oxidizing bacteria isolated from the wetland-plant rhizosphere. Applied and Environmental Microbiology 68(8):3988-3995.

Schäfer H, Muyzer G. 2001. Denaturing gradient gel electrophoresis in marine microbial ecology. Methods in Microbiology. p 425-468.

Sharma SK, Petruszewski B, Schippers JC. 2005. Biological iron removal from groundwater: A review. Journal of Water Supply: Research and Technology - AQUA 54(4):239-247.

Smeets PWMH, Medema GJ, van Dijk JC. 2009. The Dutch secret: how to provide safe drinking water without chlorine in the Netherlands. Drink. Water Eng. Sci. 2(1):1-14.

Sobolev D, Roden EE. 2004. Characterization of a neutrophilic, chemolithoautotrophic Fe(II)-oxidizing  $\hat{\text{I}}^2$ -proteobacterium from freshwater wetland sediments. Geomicrobiology Journal 21(1):1-10.

Tekerlekopoulou AG, Vayenas DV. 2008. Simultaneous biological removal of ammonia, iron and manganese from potable water using a trickling filter. Biochemical Engineering Journal 39(1):215-220.

van Halem D, de Vet WWJM, Verberk JQJC, Amy GL, van Dijk JC. (in press) 2011. Characterization of accumulated precipitates during subsurface iron removal. Applied Geochemistry.

Wolthoorn A, Temminghoff EJM, Van Riemsdijk WH. 2004a. Colloid formation in groundwater by subsurface aeration: Characterisation of the geo-colloids and their counterparts. Applied Geochemistry 19(9):1391-1402.

Wolthoorn A, Temminghoff EJM, Weng L, Van Riemsdijk WH. 2004b. Colloid formation in groundwater: Effect of phosphate, manganese, silicate and dissolved organic matter on the dynamic heterogeneous oxidation of ferrous iron. Applied Geochemistry 19(4):611-622.



## Supporting information paragraph

### Supplementary Material A

#### *Subsurface aeration at Oasen WTP Lekkerkerk*

One subsurface aeration cycle consists of two days of tap water injection in one groundwater well, followed by 40 days of extraction from the same well. During one infiltration phase a total volume of 1500 m<sup>3</sup> of tap water with 10 g m<sup>-3</sup> DO is injected into the aquifer, in total 15 kg (or 4.5 × 10<sup>2</sup> mol) of O<sub>2</sub>. From the total injected oxygen a maximum amount of ferrous iron that can be oxidized may be calculated stoichiometrically: 105 kg (1.9 × 10<sup>3</sup> mol) Fe, when all oxygen is used for iron oxidation only.

#### *Full-scale trickling filters at Oasen WTP Lekkerkerk*

The two full-scale trickling filters treated groundwater from different well fields. The subsurface aerated filter was not only fed by the subsurface aerated well, but also by other wells in the well field; the subsurface aerated well contributed 16% to the raw water flow to the trickling filter. Subsurface aeration had a limited effect on the total iron concentrations in the mixed raw groundwater and only at the beginning of the extraction period. The average production flow over the monitored period was 36.5 and 47 m<sup>3</sup> h<sup>-1</sup> for the non-subsurface and the subsurface aerated filter, respectively. The total iron concentration in the groundwater, 5.5 ± 0.6 and 3.1 ± 0.4 mg L<sup>-1</sup> for the non-subsurface aerated and the subsurface aerated filter, respectively, was virtually completely removed by the filters. During one filter run of 48 hours with an average production flow of 37 and 47 m<sup>3</sup> h<sup>-1</sup>, 9.6 ± 1.1 and 7.1 ± 1.0 kg Fe was removed from these filters respectively. Total iron in water samples was determined by ICP-MS.





# CHAPTER 7

---

## Filter coatings in groundwater trickling filters for drinking water production

**Based on:**  
de Vet, W.W.J.M., Rietveld, L.C., Heijman, S.G.J.,  
de Rooij, M.R. and van Loosdrecht, M.C.M. (2008)  
Interaction of iron, manganese and ammonium removal in bio filters  
for drinking water production, Proceedings of the AWWA Inorganic  
Contaminants Workshop, Albuquerque, New Mexico (USA).

## **Abstract**

Nitrification in groundwater filters may be inhibited by the iron removal processes in the same filters. Nitrification can be successfully maintained in full-scale filters by use of subsurface aeration, which probably changes the iron removal mechanism and the resulting filter coatings. Filter samples from several groundwater filters, with and without subsurface aeration, were compared by mass, surface extractable iron content (SEIC) and pore structure of the coatings on the filter materials. The cumulative pore area of filter coatings in drinking water filters was determined by mercury intrusion porosimetry. The results were related to the sand-specific nitrification rate of the filter samples in a standard batch test. In the non-subsurface aerated filter samples, both mass and cumulative pore area were restricted and inversely proportional to the sand-specific nitrification rate. In subsurface aerated filters, a strong increase in coating mass was observed. The high coating mass coincided with a high SEIC and cumulative pore area, but only with a slight reduction in sand-specific nitrification rate.

## **Keywords**

Drinking water, Filter coating, Iron, manganese and ammonium removal, mercury intrusion porosimetry, sand-specific nitrification rate

## 7.1. Introduction

In the Netherlands, the primary treatment of groundwater for drinking water production usually consists of rapid sand filtration. For the anaerobic groundwater of the Oasen Drinking Water Company (Oasen) in The Netherlands, the typical main compounds iron, ammonium and manganese are removed in the same biological trickling filters. No oxidizing agents other than oxygen are applied. Iron and manganese are supposedly mainly removed by chemical and physical processes. Their removal is complex, but generally robust. Nitrification is the microbial conversion of ammonia via nitrite to nitrate in two consecutive and distinct steps by different species of slow growing autotrophic microorganisms. Nitrification is often hampered in the Oasen groundwater filters. Nitrification typically starts up well with new filter sand and falls back after a production period of six months to several years. An effective way for Oasen to maintain sound nitrification is by subsurface aeration, a limited form of *in situ* iron removal (Appelo et al., 1999). In this technique, limited amounts of aerated water are periodically injected into a well, the total amount of injection water being only 1% of the extracted raw water. During subsurface aeration, mobile iron hydroxide colloids are formed in the aquifer (Wolthoorn et al., 2004a). Previous research on subsurface aeration showed that these colloids are extracted with the raw water and that synthetic iron colloids enhance nitrification in lab-scale filters (Wolthoorn et al., 2004b). It was hypothesized that the beneficial influence of iron colloids results from altering the iron removal in the filter. In trickling filters, reduced iron from groundwater is oxidized by air oxygen and removed by a combination of three mechanisms, flock filtration, adsorptive oxidation and biological iron oxidation. As for the first two chemical mechanisms, Sharma et al. (2001) demonstrated that both mechanisms result in different filter coatings. As nitrification is a biological process occurring in biofilms attached to the filter material, coating characteristics are supposed to be essential for it. A good coating for nitrification has a high porosity with ample attachment places for microorganisms and substrates. Formation of the coating is influenced by raw water quality, filter operation and pre-treatment. A relation between raw water and coating composition is self evident and will be further discussed in this paper. Some major effects of operation and pre-treatment have been described by de Vet et al. (2009a; Chapter 3). Long term monitoring of full-scale filters demonstrated the adverse effect of iron removal on the biological nitrification and the beneficial effect of subsurface aeration. The latter is shown in Figure 1.

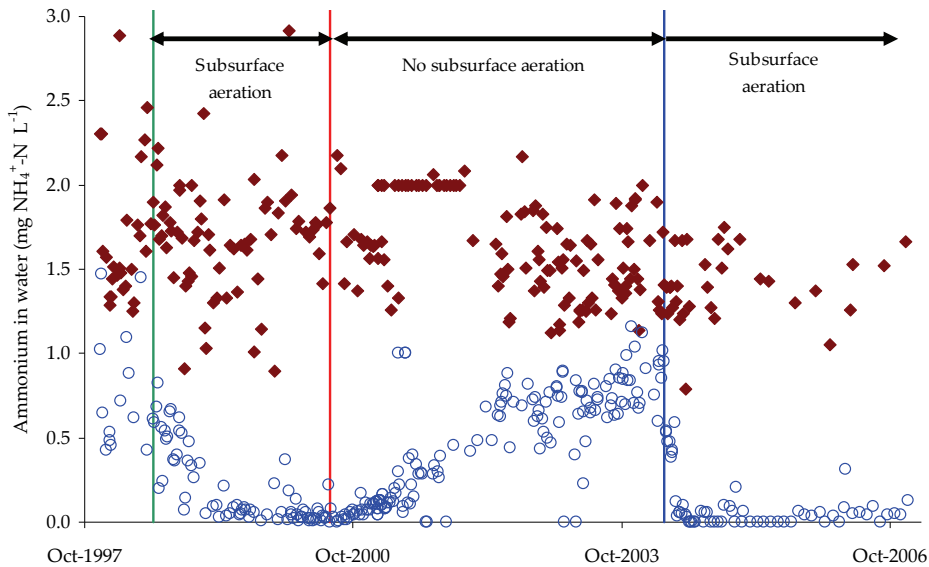

Figure 1: Ammonium concentrations in the influent (●) and effluent (○) of a groundwater trickling filter over a period of nine years of production time with and without subsurface aeration

Research by Oasen aims at imitation of the beneficial effect of subsurface aeration without injection of aerated water into the aquifer. For this, a better understanding of the action of the colloids formed during subsurface aeration is required. In this study we compared the filter coatings in full-scale filters operated with subsurface aeration with reference filters without this pretreatment. We hypothesize that the decrease in nitrification was caused by changes in the filter coating due to removal of iron and manganese and that subsurface aeration prevents this unwanted change. In this paper, we test this hypothesis by comparing the nitrifying activity to the mass and porosity of the filter coating in these filters.

## 7.2. Materials and methods

### 7.2.1. Description of Oasen full-scale filters

*A subsurface aerated and a non-subsurface aerated filter at WTP Lekkerkerk*

Two trickling filters at the Oasen Water Treatment Plant (WTP) Lekkerkerk were investigated in depth. One filter treated partially subsurface aerated groundwater, and will be referred to as the subsurface aerated filter. Another filter treating normal, non-subsurface aerated groundwater will be indicated as non-subsurface aerated filter. A picture of one of the filters is shown in Figure 2.





Figure 2: Full-scale trickling filter at Oasen WTP Lekkerkerk. Raw water is sprayed directly on top of the filter bed. The central outlet with cone is used for drainage of backwash water.

Both trickling sand filters treated groundwater from a different well field, which accounts for the differences in influent water quality. Average values for the influent- and effluent concentrations of the major removed substances in both filters are given in Table 1.

Table 1: Average influent and effluent water quality for the subsurface and non-subsurface aerated filter at WTP Lekkerkerk

		Subsurface aerated filter		Non-subsurface aerated filter	
		Influent*	Effluent**	Influent*	Effluent**
Ammonium	mg NH <sub>4</sub> <sup>+</sup> -N L <sup>-1</sup>	1.7	< 0.03	4.4	2.7
Nitrite	mg NO <sub>2</sub> <sup>-</sup> -N L <sup>-1</sup>	<0.002	<0.002	<0.002	0.022
Nitrate	mg NO <sub>3</sub> <sup>-</sup> -N L <sup>-1</sup>	<0.1	n.a.	<0.1	n.a.
Iron	mg Fe <sup>2+</sup> L <sup>-1</sup>	3.7	0.007	5.6	0.009
Manganese	mg Mn <sup>2+</sup> L <sup>-1</sup>	0.94	0.002	0.61	0.047
Methane	mg CH <sub>4</sub> L <sup>-1</sup>	0.516	<0.010	1.075	<0.010

n.a. = no analyses;

\* Averages for the influent over 2003-2006

\*\*Averages for filter effluents over only three months (July-September 2006) round the sampling date because of dynamic character filter removal efficiency



Each filter had a bed height of 2 m and an average superficial water velocity of 2.2 m h<sup>-1</sup>. The filter material was coarse river sand (fraction 1.7-2.5 mm). The trickling filters had forced ventilation with an average RQ (air to water ratio) of 10, resulting in nearly complete saturation for oxygen and stripping of methane from the water. One of the major impact factors on coating formation and characteristics and nitrifying activity was the maintenance of the filter. Two events are taken into account in this study: new filter sand and external washing of coated filter sand. New filter sand contained no significant coating or (nitrifying) biomass. During external washing, filter sand was pumped out of and then back into the filter by a water jet. In this action, part of the iron coating was removed by scrubbing. Restricted nitrification was restored temporarily to almost full, as is shown in Figure 3 for the non-subsurface aerated filter.

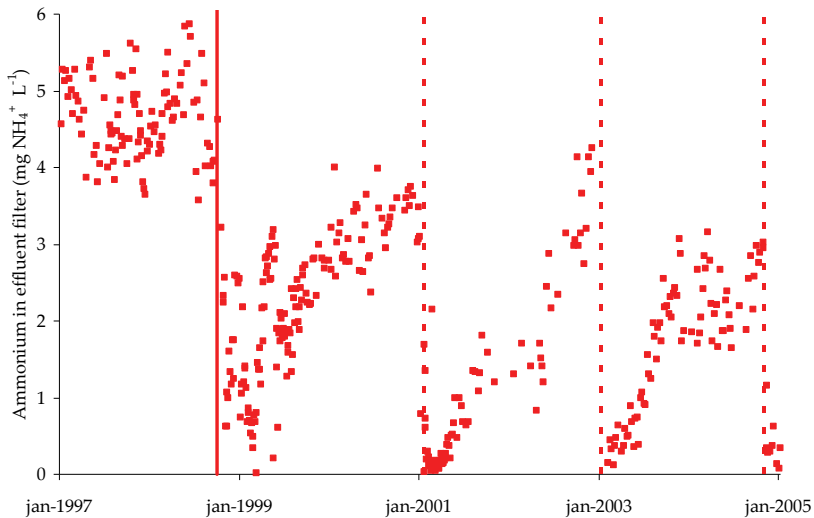

Figure 3: Ammonium concentration in the effluent of the non-subsurface aerated filter over a period of eight years of production time; at the solid line the filter material was renewed by fresh sand, at the dotted lines the existing filter sand was externally washed; the average ammonium concentration in the influent was 5.3 mg NH<sub>4</sub> L<sup>-1</sup>

Table 2 shows that the maintenance history for the subsurface aerated and non-subsurface aerated filter was comparable.

Table 2: History of the investigated full-scale trickling filters at WTP Lekkerkerk

Filter	New filter sand	External washing	Total (last) filter-runtime
Subsurface aerated filter	1998 December	2003 April 2005 January	7 years + 8 months (1 year + 7 months)
Non-subsurface aerated filter	1998 October	2001 January 2003 January 2004 November	7 years + 10 months (1 year + 9 months)

Filter samples were taken in both filters on August 23, 2006. Sand was collected at three depths (0-10 cm, 25-50 cm and 50-100 cm). At each depth, mixed samples were composited by sampling four different places over the filter bed area.

#### *Other Oasen subsurface aerated and a non-subsurface aerated filters*

A wider comparison was made in 2007 by confronting the filters from case one with five more trickling filters at other Oasen WTPs. In all but one filter, samples were composited from four different places over the filter bed area at two depths. An overview of the process parameters of the investigated filters is given in Table 3. Overall sand-specific nitrification rates may differ from the batch results (see next and *Results and discussion* sections) because they were averaged over the total bed height of two meters.

**Table 3: Filter specs of all filters in the broad comparison of 2007; influent and effluent concentrations are given as averages over the sampling period of January 2004 to October 2007; bed height was 2 m; overall sand-specific nitrification rate was calculated assuming an average hydraulic load of 1.1 m<sup>3</sup> water h<sup>-1</sup> per m<sup>3</sup> of filter sand**

Subsurface aerated (SA) or not (Non-SA)	WTP*	Sampling date	Depth filter sample cm	Filter run time after external washing Months	Ammonium		Overall sand-specific nitrification rate mg N h <sup>-1</sup> kg <sup>-1</sup>	Removal efficiency for NH <sub>4</sub> <sup>+</sup> -N %
					IN mg NH <sub>4</sub> <sup>+</sup> -N L <sup>-1</sup>	OUT mg NH <sub>4</sub> <sup>+</sup> -N L <sup>-1</sup>		
SA	LS	23-8-2006	25-100	19	1,5	0,1	1,0	96%
SA	LS	14-9-2007	0-100	33	1,5	0,2	0,9	89%
SA	PU	26-9-2007	0-100	30	4,2	0,3	2,7	94%
SA	PU	26-9-2007	0-50	10	4,2	0,4	2,6	90%
Non-SA	LT	23-8-2006	25-100	21	4,2	1,5	1,9	65%
Non-SA	LT	14-9-2007	0-100	23	4,2	1,3	2,0	69%
Non-SA	RK	18-9-2007	0-50	30	7,9	2,0	4,1	75%

WTP abbreviations\*: LS = Lekkerkerk Schuwacht; LT = Lekkerkerk Tiendweg; PU = De Put; RK = Reijerwaard

#### 7.2.2. Measurements

Ammonium was determined by colorimetric measurement. The method used had a detection limit of 0.03 mg NH<sub>4</sub><sup>+</sup>-N L<sup>-1</sup>. The overall sand-specific nitrification rate was calculated at every data point from the measured ammonium concentrations in the filter influent and effluent and the water flow over the filter divided by the fixed gross volume of the filter bed.

*Sand-specific nitrification rate (batch experiments)*

In order to quantify the nitrifying activity of the filter samples, the sand-specific nitrification rate was measured at Vitens Laboratory Utrecht based on the method proposed by Kihn et al. (2000). Instead of a synthetic medium, tap water was used. This water contained a natural bicarbonate buffer and all required macro and trace elements for nitrification, except for ammonium. At  $t = 0:00$  min, 200 mL of tap water was added to 100 g of filter sand in order to reach N-equilibrium in the liquid phase before the measurements started. At  $t = 5:00$  min, a concentrated  $\text{NH}_4\text{Cl}$  solution in tap water was added up to a concentration of  $7.8 \text{ mg NH}_4^+\text{-N L}^{-1}$  ( $10 \text{ mg NH}_4^+ \text{ L}^{-1}$ ). At  $t = 5:30, 10:00, 20:00$  and  $35:00$  min, samples were taken to analyze ammonium, nitrite and nitrate. The temperature during all measurements was  $21 \pm 1 \text{ }^\circ\text{C}$ ; the pH was  $8.15 \pm 0.15$ . Aeration and mixing were guaranteed by air bubbling and shaking. All samples were kept in a dark room at  $4 \pm 3 \text{ }^\circ\text{C}$  for at least 16 hours before analysis. Both ammonium and nitrite were determined by colorimetric measurement. Nitrate was measured by conductivity in accordance with *NEN-EN-ISO 10304-1 and 10304-2*. The sand-specific nitrification rate was calculated from the linear trend in time for the sum of  $\text{NO}_2\text{-N}$  and  $\text{NO}_3\text{-N}$  concentrations and expressed as  $\text{mg (NO}_2\text{-N + NO}_3\text{-N) h}^{-1}$  per kg of filter sand.

*Mass and composition of the coating*

All coating material was dissolved in 4M hydrochloric acid with oxalic acid after removing the sludge. The total coating mass was determined by measurement of the dry mass before and after acidification and was expressed as mass percentage of the original dried filter material. The iron concentration in the decanted acid solution was measured by ICP-MS. Surface extractable iron content (SEIC, mg Fe per g of filter sand) was calculated from the total coating mass and the iron content in the coating.

*Pore size distribution and pore area*

The pore size distribution and cumulative pore area of the filter coating samples were determined by mercury intrusion porosimetry (MIP) at the Microlab of the Delft University of Technology. MIP has been used to characterize cementitious building materials for decades (Rübner and Hoffmann, 2006). MIP also has been used to characterize iron hydroxides before (Schwertmann and Cornell, 2000), but so far not for complex coatings from drinking water filter samples. The pore structure of drinking water filter coatings has been studied by the Brunauer, Emmett and Teller (BET) nitrogen gas adsorption method (Sharma et al., 2002). In the MIP measurement, the non-wetting liquid mercury is pressed into the sample by stepwise increasing the pressure. At each pressure step, pores with a minimal diameter of entrance defined by the Washburn equation (Equation 1) were filled. In this equation,  $D$  is the pore diameter,  $\gamma$  is the surface tension of mercury,  $\Theta$  is the contact angle between mercury and the sample and  $P$  the applied pressure.

$$D = \frac{-4\gamma \cos \theta}{P}$$

Equation 1

Stepwise mercury intrusion resulted in a pore size distribution and a calculation of cumulative pore area, based on the assumption of cylindrical pores. Micrometrics AutoPore IV 9500, the MIP apparatus used in this study, spanned a pressure range of 3.7 kPa to 210 MPa, equivalent with a range in pore diameter of 402  $\mu\text{m}$  down to 7.2 nm. This pore range was used in the comparison of the subsurface aerated and the non-subsurface aerated full-scale trickling filter at WTP Lekkerkerk. These measurements were performed in 2006 in duplicate on all samples. In 2007, the intrusion measurements on the samples of the non-subsurface aerated filter showed some disruption in the measurement at higher pressures (i.e. lower pore size diameters). In the 2007 series of measurements, the incremental mercury intrusion reduced to zero at higher intrusion pressures. This resulted in a lower cumulative pore area of the coating and reduced the reproducibility of the measurements. Sample preparation is known to be a notorious influencing factor (Rübner and Hoffmann, 2006). Heating the sample may cause rupture of the pore structure. In this study, sample preparation comprised flushing to remove the sludge followed by drying. To improve the measurement, tests with different methods of drying, such as vacuum drying and drying at different temperatures - ranging from ambient to 105  $^{\circ}\text{C}$ - and with different duration -ranging from 1 hour to 7 days- were performed. So far the cause for this disruption of the mercury intrusion at high pressures has not yet been established. For comparison of all measurements in 2006 and 2007 (Table 4), the cumulative pore area has been cut off at a pore diameter of 20 nm.

### 7.3. Results and discussion

The first indication of a possible correlation between accumulation of iron and manganese in the filter coating and relapse of nitrification was found in 2000 by comparing the overall sand-specific nitrification rate and the deposition of iron and manganese in the filter coating (see Figure 4).

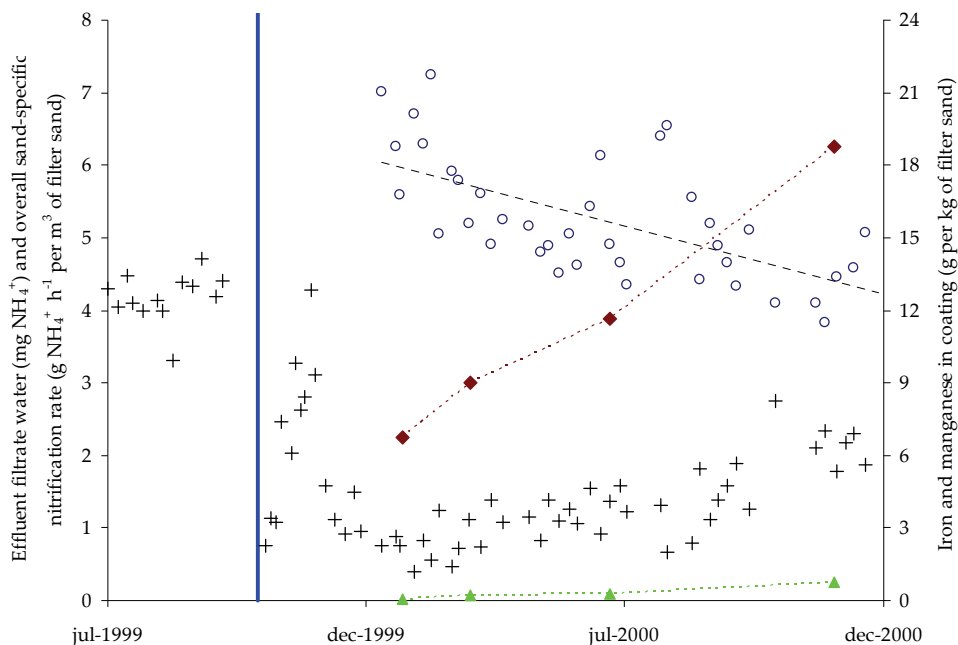

Figure 4: Iron (◆) and manganese (▲) in filter coating, ammonium in filter effluent (+) and overall sand-specific nitrification rate (o) over the filter runtime of one year after starting up with new filter sand (vertical blue line).

#### 7.3.1. Comparison of a subsurface aerated and a non-subsurface aerated filter at WTP Lekkerkerk

Both the high overall performance of the subsurface aerated filter and the poor performance of the non-subsurface aerated filter were reflected in the batch-measurements of the sand-specific nitrification rate (see Figure 5). Characterization of the microbial population by DGGE showed significant differences between both filters (de Vet et al., 2009b; Chapter 4). In the subsurface aerated filter samples, several nitrifying species were present, but no nitrifying microorganisms were found by that method in the non-subsurface aerated filter samples.

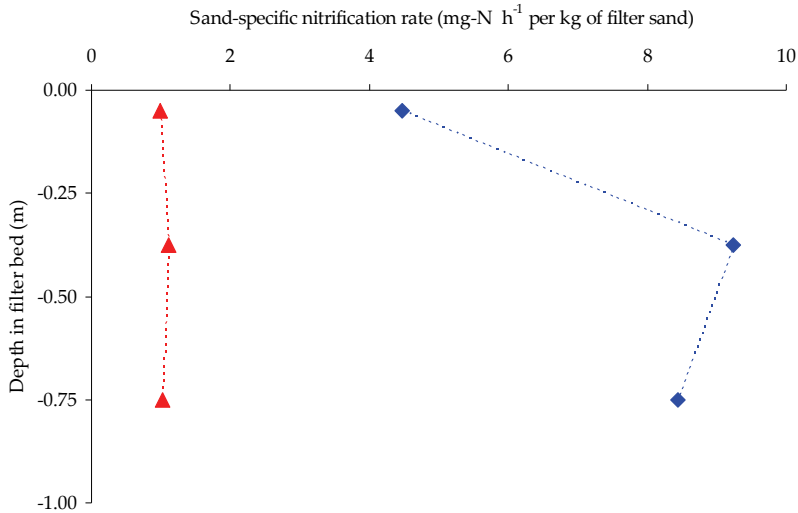

Figure 5: Sand-specific nitrification rates for samples over the top half of the filter bed of the subsurface aerated (◆) and the non-subsurface aerated (▲) filter at WTP Lekkerkerk

An example of duplicate MIP measurements on filter samples from a subsurface aerated and a non-subsurface aerated filter is given in Figure 6. The results proved to be reproducible over the whole pressure range of the AutoPore MIP apparatus. The reproducibility was better for all samples from the subsurface aerated filter.

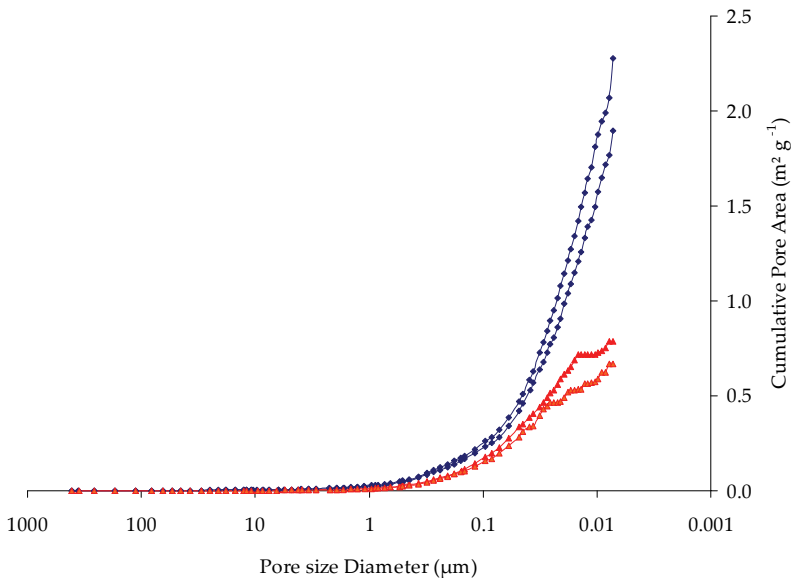

Figure 6: Duplicate MIP-measurements for a subsurface aerated (◆) and a non-subsurface aerated (▲) filter

For these two filters with comparable history, the total pore area of the filter coatings of samples from the top meter of the filter bed, determined by MIP, is shown in Figure 7. The duplicate measurements on samples from three depths from each filter showed a good reproducibility. Samples from the subsurface aerated filter showed a significantly higher cumulative pore area than the non-subsurface aerated filter and coincided with a higher sand-specific nitrification rate for the former. The maximum values for the cumulative pore area are in line with the literature. Makris at al. (2004) found a value of  $2.5 \text{ m}^2 \text{ g}^{-1}$  in iron based drinking-water treatment sludge.

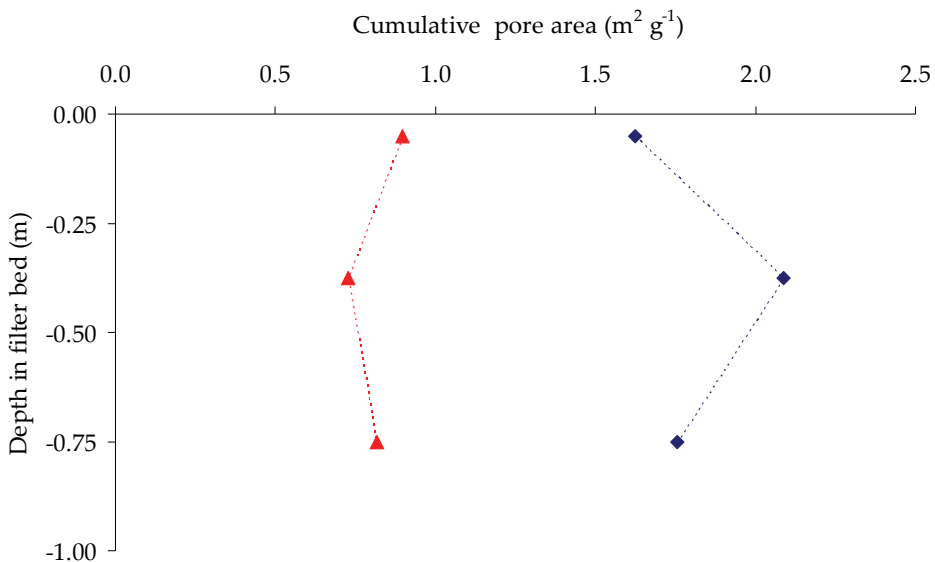

Figure 7: Cumulative pore area for samples for samples over the top half of the filter bed of the subsurface aerated (◆) and the non-subsurface aerated (▲) filter at WTP Lekkerkerk

### 7.3.2. Other Oasen subsurface aerated and a non-subsurface aerated filters

Filter samples from subsurface aerated filters generally showed a larger cumulative pore area than those from non-subsurface aerated filters for pore diameters from  $402 \mu\text{m}$  down to  $20 \text{ nm}$  (see Table 4). The low coating porosity of the sample from the subsurface aerated filter from WTP De Put forms an exception to this rule.

**Table 4: Cumulative pore area (402  $\mu\text{m}$  down to 20 nm), coating mass, SEIC of filter samples from subsurface aerated (SA) and non-subsurface aerated (non-SA) filters**

Subsurface aerated (SA) or not (Non-SA)	WTP*	Sampling date	Depth filter sample cm	Filter run time after external washing months	Pore area (20 nm – 402 $\mu\text{m}$ ) $\text{m}^2 \text{g}^{-1}$	Coating mass m/m %	SEIC $\text{gFe kg}^{-1}$ sand
SA	LS	23-8-2006	25-50	19	0.99		
SA	LS	23-8-2006	50-100	19	0.88		
SA	LS	14-9-2007	0-50	33	1.61	105	359.10
SA	LS	14-9-2007	50-100	33	1.32	90	294.30
SA	PU	26-9-2007	0-50	30		7.2	20.59
SA	PU	26-9-2007	50-100	30	0.27	8.2	17.71
SA	PU	26-9-2007	0-50	10		11.6	33.52
Non-SA	LT	23-8-2006	25-50	21	0.53		
Non-SA	LT	23-8-2006	50-100	21	0.58		
Non-SA	LT	14-9-2007	0-50	23	0.60	23	78.20
Non-SA	LT	14-9-2007	50-100	23	0.35	19.8	65.14
Non-SA	RK	18-9-2007	0-25	30	0.43	16.7	50.77
Non-SA	RK	18-9-2007	25-50	30	0.58	13.4	44.22

WTP abbreviations\*: LS = Lekkerkerk Schuwacht; LT = Lekkerkerk Tiendweg; PU = De Put; RK = Reijerwaard

Filter samples from subsurface aerated filters showed proportionality between the total mass of the coating and its cumulative pore area. In the non-subsurface aerated filter samples, however, no clear proportionality was found between total mass and cumulative pore area of the coating (see Figure 8). The SEIC showed a comparable relation with the cumulative pore area as expected, for iron was the main compound of the filter coating. For the subsurface aerated filters, the relation was even more proportional than that of the coating mass. The strong correlation between SEIC and cumulative pore area was also found by Sharma et al. (2002). In the non-subsurface aerated filter samples, however, this correlation between SEIC and cumulative pore area was not found.



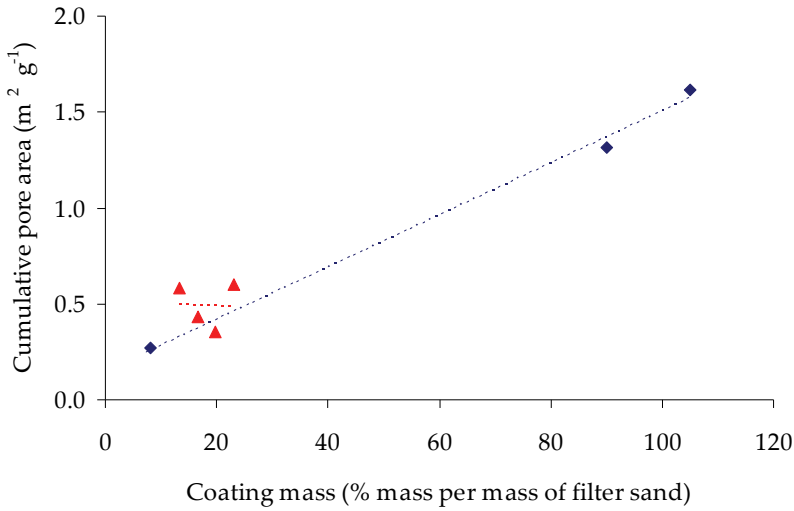

Figure 8: Coating mass versus cumulative pore area for subsurface aerated (◆) and non-subsurface aerated (▲) filters at several Oasen WTPs

For the correlation between coating mass and sand-specific nitrification rate, the differences between subsurface aerated and non-subsurface aerated filters were even more distinct. Samples from non-subsurface aerated filters showed a steep reciprocal relation. For samples of subsurface aerated filters, the relation was somewhat diffuse, but certainly less pronounced (see Figure 9). In subsurface aerated filters, increase of the filter coating did not or only limitedly inhibit the growth and activity of nitrifying microorganisms.

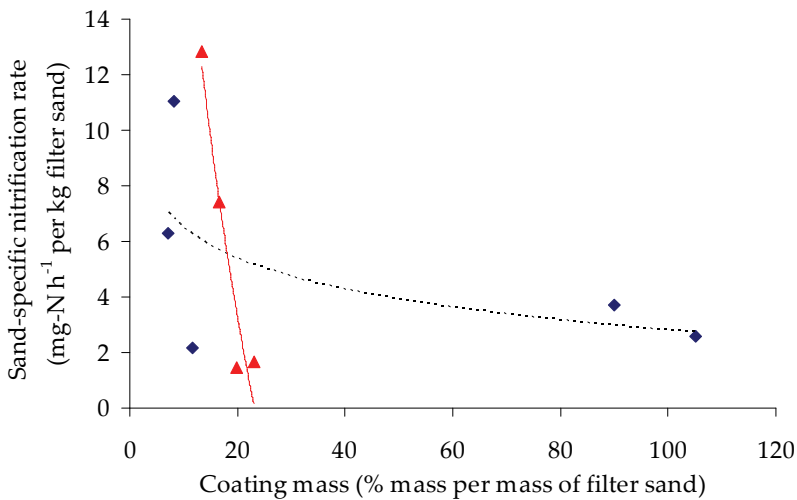

Figure 9: Relation between coating mass and sand-specific nitrification rate for subsurface aerated (◆) and non-subsurface aerated (▲) filters at several Oasen WTPs

The specific pore area of filter coatings in groundwater trickling filters may influence nitrification in various ways. Meso- and macropores may be colonized by microorganisms and may influence their attachment and washout. Micropores are also important for the adsorption of trace elements which serve as nutrients for microbial growth.

The higher mass and pore area of the filter coatings in subsurface aerated filters result in a more pronounced role for the chemical autocatalytic iron oxidation in these filters compared to non-subsurface aerated filters. As a result, biological iron oxidation may be more important in non-subsurface aerated filters. The interaction between different iron oxidation mechanisms and filter coating characteristics is further discussed in Section 10.4 of this thesis.

#### 7.4. Conclusions

- Mercury intrusion porosimetry provides a suitable method to characterize the pore structure of iron-based filter coatings in groundwater filters for drinking water production. Due to the sometimes fragile structure of the coatings, explicit care is required for the preparation and handling of the samples.
- Coating mass was restricted in non-subsurface aerated filters, but not in subsurface aerated filters.
- Samples from subsurface aerated filters showed a significant higher cumulative pore area than those from non-subsurface aerated filters.
- In subsurface aerated filters the cumulative pore area of the coating was proportional to the coating mass and SEIC.
- Sand-specific nitrification rates were strongly reciprocally related to the coating mass in non-subsurface aerated filters, but in subsurface aerated filters there was no clear relation.
- A clear relation was found between the application of subsurface aeration as pretreatment before filtration and a higher coating mass and specific nitrification rate in samples from these filters.

## References

- Appelo, C.A.J., Drijver, B., Hekkenberg, R. and Jonge, M. (1999) Modeling *In Situ* Iron Removal from Ground Water. *Ground Water* 37(6), 811-817.
- de Vet, W.W.J.M., Rietveld, L.C. and van Loosdrecht, M.C.M. (2009a) Influence of iron on nitrification in full-scale drinking water filters. *Journal of Water Supply: Research and Technology-AQUA* 58(4), 247-256.
- de Vet, W.W.J.M., Dinkla, I.J.T., Muyzer, G., Rietveld, L.C. and van Loosdrecht, M.C.M. (2009b) Molecular characterization of microbial populations in groundwater sources and sand filters for drinking water production. *Water Research* 43(1), 182-194.
- Kihn, A., Laurent, P. and Servais, P. (2000) Measurement of potential activity of fixed nitrifying bacteria in biological filters used in drinking water production. *Journal of Industrial Microbiology and Biotechnology* 24(3), 161-166.
- Makris, K.C., Harris, W.G., O'Connor, G.A. and Obreza, T.A. (2004) Phosphorus immobilization in micropores of drinking-water treatment residuals: Implications for long-term stability. *Environmental Science and Technology* 38(24), 6590-6596.
- Rübner, K. and Hoffmann, D. (2006) Characterization of mineral building materials by mercury intrusion porosimetry. *Particle and Particle Systems Characterization* 23(1), 20-28.
- Schwertmann, U. and Cornell, R.M. (2000) *Iron Oxides in the Laboratory - Preparation and Characterization*, Wiley-VCH Verlag, Weinheim.
- Sharma, S.K., Kappelhof, J., Groenendijk, M. and Schippers, J.C. (2001) Comparison of physicochemical iron removal mechanisms in filters. *Journal of Water Supply: Research and Technology - Aqua* 50(4), 187-198.
- Sharma, S.K., Petrusevski, B. and Schippers, J.C. (2002) Characterisation of coated sand from iron removal plants. *Water Science and Technology: Water Supply* 2(2), 247-257.
- Wolthoorn, A., Temminghoff, E.J.M. and Van Riemsdijk, W.H. (2004a) Colloid formation in groundwater by subsurface aeration: Characterisation of the geo-colloids and their counterparts. *Applied Geochemistry* 19(9), 1391-1402.
- Wolthoorn, A., Temminghoff, E.J.M. and Van Riemsdijk, W.H. (2004b) Effect of synthetic iron colloids on the microbiological  $\text{NH}_4^+$  removal process during groundwater purification. *Water Research* 38(7), 1884-1892.





# CHAPTER 8

---

## Assessment of nitrification in groundwater filters for drinking water production by qPCR and activity measurement

**Accepted for publication in Water Research:**  
de Vet, W.W.J.M., Kleerebezem, R., van der Wielen, P.W.J.J.,  
Rietveld, L.C. and van Loosdrecht, M.C.M.  
Assessment of nitrification in groundwater filters for  
drinking water production by qPCR and activity measurement.

## Abstract

In groundwater treatment for drinking water production, the causes of nitrification problems and the effectiveness of process optimization in rapid sand filters are often not clear. To assess both issues, the performance of a full-scale groundwater filter with nitrification problems and another filter with complete nitrification and pretreatment by subsurface aeration was monitored over nine months. Quantitative real-time polymerase chain reaction (qPCR) targeting the *amoA* gene of bacteria and archaea and activity measurements of ammonia oxidation were used to regularly evaluate water and filter sand samples. Results demonstrated that subsurface aeration stimulated the growth of ammonia-oxidizing prokaryotes (AOP) in the aquifer. Cell balances, using qPCR counts of AOP for each filter, showed that the inoculated AOP numbers from the aquifer were marginal compared with AOP numbers detected in the filter. Excessive washout of AOP was not observed and did not cause the nitrification problems. Ammonia-oxidizing archaea grew in both filters, but only in low numbers compared to bacteria. The cell-specific nitrification rate in the sand and backwash water samples was high for the subsurface aerated filter, but systematically much lower for the filter with nitrification problems. From this, we conclude that incomplete nitrification was caused by substrate limitation.

## Keywords

*amoA* gene, archaea, biofilter, groundwater, nitrification, qPCR, subsurface aeration

## Abbreviations and Notations

AOA	=	ammonia-oxidizing archaea
AOB	=	ammonia-oxidizing bacteria
AOP	=	ammonia-oxidizing prokaryotes
<i>amoA</i> gene	=	gene encoding for the $\alpha$ -subunit of the ammonia monooxygenase enzyme
DW	=	dry weight
qPCR	=	(quantitative) real-time polymerase chain reaction
WTP	=	water treatment plant

Subsurface aerated filter = filter treating a mixture of subsurface aerated and non-subsurface aerated groundwater

Non-subsurface aerated filter = filter treating non-subsurface aerated groundwater only



## 8.1. Introduction

In the Netherlands and Flanders, direct filtration of anaerobic groundwater over granular material, in most cases silica sand, is the general technique for removal of inorganic compounds, such as iron, manganese and ammonium, in water treatment plants (WTP). Because no oxidizing chemicals are applied, ammonium is removed by biological oxidation in the nitrification process. Complete removal of ammonium in drinking water treatment is essential to prevent nitrite formation and unwanted growth of microorganisms in the distribution network. Nitrification is a two-step process performed by different species of bacteria (Belser, 1979) and archaea (Francis et al., 2007). As a consequence of the high oxygen demand of the nitrification process, trickling filters, also called dry biofilters, may be used to provide sufficient oxygen when ammonium concentration exceeds two mg L<sup>-1</sup>. Even in the absence of oxygen limitation, incomplete nitrification in trickling filters is frequently encountered (de Vet et al., 2009a). The observation that nitrification becomes almost complete in the first period after startup with new filter material, indicates that inhibitors do not affect nitrification in the influent water for these filters. To maintain complete nitrification during sand filtration, the drinking water company Oasen in the Netherlands needs to apply the empirically based and effective but indirect technique of subsurface aeration. Both the nitrification problems and the beneficial effect of subsurface aeration on ammonium removal in full-scale trickling filters have been previously reported (Ibid.).

The aim of this work was to test two possible hypotheses to explain the nitrification performance at an Oasen groundwater filtration station.

The first hypothesis states that the growth of ammonia-oxidizing prokaryotes (AOP) in the subsurface aerated well might enhance nitrification in the trickling filter by continuous inoculation of AOP. Deposition of suspended nitrifying bacteria from the influent onto the filter has been suggested to be of crucial importance for filter performance (Uhl and Gimbel, 2000). In a previous study on groundwater treatment systems at Oasen, the microbial population composition in normal and subsurface aerated groundwater and active and inhibited full-scale trickling filters was determined by denaturing gradient gel electrophoresis (DGGE; de Vet et al., 2009b). That study showed a growth of ammonia-oxidizing bacteria (AOB) in the subsurface aerated well, but the method was indecisive for the quantitative importance of this inoculation for nitrification in the filter.

The second hypothesis states that the excessive washout of nitrifying microorganisms might explain the observed nitrification problems in the groundwater filters and that the application of subsurface aeration reduces the washout of nitrifying microorganisms, which improves the performance of nitrification in sub-surface aerated filters. Intensive filter backwashing, required for the prevention of clogging and diffusion limitation by removing inorganic deposits



and dead biomass, may have a negative effect on the biological processes in the filter by excessively removing active biomass. Subsurface aeration might have an indirect effect on this by inducing subsurface iron colloid formation (Wolthoorn et al., 2004) and subsequently changing the types of iron precipitates and the surface characteristics of the iron-coated filter material. These changes could enhance the attachment of biomass and limit its losses by detachment in the trickling filter during filtration and backwash.

In order to investigate these hypotheses, quantification of the abundance and activity of the ammonia-oxidizing populations in the filters over a prolonged period is essential. The effect of backwashing is usually measured by activity measurements of nitrification during filtration (Laurent et al., 2003) or in backwash water (Tränckner et al., 2008). Direct quantification methods of the active biomass, such as effluent plate counts (Ahmad et al., 1998) or microscopic enumeration of attached biomass (Kasuga et al., 2007), have been used to assess the effect of backwashing for heterotrophic bacteria, but not for autotrophic bacteria like AOB. In this article, the abundance and activity of AOP, consisting of AOB and/or ammonia-oxidizing archaea (AOA), in groundwater filters were quantified by (quantitative) real-time polymerase chain reaction (qPCR) and activity measurements. By combining qPCR and activity measurements, the specific activity of AOP was evaluated. To evaluate the above-postulated hypotheses, balances for the ammonia-oxidizing populations in the trickling filters were determined.

## **8.2. Materials and Methods**

### **8.2.1. WTP Lekkerkerk filter and water samples**

To compare the development of nitrifying activity and populations, two full-scale trickling filters at Oasen WTP Lekkerkerk were externally washed and the filter performance was monitored for nine months, after restarting the filters. During external washing, the filter sand was turbulently pumped out of a filter and back in to remove part of the accumulated filter coating and biomass. One filter treated natural groundwater from a separate well field and will be indicated further as the non-subsurface aerated filter. The other filter - further indicated as the subsurface aerated filter - was fed by a mixture of subsurface aerated and non-subsurface aerated groundwater. The water abstracted from the subsurface aerated well contributed to 16% (v/v) of the raw water flow for the subsurface aerated filter. The other wells abstracted water from the same aquifer, but were not influenced by subsurface aeration. The non-subsurface aerated filter – with nitrification problems

– was started on December 12, 2007, and the subsurface aerated filter – with complete nitrification - on January 23, 2008. Both filters had an identical history, run time and backwash program and treated well-buffered ( $\text{HCO}_3^- \sim 3.8 \text{ mM}$ ) anaerobic groundwater, with an average pH of  $7.35 \pm 0.06$  and a temperature of  $11.6 \pm 0.3 \text{ }^\circ\text{C}$ . Due to forced ventilation in the trickling filter, the pH was raised to  $7.67 \pm 0.13$  and the dissolved oxygen was close to saturation in the filter effluents of both filters. Iron and manganese were removed almost completely in both filters. Schemes of the two investigated filters and their raw water composition have been reported in de Vet et al. (2009b).

Filter performance was monitored weekly by analysis of ammonium, nitrite and nitrate in the filter influents and effluents. For determination of the abundance and activity of the AOP, extra samples were taken from the groundwater, filtrate, filter sand and backwash water of each filter. The groundwater and filtrate were sampled in duplicate for each filter system for qPCR. For the non-subsurface aerated filter, the mixed raw water from all wells was sampled. For the subsurface aerated filter, samples were taken from the subsurface aerated well and another representative well in the well field. Groundwater from the subsurface aerated well was sampled regularly during the 40 days of the abstraction phase of the subsurface aeration cycle. The filtrate of each trickling filter was sampled regularly during the filter run time of 48 hours.

Three, six and nine months after external washing, samples were taken from the filter sand and backwash water. The filter sand was sampled also after one month. Because of the cone resistance of the trickling filter beds, a specially developed pneumatic sampling device with cone, sleeves and sampling bus was used to collect filter sand. In the subsurface aerated filter, sampling could take place at four depths (0-50 cm, 50-100 cm, 100-150 cm and 150-200 cm depths), covering the whole bed depth. In the non-subsurface aerated filter, the deepest layer could not be sampled because of high cone resistance. At each depth, mixed samples were formed from samples taken at three or four different places over the filter bed area. Measurements of the specific nitrification rate were performed on each mixed sample, qPCR was performed on the mixed samples taken from 0-50 cm and 100-150 cm depths.

The two phases of the backwash program (first phase: lower flow of water + auxiliary air scour; second phase: higher flow of water) were sampled separately in the supernatant water close to the backwash water spillway. Measurements of the specific nitrification rates were performed on both samples from the two backwash phases, aliquots of both phases were mixed proportionally according to their respective volumes for analysis by qPCR.

All samples were transported and stored at  $4 \pm 3^\circ\text{C}$ . The isolation of DNA, start of the measurement of the specific nitrification rate, and N-analyses all took place within 48 hours after sampling. Control measurements showed that the storage time has not affected the outcome of the kinetic assays.

### **8.2.2. Specific nitrification rates**

As the groundwater did not contain nitrite and nitrate, the bulk nitrification rate for the filters ( $r_N$ ) was calculated by multiplying the water flow with the sum of the nitrite and nitrate concentrations in the filter effluent, both averaged over the test period.

For both filter samples and backwash water samples, the specific nitrification rates were determined in batch experiments. The batch method used for the filter samples has been described in de Vet et al. (2009b) and provides a 'sand-specific nitrification rate' in  $\text{mg} (\text{NO}_2^- + \text{NO}_3^-)\text{-N h}^{-1} \text{kg}^{-1}$  of filter sand. The volumetric nitrification rate for the backwash samples was determined as  $\text{mg N h}^{-1}$  and  $\text{L}^{-1}$  of backwash water. For each sample date, the specific nitrification rate was determined for both backwash phases. To test for possible heterotrophic nitrification, negative control measurements were conducted for all samples by the addition of  $10 \text{ mg L}^{-1}$  of allylthiourea (ATU;  $\text{C}_4\text{H}_8\text{N}_2\text{S}$ ) which totally inhibits the activity of autotrophic AOB, but only partly the activity of heterotrophic AOB (Robertson et al., 1989) and AOA (Taylor et al., 2010). The specific nitrification rate for backwash water samples was determined in 1 L batch tests. All batch reactors were continuously stirred and mildly flushed with compressed air during the entire experiment. A concentrated substrate containing  $\text{NH}_4\text{Cl}$  and  $\text{Na}_2\text{HPO}_4 \cdot 12\text{H}_2\text{O}$  in a molar ratio of 1 to 0.02 (Tränckner et al., 2008) was added at the start of the experiment to a final concentration of  $10 \text{ mg NH}_4\text{-N L}^{-1}$ , corresponding to the concentration range in the full-scale filters.

Five mL samples were taken before substrate addition and afterwards at regular intervals over one to three days, until the ammonium was depleted. At each sampling time, duplicate samples were taken from all batch reactors, except for the negative controls that were sampled only once. The samples were filtered over  $0.45 \mu\text{m}$  PTFE filters into tubes, covered and stored for analyses at  $4 \pm 3 \text{ }^\circ\text{C}$ . The temperature and pH were measured at the beginning and end of each experiment. The average and standard deviation of the temperature over all measurements was  $23 \pm 1 \text{ }^\circ\text{C}$  at the start and  $26 \pm 2.2 \text{ }^\circ\text{C}$  at the end. The pH ranged from  $7.7 \pm 0.2$  at the start to  $8.2 \pm 0.2$  and  $8.4 \pm 0.1$  for uninhibited and ATU-inhibited samples, respectively. The pH rise was caused by carbon dioxide stripping by flushing the reactor with compressed air.

The method of least squares was used to fit the measured data for  $\text{NH}_4$  and  $\text{NO}_2+\text{NO}_3$  using exponential substrate depletion and product formation curves (see Supplementary Material C for derivation). The initial volumetric nitrification rate in the backwash water samples at room temperature was determined from the initial slope of the exponential function. To exclude (bio) adsorption effects at the start of each experiment and incorrect analyses, only samples with less than a 5% deviation from the average of total inorganic N were used for this calculation, and only samples with more than  $1 \text{ mg L}^{-1}$  of  $\text{NH}_4\text{-N}$  were included to limit the effect of

substrate limitation. Because of the exponential growth phase, maintenance and decay were neglected. Results were not corrected for loss of nitrogen through assimilation.

### 8.2.3. N measurements

In all samples, ammonium, nitrite and nitrate were measured for potential losses in the total inorganic N-balance, which should be conserved when only nitrification occurs. For all full-scale filter samples, except for the backwash activity measurements, both ammonium and nitrite were determined by colorimetric measurement. Nitrate was measured by conductivity in accordance with NEN-EN-ISO 10304-1 (<http://www.nen.nl/web/Normshop/Norm/NENENISO-1030412009-en.htm>). For samples from the backwash activity measurements, ammonium, nitrite and nitrate were determined by colorimetric measurement on a Lachat Quikchem® 8500 Flow Injection Analysis System.

### 8.2.4. Quantification AOP by qPCR

To quantify AOP by qPCR, the functional gene coding for the  $\alpha$ -subunit of the ammonia monooxygenase enzyme (which catalyses the first steps of ammonia oxidation) was amplified, as described by van der Wielen et al. (2009). In short, 50 mL of autoclaved tap water were added to 2 – 5 g filter sand samples. Subsequently, the samples were sonicated for 2 min at 20 kHz in a Sonifier II W-250 and the liquid phase was collected. DNA was isolated from the liquid samples by filtration over a 25-mm polycarbonate filter (0.22  $\mu$ m pore size, type GTTP; Millipore, the Netherlands). The filter and a DNA fragment of an internal control were added to the phosphate and MT buffer of the FastDNA Spin kit for soil (Qbiogene) and stored at -20°C. The use of the internal control was used to determine PCR efficiency and was in accordance with a normalized method (NEN 6254:2009), which has been used in other studies as well (van der Wielen et al., 2009; van der Wielen and Medema, 2010). DNA was isolated using the FastDNA Spin kit for soil according to the supplier's protocol.

The *amoA* genes of AOB and AOA were amplified with previously reported primers (Francis et al., 2005; Rotthauwe et al., 1997) in an iCycler IQ real-time detection system (Bio-Rad laboratories BV, the Netherlands). Quantification was based on a comparison of the sample  $C_t$  value with the  $C_t$  values of a calibration curve based on known numbers of the *amoA* gene of AOB or AOA. The AOB numbers were calculated by assuming two *amoA* gene copy numbers per cell (Chain et al., 2003), and the AOA numbers by assuming one *amoA* gene copy number per cell (Mincer et al., 2007).

### 8.2.5. Cell-specific nitrification rate

The cell-specific nitrification rate was calculated for all samples by combining the cell number determined by qPCR and the specific nitrification rate from the batch tests of all filter sand and backwash water samples. The results of these calculations are summarized in Table 1 of the Discussion section.

### 8.2.6. AOB and AOA balances

From the qPCR results, separate balances of AOB and AOA for each filter were calculated. The balance calculation for one filter run is schematized in Supplementary Material A. For every water flow entering or leaving a filter, the total values for AOB or AOA cell numbers were calculated by multiplying the measured concentration by the flow and duration of the phase. In case the concentrations were measured at different times during a phase – like in the subsurface aerated well during the abstraction cycle and the filtrate over the filter run time - the weighted average was used. The filter bed area was 18.0 m<sup>2</sup> per filter. The average water flow over the monitored period was 36.5 and 47 m<sup>3</sup> h<sup>-1</sup> for the non-subsurface and the subsurface aerated filter, the bed height 2.03 ± 0.04 and 1.81 ± 0.02 m, and the total (dry) sand mass per filter 58 and 52·10<sup>3</sup> kg (with  $Q_{DW,sand} = 1600 \text{ kg m}^{-3}$ ), respectively.

When no accumulation (determined by measuring cell numbers on the filters samples) in time occurs, the net washout measured by qPCR balances the growth of AOP. Under the assumption of equilibrium, yield values of AOP were determined using the calculated growth of AOP and the nitrification rate, according to Equation 1. The results are summarized in Table 1 of the Discussion section.

$$Y_{x,N} = \frac{X_N \mu_{x,N}}{r_N} \approx \frac{\Delta X_{N,\Delta t}}{r_N * \Delta t} \quad \text{Equation 1}$$

Where

$\mu$	specific growth rate (h <sup>-1</sup> )
$r$	rate (mg N h <sup>-1</sup> )
$\Delta t$	time (h)
$X$	total cell number (cells)
$Y$	yield (cells mg <sup>-1</sup> N <sub>converted</sub> )

Indices

$N$	nitrification
$\Delta t$	time (h)
$x$	biomass

### 8.3. Results

#### 8.3.1. Overall performance of the full-scale filters

The overall ammonium removal performance of both full-scale filters is shown in Figure 1. The nitrification in the subsurface aerated filter was nearly complete after the startup period (A). The non-subsurface aerated filter (B) showed incomplete nitrification and a gradual relapse after the startup period of about two to three months, although less pronounced than previously reported (de Vet et al., 2009a). Because of the different groundwater source, the influent ammonium concentration in the subsurface aerated filter was lower. Previous research showed, however, that without subsurface aeration nitrification became incomplete in this filter as well (Ibid.). We have shown that the complete nitrification resulted from the application of subsurface aeration and not from the lower influent ammonium concentration (Ibid.).

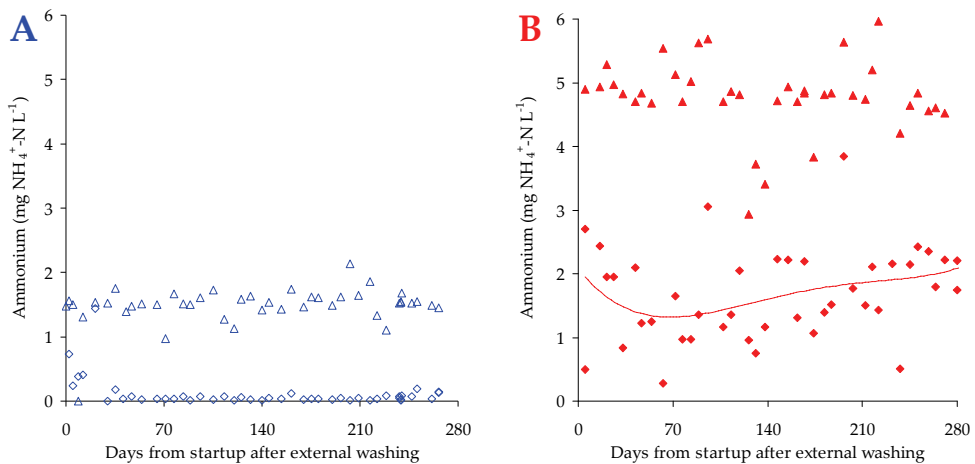
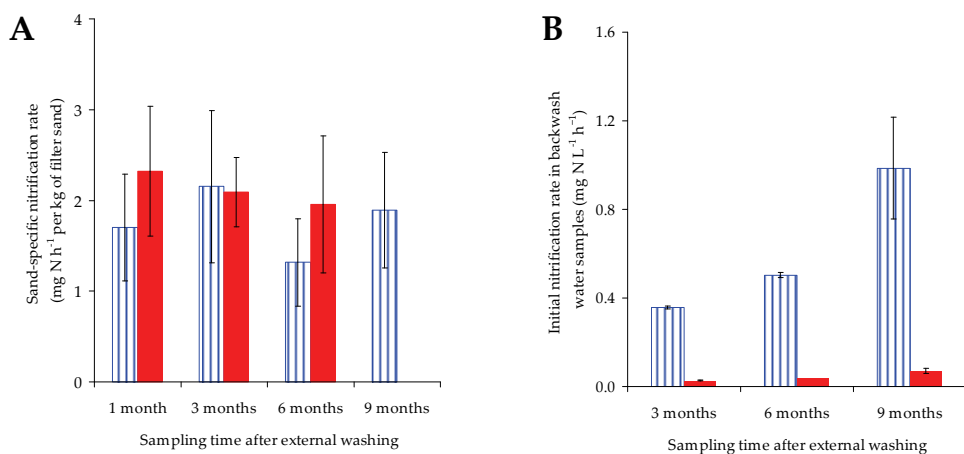

Figure 1: Ammonium concentrations in the 280 days after external washing for the subsurface aerated filter (A) and non-subsurface aerated filter (B);  $\blacktriangle$   $\blacktriangle$  influent filter,  $\blacklozenge$   $\blacklozenge$  effluent filter

Apart from the first months after startup, there was only a small loss of 5% in total nitrogen (as ammonium, nitrite and nitrate) between the influent and effluent for both filters. Stripping of ammonia (due to the high ventilation air to water ratio), biological and chemical denitrification (abiotic nitrite reduction with oxidation of ferrous iron; Tai and Dempsey, 2009) may have caused this unbalance.

### 8.3.2. (Specific) nitrification rates

The calculated bulk nitrification rate ( $r_N$ ) after a startup period of one month was  $101 \pm 20$  and  $68 \pm 15$  g (NO<sub>2</sub>+NO<sub>3</sub>)-N h<sup>-1</sup> for the non-subsurface and the subsurface aerated filter, respectively. The bulk sand-specific nitrification rate was  $1.8 \pm 0.4$  and  $1.2 \pm 0.3$  mg (NO<sub>2</sub> + NO<sub>3</sub>)-N h<sup>-1</sup> kg<sup>-1</sup> of filter sand, respectively. The lower bulk nitrification rates for the subsurface aerated filter are explained by substrate limitation because all ammonium was depleted. The profiles of the sand-specific nitrification rates over the filter bed depth differed between both filters (see Supplementary Material B). There was neither a clear difference in the sand-specific nitrification rate between both filters, nor a clear difference over time. The averages with standard deviations of the sand-specific nitrification rate over the filter bed depth for the experimental period are shown in Figure 2A. The nitrification activity in the backwash water samples was identified by fitting ammonium uptake and nitrite and nitrate production using an exponential growth model (see Supplementary Material C for two examples). The nitrification rate in the ATU-inhibited batch experiments was close or equal to zero in all cases, indicating that AOA and heterotrophic AOB did not significantly contribute to the oxidation of ammonium. The measurements of the specific nitrification rate in the backwash water showed a profound difference between subsurface and non-subsurface aerated filters (Figure 2B). The initial volumetric nitrification rate was higher in the backwash water samples from the subsurface aerated filter than in the non-subsurface aerated filter, and this difference increased further in time (Figure 2B).



**Figure 2:** Sand-specific nitrification rate for filter sand samples (A) and initial volumetric nitrification rate for backwash water samples (B) taken one to nine months after external washing; subsurface aerated filter (striped blue bars) and non-subsurface aerated filter (red solid bars); average and standard deviation for samples over the depth of the filter bed (filters and samples) and two phases of backwash program; backwash water sample from non-subsurface aerated filter after 6 months only from the second phase

### 8.3.3. AOP quantification by qPCR

In Figure 3, the average, minimum and maximum of AOP cell numbers are shown for all filter sand, influent, effluent and backwash water samples of the subsurface aerated (A) and the non-subsurface aerated filter (B) over the monitoring period. For most samples, AOB were two or more orders higher than AOA. Exceptions were both influent samples and the effluent samples of the subsurface aerated filter. When comparing both filters, AOB cell numbers, were higher in all but the influent samples of the non-subsurface aerated filter.

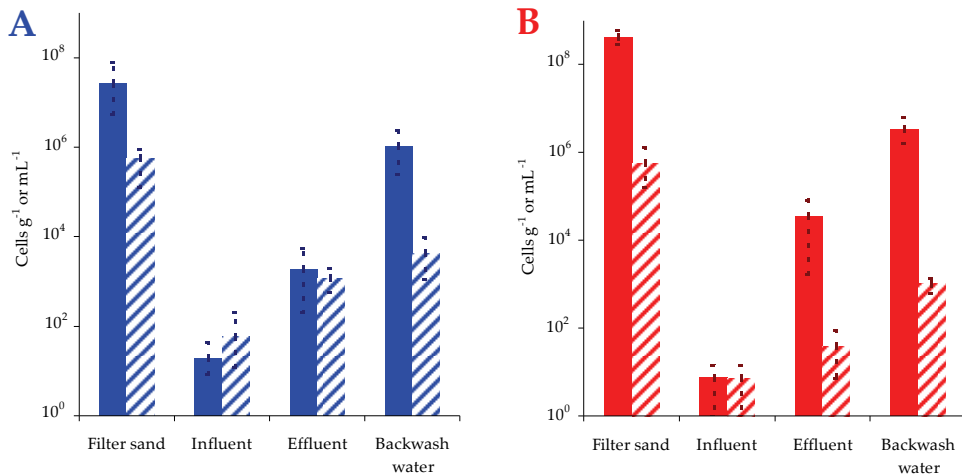

**Figure 3:** Averages of AOB (solid bars) and AOA (line bars) over the total test period of nine months; subsurface aerated filter (A), non-subsurface aerated filter (B); values for filter sand in  $g^{-1}$  and for water in  $mL^{-1}$ ; averages over 10 sand, 11 (SA) and 2 (non-SA) influent, 8 effluent and 4 backwash water samples per filter; cross bars indicate minimal and maximal values; results in filter influent under the detection limit of the method ( $<15 mL^{-1}$ ) are depicted as  $7.5 mL^{-1}$  (half of the detection limit)

The AOA cell numbers in the filter samples and the increase in numbers from the influent to the effluent samples show that AOA grew in both filters. AOA cell numbers were higher in all water samples of the subsurface aerated filter compared to the non-subsurface aerated filter. This difference can be partly explained by the inoculation of AOA from the subsurface aerated groundwater and partly by the enhanced growth in the subsurface aerated filter. This enhanced growth is shown by comparison of AOA cell numbers in the influent and effluent of both filters; the increase is much stronger in the subsurface aerated filter than for the other filter (see also AOA balances for both filters in Supplementary Material A). A comparison of the AOA cell numbers in the effluent and backwash water of this filter suggests a weak attachment of the AOA cells to the filter sand.



### 8.3.4. AOP balances

AOP balances in the two full-scale filters were assessed over the monitoring period by qPCR to compare their abundance and growth in both full-scale filters. For AOB, the balance terms for one filter run of 48 hours was calculated from the cell numbers, water flows, filter bed volumes and time (Figure 4).

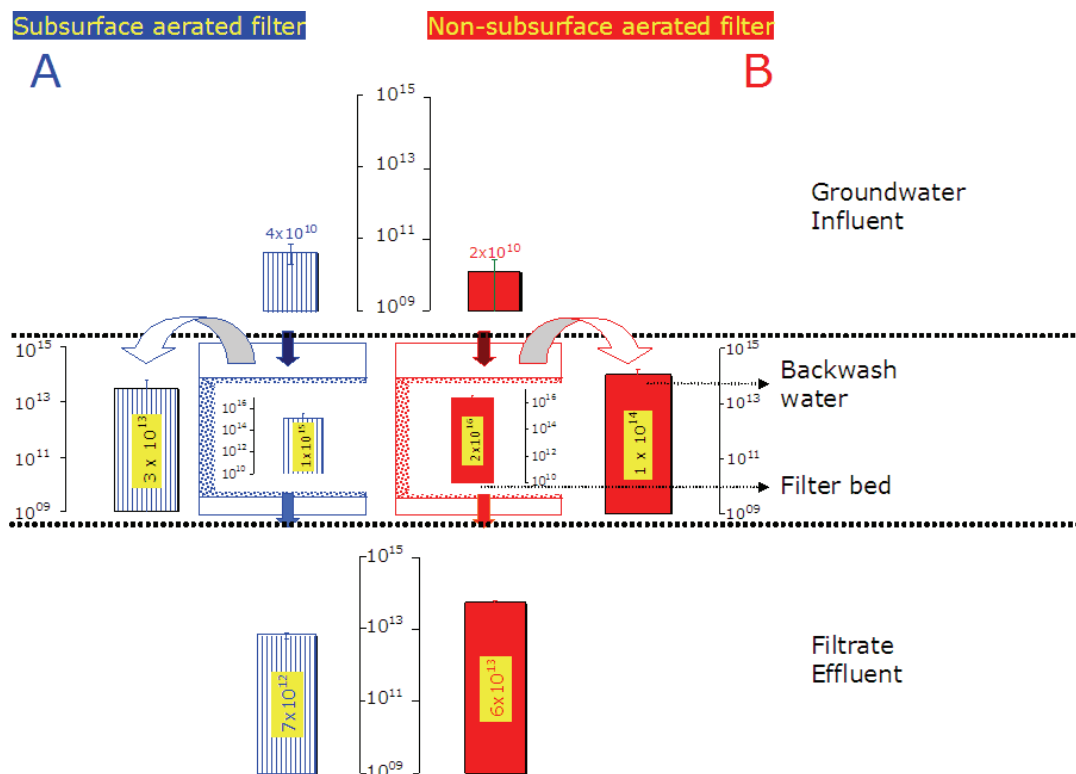

Figure 4: AOB balances for the subsurface aerated filter (A) and non-subsurface aerated filter (B) during nine months after external washing; bar graphs in the center show the cumulative cell numbers per filter run time of 48 hours for the influent (top) and effluent (bottom). The bar graphs in the middle center and outside present the cumulative cell numbers present in the filter and washed out during backwash, respectively; the curved blue and red arrows indicate the direction of the backwash flow and point towards the columns graph with the cumulative cell numbers present in the backwash water

The overall balances in Figure 4 show some similarities and also differences for the two filters. In both filters, a distinct growth of AOB was observed, as shown by the increase in cell numbers from influent to effluent water flows. Despite lower AOB cell numbers in the influent water, the growth of AOB was enhanced and the cell yield higher in the non-subsurface aerated filter compared to the other filter. This coincided with a higher total cell number present in the non-subsurface aerated filter (Discussion section 4.2).

The balances for AOA cells confirm the limited quantitative importance of AOA in these filters and are therefore shown in Supplementary Material A. The AOA balance showed negligible growth in the non-subsurface aerated filter compared to AOB. In the subsurface aerated filter, both AOA cell numbers in the influent and growth in the filters were higher, but their cell numbers still amounted to less than 10 % of the total AOP in all balance terms.

## 8.4. Discussion

The combined approach to evaluate AOP activity by qPCR and activity measurements provided a good means to evaluate the observed nitrification performances of full-scale nitrification filters and allowed a deeper understanding of AOP population dynamics in such filters. In the next subsections, some of these major issues will be discussed and related to previous research.

### 8.4.1. Detection of AOB and AOA using molecular techniques

In this study, high numbers of AOB were found in filter samples of both filters based on the amplification of functional gene markers using qPCR. These results are in contrast to previous analysis using CTO-primers targeting the 16S rRNA, which could not detect AOB in a non-subsurface aerated filter (de Vet et al., 2009b). It is likely that the AOB specific 16S primers had some mismatches with the AOB in the system studied. Maybe other 16S primer sets (such as published by Hermansson and Lindgren, 2001) might have yielded better results. As 16S rRNA is present in all bacteria, species other than AOB are likely to be targeted too, in contrast to the approach with functional markers as the *amoA* gene. The inaccuracy of the 16S approach for detection of AOB has been reported before (Hoefel et al., 2005).

The quantification of the *amoA* genes of AOB and AOA on filter sand and in backwash water suggests that AOA played a minor role in these groundwater filter systems. Only in the groundwater and filtrate of the subsurface aerated filter were AOA equally present or more abundant than AOB. Subsurface aeration stimulated the growth of AOA both in groundwater and in the trickling filter. By contrast, virtually no growth of AOA occurred in the non-subsurface aerated filter. The growth of AOA in the subsurface aerated filter did not result in a strong accumulation of AOA in the filter bed. Possibly, they do not form as strong biofilms as AOB do. For the subsurface aerated filter, the relatively low numbers of AOA compared to AOB in the backwash water and the decreasing AOA cell numbers on the filter sand in time (data not shown) demonstrate the marginal role

of AOA in ammonia oxidation. In the non-subsurface aerated filter the share of AOA in ammonia oxidation was even less significant. Recent studies suggest that pH and ammonium concentration are selecting criteria for the dominance of AOB and AOA (Prosser and Nicol, 2008 and references therein). Martens-Habbenha et al. (2009) found a very high affinity of a marine AOA, with a half half-saturation constant of 133 nM total ammonium. This affinity is much higher than of known bacteria and suggests the dominance of archaea at micromolar concentrations. It might implicate that the conditions in our studied full-scale systems and lab assays with millimolar concentrations selected for AOB. A previous study on several Dutch groundwater treatment plants showed AOB as the dominant AOP population (van der Wielen et al., 2009), which is in agreement with our results. However, for one plant in that study, a domination of AOA in the nitrification process was found, although the treated groundwater contained 1.1 mg NH<sub>4</sub> L<sup>-1</sup> (Ibid., Supplemental Material).

A comparison of the calculated cell yield (Section 4.2) and cell specific activity in the backwash water (Section 4.3) with corresponding literature values suggests that the applied qPCR method detected only a part the AOP cells in the backwash water samples. For the sand samples (Section 4.3), it seemed that the qPCR technique detected most AOP cells. This finding, together with the relatively high recovery yield of the internal control in the q-PCR reactions, suggests that the PCR method used functioned properly for the sand samples. However, the pretreatment of the backwash water samples may not have been optimal for backwash water samples that contain a high concentration of inorganic suspended matter. Still, this research shows that the application of molecular methods has added value in analyzing the biological conversions of nitrogen in full-scale drinking water filters.

#### **8.4.2. Abundance and metabolic activity of AOB**

The AOB balances for the full-scale filters (Figure 4) provide sufficient data for a decision on the two previously posed hypotheses regarding the performance of nitrification in the Oasen trickling filters. The first hypothesis, stating that enhancement of nitrification in the trickling filters by subsurface aeration works by stimulating inoculation of AOB, was rejected. Subsurface aeration increased the AOB number in the groundwater slightly, but this phenomenon did not appear crucial for the filter's functioning. The total AOB cell numbers inoculated from the groundwater were negligible compared to those present in the filter, filtrate or backwash water, suggesting that inoculation was marginal in numbers compared to growth. The quantitative results reported here confirm the qualitative observations reported earlier (de Vet et al., 2009b).

The second hypothesis, stating that the relapse of nitrification in a non-subsurface aerated filter is caused by a stronger washout of biomass, could also be rejected.

On first glimpse, this does not appear obvious. Indeed, the numbers of AOB cells washed out in the filtrate and backwash water were higher than in the subsurface aerated filter (Figure 4). However, the nitrification capacity is being determined by the AOB attached to the filter sand and not by those washed out of the filter. The AOB cell numbers present in the non-subsurface aerated filter sand samples were higher as well (Figure 4) and did not decrease in time. These observations imply a better growth of not very strongly attached AOB in the non-subsurface aerated filter as compared to the subsurface aerated filter, possibly related to differences in the iron precipitate formation between both filters (de Vet et al., 2009a). With respect to the total AOB cell numbers present in the filters, the difference between the two filters shows a reverse picture. For a filter run time of 48 hours, the total amount of washed out AOB cell numbers was on average 3% for the subsurface aerated filter and 1% for the non-subsurface aerated filter. Thus, it appears that the elevated detachment and washout of AOB from the non-subsurface aerated filter is not the primary cause for the nitrification problems.

To analyze other possible causes for the differences between both filters, some of the characteristic growth parameters for AOB in both filters are compared to each other and literature references. Averaged over the bed depth, the sand-specific nitrification rate was between 1 and 3 mg N h<sup>-1</sup> kg<sup>-1</sup> (see Figure B.1 of Supplementary Material B) or 1.5 to 5 g N h<sup>-1</sup> m<sup>-3</sup> of filter sand, comparable to the bulk nitrification rate for the whole filters (Section 3.2). Van den Akker et al. (2008) observed almost complete nitrification and a maximum nitrification rate of 12 g N h<sup>-1</sup> m<sup>-3</sup> of filter bed in drinking water trickling filters with influent NH<sub>4</sub>-N concentrations between 4 and 5 mg L<sup>-1</sup>. Westerman et al. (2000) found a maximum removal of ammonia of 14 g N h<sup>-1</sup> m<sup>-3</sup> of filter bed in the treatment of the supernatant of swine manure by upflow aerated biofilters. Despite strongly deviating process conditions, both references give comparable maximum ammonium removal capacities, which were higher than the ones found in the filters samples in this study.

The yield of AOB cells on ammonium can be calculated by combining the overall metabolic activity and the AOB growth (defined as washed out cells) in the filters for one filter run, according to Equation 1. This cell yield equals  $2 \times 10^{11}$  and  $5 \times 10^{11}$  cells mol<sup>-1</sup> N for the subsurface and the non-subsurface aerated filter, respectively. Belser and Schmidt (1980) found values between 14 and  $67 \times 10^{11}$  cells mol<sup>-1</sup> N for pure and mixed cultures in batch experiments, which is one order higher than in our research.

After the recalculation of cell numbers to biomass, the yield can also be compared to other published studies. AOB cell numbers were converted to biomass using the *Nitrosomonas* cell dimensions of  $2.4 \times 10^{-19}$  m<sup>3</sup> (Schmidt et al., 2004) with an assumed dry weight (DW) content of 30 %, leading to a DW of  $7.2 \times 10^{-14}$  g per cell. The cell yield thus calculated is 0.01 and 0.04 gDW mol<sup>-1</sup> N for the subsurface and

the non-subsurface aerated filter, respectively. These values are again one to two orders lower than the values found in batch (Loveless and Painter, 1968) and continuous (Keen and Prosser, 1987) lab experiments, 0.4 till 1.72 g mol<sup>-1</sup> N.

From the cell numbers present in and washed out from the filter (Figure 4), a specific growth rate  $\mu'$  of 0.0006 and 0.0002 h<sup>-1</sup> (doubling times between 7 and 25 weeks) was estimated for the subsurface and the non-subsurface aerated filter, respectively. The values are much lower than maximum specific growth rates reported in the literature for batch and continuous cultures (0.012-0.088 h<sup>-1</sup>; doubling times between 60 and 8 hours; Prosser, 1989, and references therein).

There are several possible causes for the observed low yields. It could be that the maintenance energy forms a significant part of the ammonium conversion. The general maintenance energy requirements at 12 °C are equal to 1.3 kJ mol<sup>-1</sup> biomass h<sup>-1</sup> (Tijhuis et al., 1993). The change in free energy of the catabolic reaction (NH<sub>4</sub><sup>+</sup> + 1½ O<sub>2</sub> → NO<sub>2</sub><sup>-</sup> + 2H<sup>+</sup> + H<sub>2</sub>O) is 276 kJ mol<sup>-1</sup>. This gives a specific substrate conversion rate required for the maintenance of 0.005 mol N mol<sup>-1</sup> X<sub>N</sub> h<sup>-1</sup> at 12 °C. This is, after temperature correction, in good agreement with values determined by Tappe et al. (1999). With the cell DW calculated above, the total cell mass present in the filter (Figure 4) was 4 and 60 moles (or 1 × 10<sup>2</sup> and 16 × 10<sup>2</sup> g) for the subsurface and the non-subsurface aerated filter, respectively. The substrate conversion needed for maintenance is 0.02 and 0.3 mol N h<sup>-1</sup>, 0.4 and 4 % of the observed bulk nitrification rate. This indicates that the limited biomass yield for nitrifiers observed in both filters was not related to high maintenance requirements. Differences between the field conditions in our research and the lab conditions in the references cited may also have influenced the yields. In the full-scale filters, factors such as the competition for nutrients with other auto- and heterotrophic bacteria, inhibition by deposited organic and inorganic compounds, and pH and temperature may have impaired the growth yield of AOB. The lower growth yield may also be related to the reduced growth rate. Glover (1985) found that the C yield from nitrification declined both with increasing age in the batch culture and with decreasing growth rates in chemostats. Predation by protozoa might also decrease the observed yields. Finally, limitations of the applied qPCR method or the DNA isolation steps may also have played role, as was discussed in Section 4.1. The main growth characteristics discussed above are once again summarized in Table 1.

**Table 1: Comparison of growth parameters between Oasen's two filters and the literature; (non)-SA = (non)-subsurface aerated**

Parameters	Unit	SA filter	non-SA filter	References
Maximum volumetric nitrification rate	$\text{g N h}^{-1} \text{m}^{-3}$	1.5-5	1.5-5	12-14
Cell yield	$10^{11} \text{ cells mol}^{-1} \text{ N}$	2	5	van den Akker et al. (2008); Westerman et al. (2000) 14-67
Biomass yield <sup>a</sup>	$\text{gDW mol}^{-1} \text{ N}$	0.01	0.04	Belser and Schmidt (1980) 0.4-1.72
Specific growth rate	$\text{h}^{-1}$	0.0006	0.0002	Loveless and Painter (1968); Keen and Prosser (1987) 0.012-0.088
Cell specific nitrification rate <sup>b</sup>	$10^2 \text{ fg N h}^{-1} \text{ cell}^{-1}$	Sand 0.2-5 Backwash water 2-20	0.02-0.08 0.1-0.2	Prosser (1989) 0.1-3

<sup>a</sup> calculated; <sup>b</sup> Section 4.3

### 8.4.3. Cell-specific nitrification rates

The cell-specific nitrification rates, calculated by division of the sand-specific and volumetric nitrification rate by the cell number for each sand and backwash water sample, are summarized in Figure 5. Only AOB cell numbers were taken into account since AOA cell numbers contributed less than 2 % of the total AOP numbers in all samples. The cell-specific nitrification rates were at least one order of magnitude larger for all samples from the subsurface aerated filter than those from the non-subsurface aerated filter. In the subsurface aerated filter, the cell-specific activity increased between three and six months, coinciding with the observed drop in cell numbers (data not shown).

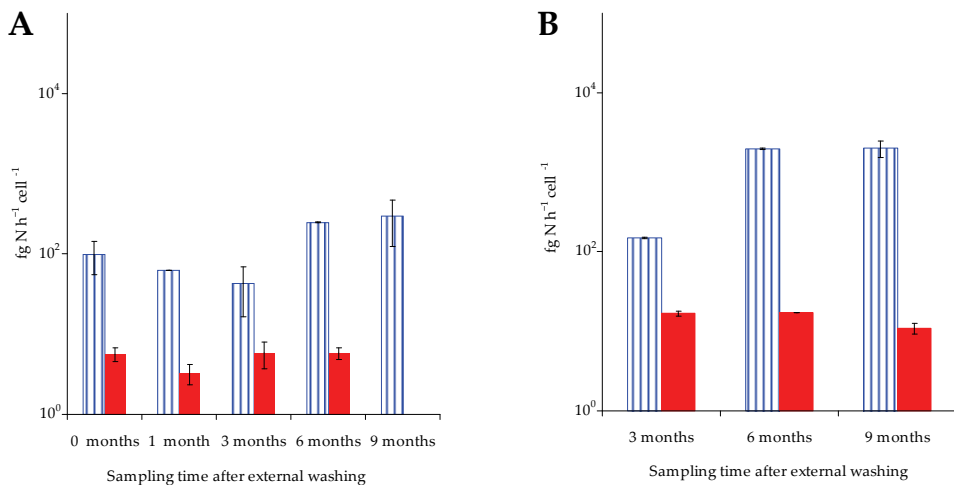

**Figure 5: Averages and standard deviations of the cell-specific nitrification rate on filter sand (A) and in the backwash water (B); blue striped bars subsurface aerated filter, red solid bars non-subsurface aerated filter**

In both the sand and backwash water, the AOB cell-specific nitrification rates were constant over time for the non-subsurface aerated filter, and stabilized at a higher level after three months for the subsurface aerated filter samples. The results from the activity measurements in the backwash water samples are remarkable because they systematically show a much higher initial volumetric nitrification rate for the subsurface aerated filter compared to the non-subsurface aerated filter, despite the lower AOP numbers present (see Figure 4 and Table C.1 of Supplementary Material C).

In the literature, a large distribution in cell-specific nitrification rates is found in batch and continuous experiments with pure or mixed cultures. Reported values range between 0.9 and 23 fmol N h<sup>-1</sup> (0.1 to 3 X 10<sup>2</sup> fg N h<sup>-1</sup> cell<sup>-1</sup>; Prosser, 1989, and references therein). The AOB cell-specific nitrification rate in the subsurface aerated filter samples was at the higher end of this reported range (0.2 to 5 X 10<sup>2</sup> fg N h<sup>-1</sup> cell<sup>-1</sup>), and at the lower end in the non-subsurface aerated filter samples (0.02 to 0.08 X 10<sup>2</sup> fg N h<sup>-1</sup> cell<sup>-1</sup>). In the backwash water, the cell-specific nitrification rate for the subsurface aerated filter samples was again at the higher end of the values reported in the literature and even higher than the maximum reported value (2 to 20 X 10<sup>2</sup> fg N h<sup>-1</sup> cell<sup>-1</sup>). For the non-subsurface aerated filter samples, the measurements were again at the lower end of the values reported in the literature (0.1 to 0.2 X 10<sup>2</sup> fg N h<sup>-1</sup> cell<sup>-1</sup>).

Consequently, the main finding from the research is that the incomplete nitrification in the non-subsurface aerated filter coincided with a systematically and significantly lower specific nitrification activity of the AOP cells compared to the much more active AOP in the subsurface aerated filter. This suggests that most nitrifying cells are dead or that their activity is severely inhibited in the non-subsurface aerated filter. The exponential growth in all assays with backwash water clearly shows that possible inhibitors had no effect on nitrifying organisms in the backwash water. Two possible causes for this inactivation or inhibition of AOP are: (i) diffusion limitation and (ii) absolute (bulk) limitation of nutrients. Limitation of the substrate diffusion may occur as a result of inadequate backwashing and formation of a thick biofilm or a covering layer that may be formed by inorganic deposits like iron (oxy)hydroxides in the groundwater filter. These inorganic deposits may also lead to absolute nutrient limitations in the bulk water phase because of the co-precipitation of phosphorus and trace elements in the iron (oxy)hydroxides. The nutrient limitation for AOB can be aggravated further by competition for these scarce nutrients by other microorganisms in the filter.

## 8.5. Conclusions

- The combination of qPCR targeting the *amoA* gene and activity measurements of ammonia oxidation is a good tool to evaluate the abundance and activity of ammonia-oxidizing prokaryotes in water treatment filters; the sampling of backwash water and the extraction of DNA from these samples requires caution.
- The inoculation of sand filters with AOP from groundwater plays a minor role in terms of numbers in the enhancement of nitrification by subsurface aeration.
- The relapse of nitrification in a non-subsurface aerated filter was not caused by an excessive detachment and washout of AOP.
- Incomplete nitrification in the non-subsurface aerated filter was not caused by a decline in and absence of AOB, contrary to the findings of de Vet et al. (2009b).
- In the non-subsurface aerated filter with incomplete nitrification, a larger AOB population with lower cell-specific nitrification activity persisted compared to the subsurface aerated filter with full nitrification.

## Supporting Information Available

- Supplementary Material A, balance scheme and AOA balance calculation for filters
- Supplementary Material B, profiles of cell numbers and sand-specific nitrification rates throughout the filter bed depth profile
- Supplementary Material C, analytical approach and results of the backwash water batch experiments

## References

- Ahmad, R., Amirtharajah, A., Al-Shawwa, A. and Huck, P.M. (1998) Effects of backwashing on biological filters. *Journal / American Water Works Association* 90(12), 62-73.
- Belser, L.W. (1979) Population ecology of nitrifying bacteria. *Annual Review of Microbiology* 33, 309-333.
- Belser, L.W. and Schmidt, E.L. (1980) Growth and oxidation kinetics of three genera of ammonia oxidizing nitrifiers. *FEMS Microbiology Letters* 7(3), 213-216.



Chain, P., Lamerdin, J., Larimer, F., Regala, W., Lao, V., Land, M., Hauser, L., Hooper, A., Klotz, M., Norton, J., Sayavedra-Soto, L., Arciero, D., Hommes, N., Whittaker, M. and Arp, D. (2003) Complete genome sequence of the ammonia-oxidizing bacterium and obligate chemolithoautotroph *Nitrosomonas europaea*. *Journal of Bacteriology* 185(9), 2759-2773.

de Vet, W.W.J.M., Rietveld, L.C. and van Loosdrecht, M.C.M. (2009a) Influence of iron on nitrification in full-scale drinking water filters. *Journal of Water Supply: Research and Technology-AQUA* 58(4), 247-256.

de Vet, W.W.J.M., Dinkla, I.J.T., Muyzer, G., Rietveld, L.C. and van Loosdrecht, M.C.M. (2009b) Molecular characterization of microbial populations in groundwater sources and sand filters for drinking water production. *Water Research* 43(1), 182-194.

Francis, C.A., Beman, J.M. and Kuypers, M.M.M. (2007) New processes and players in the nitrogen cycle: The microbial ecology of anaerobic and archaeal ammonia oxidation. *ISME Journal* 1(1), 19-27.

Francis, C.A., Roberts, K.J., Beman, J.M., Santoro, A.E. and Oakley, B.B. (2005) Ubiquity and diversity of ammonia-oxidizing archaea in water columns and sediments of the ocean. *Proceedings of the National Academy of Sciences of the United States of America* 102(41), 14683-14688.

Glover, H.E. (1985) The relationship between inorganic nitrogen oxidation and organic carbon production in batch and chemostat cultures of marine nitrifying bacteria. *Archives of Microbiology* 142(1), 45-50.

Hermansson, A. and Lindgren, P.E. (2001) Quantification of ammonia-oxidizing bacteria in arable soil by real-time PCR. *Applied and Environmental Microbiology* 67(2), 972-976.

Hoefel, D., Monis, P.T., Grooby, W.L., Andrews, S. and Saint, C.P. (2005) Culture-independent techniques for rapid detection of bacteria associated with loss of chloramine residual in a drinking water system. *Applied and Environmental Microbiology* 71(11), 6479-6488.

Kasuga, I., Shimazaki, D. and Kunikane, S. (2007) Influence of backwashing on the microbial community in a biofilm developed on biological activated carbon used in a drinking water treatment plant, pp. 173-180.

Keen, G.A. and Prosser, J.I. (1987) Steady state and transient growth of autotrophic nitrifying bacteria. *Archives of Microbiology* 147(1), 73-79.

Laurent, P., Kihn, A., Andersson, A. and Servais, P. (2003) Impact of backwashing on nitrification in the biological activated carbon filters used in drinking water treatment. *Environmental Technology* 24(3), 277-287.

Loveless, J.E. and Painter, H.A. (1968) The Influence of Metal Ion Concentrations and pH Value on the Growth of a *Nitrosomonas* Strain Isolated from Activated Sludge. *J Gen Microbiol* 52(1), 1-14.

Martens-Habbena, W., Berube, P.M., Urakawa, H., De La Torre, J.R. and Stahl, D.A. (2009) Ammonia oxidation kinetics determine niche separation of nitrifying Archaea and Bacteria. *Nature* 461(7266), 976-979.

Mincer, T.J., Church, M.J., Taylor, L.T., Preston, C., Karl, D.M. and DeLong, E.F. (2007) Quantitative distribution of presumptive archaeal and bacterial nitrifiers in Monterey Bay and the North Pacific Subtropical Gyre. *Environmental Microbiology* 9(5), 1162-1175.

Prosser, J.I. (1989) Autotrophic Nitrification in Bacteria. *Advances in microbial physiology* 30, 125-181.

Prosser, J.I. and Nicol, G.W. (2008) Relative contributions of archaea and bacteria to aerobic ammonia oxidation in the environment. *Environmental Microbiology* 10(11), 2931-2941.

Robertson, L.A., Cornelisse, R., Zeng, R. and Kuenen, J.G. (1989) The effect of thiosulphate and other inhibitors of autotrophic nitrification on heterotrophic nitrifiers. *Antonie van Leeuwenhoek* 56(4), 301-309.

Rotthauwe, J.H., Witzel, K.P. and Liesack, W. (1997) The ammonia monooxygenase structural gene *amoA* as a functional marker: Molecular fine-scale analysis of natural ammonia-oxidizing populations. *Applied and Environmental Microbiology* 63(12), 4704-4712.

Schmidt, I., Look, C., Bock, E. and Jetten, M.S.M. (2004) Ammonium and hydroxylamine uptake and accumulation in *Nitrosomonas*. *Microbiology* 150(5), 1405-1412.

Tappe, W., Laverman, A., Bohland, M., Braster, M., Rittershaus, S., Groeneweg, J. and Van Verseveld, H.W. (1999) Maintenance energy demand and starvation recovery dynamics of *Nitrosomonas europaea* and *Nitrobacter winogradskyi* cultivated in a retentostat with complete biomass retention. *Applied and Environmental Microbiology* 65(6), 2471-2477.

Tai, Y.L. and Dempsey, B.A. (2009) Nitrite reduction with hydrous ferric oxide and Fe(II): Stoichiometry, rate, and mechanism. *Water Research* 43(2), 546-552.

Taylor, A.E., Zeglin, L.H., Dooley, S., Myrold, D.D. and Bottomley, P.J. (2010) Evidence for different contributions of archaea and bacteria to the ammonia-oxidizing potential of diverse oregon soils. *Applied and Environmental Microbiology* 76(23), 7691-7698.

Tijhuis, L., Van Loosdrecht, M.C.M. and Heijnen, J.J. (1993) A thermodynamically based correlation for maintenance Gibbs energy requirements in aerobic and anaerobic chemotrophic growth. *Biotechnology and Bioengineering* 42(4), 509-519.

Tränckner, J., Wricke, B. and Krebs, P. (2008) Estimating nitrifying biomass in drinking water filters for surface water treatment. *Water Research* 42(10-11), 2574-2584.

Uhl, W. and Gimbel, R. (2000) Dynamic modeling of ammonia removal at low temperatures in drinking water rapid filters. *Water Science and Technology* 41(4-5), 199-206.

van den Akker, B., Holmes, M., Cromar, N. and Fallowfield, H. (2008) Application of high rate nitrifying trickling filters for potable water treatment. *Water Research* 42(17), 4514-4524.

Van der Wielen, P.W.J.J., Voost, S. and Van der Kooij, D. (2009) Ammonia-oxidizing bacteria and archaea in groundwater treatment and drinking water distribution systems. *Applied and Environmental Microbiology* 75(14), 4687-4695.

Van der Wielen, P.W.J.J. and Medema, G.J. (2010) Unsuitability of quantitative Bacteroidales 16S rRNA gene assays for discerning fecal contamination of drinking water. *Applied and Environmental Microbiology* 76(14), 4876-4881.

Westerman, P.W., Bicudo, J.R. and Kantardjieff, A. (2000) Upflow biological aerated filters for the treatment of flushed swine manure. *Bioresource Technology* 74(3), 181-190.

Wolthoorn, A., Temminghoff, E.J.M. and Van Riemsdijk, W.H. (2004) Colloid formation in groundwater by subsurface aeration: Characterisation of the geocolloids and their counterparts. *Applied Geochemistry* 19(9), 1391-1402.

## Supporting Information Section

## Supplementary Material A

The balance calculation for AOB or AOA is schematized in Figure A.1.

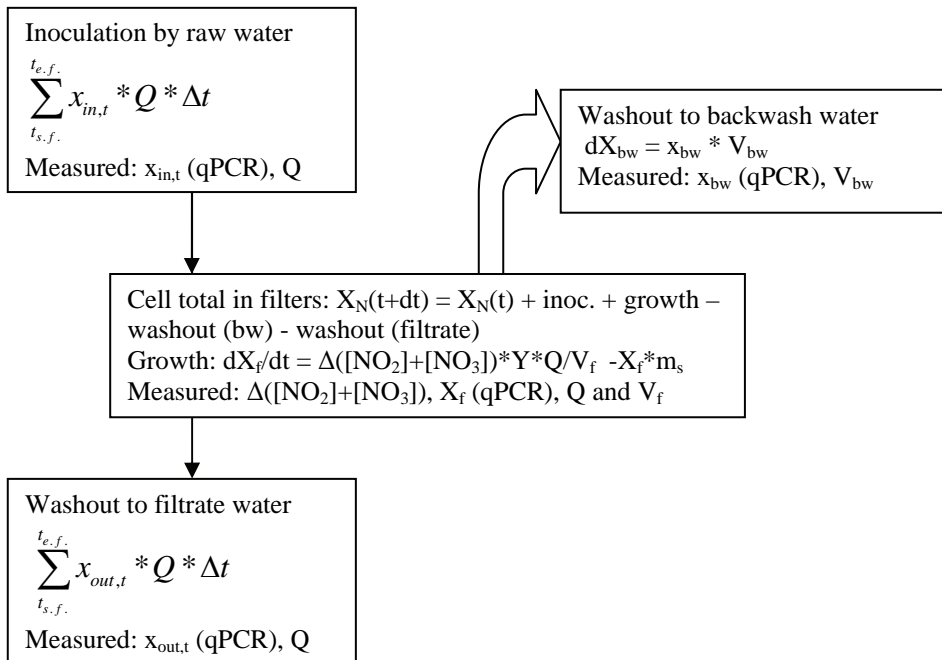

Figure A.1: Balance calculation of AOB and AOA in full-scale groundwater filters

Where

Q	flow ( $\text{m}^3 \text{h}^{-1}$ )
t	time (h)
V	volume ( $\text{m}^3$ )
x	cell concentration ( $\text{cells m}^{-3}$ )
X	total cell number (cells)
Y	yield ( $\text{cells mol}^{-1} \text{N}_{\text{converted}}$ )

Indices

bw	backwash
f	filter
in, out	in influent, effluent
t	time (h)

The balance calculation for AOA in both filters is shown in Figure A.2

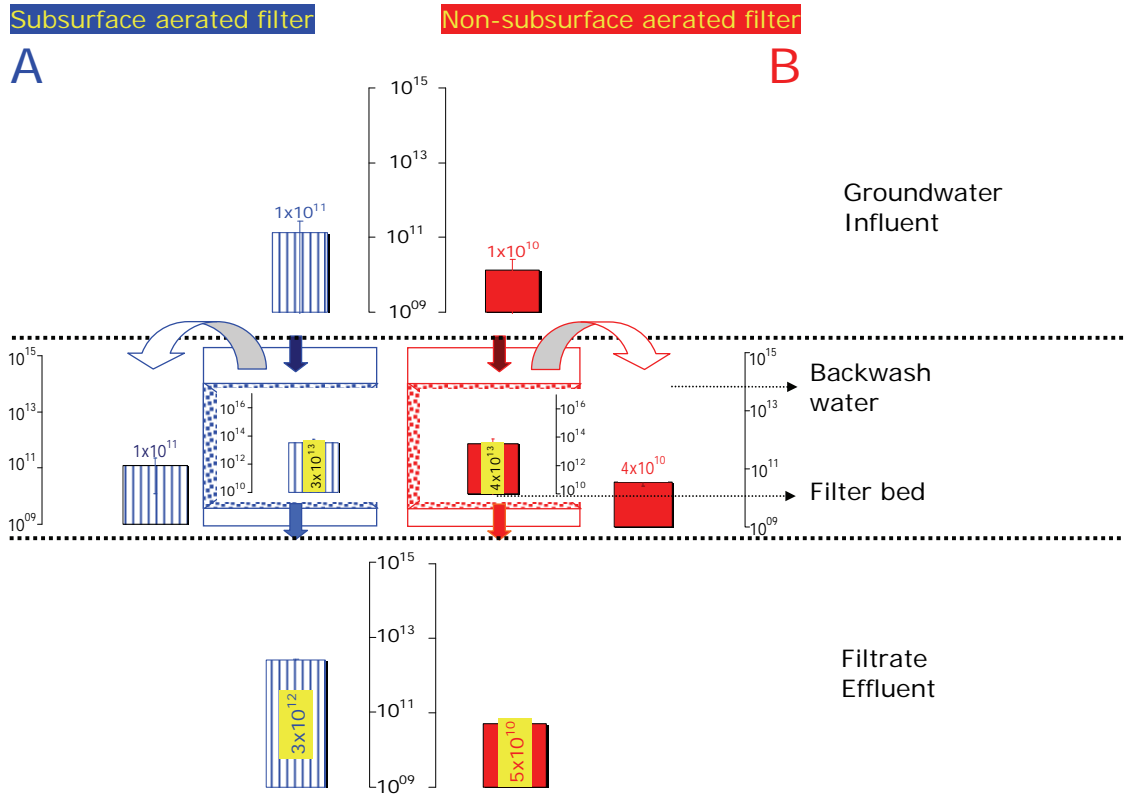
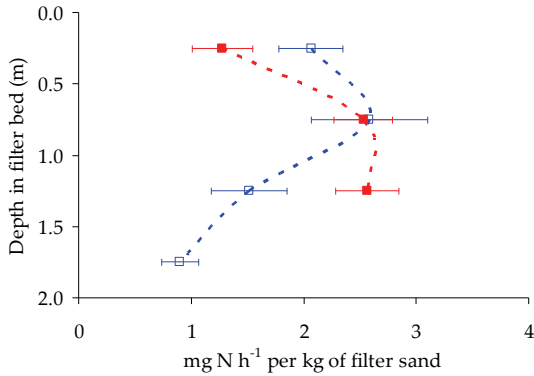

Figure A.2: *amoA* gene balances for AOA by qPCR for the subsurface aerated filter (A) and non-subsurface aerated filter (B) over 9 months after external washing; bar graphs in the center show the cumulative cell numbers per filter run time of 48 hours for the influent (top) and effluent (bottom). The bar graphs in the middle center and outside present the cumulative cell numbers present in the filter and washed out during backwash, respectively; the curved blue and red arrows indicate the direction of the backwash flow and point towards the columns graph with the cumulative cell numbers present in the backwash water

### Supplementary Material B

The sand-specific nitrification rates for both filters over the bed height are shown in Figure B.1. In the non-subsurface aerated filter, nitrification activity remained constant throughout the depth below the top of the filter bed. In the subsurface aerated filter, the highest nitrification activity was found in the layer below the top of the filter bed. The decrease in nitrification activity deeper in the filter bed is likely the result of substrate limitation.



**Figure B.1:** Sand-specific nitrification rate for filter sand samples over the bed height; subsurface aerated filter ( $\square$ ), non-subsurface aerated filter ( $\blacksquare$ ); average and standard deviation of samples taken one to nine months after external washing

The distribution of AOB cell numbers in the filter samples at two depths are shown in Figure B.2 for both filters. Despite a variation in time, the distribution of AOB over the bed height is comparable to the sand-specific activity in both filters (Figure B.1).

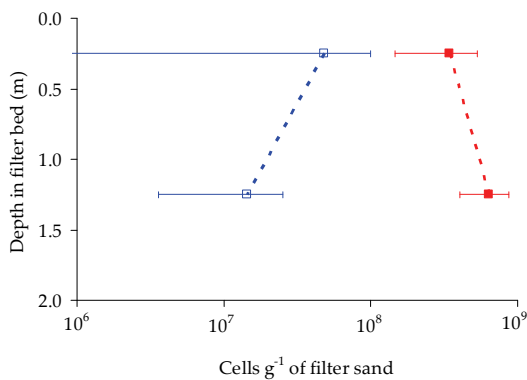

**Figure B.2:** AOB cell numbers for filter sand samples over the bed height; subsurface aerated filter ( $\square$ ), non-subsurface aerated filter ( $\blacksquare$ ); average and standard deviation of samples taken one to nine months after external washing

**Supplementary Material C**

The analytical description of exponential growth in the batch experiments on backwash water samples is given in Equation C 1 to 4b.

$$X_t = \frac{r_{N,t} * Y_{X,N}}{\mu'_{X,N}} \quad \text{Equation C.1}$$

$$x_t = x_0 * e^{\mu'_{X,N} * t} \quad \text{Equation C.2}$$

The combination of Formula 1 and 2 gives the rates in time (Formulas 3a and b)

$$r_{N,t} = \frac{\mu'_{X,N} * x_0}{Y_{X,N}} * e^{\mu'_{X,N} * t} \quad \text{NO}_2+\text{NO}_3, \text{Equation C.3a}$$

$$r_{N,t} = -\frac{\mu'_{X,N} * x_0}{Y_{X,N}} * e^{\mu'_{X,N} * t} \quad \text{NH}_4, \text{Equation C.3b}$$

Integration over time results in concentrations of NO<sub>2</sub>+NO<sub>3</sub> and NH<sub>4</sub> according to the Formulas 4a and b

$$N_{t1} = N_0 + \frac{x_0}{Y_{X,N}} * (e^{\mu'_{X,N} * t} - 1) \quad \text{NO}_2+\text{NO}_3, \text{Equation C.4a}$$

$$N_t = N_0 - \frac{x_0}{Y_{X,N}} * (e^{\mu'_{X,N} * t} - 1) \quad \text{NH}_4, \text{Equation C.4b}$$

Where

$x_0, x_t$	Concentration AOB at t = 0, t	mmol X L <sup>-1</sup>
$r_{N,t}$	Nitrification rate at t = t	mg N L <sup>-1</sup> h <sup>-1</sup>
$Y_{X,N}$	Yield AOB on ammonium	0.06 mol X (mol NH <sub>4</sub> -N) <sup>-1</sup> = 0.0043 mmol X (mg NH <sub>4</sub> -N) <sup>-1</sup>
$\mu'_{X,N}$	Maximum specific growth rate	0 < $\mu$ < 0.1 h <sup>-1</sup>
$N_0, N_t$	Concentration of N at t = t = 0, t	mg N L <sup>-1</sup>

Two examples of the measurements and the analytical approach for one batch experiment with backwash water are given in Figure C.1.

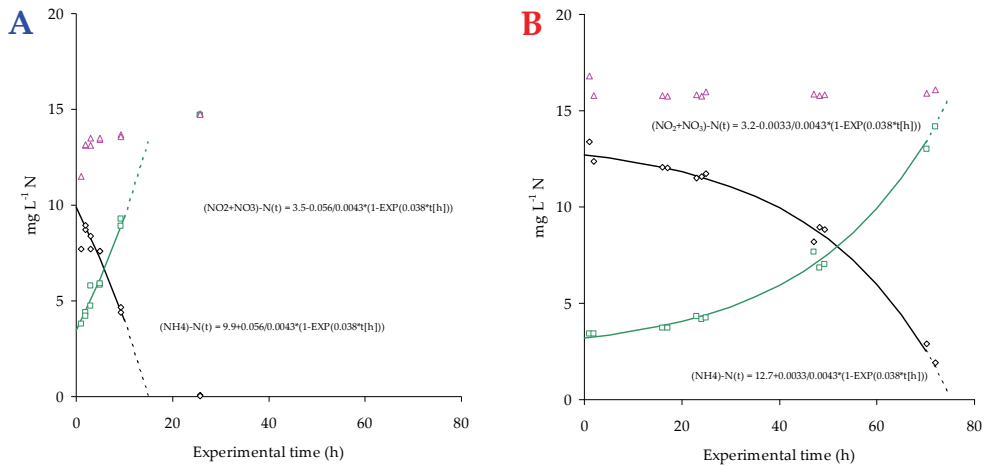

**Figure C.1:** Examples of batch experiments for determination of initial volumetric nitrification rate in backwash water from subsurface aerated filter (graph A) and from non-subsurface aerated filter (graph B);  $\Delta$  N-total,  $\diamond$  NH<sub>4</sub>-N,  $\square$  (NO<sub>2</sub>+NO<sub>3</sub>)-N

Table C.1 gives an overview of the cell numbers and the initial volumetric nitrification rates for all backwash water samples. The cell-specific nitrification rates in last column was calculated from these two measurements.

**Table C.1:** Overview of cell numbers, initial volumetric nitrification rate and calculated cell-specific nitrification rates for all backwash water samples

	Time after startup Months	Cell numbers		Initial volumetric nitrification rate		Cell-specific nitrification rates	
		Cells L <sup>-1</sup>		mg N L <sup>-1</sup> h <sup>-1</sup>		fg N cell <sup>-1</sup> h <sup>-1</sup>	
		AOB	AOA	AVERAGE	StDevP	AVERAGE	StDevP
SA filter	3	24 X 10 <sup>8</sup>	1.6 X 10 <sup>6</sup>	0.36	0.01	1.5 X 10 <sup>2</sup>	0.03 X 10 <sup>2</sup>
	6	2.5 X 10 <sup>8</sup>	1.1 X 10 <sup>6</sup>	0.50	0.01	20 X 10 <sup>2</sup>	0.4 X 10 <sup>2</sup>
	9	4.9 X 10 <sup>8</sup>	9.9 X 10 <sup>6</sup>	0.99	0.23	20 X 10 <sup>2</sup>	4.7 X 10 <sup>2</sup>
Non-SA filter	3	1.6 X 10 <sup>8</sup>	1.2 X 10 <sup>6</sup>	0.03	0.00	0.17 X 10 <sup>2</sup>	0.01 X 10 <sup>2</sup>
	6	23 X 10 <sup>8</sup>	0.6 X 10 <sup>6</sup>	0.04		0.17 X 10 <sup>2</sup>	
	9	64 X 10 <sup>8</sup>	1.4 X 10 <sup>6</sup>	0.07	0.01	0.11 X 10 <sup>2</sup>	0.02 X 10 <sup>2</sup>



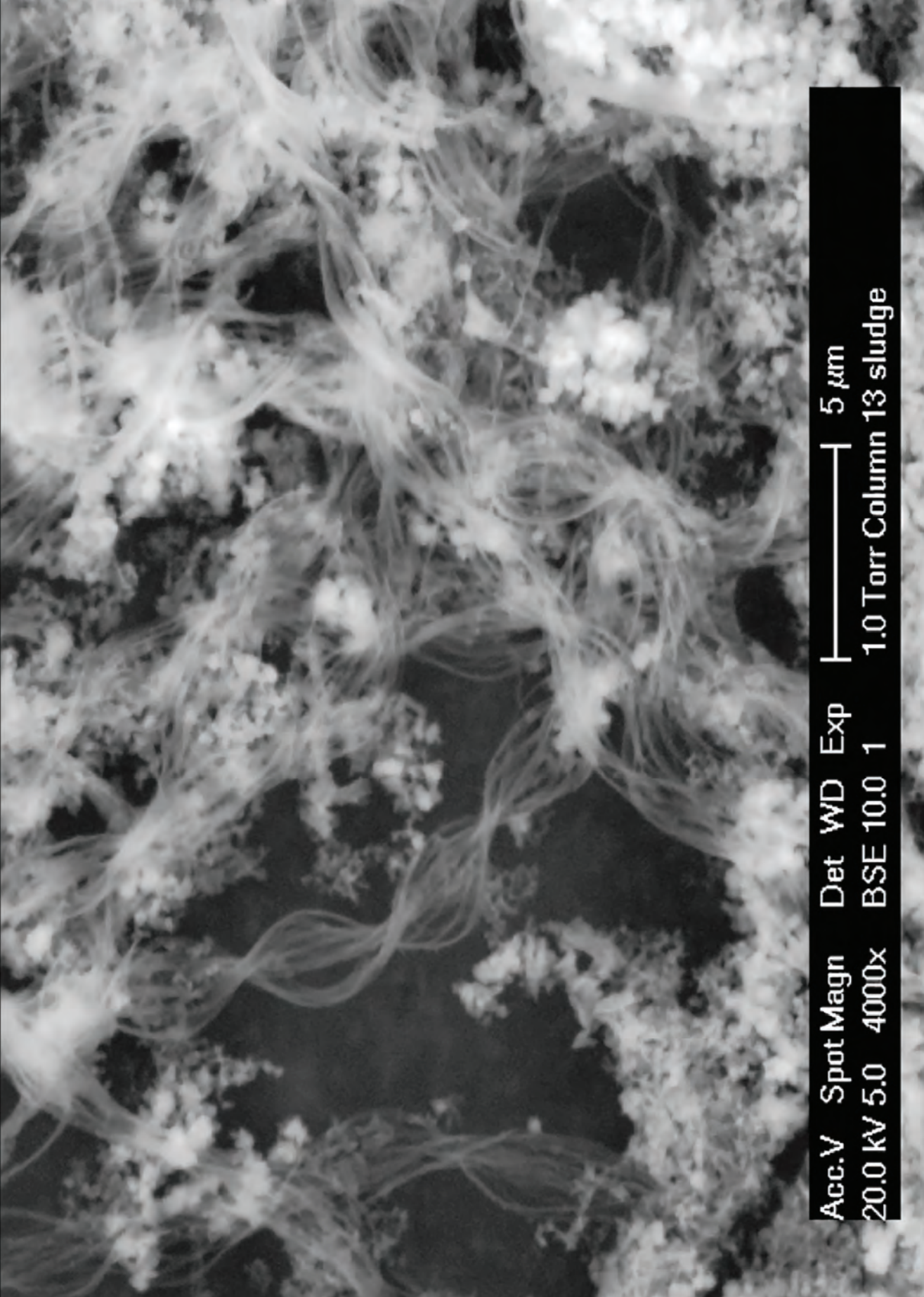

Acc.V 20.0 kV Spot Magn 5.0 4000x Det BSE WD 10.0 1 Exp 1.0 Torr Column 13 sludge | 5 μm

# CHAPTER 9

---

## Phosphorus limitation in nitrifying groundwater filters

Submitted as:  
de Vet, W.W.J.M., Rietveld, L.C. and van Loosdrecht, M.C.M.  
Phosphorus limitation in nitrifying groundwater filters.

## **Abstract**

Phosphorus limitation has been demonstrated for heterotrophic growth in groundwater, in drinking water production and distribution systems, and for nitrification of surface water treatment at low temperatures. In this study, phosphorus limitation was tested, in the Netherlands, for nitrification of anoxic groundwater rich in iron, ammonium and orthophosphate. The bioassay method developed by Lehtola et al. (1999) was adapted to determine the microbially available phosphorus (MAP) for nitrification. In standardized batch experiments with an enriched mixed culture inoculum, the formation of nitrite and nitrate and ATP and the growth of ammonium oxidizing bacteria (AOB; as indicated by qPCR targeting the *amoA*-coding gene) were determined for MAP concentrations between 0 and 100  $\mu\text{g PO}_4\text{-P L}^{-1}$ . The nitrification and microbial growth rates were limited at under 100  $\mu\text{g PO}_4\text{-P L}^{-1}$  and virtually stopped at under 10  $\mu\text{g PO}_4\text{-P L}^{-1}$ . In the range between 10 and 50  $\mu\text{g PO}_4\text{-P L}^{-1}$ , a linear relationship was found between MAP and the maximum nitrification rate. AOB cell growth and ATP formation were proportional to the total ammonia oxidized. Contrary to Lehtola et al. (1999), biological growth was very slow for MAP concentrations less than 25  $\mu\text{g PO}_4\text{-P L}^{-1}$ . No full conversion nor maximum cell numbers were reached within 19 days. In full-scale groundwater filters, most of the orthophosphate was removed alongside with iron. The remaining orthophosphate appeared to have only limited availability for microbial growth and activity. In some groundwater filters, nitrification was almost totally prevented by limitation of MAP. In batch experiments with filtrate water from these filters, the nitrification process could be effectively stimulated by adding phosphoric acid.

## **Keywords**

ATP, drinking water production, groundwater, iron removal, microbially available phosphorus, nitrification

## 9.1. Introduction

In drinking water production from anaerobic groundwater in the Netherlands and Flanders, iron, manganese and ammonium are often removed in one trickling filtration step without adding strong oxidants. Molecular research into full- and pilot-scale filters showed that not only nitrification, but also iron and manganese oxidation may be biological processes (de Vet et al., 2010). In some of these groundwater filters at the drinking water company Oasen in the Netherlands, nitrification poses regular problems. In a groundwater filter with incomplete nitrification, the cell-specific nitrification rate was much lower than in a filter with full nitrification (de Vet et al., submitted 2011a). In addition to the catabolic substrates, all microorganisms require anabolic substrates, such as inorganic carbon, oxygen, ammonium (or nitrate)-nitrogen, phosphate and trace elements, for growth.

Phosphorus (P) is an essential element in life. All cells contain phosphorus and require this element for growth, activity and regulation. Microorganisms may replace phosphorus with other elements in a P-limited environment, but only to a certain extent. The phosphorus content of a *Bacillus subtilis* may vary between 1.7 and 3.2 % of the dry weight depending on the P availability (Harder and Dijkhuizen, 1983, and references therein).

Phosphorus in the environment is mainly present in the form of phosphate. Phosphate availability in water has been the subject of many studies. There is a wide range in the phosphate content in natural water depending on the input from deposits, fertilizers, waste streams, and the dissolution of phosphate-containing ground minerals. In poor natural waters in boreal areas, the phosphate content may be so low (Miettinen et al., 1997) that it is the primary limiting compound for both prokaryotic and eukaryotic growth. Not all phosphate may be available for use by microorganisms. Next to the ionic orthophosphate form, phosphate may be present in dissolved organic complexes or in particulate form as metal or organic complexes (Scherrenberg et al., 2008). Drinking water references deal with the (unwanted) heterotrophic growth in distribution and membrane systems (Vrouwenvelder et al., 2010, and references therein), and focus on the limitation of phosphate to control and minimize heterotrophic growth. Phosphate-limited nitrification has been reported in a wastewater polishing filter (Scherrenberg et al., 2009). During drinking water production, phosphate-limited nitrification is usually related to low temperatures (Andersson et al., 2001; Kors et al., 1998; van der Aa et al., 2002). In several nitrifying filter systems, phosphate was dosed effectively to remove the limitation (Yoshizaki and Ozaki, 1993; van der Aa et al., 2002).

Here, nitrification at the Oasen water treatment plant (WTP) Lekkerkerk was studied. In the Oasen groundwater filters, the water temperature is moderately

low and constant (13 °C), but the availability of phosphate is not straightforward. Orthophosphate content is relatively high in the groundwater, but reduced in the de-ironing trickling filters (see Table 1). Phosphate may be removed by (surface) precipitation (Ler and Stanforth, 2003) and adsorption (Lijklema, 1980) on iron (oxy)hydroxides in these filters. Makris et al. (2004) found minimal desorption of phosphate from iron-containing drinking water residuals and suggested that this stability was related to the immobilization of phosphate in abundantly present micropores. Next to the chemical removal of phosphate by iron oxyhydroxides, competing biological processes and specifically biological iron oxidation might further hamper nitrification by competing for phosphate.

To assess the microbial availability of phosphate for heterotrophic growth, Lehtola et al. (1999) developed a sensitive bioassay method. They found a constant cell yield per unit of phosphate, which was confirmed by other researchers (Polanska et al., 2005),  $3.7 \times 10^8$  and  $3.2 \times 10^8$  cfu per  $\mu\text{g PO}_4\text{-P}$ . Both teams worked with a pure culture of the heterotrophic *Pseudomonas fluorescens* P17 growing on acetate and enumerated with plate counts. In this paper, we hypothesize that phosphate may be limiting nitrification in de-ironing groundwater filters. To assess the microbially available phosphorus (MAP) for nitrifiers, we adapted the method developed by Lehtola et al. (1999) and applied it to full-scale nitrifying filters that performed well and poorly. The effect of phosphorous dosing on nitrification was evaluated in batch experiments.

## 9.2. Material and methods

### 9.2.1. Standardization of microbially available phosphorus for nitrifiers

The experimental method for the determination of MAP was based on the approach of Lehtola et al. (1999), who used heterotrophic *P. fluorescence* P17 bacteria. The *adaptations* for using nitrifying bacteria where:

The setup consisted of Labinto multi-position magnetic stirring plateaus with 1 L glass bottles that each contained a steel sampling needle through a foam stopper and a magnetic stirring rod.

*Cleaning*: In order to remove all traces of phosphate, all glass bottles and magnetic stirring rods were first washed for 16 h with 5% phosphate-free detergent and then again for 6h with 2% phosphate-free detergent (Deconex# 15PF; Borer Chemie AG, Zuchwil, Switzerland), immersed in 2% HCl solution for 2 h, and then rinsed with deionized water (Millipore, Molsheim, France). Finally, the clean glassware was heated for 45 min at 120°C. The needles were washed with HCl and then rinsed with deionized water before affixing them in the bottles.

*Culture medium:* The same defined minimal inorganic nutrient solution was used as the medium for both the enrichment of the mixed inoculum and the standardization experiments. The medium was prepared with deionized water (Millipore) with the addition of the following compounds: 2.14 mM  $\text{NH}_4\text{HCO}_3$ , 1.09 mM  $\text{KHCO}_3$ , 0.992 mM  $\text{CaCl}_2 \cdot 2\text{H}_2\text{O}$ , 0.44 mM  $\text{MgSO}_4 \cdot 7\text{H}_2\text{O}$ , 2.40 mM  $\text{NaHCO}_3$ , 0.12 mM Titriplex, 1  $\mu\text{M}$   $\text{FeCl}_3 \cdot 6\text{H}_2\text{O}$  and 1  $\mu\text{M}$   $\text{MnCl}_2 \cdot 4\text{H}_2\text{O}$  (all Merck, pro analyse). The concentration of these compounds was similar to that of the drinking water, that is, the finished product of the Oasen WTP Lekkerkerk apart from the calcium content, which was lowered by 1 mM after the first experimental series to prevent  $\text{CaCO}_3$  precipitation and replaced by an extra 1 mM of  $\text{KHCO}_3$ . Trace elements ( $\text{ZnSO}_4 \cdot 7\text{H}_2\text{O}$ ,  $\text{CoCl}_2 \cdot 6\text{H}_2\text{O}$ ,  $\text{CuSO}_4 \cdot 5\text{H}_2\text{O}$ ,  $\text{Na}_2\text{MoO}_4 \cdot 2\text{H}_2\text{O}$ , all Merck) were also added to prevent limitation for other nutrients than phosphate.

*Inoculum:* A mixed culture of nitrifying bacteria originating from the filtrate water of a nitrifying trickling filter at Oasen WTP Lekkerkerk was used as inoculum. This mixed culture was enriched in a mildly aerated and slowly stirred continuous system (chemostat) at room temperature with a hydraulic retention time of 48 hours. The medium described above was used with the addition of 25  $\mu\text{g PO}_4\text{-P L}^{-1}$ . *Standardization experiments* were executed under the addition of different amounts of phosphate ( $\text{Na}_2\text{HPO}_4 \cdot 12\text{ H}$ ; Merck pro analyse) into the culture medium. To optimize the method, the standardization experiments were run four times with small differences in inoculum, medium composition and phosphate addition. In the Results Section, we focus on the findings from the last series and discuss the major differences from earlier series. Each standard series contained six to eight concentrations of phosphate, ranging from 0 to 100  $\mu\text{g PO}_4\text{-P L}^{-1}$ . The phosphate was added from two phosphate standards (1.0 and 25  $\text{mg PO}_4\text{-P L}^{-1}$ ) that were prepared in acid-washed 1L bottles with deionized water (Millipore). After adding the nutrient solution, phosphate and deionized water totaling 249 mL per bottle, the standards were pasteurized at 60°C in a water bath for 35 min. After cooling, the samples were inoculated with 1 mL of inoculum described above. The cell concentration determined by qPCR in duplicate was  $3.7 \pm 2.0 \times 10^1$  cells  $\text{mL}^{-1}$  directly after inoculation. The inoculated bottles were incubated at room temperature on Labinco magnetic stirring plates. The bottles remained closed with foam stoppers during the entire experiment.

### 9.2.2. Measurements of activity and growth of nitrifying bacteria

In addition to Lehtola et al. (1999), not only the cell yield was measured but also the activity of the nitrifying bacteria. Nitrification activity was monitored in time by analysis of  $\text{NH}_4\text{-N}$  and  $(\text{NO}_2+\text{NO}_3)\text{-N}$ . The maximum nitrification rate was defined as the maximum slope between the subsequent points in the  $(\text{NO}_2+\text{NO}_3)\text{-N}$  graphs. The growth of biomass was determined by ATP measurement and qPCR. The frequency of sampling (once per 3-4 days up to twice a day) was determined

by test strips for NO<sub>2</sub>-N (Merckoquant 1.10007.0001) and for NH<sub>3</sub>-N (Hach Aquachek Ammonia cat. 27553-25). Based on these measurements, the ATP-concentration was determined at the (visible) beginning of the nitrification activity (NO<sub>2</sub>-N by test strip > 0.5 mg L<sup>-1</sup>) for each sample. For 5 µg PO<sub>4</sub>-P L<sup>-1</sup>, no sample was taken at this point as no activity was measured before the end of the experiment. Each experiment was ended as soon as all ammonium was depleted, or after 19 days in the other cases. At that moment, samples were taken for ATP measurement and qPCR.

### 9.2.3. Quantification of AOB by qPCR

To quantify ammonia-oxidizing bacteria (AOB) by qPCR, part of the functional gene coding for the  $\alpha$ -subunit of the ammonia monooxygenase enzyme was amplified until a threshold value C<sub>t</sub> was reached, as described by van der Wielen et al. (2009). The method was applied with minor moderation at Bioclear (Groningen, the Netherlands), where detailed protocols and primer sequences are available on request.

### 9.2.4. Chemical analyses

*Orthophosphate*: Samples were analyzed colorimetrically by measurement of extinction at 880 nm of molybdenum blue, formed after reduction by ascorbic acid from phosphomolybdic acid, which in its turn was formed by reaction of orthophosphate and molybdate in an acid solution catalyzed by antimony.

*Ammonium, nitrite and nitrate*: Samples were filtered over a 0.45 µm PTFE filter, stored cool (2-8 °C) and analyzed within two weeks after sampling. Ammonium and the sum of nitrite and nitrate were determined by colorimetric measurement on a Lachat Quikchem® 8500 Flow Injection Analysis System.

*ATP*: As a general biomass measurement, ATP was determined by luminescence after reaction with luciferin-luciferase using an Aqua-tools Quench-Gone™ kit and a Kikkoman C-110 LumiTester luminometer, in accordance with the supplier's protocols. ATP was extracted from two duplicate 10 mL samples with the extraction reagent Ultralyse 7. The ATP extracts were stored cool (2-8 °C) and analyzed within one week after sampling. The extracts were diluted with the prescribed Ultralute. After the addition of Luminase (luciferase enzyme reagent), the ATP-content was calculated from the measured luminescence by comparing it with a standard (UltraCheck 1). For each set of a maximum 14 samples, one calibration standard was used. The detection limit of the method was 20 pg ATP L<sup>-1</sup>.

### 9.2.5. Modeling of the standardization experiments

The metabolic activity in the MAP calibration tests was modeled using Excel with iterations. Besides the standard exponential growth model (Equation 1), the specific growth rate was corrected with a Monod factor for the most limiting substrate, ammonia or phosphate (Equation 2). As phosphorus is built into new cells, the remaining orthophosphate concentration was calculated for each time step by subtracting the fixed phosphorus (multiplying P yield on N-conversion (Equation 3)). Finally, the sum of nitrite and nitrate were calculated (Equation 4). The initial biomass concentration  $[X_{t0}]$ , the maximum specific growth rate under lab conditions ( $\mu'_{max}$ ), the affinity constants for ammonia-N ( $K_N$ ) and phosphate-P ( $K_P$ ), and the P content of biomass (m/m) were optimized by 'Solver' function to fit all measured data using the method of least squares.

$$[X_{t2}] = [X_{t1}] * e^{\{AVG(\mu'_{t1}; \mu'_{t2}) * (t_2 - t_1)\}} \quad \text{Equation 1}$$

$$\mu'_{spec} = MIN \left[ \frac{[NH_{3,t}]}{k_N + [NH_{3,t}]}, \frac{[P_t]}{k_P + [P_t]} \right] * \mu'_{max} \quad \text{Equation 2}$$

$$[P_{t2}] = [P_{t1}] - Y_{X,P} * ([N_{t2}] - [N_{t1}]) \quad \text{Equation 3}$$

where:  $Y_{X,P} = Y_{X,N} * P\% \left\{ P - content DW, \frac{m}{m} \right\}$

$$[N_{t2}] = [N_{t1}] - \frac{[X_{t1}^{AOB}]}{Y_{X,N}} * \left( 1 - e^{AVG(\mu_{t1}; \mu_{t2}) * (t_2 - t_1)} \right) \quad \text{Equation 4}$$

where:  $N_t = SUM \left[ NO_2^- - N + NO_3^- - N \right]_t$

### 9.2.6. Determination of MAP for AOB in samples from full-scale drinking water filters

Filtrate water samples were collected from two sets of full-scale filters treating groundwater from separate well fields at the Oasen WTP Lekkerkerk. Each filter set consisted of a first and a second filter in series. The effluent of the first filter was directly (and without blending) fed to the second filter. One of these filter sets showed complete nitrification (Filter set 1), the other (Filter set 5) had nitrification problems (see Table 1). Schemes of the two investigated filters, their raw water composition and their nitrification performance have been reported in de Vet et al. (submitted 2011a) and references therein. All water samples were well buffered and contained sufficient inorganic nutrients and no chlorine or other disinfectant. The incubation bottles were cleaned before sampling and the same trace elements mentioned in the previous section were added to the samples to ensure that no inorganic nutrients other than phosphate restricted microbial growth. An exact



sample mass per bottle of 249 g was set by pipetting and weighing. The incubation bottles were pasteurized at 60°C in a water bath for 35 min to inactivate all indigenous bacteria. After cooling, the samples were inoculated with 1 mL of inoculum described above. The MAP analysis was started within 8 h after sampling.

#### **9.2.7. Batch measurements with and without phosphate dosing**

To confirm the phosphate limitation in filtrate waters from the filters with incomplete nitrification and to test the removal of this limitation, phosphate dosing was applied in batch tests, comparable to the MAP measurements, with slight moderations. To each batch incubation, 30 mg NH<sub>4</sub>-N L<sup>-1</sup> (2.14 mM NH<sub>4</sub>HCO<sub>3</sub>) was dosed at the beginning of the measurement and once more when all ammonium was consumed in the most active incubations. An extra buffer capacity was added in the form of 2.14 mM KHCO<sub>3</sub>. A surplus concentration of phosphate (0.043 mM of NaH<sub>2</sub>PO<sub>4</sub>·H<sub>2</sub>O) was added to the positive tests, and no phosphate was added to the controls. The tested waters were sampled from the filtrate water of the first and second full-scale filter at Oasen WTP Lekkerkerk with incomplete nitrification. Experiments were performed singularly for the first filtrate and in duplicate for the second filtrate water. Nitrification was monitored over time by sampling and analysis of the sum of nitrite and nitrate.

### **9.3. Results**

#### **9.3.1. Standardization of a test for microbially available phosphorus for nitrifiers**

Nitrification was monitored in tests with varying amounts of phosphate added. In tests with low MAP added (0, 0.5 and 2 µg L<sup>-1</sup> PO<sub>4</sub>-P), no formation of nitrite or nitrate was measured in 11 days of the experiment. The formation of nitrite and nitrate in time is shown in Figure 1 for microbially available phosphate (MAP) - concentrations between 5 and 100 µg PO<sub>4</sub>-P L<sup>-1</sup>.

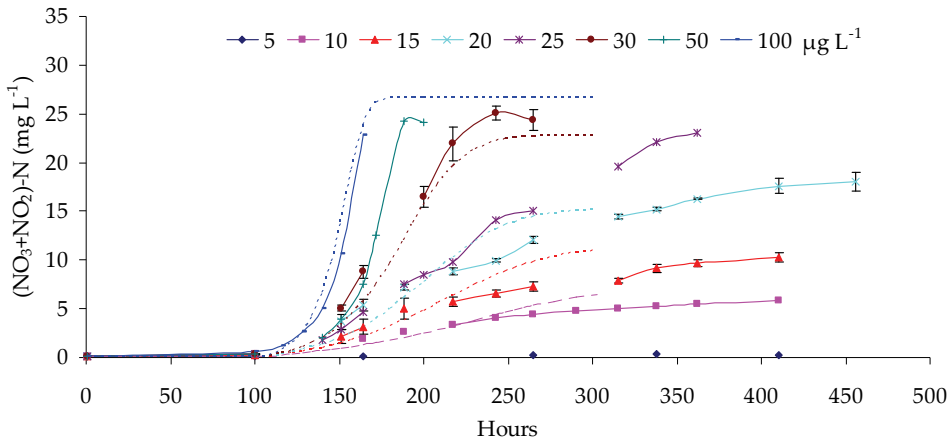

**Figure 1:** Sum of nitrite and nitrate concentrations in time for MAP standardization experiments with different MAP concentrations; dotted lines represent the best model fit with lag time and Monod kinetics for ammonia and phosphate

A batch growth model was fitted through the experimental data. The best fit was obtained with a lag time of 105 h, an affinity constant  $k_P$  of  $45 \mu\text{g PO}_4\text{-P L}^{-1}$  and with a biomass P content of  $11 \text{ mg P g}^{-1}\text{DW}$ , an affinity constant  $k_N$  of  $10 \text{ mg NH}_4\text{-N L}^{-1}$ , based on Suzuki et al. (1974) at pH 7.8 and a presumed biomass yield of  $0.12 \text{ gDW g}^{-1} \text{ NH}_4\text{-N}$  according to Hunik et al. (1994). Based on the biomass concentrations calculated in the model and provided in the literature (Tappe et al., 1999), maintenance can only partially explain the elongated nitrification activity at these low values. Van der Aa et al. (2002) reported a reduced respiration in lab-scale nitrifying filters at values under  $3 \mu\text{g PO}_4\text{-P L}^{-1}$  and concluded that the affinity of AOB for phosphate  $k_P < 3 \mu\text{g PO}_4\text{-P L}^{-1}$ . These experiments, however, only showed the influence of the P concentration on activity, while in our experiments the effect on growth has been studied. It is known that affinity coefficients can indeed vary when obtained from activity or growth experiments. Boon et al. (1999) showed that the specific activity and growth were uncoupled during the first 16 hours of batch experiments with *Thiobacillus ferrooxidans*.

The biomass concentrations at the end of the standardization experiment (measured by ATP and qPCR) at different MAP concentrations between 5 and  $100 \mu\text{g PO}_4\text{-P L}^{-1}$  are shown in Figure 2. The biomass formation was limited by ammonia depletion at MAP concentrations over  $20 \mu\text{g PO}_4\text{-P L}^{-1}$ .

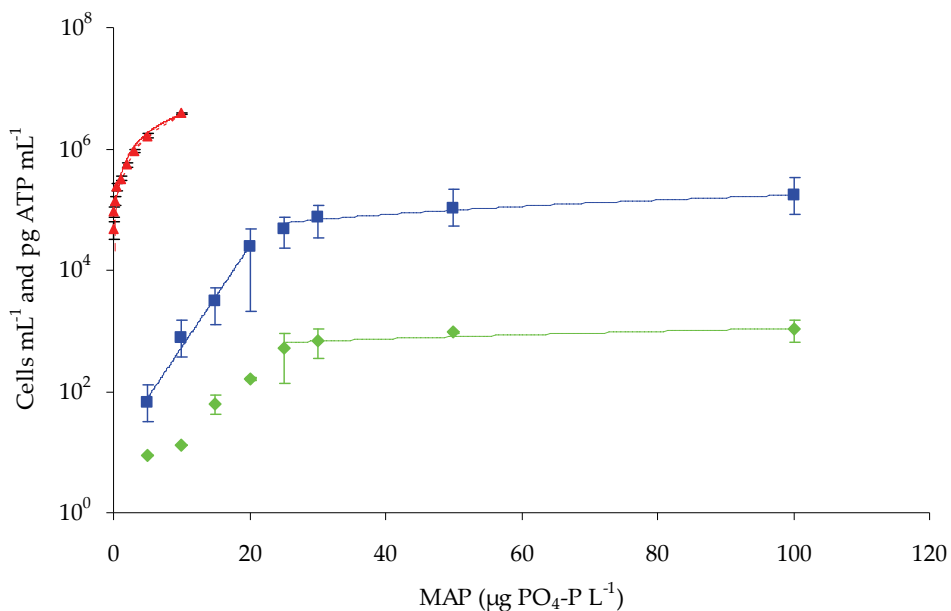
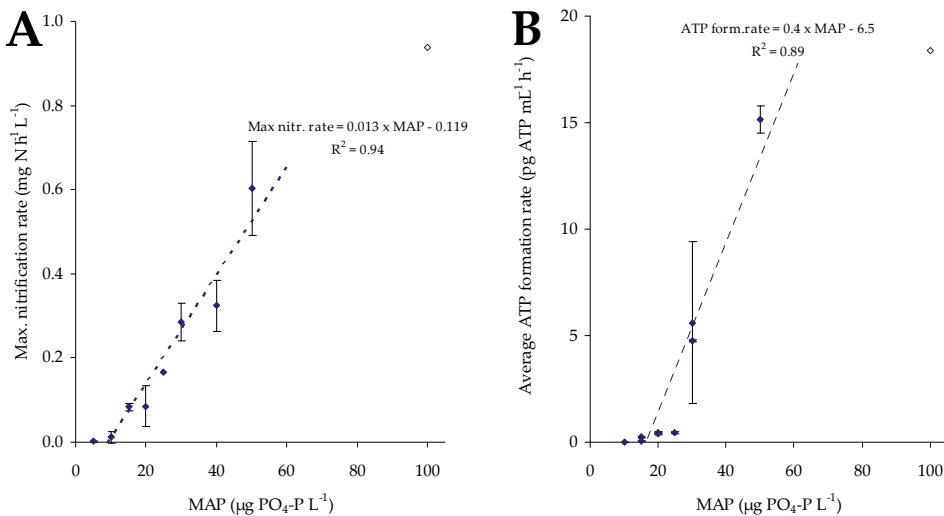

Figure 2: ATP concentrations formed (♦) and AOB cells grown (■; by qPCR with *amoA* marker) at the end of the standardization experiments with different MAP concentrations; relationship between AOB and MAP: exponential in range 5 – 20  $\mu\text{g PO}_4\text{-P L}^{-1}$  ( $R^2 = 0.99$ ), linear in range 25 – 100  $\text{PO}_4\text{-P L}^{-1}$  ( $R^2 = 0.97$ ); CFU of *P. fluorescens* P17 by plate counting (▲; adapted from Lehtola et al. (1999), linear relationship between CFU and MAP ( $R^2 = 0.99$ ))

We found a constant ATP content per cell of  $28 \pm 19 \times 10^{-3}$  pg or  $56 \pm 38 \times 10^{-9}$  nmol for all MAP concentrations (except for the  $5 \mu\text{g PO}_4\text{-P L}^{-1}$  incubation). These values are higher than found in the literature for heterotrophs. Hammes et al. (2010) determined an average value of  $0.2 \times 10^{-9}$  nmol ATP cell $^{-1}$  for 102 samples of groundwater, surface water, drinking water and bottled water, and wastewater effluent. Magic-Knezev and van der Kooij (2004) reported values for detached mixed culture biomass from granular active carbon ( $0.04 \times 10^{-9}$  nmol ATP cell $^{-1}$ ) and rapid sand filters ( $0.7 \times 10^{-9}$  nmol ATP cell $^{-1}$ ). The maximum cell-specific ammonia oxidation rate was  $2.0 \pm 2.4 \times 10^4$  fg N cell $^{-1}$  h $^{-1}$  and was independent from the MAP concentration. At lower MAP concentrations, the ammonia oxidation rate decreased after an early maximum value (see Figure 1), so the cell-specific rate did as well. The maximum cell-specific ammonia oxidation rate was, again, higher than the values reported in the literature ( $0.1$  to  $3 \times 10^2$  fg N h $^{-1}$  cell $^{-1}$ ; Prosser, 1989, and references therein). Both comparisons with the literature indicate a calibration problem in our qPCR measurements, resulting in values that were systematically a factor  $10^2$  too low in the batch and filtrate samples. The applied primer set may not have targeted well the dominant AOB in these samples. We found a constant cell yield on P for a MAP concentrations ranging from 20 to 100  $\mu\text{g PO}_4\text{-P L}^{-1}$ , which

was comparable with the values from Lehtola et al. (1999) and Polanska et al. (2005) after correction with this factor.

Despite this error, the results (especially the trend) from the qPCR measurements form a useful validation of the ATP measurements. For MAP concentrations under  $25 \mu\text{g PO}_4\text{-P L}^{-1}$ , the correlation between MAP and ATP or cell yield appeared to be exponential and not linear, thus conflicting with our model and the findings of Lehtola et al. (1999), who found a linear relationship. However, at these low concentrations, the growth of AOB was so slow that nitrification and AOB cell growth were still incomplete at the end of the experiment, and the maximum activity was reached well before that (see Figure 1). The maximum nitrification rate was linearly correlated to the MAP concentrations between 10 and  $50 \mu\text{g PO}_4\text{-P L}^{-1}$  (Figure 3A;  $R^2 = 0.94$ ). For MAP of  $100 \mu\text{g PO}_4\text{-P L}^{-1}$ , the maximum rate was limited by the ammonium depletion at the end of the experiments. Cell growth reduced the MAP and, as a result, reduced population activity further. Figure 3B shows that the increase in ATP, defined as the difference of ATP at the (visible) beginning of the nitrification activity and the end of the experiment divided by the elapsed time, was also linearly correlated to the MAP for concentrations higher than  $5 \mu\text{g PO}_4\text{-P L}^{-1}$  ( $R^2 = 0.89$ ).



**Figure 3: Maximum nitrification rates (Graph A) and average ATP formation rate (Graph B) during the standardization experiments for different MAP concentrations**

Regarding the experimental approach, it should be concluded that final ATP or cell numbers are not the most feasible means to determine MAP for nitrifiers. It takes a long time (weeks to months, if ever) to reach maximum cell numbers, especially at MAP concentrations of less than  $30 \mu\text{g PO}_4\text{-P L}^{-1}$ . The maximum nitrification or

growth rate was reached sooner, held a linear relationship with the MAP concentration in the range between 10 and 50  $\mu\text{g PO}_4\text{-P L}^{-1}$  and has, therefore, been used as a calibration line for measurements of MAP in environmental samples.

### 9.3.2. MAP for AOB in samples from full-scale drinking water filters

The MAP batch experiments were performed with four filtrate water samples from the full-scale groundwater filters at WTP Lekkerkerk to assess phosphate limitation. The measured maximum nitrification rates, final cell numbers and final ATP concentrations in these samples are given in Table 1. The MAP calculated from the maximum nitrification rate based on the standard experiments (Figure 3) is given as well. The formation of  $\text{NO}_2+\text{NO}_3$  for these filter samples during the MAP measurements is given in Figure 4A.

**Table 1: Orthophosphate, final cell numbers and ATP concentrations and maximum nitrification rates in MAP batch measurements with samples from full-scale groundwater filters at WTP Lekkerkerk**

Effluent Filter	Nitrification full-scale filters	PO <sub>4</sub> -P	ATP yield	AOB yield	Max. nitrification rate	MAP ( $\mu\text{g/L}$ )
		$\mu\text{g L}^{-1}$	$\text{pg mL}^{-1}$	Cells $\text{mL}^{-1}$	$\text{mg N L}^{-1} \text{h}^{-1}$	
1st filter 1 <sup>I</sup>	Full	80	257 ± 81	16 × 10 <sup>3</sup>	0.09	16
2nd filter 1	Full	80	25 ± 2	1.9 × 10 <sup>3</sup>	0.03	11
1st filter 5 <sup>V</sup>	Incomplete	30	117 ± 27	0.4 × 10 <sup>3</sup>	0.00	≤10
2nd filter 5	Incomplete	20	6	0.05 × 10 <sup>3</sup>	0.00	≤10

NOTES:

<sup>I</sup> groundwater for first filter 1 contained 545 ± 144  $\mu\text{g PO}_4\text{-P L}^{-1}$  (average and st. deviation for 22 values in 2010)

<sup>V</sup> groundwater for first filter 5 contained 742 ± 156  $\mu\text{g PO}_4\text{-P L}^{-1}$  (average and st. deviation for 22 values in 2010)

Not all measured orthophosphate in the filter effluents was available for growth of AOB. The measurement of orthophosphate is influenced by pretreatment (Scherrenberg et al., 2008) and the acid pretreatment of our unfiltered samples may have decomplexed metal or calcium-bound phosphate, resulting in an overestimation of the available orthophosphate.

The calculated MAP concentrations coincided with the nitrification performance in the full-scale filters of WTP Lekkerkerk. Nitrification was complete in the 1st filter of Filter set 1, but incomplete in both 1st and 2nd filters of Filter set 5. For these full-scale filters, the ATP yield was not equivalent to the nitrifying activity or AOB cell growth, and the high ATP concentration may be related to other microorganisms in the filter samples.

### 9.3.3. Batch measurements with and without phosphate dosing

To validate the phosphate limitation in the 1st and 2nd filters of Filter set 5 from WTP Lekkerkerk, the MAP batch experiments were repeated with and without

dosing of phosphoric acid. The formation of nitrite and nitrate over time for these experiments is shown in Figure 4B.

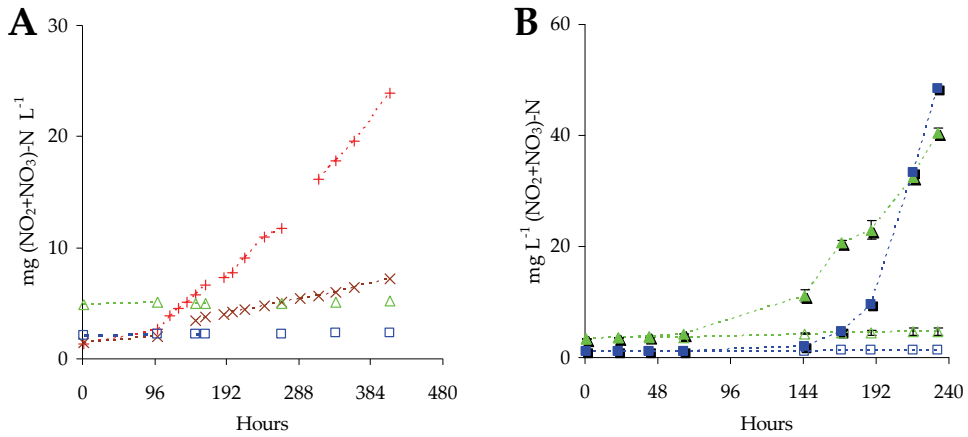

Figure 4:  $\text{NO}_2 + \text{NO}_3$  in batch experiments with filtrate water from full-scale filters at Oasen WTP Lekkerkerk; open symbols: references without dosing of phosphate; Graph A: application of MAP method, 1st (+) and 2nd (×) filtrate from filter set with full nitrification; Graph A and B: 1st (□) and 2nd (△) filtrate from filter set with incomplete nitrification; Graph B: effect of addition of phosphate to filtrate water from filter set with incomplete nitrification (solid symbols, 1st (■) and 2nd (▲) filtrate

Figure 4B shows that inhibition of nitrification in the filtrate of the full-scale filters with incomplete nitrification is effectively removed by the addition of phosphoric acid.

## 9.4. Discussion

### 9.4.1. AOB have lower affinity for phosphate than heterotrophs

For this work, we carried through minimal necessary adaptations to the existing MAP bioassay method of Lehtola et al. (1999) to be able to use it for AOB and still be able to compare the results with the original method for heterotrophs. For lower MAP concentrations, our results with AOB showed a striking difference from their results using a heterotrophic pure *Pseudomonas* culture. We found a strong growth limitation at low MAP concentrations resulting in an extended growth period. Lehtola et al. (1999) reported a rapid growth until total phosphate depletion and no effect from phosphate concentration on the growth rate. The clear-cut proportional relationship between MAP and cell yield found by those researchers was not found in our standardization experiments. Where the heterotrophic *Pseudomonas* bacteria reached the maximum cultivable cell number within six days, the mixed culture

of AOB we used did not reach their maximum yield of DNA fragments within 19 days at a lower MAP. Robertson and Alexander (1992) found lower rates of substrate conversion and cell growth for mineralization of trace concentrations ( $10 \mu\text{g L}^{-1}$ ) of glucose at lower phosphate concentrations by *Pseudomonas* spp. These researchers found a strong effect of calcium concentration and pH on the activity of the heterotrophic bacteria. An important difference in MAP between our experiments and those of Lehtola et al. (1999) may be found in the composition of the used media and the pH during the experiments. Even though Lehtola's group did not give the exact medium composition nor the pH during their experiments, some major differences are clear. Our medium contained more calcium, magnesium and bicarbonate than theirs. Preliminary modeling of the speciation with PHREEQC-2 (2.17.5-4799), indicate that, depending on the pH, only 76 to 86 % of P was in the oxoanionic form in our experiments, but 99% in the experiments of Lehtola et al. (1999). The rest was complexed with calcium and magnesium. In the hard water of WTP Lekkerkerk, even less phosphate will be present in the oxoanionic form.

While the maximum growth rate is already reduced at MAP concentrations under  $100 \mu\text{g PO}_4\text{-P L}^{-1}$ , it approaches nil when MAP is lower than  $10 \mu\text{g PO}_4\text{-P L}^{-1}$ . AOB showed a much lower affinity for phosphorus than the heterotrophic *Pseudomonas* bacteria. This means AOB is extra sensitive to the growth of competing microorganisms with a higher affinity. The reduced affinity for phosphate in our experiments may be related to a difference in the phosphate uptake system, but this cannot be concluded from these results.

The application of a mixed instead of a pure culture has both advantages and drawbacks. The mixed culture, enriched from the same environment, is likely to be better adapted to the circumstances in the environmental samples tested. On the backside, the influence of other species than nitrifiers in the mixed culture cannot be excluded and replication of the affinity tests with pure AOB cultures would be a useful extension. We tested different inocula (originating from a wastewater plant and several drinking water plants), used different purification or enrichment methods) and found that initial cell concentration and their preloading with phosphate were more important factors than the origin of the inoculum.

#### **9.4.2. Determining factors for MAP in full-scale groundwater filters**

The results described in this paper show that the lack of available phosphate may indeed inhibit nitrification in groundwater filters. At low MAP concentration (less than  $25 \mu\text{g PO}_4\text{-P L}^{-1}$ ), the growth of AOB is slow but continues steadily until a big population of almost inactive cells has developed. This was found in the Oasen full-scale trickling filter with incomplete nitrification (de Vet et al., submitted 2011a).

As mentioned previously, not all phosphate in natural water will be biologically available (for nitrification) in the form of ionic orthophosphate. During filtration of iron-containing groundwater, most of the orthophosphate was removed in the filter with full nitrification, but even more was removed in the filter with incomplete nitrification (see Table 1). This further reduction may be related to the growth of the iron-oxidizing bacteria (IOB) of the *Gallionella* spp., which were found growing in the filter with incomplete nitrification, but to a much lesser extent in the filter with full nitrification (de Vet et al., submitted 2011b). The decreased orthophosphate concentrations may be caused by the biotic uptake of the IOB, but also related to the sorption capacity of the formed iron precipitates. Rentz et al. (2009) demonstrated a high phosphate sorption capacity for *Leptothrix*'s biogenic iron oxihydroxides.

#### 9.4.3. Implications for drinking water nitrification

Our findings have at least two important implications for drinking water nitrification. At low concentrations of MAP, the growth of AOB may be insufficient to maintain full nitrification in treatment systems, where the ammonium loading or filter operation is dynamic. This may, for instance, be the case with increasing ammonium concentrations in surface water during a cold period, due to reduced natural nitrification (van der Aa et al., 2002) and with the detachment of poorly attached biomass during filter backwashing. In biological filtration of anoxic groundwater containing iron and ammonium, phosphate concentrations are strongly reduced by chemical co-precipitation and adsorption in the iron oxyhydroxides and even further by biological iron oxidation. MAP may thus become so low that it virtually limits the nitrification totally. In the case of limiting MAP, the dosing of phosphoric acid after iron removal is completed may enhance nitrification. Such addition of phosphate to the water needs to be minimized in order to control the unwanted growth of microorganisms during the distribution of drinking water.

In this respect, the low affinity of AOB for phosphate offers opportunities as well, as it may be used to control nitrification when not wanted. The limitation of phosphate for control of heterotrophic growth is already being studied to prevent membrane biofouling (Vrouwenvelder et al., 2010) and biological growth in the distribution systems (Sathasivan and Ohgaki, 1999). Thus, the limitation of phosphate appears to be promising for the nitrification control in distribution systems. In this light, the common application of chloramination for disinfection and phosphate dosing for corrosion prevention should be reconsidered.



## 9.5. Conclusions

- The bioassay of Lehtola et al. (1999) was successfully adapted to assess microbially available phosphorus (MAP) for nitrification and growth of ammonia-oxidizing bacteria (AOB);
- The nitrification and AOB growth rate was reduced at MAP concentrations as high as 100  $\mu\text{g PO}_4\text{-P L}^{-1}$  and approached nil with MAP under 10  $\mu\text{g PO}_4\text{-P L}^{-1}$ .
- AOB showed a stronger inhibitory effect by low MAP concentrations than the heterotrophic *Pseudomonas* bacteria used by Lehtola et al. (1999).
- Inhibition of nitrification by limitation of MAP was found in drinking water filters treating anoxic groundwater; the inhibition could be removed in batch experiments with the addition of phosphoric acid.

## Acknowledgements

The authors gratefully acknowledge the contribution of Mathieu Lecouillard for his work with MAP measurements, Dennis Verwaal for his assistance with the full-scale filters research and Sabine Doddema and Inez Dinkla for application of the qPCR.

## References

- Andersson, A., Laurent, P., Kihn, A., Prévost, M. and Servais, P. (2001) Impact of temperature on nitrification in biological activated carbon (BAC) filters used for drinking water treatment. *Water Research* 35(12), 2923-2934.
- Boon, M., Ras, C. and Heijnen, J.J. (1999) The ferrous iron oxidation kinetics of *Thiobacillus ferrooxidans* in batch cultures. *Applied Microbiology and Biotechnology* 51(6), 813-819.
- de Vet, W.W.J.M., van Genuchten, C.C.A., van Loosdrecht, M.C.M. and van Dijk, J.C. (2010) Water quality and treatment of river bank filtrate. *Drink. Water Eng. Sci.* 3(1), 79-90.
- de Vet, W.W.J.M., Kleerebezem, R., van der Wielen, P.W.J.J., Rietveld, L.C. and van Loosdrecht M.C.M. (submitted 2011a) Assessment of nitrification in groundwater filters for drinking water production by qPCR and activity measurement.

de Vet W.W.J.M., Dinkla, I.J.T., Abbas, B.A., Rietveld L.C., van Loosdrecht M.C.M. (submitted 2011b) *Gallionella* spp. in trickling filtration of subsurface aerated and natural groundwater.

Hammes, F., Goldschmidt, F., Vital, M., Wang, Y. and Egli, T. (2010) Measurement and interpretation of microbial adenosine tri-phosphate (ATP) in aquatic environments. *Water Research* 44(13), 3915-3923.

Harder, W. and Dijkhuizen, L. (1983) Physiological responses to nutrient limitation. *Annual Review of Microbiology* 37, 1-23.

Hunik, J.H., Bos, C.G., Van den Hoogen, M.P., De Gooijer, C.D. and Tramper, J. (1994) Co-immobilized *Nitrosomonas europaea* and *Nitrobacter agilis* cells: Validation of a dynamic model for simultaneous substrate conversion and growth in  $\kappa$ -carrageenan gel beads. *Biotechnology and Bioengineering* 43(11), 1153-1163.

Kors, L.J., Moorman, J.H.N., Wind, A.P.M. and Van Der Hoek, J.P. (1998) Nitrification and low temperature in a raw water reservoir and rapid sand filters. *Water Science and Technology* 37(2), 169-176.

Lehtola, M.J., Miettinen, I.T., Vartiainen, T. and Martikainen, P.J. (1999) A new sensitive bioassay for determination of microbially available phosphorus in water. *Applied and Environmental Microbiology* 65(5), 2032-2034.

Ler, A. and Stanforth, R. (2003) Evidence for surface precipitation of phosphate on goethite. *Environmental Science and Technology* 37(12), 2694-2700.

Lijklema, L. (1980) Interaction of orthophosphate with iron(III) and aluminum hydroxides. *Environmental Science & Technology* 14(5), 537-541.

Magic-Knezev, A. and van der Kooij, D. (2004) Optimisation and significance of ATP analysis for measuring active biomass in granular activated carbon filters used in water treatment. *Water Research* 38(18), 3971-3979.

Makris, K.C., Harris, W.G., O'Connor, G.A. and Obreza, T.A. (2004) Phosphorus immobilization in micropores of drinking-water treatment residuals: Implications for long-term stability. *Environmental Science and Technology* 38(24), 6590-6596.

Miettinen, I.T., Vartiainen, T. and Martikainen, P.J. (1997) Phosphorus and bacterial growth in drinking water. *Applied and Environmental Microbiology* 63(8), 3242-3245.

Polanska, M., Huysman, K. and Van Keer, C. (2005) Investigation of microbially available phosphorus (MAP) in flemish drinking water. *Water Research* 39(11), 2267-2272.

Prosser, J.I. (1989) Autotrophic Nitrification in Bacteria. *Advances in microbial physiology* 30, 125-181.

Rentz, J.A., Turner, I.P. and Ullman, J.L. (2009) Removal of phosphorus from solution using biogenic iron oxides. *Water Research* 43(7), 2029-2035.

Robertson, B.K. and Alexander, M. (1992) Influence of calcium, iron, and pH on phosphate availability for microbial mineralization of organic chemicals. *Applied and Environmental Microbiology* 58(1), 38-41.

Sathasivan, A. and Ohgaki, S. (1999) Application of new bacterial regrowth potential method for water distribution system - A clear evidence of phosphorus limitation. *Water Research* 33(1), 137-144.

Scherrenberg, S.M., Menkveld, H.W.H., Bechger, M. and Van Der Graaf, J.H.J.M. (2009) Phosphorus and nitrogen profile measurements to locate phosphorus limitation in a fixed bed filter, pp. 2537-2544.

Scherrenberg, S.M., Van Nieuwenhuijzen, A.F., Menkveld, H.W.H., Den Elzen, J.J.M. and Van Der Graaf, J.H.J.M. (2008) Innovative phosphorus distribution method to achieve advanced chemical phosphorus removal, pp. 1727-1733.

Suzuki, I., Dular, U. and Kwok, S.C. (1974) Ammonia or Ammonium Ion as Substrate for Oxidation by *Nitrosomonas europaea* Cells and Extracts. *J. Bacteriol.* 120(1), 556-558.

Tappe, W., Laverman, A., Bohland, M., Braster, M., Rittershaus, S., Groeneweg, J. and Van Verseveld, H.W. (1999) Maintenance energy demand and starvation recovery dynamics of *Nitrosomonas europaea* and *Nitrobacter winogradskyi* cultivated in a retentostat with complete biomass retention. *Applied and Environmental Microbiology* 65(6), 2471-2477.

van der Aa, L.T.J., Kors, L.J., Wind, A.P.M., Hofman, J.A.M.H. and Rietveld, L.C. (2002) Nitrification in rapid sand filter: Phosphate limitation at low temperatures. *Water Science and Technology: Water Supply* 2(1), 37-46.

van der Wielen, P.W.J.J., Voost, S. and van der Kooij, D. (2009) Ammonia-oxidizing bacteria and archaea in groundwater treatment and drinking water distribution systems. *Appl. Environ. Microbiol.*, AEM.00387-00309.

Vrouwenvelder, J.S., Beyer, F., Dahmani, K., Hasan, N., Galjaard, G., Kruithof, J.C. and Van Loosdrecht, M.C.M. (2010) Phosphate limitation to control biofouling. *Water Research* 44(11), 3454-3466.

Yoshizaki, T. and Ozaki, M. (1993) On removal of ammonia nitrogen by addition of phosphoric acid in ozone-granulated active carbon treatment. *Water Supply* 11(3-4), 321-330.





# CHAPTER 10

---

## Concluding remarks

## 10.1. Introduction

The nitrification problem in groundwater trickling filters is a complex one. At the initial phase of this research project, nitrification in groundwater trickling filters was regarded as an exceptional biological activity in a world dominated by abiotic, chemical and physical removal processes. The only -well recognized- potentially competing microbial process of methane oxidation proved to be irrelevant for trickling filtration, because almost all methane is removed physically by stripping in these filters (see Chapter 2). As for manganese oxidation in drinking water filters, this process was generally perceived as chemical (Graveland and Heertjes, 1975), although clear indications of the relevance of the biological process existed (Vandenabeele et al., 1992). Nitrification problems were perceived in relation to inorganic precipitates. Small colonies of nitrifiers were constantly encapsulated by the precipitation products of the chemical iron (and manganese) oxidation. The hypotheses b and c in Chapter 1 reflect this physical-chemical approach: homogeneous or autocatalytic chemical iron oxidation, attachment and detachment of nitrifying microorganisms, diffusion limitation of substrates into the precipitates and nutrient limitation by adsorption on or precipitation in these precipitates.

Investigations into the development and activity of the microbial populations in the active and poorly active nitrifying groundwater filters have provided a different angle of the nitrification problem. They showed, that nitrifiers were not the only dominant group of active microorganisms in groundwater trickling filters. As core of this thesis, the major microbiological findings from Chapter 4 to 6 and 8 are first summarized and commented on in section 10.2. One of the most striking and unexpected observations was, that the -supposedly- strictly micro-aerophilic iron-oxidizing *Gallionella* bacteria thrived in groundwater trickling filters, despite the neutral pH and oxygen saturation of the water. As major discussion points with respect to chemical and biological iron oxidation, the kinetics of heterogeneous chemical iron oxidation and the prerequisites for the growth of *Gallionella* spp. are evaluated in section 10.3.

The question if and in what manner iron removal might hamper nitrification has been addressed in Chapter 7 to 9. Analysis of the (mainly iron oxyhydroxide) filter coatings revealed no difference in specific pore area between filters with full and with incomplete nitrification, but a huge difference in coating mass (Chapter 7). Some considerations and research questions about the formation of filter coating are further discussed in section 10.4.

The quantification and balancing of AOB in Chapter 8 showed no excessive detachment and washout of these bacteria from trickling filters with nitrification problems. The combination of these cell enumerations and activity measurements of the AOB in filter and backwash water samples, however, pointed towards bulk nutrient limitation rather than diffusion limitation (see also the discussion in that

chapter). The limiting essential nutrient in these groundwater filters was phosphate, as demonstrated in Chapter 9. The limitation could effectively be removed in lab tests by dosing of phosphate. Some constraints of phosphate limitation and addition and further implications are discussed in section 10.5. Finally, section 10.6 suggests some alternative techniques to influence the microbial population and to enhance specific activities, such as nitrification, in biological groundwater trickling filters.

Summarizing the outcome of this thesis, Figure 1 shows how a combination of biological and chemical factors caused the nitrification problem in Oasen groundwater trickling filters (B). This Figure also hypothesizes, how subsurface aeration enhanced the chemical autocatalytic iron oxidation, thus preventing the growth of iron-oxidizing bacteria (IOB) and the strong adsorption of phosphate on biogenic iron precipitates, resulting in full nitrification (A).



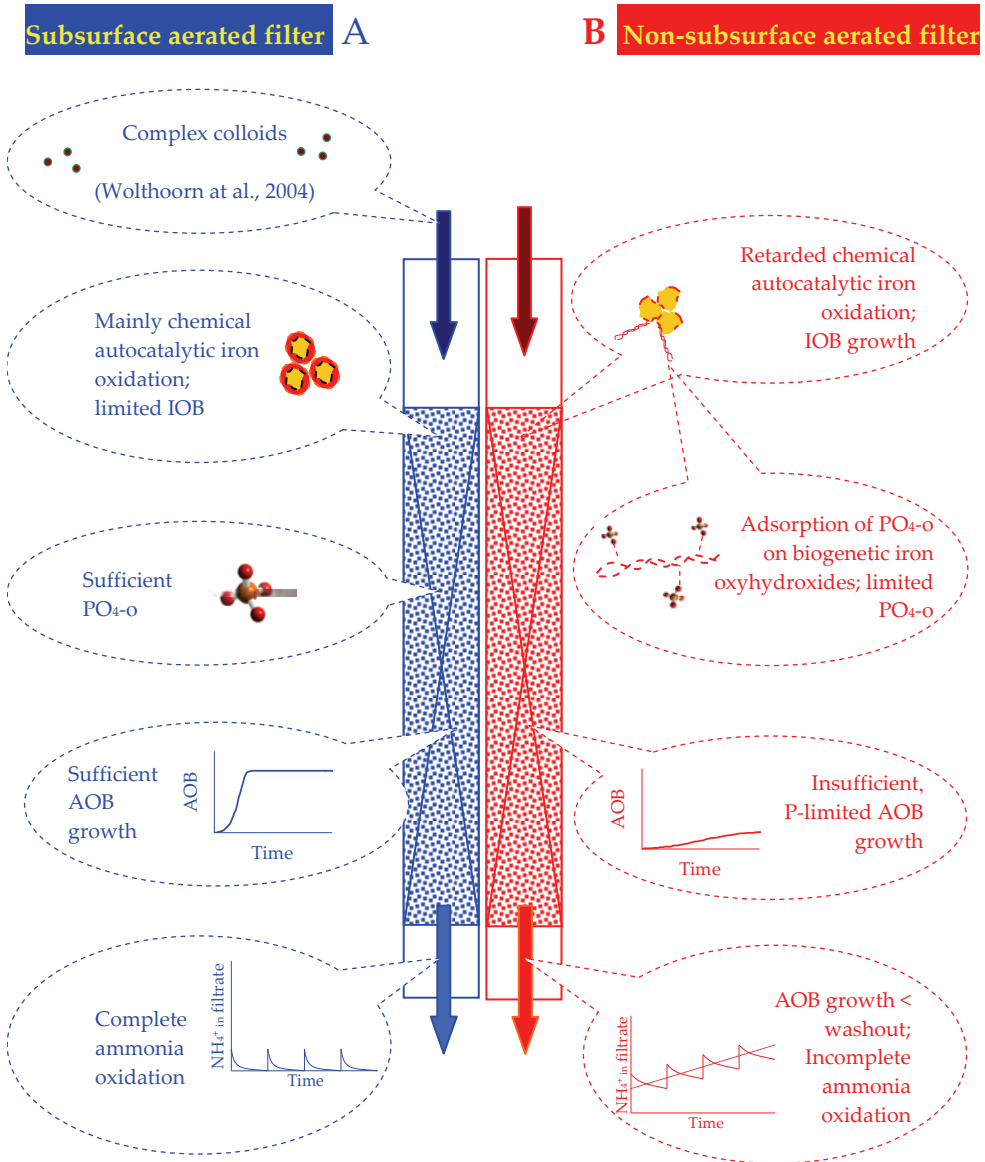

Figure 1: Mechanistic scheme of the building block of full ammonia oxidation in a subsurface aerated filter (left, A) and incomplete ammonia oxidation in a non-subsurface aerated filter (right, B)

## 10.2. Biological activity in groundwater trickling filters

Opposed to wastewater technology, microbial processes are often regarded as unwanted, uncontrollable and, above all, little relevant in drinking water production. For the removal of inorganics from anaerobic groundwater, the application of biological processes is still confined to specific water qualities or process conditions and even there, the relevance of microbiology is under dispute (Sharma et al., 2005). In the turmoil of chemical processes, especially the impressive accumulation of iron and manganese precipitates, the bacterial processes are not easily recognized in these filters. Application of molecular techniques has boosted the knowledge in this field. The sensitive molecular techniques, used in this thesis, have provided a good means to assess the complex microbial populations in the, so far, only fragmentally characterized systems of groundwater trickling filters. Quantitative molecular techniques were successfully applied to evaluate the relevance of biological processes in the iron oxidation and nitrification of groundwater. qPCR for the quantification of (the DNA) of specific microorganisms provided a good tool to compare different systems and conditions and to evaluate changes in time.

Major new microbiological insights in this thesis are:

- Other bacterial species than generally accepted in textbooks (de Moel et al., 2006) Degrémont, 2007) are the dominant players in groundwater nitrification; ammonia-oxidizing archaea were also present in these filters, but not dominant in the investigated systems (Chapter 4).
- The importance of *Gallionella* spp. was demonstrated under unexpected, namely NOT micro-aerophilic, conditions in well aerated trickling filters and lab-scale setups at neutral pH (Section 10.3.2; Chapter 4 to 6).
- Inoculation of ammonia-oxidizing bacteria (AOB) and *Gallionella* spp. from the subsurface aerated groundwater was marginal to their growth in the trickling filter; the nitrification problem was not caused by excessive detachment and washout of microorganisms either (Chapter 6 and 8).
- The more distinctive identification of *Gallionella* spp. in groundwater and trickling filters through clone libraries revealed different dominant subspecies in these systems and underlined the importance of selecting conditions in each niche and the insignificance of inoculation with maladjusted species (Chapter 6). A similar picture was found by DGGE for AOB (see Chapter 4): *Nitrosospira* spp. stimulated in the subsurface aerated well were outcompeted by *Nitrosomonas* spp. in the filter.
- The assessment of the cell specific activity by combination of cell numbers by qPCR and cell activity measurements of AOB provided clues about the

cause of the nitrification problems. No systematic difference in cell specific activity was found between biofilms on coated sand and planktonic (suspended) cells in backwash water, suggesting diffusion limitation was not decisive. The strongly reduced cell specific activity in all samples from full-scale filters with incomplete nitrification pointed towards a limitation for an essential nutrient (Chapter 8 and 9).

This thesis focused on (the interaction of) AOB and one genus of IOB, *Gallionella* spp., that were important in the investigated groundwater treatment systems. Other iron- and manganese-oxidizing species were present and may have been relevant as well. Indications for manganese-oxidizing bacteria (MOB) were found in older trickling filters, emphasizing the biological nature of manganese removal in these groundwater filters (Chapter 2 and 4) and not only during startup of the process (Burger et al., 2008). The end of the startup period of the manganese removal of three to six months in trickling filters coincided with the start of the nitrification problems and might also have had an impact. Sheaths of MOB were found more abundantly in backwash water from a non-subsurface aerated filter than from a subsurface aerated filter. Growth conditions for *Leptothrix* spp. and other (facultative) MOB, their interaction with the chemical autocatalytic oxidation process and their competition with other species in the complex groundwater filters is recommended for future research.

### 10.3. Chemical versus biological iron oxidation

#### 10.3.1. Kinetics of heterogeneous chemical iron oxidation in natural groundwater

At the startup of this research project, the general line of thought was that iron oxidation in trickling filters under neutral and well aerated conditions was predominantly chemical and that the kinetics of this chemistry was well established. During this research, however, some major objections have arisen concerning these points. Some aspects of the heterogeneous chemical iron-oxidation are discussed in Annex B. We found that the literature (Sung, 1980) described the kinetics of homogeneous iron oxidation adequately for our groundwater (see Chapter 5). However, low temperature has a big, reducing impact on the oxidation rate and homogeneous iron oxidation is marginal in trickling filtration of anaerobic groundwater, because of a residence time of only seconds between spraying and filtration.

The kinetics of autocatalytic iron oxidation from the literature (Tamura et al., 1976) did not describe our experimental results (see Chapter 5). The autocatalytic iron

oxidation was seriously retarded in natural water. The complex interactions of IOB and their biogenic iron precipitates with the autocatalytic iron oxidation are not fully understood yet. Knowledge of the essential role of iron in natural and engineered redox systems is expanding rapidly. Ferrous iron has been shown to chemically reduce not only oxygen but also nitrogenous compounds in water treatment, resulting in emissions of nitrous oxide greenhouse gas (Tai and Dempsey, 2009; Kampschreur et al., submitted). In combination with the general process of bacterial dissimilatory reduction of ferric iron, IOB have been shown to maintain rapid micro-scale iron redox cycling (Roden et al., 2004). Clearly, a broad field of research challenges lies ahead.

### 10.3.2. Are *Gallionella* spp. strictly micro-aerophilic?

Although the exact causes for the retarded autocatalytic iron oxidation in natural water are not clear, this thesis demonstrates at least one important consequence: IOB can grow under broader conditions than the previously thought low dissolved oxygen (DO) concentration and neutral to slightly acidic pH only. Hanert (2006) listed a broad array of the environments where *Gallionella* spp. have been found and concluded that the stability of ferrous iron in combination with oxygen is crucial for their existence, more than mere pH or Eh.

The observed retarded chemical oxidation in presence of natural organic matter gives extra possibilities for *Gallionella* spp. to grow. Growth of *Gallionella* spp. at neutral pH and considerable partial oxygen pressure has also been observed by other researchers (James and Ferris, 2004; Li et al., 2010). Growth of *Gallionella* is influenced by other criteria as well. Emerson and Revsbech (1994) found that *Leptothrix* spp. grew more dominantly at higher DO concentrations than *Gallionella* spp. near an iron seep in Denmark. This confirmed, in their opinion, the obligate micro-aerophilicity of *Gallionella* spp.. Their results may, however, be interpreted differently as well. Reduction in oxygen content in the depth of the mat may not have favored the growth of *Gallionella* over *Leptothrix* spp., but of secondary chemical oxidation products (Ibid., Figures 2 and 4), suggesting that another nutrient than oxygen limited the growth of both microorganisms. Next to phosphate, other limiting nutrients, whether or not in combination with natural inhibitors (Bédard and Knowles, 1989), may be at the origin of nitrification and other microbial growth problems as well.

The twisted stalks formed by *Gallionella* spp. may be crucial in the competition with chemical iron oxidation, but their function is still not totally understood. They are certainly not an essential part in the metabolism. Hallbeck and Pedersen (1995) studied the growth of *Gallionella* in gradient tubes and observed growth but no stalk formation under micro-aerobic conditions, at a pH lower than 6 and an

### Concluding remarks

oxidation-reduction potential lower than -40 mV, and only a strong stalk formation under aerobic conditions in the stationary growth phase. Based on these observations, they suggested that chemical iron oxidation inhibits IOB growth and stalk formation serves a protective role against radicals formed by chemical oxygen reduction. In recent research, Chan et al. (2011) showed that the stalks consist of nanoscale particles of ferric iron and polysaccharide complexes and they proposed that these organic complexes are essential in retarding the growth of inorganic minerals. The hindrance of the chemical iron oxidation by the presence of bacteria was also shown by Fakhri et al. (2008).

It is possible that excreted polysaccharides may bind to the existing or newly formed inorganic iron oxyhydroxides surfaces and retard the rate of chemical autocatalytic iron oxidation. In this way biological iron oxidation may outpace the autocatalytic process that is dominant after the startup of groundwater trickling filters. In the previous section, we already indicated complexation of groundwater compounds with the iron oxyhydroxides surfaces as retarding process for the autocatalytic iron oxidation. At this point it is still unclear whether the growth of *Gallionella* spp. is the cause or result of this retardation.

To finalize this section, the observed effects of subsurface aeration, both *in situ* and in the trickling filters, leave questions open for continued research. *Gallionella* spp. are able to grow in this intermittently operated system, with cycles of injection with aerated tap water during two days alternated with extraction of anoxic groundwater during forty days. The IOB might be growing on the interfaces of stagnant and permeable zones or might be able to store ferrous iron or oxidizing compounds. Further research questions are: What is the role, of the *Gallionella* spp., which are inoculated from the subsurface aerated well into the trickling filter? How does subsurface aeration effect the growth of *Gallionella* spp. in the trickling filters? Do the suspended, colloidal iron oxyhydroxides particles from the subsurface aerated well (Wolthoorn et al., 2004) inhibit the *Gallionella* spp. growth in the trickling filter and is this effect directly, or via enhancement of the autocatalytic chemical oxidation? For the experimental setup, batch and continuous kinetic and growth experiments are suggested with combinations of defined and natural media, in the presence and absence synthetic and biogenic oxyhydroxides, synthetic and natural iron colloids and IOB. Analytical methods should include IOB growth, iron oxidation degree and characterization of iron surfaces.

#### 10.4. Formation of filter coating as evidence for chemical autocatalytic iron oxidation?

Characterization of the filter coatings (see Chapter 7) revealed that the accumulation of inorganic precipitates in itself does not result in nitrification problems. The pore size distribution of the filter coating in filters with and without nitrification problems was comparable but filters with full nitrification contained substantially more coating mass than filters with incomplete nitrification. Despite this distinct result, many questions about formation and role of the iron coating in groundwater filters remain open for further research. The formation of coating depends on many factors. Whether the oxidized iron contributes to coating formation depends at minimum on the occurring oxidation process and history and operation (especially backwashing) of the filter. Iron oxyhydroxides formed on the coating surface by the autocatalytic chemical processes are likely to be an integral and probably irreversible part of the coating. The iron flocs from homogeneous oxidation are in principle well removable by an adequate backwashing with filter bed expansion. However, the ferric iron in the flocs in presence of ferrous iron from the groundwater may be transformed onto the coating (Pedersen et al., 2005), especially during the long contact times in poorly backwashed filters. In the microbial oxidation process, the primary biological precipitates are formed at the IOB cell walls (Chan et al., 2011) and may, at their formation, be more or less strongly bound to the filter coating. Subsequent removal during filter backwash or transformation onto the coating may occur. The extent of coating formation might indicate the distinction between biological and chemical catalytic iron oxidation in groundwater filters. The formation of filter coating and the growth of IOB were reversely related in groundwater trickling filters (Chapters 6 and 7): in the subsurface aerated trickling filter, a strong coating formation was combined with limited growth of IOB, but the non-subsurface aerated filter showed an opposite picture. The material in the examined filter was relatively old (Chapter 6: more than 9 years; Chapter 7: more than 7 years after renewal of the filter sand). In more recently refilled filters, examined 2.5 years after renewal of the filter sand in Chapter 3 no clear distinction in coating mass was found between the two types of filter. In the filtration column experiments (Chapter 8), most of the oxidized iron was incorporated into the coating, despite the dominantly biological oxidation process and the experimental period of only 6 months. Although our research can not give a decisive answer, IOB have to grow in competition with the autocatalytic chemical iron oxidation in trickling filters, and the distinction in coating formation may only occur in poorly backwashed filters after a period from the startup with new filter sand. In the same period, nitrification problems start to occur.

## Concluding remarks

Another aspect of filter coating is encountered during groundwater filter maintenance (see also Chapter 7). When the filter efficiency decreases -observed as irreversible clogging, short circuiting or reduced filter run times and removal efficiencies-, the filter material may be externally washed to remove accumulated deposits and biomass. External washing might restore almost complete nitrification just as the application of new filter material. The beneficial effect of external washing for nitrification often decreases in time (see Figure 2).

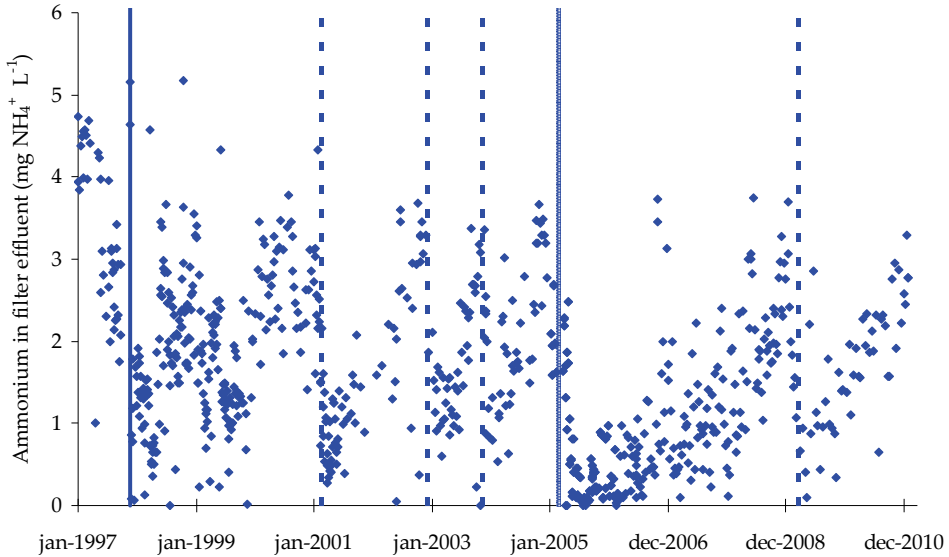

**Figure 2: Ammonium concentration in the effluent of a full-scale filter at Oasen WTP Lekkerkerk over the period of twelve years; solid lines indicate the application of new filter material, dotted lines external washing**

The working mechanism and relevant factors of external washing are not fully understood yet. This thesis suggest that external washing works specifically by removal of IOB and their biogenic iron precipitates rather than by removal of deposits in general. The better IOB are removed or inactivated during external washing, the longer nitrification stays complete afterwards. The accumulation and aging of filter deposits, their relation with biological and chemical removal efficiencies and the optimization of maintenance actions deserve further investigation.

### 10.5. Phosphate limitation in groundwater nitrification and other applications

Full-scale groundwater filters may encounter serious nitrification problems due to low microbially available phosphate (MAP) as was demonstrated by batch experiments with filtrate water from full-scale filters with incomplete nitrification (Chapter 9). Comparison of AOB and the heterotrophic *Pseudomonas* bacteria used by Lehtola et al. (1999) revealed that the former have a lower affinity for phosphate than the latter. The growth of *Gallionella* spp. (Chapter 5 and 6) and manganese-oxidizing bacteria (Chapter 2 and 4) in filters with incomplete nitrification and under limited phosphate availability suggest that those two groups of bacteria also have a higher affinity for phosphate than AOB. Further research under controlled conditions with pure and mixed cultures could confirm this hypothesis.

The addition of phosphoric acid to these phosphate limited filtrate waters reproducibly and effectively stimulated the nitrification in batch experiments (Chapter 9). The addition of phosphate was also tested on a full-scale filter with incomplete nitrification, but the results have not been published.  $36 \mu\text{g P L}^{-1}$  was dosed to the influent of the filter in the form of phosphoric acid during three months. Subsequently, the addition was stopped for almost five months. Figure 3 shows the ammonium concentration in the effluent of the filter, with a constant influent concentration between 2.5 and 3.0 mg  $\text{NH}_4\text{-N L}^{-1}$ . The short-term variability was caused by sampling at different times during the filter runtime of 12 days. The relapse caused by washout of AOB during backwashing is clearly visible by the peak levels of ammonium. Despite these fluctuations, a distinct decrease of ammonium in the filter effluent could be seen shortly after the start of the phosphate addition, indicating that the addition was successful for the enhancement of nitrification (The blue open symbols ( $\Delta$ ) indicate the ammonium levels at a filter run of 5 days after the filter backwash). The relapse of nitrification after the stop of the phosphate addition was slowly and gradually and became evident only four or five month after ending of the dosage. The phosphate addition could not be repeated due to planned filter maintenance, so future tests will have to be performed to reproduce the enhancing effect on the ammonia oxidation.



## Concluding remarks

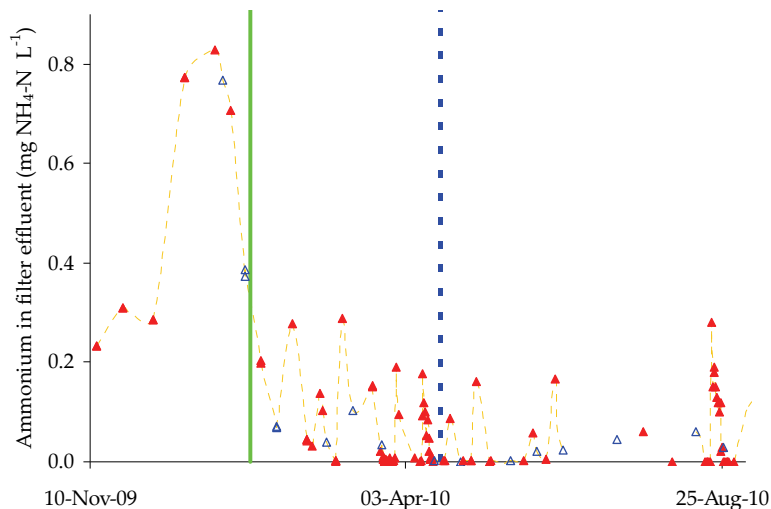

**Figure 3: Ammonium concentration in the effluent of a full-scale filter at Oasen WTP Lekkerkerk; start of phosphate addition (solid green line), stop of phosphate addition (dashed blue line); ▲ samples during filter run time, Δ samples taken 5 days after filter backwash**

The full-scale test suggests that a filtration system may react slowly to variations in water quality. The filter system with inorganic precipitates and biofilms will have been loaded with phosphate during addition and the adsorbed phosphate will have been released over a longer period with phosphate deficiency in the influent water. This preloading and long term release was also measured with microelectrodes by Lee (2009) in biofilms in distribution pipes. This observation bares importance for the approach in which limitation of phosphate is applied to control biological growth during drinking water distribution (Miettinen et al., 1997) and biofouling (Vrouwenvelder et al., 2010). Phosphate should be kept at a low level constantly and peaks should be avoided. The combined application of chloramination for secondary disinfection and phosphate dosing for corrosion prevention during drinking water distribution in the USA and other countries should be reconsidered (Zhang et al., 2009).

Iron oxyhydroxides are commonly used in wastewater treatment to reduce dissolved phosphate (Yeoman et al., 1988). The observed growth of *Gallionella* spp. and strongly reduced levels of MAP in the filters with nitrification problems indicate that biological iron oxidation may be able to reduce the levels of phosphate even further (Chapter 5 and 9). Promising in this respect is the application of the ferritin protein, that plays a key role in the iron metabolism in bacteria and animals alike and may store up to 4500 ferric iron ions per molecule (Harrison and Arosio, 1996). Jacobs et al. (2010) developed nanoscale ferric iron particles stabilized within thermostable ferritin, that had a high capacity and rapid kinetics for reversible adsorption of oxoanions such as phosphate (and arsenate).

## 10.6. Alternative methods for enhancing nitrification

This thesis has produced an increased understanding of the complex groundwater treatment systems called biological trickling filters (see Figure 1 of this Chapter). The final issue to be discussed here is, whether it has also delivered the sought alternatives for subsurface aeration to maintain durable nitrification in the trickling filters.

The solutions are curative or preventive. The first approach uses and stimulates all natural occurring biological processes in groundwater filters. As a part of this approach, the addition of phosphate is the most direct and effective solution to enhance the nitrification process. Still, its full-scale application has some drawbacks. The dosage of phosphate needs to be minimized, because of the possible consequences for biological growth in distribution systems. Intermittent phosphate dosage, that uses the preloading capacity of biofilms and precipitates in trickling filters for phosphate, might be an option for optimization. Biogenic iron oxyhydroxides may also be used in an extra filtration step to reduce excess phosphate left after the addition to stimulate the nitrification. At Oasen, phosphate addition was so far only applied to a second stage trickling filter, without iron in the filter influent. The dosage directly into the ferrous iron containing groundwater was not yet tested and will pose challenges, because the dosed phosphate will be removed alongside the biological iron removal. Separation of iron removal and nitrification process in consecutive filter steps followed by phosphate addition after the first de-ironing filter looks promising. Because of the high efficacy and rapid kinetics of the biological iron oxidation, high filtration rates may be applied in the first dedicated iron removal filter, resulting in a much more compact building.

The discovery of abundant growth of IOB (and MOB) in the filters with incomplete nitrification has opened another, preventive approach to maintain full nitrification: the enhancement of chemical autocatalytic iron (and manganese) oxidation and suppression of the growth of IOB (and MOB) in these filters. Possible interventions might be the dosage of oxygen, raise of pH, removal of NOM (by ultra filtration or IEX) or dosage of (complex) ferric iron colloids to the groundwater entering the trickling filter. Oxygen may be added in gaseous form or through a (5 to 10%) side stream with aerated water. Extra contact time between oxygenation and filtration will lead to pre-oxidation of iron. However, pre-oxidation alone does not guarantee the inhibition of IOB, as was shown in the filter column experiments in Chapter 5, and attention should be given to the formation of autocatalytic precipitates. Dosage of  $\text{FeCl}_3$  in the influent of a full-scale groundwater trickling filter had no clear effect on the nitrification. Dosed in dissolved form, ferric iron will have polymerized (flocked out) to aggregates that may not have been incorporated into the autocatalytic iron coating on the filter material. The effect

### Concluding remarks

might have been different for complex iron colloids as proposed by Wolthoorn et al. (2004). She found that the natural, *in situ* and predominantly biologically formed, colloids had relatively high P content (Fe: P on molar basis: 1: 0.42 to 0.43; *Ibid.*). The concentrations of colloids in the natural water were too low to supply sufficient phosphate for AOB, but the presence of P (and other elements) mobilized the colloids, so they could reach the trickling filters without further aggregation to perform their autocatalytic action as soon as the groundwater was oxygenated.

Oxygenation of the raw water by a side stream of aerated water was tested several times by recirculation of filtrate water (Figure 4) and worked often but not always. The positive effect on nitrification vanished immediately after ending the recirculation. The mechanisms by which recirculation stimulates nitrification - inoculation of AOB, enhancement of chemical iron (and manganese) removal or suppression of IOB- are still unknown and further research is needed.

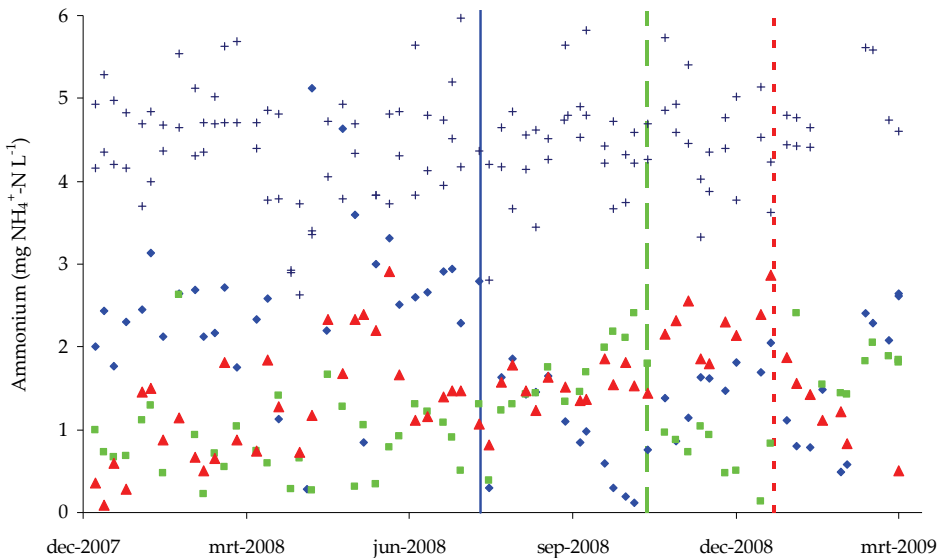

Figure 4: Effect of recirculation of second filtrate on the nitrification in first groundwater trickling filters at WTP Lekkerkerk; +: influent concentration; solid blue line: start recirculation of first filter 4, ◆ effluent first filter 4; long striped green line: start recirculation of first filter 6, ■ effluent first filter 6; dashed red line: start recirculation of first filter 4 and 7; ▲ effluent first filter 7;

Biological treatment of groundwater is a very effective and highly efficient technique in drinking water production, as long as the system is designed and monitored for the optimal growth conditions of the needed microbial populations.

## References

- Bédard, C. and Knowles, R. (1989) Physiology, biochemistry, and specific inhibitors of CH<sub>4</sub>, NH<sub>4</sub><sup>+</sup>, and CO oxidation by methanotrophs and nitrifiers. *Microbiological Reviews* 53(1), 68-84.
- Burger, M.S., Mercer, S.S., Shupe, G.D. and Gagnon, G.A. (2008) Manganese removal during bench-scale biofiltration. *Water Research* 42(19), 4733-4742.
- Chan, C.S., Fakra, S.C., Emerson, D., Fleming, E.J. and Edwards, K.J. (2011) Lithotrophic iron-oxidizing bacteria produce organic stalks to control mineral growth: implications for biosignature formation. *ISME Journal* In press.
- de Moel, P.J., Verberk, J.Q.J.C. and van Dijk, J.C. (eds) (2006) *Drinking water : principles and practice*, Singapore : World Scientific.
- Degrémont (ed) (2007) *Water Treatment Handbook*, Lavoisier SAS.
- Emerson, D. and Revsbech, N.P. (1994) Investigation of an iron-oxidizing microbial mat community located near Aarhus, Denmark: Field studies. *Applied and Environmental Microbiology* 60(11), 4022-4031.
- Fakih, M., Châtellier, X., Davranche, M. and Aline, D.I.A. (2008) *Bacillus subtilis* bacteria hinder the oxidation and hydrolysis of Fe<sup>2+</sup> Ions. *Environmental Science and Technology* 42(9), 3194-3200.
- Graveland, A. and Heertjes, P.M. (1975) Removal of manganese from ground water by heterogeneous autocatalytic oxidation. *Trans. Inst. Chem. Eng.* 53, 154-164.
- Hallbeck, L. and Pedersen, K. (1995) Benefits associated with the stalk of *Gallionella ferruginea*, evaluated by comparison of a stalk-forming and a non-stalk-forming strain and biofilm studies *in situ*. *Microbial Ecology* 30(3), 257-268.
- Hanert, H.H. (2006) *The Prokaryotes, A Handbook on the Biology of Bacteria*, pp. 990-995, Springer.
- Harrison, P.M. and Arosio, P. (1996) The ferritins: Molecular properties, iron storage function and cellular regulation. *Biochimica et Biophysica Acta - Bioenergetics* 1275(3), 161-203.
- Jacobs, J.F., Nahid Hasan, M., Paik, K.H., Hagen, W.R. and Van Loosdrecht, M.C.M. (2010) Development of a bionanotechnological phosphate removal system with thermostable ferritin. *Biotechnology and Bioengineering* 105(5), 918-923.
- James, R.E. and Ferris, F.G. (2004) Evidence for microbial-mediated iron oxidation at a neutrophilic groundwater spring. *Chemical Geology* 212(3-4 SPEC.ISS.), 301-311.
- Kampschreur, M.J., Kleerebezem, R., de Vet, W.W.J.M., van Loosdrecht, M.C.M. (submitted) Reduced iron induced nitric oxide and nitrous oxide emission from water treatment systems.
- Lee, W.H. (2009) Development and Use of Microelectrodes to Evaluate Nitrification within Chloraminated Drinking Water System Biofilms, and the

### *Concluding remarks*

Effects of Phosphate as a Corrosion Inhibitor on Nitrifying Biofilm. PhD thesis, University of Cincinnati, Cincinnati.

Lehtola, M.J., Miettinen, I.T., Vartiainen, T. and Martikainen, P.J. (1999) A new sensitive bioassay for determination of microbially available phosphorus in water. *Applied and Environmental Microbiology* 65(5), 2032-2034.

Li, D., Li, Z., Yu, J., Cao, N., Liu, R. and Yang, M. (2010) Characterization of Bacterial Community Structure in a Drinking Water Distribution System during an Occurrence of Red Water. *Appl. Environ. Microbiol.* 76(21), 7171-7180.

Miettinen, I.T., Vartiainen, T. and Martikainen, P.J. (1997) Phosphorus and bacterial growth in drinking water. *Applied and Environmental Microbiology* 63(8), 3242-3245.

Pedersen, H.D., Postma, D., Jakobsen, R. and Larsen, O. (2005) Fast transformation of iron oxyhydroxides by the catalytic action of aqueous Fe(II). *Geochimica et Cosmochimica Acta* 69(16), 3967-3977.

Roden, E.E., Sobolev, D., Glazer, B. and Luther III, G.W. (2004) Potential for microscale bacterial Fe redox cycling at the aerobic-anaerobic interface. *Geomicrobiology Journal* 21(6), 379-391.

Sharma, S.K., Petrusevski, B. and Schippers, J.C. (2005) Biological iron removal from groundwater: A review. *Journal of Water Supply: Research and Technology - AQUA* 54(4), 239-247.

Sung, W. (1980) Kinetics and product of ferrous iron oxygenation in aqueous systems. *Environmental Science and Technology* 14(5), 561-568.

Tai, Y.L. and Dempsey, B.A. (2009) Nitrite reduction with hydrous ferric oxide and Fe(II): Stoichiometry, rate, and mechanism. *Water Research* 43(2), 546-552.

Tamura, H., Goto, K. and Nagayama, M. (1976) Effect of ferric hydroxide on the oxygenation of ferrous ions in neutral solutions. *Corrosion Science* 16(4), 197-207.

Vandenabeele, J., de Beer, D., Germonpré, R. and Verstraete, W. (1992) Manganese oxidation by microbial consortia from sand filters. *Microbial Ecology* 24(1), 91-108.

Vrouwenvelder, J.S., Beyer, F., Dahmani, K., Hasan, N., Galjaard, G., Kruithof, J.C. and Van Loosdrecht, M.C.M. (2010) Phosphate limitation to control biofouling. *Water Research* 44(11), 3454-3466.

Wolthoorn, A., Temminghoff, E.J.M. and Van Riemsdijk, W.H. (2004) Colloid formation in groundwater by subsurface aeration: Characterisation of the geocolloids and their counterparts. *Applied Geochemistry* 19(9), 1391-1402.

Yeoman, S., Stephenson, T., Lester, J.N. and Perry, R. (1988) The removal of phosphorus during wastewater treatment: A review. *Environmental Pollution* 49(3), 183-233.

Zhang, Y., Love, N. and Edwards, M. (2009) Nitrification in drinking water systems. *Critical Reviews in Environmental Science and Technology* 39(3), 153-208.





---

# ANNEXES



## Annex A: Health risks and standards for inorganic groundwater compounds

The current standards and guidelines for iron and manganese in drinking water are based on esthetical, rather than health arguments. Taste and discoloration of laundry and sanitary equipment may occur at concentrations as low as 0.3 and 0.1 mg L<sup>-1</sup>, while the suggested lower limits for health effects are 2.0 and 0.5 mg L<sup>-1</sup> for iron and manganese respectively. For iron no health based guideline was established by the World Health organization (WHO, 2008), for manganese a health based guideline of 0.4 mg L<sup>-1</sup> is related to the suspicion of adverse neurological effects. The presence of ammonium in drinking water causes no direct health risks, as toxicological effects can only be observed at concentrations over 200 mg kg<sup>-1</sup> of body weight, and drinking water intake is a marginal source in this respect. Even organoleptic problems with respect to taste and odor only arise at concentrations above 35 mg L<sup>-1</sup> of ammonium and 1.5 mg L<sup>-1</sup> of ammonia, respectively, both being highly above concentrations found in drinking water. The WHO did not establish guidelines for ammonium. However, ammonium in drinking water may present an indirect risk from the formation of nitrite and nitrate by nitrification. Both compounds may cause health risks by methaemoglobinaemia (WHO, *Ibid.*). In this disorder, the oxygen transporting iron-containing hemoglobin is oxidized to methaemoglobin through reduction of nitrite, reducing the oxygen transport capacity of the blood to the tissues in the human body. Especially bottle-fed infants are sensitive for this (the so called blue-baby syndrome). Nitrite can also form carcinogenic N-nitroso compounds in the body. Nitrate is not a direct health risk, but may be reduced to nitrite in the human body. Although nitrite and nitrate are not present in anaerobic groundwater, the standards for these compounds are relevant for the treatment of ammonium containing (ground)water by nitrification, because they maximize the allowable ammonium content in the groundwater to 10 mg NH<sub>4</sub><sup>+</sup>-N L<sup>-1</sup> according to the USEPA standards and 11.3 mg NH<sub>4</sub><sup>+</sup>-N L<sup>-1</sup> according to the WHO and Dutch standards (see Table A.1). The Environmental Protection Agency of the United States (USEPA) applies a comparable motivation for the standard as the WHO. In the Dutch standards for drinking water (VROM (2001), iron, manganese and ammonium are classified as 'Indicative parameters', with an operational background for ammonium and an organoleptic/esthetic background for iron and manganese. In these standards, nitrite and nitrate are regulated as chemical parameters. The standards of Oasen Drinking Water Company are twice as strict as the Dutch standard for all inorganic compounds but nitrate. An overview of the standards and guidelines for iron, manganese, ammonium, nitrite and nitrate are given in Table 1.

**Table A.1: Standards and guidelines for drinking water**

Parameter	Unit	WHO guidelines*	USEPA**	Dutch standard***	Oasen guideline
Iron	mg L <sup>-1</sup>	- (see above)	0.3 #	0.20	0.10
Manganese	mg L <sup>-1</sup>	0.4	0.05 #	0.05	0.025
Ammonium	mg NH <sub>4</sub> <sup>+</sup> L <sup>-1</sup>	- (see above)	-	0.20	0.10
Nitrite	mg NO <sub>2</sub> <sup>-</sup> L <sup>-1</sup>	3 0.2 #	3.2 (1 mg NO <sub>2</sub> <sup>-</sup> -N L <sup>-1</sup> )	0.05	0.025
Nitrate	mg NO <sub>3</sub> <sup>-</sup> L <sup>-1</sup>	50	44 (10 mg NO <sub>3</sub> <sup>-</sup> -N L <sup>-1</sup> )	50	50

\* WHO (2008); # long-term exposure

\*\* USEPA (2009); # Secondary Drinking Water Regulations

\*\*\*VROM (2001)

## References

USEPA (2009) 2009 Edition of the Drinking Water Standards and Health Advisories, Office of Water U.S. Environmental Protection Agency Washington, DC.

VROM, D.M.o. (2001) Waterleidingbesluit. VROM, M.o. (ed), Staatsblad van het Koninkrijk der Nederlanden.

WHO, W.H.O. (2008) Guidelines for Drinking-water Quality, 3-rd edition, Geneva.

## Annex B: some kinetic aspects of heterogeneous chemical iron oxidation

Heterogeneous chemical iron oxidation comprises a homogeneous and autocatalytic process. The kinetics of the homogeneous iron oxidation in synthetic water has been established by different researchers (Stumm and Lee, 1961; Sung, 1980). The general kinetic equation for homogeneous iron oxidation is given by Equation B.1:



This kinetics for homogeneous iron oxidation was confirmed in our experiments in natural groundwater (Chapter 8) and by other researchers (Davison and Seed, 1983). Theis and Singer (1974) found a strong inhibiting effect, while Liang et al. (1993) found an enhancement of the homogeneous iron oxidation by (natural and pure) organic matter. We did not observe either of these effects in our experiments. The homogeneous oxidation rate was proportional to the square of the OH<sup>-</sup> concentration. One aspect, even though in line with existing knowledge, needs to be emphasized here. Temperature has a strong effect on the kinetics, see Figure B.1.

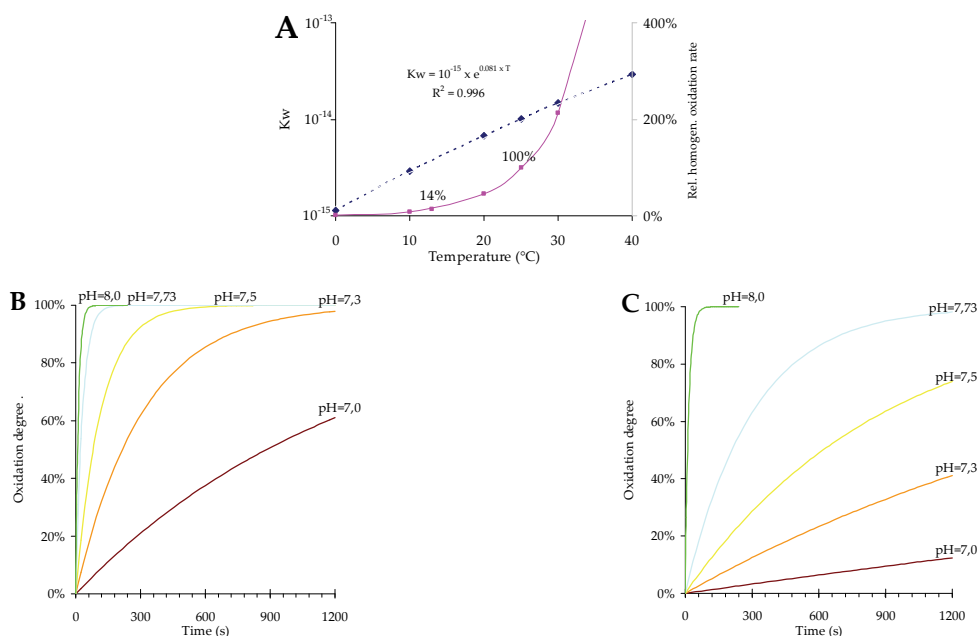

**Figure B.1:** Effect of pH and temperature on homogeneous iron oxidation; graph A: relation between temperature,  $K_w$  (Stumm and Morgan, 1996; Marshall and Franck, 1980); left Y-axis) and relative oxidation rate (right Y-axis); homogeneous oxidation degree of iron in time at 25 °C (graph B) and at 13 °C (graph C (with  $k = 4.0 \times 10^{13} \text{ M}^{-2} \text{ atm}^{-1} \text{ min}^{-1}$  at 25 °C, ionic strength = 0.009 M; (Sung, 1980)

Most kinetic experiments have been obtained under laboratory conditions (e.g. at 20 or 25 °C; graph B.1B; Sung, 1980). The thermodynamic effect of temperature on water dissociation and thus OH<sup>-</sup>-concentration and even more so on the rate constant for homogeneous iron oxidation is large due to an exponential relation between the dissociation constant of water ( $K_w$ ) and temperature (see Figure B.1A). As a result, the homogeneous iron oxidation at moderately low groundwater temperature in the Netherlands (13 °C; graph B.1C) is much slower than determined in the laboratory experiments. At higher temperatures homogeneous iron oxidation will proceed quicker and be relatively more important. The importance of temperature correction for iron speciation was previously emphasized by Lofts et al. (2008). With only seconds of oxidation time during spray aeration, homogeneous chemical iron oxidation is marginal in trickling filtration of anoxic groundwater at moderate and low temperature.

From this we conclude, that the iron oxidation in groundwater trickling filters is a chemically or microbially catalyzed process. During the first period after startup with new filter sand, autocatalytic iron oxidation will be the dominant mechanism, in the absence of a sufficiently large population of iron-oxidizing bacteria (IOB). After that, IOB may have grown sufficiently to overcome the autocatalytic chemical process. The relative importance of the chemical autocatalysis and the microbial catabolism can be assessed by molecular techniques (see Chapter 8). The kinetics of the autocatalytic iron oxidation process has been established by other researchers under laboratory conditions (Tamura et al., 1976). The oxidation rate was found to be inverse proportional to the H<sup>+</sup> concentration (so no effect of temperature depending water dissociation) and proportional to the concentrations of dissolved oxygen, ferric and ferrous iron. The general kinetic equation for autocatalytic chemical iron oxidation is given by Equation 2:

$$-dFe/dt = k_2 * [Fe^{3+}] * [Fe^{2+}] \quad \text{Equation 2 (Ibid.)}$$

Where

$$k_2 = k_{s,o} * [O_2] * K * [H^+]^{-1} \quad \text{Heterogeneous oxidation rate constant, Equation 2a}$$

$$k_{s,o} = 4380 \text{ M}^{-1} \text{ min}^{-1} \quad \text{Surface rate, Equation 2b}$$

$$K = 10^{-4.85} \quad \text{Adsorption constant of Fe}^{2+} \text{ on FeOOH, Equation 2c}$$

The kinetics of the autocatalytic iron oxidation is still under dispute even in these defined systems. The role of adsorbed ferrous iron in the autocatalytic oxidation is still uncertain. Sung (1980) proposed dissolved and adsorbed iron to be in equilibrium, making the adsorbed ferrous iron an intermediate in the adsorption

oxidation process. Park and Dempsey (2005) found that the adsorbed ferrous iron concentration was independent from the dissolved ferrous iron and suggested a model, where oxidation of ferrous iron and reduction of oxygen are separated in place, and the adsorbed ferrous iron only transfers electrons for oxygen reduction. In both cases the availability of active or adsorption spots at the iron oxyhydroxide surface is rate determining for the catalytic iron oxidation and may be reduced by surface complexation with other groundwater compounds, such as cations and organic matter. Our research in Chapter 8; indicated that autocatalytic iron oxidation was seriously retarded in natural water. The inhibiting effect of natural organic matter (NOM), such as humic acids, on autocatalytic iron oxidation has already been reported before by other researchers (Wolthoorn et al., 2004). Adsorption of this NOM is depending on their characteristics (Weng et al., 2006)) and presence of other complexing ions, such as calcium (Weng et al., 2005), in the groundwater.

## References

- Davison, W. and Seed, G. (1983) The kinetics of the oxidation of ferrous iron in synthetic and natural waters. *Geochimica et Cosmochimica Acta* 47(1), 67-79.
- Liang, L., Andrew McNabb, J., Paulk, J.M., Gu, B. and McCarthy, J.F. (1993) Kinetics of Fe(II) oxygenation at low partial pressure of oxygen in the presence of natural organic matter. *Environmental Science and Technology* 27(9), 1864-1870.
- Lofts, S., Tipping, E. and Hamilton-Taylor, J. (2008) The chemical speciation of Fe(III) in freshwaters. *Aquatic Geochemistry* 14(4), 337-358.
- Marshall, W.L. and Franck, E.U. (1980) EQUATION FOR THE ION PRODUCT OF WATER; 0-1000 degree C, 1-10,000 BARS. Infotech State of the Art Report, 506-512.
- Park, B. and Dempsey, B.A. (2005) Heterogeneous oxidation of Fe(II) on ferric oxide at neutral pH and a low partial pressure of  $O_2$ . *Environmental Science and Technology* 39(17), 6494-6500.
- Stumm, W. and Morgan, J.J. (1996) *Aquatic chemistry: chemical equilibria and rates in natural waters*, Wiley-Interscience, New York.
- Sung, W. (1980) Kinetics and product of ferrous iron oxygenation in aqueous systems. *Environmental Science and Technology* 14(5), 561-568.
- Tamura, H., Goto, K. and Nagayama, M. (1976) Effect of ferric hydroxide on the oxygenation of ferrous ions in neutral solutions. *Corrosion Science* 16(4), 197-207.
- Theis, T.L. and Singer, P.C. (1974) Complexation of iron(II) by organic matter and its effect on iron(II) oxygenation. *Environmental Science and Technology* 8(6), 569-573.

Weng, L., Van Riemsdijk, W.H., Koopal, L.K. and Hiemstra, T. (2006) Adsorption of humic substances on goethite: Comparison between humic acids and fulvic acids. *Environmental Science and Technology* 40(24), 7494-7500.

Weng, L.P., Koopal, L.K., Hiemstra, T., Meeussen, J.C.L. and Van Riemsdijk, W.H. (2005) Interactions of calcium and fulvic acid at the goethite-water interface. *Geochimica et Cosmochimica Acta* 69(2), 325-339.

Wolthoorn, A., Temminghoff, E.J.M., Weng, L. and Van Riemsdijk, W.H. (2004) Colloid formation in groundwater: Effect of phosphate, manganese, silicate and dissolved organic matter on the dynamic heterogeneous oxidation of ferrous iron. *Applied Geochemistry* 19(4), 611-622.

## Annex C: Microbial species in groundwater treatment

### C1: Phylogeny of iron-oxidizing bacteria

The existence of iron-oxidizing bacteria (FeOB) is long-known to mankind. *Gallionella ferruginea* was first described by Ehrenberg in 1836, *Leptothrix ochracea* by Kützing in 1843 and the filamentous *Crenothrix polyspora* by Cohn in 1870 (Cholodny (1926)). FeOB are found in a broad range of environments from acidic (such as *Thiobacillus ferroxidans* growing at pH 2 and below) to circumneutral. Most of them are micro-aerophilic, but anoxic growth on ferrous iron oxidation has been reported in bacteria using phototrophy or NO<sub>3</sub> reduction (Emerson and Floyd (2005) and references therein). A recent overview of the physiology, phylogeny, habitats and environmental relevance is given by Emerson et al. (2010). The ability to catabolize ferrous iron under acidic conditions is widespread under prokaryotes, but at circumneutral pH limited to members from the  $\beta$ -Proteobacteria such as *Gallionella*, *Leptothrix*, *Sideroxydans*, *Thiobacillus* and *Sphaerotilus* spp. while only some genera in the  $\gamma$ -Proteobacteria class are described, such as from the *Siderocapsaceae* family (Ibid.). Because of the important role of bacteria in the (natural) iron chemistry and the possibilities of the new molecular techniques, FeOB gain renewed interest. Recent publications on FeOB comprise freshwater seeps (Duckworth et al. (2009) and wetlands (Wang et al. (2009a) and a drinking water distribution system (Li et al. (2010)).

Only recently a novel species in a distinct phylogenetic lineage of iron-oxidizers in the class of Proteobacteria was enriched from a deep-sea environment, the  $\zeta$  (zeta)-Proteobacteria *Mariprofundus ferrooxydans* (Emerson et al. (2007) Despite its remote phylogenetic relation with the well-known *Gallionella* sp., it shows remarkable morphological resemblance with these bacteria, such as the formation of stalks. Chan et al. (2011)'s research into the growth and composition of these stalks provide new insights in the way these organisms may survive and even predominate in an environment with chemical iron oxidation. One of their main findings was the stabilization of biogenic formed ferric iron particles by complexation with polysaccharides.

### C2: Phylogeny of nitrifying microorganisms

Until 2005 nitrification was considered to be an exclusively bacterial process and was never found in the other domains of life. All known ammonia-oxidizing bacteria (AOB) belong to the  $\beta$  subdivision of the Proteobacteria, except for most of the *Nitrosococci* spp., belonging to the marine  $\gamma$ -proteobacterial lineage. The main AOB genera are *Nitrosomonas* spp. and *Nitrosospira* spp., the latter comprising the

subgenera *Nitrosovibrio* and *Nitrosolobus*. (Bothe et al. (2000). Nitrite-oxidizing bacteria (NOB) show a wider phylogenetic origin and are found in the  $\alpha$ ,  $\gamma$  and  $\delta$  subdivisions of the class of Proteobacteria. The main NOB genera in these subdivisions are *Nitrobacter* spp., *Nitrococcus* spp. and *Nitrospina* spp. respectively. The genus *Nitrospira* spp. belongs to a distinct phylum..

Archaea have been considered extremophiles until their discovery in moderate environments by molecular techniques in the early nineties of last century. Nonthermophilic archaea were first encountered in oxygenated coastal surface waters by DeLong (1992). Archaeal methanogenesis was found in marine systems (Munson et al. (1997) and later in non-saline grassland soil (Nicol et al. (2003).

In 2005, the first ammonia-oxidizing archaea was cultured in isolation from a marine aquarium by Könneke et al. (2005) and was named *Nitrosopumilus maritimus*. Ammonia-oxidizing archaea have since been reported in many marine, soil and wastewater systems and industrial processes (Leininger et al. (2006), Park et al. (2006); Caffrey et al. (2007); Mosier and Francis (2008); Wang et al. (2009b); Wells et al. (2009); Zhang et al. (2009); Dang et al. (2010); Yapsakli et al. (2011). Some AOA have a higher affinity for ammonium than AOB (Martens-Habbena et al. (2009), which gives them a competitive advantage under oligotrophic conditions. All selecting criteria for AOB or AOA are still not known, but pH, sulfide and phosphate (Erguder et al. (2009), zinc (Mertens et al. (2009), DOC (van der Wielen et al. (2009)) and nitrogen (Di et al. (2009) concentrations have been suggested as other possible factors. Overviews of the current knowledge on nitrifying bacteria and archaea is provided by Francis et al. (2007), Prosser and Nicol (2008) and You et al. (2009).

Regarding the literature on drinking water, textbooks generally limit AOB to *Nitrosomonas* spp. and NOB to *Nitrobacter* spp. (Symons et al. (2001), de Moel et al. (2006); Degrémont (2007); Mutschmann and Stimmelmayer (2007).

As for full-scale nitrifying trickling filters, microbial population composition has so far only been determined for wastewater treatment (Biesterfeld et al. (2001), Rowan et al. (2003), Biesterfeld et al. (2003), Lydmark et al. (2006); . Only few references so far address the community composition of both nitrifying bacteria and archaea in drinking water production systems. Qin et al. (2007) investigated a full-scale aerated submerged biofilm reactor as pretreatment of surface water for drinking water production. The relative abundance of AOB and AOA was studied in drinking water distribution systems van der Wielen et al. (2009) and granular activated carbon filters (Kasuga et al. (2010a); Kasuga et al. (2010b).



## References

- Biesterfeld, S., Figueroa, L., Hernandez, M. and Russell, P. (2001) Quantification of nitrifying bacterial populations in a full-scale nitrifying trickling filter using fluorescent *in situ* hybridization. *Water Environment Research* 73(3), 329-338.
- Biesterfeld, S., Russell, P. and Figueroa, L. (2003) Linking nitrifying biofilm structure and function through fluorescent *in situ* hybridization and evaluation of nitrification capacity. *Water Environment Research* 75(3), 205-215.
- Bothe, H., Jost, G., Schloter, M., Ward, B.B. and Witzel, K.P. (2000) Molecular analysis of ammonia oxidation and denitrification in natural environments. *FEMS Microbiology Reviews* 24(5), 673-690.
- Caffrey, J.M., Bano, N., Kalanetra, K. and Hollibaugh, J.T. (2007) Ammonia oxidation and ammonia-oxidizing bacteria and archaea from estuaries with differing histories of hypoxia. *ISME Journal* 1(7), 660-662.
- Chan, C.S., Fakra, S.C., Emerson, D., Fleming, E.J. and Edwards, K.J. (2011) Lithotrophic iron-oxidizing bacteria produce organic stalks to control mineral growth: implications for biosignature formation. *ISME Journal* In press.
- Cholodny, N. (1926) *Die Eisenbakterien : Beiträge zu einer Monographie*, Jena : Verlag von Gustav Fischer, Berlin-Dahlem.
- Dang, H., Luan, X.W., Chen, R., Zhang, X., Guo, L. and Klotz, M.G. (2010) Diversity, abundance and distribution of amoA-encoding archaea in deep-sea methane seep sediments of the Okhotsk Sea. *FEMS Microbiology Ecology* 72(3), 370-385.
- de Moel, P.J., Verberk, J.Q.J.C. and van Dijk, J.C. (eds) (2006) *Drinking water : principles and practice*, Singapore : World Scientific.
- Degrémont (ed) (2007) *Water Treatment Handbook*, Lavoisier SAS.
- DeLong, E.F. (1992) Archaea in coastal marine environments. *Proceedings of the National Academy of Sciences of the United States of America* 89(12), 5685-5689.
- Di, H.J., Cameron, K.C., Shen, J.P., Winefield, C.S., Ocallaghan, M., Bowatte, S. and He, J.Z. (2009) Nitrification driven by bacteria and not archaea in nitrogen-rich grassland soils. *Nature Geoscience* 2(9), 621-624.
- Duckworth, O.W., Holmström, S.J.M., Peña, J. and Sposito, G. (2009) Biogeochemistry of iron oxidation in a circumneutral freshwater habitat. *Chemical Geology* 260(3-4), 149-158.
- Emerson, D., Fleming, E.J. and McBeth, J.M. (2010) Iron-Oxidizing Bacteria: An Environmental and Genomic Perspective. *Annual Review of Microbiology* 64(1), 561-583.
- Emerson, D. and Floyd, M.M. (2005) Enrichment and isolation of iron-oxidizing bacteria at neutral pH. *Methods in Enzymology* 397, 112-123.

Emerson, D., Rentz, J.A., Lilburn, T.G., Davis, R.E., Aldrich, H., Chan, C. and Moyer, C.L. (2007) A Novel Lineage of Proteobacteria Involved in Formation of Marine Fe-Oxidizing Microbial Mat Communities. *PLoS ONE* 2(8), e667.

Erguder, T.H., Boon, N., Wittebolle, L., Marzorati, M. and Verstraete, W. (2009) Environmental factors shaping the ecological niches of ammonia-oxidizing archaea. *FEMS Microbiology Reviews* 33(5), 855-869.

Francis, C.A., Beman, J.M. and Kuypers, M.M.M. (2007) New processes and players in the nitrogen cycle: The microbial ecology of anaerobic and archaeal ammonia oxidation. *ISME Journal* 1(1), 19-27.

Kasuga, I., Nakagaki, H., Kurisu, F. and Furumai, H. (2010a) Abundance and diversity of ammonia-oxidizing archaea and bacteria on biological activated carbon in a pilot-scale drinking water treatment plant with different treatment processes. *Water Science and Technology* 61(12), 3070-3077.

Kasuga, I., Nakagaki, H., Kurisu, F. and Furumai, H. (2010b) Predominance of ammonia-oxidizing archaea on granular activated carbon used in a full-scale advanced drinking water treatment plant. *Water Research* 44(17), 5039-5049.

Könneke, M., Bernhard, A.E., De La Torre, J.R., Walker, C.B., Waterbury, J.B. and Stahl, D.A. (2005) Isolation of an autotrophic ammonia-oxidizing marine archaeon. *Nature* 437(7058), 543-546.

Leininger, S., Urich, T., Schloter, M., Schwark, L., Qi, J., Nicol, G.W., Prosser, J.I., Schuster, S.C. and Schleper, C. (2006) Archaea predominate among ammonia-oxidizing prokaryotes in soils. *Nature* 442(7104), 806-809.

Li, D., Li, Z., Yu, J., Cao, N., Liu, R. and Yang, M. (2010) Characterization of Bacterial Community Structure in a Drinking Water Distribution System during an Occurrence of Red Water. *Appl. Environ. Microbiol.* 76(21), 7171-7180.

Lydmark, P., Lind, M., Sörensson, F. and Hermansson, M. (2006) Vertical distribution of nitrifying populations in bacterial biofilms from a full-scale nitrifying trickling filter. *Environmental Microbiology* 8(11), 2036-2049.

Martens-Habbena, W., Berube, P.M., Urakawa, H., De La Torre, J.R. and Stahl, D.A. (2009) Ammonia oxidation kinetics determine niche separation of nitrifying Archaea and Bacteria. *Nature* 461(7266), 976-979.

Mertens, J., Broos, K., Wakelin, S.A., Kowalchuk, G.A., Springael, D. and Smolders, E. (2009) Bacteria, not archaea, restore nitrification in a zinc-contaminated soil. *ISME Journal* 3(8), 916-923.

Mosier, A.C. and Francis, C.A. (2008) Relative abundance and diversity of ammonia-oxidizing archaea and bacteria in the San Francisco Bay estuary. *Environmental Microbiology* 10(11), 3002-3016.

Munson, M.A., Nedwell, D.B. and Embley, T.M. (1997) Phylogenetic diversity of Archaea in sediment samples from a coastal salt marsh. *Applied and Environmental Microbiology* 63(12), 4729-4733.

Mutschmann, J. and Stimmelmayer, F. (2007) *Taschenbuch der Wasserversorgung*, Vieweg & Sohn Verlag.

Nicol, G.W., Glover, L.A. and Prosser, J.I. (2003) Molecular analysis of methanogenic archaeal communities in managed and natural upland pasture soils. *Global Change Biology* 9(10), 1451-1457.

Park, H.D., Wells, G.F., Bae, H., Griddle, C.S. and Francis, C.A. (2006) Occurrence of ammonia-oxidizing archaea in wastewater treatment plant bioreactors. *Applied and Environmental Microbiology* 72(8), 5643-5647.

Prosser, J.I. and Nicol, G.W. (2008) Relative contributions of archaea and bacteria to aerobic ammonia oxidation in the environment. *Environmental Microbiology* 10(11), 2931-2941.

Qin, Y.Y., Li, D.T. and Yang, H. (2007) Investigation of total bacterial and ammonia-oxidizing bacterial community composition in a full-scale aerated submerged biofilm reactor for drinking water pretreatment in China. *FEMS Microbiology Letters* 268(1), 126-134.

Rowan, A.K., Snape, J.R., Fearnside, D., Barer, M.R., Curtis, T.P. and Head, I.M. (2003) Composition and diversity of ammonia-oxidising bacterial communities in wastewater treatment reactors of different design treating identical wastewater. *FEMS Microbiology Ecology* 43(2), 195-206.

Symons, J.M., Bradley, L.C. and Cleveland, T.C. (2001) *Drinking Water Dictionary*. Symons, J.M. (ed), McGraw-Hill.

van der Wielen, P.W.J.J., Voost, S. and van der Kooij, D. (2009) Ammonia-oxidizing bacteria and archaea in groundwater treatment and drinking water distribution systems. *Appl. Environ. Microbiol.*, AEM.00387-00309.

Wang, J., Muyzer, G., Bodelier, P.L.E. and Laanbroek, H.J. (2009a) Diversity of iron oxidizers in wetland soils revealed by novel 16S rRNA primers targeting Gallionella-related bacteria. *ISME Journal* 3(6), 715-725.

Wang, Y., Ke, X., Wu, L. and Lu, Y. (2009b) Community composition of ammonia-oxidizing bacteria and archaea in rice field soil as affected by nitrogen fertilization. *Systematic and Applied Microbiology* 32(1), 27-36.

Wells, G.F., Park, H.D., Yeung, C.H., Eggleston, B., Francis, C.A. and Criddle, C.S. (2009) Ammonia-oxidizing communities in a highly aerated full-scale activated sludge bioreactor: Betaproteobacterial dynamics and low relative abundance of Crenarchaea. *Environmental Microbiology* 11(9), 2310-2328.

Yapsakli, K., Aliyazicioglu, C. and Mertoglu, B. (2011) Identification and quantitative evaluation of nitrogen-converting organisms in a full-scale leachate treatment plant. *Journal of Environmental Management* 92(3), 714-723.

You, J., Das, A., Dolan, E.M. and Hu, Z. (2009) Ammonia-oxidizing archaea involved in nitrogen removal. *Water Research* 43(7), 1801-1809.

Zhang, T., Jin, T., Yan, Q., Shao, M., Wells, G., Criddle, C. and Fang, H.H.P. (2009) Occurrence of ammonia-oxidizing Archaea in activated sludges of a laboratory scale reactor and two wastewater treatment plants. *Journal of Applied Microbiology* 107(3), 970-977.



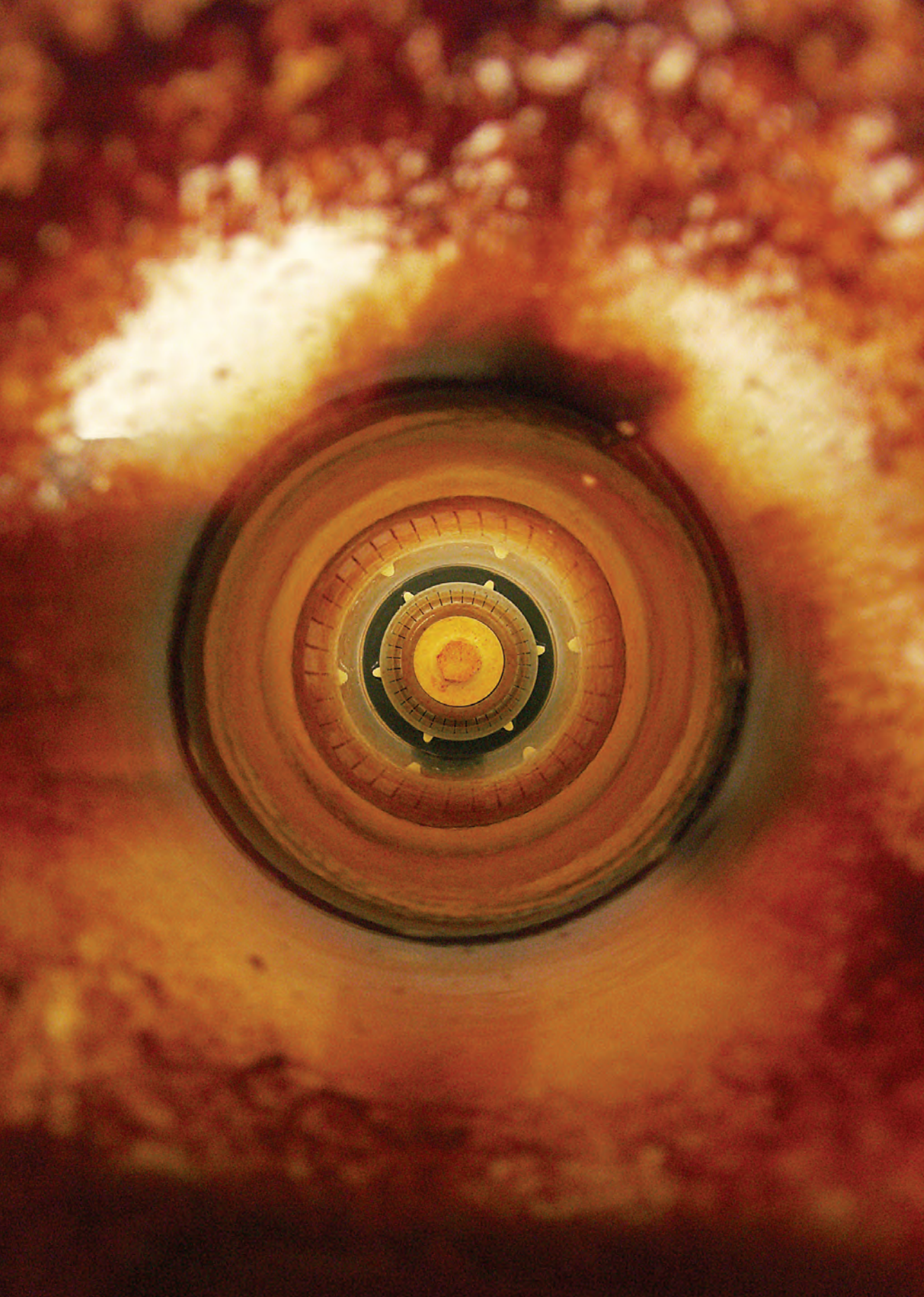

SUMMARY

---

SAMENVATTING



## Biological Drinking Water Treatment of Anaerobic Groundwater in Trickling Filters

Biological removal of inorganic compounds from anaerobic groundwater is commonly applied during drinking water production in Europe. Nitrification is an efficient, two step biological process for ammonium removal from groundwater. Distinct microorganisms first oxidize ammonia to nitrite; a second group of microorganisms further oxidize nitrite to nitrate. Sometimes the first step fails, like in the case of the Dutch drinking water company Oasen, but failure of nitrite oxidation has not been observed except for short periods during filter startup. Ammonia oxidation typically becomes almost complete after the startup of a filter with new filter material, but begins to relapse after half a year of production. The only way to restore and keep full nitrification is the application of subsurface aeration, a very limited form of *in situ* iron removal. Former research at Wageningen University (Wolthoorn, 2003) provided a strong relation between iron oxyhydroxide colloids, formed in the aquifer and a stable nitrification in the filter. A mechanistic explanation for such a correlation is, however, lacking (**Chapter 1**). This thesis focuses on a better understanding of the biological processes in the filter. This knowledge is combined with existing chemical knowledge in order to find such a mechanistic explanation for the nitrification failure. Based on this process knowledge, improvements can be suggested.

First of all, the backgrounds and processes of the drinking water production from groundwater by Oasen are presented and analyzed. **Chapter 2** describes how the groundwater quality in the Oasen area results from the mixture of riverbank infiltrate and percolating polder water by comparing the water quality in Oasen groundwater wells with geohydrological modeling. Oasen produces drinking water from groundwater recharged by infiltration from the river Rhine in polder areas in the west of the Netherlands. During soil passage, the groundwater changes in quality by reduction and oxidation processes and becomes deeply anaerobic. Reductive dissolution of soil minerals and mineralization of organic matter 'enrich' the groundwater with methane, iron, ammonium, manganese, calcium, alkalinity and phosphate. This chapter further analyses the full-scale filter performance of groundwater trickling filters for possible interferences in the removal processes of methane and manganese with nitrification. Methane is not likely to interfere with nitrification because it is stripped very efficiently in trickling filters. Considering the order of standard potentials, the oxidation of manganese should occur after nitrification and therefore not interfere with it. Observation of the full-scale filters, however, showed that incomplete nitrification occurred in combination with full manganese removal and that the manganese removal appeared to be mainly microbial, so competition with nitrification might

occur. For iron, the application of effective full-scale techniques strongly suggests that iron removal does certainly interfere. The typical relapse of nitrification in the Oasen trickling filters starting within half a year after startup is postulated to be related to the accumulation of products from the iron removal. **Chapter 3** compares the long standing ammonium removal capacities for filters enhanced by two full-scale methods - backwashing with filter bed expansion and pretreatment by subsurface aeration - with reference filters. The effective removal of accumulating iron deposits from the filter, by application of dual layer filters and backwash in expansion, reduced the sludge accumulation in the filter and slowed down the relapse in nitrification. Subsurface aeration durably enhanced nitrification in the trickling filters and increased the manganese content of the mainly iron oxyhydroxide coating on the filter material.

The remainder of the thesis focuses on the biological populations and processes in groundwater trickling filters. Full-scale filters, treating subsurface aerated groundwater and showing full nitrification filters, are systematically compared with others filters, treating non-subsurface aerated groundwater and displaying incomplete nitrification.

Chapters 4 to 6 and 8 concern the general identification of all microorganisms and the more detailed identification and quantification of relevant groups by molecular techniques. **Chapter 4** characterizes the microbial populations in both subsurface aerated and non-subsurface aerated groundwater and trickling filters, using denaturing gradient gel electrophoresis (DGGE), with general bacterial and archaeal 16S rRNA PCR primers and specific primers for nitrifying bacteria (CTO primers) and *Nitrobacter* spp.. Sequences related to the iron-oxidizing *Gallionella* bacteria and to ammonia-oxidizing bacteria (AOB) of the *Nitrosovibrio* and *Nitrosospira* genera were detected in subsurface aerated groundwater only. Of the archaea, sequences related to the methanogenic *Methanosaeta* genus could be identified in both types of groundwater and filter samples, probably flushed in, but not active in the trickling filters. *Nitrosomonas* spp. were identified as the dominant AOB and *Nitrosospira* spp. as the dominant nitrite-oxidizing bacteria (NOB). Ammonia-oxidizing archaea (AOA) related to *Cenarchaeum symbiosum* and *Nitrosopumilus maritimus* grew in that filter as well. No AOB, AOA or NOB could be identified after DGGE separation in any of the non-subsurface aerated filter samples. No *Nitrobacter* spp. were found in any of the filter samples, contrary to its general mentioning as dominant species in textbooks. Sequences related to the facultative iron- and manganese-oxidizing *Leptothrix discophora* were found in both filters, but more dominant in the non-subsurface aerated filter.

From the identification, three groups were chosen as most relevant for further research: all AOB and AOA and the lithotrophic and supposedly strictly micro-



## Summary

aerophilic iron-oxidizing *Gallionella* bacteria. *Leptothrix* spp. were reluctantly left out in this stage because of a wide phylogenetic distribution (so the impossibility at the time to design adequate primers to cover them all) and the known mixotrophy of several species (so the possibility of their growth on other substrates than iron or manganese). In Chapters 5, 6 and 8, quantitative molecular techniques (qPCR) were applied to groundwater, filter, filtrate and backwash water samples to make balances for the growth of the three chosen groups of organisms.

The unexpected growth of the *Gallionella* spp. in competition with the chemical iron oxidation in oxygen saturated trickling filters under neutral conditions is the subject of **Chapter 5**. Its growth was assessed by qPCR targeting part of the 16S rRNA coding gene in full-scale groundwater trickling filters and in lab-scale setups with fully aerated complex natural water. The effect of pH (in the range 6.5 to 8.25) on the iron oxidation rate (by 1,10-phenanthroline method) and growth of *Gallionella* spp. (by qPCR) was determined in experiments in oxidation columns with 16 minutes of contact time. *Gallionella* spp. grew comparably well in all columns with pH up to 7.7 and only significantly less at pH 8.25. The rate of iron oxidation directly after startup depended strongly on pH and corresponded to the references on homogeneous iron oxidation, corrected for the low water temperature (13 °C). After the first week, iron-oxidizing bacteria and freshly formed iron oxyhydroxides accumulated in the oxidation columns, but the increase in oxidation rate from this was much less than expected from the literature on chemical autocatalytic oxidation. The effect of 16 minutes of pre-oxidation on the growth of *Gallionella* spp. in trickling filters was assessed in similar experiments on oxidation in filtration columns. *Gallionella* spp. grew in filter columns with or without pre-oxidation alike. *Gallionella* growth was confirmed in full-scale trickling filters and was not even inhibited after plate aeration. Yield based calculations in the lab- and full-scale filters indicate that the iron oxidation was mainly biological. From the *Gallionella* spp. cell numbers, determined by qPCR, balances were made for subsurface and non-subsurface aerated groundwater and filter systems (**Chapter 6**). In addition, the variation of *Gallionella* spp. in groundwater and filters was assessed through the construction and sequencing of clone libraries. *Gallionella* spp. grew abundantly in the subsurface aerated well and yield based calculations suggest that biological iron oxidation played a major role in the *in situ* iron removal system. The *Gallionella* spp. inoculated from the subsurface aerated well hardly continued to grow in the filter treating that water. In the normal non-subsurface aerated groundwater trickling filter with incomplete nitrification, *Gallionella* spp. grew excessively. Identification of *Gallionella* spp. revealed that the species growing in the non-subsurface aerated filter were phylogenetically distinct from the species found growing in the soil during subsurface aeration.

The last three chapters evaluate the possible mechanisms that determine the efficiency of nitrification in groundwater trickling filters. In **Chapter 7**, the coating of both types of filters are compared by mass and (surface extractable) iron content, specific surface area (by mercury intrusion) and sand-specific nitrification rate. For filters with a comparable history and iron loading, the sand-specific nitrification rate and the mass of iron in the filter coating was significantly higher in subsurface aerated filters than in non-subsurface aerated filters. The specific pore area per mass of coating did, however, not differ between both filter types.

**Chapter 8** focuses on AOB and AOA. In all filter and backwash samples, their cell numbers were determined by qPCR targeting the functional *amoA* gene and their activity was measured in batch experiments. The *amoA* gene codes for the  $\alpha$ -subunit of the ammonia monooxygenase enzyme (which catalyses the first step of ammonia oxidation). The growth of AOB was stimulated in the subsurface aerated well and continuous inoculation onto the filter occurred, but the inoculated cell numbers were negligible compared to the growth in the filters. AOA growth was also stimulated in the subsurface aerated well, but these microorganisms played a minor quantitative role in both filter systems compared to AOB. The nitrification problem was not caused by an excessive washout of AOB during production or backwash of the filter. The subsurface aerated filter had a relatively small population of AOB with a high cell specific nitrification rate. In the non-subsurface aerated filter with incomplete nitrification, more AOB grew, but they were less active. The main difference between an active and a poorly nitrifying filter was the activity of the individual cells. No systematic differences in this respect were found between filter and backwash water samples, indicating that filter clogging or diffusion limitation was not decisive, but absolute (bulk) limitation of an essential nutrient was at stake.

**Chapter 9** elaborates on the limitation of the essential nutrient phosphorus. This chapter presents a lab method to assess the microbially available phosphorus (MAP) for AOB, based on the bioassay method of Lehtola et al. (1999). AOB have a lower affinity for phosphate and their growth is stronger limited by low concentrations than in case of the heterotrophic bacteria used by Lehtola et al. (Ibid.). The MAP, assessed by this method, is almost nil in some filtrates from Oasen full-scale groundwater filters. Phosphate addition to these types of water effectively removed limitation for nitrification in lab experiments. Phosphate in the groundwater (co)precipitated with the iron oxyhydroxides in the Oasen groundwater filters. The competition for phosphate by *Gallionella* spp. and precipitation of phosphate with biogenic iron oxyhydroxides are hypothesized as determining factor in the phosphate limitation for AOB.

## Summary

Summarizing, this thesis provides a coherent description of the essential elements of the nitrification problem in the Oasen groundwater filters (see Figure 1 in **Chapter 10**). The incomplete nitrification in the investigated Oasen groundwater trickling filters was caused by lack of available phosphate, resulting in too limited growth to maintain full nitrification. The limiting phosphate in the groundwater filters resulted from chemical (co)precipitation with iron oxyhydroxides and was worsened by the growth of iron-oxidizing bacteria and the efficient adsorption of phosphate on the biogenic iron oxyhydroxides. Subsurface aeration is hypothesized to enhance the chemical iron oxidation by the catalytic action of *in situ* formed colloids (Wolthoorn, 2003), preventing the growth of iron-oxidizing bacteria and formation of biogenic iron oxyhydroxide precipitates. The chemically formed iron oxyhydroxide precipitates have a lower adsorption capacity for phosphate and leave sufficient phosphate available for AOB.

To resolve the nitrification problem without the application of subsurface aeration, two solutions are suggested. The phosphate limitation for AOB can be removed directly by dosage of phosphate to the filter. Alternatively, sufficient phosphate can be brought about by the suppression of the growth of iron-oxidizing bacteria through the stimulation of the chemical autocatalytic iron oxidation.

## References

Lehtola, M.J., Miettinen, I.T., Vartiainen, T. and Martikainen, P.J. (1999) A new sensitive bioassay for determination of microbially available phosphorus in water. *Applied and Environmental Microbiology* 65(5), 2032-2034.

Wolthoorn, A. (2003) Subsurface aeration of anaerobic groundwater. Iron colloid formation and the nitrification process. PhD-thesis, Wageningen University.

## Biologische zuivering van anaeroob grondwater tot drinkwater in droogfilters

Hoewel de mogelijkheden voor het gebruik van andere bronnen de laatste decennia zijn toegenomen, wordt drinkwater wereldwijd nog steeds vooral uit grondwater bereid. In Europa wordt vaak biologische filtratie gebruikt om de ongewenste anorganische componenten uit het grondwater te verwijderen. Nitrificatie is een efficiënt getrappt biologisch proces om ammonium uit grondwater te verwijderen. De eerste trap, de omzetting van ammonium in nitriet, levert soms problemen op, zoals het geval is bij het Nederlandse drinkwaterbedrijf Oasen. De tweede trap, de omzetting van nitriet in nitraat, verloopt normaal gesproken probleemloos. De ammoniumverwijdering komt meestal goed op gang direct na vervanging van het filtermateriaal, maar begint binnen een half jaar terug te vallen. De enige manier waarop Oasen een duurzame nitrificatie in stand weet te houden, is door toepassing van ondergronds beluchten, een gematigde vorm van ondergronds ontijzeren. De techniek van ondergronds beluchten kent enkele bezwaren. De werking ervan is onbekend, waardoor ze moeilijk te optimaliseren is. Daarnaast bestaat het risico op ophoping van natuurlijk aanwezige zware metalen in de bodem rondom de ondergronds beluchte put. Eerder onderzoek aan de Wageningen Universiteit (Wolthoorn, 2003) toonde een sterke relatie aan tussen in het watervoerende pakket gevormde ijzercolloïden en een stabiele nitrificatie. Een mechanistische verklaring voor deze relatie ontbreekt echter nog. Dit proefschrift richt zich op een beter begrip van de biologische processen in de grondwaterfilters. Hiermee kunnen alternatieve oplossingen voor een stabiele nitrificatie gevonden worden.

Oasen wint grondwater in het poldergebied van Zuid-Holland. De kwaliteit van dit grondwater wordt bepaald door de menging van enerzijds infiltrerend rivierwater uit de Lek en anderzijds percolerend veenpolderwater. De mengverhouding van beide watersoorten bepaalt in belangrijke mate de kwaliteit in de winput. Hoe dichterbij de rivier, hoe groter het aandeel rivierwater. Tijdens de bodempassage verandert de grondwaterkwaliteit door interactie met bodembestanddelen en wordt diep anaeroob. Door oplossing van bodemmineralen en mineralisatie van organische stoffen, die vooral uit het veen spoelen, wordt het grondwater 'verrijkt' met methaan, ijzer, ammonium, mangaan, calcium, bicarbonaat en fosfaat. Deze stoffen moeten geheel of gedeeltelijk uit het grondwater verwijderd worden tijdens de zuivering tot drinkwater in droogfilters. Een belangrijk uitgangspunt van dit proefschrift is, dat de nitrificatie gestoord kan worden door de gelijktijdige verwijdering van de andere grondwatercomponenten. Voor methaan is dit niet waarschijnlijk, omdat het zeer goed uitgeblazen wordt

tijdens droogfiltratie. De verwijdering door oxidatie van mangaan lijkt de nitrificatie niet te storen omdat deze - uit oogpunt van de volgorde van de standaardpotentialen - pas plaatsvindt na de nitrificatie. De praktijk van Oasen leert echter, dat nagenoeg volledige ontmanging voorkomt in de droogfilters terwijl de nitrificatie verre van compleet is. Moleculair en microscopisch onderzoek hebben aangetoond, dat de ontmanging voor een belangrijk deel ook biologisch van aard is, waardoor competitie met nitrificerende bacteriën niet uitgesloten is. Dat de ijzerverwijdering de nitrificatie zeker stoort, volgt uit de effectieve toepassing van productietechnieken die de ontijzering beïnvloeden. De terugval van de nitrificatie een half jaar na de vervanging van het filtermateriaal valt samen met de ophoping van ijzerafzettingen. De toepassing van ondergronds beluchten zorgt voor een veranderde samenstelling van deze ijzerafzettingen, met ondermeer een hoger mangaangehalte. Door toepassing van dubbellaags filterbedden en terugspoeling met expansie hoopt minder (ijzer)slib op in het filterbed en blijft de nitrificatie langer op hoog niveau vergeleken met grof zand filterbedden, die zonder expansie gespoeld worden.

De systematische vergelijking van productiefilters die normaal grondwater zuiveren met filters, die ondergronds belucht grondwater behandelen levert veel nieuwe inzichten op over de werking van de biologische zuivering en vormt een hoeksteen van dit proefschrift. Dit onderzoek werd voor een belangrijk deel uitgevoerd op het Oasen zuiveringsstation (ZS) Lekkerkerk.

Eveneens zeer belangrijk in dit proefschrift zijn de moleculaire (DNA)technieken waarmee de microbiële populaties in grondwater en filters zijn gekarakteriseerd en specifieke groepen gekwantificeerd. Voor de eerste identificatie is *denaturing gradient gel electrophoresis* (DGGE) gebruikt, met algemene 16S rRNA primers voor zowel bacteriën als archaea en specifieke primers voor nitrificerende bacteriën (zgn. CTO primers) en voor *Nitrobacter* spp.. In het ondergronds beluchte grondwater werden DNA-sequenties gevonden die verwant waren met het DNA-profiel van ijzeroxiderende *Gallionella* bacteriën en van ammoniakoxiderende bacteriën (AOB) uit de geslachten *Nitrosovibrio* and *Nitrospira*. Methaanvormende archaea van het geslacht *Methanosaeta* werden aangetroffen in beide typen grondwater en filters. Zij werden waarschijnlijk met het grondwater opgepompt en waren niet actief in de droogfilters. In het ondergronds beluchte filter waren *Nitrosomonas* spp. de dominante AOB en *Nitrospira* spp. de dominante nitrietoxiderende bacteriën (NOB). Ammoniakoxiderende archaea (AOA), verwant met *Cenarchaeum symbiosum* en *Nitrosopumilus maritimus*, groeiden ook in dit filter. Geen enkele AOB, AOA of NOB konden aangetoond worden na DGGE in de monsters uit het niet-ondergronds beluchte filter. *Nitrobacter* spp. werden in geen enkel filtermonster gevonden. De vermelding in tekstboeken dat *Nitrobacter* de dominante NOB in drinkwaterfilters is, is derhalve onjuist. Sequenties, verwant

met de facultatief ijzer- en mangaanoxiderende *Leptothrix discophora* bacteriën werden in beide filters gevonden, maar het meest in het niet-ondergronds beluchte filter.

Drie van de meeste relevant geachte groepen micro-organismen zijn uitgekozen voor verder onderzoek met de kwantitatieve moleculaire techniek *Quantitative polymerase chain reaction* (qPCR): AOB, AOA en de lithotrofe, als strikt micro-aerofiel aangemerkte *Gallionella* bacteriën. De groep met *Leptothrix* spp. werd met tegenzin niet verder onderzocht, vanwege een brede fylogenetische oorsprong (en dus de onmogelijkheid om geschikte primers te ontwerpen) en de bekende mixotrofie van verschillende soorten (en dus de mogelijkheid om te groeien op andere (organische) substraten dan ijzer of mangaan). Voor *Gallionella* spp. werd een qPCR ontwikkeld met 16S rRNA primers gebaseerd op de *Gallionella* spp. uit het ondergronds beluchte grondwater. Tegen de verwachting in bleek *Gallionella* spp. te groeien in de productie-droogfilters en in de proefopstellingen op labschaal met zuurstofverzadigd, natuurlijk water (drinkwater van ZS Lekkerkerk). Het effect van de zuurgraad (van 6,5 tot 8,25) op de ijzeroxidatiesnelheid (gemeten met de 1,10-fenanthroline methode) en op de groei van *Gallionella* spp. (gemeten met qPCR) werd bepaald in opwaarts doorstroomde oxidatiekolommen met een vaste verblijftijd van 16 minuten. *Gallionella* spp. groeiden vergelijkbaar snel bij alle pH's tot 7,7 en alleen langzamer bij een pH van 8,25. De oxidatiesnelheid van ijzer aan het begin van het experiment was sterk pH-afhankelijk en kwam – na correctie voor de constante, lage grondwatertemperatuur van 13 °C - overeen met de literatuur. Na een week hoopten zich *Gallionella* spp. en gevormde ijzerprecipitaten op onderin de oxidatiekolommen, maar de toename in ijzeroxidatiesnelheid was veel geringer dan verwacht mocht worden op basis van de literatuur over chemische autokatalytische ijzeroxidatie.

Het effect van vooroxidatie op nageschakelde droogfiltratie werd in een vergelijkbare proefopstelling, maar nu met oxidatie- en filterkolommen, onderzocht. *Gallionella* spp. groeiden in vergelijkbare mate in de filterkolommen met of zonder vooroxidatie. De groei van *Gallionella* spp. werd bevestigd met behulp van qPCR en fasecontrast-microscopie in droge productiefilters op verschillende zuiveringstations van Oasen en werd zelfs niet onderdrukt in een droogfilter na een plaatbeluchter. Berekeningen gebaseerd op yield (celopbrengst per substraateenheid) maken aannemelijk, dat de ijzeroxidatie in de lab- en productiefilters voornamelijk biologisch was.

Op basis van de cel aantallen *Gallionella* spp. in alle in- en uitgaande waterstromen, bepaald met qPCR, zijn balansen gemaakt voor zowel het ondergronds beluchte grondwater en filter als voor het filtersysteem zonder ondergrondse beluchting. Daarbij werd de soortenvariatie in beide typen grondwater en filters nader bepaald door constructie en sequentie-identificatie van zgn. clone libraries. *Gallionella* spp.

groeiden overvloedig in de ondergronds beluchte put en op yield gebaseerde berekeningen suggereren dat biologische ijzeroxidatie een overheersende rol speelde in dit ondergrondse systeem. De *Gallionella* spp. uit de ondergronds beluchte put groeiden echter nauwelijks door in het droogfilter. In het andere droogfilter dat onvolledige nitrificatie toonde en gevoed werd met normaal, niet-ondergronds belucht grondwater, groeiden *Gallionella* spp. echter overvloedig. Uit de soortenkarakterisering bleek, dat in het niet-ondergronds beluchte filter andere soorten *Gallionella* spp. groeiden dan in het watervoerende pakket tijdens ondergronds beluchten.

Om de relatie tussen de ontijzering, de groei van *Gallionella* spp. en de nitrificatieproblemen beter te begrijpen, zijn fysische en biologische eigenschappen van de ijzercoating op de filtermaterialen uit het ondergronds beluchte en het niet-ondergronds beluchte filter onder de loep genomen. Zandmonsters uit een ondergronds beluchte filter vertoonden een aanzienlijk hogere zandspecifieke nitrificatiesnelheid en veel meer aangegroeide coatingmassa dan uit het niet-ondergronds beluchte filter. Het specifieke porieoppervlak (per massa-eenheid filtercoating), bepaald door kwikintrusiemetingen, verschilde echter niet voor beide typen filters.

Voor de kwantificering van AOB en AOA werd gebruik gemaakt van qPCR-methoden met functionele primers gericht op het *amoA* gen. Het *amoA* gen codeert voor de  $\alpha$ -subeenheid van het ammoniak-monooxygenase enzym (dat de eerste trap van de ammoniakoxidatie katalyseert). Gedurende 9 maanden werden zo de celantallen AOB en AOA in filterzand-, grondwater- en spoelwatermonsters bepaald. Parallel hieraan werd in de filterzand- en spoelwatermonsters de specifieke nitrificerende activiteit bepaald in potjesproeven. De groei van AOB werd gestimuleerd in de ondergronds beluchte put waardoor voortdurend AOB op het filter werden geïnculeerd, maar de aantallen AOB waren verwaarloosbaar vergeleken met de groei in het filter. AOA groeiden eveneens in de ondergronds beluchte winput. Kwantitatief speelden AOA in de onderzochte systemen echter een verwaarloosbare rol vergeleken met AOB. Het nitrificatieprobleem werd niet veroorzaakt door overmatige uitspoeling van AOB tijdens productie of terugspoelen van het filter. Het ondergronds beluchte filter huisvestte een relatief kleine populatie zeer actieve AOB. In het niet-ondergronds beluchte filter, daarentegen, groeiden meer AOB, maar zij waren veel minder actief. Het belangrijkste verschil, dat gevonden werd tussen een filter met volledige en een ander met onvolledige nitrificatie, was de (specifieke) activiteit van de individuele AOB cellen. Er werden geen structurele verschillen gevonden tussen filter- en spoelwatermonsters. Dit duidt erop, dat er bij nitrificatieproblemen geen sprake is van filterbedverstopping of diffusielimitatie, maar van een absolute limitatie van een essentieel nutriënt in de bulk van het te behandelen water.

Met behulp van potjesproeven gebaseerd op de biologische testmethode voor microbiëel beschikbaar fosfaat (microbially available phosphate, MAP) ontwikkeld door Lehtola et al. (1999) werd onderzocht of de essentiële voedingsstof fosfaat limiterend was voor de nitrificatie. Dit bleek inderdaad het geval. Uit standaardisatie-experimenten volgde, dat AOB een lagere affiniteit voor fosfaat hebben dan heterotrofe bacteriën. Hierdoor wordt de groei van AOB al gelimiteerd bij een MAP van  $50 \mu\text{g PO}_4\text{-P L}^{-1}$ . In het filtraat van slecht nitrificerende Oasen droogfilters werd vrijwel geen MAP aangetoond. Na toevoeging van fosfaat, in de vorm van fosforzuur, aan filtraatmonsters uit slecht nitrificerende filters trad ongelimiteerde exponentiële groei op in batchexperimenten. De belangrijkste vorm van fosfaat in grondwater, orthofosfaat, slaat tijdens de grondwaterzuivering grotendeels met ijzerprecipitaten neer. Daarnaast groeien in slecht nitrificerende filters *Gallionella* bacteriën, waarvan de biogene ijzerafzettingen een hogere adsorptiecapaciteit voor fosfaat hebben dan hun chemisch gevormde equivalenten. Hierdoor wordt het fosfaatgehalte verder verlaagd tot limiterende niveaus voor de groei van AOB.

Samenvattend levert dit proefschrift een coherente beschrijving van de essentiële elementen van het nitrificatieprobleem in de Oasen grondwaterfilters (zie figuur 1 van hoofdstuk 10). De onvolledige nitrificatie in de onderzochte filters werd veroorzaakt door een tekort aan beschikbaar fosfaat, met als gevolg onvoldoende activiteit en groei van de AOB populatie om, ondanks filterspoelingen, volledige nitrificatie in stand te houden. Het tekort aan fosfaat kwam voort uit de chemische coprecipitatie met ijzer tijdens de grondwaterontijzering, versterkt door de groei van ijzeroxiderende *Gallionella* bacteriën en de versterkte adsorptie van fosfaat op hun biogene ijzerafzettingen. Voor de stimulerende werking van ondergronds beluchten wordt de volgende stelling geponeerd: Ondergronds beluchten stimuleert door de werking van ondergronds gevormde colloïden (Wolthoorn, 2003) de chemische autokatalytische ijzeroxidatie, waardoor de groei van ijzeroxiderende bacteriën en de vorming van biogene ijzerprecipitaten wordt geremd. Chemisch gevormde ijzerafzettingen hebben een lagere adsorptiecapaciteit voor fosfaat, waardoor voldoende fosfaat beschikbaar blijft voor AOB.

Voor de oplossing van het nitrificatieprobleem zonder ondergronds beluchten worden twee oplossingen voorgesteld. De fosfaatlimitatie voor AOB kan rechtsreeks worden opgeheven door de dosering van fosfaat aan het filterinfluent. Voldoende beschikbaar fosfaat kan ook worden bewerkstelligd door de onderdrukking van de groei van ijzeroxiderende bacteriën via de stimulatie van de chemische, autokatalytische ijzeroxidatie.





# ACKNOWLEDGEMENTS

---

## DANKWOORD

## Acknowledgements

Toen ik een kleine vijf jaar geleden aan mijn promotieonderzoek begon, leek ik zeeën van tijd te hebben. Nu ik vlak voor de afronding van mijn proefschrift zit, komt ook voor deze oceaan van tijd en mogelijkheden de kustlijn in zicht. Het dankwoord vormt altijd de eigenlijke afronding van het schrijfwerk en biedt een goede gelegenheid om terug te kijken. Het is een boeiende, indrukwekkende reis geweest, zowel in overdrachtelijke als in fysieke zin. Er zijn de afgelopen jaren nieuwe werelden voor mij opengestaan op twee faculteiten van de TU Delft en zeker ook tijdens de steeds interessantere en leukere buitenlandse conferenties. Inhoudelijk ben ik ergens anders uitgekomen dan we aan het begin dachten, maar we zijn wel een stuk verder gekomen. Persoonlijk ben ik gegroeid, ik heb het onderste uit de kan gehaald. Ik heb ontdekt hoe leuk ik de begeleiding van (jonge) leergierige mensen vind. Mijn promotiewerk heeft perioden van ontdekkingen gekend, van bevlogen doorwerken, maar ook van onzekerheid en eenzaam tobben. Juist die fasen, waarin de onderzoeksresultaten maar nergens op leken te slaan, gingen vooraf aan een doorbraak in het denken. Voor mij zijn die ontdekkingen nog steeds het opzienbarende, zoals bij de vondst van ijzeroxiderende bacteriën in droogfilters, waar ze, volgens de bestaande theorieën, niet konden gedijen. De innerlijke strijd tussen de twijfel aan de eigen experimentele aanpak en het toelaten van nieuwe inzichten heeft mij fundamenteel begrip gegeven van de aard van (wetenschappelijk) onderzoek: de wetenschapper moet systematische en zorgvuldige waarneming laten prevaleren boven conventie.

Promoveren is monnikenwerk, *10% inspiratie en 90% transpiratie*, precies zoals de ooit beoogde begeleider Erwin Temminghoff mij ooit beloofde. Maar ondanks de vele uren werk in *'eenzame opsluiting'* had ik dit werk nooit kunnen volbrengen zonder de steun van velen, die ik hier graag wil noemen.

Allereerst wil ik mijn eerste promotor Mark van Loosdrecht bedanken om mij als promovendus in de gelegenheid te stellen en de ruimte te geven om onder zijn hoede, binnen zijn vakgebied en op zijn afdeling, Milieubiotechnologie, ruim vier jaar te mogen werken. Het was me een eer en (door de jaren in toenemende mate) een genoegen. Mark, je hebt mij werkelijk vrijwel de totale vrijheid gegeven om mijn weg te kiezen, maar mij wel gewezen op valkuilen en dwaalsporen. Achteraf gezien is het ook zeer nuttig gebleken, dat je mij het eerste jaar al aanzette tot het reviewen van andermans en schrijven van eigen peer reviewed artikelen. Jouw commentaren op teksten die er echt om doen (lees artikelen en hoofdstukken) waren fenomenaal. Ik bewonder je kracht en optimisme waarmee we tijdens jouw ziekte zo kraakhelder hebben kennisgemaakt. Biotechnologie en civiele gezondheidstechniek waren (en zijn) twee werelden, maar sinds we aan elkaar zijn gaan wennen, blijkt 1 en 1 toch maar weer meer dan 3 te zijn. Ik hoop in de toekomst zo af en toe op jouw afdeling en met jou verder te mogen werken.

Als tweede (maar zeker niet op de tweede plaats!) wil ik mijn tweede promotor Luuk Rietveld bedanken. Luuk, jij bent al bijna twee decennia geregeld mijn

leermeester en begeleider geweest. Voor de eerste keer tijdens mijn civiele studie op stage in Chili (*creatief met PVC*), na de afronding van mijn master, door mij voorzichtig, maar volhardend weer te betrekken bij (modellerings)onderzoek en nu de laatste jaren tijdens mijn proeve van wetenschappelijke bekwaamheid. Steeds positief, met die heerlijke vette lach en altijd in voor een geintje, pragmatisch, maar ook verrassend kritisch en opbouwend creatief bij je commentaar op mijn werk. Ik ben benieuwd in welke richting de civiele drinkwatertechniek zich ontwikkelt, nu jij een van de roergangers bent geworden. Ik zie in ieder geval uit naar toekomstige samenwerking met jou in ons grenzeloos boeiende vakgebied.

Als derde wil ik speciaal Arie Haasnoot bedanken. Momenteel hoofd Productie bij mijn drinkwaterbedrijf Oasen en al meer dan een decennium mijn leidinggevende. Arie, zonder jou was dit promotieonderzoek waarschijnlijk nooit van de grond gekomen. Je hebt me vanaf het begin gestimuleerd om mijn ambities waar te maken, maar ook altijd voor de benodigde ruimte (in tijd en geld), ondersteuning en erkenning binnen Oasen gezorgd.

Mijn waarde paranimfen Dirk van der Woerdt en Doris van Halem: jullie hebben ieder op je eigen manier een essentiële bijdrage aan mijn onderzoek geleverd en daarnaast mag ik jullie ook mijn vrienden noemen. Dirk, je hebt mijn onderzoekszin aangewakkerd en ontwikkeld in al die jaren dat jij, vóór dit promotieonderzoek, mijn toegepast onderzoek bij Oasen aan- en bijstuurde en organiseerde. In jouw project heb ik kennis gemaakt met promotieonderzoek bij de begeleiding van Anke Wolthoorn tijdens haar promotiewerk aan de WU. Onze werkrelaties is wat minder frequent geworden nu jij bij Waterbedrijf Groningen werkt, maar onze persoonlijke contacten zijn opgebloeid. Ik zie nu alweer erg uit naar onze klimvakantie komende zomer. Doris, onze onderzoeksonderwerpen zijn zo verwant en onze projecten lopen zo parallel, dat het logisch maar vooral ook zeer inspirerend is om veelvuldig met je samen te werken. Een samenwerking die, naast altijd inspirerende (en zelfs na uren, veel te korte) discussies, meerdere peer reviewed artikelen en conferentiepapers heeft opgeleverd. Ik wens jou heel veel succes en inspiratie bij de afronding van jouw eigen promotieonderzoek dit jaar.

Dan mijn directe collega onderzoekers (in opleiding of volleerd) bij Milieubiotechnologie. Marlies Kampschreur, Merle de Kreuk, Wouter van der Star, Leon van Paassen, Raymon Frediansyah, Mari Winkler en Shiva Salek. Wat was het zoeken in het begin. Al werkten we allen aan waterzuivering (en geotechniek) en spraken we dezelfde Nederlandse en Engelse taal, onze achtergrond, werkwijze en belangstelling leken soms onoverbrugbaar ver uit elkaar te liggen. Maar dankzij jullie warme belangstelling heb ik me steeds thuis gevoeld en door de jaren heen zijn we elkaars onderzoek steeds beter gaan begrijpen en waarderen. Als kamergenoten, soms wel met zijn zessen op een kamer, hebben we ook lief en leed gedeeld. Dank je! Bewust heb ik gekozen om mijn promotieonderzoek niet op mijn eigen afdeling, (civiel) Watermanagement, maar in de voor mij nieuwe wereld van

## *Acknowledgements*

de milieubiotechnologie te doen. Het zoeken en de vele opbouwende discussies in N- en Fe-cycle meetings en colloquia hebben me het nut van andere benaderingen geleerd. Marlies, wat was het geweldig om na veel zoeken een bijdrage te kunnen leveren aan jouw NO<sub>x</sub>-onderzoek. Onze gezamenlijk peer reviewed artikel vormt voor mij een kroon op onze samenwerking. Mari en Shiva, ik wens jullie veel succes met jullie eigen promotiewerk en ben er zeker van dat het geweldig resultaat gaat opleveren.

Woorden van dank en waardering ook voor de mensen die me door de jaren heen bij mijn onderzoek geholpen hebben. Petra (Looijestijn-)Lafeber, die nu thuis van haar twee schitterende kinderen geniet, voor haar jarenlange enthousiaste en betrouwbare bijdrage aan het kolommenonderzoek, meetopstellingen en analyses. I want to thank the great students that were involved in my research during their BSc or MSc education. I cannot but praise their dedication and eagerness to learn. Mark Hanemaaijer, ik vond het inspirerend om (helaas slechts) een paar maanden met je te werken. Jouw geslaagde werk met gradiënt tubes en DGGE is opgenomen in een peer reviewed artikel en een hoofdstuk van dit proefschrift. Daarbij was je altijd positief en open om nieuw werk op te nemen en anderen te helpen, zoals met de ijzermetingen, voor Chloé en later bij Oasen. Chloé Outin, you have been very enthusiastic in trying out experimental setups for new MPN and batch methods for manganese oxidizing bacteria. Faiza Khelifi, your exploratory work with batch experiments on trace element-limited nitrification planted the seed for later successful work on phosphorus limitation. Mathieu Lecouillard, your energetic constitution was great; we really achieved the unimaginable in only a few months time. The work we produced has resulted in a conference paper, a peer reviewed article and a chapter in this thesis. Bravo! Tot slot heb ik erg genoten van de inzet van Thijs, Vikash en Yvonne, die tijdens mijn promotieonderzoek naast mijn eigen project heb begeleid.

Inez Dinkla van Bioclear, we hebben de afgelopen jaren een mooie onderzoekssamenwerking opgebouwd. Je had vanaf het begin, nog voor wij wisten van ijzeroxiderende bacteriën, gelijk, dat de kern van nitrificatieprobleem ligt in competitie. Door de jaren heen heb je me gevoed en opgeleid in de microbiologische aanpak. Jij bent coauteur van twee peer reviewed artikelen (en hoofdstukken in dit proefschrift) en van nog meer conferentiebijdragen. Bedankt! Chris van Schaijk, oud-collega bij Oasen, bedankt voor jouw (ordenende) ondersteuning gedurende het grootse deel van mijn onderzoeksproject, bij de bouw van de kolommenopstelling en het op orde houden van de geldstromen, maar ook je betrokken gesprekken over voortgang en betekenis van mijn werk. De andere oud-collega en vriend Caspar van Genuchten voor interessante discussies en een mooi gezamenlijk peer reviewed artikel (en conferentiepaper). Nu je in Australië zit, mis ik je niet alleen op het persoonlijke vlak. Oasen collega Menno van Leenen, je bent met vallen en opstaan mijn onderzoekscollega aan het worden.

Ik hoop dat we samen nog meer mooie resultaten gaan bereiken en nog meer interessante conferenties mogen bezoeken. Ruud Kolpa, dank je voor je betrokkenheid bij de begeleidingsgroep gedurende de afgelopen jaren ondanks je drukke eigen werk.

Speciale dank ook voor enkele mensen, die mij persoonlijk gecoacht en geholpen hebben tijdens stressvolle fasen in het onderzoek. Paula Meesters, bedankt voor je relativerende gesprekken en voor de nuttige EFT techniek, die ik nog steeds (af en toe) gebruik. Margriet de Zeeuw, voor de gesprekken gedurende twee jaar, die mij meer inzicht in en grip op de grilligheden van mijn persoonlijkheid hebben verstrekt. Karin (Lekkerkerker-)Teunissen, je hebt me weer geleerd om rustig hard te lopen, iets wat ook voor andere onderdelen van mijn leven zijn waarde heeft bewezen. Mijn Afghaanse vriend, die me zo vaak heeft gesteund in de benodigde volharding.

Op beide faculteiten ben ik ook begeleid door andere docenten en collega onderzoekers, waar ik graag nog meer mee had samengewerkt. Wie weet wat er nog komt! Ik noem speciaal Robbert Kleerebezem, Gerard Muijzer en Ben Abbas bij Milieubiotechnologie, Hans van Dijk, Bas Heijman en Mario de Rooij bij Civiele Techniek en Paul van de Wielen bij KWR. Dank voor jullie betrokken kameraadschap, directe en sturende commentaren, inbreng van jullie grote expertise, jullie hulp bij opzet en evaluatie van onderzoek en het coauteurschap van enkele artikelen. Ger Koper van Delft Chemtech die mij geheel belangeloos en met veel geduld tijdens zijn onvolprezen pizza-courses de grondbeginselen van de oppervlakte- en colloïdchemie heeft bijgebracht.

A special thanks also for my colleague EBT researchers, with whom I had so often intensive personal and work related contacts. Florence Marty, thanks for your warm personal contacts and your help with biological and molecular techniques. Dana Vejmelkova, dear Dana, we had such warm contacts and it has been great to struggle with you on the never-ending quest for the understanding of the iron chemistry and biology. I hope to visit you in Prague soon. Dmitry Sorokin, you are one of my inspiring examples as a researcher and still you took ample time and interest in my work. Geert van der Kraan, dank je voor de altijd stimulerende inhoudelijke en wereldbeschouwelijke discussies. Yang Jiang, thanks for your interest and our discussions. We are going to defend our PhD work on the very same day and I hope we will have a great party together afterwards.

Thanks as well to the other colleagues at EBT, the 'inhabitants' of the van Itersonhal and the Kluver lab: Udo, Mario, Rob, Dirk, Marco, Guus, Mirjam, Carlos, Paula, Ann-Charlotte, Tommaso, Joao, Krisztina, Edris, Sander, Olga, Gijs, Jelmer, Emel, Hans, Katja, Margarita, Kees, Albertas, Bart, Chris, Andrea, Helena, Lesley, Cristian, Henk, Anouk, Simona and Janine. More than our microbes, *you* made it a living and caring place to work. Thanks for your companionship and help. Heel veel dank ook aan de ondersteunende staf, Sjaak, Jos, Robert, Rowdy, Ginie,

## *Acknowledgements*

Herman, Jenny, Astrid, Kristel, Arno (en zijn collega's van de werkplaats), Mo, Kees, Lies, Ank, Miranda (en haar collega's van het secretariaat), Hans Kemper (en zijn collega's van Servicepunt) en de analisten Max, Stef, Cor, Johan en Gert. Jullie hebben me geweldig en snel geholpen bij de meest uiteenlopende praktische zaken. Then to my other department, Watermanagement. Even though I haven't been too regular a visitor in the past years, it still feels like another home to me. I enjoyed the good talks, the nice treats and the discussions at colloquia (which we should cherish) and other occasions. Sommige mensen wil ik speciaal in het zonnetje zetten. Mieke Hubert, jij bent een geweldige secretaresse van de afdeling en een ware moeder. Dank je voor alle steun en regelwerk, zeker ook bij de afronding van mijn proefschrift en de voorbereiding van mijn promotie. Tonny Schuit en Patrick Andeweg, veel dank voor de hulp bij de kolommeninstallatie en analysemethoden en voor jullie nuchtere, zorgvuldige en praktische adviezen. Jasper Verberk voor je regelmatige praktische ondersteuning en geweldige BBQs. Other colleague researchers, Gert-Jan, Arne, Alex, Ignaz, Patrick, Sheng, Cheryl, Samuele, Petra, Anke, René, David, Remy, Maarten, Arie, Wilfred en Guido, for lively discussions and good suggestions.

Ik dank Arjan Thijssen van Microlab voor zijn vakkundige hulp bij de kwikintrusiemetingen en de mooie ESEM-opnamen en ook Rick van Beek voor zijn efficiënte Quickchem analyses. I want to thank Amer El-Kalliny for his help with ATP measurements.

Ik dank de directie, het MT maar zeker ook de collega's van Oasen voor de gelegenheid, de ruimte en ondersteuning die jullie mij gegeven hebben. Hoewel het bijna onbegonnen werk is, wil ik enkelen met name noemen. Rob van Klaveren voor je steun tijdens de opstartfase en Willem-Jan Knibbe tijdens de afronding van mijn promotiewerk. De operators van ZS Lekkerkerk, Peter, Dennis en Patrick voor je hulp en gezelligheid. De mannen van de onderhoudsploeg, Jaap, Frans, Henk en Jeffrey, voor jullie noeste arbeid en de ervaring die jullie gedeeld hebben over filterverstopping en extern reinigen. De andere directe collega's van mijn afdeling Onderzoek, Gert, Isabelle, Etta, Harrie, Karim, Falco, Maarten en Ed, voor het opvangen van mijn normale technologiewerk en je belangstelling en ondersteuning. Joost voor je vlotte en enthousiaste berichtgeving. Oud-collega Wilfred Burger voor onze jarenlange samenwerking in toegepast onderzoek, die gelukkig nu weer opbloeit. Ik dank de monsternemers, planners en laboranten van Vitens lab, Alie, Christel, Asmail, Peter, Jos, Chris, Maarten, Hennie, Gerard, Hugo, Jeroen en hun collega's voor hun prettige en flexibele ondersteuning van mijn onderzoek. Ik dank Tony Appelo, Erwin Temminghoff en Pieter Stuyfzand voor hun adviezen bij de definitie van mijn project. Bart Benschop voor geweldig mooie foto's en Esther Teunissen voor haar creatieve finishing touch aan mijn proefschrift.



Met zo'n lange lijst van dankbetuigingen vraag ik me af of iedereen gehad heb. Mocht ik iemand uit deze lange en intensieve periode vergeten zijn, dan verontschuldig me ervoor. Ik denk aan mijn grootvader Piet Kusters en aan mijn schoonvader Wolter Kats, die beide zo trots zouden zijn geweest. Ik denk aan mijn broer en vader. Luc, door onze geweldige sportieve jeugd, heb ik de energie gehad om tijdens deze slijtageslag door te zetten. Papa, je hebt me vaak gezegd dat jij rond mijn huidige leeftijd nog eens de diepte in had willen gaan. Wel, ik heb het nu gedaan en het is goed geweest!

Als laatste wil ik mijn bijzondere vrouw Sietske bedanken. Dank je voor je correctiewerk en hulp. Siet, je hebt het uitgehouden met me, we zijn er bijna. Na deze lange tijd, waarin ik vaak onbeschikbaar was, wens ik ons heerlijke tijden toe.

**Weren**



## Over Weren



Weren de Vet werd op 12 oktober 1962 in s' Hertogenbosch geboren en groeide op in het Brabantse dorp Helvoirt.

Na zijn middelbare school heeft hij een vijftal jaren gewerkt in de eerstelijns opvang van daklozen, verslaafden en psychiatrische patiënten bij Release in Utrecht. In die stad was hij medeoprichter en bestuurder van de daklozenopvang Sleep-Inn 't Snurkhuis.

In 1988 begon hij zijn Ir.-opleiding Civiele Techniek aan de Technische Universiteit Delft. Tijdens zijn studie werkte hij drie maanden aan de drinkwatervoorziening van San Juan de la Costa in zuid-Chili. In 1994 publiceerde hij een gedenkboek voor het 45-jarige jubileum van de Afdeling Geotechniek van het KIVI.

In 1997 behaalde hij zijn Ir.-diploma binnen de afdeling Watermanagement van de faculteit der Civiele Techniek aan de TU Delft. Tijdens zijn afstuderen, werkte hij anderhalf jaar in proefonderzoek voor het ontwerp van Waterproductiebedrijf Heel van de WML.

Sindsdien heeft Weren gewerkt als technoloog bij het drinkwaterbedrijf Oasen (voorheen WZHO) in Zuid-Holland. Daar ontwikkelde hij zich tot specialist in grondwaterbehandeling door beluchting en filtratie. Tussen 2002 en 2004 werkte hij bij de coöperatie Hydron in Nieuwegein, waarin hij zich specialiseerde in membraanfiltratie en maatoplossingen voor huishoud- en industriewater.

In dienst van Oasen begon hij in juni 2006 promotieonderzoek over biologische grondwaterfiltratie op de afdelingen Biotechnologie en Watermanagement van de TU Delft, waarvan dit proefschrift de afronding en het resultaat is.

## List of Publications

### *Journal papers*

**Vet, WWJM de**, Rietveld, LC & Loosdrecht, MCM van (2009). Influence of iron on nitrification in full-scale drinking water trickling filter. *Journal of Water Supply Research and Technology-Aqua*, 58(4), 247-256.

Rietveld, LC & **Vet, WWJM de** (2009). Dynamic modeling of bentazon removal by pseudomoving bed granular activated carbon filtration applied to full scale water treatment. *Journal of Environmental Engineering-Asce*, 243-249.

**Vet, WWJM de**, Dinkla, IJT, Muijzer, G, Rietveld, LC & Loosdrecht, MCM van (2009). Molecular characterization of microbial populations in groundwater sources and sand filters for drinking water production. *Water Research*, 43, 182-194.

Halem, D van, Olivero, S, **Vet, WWJM de**, Verberk, JQJC, Amy, GL & Dijk, JC van (2010). Subsurface iron and arsenic removal for shallow tube well drinking water supply in rural Bangladesh. *Water Research*, 44, 5761-5769.

**Vet, WWJM de**, Genuchten, CCA van, Loosdrecht, MCM van & Dijk, JC van (2010). Water quality and treatment of river bank filtrate. *Drinking Water Engineering and Science*, 3, 79-90.

Halem, D van, **Vet, WWJM de**, Verberk, JQJC, Amy, G & Dijk, JC van (2011). Characterization of accumulated precipitates during subsurface iron removal. *Applied Geochemistry* 26(1), 116-124.

**Vet, WWJM de**, Kleerebezem, R, Wielen, PWJJ van der, Rietveld, LC & Loosdrecht, MCM van (2011). Assessment of nitrification in groundwater filters for drinking water production by qPCR and activity measurement. Accepted for publication in *Water Research*.

### *Book Chapter*

Appelo, CAJ & **Vet, WWJM de** (2003). Modeling in situ iron removal from groundwater with trace elements such as As. In: Welch, AH, Stollenwerk, KG (Eds.), *Arsenic in Groundwater*, pp. 381-401, Kluwer Academic, Boston.

### *Conference papers*

Teunissen, K, **Vet, WWJM de**, Abrahamse, AJ, Leijssen, H, Rietveld, LC & Dijk, JC van (2007). Removal of both dissolved and particulate iron from groundwater. In s.n. (Ed.), *Particle Separation* (pp. 1-8). Toulouse: IWA.

**Vet, WWJM de**, Rietveld, LC & Loosdrecht, MCM van (2007). Influence of iron nitrification in drinking water filters. In M Meireles (Ed.), *Particle separation 2007 - From particle characterisation to separation processes* (pp. 1-8). Toulouse: IWA.

## *List of Publications*

**Vet, WWJM de**, Rietveld, LC, Heijman, SGJ, Rooij, MR de & Loosdrecht, MCM van (2008). Interaction of iron, manganese and ammonium removal in bio filters for drinking water production. In s.n. (Ed.), *AWWA Inorganic Contaminants Workshop* (pp. 1-13). Albuquerque: AWWA.

Halem, D van, **Vet, WWJM de** & Dijk, JC van (2008). Subsurface iron removal for drinking water production: understanding the process and exploiting beneficial side effects. In s.n. (Ed.), *AWWA Water Quality Technology* (pp. 1-11). Cincinnati: AWWA.

**Vet, WWJM de**, Rietveld, LC & Loosdrecht, MCM van (2008). Iron coatings in pilot dry groundwater biofilters. In s.n. (Ed.), *AWWA Water Quality Technology* (pp. 1-9). Cincinnati: AWWA.

Halem, D van, Laan, H van der, **Vet, WWJM de**, Amy, GL & Dijk, JC van (2009). Subsurface iron removal: modelling the process. In JQJC Verberk & P Ross (Eds.), *Young Water Professionals BeNeLux* (pp. 1-6). Eindhoven: IWA.

Mikkers, AJ, Heijman, SGJ & **Vet, WWJM de** (2009). Ammonium removal from anaerobic groundwater with zeolites. In JQJC Verberk & PS Ross (Eds.), *IWA Young Water Professionals BeNeLux 2009* (pp. 1-9). Eindhoven: IWA.

**Vet, WWJM de**, Genuchten, CCA, Loosdrecht, MCM van & Dijk, JC van (2009). Water quality and treatment of river bank filtrate. In AWC van der Helm & SGJ Heijman (Eds.), *Proceedings High Quality Drinking Water Conference 2009*, 9 & 10 June, Delft (pp. 1-20). Delft: TU Delft.

**Vet, WWJM de**, Rietveld, LC & Loosdrecht, MCM van (2009). Microbial population dynamics in groundwater. In s.n. (Ed.), *International Conference Biofilms 2009* (pp. 1-8). Davis, USA: IWA.

**Vet, WWJM de**, Leenen, MT van, Rietveld, LC & Loosdrecht, MCM van (2010). Iron removal in trickling filters. Biological or chemical? In s.n. (Ed.), *2010 Water Quality Technology Conference* (pp. 1-8). Savannah: AWWA.

**Vet, WWJM de**, Rietveld, LC & Loosdrecht, MCM van (2010). Phosphorus limitation in nitrifying groundwater filters. In s.n. (Ed.), *Water Quality Technology Conference and Exposition* (pp. 1-11). Savannah: AWWA.

## *Relevant talks*

**Vet, WWJM de** (2007, October 17). Sandfiltration, more than classical treatment. Leeuwarden, the Netherlands. Lecture + abstract Opening congress TTIW, Wetsus, Leeuwarden, the Netherlands, October 17, 2007.

**Vet, WWJM de**, Rietveld, LC, Heijman, SGJ, Rooij, MR de & Loosdrecht, MCM van (2008, January 29). Interaction of iron, manganese and ammonium removal in bio filters for drinking water production. Albuquerque, New Mexico, USA. Lecture AWWA Inorganic contaminants workshop, Hyatt Regency Albuquerque, NM, USA, January 27-29, 2008.

**Vet, WWJM de**, Rietveld, LC & Loosdrecht, MCM van (2008, November 18). Iron Coatings in Pilot Dry Groundwater Biofilters. Cincinnati, Ohio, USA. Lecture AWWA Water Quality Technology, Duke Energy Center, Cincinnati, OH, USA, November 16–20, 2008.

**Vet, W.W.J.M. de** (2008, November 18). Subsurface Iron Removal for Drinking Water Production: Understanding the Process and Exploiting Beneficial Side Effects. Cincinnati, Ohio, USA. Lecture AWWA Water Quality Technology, Duke Energy Center, Cincinnati, OH, USA, November 16–20, 2008.

**Vet, WWJM de** (2009, March 26). Nitrification in groundwater for drinking water production. Delft, the Netherlands. Lecture + abstract Seminar trends in Environmental Biotechnology, Nederlandse Biotechnologische Vereniging, Unesco-IHE, Delft, the Netherlands, March 26, 2009.

**Vet, WWJM de** (2009 June 10). Water quality and treatment of river bank filtrate. Delft, the Netherlands. Lecture TU Delft High Quality Drinking Water Conference 2009, Delft, the Netherlands, June 9-10, 2009.

**Vet, WWJM de** (2009, September 13). Microbial population dynamics in groundwater filters. UC Davis, California, USA. Lecture + abstract IWA Biofilm Conference, Processes in Biofilms: fundamentals to applications, Davis, CA, USA, September 13-16, 2009.

**Vet, WWJM de** (2010, June 1). Biological treatment for the removal of inorganic contaminants. Phoenix, Arizona, USA. Lecture Workshop on Biological Drinking Water Treatment at the 7<sup>th</sup> IWA Leading Edge Technology Conference, Arizona Biltmore, Phoenix AZ, USA, June 1-4, 2010.

**Vet, WWJM de** (2010, November 15). Iron removal in trickling filters, biological or chemical. Savannah, Georgia, USA. Lecture Water Quality Technology Conference, Savannah International Trade & Convention Center, Savannah, Georgia, November 14-18, 2010.

**Vet, WWJM de** (2010, November 17). Phosphorus limitation in nitrifying groundwater filters. Savannah, Georgia, USA. Lecture Water Quality Technology Conference, Savannah International Trade & Convention Center, Savannah, Georgia, November 14-18, 2010.

**Vet, WWJM de & Huysman, K** (2011, June 9). Biological iron oxidation: prerequisites and full-scale applications. Amsterdam, the Netherlands. Lecture 8<sup>th</sup> IWA Leading Edge Technology Conference on Water and Waste Water Technologies, Hotel Okura Amsterdam, the Netherlands.

### ***Other publications***

**Vet, WWJM de**, Burger, W, Wolthoorn, A & Woerd, D van der (2002). Methaanbelasting irrelevant voor filterverwerking. H<sub>2</sub>O: tijdschrift voor watervoorziening en waterbeheer, 34(1), 26-29.

*List of Publications*

Wolthoorn, A, **Vet, WWJM de**, Woerdt, D van der & Temminghoff, E (2005). Het wonder van Nieuw Lekkerland. H2O: tijdschrift voor watervoorziening en waterbeheer, 37(3), 37-40.

**Vet, WWJM de** & Burger, W (2006). Duurzame nitrificatie door dubbellaags droogfiltratie. H2O: tijdschrift voor watervoorziening en waterbeheer, 39(22), 39-42.

Abrahamse, AJ, **Vet, WWJM de**, Scholte, P & Heijman, SGJ (2007). Toepassing zeolieten voor verwijdering ammonium bij de drinkwaterzuivering. H2O: tijdschrift voor watervoorziening en waterbeheer, 18, 34-36.

**Legends for photos**

- p 0 Sunrise at the water tower of Krimpen a/d Lek, the Netherlands
- p 16 First step trickling filters at WTP Reijerwaard, Ridderkerk, the Netherlands
- p 40 Filter bottom and backwash water overflow of a first trickling at WTP Lekkerkerk,  
Krimpen a/d Lek, the Netherlands
- p 60 FISH-picture of chemostate culture inoculated with supernatant of sonified filter  
material from a first trickling filter at WTP Lekkerkerk
- p 88 Weren at the filter columns' setup at WTP Lekkerkerk (© Bart Benschop)
- p 118 Phase contrast picture (magnification 400x) of sludge from the spraying system of  
a first trickling filter at WTP Lekkerkerk after partial recirculation of 2<sup>nd</sup> filtrate
- p 138 Oven dried filter material before mercury intrusion measurement
- p 156 Spraying directly on top of a trickling filter at WTP Lekkerkerk (© Bart Benschop)
- p 184 ESEM-picture (magnification 4000x) of sludge from an oxidation column operated  
under oxygen saturation and at pH 7.7
- p 204 Water drops (Nikon F50, flashlight)
- p 236 Reflections of a filter nozzle in an emptied column of the filter columns' setup  
at WTP Lekkerkerk