

Memorandum M-578

DETERMINATION OF THE MATHEMATICAL MODEL
FOR THE NEW DUTCH GOVERNMENT CIVIL AVIATION
FLYING SCHOOL FLIGHT SIMULATOR

J.A. Mulder
J.H. Breeman
J.P.F. Verbraak

M. Baarspul
A.M.H. Nieuwpoort
P.S.J.M. Steeman

To be presented as Paper No. 15
at the 18th Sunnal Symposium
'Flight Testing, World Wide'
of the Society of Flight Test Engineers
Amsterdam, September 28 - October 2, 1987

DELFT - THE NETHERLANDS

July 1987

DETERMINATION OF THE MATHEMATICAL MODEL
FOR THE NEW DUTCH GOVERNMENT CIVIL AVIATION FLYING SCHOOL
FLIGHT SIMULATOR

J.A. Mulder*, M. Baarspul*,
J.H. Breeman**, A.M.H. Nieuwpoort**,
J.P.T. Verbraak+, P.S.J.M. Steeman+

Abstract

In the spring of 1986 the Dutch Government Civil Aviation Flying School (RLS) decided to purchase an FAA Phase II flight simulator for the Cessna Citation 500 business jet, used in the final part of civil aviation pilot training. The objective was to transfer part of the type-training from the aircraft to the simulator, enabling the RLS to reduce its fleet from six to three aircraft. For the Citation 500, which was developed in the late sixties, no adequate mathematical model and data package were available. Therefore, the National Aerospace Laboratory (NLR) and the Faculty of Aerospace Engineering of Delft University of Technology (DUT) were selected to execute a flight test program, identify mathematical models of aerodynamic forces and moments, engine performance characteristics, flight control system and landing gear and to evaluate the models with off-line and pilot-in-the-loop-real-time simulations. In the paper the emphasis is on the flight test program, the high accuracy flight test measurement system and the system identification techniques applied to synthesise the mathematical models.

1. Introduction

Most mathematical models for flight simulators to date are based mainly on windtunnel measurements of scaled down models of aircraft or aircraft parts, theoretical analysis and data from the engine manufacturer.

In the spring of 1986 the Dutch Government Civil Aviation Flying School (RLS) decided to purchase an FAA phase II flight simulator for the Cessna Citation 500 business jet, used in the final part of civil aviation pilot training, see Fig. 1. The objective was to transfer part of the type training from the aircraft to the simulator, enabling the RLS to reduce its fleet from six to three aircraft. For the Citation 500, which was developed in the late sixties, no adequate mathematical model was available. No aerodynamic data package existed or was accessible, while only very limited information was available from the engine manufacturer. The problem is not new, and applies to many existing aircraft types. A good option as recommended in Ref. 9 is to execute an experimental program with one of the available aircraft in order to form a database from which an adequate mathematical model could be developed. The National Aerospace Laboratory (NLR) and the Faculty of Aerospace Engineering of Delft University of Technology (DUT) were selected to perform this challenging task. One of the aircraft with registration PH-CTA was equipped with an

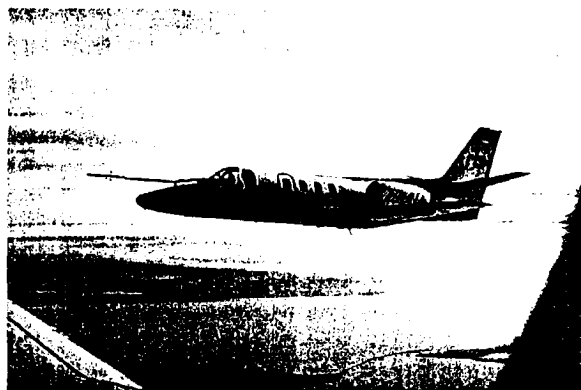

Fig. 1:
Cessna Citation 500 test aircraft equipped with nose boom.

advanced high accuracy flight test measurement system and a flight test program was carried out consisting of twenty three test flights and more than 52 flight test hours. A database was formed from which a mathematical model could be developed. Different types of system identification techniques were applied to develop models of the aerodynamic forces and moments, the static and dynamic engine performance, the flight control system and the landing gear.

In the present paper the high accuracy measurement system is discussed in Section 2. The flight test program is described in Section 3. Section 4 is a brief introduction to system identification and discusses the identification of the aerodynamic, engine, flight control system and landing gear model. Section 5 is used to present some results of the so-called Proof of Match (POM). Some concluding remarks are made in Section 6.

2. High accuracy measurement system

In all flight test programs supported or carried out by NLR and DUT there has been a heavy emphasis on the maximization of overall measurement accuracy within existing technical constraints. The present flight test program was no exception in this respect. The rationale behind this is that the extra costs of advanced measurement techniques will eventually pay-off in the form of high accuracy time histories and an easier and therefore more expedient data-analysis & model-building process. Earlier flight test programs in which measurement techniques of similar quality were used are reported in Ref.'s 6, 10, 13 and 14, see also Ref. 15.

* Delft University of Technology, Faculty of Aerospace Engineering, Delft (DUT)

** National Aerospace Laboratory, Amsterdam (NLR)

+ Government Civil Aviation Flying School, Eelde (RLS)

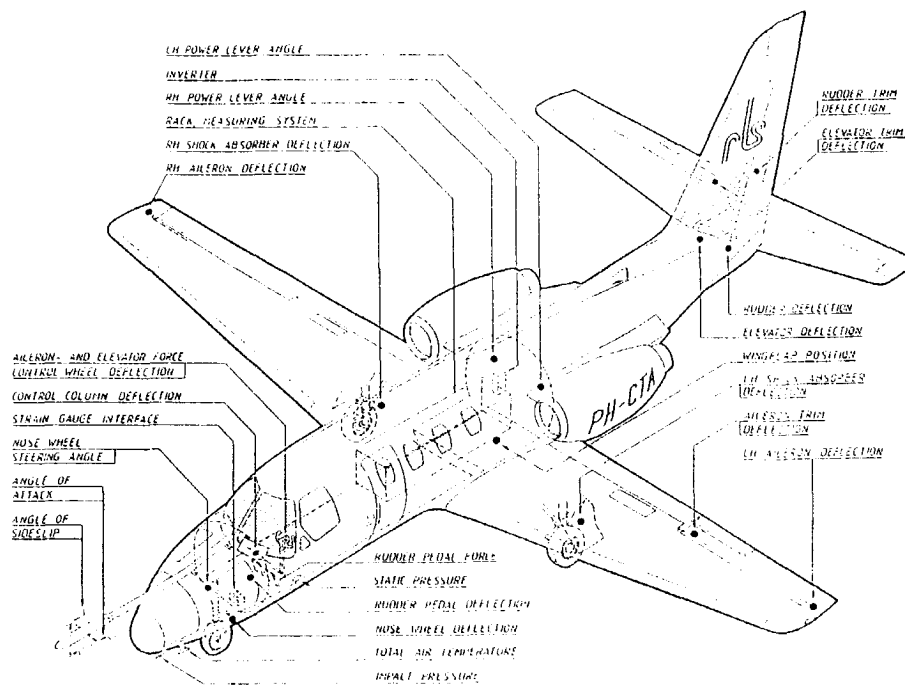

Fig. 2:
Flight test transducer lay out.

Fig. 2 shows the position of the specially designed and installed transducers for the measurement of elevator, aileron and rudder control surface and trim tab deflections, wing flap angle, column, wheel and rudder pedal control forces and displacements, main and nose gear shock absorber compression, nose wheel steering angle, power lever angles, total temperature and angle of attack and side slip angle. Note that a specially designed nose boom was installed on the aircraft in order to reduce aircraft induced position errors in the measurements of angle of attack and side slip angle. If possible, standard onboard systems and transducers were used such as for the measurement or detection of engine speeds, it and fuel flow, fuel quantity, stick shaker and anti skid warning, landing gear down and up locks, speed brakes deployed and retracted and radar altitude. Also the standard aircraft pitot tube and static sources were used, in combination, however, with high accuracy barometric transducers and formation flights for the measurement of position errors.

The rack of the measurement system is shown in Fig. 3, see also Fig. 2. The system contained high accuracy barometric transducers in a temperature controlled box, a Honeywell laser-gyro Inertial Reference System (IRS), a signal conditioning unit, anti-aliasing filters and a standard NLR Remote Multiplexer Digitizer (RMDU). Digitized data was stored on one track of a 14 track tape recorder with enough capacity as to allow continuous recording of all transducer outputs during the whole test flight from before engine start until after engine shut down. A reference time signal was recorded on a separate track. Transducer signals were, depending on frequency contents, sampled with sample frequencies ranging from 50 to 2 Hz. Three accelerometers positioned

in the cockpit for vibration measurements, however, were sampled at a higher rate of 256 Hz.

The first stage of data analysis, called elementary data analysis, was used to transfer the data to a common time frame, digitally filter for data compression, apply calibration formulas and to compute the physical variables needed in the second stage of data analysis. The second stage is concerned with aircraft state reconstruction and the identification of the mathematical models required for flight simulation, see Section 4 below.

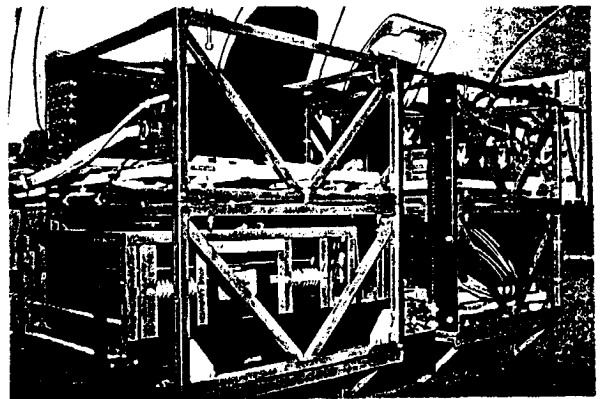

Fig. 3:
Rack of high accuracy measurement system as installed in the cabin.

3. Flight test program

The objectives of the flight test program were the execution and measurement of different kinds of flight test manoeuvres for the identification of a flight simulation model and the measurement of input-output time histories as required in the Approval Test Guide (ATG), see Ref. 3.

Twenty three test flights were made resulting in a total flight test time of slightly over 52 hours. Fifteen of these test flights were devoted to the identification of the flight simulation model, six were used to execute and measure ATG manoeuvres while the remaining two flights were formation flights used for position error correction measurements of the total and static pressure sources. In addition, a first flight was made on January 27, 1987 as a check flight of the flight test measurement system, and two more 'flights' were used for taxi trials. The last flight was made on April 8, 1987.

The flight test program for model identification was carefully designed in the sense that flight test manoeuvres were evenly distributed in the admissible flight envelope. Two different kinds of flight test manoeuvres were used for model identification:

- quasi-stationary manoeuvres for large but slow variations of variables;
- dynamic manoeuvres for fast but small variations of variables.

Examples of quasi-stationary manoeuvres were quasi-stationary longitudinal accelerations and decelerations at approximately constant thrust and altitude, quasi-stationary and approximately rectilinear side slip excursions to port and starboard, trim tab excursions at an approximately constant nominal flight condition and turns at approximately constant altitude with slowly increasing and decreasing roll angle.

Examples of dynamic manoeuvres were small elevator, aileron or rudder doublets starting from approximately stationary, rectilinear flight conditions and small left and right power lever doublets.

Ease of implementation was the main reason for using doublet shaped input signals rather than for instance the 'optimal' but much more complex input signals as proposed in Ref. 15. It was for the same reason that the elevator, aileron and rudder doublets were implemented sequentially in independent manoeuvres rather than simultaneously, which might be preferable from a theoretical point of view.

The different types of flight test manoeuvres were combined in a tight schedule for maximum efficiency. In a typical scenario the aircraft is at 1000 feet below the nominal flight test altitude in a low speed flight condition with both engines set at climb thrust. On approaching the nominal altitude the aircraft is accelerated smoothly to maximum speed or placard speed while keeping the elevator control forces low with the elevator trim. Next the power levers are closed and the aircraft is decelerated to the nominal flight test speed, at which speed cruise thrust is selected. After stabilizing at the nominal flight altitude and speed an elevator doublet is implemented, next an aileron and a rudder doublet. The remaining manoeuvres at this nominal flight

condition are quasi-stationary: elevator, aileron and rudder trim excursions, side slips and a turn with varying roll angle. A typical heading change during the turn is 180°. Next the aircraft is accelerated or decelerated to a new nominal flight speed, the aircraft configuration is changed according to the flight plan and the same sequence of dynamic and quasi-stationary flight test manoeuvres is repeated.

In addition to the dynamic and quasi-stationary flight test manoeuvres above, two types of stalls were performed for model identification: stalls at constant pitch attitude and stalls at constant pitch rate. Furthermore, during taxi trials, doublets were implemented on the nose wheel steering and on the left and right main wheel brakes. Dynamic manoeuvres and quasi-stationary side slips were also executed at very low altitudes above the runway in order to evaluate ground effects in the aerodynamic model. In the design of the flight test program for model identification aircraft weight and center of gravity were systematically varied such as to enhance the 'identifiability' of certain model parameters.

The Approval Test Guide (ATG), see Ref. 3, prescribes measurements in stationary flight conditions as well as the execution of special dynamic manoeuvres. These flight conditions and manoeuvres were to be used for the so-called Proof of Match (POM) and therefore were flown only in extremely stable atmospheric conditions where unwanted and unknown inputs due to atmospheric turbulence could be expected to be virtually nonexistent. Results of this part of the flight test program are presented in Section 5 below.

4. Mathematical model development

A variety of System Identification techniques was used to develop the mathematical models mentioned above of the aerodynamic forces and moments, static and dynamic engine performance, the flight control system including aerodynamic control surface hinge moments and the landing gear including main wheel brakes and nose wheel steering.

System Identification may be defined as the set of techniques and algorithms which may be used to select 'proper' mathematical model forms and estimate the corresponding set of parameter values from input-output measurements of the responses of some system on deliberate input signals or disturbances. System identification has been successfully applied now to diverse problems in it seems almost all scientific disciplines, see e.g. Ref. 5. A classical introduction to system identification is Ref. 7.

Two basically different types of system identification techniques exist which were both successfully applied in the development of the mathematical models mentioned above, see Ref. 7. The first type seems at present the most popular in the aerospace community; it may adequately be characterized as 'model-adjustment technique'. The idea is to implement a simulation model in the computer and to drive the model with the same inputs as the actual system. If the observations of the output of the actual system differ from the simulated output, see curves 3 and 1 in Fig. 4, this must be caused by a difference in initial

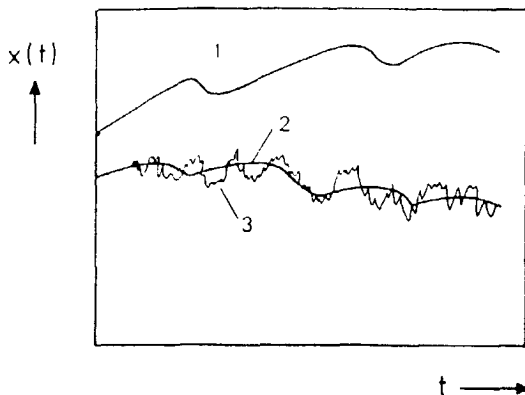

Fig. 4:
Principle of model-adjustment technique.

conditions and/or the parameters in the simulation model having wrong values. By selecting 'optimal' initial conditions and parameter values, the simulation curve 2 might result. Obviously, the remaining lack of fit is not of much interest as is clearly caused by observation measurement errors. In mathematical terms the selection of the optimal initial conditions and parameter values corresponds to solving a nonlinear function optimization problem, to which a wide variety of algorithms may be applied in principle. Often the Gauss-Newton method is used and the minimization of the differences between observations and simulation placed in the context of Maximum Likelihood (ML) estimation theory. The resulting parameter values may then be indicated as Maximum Likelihood estimates, see Ref. 12. The ML parameter estimation technique is applicable to linear as well as nonlinear dynamic systems. Usually the inputs to the system are assumed to be exactly known.

However, the ML technique applies also to cases where the inputs to the simulation model are corrupted with measurement noise or where unmeasurable disturbances act on the system, be it that the corresponding algorithms become much more involved, e.g. see Ref. 12. The second type of system identification techniques is indicated in Ref. 7 as 'using explicit mathematical relations'. It is possible now to compute in one step the wanted parameter values from input-output measurements without having to solve a nonlinear optimization problem. The so-called 'equation error' methods fall in this category. As an example may serve a first order dynamical system:

$$\dot{x}(t) = a x(t) + b u(t), \quad (4.1)$$

in which $x(t)$ and $u(t)$ denote the state and the input respectively. Let b be a known, and a an unknown parameter. In the first type of technique (4.1) would be numerically integrated in order to compare the solution with a measured response, i.e. a measurement of $x(t)$ in some time interval. In the second type of technique it is assumed that

not only $x(t)$ and $u(t)$, but in addition also $\dot{x}(t)$ is measured. An estimate \hat{a} of the value of a may then be obtained from measurements at at least time instant t_1 as:

$$\hat{a} = \frac{\dot{x}(t_1) - b u(t_1)}{x(t_1)}. \quad (4.2)$$

If more measurements are made at more instants of time it is possible to compute a so-called least squares estimate by applying regression analysis. The obvious advantage of using the second type of system identification technique is: that a usually cumbersome optimization problem is avoided. The disadvantage is that more variables must be measured: in the case of the example, $\dot{x}(t)$ must be measured in addition to $x(t)$ and $u(t)$.

The second type of identification techniques becomes particularly attractive in those cases where the structure of the mathematical model is not yet precisely known. System identification in those cases becomes in essence a process of trial and error if the a priori model structure proves to result in an unsatisfactory fit to the measurements. Usually based on engineering insight and intuition, a set of model extensions is put forward, implemented in the a priori model and an extended set of parameter values is estimated from the measurements. It may be, and is even probable, that the process of evaluating a set of model extensions must be repeated one or more times if a selected model extension does indeed improve the model fit, but not enough. It is self evident that this process of trial and error may be performed much more efficiently if one of the second types of identification techniques can be used rather than having to solve a series of in itself cumbersome nonlinear optimization problems.

An important objective of the flight test program was the development of a mathematical model of the aerodynamic forces and moments which would apply to all aircraft configurations and all admissible flight conditions. It is common practice to model the dimensionless aerodynamic force and moment coefficients in terms of linear or nonlinear polynomials in variables as angle of attack α , sideslip angle β and their derivatives with respect to time, body rotation rates and control surface deflections, e.g. see Ref. 15. The parameters in the polynomials, the so-called aerodynamic derivatives, will in general depend on aircraft configuration and flight condition. The aircraft equations of motion may now be written as:

$$\dot{\underline{x}}(t) = f(\underline{x}(t), \underline{u}(t), \underline{\theta}), \quad (4.3)$$

in which $\underline{x}(t)$ and $\underline{u}(t)$ denote a state vector and a vector of input variables respectively, and $\underline{\theta}$ denotes a vector of yet unknown parameters. The response of the aircraft during a dynamic flight test manoeuvre is observed with a variety of sensors such as accelerometers, rate gyro's, pressure transducers and vanes, see Section 2 above. These observations may be written as:

$$\underline{y}(t) = h(\underline{x}(t), \underline{u}(t), \underline{\theta}). \quad (4.4)$$

see Ref. 15. If it can be assumed that the input signals, i.e. control surface deflections and power lever angles or engine thrust, are measured with negligible errors then it will be clear from

the above that at first sight it appears that the system identification technique needed to estimate the parameters in θ is of type 1. Since the parameters in θ vary with aircraft configuration and flight condition it is essential to evaluate these variations by executing and analyzing flight test manoeuvres at all relevant aircraft configuration - flight condition combinations, see also Section 3. The resulting number of flight test manoeuvres, however, is large, and consequently the development of an 'adequate' aerodynamic model would be a cumbersome task as it requires the solution of an even much larger number of nonlinear optimization problems as explained above.

In the present flight test technique the presence of virtually perfect accelerometers and rate gyro's in the measurement system is exploited. It is easily shown that the corresponding signals, i.e. specific aerodynamic forces and body rotation rates may be interpreted as input signals to a dynamical system model describing the evolution of the aircraft's state, see e.g. Ref. 14. A state reconstruction problem may be defined, which is readily solved by applying a type 1 system identification technique or standard extended Kalman filtering and smoothing algorithm's e.g., see Ref. 13. In the terminology of type 1 system identification techniques, computed time histories of for instance airspeed and side slip angle are matched to corresponding measured time histories by selecting 'optimal' initial conditions and estimating (very small) transducer bias errors. The result is an accurate and complete state vector trajectory estimate. The main advantage of carrying out a state reconstruction is that next a type 2 system identification technique may be applied to estimate the aerodynamic derivatives, see Table 1. The resulting 'two step' method for

would be based on a mechanical-thermodynamic model of all engine parts as compressors, combustion chambers, turbines, exhaust and the fuel control unit. The resulting model would be valid for quasi-static performance as well as for dynamic response characteristics at the cost, however, of considerable demands on real-time computer capacity. Therefore, a more heuristic model structure was preferred in the present context, consisting of two submodels for static engine performance and dynamic engine response to fast power lever angle variations. The static model was based on functional relations in graphical form as resulting from dimensional analysis and were provided by the engine manufacturer. The dynamical model consisted in fact of a set of linear dynamical models for low speed and high speed compressor speed, exhaust gas temperature etc.

Engine gross thrust and ram drag are in fact aerodynamic forces, and therefore should be included in the aircraft's aerodynamic model. In principle, it is possible now to identify the parameters in the model of static engine performance simultaneously with the aerodynamic derivatives mentioned above by using type 2 identification techniques and selecting those flight test manoeuvres where the power lever angle variations were slow or negligible. Type 2 identification techniques allow the composition of 'global' data sets for identification. Global data sets are composed of measurements at selected time instants or intervals in an arbitrary number of flight test manoeuvres or quasi-steady flight conditions (e.g. climbing or descending flight conditions). If a global data set is composed such that flight conditions in all significant parts of the flight envelope at different representative levels of engine thrust are included, then the identified aerodynamic and static engine thrust models may be expected to closely approximate the actual cruise, climb and descent performance.

System Identification Technique	
Type 1	Type 2
. aircraft state trajectory	. aerodynamic forces and moments
. dynamic engine response	. static engine performance
. flight control system	. flight control system
. landing gear side forces	. landing gear strut and wheel compression
. nose wheel steering	. main wheel brakes

Table 1:
Classification of identification problems.

the identification of aerodynamic derivatives was successfully applied in several flight test programs, including the present one. The performance of the two-step method is perhaps most clearly demonstrated in the so-called 'proof of match' time histories shown in Section 5 below. One approach to the identification of the engines

Type 1 identification techniques were used to identify the models in the dynamic engine response model. Acceleration constraint first order linear dynamic models proved to result in good fit to actually measured responses. The model parameters proved to be altitude dependent. Results in the form of a POM are shown in Section 5 below.

The flight control system (FCS) of the Citation 500 is fully mechanical. The aerodynamic hinge moments on the control surfaces must be counter balanced by pilot generated control forces. A model of the control hinge moments was therefore an essential part of the flight control system model and, unlike the case of irreversible control systems with artificial feel, the identification had to be based on measurements in flight. A simplified representation of the FCS was made as shown in Fig. 5 for the elevator control system. Next the equations of motion were derived taking account of the effects of the motion of the aircraft on the FCS response, see Ref. 8. The equations of motion could be written in the form of a Multiple-Input-Multiple-Output (MIMO) system, with inputs: the control force, longitudinal and vertical specific aerodynamic forces, pitch rate and acceleration, airspeed, angle of attack and trim tab angle, and with outputs the control column and elevator deflection. The order of the model depended on which assumptions were made, e.g. a fourth order model resulted if the masses

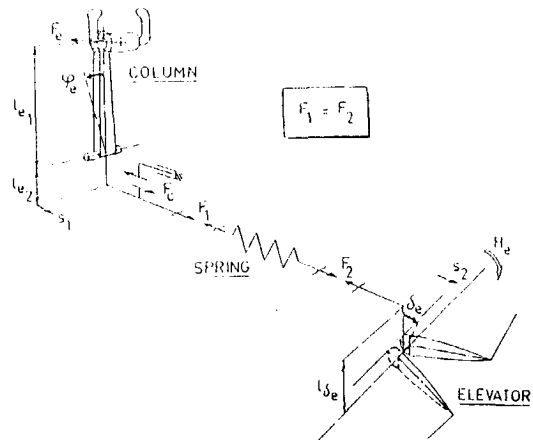

Fig. 5:
Simplified representation of the elevator flight control system.

of the forward system (control column) and the aft system (elevator) were taken into account, while a second order model resulted if the mass of the elevator was assumed to be negligible. Since the FCS model represents a dynamical system, type 1 identification methods had to be applied for selection and estimation of the model parameters, see Table 1.

The process which finally resulted in adequate models proved to be time consuming, not very straightforward and rather cumbersome. In particular, it was not very easy to distinguish between the case of an ML optimization converging towards a local rather than the global maximum of the likelihood function on the one hand and a model for which the best fit to measurements was inadequate on the other. The finally selected models for the elevator and rudder FCS were of the fourth order while a sixth order model was selected for the aileron FCS (accounting for the masses of the control wheel and each of the ailerons). These models were used next to analyze flight test manoeuvres in a number of representative flight condition-aircraft configuration combinations in order to estimate the corresponding variations of the aerodynamic hinge moment derivatives. Some POM time histories of the resulting FCS models are shown in Section 5 below.

The above FCS identification with type 1 identification techniques was performed at DUT. An alternate approach was followed at NLR using second order models and type 2 identification techniques, see Ref. 11. Numerical differentiation techniques were used to obtain first and second order time derivatives of the FCS motion as required in type 2 techniques, see the present Section above. (Ref. 8 applies also type 2 techniques, however, numerical differentiation is avoided by assuming installation of accelerometers on the control manipulator). The resulting differences between type 1 and type 2 estimates of the aerodynamic hinge moment derivatives were small enough as to warrant a more detailed exploration of the potentialities of type 2 identification techniques, especially in those cases where an adequate model structure has yet to be developed.

Type 1 and type 2 identification techniques were used to identify the four submodels of the

landing gear model as shown in Table 1. The fact that it was possible to apply type 2 techniques to the identification of the gear strut and wheel compression models and the main wheel brake model was due to the IRS, see Section 3 above, resulting in high accuracy time histories of the specific external forces on the aircraft, the body rotation rates, accelerations and attitude angles. If the aerodynamic forces are either neglected (low taxi speed) or computed (higher taxi speeds and using in flight identified aerodynamic models), then it is possible to compute the normal, side and longitudinal ground-wheel reaction forces. Strut compression characteristics for example may then be presented directly in graphical form. Fig. 6

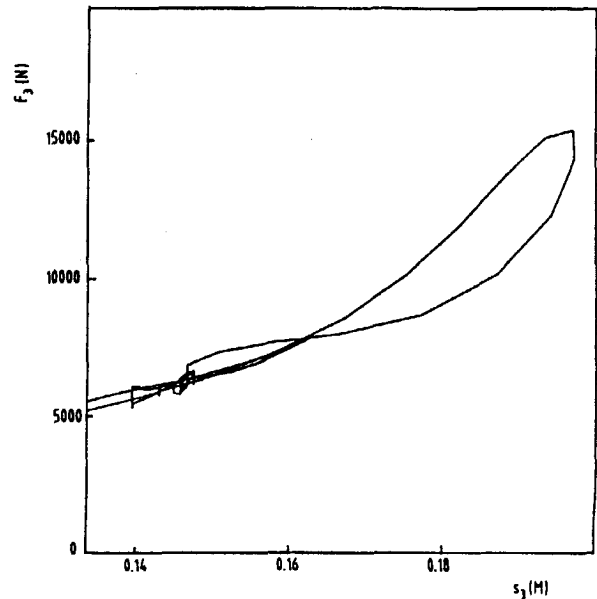

Fig. 6:
Nose wheel strut force F_3 and strut compression s_3 response on brake application.

shows the resulting characteristic of the nose wheel strut as obtained from measurements of a response of a main wheel brakes application. Similar plots may be derived for the main landing gear during high speed tight turns or during lift-off and landing.

The model of the landing gear side forces was taken from Ref. 2. Application of type 1 identification techniques to a dynamical model in which the wheel slip angles were explicitly calculated allowed to improve several a priori parameter values.

A typical result in the form of measured and computed wheel side force time histories is shown in Fig. 7.

Finally, type 1 identification techniques were also applied to the identification of the nose wheel steering model. Nose wheel steering is via springs connected to the rudder pedals. Dynamical models of order two and four were evaluated. It turned out, however, that a quasi-static model performed surprisingly well if a proper ground reaction (centering) model was included. Fig. 8 shows measured and computed nose wheel angles

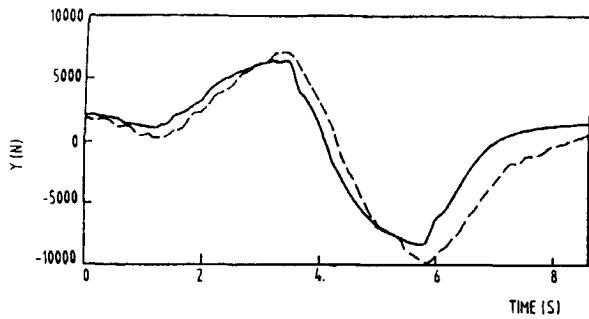

Fig. 7:
Computed and measured total side force Y during a 'nose wheel doublet' taxi manoeuvre.

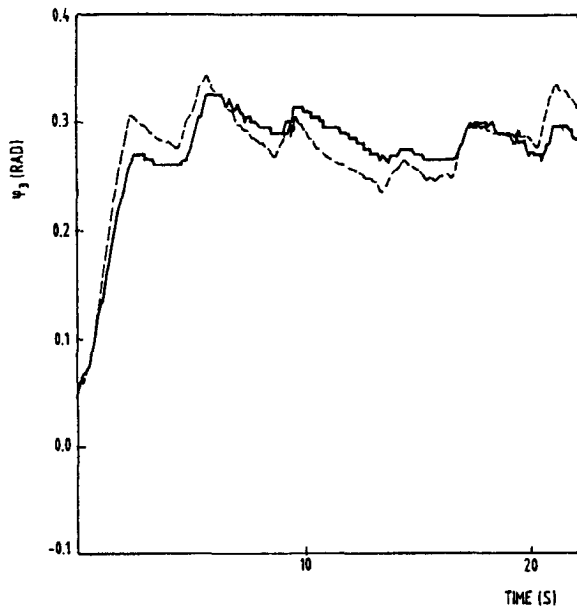

Fig. 8:
Computed and measured nose wheel angle during initiation of turn.

for the case of a pedal force for an input and an approximately stationary turn.

5. Computer generated checkout and proof of match

The purpose of the Computer Generated Checkout (CGC) is to support tests, which will demonstrate that the mathematical model and data package has been correctly incorporated into the simulator by the manufacturer. To this end a number of on-ground and in flight checks, see Ref. 16, were carried out using the six DOF engineering simulation of DUT, see Ref. 4. The CGC-data were initially provided for an a priori mathematical model of the Citation 500 and updated later for the flight test proven model.

Next, a quantitative validation of the quasi-stationary and dynamic characteristics of the mathematical model was carried out, the so-called Proof of Match (POM). In the POM simulated responses are directly compared to aircraft flight traces providing for an objective examination of the fidelity of the mathematical model. For the generation of POM-data the data-files resulting from flight tests are read from the flight test tapes. In this manner the control surface and power lever angles, as measured by the flight test measurement system are used as the input signals to the six DOF engineering simulation. The responses on these input signals are plotted against the same responses as measured in the aircraft. Special flight test manoeuvres were carried out for this purpose. These manoeuvres are described in detail in the so-called Approval Test Guide (ATG), see Ref. 3. Typical examples of ATG manoeuvres are:

- power change dynamics;
- phugoid and short period motion;
- dutch roll (yaw damper off and yaw damper on);
- control column, control wheel and rudder pedal releases;
- take-off and landing.

The generation of the CGC and POM-data was performed using an interactive software routine, see Fig. 9, developed by A.O. Struckman as part of

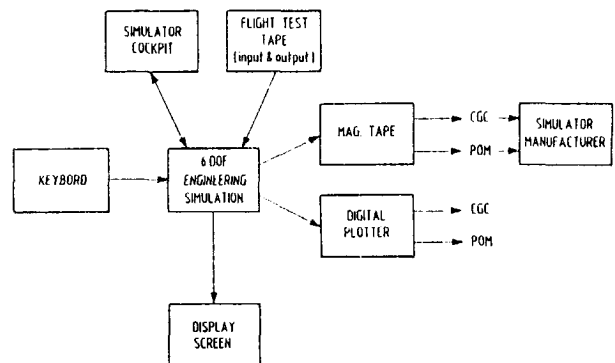

Fig. 9:
Basic elements of CGC and POM-data generation.

his thesis work at DUT. The routine allows different kinds of control inputs to the engineering simulation. These control inputs may either be generated with the computer keyboard, the flight simulator cockpit controls, or may be read from a flight test (ATG) data tape. The keyboard and simulator cockpit options allow the operator to 'fly' the simulated aircraft through different kinds of manoeuvres such as required for the CGC. The third option becomes essential in the POM, where the simulation must be driven with exactly the same input signals (control forces or control displacements) as in the actual flight test manoeuvre to which the simulated response must be matched.

CGC and POM-data were generated for the following submodels of the Citation 500 mathematical model:

- aerodynamic model;
- engine model;
- flight control system model;
- landing gear model.

Some examples of the POM of the different submodels of the Citation 500 are presented in figs. 10 through 16. In these figures, the admissible maximum tolerances applied to the comparison of the flight test data with the mathematical model responses in order to determine whether or not a match has been achieved, are shown. These tolerances were taken from FAA AC 120-40A, see Appendix 5 of Ref. 1.

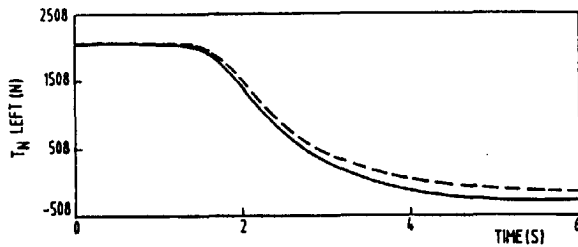

Fig. 10:
POM of power change dynamics:
Flight Tolerance: ± 5 lb or 20%
Simulator

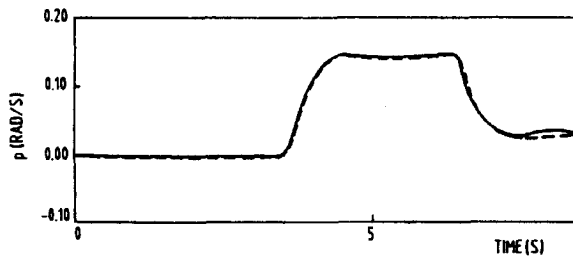

Fig. 11:
POM of roll response:
Flight Tolerance: $\pm 10\%$ of roll
Simulator rate or $\pm 2^\circ/\text{sec}$

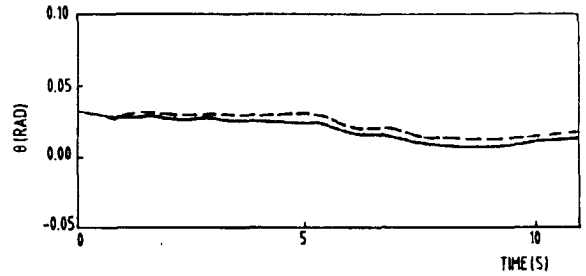
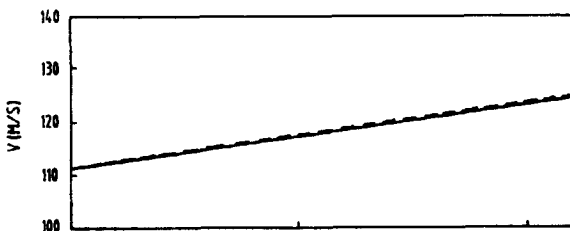

Fig. 12:
POM of level flight acceleration:
Flight Tolerance: ± 3 KTSV and
Simulator $\pm 1\ 1/2^\circ \theta$

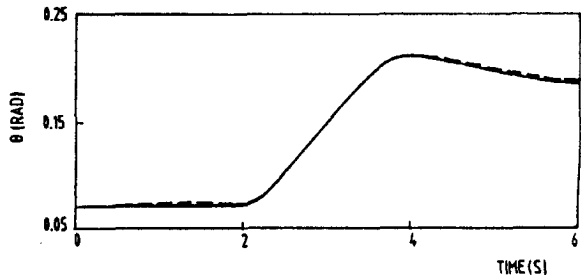
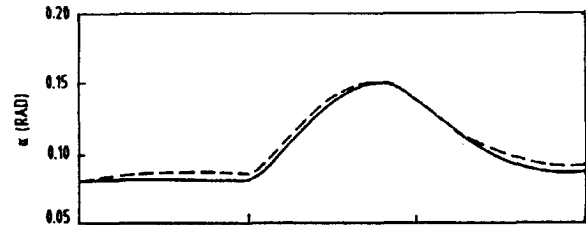

Fig. 13:
POM of short period motion:
Flight Tolerance: $\pm 1\ 1/2^\circ \alpha$ and
Simulator $\pm 1\ 1/2^\circ \theta$

Although only a small sample of the total POM-data is presented here, these figures demonstrate the excellent correlation (well within the required tolerance) between the flight test and engineering simulation data.

6. Concluding remarks

Phase II flight simulation may sometimes be hampered by an inadequate or even almost non-existent database. This may dictate a flight test program and the identification of a mathematical model from flight test data.

Such a flight test program was carried out in the present work with a Cessna Citation 500. High accuracy measurement techniques were employed in order to maximize the quality of the resulting database. Different types of system identification techniques were successfully applied to the identification of an aerodynamic model, engine model, flight control system model and landing gear

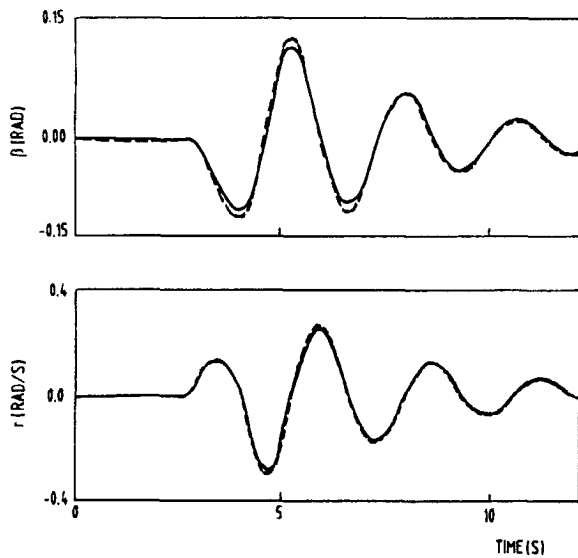

Fig. 14:
POM of Dutch roll dynamics:
Flight ——— Tolerance: ± 1 sec or 10%
Simulator - - - - - of period

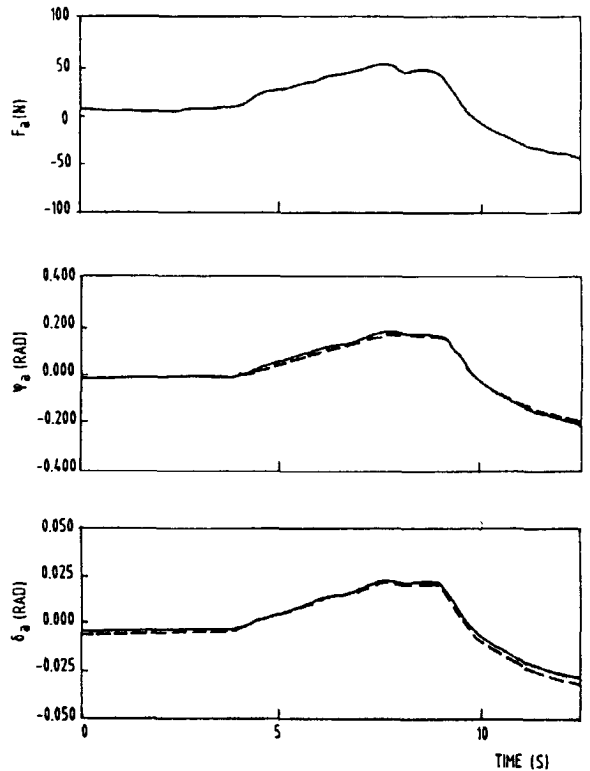

Fig. 16:
POM of aileron wheel force, position and surface position:
Flight ——— Tolerance: $\pm 1^\circ$ aileron,
Simulator - - - - - ± 3 lbs or 10%

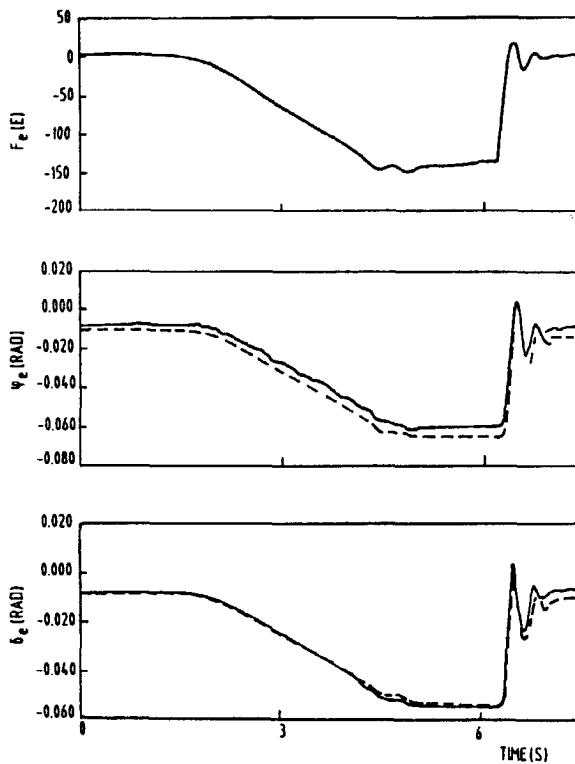

Fig. 15:
POM of elevator release:
Flight ——— Tolerance: $\pm 2^\circ$ elevator,
Simulator - - - - - ± 5 lbs or 10%

model. The resulting models were implemented in a 6 DOF engineering simulation which could be driven by flight recorded input signals. A Proof of Match was made for a set of flight conditions and special flight test manoeuvres from which it could be concluded that the identified mathematical model was a very adequate representation of the actual engine-airframe characteristics.

7. References

1. Anon., 'Federal Aviation Administration. Advisory circular AC no. 120-40A on airplane simulated and visual system evaluations', US Department of Transportation.
2. Anon., '757-200 crew training simulator-ground handling data', Boeing Commercial Airplane Company, Seattle, Washington, 1980.
3. Anon., 'Citation 500 aircraft pilot test procedures for FAA Phase II ATG manoeuvres', CAE Electronics Ltd, Revision 1, January 1987.
4. M. Baarspul, 'Flight simulation techniques with emphasis on the generation of high fidelity 6 DOF motion cues', ICAS paper no. 86-5.3.3, London, September 1986.

5. H. Barker and P.C. Young (eds.), 'Proceedings of the 7th IFAC Symposium on Identification and System Parameter Estimation', York, U.K., July 1985.
6. J.H. Breeman, L.J.J. Erkelens and A.M.H. Nieuwpoort, 'Determination of performance and stability characteristics from dynamic manoeuvres with a transport aircraft using parameter identification', AGARD FMP Symposium on Flight Test Techniques, Lisbon, 1984.
7. P. Eijkhoff, 'System identification', John Wiley and Sons, 1974, ISBN 0-471-24980-7.
8. J.G. den Hollander, 'Identification of primary flight control system characteristics from dynamic measurements', report LR-348, Delft University of Technology, Delft, November 1982.
9. L.G. Janssens and T. Marshall, 'How to make simulators fly like airplanes', AIAA-86-9777.
10. R.C. de Jong and J.A. Mulder, 'Accurate estimation of aircraft inertia characteristics from a single suspension experiment', Journal of Aircraft, June 1987.
11. H. Kannemans, 'Private communication, NLR, June 1987.
12. R.E. Maine and K.W. Iliff, 'Identification of dynamic systems', AGARDograph no. 300, Vol. 2, January 1985.
13. J.A. Mulder, 'Estimation of the aircraft state in non-steady flight', AGARD Conference Proceedings no. 172 on Methods for Aircraft and Parameter Identification, Hampton, Virginia, November 1974.
14. J.A. Mulder and J.G. den Hollander, 'Status of dynamic flight test technology - model identification for flight simulation', SAE paper no. 810597, Wichita, April 1981.
15. J.A. Mulder, 'Design and evaluation of dynamic flight test manoeuvres', report LR-497, Delft University of Technology, Delft, October 1986.
16. J. Shlien, 'Citation 500 flight simulator design and performance data requirements', CAE Electronics Ltd, Revision 1, August 1986.

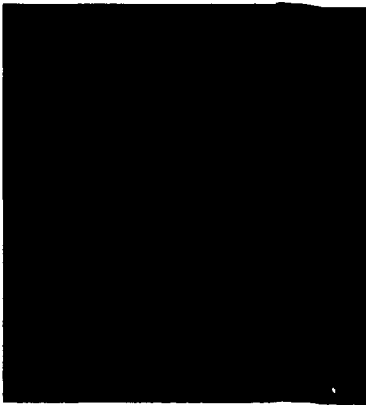

Memorandum 578



60142031291

866328