



STEERABLE  
NEUROENDOSCOPIC BIOPSY  
FORCEPS: expanding the reach

**Individual Double Degree Master Thesis by Maaïke M. Weber**

4341910

October 2020

Master thesis in fulfillment of the requirements for the degree of Master of Science in the fields of:

**Master Integrated Product Design**

Faculty of Industrial Design Engineering  
Delft University of Technology

**Master BioMedical Engineering**

Medical devices and bioelectronics  
Faculty of Mechanical, Maritime and Materials Engineering  
Delft University of Technology

Assignment by  
DEAM BV  
Science Park 402  
1043 AJ Amsterdam

Graduation committee  
Chair Industrial Design Engineering  
Chair Biomedical Engineering  
Mentor Industrial Design Engineering  
Mentor DEAM

Dr. ir. Johan F. M. Molenbroek  
Prof. dr. Jenny Dankelman  
Dr. ir. Helen Y. Yuan  
Meng. Wimold P. S. Peters

This thesis is confidential and cannot be made public until October 16, 2022.

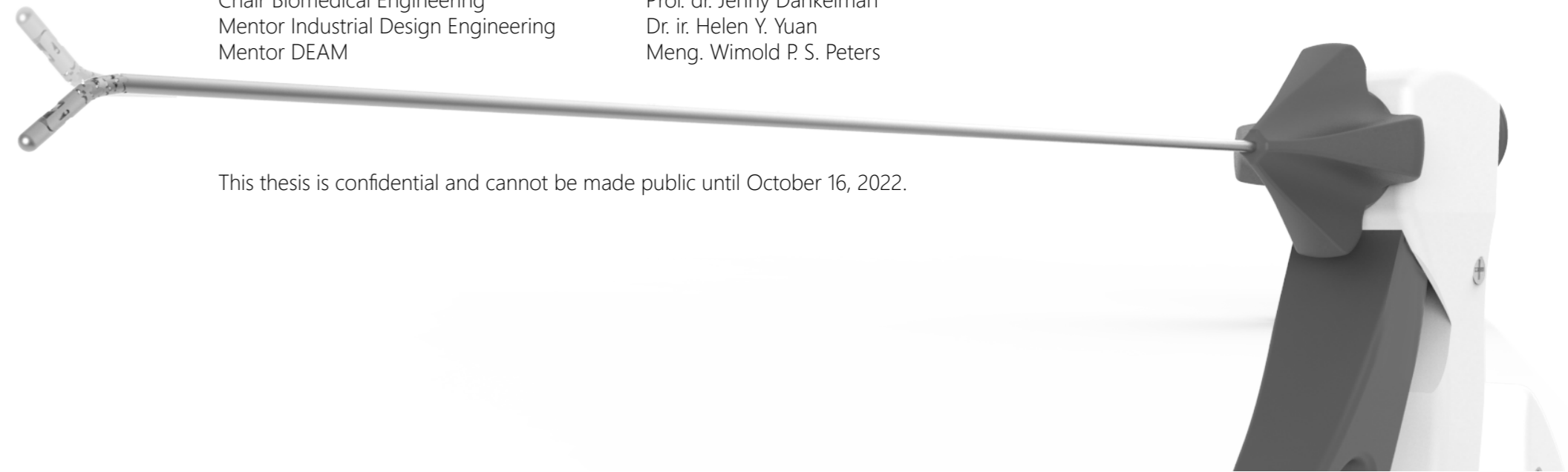



# Summary

This MSc IDD thesis describes the research, design, prototyping and testing of a steerable biopsy forceps for intraventricular neuroendoscopy. The instrument is a surgical tool that is designed to innovate the procedure of intraventricular neuroendoscopy, dramatically improving access to otherwise impossible to reach areas in the ventricle. It combines the strong suits of the traditional instruments like handle angle, precision and control with the improvements of today; flexibility in the articulate tip, a stable handle facilitating multiple grips. The assignment came from the clinic, from neurosurgeon prof. dr. Eelco Hoving, to be precise. Dr. Hoving identified the need for more versatile instruments to perform his procedures. Prof. dr. Hoving is clinical director at Prinses Máxima Centrum. DEAM partnered with dr. Hoving and challenged me to solve the problem.

## Problem definition

The clinical problem that was the origin of this project is straight-forward; literally. The current golden standard for neuroendoscopy, is a combination of several straight, rigid instruments. Once the surgeon has inserted the instruments, any therapeutic or diagnostic action can only be carried out in-line with the shaft of the trocar. A tumor, cyst or any other targeted area that lies just a millimeter to the left or right of the axis of the trocar is **unreachable**, without moving the full endoscopic system. This movement possibly **damages** the cortex that is surrounding the shaft of the trocar or even nicks a vein or artery. In current intraventricular neuroendoscopy, only 5% of the potential cases can be treated by endoscopy, rather than craniotomy, because of the reachability problems. In history, the intraventricular procedures have been attempted with a flexible endoscope. However, this instrument was difficult to use and orientation inside the ventricle was impossible. Incorporating steerability in this instrument asks for a completely new handle; the stability of the traditional scissors is completely lost after the addition of a joystick..

## Design approach & methodology

Challenge: combine knowledge from IPD and BME to create a working prototype based on detailed user research defining the scope of the study, finding all

struggles related to the current instruments, everything that is important to take into account concerning the context of neuroendoscopy and how to apply current-day knowledge about ergonomics. The approach to all this:

1. My vision: thorough (user) research, expert advise, involvement of stakeholders, quantify the findings
2. DEAM's vision: desirability (user research), feasibility (engineering models), viability (business model generation)

Key opinion leader (KOL) dr. Hoving was interviewed and surveys were used among other neurosurgeons to determine the user requirements for the new instrument. Throughout the project, prototypes in all types of media were created and evaluated with the end-user or other experts. Paper an digital prototypes to develop the tip concept, clay, foam and 3D printed ones to find the handle shape. This yielded the solid basis used to make all design decisions.

## Design proposal & evaluation

The proposed design is a steerable neuroendoscopic forceps for intraventricular use, designed based on thorough user research and secondary research in literature. Multiple rounds of prototypes were evaluated with the end user. The final prototype was fully functional. A box trainer was developed for the final user evaluation. The shape of the handle uses the palm of the hand for stability instead of the thumb. The user can choose to use one or two fingers to stabilise at the other side. The thumb controls the joystick by pressing, tilting and releasing in the desired position. Once in position, the trigger can be actively closed and opened. The dimensions of the controls are either derived from the old instrument or based on human factor guidelines. The results of the user evaluation were promising. Additionally, a significant decrease of movement in the sagittal plane compared to the old instrument was observed during use.

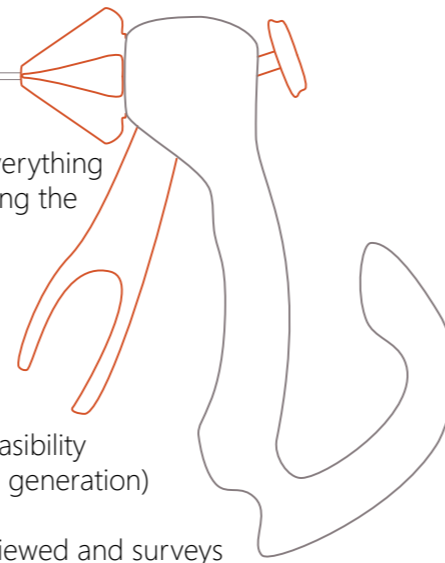

# Preface

things. Helen for always being there to answer my questions on literature as well as the practical matters. I want to thank Johan for being the peaceful and knowledgeable supervisor he is, never short of a relevant anecdote or applicable scientific source. I want to thank Wimold for taking me so seriously, for making me feel relevant in the world of medical device design and for offering me so much professional knowledge.

A special thanks goes out to dr. Eelco Hoving, who was my connection to the clinical world. For patiently enlightening me on the practices of neurosurgery and being so clear in what he as a user needs from a surgical instrument. Although not officially part of my supervisory board, Jules Scheltes, has given me the answers to my questions concerning the mechanism design, and helped me make decisions when I was in doubt.

All other colleagues at DEAM I want to thank for being super involved and always prepared to help.

People close to me have helped me get through the process of graduating from my masters, for which I cannot thank them enough. Mom, dad, Roza, Veerle, Jeanine, Tiara, Xiao, Ilja and everyone else, thanks for being there.

This report presents the instrument that I have developed for the obtaining of my individual double degree in Integrated Product Design and Biomedical Engineering.

During this project I went through the full product design engineering cycle of performing several levels of research, ideating, prototyping, and evaluating, in order to prepare a set of recommendations for further development of the next full prototype. To go from theory to a fully functional prototype that could be tested with the end-user was a rewarding experience making me so enthusiastic for the future.

The project at DEAM has been such an ambiguous experience, where on the one hand I have gained a lot of confidence working in a professional environment, where I have had a taste of what it is like to work for a company instead of for the university or an external client. However, I cannot ignore the fact that on the other hand, the whole project was tainted by the Covid-19 pandemic, and almost all of my work on it was done from my bedroom. This knocked down some of the aforementioned confidence. Nevertheless, I am proud of what I have accomplished and I hope one day parts of my design will make it to the OR, where it will improve patients' lives, patients that before could not be helped.

I want to thank all the members of my supervisory board; Prof. dr. Jenny Dankelman, Dr. ir. Helen Y. Yuan, Dr. ir. Johan F. M. Molenbroek and Meng. Wimold P. S. Peters. As a steady whole, completing each other's expertise, and individually. Jenny for the guidance on what is important to become a biomedical engineer, but also for helping me not to worry too much and to see the important

# Contents

List of figures, tables & Abbreviations	8	1.6 Personas & User Scenario	40	PART 3: Evaluation	78	Appendix 2.5: Test protocol 2nd generation	A23
Introduction	10	1.6.1 Personas	41	3.1 Introduction	79	Appendix 2.6: Results 2nd generation evaluation	A24
Starting point	13	1.6.2 Clinical problem definition & user scenario	41	3.2 Cost	80	Appendix 2.7: Iterations of the mechanism	A26
Approach & method	15	1.7 User requirements & Conclusions	44	3.3 Field of view	80	Appendix 2.8: Final prototype sketches	A28
PART 1: Analysis	16	PART 2: Synthesis	46	3.4 User testing methods	81	Appendix 2.9: Assembly protocol	A29
1.1 Introduction	17	2.1 Introduction	47	3.5 Results	83	Appendix 2.10: Bill of materials	A33
1.2 Finding the audience	18	2.1.2 Tip design starting point	48	PART 4: Wrap-up	88	PART 3: Evaluation	A34
1.3 The surgeon	19	2.2 The tip design	49	4.1 Overall discussion & Recommendations	89	Appendix 3.1: Injection Molding results	A35
1.3.2 Survey with neurosurgeons	22	2.2.1 Physical design space	49	4.2 Conclusions	91	Appendix 3.2: Full results usability test	A37
1.3.3 Follow-up Survey	23	2.2.2 Effects of tumor location, insertion and steering angle	50	Bibliography	94	Appendix 3.3: Full results stability test	A38
1.3.4 Ergonomics in literature	23	2.2.3 Design of the end-effector	51	Appendix		BME Articles	A39
1.4 The Patient	30	2.3 The handle design	52	PART 1: Analysis	A3	A: BME Literature study	A40
1.4.1 Anatomy & brain properties	30	2.3.1 Generation 1	52	Appendix 1.1: Interview slides	A4	B: BME Thesis article	A41
1.4.2 Patient profile & Market size estimation	31	2.3.1.2 User Evaluation	54	Appendix 1.2: User survey	A8		
1.5 The Market	32	2.3.1.3 Handle design & the personas	55	Appendix 1.3: User survey follow-up	A9		
1.5.1 DEAM, the company	32	2.3.1.4 Harris profile	55	Appendix 1.4: UR/PS	A11		
1.5.2 The other side of the market	34	2.3.2 Prototype Generation 2	56	Appendix 1.5: Questions hospital purchaser	A12		
1.5.3 Current neuroendoscopic instruments	34	2.3.2.1 Creating the prototypes	56	Appendix 1.6: Cultural study	A13		
1.5.4 Other grip types	35	2.3.2.2 User evaluation	59				
1.5.5 Steerable medical instruments	36	2.3.2.3 Harris Profile	61				
1.5.6 Trends in endoscopic surgery	38	2.4 Design integration	62				
		2.4.1 Introduction	62				
		2.4.2 The mechanism inside the handle	63				
		2.4.3 Handle shape, control design & ergonomics	65	PART 2: Synthesis	A15		
		2.4.4 Manufacturing & assembly	68	Appendix 2.1: MatLab Simulation tip variables	A16		
		2.4.5 Material selection	71	Appendix 2.2: Handle ideation	A17		
		2.4.6 Final test design	76	Appendix 2.3: Second generation ideation	A18		
				Appendix 2.4: 2nd generation prototypes	A22		

# List of figures, tables & Abbreviations

## Figures

- Figure 1. Traditional intraventricular neuroendoscopy
- Figure 2. Rigid (current) vs steerable (future?) instrument
- Figure 3. The three types of unwanted movement
- Figure 4. Method used during the literature study
- Figure 5. Design approach, adapted from IDEO
- Figure 6. Final procedure scenario/project scope
- Figure 7. Preview of follow-up survey
- Figure 8. Evaluation of MDD
- Figure 9. insertion angle influence on handle
- Figure 10. Minop handle with comfortable finger spans from Wagner
- Figure 11. The angle of the endoscope
- Figure 12. Form language LaproFix & LaproFlex
- Figure 13. Analysis of the Minop handle
- Figure 14. Types of handles
- Figure 15. Types of steerable instruments on the market
- Figure 16. The Cambridge Endo
- Figure 17. The r2DRIVE
- Figure 18. Array principle of the VisionSense 3D visualisation
- Figure 19. Persona 1
- Figure 20. Persona 2
- Figure 21. Persona 3
- Figure 22. DEAM tip prototype
- Figure 23. Checking the model with MRI scans
- Figure 24. Prototype at small angle poking out of ventricle
- Figure 25. The tip in the coordinate system used for the simulation, with the tip in green/grey
- Figure 26. Tip design proposals
- Figure 27. DEAM end-effector prototype now optimised for biopsy
- Figure 28. First generation handle design proposals
- Figure 29. A still from showing the set-up. The elbow is visibly raised, however, this is due to the table height.
- Figure 30. The Harris profile evaluating the first concept generation on the user requirements
- Figure 31. Process of developing the second generation of handle concepts
- Figure 32. Second generation handle design proposals
- Figure 33. Test set-up concept

- Figure 34. Dr. Hoving using the prototype in the actual set-up
- Figure 35. The Harris profile evaluating the second concept generation on the user requirements
- Figure 36. Second generation basis & necessary contact surfaces
- Figure 37. The three functions and how they work distally
- Figure 38. Variables to calculate shortening of the steering cables
- Figure 39. Variables to calculate shortening of the steering cables
- Figure 40. The free body diagrams of the end-effector and distal bending control
- Figure 41. Grip patterns & control movements
- Figure 42. Handle dimensions in comparison with the Minop handle
- Figure 43. Render of articulated joystick
- Figure 44. Joystick in prototype, overmold in purple
- Figure 45. The joystick locked into position, with a bend at the tip of around 30°
- Figure 46. The full frame with the mechanism inside can be placed in the gluing tool
- Figure 47. The mold, with the joystick insert
- Figure 48. Filling the mold
- Figure 49. Close-up of the steering cables and core tube exiting the shaft neatly
- Figure 50. Tightening of the screw securing the core tube
- Figure 52. Gluing the steering cables is done with a syringe
- Figure 53. Half of the prototype with all the materials visible
- Figure 54. Exploded view of the prototype. The numbers correspond to the BOM in Appendix 2.10
- Figure 55. CES Edupack output for the shell parts & joystick
- Figure 56. Stresses in the trigger
- Figure 57. Stresses in the frame
- Figure 58. Stresses in the handle shells
- Figure 59. Stresses in the joystick
- Figure 60. The box trainer with at A. the yarn representing a posterior tumor and at B. the yarn representing the ventricle floor
- Figure 61. The box trainer with the endoscope
- Figure 62. Endoscope vision of the yarn
- Figure 63. The 2D model of the articulating tip
- Figure 64. Relevant hand spans, from Wagner [68]
- Figure 65. Interface of the Tracker software
- Figure 66. Mean rating of the device sorted per UR
- Figure 67. Individual movement results
- Figure 68. Mean movement results

## Tables

- Table 1. The audience
- Table 2. Specifications of instruments currently used for neuroendoscopy
- Table 3. Dimensions of game joysticks
- Table 4. User requirements
- Table 5. Tip dimension simulation results with several inputs
- Table 6. Finger spans per participant together with their mean rating of the design

## Abbreviations

CSF	Cerebrospinal fluid
ETV	Endoscopic third ventriculostomy
FoM	Foramen of Monro
HCD	Human-Centered design
INE	Intraventricular Neuroendoscopy
KOL	Key opinion leader
MIS	Minimally invasive surgery
PS	Product specification
SNI	Steerable neuroendoscopic instrument
UR	User requirement

# Introduction

## Intracentricular neuroendoscopy

Intraventricular neuroendoscopy (INE) is a relatively 'new' way to perform brain surgery, endoscopes for neurosurgical application became fully developed around the 1980's [1]. Intraventricular neuroendoscopy is a term for a specific form of brain surgery where an endoscope is brought into the ventricles of the brain, as opposed to opening up the skull and operating through a craniotomy [2]. Roughly all indications for IVE are cerebrospinal fluid pathway (CSF) obstruction, caused by cysts, tumors stenosis or congenital defects. Procedures like endoscopic third ventriculostomy (ETV), septostomy, foraminoplasty, aqueductoplasty, stent placement, and cyst and tumor removal can be performed through IVE [3], [2]. Total resection can be performed on certain tumors. If biopsy by neuroendoscopy confirms presence of a lesion which is impossible to remove by neuroendoscopy, it can be removed through microsurgery or open surgery. Neuroendoscopy is minimally invasive, as the opening that is needed only has a diameter of about 6-8mm, depending on the brand of endoscopic system that is being used. Figure 1 shows what such a procedure looks like, including the vision

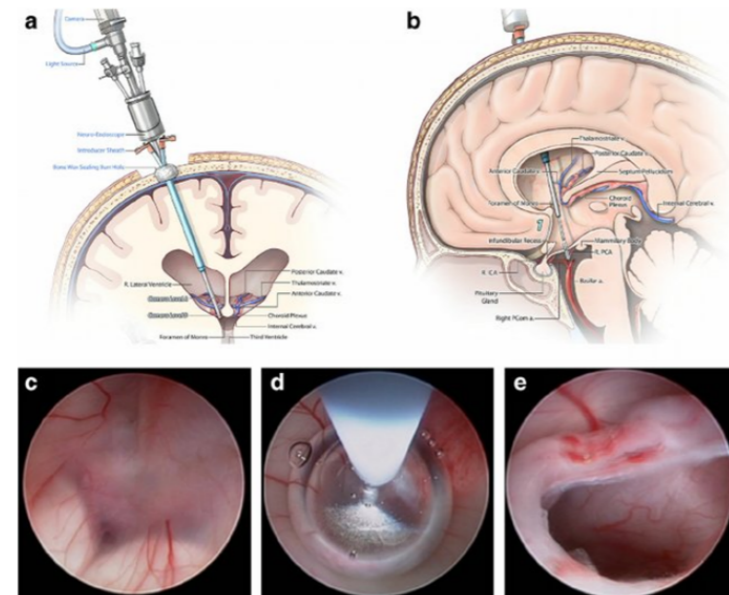

Figure 1. Traditional intraventricular neuroendoscopy [7]

of the surgeon through the endoscope. The benefits of minimally invasive surgery over 'normal' surgery, are; less pain, faster recovery after an operation, earlier return to normal life and better cosmetic results [4]. The benefits of the endoscope over microscopic surgery are the ability to reach places deep inside the brain (where there is not enough light for microsurgery), through narrow surgical corridors, ensuring minimal damage, with clear vision [3]. IVE shortens the recovery time and hospital stay of the patients [5].

The ventricles are cavities inside the brain which regulate pressure of the cerebrospinal fluid (CSF). There are four ventricles: the 2 lateral ventricles, the third and the fourth (see Figure 1). The choroid plexi, a specific type of tissue, inside the ventricles produce the CSF. Intraventricular endoscopy is performed when therapeutic or diagnostic procedures have to be carried out in the ventricles of the brain. Most commonly, the technique is used to treat or diagnose conditions like tumors, cysts and hydrocephalus [6].

The specifics of the intraventricular neuroendoscopic procedure depend on the goal of the surgery (biopsy, fenestration, resection). Nonetheless, for such a minimally invasive procedure, it is important to prepare by studying preoperative images, to make sure that during the procedure, the endoscope is inserted correctly. By drawing a straight line from the location of interest, to the skin, while avoiding vital structures, the entry location on the skin is determined. But, before even determining that route, it has to be determined whether it is even possible to use endoscopy, or whether the anatomy of the patient makes it impossible to enter the ventricles with the endoscopic system (too-small ventricles due to the absence of hydrocephalus, tumors obstructing the way).

When all this has been established, the patient can be called in for surgery, where they are prepared by positioning them and especially their head, the angle with the rest of their body, to make it as comfortable as possible for the surgeon to reach the right location. The planned entry location is indicated on the skin of the patient. Once everything is ready, a hole is drilled in the skull, after which the instruments are introduced one by one.

The actual therapeutic or diagnostic action is carried out once the visualisation through the endoscope is optimised. Instruments like scissors, graspers, forceps but also simple knives, hooks and blunt probes. More advanced instruments can be little balloons and even electrocautery. The situation is constantly monitored on visibility, presence of bleeding and other important circumstances. Once the procedure is carried out, everything is checked once more for bleeding, while the endoscopic system is slowly retracted from the brain. Naturally, after specific periods, follow-up scans are performed.

## Current instruments & challenges

The trocar, endoscope and other instruments are compatible. Today, the rigid endoscopic systems with around 2mm working channels (like the Aesculap MINOP system) are the golden standard for intraventricular endoscopy. These are

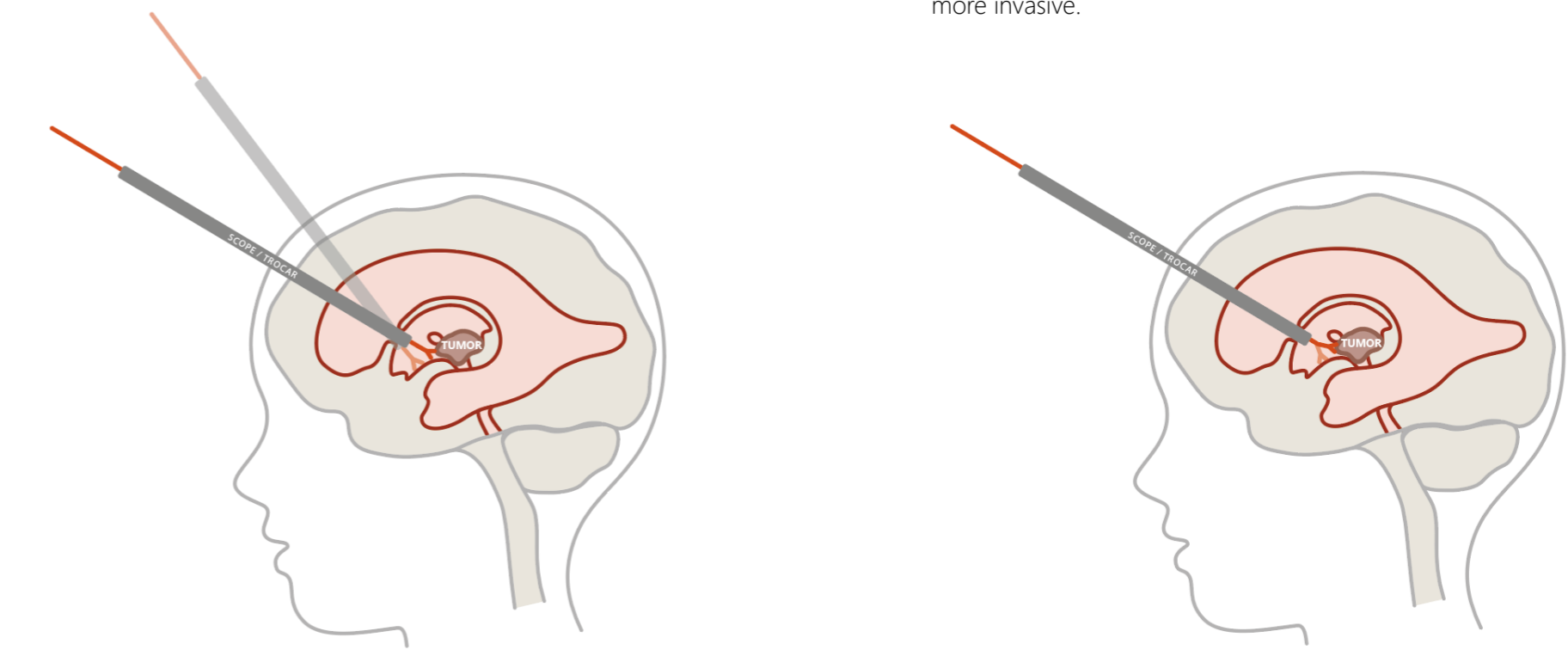

Figure 2. On the left: rigid (current) VS on the right: steerable (future) instrument

rigid systems, where the doctor can choose to use one of several trocars, all with the same length, but with slightly different diameters, depending on the number of working channels. The trocar is always used with a scope and depending on the procedure, other instruments are inserted into the working channel(s).

These rigid instruments pose two main challenges; they have a **limited reach** and once in position, it is close to impossible to reposition without **damaging surrounding tissue**. Accordingly, expanding the reach of the endoscopic instruments as well as minimising movement in the endoscopic system are the primary goals of this project. Additional problems are for instance the fact that there is only one trajectory possible from the skull, through the Foramen of Monro (FoM), to the middle of the third ventricle. If this trajectory is somehow impossible in a patient due to their anatomy, it is impossible to use endoscopy and so the surgery will become much more invasive.



These problems are illustrated in Figure 2.

The repositioning during endoscopy is so dangerous because of the scale; the third ventricle is extremely small (smaller than a ping-pong ball) and large arteries lie extremely close to each other and the instruments [7]. Three types of movement can be identified that at all times must be avoided. Figure 3 illustrates these. This figure will remain important throughout the report. Type 1&2 can occur easily throughout the procedure, whereas type 3 is a more rare. The insertion depth is guarded closely, as unintentionally inserting the system much deeper would have grave consequences.

### The assignment

Having identified these struggles in the clinic, prof. dr. Hoving, clinical director at the Prinses Máxima Centrum for paediatric oncology, together with DEAM, a company specialised in steerable surgical instruments, commissioned this

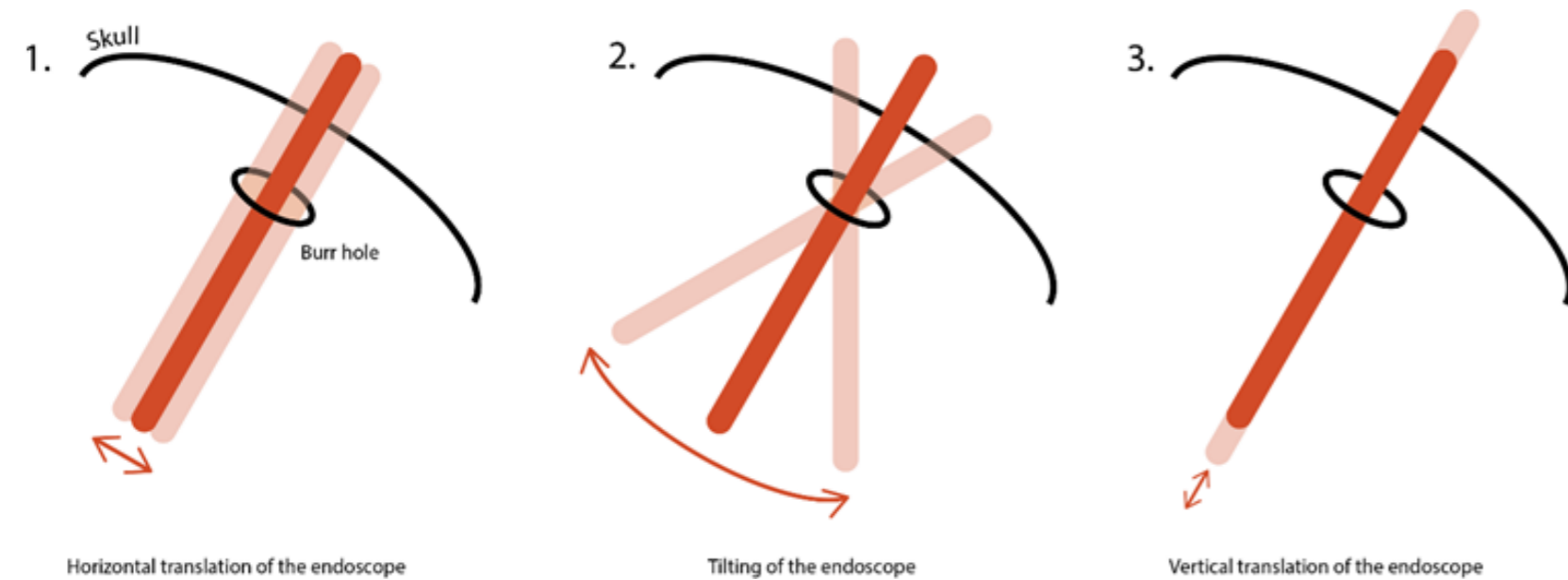

Figure 3. The three types of unwanted movement

graduation project. It was the first step towards the design of a steerable neuroendoscopic forceps, for which extensive literature and user research was performed to find the user requirements and product specifications. Several prototypes were developed and tested with dr. Hoving, before finally creating a fully functional prototype. The user evaluation of this prototype was the final result of the project. The results and recommendations from this evaluation can be used in future development of the instrument.

This project had a very clear expected outcome. Rather than a design process where the optimal solution to a known problem has to be found, or a process where even the problem is still hard to pinpoint, this project starts from a clear wish. The problem is a real daily struggle of the surgeon and the solution, according to the assignors, is an instrument that offers freedom at the tip without introducing unwanted movement in the rest of the system.

# Starting point

Prior to this graduation project, a literature study for the course BME Literature Study (BM51010) was performed, which was concluded by writing an article, in which a theoretical framework to steerability and intraventricular neuroendoscopy was presented. The full study is included in Appendix A. This decision was made to prevent self-plagiarism and clarify whether the information that is stated comes from the study or is generated during the master thesis project.

### Goal & method

The goal was to identify which risks and problems in current day intraventricular neuroendoscopy can be diminished by a steerable instrument design, and to theorise how this could be achieved.

This period was ultimately used to gain a deep understanding, as well as determine the (theoretical) scope of the researches that were left to come, like interviews, questionnaires and observations, which all joined together form the basis of the final design.

Some findings were not conclusive or even completely different from practice, as was found out later. Other topics touched upon in the study, found more elaboration and deepening during the graduation project, after the article was finalised.

The method used during the study is summarised in Figure 4. Three rounds of selecting relevant scientific material were performed, where in the first round the relevant scope (most important INE procedure, most used instruments) was determined. This creates the opportunity to evaluate product requirements for this specific procedure in detail, rather than keeping it vague and universally applicable to several kinds of procedures. In the second round, more specific literature was selected, after which a timeline of such a procedure is created, including all the devices that are being used and the risks and problems that could be encountered. This offers a framework for the analysis after the third round. The third round yielded literature even more specific to those problems and risks. It also offered an insight in where opportunities for improvement lie, with the aim of finding guidelines and requirements for a steerable neuroendoscopic instrument.

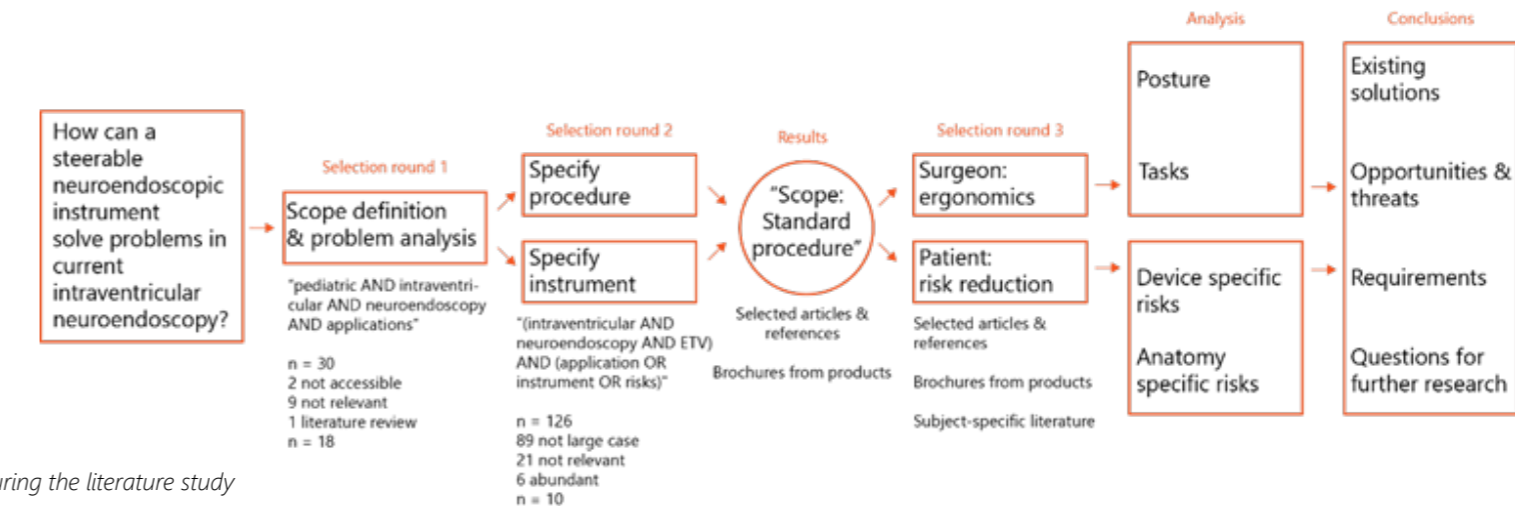

Figure 4. Method used during the literature study

## Conclusion

Two types of findings were presented in the article: 1) the initial scope to this graduation project and 2) additional findings on the current problems in the process of performing a neuroendoscopic procedure, the anatomy and physiology of the brain, ergonomics of the surgeon.

The five most important findings in the first category are:

1. The most often performed procedure is endoscopic third ventriculostomy. This procedure aims to reestablish CSF flow from the third ventricle to the rest of the body, bypassing the fourth ventricle.
2. Most procedures are performed freehand, meaning no fixation system or robot arm is used to keep the endoscope still. The surgeon holds the endoscopic system in their non-dominant hand, while performing the procedure with their other.
3. The most popular brands are GAAB and Minop. The dimensions of these systems need to be kept in mind when designing for them.
4. The endoscopes used during neuroendoscopy have varying angles. The benefit of using an angles lens is being able to “look around” instead of straight ahead. The downside is that orientation is easily lost and vision is counterintuitive.
5. The instruments that would benefit most from steerability are the hinged instruments; think scissors, forceps and graspers. These are used often and for the more complicated tasks, for which precise articulation would be most useful.

The findings of type 2, in the shape of a textual user scenario, can be found in the paper, in Appendix A. From the combined findings, as well as from information gained from talking to experts, the initial project brief was formulated. From there, the rest of the research during the analysis part of this project was carried out. The next section explains how this analysis was approached.

# Approach & method

The methodology that was applied throughout this project sprung from experience, based on previous medical design projects and what worked there: do extremely thorough research in all areas relevant to the clinical problem and keep the stakeholders involved from the beginning to the end. Additionally, use tools like the different types of journey maps and personas to visualise the concrete problem and its context.

The Delft Design Guide also proposes a couple of methods, points of attention and approaches for medical design. It highlights the need for thorough research, through several cycles, to understand what the true challenge is and to design meaningful and sustainable solutions, where they add that it especially critical to understand the healthcare systems and processes. The book also stresses the need for added value for all the stakeholders in medical design and to use co-design or co-creation methods to facilitate creating this value. This approach is very human-centred.

The people of DEAM are true believers of human-centred design as an umbrella approach for their design engineering. They use the HCD handbook to organise their projects and consequently apply other methods to specific challenges. How this approach has played out in a practical sense is their system of creating product requirements. The very start and basis of their projects is to conduct user research, through observation, interviewing and other inquiries, on which they base an extensive set of user requirements. These requirements are in the shape of a wish or a must and can all be translated into several product specifications per user requirement. This set of product specifications shows exactly how the user requirements translate to direct, quantifiable characteristics of the product. They go back and forth, from these two documents, to testing a prototype with the user, to again gain input on the two documents.

The approach of DEAM ties in directly with the suggested HCD approach of the Delft Design Guide and the intended approach described in the first paragraph of this chapter. In every step of this project, the theory can be traced back to these ideas.

These theories translate directly to the practical methods used. For each step of the process, HCD methods were used to involve the user in the decision maker. Before starting user research, the audience was defined, a key step in the IDEO HCD method. During interviews, both premade and live drawings were used. Surveys included illustrations and always offered the opportunity to the respondents to ask questions [9].

All the input was used to frame the assignment better and better, to be certain of creating the most desirable product as a result.

The approach is summarised in Figure 5.

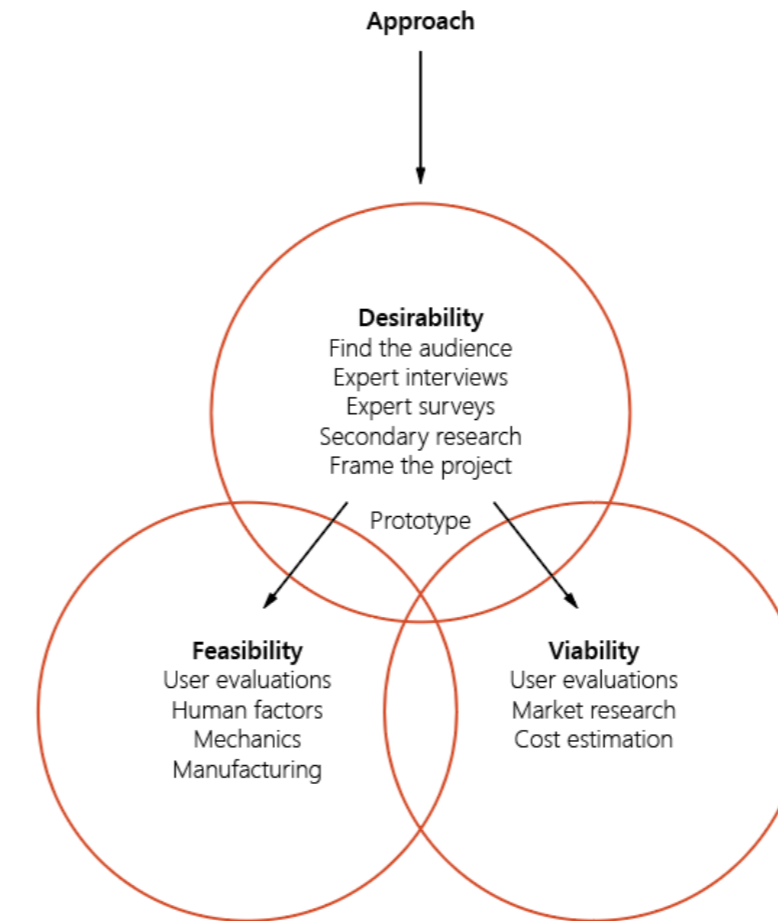
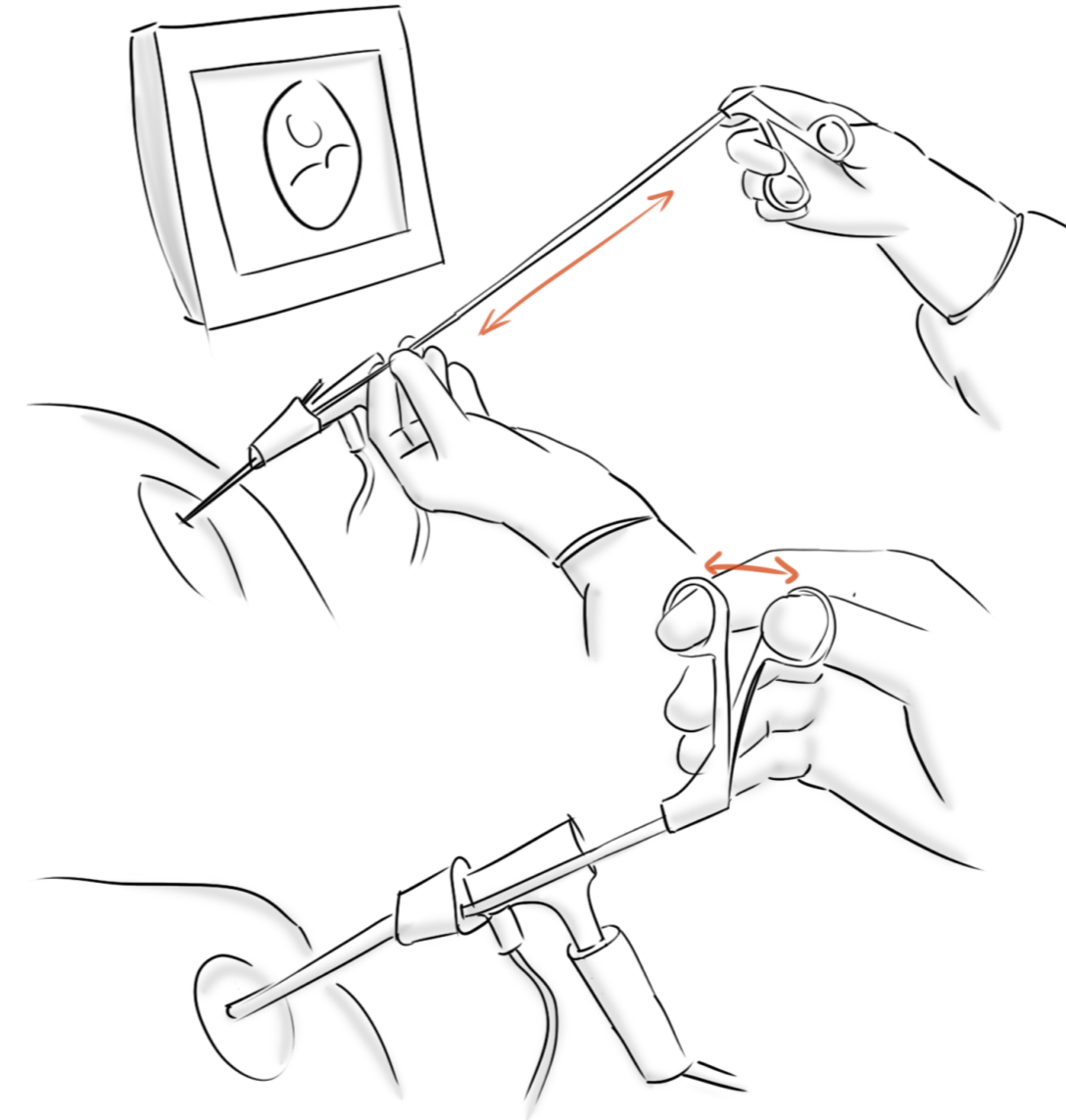

Figure 5. Design approach, adapted from IDEO [9]

## PART 1: Analysis



## 1.1 Introduction

As was explained in the introduction, this project aims to 1) explore & define the problems the neurosurgeon encounters 2) find all possible requirements to the solution and 3) to optimise that solution. The analysis section of this report aims to cover step 1 and most of step 2, by using first using (grey) literature and otherwise generated information to define the context of the product, from manufacturing to usage. This information is then used to set up two researches; a survey and an interview.

In line with the HCD approach, all the findings are translated into a set of user requirements. For each of these requirements, the list specifies whether it is a must or a wish. The rationale is listed per requirement, as well as where the requirement originates from (which part of the user research). The user requirements can be translated into necessary characteristics of the product. That means that one user requirement can result in multiple such characteristics. These characteristics, or product specifications, all correspond to an acceptance criterion and rationale as to why the product specification is important. Sometimes, the rationale refers to literature or other sources, to point out the origin of the acceptance criterion. Creating these documents is not a one-way process. Some requirements or specifications actually originate from user testing during synthesis phase rather than the analysis phase, when old requirements were debunked or the theory seemed incomplete. These specifications largely represent the design decisions, meaning they actually summarise the findings from the analysis phase but also dictate the synthesis phase.

Taking this approach ensures the desirability of the design, from which feasibility and viability will follow, which is why every section will start with why and how it's analysis contributes to defining desirability, and how that leads to feasibility and viability.

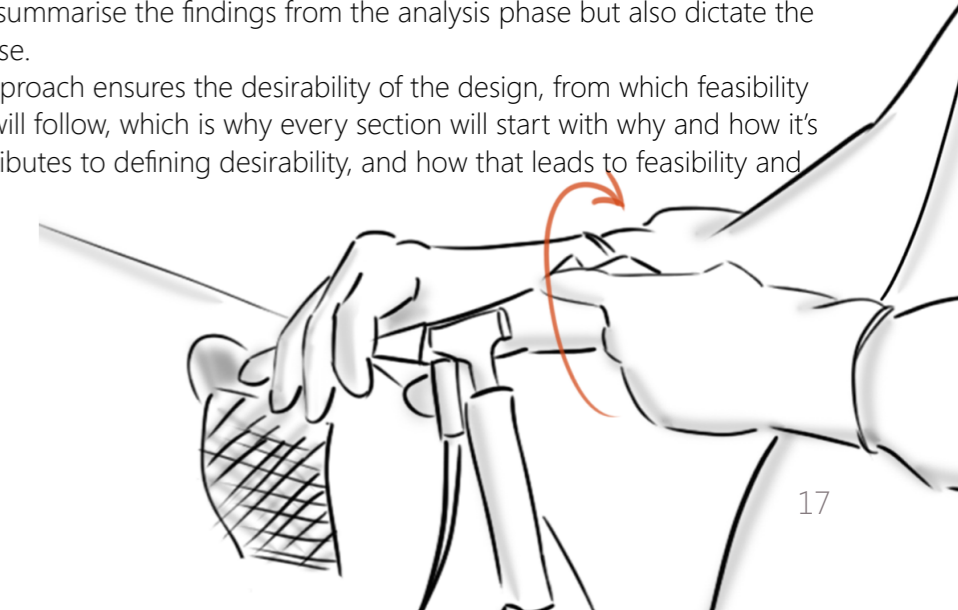

# 1.2 Finding the audience

The first step of the HCD approach should be to identify the users and other stakeholders. How else is one going to find out what is desirable? IDEO calls this “Defining your audience”; Considering the broad spectrum of people who will be touched by the design solution [8].

To do so, a simple brainstorm session to the question “during the full lifecycle, which persons hold a stake in the design of the steerable neuroendoscopic instrument?” was done to come up with all possibly involved parties. Within this project, not all stakeholder’s requirements can be met however. Therefore, the brainstorm session essentially yields two lists; one with the stakeholders that will be considered within this project and one with stakeholders that will not.

The decision on which to include was made based on accessibility for inquiries during the project. This list is presented in Table 1 (in random order).

These 4 stakeholders will be considered (through means of interviews, questionnaires etc.) in every step from now on, next to the project partners (the faculties of IDE, BME, DEAM and Máxima Centre for child oncology).

Table 1: The audience

Stakeholders of the design within project scope	Stake	Role in project	Stakeholders outside project scope	Reason
The Surgeon	End-user	Continuous involvement	Suppliers	Irrelevant at this prototyping stage
DEAM	Engineer/manufacturer/sales	Continuous involvement	Hospital cleaning dpt	Designed for single-use
Hospital purchasing dpt	Judges added value	Consulting at start	Instrument technician	Designed for single-use
Patient	Indirect user	Information from literature	Health insurance	Irrelevant at this prototyping stage
			Investors	Irrelevant at this prototyping stage
			Hospital stock manager	Designed for single use
			Surgical assistant	Less relevant than end-user

# 1.3 The surgeon

First and foremost, the surgeon is the one who will be holding the instrument. Their opinion on what is important concerning the product, the procedure and the rest of the context will be decisive in creating the input that leads to the design of an adequate instrument. The first step to gain in-depth information through a 1.5 hour long expert interview with KOL prof. dr. Hoving. Parallely, 8 neurosurgeons with significant experience in neuroendoscopy filled out a questionnaire concerning all the topics literature research could not cover. This questionnaire was followed up by a more specific worksheet, with illustrations on theories to be tested and even some early ideas. The results from these researches are presented in this section.

## 1.3.1 Interview prof. dr. Hoving

### Objective

The interview with prof. dr. Eelco Hoving was performed first and foremost to initiate generating the design input documents. It was also performed to validate the scope of this project that was specified at the start, based on literature research (see Section “Starting point”) and other findings.

### Method

The initial idea was to do an interview using paper prototypes and other worksheets, to facilitate a fruitful and interactive interview, to try to minimise the knowledge and culture gap between the engineer and the surgeon. However, due to circumstances, the interview was moved to an online environment. To guide the interview, a set of PowerPoint slides was made instead (see Appendix A1). These slides consisted of sketches, as a medium of discussion, as well as the interview questions, so it was easy to go back to the questions and force structure into the conversation. Every slide represented another step of the surgery, to be able to pinpoint where the new instrument could potentially have added value or pose new challenges. During the interview, sketches were made on the screen as well, to be able to really verify the essence of the discussion topics.

### Results

#### New trajectories & the burr hole

Dr. Hoving states that It is not likely that completely new trajectories will become available using the steerable instrument. It is not necessary to find completely new trajectories, as the one that is currently used is more or less safe. The riskiest area to cross is the FoM, close to the fornix. This is where part of the memory of the patient is located. It will rather be small changes in the trajectory, to compensate for distorted anatomy, rather than completely new ways to approach the ventricles. However, he theorises that as transnasal intracranial surgery is being performed, it could possibly be done with the new instrument. All surgeons are used to the standard approach, they know how to do it as long as the anatomy is not too distorted. The question is; is familiarity a good reason to stick to an approach. Since there will probably be no dramatic change in the trajectory, the positioning of the patient will not change too much either. The burrhole size is always bigger than the trocar diameter. It has to be bigger, to go in smoothly, without using force, and to make sure that there is some room for feeling what tissue is being crossed. There is little room for error when entering the brain with the trocar. Small deviations from the planned path can be compensated for by the steerability.

#### Movement in the system

Any movement in the system, whatever the cause, is potentially dangerous. The goal is to have no movement, especially after passing the FoM. That also means that the skull cannot be used to apply force on (by the trocar), as there is a risk that when resting the trocar on the skull, the system tilts and slices through the brain tissue. Additionally: the deeper into the brain, the more risky movement becomes.

#### Dimensions of the system

The dimensions of the articulating end will be a trade-off, as a long tip will be unusable for the large radius of movement. A too-short tip will not have any benefits over a rigid instrument, as it will not be able to reach anything.



The focus point of the camera is another limiting factor. Prof. Hoving estimates it to be at around 20-30mm.

#### Usability

The tip should not necessarily go to the neutral position automatically OR stay locked in a curve. The most important thing is that it is possible to steer and cut or grab at the same time. Additionally, a possible lock should be critically evaluated; the danger with a locking tip is that it damages tissue or might be damaged itself during retraction. There is no tactile feedback in the current systems, but this is not really problematic. It's mostly replaced by vision. It might be difficult to see small steering angles due to the axial vision, but the steering might also contribute to the 3D sensation. This has to be figured out through tests.

There should not be a strict limit to the steering angle for the tip to be impossible to steer out of view by design, as the angle of view is determined by the length of the instrument sticking out the scope.

The weight of the instruments is not critical, as the endoscope + camera is many times heavier than the instruments. This weight is also what causes physical discomfort for the surgeon.

#### Other findings

The length of a procedure is not determined by the speed of every step, but by the number of steps. Meaning, sometimes a procedure is complicated and lengthy because for instance many different instruments have to be used, or the procedure requires a lot of cautery in between tissue removal. However, ETV lasts in general about 30 mins, biopsy about 1h.

The dimensions of the instrument and packaging are not critical when it comes to the space it takes up on the surgical cart. If it is reusable, it has to fit in a sterilisation tray. There is no clinical preference for either reusable or disposable instruments, as long as it does not feel floppy or cheap/plastic-y in the case of disposables. The experience has to be very trust-worthy.

#### New project scope

As mentioned in the Section "Starting Point", the decision was initially made to focus on a specific procedure: ETV. This is a procedure that is performed often and it is a very difficult one, as the third ventricle is extremely small.

However, to really benefit from steerability, it is better to focus on a combined procedure, where there is not only ETV, but also biopsy taking (see Figure 6). Especially since the ETV is carried out in the front of the ventricle, whereas the tumor is usually located more posterior. Even more beneficial: sometimes two burr holes have to be used to do such a combined procedure. Naturally, reducing the number of burr holes from 2 to 1 is extremely beneficial.

To assume the endoscope is used freehand is fair. Using the endoscopic system in such a way creates a more '3D-feel', as it is possible to move the system continuously. Only rare tumor resection procedures that last longer than an hour actually need a fixator arm.

Prof. dr. Hoving has a personal preference for a 0 degree endoscope, as it has the widest view and it's literally the most straightforward.

It is important to plan beforehand which kind is going to be used. It is almost impossible to switch during the surgery.

The hinged instrument is a good choice to design the handle for.

#### Re-evaluation of the findings

The results from the interview described above were discussed again with professor Hoving, mainly focusing on the project boundaries concerning the dimensions of the ventricles and thus the required dimensions of the instrument. The goal was to evaluate whether there is a need for a range of sizes, or it can be assumed that the ventricles are always on the larger side of the 'curve', thinking of the range of ventricle sizes as a normal distribution.

#### Conclusions

The ventricles are almost always enlarged. This definitely gives extra space to work in, also in very young children. Based on this fact, the articulate tip dimensions can be designed. Prof. dr. Hoving also mentions that the Minop system is quite robust and hefty, making it impossible to use in small size ventricles anyway. He also advises to keep to the dimensions of currently used end-effectors, as they are good as they are and not in most need of redesigning. This could be a subject of further investigation (see Recommendations in Section 4). He lists the dimensions as the tip sticking out of the endoscope for about 3-5 mm to be in view and usable. In total, to be able to see the instrument in focus, it has to stick out 20-30 mm.

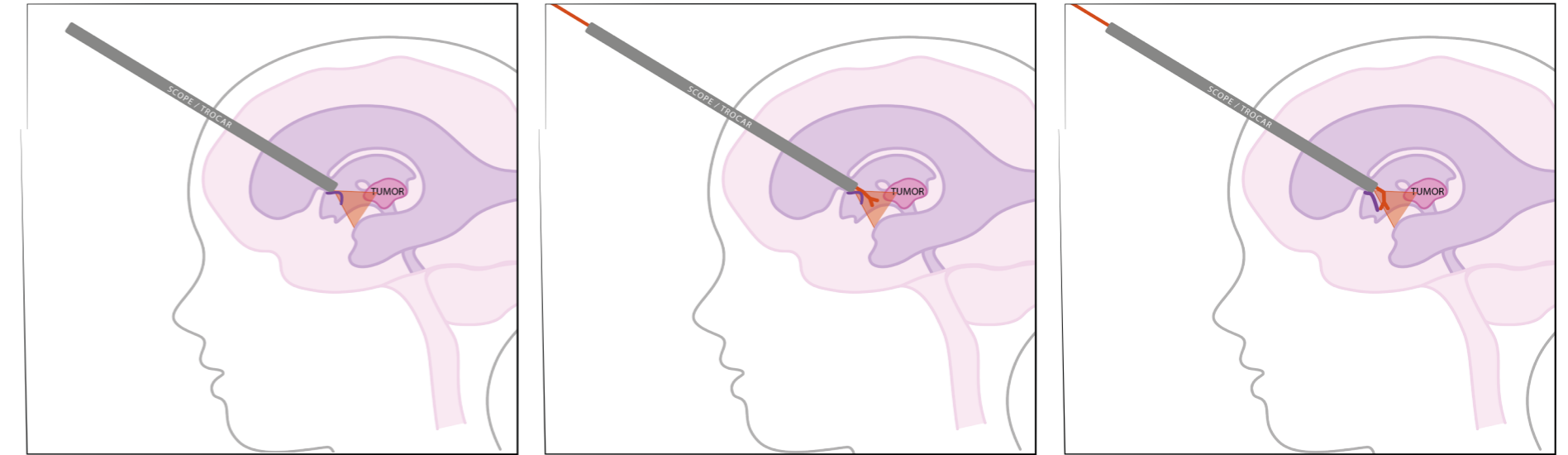

The endoscope is situated in such a way that it has both a) the third ventricle floor AND b) the tumor in view OR c) it can be rotated towards either of these

The steerable instrument is introduced

The surroundings can be rearranged or optimised by moving structures with the steerable tip

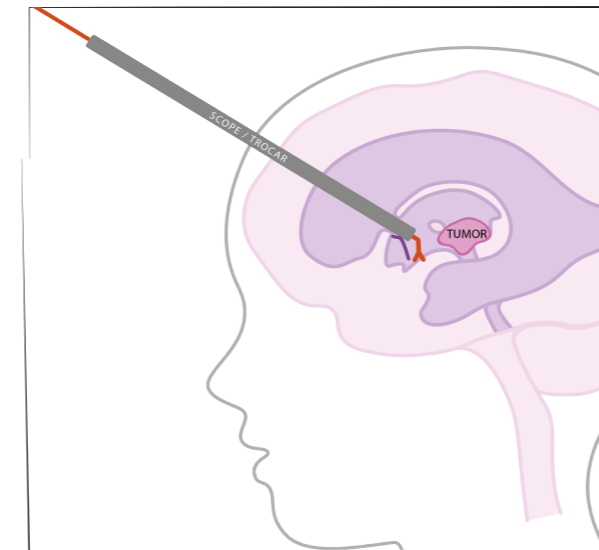

ETV can be performed first, perforating and stretching the fenestration (posterior)

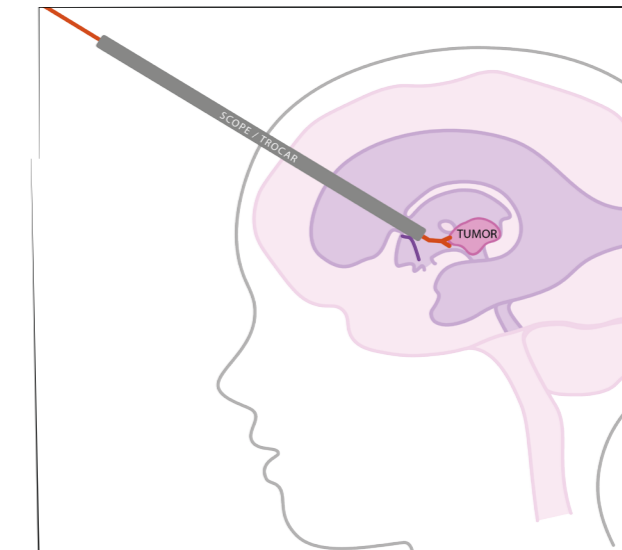

Then, a biopsy can be performed on the tumor, on the complete other side of the ventricle (posterior)

Figure 6. Final procedure scenario/project scope

### 1.3.2 Survey with neurosurgeons

#### Objective

This research aimed to fill knowledge gaps that were identified during the BME literature study as well, which were left open after the interviews and conversations with stakeholders. To fill these gaps, questions specifically covering those topics were formulated.

#### Method

A survey was spread among colleagues of prof. dr. Hoving, as well as neurosurgeons reached through ResearchGate and LinkedIn. There were three core research questions:

1. Are the neurosurgeons aware of a specific culture or trend in neurosurgery, if any?
2. Can the neurosurgeons provide guidelines concerning the dimensions of the steerable tip and if yes, what are they?
3. Can the neurosurgeons indicate any problems related to ergonomics or more generally usability in the current instruments and if yes, which?

These questions were translated into sub-questions addressed to the surgeons. The participants were contacted through 3 channels: Initially, these surgeons were reached through ResearchGate. Only two replied, of which one finally filled in the questions. Additionally, the Canadian contact Kyle Eastwood was contacted to ask whether he could spread the questionnaire in his network and third, prof. dr. Hoving asked his colleagues to fill in the survey. Finally, this yielded 8 participants. Naturally, such a small number of participants does not allow for any kind of statistical analysis, but it nevertheless provided some insights.

#### Results

A table with the plain results is presented in Appendix 1.2. Concerning the question on the culture of neurosurgery, respondents mostly replied there was no way to describe the typical neurosurgeon. However, some replied that there is a trend of neurosurgeons acquiring more and more subspecialisations, instead of being educated as ‘all-round’ neurosurgeons.

All respondents agree that there is a need for innovation in neuroendoscopic instruments and to have an interest in using steerable instruments to perform their surgeries with. The reason for this want to change their instrumentation consists of multiple problems the surgeons experience with it. The reach of the current instruments is very limited, as the instruments can only be used and manipulated in-line with the endoscope. The respondents think the handles of current instruments can be very unpredictable, crude, with a lot of friction, non-ergonomic. A steerable device could offer dexterity and freedom to operate. Right now, it’s largely impossible to reach target areas. Respondents also describe a limited range of instruments and the impossibility of bimanual operation as problems.

The technical specification questions do not all yield majorities, but an overview is more or less: To benefit from steerability, the respondents expect they need a 40-90 degree articulation, in all planes. The respondents would like the articulating tip to be short; around 3mm. They also stated that the tip of the instrument usually sticks out 4-5mm from the trocar. The end-effectors benefiting most from the option of articulation are scissors, bipolar coagulation, biopsy forceps, normal forceps, suction. However, the question was not always understood. The wording the respondents would use to describe the action performed with these instruments is: biting with sharp edges with the option to rotate and twist tissue lose. Bite, cut, perforate, grab. Essentially all actions that were suggested. Current handles have a combination of rotation and a scissor-like movement. There is a lack of fluent movement, they cannot bend. Ergonomics are very important, especially for the fine manipulation. The opening and closing of the instruments is very abrupt.

Concerning the types of endoscope, most chose 3D endoscopy combined with a head-mounted display (HMD), a scope with variable angle and HMD, or 3D endoscopy with a normal display. The respondents mostly did not expect problems concerning the combination of a steerable instrument and a 2D display. The respondents do not expect robot surgery is the future of neurosurgery, as long as hand-held instruments will have tactile feedback and fluent, dynamic, interaction. If in the future the surgeries become more complicated and thus more lengthy, robot surgery might be beneficial, for instance, to hold the endoscope still.

### 1.3.3 Follow-up Survey

As mentioned, a follow-up study was performed with a selection of the respondents of the survey. The worksheet for this study can be found in Appendix 1.3.

This worksheet contained the initial, unclear questions from the survey and the general results, as below which the new, more clearly phrased and illustrated questions were presented (see Figure 7). These questions were completely open, encouraging more thorough replies.

**Originele vraag 1: Hoeveel millimeter steekt het instrument uit de trocar tijdens gebruik?**

**Antwoorden:**

- 16.7%: onbekend
- 16.7%: Afhankelijk van de lens (geschat op 4-5mm)
- 33.3%: 4-5mm
- 33.3%: meer dan 5mm

**Nieuwe vragen:**

1.1 Komt de aangegeven lengte in uw antwoord overeen met de lengte aangegeven in de afbeelding hieronder (Figuur 1)? Indien onjuist, hoe zou u deze lengte nu schatten?

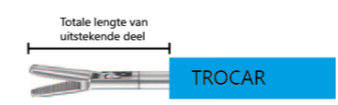

**Figuur 1: Illustratie uitstekend instrument**

1.2 Zijn de afmetingen van de bekjes van de huidige instrumenten (van scharen/biopsietangetjes/paktangetjes) naar behoeven? Of moet die ook worden herontworpen?

Antwoordveld, typ hier uw antwoord

Figure 7. Preview of follow-up survey

#### Results

##### Ergonomics

The respondents agree that the absence of CANS and RSI might be due to the short operating times in neuroendoscopic procedures. However, that does not mean there are not improvements possible, maybe even to an extent where more difficult procedures can be performed endoscopically (now done in open or

microscopic surgery). The weight of the endoscope is the most limiting factor to a comfortable, ergonomic posture for the surgeon. Fixation of the endoscopic system is possible, but this is also very limiting during surgery. It inhibits any movement, so also tiny, necessary adjustments.

##### Type of endoscope

The most significant problem is being limited to having to work in-line with the trocar. Meaning, the planning of the trajectory is so crucial and prone to mistakes. That means sometimes even 2 trajectories are needed to perform one procedure. A variable angle endoscope is not necessary, as long as the tip stays within vision. If necessary, one could switch to another camera with another angle. However, it is less intuitive to use than a fixed angle endoscope, as the loss of orientation is easily induced by changing the angle of view.

##### Shaft length

The respondents agree that adding steerability will introduce unavoidable extra length of the shaft exiting the trocar. The respondents estimate that most instruments’ end-effectors have a length of 4-10mm. The respondents estimate an added 5mm, so including the end-effector, that is a total of 12-15mm. They do however state that the shorter the total tip can be, the better, as not all ventricles are large enough to accommodate for the 15mm tip. The current end-effectors work perfectly fine and do not need any improvements. Many shapes and sizes are already available. They also agree that the smaller the bending radius is, the better, as it would prevent the tip from swaying into tissue.

#### Discussion

There is still the possibility that the questions asked in this follow-up were too abstract, but the answers did not seem to reflect that. Quality information on the dimensions of the tip were obtained, as well as on the specifics of the significance of ergonomic design for neuroendoscopy. This information, together with that of the survey and the interview made it quite literally to the user requirement document (see Appendix 1.4)

### 1.3.4 Ergonomics in literature

As part of the research on the surgeon, a literature study was performed on the ergonomics of the hand. It is expected that the intended users can only partly indicate their needs when it comes to the ergonomics of the handle. That is why a short literature research was performed to be able to find such requirements. The theoretical background ensures the feasibility of the new design.

Matern et al state: “The ergonomic deficiencies of various minimally invasive surgery (MIS) instrument handles are well-known.”

For laparoscopic instruments, quite some research has already been performed to provide design requirements [31], [61]. These surgeries can take hours and the proper body and hand posture are critical. However, it is a fact that neuroendoscopic surgeries are relatively short, so the posture is less critical. This is reflected in literature, as there is no literature to be found on problems in ergonomics specifically in neurosurgeons. It is thus neither possible to perform a study on the size of the problem nor on the specific problems encountered during the use of current instruments.

An insight in the ergonomic problems arising from performing minimally invasive surgery: Nearly 20% of surgeons in the UK and the US have stated to have to retire early due to physical complaints caused by performing laparoscopic surgeries, where 76% has experienced back pain while performing laparoscopic surgery [62].

However, the complaints that result from performing laparoscopic surgery cannot be assumed as the same complaints in neurosurgeons (for the results on complaints in neurosurgeons, see Section 1.3.1, 1.3.2 and 1.3.3 about the interview and surveys).

General guidelines for the instrument were already presented in the BME literature study, which can be found in Appendix A). This section aims to find what, generally, are the complaints in surgeons when using precision instruments and whether there are any specific design requirements to be found when it comes to such precision instruments concerning the anatomy of the hand.

#### *Work-related musculoskeletal disorders in neurosurgeons*

A study by Gadjudj et al. from February this year looks into complaints specifically in neurosurgeons. They found that in 417 respondents, 33.1% stated that the operating room is furnished ergonomically and 90.7% stated that ergonomics is an underexposed field in neurosurgery [63]. The fact that this study just came out

also illustrates the novelty of this field of design for ergonomics.

90.7% is a disappointingly high percentage. However, only half of the respondents performed endoscopic procedures, meaning that the problem can be in mostly microsurgery for instance. 24.5% does agree that minimally invasive surgery (MIS) causes more physical discomfort than traditional surgery, but endoscopy is in the bottom, ranking below microsurgery (in likeliness to cause pain or discomfort). 25.8% disagrees with that. When performing MIS procedures, physical complaints concentrate in the neck and back. This is usually caused by the operating table or monitor being positioned at the wrong height [64]. That kind of OR furnishing is out of the scope of this project.

The wrists cause problems in up to 50% of the cases and the fingers up to 30%.

This is within scope. The rest of this chapter investigates how these numbers could be reduced by using the limitations of human anatomy as design input.

#### *General Anatomy of the Hand*

The anatomy of the hand imposes specific limitations in movement on specific fingers, meaning that some fingers are more fit for a specific task than another finger. How tendons are attached makes it almost impossible for one finger to move relative to the other, for instance. These limitations make that there is only a limited amount of types of grip patterns. This section gives a short overview of those limitations, and how they influence the design.

The hand and its structure is made up from how the 27 bones that are inside are shaped. There are 8 bones in the wrist, 5 in the palm and 14 in the fingers. All fingers have three of these bones, the phalanges, whereas the thumb has two.

The size and specific shape of these bones and how they interact with the extrinsic and intrinsic muscles determines the size of the hand and how much force can be exerted with it [65], [66]. The phalanges enable simple hinged flexion and extension (and some very limited ab- and adduction, to be complete), whereas the bones in the thumb enable flexion, extension, abduction, adduction and opposition. The hand is a very complex body part and still a subject of a lot of scientific studies.

Extension of the fingers is weaker than flexion, the hand is made for grabbing rather than spreading [67]. Flexing the fingers forcefully is done by the extrinsic muscles, whereas the delicate movements are done with the intrinsic muscles. Especially the movements of the thumb are important in precise activities, as it has the greatest degree of independence. The index finger is the next in line, as it

also has a great degree of independence.

The other fingers have comparable functionality. The little finger is the 5th digit of the hand. It is used the least, compared to the other fingers. It also has the smallest range of motion [68]. The little finger and the ring finger share an extending tendon, making it close to impossible to extend these fingers separately [66].

All fingers together are super powerful and can exert a great amount of gripping force, about which more in a later section [69].

#### *Types of grasping*

There are roughly two types of grasps: the power grasp and the precision grasp. In the power grasp, there is no further movement in the hand, all movements come from the arm. The precision grasp is the opposite, where all the movement in the system is produced by finger or hand movements. Naturally, a combination can occur, which is called an ‘intermediate grasp’.

Then, there are three types of opposition when holding a product: 1) Pad opposition: hand surfaces are parallel to the palm (like in holding a pen), 2) Palm opposition: hand surfaces are perpendicular to the palm (like in holding a hammer) and 3) Side opposition: hand surfaces move transversally to the palm (holding a key) [70].

Then, there are several ways to classify grip types. One of those consists of a set of 7 grip types [71]:

1. Hammer grip
2. Baseball batter grip
3. Precision grip (tip to tip)
4. Lateral Prehension
5. Key grip
6. Hook grip
7. Tripod (pen) grip

These grip types are important to keep in mind when designing a handle, as they describe the naturally occurring ways for human hands to grab and hold objects and instruments. Meaning, when the grip of a new product resembles one of these, it can be assumed that holding the new product will be intuitive (it does not mean operating the instrument will be).

Since precision is important during neurosurgery, the tip to tip grip could be

applied in the new instrument. However, most handles of surgical instruments are based on the hammer grip (pistol, shank, see Section 1.5.3).

#### *Control input*

The steering technology from DEAM requires the incorporation of some sort of ball joint inside the handle. There is a limited amount of options to do so, especially when taking into account movement in the system should be prevented. During the analysis phase, it was assumed a joystick would be the only solution, which was confirmed during the evaluation of the first generation handle concepts (see Section 2.2.3).

No studies seem to exist specifically addressing the comfortable forces in operating a finger joystick, which is why a broader, less deep search was performed for this section. Most studies focus on either pinch force or some sort of power grip force.

#### *Thumb*

The thumb plays a critical role in performing successful manipulation tasks because of its strength, stability, mobility and dexterity [72]. It is thus no wonder all game controllers, over the years, have had joysticks operated by the thumb [73]. The NES max 1988 was the first controller with a thumb pad based joystick controller [74]. It is thus important to explore the ergonomics of the thumb.

Thumb joysticks are operated by performing thumb abduction and adduction, as well as flexion and extension of the thumb, with the rest of the hand in palm opposition [72].

#### *The thumb's range of motion*

The range of motion of the thumb can be described in forced circumduction:

- 102.8 ± 9.9 mm abduction/adduction

- 130.7 ± 14.1 mm in flexion/extension

Or in operational (comfortable random movement):

- 67.3 ± 16.1 mm abduction/adduction

- 73.1 ± 18.0 mm flexion/extension

Which is significantly lower than that of circumduction (p 5 0.001). [72] However, there is also a minimal detectable deviation (MDD). Imaginably, a too-small movement is not easy to control or even impossible to make.



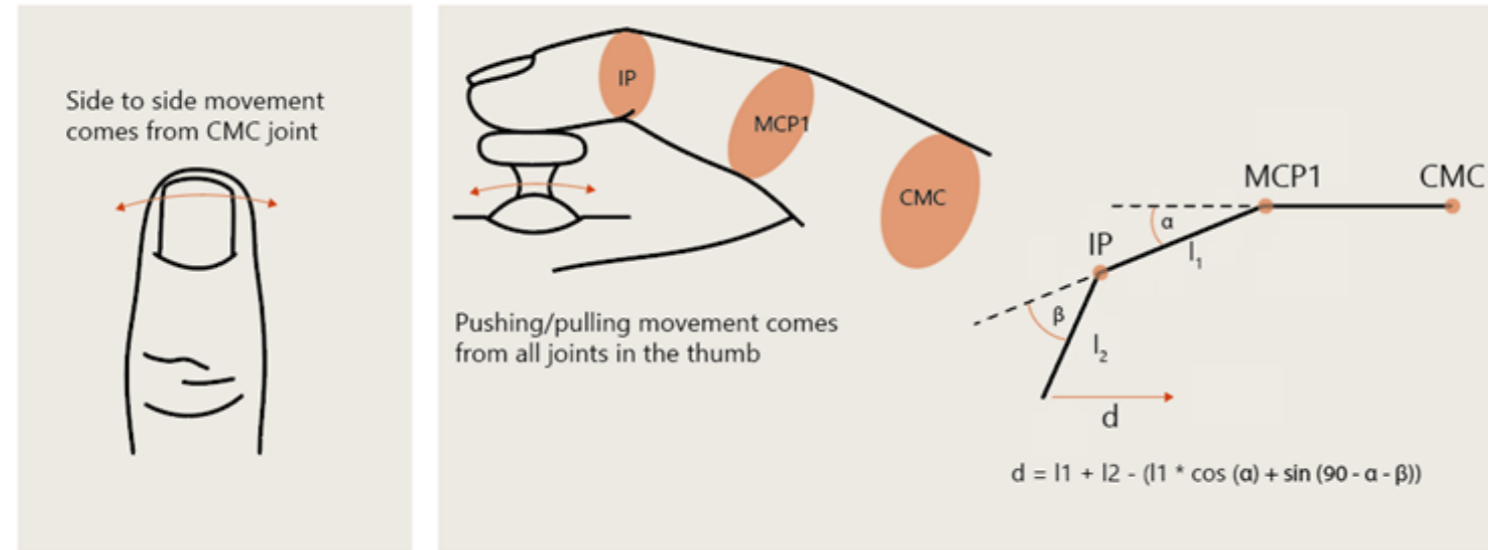

Figure 8. Evaluation of MDD

It is impossible to find the MDD of the thumb related to joystick control, so this has to be found by viewing the thumb as a set of segments, connected by hinges (the joints). These segments and joints are illustrated in Figure 8. The joints are the interphalangeal joint (IP), the metacarpophalangeal joint (MCP1) and the carpometacarpal (CMC), from distal to proximal. The movement in the MCP1 is 14-19°, IP: 14-30° [75], in the CMC: 7.1-16.5° [76] and in the Lpd: 21.67 ± 1.6mm, Lpp: 31.57 ± 3.13mm [77]. Using the means, the MDD is around 6mm.

#### Force

As mentioned, there is no such thing as 'comfortable joystick force'. However, depending on the action that is performed, the weight and diameter of the product that is being held/manipulated (grip span), literature shows that the mean force the thumb can exert ranges anywhere from 2.4-8.3 Newton [69]. The forces measured in these studies were measured while doing normal, comfortable grasping tasks, meaning the force is measured normal to the surface of the sensor [69].

Considering pure ab- and adduction of the thumb, these values range from 8.5N

(40-54 kg women) to 23.4 N (91.2-97.5 kg men) and 53.1N (40-54 kg women) to 85.7 N (91.2-97.5 kg men), respectively. However, these values are found by measuring the maximum forces, not comfortable forces [78].

Other factors like amount of repetitions, the build of the user, the gender as well as whether the dominant hand is used (it is assumed it is), will also influence the performance of the thumb, as with any other ergonomic measure [79].

Daams points out that 'comfort is controversial', because there is no standard method of measurement [80]. Is it 50% of the max force? Or 10%? The order difference between the 2.4-8.3N in normal tasks, vs the 85.7 N in the maximum force task (although another movement), might indicate it's rather 10% than 50%. For now, it seems most appropriate to assume a comfortable force for joystick use with the thumb at around 2N.

#### Wrist steering

Another option for steering the tip is using the wrist joint. This is how the LaproFlex is used, so it would be a logical option to apply the same method in this device. Since it is already being applied in the LaproFlex, a set of specifications

to this type of steering already exists. Being able to use these would be a nice short cut, if not for the following; This type of steering was tested in the first user evaluation session (see Section 2.3.1). Dr. Hoving did not prefer this type of actuation, as it would introduce too much movement in the system. This is also the reason the existing knowledge about wrist steering is not presented here.

#### End-effector control

For the operation of the trigger/ end-effector control, any finger but the pinky and the ring finger (on its own) are suitable, as it requires some force and quite a lot of precision. However, the thumb is already occupied. Depending on whether the control will be in the shape of a button, trigger, lever, slider, the most suitable finger should be selected, based on the knowledge from this chapter. Precision is usually achieved by using the distal phalanges of the finger [61].

Section 2.3.1 in Synthesis presents which and how the end-effector control was chosen and how the corresponding product specifications were chosen. The Handbook of Human Factors in Medical Device Design by Wiklund et al was used for that purpose.

#### Insertion angle

As was found in literature and later confirmed with prof. dr. Hoving (see Section 1.6.2 and 2.2.2), the insertion angle can vary, as the steerability enables the surgeon to use the optimal trajectory from the scalp to the target area.

That means, in order to facilitate the appropriate posture as found in literature the handle must facilitate several ways to be held, see Figure 9.

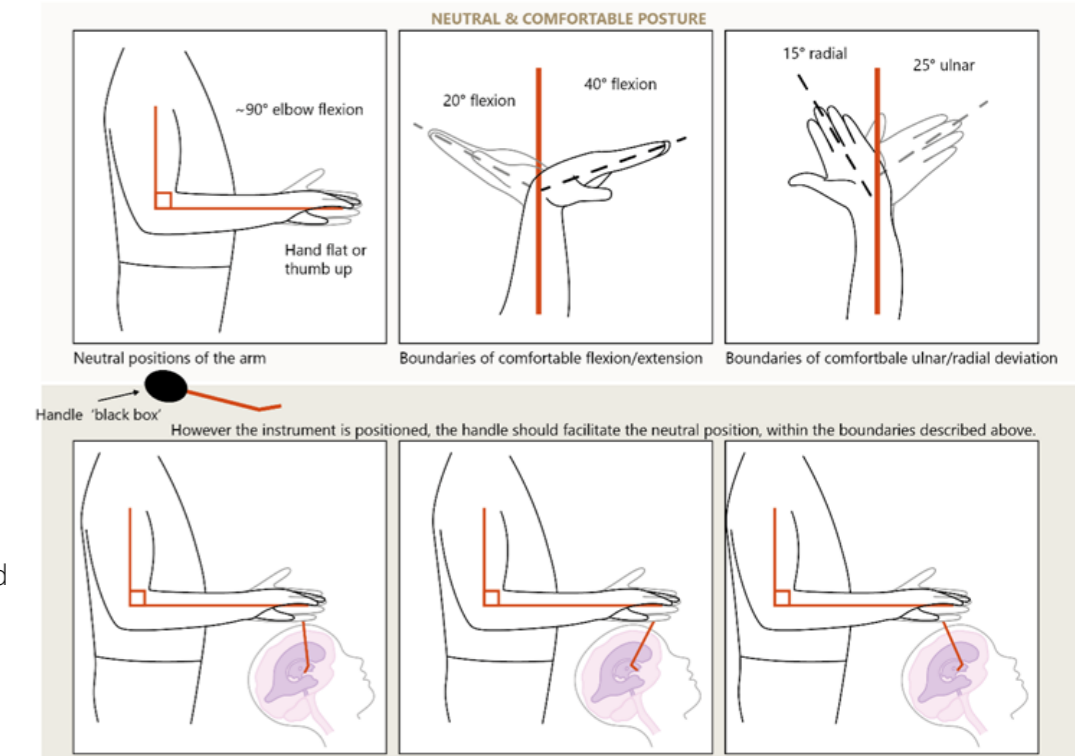

Figure 9. insertion angle influence on handle based on article by van Veelen et al. [81]

### Sensory feedback

An interesting subject in tool design is feedback design. Manual minimally invasive surgery (MIS), surgeons feel the interaction of the instrument with the patient via a long shaft, which eliminates tactile cues and masks force cues. This leads to increased intra-operative injury [82].

When using a tool, the user should receive tactile (pressure, impact, changes in texture), visual (text indicating measurements, lights) and/or auditory (clicks for step-wise rotary wheels, a hum from electrocautery devices) feedback of the status of the tool and the task. The Handbook of Human Factors in Medical Device Design prescribes design guidelines concerning sensory feedback:

1. Some form of sensory feedback is essential
2. Tactile feedback should be applied when possible
3. Visual scales should have good contrast and readability
4. Avoid using scales on handles, where the scale can be obscured by the hand holding the device [61]

It was decided to not include any electrical components in the new design, for the sake of reasonable pricing as well as safety.

Table 3. Dimensions of game joysticks

Console	Stick diameter [mm]	Pad diameter [mm]	Stick length [mm]
Wii	10	16	6
PlayStation	9.5	18	4
Switch	4	15	4
xBox	10	18	5

In game controllers, the sockets of the joysticks are sometimes shaped like a hexagon or an octagon, giving both tactile and visual feedback on the position of the joystick.

Many other feedback solutions are usually quite simple to incorporate. Visual indications can be applied almost always (except for the ones that require electricity), but are not necessarily the best solutions, as they can be obscured

by the hand during use, or otherwise not always legible (too small letters, not enough contrast possible).

Tactile and auditory feedback require some more work, as they're often part of some sort of mechanism. They are however more intuitive.

For comparison, the dimensions of a couple of thumb sticks were measured, see Table 2.

### Conclusion

Altogether, the most important conclusion is the necessity to link each finger to an appropriate function. The thumb and index finger are the most flexible and have the largest reach and are also the best at moving independently. They are most suitable to use for the precision tasks of controlling the end-effector control and the joystick of the steerable tip.

The force and reach envelope of all fingers naturally depends on the size of the hand. However, some broad guidelines can be derived from the investigation. The thumb can exert, when 2-3N the force is around 3.5N ( $3 < F < 4$ ).

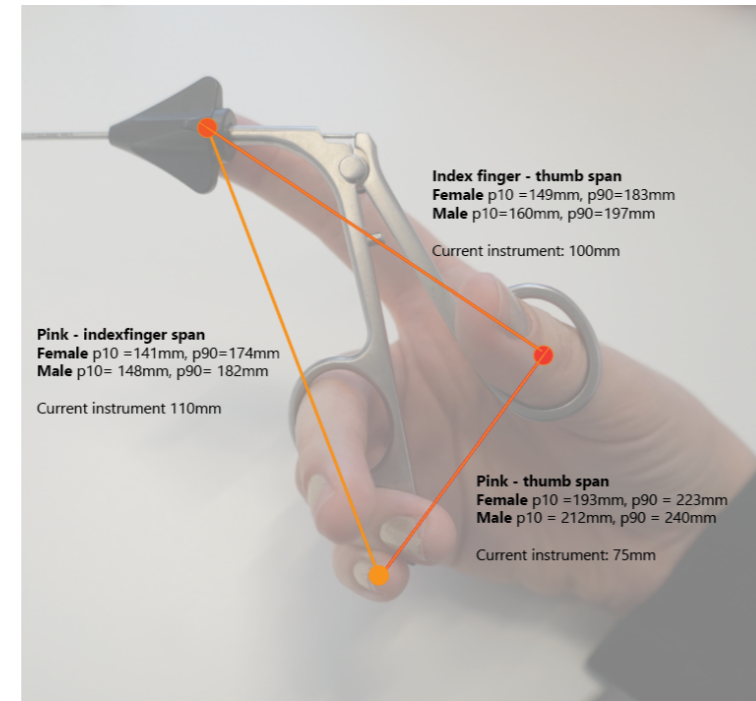

Figure 10. 2mm shaft handle for Minop instrument with comfortable finger spans from Wagner

The most important measurements are shown in Figure 10, projected over the old instrument, together with the current measurements of the instrument. This instrument is the golden standard and very much appreciated by its users. These dimensions can be used as a base for the design, however, the grip type will probably change, as a new control (for steerability) has to be incorporated. The design of the joystick and the feedback it gives to the user should be kept simple yet effective; the shape and dimensions of the stick determine how well the movement at the joystick represents the movement at the tip.

From the findings in this section, the table below was created (Table 4), depicting the suitability of each finger per control type.

Table 4. Finger suitability for the three functions

	Thumb finger	Index finger	Middle finger	Ring finger	Little finger	Little&ring	Ring&middle	Middle&Index
Rotation	Yes	Yes	Yes	Maybe	Not probable	Not probable	Not probable	Not probable
Steering	Yes	Maybe	Maybe	Not probable	Not probable	Maybe	Maybe	Maybe
Opening/closing end-effector	Yes	Yes	Yes	Maybe	Maybe	Yes	Yes	Yes

# 1.4 The Patient

The next audience member or stakeholder is the patient. The patient is an indirect user of the product, as should benefit from the introduction of steerability. The way this indirect user influences steerability is by how the instrument will have to accommodate for characteristics of the patients, like how their anatomy generally looks, how they are positioned for surgery and how many patients even present with treatable ventricle related problems.

## 1.4.1 Anatomy & brain properties

The human brain is an endlessly intricate organ. As mentioned in the introduction, there are four ventricles inside, of which the third is the focus during this project. Beyond those ventricles, there are veins, arteries, structures that house the memory, speech, that produce hormones or control your muscles. This section aims to briefly list the specifications of the most relevant anatomical structures to the design of the new instrument for combined ETV and biopsy. The third ventricle varies in size enormously, depending on whether the patient has hydrocephaly or other problems with pressure regulation in the ventricles. In normal brains, the third ventricle is about 3x6x18mm [10]. In hydrocephalic

brains, this is about 9.5-27.5mm with a mean of 14.5 (width) by 10.9-26.3mm with a mean of 16 (height) by 35mm (depth) [10], [10]. Since the results from the survey showed that most neuroendoscopic procedures are performed in enlarged ventricles (since the endoscopic system simply does not fit inside small ventricles), it is deemed safe to assume the physical design space of the articulate tip is somewhere close to the means of the dimensions of the hydrocephalic third ventricle. A tumor or any other type of suspicious tissue can be located anywhere in the depth of the ventricle, usually posterior to the FoM. For a successful diagnosis, Cappabianca et al. advice at least three biopsy specimens. The biopsy forceps thus have to be robust enough to do so. The forceps should also be able to grab a loose piece of other tissue or stretch the ventriculostomy by opening the end effector [3]. Then, the burr hole placement and the route to the FoM and consecutively the third ventricle has to be taken into account. The standard placement is just 2-3cm lateral of the medial line and 12 cm from the nose bridge (or 2cm frontal of the coronal suture) [11]. That means that, assuming a 2cm burr hole placement variation in all directions, the trocar is at an angle of 15° in the lateral plane, measured from the FoM, between the instrument and the y-axis, see Figure 11, -10° and +40° [12]. The FoM itself also varies in size, making it more or less difficult to orient an place the endoscopic system. It ranges from 1.9-21.9 x 1.6-28.5 (mean 7.3x7.4) [10]. The steerability of the tip needs to compensate for the lack of room that is present in the FoM, as this narrow channel usually is the limiting factor to minor adjustments of the shaft of the system after placement [11]. Concerning the mechanical properties of the brain tissue; there really is no way to pinpoint or quantify it. The tissue's properties vary throughout the brain, but also depending on the kind of surgery that is being performed and the CSF pressure. The only thing that is known is that it behaves non-linear viscoelastically [13]. some studies have measured the forces that are exerted by neuroendoscopic instruments during specific procedures [44]. These studies were summarised by Eastwood, where it was concluded that they lie between 0.01N and 0.5N.

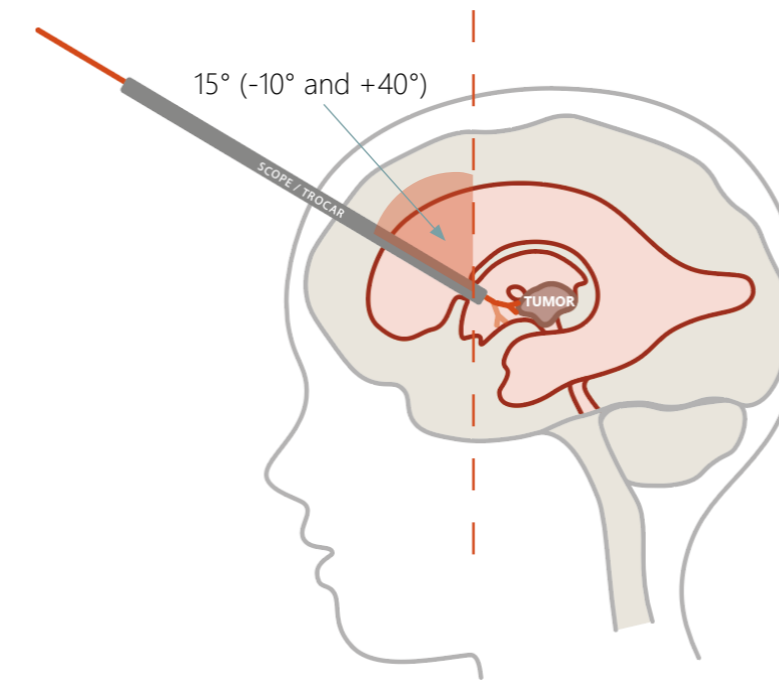

Figure 11. The angle of the endoscope

## 1.4.2 Patient profile & Market size estimation

In any case, the market size is small. Neuroendoscopic procedures are rare, for a reason. Instruments are just not adequate for most conditions of the ventricles. A grant application for robot technology for neuroendoscopy states that neuroendoscopy is only applied in 5% of the potential cases for neuroendoscopic treatment, which makes up 1% of all brain surgeries [15]. It is difficult to find any statistics concerning the amount of such procedures and thus to estimate the market size, although trend watchers seem to expect growth over the next 5 years [16]. There are roughly two cases where the instruments are inadequate: when the ventricular system is too small for the trocar to enter, in which case the introduction of a steerable instrument will not offer a solution. The amount of patients for whom the instrument could offer a solution, while considering the amount of available neurosurgeons specialised in endoscopy determines the market size. One can take several approaches to estimate that

amount of patients. According to Zorgkaart Nederland, there are 153 registered neurosurgeons in The Netherlands [17], of which only a small portion is specialised in neuroendoscopy and or paediatric neurosurgery. According to that same website, 7 neurosurgeons are specialised in paediatric neurosurgery. The website does not list the amount of surgeons specialised in endoscopy. The International federation of neuroendoscopy was contacted for information on their members per country. The International Federation of Neuroendoscopy has 4 members in The Netherlands, 66 members in Europe and 249 members worldwide. All these surgeons can be seen as potential users. In the Dutch UMCG, 154 children received ETV between 1998 and 2007, so roughly 15 a year [18]. Extrapolating by assuming a similar amount in all academic hospitals, that would be ~150 a year in NL. Additionally, the amount of babies born with a some condition related to hydrocephalus was found. >200 babies born per year in NL possibly needing neuroendoscopic procedure, assuming all these babies with could be treated with such a procedure [19]. This number was estimated by finding the incidence of aqueductal stenosis, pineal tumor, tectal plate tumor, 4th ventricle tumor, Dandy-Walker syndrome and Chiari I and multiplying this by the amount of babies born a year in The Netherlands [20], [21], [22], [23], [24], [25], [26]. The amount of indications that develop during the first years of life is harder to estimate.

Concluding, it is difficult to estimate the market size, as the introduction would hopefully increase the market size, but by an unknown amount. The market is small and the initial amount of users (neurosurgeons) in The Netherlands is estimated at around 10-20 (of the 153 neurosurgeons in NL). Assuming they all have an average of 10-30 endoscopic procedures a year (from the averages presented above), that would be max. 20\*30=600 procedures a year right now where the new, articulate instrument could be used. Assuming that the steerability would increase the amount of indications by 95% (from the estimated 5% it has now), that would result in 12.000 pieces needed for the first year. This is the most optimistic case. In more distant future, a miniature steerable instrument like the one designed during this project, might be useful for other procedures (other neurosurgery that does not take place inside the ventricles for instance).





# 1.5 The Market

This section represents the other two members of the audience introduced in Section 1.2. It introduces the family of products the new design will belong to, and how that family affects the design requirements.

## 1.5.1 DEAM, the company

### Objective

The goal of this chapter is to learn about DEAM, their vision, competences and strategy. This information will be used to determine requirements for the new steerable instrument. As the expected outcome is a steerable instrument for intraventricular neuroendoscopy, it is not the goal to determine the new strategy for DEAM, but rather to elaborate on the one they have chosen by launching this project.

### Method

The findings are concluded from experience of working at DEAM, analysing the website and conversations with employees of DEAM.

### History

DEAM could be described as a TU Delft spin-off, as their starting point was a technology developed at the BITE Group, a research group in bio-inspired design at the faculty of 3mE. This technique is a steering technique inspired by the tentacles of an octopus. After years of development, they were able to bring a steerable laparoscopic instrument to the market: The Laproflex. The handle they have designed for this product was innovative enough on its own to also be applied to a rigid instrument as well, The Laprofix. The company was not always meant to manufacture their own products. The initial strategy was to sell the steering technique to large medical device companies, where it would be more efficient to develop the technique into products. However, these projects did not always took off to the likings of DEAM or the other party, which is why they have transitioned to a design & manufacturing company. The team is still growing, as DEAM starts to sell more of their products.

Currently, there are 10 permanent employees, from sales experts to engineers and production employees. For manufacturing their products, they have a production facility and cleanroom in place.

### Vision & ambition

The ambition of DEAM as stated on their website is: “DEAM makes steerable instruments to facilitate the work of surgeons. Together we achieve the best and most beautiful solutions for our users through observations, thought processes and performance.”

By applying a fourfold vision [27]:

1. A fair price: Everyone wants affordable care. We contribute by being honest and transparent in our pricing.
2. Small ecological footprint: We manufacture as much as possible ourselves and our suppliers are close by.
3. Human centered design: Observation determines our design choices – ergonomics and steerability ensure user satisfaction.
4. “If we do something, we do it champions league level” (goal = highest level/first class engineering and design)

The first and second statements of the vision were of guidance during this project too. The third statement plays a role, but it is not the focus to create a sustainable design, as that would imply a whole new set of product requirements and make it very difficult to design within the available timeframe.

### Portfolio

The portfolio currently consists of the two products, described above. However, DEAM is constantly looking into developing new, steerable medical devices. The Laproflex is the most important one: A steerable laparoscopic instrument, with 4 available end-effectors. It has a 60

degree bending angle in ‘all’ directions. It also has 360 degrees of rotation. It is thus not continuous. The handle is designed in such a way that it facilitates a natural position of the hand, without pressure points. Its diameter is 5mm, the shaft has a length of 320mm. The Laprofix is exactly the same, except for the absence of steerability. In Figure , the green one is the Laprofix, whereas the Laproflex is blue. These single colour accents highlight the actuators. The other usecases are the ridges on the rotator actuator. The form language and other aspects of the instrument were evaluated in Figure 12.

Wimold, DEAM’s CEO, highlights that the design is based on designs by Joris Laarman, who used additive manufacturing techniques to create very organic, bio-inspired designs, where the amount of material is optimised for functionality (strength or stiffness). This leaves super light, bone-like structures. This philosophy is applied in the Laproflex handle too, as the minimal amount of material is used while preserving functionality and ergonomics. Many iterations have been made on the handle, all to ensure comfort and intuitive use – answering questions like: ‘how to prevent axial rotation of the instrument in the hand while using?’ resulting in the shape of the lever that is held between the index and middle finger, or ‘How to design the lever in such a way the user can actively open AND close the end-effector?’, which resulted in the lever’s flange that curves over the fingers.

Another, very interesting aspect of the Laproflex’s design, is the fact that the inside mechanism is completely independent from the encasing, making it more stable (not dependent on irregularities of the encasing) and easier to make adjustments to either part of the design. That is why it was a small step to start manufacturing the Laprofix!

### Conclusion

DEAM is a commercial business that puts human-centered design first. The growing company still needs daily hard work by all employees, but laparoscopic surgeons are most definitely seeing the advantages of steerable surgical instruments. Together with the academic world, they look into ways to bring these advantages to more surgical areas. Considering the Ansoff growth matrix, this graduation project is product diversification for DEAM, at least for some degree. The market is relatively new for them as their current products are designed for laparoscopy, not for neuroendoscopy. The new product is not a steerable laparoscopic instrument,

but a neuroendoscopic instrument. However, this instrument will be very similar, in applying the same steering technique. So, the step of developing a steerable neuroendoscopic instrument, is not as far-fetched and does not require a new design or sales approach compared to their existing products, except for one thing. This device is a class III device according to the MDR, as it is in contact with the central nervous system, whereas the LaproFix and Flex are class II. Getting a class III device to the market is more difficult and requires more extensive testing.

The most important conclusion is that a new product has to promote their vision as well as be profitable. Additionally, as DEAM already has manufacturing facilities in place, it would be preferable to develop a design that is manufacturable there. These three aspects are all in line with the HCD approach of ensuring desirability (user satisfaction), feasibility (manufacturability) and viability (profitable).

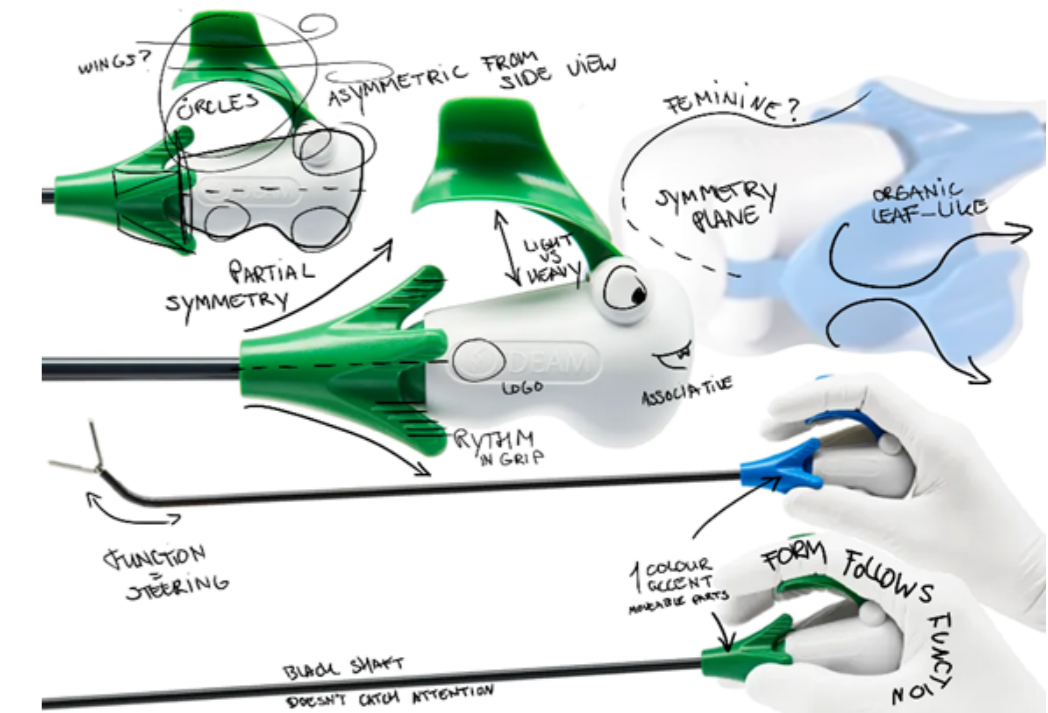

Figure 12. Form language LaproFix & LaproFlex

### 1.5.2 The other side of the market

To find out what the rationale of the opposite side of the market; the buyers is like, an email questionnaire was shared with René Dullaart, the manager of purchasing at ErasmusMC. The questions asked are included in Appendix 1.5. Naturally, the results that are found may not be applicable to the buying behaviour of other hospitals.

The main conclusions that can be drawn from this inquiry concern the buying behaviour concerning new products, that the hospital never held in stock before. René Dullaart states that it is extremely rare that such products are ever bought by the hospital, but when they are, the deciding factor is the 'added value'. He specifies this general requirement by saying that could be significant reduction of operation time, unprecedented ergonomic features or significant surgical outcome improvements. He emphasises the importance of ergonomics, as this is an important factor for the users, thus for the purchasing department.

Apparently however, the purchasers at ErasmusMC do not try the instruments themselves, before purchasing them. The decision to purchase is thus not based on their own experience. Additionally, purchasing is not based on the active recommendation by physicians (who for instance tried the instrument at some type of conference).

The purchaser does however inquire with the potential users before buying instruments, surgeons and surgical assistants alike. Their requirements are of course dependent on the type of instrument and use.

### 1.5.3 Current neuroendoscopic instruments

As was explained in the Section 'Starting Point', it was already determined in the literature study which brands of endoscopic systems are most popular and what their general specifications are. This section goes just a little deeper, highlighting the important specifications and most relevant limitations, as well as listing all that is good about these designs.

To be able to be compatible with the Minop and GAAB systems, the instrument should have a diameter of max < 3mm. In that case, two of these instruments could even be used next to each other in the oval channel of the Minop (see all specs in Table 2). Some of the mechanical properties were also estimated, to base the needed properties of the new design on, assuming that the steerable shaft will

have to handle similar loads. The calculations were done assuming the material is austenitic stainless steel with a Young's modulus of 200GPa and a density of 8kg/m<sup>3</sup>. Additionally, an analysis of all controls and movements was done, presented in Figure 13.

Table 2. Specifications of instruments currently used for neuroendoscopy

Specification	Minop	GAAB
Scope angle [°]	30, 0	70, 45, 30, 6, 0
Trocar L [mm]	150	130
Scope L [mm]	180	150 or 180
Trocar od [mm]	8.3	6.5
Scope od [mm]	2.7	4
#working channels	1 or 2	1 (0°) or 2 (30°)
Working channel in scope[yes/no]	No	Yes
Working channel id [mm]	3.7x6.5 or 2.2	3
Instrument length id [mm]	25	300
Length rotation knob [mm]	50	
Trigger length [mm]	60	
Handle length [mm]	85	
Weight instrument [g]	87	
Weight endoscope [g]	58	
Weight camera [g]	10	
Axial stiffness [N/m]	122	
Bending stiffness [N/m]	155	

Measured at Máxima Centrum

An effort was made to find the prices of these instruments. The exact price of one single instrument could not be found. A full neuroendoscopy set, including endoscopes, trocar and multiple instruments, costs around 9000 dollars. A separate trocar around 500 and a separate endoscope 2200. A much bigger instrument for skull base surgery through the nasal cavities is 70 dollars [28]. All these instruments are reusable and made to be disassembled and cleaned, before being reassembled and used again. They are very high quality. That means that a disposable instrument, which the new instrument will be (due to how difficult it is to clean the shaft parts), should be priced well below these numbers, or bring significant improvements in operating time, surgical outcomes, experience of the surgeon or all of the above.

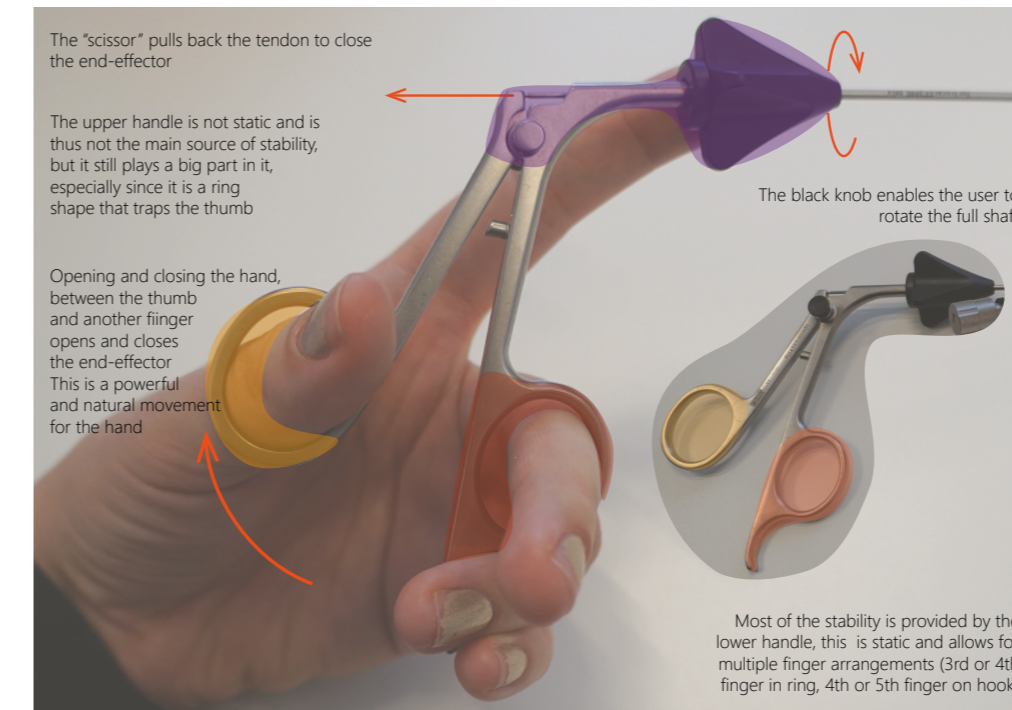

Figure 13. Analysis of the Minop handle

### 1.5.4 Other grip types

There are roughly six types of surgical instrument grips, depicted in Figure 14 below. These grips all enable the user to open the end effector. This opening motion is always accomplished through an opening/closing motion of the hand. This is the most powerful motion for the fingers, as well as the most effective (largest movement). More about these motions was presented in Section 1.3.4. The GAAB system by Karl Storz is as popular according to literature as the Minop system by Aesculap B Braun. However, the Minop system is the one that is present at the Máxima Centre for paediatric Oncology, so this system will be the main system that is designed for. Both these instruments fall into the "scissors" category.

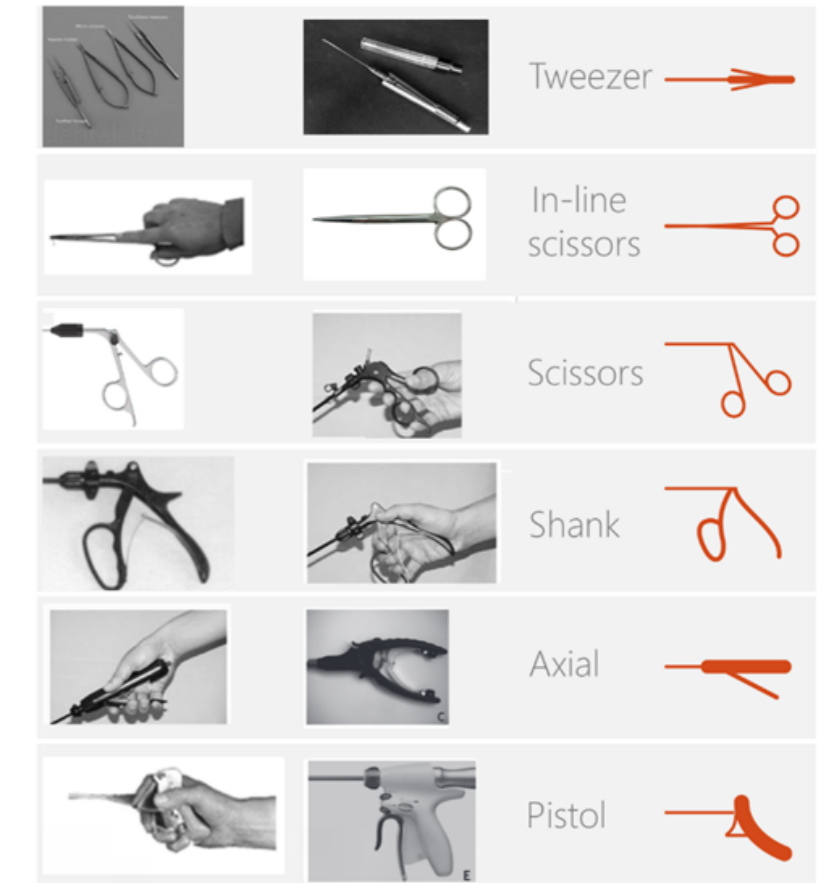

Figure 14. Types of handles [29], [30], [31]



### 1.5.5 Steerable medical instruments

To date, there is no company commercially manufacturing steerable instruments for neuroendoscopic use. Some probing yielded that at least one company is working on miniaturisation of their steerable grasper (surge-on). Existing steerable laparoscopic instruments are scarce too.

The smallest diameter steerable instrument by B Braun is 5 mm, as is the one by DEAM, by LogiFlex, the Snowden-Pencer. Flexdex is 7.5mm. Artisential is 8mm. This is not necessarily the minimum diameter possible, but rather compatible with existing trocars for laparoscopy. The 5mm & 10mm diameter trocars are the most used trocars. Caiman can articulate 80 degrees, which is similar to the LaproFlex. Other instruments do not state the maximum degrees of articulation. They all state that they have a 360 degrees of freedom rotationally. The figure on the next page (Figure 15) lists the pros and cons of these steerable instruments and also compares them to the handle types described in the previous section. A side note: the HandX is actually a hand-held robotic instrument. However, the steerability is operated through wrist motions.

Beyond these existing instruments, steerable medical instruments are a hot topic in scientific research, where other technologies like concentric pre-bent tubes or steerable tips controlled by magnetic fields are being described as solutions. However, these are not fully developed and might not even be suitable for use in neurosurgery.

Next to these products that are currently on the market, it is also interesting to look at two examples of these instruments that went to market but failed. Cambridge Endo was a company that worked on multiple instruments, all based on extensive testing, including a lot of work on developing an ergonomic handle. However, the company had to file for bankruptcy [38], [39]. It has probably suffered from new regulations in medical devices, but it also just looks super complicated to use (see Figure 16), as there are many controls. The shape of the handle is quite innovative, but to the conservative surgeon population, it might have been a bridge too far. The possibility to change the position of the lever to accommodate for left- or right handed use, the strange finger socket and the fact that there are 5 controls altogether makes this design an example of what to avoid in a design that is meant to be intuitive.

Another failed project aiming to introduce steerability to the OR is r2 DRIVE by Tuebingen, an articulating laparoscopic instrument (See Figure 17). Again, a

very innovative type of handle, best described as an upside-down shank handle, where bending the handle up and down articulates the tip. The problem is, the mechanism works in such a way that rotating the shaft with the tip at an angle, will cause the tip to rotate like a wind mill, as opposed to the DEAM steering, where the tip stays in the same angle while rotating the full shaft. That is why they needed to incorporate an extra control for rotating just the tip [40]. The disruptive handle, the extra control and possibly organisational flaws caused this project to fail. The handle of the new design thus needs to be innovative, yet recognisable.

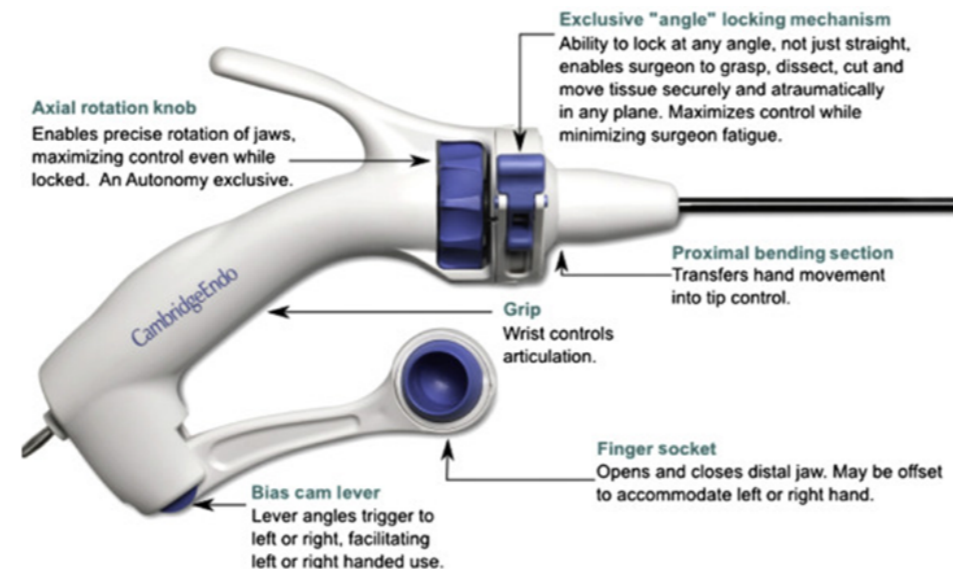

Figure 16. The Cambridge Endo [39]



Figure 17. The r2DRIVE [41]



	Arc	Lever/slider	Bending	Rotation
Products	 Flexdex	 Aesculap	 HandX	 Surge-on
Downsides	<ul style="list-style-type: none"> <li>- Bulky</li> <li>- Causes torque/non-axial movement</li> <li>- Less flexibility (especially in Flexdex)</li> </ul>	<ul style="list-style-type: none"> <li>- Less intuitive than arc/bending</li> <li>- Slow/indirect</li> </ul>	<ul style="list-style-type: none"> <li>- Causes torque/non-axial movement in the tissue</li> <li>- Large movements needed</li> </ul>	<ul style="list-style-type: none"> <li>- Unfamiliar/new mechanism</li> <li>- Less intuitive</li> <li>- No axial rotation possible</li> </ul>
Advantages	<ul style="list-style-type: none"> <li>+ Intuitive</li> <li>+ Comfortable for the hand</li> <li>+ Direct replacement for robot surgery</li> </ul>	<ul style="list-style-type: none"> <li>+ No non-axial movement</li> <li>+ Many options to control</li> <li>+ Easy to prevent unwanted movements</li> </ul>	<ul style="list-style-type: none"> <li>+ Intuitive</li> <li>+ Comfortable</li> <li>+ Relatively small</li> </ul>	<ul style="list-style-type: none"> <li>+ Comfortable</li> <li>+ Stays at angle</li> <li>+ Easy to disassemble</li> </ul>

Figure 15. Types of steerable instruments on the market [32], [33], [34], [35], [36], [37]

### 1.5.6 Trends in endoscopic surgery

To quote the email from Kyle Eastwood, the only author who has published about articulating instruments for neuroendoscopes: "I think there is clear need for steerable tools in the head and neck. For this reason, there will be some [market] growth." [51]. Eastwood continues to explain that he thinks this growth is based on the need for articulate hand-held instruments compatible with current and future equipment, as opposed to relying on the hopes that one day surgical robots will be suitable for intraventricular surgery. This section aims to go into current developments in endoscopic surgery and how the new design will have to be compatible with these, in order to keep up with the aforementioned growth.

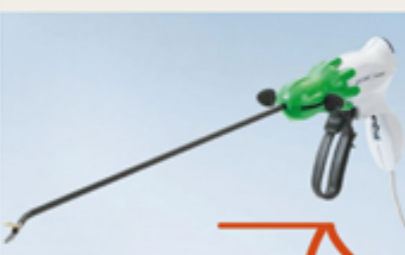
#### *New types of endoscopes*

As was mentioned briefly in the section presenting the survey results (1.3.3), there are some developments in the area of neuroendoscopy (where most respondents chose 3D endoscopy combined with a head-mounted display (HMD) as their preferable future system, a scope with variable angle and HMD, or 3D endoscopy with a normal display).

The first development to be discussed is the introduction of 3D endoscopy. Current two-dimensional endoscopes lack stereoscopic view since they use one lens and a simple camera [52]. Some major developments are happening; the 3D endoscope VisionSense was developed and apparently has been on the market for 4 years now [53]. It is a 4mm diameter endoscope, combined with software that can translate the camera image to desired left and right eye images. NB: this diameter would not be compatible with the Minop InVent, as the scope channel is only 2.8mm in diameter. It is unclear whether the VisionSense endoscope has working channels of its own, eliminating the need for a trocar. Another limiting factor is that, at least in the existing 3D endoscopes, the field of view is smaller than in 2D endoscopes, so a smaller area inside the ventricle is visible, due to how the technique works; there are two apertures, only .8mm apart from each other (this is called the "virtual interpupillary distance"). The two light beams falling through an array of about 1000 micron-sized optical elements, after which it falls on a sensor (see Figure 18). This creates a lot of tiny images, all from a slightly different angle. The small interpupillary distance makes the image sharp but very focused. Additionally, the endoscope itself is smaller in diameter than in 2D endoscopes [52].

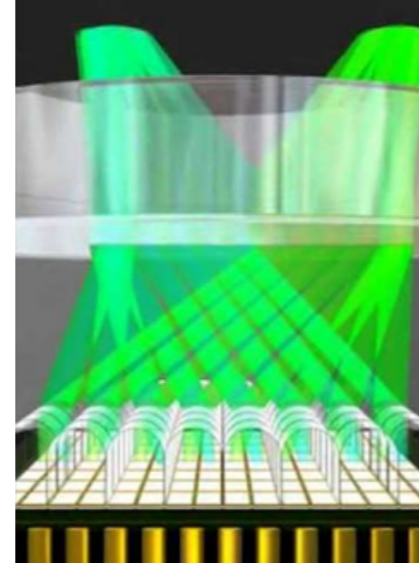

Figure 18. Array principle of the VisionSense 3D visualisation [54]

The system also, to date, requires the user to wear passive glasses to see the imagery in 3D. It displays the 3D image on their special screen, think 3D cinema glasses.

The benefit of using this type of endoscope with steerable instruments is that the articulate tip of the instrument moves in 3D, which can then be captured by the endoscope, rather than the surgeon having to guess and mentally calculate how the tip is moving from 2D footage, going from shadows and other markers. It is impossible to print an example of the effect; one, because it would require the viewer to wear the 3D glasses and two there are no examples with articulate instruments, used on representative tissue.

It is theorised that with the technology improving, 3D endoscopes, combined with a hand held articulate instrument, could reduce the need for the development of surgical robots, at least in neurosurgery, as this combination has the same effect, without the distance between the surgeon and the patient, imposed by the robot. When combined with a head-mounted display (HMD), it could also decrease the ergonomic problems neurosurgeons experience by having to look at a static monitor (about which more in the Ergonomics section 1.3.4).

That means the instrument must be extremely intuitive to use, as it would be less easy to rely on vision, as the eyes of the surgeon are covered by the display. Some HMDs project the endoscope image over the surgeon's environment (see-through HMDs), but that field of imaging is also still being researched [55]. Developments in overlaying preoperative 3D scans through AR techniques are in the pipeline [56].

Next to the 3D endoscopes, there is another type of innovative endoscopes that could be useful to combine with an articulate instrument. As opposed to a fully flexible endoscope, a type that fell out of fashion years ago due to its lack of image quality and possibility to orient after repositioning, the multidirectional endoscope is rigid [57], [58]. That means that, without having to switch out the endoscope during surgery, the direction of the lens can be changed. That way, the tip of the articulate instrument can essentially be followed around, controlling the lens of the scope with a joystick, never being steered out of view. The view would still be 2D, but by being able to change the direction of the view, a 3D perception can be created.

It could not be identified whether a combination is on the way; multidirectional view in 3D. It might be because the 3D perception of the multidirectional endoscopes is sufficient.

Neither of these endoscopes is used at the Máxima Centre. Therefore, it will be impossible to test the instrument with these endoscopes. However, the design will be made with these developments in mind.

#### *Hybrid surgery*

Some respondents in the survey mention the need for good and workable fixation of the endoscopic system. Currently, the fixation systems are quite basic; they are literally a mechanical arm that fixes the system in place by tightening a bolt. Once the system is fixed, it is very cumbersome to change and readjustment is not smooth.

To fix that, robotic fixator arms are being developed. That way, the fixation can be smoothly and subtly readjusted. The robot is the assistant, rather than something that is in between the surgeon and the patient. In fact, a couple of these robotic arms already exist [59]. Judging by the results from the survey mentioning that current neurosurgical robots are not precise and subtle enough, these devices are still under development. Introduction of these robotic arms to the OR would mean less problems with holding the endoscopic system still and thus the focus of the

handle of the articulate instrument could be less on keeping it stable and more on the manipulation of the other controls. However, it is unclear how far hospitals are in widely adopting such robots. Also, these robotic arms are expensive and bulky, so it is best not to rely on such devices.

#### *Other trends*

If you have to believe trend watch websites, the main trends in the medical field concern sustainability [60]. Researchers and people in the industry are working hard to find ways to reprocess materials or full instruments, by creating infrastructures between the hospitals and cleaning and recycling stations. It was decided to leave this (very important) aspect out of scope, for now, and really focus on creating a well-performing user-desirable instrument.

#### *Concluding*

Most future trends concern the improvement of visualisation. The use of an instrument that moves in 3D too would be extremely beneficial and increase the user's freedom tremendously, maybe to the extent of being able to compete with the dexterity of surgical robots.



# 1.6 Personas, User Scenario and conclusions

## 1.6.1 Personas

From a brief cultural research,, together with the user research, 3 personas were comprised, to give three very different kinds of intended users a face. To keep in mind that the design should be suitable for specific groups of people, by giving them a name. Essentially, the findings from the cultural research, as well as the direct user research, were summarised in these three personas. The cultural research is included in Appendix 1.6.



Figure 19. Persona 1

**KOL:** This first persona is the more traditional, older surgeon. He was based on the statistics concerning the average age of neurosurgeons, as well as the results from the historical analysis, as well as the findings from the interviews that were used for the ‘neurosurgery and gender’ section. His quote is directly inspired by another interview with such an older, experienced neurosurgeon.



Figure 20. Persona 2

**New:** The second persona is a young female surgeon. First of all, when determining the dimensions of the handle, it is important to include her, as the handle has to be usable for female surgeons. Still, the world is mostly not designed for women [89]. Additionally, it was found that the amount of female neurosurgeons is rising.



Figure 21. Persona 3

**Majority:** The third persona is a young neurosurgeon, who is on a roll in his career, specialising in his favourite area of neurosurgery. This trend towards further and further specialisation was found in the questionnaire and confirmed with prof. dr. Hoving. This persona is interested in trying, and talking about, innovative equipment. If he can be the first one to try new stuff, he will.

## 1.6.2 Clinical problem definition & user scenario

The clinical problem addressed in this project is multifaceted. Using endoscopes, neurosurgeons can navigate their instruments through the ventricles to reach lesions with less damage to healthy brain tissue than occurs in open surgery. However, there are some risks involved. These risks and problems are always related to the fact that the design forces the surgeon to choose one straight line as the approach to the target area. Limited options are available and in some cases, this means that blood vessels are damaged and hemorrhagic events occur. Other trauma to tissues like the fornix,

where part of the memory is located, can be caused by (mal)positioning of the endoscope, or by non-axial movement of the endoscope in an effort to reach the target area. Additionally, flaps of tissue can occlude the visualisation of the endoscope. There is no way to move these flaps out of the way. The only way to improve visibility is by moving the endoscopic system further into the ventricle, which might cause other problems, like moving past the tumor.



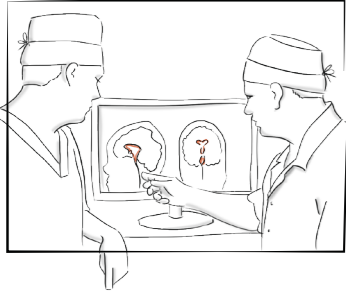
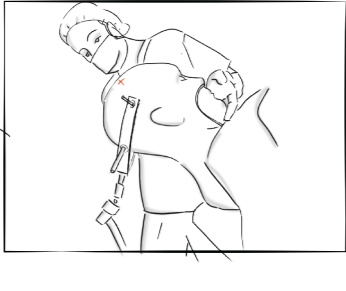
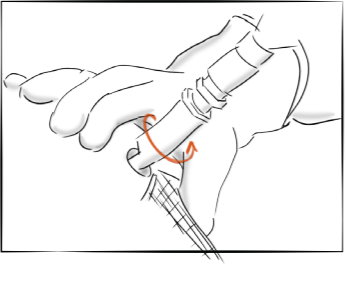
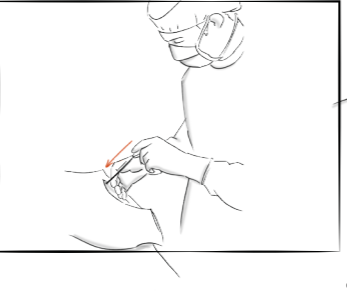
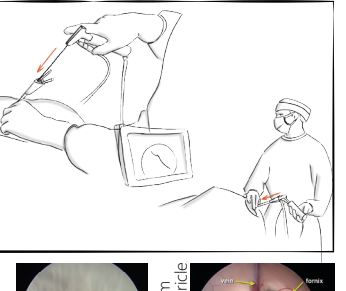
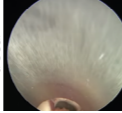
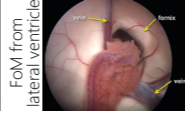

To gain full understanding of the scenario in which the new design will be used and to clarify this to other parties, a user scenario was determined. The aforementioned problems are indicated in the user scenario, see the next two pages. It summarises the problems that were identified, possibly to be solved by introducing a steerable instrument in the ‘opportunity’ row. It also contains a row where the risks of introducing a steerable instrument are indicated, as such a novel instrument will naturally affect the safety and familiarity of the interaction between the surgeon and the endoscopic system. The last row contains some notes, food for thought to keep in the back of the mind during designing.

## Effects of introducing a steerable instrument into neuroendoscopic ETV and biopsy

Tasks	1. Make MRI scans in two views` 2. Line from in between the lesion (posterior) and the third ventricle floor (anterior) is drawn, through the Foramen of Monro, to the skin	1. Position the head, the nose pointing exactly forward 2. Determine right angle of neck flexion	1. The planned position of the burr hole is marked on the head 2. The right size drill head is selected 3. The burr hole is applied	1. Determine the right angle (exactly perpendicular to the skull) 2. Insert the trocar approximately 5cm into the brain to reach the lateral ventricle	1. When the trocar is in place, the endoscope can be inserted slowly 2. Vision is ensured and the system can be navigated through the FoM to the ventricle
Scope					
					

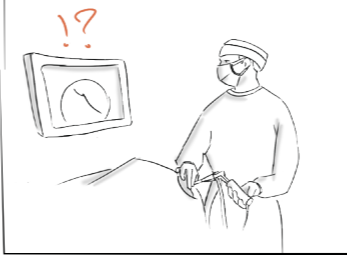
	Preoperative planning	Surgical preparation	Application of burr hole(s)	Insertion of the trocar	Insertion & navigation scope
Threats	The standard trajectories, an experienced surgeon can do that blindfolded. Using approaches that are less familiar to surgeons, might be less intuitive to apply.		Care should be taken that the unfamiliar burr hole placement does not cause (ergonomically) less appropriate approach of the third ventricle.		
Opportunities	There are more possibilities concerning trajectory planning. As long as the trajectory passes through the FoM, important structures can be avoided. Transnasal approaches even.		The freedom in burr hole application could make the burr hole more accessible for the surgeon.	This step is done 'blind', which means some minor deviations from the trajectory can occur, which can be compensated for by the steerable instrument.	
Notes	The size of the lesion and the overall size of the brain, the ventricle and the venous anatomy all influence the planned trajectory.	The location of the burr hole determines the needed amount of neck flexion.	The burr hole is always considerable larger than the diameter of the trocar, to ensure forceless insertion and flexibility in the system.	Only small deviations can be compensated for, larger ones just result in passing by the ventricle altogether.	There is no non-axial movement possible, especially deeper in the brain. Introducing anything into the trocar, has to be done without putting loads or torques on the trocar.

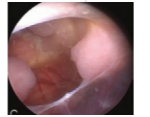
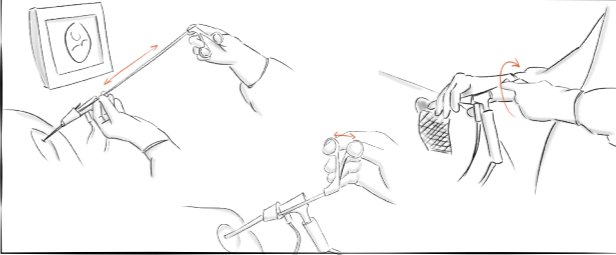
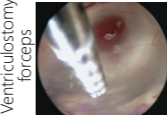
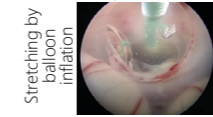
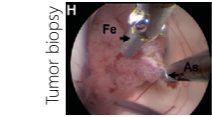
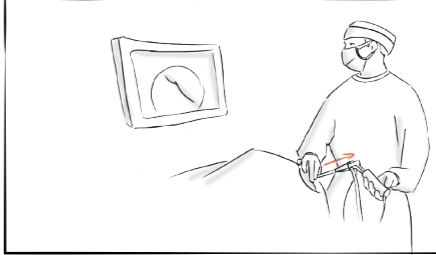
## Steps where the instrument is inside the patient

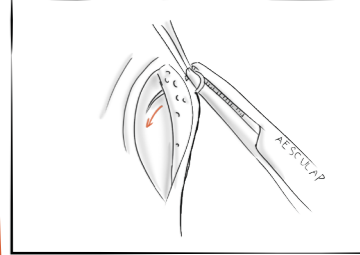
6. Evaluation of the situation	7. Therapy: ETV & biopsy	8. Retraction of the system	9. Hole closure
<p>1. The area that will be operated on has to be evaluated on reachability and visibility</p> <p>2. If relevant, flaps of tissue can be moved out of view. To do this, the instrument has to be inserted first.</p>   	<p>1. Usually, the ETV is performed first, for which a small steering angle is enough. The floor is perforated and may be expanded with a balloon.</p> <p>2. To perform the biopsy, the tip is steered posteriorly and possibly a bit in the frontal plane, to reach the perfect spot to take some biopsies, like the least venous spot.</p>    	<p>1. After the full procedure is performed, the instruments are retracted through the trocar.</p> <p>2. The trocar-endoscope combination is retracted too, while checking for bleeding on the way.</p>  	<p>1. The dura is closed.</p> <p>2. The burr hole is filled with some sort of bone filler, to protect the brain tissue.</p> <p>3. The skin is closed.</p> 
<p>From the second the steerable instrument is introduced, there is the risk of steering 'out of view' and damaging structures without knowing it.</p> <p>The dexterity of the instrument can be used to move structures occluding the view.</p> <p>Anatomy can be extremely distorted, so that, even after studying MRI scans, it can be difficult to recognise during this step. Anatomy can even change between making the MRI scans and performing the procedure.</p>	<p>Next to steering out of view, the complexity of a steerable instrument compared to a rigid instrument could impose all kinds of struggles, where it distracts from other tasks, or increases the procedure duration.</p> <p>During this step, the benefits are most evident. The instrument's end effector can reach locations inside the ventricle that are impossible to reach with a rigid instrument, without moving the full system and possibly damaging structures. Sometimes it is even needed to use a second burr hole.</p> <p>It is very important to use the anatomic landmarks, to perform the procedure without damaging blood vessels or important brain structures.</p>	<p>When removing the instrument, either on its own, through the trocar or together with the rest of the system, great care should be taken to do so when the instrument is in its neutral, straight state, to prevent damage to the instrument and the tissue.</p> <p>Something that is out of the scope of this project, but worth mentioning; it could be easier to coagulate any bleeding with a steerable instrument, but especially during retraction. The bleeding in the cortex, if present, is in tissue exactly parallel to the trocar.</p> <p>Retraction has to be done slowly, otherwise tissue can still be damaged, even though the procedure is already performed.</p>	<p>Using a steerable instrument, only one burr hole is needed, where sometimes two are needed with a rigid instrument. This makes recovery faster and is cosmetically beneficial.</p>



## 1.7 User requirements & Conclusions

All of the information of the analysis phase can be summarised in 12 user requirements (see Table 4). As introduced in Section 1.1, these requirements can be translated into technical product specifications. The full document includes these specifications, as well as the rationale and sources behind the requirements and specifications. This document is presented in Appendix 1.4. Most user requirements were derived from the interview with prof. dr. Hoving and the two surveys.

As discussed, these requirements are the basis of the design process. Any decision can be traced back to one of the twelve requirements. They are organised by importance; 1 being the most influential and 12 being the least.

Table 4. User requirements

#	Requirements
1.	Minimal movement of complete system during free-hand use
2.	The new design can be used in commonly used trocars/endoscopes
3.	The new design is optimised for a combined procedure of ETV and biopsy
4.	The new design can be used in most regular hand sizes
5.	The new design can be used right and left-handed
6.	Feedback about the state of the tip is provided
7.	One hand can operate the instrument and all controls
8.	Acceptable strain and stress on all fingers during use of the controls and smooth control
9.	It is possible to align jaw properly to tumor
10.	The new design feels trustworthy
11.	The end-effector can be actively closed AND opened, to be able to stretch fenestrations
12.	The new design can be easily used in the context

## Conclusion

Most of the relevant information gained throughout the analysis phase is summarised in the personas, the scenario and the user requirements. A short conclusion is in order just to give an overview of how the findings and the analysis process contributed to the overall project; research was performed concerning the patient (literature), the surgeon (interviews, surveys and literature) and the market (email correspondence, interviews and literature). The patient's anatomy poses challenges when the ventricles are exceptionally large, small, or deformed or when the venous structure is in the way of the endoscope. The surgeon mainly faces challenges during the surgery concerning the lack of flexibility in the instruments, as well as problems with visibility. The surgeries are short and there are not many RSI-related complaints known. The instrument will have to have certain dimensions for a stable grip and the controls should be carefully allocated to the right finger. For the instrument to be viable, it should have quantifiable added value and fit into the portfolio of DEAM; organic shapes with clear functionality. Many handle shapes have been designed and some failed, probably due to overcomplication of the shape and controls. This has to be avoided.

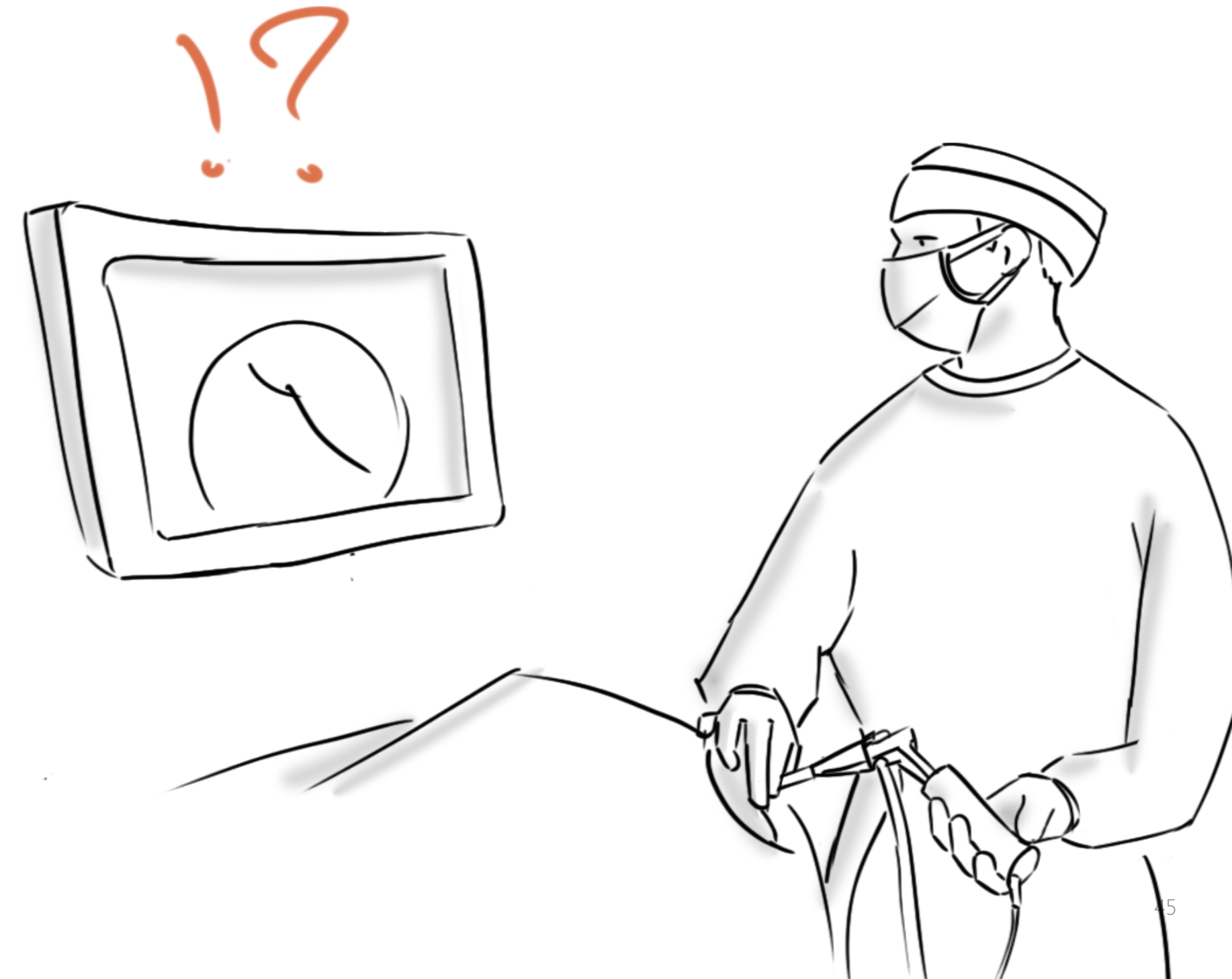

## 2.1 Introduction

The synthesis can be divided into three parts; the first part describes the designing of the tip, the second part describes the designing of the handle and the third part describes how both sides of the product are merged into one product. To start off each of these parts, the relevant user requirements and product specifications are summarised, including the number of the user requirements and product specifications that is being referred to, after which the further approach is explained and the results are presented. To start off, the next paragraphs clarify the boundaries of the synthesis phase.

### *Design challenges & take-aways from Analysis*

- Keep the system still/prevent non-axial movement throughout use
- Find the optimal dimensions of the tip
- Design and report in such a way that the end result can be used to build upon to finally create a product according to medical device regulations
- Design a handle that is intuitive to use with one hand
- Design a product that is generally compatible with existing endoscopic systems
- Visualisation: 3D movement in a 2D view OR introducing 3D endoscopes, which introduces new requirements

## PART 2: Synthesis

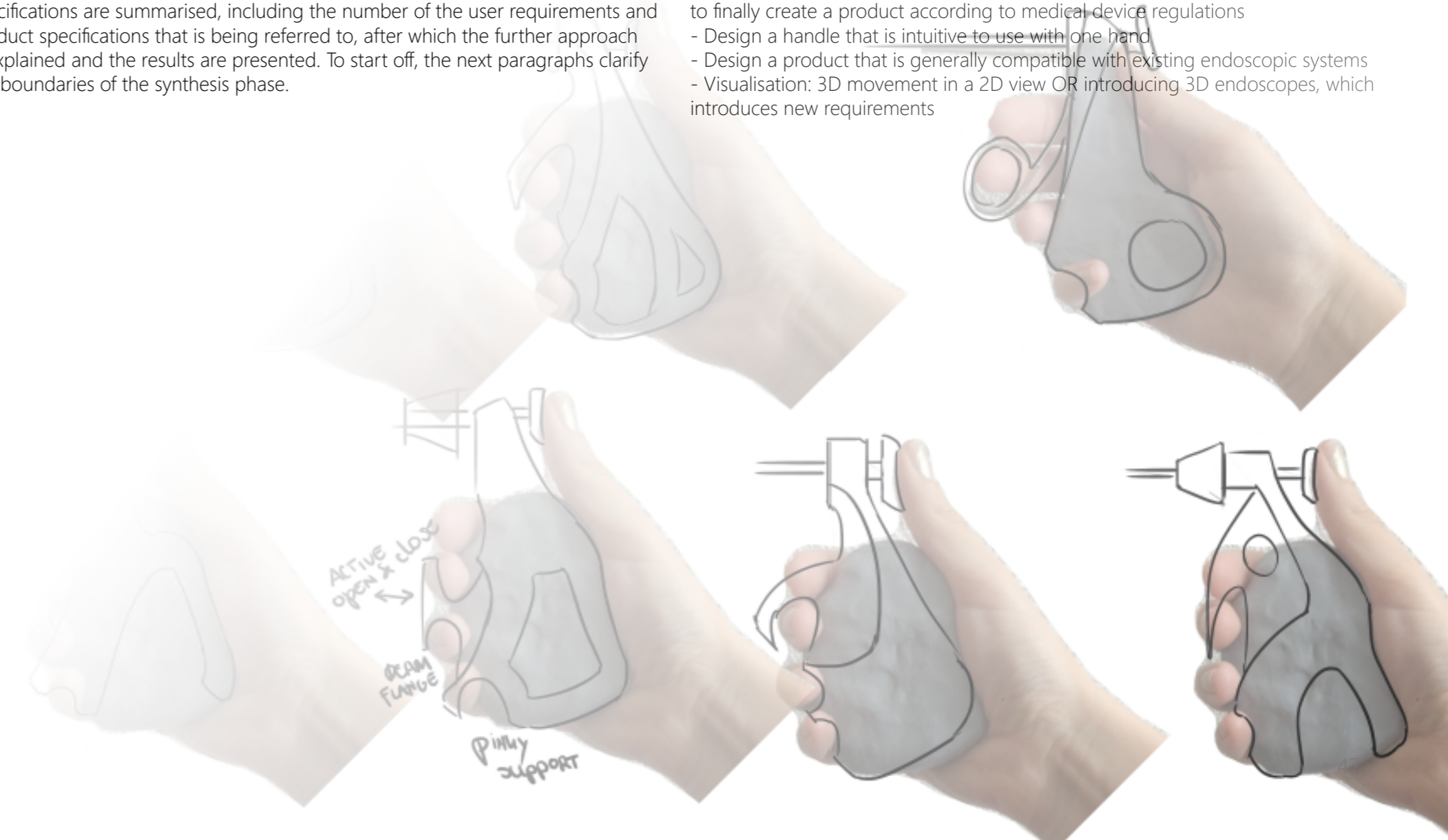
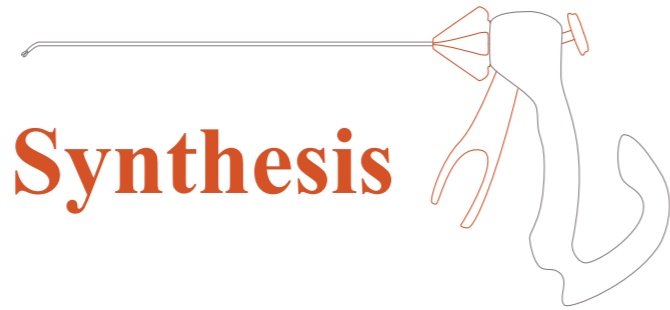

### 2.1.2 Tip design starting point

This paragraph will analyse and list the key factors of the technology inside their steerable product.

Next to the LaproFlex, which is on the market, DEAM has a 1.8mm diameter shaft prototype, essentially a scaled-down version of the LaproFlex. This prototype is neither optimised for use inside the third ventricle, nor does it have a (satisfactory) handle. This prototype also includes an end-effector (grasper forceps).

The tip is of 2 DOF: multiple planes – type steerability. It has the possibility of omni-directional steering in which the catheter tip is able to bend in multiple planes, depending on the amount of steering cables. The design that will be used has 12 cables, so can be steered in 6 planes. This method allows for steering without having to axially rotate the entire catheter shaft inside the body. This strongly simplifies the steerability for the surgeon and allows for procedures with increased level of complexity .

The amount of links determines: 1) The length of the bending portion of the shaft (min. added length per link for this prototype 1mm) and 2) the maximum bending angle – the links are shaped in such a way that they only facilitate so many degrees of articulation. Adding more links essentially adds more degrees of articulation. There is no standard formula for how this actually adds up, but testing in solidworks pointed out that e.g. for 5 links, the maximum angle is about 40 degrees. Beyond that, the links will start to behave strangely.

In Figure 22, the drawing of the existing 1.8mm diameter shaft is presented. The length of the articulating portion as well as the shape and size of the end-effector are not optimised.



Figure 22. DEAM tip prototype

### Finding the optimal dimensions

To be able to determine the optimal dimensions of the steerable tip and shaft, several variables are of importance, together with the assumptions and boundaries presented in the last section. The variables and the applicable requirements are presented in the section below.

The user requirements addressed in this section are 2, 3 and 6, of which specifications 2.1, 2.2, 3.2, 3.1, 3.15, 3.16, 3.17 specifically. All the specifications regard the dimensions of the third ventricle that should be taken into account. Most importantly, that the mean height of a hydrocephalic third ventricle is 16mm, so the articulation portion of the shaft should not be longer than that in order to work properly in the sagittal plane. Additionally, the tumor can be located anywhere in the ventricle, but usually it is more posterior (about -10mm to 35mm along the x-axis measured from the FoM) [7].

## UR/PS

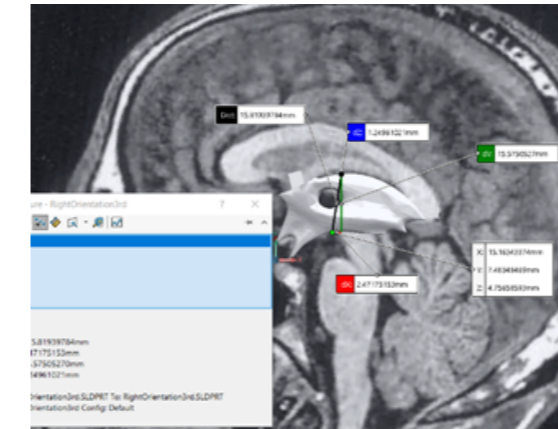

Figure 23. Checking the model with MRI scans

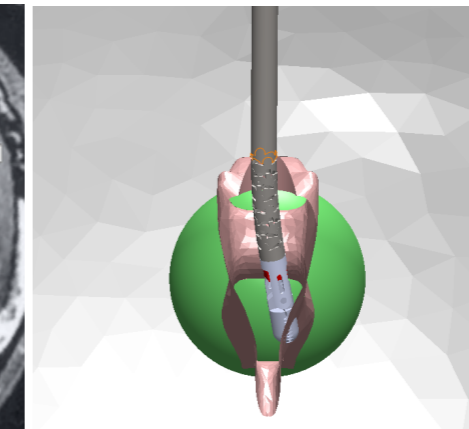

Figure 24. Prototype at small angle poking out of ventricle

## 2.2 The tip design

### 2.2.1 Physical design space

To get started with determining how much the prototype would have to be adjusted, SolidWorks was used. A 3D head model from DINED was downloaded, one of 95th percentile, emulating a hydrocephaly [92]. This was overlaid with MRI scans, in order to consequently scale a 3D model of a third ventricle over it. This model was downloaded from BodyParts3D [93].

Now, it was not only theoretically evident that the tip of the prototype was too long to move inside the ventricle, it was visible. Especially in the frontal plane, there is almost no room to use the steerability due to the large steering radius. That had to be changed.

### 2.2.2 Effects of tumor location, insertion and steering angle

To find the influence of all these variables, a simple MatLab code was written (see Appendix 2.1), based on the following assumptions:

- In the frontal plane: Ventricle is small and the steering radius or length of the tip are less relevant, as there is almost no movement possible
- In the sagittal plane: There is a lot more room and it depends on how the trocar is inserted and where the tumor is, how easy the steerable tip can reach the tumor.
- Tumor location varies over x-axis (anterior to posterior)
- The optimal trajectory to the target area is used, so the insertion angle varies



**For the location of (xt, yt):**

$$x_b = L \cdot \sin(b);$$

$$L = -x_b + x_t / (\sin(b+a));$$

$$y_b = -L \cdot \cos(b);$$

$$y_t = y_b - L \cdot \cos(b+a);$$

**For true length of steerable tip:**

$$l_{half} = l - l_{tip};$$

$$th = 0.5 \cdot (180 - a);$$

$$\phi = 90 - th;$$

$$l_{true} = 2 \cdot ((\pi \cdot (l_{half} / \tan(\phi)) \cdot \phi) / 180) + L + l_{tip}$$

**Results**

One can consider the Matlab code as a collection of digital prototypes, used to investigate several combinations of the variables. The effect of these combinations on the amount of ‘tumors’ the tip can reach, is presented in Table 5. It is visible that the  $A_{max}$  does not influence the ‘reachability’ too much and neither does the  $L_{tot}$ , meaning that small variations in millimeters are not going to make or break the tip design.

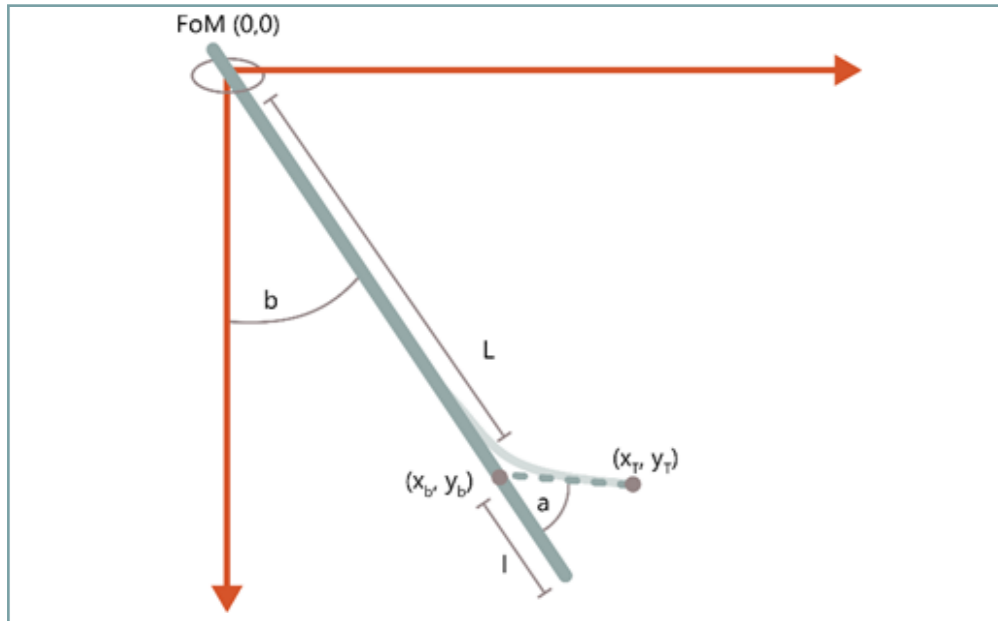

Figure 25. The tip in the coordinate system used for the simulation, with the tip in green/grey

Table 5. Tip dimension simulation results with several inputs

$a_{max}$	$L_{tot} = 16mm$	$L_{tot} = 13mm$	$L_{tot} = 10mm$
Rigid	22%	22%	22%
40°	58%	56%	55%
50°	60%	58%	56%
80°	65%	63%	60%

**Conclusions**

There are two ways to influence the length of the articulating tip. One is by removing one or more of the links of the shaft, the other is by decreasing the length of the biopsy jaws. With the maximum length and the influence of the other variables identified in the test, the following three options can be identified:

*Option 1:* using length of existing biopsy forceps end-effector, maximising biopsy specimen size, **short  $L_{tot}$ , small  $a_{max}$** , movement possible in frontal plane

*Option 2:* making the end-effector **shorter, smaller specimen, maximising the  $a_{max}$**

*Option 3:* using length of existing biopsy forceps end-effector, maximising biopsy specimen size, **longer  $L_{tot}$ , bigger  $a_{max}$** , less/no movement possible in frontal plane

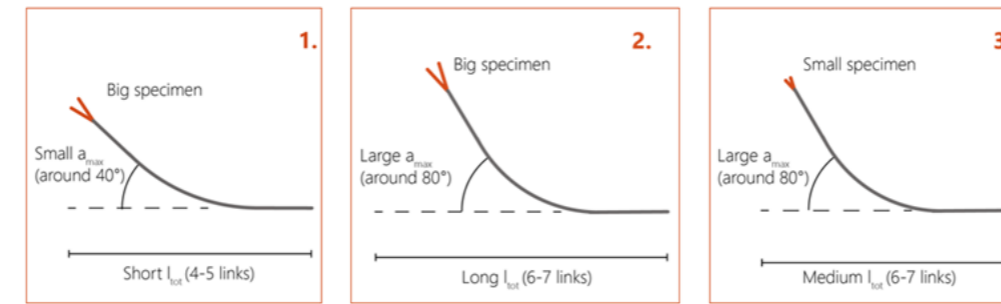

Figure 26. Tip design proposals

**User evaluation**

The three tip concepts were evaluated with the user by presenting the three illustration is Figure 26, and performing thought experiments based on the following questions: 1) Is the trade-off of a shorter articulating section corresponding to a smaller  $a_{max}$  problematic? (in which case the DEAM steering mechanism might not be suitable at all) 2) Would decreasing the length of the end-effector “beak” be desirable? 3) Would the short length/small  $a_{max}$  diminish the purpose of steerability?

The summarised response of dr. Hoving was as follows: In his mind, not much steerability is needed to reach significantly more areas than without steerability, even in large ventricles. It is thus better to stay on the safe side by using small dimensions and still having the maximum amount of biopsy samples. It is important to have enough specimens to perform the tests [94] [95].

**2.2.3 Design of the end-effector**

The design of the end-effector of the instrument determines the shape and size of the biopsy sample. During the first user evaluation mentioned, it was clear that the end user did not want to compromise concerning the sample size of a biopsy. That conclusion led to the following requirements.

The user requirements addressed in this section are 2, 3 and 6, of which specifications 3.1, 3.9, 3.18, 11.1 specifically. The specifications regard the dimensions of the third ventricle that should be taken into account, as well as the appropriate dimensions of a ventriculostomy fenestration and the appropriate shape of a biopsy forceps [7], [96].

**UR/PS**

What is so special about the DEAM end-effector prototype, is the hinge design. It was designed especially to make the design shorter than those of the Minop, without compromising on the sample size. Additionally, only one core cable or rod is needed. Initially, it was planned to rule the design of the end-effector out of scope, since the design of such a tiny system is a quite specialist task. However,

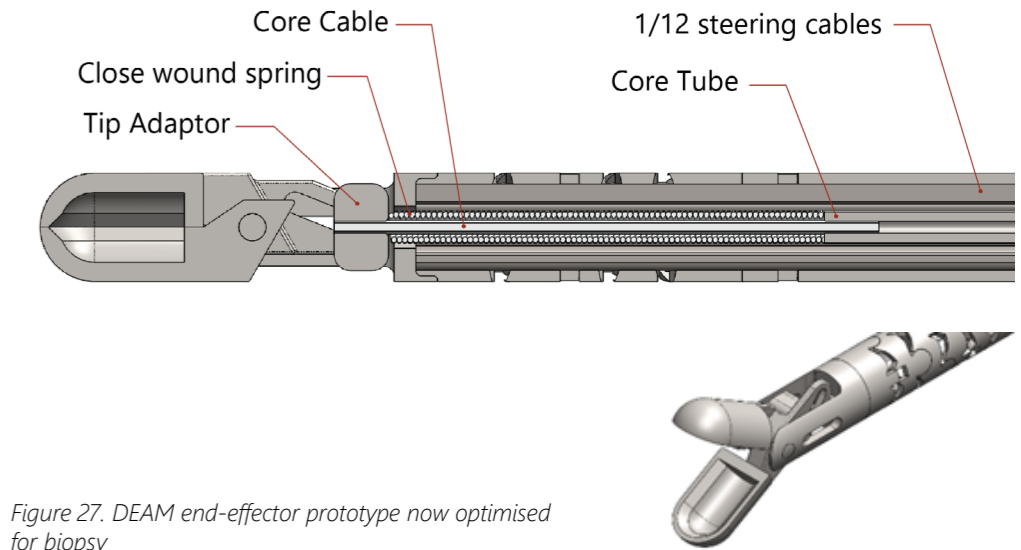

Figure 27. DEAM end-effector prototype now optimised for biopsy

since the prototype is already completely developed and it only had to be optimised for the purpose of Etv/biopsy combination, it was decided to include that step anyway.

In order to take a biopsy sample, the forceps should be hollow and sharp. In laparoscopy and other fields of minimally invasive surgery, the biopsy forceps have sharp teeth (alligator forceps). However, for softer tissues like the brain, no teeth are needed [97]. However, it was impossible to find the volume of the current biopsy cups, which is why the volume in the new design was just maximised in terms of remaining wall thickness and available manufacturing techniques. The new design is presented in Figure 27. In Section 2.4, the real-life end result will be presented.

Since the last requirement is to be able to actively open and close the end-effector, a stiff tube is used to compress and open the end-effector. However, the tube cannot continue over the whole length, like in traditional instruments. It has to be discontinued over the articulating section, otherwise it would render that section too stiff to bend. A close wound spring is used to carry the compression to the translating adaptor.

To create tension to close the end-effector, a cable is connected to the core tube and the tip adaptor, after being threaded through the spring.



## 2.3 The handle design

It was decided that usability testing would have to be a rather continuous process throughout the project, to test whether the device would meet its intended user's needs and to identify possible risks of use (very important in medical device design) [98]. All evaluations were performed with prof. dr. Hoving, the representative user.

### 2.3.1 Generation 1

In the first generation of clay models, the focus was on the 'configuration' of all the controls and the shape of the handle. Five concept directions with corresponding clay models were created to test these 'configurations' and shapes. The next page summarises these "configurations". So, with the scheme about the comfortable postures in Section 1.3.4, as well as the restrictions concerning finger-task matching and technical limitations in mind, the first set of handle models were fabricated. All five models can be grasped in a number of ways, to facilitate for the variable insertion angle.

All five concept directions were feasible in the sense that the controls were reachable and technically more or less possible.

The user requirements addressed in this section are 1, 4, 5 and 12, of which specifications 1.3, 1.4, 4.1, 5, 12.1, 12.2, 12.4 specifically.

The specifications regard the shape and angle of the handle, how it should be comfortable to hold the handle under several angles. Additionally, the handle should be symmetrical. The controls should all be reachable with one hand and the trigger should not be flush when fully pressed, to prevent gloves from becoming caught.

UR/PS

### Approach

The focus for this generation was also on trying to keep the handle small; some were inspired on the tweezer-like instruments in Section 1.5.4, others more subtle versions of other types of grips. The subtlety also strokes with the notion of the dimensions of the third ventricle and the tip that is moving with that ventricle. The rationale was that tiny movements on the distal end of the instrument required a delicate and fine handle. Dr. Hoving made very clear in the interview how much of an art it is to perform procedures inside the ventricles of the brain. The goal was to convey this feeling in the subtlety of the models. Consequently, the approach of Form follows function, no use making nice sketches. The only step that came before the first clay models, was doing some "how to-" ideation rounds. Of which a couple of examples are presented in Appendix 2.2. The following "configurations" resulted from that.

1. Thumb joystick-round (became concept 4)
2. Thumb joystick symmetrical above and below shaft (became concept 1)
3. Thumb joystick-pistol (became concept 5)
4. Middle/ring finger joystick (became concept 3)
5. Proximal bending (with fixation) (became concept 2)

The ideation resulted in 5 concept directions, presented in Figure 28. This figure shows on what kind of grip they are inspired, as well as the special attributes per direction and how these conform with the requirements.

#### CONCEPT 1

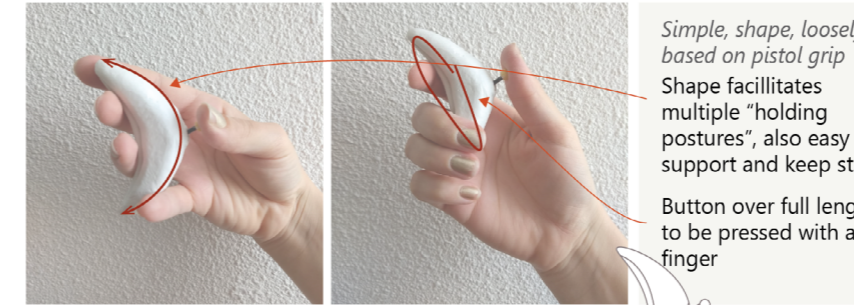

Simple, shape, loosely based on pistol grip  
Shape facilitates multiple "holding postures", also easy to support and keep still  
Button over full length, to be pressed with any finger

#### CONCEPT 4

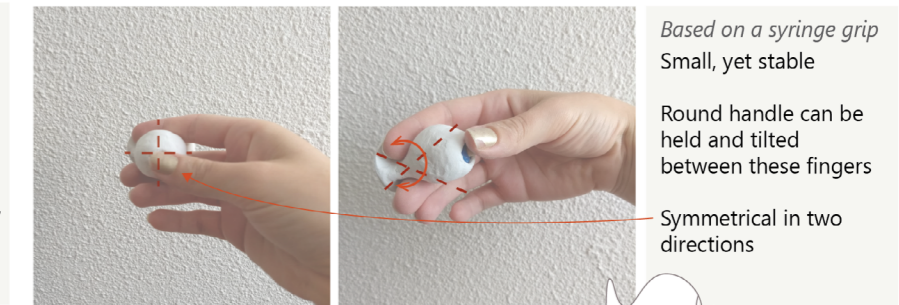

Based on a syringe grip  
Small, yet stable  
Round handle can be held and tilted between these fingers  
Symmetrical in two directions

#### CONCEPT 2

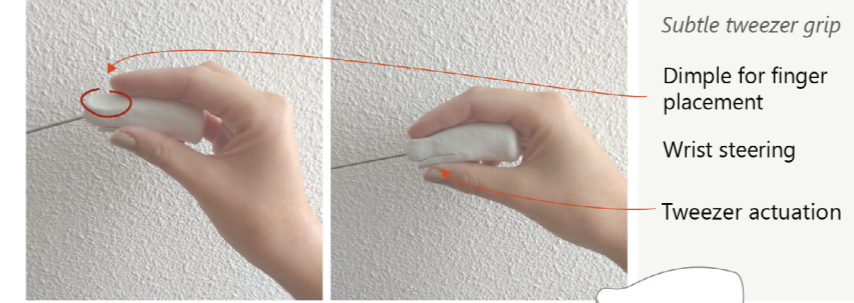

Subtle tweezer grip  
Dimple for finger placement  
Wrist steering  
Tweezer actuation

#### CONCEPT 5

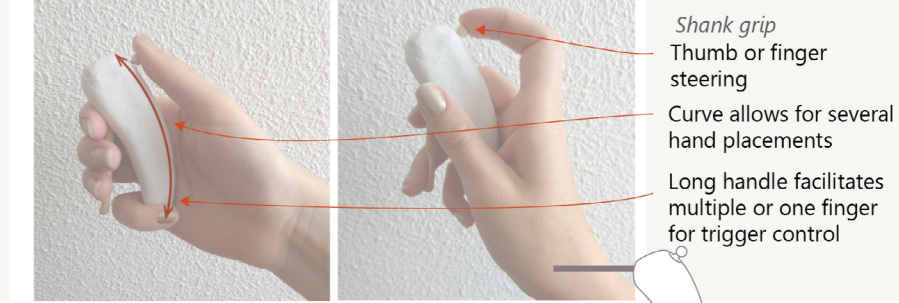

Shank grip  
Thumb or finger steering  
Curve allows for several hand placements  
Long handle facilitates multiple or one finger for trigger control

#### CONCEPT 3

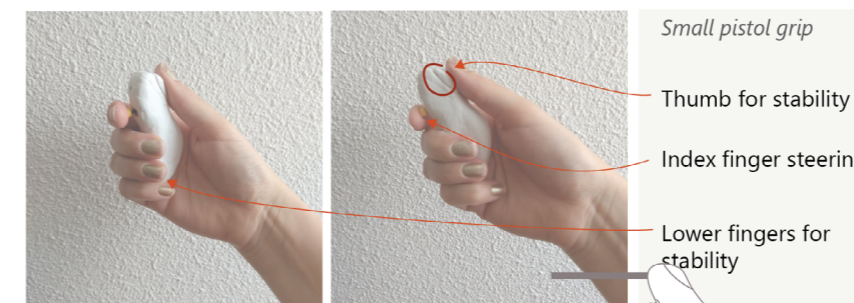

Small pistol grip  
Thumb for stability  
Index finger steering  
Lower fingers for stability

Figure 28. First generation handle design proposals



### 2.3.1.2 User Evaluation

#### Objective

To determine in an early stage of the process, which type and configuration of the handle was most preferable for the user.

#### Method & materials

The materials that were used are the 5 clay models (presented in Figure 28). These clay models were equipped with a bike spoke to mimic the shaft of the instrument, as it has the exact same diameter as a real neuroendoscopic instrument. To properly test the prototypes, an official anatomical mannequin was used, which was placed on the table. See Figure 29 what the set-up was like in prof. dr. Hoving's office.



Figure 29. A still from showing the set-up. The elbow is visibly raised, however, this is due to the table height.

To record the test for later observational results, a camera plus tripod was used. Next to using the observations as results, prof. dr. Hoving was asked to think aloud, which was naturally recorded together with the visual footage. To encourage this, A4 sheets depicting how the model can be held to make sure the right attributes are being evaluated. These sheets also contained probing questions.

#### Conclusion & discussion

The most important take-aways from testing these first prototypes was that first and foremost, the test set-up should have been more realistic. The comfort of the hand holding the handle can be tested without a representative context, but the rest of the body will take positions it would not during a surgery. Additionally, prof. dr. Hoving did mention that the shaft-handle angle of the current instrument is perfect and should not be altered.

Then, concerning the prototypes; the challenge shifts from making a handle that facilitates multiple grips and insertion angles, to being extremely stable, first and foremost. The reason for this is twofold: 1) Using the controls (especially the joysticks) in the prototypes urged prof. dr. Hoving to worry about the movement they introduce and 2) adding a control; the joystick, occupies one finger with the task of operating that control, meaning it can no longer contribute to stabilising the handle.

Additionally, prof. dr. Hoving pressed the matter that being able to actively open the end-effector is extremely important. Surgeons use this functionality to open and stretch fenestrations. A simple spring-loaded button to open the end-effector thus is not enough.

Prof. dr. Hoving stated a couple of times (sometimes indirectly), that he preferred the handles that were closest to the current instruments. It was concluded from these statements that the design should be intuitive and in terms of grip-type, close to the current instruments. That meant that concept 1 and 5 had the liking of prof. dr. Hoving. He also thought concept 4 was promising, mostly because of its stability and subtle size. He was most happy about concept 5.

The joystick cannot be directly opposite from the end-effector control without proper stabilisation, as you will have to put force on the joystick, risking unwanted steering. The use cues should all be very clear to make the interaction with the instrument as smooth as possible. Prof. dr. Hoving did not favour the thumb controlling the end-effector, as it is not in line with its physiological function.

### 2.3.1.3 Handle design & the personas

Persona 1 motivates the decision to take the more conservative and familiar approach of concept direction 5, the direction inspired by the pistol or shank grip. This grip is used in many medical instruments, and for good reasons; To satisfy the needs of persona 2 and 3, the design is innovative in other ways, as the steerability functionality is already a big leap from the current instruments. Additionally, by focusing on a more traditional style of grip, the dimensions can be finetuned to the needs of the users that fall into the category of persona 2 and more time can be attributed to the aesthetics of the design, satisfying the needs of the users that fall into the category of persona 3.

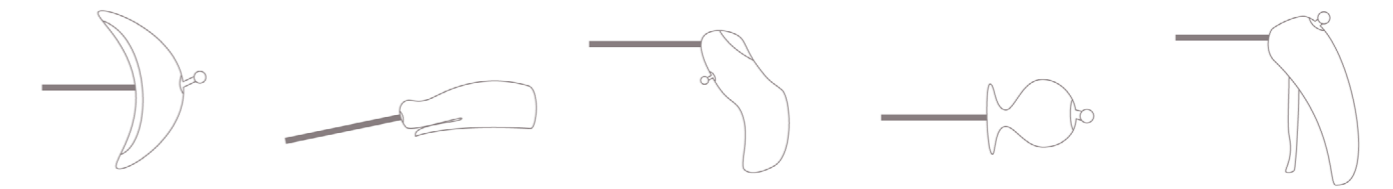

#User requirement	Concept direction 1				Concept direction 2				Concept direction 3				Concept direction 4				Concept direction 5			
	--	-	+	++	--	-	+	++	--	-	+	++	--	-	+	++	--	-	+	++
1. Insertion angles																				
2. Common trocars																				
3. Steerability																				
4. Minimal movement																				
5. Left & right hand																				
6. Single hand																				
7. Comfortable strain																				
8. Optimised for context																				

Figure 30. The Harris profile evaluating the first concept generation on the user requirements

### 2.3.1.4 Harris profile

The Harris profile presented in Figure 30 summarises the conclusions drawn from the user research, so from the observations combined with the interview outcomes. In the profiles, the concept directions are scored on the requirements that were set for this generation of prototypes.

Overall, it shows that direction 5 is most promising, whereas the rest is less clear. Concept direction 4 scores highest on the most important requirement, whereas concept direction 2 scores well on the first three most important ones, even though prof. dr. Hoving did not like it too much. It is assumed that this was due to the prototype rather than the true idea behind it. However, it was decided not to risk it by continuing to work on this concept direction. Concept 4 is doing very well and this was also reflected in prof. dr. Hoving's feedback. Concept 1 was scored quite neutrally (no super negative scores), even though prof. dr. Hoving was very enthusiastic about it. It was decided that this direction needs a lot of work but might be promising.

### 2.3.2 Prototype Generation 2

This generation had the feedback from the first incorporated, which means the focus was on concept direction 1 (multi-grip) and 5 (pistol-grip), with a thumb stick for steerability and some lever functioning as the trigger for opening and closing the end-effector.

They were fabricated from foam and then 3D scanned and printed in order to have higher fidelity prototypes than during previous test.

The main focus of this set of models was to find stability. Looking back at Section 1.3.4 about ergonomics and types of grips, the type of grip applied can be classified as the “fixed hook”; the thumb is abducted and virtually not involved in the gripping activity, thus not contributing anymore to the stability.

This need for stability moved the requirement of a fine and delicate handle to the background, as well as the requirement of facilitating multiple grip types. The relevant requirements and specifications are listed below. Some overlap with the requirements for the previous generation, which are highlighted in bold.

The user requirements addressed in this section are 1, 3, 7, 8, 9, 11, and 12, of which specifications **1.3**, 3.2, 3.7, 7.1, 7.2, 8.3, 8.4, 8.5, 8.6, 9.1, 9.2, 11.1, 11.2 and **12.1** specifically.

The specifications regard the shape and angle of the handle, how it should be appropriate for use wearing gloves and how the joystick should be lockable at the desired angle.

The comfortable spreads of the hand of 10th percentile people was used as a requirement for the dimensions of the handle and the trigger’s travel distance also has a limit; between 0.6 and 2mm.

UR/PS

#### 2.3.2.1 Creating the prototypes

Many more pictures and extensive evaluation of the models can be found in Appendix 2.3. To create the prototypes for the user evaluation with the focus on stability, an appropriate approach had to be found. As the shape has to be organic, complex, and all supports in the handle have to be symmetrical,

otherwise it would not be usable for left- and right handed users, It was decided to use clay to find the ultimate outline of the handle.

After finding the outline, sketches could be made over that outline, including sketches for the trigger. Infinite options are possible, but eventually, one basic foam model was made, where 3 triggers could be inserted. These were tested briefly with family members, purely for the sake of testing with several hand sizes. Based on the conclusions from that model, 5 foam models were made, each with their own special characteristics. To quickly make 3D printable, high fidelity prototypes to do a next set of user tests, without having to model the handles in SolidWorks, these models were 3D scanned, and edited in SolidWorks, in order to have moving parts, moving in a similar way as a real handle would. The main bodies of the handles were printed with Ultimakers, whereas the joysticks had to move smoothly, so these were printed in a Formlabs printer. This whole process is illustrated in Figure 31.

#### Locking

It would be most useful to be able to lock the joystick, as it is difficult to keep the thumb exactly still. It is not favourable to require an extra action of the user to lock the joystick into position: making a press lock requires force on the joystick and it is difficult to keep in the exact same position while pressing down.

Requiring yet another finger to do the locking could take away from stability. That is why it was decided to use built-in friction in the joystick. It should be just enough to keep the joystick in one position when tissue is pressing it into another. However, it should not be too much to overcome with thumb, or that it would cause tissue damage.

To simulate built-in friction in the prototypes, a glue was embedded in the “sockets” of some of the joysticks. Additionally, the joysticks had slightly varying shapes and sizes, to be able to test the impact of that.

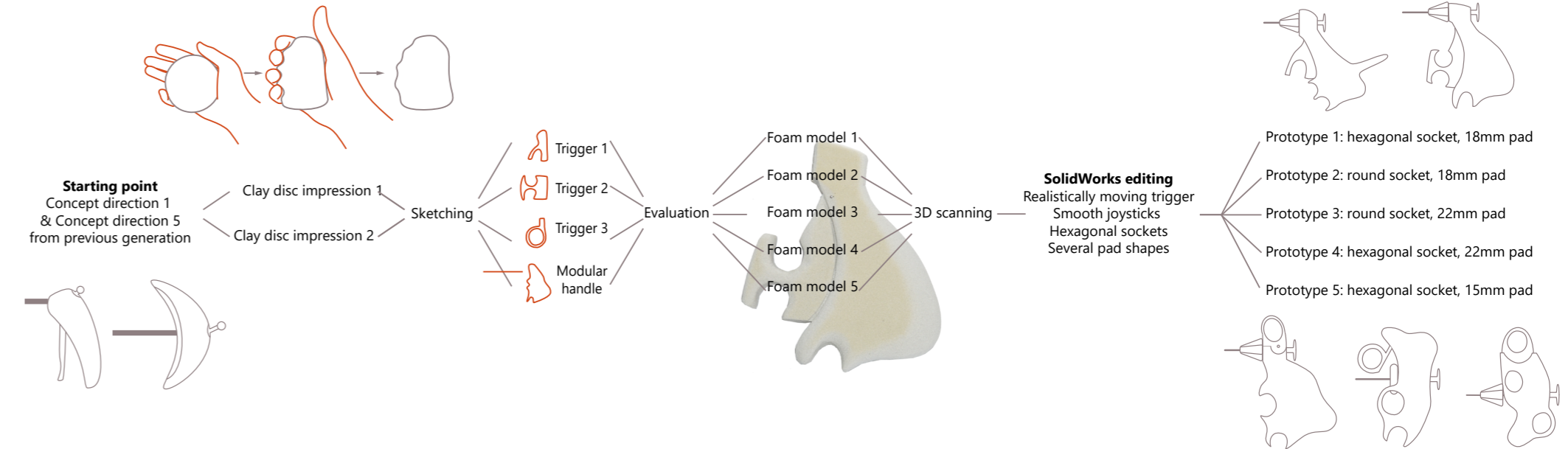

Figure 31. Process of developing the second generation of handle concepts



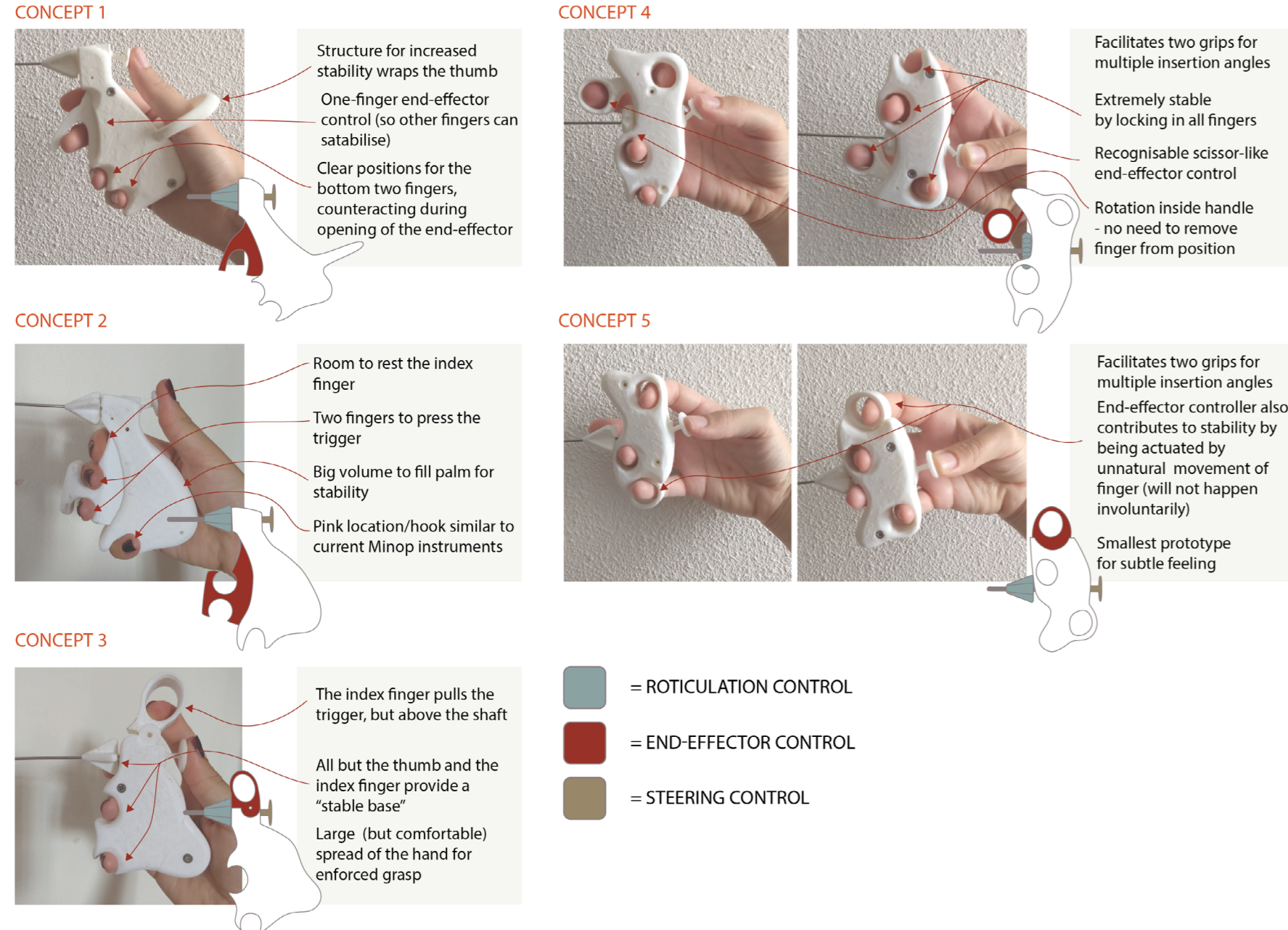

Figure 32. Second generation handle design proposals

### 2.3.2.2 User evaluation

#### Objective

The objective was to evaluate the five handles in a more realistic setting, so with a "patient" lying on the table, in a realistic position, entering the anatomical mannequin's brain with a functional endoscope. This was done to be able to simulate the posture of the surgeon at work, as well as the interaction of the handle with the endoscope. How this set-up was created, is depicted in Figure 33. The handle prototypes were evaluated on all relevant requirements stated at the beginning of this section, with the focus on the magnitude of force on and movement on the rotation knob and a possible need for locking controls. Additionally, the suitability for freehand procedures was evaluated, as well as single-handed use. The most important focus was the prevention of movement in the shaft. Photos of all 5 3D printed prototypes can be found in Appendix 2.4. Naturally, over-all comfort and posture is evaluated too.

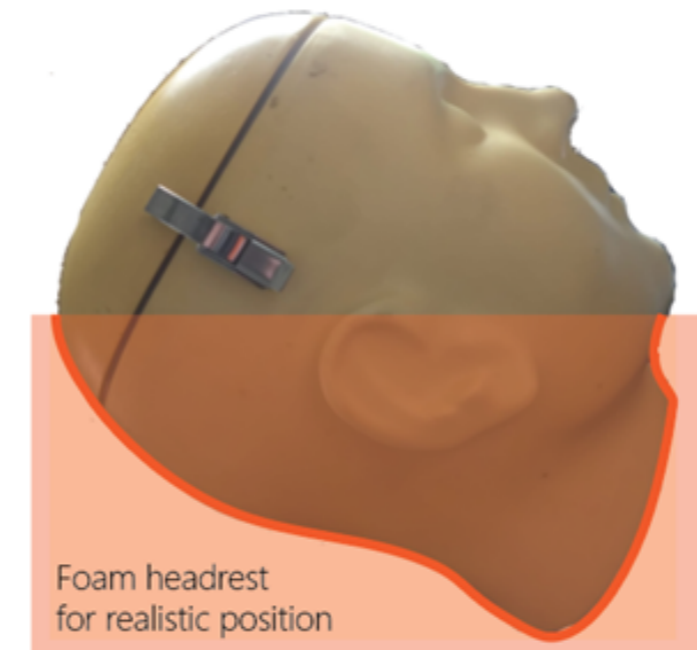

Figure 33. Test set-up concept

#### Method & materials

All 5 prototypes were tested, while using an endoscope made from a small camera from bol.com and some tubing resembling the dimensions of a real Minop endoscope. To make sure the concepts are compared fairly, a test protocol was made, where the participants had to carry out a specific task. During the task, the participants were asked to think aloud and after the task the participants were asked to fill out a questionnaire, on a laptop. The test protocol and list of questions can be found in Appendix 2.5. Again, a camera was brought and installed on a tripod, to record how the participants performed the task with the prototype on the mannequin and what they were saying while doing so.



Figure 34. Prof. dr. Hoving using the prototype in the actual set-up

### Results

The main observation was that the handles could have been developed further before doing this test. In design, this is almost always the case; once the 3D prints are ready, new ideas and improvements arise and there is no time to apply these. Prof. dr. Hoving is very clear and brief in his opinion, and quite critical too. This test was piloted with laymen, who were overall more positive concerning the comfort. Naturally, these participants do not know how precise the task is that has to be carried out, and what the exact context of use would be. Another neurosurgeon at the Maxima Center tested concepts as well (dr. Ouwekerk). The results per prototype are below as evaluated by prof. dr. Hoving and dr. Ouwekerk. The general outcomes of the questionnaire are summarised as well. All pros and cons Appendix 2.6.

### Concept 1

This concept received a very positive evaluation, especially the simplicity of the trigger and the simplicity of the handle. The additional loop for stability was not needed and takes up a lot of space

### Concept 2

This concept immediatly had prof. dr. Hoving say: "good stability, all fingers contribute to the stability and the thumb can steer".

### Concept 3

Again, the finger placement was less intuitive than the first one. For this concept, the 3D scanning did not completely succeed so the trigger was drawn quickly in SolidWorks, to finish the drawings in time to send to the printer. As described in Figure 32, the idea behind this concept was to have a solid "base" at the bottom of the handle, where 3 finger and the palm of the hand stay static and provide stability, and all the controls of the handle are towards the top. However, this rationale was not appreciated.

### Concept 4

The rotation in this concept is quite difficult, whereas the finger positioning is quite comfortable. The problem with such a "banana" handle, where all the finger tips contribute to the stability, it is difficult to operate the controls, especially rotation.

### Concept 5

Overall, this prototype was evaluated as disappointing, especially due to the impossibility of combining the movements, as well as poor allocation of function to fingers.

### Questionnaire results

Unsurprisingly, the interview/observation results mostly matched the questionnaire results, although arm and wrist comfort was quite good in all the prototypes. The emphasis should be on the "tweezer grip" and safety, without practice. My theory is that the perfect angle between the handle and the shaft is an inferior requirement to for instance "the controls can all be used at the same time" or "the joystick provides stable and predictable steering". There are two reasons for that: 1) the amount of time that the instrument is actually used it very small; around 15 minutes. 2) I quote the second neurosurgeon who came to test the handle: the surgeon has a responsibility in keeping a sustainable posture throughout the surgery, assuming the table is set at the right height etc. All in all, there is a clear preference for concept 1 & 5. The full results are shown in Appendix 2.6.

### Final test & phantom

I proposed some options concerning the phantom and test setup for the final test. Dr Hoving was especially interested in the performance of the device as well as the usability. To test that, he said it was less important to have a realistic-looking phantom rather than a functional one: use fruit or vegetables, like a bell pepper or a pumpkin. That way, it is easy to reproduce and no time goes into developing the phantom. As the non-axial movement in the shaft is considered one of the critical points in the design, it might be necessary to simulate the actual tissue that would surround the long shaft, to get a realistic idea of what the movement in the shaft would be during actual use.

### Built-in friction vs locking vs step-wise steering

As shone through in the rest of this report, prof. dr. Hoving was quite fond of the friction in the joystick as a means of locking the joystick in position, as well as slowing down the steering motion, so providing a layer of safety. We did not have time to discuss the shape of the socket (octagonal vs just circular), but I think applying some guidance in the shape of the octagonal socket should be good, one could simply ignore the imposed steps.

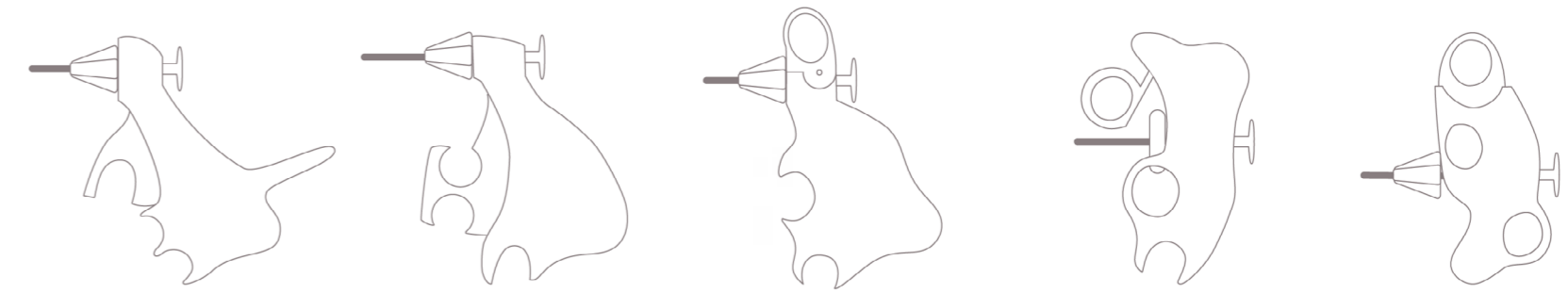

### 2.3.2.3 Harris Profile

Somehow, the stability of concept 1 and the more comfortable trigger of concept 5 will have to be combined into a handle that is light weight and accommodates for most hand sizes. The dimensions seem about right already, but they can be fine-tuned, especially regarding the rotation knob and the shape of the joystick. Dr. Ouwekerk suggested a horse-shoe shape joystick pad for instance. Tension in the hand has to be prevented, while keeping the stable grip. All findings were combined in yet another Harris profile, visible in Figure 35.

#User requirement	Concept direction 1				Concept direction 2				Concept direction 3				Concept direction 4				Concept direction 5			
	--	-	+	++	--	-	+	++	--	-	+	++	--	-	+	++	--	-	+	++
1. Minimal movement																				
2. Common trocars																				
3. ETV + Biopsy																				
4. Left & right hand																				
5. Single hand																				
6. Comfortable strain																				
7. Forceps alignment																				
8. Active opening/closing																				
8. Optimised for context																				

Figure 35. The Harris profile evaluating the second concept generation on the user requirements



# 2.4 Design integration

## 2.4.1 Introduction

The third generation of the handle prototype will be yet again based on the feedback on the previous. The difference is that the actual mechanism will be incorporated in this handle to be able to test it as a whole. The focus is on developing a prototype that is fully functional and approaches the “real product” much as possible. The main challenges during the development of this prototype were:

- Mechanism functionality
- Stability
- Hand anatomy & controls
- Materials & manufacturing
- Aesthetics & experience

The requirements to this prototype are listed to the right. All requirements that were mentioned in previous sections are applicable too. It was decided not to repeat these but to only show the ones that were not considered thus far. This section will start with the mechanism design, as this is where all elements tie in with each other; what is mechanically needed to make the instrument work well on the one hand and the comfort and intuitive movements for the user on the other. This chapter aims to focus on presenting the final results and prototype, rather than on the process. For iteration steps, refer to Appendix 7. With that established, the mechanism could be designed. Roughly two versions of the mechanism were designed, with a lot of “sub versions”, before the final version came to be.

The user requirements addressed in this section are 1, 2, 3, 4, 6, 7, 8, 9, 10, and 12, of which specifications 1.1, 1.2, 2.3, 3.4-3.6, 3.8, 3.11-3.14, 4.2, 4.3, 6.1, 7.3, 8.1, 8.7, 8.8 10.1, 10.5 12.3 **1.3**, 3.2, 3.7, 7.1, 7.2, 8.3, 8.4, 8.5, 8.6, 9.1, 9.2, 10.3, 10.4, 10.6 and 12.3 specifically. The specifications regard the more technical requirements to the design; The device should be able to withstand a force 20.6 N, the joystick should be operable with a comfortable force of <2.4N. The trigger force should be comfortable, approximately below 5N. The end-user should evaluate these input forces as comfortable. The same goes for the control dimensions; the trigger should be between 5-8.9cm long, and/or evaluate as comfortable. The tip should be able to withstand forces of .5N without spontaneously bending, or the end-user should evaluate the stiffness as adequate.



Figure 36. Second generation basis & necessary contact surfaces

## 2.4.2 The mechanism inside the handle

As stated in the introduction, one of the main challenges is to now integrate the mechanism in such a way that it can run smoothly and intuitively. A recap of the needed functionalities in the mechanism is needed, which consists out of roughly three points, together with some extra notes:

1. The core tube in the shaft should be pushed and pulled over a specific length. This length is determined by the shape of the slots in the end effector. For this specific design, that is 1.6mm. However, to be able to exercise force on the tissue, the handle should enable more translation than exactly that.
  - a. The core tube is surrounded by steering cables (see Figure 37). One of the biggest challenges of this mechanism is to “reach” the core cable, to be able to push/pull it.
2. The steering cables have to be pulled over specific lengths, for which a general formula was created, depending on the maximum bending angle (see below). With the desired variables filled out, the maximum shortening of a cable is 4mm.
  - a. The cables are also loaded with compression, meaning they have to be embedded or guided at all times, in order to prevent them from buckling out and being damaged or blocking the system.

$$\text{Shortening of steering cable} = \left( \frac{\left( \left( \sqrt{\frac{360}{\theta} * C_1} - a \right) * \pi \right)^2}{\frac{360}{\theta}} \right) - C_1$$

3. The shaft has to be rotated, to be able to properly align the forceps with the target tissue.

With this and the specifications stated on the previous page, the mechanism inside the handle was designed (see Figure 40). Next to using the aforementioned criteria as design input for the mechanism, much thought was put into how to optimally use the manufacturing techniques at hand, as well how to optimise assembly.

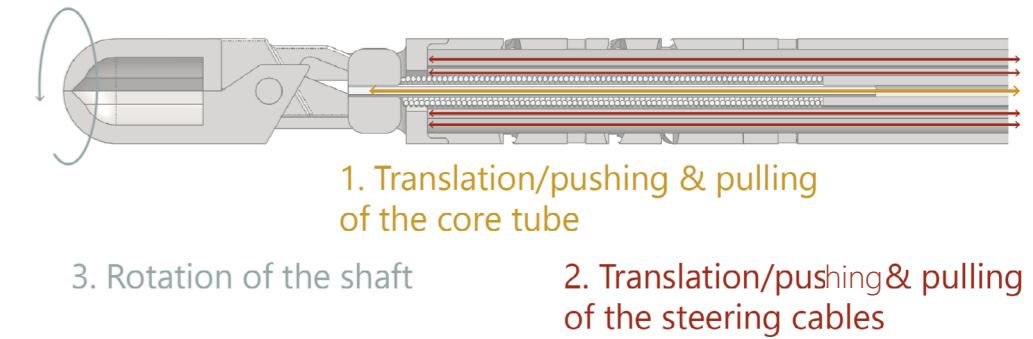

Figure 37. The three functions and how they work distally

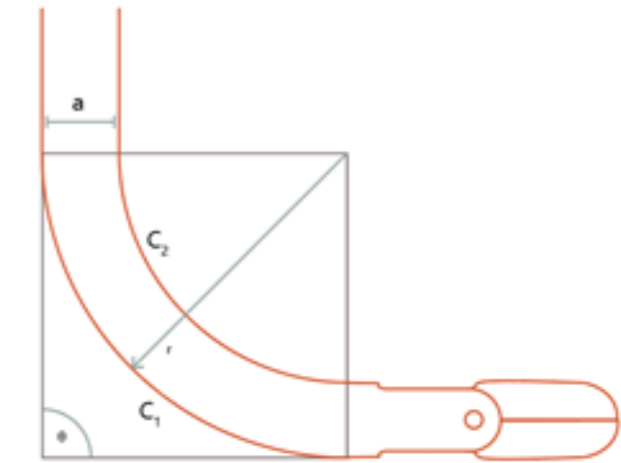

Figure 38. Variables to calculate shortening of the steering cables

### Forces on the tissue

Figure 39 shows the mechanism in the handle in detail. Without describing the assembly as-is in endless detail, some things are worth mentioning:

Since the core tube actuating the end-effector is surrounded by the steering cables and all aforementioned parts rotate with the shaft, a solution had to be found to still be able to translate the core tube. The solution in this prototype is to spread and guide the steering cables over the white part, the slider beam, through the “gutters” best visible in the most left picture guide the steering cables, so they run smoothly and do not buckle.

Now the core tube is accessible to the part that moves over the x-axis (movement 1), the slider. The slider rotates together with the shaft to prevent the steering cables from twisting up. The trigger moves the slider back and forth by means of a circular portion. The circular recess in the trigger part allows for readjustment of the core tube.

At the maximum comfortable input forces, the forces on the tissue are around 8-9N, when steering or grabbing tissue with the biopsy forceps (although dependent on the angle of the tip). Referring back to Section 1.4.1 about the forces used during neuroendoscopy, this is much more than needed on average. The free body diagrams in Figure 40 shows how these forces were calculated in a very simplified, 2D manner.

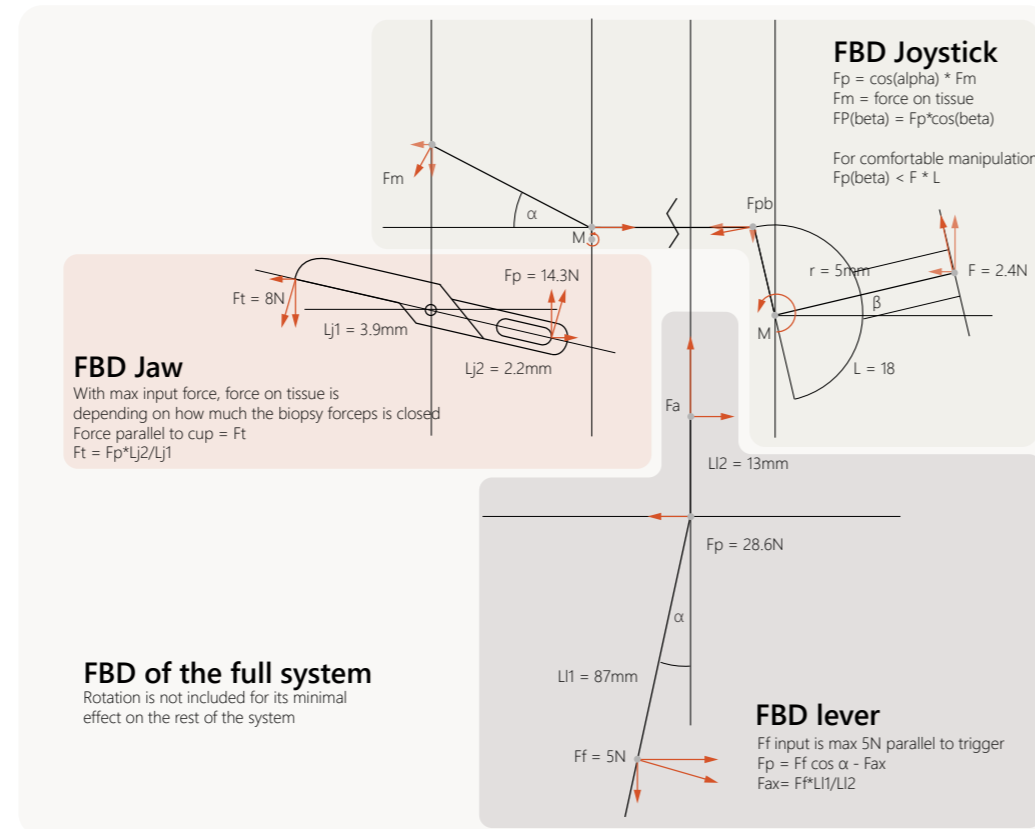

Figure 40. The free body diagrams of the end-effector and distal bending control

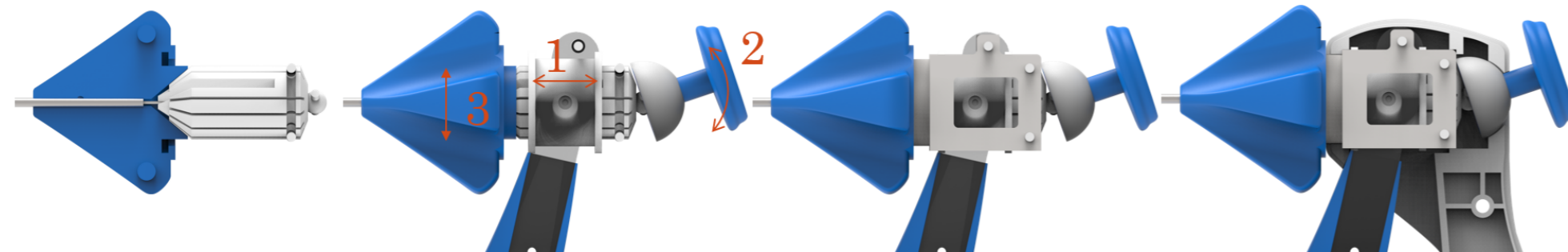

Figure 39. Variables to calculate shortening of the steering cables

### 2.4.3 Handle shape, control design & ergonomics

Next to the functional notes on the mechanism, it is important to remember what else has influence on the design of the mechanism. For instance, the width of the mechanism (in the x-direction, see Figure 41), which has to be located in line with the shaft to function, determine the distance between the thumb stick and the rotulator. That distance is limited by the thumb-index finger span 149-197mm or 25 degrees. To prevent over-stretching, the distance in the design should be much smaller than that.

An overview of how the design conforms with these dimensions can be found in the next few sections.

### Handle shape

The handle shape is largely based on Figure 36 in the introduction. The rationale behind the “hook” is that the goal was to use as little material as possible and to only offer the contact surfaces strictly necessary. Additionally, the top of the hook can be used to rest the thumb on when the tip is in position and the joystick is locked.

The handle is quite big and relies on the spread of the hand for stability. Separate parts of the handle are explained in the next few sections.

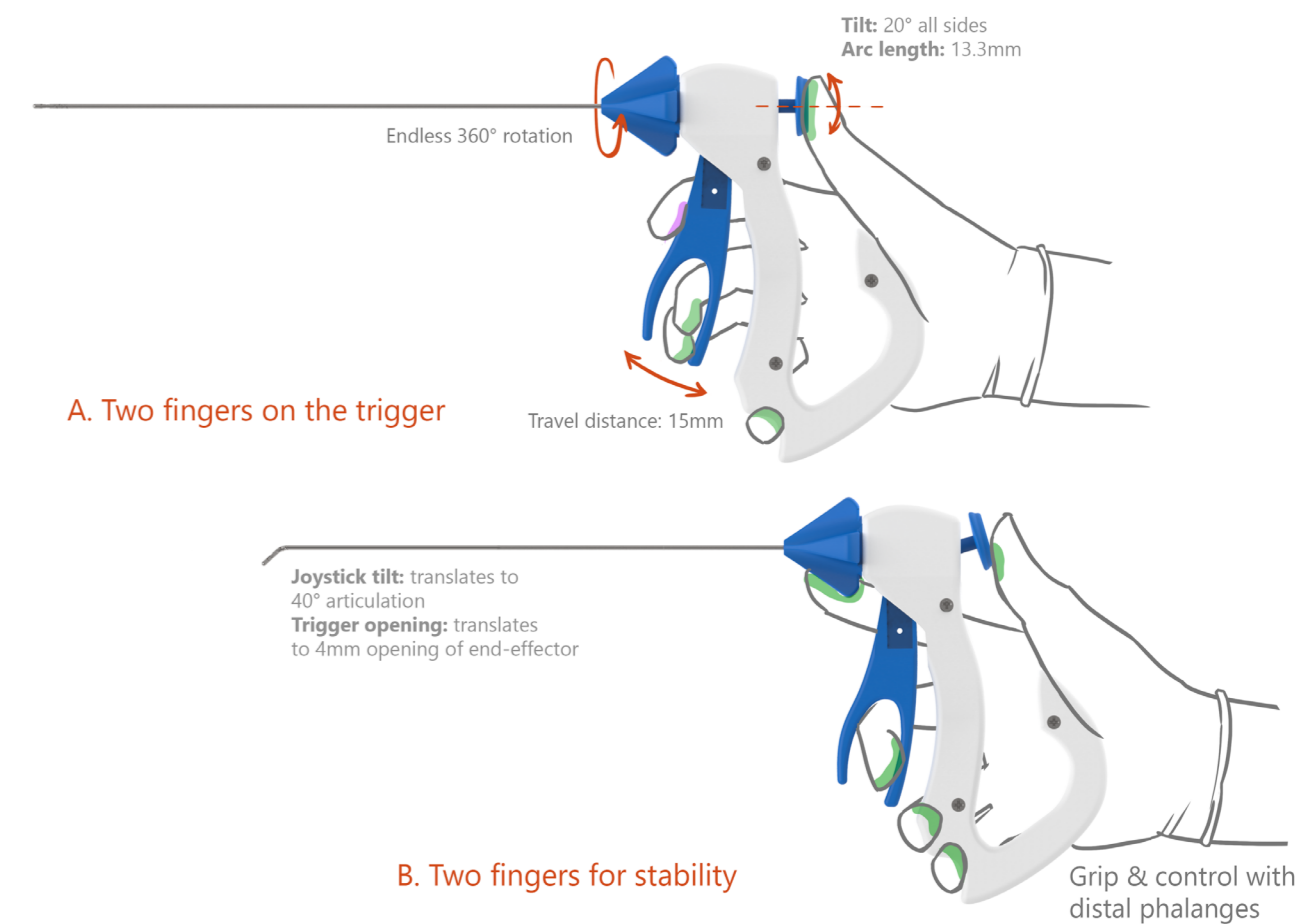

Figure 41. Grip patterns & control movements

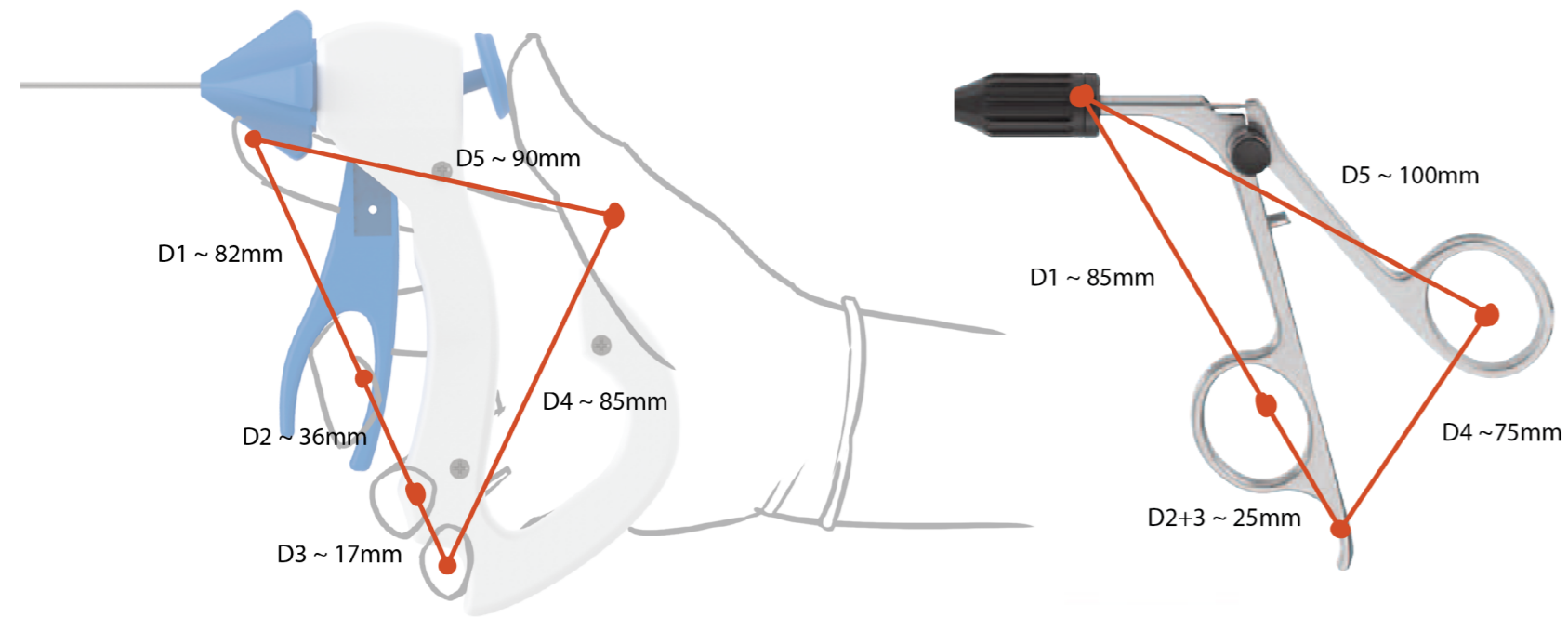

Figure 42. Handle dimensions in comparison with the Minop handle

### The trigger

The dimensions of all controls are in line with the product specifications that resulted from the user and ergonomics research. They are presented in Figure 42. The dimensions are chosen to facilitate mainly specification 4.3, of using the distal phalanges to operate the device. Figure 42 shows how the dimensions compare to the current instrument.

Figure 41 shows how the handle accommodates for several grip patterns, so the user can decide whether they want to actuate the end-effector control with one or two fingers. The benefit of using only the middle finger to actuate the trigger is that the ring finger can be used too, to stabilise the handle and use very subtle motions to open and close the end-effector.

Room is present for the index finger to rest on whilst not engaged in rotation at the location highlighted in purple in Figure 41.

The lever on the current instrument translates the movement produced by the thumb to a translation that is approximately 8 times smaller than the input. The new design has a slightly smaller ratio of 7, so it is more direct. Additionally, an opening motion in the hand, translates to an opening motion in the end-effector. A similar translation should be applied in the new design, to make sure the end-effector will behave in a predictable way.

The slot where the third and/or fourth fingers go is smaller than the rings in the Minop handle, at 20mm width (p90 index finger breadth), instead of 30mm. This is done to have a more direct reaction of the trigger on the opening- and closing movement of the fingers (and the fingers do not move around that much) [116].



Figure 43. Render of articulated joystick

### The joystick

The shape of the joystick, visible in Figure 43 and 44, is especially designed for this instrument, to accommodate the reach envelope of the thumb that was identified in Section 1.3.4. However, to make sure it is still usable with a larger or smaller thumb, or when a lot of force has to be exercised on the joystick, the shape is different from joysticks found in normal game controllers. It has 3 main components; the 'cup', where the thumb can fall into and force can be applied to the walls of the 'cup', 2) the little half dome, to rest the thumb on and apply very



Figure 44. Joystick in prototype, overmold in purple

subtle manipulations with and 3) the side flanges, where the thumb can apply force to the outer edge of the joystick comfortably, when the thumb is too short to reach the middle of the joystick at all times.

The joystick's sphere has an overmold of "grippy" material, that, in combination with the spring that pushes the joystick backward, acts as a lock to keep the joystick in position. This overmold was designed from a requirement from an overmold design guide, where it was stated that the thickness should be well over typically  $> 0.040$  [117].

The movement at the joystick in degrees translates to twice that amount at the tip. This makes for a very direct steering reaction, without much movement of the thumb. This was chosen over a very subtle, unnoticeable reaction at the tip.

### The rotulator

The rotulator control is fairly unchanged and the dimensions are purely based on the requirements from the Handbook. The only difference is that, now the mechanism is located at the top, meaning a large volume is in between the index finger and the thumb. The index finger has to reach around that volume. The shape is visible in Figure 45.

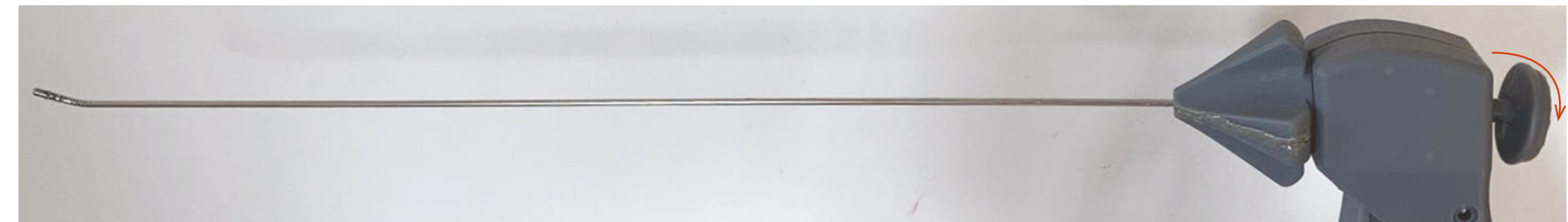

Figure 45. The joystick locked into position, with a bend at the tip of around 30°



#### 2.4.4 Manufacturing & assembly

DEAM prides itself about keeping their production local and a lot of thought goes into ease of assembly, making that production efficient and precise. Extra thought was put into this part of the design of the new steerable instrument. The protocol is included in Appendix 2.9, including pictures and notes.

After incorporating the user requirements leading up to product specifications, the requirements concerning the digital design & architecture as well as the physical assembly steps, have to be met. These requirements are mostly based on thought experiments (i.e. if one would assembly this subassembly first, how could it be placed in the parent assembly?) as well as the expertise shared by the people from DEAM.

These requirements are quite specific to the design of the mechanism, which is why they could not be specified earlier on in the process.

1. It should be possible to perfectly align the joystick in such a way that all steering cables have the same length when the joystick is in neutral position
2. It should be possible to adjust the length of the core cable to allow for perfect control of the end-effector, as the stroke of this cable is only around 2mm
3. When feeding the steering cables from the end of the shaft, all the way to the joystick, they have to be distinguishable at all times, to prevent accidentally crossing two of the tiny cables, rendering the steerable shaft useless
4. It must be impossible to over tighten the assembly, creating too much friction and rendering the mechanism impossible to use.
5. Minimise amount of parts and assembly steps
6. The manufacturing tolerances should have the least possible impact on the mechanism
7. It should be possible to make and tweak the friction layer of the joystick.

#### The frame

The frame (already visible in Figure 40, but also in Figure 46) takes away the need for the two shell parts to perfectly align. The full mechanism now only relies on the tolerances of the frame to run smoothly. The holes for the pins are designed too-small, so that facing holes can be drilled at the same time for perfect alignment.

The spacer keeps the levers from moving towards each other.

#### The steering cables & gluing tool

To be able to perfectly align the cables and prevent entanglement, a tool was developed that can be used during assembly. Figure 45 shows how the mechanism can be placed into the tool, after which the cables can be threaded through and the shaft can be placed in the gluing tool too.

This tool facilitates alignment of the shaft so it will perfectly fit into the rotulator knobs later. On the other end of the tool, it aligns the steering sphere and thus makes sure the steering cable all have the same length. At the same time, it keeps the cables from entanglement (Figure 49). The tool also sets the slider to one side completely, so the core tube (actuating the end-effector) is set to the right default. There are openings at both sides, so the screwdriver can reach the bolt that secures the core tube (see Figure 50).

The steering sphere combined with the cable guide arrange the cables in slots so they are equally spaced. The cables leave the back end, to be pulled tight, glued and cut off (Figure 51&52). The cable guide makes for a smooth surface for the joystick to rotate about, so there is no need for sanding after.

#### Friction layer mold

The friction layer discussed in section 2.4.3 can be applied to the joystick by means of the mold that was designed, see Figure 47 & 48. It has a Luer connection so that it can be filled by a simple syringe containing the liquid rubber under pressure. The halves of the mold can be aligned by inserting pins into the aligning holes, before which these holes are drilled in one go, so that the mold halves are perfectly aligned.

The rubber is left to cure and post processed by cutting off excess rubber. Now the Joystick has its friction overmold.

#### Amount of parts and steps

The prototype now consists of 33 parts. The shaft that was used, was already available in the archives of DEAM. Only the end-effector was assembled onto the shaft, by gluing the adaptor on the proximal end.

The handle and the mechanism inside alone consist of 21 parts and can be assembled in around 20 steps. With the gluing tool and the possibility to readjust the tension on the core tube, it is quite simple to assemble the handle. However, it is still time consuming and could be optimised, by designing better tools and improving the overall assembly, more about which more in the Discussion.

The mechanism frame can be placed in the gluing tool upside-down

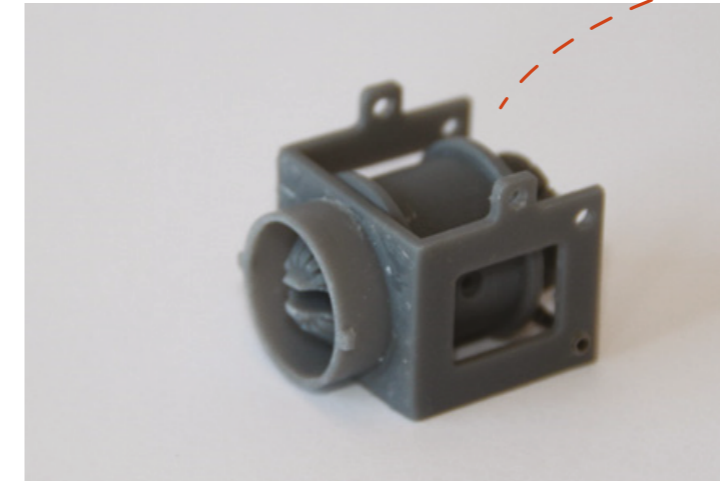

Figure 46. The full frame with the mechanism inside can be placed in the gluing tool

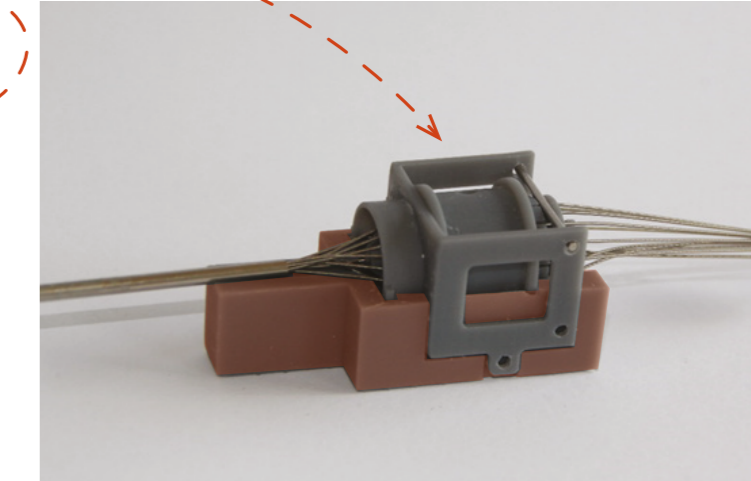

Figure 47. The mold, with the joystick insert

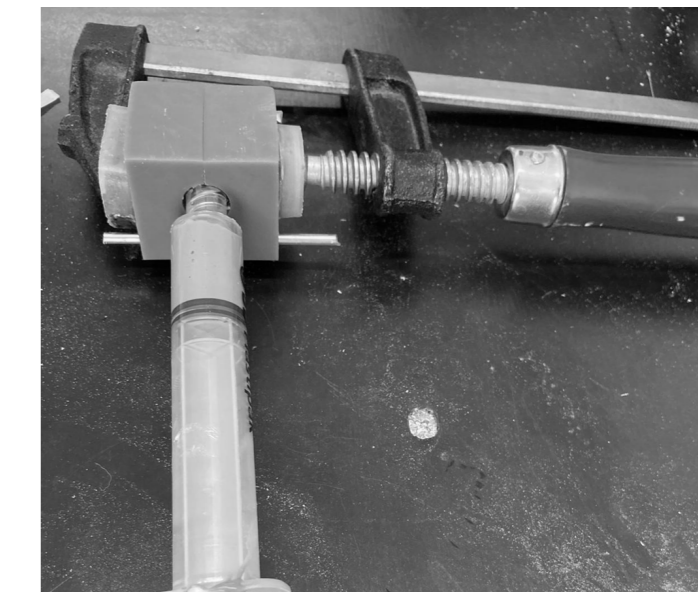

Figure 48. Filling the mold



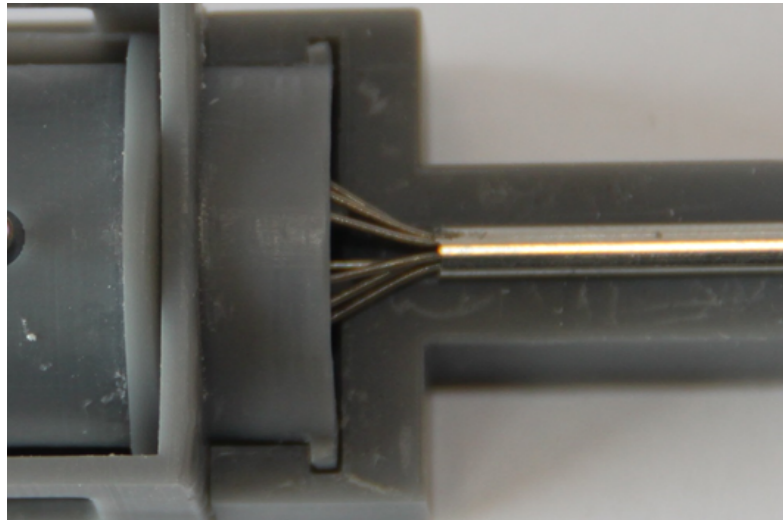

Figure 49. Close-up of the steering cables and core tube exiting the shaft neatly

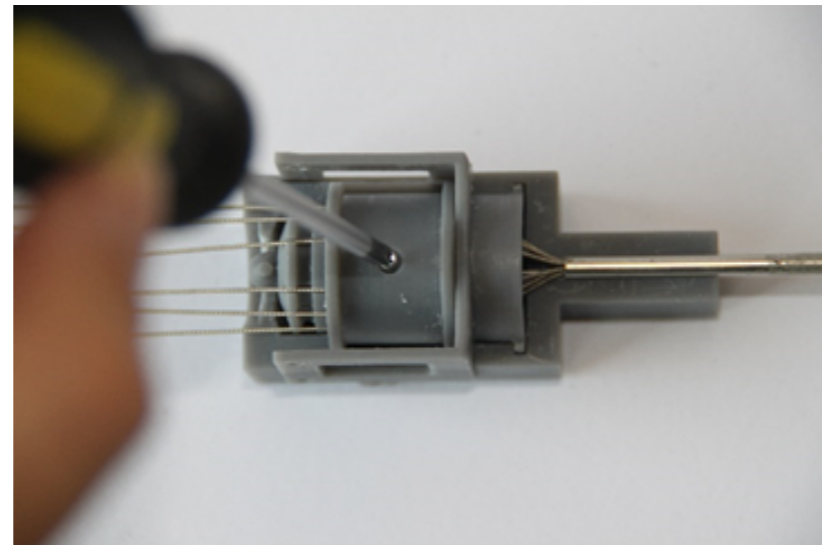

Figure 50. Tightening of the screw securing the core tube

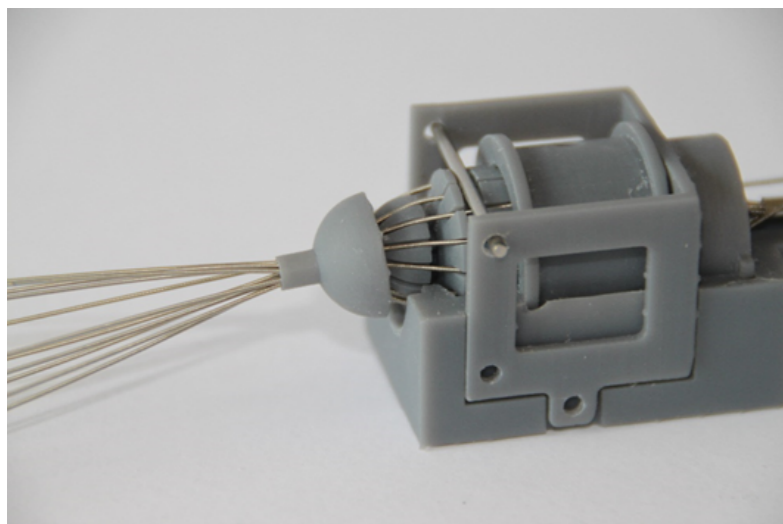

Figure 51. The steering cables arranged in cable guide, before gluing them

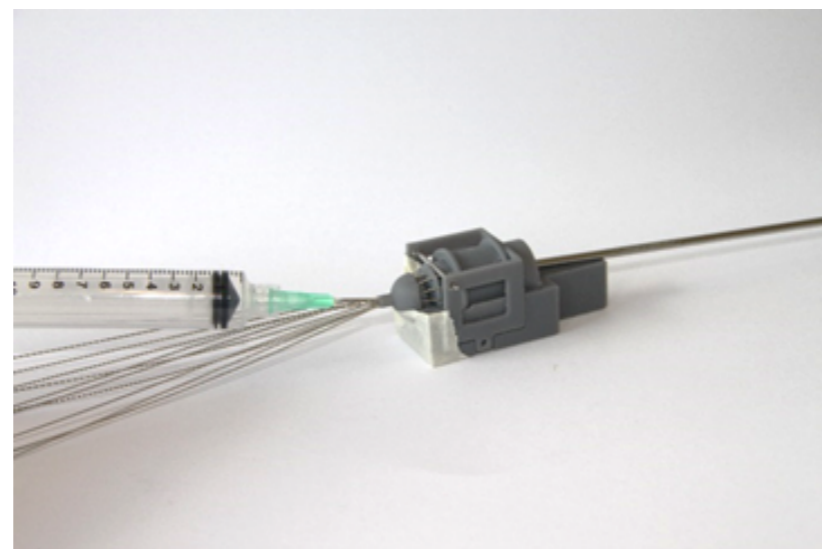

Figure 52. Gluing the steering cables is done with a syringe

#### 2.4.5 Material selection

The instrument consists of many parts, for the exploded view, see Figure 54. Many parts are stock parts, like the cover tubes of the core cable, the cover springs of the steering cables, screws, the cables itself etc. The shaft and tip parts are not stock parts, but still parts that have already been fully developed. These parts are left out of consideration in this chapter, as these are standard parts already in possession of DEAM and are validated for biomedical use accordingly. For the full part lists, see Appendix 2.10, where the parts for which a material analysis was performed. A recap of the criteria for the material choice:

- The materials have to be strong enough to withstand:
  - Max squeezing force of all fingers
  - Max thumb force (concerning friction & strength and stiffness)
- Biocompatibility (Class III according to Rule 6 of MDR: All surgically invasive devices intended for transient use are classified as class IIa unless they: are intended specifically for use in direct contact with the heart or central circulatory system or the central nervous system, in which case they are classified as class III [109]).

And specifically for the prototype:

- Either 3D printable, millable, laser cuttable or stock parts, for the sake of accessibility

For the "real product":

- Injection moldable for the plastic parts
  - Despite the market size, injection molding is the manufacturing method that ensures high precision, wall thicknesses could be reduced, quality can be assured [110]
- Millable for the metal parts
  - Precision, no brittleness.

#### The prototype

The materials for the prototype were selected based on accessibility and suitability in terms of mechanical properties. The aesthetics and cost per piece were inferior criteria.

Additive manufacturing, cnc milling, as well as laser cutting are the rapid prototyping techniques that were available to me, meaning the materials available

for selection are limited to 3D printable/millable/laser cuttable polymers and metals (assuming ceramics are already out of question).

After drawing that conclusion, two approaches are possible: find the most appropriate material concerning the mechanical properties, or use the machines that are easiest to access and accept the material properties of the parts that they produce.

Since the product is meant for a very delicate procedure, it is assumed that the stresses in the mechanism will stay low, which is also reflected in the product specifications (see Appendix 1.4). This is the motivation to opt for using the most accessible machines. DEAM has a formlabs printer, which produces rather homogeneous, smooth looking parts. This is suitable for any part that is not prone to warping (very long or flat or thin parts). In the case of long thin parts, like the levers, it was better to use lasercut parts.

Altogether, the prototype is heavier than intended (93 grams). This is mainly due to the heavy trigger, which is obviously over engineered and if integrated with the levers and completely shelled, it could have been much lighter. The mechanism including the frame are also quite bulky, as it was designed to be 3d printed (see Figure 53). Smaller dimensions would have made it impossible to print the parts. More about these decisions can be found in the Discussion section.

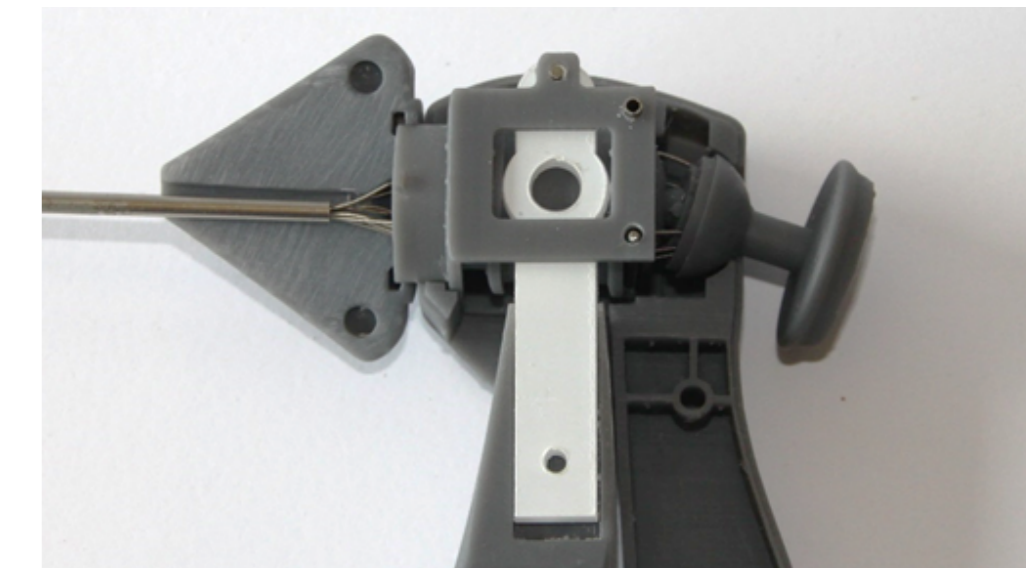

Figure 53. Half of the prototype with all the materials visible

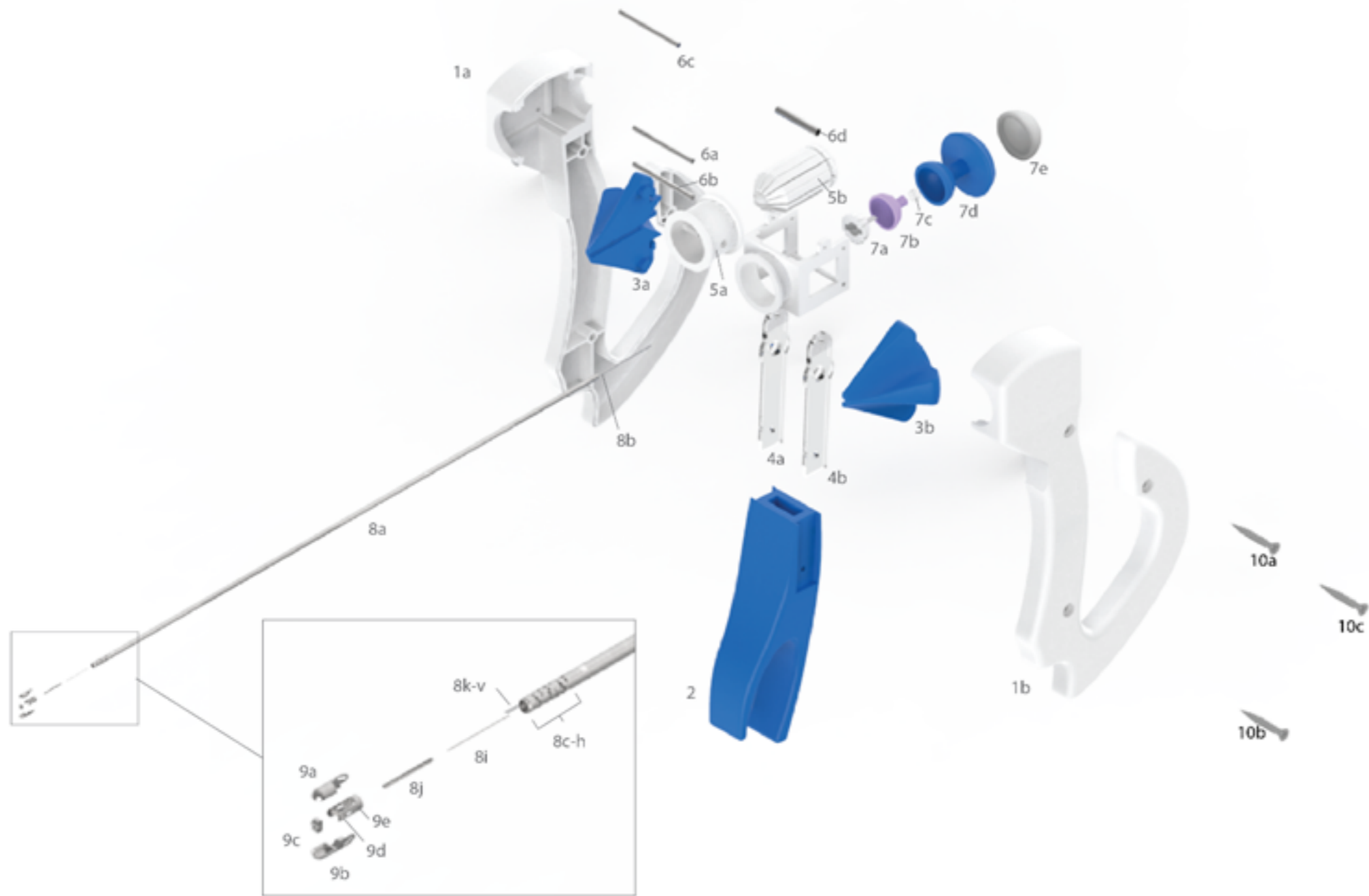

Figure 54. Exploded view of the prototype. The numbers correspond to the BOM in Appendix 2.10

### The envisioned product

The materials for the “real product” however, should comply with far stricter requirements, especially concerning the manufacturing method and accompanying tolerances, as well as reliability, biocompatibility and aesthetics. For this, rather critical, selection process, CES Edupack was used. This software package plots materials in a graph according to input concerning the desired material properties, mechanical and chemical. The product specifications concerning force (Appendix 1.4) were used as input to those FBDs. There is no model that was optimised for the envisioned materials and their manufacturing methods, which is why this section is more of an introduction to the selection process rather than a guide to the perfect materials.

### DEAM materials

An additional guideline to the selection of the appropriate materials is using the materials that were implemented in the LaproFlex as a guideline. For the outer handle shells, a specific type of polycarbonate (Makrolon®) was used. Some part of the mechanism are milled from stainless steel.

### Shell parts & joystick

This analysis was performed based on:

1. Injection molding appropriate
2. Biomedical material for surgical device transient use
3. Min Young’s modulus: 0.3 GPa
4. Price: Max 4GBP/kg

The results, are ranked by price in Figure 55.

PET is cheap and passes all the stages, but is just not suitable for the product. It is clear and usually applied to thin-walled products, like bottles and films. PVC is more often applied in extrusion and does not have very great optical properties. Pom is very stiff and a bit brittle, as is PLA. PCTG and PCTA both can be injection molded, but quite poorly. PC seems a good choice, concerning price it is in the middle and is very injection moldable, not too stiff or brittle and nice aesthetical qualities. PC is also very suitable for overmolding of the friction layer in the joystick, which is why the joystick will be made of the same material as the shell parts.

Name	Price (GBP/kg)
PET (unfilled, amorphous)	1 - 1.16
PET (unfilled, semi-crystalline)	1 - 1.16
PVC (semi-rigid, molding and extrusion)	1.34 - 1.5
PVC (rigid, molding and extrusion)	1.44 - 1.49
MABS (unfilled)	1.62 - 1.73
PVC (rigid, high impact, molding and extrusion)	1.93 - 1.97
POM (copolymer)	1.93 - 2.1
PLA (30% mineral, impact-modified)	1.95 - 2.45
PLA (30% natural fiber)	2.07 - 2.78
PLA (general purpose)	2.14 - 2.82
PLA (30% glass fiber)	2.26 - 2.79
PCTA (unfilled)	2.35 - 2.51
PLA (10% mineral, impact-modified)	2.36 - 2.89
PC (low viscosity, molding and extrusion)	2.43 - 2.7
PLA (10% glass fiber)	2.51 - 3.17
PLA (high impact)	2.56 - 3.14
PLA (impact modified)	2.6 - 3.24
PLA (flame retarded)	2.74 - 3.7
ABS+PC (injection molding and extrusion)	2.83 - 3.17
PMMA (molding and extrusion)	2.89 - 3.64
PCTG (unfilled)	3.08 - 4.1
POM (copolymer, 2-20% PTFE)	3.18 - 3.63
PMMA (impact modified)	3.3 - 4.01
TPU (ether, aromatic, Shore D75)	3.3
TPU(r) (molding)	3.39 - 3.71
PPE+PS alloy (high glass transition)	3.43 - 3.52
Copolyester, Tritan-type (unfilled)	3.8 - 3.84

Figure 55. CES Edupack output for the shell parts & joystick

### Rotulator & Joystick

Similar to shell parts. It would have been preferable to also weigh in friction coefficient, but this was apparently impossible in CES. So, the selection of the best material for these parts was again based on the young’s modulus, the price, the aesthetics and, of course, biomedical application suitability. One could decide that, since especially the rotulator is quite bulky in shape and will never endure high loads, it could be made from a less strong and stiff material than the shell parts. Polypropylene would be much cheaper than PC and also extremely suitable for injection molding.



### SteeringSphere, SliderBeam & Slider

These parts will never be visible to the user, so optical qualities are of lesser importance. However, the polycarbonate was sufficient concerning its mechanical properties in the solidworks simulation for these parts (in terms of deformation, stress and strain). For the convenience of not having to find another material for each part, it is assumed that polycarbonate is also suitable for these parts.

### Cable guide

The cable guide is a part that serves to make the assembly easier. It traps the glue that secures the cable between the steering sphere and its inside surface, to make sure the bearing surface with the joystick is smooth.

Several glues can be used to do so, but since it is not sure which is optimal, it is assumed that it might be a glue that has to be cured with uv light. For the light to penetrate, this part should be transparent.

### Frame

The frame assembly consists of the frame itself and three pins. The frame will be clamped completely within the shell parts and so have very low mechanical requirements. As the SolidWorks Simulations pointed out, these pins could be manufactured in PC too. These pins did show the largest displacements, which could be noticeable to the user. One of the user requirements is to make the product feel sturdy and trustworthy, and such large displacements do not help that. That is why it was decided to make the pins biomedically approved stainless steel.

### Overmold

First things first: Overmolding is a manufacturing process during which a single part is created, by molding one or more materials over a first material (the substrate) using two or more different materials in combination. Typically the first material, sometimes referred to as the substrate, is partially or fully covered by subsequent materials (overmold materials) during the manufacturing process. An overmold design guide advises to use the flexural modulus rather than the young's modulus, as it relates closer to how flexible and soft it feels (a very flexible material can still have a high young's modulus and vice versa). However, this is still misleading, as not all soft rubbers or other overmold materials are especially "grippy". So, it is difficult to find the requirements on which to base this selection,

except that it should be suitable for biomedical use. It should adhere well with the base material as well. CES does not offer the possibility of entering a desired coefficient of friction (COF).

When plugging a low flexural modulus (0.003GPa, guess based on desired feel), biomedical material and excellent injection moldability into CES, polyurethane rubber (TPE), a thermoplastic rubber with shore A ranging from 50-92 is the result. Shore A of 50 is usually found in products like a soft pencil eraser, whereas 90 would be comparable to electrical wire covers. To find the perfectly suitable properties of the TPE applied in this overmold is a task for further research.



### Static simulations

To evaluate the design on its strength, stiffness and general resistance to deformation and loads, SolidWorks simulations were performed. The input for these analyses comes from the forces that were estimated in Section 2.4.2. This analysis was done parallel to the material selection. For these simulations, it was assumed that the tip mechanism is already validated by DEAM, so it was not needed to check whether the cables and such would be up to the task. During the analyses, zero friction in the system is assumed and the safety factor was set at 1.5, since it is a delicate product and is not expected to be handled with great force. The yield strength of the material is 6.9MPa, Additionally, it is unknown how much force is applied on the brain tissue exactly during ETV/biopsy (see Section 1.4.1), except that the forces are extremely low (0.01-0.5N), so the risk is rather to damage the brain tissue than to damage the product during surgery [44].

### Results

In the static simulation, the maximum stress on the shell was 2.6MPa, on the joystick it was 1.0E-1MPa and in the trigger it was 1.3MPa. All well below yield strength. No large displacements were detected. On the pins keeping the sliderbeam in place in the frame (due to the trigger force), the yield strength was exceeded (6.9MPa), which is why in the final prototype, these were replaced by stainless steel pins. The stresses are visible in Figure 56-59.

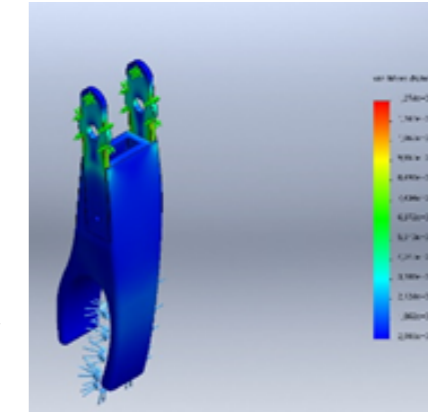
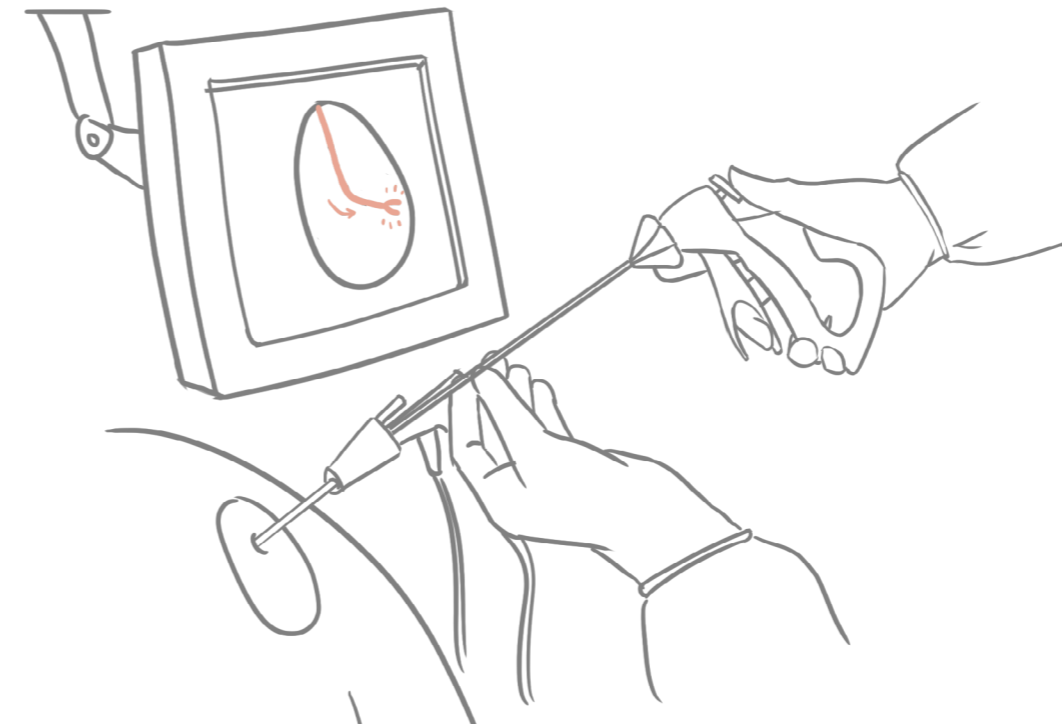

Figure 56. Stresses in the trigger

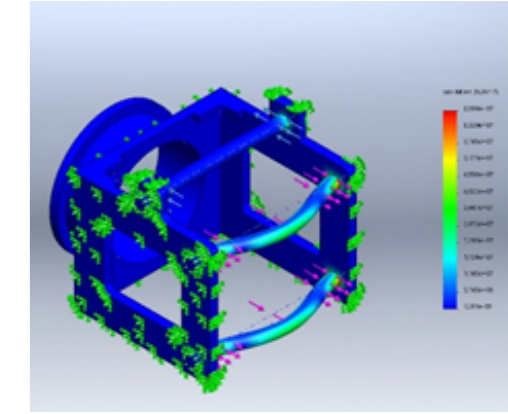

Figure 57. Stresses in the frame

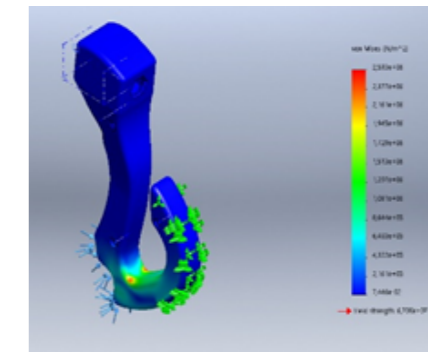

Figure 58. Stresses in the handle shells

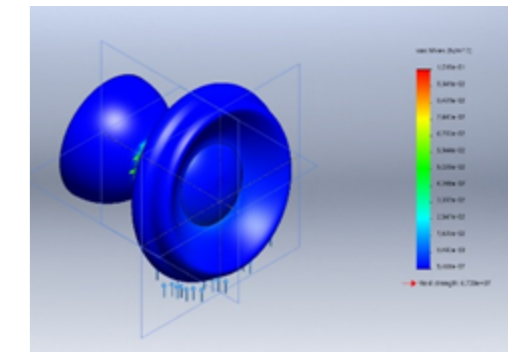

Figure 59. Stresses in the joystick

#### 2.4.6 Final test design

To be able to test the performance of the newly designed instrument, a phantom or box trainer that facilitates for measurement of the relevant variables had to be designed.

The final test aims to investigate what the effect of the new instrument is, compared to the old instrument and whether the new design imposes new risks and whether the ergonomics of the handle are satisfactory.

This section describes the design of the test set-up, on which requirements the design was based and how the possible effects mentioned above can be measured.

A minor investigation on phantoms and box trainer was performed, of which below the findings are presented:

There are roughly four categories of phantoms or trainers.

**1)** designed to really emulate a patient, to not only be able to only train the use of the instruments, but to also have an experience that is similar to the real surgery, where the anatomy of the patient can be in the way (e.g. the nose of the patient prevents the surgeon from manoeuvring over the face of the patient). This type is thus mainly meant to prepare the surgeon for a real surgery, rather than for the use in studies concerning the instruments that are being used. These “dummies” could however be used in other types of studies, concerning the performance of the surgeon [42], [43]. These also exist specifically for neuroendoscopy. **2)** emulates one type of organ or structure really well (in terms of mechanical properties, colour etc.), to be able to test the skills of the surgeon or the behaviour of an instrument (e.g. surgical instruments, imaging techniques) in that specific tissue. These kinds of phantoms are developed by meticulous studying of the real tissues and how to translate that to synthetic materials [44], [45]. **3)** Ex-vivo real organs, prepared some way or another in order to be preserved and to have some specific functionalities, like moving lungs [46], [47]. This type is extremely hard to come by and to handle. It has to be used in a lab and there are several other regulations to it [48]. The tissue will change over time and the use is not completely repeatable. **4)** The last category is the box trainer. Rather than emulating tissue or bodyparts, this type of “phantom” aims to really present a repeatable task to the user, which can sometimes not even resemble the real procedure. There is an extremely wide range of types of trainer boxes,

from really high-tech, including sensors to measure the instrument’s positions in order to project them in some sort of virtual environment, to very do-it-yourself, consisting of a plastic container with three holes; two for the instruments and one for the camera [49], [50]. And any level of fidelity in between. The camera is connected to a smartphone or monitor and there you have it. These boxes are effective to train a user but also to measure the basic behaviours of the instrument being used. DEAM makes their own trainers.

#### Conclusion

The goal is to create a phantom that first and foremost can be used to test the performance of the final prototype and how it fills the user requirements. Based on the analysis above, a box trainer is most fitting, it is simple yet effective. The four statements below comprise the hypotheses that have to be tested in the box trainer design:

1. The movement in the endoscopic system needed to reach the target area is reduced in the new design
2. The newly introduced controls do not cause new/more movement in the shaft
3. The handle is intuitive to use
4. The physical ergonomics of the handle are equal to or better than the old design

Which in turn can be translated into a list of requirements specific to the test set-up:

1. The study is comparative (rigid vs new instrument)
2. The task the user has to perform is completely repeatable by every participant
3. The task should be representative of the actual ETV/biopsy procedure that the instrument is designed for

The appropriate dimensions of the box trainer had to be found, in reality, the third ventricle is very small; 9.5-27.5mm with a mean of 14.5 (width) by 10.9-26.3mm (height) [7]. These dimensions do not facilitate the endoscope that was made to imitate the neuroendoscope. Additionally, laymen test persons would not be able to operate in such a small environment. For that reason, the size was slightly increased. Tests were done to evaluate visibility of the yarn and finally it was decided to make the box 30x40x30mm. The full set-up and the use of the instrument are presented in Figure 63 and 64.

The dimensions of the especially designed box trainer create a situation where the insertion angle of the trocar resembles the insertion angle during a real neuroendoscopic procedure.

The task has to resemble the intended procedure; an ETV/biopsy combination, roughly meaning there are two locations of interest: the anterior floor of the third ventricle (A in Figure 60) and the posterior section of the cavity (B in Figure 60). Therefore, the box has touchpoints in those locations. To be able to test the end-effector, the touchpoints should be somewhat flexible and possible to grasp and manipulate. Coloured yarn was chosen to fulfil this job; that way the task can be easily explained to the participants. Additionally, the yarn can be replaced in case they snap or are otherwise damaged. See Figure 62 for the endoscope vision.

#### Tracking the handle

To be able to quantify the stability of the SNI during the task, the participants holding the SNI were filmed en profil. The shaft of the trocar was marked with 2 markers, which were positioned at 35mm apart from each other. On the trainer box, another marker indicates the origin of the coordinate system that is used during the video analysis (see Figure 61). For the full set-up, see the next chapter. The footage was later analysed with tracking software, so the locations of the trackers could be identified over time. The trainer restricts the movement to some degree, enforcing a certain insertion angle.

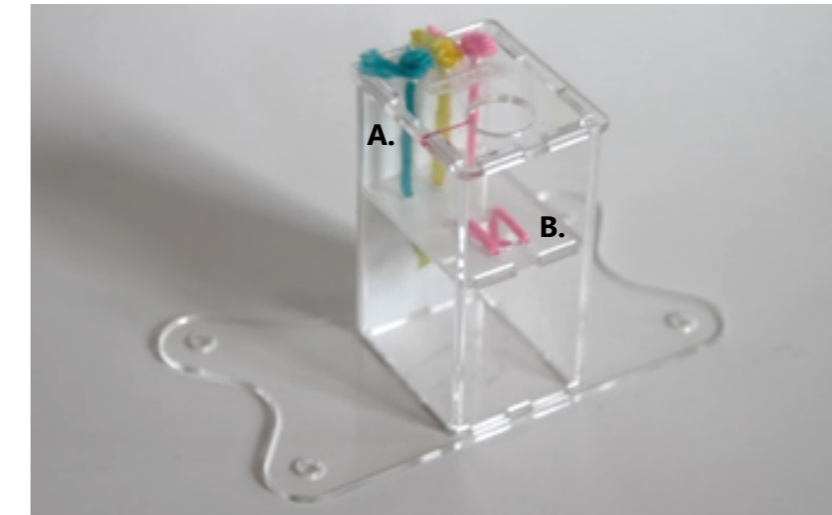

Figure 60. The box trainer with at A. the yarn representing a posterior tumor and at B. the yarn representing the ventricle floor

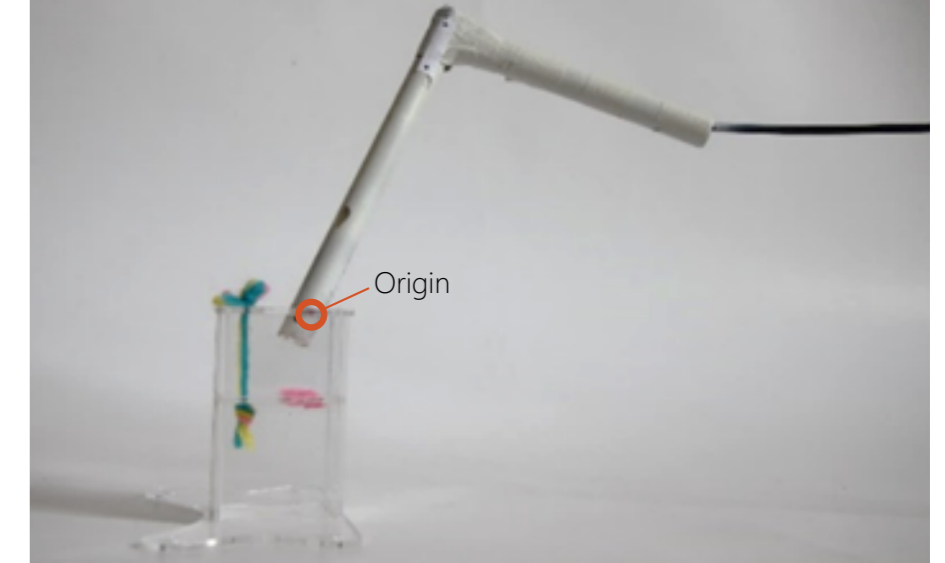

Figure 61. The box trainer with the endoscope

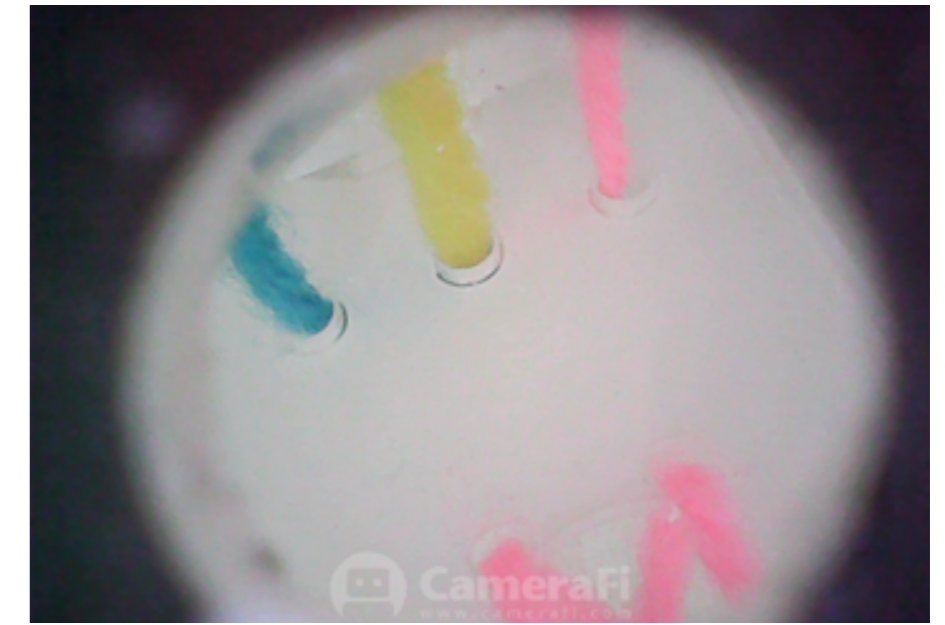
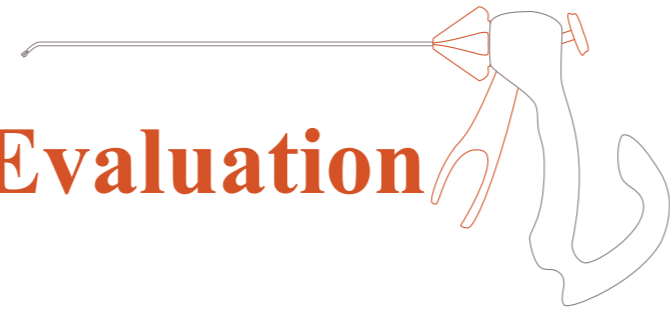

Figure 62. Endoscope vision of the yarn



## PART 3: Evaluation



## 3.1 Introduction

This final chapter aims to evaluate the prototype on the user requirements, product specifications and other points that were made in the analysis section. The desirability, viability and feasibility were tested, either qualitatively or quantitatively.

But, before the approach to the evaluation and the results are introduced, let's look back on the design process presented in the last chapter and list the take-aways: The ideation cycles were fairly short and most design decisions were based on user feedback. As early as during the analysis phase, the first ideas were evaluated with prof. dr. Hoving, from which the user requirements resulted. The first prototypes were based on this input, aiming to find the most desirable handle shape and control configuration. The best two concept directions were used as input for the new prototypes, from which again two were selected to base the final prototype on.

During the development of the prototypes, the product specifications were collected and specified from the findings from user- and secondary research. In the end, this yielded a fully functional prototype, as well as a simple test environment. The main input underlying the design decisions of the final prototype are; the handle is operated with the distal phalanges, the palm of the hand is used to stabilise, the last two digits can be used to counteract the trigger motion, the joystick is lockable and the operations are subtle but direct.

It was concluded that a box trainer had to be designed to be able to test the performance of the final prototype. A box trainer was developed, with two simple tasks resembling a combined ETV/biopsy procedure.

During the evaluation, all of the above are tested and reflected upon.



### 3.2 Cost

This section presents the expected cost of one instrument. Since the material selection was quite basic this cost estimation is also just an approximation. Naturally, before transitioning to injection molding, rapid prototyping is more profitable even when making up to a 100 pieces, since the investment in tooling is so large. The cost estimation was based on:

- The manufacturing methods (with moderate to high precision)
- The masses of the materials
- First batch size of 12000 pcs (batch size based on market size from Section 1.4.2)
- Investment costs for the molds
- Estimation of cost of stock parts

The injection molding parts would all be around 1-3 dollars. There are the shell parts (together around 3 dollars), the joystick parts (3 parts also adding up to around 3 dollars), the trigger (around 2 dollars), the sliderbeam (around 2 dollars) and the rotulator parts (around 2). The full results of the injection molding casts as calculated with Custompartnet.com is presented in Appendix 3.1.

For comparison, with a batch size of ten times smaller (12000pcs), the parts would be around 20 dollars.

Some of the more specialist stock parts like the capillary tubing needed as the core of the shaft (for end-effector actuation) is quite expensive; a single piece is 50 euros (personal communication with Salomon's metalen bv). In bulk it might be around five times less, so it is assumed to cost around 10 euros. The outer tube with laser cut profiles is very costly, as are the machined tip parts, because of their tiny size and needed precision. These parts are estimated at around 60 euros.

The rest of the cables, screws and springs are estimated at around 15 euros. All in all, the cost would be at least a 100 euros, solely for materials and manufacturing. It then has to be transported, assembled, sterilised etc. To put that into perspective, the average neuroendoscopic surgery in January 2007 to January 2014 cost \$19,736 in the US [112], whereas the costs of a craniotomy are sometimes twice that amount (\$34 804 to \$46 798 based on this research) [113]. Furthermore, sterilising an instrument costs, depending on the complexity, around 3.19 dollars each time, on top of the initial investment of the rigid instrument (of around 200 euros) [114].

Concluding, the articulate new design will probably, at this point, increase the cost

of a neuroendoscopic procedure, but will at the same time lower the amount of craniotomies needed, reducing the cost of all brain surgery together. Hopefully, it would also reduce operating time (as it eliminates the need for cumbersome and precise repositioning of the full system) and work-related musculoskeletal disorders in neurosurgeons (as it eliminates the need for awkward positions for good placement of the shaft) and thereby balance out the higher price of the instrument itself. Hopefully, future business case development can identify more relevant areas where a steerable instrument with a small diameter shaft can be useful.

### 3.3 Field of view

Now the dimensions of the tip and the performance of the prototype are known, a short calculation can be performed to evaluate the effects on the visibility of the tip during steering. The formulas used are based on Figure 63. The opening angle of the end-effector is also taken into account. The end-effector plus articulating section is now 13.9mm, where  $l_1$  is 7.3,  $l_2$  and 6.6. For the tip to be in focus,  $b+c$  should equal around 25mm, which is the case at  $L$  is 12. At the maximum steering angle, the tip will always be visible. However, when the tip is closer to the lens, at for instance  $L=5$ , the tip will steer out of view using a regular 0 degree endoscope. When using an angled endoscope, that would not be the case (in one direction of course).

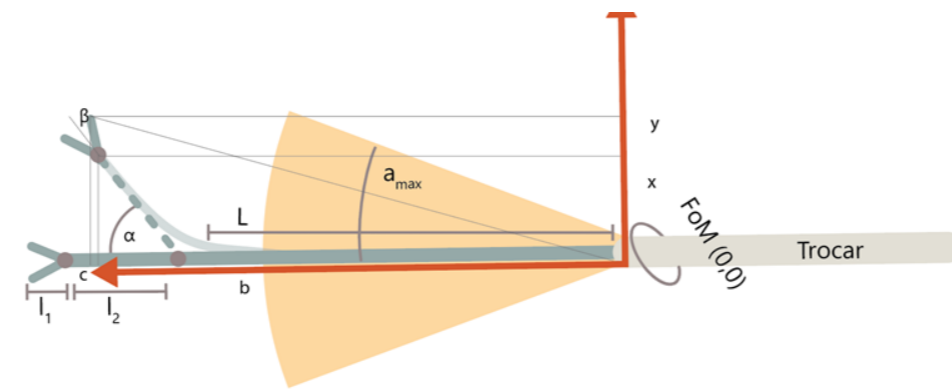

Figure 63. The 2D model of the articulating tip

$$\sin^{-1}\left(\frac{x+y}{b+c}\right) < a_{max}$$

$$x = l_1 * \sin(\alpha)$$

$$y = l_2 * \cos\left(90 - \left(\alpha + \frac{1}{2}\beta\right)\right)$$

$$b = l_1 * \tan(\alpha) + l_e$$

$$y = l_2 * \tan\left(90 - \left(\alpha + \frac{1}{2}\beta\right)\right)$$

### 3.4 User testing methods

As explained in the test design section, the final usertest consists of two parts: 1) testing the usability and thus the performance in terms of user requirements and 2) objectively testing stability of the new system. The null hypothesis concerning the stability is that there is no change in movement of the endoscopic system during the procedure after introducing steerability.

This test is meant to truly evaluate how well the new, instrument with steerable tip was designed in terms of desirability, the first part of HCD. If the design scores well on this front, the viability and feasibility follow.

That means that part of the methods & materials are overlapping for these two parts. These are explained below. The parts that are specific to usability and stability are presented later.

#### Materials

For this user evaluation, the box trainer set-up introduced in Section 2.4.6 was used. To film and record any comments, a camera was set-up. For the comparison between the old and the new design, a dummy of the Minop forceps was 3D printed. For the endoscope vision, a smartphone is connected to the endoscope that was created for this test. This endoscope is marked with coloured dots for movement tracking.

To evaluate the instrument after use, a questionnaire was created.

#### Method

A camera is set up so that the participant is filmed en profil. Up to the shoulders are in frame, their faces are left out. The distance to the box trainer is at approximately the same distance for every test. Additionally, the box trainer was positioned at the same height from the floor every time.

The experiment is explained to the participant and permission to record is requested.

The participants are asked to perform the task that was designed for the box trainer that was presented in Section 2.4.6. First, they are asked to manipulate all the coloured strings with a dummy of the traditional Minop instrument. They have unlimited time. It is encouraged to think aloud, although most participants were too occupied with the task. Then, they are asked to perform the same task with the new design, but with the extra assignment of using the steerability instead of moving the full instrument in order to reach the strings.

Afterwards, three measurements of their hands were taken:

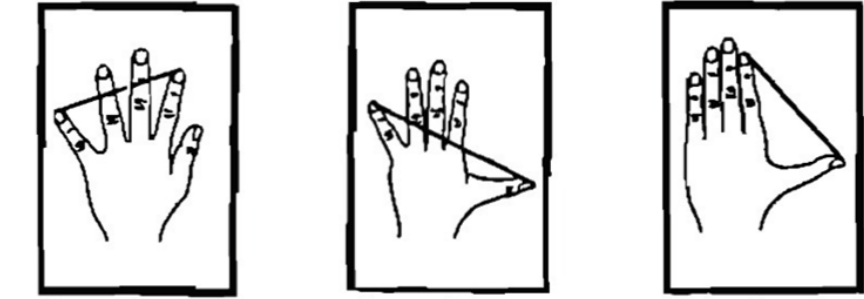

Figure 64. Relevant hand spans, from Wagner [68]

#### Participants

In order to receive expert feedback as well as input on intuitiveness and ergonomics from non-surgeons, the participants are mixed. 1 neurosurgeon and 9 laymen took part in the experiment. Additionally, a neurologist gave some input without doing the full experiment.

#### Usability-specific method & variables

To test the usability of the new design, the participant is asked to perform a visual inspection first. The prototype is presented laying flat on the table. Once the participant thinks they have a good impression of the device, they are asked to rate the first five statements of the questionnaire. All statements are phrased positively, i.e. "the instrument feels trustworthy during use." and can be rated on a 5-point Likert scale (so 1 meaning worst and 5 meaning best rating).

Then, the hands-on task explained in the previous section is performed by the participant. During the task, the participants are requested to think aloud. When the task is performed with both instruments, the participant is asked once more whether there are any comments or questions.

Then, the second and last section of the questionnaire is filled out by the participant. These statements all address the user requirements previously formulated. In some cases, multiple statements were offered per requirement. The full list of statements can be found in Appendix 3.2, including the full results. 5 extra statements meant only for the neurosurgeon were included at the end of the questionnaire. These all concerned rather specific aspects of the instrument, i.e. "the tip has appropriate rigidity at neutral angle".

### Stability-specific method & variables

To be able to quantify the stability of the SNI during the task, the participants holding the SNI were filmed en profil. The shaft of the trocar was marked with 2 markers, which were positioned at 35mm apart from each other (using graph paper). On the trainer box, another marker indicates the origin of the coordinate system that is used during the video analysis (see Figure 65). For the full set-up, see the collage on page 84. The footage was later analysed with tracking software, so the locations of the trackers could be identified over time. The trainer restricts the movement to some degree, enforcing a certain insertion angle. This software "Tracker" was especially coded for the purpose of analysing the footage of handling the instruments. This software has been used for a couple of other scientific studies [115]. For this method, a template is created by snipping one of the frames in the footage, to only contain one of the markers on the trocar. Every test requires a new template, to correct for light conditions. The software yields path lengths of the movement of the markers for per frame in millimeters, as well as the angle of the marker with the coordinate system. This software was used to evaluate the movement in the endoscope when performing the task with the Minop dummy and with the new instrument.

For every frame, the algorithm loops through the pixels surrounding the pixels that were identified as a match with the template in the last frame, to compare that area and its surrounding pixels to the template.

Referring back to Figure 3, in the Introduction section, 3 types of unwanted movement have to be identified. In movement 1 & 3, the angle of the endoscope stays the same, whereas in movement 1, the endoscope tilts. Excel was used to process the results from the software.

To identify movement type 1&3 (together), the path length of the frame was counted if the angle stayed the same (<1 degree variation). To identify movement type 2, the path length was counted if the angle changes (>1 degree variation). Naturally, this is a 2D analysis.

A two-tailed paired T-test was used to evaluate possible significant change in movement in the endoscopic system with the introduction of steerability. The means per frame per participant for each type of movement while using the Minop dummy and the new prototype were used as input.

Since there was no time limit to the task, it was not possible to use total path lengths.

A marker on the trainer box indicates the location where the origin of the coordinate system is set.

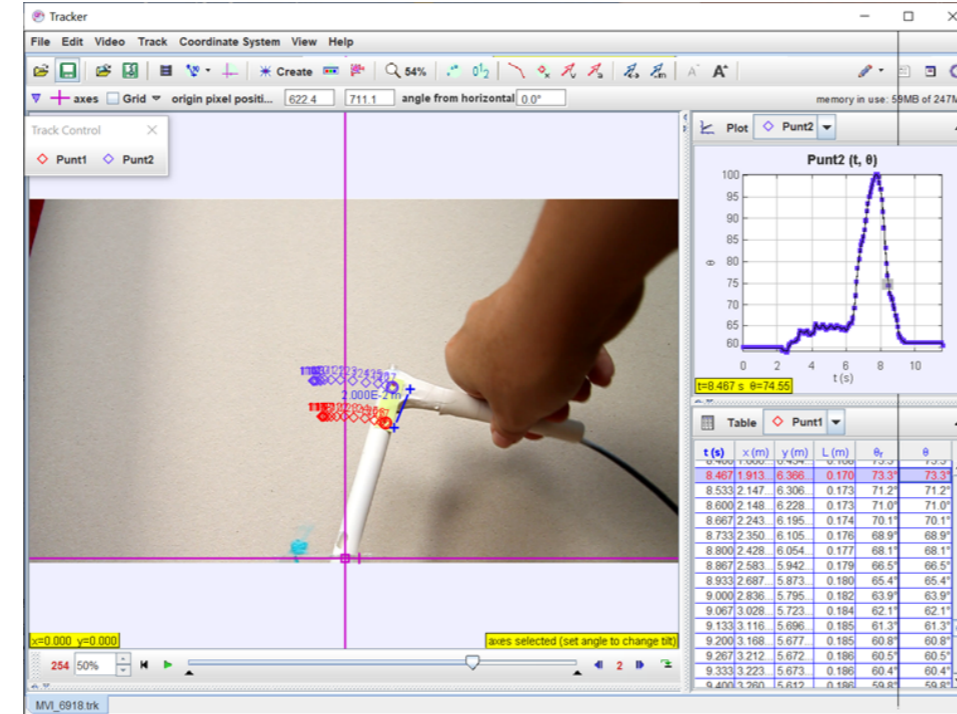

Figure 65. Interface of the Tracker software

### 3.5 Results

#### Usability

##### Observations & Thinking aloud

The full results per participant are included in Appendix 3.2, except those from prof. dr. Hoving, which are presented here:

The hook initially is confusing and does not give an immediate idea of how to hold the instrument, however, the handle looks robust and trustworthy. The old instrument facilitates relaxation in the hand, and there isn't any tension in the fingers, whereas the new instrument determines the grip completely, so maybe more freedom needed for more comfort. The steerability is amazing and the movement needed to move joystick is good (the amount and the force).

Somehow, the deviation to the right is easier than to the left, which is either caused by the shape of the bottom of the handle, or by some mistake made during assembly. Prof. dr. Hoving states that the shape of the handle is good, but the size is too big. Prof. dr. Hoving likes the hook to clamp the thumb while opening the trigger, looking for yet another added lever of stability. At some point, the hand has to move over the handle to use the controls, especially when going back and forth between steering a bit, opening the end-effector a bit, steering a bit etc. Prof. dr. Hoving thinks the rotation control is good and well positioned. When using the middle- and indexfinger to open the trigger, stabilising with the pink is troublesome.

Almost none of the participants (excluding two) immediately hold the handle correctly. The hook shape is the culprit; does the thumb go through? Do you hold the hook? Multiple participants state that the handle is slightly too large to comfortably place the little finger in the designated spot, but it is possible. Five participants state it is very nice and fun to use the prototype and want to keep going after they have fulfilled the task. Two participants used two hands at some point, to reposition the handle inside the dominant hand. Four participants tend to use the hook as if the handle were a pair of scissors.

##### Questionnaire

All statements were all rated neutrally or positively on average. The lowest (3/5) was on the statement "it is comfortable to hold an control the handle". The highest rating (4.5/5) was on the statement "The forces required to operate the trigger are comfortable". The ratings per statement for all participants is included in Appendix 3.2. This table also includes the hand measurements of the participants.

To provide an insightful overview of the results, Figure 66 was made. It presents the 12 user requirements that were presented in the conclusion of Section 1.7, but now including the mean score per requirement, calculated from the mean scores of the corresponding statements.

The hand measurements can be summarised as follows: the span between the index- and little finger had a mean of 142mm, ranging from 115mm to 170mm. The span between the thumb and the little finger had a mean of 195mm, ranging from

#### Mean score per user requirement

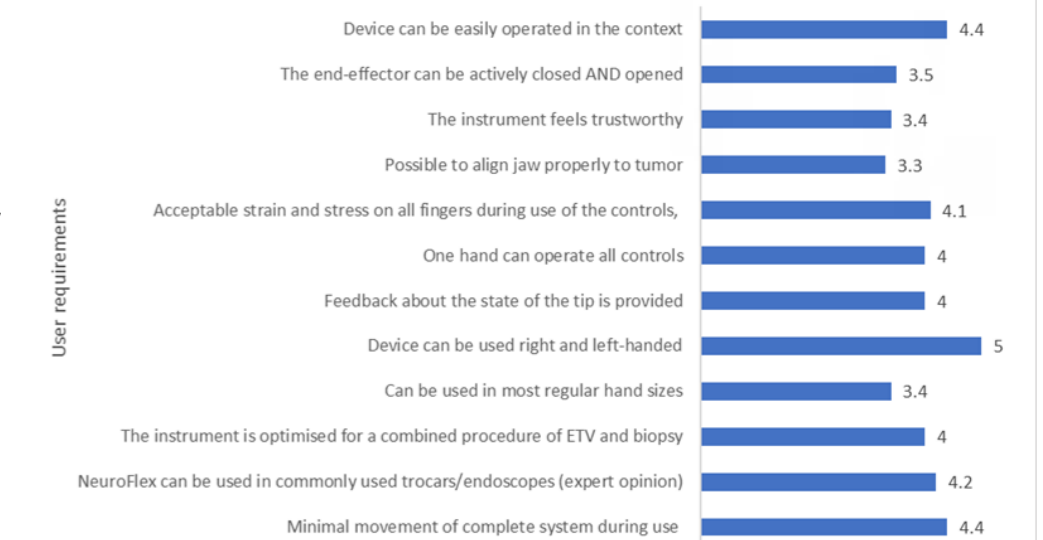

Figure 66. Mean rating of the device sorted per UR

160 to 230mm. Lastly, the span between the thumb and indexfinger had a mean of 164mm, ranging from 140 to 200mm. The hand measurements are shown in Table 6, paired with the mean rating the specific participant gave, sorted from highest to lowest rating. No significant correlation between any of the spans and the mean scores could be identified ( $p > 0.05$ ). Finally, the final 7 statements were only aimed at the expert user. These were rated with a mean of 3.7. The highest score was on compatibility and ease of insertion with the trocar. The stiffness of the tip was rated with a 4 in bent and neutral position. The adequacy of the steering angle was rated with a 4/5 too. The trigger control however was rated with a 1/5.



### Discussion

To have used the guidelines of “Handbook of Human Factors in Medical Device Design” might have been inappropriate as these guidelines are too general and not focused on the subtlety of brain surgery. The guidelines for the trigger length, the handle width and that the distal phalanges of the fingers should be operating the handle, together with the feedback on previous handles where the feedback was usually that the shapes were giving too much freedom to the user and were too small, yielded this rather large handle. As a result, the handle was too big for some of the participants to make subtle movements.

Table 6. Finger spans per participant together with their mean rating of the design

Span 1 (2-5) [mm]	Span 2 (1-5) [mm]	Span 3 (1-2) [mm]	
140	200	160	4.7/5
145	230	200	4.5/5
140	210	140	4.1/5
115	175	145	4.1/5
125	185	155	4/5
145	160	140	3.6/5
140	180	160	3.6
140	190	170	3.5
170	200	175	3.3
160	220	200	3.1
142	196	164	Means

In the traditional handle, the opening movement of the hand was easy, since the handle consists of rings and it is easy to counteract the moving backward of the thumb with the finger that is located in the other ring. It was theorised that the same counteracting could be performed without rings, by the last two digits and the pad of the thumb/palm. It seems that, since many participants used the palm stabiliser part to hook their thumb and so mimic the thumb ring that the old instrument had.

The fact that it did not seem intuitive how to hold the handle might be due to the

fact that the prototype is all in one colour; if the controls were coloured like in the renders presented in Section 2.4, it might have been more clear how to hold the handle, where to place which fingers.

Some of the participants mention it would not be possible to use the controls at the same time. However, this is an interesting comment, as it is not needed to use them at the same time. The tip can be set to an angle and then left alone, in order to perform the biopsy or any other procedure.

The table on which the box trainer was set up, was always at the same height. However, the participants were not all the same height. This might have had an effect on the comfort of the posture the participants had, being reflected in the results. The perfect table height is a 0.7 - 0.8 of elbow height, meaning the table would have to be changed for every participant [81]. during the test, there was not access to a completely adjustable table.

The hand measurements that were used during the interpretation of the results were measured without special equipment, just using a ruler. The “active spread”, although thoroughly explained, might be interpreted differently by every participant. These measurements might thus not be completely reliable. An alternative would be 3D scanning of the hand, to have a more objective insight in the size of the participants’ hands.

### Conclusions

The focus on stability, which was tried to be reached by completely locking the hand in position by creating a hand-filling shape, might have been too strong. Prof. dr. Hoving and dr. Brandsma both suggested that more freedom is desirable, in order to make subtle movements. However, prof. dr. Hoving did like the shape and saw the potential.





### Stability test results

The means of the four categories of movement were calculated per frame for each participant. The mean non-angular movement (type 1 and 3) was 0.07mm ( $\sigma^2=0.0004$ ) for the Minop dummy and 0.04mm ( $\sigma^2=0.0002$ ) for the newly developed prototype. The mean non-angular movement (type 2) was 0.12mm ( $\sigma^2=0.0028$ ) for the Minop dummy and 0.18mm ( $\sigma^2=0.0072$ ) for the newly developed prototype. The results per participant are shown in Figure 67 and in means with their  $\sigma$  in Figure 68. There is much more angular movement than non-angular movement in the endoscope when using either the Minop or the new prototype, even though this category consists of a combination of movement 1&2 (movement along the axis and parallel to the axis of the endoscope). The figure visually indicates more movement while using the Minop dummy, for both categories. The T-test showed significantly less non-angular movement in the newly developed prototype than in the old instrument ( $p=0.0091$ ). The angular movement reduction was only significant in one direction ( $p=0.0315$ ) but not in both ( $p=0.0630$ ). The full T-test results can be found in Appendix 3.3.

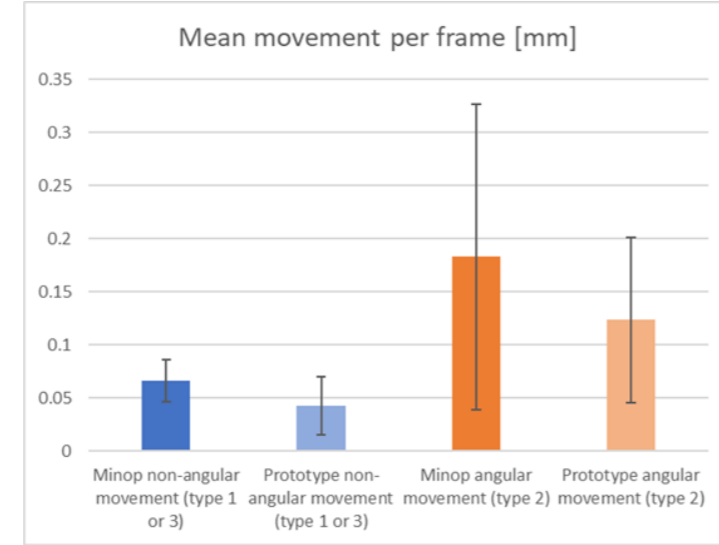

Figure 68. Mean movement results

### Discussion

Since the software that was used is a third party software and not developed specifically for this experiment, it might be that it is not precise enough or otherwise introduces errors. In future research, software should be developed specifically to analyse the types of movement of the endoscope. In a perfect scenario, the tracking would be done in 3D, in order to also evaluate the movement in the frontal plane. Because of the shape of handle (mirrored over the sagittal plane, not the frontal), the movement in this plane could be totally different from that in the analysed plane.

It was decided to use the average path in millimetres per video frame to analyse the movement of the endoscope, since the amount of time spent on the task varied greatly among the participants.

### Conclusion

The significantly lower movement detected in the endoscope while using the steerable instrument is a promising result that provides grounds to believe that steerability is not only convenient but also quantifiably more safe. This finding is also a basis to selling the product; a measurable added value.

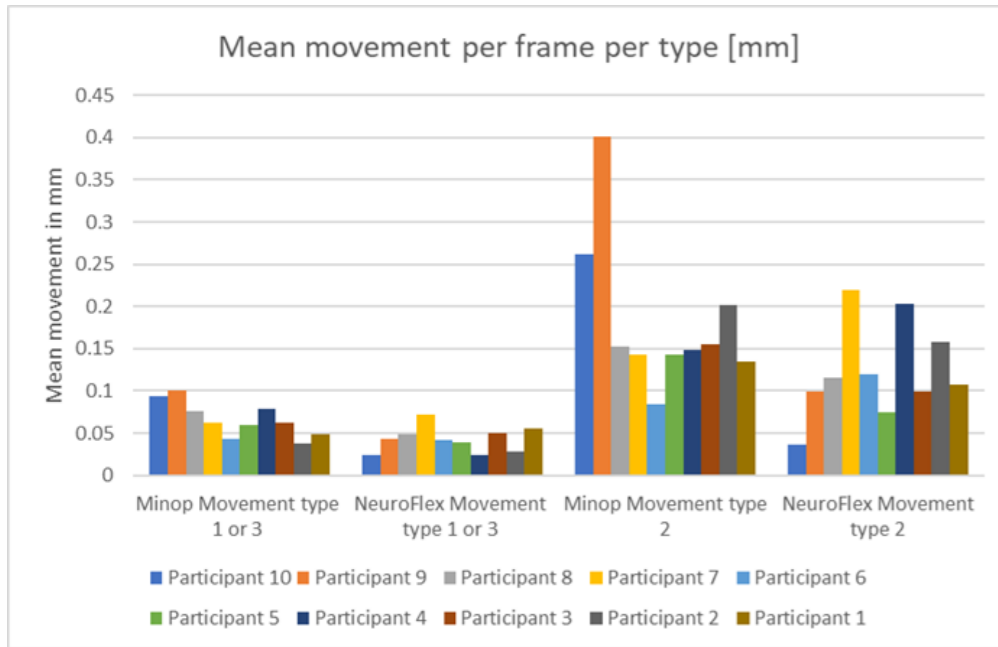

Figure 67. Individual movement results

## PART 4. Wrap-up



### 4.1 Overall discussion & Recommendations

#### *The project*

This graduation project came close to full circle; in the beginning there was nothing but an assignment, no user research, no requirements. From there, an effort was made to gain as much information from potential users and other stakeholders as possible, as well as a deep-dive into human-factors literature. The following ideation and prototyping yielded another portion of user input. In the end, the expected outcomes were met; a fully functional prototype was developed, even though the resources were much less accessible during this period of a global pandemic.

The prototypes were never perfect and each time it became clear some aspects had been missed. But, that is what testing is for. It is exciting to find results that were beyond expected and use them for the next idea. Working with prof. dr. Hoving was an exciting challenge; collaborating with a doctor with such a full schedule is difficult at times, but it made the input at every user evaluation all the more valuable. Another lesson I have learned from this is: it's okay to take more time if needed, maybe even reschedule a meeting and improve the prototypes before evaluating with the user.

Every visit to the Máxima Centre was a kind of reality check, a moment to experience how I was drifting off, ideating at my desk, or going in the right direction. As was the day that I got to use the 3D scanner, to turn my clay and foam models into 3D printable handles, and the day I assembled the final prototype in DEAM's workshop. It all came down to how well I applied that one drop of glue. Each one of these milestones kept me going.

The final experiment, with prof. dr. Hoving and my family and friends was yet another eye-opening experience, where 10 different opinions and experiences yielded so much information I was sad I did not have more time to work on the next prototype.

It would have been desirable to already develop the next design vision (a vision including the shape and dimensions of the handle), based on all the findings from the final experiment. There was however, no time to do so within the time span of the project. More about this in the last paragraph of this discussion "What's next".

#### *Findings*

The findings of the final evaluation show that all user requirements are rated positively on average, especially the use in context (UR 12) and the movement in the system (UR1). This is very promising! However, some of the requirements did receive some negative evaluations, like the position and size of the trigger. All-in-all this makes it very clear where the room for improvement lies; the relative distances between the controls.

In the end, the prototype was only tested with a user that would fall into the category of persona 1. As mentioned, the prototype was rated quite positively by this user, except for the found lack of freedom in the hand due to the size. The rest of the test persons were either in their twenties (so they would be most similar to persona 2) or also 60+. The bulk of the questionnaire results thus could not be linked to the personas, which is a shame.

In the end, the grip is quite large and more like the hammer grip than the tip-to-tip grip described in the Analysis Section 1.3.4. That decision was mostly based on the user evaluation of the first prototype, where prof. dr. Hoving was extremely negative about the tip-to-tip concept, after it was immediately rejected as a possible concept direction. Still, considering the need for high precision, this direction might need to be reconsidered and compared to the hammer/pistol grip.

#### *Prototyping limitations & recommendations*

The prototyping now was mostly based on speed and accessibility; make everything 3D printable, laser cuttable and only in the case of the end-effector; millable. If more freedom would have been taken in terms of manufacturing methods of the prototype, it could have been less bulky (if the slider and sliderbeam would have been milled too, for instance). It would also run more smoothly, especially the rotulator could have used a perfectly smooth metal bearing.

Due to the problems with DEMO, the planned end-effector sub assembly is quite different from how it was intended; the end-effector is recycled from another DEAM prototype. The jaws are not biopsy jaws but grasper jaws. The cable that opens and closes it, is much thicker than the intended cable, making the tip more

stiff. It is also too thick to be sheathed in a capillary tube and spring, meaning it is less easy to actively open the end-effector (as one cannot compress a cable). The cable (instead of smooth tube) also causes more friction inside the shaft, making it harder to move the steering cables alongside the core cable.

#### *Testing limitations & recommendations*

The final evaluation did not include technical evaluation, except from measuring the maximum bending angle, which was satisfactory. To gain much more insight and really evaluate the performance of the tip, force testing in tissue mimicking phantom would be very beneficial. The expert user now has rated the tip as adequately stiff, in neutral and bent position, but to really evaluate this, (real) tissue should be handled, maybe while somehow measuring the forces on the steering cables.

Next to the phantom, it would be good to evaluate especially the usability with a real endoscope, under OR lighting, while wearing the right type of gloves etcetera. The effects of such circumstances are now unknown.

The envisioned design shown in the renders in Section 2.4 has coloured controls and a white body. In the final prototype, it was not possible to print the controls in a separate colour. Possibly, this contributed to the confusion as to how the instrument should be held and operated. Especially the trigger and rotulator were not immediately interpreted as moving controls but rather as rigid parts of the body of the handle. For a next test, it would be preferable to 3D print the controls in another colour than the body, to be able to evaluate the intuitiveness better.

#### *Design recommendations*

To further the design of the SNI, several more iterations of the handle will have to be developed. For instance, the exact effect of the length of the trigger and the joystick on the intuitiveness of use could be tested in a large variation of hand sizes. A shorter handle might be desirable for preventing accidentally gripping tissue too hard, a longer handle might be comfortable for the detectable travel distance. The effect of the dimension of the handle in the x, y or z direction could also be evaluated through 3D printing variations of that.

The design was somewhat optimised to prevent unwanted friction, by using the frame for the mechanism instead of difficult-to-align shell parts and minimising

the amount of ebaring surfaces. However, there still is quite a lot of friction, especially somewhere in the rotulator. This naturally has to be solved, before it can be used in the soft tissue of the brain. Having to use too much force to use the controls can be extremely dangerous. If the rotulator could be made of only one, rather than two pieces, it would already help. Further experiments have to point out what exactly is causing the high friction. The same goes for any deformation in the system, for example, in the frame, that makes the system sluggish and prevents the user from feeling what is going on at the distal end of the instrument. Further experiments have to point out what causes this and how it can be solved in the next prototype.

Naturally, the final prototype was designed in such a way that there are no sharp edges, no parts that can easily detach and a limited steering angle, all for safety. However, when the prototype is fully functional on a more than satisfactory level, a full risk evaluation should be performed, going through the full user scenario.

#### *In context*

As mentioned, there is only one other publication known specifically presenting the design of a steerable neuroendoscopic instrument [44]. The development of this instrument focused mostly on the articulating tip and its performance and as a result they have developed an extremely well evaluated and optimised non-assembly (compliant) tip. However, this tip can only bend in one plane, whereas the prototype presented in this report can theoretically bend in all planes, partially eliminating the need for rotation of the shaft and thus requiring less input of the user and decreasing movement in the system. The first author of this study was contacted (as mentioned in Section 1.3.2). He stated that not much development went into the handle design; it was designed to be functional (although some iterations were made), whereas the prototype presented in this report used the theory of handle design combined with input from prototype evaluations to design the shape of the handle as it is.

Considering the stability results (how there is significantly less movement in the system), is extremely promising also when considering the introduction of robotics in neuroendoscopy. Surgical robots have the main benefit of being able to filter out any unwanted movement caused by the operator and to translate large movements to very precise movements. This instrument has the potential to compete with robots in this area.

#### *What's next?*

As a final step to this project, although after the moment of graduation, one more generation of the prototype will be developed. Feedback concerning the size of the handle will be incorporated and the final design of the end-effector will be used. Together with the prototype, a new version of the box trainer will be developed and manufactured. Both will be presented to prof. dr. Hoving, as a thank you and as a symbol for future development of the product.

Hopefully, the project will be continued with other talented engineers, who can improve the handle and the mechanism until it can finally be used to improve surgical outcomes and, ultimately, the lives of patients.

#### 4.2 Conclusions

During this project, a steerable neuroendoscopic forceps for intraventricular use was designed, based on thorough user research and secondary research in literature. Multiple rounds of prototypes were evaluated with the end user. The final prototype was fully functional. A box trainer with standard task was developed to do the final evaluation on usability and stability during use, where 10 participants evaluated the handle through thinking out loud and through a post-use questionnaire. The stability analysis was done through video analysis.

The results of the user evaluation were promising, as especially the user requirements concerning the performance were easily met according to the questionnaire outcomes.

The handle needs another thorough design iteration concerning the degrees of freedom of the hand.

Additionally, a significant decrease of movement in the sagittal plane compared to the old instrument was observed during use. Especially this finding is exciting and promising; further development of this device would bring us one step closer to make neuroendoscopy safer and more widely applicable.





# Bibliography

- [1] K. W. Shim, E. K. Park, D.-S. Kim en J.-U. Choi, „Neuroendoscopy: Current and Future Perspectives,” *Journal of Korean Neurosurgical Society*, vol. 60, nr. 3, pp. 322-326, 2017.
- [2] H. W. S. Schroeder, „General principles and intraventricular neuroendoscopy: endoscopic techniques,” *World Neurosurgery*, vol. 79, nr. 2, 2012.
- [3] P. Cappabianca, G. Cinalli, M. Gangemi, A. Brunori, L. M. Cavallo, E. de Divitiis, P. Decq, A. Delitala, F. Di Rocco, J. Frazee, U. Godano, A. Grotenhuis, P. Longatti, C. Mascari, T. Nishihara, S. Oi, H. Rekate, H. W. S. Schroeder, M. M. Souweidane, P. Spennato, G. Tamburrini, C. Teo, B. Warf en S. T. Zymberg, „Application of neuroendoscopy to intraventricular lesions,” *Neurosurgery*, vol. 62, nr. 2, pp. SHC575-SHC598, 2008.
- [4] „Multiple benefits to minimally invasive surgery,” Mayo Clinic, [Online]. Available: <https://www.mayoclinichealthsystem.org/hometown-health/speaking-of-health/multiple-benefits-to-minimally-invasive-surgery>. [Geopend 28 04 2020].
- [5] Z.-Q. Hu, F. Guan, W.-C. Peng, H. Huang, Z.-Y. Ren, Z.-Y. Wang, J.-D. Fu, Y.-B. Li, F.-Q. Cui, B. Dai, G.-T. Zhu, Z.-Y. Xiao en B.-B. Mao, „Application of neuroendoscopic surgical techniques in the assessment and treatment of cerebral ventricular infection,” *Neural Regeneration Research*, vol. 14, nr. 12, p. 2095, 2019.
- [6] D. Purves, G. J. Augustine en D. Fitzpatrick, „The Ventricular System,” *Neuroscience*, nr. 2nd edition, 2001.
- [7] F. Duffner, H. Schiffbauer, D. Glemser, M. Skalej en D. Freudenstein, „Anatomy of the cerebral ventricular system for endoscopic neurosurgery: a magnetic resonance study,” *Acta Neurochirurgica*, vol. 145, pp. 359-368, 2003.
- [8] O. A. Choudhri, A. H. Feroze, J. Nathan, S. Cheshier en R. Guzman, „Ventricular endoscopy in the pediatric population: review of indications,” *Child s Nervous System*, vol. 30, nr. 10, 2014.
- [9] IDEO, „Define Your Audience,” IDEO, 2017. [Online]. Available: <https://www.designkit.org/profiles/300606>. [Geopend 20 August 2020].
- [10] F. Duffner, D. Schiffbauer, D. Glemser, M. Skalej en D. Freudenstein, „Anatomy of the cerebral ventricular system for endoscopic neurosurgery: a magnetic resonance study,” *Acta Neurochirurgica*, vol. 145, nr. 5, pp. 359-368, 2003.
- [11] E. Hoving, Interviewee, User research interview. [Interview]. 2020.
- [12] D. Hellwig, J. A. Grotenhuis, W. Tirakotai, T. Riegel, D. M. Schulte, B. L. Bauer en H. Bertalanffy, „Endoscopic third ventriculostomy for obstructive hydrocephalus,” *Neurosurgical review*, 2004.
- [13] L. E. Bilston, „Brain tissue mechanical properties,” *Biomechanics of the Brain*, pp. 69-89, 2011.
- [14] E. Sari, V. Sari, V. Akgün, E. Özcan, S. İnce, O. Babacan, M. Saldır, C. Acikel, G. Basbozkurt, S. Yesilkaya, C. Kilie, K. Kara, S. Vurucu, M. Kocaoglu en E. Yesilkaya, „Measures of ventricles and evan’s index: from neonate to adolescent,” *Pediatr Neurosurg*, vol. 50, nr. 12, 2015.
- [15] P. E. Dupont, „Improving the Safety and Efficacy of Intraventricular Neurosurgery via Robotics,” NIH, 2017. [Online]. Available: <https://grantome.com/grant/NIH/R01-NS099207-01A1>. [Geopend 29 04 2020].
- [16] MarketWatch, „Neuroendoscopy Market – 2019 Industry Trends, Size, Growth Insight, Share, Emerging Technologies, Share, Competitive, Regional, And Global Industry Forecast to 2024,” 2019. [Online]. Available: <https://www.marketwatch.com/press-release/neuroendoscopy-market-2019-industry-trends-size-growth-insight-share-emerging-technologies-share-competitive-regional-and-global-industry-forecast-to-2024-2019-06-04>. [Geopend 29 04` 2020].
- [17] Z. Nederland, „153 neurochirurgen in Nederland,” [Online]. Available: <https://www.zorgkaartnederland.nl/neurochirurg>. [Geopend 29 04 2020].
- [18] G. E. Breimer, „Improving outcomes in pediatric endoscopic third ventriculostomy through outcome analysis and surgeon training,” *University of Groningen*, 2017.
- [19] E. A. El Refaee en A. A. Abdullah, „Endoscopic Third Ventriculostomy, Indications and Challenges,” in *Hydrocephalus - Water on the Brain*, InTech, 2018.
- [20] „Epidemiology of Aqueductal Stenosis in Children,” ISPN, [Online]. Available: <https://www.ispn.guide/hydrocephalus-and-other-anomalies-of-csf-circulation-in-children/aqueductal-stenosis-in-children-homepage/epidemiology-of-aqueductal-stenosis-in-children/>. [Geopend 30 04 2020].
- [21] A. M. Isaacs, J. Riva-Cambrin, D. Yavin, A. Hockley, T. M. Pringsheim, N. Jette, B. C. Lethebe, M. Lowerison, J. Dronyk en M. G. Hamilton, „Age-specific global epidemiology of hydrocephalus: Systematic review, metanalysis and global birth surveillance,” *PLoS*, vol. 13, nr. 10, 2018.
- [22] M. Moschovi en G. P. Chrousos, „Pineal gland masses,” UpToDate.
- [23] D. Michaud, D. Schiff en T. Batchelor, „Incidence of primary brain tumors,” UpToDate, 2019.
- [24] „Epidemiology of Dandy-Walker Syndrome in Children,” ISPN, [Online]. Available: <https://www.ispn.guide/hydrocephalus-and-other-anomalies-of-csf-circulation-in-children/dandy-walker-syndrome-in-children-homepage/epidemiology-of-dandy-walker-syndrome-in-children/>. [Geopend 30 04 2020].
- [25] J. A. Hidalgo, C. A. Tork en M. Varacallo, „Arnold Chiari Malformation,” in *StatPearls*, StatPearls Publishing, 2020.
- [26] StatLine, „Geboorte; kerncijfers,” CBS, 2019.
- [27] „DEAM - About us,” DEAM, [Online]. Available: <https://www.deam.com/about-us/>. [Geopend 23 April 2020].
- [28] „IMED SALES,” NationalSales, LTD, 2020. [Online]. Available: <https://imedsales.com/index.php?route=common/home>. [Geopend 02 08 2020].
- [29] C. C. J. Alleblas, *Ergonomics and haptic feedback in minimally invasive surgery*, Enschede: Radboud Universiteit Nijmegen, 2018.
- [30] A. G. González, D. R. Salgado, L. G. Moruno en A. S. Rios, „An Ergonomic Customized-Tool Handle Design for Precision Tools using Additive Manufacturing: A Case Study,” *Applied Sciences*, vol. 8, nr. 7, 2018.
- [31] U. Matern, G. Kuttler, C. Giebmeyer, P. Waller en M. Faist, „Ergonomic aspects of five different types of laparoscopic instrument handles under dynamic conditions with respect to specific laparoscopic tasks: An electromyographic-based study,” *Surgical Endoscopy and Other Interventional Techniques*, vol. 18, pp. 1231-1241, 2004.
- [32] FlexDex, „REDEFINING ROBOTIC SURGERY,” FlexDex, [Online]. Available: <https://flexdex.com/>. [Geopend 20 August 2020].
- [33] N. L. Szoka, „Artisential Articulating Laparoscopic Instrument(s),” SAGES, 2019. [Online]. Available: <https://www.sages.org/publications/tavac/artisential-articulating-laparoscopic-instruments/>. [Geopend 20 August 2020].
- [34] BBraun, „Caiman 5,” BBraun, [Online]. Available: <https://www.bbraun.com/en/products-and-therapies/laparoscopic-surgery/caiman-advanced-bipolar-technology/products/caiman-5.html>. [Geopend 20 August 2020].
- [35] smith&nephew, „Access hard to reach sunus anatomy,” 2014. [Online]. Available: [https://www.smith-nephew.com/global/assets/pdf/products/surgical/ent/serpent\\_brochure\\_52268b.pdf](https://www.smith-nephew.com/global/assets/pdf/products/surgical/ent/serpent_brochure_52268b.pdf). [Geopend 20 August 2020].
- [36] T. Snow, „HandX™ by Human Xtensions,” SAGES, 2018. [Online]. Available: <https://www.sages.org/publications/tavac/handx-by-human-xtensions/>. [Geopend 20 August 2020].
- [37] Surge-on, „New scientific article on our steerable mechanism for laparoscopy!,” Surge-on, 2019. [Online]. Available: <https://www.surge-on.nl/surge-on/new-published-scientific-article-on-our-steerable-mechanism-for-laparoscopy/>. [Geopend 20 August 2020].
- [38] B. Perriello, „Cambridge Endo files for Chapter 11 bankruptcy,” 2015. [Online]. Available: <https://www.massdevice.com/cambridge-endo-files-for-chapter-11-bankruptcy/>. [Geopend 20 August 2020].
- [39] CambridgeEndo, „CambridgeEndo laparoscopic instruments White Paper & Data Sheet,” 2006. [Online]. Available: <http://cargocollective.com/jtoomey/CambridgeEndo-laparoscopic-instruments-White-Paper-Data-Sheet>. [Geopend 20 August 2020].
- [40] T. Scientific, „Explore your newart 2 DRIVE,” 2010. [Online]. Available: [http://www.tuebingen-scientific.com/uploads/tx\\_sbdownloader/radius\\_r2\\_Drive.pdf](http://www.tuebingen-scientific.com/uploads/tx_sbdownloader/radius_r2_Drive.pdf). [Geopend 20 August 2020].
- [41] TuebingenScientific, „The new “art 2 DRIVE”,” TuebingenScientific, 2010. [Online]. Available: <http://www.tuebingen-scientific.com/index.php?id=114&L=0%27%22>. [Geopend 20 August 2020].
- [42] R. Bergeron, „High-tech dummies help doctors save lives,” *Houston Style Magazine*, 2013. [Online]. Available: <http://stylemagazine.com/news/2013/oct/24/high-tech-dummies-help-doctors-save-lives/>. [Geopend 23 07 2020].
- [43] S. T. Zymberg en F. V. G. Filho, „Neuroendoscopic Training: Presentation of a New Real Simulator,” *Mihnnally Invasive Neurosurgery*, vol. 53, nr. 1, pp. 44-46, 2010.
- [44] K. Eastwood, „Analysis and Design of Articulate Neuroendoscopic Instruments Using Contact-Aided Compliant Mechanisms,” 2018.
- [45] L. Ntombela, B. Adeleye en N. Chetty, „Low-cost fabrication of optical tissue phantoms for use in biomedical imaging,” *Heliyon*, vol. 6, nr. 3, p. e03602, 2020.

- [46] E. Nicolas, S. Callé, S. Nicolle, D. Mitton en J. Remenieras, „Biomechanical characterization of ex vivo human brain using ultrasound shear wave spectroscopy,” *Ultrasonics*, vol. 84, pp. 119-125, 2018.
- [47] M. Bögel, H. Hofmann en J. Hornegger, „Respiratory Motion Compensation Using Diaphragm Tracking for Cone-Beam C-Arm CT: A Simulation and a Phantom Study,” *International Journal of Biomedical Imaging*, vol. 5, pp. 520-540, 2013.
- [48] I. 194, „ISO 10993-1:2018,” ISO, 2018.
- [49] K. Hagelsteen en A. Langegard, „Faster acquisition of laparoscopic skills in virtual reality with haptic feedback and 3D vision,” *Minimally invasive therapy & allied technologies: MITAT: official journal of the Society for Minimally Invasive Therapy*, vol. 26, nr. 5, pp. 1-8, 2017.
- [50] J. H. Beard en L. Akoko, „Manual laparoscopic skills development using a low-cost trainer box in Tanzania,” *Journal of surgical education*, vol. 71, nr. 1, pp. 85-90, 2014.
- [51] K. Eastwood, Interviewee, E-mail communication. [Interview]. 2020.
- [52] J. J. Van Gompel, M. H. Tabor, A. S. Youssef, A. P. Carlson, H. R. van Loveren en S. Agazzi, „Van Gompel, J. J., Tabor, M. H., Youssef, A. S., Lau, T., Carlson, A. P., van Loveren, H. R., & Agazzi, S. (2013). Field of view comparison between two-dimensional and three-dimensional endoscopy,” *The Laryngoscope*, vol. 124, nr. 2, p. 387–390, 2013.
- [53] A. Di Ieva, M. Tam, M. Tschabitscher en M. D. Cusimano, „A journey into the technical evolution of Neuroendoscopy,” *World Neurosurgery*, vol. 82, nr. 6, pp. e777-e789, 2014.
- [54] A. Berman, „An Unusual Means is Used to Capture 3D in the Visionsense 4mm Camera,” *Display Daily*, 2016. [Online]. Available: <https://www.displaydaily.com/article/display-daily/an-unusual-means-is-used-to-capture-3d-in-the-visionsense-4mm-camera-2>. [Geopend 14 07 2020].
- [55] R. Rahman, M. E. Wood en L. Qian, „Head-Mounted Display Use in Surgery: A Systematic Review,” *Surgical Innovation*, 2019.
- [56] X. Xu, Y. Zheng, S. Yao, G. Su, B. Xu en X. Chen, „A low-cost multimodal head-mounted display system for neuroendoscopic surgery,” *Brain and Behavior*, vol. 8, p. e00891, 2018.
- [57] C. Teo en P. Nakaji, „Neuro-oncologic applications of endoscopy,” *Neurosurgery clinics of North america*, vol. 15, nr. 1, pp. 89-103, 2004.
- [58] W. Grand, J. Leonardo, A. J. Chamczuk en A. J. Korus, „Endoscopic third ventriculostomy in 250 adults with hydrocephalus,” *Neurosurgery*, vol. 78, nr. 1, pp. 109-119, 2016.
- [59] M. S. Eljamel, „Robotic Applications in Neurosurgery,” in *Medical Robotics*, I-Tech Education and Publishing, 2008, pp. 41-62.
- [60] C. Consulting, „2020 Medical Device Trends,” *Clarkston Consulting*, 2020.
- [61] M. E. Wiklund, M. B. Weiniger en D. J. Gardner-Bonneau, *Handbook of Human Factors in Medical Device Design*, CRC Press, 2010.
- [62] P. Pordage, „One in five surgeons set to retire early due to physical toll,” *CMR Surgical*, 2019. [Online]. Available: <https://cmrsurgical.com/one-in-five-surgeons-set-to-retire-early-due-to-physical-toll/>. [Geopend 12 05 2020].
- [63] P. S. Gadjradj, K. Ogenio, I. Voigt en B. s. Harhangi, „Ergonomics and Related Physical Symptoms Among Neurosurgeons,” *World Neurosurgery*, vol. 134, pp. e432-441, 2020.
- [64] C.-C. H. Stucky, K. D. Cromwell, R. K. Voss, Y.-J. Chiang, K. Woodman, J. E. Lee en J. N. Cormier, „Surgeon symptoms, strain, and selections: review and meta-analysis of surgical ergonomics,” *Annals of Medicine and Surgery*, vol. 27, pp. 1-8, 2018.
- [65] G. J. Tortora en B. Derrickson, „Muscles of the palm that move the digits - intrinsic muscles of the hand,” in *Principles of anatomy & physiology*, Wiley, 2014, pp. 372-375.
- [66] G. J. Tortora en B. Derrickson, „Muscles of the forearm that move the wrist, hand, thumb and digits,” in *Principles of Anatomy & Physiology*, Wiley, 2014, pp. 368-372.
- [67] J. Park en D. Xu, „Multi-Finger Interaction and Synergies in Finger Flexion and Extension Force Production,” *Frontiers in Human Neuroscience*, vol. 11, 2017.
- [68] C. H. Wagner, „The pianist’s hand: anthropometry and biomechanics,” *Ergonomics*, vol. 31, nr. 1, pp. 97-131, 1988.
- [69] C. Pylatiuk, A. Kargov, S. Schulz en L. Döderlein, „Distribution of grip force in three different functional prehension patterns,” *Journal of Medical Engineering &*

Technology, pp. 176-182, June 2006.

- [70] T. Feix, J. Romero, H.-B. Schiedmayer, A. M. Dollar en D. Kragic, „The GRASP Taxonomy of Human Grasp Types,” *IEEE TRANSACTIONS ON HUMAN\_MACHINE SYSTEMS*, nr. 1, 2016.
- [71] S. Shahid, „Anatomy of grip,” *KenHub*, 2020.
- [72] J. Tang, X. Zhang en Z.-M. Li, „Operational and maximal workspace of the thumb,” *Ergonomics*, 19 Jun 2008.
- [73] F. Ortega, F. Abyarjoo, A. Barreto, N. Rishe en M. Adjouadi, *Interaction design for 3D user interfaces: The world of modern input devices for research, applications, and game development*, A K Peters/CRC Press, 2016.
- [74] „XE-1 AP,” *Segaretro*, 2017. [Online]. Available: [Segaretro.org](http://Segaretro.org). [Geopend 25 05 2020].
- [75] L. Reissner, G. Fischer, R. List, W. R. Taylor, P. Giovanolli en M. Calcagni, „Minimal detectable difference of the finger and wrist range of motion: comparison of goniometry and 3D motion analysis,” *J Orthop Surg Res*, vol. 14, 2019.
- [76] C. C. Norkin en J. White, *Measurement Of Joint Motion: A Guide To Goniometry*, F.A. Davis, 2016.
- [77] A. Buryanov en V. Kotiuk, „Proportions of Hand Segments,” *Int J Morphol*, vol. 28, nr. 3, pp. 755-758, 2010.
- [78] L. M. Rozmaryn, J. J. Bartko en M. Lizza, „The Ab-Adductometer: A New Device for Measuring the Muscle Strength and Function of the Thumb,” *Journal of Hand Therapy*, vol. 20, nr. 4, pp. 311-325, 2007.
- [79] C. L. Shivers, G. A. Mirka en D. B. Kaber, „Effect of Grip Span on Lateral Pinch Grip Strength,” *Human Factors*, vol. 44, nr. 4, p. 569–577, 2002.
- [80] B. J. Daams, „Human force exertion in user-product interaction,” *TU delft Library*, 1994.
- [81] M. A. van Veelen, J. J. Jakimowicz en G. Kazemier, „Improved physical ergonomics of laparoscopic surgery,” *Minimally Invasive Therapy & Allied Technologies*, vol. 13, nr. 3, pp. 161-166, 2009.
- [82] A. Okamura, „Haptic Feedback in Robot-Assisted Minimally Invasive Surgery,” *Curr Opin Urol*, vol. 19, nr. 1, pp. 102-107, 2009.
- [83] F. J. Seagull, E. Sutton, T. Lee, C. Godinez, G. Lee en A. Park, „A validated subjective rating of display quality: the Maryland Visual Comfort Scale,” *Surg Endosc.*, vol. 25, nr. 2, pp. 567-71, 2010.
- [84] *The Columbia Electronic Encyclopedia*, „Hippocratic school of medicine,” 2013.
- [85] D. Hadjupanayis, R. Ormond en C. G., „The history of neurosurgery and its relation to the development and refinement of the frontotemporal craniotomy,” *Neurosurgical focus*, 2014.
- [86] D. R. Ormand en C. G. Hadjipanayis, „The history of neurosurgery and its relation to the development and refinement of the frontotemporal craniotomy,” *Journal of neurosurgery*, vol. 4, 2014.
- [87] D. R. Felbaum, A. Siu, H. R. Syed, C. J. Neal, M. N. Nair, K. M. McGrail, A. J. Caputy en D. C. Shields, „Creating a Culture of Collaboration: A Brief History of Academic Neurosurgery in Washington, DC,” *Neurosurgery*, p. 1029–1039, 2017.
- [88] Centraal Bureau voor de Statistiek, „Medisch geschoolden; arbeidspositie, positie in de werkkring, naar beroep [dataset],” 4 maart 2019.
- [89] S. Samuel, „Women suffer needless pain because almost everything is designed for men,” *VOX*, 2019. [Online]. Available: <https://www.vox.com/future-perfect/2019/4/17/18308466/invisible-women-pain-gender-data-gap-caroline-criado-perez>. [Geopend 30 04 2020].
- [90] K. van Baarsen, Interviewee, Follow-up user survey. [Interview]. 2020.
- [91] Respondents, Interviewee, User research survey. [Interview]. 2020.
- [92] DINED, „Dutch children, 0.5-7.0 years (NL),” *DINED 3D*, 2020.
- [93] K. O. e. al., „BodyParts3D,” *National Institute of Genetics*, [Online]. Available: <https://lifesciencedb.jp/bp3d/>.
- [94] E. Hoving, Interviewee, First prototype evaluation. [Interview]. 2020.
- [95] P. Cappabianca, G. Cinalli, M. Gangemi, A. Brunori, L. M. Cavallo, E. de Divitiis, P. Decq, A. Delitala, F. Di Rocco, J. Frazee, U. Godano, A. Grotenhuis, P. Longatti, C. Mascari, T. Nishihara, S. Oi, H. Rekate, H. W. Schroeder, M. M. Souweidane, P. Spennato, G. Tamburrini, C. Teo, B. Warf en S. T. Zymberg, „Application of Neuroendoscopy to Intraventricular Lesions,” *Neurosurgery*, vol. 62, 2008.



- [96] J. Di Vincenzo, D. Keiner, M. Gaab, H. Schroeder en J. Oertel, „Endoscopic third ventriculostomy: Preoperative considerations and intraoperative strategy based on 300 procedures,” *Journal of Neurological Surgery Part A: Central Europeam Neurosurgery*, vol. 01, pp. 20-30, 2013.
- [97] S. Abudayyeh, J. Hoffman, H. El-Zimaity en D. Y. Graham, „Prospective, Randomized, Pathologist-Blinded Study of Disposable Alligator-Jaw Biopsy Forceps for Gastric Mucosal Biopsy,” *Dig Liver Dis*, nr. 5, p. 340–344, 2010.
- [98] M. Wiklund, J. Kendler en A. Strohlic, *Usability testing of medical devices*, CRC Press, 2016.
- [99] NASA, „Man-System Integration Standards (NASA-STD-3000) Revision B,” *NASA Standards*, 1995.
- [100] M. Weinger en e. al., „Handbook of human factors in medical device design,” CRC Press Taylor & Francis Group, 2010.
- [101] I. Mebes, K. Diedrich en C. Banz-Jansen, „Total laparoscopic hysterectomy without uterine manipulator at big uterus weight >280g,” *Gynaecology & obstetrics*, pp. 131-134, 2012.
- [102] J. Tang, X. Zhang en Z.-M. Li, „Operational and maximal workspace of the thumb,” *Ergonomics*, 2008.
- [103] I. A. M. J. Broeders, „Handboek endoscopische chirurgie,” 2009.
- [104] J. Park en D. Xu, „Multi-Finger Interaction and Synergies in Finger Flexion and Extension Force Production,” *Frontiers in Human Neuroscience*, vol. 11, 2017.
- [105] Genicon product catalog, 2017.
- [106] Medtronic, *Sonicision™ System product manual*.
- [107] C. Pylatuk, A. Kargov, S. Schulz en L. Döderlein, „Distribution of grip force in three different functional prehension patterns,” *Journal of Medical Engineering*, pp. 176-182, 2006.
- [108] V. Esaulov, „Playing With Computers.,” KASS, 2018. [Online]. Available: <https://kartsci.org/kocomu/computer-history/computer-games-history/>. [Geopend 27 06 2020].
- [109] THE EUROPEAN PARLIAMENT AND COUNCIL OF THE EUROPEAN UNION, „REGULATION (EU) 2017/745,” *Official Journal of the European Union*, 2017.
- [110] E. Tempelman, H. Shercliff en B. Ninaber van Eyben, „Chapter 8. Injection Molding of Thermoplastics,” in *Manufacturing and Design*, Burlington, MA, USA, Butterworth-Heinemann, 2014, pp. 121-156.
- [111] J. J. Corbett en D. E. Haines, „Chapter 6 - The Ventricles, Choroid Plexus, and Cerebrospinal Fluid,” in *Fundamental Neuroscience for Basic and Clinical Applications (Fifth Edition)*, Elsevier, 2018, pp. 93-106.
- [112] C. I. Eseonu, K. Refaey, O. Garcia, R. Salvatori en A. Quinones-Hinojosa, „Comparative Cost Analysis of Endoscopic versus Microscopic Endonasal Transsphenoidal Surgery for Pituitary Adenomas,” *J Neurol Surg B Skull Base*, vol. 79, nr. 2, pp. 131-138, 2018.
- [113] C. I. Eseonu, J. Rincon-Torroella, K. Refaey en A. Quinones-Hinojosa, „The Cost of Brain Surgery: Awake vs Asleep Craniotomy for Periolandic Region Tumors,” *Neurosurgery*, vol. 81, nr. 2, pp. 307-314, 2017.
- [114] M. M. van Meter en R. A. Adam, „Costs associated with instrument sterilization in gynecologic surgery,” *Am J Obstet Gynecol*, vol. 215, nr. 5, pp. 652E1-652E5, 2016.
- [115] D. Brown, R. Hanson en W. Christian, „Tracker: Video Analysis and Modeling Tool,” 2020. [Online]. Available: <https://physlets.org/tracker/>. [Geopend 10 09 2020].
- [116] DINED, „Dutch adults, dined2004,” *DINED 3D*, 2020.
- [117] GLS, „Overmolding Guide,” *GLS*, 2004

