

## Energy storage on ships

Coraddu, Andrea; Gil, Antoni; Akhmetov, Bakytzhan; Yang, Lizhong; Romagnoli, Alessandro; Ritari, Antti; Huotari, Janne; Tammi, Kari

**DOI**

[10.1016/B978-0-12-824471-5.00012-8](https://doi.org/10.1016/B978-0-12-824471-5.00012-8)

**Publication date**

2022

**Document Version**

Final published version

**Published in**

Sustainable Energy Systems on Ships

**Citation (APA)**

Coraddu, A., Gil, A., Akhmetov, B., Yang, L., Romagnoli, A., Ritari, A., Huotari, J., & Tammi, K. (2022). Energy storage on ships. In F. Baldi, A. Coraddu, & M. E. Mondejar (Eds.), *Sustainable Energy Systems on Ships: Novel Technologies for Low Carbon Shipping* (pp. 197-232). Elsevier. <https://doi.org/10.1016/B978-0-12-824471-5.00012-8>

**Important note**

To cite this publication, please use the final published version (if applicable). Please check the document version above.

**Copyright**

Other than for strictly personal use, it is not permitted to download, forward or distribute the text or part of it, without the consent of the author(s) and/or copyright holder(s), unless the work is under an open content license such as Creative Commons.

**Takedown policy**

Please contact us and provide details if you believe this document breaches copyrights. We will remove access to the work immediately and investigate your claim.

***Green Open Access added to TU Delft Institutional Repository***

***'You share, we take care!' - Taverne project***

**<https://www.openaccess.nl/en/you-share-we-take-care>**

Otherwise as indicated in the copyright section: the publisher is the copyright holder of this work and the author uses the Dutch legislation to make this work public.

## CHAPTER 5

# Energy storage on ships

**Andrea Coraddu<sup>a</sup>, Antoni Gil<sup>b</sup>, Bakytzhan Akhmetov<sup>b</sup>, Lizhong Yang<sup>b</sup>,  
Alessandro Romagnoli<sup>c</sup>, Antti Ritari<sup>d</sup>, Janne Huotari<sup>d</sup>, and Kari Tammi<sup>d</sup>**

<sup>a</sup>Faculty of Mechanical, Maritime, and Material Engineering, Delft University of Technology, Delft, the Netherlands

<sup>b</sup>Surbana Jurong, Nanyang Technological University Corporate Lab, Singapore, Singapore

<sup>c</sup>School of Mechanical and Aerospace Engineering, Nanyang Technological University, Singapore, Singapore

<sup>d</sup>Department of Mechanical Engineering, Aalto University, Espoo, Finland

### 5.1. Introduction

This chapter deals with the potential usage of different types of energy storage technologies on board ships, a recent development that is gaining additional grounds in the latest years. Energy storage, both in its electric and thermal forms, can be used both to transfer energy from shore to the ship (thus working similarly to a fuel) or to allow a better management of the onboard machinery and energy flows.

This chapter is made of two main parts. Section 5.2<sup>1</sup> deals with electrical storage by first introducing a description of the main characteristics of marine batteries (subsection 5.2.1) and then showing how batteries can be included in a mathematical modeling environment (subsection 5.2.2). The main types of ship energy system configuration that include the use of batteries are presented in subsection 5.2.3 while the main alternatives available for system control are presented and discussed in subsection 5.2.4. Finally, various examples of the application of electrical energy storage to case studies are presented in subsection 5.2.5.

Section 5.3<sup>2</sup> deals with thermal energy storage (TES) instead. The main types of TES technologies available for use on ships are summarized in subsection 5.3.1, while a few applied examples in shipping are presented in subsection 5.3.2. The general pros and cons, together with future perspectives about the use of TES technologies in shipping are finally discussed in subsection 5.3.3.

<sup>1</sup> Section 5.2 of this chapter was the result of the work of Antti Ritari, Janne Houtari and Kari Tammi from Aalto University.

<sup>2</sup> Section 5.3 of this chapter was the result of the work of Antoni Gil, Bakytzhan Akhmetov, and Lizhong Yang from Surbana Jurong, and Alessandro Romagnoli from Nanyang Technological University.

## 5.2. Electrical energy storage

### 5.2.1 Battery characteristics

#### *Lithium based chemistries*

Battery chemistries suitable for ship energy systems are primarily lithium based. Under this category, the chemistries currently commercially available for mobile machines in general, and ships specifically, are lithium nickel cobalt aluminum oxide ( $\text{LiNiCoAlO}_2$ , NCA), NMC, lithium manganese ( $\text{LiMn}_2\text{O}_4$ , LMO), lithium ( $\text{Li}_2\text{TiO}_3$ , LTO), and lithium iron phosphate battery ( $\text{LiFePO}_4$ , LFP) [1]. These chemistries offer different tradeoffs between cost, life span, specific energy, specific power, safety, and thermal performance. NCA provides high performance in multiple dimensions, but it is prone to thermal runaway. Similarly, LMO is challenging from a safety perspective. LTO and LFP chemistries, on the other hand, have a low risk of thermal runaway, but high cost and weak specific energy. For hybrid ships, NMC provides an attractive balance between the six dimensions. Specifically, NMC offers high specific energy and energy density, which is important in ships with limited space, while also satisfying high power applications, such as supplying thruster power peaks during maneuvering.

C-rate is the charge (or discharge) current divided by the nominal capacity. For example, a 1 Ah battery charged at 10 A has C-rate 10 and a 1 Wh battery charged in 30 minutes has C-rate 2. Suppliers specializing in maritime battery systems currently offer mainly NMC packs with maximum C-rates between one and four [2].

#### *Battery requirements in marine applications*

It is important to note that vital components of a ship's energy system must be approved by classification societies. To receive approval, the installations should conform to various technical reference documents which offer guidelines for development. For example, the explosion and fire hazard risks of Li-ion batteries are evaluated in [3]. The design of the installations layout, ventilation and fire suppression systems must conform to such rules to receive classification society approval. DNV-GL rules concerning maritime battery installations are evaluated in general in [4].

#### *Hazard management*

Classification societies impose strict rules regarding the safety aspects of marine battery systems. In case of a fire in a cell, propagation must be prevented by either insulating each cell, or alternatively limiting the propagation to a group of cells with total capacity less than 11 kWh [5]. Importantly, the propagation must halt even without extinguishing, which increases complexity and cost of the module design. Such design and safety requirements are in stark contrast to the automotive sector, where a trend is towards structurally integrated packs in which all the cells are packed together and the spaces filled with an adhesive.

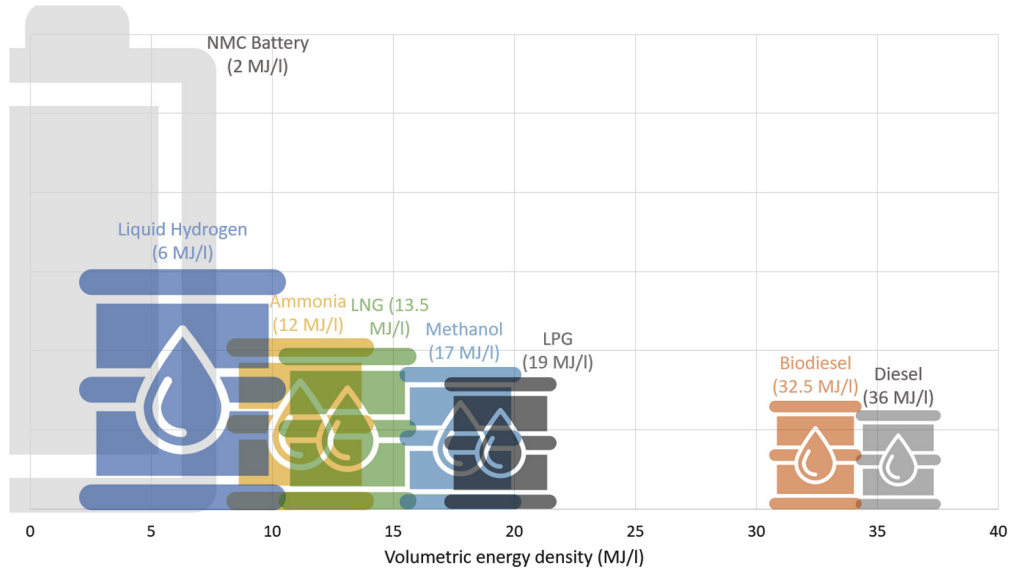

**Figure 5.1** Comparison of volumetric energy densities and fuel tank sizes of emerging fuels and NMC batteries.

Fire risk and potential toxic gas development is managed by locating all battery system components to a dedicated battery space in the vessel. The battery space boundaries must be vessel structures and the space requires continuously running mechanical ventilation. Fire detection and extinguishing are required.

### **Cost development**

Strict safety requirements, electrical interconnections between modules and packs, as well as pack level energy management electronics increase the cost of marine battery systems. While the cells constitute 80% of total battery cost in battery-electric passenger vehicles, the share is only 40% for large capacity marine battery systems [6]. This implies that improvements in cell chemistry, manufacturing and production scale will not reduce the cost of marine battery systems to the same extent as in automotive sector.

### **Comparison of volumetric energy density of fuels**

One of the most important properties of ship fuels is their volumetric energy density. A higher volumetric energy density allows a ship to operate longer without bunkering and thus generate more profits. Fig. 5.1 demonstrates this energy density for a variety of selected fuels. Based on the figure, it is evident that batteries and hydrogen are infeasible as the primary energy sources for the majority of shipping. Most of the potential alternative fuels occupy the middle region of the graph, just below 20 MJ/l.

### Case 5.1 Is electrification of intercontinental shipping attainable?

The Trans-Pacific trade route has the highest containerized cargo flow among the major trans-oceanic trade routes [7]. What would it take to construct a battery powered electric ship for this trade route?

Consider a 14000 teu New Panamax container ship, a common size in trans-oceanic shipping. The power required to propel the ship at a design speed of 21.5 knots is 40.09 MW [8]. At a reduced slow steaming speed of 16 knots, the required power is 16.38 MW assuming a cubic power curve for frictional resistance.

The 10400 km Trans-Pacific voyage between the ports of Shanghai, China and Los Angeles, USA, takes 15 days at this slow steaming speed. Total propulsion energy for the voyage is 5757 MWh. To match this demand, the battery needs to store 6396 MWh when the 90% total efficiency of the electric powertrain is accounted for.

Specific energy of commercial Li-ion cells has reached 300 Wh/kg, still 40 times lower compared to conventional marine fuels HFO and MGO. With this specific power the battery weights 21321 tons, which is 14.2% of the 150000 DWT cargo capacity of the New Panamax size ship. For comparison a conventional low speed two stroke Diesel engine for this ship category weights 1619 tons and fuel for the voyage weights 1022 tons.

### ***Onshore power supply infrastructure***

Onshore power supply (OPS) provides electricity for both hotel activities and battery charging while a ship is docked. A port receives its electricity from the medium voltage local distribution network. Voltage and frequency vary between grids, but a voltage of 10 kV and frequency of 50 Hz is used in Northern European countries [9]. High voltage shore connection (HVSC) enables transferring the electric power from shore to ship in a single cable, whereas low voltage shore connection (LVSC) requires complex cable management system for possibly 10 or more cables. Power rating in the range of 2.5–6.5 MW is standard in ports that supply HVSC. A 2.5 MW 11 kV/50 Hz HVSC system described in standard IEC/IEEE 80005 can be assumed unless more detailed specifications are available.

Drawing electricity from OPS requires interface equipment, control and monitoring systems and a transformer onboard the ship for stepping down the shore medium voltage (e.g. 11 kV) to low voltage (e.g. 660 V) of the ship grid. Both 50 and 60 Hz frequency networks are used in ships, and a frequency converter is required in the case that the OPS has a different frequency than the ship.

The ship operator faces the OPS investment cost in the electricity price margin that the port operator charges on top of the retail price. One port operator reports charging 25 EUR/MWh (22% of total price for ship operator), which pays back the OPS investment in 8 years [10].

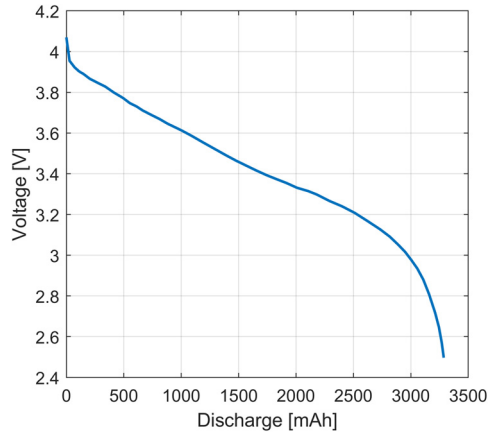

**Figure 5.2** Panasonic NCR18650B Li-ion cell open circuit voltage as a function of discharge at 25 °C [11].

**Table 5.1** Panasonic NCR18650B cell data.

Parameter	Value	Unit
Nominal voltage	3.6	V
Rated maximum capacity	3250	mAh
Internal resistance	50	mΩ
Weight	48	g

## 5.2.2 Battery modeling

A battery pack consists of cells connected in series and parallel configuration. The number of cells connected in series determines the nominal voltage and the number connected in parallel determines the rated capacity. Cells are characterized by internal resistance, nominal voltage and rated maximum capacity, which is typically given in ampere hours. The cell voltage depends on the discharge level (Fig. 5.2).

### Case 5.2 Battery pack sizing

The design task is about sizing of a battery pack for an electric boat. The pack should have a rated capacity of 17.5 kWh and nominal voltage of 200 V. The battery cell used is Panasonic NCR18650B [11].

1. How many cells must be connected in series and parallel?
2. How much does the battery pack weight?
3. What is the internal resistance of the battery pack?

Table 5.1 presents the cell data needed for the sizing task. The pack voltage is the sum of the voltages across cells connected in series. The required 200 V divided by the nominal cell voltage 3.6 V gives the number of cells required in series:  $\frac{200\text{V}}{3.6\text{V}} \approx 56$ . The series connected cells have a total capacity  $3.25\text{ Ah} \cdot 56 \cdot 3.6\text{ V} = 655\text{ Wh}$ . Connecting these strings in parallel increases capacity but the voltage remains the same. The required number of string in parallel is  $\frac{17500\text{ Wh}}{655\text{ Wh}} \approx 27$ .

The total resistance of each string of series connected cells is given by the addition of the individual resistances:  $56 \cdot 50\text{ m}\Omega = 2800\text{ m}\Omega$ . Then, the total resistance is the reciprocal of the sum of reciprocals of the resistances of the 27 parallel strings:

$$\frac{1}{\frac{27}{2800\text{ m}\Omega}} = \frac{2800\text{ m}\Omega}{27} = 103.7\text{ m}\Omega. \quad (5.1)$$

The aggregate weight of the cells is  $56 \cdot 27 \cdot 0.048\text{ kg} = 72.6\text{ kg}$ . The battery pack includes housing, cooling and battery management system (BMS), which is why the weight of the battery is estimated as 145.1 kg, double the weight of the cells it contains.

A basic battery model needs to capture the evolution of state of charge (SoC) over time and the power dissipation due to internal resistance. A simple circuit model of a battery considers a single resistor in series with the voltage source (Fig. 5.3). The resistor models the steady state internal resistance of the battery. The internal resistance transforms the electrical energy into heat proportional to the current.

The battery terminal voltage  $V_b$  is the open-circuit voltage  $V_{OC}$  subtracted by the resistive losses caused by the internal resistance:

$$V_b(t) = V_{OC}(SoC(t)) - R_{INT}i_b(t), \quad (5.2)$$

where  $i_b$  is current and  $R_{INT}$  is internal resistance. The state of charge updates according to

$$SoC(t) = 1 - \frac{1}{Q} \int_0^t i_b(t) dt, \quad (5.3)$$

where  $Q$  is capacity of the battery.

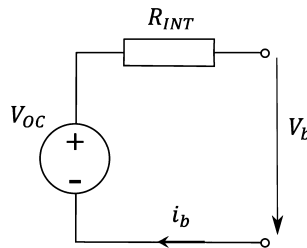

**Figure 5.3** Battery circuit model that considers the steady state internal resistance.



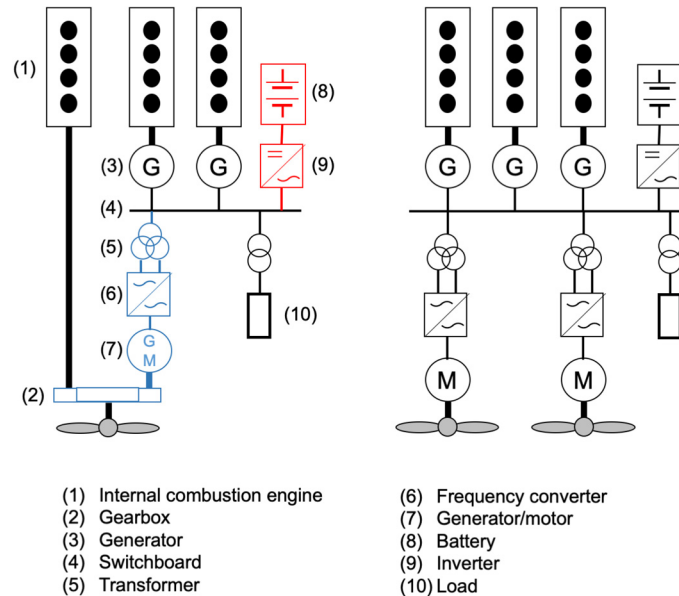

**Figure 5.4** Hybrid propulsion system with hybrid power supply (left), electrical propulsion system with hybrid power supply (right). Adapted from [12].

### 5.2.3 System configurations

#### *Mechanical propulsion with shaft generator/motor and hybrid power supply*

Most ships sail ocean crossing routes at a constant speed. In this type of operation, the highest fuel to propeller conversion efficiency is achieved by mechanical propulsion. The most common configuration is a single low speed two-stroke engine connected directly to a propeller shaft, illustrated in Fig. 5.4 (left) by solid black components. Car decks in roll-on/roll-off ships prevent fitting two-stroke engines, and low profile medium speed four-stroke engines are used instead, driving two propellers via gearboxes.

The mechanical propulsion configuration can incorporate a battery (components in red (light gray in print version)) to the electricity grid. If minimum capacity and power requirements are satisfied, the battery can replace one of the auxiliary engines. The blue components (mid gray in print version) represent an electric machine connected to the propeller shaft via a gearbox. The power output from the main diesel engine can be channeled to the electricity grid and battery charging by operating the machine as a generator. Alternatively, when power flows from the battery, it can drive the propeller with the electric motor and allow switching off the main engine(s). Applications of this configuration have been limited to tugs and yachts.

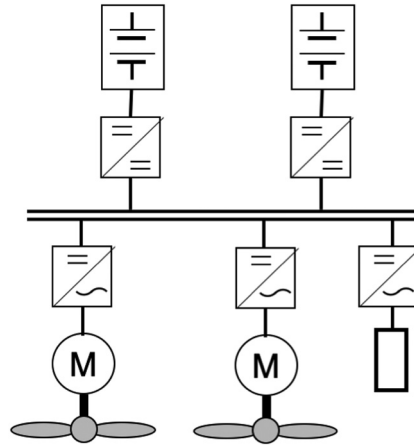

**Figure 5.5** Battery-electric propulsion with DC distribution.

### ***Electrical propulsion with hybrid power supply***

Fig. 5.4 (right) shows an electrical propulsion system configuration, which achieves higher overall efficiency than the mechanical propulsion in ships that have varying operation profile. A battery supplements generating sets as power sources, and is connected to the medium voltage AC main switchboard via a bi-directional inverter. A typical diesel electric configuration in cruise ships and ferries consists of three or four generating sets of two different maximum power ratings. Although the battery can absorb load variation in the grid and improve engine operating points, the charging and discharging losses are likely to cancel out savings from more efficient engine operation. This is mainly due to the different sizes of the generating sets, allowing a combined operation in a way that avoid inefficient operating region in any single engine, regardless of total power demand.

### ***Battery-electric propulsion with DC distribution***

A DC-grid configuration supports straightforward integration of electrochemical cell based devices, such as batteries and fuel cells (Fig. 5.5). The main propulsion consists of AC synchronous motors used with variable speed drives, exactly as in the AC grid configurations in Fig. 5.4. AC grid fed variable speed drive has three main components: a rectifier, a DC link and an inverter. The drive design is simplified when fed from a DC grid, as the rectifier is redundant.

In an all-electric vessel, batteries are the main source of energy for propulsion motors and auxiliary loads. In this case two independent systems, located in separate spaces, are required according to classification society rules [5]. Moreover, both systems must have sufficient capacity for a typical operation cycle.

### 5.2.4 Design and control considerations

In general, ship energy systems are controlled by rule-based systems. These systems respond to measurable inputs according to some simple rules, such as “if power demand exceeds  $x$ , start generating set  $y$ ”. Such rule-based systems can be sufficient when the energy system layout is simple. Although, optimal control cannot be guaranteed with such systems.

In traditional ship energy systems, the control decision at a certain time instant is relatively simple. A certain amount of power demand exists, and a decision must be made on which power producing units to use to answer this power demand. Usually, there is no need to decide exactly how much power to produce with each active unit, as power production is almost always split equally among online producing units. Such control problems are generally referred to as unit commitment problems in energy system control design.

Introducing an energy storage into the system complicates this control aspect by a significant margin. In addition to the unit commitment problem, the control system must also make a decision whether to discharge or charge the energy storage, and by how much. Such a decision is continuous, and dependent on the future expected power profile of the ship. For a thorough accounting of different ship energy system layouts and their control, including a battery electric hybrid energy system, see [12].

BMS is responsible for low level control of the battery. BMS monitors the pack and estimates SoC and state-of-health. The system controls charging, balances cells, prevents misuse and communicates with vehicle control unit.

#### ***Rule-based control***

In a relatively simple control setting, the energy system including the battery can be controlled via a rule-based control logic. Such systems are often configured based on pre-determined operational modes, where the response of the energy system is tied to these operational modes.

An exemplary operational mode might harbor maneuvering with auxiliary thrusters, where the inevitable power spikes can be estimated to be short, and should thus be handled by the battery. Vice versa, open-sea operation could constitute an operational mode where the battery can be charged by producing excess power with generating sets to move them closer to their operating point as well as charging the battery.

Rule-based control approaches benefit from being simple to understand and predictable. However, due to the heuristic nature and rigidity of the methods, optimization based approaches to energy system management can be expected to outperform rule-based control systems.

### ***Optimization approaches***

In a typical optimal control problem, a constrained cost function is minimized by controlling decision variables. In energy system management, this cost function typically takes the form of cumulative fuel cost of all power producing units, whereas the decision variables express the power flow to and from the power producing units. The optimization constraints ensure at least that the power balance between demand and production is maintained, and that the power ratings of power producing units are not exceeded.

In the Equivalent Consumption Minimization Strategy (ECMS) [12], the charging and discharging action of the battery is associated with an equivalent fuel cost to link the battery and the generating sets in the cost function. The task of the ECMS is to then find the optimal power split so as to minimize this combination of actual fuel cost and equivalent fuel cost. The true optimality of such an approach is of course dependent on the equivalent fuel cost selection, but such approaches have been shown to work well in practice.

In case the future power demand profile of the vessel can be estimated, model predictive control approaches can be utilized to produce efficient and robust energy system management. Methods for predicting a ship's power demand will be briefly discussed next.

### ***Predicting power demand***

Ship power demand predictors can be divided into black-box models, which are based on statistical models fitted to observed data, white-box models which are based on first principles or gray-box models which are combinations of black- and white-box models. The power demand profile of a ship is most profoundly dominated by propulsion demand, especially in merchant ships. For this reason, gray-box methods such as the Holtrop and Mennen's methodology [13] are widely used. Holtrop and Mennen's method specifically is focused on estimating the resistance encountered by a ship.

Black-box models for power demand prediction usually employ artificial neural networks and/or regression models for predicting power demand. Such models are especially useful for vessels with high auxiliary power requirements, as hotel load is particularly hard to predict with models based on first principles. These models require large amounts of data to train.

Gray-box models have often been found to achieve highest accuracies of predictive models. They usually employ other gray-box models, such as the Holtrop and Mennen's method for still water resistance or Isherwood's model for wind resistance [14] along with black-box models such as artificial neural networks and/or regression models. Injecting statistical learning based methods with some previous knowledge, in this case in the form of gray-box models, has been demonstrated to increase the learning speed and data efficiency of statistical methods by a significant amount.

### ***Model predictive control***

Once an estimate of future power demand has been generated with the methods described in the previous chapter, an optimization model can be employed to solve the unit commitment strategy for some future time period. However, such a strategy can be sensitive to prediction errors in future power demand estimation. For this reason, it is often safer to employ model predictive control.

In model predictive control, the unit commitment of the energy system is optimized according to some predicted demand horizon, the first optimized action is taken and the actual the state of the energy system is observed. Future power demand is then predicted for a new prediction horizon using the observed state of the energy system as input. Unit commitment is then optimized against the new demand prediction horizon, using the observed state as the initial condition. The first control action is then taken, and the methodology continued in a similar fashion. A detailed description of a unit commitment optimization model is given in [15], and a demonstration of its application in a model predictive control format is shown in [16].

### **5.2.5 Examples of battery use cases in marine applications**

As stated earlier, the weight, volume and price of batteries makes them infeasible as the sole energy carrier for large ocean-going vessels. However, there are certain auxiliary tasks where batteries can be utilized to improve the overall efficiency of a ship's energy system, even if the batteries capacity is small compared to the total output capacity of the energy system. Ideal vessel candidates for battery hybridization have large power demand variations, high redundancy requirements and low utilization of one of the vessels engines for long periods of time. Ship types of interest are ferries, offshore vessels, drill ships, shuttle tankers, wind farm vessels, icebreakers, passenger boats, fishing boats, tugs and other workboats, as listed by the DNV-GL battery handbook for maritime applications [4]. This section describes various use-cases for maritime battery installations in detail, and also considers the applicability of batteries as the sole power source for short-sea operations.

#### ***Shifting diesel engine operating points closer to peak efficiency***

A typical diesel engines specific fuel oil consumption (SFOC) curve is shown in Fig. 5.6. Peak efficiencies are typically reached when the engine is operated at around 85% load whereas lower engine loads decrease fuel efficiency exponentially.

Operating the engines at 85% load can be difficult especially in ship energy system configurations where multiple generating sets are used to supply power. This is due to the redundancy requirement of spinning reserve retainment, which is enforced so that the ship does not undergo a black out even if one of the generating sets fails. For example, the generating set project guide of one engine provider recommends

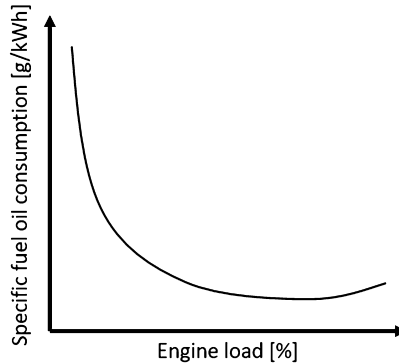

**Figure 5.6** Generic SFOC curve of a marine diesel engine.

that maximum attained engine load is kept below 75% when four generating sets are operated in parallel [17].

Such redundancy measures inadvertently lead to operating the engines at a sub-optimal load level for the majority of the ship's operational profile. However, if the power stored in a suitably sized on-board battery is treated as a source of this redundant power reserve, the engines can be safely operated at their maximum efficiencies without a worry of undergoing a black out. Furthermore, the possibility of charging and discharging a battery essentially decouples energy production and energy demand in time. This allows to for example overproduce power with generating sets in such a way that the engines reach optimal load conditions, and store the excess energy into the battery. This excess energy can then later be used during a power demand peak, which would otherwise require starting additional engines. The utilization and application of such methods is studied in [15].

### Case 5.3 Passenger ferry battery dimensioning based on real world operation

In this case study report, we focus on a battery energy reserve application in which the battery provides value even when it is not actively operated [15]. Ships operating in coastal areas and archipelagos run auxiliary engines at low loads to ensure power availability. The cost of this safety feature is the low efficiency and high fuel oil consumption of the low loading operation. A potential for reducing fuel oil consumption is apparent by augmenting the auxiliary electricity grid with a battery that brings flexibility and enables the auxiliary diesel engines to operate closer to the design point where efficiency is maximized.

Specifically, a diesel mechanical roll-on/roll-off passenger ferry operating in the Baltic Sea is the focus of this case study. The ship in question is Silja Serenade in the route Helsinki –

Mariehamn – Stockholm. An auxiliary engine power output logging dataset was acquired to support the analysis.

A rigorous evaluation of the battery system economic feasibility entails formulating an optimization model that solves for installed battery capacity and a power management strategy with the goal of minimizing installation and operation cost. In addition to the reserve power use case, the battery could also supply thruster induced power peaks in port maneuvering.

Auxiliary network of the case ship consists of four generating sets of two different ratings. Since all the generating sets supply the same alternating current grid, the connected engines must be load balanced. This attribute is inherently nonconvex, leading to optimization model formulation that is difficult to solve. Incorporating engine on/off logic relations via binary variables convexifies the problem. On the other hand, the relations in the energy storage model are inherently linear.

Applying the optimization model with the Silja Serenade data yields a solution showing fuel oil consumption reduction by 257.5 tons annually due to improved auxiliary engine efficiency. A 940 kWh battery capacity is required to achieve this saving. In the end, the battery system total cost advantage was found to vary from –0.61 to 2.82 million during a ten-year investment period, depending on fuel oil and battery system costs applied in the modeling. In addition, the battery almost halved the total auxiliary engine running hours, which would translate directly to reduced maintenance costs.

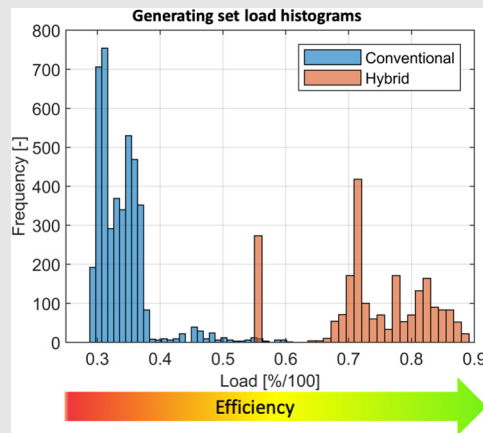

### ***Supplying electricity at port stay when shore connection is unavailable***

Historically, ships have had a major contribution in the emission of local pollutants such as particulate matter, sulfur oxides and nitrogen oxides due to the use of heavy fuel oil. This has been particularly detrimental for populations living in coastal regions with high marine traffic, and those that live near busy harbors. Recently, the International Maritime Organization has imposed regulations that limit the emissions of these pollutants. These regulations are expected to have drastically positive health benefits as

noted in [18], but further methods for pollution reduction near living environments are needed.

One solution could be to replace the source of power from diesel to electricity stored in batteries during port stays. Moored vessels in harbor retain a portion of their power production for needs such as heating, lighting and ventilation. However, the magnitude of this hotel load is considerably smaller compared to that needed for propulsion. A reasonably sized on-board battery could be charged fully with the ship's main engines during cruising, and then depleted to supply hotel load during port operations. Such methods, coupled with supplying the hotel load from a shore connection, would have a major impact in reducing local emissions in harbors.

### ***Zero local emission port arrival and departure***

Although current Li-ion-based chemistries are infeasible for providing the entire energy demand for ocean-crossing voyages, short distance port arrival and departure sailing legs are potential applications of batteries for zero local emission sailing [19]. A shipowner considering this function needs to evaluate the trade-off between battery investment cost and fuel cost. Lower speed on the battery powered leg corresponds to smaller required battery capacity and investment cost. On the other hand, the slower speed on the battery powered legs must be compensated by higher speed (and fuel cost) throughout the rest of the voyage given that the total voyage duration is fixed. Recent work has proposed that the optimal tradeoff point exhibits a large, even 50% speed reduction in battery powered legs [20]. Moreover, the higher speed throughout the rest of the voyage may increase the total amount of greenhouse gas emissions.

### ***Supplying thruster induced power demand peaks that would otherwise require starting up an additional engine***

A typical auxiliary power consumption profile of a vessel journey consists of a steady base hotel load and transient thruster use when maneuvering in harbors. The magnitude of thruster power peaks is typically at least twofold compared to the base load [15]. One or more additional auxiliary engines must be started to supply these peaks. In order to avoid excessive wear and load, the engines require warming up and cooling periods when disconnected from the grid and shut down. During these operation modes, an engine is idling and consuming fuel. Supplying the thruster power peaks from a battery eliminates the need to start additional engines, and the associated fuel use. However, this battery use case alone is unlikely to justify battery investment economically, since maneuvering events are infrequent for most ships.

### ***Improved dynamic performance for ice load management***

Dual fuel engines have experienced widespread adoption in recent years. Ships equipped with these engines can run either on gas or liquid fuel and switch from gas to liquid



operation mode (and vice versa) even under high load. However, sudden load peaks have been observed to cause unintended switching from gas to liquid fuel mode. For instance, ice going ships equipped with dual fuel engines commonly experience difficulty at remaining in gas mode [21]. A hybrid powertrain configuration, featuring a battery with fast load ramping functionality, can effectively mitigate issues arising from ice loads.

### ***Energy recuperation in ships with heavy cranes***

Regenerative braking is a key advantage of electric powertrains. In electric vehicles, the electric propulsion motor can function as a generator, converting the vehicle's kinetic energy to electric energy, which flows back to the battery. However, ships have limited potential to recover kinetic energy, because operation profiles involve mostly sailing at constant speeds, and reducing speed by active braking is not necessary. On the other hand, significant energy recovery potential exists in ships that are equipped with heavy cranes and electrically driven hoist. When a load is lowered, it needs to be slowed down by the hoist motor. Instead of dissipating the generated electric power as heat in resistors, it can be directed to the electricity grid for charging a battery. 30% energy consumption reduction has been reported for bulker cranes [22].

### **5.3. Thermal energy storage**

During last years, large number of investigations were focused on waste heat recovery (WHR) as the most technically affordable and immediate solution to reach the EEDI proposed.

Another potential solution to increase the energetic efficiency of the ship main engine is the integration of thermal energy storage (TES) systems. Energy recovery devices are based on the waste heat or cold energy capture and its immediate use during the operation time of the main equipment which generates the surplus of heat or cold, while TES systems allow to detach the energy recovery from the energy consumption, independently of the operation mode of the main equipment.

Thus, WHR technology may also be improved in some cases by integrating thermal energy storage (TES) to the WHR system, contributing to increase the global efficiency.

The development of Thermal Energy Storage (TES) systems has been a key milestone for the global deployment of solar energy, contributing to balance the demand with the supply and making it more reliable. This technology was also integrated to industrial applications where the operation requires high energy intensity in some periods of the processes alternated with low intensity ones. Then, the surplus of energy production may be stored to be used, for example, for pre-heating purposes once the high intensity period starts again, increasing the overall efficiency of the plant.

TES systems are basically integrated by a storage material, which is the responsible for storing the energy, and the storage tank or heat exchanger, the technology that

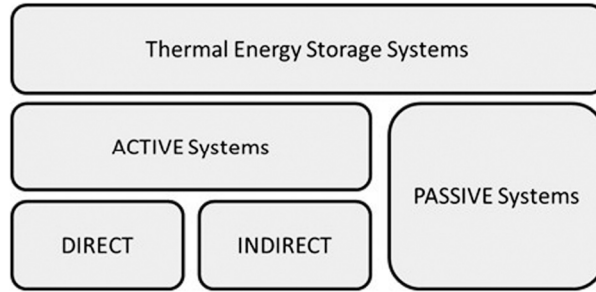

**Figure 5.7** Scheme of TES systems classification.

makes possible the heat transfer between the storage material and the energy supply source or consumption.

Thermal Energy Storage systems experienced a rapid development during last decades mainly due to the deployment of concentrated solar power technologies. In this sector, the need of integrate efficient and economic viable facilities to store the thermal energy during production excess to be used during peak demand periods encouraged the research of new concepts and methodologies.

The current maturity of the TES technologies available may benefit also other sectors, like industrial, residential or transport, to increase their energetic efficiency by managing the surplus of heat or cold generated. In general, the different types of TES systems may be classified as active and passive systems, as Fig. 5.7 shows [23].

Active systems are characterized by forced convection heat transfer in the storage material, which circulates through the waste heat capture facility. Usually, these systems involve some liquid material which may act as storage media, heat transfer fluid (HTF) or both at same time.

Active systems, in turn, may be divided into Direct systems and Indirect systems. In Direct systems the storage media acts as heat transfer fluid (HTF), which means it directly absorbs the energy from the heat source and transports it to the storage system. That means the material requires particular characteristics to be a good HTF and a good storage material. The materials used are usually liquids to take profit of the low thermal expansion experienced with the increase of temperature.

Oppositely, in indirect systems, where the energy is gathered by a second fluid, acting as HTF, and its transferred to the storage media by the use of a heat exchanger. In this case, the storage material uses to be also liquid.

On the other hand, passive systems are characterized by using a static storage material, where the HTF transporting the energy gathered on the waste heat source circulates through the storage material and the heat transfer process is mainly driven by conductive process in the side of the material.

### 5.3.1 Types of thermal energy storage systems

#### *Sensible heat storage materials*

Sensible heat storage process is based on an increment on the temperature of the storage material (solid, liquid or gas) by increasing its internal energy.

The total stored energy depends basically on the thermo-physical properties of the material like density  $\rho$  [ $\text{kg}/\text{m}^3$ ] and specific heat  $c_p$  [ $\text{J}/\text{kg K}$ ]; the volume of the storage material involved in the process  $V$  [ $\text{m}^3$ ]; and the gradient between the initial and final temperatures [K] of the material on the heating process: the larger the temperature gradient, the larger the amount of energy stored.

$$Q = \int_{T_{\text{initial}}}^{T_{\text{final}}} (V \cdot \rho \cdot \bar{c}_p) dT. \quad (5.4)$$

The materials used as sensible storage media involve solids like ceramic, rocks, concrete, solid particles and some industrial waste materials, which may represent an advantage in terms of structural stability with temperature and low level of interaction between storage and vessel materials, which reduces the possibility of corrosion. Moreover, the thermal expansion of materials also needs to be evaluated in advance in order to avoid ratcheting effects on systems based on thermocline concept, or poor contact effect with the HTF pipes after some thermal cycles due to the different expansion coefficients between storage media and pipes. Regarding the liquid storage media molten salts or different kind of thermal oils are commonly used, including gas substances (steam). When it comes on liquid storage materials, the main advantage lays on taking profit of its convection effect, which helps to increase the heat transfer coefficient between the HTF and the storage material. The use of gases as sensible storage media requires pressurized vessels which makes the system more complex and costly compared with solid or liquid based systems. Moreover, the amount of energy stored in gases is usually lower compared with the systems based on liquid media. For this reason, no systems based on gases as storage media had been developed until date.

#### *Latent heat storage materials*

Latent heat processes consist on heating a material until it experiences a phase change, from solid to liquid or liquid to gas. When the material reaches its phase change temperature it absorbs a large amount of heat, at constant temperature, in order to carry out the transformation. The heat absorbed during the process is known as latent heat of fusion or vaporization depending on the case. The energy stored during the phase change is released when the material is cooled down again.

Fig. 5.8 explains the storage mechanism: the material in solid state is heated and its temperature begins to increase in direct proportion to the received energy until it reaches the melting temperature, which consists on a sensible heat process. Beyond this

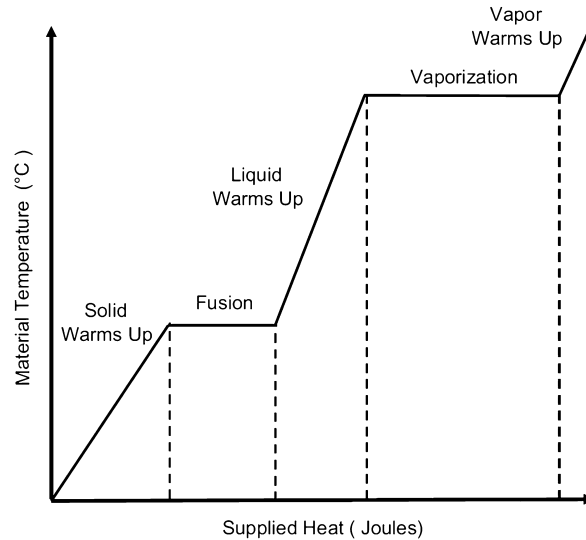

**Figure 5.8** Heat or thermal energy stored by a given material through temperature increase in a latent heat process.

point, the energy delivered to the material ceases to raise the temperature, and it is used instead to perform the transition from solid to liquid (latent heat), that is, the material stores isothermally the thermal energy received; once the transformation is complete and the material is completely in the liquid state, the temperature begins to increase again as in a sensible heat process, until it reaches the vaporization point where the occurred in the first phase change is repeated. The heating process works the same way for cooling, which means that it is possible to extract the stored energy as latent heat at a constant temperature, even if this process, mainly due to thermal losses to the ambient, is not reversible.

Latent heat storage processes are based on a phase change on the material:

- solid – solid, between polymorphic phases of the material;
- solid – liquid (fusion or melting/ freezing or solidification), is the most studied and extended form of storage by phase change at large scale;
- liquid – gas (vaporization/condensation), which actually have the highest latent heat of phase change. However, the important changes on volume from liquid to solid imply large volumes of storage vessels and discard this process for real thermal energy storage applications;
- solid – gas (sublimation/deposition), again, the important volume change represents a definitive drawback to seriously consider this process like a reliable energy storage process.

Regarding the solid–liquid phase change processes, the latent heat involved can be calculated according Eq. (5.2):

$$Q = M \cdot x_m \cdot \Delta H_m, \quad (5.5)$$

where  $M$  is the total mass of storage material [kg];  $\Delta H_m$  is the storage material enthalpy of melting [kJ/kg] and the  $x_m$  is the fraction of the storage material amount melted. On the other hand, heat transfer processes only take place when a temperature gradient is applied between the storage material and the HTE. Then, in real applications a temperature gradient is always needed between the initial and final points, and part of the energy is stored by the material as sensible heat (Fig. 5.8). Eq. (5.6) describes the total energy stored during the phase change process in a more accurate form, including the sensible heat storage part:

$$Q = \int_{T_{\text{initial}}}^{T_{\text{melting}}} (M \cdot c_{p \text{ sol}}) dT + M \cdot x_m \cdot \Delta H_m + \int_{T_{\text{melting}}}^{T_{\text{final}}} (M \cdot c_{p \text{ liq}}) dT. \quad (5.6)$$

The first main advantage of storage systems based on latent heat processes over these based on sensible heat is the fact that the phase change takes place at constant temperature, for fusion (or melting) and solidification, which simplifies the temperature control at the outlet of the TES system and posterior operation of the plant.

The second main advantage of the phase change is that it involves in the process larger quantity of energy compared with sensible heat processes, representing an increase of the energy density of the storage system and, consequently, an opportunity to compact it.

However, despite the strong advantages that phase change materials (PCM) present compared with sensible heat ones as potential TES materials, there is also many drawbacks to overcome and that limit their use at current moment. Liu et al. [24] listed, among them, thermal expansion differences with the vessel material, thermal stability at mid-long term, limited number of potential materials for a given temperature range; potential corrosion problems between the PCM and the vessel material and the high cost of PCMs compared with the materials used on sensible heat storage.

### **Thermo-chemical storage**

Thermo-chemical energy storage is based on chemical reactions with high energy involved in the process. The products of the reaction are separately stored, and the heat stored is retrieved when the reverse reaction takes place. Therefore, only reversible reactions can be used for thermo-chemical storage processes.

Usually, chemical energy conversion has better energy storage performance and efficiency than thermo-physical methods (sensible and latent heat storage). The most important challenge is to find the appropriate reversible chemical reaction that matches

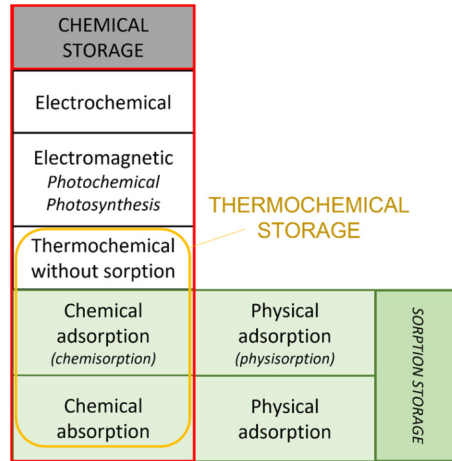

**Figure 5.9** Scheme of an open sorption storage system [25].

with both the energy source used and the final energy application. This energy storage method also provides the advantages of high storage densities and minor thermal losses due to the products from the reaction are stored at ambient temperature.

Thermochemical energy storage mechanisms may be divided between chemical reactions and chemical sorption systems (Fig. 5.9).

Thermochemical without sorption is based on heating a compound to cause chemical-molecular separation. In general, chemical reactions take place above 200 °C with higher energy density. However, not all the reactions are completely reversible.

Sorption is a phenomenon of capture of a gas or vapor (sorbate) by a condensate substance, solid or liquid (sorbent), and may involve both thermo-physical and thermo-chemical aspects. The sorption process initially involves the reversible chemical reactions between a chemical sorbent and a sorbate, mainly the hydration reaction between salt hydrates and water vapor and the coordination reaction between ammoniate and ammonia. Sorption includes both absorption and adsorption.

Absorption is defined, in the frame of energy storage, as the phenomenon in which a gas enters in a liquid (absorbent). On the other hand, adsorption refers to the phenomenon of the binding of a gas on a surface of a solid or porous material. Adsorption may be subdivided on physisorption (physical adsorption, which is related with Van der Waals forces) and chemisorption (chemical adsorption, which involves valency forces). Chemisorption processes offer larger heat of sorption compared with physisorption, but they may be not reversible.

Regarding sorption systems, there are two types: closed and open storage systems.

Open sorption storage system is open to environment, and the air transports water vapor and heat in and out of the sorbents (Fig. 5.10). In the desorption process (charging), hot air desorbs the water from the adsorbent, leaving the system cooler and

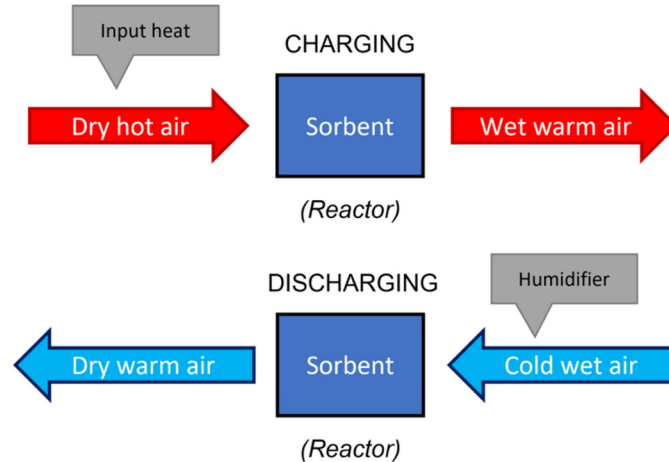

**Figure 5.10** Scheme of an open sorption storage system [26].

saturated. In the adsorption process (discharging), cold wet air enters the sorbent, which adsorbs the water vapor, and the air leaves the storage warm and dry [26]. Open sorption systems allow a simple manufacturing of the reactor, compared with closed systems.

In a closed sorption system, there is no mass exchange with the environment. The heat is transferred to and from the adsorbent by a heat exchanger, usually called the condenser/evaporator. The heat has to be transported to the absorber at the same time as it is extracted from the condenser to keep the HTF, usually water, flowing from the adsorber to the condenser/evaporator.

The advantages of closed systems compared to open systems include higher energy density, being able to reach higher output temperature for heating operations, being able to supply lower temperatures for cooling, and being able to produce ice in the evaporator.

As already mentioned, TES technologies have been widely developed to recover and store the thermal energy at high temperature [23,27]. However, an increasing interest on recovering waste cold energy, in particular from liquefied natural gas (LNG) regasification process, had been noticed in the last years, using similar TES systems than the ones already developed for high temperature applications [28]. Then, the availability of so wide range of TES systems at different temperature ranges opens the possibility to easily apply the existent solutions in other fields like shipping and maritime transport.

### 5.3.2 Implementation of thermal energy storage on ships

Thermal energy storage technologies have been applied in many other fields, where balancing of mismatch between energy production and demand is required. Moreover, during last decades a large amount of research projects have been founded to

develop new and more efficient TES systems at different temperature levels. The target in concentrated solar power industry is to cumulate the heat from the sun to keep the electricity generation after the sunset. In industrial applications, the objective is to recover waste heat from the exhaust gases or excess heat from the process, in order to revert it later to the same process.

In this case, it may be considered the maturity of the TES technology is more than enough to be applied in ships. In fact, some authors have already proposed to incorporate TES systems in ships in order to reduce the energy consumption on board and as well as decarbonize the sector and achieve the reduction of pollutant emissions established by IMO in 2019.

There may be scope to adapt some power industry thermo-chemical energy storage developments for future application in maritime propulsion, especially as future oil prices rise. Given the space that thermal energy storage systems may occupy aboard a ship, tugs would be the most likely vessels to operate on stored thermal energy, moving ships around harbors and/or pushing and navigating barges on short coastal voyages or along inland waterways. Such tugs may spend limited time in port under thermal recharge, as spent material may be transferred off and reprocessed material transferred on to the vessel during short layovers.

### ***Study of application of a TES system in merchant ships***

A preliminary study of TES application on merchant ships was presented by Baldi et al. [29] in 2015. The authors proposed the recovery of the exhaust gases from the Diesel engine of a product tanker using a heat recovery exchanger (HRE) coupled to a 1000 m<sup>3</sup> cylindrical tank, assuming a marine thermal oil as storage media. Fig. 5.11 displays the scheme of the system proposed.

The thermal energy stored during the cruise period must serve, once in port, to satisfy the heat demand for cargo tank cleaning and for heating high-viscous cargo. For this end, at present moment the ship integrates 2 auxiliary boilers able to generate 14,000 kg of steam at 9 bar.

The operation of the storage was established in cycles where the charging occurs during sea passage, and the available thermal energy recovered from the exhaust gas that exceeds the heat demand from users; when the maximum storage temperature is reached, excess heat is dumped. During port stays, the heat demand is fulfilled by the storage tank, and when a minimum storage temperature (based on the required temperature level of the thermal users) is reached, the auxiliary boilers are used to produce the required auxiliary heat demand.

The capacity of the storage tank was optimized based on the distribution of the energy demand of the auxiliary systems during the port stays of the ship, evaluated during the 31 months of measurements (Fig. 5.12). From this data, the estimated amount of thermal energy required in port between 200 and 300 GJ.



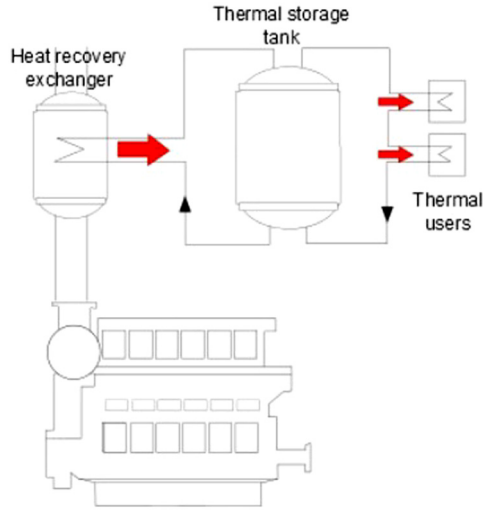

Figure 5.11 Scheme of the HRE and TES tanks proposed [29].

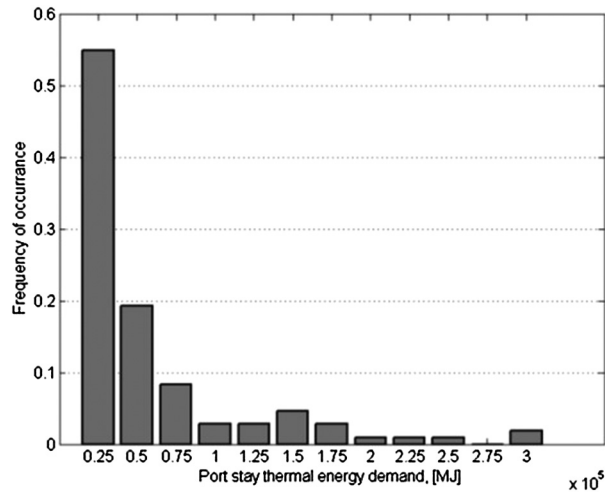

Figure 5.12 Statistical distribution of port stay energy demand [29].

The paper concluded that to optimize the fuel consumption on the boiler the storage capacity is the key parameter and should be included in a range of 500 m<sup>3</sup> to 2500 m<sup>3</sup> depending on the desired performance of the system (respectively reducing boiler fuel consumption by 60% and 90%).

Even if the wasted energy available from the exhaust may lead to higher ratios of energy recovery, a further reduction in boiler fuel consumption demands increasing

storage size is not justified by corresponding savings. Moreover, the heat loss through tank walls becomes more and more relevant with increasing storage tank size. Then, the optimized size of the TES tank of 1000 m<sup>3</sup> capacity, that could reduce the fuel consumption from the boilers by 80%.

This study assumed many of the relevant parameters to accurately evaluate the techno-economical viability of the implementation of TES on merchant ships, like the exhaust specific heat, global heat exchange coefficient in the heat recovery exchanger (HRE) and efficiency of the auxiliary boilers. However, it represents a good benchmark of the methodology to follow in this type of evaluations and shows that the application of TES systems in ships may present potential economic and environmental benefits.

### ***Theoretical study of hot water supply in a cruise ship by using a TES system***

The hot water in a cruise ship during hoteling periods may be supplied by a TES system instead of using only boilers.

Another potential implementation of a TES system in cruise ships proposed by Manzan et al. [30] is the use of the waste heat from the engine to produce the fresh and hot water necessary on board for utilities, including shower or sink water, swimming pools or spas, but also the water necessary in kitchens and laundries.

Thermal energy supply is always problematic in a cruise ship in port situation, especially in terms of water preparation. The potable hot water requires a large amount of energy from the power plant, which is usually obtained by using the different energy sources available on board like waste heat recovery systems or boilers, which means an increase on fuel consumption. This becomes especially critical in hoteling periods, when the cruise ship is in port: due to the reduced number of active engines, the amount of waste heat from the cooling line is also reduced and is not able to supply the energy required by the demand. In this theoretical study the authors evaluated the potable hot water demand in the cruise ship during hoteling time to optimize the size of the TES system.

As already mentioned, the standard water heating system is based on waste heat recovery system supported by a set of heaters. Fig. 5.13 displays both the standard scheme and the scheme proposed by the authors integrating a TES system, where the water heated by the available excess of heat from the engine's cooling system and stored. Once in port, the heat stored is used as support system of the heaters, reducing the fuel consumption.

The amount of water consumption was estimated at 540 m<sup>3</sup>, considering 5000 people on board. Then, the profile of draw was assumed considering 3 different peak hours of consumption, as shown in Fig. 5.14.

Moreover, the authors simulated two different cases for the TES system: one in which the heat is stored only by water and another one in which 20 m<sup>3</sup> of PCM (S58S), with a phase change temperature of 58 °C, was added to the TES tank.

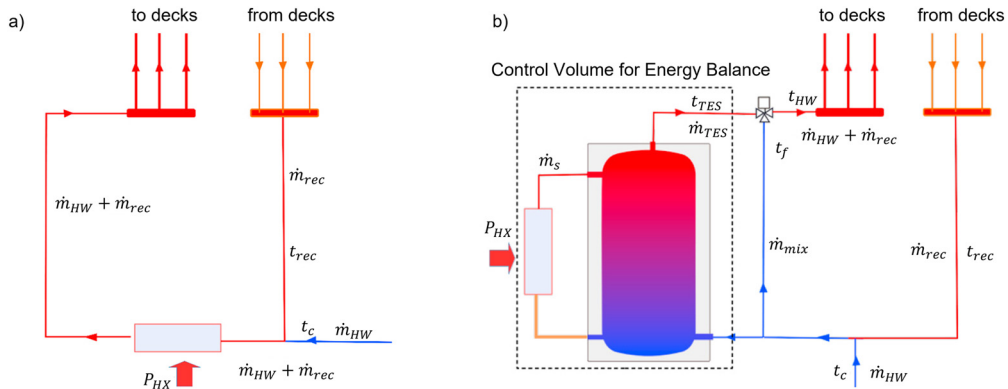

**Figure 5.13** Scheme of hot water preparation on cruise ships: a) standard hot water preparation systems; b) hot water preparation system integrating a TES tank.

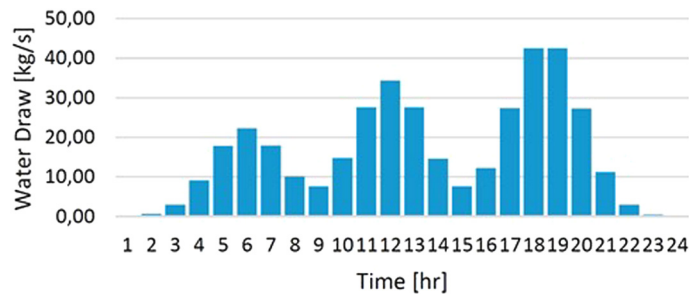

**Figure 5.14** Water draw distribution estimated, according to Manzan et al. [30].

The simulations demonstrated that the PCM allows to provide water at higher temperature even during the last peak of demand of the day.

The authors concluded the TES in CS may be a potential solution to increase their energetic efficiency and reduce the CO<sub>2</sub> emissions.

The solutions presented in the present paper show that, by using a thermal storage system, the heating power required for hot water preparations can be reduced up to 39% thus decreasing the need of additional heating sources.

However, this study is simplified simulation and parameters like water consumption profile is theoretical and just an assumption.

### ***Theoretical evaluation of a CTES system integration in an all-electric ship***

A 1D numerical model to evaluate the integration of a cold thermal energy storage (CTES) system in an all-electric ship is presented by Yang et al. [31]. The mathematical model considers a PCM as storage media but taking into account a limited number of parameters in its equations.

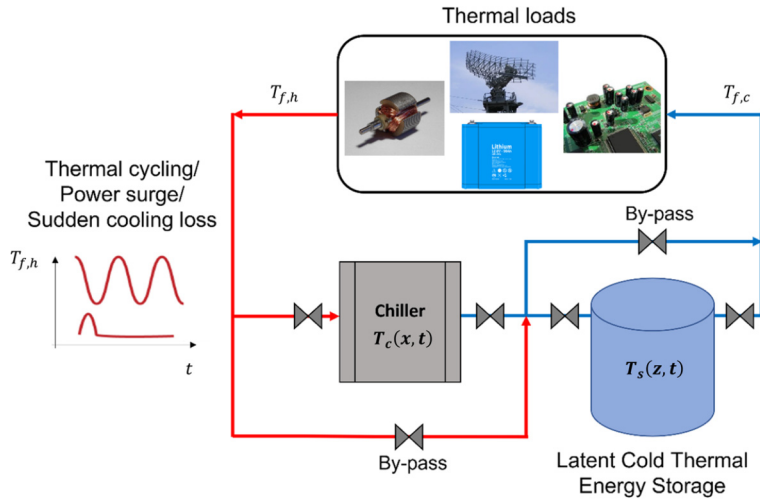

**Figure 5.15** Diagram of the all-electric propulsion system with the chiller for the cooling of devices and CTES proposed by Yang et al. [31].

In order to mitigate the effects of thermal cycling and cooling loss in an all-electric ship, Yang et al. [31] evaluated the viability of integrating a CTES system to provide additional thermal damping.

On all-electric ships the non-linear ship operation dynamics leads to thermal fatigue of the devices and to their potential failure at mid term. Moreover, the thermal lack resulting from the heat exchanger thermal inertia may also impact on the desired temperature of the chilled water. And finally, in case of a sudden loss of cooling power may also lead to a quick rise on the temperature of the coolant.

These three reasons lead to the authors to propose the installation of a CTES system using PCM as storage media (Fig. 5.15), and being used as a heat sink to mitigate the sudden rises and drops of coolant temperature in the above mentioned cases. During the damping periods the PCM is charged and then discharged when the heat exchanger is not able to fulfill the cooling demand by itself.

In the paper, authors numerically analyzed the damping effects with and without the CTES, and compared the results. In this study no PCM was selected. The reason is the numerical model is presented in nondimensionalized form, which aims to be flexible to evaluate the optimal size of the CTES system for any type of PCM and heat exchanger.

The conclusion is the integration of a CTES into an all-electric ship may theoretically be a solution to its thermal issues (thermal cycling or cooling loss), especially taking into account other factors like operation period, required chiller power, and optimal design of heat exchanger combined with a CTES.

The model aims to be versatile enough tool to size a CTES system for any all-electric ship. But despite the results presented shown the integration of CTES system may represent a viable solution to thermal damping effects, further analysis on cost, versatility of the CTES system and design limitations is still required. In particular, the selection of the PCM involves relevant issues in terms of compatibility with the CTES system vessel, long term stability and energy density, among others.

### ***Potential use of TES for cold energy storage on ships***

In this part of the chapter, and taking as baseline the work presented by Baldasso et al. [32], an example of the potential use of TES systems in ships is described. As already mentioned, the new regulation approved by IMO in 2020 limits significantly the sulfur in the fuel oil used on board ships. In particular, up to a 0.50% (mass by mass) when operating outside designated emission control areas and even stricter in within (0.1%).

As a result, most ships may switch to using low sulfur fuel such as LNG to meet regulations, which are applicable since 1st of January 2020. The use of LNG as main fuel in ships may lead to new opportunities to recover waste heat and specially waste cold from the regasification process. In fact, the use of LNG cold energy on board a vessel has been already proved on the ferry Viking Grace, operating on the trans-Baltic route between Turku and Stockholm [32] and where the cold energy made available by the LNG regasification process is recovered on board to reduce the fuel consumption of the heating, ventilation, and air cooling (HVAC) system. This is the first large-scale passenger ferry to be powered by LNG as well as being fitted with a rotor sail.

Similar case is the Viking Glory, also from Viking-line and also powered by LNG, will start its operation also on the trans-Baltic route in January 2022, integrating a similar cold recovering systems than Viking Grace.

However, none of these examples integrated a TES system to recover and subsequently use the cold energy from the LNG regasification during, for example, hoteling periods.

Taking the Viking Grace as baseline, Baldasso et al. [32] proposed different ways to recover and use the wasted cold form LNG regasification in ferries featuring a low pressure fuel supply system, and in long-distance containerships featuring a high pressure fuel supply system. The solutions proposed were compared with regards to the attained fuel savings, if implemented on board the two reference vessels.

One of the options proposed consists on integrating an organic Rankine cycle (ORC) (for more detailed information about ORC refer to Chapter 4, Section “Technologies for power generation”), taking also profit of the wasted heat from the engines as heat source and the wasted cold from the regasification as cold sink. The LNG turbine is utilized only when a low pressure supply is employed for the LNG. Fig. 5.17 shows a simplified sketch of how the cold energy utilization could be implemented on board of a cruise or merchant ship powered by LNG.

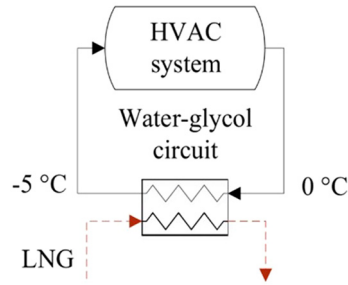

**Figure 5.16** Scheme of proposed system to recover the wasted cold for marine HVCA [32].

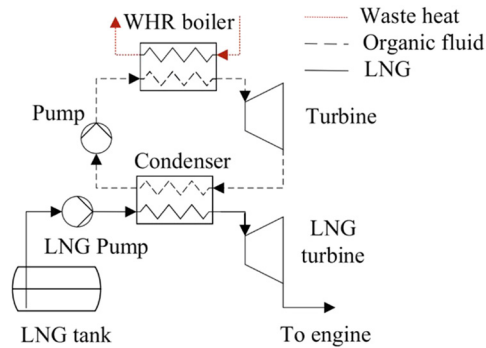

**Figure 5.17** Diagram of ORC configuration on LNG powered vessels, proposed by [32].

According to the calculations presented in the paper, implementing an organic Rankine cycle power system harvesting heat from the exhaust gases and rejecting it to the liquefied natural gas is the solution that shows the highest savings for both types of vessels.

The second solution proposed was to use the LNG to cool down the main engine scavenge air to enhance the engine performance. The scheme in Fig. 5.18 shows the proposed layout of the air cooler system in order to take profit of the waste cold, and the fuel savings resulted in a range between 0.41% and 0.44%.

Finally, the third proposal was aligned with the one already integrated by Viking Lines in their ships: the usage of the wasted cold to reduce the HVAC load (Fig. 5.16). In this case, the fuel savings were estimated between 0.43% and 0.84% of the main engine, depending on the estimated efficient of performance of the chillers and the reference vessel.

Based on these considerations, the integration of a TES system could achieve a positive outcome when evaluated in cruises using LNG as fuel. The need of HVAC and supply of drinkable water during hoteling periods requires the power of auxiliary

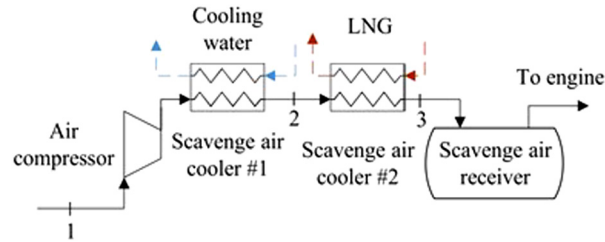

**Figure 5.18** Additional air cooling system for scavenge air supply [32].

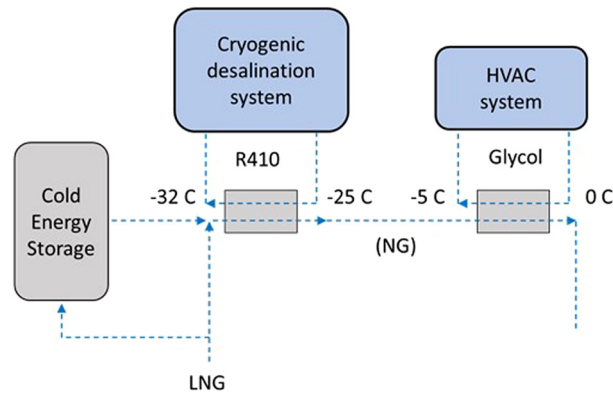

**Figure 5.19** Scheme of the proposed cold TES system integration to provide desalinated seawater and HVAC by using the cold recovered from LNG regasification (adapted from [32] and [33]).

engines, and the integration of a TES system could contribute to reduce the amount of energy required.

Currently, some modern cruise ships like the MSC Meraviglia already integrate seawater desalination devices to produce the water required on board. In the case of the Meraviglia, the technology selected is a multi-effect distillation (MED) system powered by the waste heat from the engines. But cryogenic technology may also be used to desalination, which opens the opportunity to store the waste cold in a single TES system and subsequently use it in cascade to feed both seawater desalination and HVAC systems (Fig. 5.19), enhancing the overall efficiency of the ship facility.

### 5.3.3 Considerations of TES design for marine sector and its potential benefits and drawbacks

According to the report elaborated by IMO on 2020, the greenhouse gas (GHG) emissions of total shipping, expressed in CO<sub>2</sub>e (carbon dioxide equivalent) – which includes CO<sub>2</sub>, methane (CH<sub>4</sub>) and nitrous oxide (N<sub>2</sub>O) – increased a 9.6% from 2012 (977 million of tonnes) to 2018 (1,076 million of tonnes). However, annual carbon intensity

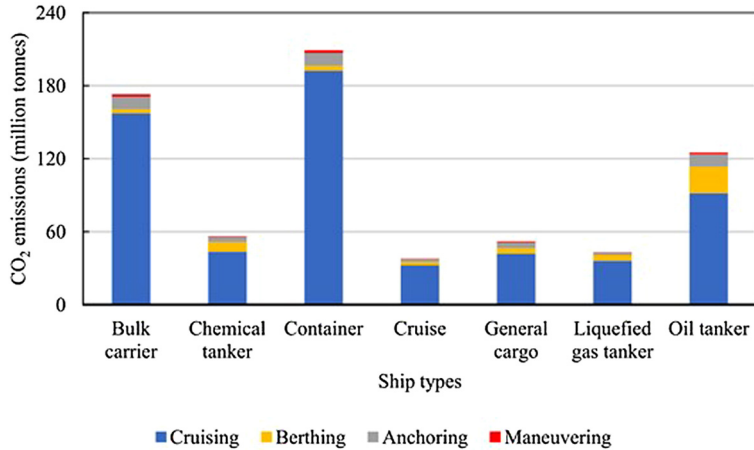

**Figure 5.20** Shipping CO<sub>2</sub> emissions in 2015 by ship type and operating phase [34].

performance of individual ships fluctuated over years. The upper and lower quartiles of fluctuation rates in EEOI of oil tankers, bulk carriers and container ships were around  $\pm 20\%$ ,  $\pm 15\%$  and  $\pm 10\%$ , respectively.

Xing et al. [34] reviewed all the potential countermeasures to reduce the CO<sub>2</sub> emissions from ships proposed by International Maritime Organization (IMO). In an effort to understand the origin of the CO<sub>2</sub> emissions for every type of ship, they classified them into four main categories, according the operating phases common to any type of ship: cruising, when the ship is moving from the origin to the destination; berthing, the period during which the ship is loading or unloading; anchoring, referring to the period the ship spends awaiting the berth or tide before entering to the port; maneuvering, which is the period in which the ship enters or exits coastal waters, crossing other ships on the way, before or after the berthing.

The results of this analysis are presented in Fig. 5.20, where it may be noted that the energy consumption during cruising periods is the more relevant one to be targeted to evaluate the economic viability of TES systems.

Nevertheless, thermal energy storage concept had been developed to overcome the mismatch between energy production and demand in terms of time or space, or both at same time. The cruising period is dominant in the operation life of a ship, and strongly determines its total CO<sub>2</sub> emissions. During this period, a large amount of waste heat is available to be recovered and reused for different purposes, from hot water production and heating of spaces for crew to desalination of water. For this end, waste heat recovery (WHR) is apparently the technology that better matches with the case, due to the wasted heat is reused on demand.



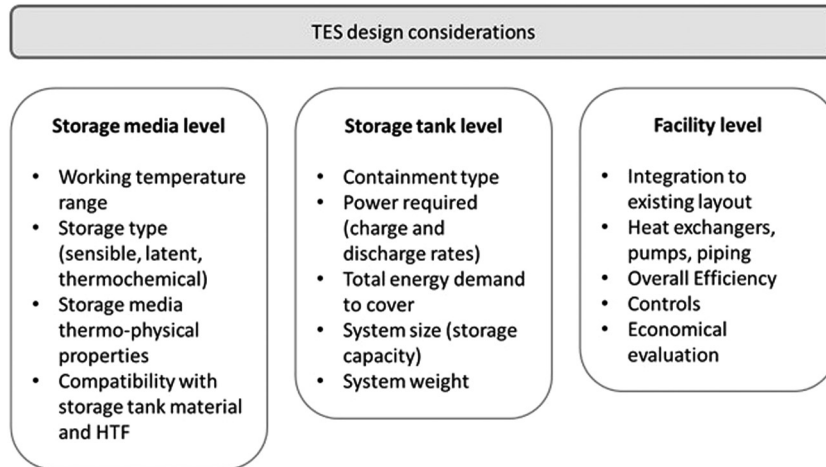

**Figure 5.21** Considerations to take into account during a TES system design.

The waste heat available during cruising periods exceeds the capacity of WHR systems and it could be stored for its posterior use, increasing the global efficiency of the power system onboard. But the integration of a TES system requires space in the vessel which may reduce the load capacity of the ship and represents an extra load to be transported which could eventually lead to an increase in CO<sub>2</sub> emissions.

Summarizing, despite the benefits that the integration of a TES system in a ship may bring in terms of CO<sub>2</sub> emissions reduction and even in terms of economic savings due to the fuel consumption, the drawbacks must also be properly evaluated to determine the suitability of the facility for every type of ship.

Along of the design of a TES system there are many considerations to be taken into account. Regarding the selection of the most suitable storage media, it starts identifying the working temperature range of the heat or cold source from where to recover the thermal energy, together with the temperature needed for the final application of the energy stored. That may define the type of storage principle to select: sensible or latent heat, or thermochemical. Obviously, in a ship the objective is to minimize the system size. Then, amount of storage media necessary in the TES system may be defined by its energy density and thermo-physical properties, together with the amount of total energy demand to be covered. Another aspect to be considered is the compatibility of the storage media and the material of the tank, which may determine the operational life of the whole TES system.

Fig. 5.21 summarizes the considerations to evaluate storage media, storage tank and facility levels.

The storage tank design is usually a heat exchanger and must be selected based on the power required by the final application and sized considering the storage capacity

needed. Finally, the integration of the TES facility in the ship requires the evaluation of the existing propulsion layout, definition of the optimal system control and an economical and energetic evaluation to determine the increase on the overall efficiency of the propulsion system.

Thus, the use of TES systems onboard must be very carefully evaluated for each type of vessel in terms of technical and economical feasibility. The advantages and disadvantages may be different for each case, but in general, the potential benefits of integrating a TES system in a ship are:

- Increase of global efficiency of the power block by reducing the fuel consumption
- Reduce the CO<sub>2</sub> emissions
- Optimize the number of devices needed as auxiliary heating systems, which may lead to a reduction of the ship load

However, some of the design considerations listed in Fig. 5.18 may also represent a drawback. For example, the space required to allocate the TES system and corresponding ancillary (like heat exchangers, pumps, piping, etc) is going to result on a reduction on the load capacity of the ship. Then, the size of the TES system must be calculated in order to determine the optimal balance between the energy storage need and the volume required by the TES.

The layout of the propulsion engines may also become a problem for the installation of a TES system. In some cases, the ship engines are not located in the same area of the vessel and that could increase the complexity of the facility and require more pumping power and better insulation to reduce the thermal losses inherent to TES technology.

In addition, the total weight of the TES facility is another parameter to be studied due to the system is going to be carried along the vessel travel, which leads to an increase of fuel consumption. The environmental impact of carrying a TES system on board was not considered by none of the studies published until date. This evaluation could give a more accurate view of the energetic viability of integrating this type of system in a ship, simply by comparing the energy released during the periods where the main engine is not in operation against the energy necessary for transporting the system during the cruise operation period.

Eq. (5.7) states that in order to reduce the CO<sub>2</sub> emissions of a given type of ship the net energy released by the TES must be larger than the energy necessary to transport it. The effect is more positive when the TES system allows to reduce the number of auxiliary devices, contributing to remove their weight and reduce CO<sub>2</sub> emissions even more.

$$E_{\text{released}}^{\text{Net}} > E_{\text{transport TES}} - E_{\text{transport Aux devices}} \quad (5.7)$$

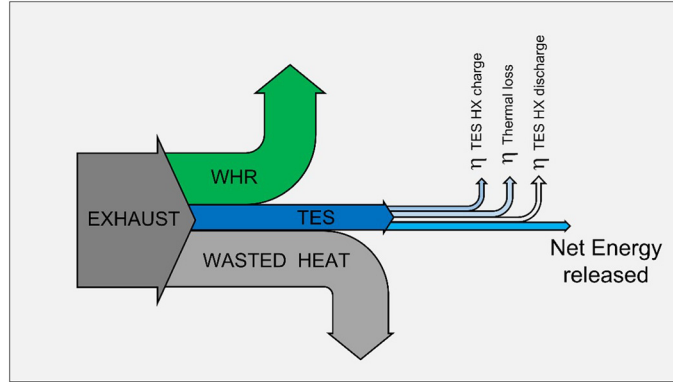

**Figure 5.22** Sankey diagram representing the general approach of the waste heat recovered from the exhaust gases of the engine.

The energy necessary to move the TES system and the auxiliary devices may be expressed in terms of kinetic energy by Eq. (5.8) and Eq. (5.9), respectively.

$$E_{\text{transport TES}} = \frac{1}{2} M_{\text{TES}} \cdot v_{\text{Ship}}^2 = \frac{1}{2} (M_{\text{heat exchanger}} + M_{\text{storage media}}) \cdot v_{\text{ship}}^2 \quad (5.8)$$

$$E_{\text{transport Aux devices}} = \frac{1}{2} M_{\text{Aux Dev}} \cdot v_{\text{ship}}^2 = \frac{1}{2} (M_{\text{engine}} + M_{\text{fuel}}) \cdot v_{\text{ship}}^2 \quad (5.9)$$

From Eq. (5.7), Eq. (5.8), and Eq. (5.9), and assuming the weight of the engine could be in a similar range of the weight of the tank or heat exchanger used in the TES system, it may be concluded that:

$$M_{\text{fuel}} > M_{\text{storage media}} \quad (5.10)$$

In other words, to release the same net energy, the energetic density of the storage media must be larger than the one of the fuel used in the vessel engines.

The net energy released by the TES facility may be evaluated as shown in Fig. 5.22, assuming the ship already integrates a WHR system, and the energy from the exhaust (or jackets) is partially not recovered. Then, the energy captured by the TES system is affected by the heat exchanger efficiency during charging and discharging periods, as well as its inherent thermal losses.

Eq. (5.11) mathematically expresses the terms already explained, which need to be analyzed and determined for each particular case, and they are directly related to the operation of the ship, the type of storage media selected, together with the type of heat exchanger and the insulation material properties and thickness.

Then, the energy density of the material must be as higher as possible to maximize the energy stored per unit of weight. For this end, the better candidates are the thermo-

chemical storage materials or phase change materials. The former are still under research or demonstration phase before to be applied at commercial scale; but the latter presents a relevant list of potential candidates.

$$E_{\text{released}}^{\text{Net}} = (E_{\text{eg}} - E_{\text{WHR}} - E_{\text{wasted}}) \cdot n_{\text{TES HX ch}} \cdot n_{\text{th loss}} \cdot n_{\text{TES HX dis}} \quad (5.11)$$

Energy efficiency measures are a priority in the near term to reduce the carbon intensity of maritime sector in the next years. Since 2017, IMO has been proposing policies to rapidly promote the adoption of cleaner technologies and fuels for oceangoing vessels. Some of the solutions are focused on technical aspects, like installing waste heat (or cold) recovery systems to retrofit the engines or provide part of the energy required on board for heating, cooling, seawater desalination or other purposes.

Until the date, only few attempts to justify the integration of TES systems in ships have been presented, and all of them are studied based on numerical analysis. In fact, the deployment of TES in maritime transport may be justified in a limited type of ships, like cruises, where even during hoteling (or staying on port) periods the thermal energy consumption is still remarkable.

In fact, TES was conceived to balance the mismatch between energy demand and production periods. Then, as shown in Fig. 5.15, ships spend a large amount of time on cruising operation, when the energy demand is stable and supplied by the main engines, and the waste heat or cold may be recovered and retrofitted to the engines or other auxiliary supplies.

The integration of a TES system in a ship presents some relevant drawbacks to overcome before their extended use on maritime applications, all of them related with the obvious need to transport the TES system in the ship: that requires a certain room to be dedicated to the TES which leads to a decrease on the load capacity of the vessel. Moreover, the need of the ancillary related with the TES like heat exchangers, connections to the waste heat or cold source and to the respective boiler or chiller makes the integration more complex in existing ships.

Another point to consider is that the TES system represents an added weight in the ship that penalties on extra energy consumption: understanding the amount of energy saved by the system must be larger than the energy required to move it is critical to avoid a potential increase on fuel consumption and CO<sub>2</sub> emissions.

Then, the need of a high energy density storage media that may be compared with existing fossil fuels, or even larger, is the main target to make viable the deployment TES systems in maritime sector. Summarizing, the integration of TES systems in vessels may a priori represent an advantage in terms of energy consumption and CO<sub>2</sub> emissions reduction, but the storage media and technologies currently available are still far to represent an effective solution on decreasing the environmental impact of maritime industry.

## References

- [1] A. Dinger, R. Martin, X. Mosquet, M. Rabl, D. Rizoulis, M. Russo, G. Sticher, Batteries for electric cars: challenges, opportunities, and the outlook to 2020, The Boston Consulting Group 7 (2010).
- [2] Corvus Energy, Corvus energy products, <https://corvusenergy.com/products/>, 2021. (Accessed 11 November 2021).
- [3] DNV-GL Technical, Reference for Li-ion Battery Explosion Risk and Fire Suppression, Report No.: 2019-1025, Rev. 04, Document No.: 1144K9G7-12, 2019.
- [4] DNV-GL, Dnv gl handbook for maritime and offshore battery systems, Report No.: 2016-1056, Rev. 01, Document No.: 15DJV2L-2, 2016.
- [5] DNV-GL, Rules for classification, ships – Part 6 Additional class notation, Chapter 2 Propulsion, power generation and auxiliary systems, 2020.
- [6] MAN Energy Solutions, Batteries on board ocean-going vessels, [Online], [https://www.man-es.com/docs/default-source/marine/tools/batteries-on-board-ocean-going-vessels.pdf?sfvrsn=deaa76b8\\_14,2020](https://www.man-es.com/docs/default-source/marine/tools/batteries-on-board-ocean-going-vessels.pdf?sfvrsn=deaa76b8_14,2020). (Accessed 1 February 2021).
- [7] UNCTAD, Review of maritime transport 2020, 2020.
- [8] MAN Energy Solutions, Propulsion of 14,000 teu container vessels, 2018.
- [9] Finnish Energy, Structure of the electricity networks, [https://energia.fi/en/energy\\_sector\\_in\\_finland/energy\\_networks/electricity\\_networks](https://energia.fi/en/energy_sector_in_finland/energy_networks/electricity_networks), 2021. (Accessed 29 October 2021).
- [10] V. Rantio, Onshore power supply case study – port of Helsinki, in: BPO Seminar on Onshore Power, 15th April 2015, 2015.
- [11] Panasonic, Specifications for NCR18650BF, 2021.
- [12] R. Geertsma, R. Negenborn, K. Visser, J. Hopman, Design and control of hybrid power and propulsion systems for smart ships: a review of developments, *Applied Energy* 194 (2017) 30–54.
- [13] J. Holtrop, G. Mennen, An approximate power prediction method, *International Shipbuilding Progress* 29 (1982) 166–170.
- [14] R.M. Isherwood, Wind resistance of merchant ships, *Transactions of Royal Institution of Naval Architects* 115 (1973) 327–338.
- [15] A. Ritari, J. Huotari, J. Halme, K. Tammi, Hybrid electric topology for short sea ships with high auxiliary power availability requirement, *Energy* 190 (2020) 116359.
- [16] J. Huotari, A. Ritari, J. Vepsäläinen, K. Tammi, Hybrid ship unit commitment with demand prediction and model predictive control, *Energies* 13 (2020) 4748.
- [17] MAN, Project guide – marine four-stroke diesel engine compliant with IMO tier II, [Online], <https://marine.man-es.com/four-stroke/project-guides/project-guides-download>, 2020. (Accessed 15 January 2021).
- [18] M. Sofiev, J.J. Winebrake, L. Johansson, E.W. Carr, M. Prank, J. Soares, J. Vira, R. Kouznetsov, J.-P. Jalkanen, J.J. Corbett, Cleaner fuels for ships provide public health benefits with climate tradeoffs, *Nature Communications* 9 (2018) 1–12.
- [19] Finnlines, Hybrid ro-ro vessels sail into a green future, <https://www.finnlines.com/company/news-stories/finnlines-news-22020/hybrid-ro-ro-vessels-sail-green-future>, 2020. (Accessed 6 August 2021).
- [20] A. Ritari, K. Spoof-Tuomi, J. Huotari, S. Niemi, K. Tammi, Emission abatement technology selection, routing and speed optimization of hybrid ships, *Journal of Marine Science and Engineering* 9 (2021).
- [21] M. Loponen, Application of energy storage systems for ice load management in ships, Master's thesis, Aalto University, School of Engineering, 2019.
- [22] E. Ovrum, T.F. Bergh, Modelling lithium-ion battery hybrid ship crane operation, *Applied Energy* 152 (2015) 162–172.
- [23] A. Gil, M. Medrano, I. Martorell, A. Lazaro, P. Dolado, B. Zalba, State of the art on high temperature thermal energy storage for power generation. Part 1 – concepts, materials and modellization, *Renewable & Sustainable Energy Reviews* (2010).
- [24] M. Liu, W. Saman, F. Bruno, Review on storage materials and thermal performance enhancement techniques for high temperature phase change thermal storage systems, *Renewable & Sustainable Energy Reviews* (2012).

- [25] K. N'Tsoukpoe, H. Liu, N. Le Pierrès, L. Luo, A review on long-term sorption solar energy storage, *Renewable & Sustainable Energy Reviews* 13 (2009) 2385–2396.
- [26] N. Yu, R. Wang, L. Wang, Sorption thermal storage for solar energy, *Progress in Energy and Combustion Science* 39 (2013) 489–514.
- [27] M. Medrano, A. Gil, I. Martorell, X. Potau, L. Cabeza, State of the art on high-temperature thermal energy storage for power generation. Part 2 – case studies, *Renewable & Sustainable Energy Reviews* (2010).
- [28] L. Yang, U. Villalobos, B. Akhmetov, A. Gil, J. Onn, A. Palacios, A comprehensive review on sub-zero temperature cold thermal energy storage materials, technologies, and applications: state of the art and recent developments, *Applied Energy* 288 (2021).
- [29] F. Baldi, C. Gabrieli, F. Melino, M. Bianchi, A preliminary study on the application of thermal storage to merchant ships, *Energy Procedia* 75 (2015) 2169–2174.
- [30] M. Manzan, A. Pezzi, Z.E. De, A. Freni, A. Frazzica, B. Vaglieco, Potential of thermal storage for hot potable water distribution in cruise ships, *Energy Procedia* 148 (2018) 1105–1112.
- [31] S. Yang, J. Ordonez, Cold thermal energy storage for reliable ship cooling under thermal cycling and cooling loss, in: *IEEE Electr. Sh. Technol. Symp. ESTS 2019*, 2019, pp. 67–72.
- [32] E. Baldasso, M. Mondejar, S. Mazzoni, A. Romagnoli, F. Haglind, Potential of liquefied natural gas cold energy recovery on board ships, *Journal of Cleaner Production* 271 (2020).
- [33] W. Lin, M. Huang, A. Gu, A seawater freeze desalination prototype system utilizing lng cold energy, *International Journal of Hydrogen Energy* (2017) 1–9.
- [34] H. Xing, S. Spence, H. Chen, A comprehensive review on countermeasures for CO<sub>2</sub> emissions from ships, *Renewable & Sustainable Energy Reviews* 134 (2020).