

# INNOVATION IN RENOVATION

OPTIMIZING INTERIOR INSULATION  
APPLICATION WORKFLOW

MASTER THESIS

EKTA KAPOOR





**INNOVATION IN RENOVATION**

*optimizing interior insulation application workflow*

**EKTA KAPOOR**

*Student number 4735293*

*1ST July 2019*

**MENTORS:**

**Ir. ERIC VAN DEN HAM**

**Dr.ing. THALEIA KONSTANTINOOU**

**BOARD OF EXAMINERS DELEGATE:**

**Drs. ANDRÉ MULDER**

# ACKNOWLEDGEMENTS

I am extremely grateful to my family, friends and colleagues for the constant motivation and support they offered throughout my thesis.

I want to thank my mentors Ir. Eric van den Ham and Dr.ing. Thaleia Konstantinou for their guidance and critiques which helped shape the outcome of the research. I am deeply grateful to Eric for having faith in me and motivating me at every roadblock I faced. Thaleia has immensely helped me by keeping a critical eye ensuring a clean and precise workflow.

I also want to thank my parents, Manoj Kapoor and Sunita Kapoor for calming me during stressed times and answering my late night distressed calls with positivity and encouragement. Thank you dad for being involved in every phase of my research and inspiring me. My brother Ajay deserved a special thanks for being supportive and pushing me to do better.

A huge gratitude to all my friends in India and Delft who have helped me at various stages in my project as well as been an emotional support.

Lastly, I want to express my gratitude to Marnix van der Wolk from FARO without whose support with the demonstration this research would not have been successful.

# TABLE OF CONTENTS

ABSTRACT.....	7
<b>01 INTRODUCTION.....</b>	<b>9</b>
1.1. Context.....	10
1.2. Energy efficiency in existing building.....	10
1.3. Protected buildings and Interior renovation .....	11
1.4. Problem statement.....	11
1.5. Focus and limitation.....	11
1.6. Research objective .....	12
1.7. Research methodology.....	12
<b>02 INTERIOR ENERGY RENOVATION.....</b>	<b>15</b>
2.1 Introduction.....	16
2.2 Interior renovation workflow.....	17
2.3 Challenges and Barriers.....	18
2.4 Workflow Optimization .....	19
<b>03 INSULATION MATERIAL .....</b>	<b>21</b>
3.1 Thermal insulation.....	22
3.2 Insulation of envelope : transparent V/s opaque.....	24
3.3 Common insulation material .....	25
3.4 Superinsulators .....	26
3.5 Material properties.....	27
3.6 Conclusion.....	36
<b>04 PROCESS INNOVATION .....</b>	<b>38</b>
4.1. Digital Data Capture .....	39
4.2. Processing.....	41
4.2.1 3D workspace.....	41
4.2.2 Layout.....	42
4.3. Virtual environment .....	42
4.4. Conclusion.....	43
<b>05 PRODUCT DESIGN.....</b>	<b>44</b>
5.1 Product design .....	45
5.2 Design development.....	46
5.3 Global solution.....	50

5.4	Production .....	52
5.5	Performance assessment .....	54
5.6	Conclusion .....	55
<b>06</b>	<b>DEMONSTRATION WORKFLOW .....</b>	<b>56</b>
6.1.	Demonstration room .....	57
6.2.	Measurement .....	58
6.3.	Digital Model .....	61
6.4.	Design layout .....	62
6.5.	Ornaments .....	67
6.6.	Connections .....	68
6.7.	Installation sequence .....	73
6.8.	Visualization .....	74
6.9.	Conclusion .....	76
<b>07</b>	<b>CONCLUSION .....</b>	<b>77</b>
7.1.	Sub- Research questions .....	78
7.2.	Main research question .....	80
7.3.	Future developments .....	81
<b>08</b>	<b>SUSTAINABILITY ASSESSMENT .....</b>	<b>82</b>
<b>09</b>	<b>REFERENCES .....</b>	<b>86</b>
<b>10</b>	<b>APPENDIX .....</b>	<b>93</b>



# ABSTRACT

In the times of growing attention towards renovation for energy efficiency in the built environment, the building stock particularly associated with heritage value deemed monumental or protected is currently exempted under the Dutch law to comply with the energy performance guidelines.

Limitations with regards to protecting the aesthetics of these heritage buildings make interventions for energy saving restricted to interior application. While it is necessary for these buildings to be more efficient, the process of interior energy renovation is complex in terms of financing, space, thermal performance and managing stakeholders.

This thesis researches into ways to simplify and streamline the process of interior renovation with a focus on application of thermal insulation to the envelope to reduce transmission losses. The present challenges are addressed by three interventions in the workflow of the renovation process starting with a shift to super insulation material for better performance and space saving. Digital data capture and processing create opportunity of an integrated process of digital design to production. Lastly prefabrication of insulation ensures reduction of onsite time.

The result is a globally adaptable approach towards an optimized renovation workflow that creates an synergy between energy efficiency, performance, production and preservation of the architectural heritage while keeping the occupants central.





# 01 INTRODUCTION

*This chapter addresses the importance for making existing homes more energy efficient to achieve global vision of sustainable development. The current scenario of renovation process and the problems that are associated with the process form the inspiration behind the research and thus a methodology is described to solve these challenges.*

## 1.1. Context

The building sector is amongst the biggest industries responsible for depleting the global resources estimated to use about “40% of global energy, 25% of global water, 40% of global resources, and emitting approximately 1/3 of GHG( greenhouse gas) emissions” (UNEP, 2016). Reducing the Co<sub>s</sub> emissions is one of the top priorities of the European Union member states. The national schemes and international agreements to fight against climate change has led to various measures being adopted in all sectors to reduce the impact on the environment. As per the energy performance for building directive of 2018, all new constructions should be nearly net zero energy by 2020 with smarter buildings that support automation and control. For the existing building, more money and support to renovate at least 3% of the stock each year will be provided.

To achieve this goal, the Dutch energy agreement for sustainable growth has set goals to invest in rental home insulations and an energy label for every home. There is a renovation target of 300,000 homes and improvement of existing residential buildings by two label classes (20/30% more energy efficient) by 2020. Rented buildings must have an average label B in social housing and minimal label C for 80% of private rental in 2020. With the introduction of Energy Performance Certificate (EPC) regulations, the Netherlands aims to further improve energy efficiency and reduce the carbon footprint. (“GBPN - Netherlands,” n.d.)

However, as per the current statistics, 70% of the existing homes have an energy performance label C or below out of which only 1% are renovated every year which is lower than the required rate of 3%. (“Energie label woningen | RVO.nl,” n.d.)

## 1.2. Energy efficiency in existing building

The recent years have seen an increase in initiatives and measures to improve the energy efficiency in existing buildings. However, a large percentage of the building stocks is made up of the existing buildings creating opportunities for improvement.

Energy efficiency in existing dwellings can be achieved by reducing energy demand and having renewable source of energy generation. Most common renovation technologies and practices include installing external/internal insulation and improving the airtightness of the transparent and opaque building envelope, roof retrofitting, installation of photovoltaic panels, installation of heat recovery and efficient HVAC systems, etc. (D'Oca et al., 2018). One of the key steps to reduce energy demand is to thermally insulate the buildings.

### **1.3. Protected buildings and Interior renovation**

Many of the houses in the Netherlands and Europe have associated heritage values that largely restrict any modification to the aesthetics of the buildings. Such homes with the provincial or municipal monument status are not obligated by law to have an energy label ("Energie label woningen | RVO.nl," n.d.). The lack of solutions and motivation typically results in higher energy consumption of these homes. The ambition of a transition to a sustainable society presents the challenge of preserving this heritage while improving the energy performance of the built environment.

The exterior facades of such buildings cannot be altered which means the traditional renovation strategies are not applicable. Energy performance enhancing measures and strategies thereby only can be applied in the wall cavities space or on the interior sides of the external surfaces.

### **1.4. Problem statement**

The renovation process of protected buildings is complex due to various factors at play which influence the outcome of the renovation such as different building typologies, existing conditions buildings, occupants, location, bye-laws and finances. Furthermore, there are a lot of stakeholders involved such as the housing associations, contractors, manufacturers, municipality and of course the building owners that make coordination difficult and might lead to a conflict of interest.

The actual process of renovation is also faced with problems such as :

- a) Occupant discomfort with the disruption of daily life due to the onsite works
- b) The time taken to renovate directly corresponds to labour cost
- c) Adding insulation material results in a significant increase in wall thickness
- d) Every house, every room, every décor may be different which adds to the increased cost of personalisation
- e) Lack of awareness and unwillingness to renovate for energy reduction without tangible benefits.

### **1.5. Focus and limitation**

Amongst the different typologies of existing buildings with a protected status, the residential buildings in the Netherlands are chosen for this research. Residential properties that have plot line restrictions for extension can also be included in the target group. To achieve energy efficiency standards, such buildings need to undergo interior intervention.

The study focuses on the energy demand reduction by reducing heat transfer through the external envelope by insulating the external envelope from the interior. The window and glass parts of the envelope are exempted from this study focusing only on the adding solutions to the walls.

## 1.6. Research objective

### Aim

This thesis aims to create a model workflow for the renovation process of existing protected buildings by researching into super insulation material and technological advancements to aid production and assembly.

### Research Question

*How can the advancements in insulation material and technologies help to optimize the energy renovation process of interior envelope?*

### Sub research -Question

In the context of existing building renovation, the following questions were established.

*What are the current practices for energy renovation process in housing sector?*

*What are the challenges and barriers in practice with regards to insulating protected facade buildings?*

To aid the optimization of the renovation workflow, the following questions are essential,

*What are the advancements in insulation material and what are their advantages over conventional material?*

*What are the technological advancements that can aid renovation process?*

## 1.7. Research methodology

This thesis project is based on a design through research methodology where a study of current renovation strategies is used to identify shortcomings and propose solutions. To answer the research questions the research progresses in five phases;

### **Phase 1- Foundation**

The first phase undertakes the literature study regarding energy efficient renovations with special focus on interior insulation application strategies in heritage/protected buildings. The current practices in the complete workflow will be analysed. Various research projects covering the topics of energy renovation will be studied for case studies and examples to better understand current practices. This phase results in the formation of the problem, statement and subsequently, the research question.

### **Phase 2- Material**

Starting with the literature research about new materials for insulation, this stand-alone phase aims to create a collective data set for new age insulation material where each material will be analysed for its performance, occupant impact, environmental impacts, advantages and dis-advantages of use.

### **Phase 3- Digitalization**

The third phase researches into ways to make the renovation workflow digital. Data capture techniques with 3D laser scanning will be explored which can potentially reduce errors associated with manual measuring work. By extension, data processing software with the ability of digital space model and optimize layouts, will be explored to reduce wastage and for precise construction. This phase results in product information that can be used for production.

### **Phase 4- Product design.**

Building upon the previous phase, the possibility of industrialization with prefabrication is analysed. The product design phase will focus on how the information from the digital design can make insulation material better integrated, adaptable and suitable to for application to the interior surfaces. The output of this phase leads to a factory made product that can be delivered on site and fixed.

### **Phase 5- Validation**

The last phase is validation where the proposed workflow will be tested in a case study building. The demonstration will provide insight regarding the feasibility of the process with real life challenges and deviations from the model workflow that might occur. Computer simulated analysis will be conducted to assess performance.

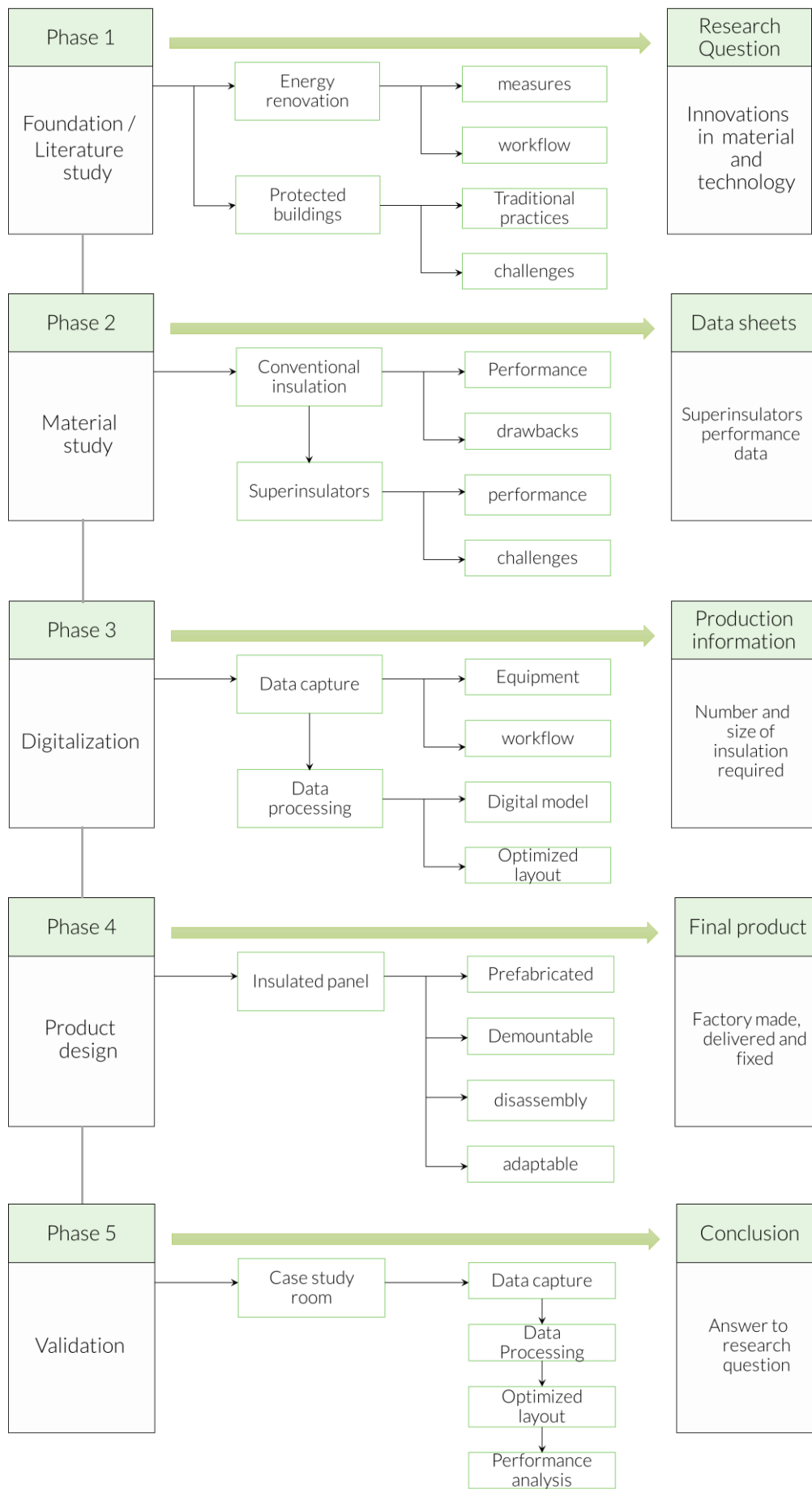

## **02** INTERIOR ENERGY RENOVATION

*The traditional practices engaged for interior insulation application result in a workflow that is tedious, slow and results in high discomfort to the occupants. An optimised workflow is proposed that should reduce the time spent on site by taking digitalising the work and taking the process off-site.*

## 2.1 Introduction

The energy refurbishment process can be classified into two categories depending on their focus area – construction and building services.

The construction refurbishment looks into the following:

- Insulation of opaque envelope
- Upgradation of transparent envelope
- Improvement of summer heat protection
- Improved use of daylight
- Integration of natural ventilation

The building services concerns the following

- Replacement of old boilers
- Integration of solar water heat and PV energy generation
- Upgradation of lighting systems to an efficient one
- Change of old appliance to an energy star labelled

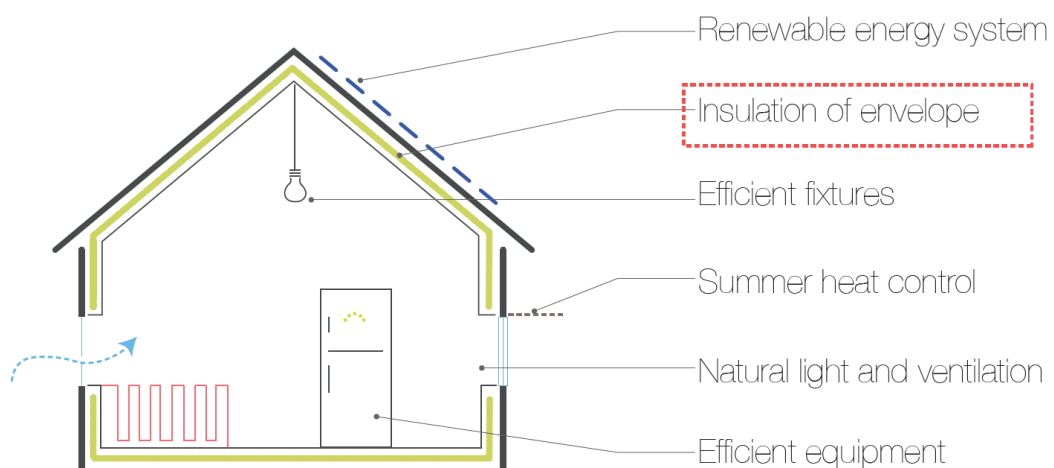

*Figure 1 representative strategies to improve energy efficiency in a home*

Figure 1 highlights the strategies that can be implemented to make a home more energy efficient. The envelope of a building is a barrier between the indoor and outdoor environment and also is responsible for exchange of heat between them. In the chronological order of undertaking, reduction of the heat transmission is the first step to take towards energy efficiency.

The optimum and commonly adopted solution for insulating the envelope is to insulate the exterior surfaces. Interior insulation application systems are associated with a number of disadvantages including non-elimination of thermal bridges, reduction of indoor space, transformation of interiors and high condensation risk. (Odgaard T., Bjarløv SP., Rode C., & Vesterlørkke M., 2015)



## 2.2 Interior renovation workflow

In cases where the interior insulation is applied, the process of interior renovation is cumbersome and requires a lot of onsite work. Figure 2 highlights the typical workflow followed in the process of application of insulation for interior renovations.

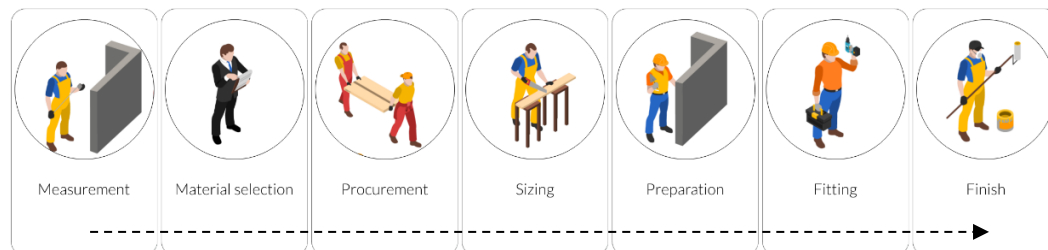

Figure 2 Typical workflow of insulation application for interior renovation

Measurement- the first step in the process is to identify the wall which need insulation, measure and record the dimensions of the surfaces.

Choice of insulation- the type of insulation is selected based on the existing conditions and space availability.

Procurement- purchase the material and gather specialised tools that may be used for cutting and application

Sizing- In case of a rigid insulation, cut the material to appropriate size in an open and ventilated space as cutting fibrous material can release smaller particles into the surrounding.

Preparation- Before the insulation can be applied to the wall, the surfaces should be cleaned of any dust and levelled in case of uneven surfaces. Next, prepare the support system such as wooden strips for fitting the insulation.

Fixing- the insulation is fitted into the support system and fastened to the wall with mechanical fasteners or special adhesives. Spray-in insulations can be directly sprayed within the supports.

Finishing- depending on the material and existing construction, a vapour barrier will need to be attached before applying the final finish of cement render or interior wall boards.

Ventilation- spray based insulations typically require 24 hours of ventilation before reuse.



Figure 3 application of batt insulation and spray-in insulation. Retrieved from <https://www.wikihow.com/Insulate-Walls>

### 2.3 Challenges and Barriers

Existing buildings set limits to what extent the existing technical solutions can be implemented. This limitation is more relevant where the architectural value of the building needs to be conserved making the retrofit process more challenging. The bottlenecks preventing a smooth renovation process are discussed below.

Stakeholders : the division of tasks and responsibilities between the different stakeholders such as housing associations, contractors, architect, municipality and occupants, leads to different aspirations and goals from the renovation process. (Transition Zero, n.d.)

Preparedness: The interior insulation often time requires the internal surfaces to be stripped off of the surface finishes. This also means taking out heating equipment, various wall and ceiling fixtures and fixed furniture which leads to temporary occupant relocation for the duration of work and is a labour intensive work making it challenging for homeowners. Only once this process is done, the measuring system can start.

Condensation and Mould: Interior insulations are challenging to implement compared to external insulation. In terms of the building physics, in case of interiors, the dewpoint is located between the warm insulation layer and the cold external wall. Dewpoint is the term for a temperature threshold below which water vapour is precipitated which presents the risk of moisture condensation and mould development(“Installation practice with interior insulation,” n.d.; van der Linden, Kuijpers-Van Gaalen, & Zeegers, 2018)

Space: In residential buildings using traditional insulating materials such as mineral wool or cellular foams implies insulating layer thickness of 15 to 20 cm. (“Superinsulating materials,” 2014) suggesting a significant decrease in the floor area. To achieve the required thermal performance, a thicker section of insulation would be used.

Discomfort: The process of application of insulation is extensive on time and labour. From measuring until the finishing, the job is provides disruption to the daily life. Some insulation material require a day of ventilation before the space can be inhabited leaving the occupant out of the buildings.

## 2.4 Workflow Optimization

The occupants are the most important stakeholder in the renovation process. Three areas of improvement have been identified to different options to overcome the shortcomings of the existing challenges in a bid to make interior renovations more acceptable to the people.

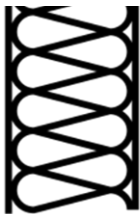

Material – The insulation material is the key element for the renovation process. There are a lot of option that are commercially available. Their key performance indicator is the thermal conductivity. A better performance indicates higher thickness. But there exist superinsulation material that have extremely low thermal conductivity values and result in slimmer sections which ultimately result in space saving.



Process innovation - replacing the need of manual labour for measurement purposes, the process innovation suggests digital data capture and processing technique for precise and error free manufacturing. Technologies such as laser scanning can efficiently replicate actual conditions in digital 3d workspace. In the digital work environment, simulations and tests can be carried out for evaluation.



Product design- Fabrication in a factory has been demonstrated to be more accurate, faster, and more secure than fabrication on site as is done in current renovations practices. Fewer builders are required onsite and the effective time on site is the assembly time. In conjunction with process innovation it leads to lesser errors in manufacturing.

Applied together, these three solutions can effectively improve thermal performance, save floor space, reduce the number of parties involved, reduce on-site time for measuring and workmanship and avoid nuisance to the occupants.

The suggested workflow essentially takes task out of the site and brings in the final product as illustrated in figure 4 below :

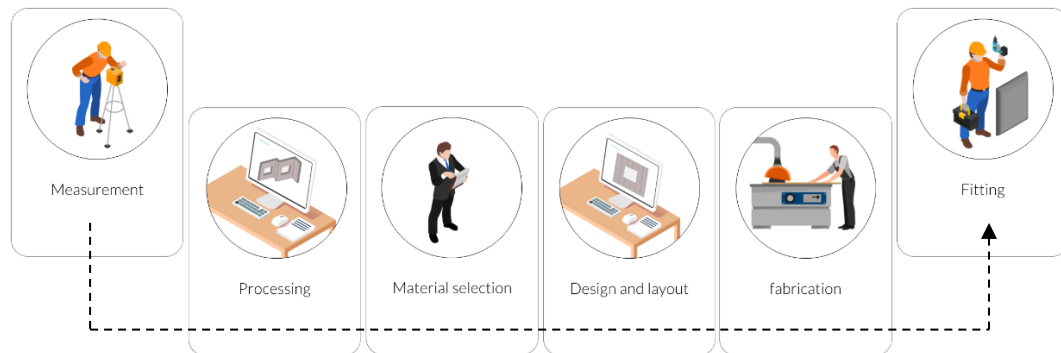

Figure 4 Proposed workflow that limits the interference on site

The key steps followed here are:

Measurement- using a laser scanning equipment for an accurate measurement.

Processing- the captured data from the laser scanner is processed to create 3D models in the digital workspace.

Choice of insulation- from a matrix of properties of super insulating material.

Design and layout- in the digital environment find the best layout for the chosen insulation material.

Prefabrication- the exact number and size of the insulation is sent to the production factory where the insulation is prefabricated as a sandwich module finished with the desired wall finish.

Assembly- The ready and finished product is brought to site to be fixed.

## 03 INSULATION MATERIAL

*With the thermal performance of envelopes becoming more stringent, the commonly used insulation require a thicker section of the material to meet these requirement resulting in a significant loss of floor space in interiors. Superinsulators are material with substantially higher thermal resistance such that they require almost 1/5<sup>th</sup> of the space required by common material.*

### 3.1 Thermal insulation

The measures to improve the energy performance of an existing building include reducing the heat transfer through envelope, improving daylight and natural ventilation, upgrading the lighting and HVAC equipment and meet the energy demand with inclusion of renewable energy generation sources. The primary step however is to restrict the heat transfer and infiltration between the building interiors and the outside making it crucial to understand the heat exchange process.

A well-insulated building reduces the heat transfer between the interior surfaces and the outdoors. "Insulation extends the lifespan of the building" (Boži, 2015) by minimizing risk of condensation and subsequent corrosion or mould growth which in turn results in an improved indoor climate.

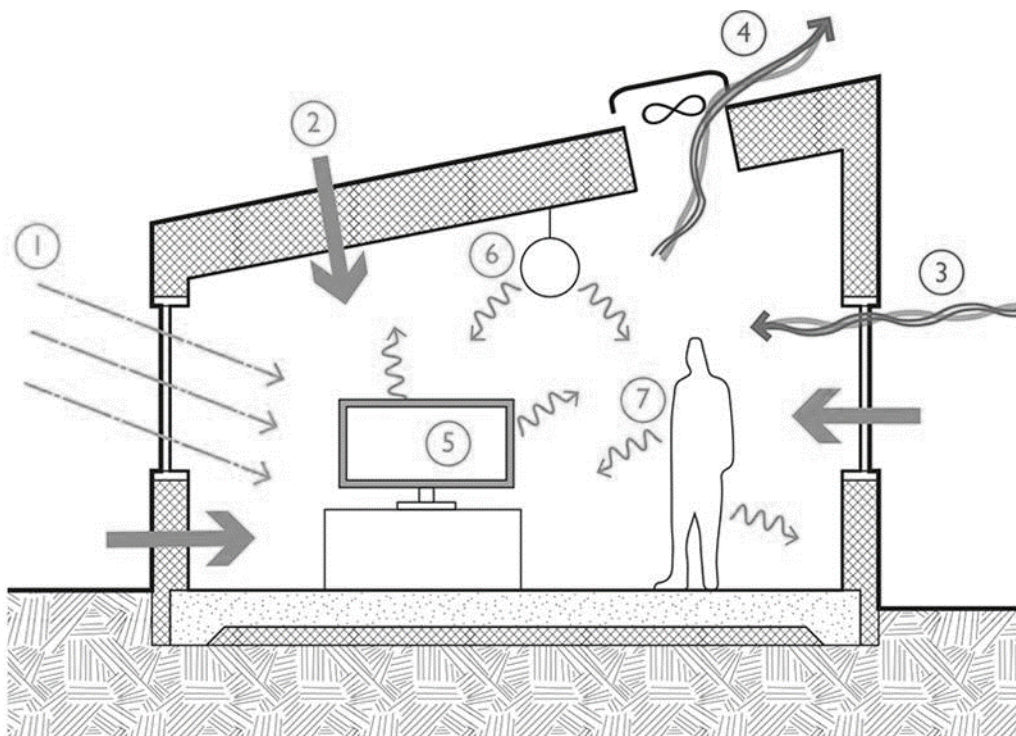

Figure 5 Heat balance in a room. Legend: 1. Solar gain 2. Transmission 3. Infiltration 4. Ventilation 5. Appliances 6. Lighting 7. People . Retrieved from <https://sefaira.com/uncategorized/recap-of-master-class-03-building-science-101/>

The heat balance equation can be expressed as

$$Q_{\text{solar}} + Q_{\text{transmission}} + Q_{\text{infiltration}} + Q_{\text{ventilation}} + Q_{\text{internal}} = 0 \quad [\text{eq. 1}]$$

Heat transfer through transmission ( $Q_{\text{transmission}}$ ) is defined by the following equation:

$$Q_{\text{transmission}} = U \cdot A \cdot (t_e - T_i) \quad [\text{eq. 2}]$$

Where,

$U$  = thermal transmittance of the wall [ $\text{W}/(\text{m}^2 \cdot \text{K})$ ]

$A$  = area of the wall [ $\text{m}^2$ ]

$T_e$  = outside temperature [ $^{\circ}\text{C}$  or  $\text{K}$ ]

$T_i$  = inside temperature [ $^{\circ}\text{C}$  or  $\text{K}$ ]

From the above equation, the only variable that can change for an existing building is the  $U$ -value. This can be done by improving the insulation properties of the opaque and transparent envelope of the building by decreasing the thermal conductivity or increasing the thickness of construction.

$$U = \lambda/d = 1/R \quad [\text{eq. 3}]$$

Where,

$d$  = thickness of wall [ $\text{m}$ ]

$\lambda$  = thermal conductivity [ $\text{W}/(\text{m} \cdot \text{K})$ ] is the rate at which heat passes through a square meter of surface area of the material with 1 Kelvin temperature change.

$R$  = thermal resistance of the wall [ $(\text{m}^2 \cdot \text{K})/\text{W}$ ] is the construction's ability to prevent the transfer of heat through a given thickness.

The total resistance ( $R$ ) of the wall is the sum of the resistance of each layer of construction. (van der Linden et al., 2018)

$$R = R_{m1} + R_{m2} + R_{m3} + \dots R_{mn}$$

Where,

$R_{m1}, R_{m2}, R_{m3}, \dots R_{mn}$  = thermal resistance of each layer in  $\text{m}^2 \cdot \text{K}/\text{W}$

In a multi-layer construction, the heat transfers from one surface to the other. Heat transfer also takes place between the indoor surface and indoor air as well as between the outer surface and outdoor air. Therefore, these surface resistance should be added to the resistance of layers to achieve the total thermal resistance.

$$R = R_{si} + R_{m1} + R_{m2} + R_{m3} + \dots R_{mn} + R_{se} \quad [\text{eq. 4}]$$

Where,

$R_{si}$  = heat resistance of indoor surface [ $\text{m}^2 \cdot \text{K}/\text{W}$ ]

$R_{se}$  = heat resistance of outside surface [ $\text{m}^2 \cdot \text{K}/\text{W}$ ]

Greater the R value or lower the U-value indicates a better thermally performing material. The efficiency of the insulation material is directly proportional to its thickness and thermal conductivity.

### 3.2 Insulation of envelope : transparent V/s opaque

Heat transmission occurs through the path of least resistance. In an envelope these are generally the window area as glass has a much lower thermal resistance compared to the wall construction. This difference is significantly higher in case the windows have a single glazing. In such cases the first step is to replace the glazing to at least a double glazing. Depending on the percentage of glazed area with respect to the wall area, the impact of insulating the wall construction can vary.

To understand the effects of insulating walls and upgrading to better performance, a model room was simulated under different conditions for the heating energy demand in the Netherlands. Refer Appendix A for workflow.

In the base case, the model room is an 18 m<sup>2</sup> room with one external façade (west facing) and 3 internal walls. Only the external wall is considered for the heat exchange while all other surfaces are made adiabatic. The wall construction of the external façade is 260mm brick masonry with 19mm gypsum plaster. The wall has a single pane window occupying 60% of the wall surface.

At 60% Window to wall ratio, The room requires 130kWh/m<sup>2</sup> annual demand for heating energy.

By changing the glass to a double glazing with a U-value of 2.8 W/m<sup>2</sup>K (from 5.8 W/m<sup>2</sup>K for single glazing), the heating energy demand drops by 27% to 94.5 kWh/m<sup>2</sup>.

To the above configuration, adding an insulation with a U-value of 0.3 W.m<sup>2</sup>K, can further reduce the heating energy demand by 35% to 61 kWh/m<sup>2</sup>

The effect of adding insulation is more prominent in cases where the window percentage is lower than 80%.



	Thermal load (kwh/m <sup>2</sup> )	Heating energy (kwh/m <sup>2</sup> )	Heat reduction
At 60 % WWR			
Uninsulated wall with single glazing	140.13	129.73	
Uninsulated wall with double glazing	104.57	94.54	↓ 35.19
Insulated wall with double glazing	71.4	61.13	↓ 33.41
At 40% WWR			
Insulated wall with double glazing	62.00	54.00	
At 80% WWR			
Insulated wall with double glazing	81.29	68.67	

Table 1 Heating energy reduction with respect to glazing ratio simulated in a shoebox model

### 3.3 Common insulation material

Insulation of interior spaces is conventionally found in the form of either spray insulation type, a rigid board or flexible blanket that can be glued or mechanically fastened to an existing wall.

Commonly used material include Glass wool, Rock wool, Expanded perlite, Exfoliated vermiculite, Expanded Polystyrene (XPS), Polyurethane rigid foam (PUR), Phenolic foam, Wood wool, Cellulose fibres, Hemp and other organic insulations.

Figure 6 shows the thermal conductivity value of different insulation material. The common material have a significantly higher value. With the baseline requirement for the envelope's thermal performance becoming more stringent, the traditional material will need a thicker layer of insulation to meet the criteria. (Boži, 2015) A thicker layer of insulation in the interior means a decrease in the usable floor area and complex connections between wall and window frames, skirting, etc. elements. A thicker section also suggests more stress on the raw material sources for production and consequently an increase in the energy consumption.

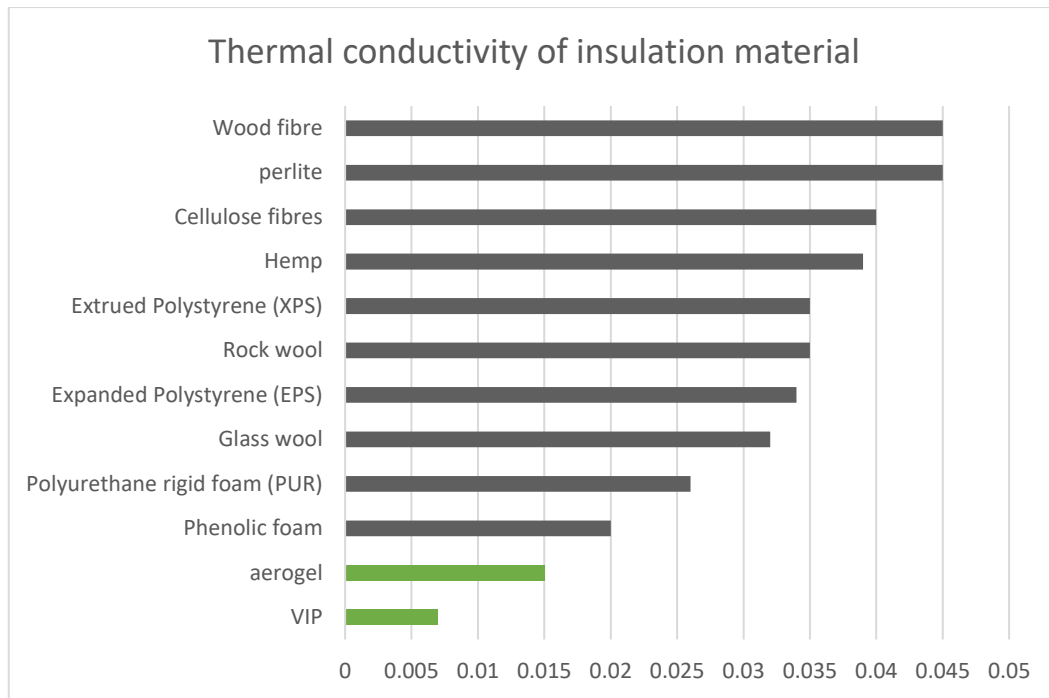

Figure 6 The thermal conductivity value of different insulation material

### 3.4 Superinsulators

Thermal insulation property of traditional materials has a play-off between the improvement of insulation value and the wall section thickness which directly reflects in reduced floor space. Ideally a very low U-value could be achieved with a much thicker multi-layered wall construction (Elmer, Shatat, Tetlow, & Riffat, 2015)

Superinsulators are a classification of insulation material that are developed to reduce the thickness of the insulating layer without compromising on the thermal performance. Aerogel and Vacuum Insulation panel are two material that fall under the category of high performance superinsulators.

In comparison to conventional material, these material provide the same thermal performance for a fraction of thickness. The figure 7 below highlights the different thickness of insulation required to meet a U-value of 0.3 W/m<sup>2</sup>K when applied to an existing brick masonry wall.

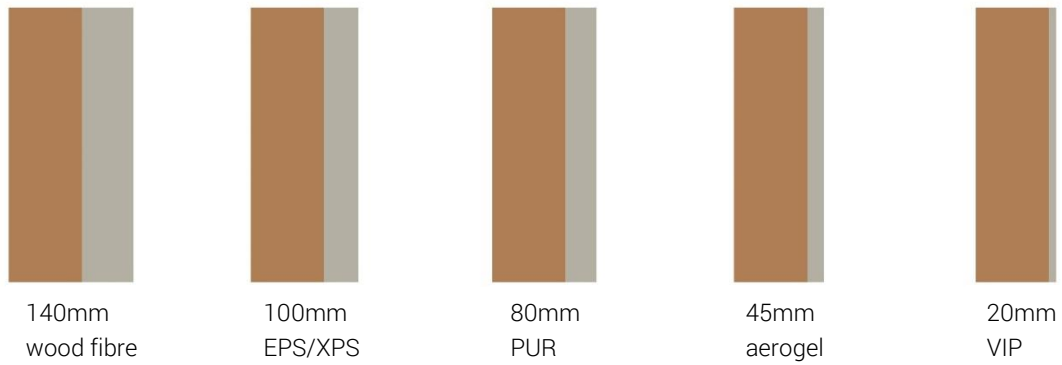

Figure 7 thickness of different insulation with respect to a U-value of 0.3 W/m<sup>2</sup>K

Quenard (2013) explains that the traditional insulation material cannot reach a lower thermal conductivity value due to the fact that they “rely on still air embedded in cavities, pores or cells to prevent any convection.” For improved performance, he suggests:

- Removing the gas by creating vacuum conditions as in case of Vacuum insulation panels;
- Changing the gas by replacing the air by an inert gas like krypton as in case of double glazed windows;
- Or trapping air in tiny pores with nano-porous material to reduce mean free path for energy transfer between molecules as in case of Aerogels.

### 3.5 Material properties

In the refrigeration and space industries, vacuum insulation panel (VIP's) and aerogels have been used for many years but only recently are being recognized by the building industry. The limitation for a wide scale adoption of these material can be attributed to their high cost. The section below discusses the two superinsulation material on the parameters of:

- a) Physical form
- b) Area of application
- c) Thermal performance
- d) Fire resistance
- e) Vapour permeability
- f) Average life and end-of-life
- g) Challenges

Refer Appendix B for a Cumulative matrix comparing these properties for all super insulator material options.

### 3.5.1. Vacuum insulation panel

Vacuum Insulation panels are super insulation that have a highly porous rigid core, generally of fumed silica, and wrapped in an gas-tight envelope from which air has been evacuated. ("What are Vacuum Insulation Panels?," n.d.) These rigid panels 10mm to 50mm thick and commercially available in sizes of 1000mm/ 500 mm x 600mm. They are suitable for use on exterior walls, interior walls, cavity space, floors an compact roofs, door and window reveals.

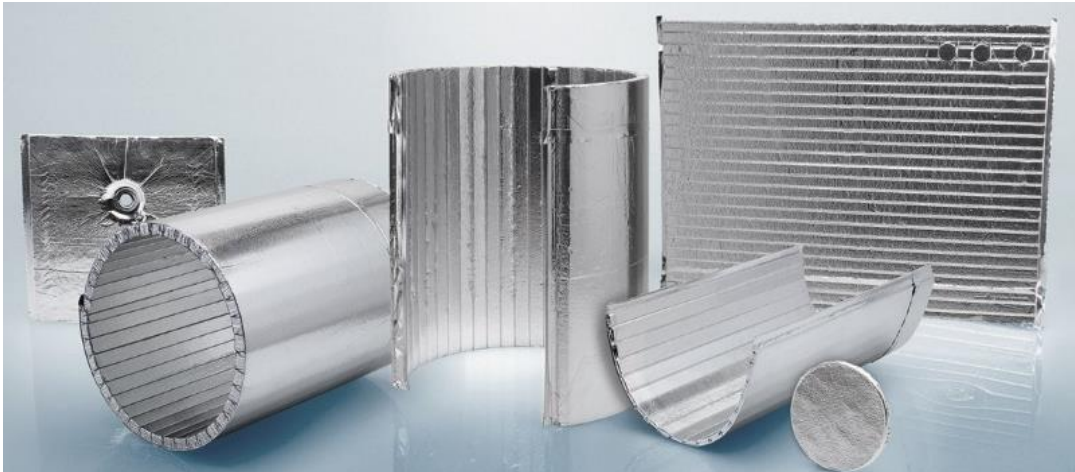

Figure 8 Vacuum Insulation panel shapes and sizes [digital image] Retrieved from <https://vipa-international.org/>

### Performance

VIP's have the lowest thermal conductivity value of 0.004W/mK but can go up to 0.007 W/mK due to aging and loss of vacuum. (VA-Q-TEC, 2018). The core material is non-combustible (fire class A) but the polymer foil barrier is inflammable. The product is approved for general construction purposes.

The product is impermeable to air or moisture which makes it important to have sealed connections barring any transfer. The product was simulated for its moisture and temperature performance using Ubakus.de – an online software. The boundary conditions were set with 20°C inside and -5°C outside air temperature. A wall construction of 260mm brick wall was simulated with 20mm thick VIP finished with 10mm particle board.

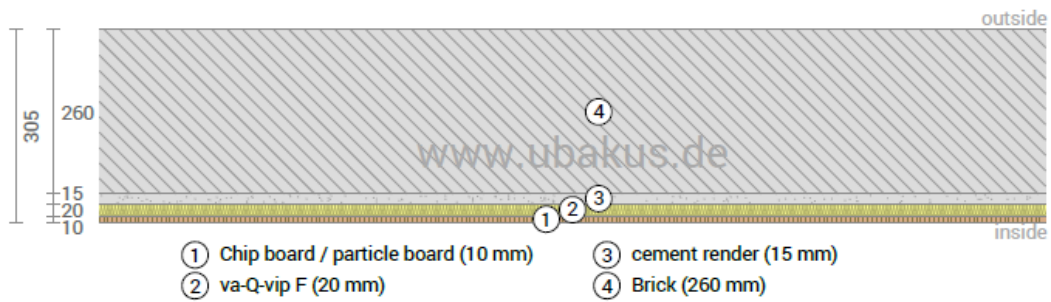

Figure 9 construction assembly for simulation. Visualization from simulation website [www.ubakus.de](http://www.ubakus.de)

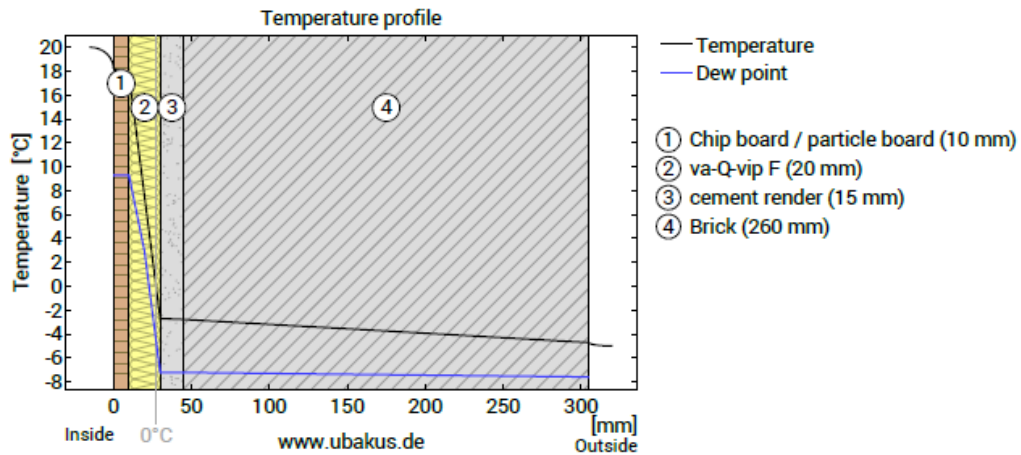

Figure 10 The temperature profile through the construction managing to be above the dew point threshold value. Visualization from simulation website [www.ubakus.de](http://www.ubakus.de)

The dew-point indicates the temperature, at which water vapour condensates. As long as the temperature of the component is everywhere above the dew-point temperature, no condensation occurs. If the curves have contact, condensation occurs at the corresponding position

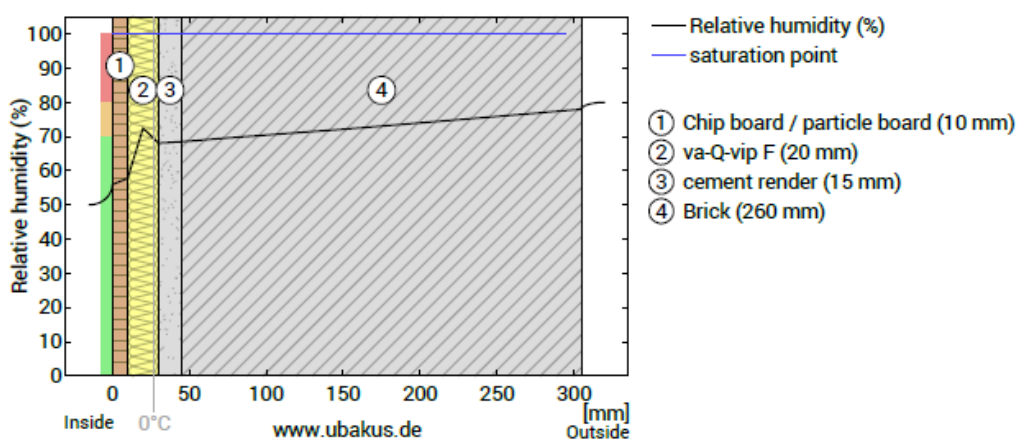

Figure 11 Profile of the relative humidity value across the section. Visualization from simulation website [www.ubakus.de](http://www.ubakus.de)

The temperature of the inside surface is 18.2°C leading to a relative humidity on the surface of 56%. Mould formation is not expected under these conditions. The insulation thus does not require any other form of vapour protection.

## Application

The most common fixing method for VIP include friction fitting with foam based sealer or with furring strips. Figures 12 (i)(ii)(iii) show different techniques used in practice.



Figure 12 (i) VIP fixing with aluminium channels finished with OSB board. Retrieved from <https://www.kevothermal.eu/applications/construction/internal-wall>

(ii) VIP fixing with furring strips. Retrieved from <https://www.hirecentres.com/content/78-the-Most-Energy-Efficient-Materials-from-which-to-Build-a-House>

(iii) VIP fixing with XPS foam strips. Retrieved from <https://www.kevothermal.eu/applications/construction/external-wall>

Once in place, the insulation needs to be finished with tough impact material such as OSB boards or mesh reinforced plaster to keep the panels protected.

## Sustainability

The VIP's have a life expectancy of 25 years. Post that the thermal performance will decrease with loss of vacuum. This leads to a more frequent need of insulation replacement.

At the end of life, the core material of fumed silica can be separated, broken down and then be completely recycled. However it is more complex to separate the thin films of PE and aluminium that form the gas tight envelope and require specialized recycling methods. The current trend is to send to landfills where the inert nature does not harm the environment but definitely adds to the non-degradable waste

## Challenges

Handling of VIP needs special care as the foil envelope is delicate and can be easily damaged during transport or fixing. Additionally, the panels have a production tolerance of -3mm to +5mm which leads to addition of filler insulation ( PU foam) to fill in the gaps.

### 3.5.2. Aerogel

Aerogels are porous solid material that have extreme low densities with air forming 95-99% of the volume. Aerogels are fragile in their natural form and mixed with fibres to form aerogel blankets or replace a percentage of cement to form insulating plaster and concretes.

Aerogel blankets are available in 5mm or 10mm thickness as flexible blankets in the 10 meter rolls that are 1470mm wide. The aerogel component of Spaceloft® is synthetic amorphous (non-crystalline) silica with PET/glass fibre and additives (aspen aerogels, n.d.)

The boards are basically aerogel blanket that come finished with Magnesium oxide boards. These are available in the size of 2400mm x 1000mm rigid board. They are suitable for use on exterior walls, interior walls, cavity space, floors and compact roofs, door and window reveals

Aerogel plasters are not restricted by shape or size of the surface. Available as dry premix with cement, the render can be applied to the required thickness

Aerogels granules are 1mm to 5mm in size and can be loose filled in any container. Most commonly used in windows or skylight due to the high light transmission value.



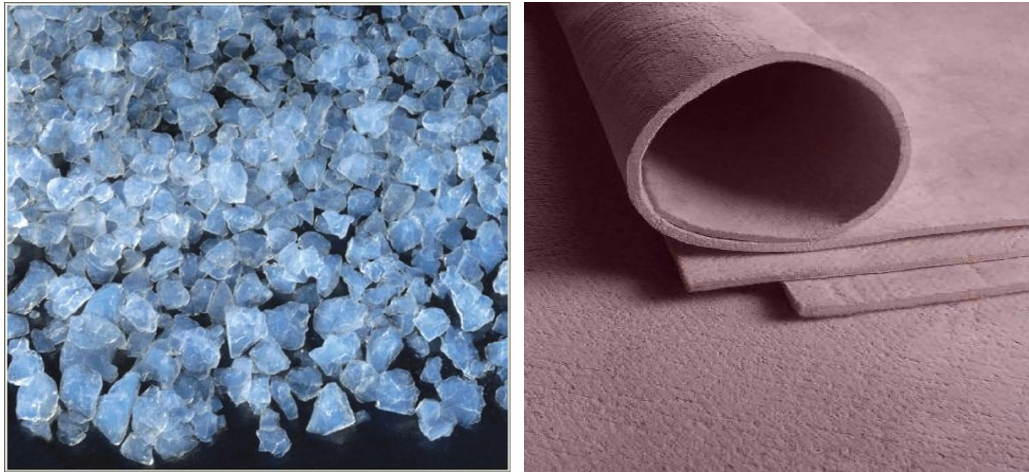

Figure 13 (i) aerogel granules , retrieved from <https://www.powermag.com/aerogel-coating-for-surface-insulation>

(ii) aerogel blanket insulation , retrieved from <https://sa.rsdelivers.com/product/rs-pro/mbl-10/aerogel-miroporous-blanket-thermal-insulation/1034078>



Figure 13 (iii) aerogel plaster, retrieved from <https://www.nanowerk.com/news/newsid=19100.php>

(iv) aerogel board, retrieved from <https://www.proctorgroup.com/products/spacetherm>

## Performance

Aerogel based products have thermal conductivity values ranging from 0.015 W/mK for aerogel blankets, 0.016 for aerogel boards, 0.019 for loose granules and 0.028 W/mK for aerogel plaster render depending on the percentage of aerogel in the components. All aerogel based products are classified C-s1,d0 i.e difficult to ignite, no/hardly smoke and no flaming droplets. (aspen aerogels, n.d.)

Aerogel is hydrophobic in nature and the products are water vapour permeable. The 4 aerogel based products were simulated for their moisture and temperature performance using Ubakus.de – an online software. The boundary conditions were



set with 20°C inside and -5°C outside air temperature. A wall construction of 260mm brick wall was simulated with 20mm thick different insulations finished with 10mm particle board.

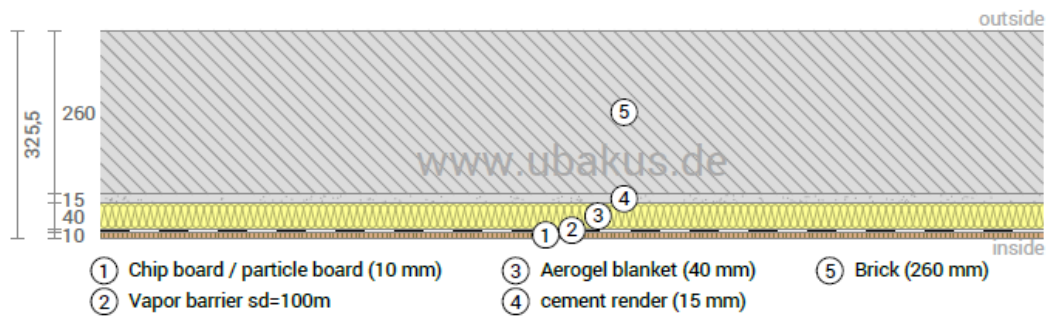

Figure 14 construction assembly for simulation with 40mm aerogel blankets. Visualization from simulation website [www.ubakus.de](http://www.ubakus.de)

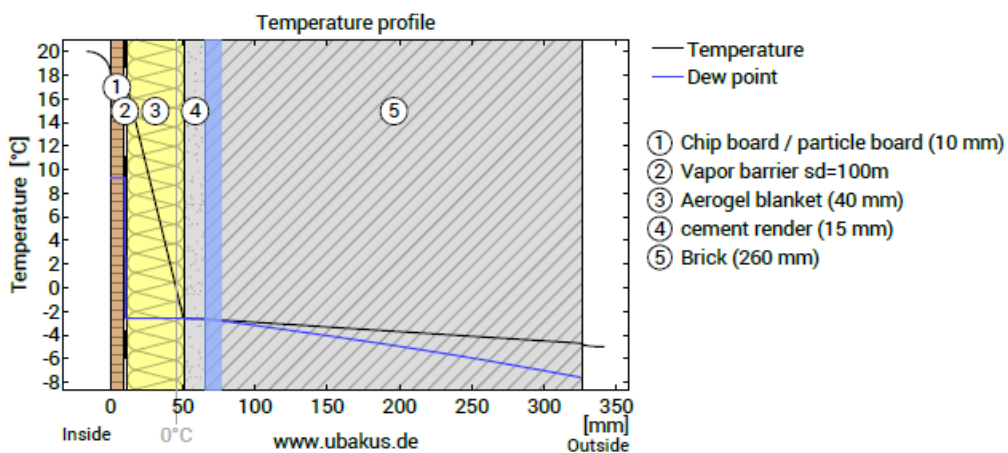
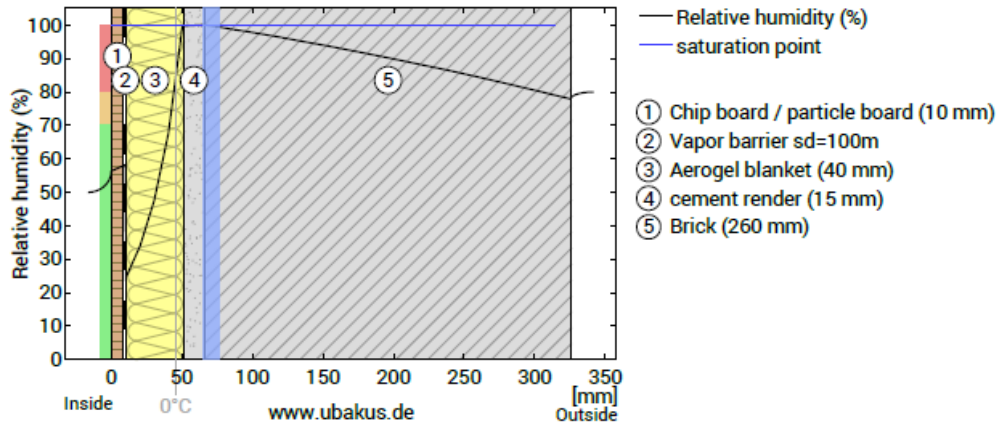

Figure 15 The temperature profile through the construction managing to be above the dew point threshold value. Visualization from simulation website [www.ubakus.de](http://www.ubakus.de)

The temperature profile across the construction is above the dew point profile and thus no condensation occurs. A vapor barrier is extremely important to use with aerogel products. Without this layer, there is 4.0 kg of condensation water per square meter which would take approximately 124 summer days to dry and result in mould growth. The permitted limit is 90 days.



The temperature of the inside surface is 18,1 °C leading to a relative humidity on the surface of 56%.Mould formation is not expected under these conditions.

### Application

The most common fixing method for aerogels include adhesive with mechanical fasteners drilled through the board material. The grains can be loose filled or mixed with an adhesive to retain form. The plaster is simply sprayed on the surface.

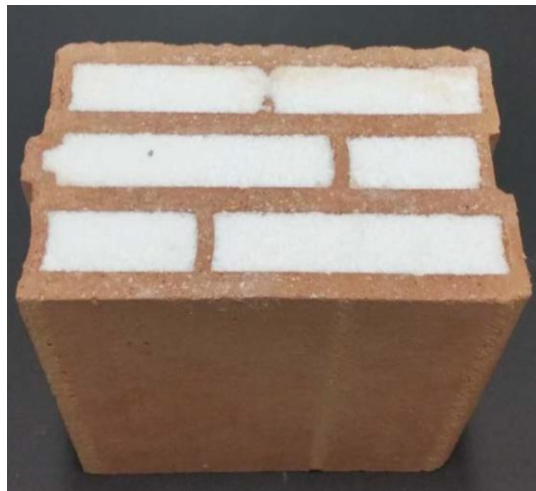

*Figure 16 (i) aerogel blanket glued to walls. Retrieved from <https://www.engineshed.scot/building-advice/common-problems/how-to-insulate-stone-walls/>*

*(ii) Aerogel granules in cavity infill. Retrieved from <http://www.aerogel.org/community/aerobrick-a-novel-aerogel-filled-insulating-brick/>*

*(iii) Aerogel plaster spray. Retrieved from <https://www.eurekalert.org/multimedia/pub/46731.php>*

Aerogel blankets and boards can be finished with tough impact layer such as gypsum, wood fibre board, calcium silicate board, cement fibre board etc. or direct plaster of lime, gypsum, clay, or polymer modified coating on a reinforcing mesh. The plaster requires a reinforcing mesh before the final render (mineral based) can be applied and then painted for finish.

### **Sustainability**

Aerogel products have a life expectancy of about 50 years. At the end of product life, aerogel blankets can be separated into fibre and aerogel from which the silica components can be composed into new insulation.

Aerogel plaster have a shorter life at 20 years and it is more difficult to separate aerogel grains from the plaster mix. As a result, the plaster can only be broken into smaller pieces and be used as insulated infills.

The loose grains can simply be extracted and reused in another application.

### **Challenges**

the most critical element with aerogels is the vapour barrier which should be continuous to prevent condensation and mould formation. Aerogel plaster require a long curing time of at least 10 days before the final render can be applied.

### 3.6 Conclusion

Material thickness : Based on the thermal performance of the VIP's and aerogel products, the former is has lowest thermal conductivity and subsequently lowest thickness making it most suitable for application in areas with high space limitation.

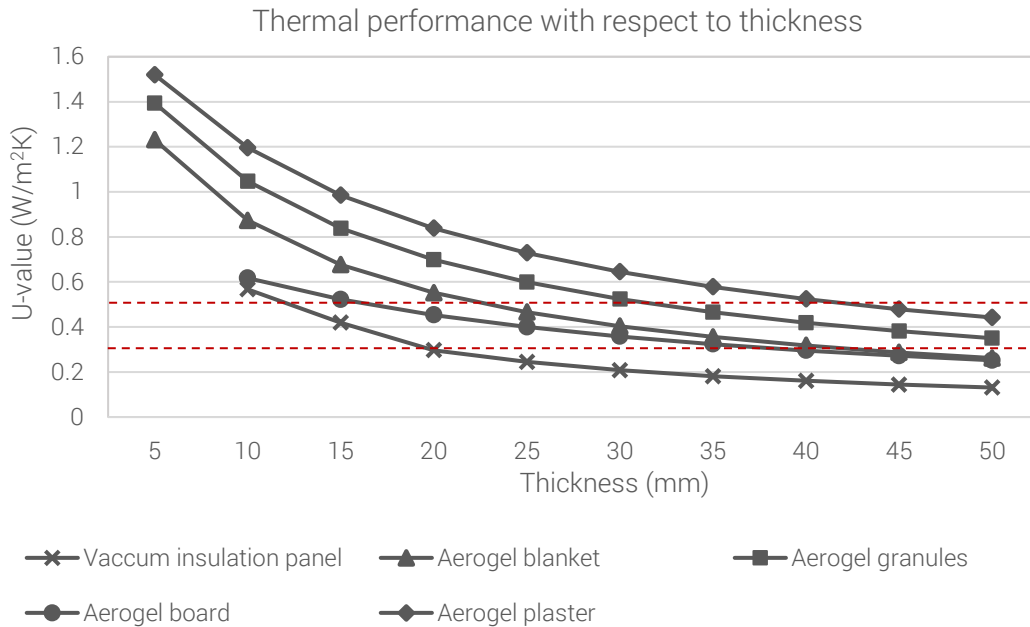

Figure 17 Comparative analysis of U-value performance of superinsulation material with respect to the layer thickness

The building decree states the requirement of an U-value of 0.3 W/m<sup>2</sup>K for compliance which means a 20mm thick VIP or a 40 mm thick Aerogel blanket. This threshold value can be adjusted in conjugation with other efficient systems.

The future prospect of Low temperature/ Medium temperature heating being adopted for use in heating homes helps save a lot of energy that a home would typically use. With the vision of reaching low energy homes, a home with low temperature heating system can install higher thermal resistant insulation. For such homes, an approximate U-value of 0.5 W/m<sup>2</sup>K is considered which can be advantageous with superinsulators. With LT homes, an aerogel blanket of only 20mm can achieve the performance requirement.

Vacuum Insulation Panel : VIP's have some shortcomings regarding the delicate nature of the panels that can be easily damaged during transport or handling. An encasing of the panel can make them more resistant and robust.

Care should also be taken for correctly sizing the insulation. Once manufactured, VIP's cannot be altered in shape or size. The aerogel products can be cut on site and require basic personal protection gear.

Aerogel products: Aerogel blankets are the most sustainable superinsulation material. Research is being conducted to replace the silica in aerogel with cellulose to make the material natural and biodegradable.

Aerogel boards have similar properties to aerogel blanket but are less sustainable to use due to the outer rigid board glued to the aerogel blanket making separation more difficult. Not having any benefits for use over the blankets, this product will not be considered for further development

Aerogel granules are best suited for infills in transparent containers where the light transmission properties of the material can be utilised. Performance wise, it does not surpass the blankets or board and will therefore not be considered for further development.

## **04** PROCESS INNOVATION

*Process innovation envisions a fully-automated production process, starting with digital data capture using advanced geomatics and digital reconstruction leading to a fully-automated production process*

## 4.1.Digital Data Capture

The first step towards a digital workflow is to capture data for an accurate recreation in the digital workspace. Traditional data capture techniques involve manual measurement of every surface in the target space and then drafting as per the measurements for further processing. "Data capture techniques can be applied to the recording, analysis, conservation and visualisation of the historic environment." (Frost, 2018)

Digital documentation aims to capture the surface properties of a set of points in a 3D space of an existing building and with this collection of points, create a point cloud. Based on the resolution and accuracy of the capture, the point cloud can record level of detail. In the built environment, this technique helps to identify any changes that occurred over the years or any discrepancies with the construction drawings or simply for visualisations.

### Data capture techniques

From built environment data capturing techniques depend on the scale of the target object and the desired accuracy. The techniques are discussed below

#### Terrestrial Laser Scanning



TLS scanners use light detecting and ranging technique to acquire measurement. This works by firing a beam of laser light at a surface and measuring its return properties to gauge distance between its origin and the object surface. Scanners spin a mirror to take measurements along vertical lines of data as they rotate, capturing the surrounding environment with a near-spherical line of sight. (Frost, 2018).The laser light is reflected off the first surface of contact and thus can only relay data that is in the equipment's sight range.

Figure 18 Faro focus S-350 scanner. Retrieved from: <https://www.faro.com/products/construction-bim-cim/faro-focus/>

#### Total/ Multi-station



Total stations are LiDAR based survey instruments used for accurate measurement of long range distance and can record levels and site monitoring. According to (Frost, 2018) total stations works by taking measurements with a prism which can capture points directly from the surface.

Figure 19 Leica Builder 300 total station . Retrieved from : <https://www.sccssurvey.co.uk/leica-builder-300-total-station-set.html>

## Global Navigation Satellite system (GNSS)



GNSS uses satellites to determine location and measure distance. They are responsible for delivering autonomous geo-spatial positioning along with extensive global coverage

Figure 20 Global navigation satellite. Retrieved from <https://www.orosk.com/things-you-dont-know-about-global-navigation-satellite-systems/>

## Simultaneous Localisation and Mapping

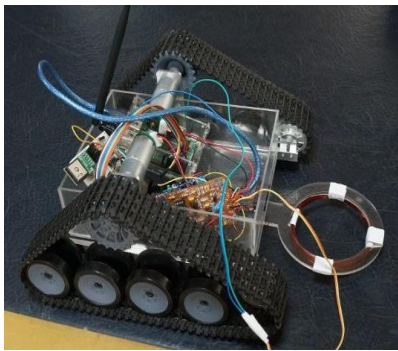

Scanners can be attached to vehicles, as part of a system that generally also includes a GPS device and an inertial navigation sensor, and used to scan large areas while driving. The accuracy of the data collected depends on the quality of the inertial navigation unit, the speed at which data is collected, and the quality of the software used to process the data.

Figure 21 Scanner attached to a remotely controlled robot. Retrieved from [https://media.licdn.com/dms/image/C5112AQHLGU\\_jqPwtdg/article-cover\\_image-shrink\\_423\\_752/0?e=1567036800&v=beta&t=ef1ulHdkaSUjHCjVYXURqvJqWtjh6dPeaqmNcRjMSXo](https://media.licdn.com/dms/image/C5112AQHLGU_jqPwtdg/article-cover_image-shrink_423_752/0?e=1567036800&v=beta&t=ef1ulHdkaSUjHCjVYXURqvJqWtjh6dPeaqmNcRjMSXo)

## Photogrammetry



Passive sensors, like digital cameras, deliver 2D image data, which can be afterwards transformed into 3D information. The photogrammetric method generally employs minimum of two images covering the same static scene or object acquired from different points of view. Using automatic location of common points in both, the digital photogrammetric system is also able to build up a digital model of the scene. (Faltynova, Matouskova, & Sedina, 2016)

Figure 22 GOM Pontos Live, a mobile optical 3D measuring system consisting of two high-speed camera. Retrieved from [www.r-design.hu/hu/pontos-rendszer](http://www.r-design.hu/hu/pontos-rendszer)



## 4.2.Processing

Typical outputs of the scanning process include processed and registered point cloud, photo-textured 3D model of space, set of computer aided drawings, area and distances of objects , visualisation for interactive virtual reality environment and BIM model.

The information from the digital data set is used to create 3D model which are then used to identify complex areas to insulate and an optimised layout of the insulation.

### 4.2.1 3D workspace

Normally, the point clouds are unstructured data set that are organised into a 3D model. This is done by the data processing software that come with the scanning equipment by matching the geolocation of the scans and stitching multiple scans based on location and orientation.

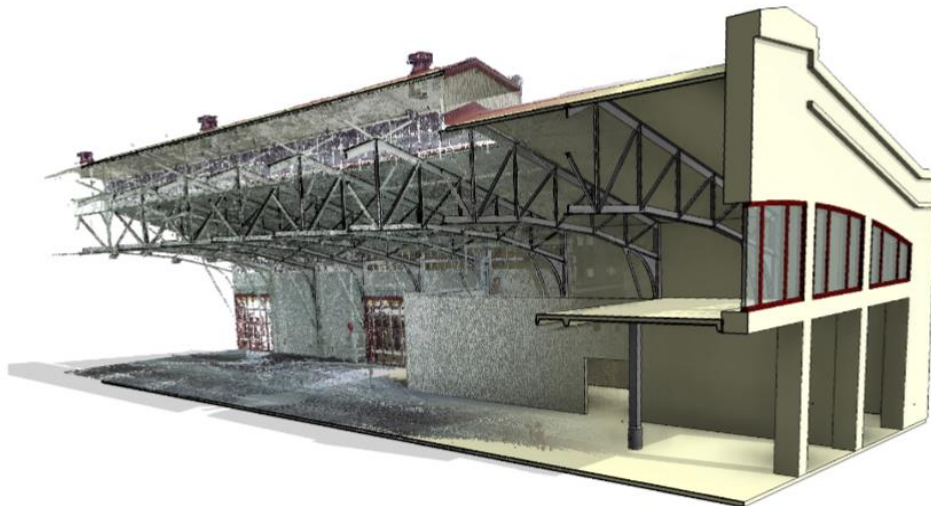

Figure 23 Example of 3D construction of Point cloud in Revit. Retrieved from: MANUAL\_As-Built 2018 for Revit\_EN.pdf

Software such as Autodesk Revit, rhino, meshlab, geomagic wrap, cloud compare etc. help in reconstructing NURBS surfaces by simplifying the number of points in each plane.



Autodesk Revit



Rhinoceros



Geomagic wrap



MeshLab - mesh



CloudCompare

A manual reconstruction is also an option to redraw surfaces over point cloud reference but can often lose accuracy and curvatures in such a way. The reconstructed model needs to be checked for manifolds and water-tight constraints. (Nan, 2018)

## 4.2.2 Layout

A 3D model opens up a lot of possibility regarding how the renovation is implemented. For interior renovation, one of the benefits of digital workflow is the ability to predetermine the sizing and arrangement of insulation on the walls. A parametrical workflow helps in finding out the most optimum arrangement with standard sizing and least material wastage.

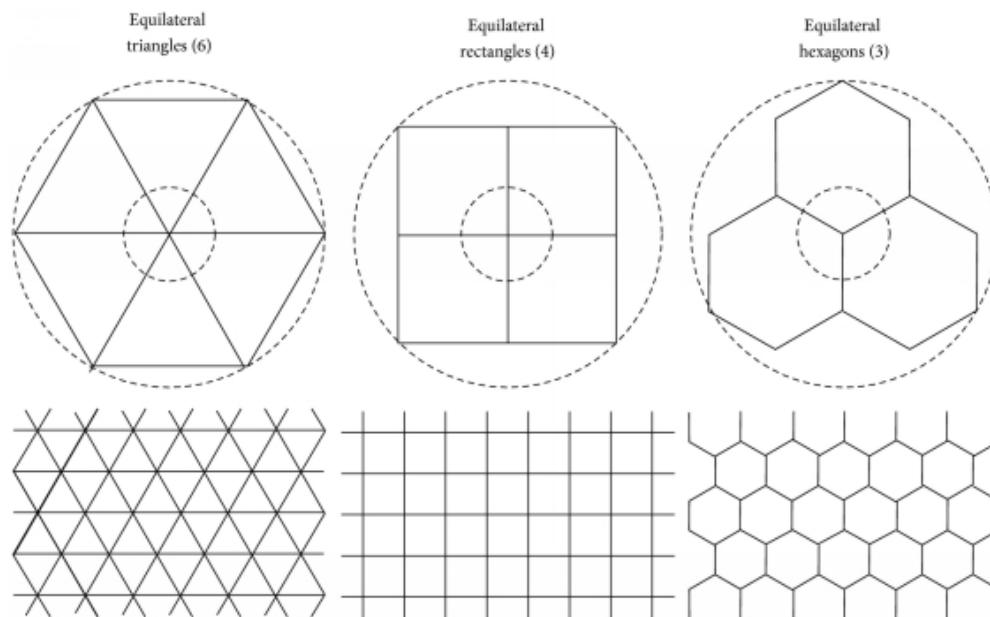

*Figure 24 Sub-dividing the wall surface into smaller units (of size suitable for ease of transport and installation) with tessellation for optimum layout . Retrieved from: Study of the Control of Geometric Pattern Using Digital Algorithm.pdf*

## 4.3. Virtual environment

The 3D model constructed can be imported into a virtual reality /augmented design software such as Unreal engine or Unity 3D. Real life visualisations can help the occupants to see and feel the effects of the renovation in their houses. It offers a unique experience to integrate their views and wishes for the choice of finish and acceptable layout.



Figure 25 Example of virtual environment to experience the reformed spaces. Retrieved from [www.livehome3d.com/useful-articles/vr-in-home-design](http://www.livehome3d.com/useful-articles/vr-in-home-design)

#### 4.4. Conclusion

A Terrestrial Laser Scanning (TLS) system is the most appropriate method for interior surveying. These can be hand held or mounted. While photogrammetry is better suited for smaller objects, the other systems are more efficient on a larger scale of survey.

For a thorough scan, it is important to clear the line of sight and recommended to take multiple scans from different positions to ensure a full coverage of the target view.

Scan resolution determines the level of detail captured and also the file size. A high resolution scan easily contain a billion points that require a good configuration computer to process.

Management of these acquired points is done through specialised software to create BIM model that require extra knowledge and skill.

The ultimate 3D reconstruction algorithm is still a challenge and a subject of intensive research. In the future interoperability with BIM model and data exchange could be reached

It is a crucial step to aid fabrication of accurately dimensioned and optimally arranged insulation units.

## 05 PRODUCT DESIGN

*Product design innovation takes advantage of the digital design to involve prefabrication as an integral step to achieve accurately sized insulation along with saving time. To optimize workflow to reduce onsite time, the insulation is designed as a sandwich panel assembly that already comes with a surface finish and only require the action of fitting in place.*

## 5.1 Product design

From the material study we have the knowledge about how the superinsulators are applied in the building projects. Most of the reported damaged of VIP's have occurred during transport or handling while they are being installed at the building site. (Kalnæs & Jelle, 2014). Aerogel plaster have a credibility for being cast and moulded to any shape and form but require large curing time (10 days) and all insulation material are either glued to the wall or have finishes glued to them. This approach of fixing with adhesives is fast and cheap but have a negative impact on the retrieval of the different material layer at the end of product life.

These shortcomings can be answered with smart and integrated product design innovations. There following developments that can address the issues with current insulation application.

### **Prefabrication**

An off-site, factory produced insulated unit can potentially take the work of cutting insulation, fixing it and finishing it away from the site and in turn deliver a single finished product that just needs to be fixed to the walls. The factory produced panel will reduce the duration of construction and assembly processes on-site and improve the accuracy and tolerance of construction. Consequently it will also reduce intrusiveness and disturbance for the inhabitants.

With assistance from the computer aided drawings and dimensions generated in the digital workspace, prefabrication of the insulated units result in an accurate manufacturing process.

### **Sandwich panel**

A sandwich panel is essentially an insulation material encased in a protective layer. On the same principle, a sandwich panel in envisioned to be encased in such a way that protective layer exposed to the interior is a wall finish layer that does not require any additional finish upon installation. Figure 26 highlights some examples of commercially available sandwich panels with VIP's. These however require a layer of render finish.

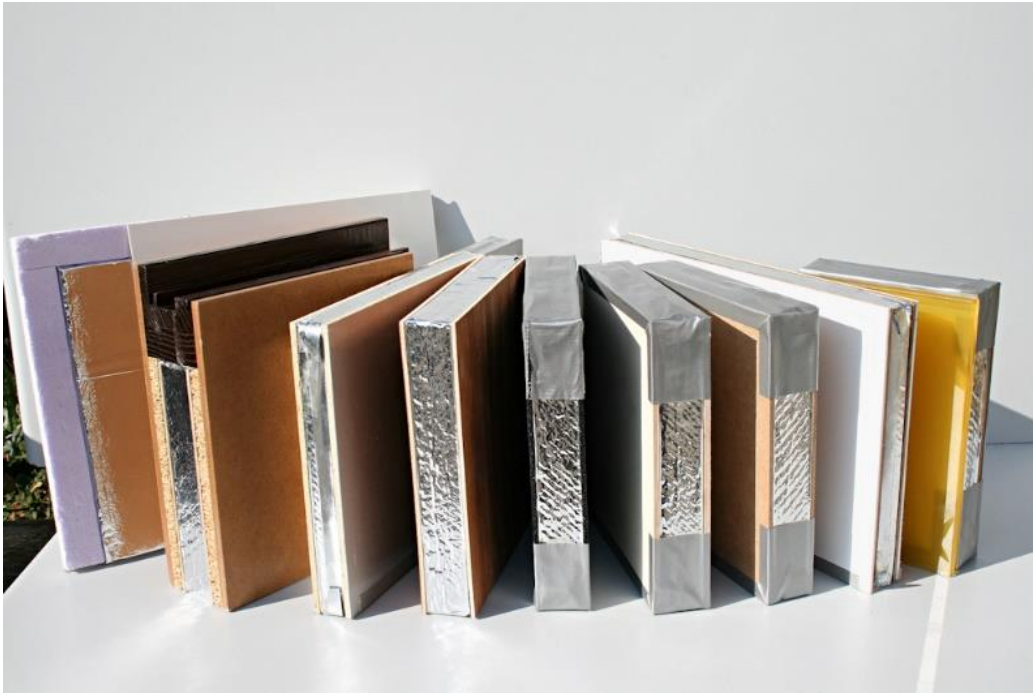

Figure 26 Vacuum insulation panel available as a sandwich panel.

Retrieved from <http://www.bine.info/en/publications/publikation/daemmen-durch-vakuum/vip-fuer-den-markt/>

### **Demount and disassemble**

As per the current practice of design and fixing of sandwich panels, adhesives are heavily used to attach layers together or fix insulation to the wall. Being glued makes it difficult to recover material at the end of their lives or in case of demolition thereby adding to the waste. A demountable construction ensures that the panel can be safely removed from the wall without any harm to either. A panel designed for disassembly is held together by mechanical means which can be segregated into the different layers.

### **Adaptability**

An adaptive system aims to provide a single solution that can work with any insulation material. While now a days, every insulation has its own fixing mechanism, having one system that works with others promotes re-usability.

## **5.2 Design development**

With the above design goals, three options were developed for a prefabricated sandwich panel with a standard insulation of size of 1000mm by 600mm that can be demountable and dis-assembled at its end of life. All design options can be adopted for various insulation material in the same concept.

### Design option 1 : wooden stud frame

Wooden furring strips forming a frame within which the insulation sit. The finish board is the layer that holds the product together. The thickness of the wooden member accommodates the screws that attach the finish board. On-site application requires a drill and screws to fix the panel to the wall. This design option is easy to produce with few only 4 elements. On the downside, the wooden studs significantly add to the total thickness of the panel.

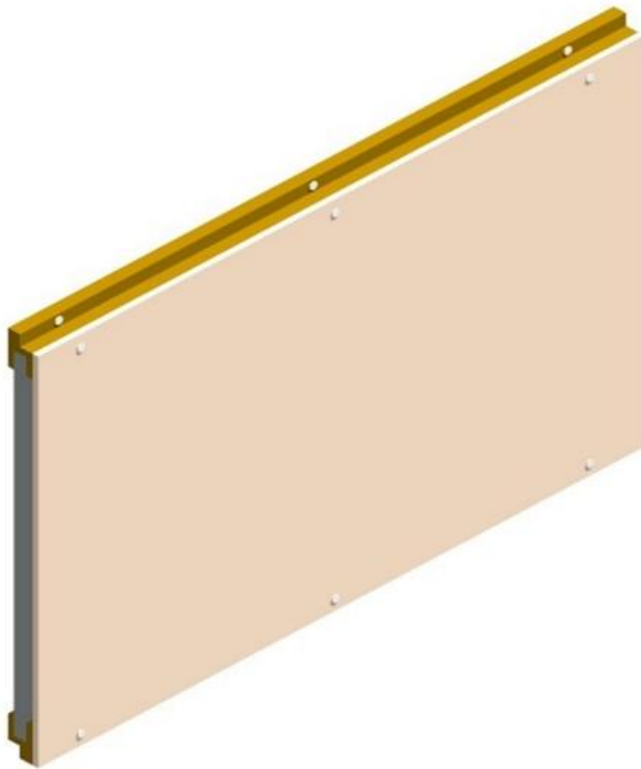

Figure 27 Interlocking panel unit with wooden studs.

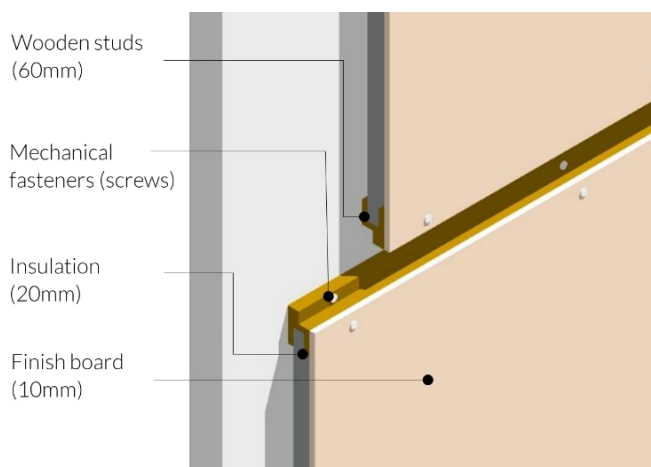

Figure 28 Design option 1- wooden brackets holding the insulation fixed with mechanical fasteners and connected with a shiplap joint

## Design option 2 :

This design option has the insulation enclosed between a backing board and a front finish board that are held together with C-profile element such that the panels can be fixed in a tongue and groove joinery. This connection type ensures a tight fit minimizing thermal bridges. This scheme works with vacuum insulation panel for added protection and for fibrous material for strength. On the downside, the backing material is not functionally required and can be seen as waste of material. With too many small elements, fixing these panels to the wall will be challenging.

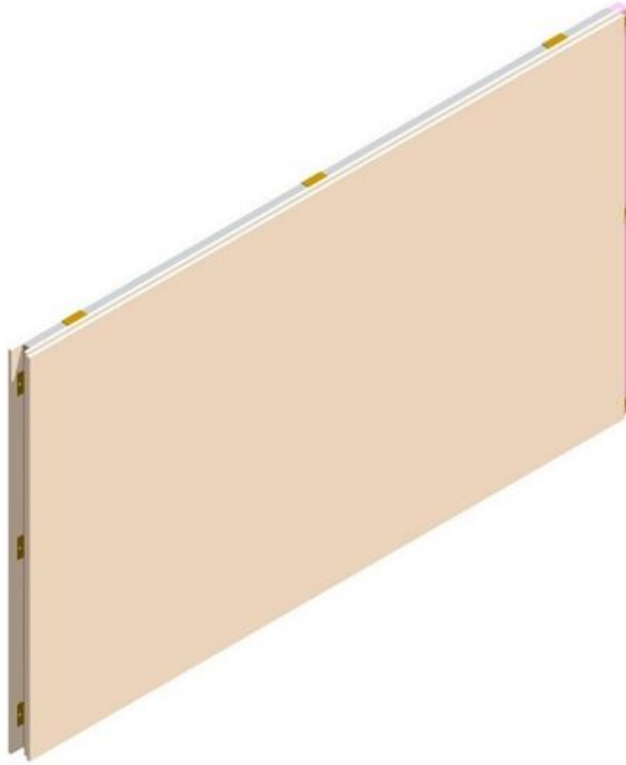

Figure 29 Design option 2 – interlocking panel with front and back casing forming tongue and groove design

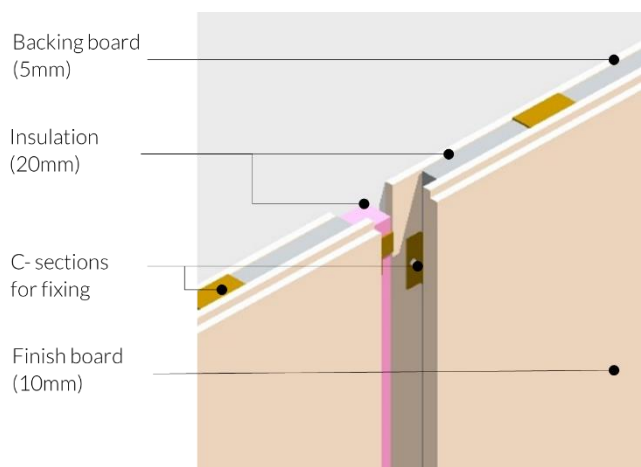

Figure 30 Design option 2 – tongue and groove joints for connection between 2 panel held together by small c- profiles



### Design option 3 :

This sandwich panel comprises of the insulation enclosed in two steel/pvc channels at the top and bottom. While the channels ensure a friction fit, the finish board hold the components together. The finish board is attached to the channel via z-clips that make the layer easily demountable. An extra layer of XPS/aerogel insulation is required to act as thermal breaks where the channels sit one over other forming a shiplap joint. Use of metal/plastic sections lead to a reduced thickness of the panel.

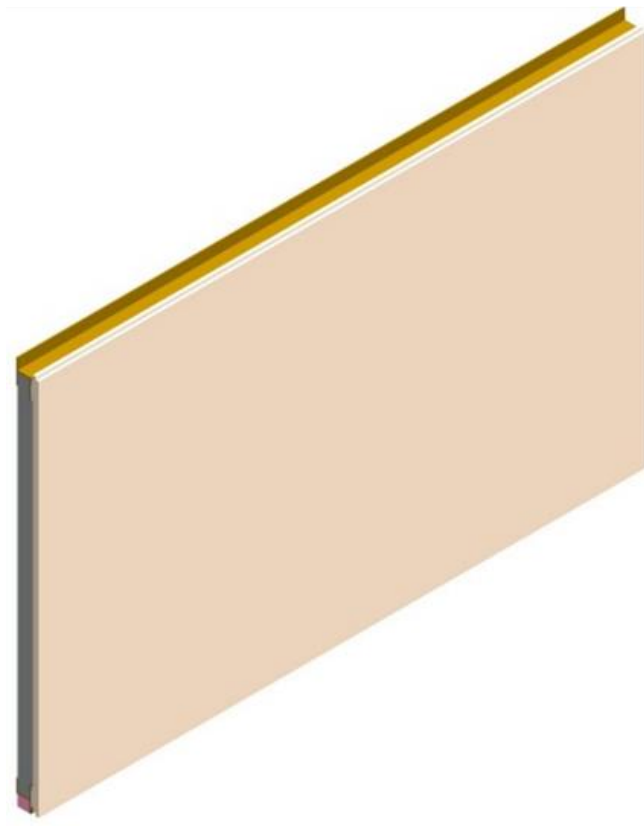

Figure 31 design option 3 - Interlocking panel unit with metal/plastic channels for fixing and support

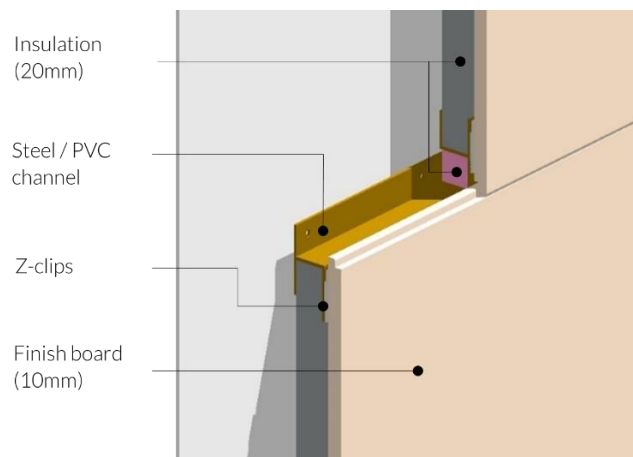

Figure 32 design option 3- The h-channels hold the insulation and are also the connection point to the wall surface via mechanical fasteners.

### 5.3 Global solution

The design option 3 is chosen as the preferred product that can be a singular system that can work with different insulation cores. The sandwich panel is designed in such a way that the product is manufactured and delivered as a single unit but is easily disassembled and assembled back. Figure 33 below depicts the elements that combine together to form a single panel unit.

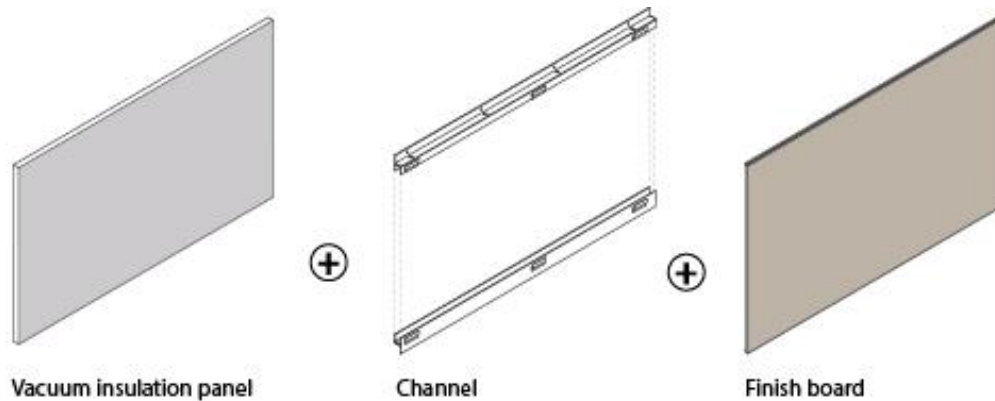

Figure 33 production sequence for VIP integrated panel

The same assembly can be adjusted to accommodate different insulation material with the inclusion of a vapour barrier.

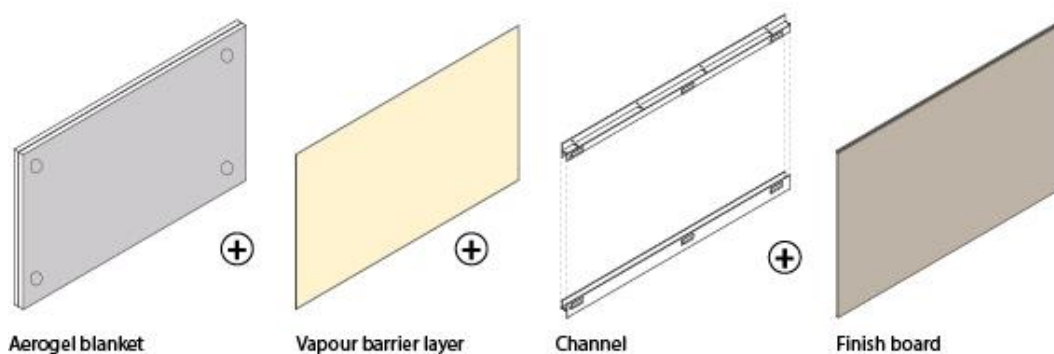
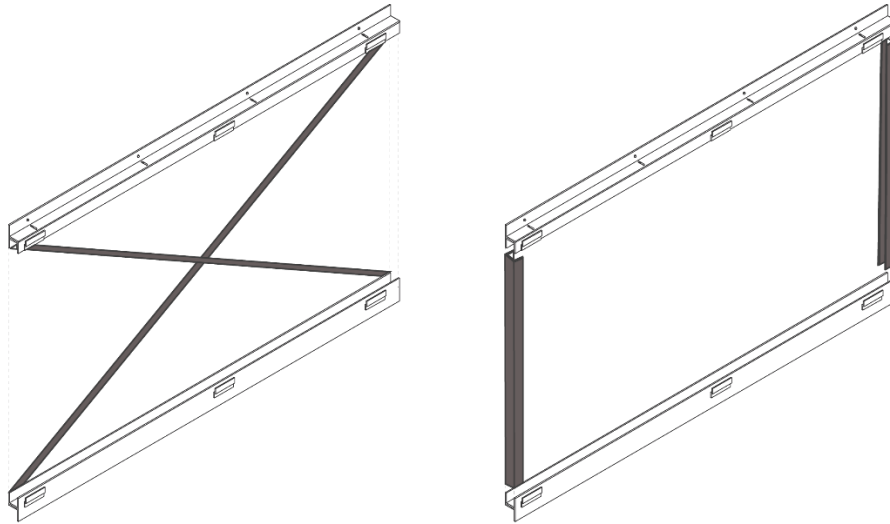

Figure 34 production sequence for aerogel blanket integrated panel

For fibrous material that do not have enough rigidity to keep shape within the 2 channels, additional supports can be added to the channels as depicted in figure 35.

The first option employs a X-brace on the back of the panel. Insulation can be fixed to the brace for extra support without adding to the thermal bridging. The second option uses C-channels on the sides to create a casing for the material. The material of the channels can greatly influence the effect of thermal bridge as well as require extra care while fixing to ensure a vapour tight fit.



*Figure 35 Bracing options for non-rigid flexible insulation material.*

To promote adaptability and reusability, the channels that hold the insulation in place have been designed to be expandable to be able accommodate a thicker material such that different profiles do not need to be created for use with different insulations.

The channel is made up of a T-profile and an L-profile that are fixed to each other via slotted hole mechanism. Loosen the screw to slid the L-profile out and tighten again to retain the expanded size.

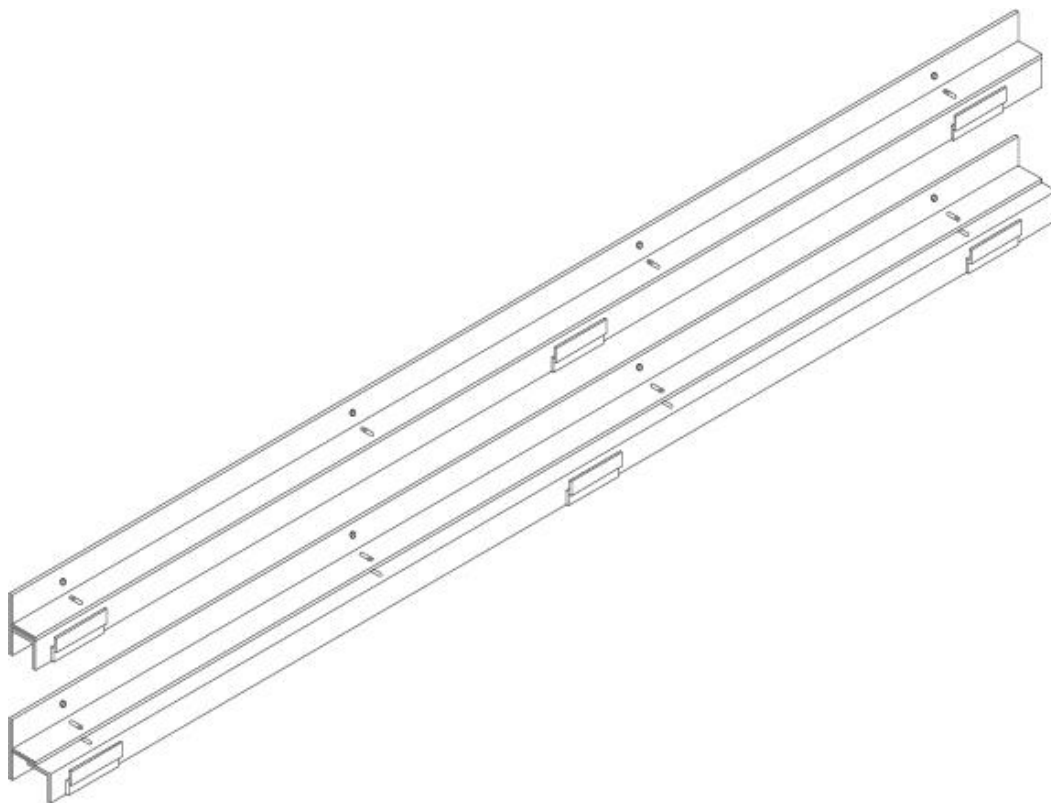

*Figure 36 adjustable profiles to fit different insulation thickness*

Changeable skins is a unique feature that give the users an extra control over the aesthetic of the panel throughout the lifetime. While the insulation has a high life expectancy, the finish layer is more prone to wear and tear and requires changing every few years or with every change in the room aesthetics.

A benefit of having demountable finish layer is that they are also easy to replace. This is an important feature that supports material leasing schemes and promoted a circular economy since these finish layers can be exchanged and used in a new project.



*Figure 37 changeable finish layer.*

## 5.4 Production

Once the insulation material and the required finish is finalised, the information is sent to the factory for production and then to assembly. The factory dealing with the production of these insulated sandwich panel will work on assembling the different layers together to form a single prefabricated product. The insulation as in case with VIP's will be manufactured to size and brought to the assembly line where the channels are attached to it. The XPS block is friction fit inside the channel. Finish boards with the customer preferences also reach the assembly line and are attached to the channels via the z-clips. With all the layers assembled, the finished product is marked and ready for shipping. Figure 38 describe the workflow in an infographic.

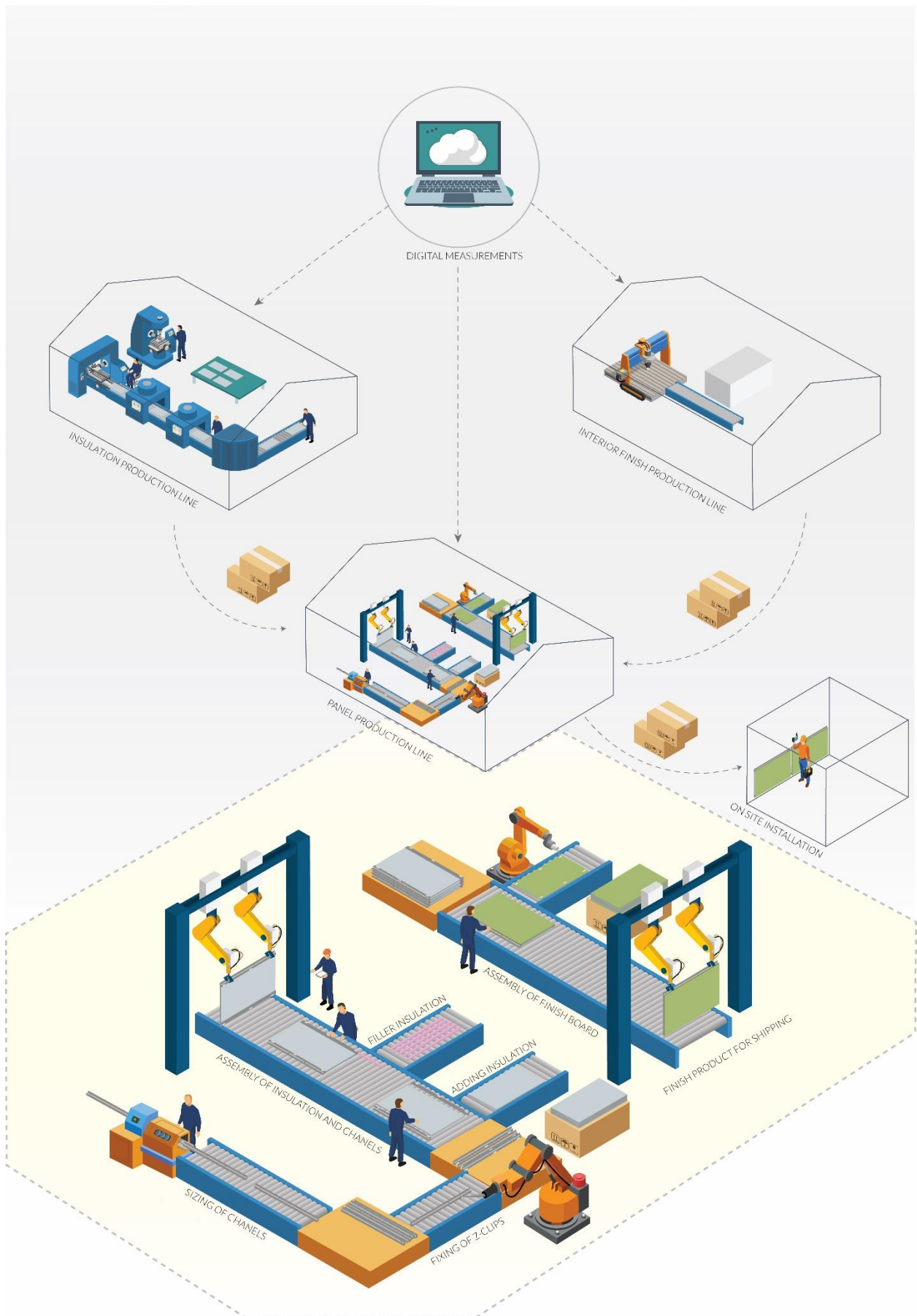

Figure 38 Assembly line workflow for creating a prefabricated insulated sandwich panel

## 5.5 Performance assessment

### 5.4.1 Thermal bridge

A section of the wall was simulated for the thermal bridge effect using THERM for Honeybee in the grasshopper interface. The material properties for each layer were specified in the software. The three different simulations show the effect of thermal bridging with changing the material of the channel that holds the insulation and fix to the wall.

The first image depicts the temperature gradient in a single dimension through the wall section with a PVC channel. The second one simulates with steel as the channel material and the third includes a strip of neoprene in the connection between steel and the wall to act as thermal break.

The PVC material has a better thermal performance than steel but has a far greater environmental impact. A wood composite material "Treeplast" can be a great alternative for the channel material that has performance values similar to plastic but is a completely bio-degradable material.

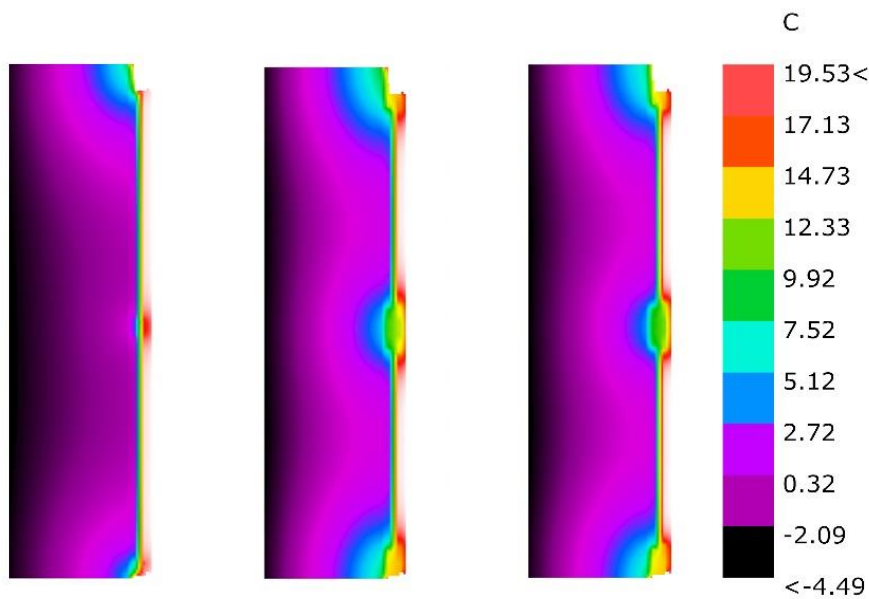

Figure 39 (i) temperature difference across wall section with PVC channel; (ii) temperature difference across wall section with steel channel; (iii) temperature difference across wall section with steel channel with a strip of neoprene

## 5.6 Conclusion

While a lot of examples exist for prefabricated panels and demountable panels, there are hardly any products that have both the function together. Prefabricated insulation panels have glued or casted layers that make disassembly difficult. On the contrary, systems which are demountable often work best when installed on site to ensure a tight seal.

The proposed sandwich panel has more elements of connections than conventional prefabricated solutions but it is able to incorporate demountability. A panel that can be disassembled leads to a shift of perspective against the life cycle of products.

The finish board is attached to the frame with interlocking z-clip. A easy system to dis engage the front layer give the user a freedom to upgrade the finish with new interior aesthetics over the years. In case of any damage to the insulation (in case of VIP's) in one panel, replacing the insulating layer is easy without taking down every panel.

## **06** DEMONSTRATION WORKFLOW

*The three areas of optimization – material, digitalization, product design - discussed in the previous chapters are applied to a case study room to assess the feasibility of the proposed workflow for renovation.*



## 6.1. Demonstration room

The Faculty of Architecture and built environment at TU Delft is a historical building where a small meeting room is chosen purpose of demonstration of the proposed workflow. The room has a west facing external wall with 30% glazed area.

The external wall is adorned with cable conduits and water pipes supplying to the radiator. The wooden beams at the ceiling intersect abruptly with the existing wall.

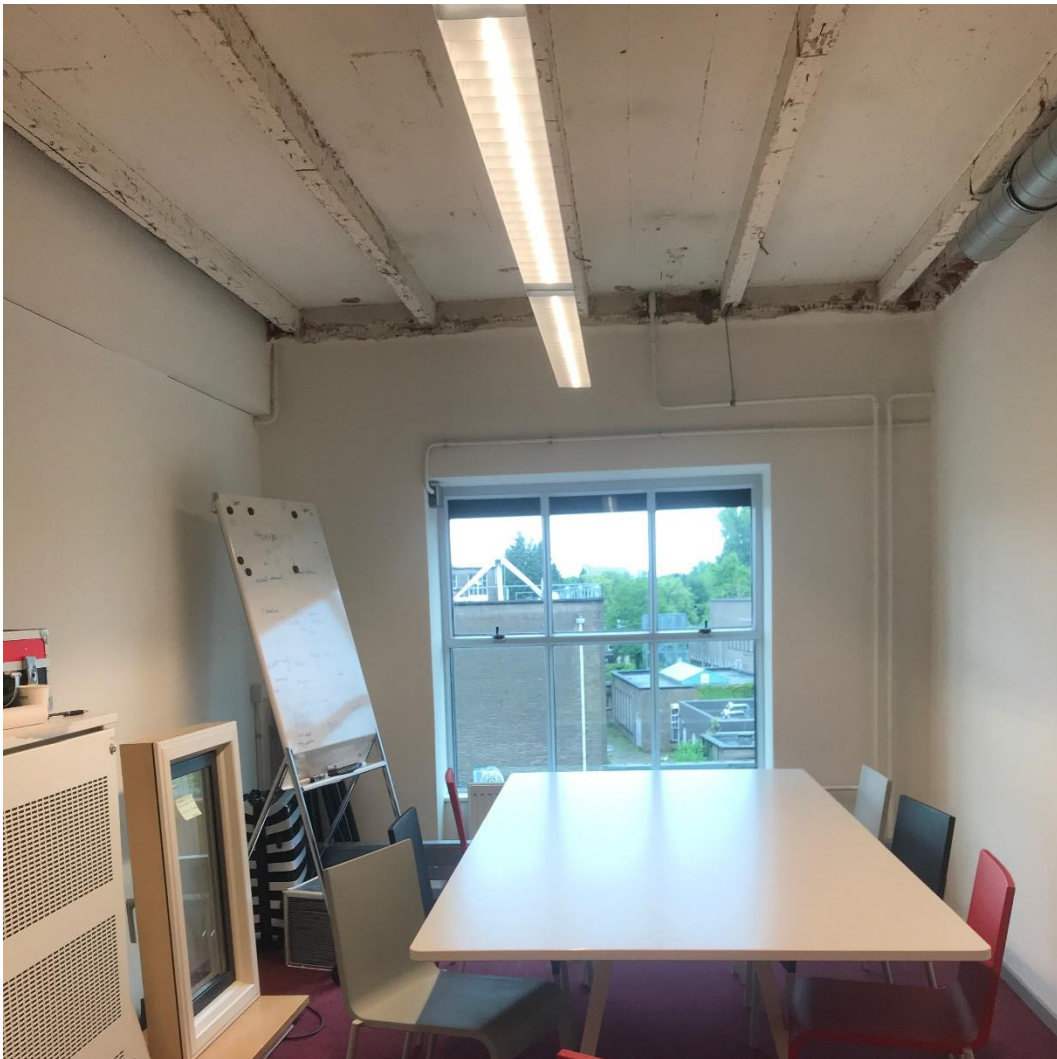

*Figure 40 The existing condition of the case study room showing the external wall*



Figure 41 The network of cable conduits and pipes attached to the surface

## 6.2. Measurement

3D scanner manufacturing company FARO was approached to help conduct a demonstration of the scanning technology in the case study room. Marnix van der Wolk, Sr. Account manager at the company guided through the complete process of scanning and processing data. Before beginning the process, as the only preparedness measure, it was required was to clear out any loose furniture and items that can potentially hinder the laser imaging.



Figure 42 The scanning equipment is easily portable with the items fitting a briefcase along with a lightweight carbon fibre tripod stand

The following points describe the steps followed for the measurement workflow.

Step 1: To begin with, suitable location of the machine is decided. It is agreed for the demonstration, 2 scans should be sufficient with a focus on getting detailed information from the external wall.

Step 2: The scanner is operated via a laptop with the FARO SCENE software which enables remote access. Predefined setting for interior scan with distance up to 10m is chosen which pertains to a scanning resolution of 1:8 ( if the scanner is 10m away, the point distance will be 12.3mm). The distance between points determines the level of detail that will be captured in point cloud.

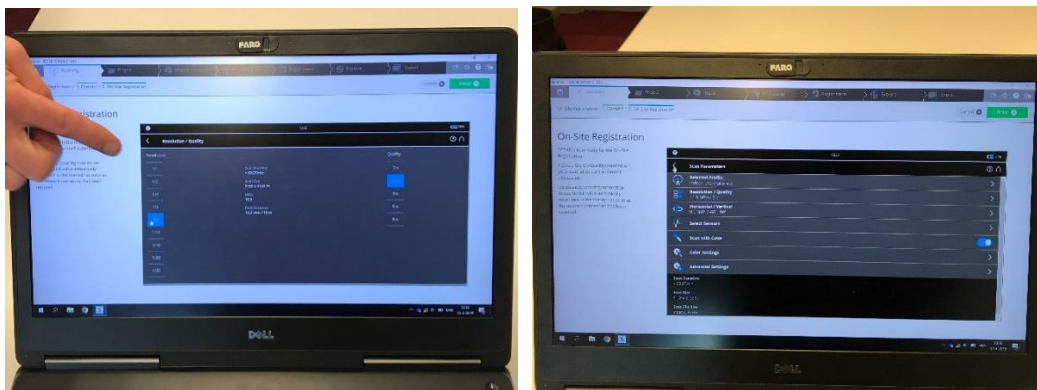

Figure 43 The user interface of Faro SCENE software

Step 3: Start the process. The scanner took 2 minutes and 37 seconds to collect the scan points as well as a coloured photographic representation. The same is done from the second scan location.



Figure 44 The scanner takes a 360 degree coloured photograph of its surrounding.

Step 4: The FARO SCENE software is programmed to stitch the 2 scans together upon registration with an error of 0.04mm and 73% overlap. However some post processing of the point cloud is required. For the demonstration room, the glass in the windows reflects the interior space which was also captured by the laser. The extra noise needs to be deleted. There are also instance of reflective surfaces (metallic elements) which have not been captured properly due to light scattering.



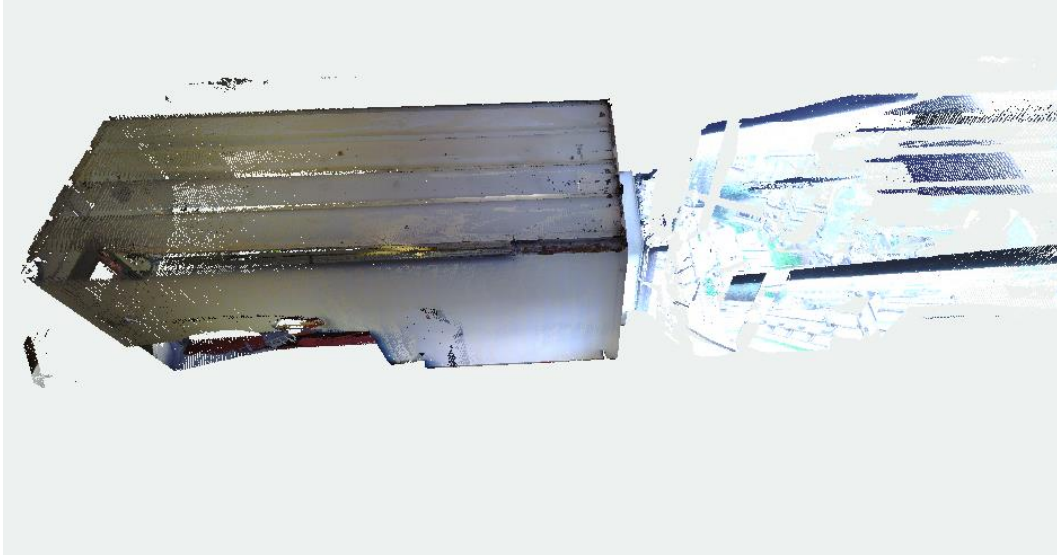

*Figure 45 Extra points created as part of internal reflections of the window glazing. This noise needs to be manually filtered out*

Step 5: The room is clipped to work only on the section with the external wall. The point cloud data is exported for further processing in Autodesk Revit software.



*Figure 46 Coloured representation of the point cloud after being cleaned and cropped only to include the external wall*

### 6.3. Digital Model

A digital model is built upon the point cloud by drawing elements in place of the points. Two software, Autodesk Revit and McNeel Rhinoceros were both used to create 3D model(Myers, 2018). There exist software specially designed to work with point clouds, the time frame of this thesis did not allow for exploration and a manual reconstruction was opted instead. Rhinoceros is chosen for further processing.



Figure 47 The building elements modelled over the point cloud in Revit



Figure 48 The building elements modelled over the point cloud in Rhinoceros

#### 6.4. Design layout

A crucial part of the renovation process is defining an optimised layout for the panels. The insulation panels should be designed to the maximum size to minimize connections and consequently thermal bridges.

The external wall of the case study room has a recessed niche with the window which results in multiple small sized surfaces each of which would require custom prefabrication and added corner connections.

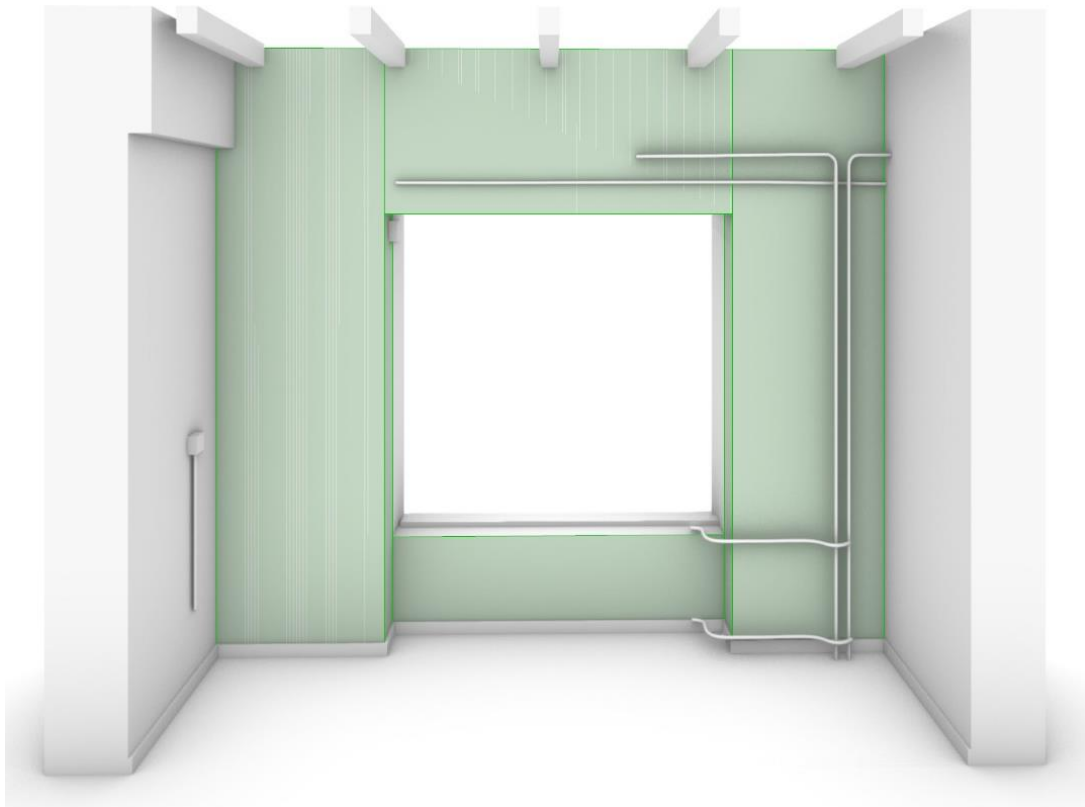

Figure 49 Graphical image highlighting the surfaces that form the external wall

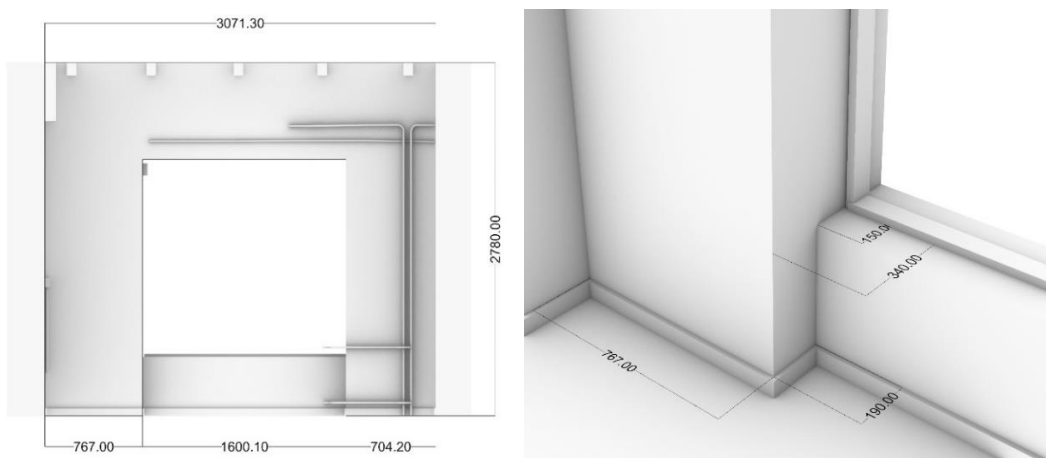
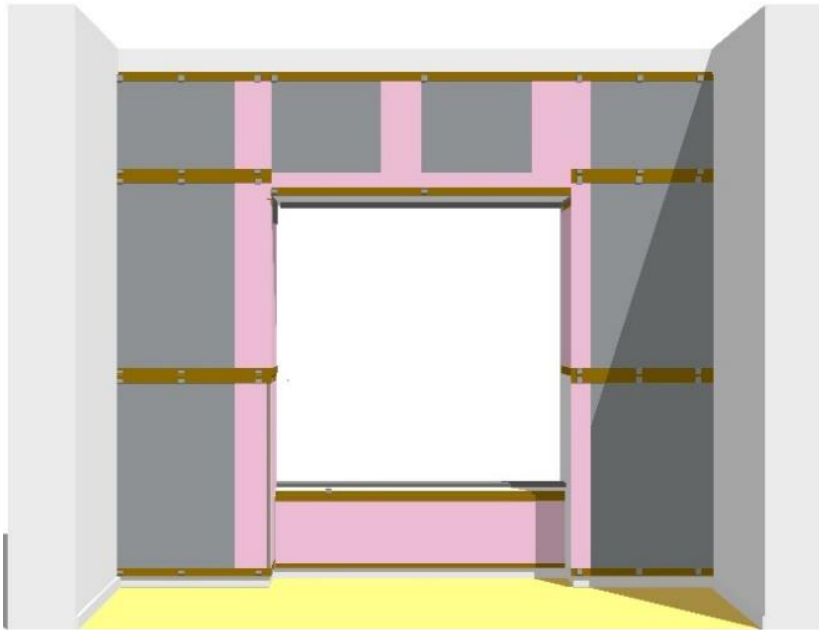

Figure 50 The dimension of the internal surfaces of the exterior wall

Different layout options are explored for how the prefabricated panels can be arranged on the case study wall to minimise connections and provide perfect fit.

**Option 1** commercially available standard size insulation

This option is valid only for Vacuum Insulation panels which are available in standard size. To save cost on custom fabrication, the aim is to fit the maximum number of standard sized insulation panels on the surface and fill the remainder space with other flexible insulation like aerogel blankets or XPS foam cut-outs.



*Figure 51 shows the arrangement of standard sized vacuum insulation panels with XPS foam as filler material. For an understanding of the insulation material, this visualisation does not show the finish boards.*

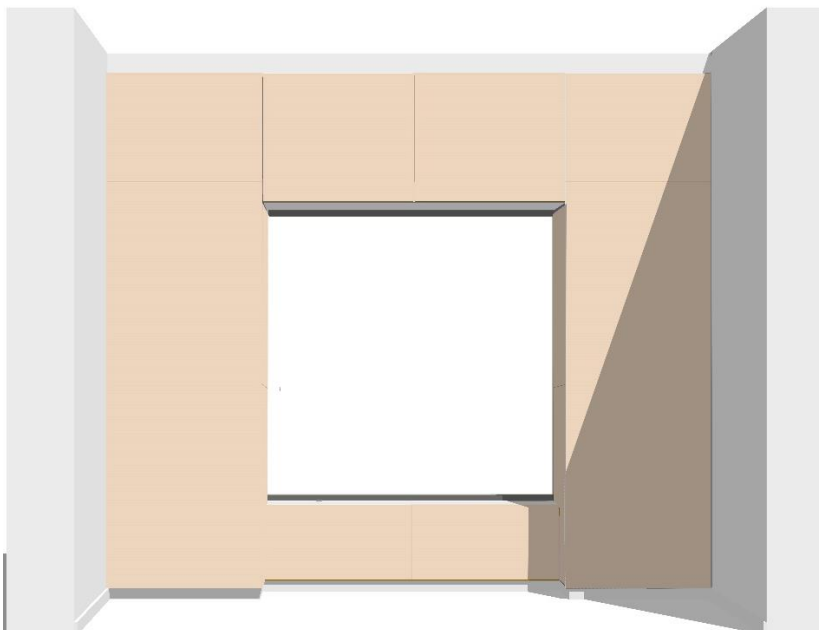

*Figure 52 visualisation of panels with standard size insulation make it difficult to have the best aesthetics*

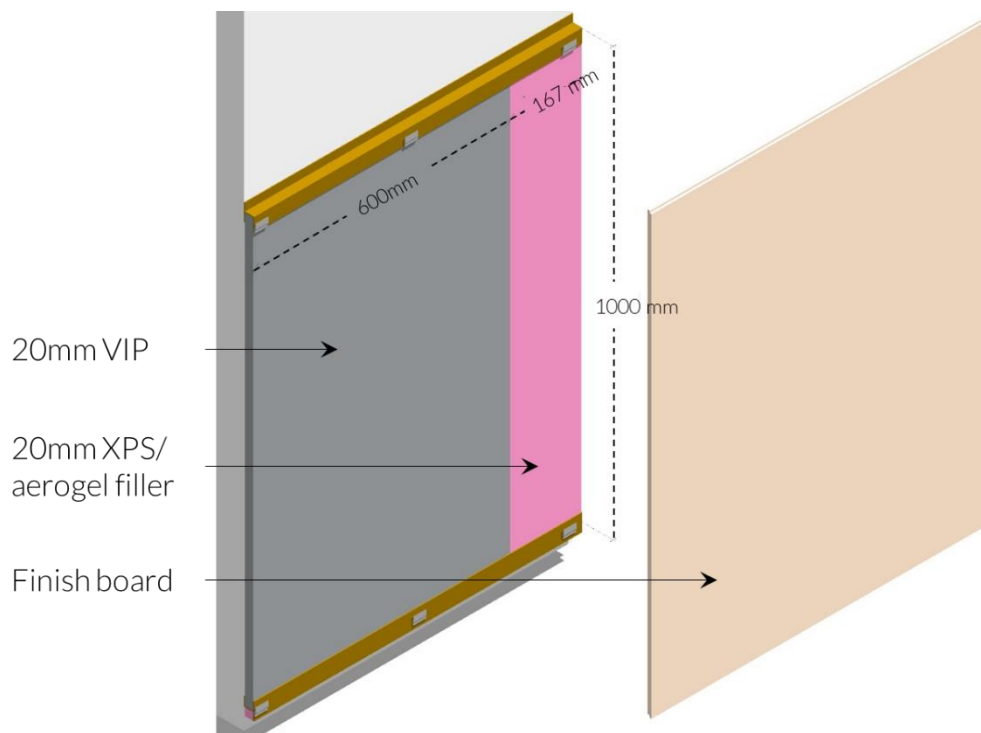

*Figure 53 An exploded section shows the arrangement of the two insulation in the proposed standard panel composition and fixing mechanism*

This arrangement can be more rigid due to fixed size VIP. In areas which are smaller than the conventional size, an alternate insulation material would be employed which can greatly reduce the thermal performance of the wall.

### **Option 2** custom sized panel

This layout options relies on manufactured-to-size custom insulation panels by sub-dividing the surface into equal sized panels or to align with existing aesthetical lines. This method is more expensive but has a better performance with homogeneous insulation material and lesser number of elements to oblivate thermal bridges.



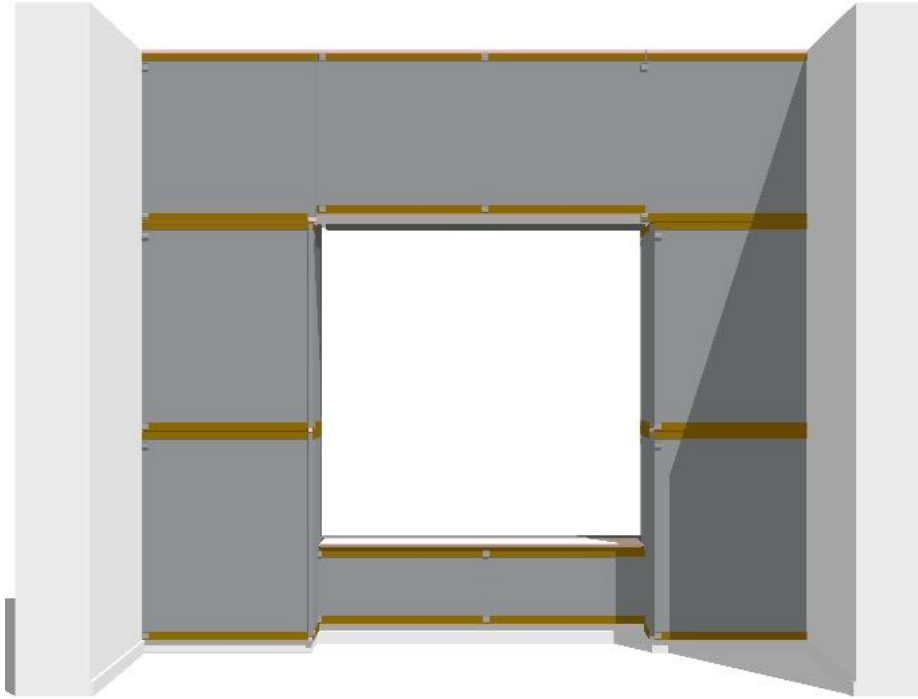

*Figure 54 custom sized insulation placed in the optimum arrangement. For an understanding of the fixing of insulation material, this visualisation does not show the finish boards*

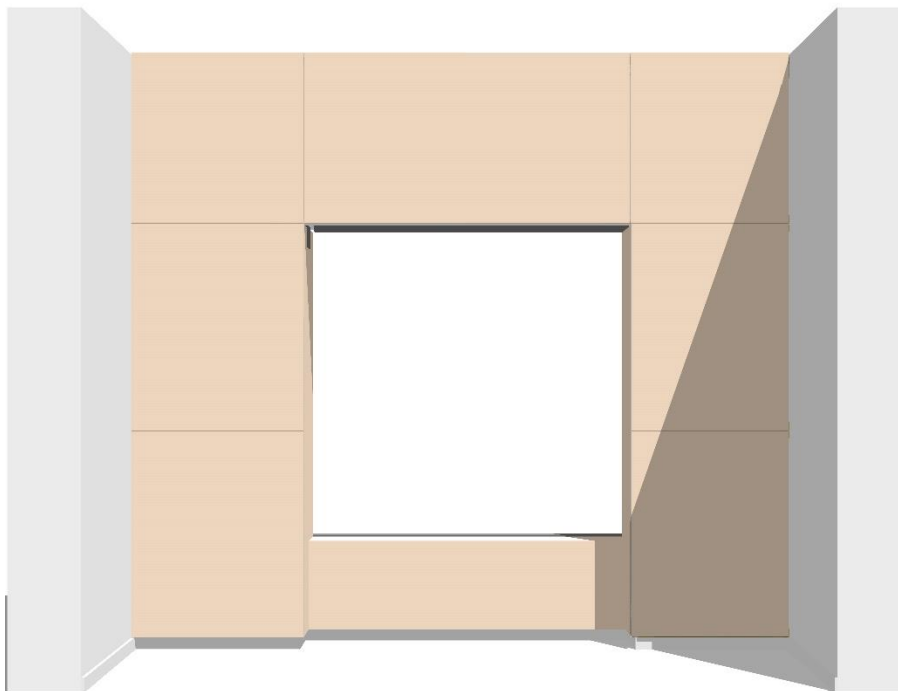

*Figure 55 a homogeneous line up of panel conforming to the visual lines of the niche surfaces*

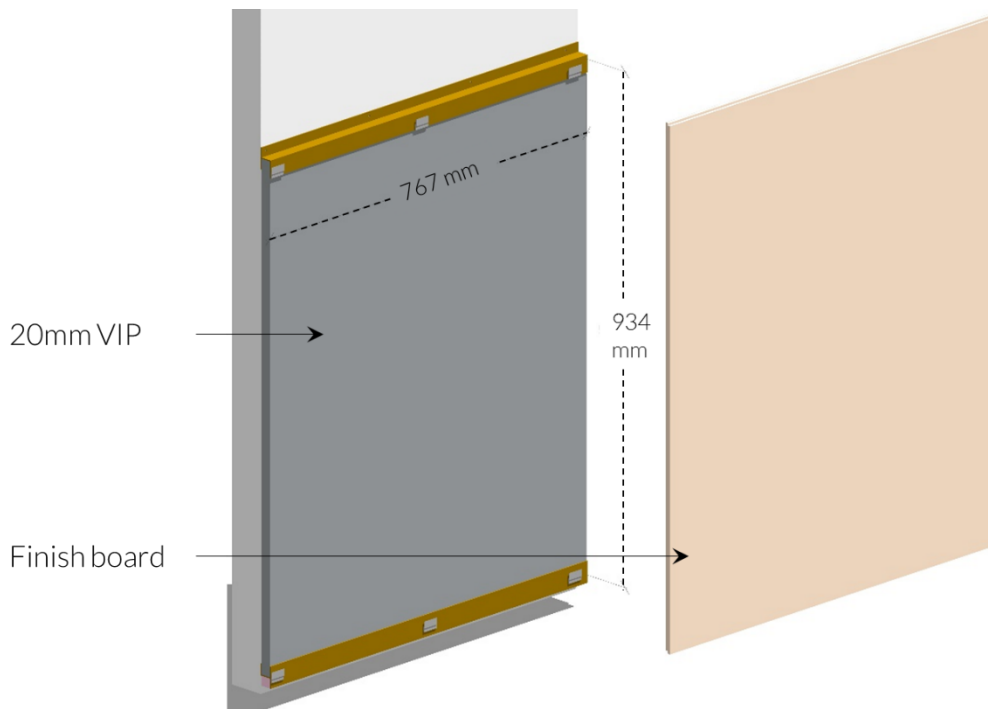
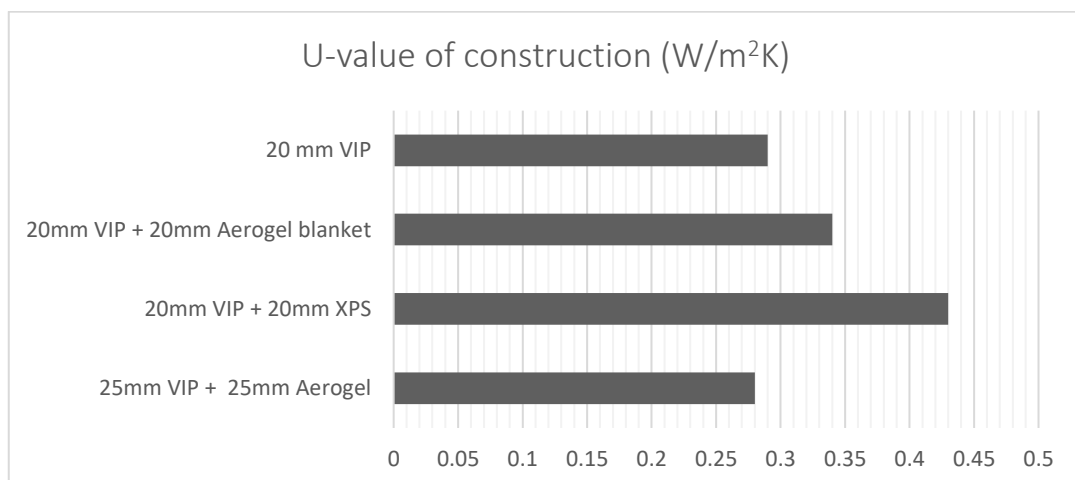

Figure 56 custom panel sizes can lead to very specific measurements which could increase the cost and the time to custom create a variety of panel.

### Conclusion

The finished products look the same for both the design cases. The difference being that one has two different insulation – a standard size VIP and filler foam material while the other has only a single customized VIP as insulation.

Since the layout option 1 uses standard size insulation, this scheme is more economical than an custom sized insulated panel. On the other hand, adding XPS insulation with VIP can effectively bring the U-value of the wall from 0.29 W/m<sup>2</sup>K to 0.43 W/m<sup>2</sup>K. With aerogel this value is more acceptable with the value of 0.34W/m<sup>2</sup>K.



In case of an low temperature heated building with the maximum value of 0.5 W/m<sup>2</sup>K, both the cases work well.

The decision can therefore be made on the budget and the target energy performance value.

## 6.5. Ornaments

Traditionally, all the fittings would be removed before work can begin. But the prefabricated panel will need to work around any obstacles and present an integrated solution that minimizes disturbance. In this case, it becomes important to first identify the areas where the objects intersect the wall and how distant they are.

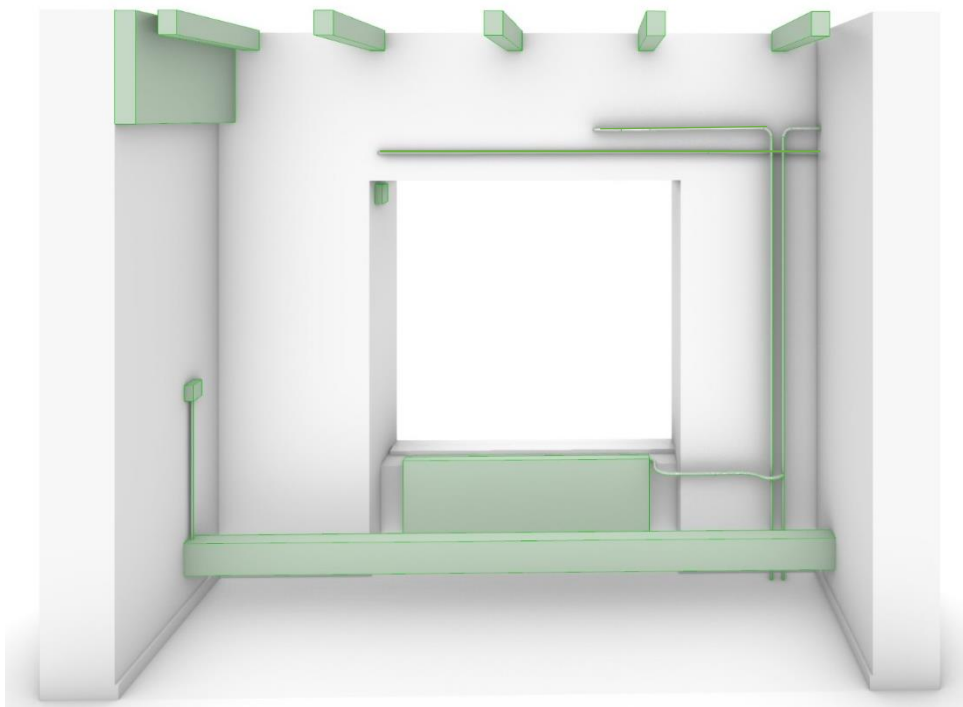

*Figure 57 graphical image highlighting the different elements on the wall that can hinder the insulation application process*

The image above highlights the elements that are fixed to the external wall and add to the complexity of renovation process.

The perpendicular distance of the innermost face of the objects to the external wall were calculated to decide whether the objects would hinder the insulation application or if the panels can fit in the space between them and the wall.

In this particular case, the distances vary from 230mm (cable tray), 87mm (beams), 80mm (radiator), 67 mm (hot water pipe), and as low as 5mm for the data cable.

From this step it can be concluded that depending on the thickness of the chosen insulation, the final insulation panel design will need to incorporate the cable conduit and the hot water pipes.

## 6.6. Connections

The problem areas discussed in the previous section present challenges on integrating the existing elements into the design. The prefabricated panel developed would need to be adjusted with edge details for corners and incorporating the cable conduit.

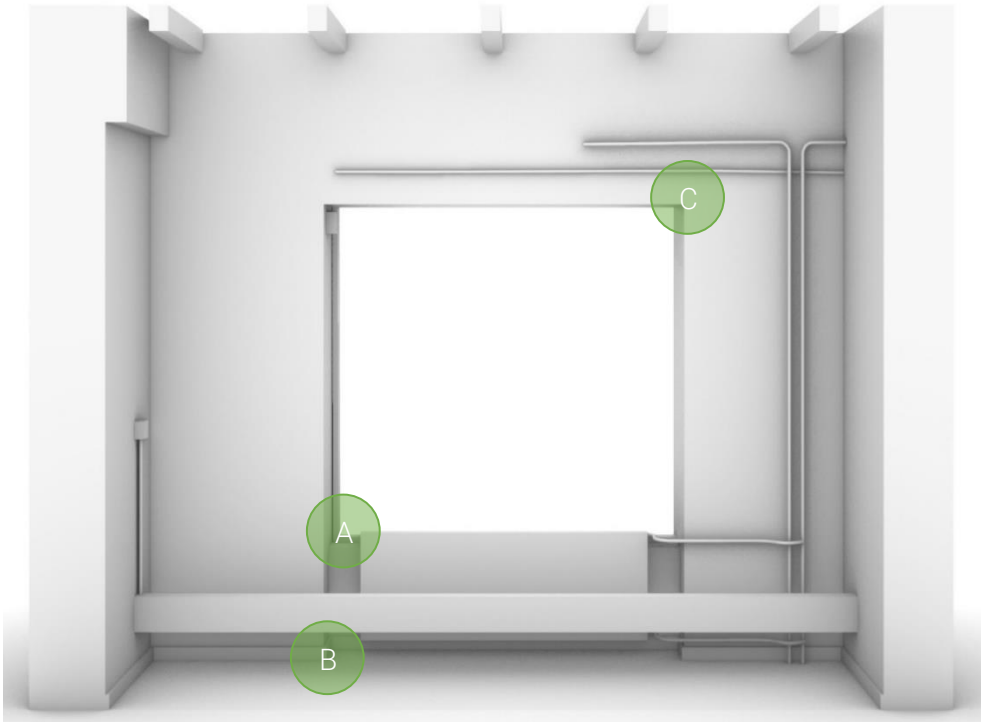

Figure 58 highlights the three areas of detail addressed. The first is the corner and window reveal, the second is the skirting and third is the integration of pipes .

### 6.6.1 Detail A - corner and sill

The corner and sill detail in this case requires special attention due to their small sized surfaces.

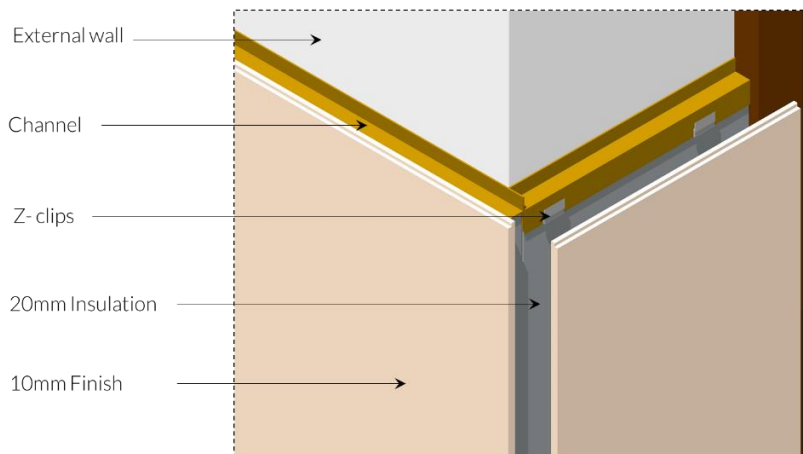

Figure 59 corner connection with the interior finish away to understand the edges

Figure 60 is a horizontal section through the corner and sill of the window. It highlights the deviation from the standard design that must be made to have neat corners without any thermal gaps.

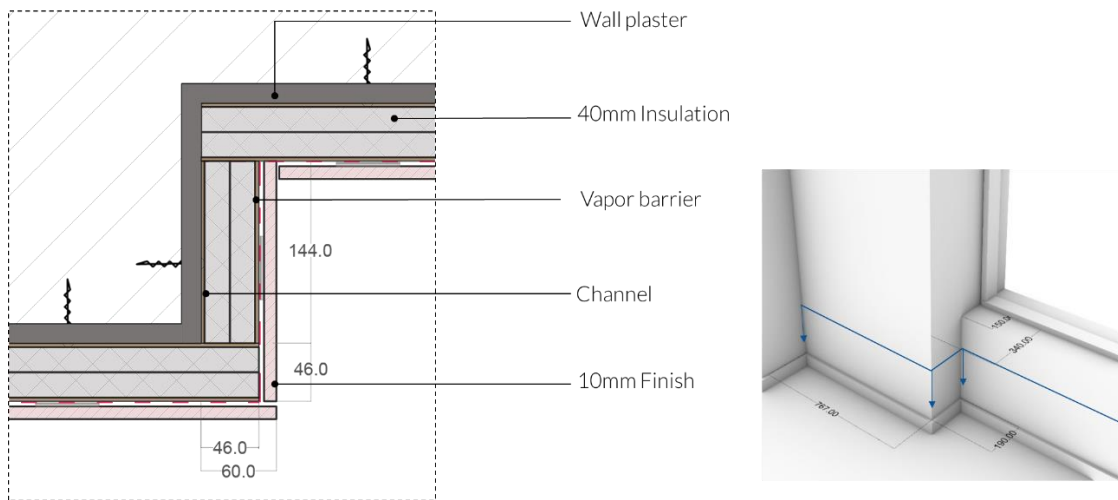

Figure 60 the side wall panel comes with an extended width of finish board while the sill panel finish board has a width shorter than the insulation.

Figure 61 is a vertical section through the window reveal and the sill wall. Fixing to the wooden frame requires an extra channel that would support and keep the panels in place. However, this detail work with wooden frame due to its thicker section allowing for fixing. A metal frame would require some sealant layer to ensure air and moisture tightness.

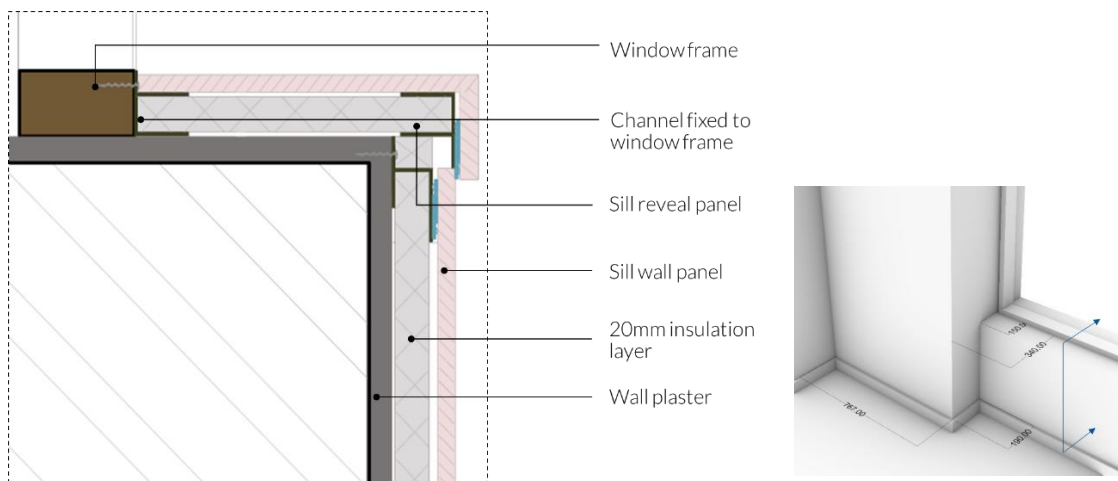

Figure 61 window sill and wall intersection highlighting the fixing scheme of the window reveal panel

### 6.6.2 Detail B – Skirting

The existing skirting is covered with a sandwich panel designed for it. Comprised of 10mm insulation, a channel for fixing and a 15mm wooden/tile finish that are screwed together. The channel has provision for fixing to the wall.

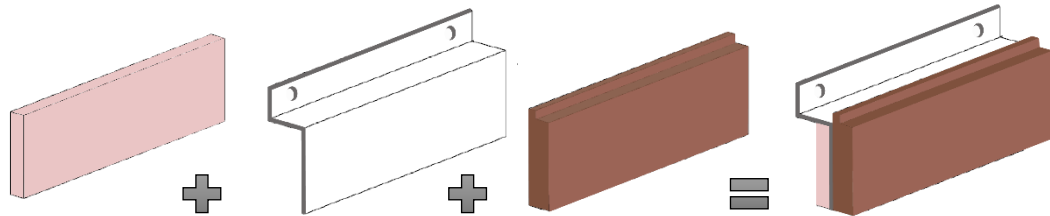

Figure 62 the elements that come together to form the insulated skirting panel

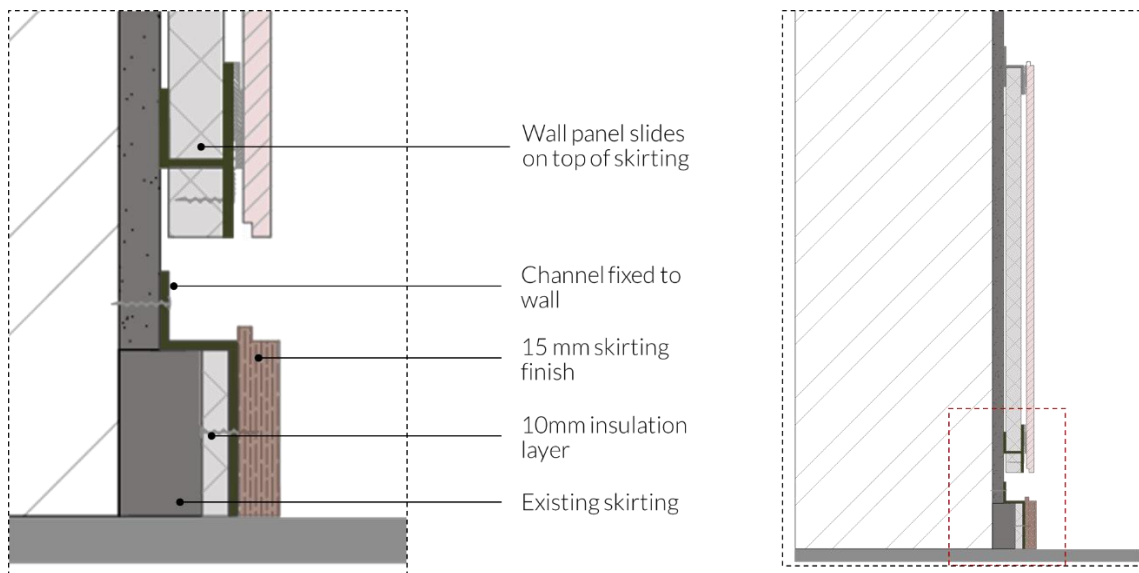

Figure 63 vertical section highlighting the fixing of the skirting panel. The skirting finish is designed such that the wall panel can be fitted in top forming a shiplap joint. For easy understanding the wall panel is shown offset from the skirting panel.

### 6.6.2 Detail B - pipeline

There are 3 possible solutions to tackle any objects that might hinder the application of insulation.

The first and most commonly used way, Option A. is to remove all elements before work commences. While this will make application easy, it requires a lot of pre and post job work of removal and reinstallations.

The other two option work around these elements to ensure minimal impact. The Option B is suitable when there are conduits running next to the wall with less than 30 mm space in between. In this case, a deliberate break is created in the insulation

to accommodate the pipes as shown in figure 64. The pipes in this case are concealed in between the insulation and the finish board is attached as usual.

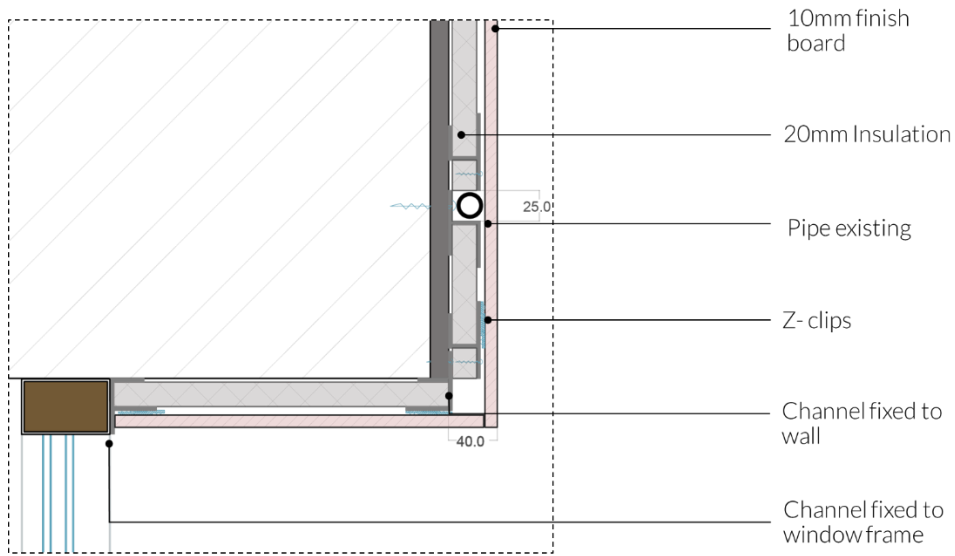

Figure 64 vertical section through the lintel wall where a pipe goes through the insulation.

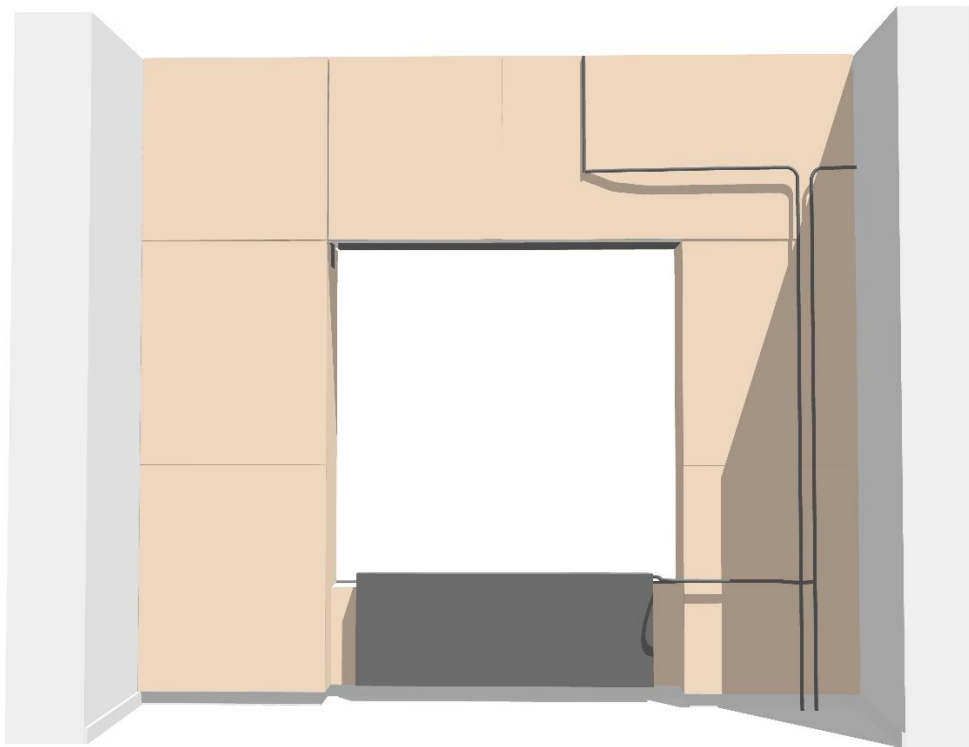

Figure 65 representation of the look with the pipeline incorporated between the insulation.

The third way, Option C, offers a way to hide all the pipelines by creating a fake cavity space between the insulation and the finish board layers. This option might be visually more attractive but a lot of extra space is wasted in creating the cavity .

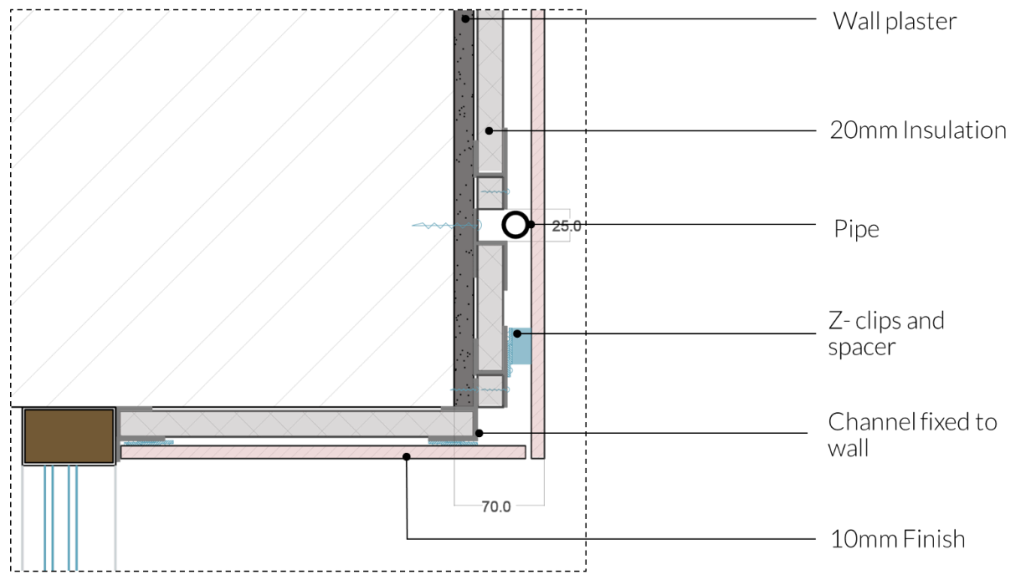

Figure 66 A spacer block is added to create a cavity space to between the insulation and board.

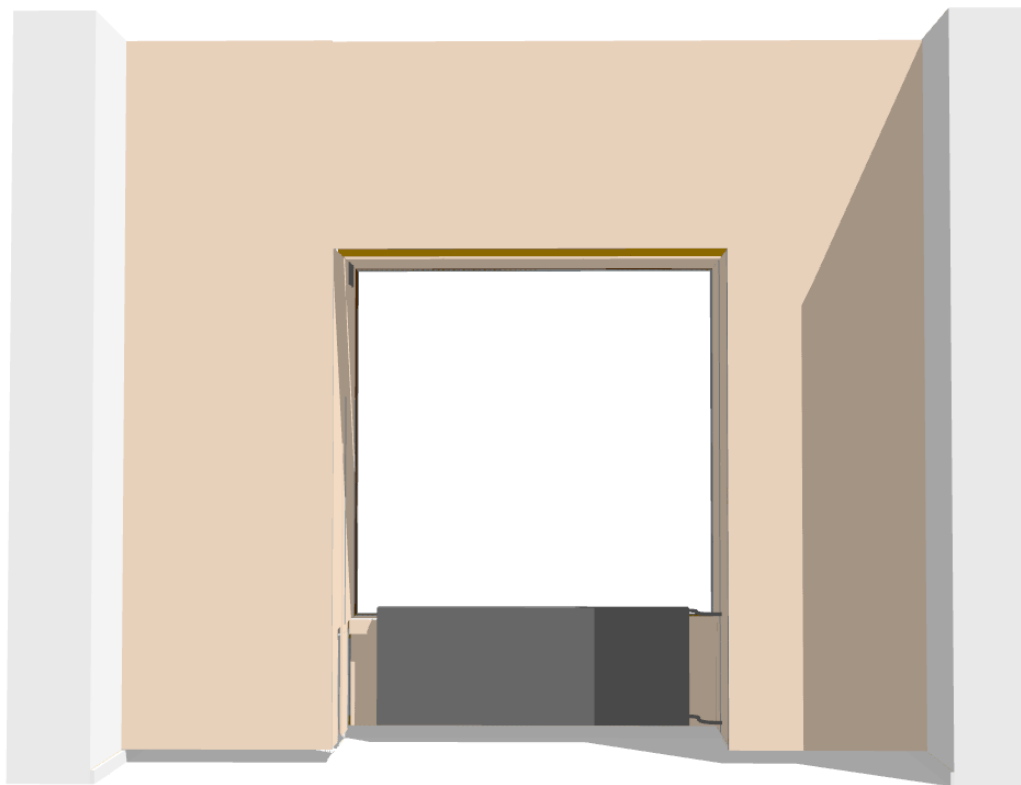
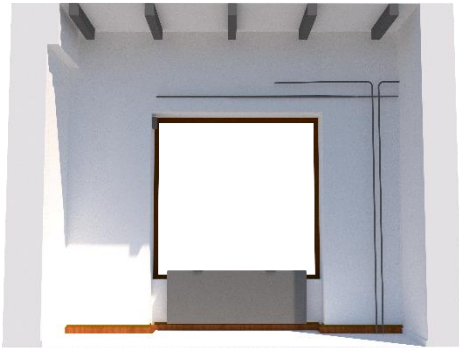

Figure 67 Option C of creating a break in the insulation for intersecting pipes. Here the finish board has been pulled out to create a cavity space where the all the pipes can hide.



## 6.7. Installation sequence

During the detailing phase of the project, it was observed that fixing of the panels needs to be followed in a chronological order else they would not fit. Therefore, the panels come with an installation guide to help the installers with the process. Refer Appendix C for the guide. The following image sequences describe the process in the order to be followed.



Step 1: install the skirting panel

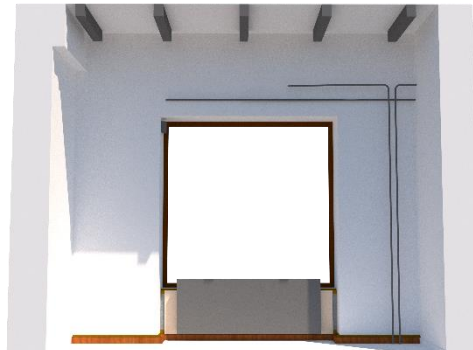

Step 2: sill panel, slide behind radiator

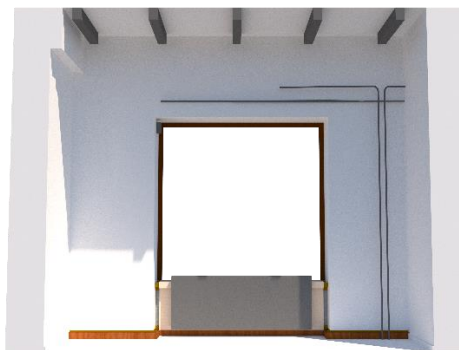

Step 3: sill window reveal

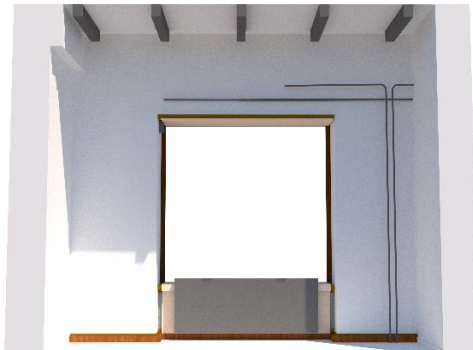

Step 4: lintel window reveal

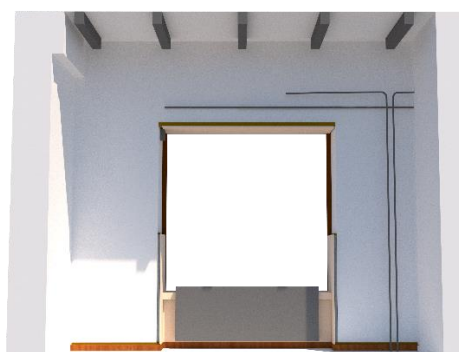

Step 5: bottom panels of window side

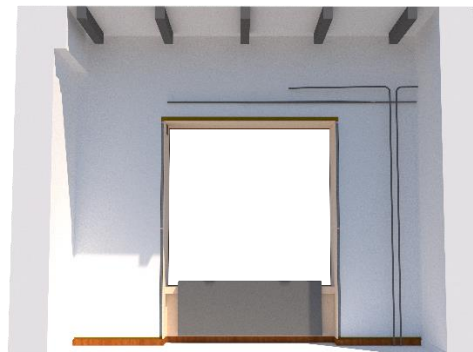

Step 6: top panels of window side

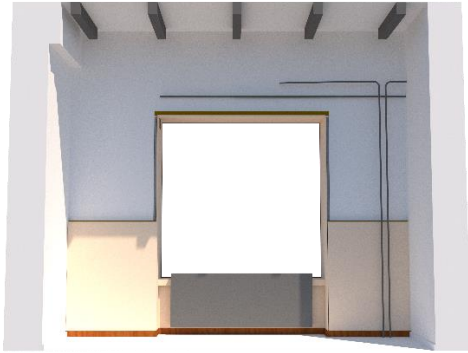

Step 7: bottom panels on wall

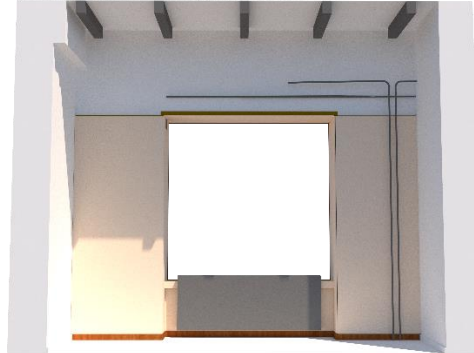

Step 8: middle panel on wall

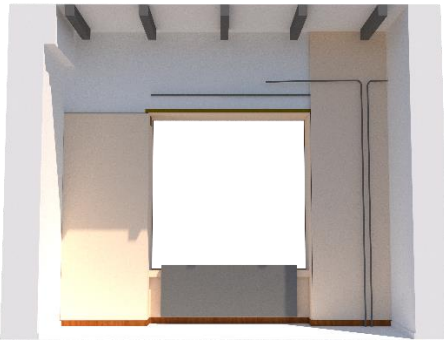

Step 9: top panel, slide behind pipes

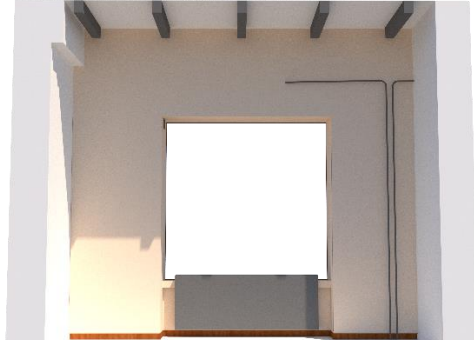

Step 10: adjacent panel fixed to finish

## 6.8. Visualization

The demonstration room is visualised with the insulated panels in place with different finishes.

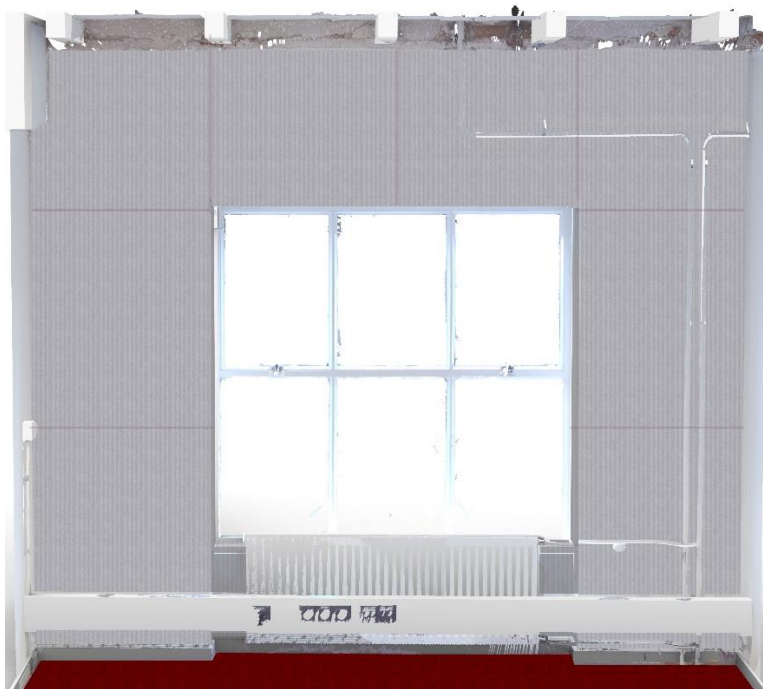

Figure 68 Schematic view of panel layout

Before and After visualization of the room.



## 6.9. Conclusion

For the data capture- The laser light is reflected off the first surface of contact and thus can only relay data that is in the equipment's sight range. Therefore, the target to be scanned needs to be free of obstructions as much as possible to allow for direct visuals. For a thorough scan, it is recommended to take multiple scans from different positions.

The FARO SCENE software does most of the work of stitching the scans and forms point cloud. To extract data from this point cloud can be done in various parts in various software which require a good understanding of point clouds and meshes and a clear goal of what need to be done.

For processing information- Lack of knowledge and time constraint led to draw over the point cloud rather than process them to extract information regarding the surfaces. As a result the accuracy is not very good. Some software exist that deal specifically in point cloud and the literature research was used as foundation to prove that the it is possible to get accurate measurements from the scanner.

The design layout options are user dependent and are relevant for Vacuum insulation panel. Using standard size panel can will be a cheaper solution but the performance will be compromised with infills of lower resistance material. If budget allows, a custom sized prefabricated panel with VIP's will be better for the performance. Since Aerogels come as a wide roll, there application will always be by cutting to size.

The case study demonstrate how the typical connection details need to be modified as in the case with the cable pipe. The easiest option would be to relocate the pipe such that it does not sun through the insulation. But with an integrating approach, options are also created for accommodating the pipes by insulating around the pipe. The area becomes a thermal bridge but incorporated the existing features as they are. Taking advantage of the disassembly friendly construction, the fixing of the finish board can be made out of a wider material to create a cavity conditions and hide any pipes behind it.

Collectively as a process for renovation, the proposed workflow can manage to save space with the material, measurement time , application time, material use and wastage. Most importantly with visualizations and personalisation, it engages the occupants in the process but does not cause on site disturbances.

## **07** CONCLUSION

## 7.1. Sub- Research questions

*What are the current practices for energy renovation process in housing sector?*

Most common practices for energy renovations in the residential sector start with insulation of the external/internal envelope followed by installing efficient boilers, changing fixtures and installing renewable energy generation systems. The process of insulation of the envelope is rather tedious work that requires to first measure the walls, identify which insulation would work best for the house depending on the existing construction, calculate how much insulation would be required, gather supplies and specialised tools for cutting the insulation to size, clean and treat the walls to ensure an even surface for adhesion, prepare structural system to support the insulation, apply the insulation to the wall, apply vapour retardant membrane and finally cover with a wall finish of choice.

*What are the challenges and barriers in practice with regards to insulating protected facade buildings?*

Preservation of the culture and heritage is an important factor in protected buildings that limits the degree of renovation that can be implemented to the façade of a building. As a result these buildings cannot undergo any renovation that will alter or impact the facade aesthetics and are therefore not required by the law to meet with the energy performance requirements. Furthermore, it is more challenging to insulate from the interior rather than the exterior. The factors acting as barriers are:

1. Preparation- of surfaces before measurement and application of insulation can happen. This includes any decoration, wall finishes, fixtures, skirting etc. and makes the process labour intensive and time consuming.
2. Condensation- insulation applied to the interior is more prone to develop condensation and promote mould growth if a vapour barrier is not applied.
3. Space- insulating on the interior takes away useful floor space. For a high performance, the insulation will be 100mm to 150mm thick in section.
4. Discomfort- the long duration of the process often needs occupants to vacate the building leading to temporary dislocation.

*What are the advancements in insulation material and what are their advantages over conventional material?*

Superinsulators are advanced insulation material that are superior from the traditional ones due to their extremely low level of thermal conductivity. Vacuum insulation panel and aerogel based insulation products fall under this category. Since the thermal performance is directly dependent on thickness, for a U-value of  $0.3 \text{ W/ m}^2\text{K}$ , a Vacuum insulation panel required only 20mm of material thickness in comparison to the best performing mineral wool with a thickness of 100mm. The

slimmer profiles of insulation material saves crucial floor space without compromising on the thermal performance. The vacuum insulation are airtight and vapour-tight and thus do not pose any threat to mould growth. The aerogel material are hydrophobic but vapour open and require a vapor barrier membrane to stop vapour transfer.

Additionally, more research is being conducted to find new Nano-material as well as bio-based and sustainable alternative material. For example, cellulose is an alternative to the silica component in aerogel production making the material a bio-based high performing superinsulators.

#### *What are the technological advancements that can aid renovation process?*

Technological advancements with machine learning provide the means to automate process. The first technology introduced is data capture using laser scanner to get accurate measurements in a time duration of minutes. Combined with post processing, the point cloud data captured can be translated into a digital model and used for various purposes such as Virtual reality projects or as a record.

Production techniques such as prefabrication, ease of demounting, ease of disassembly decrease the onsite assembly time. Coming in a single product, the sandwich panel system comes with has a surface finish that also protects the insulation inside. Once on site, the only action required is to mechanically fix these panels into place. There is no cutting or cleaning work. Prefabrication also reduces the material waste by manufacturing products precisely to the dimension.

The proposed workflow works in principle by using the digital data capture technology to create an accurately dimensioned 3D model through details and measurements of surfaces are extracted to create layouts for insulation. The quantity and sizes can then assist the prefabrication process where custom sized panels are created and shipped for application.

By doing so, the new workflow has eliminated hours of manual measurement, transfer of the dimensions to a CAD software, sizing and cutting of material and labour intensive work of applying insulation material, its support system and the surface finishes.

## 7.2. Main research question

*How can the advancements in insulation material and technologies help to optimize the energy renovation process of interior envelope?*

The key shortcomings of the current renovation processes are that they take a lot of time to measure and install a thick section of insulation that takes up crucial floor space and in this process, leave a lot of construction waste and become a nuisance to the occupants. This process, however can be optimized to overcome these barriers and make interior renovations better accepted.

Super insulation material have an advantage of saving space over common insulation material. With reduced thickness of material, these are particularly beneficial in situations where there is a limitation in area or tight corners as they can easily fit in between. Material such as Aerogel blankets are flexible to cover curved surfaces for an even wider range of application. Places that could not renovate due to lack of space, can now fulfil their energy efficiency goal.

Digital data collection by means of a laser scanning can greatly reduce the time for measuring surfaces to a few minutes per room. While capturing is the easy part, processing of this data by digital means becomes an important task. A mistake in this step can lead to an inaccurate data generation and inaccurate production. Software knowledge and machine learning form an integral part of this process. And while much innovation is happening in this sector, in case of the demonstration room, insufficient knowledge and lack of time lead to manual regeneration of not very accurate model. This technique can be valuable for places with complex geometries or with high level of detailing or with large scale projects to also justify the finances of getting a laser scanner and skilled software workers.

Prefabrication is not a new concept and is widely used. But combined with digital design, this technique can prove to be extremely helpful in the renovation process by saving application time, labour cost and occupant discomfort. Product design uses the regenerated 3D model from the scanning process to design produce prefabricated insulated sandwich panel that just need to be installed on site. An integration with digital design is crucial because every room, every building will have some atypical unusual connections that require a custom solution. On the other hand, depending on the number of customised members, the production process itself can take more time than in case of a standard application.

The product design tries to preach the concepts of adaptability and reusability to reduce single use products and control the waste. To achieve that, the panel are designed such that each element can be separated from the panel into its original form without any damage. These can then be reused in another project. While this concept is environment conscious, it also leads to more elements of connections



and fixing. Adhesives are so integrated into the production and fixing process that the alternatives seem complex with too many elements.

The demonstration project highlights how a new project can bring about new challenges with respect to the complexity of wall surface, angled connections or fixtures on the wall. The product needs to evolve with every situation. The research has presented some options for material, layout and panel design but there is no one correct solution, Every option can be adopted based on the boundary conditions and situations.

To conclude, the proposed workflow can make the renovation process a lot smoother and managed for the occupants and more sustainable than the current but it also increase the work on the backhand with all the processing and design of each panel. Advance material, digitalization and prefabrication helps to streamline the production, the process needs an active involvement and therefore cannot be completely automated.

### **7.3.Future developments**

Given the time frame of the project, only some parts of the renovation process have been addressed in detail while some have been assumed to be true based on the literature study of the topic.

This study focuses only on insulating the opaque envelope. Nevertheless, the impact of glazing on the thermal performance is equally important. It is established that the windows are the weakest links and thereby must be insulated first. It will be interesting to see the developments in improve window efficiency and how they can also be incorporated in the proposed workflow.

The study briefly explores a digital workflow of translating point cloud data from laser scanning to an accurate 3d model. For the thesis, a model has been manually drawn over the point cloud in Revit and Rhinoceros software but this method is not very accurate. EU research project EASEE (2014) developed a "retrofitting planner" tool which is able to translate point cloud data to surfaces with a high accuracy. Other tools such as Geomagic Wrap also offer solutions to deal with point clouds. Working with point clouds is a fairly recent topic and with growing popularity of laser scanning it will be beneficial to develop a tool.

Another topic to dive into is a parametric digital workflow that allows the designer to find out the best arrangement of insulation panels. For the case study room, the process was done manually on the criterial of standard panel sizing and aesthetics.

Lastly it will also be interesting to see how the workflow performs on actual application with built prototype to be installed. This study could not test regarding the strength and stability of the design which might influence and alter the design of the panels.

## **08** SUSTAINABILITY ASSESSMENT

This thesis planned to inculcate sustainable development into renovation process association with culture and heritage.

Sustainable development is based on the PPP model that works on a merger of interest between People, Planet and Profit. Anke van Hal (2018) describes the merger of interest with firstly, identifying the interest of people, then address their interest using measures that also represent the interest of planet and lastly plan financial models to invest in such measures.

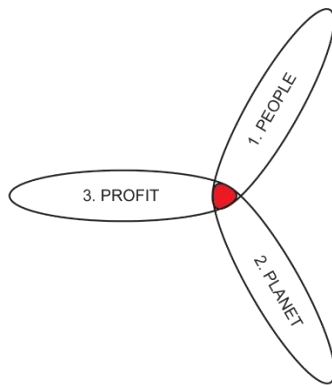

Figure 69 The synergy of People, Planet and Profit in an merger of interest. Source: Anke van Hal (2018)

## PEOPLE

This perspective places the focus on occupant needs and addresses them in an environmentally friendly way. Homes come with a lot personalized spaces that holds an emotional value and can make the renovation process very sensitive in nature. Interior renovations rarely done because of the extensive level of interventions and the time taken to complete works. The thesis proposes an optimized workflow of the renovation process to reduce the impact on occupants by reducing the time spent on site and streamlining the production process such that no work would be done on site in a bid to make energy renovations more accepted in the society.

Digitalization of the measuring process already reduces the time to manually measure a space. Digital design combined with off-site prefabrication ensures that the next time the occupants will be disturbed would be to install the insulated panel that already come with a finish further reducing on-site time. A special benefit of having a laser scanner is the ability to also involve the people at a design stage where they can see on a digital platform how the intervention will change their interior spaces and customise finishes as per their desire.

## PLANET

Efforts have been made at every phase of the research to identify the most sustainable options by evaluation of material options.

**Choice of insulation material** - In the first phase of material research, the primary aim was to choose material that have a high performance and low thickness ratio to address the space constraints of insulating walls. These material are then assessed on the their life span and end-of-life use.

Aerogel blanket product does not contain any substance that may be dangerous to environment or health. After a 50 year life span, the material can still be re-used or recycled into its main components of glass fibre and aerogel. Silica aerogel is inert and does not harm the soil or water in case of introduction to landfills. However, the life cycle assessment analysis shows that the production stage of the process dominates the environmental impacts. Aerogels are currently produced using silica as a raw material which adds to the cost and higher CO<sub>2</sub> production.

Vacuum panels comprise of a core, made of fumed silica, infrared opacifiers and cellulose fibres which is heat-sealed under vacuum into a metallised high-barrier film. Production of VIP's happen in a controlled environment that ensures no environmental pollution is triggered during application. After an average life span of 30 years, the panel can be broken into components where the core is crushed and recycled for new core productions. The metallised plastic composite film needs special recycling. As with aerogels, the core production accounts for nearly 95% in the LCA.

As per the current scenario, the Aerogel based products are more sustainable compared to the Vacuum panels with every component separable and recyclable. Furthermore, research is being conducted for alternative source of raw material. González, Nadargi, Goiti, Ocejó, & Vegas (2017) have researched about extracting silica out of the construction demolition waste such as siliceous concrete sand, building glass, mineral wool etc thereby reducing the stress on extracting raw silica. Long, Weng & Wong (2018) have synthesised Aerogel from cellulose instead of silica. The cellulose based Aerogel has "renewability, biocompatibility, and biodegradability of cellulose, while also having other advantages, such as low density, high porosity, and a large specific surface area." The cellulose aerogel can also be developed as a alternate for silica aerogel for the core of vacuum panels.

**Conscious design** - The second phase of design decisions for a prefabricated panel resonate with the ideology of a circular adaptable design. The aim of the design innovation was to have a product that can be prefabricated to reduce onsite time and impact, be easily assembled, be demountable and dis-assembled

The commercially available insulated sandwich panel rely heavily on the use of adhesives for fixing multiple layers together which makes elements difficult to separate at the end of product life for recycling. To tackle this, the different layers of the panel are fitted into channels that keep them together. The channel are then fixed to the wall using mechanical fasteners. The finish board are attached with clips that can be easily removed to access or insulation at its end of life.

The channels holding the insulation can be adapted to accommodate insulation of varying thickness without changing the system. This feature promotes reusability and adaptability of the same product in different conditions making the final design 'one product fits all'.

A dilemma was faced with regards to the material of the fixing channels. The common materials are steel and plastics. While steel is more environmentally friendly than plastic, the latter has a better thermal resistance and does not act as a thermal bridge. Wood on the other hand, is sustainable with a good thermal resistance but in the current design scheme would lead to a significant increase in the thickness of the panel and negates the advantages of having slimmer insulation. An alternate material "Treeplast" is found to be suitable as it is a 100% natural wood based composite. The material can be extruded into profiles and carry loads although the thermal conductivity properties are not known yet. Innovations in natural fibre reinforced composites with bio resin can also prove to be a sustainable material option.

## **PROFIT**

The most prominent barrier in the widespread acceptance of superinsulator material is the high cost which is associated with production of the material itself. Likewise, the laser scanner equipment is quite expensive to purchase for a single household and require expensive software for post processing. However these additional cost can be compensated by smarter and adaptable design that lead to lesser material requirement, lesser labour cost and no demolition costs. Moreover, in large scale projects, for examples with an housing corporation, the high demand lowers the supply cost. The insulation panels are designed such that one assembly line can prepare products with different insulations, within the same framework, based on the requirement thereby reducing additional cost for customised sections. On the same line of thought, the panels are designed to comply with the commercially available sizes as well as customised shapes based on the budget.

Lastly, the European Union commissioned projects such as VIP4ALL are developing prototypes of vacuum insulation panel that are affordable by replacing the core material of fumed silica by cheaply produced natural material. ("VIP4ALL - Home," n.d.)

## **09** REFERENCES

## Reference list

- (1) (PDF) The state of the art: Super-insulation construction materials under the UK's domestic energy building: aerogel and vacuum insulation technology applications. (n.d.). Retrieved December 24, 2018, from ResearchGate website:  
[https://www.researchgate.net/publication/299470010\\_The\\_state\\_of\\_the\\_art\\_super-insulation\\_construction\\_materials\\_under\\_the\\_UK's\\_domestic\\_energy\\_building\\_aerogel\\_and\\_vacuum\\_insulation\\_technology\\_applications](https://www.researchgate.net/publication/299470010_The_state_of_the_art_super-insulation_construction_materials_under_the_UK's_domestic_energy_building_aerogel_and_vacuum_insulation_technology_applications)
- 1ST-IMPRESS-E-BULLETIN.pdf*. (n.d.). Retrieved from <http://www.project-impress.eu/wp-content/uploads/2017/09/1ST-IMPRESS-E-BULLETIN.pdf>
- Advanced Materials for Energy Efficient Buildings - Smart Cities Stakeholder Platform.pdf*. (n.d.).
- aspen aerogels. (n.d.). *Tecchnical guidance document - spaceloft aerogel blanket insulation*.
- Boži, J. (2015). NANO INSULATION MATERIALS FOR ENERGY EFFICIENT BUILDINGS. *Contemporary Materials*, 11. <https://doi.org/doi:10.7251/COMEN1502149B>
- Deliverable 7.10 Second journal conference paper*. (n.d.). Retrieved from <http://www.project-impress.eu/wp-content/uploads/2017/09/D7.10-Second-journal-conference-paper.pdf>
- Design Energy-neutral monument. (n.d.). Retrieved December 19, 2018, from <http://energieneutraalmonument.nl/proces/>

D'Oca, S., Ferrante, A., Ferrer, C., Perneti, R., Gralka, A., Sebastian, R., & op 't Veld, P. (2018). Technical, Financial, and Social Barriers and Challenges in Deep Building Renovation: Integration of Lessons Learned from the H2020 Cluster Projects. *Buildings*, 8(12), 174.  
<https://doi.org/10.3390/buildings8120174>

Elmer, T., Shatat, M., Tetlow, D., & Riffat, S. (2015, August). *The state of the art: super-insulation construction materials under the UK's domestic energy building: aerogel and vacuum insulation technology applications*. Presented at the 14th International Conference on Sustainable Energy Technologies – SET 2015, Nottingham, UK. <https://doi.org/DOI:10.13140/RG.2.1.1851.0327>

Energie label woningen | RVO.nl. (n.d.). Retrieved December 14, 2018, from <https://www.rvo.nl/onderwerpen/duurzaam-ondernemen/gebouwen/wetten-en-regels-gebouwen/bestaandebouw/energielabel-woningen>

Energie labels - Dashboard - Nederland. (n.d.). Retrieved December 22, 2018, from <https://energiecijfers.databank.nl/dashboard/Energie labels/>

*EnergieSprong\_UK-Transition\_Zero\_document.pdf*. (n.d.). Retrieved from [https://energiesprong.org/wp-content/uploads/2017/04/EnergieSprong\\_UK-Transition\\_Zero\\_document.pdf](https://energiesprong.org/wp-content/uploads/2017/04/EnergieSprong_UK-Transition_Zero_document.pdf)

Energieverbruik en -besparing - Dashboard - Nederland. (n.d.). Retrieved December 22, 2018, from



<https://energiecijfers.databank.nl/dashboard/Energieverbruik-en--besparing/>

*EN\_Projectsheet\_Driebergen\_E-nul\_LowRes.pdf*. (n.d.). Retrieved from

[https://www.zecc.nl/uploaded\\_files/project/EN\\_Projectsheet\\_Driebergen\\_E-nul\\_LowRes.pdf](https://www.zecc.nl/uploaded_files/project/EN_Projectsheet_Driebergen_E-nul_LowRes.pdf)

*epd725 Spaceloft Aerogel Insulation.pdf*. (n.d.). Retrieved from

<https://gryphon4.environdec.com/system/data/files/6/11160/epd725%20Spaceloft%20Aerogel%20Insulation.pdf>

Faltynova, M., Matouskova, E., & Sedina, J. (2016). BUILDING FACADE

DOCUMENTATION USING LASER SCANNING AND PHOTOGRAMMETRY AND DATA IMPLEMENTATION INTO BIM. *The International Archives of the Photogrammetry, Remote Sensing and Spatial Information Sciences, XLI-B3, 2016*, 215–220. Prague, Czech Republic.

Frost, A. (2018). *applied digital documentation in the historic environment*. Edinburgh: Historic Environment Scotland.

GBPN - Netherlands. (n.d.). Retrieved May 21, 2019, from Global Buildings

Performance Network website: <http://www.gbpn.org/databases-tools/rp-detail-pages/netherlands>

González, F. R., Nadargi, D., Goiti, E., Ocejo, M., & Vegas, I. (2017, June 21). *Novel circular economy business model of high-added value products for energy efficiency: from C&DW to aerogels*. Presented at the International HISER Conference on Advances in Recycling and Management of Construction and Demolition Waste, Delft, The Netherlands.

- Infographic energielabel cijfers 2017 (jpg) | RVO.nl. (n.d.). Retrieved January 5, 2019, from <https://www.rvo.nl/file/infographic-energielabel-cijfers-2017-jpg-0>
- Installation practice with interior insulation. (n.d.). Retrieved January 7, 2019, from [https://www.engenius.at/fileadmin/user\\_upload/gebaeudesanierung\\_einfuehrung/en/web/installation\\_practice\\_with\\_interior\\_insulation.html](https://www.engenius.at/fileadmin/user_upload/gebaeudesanierung_einfuehrung/en/web/installation_practice_with_interior_insulation.html)
- Kalnæs, S. E., & Jelle, B. P. (2014). Vacuum insulation panel products: A state-of-the-art review and future research pathways. *Applied Energy*, *116*, 355–375. <https://doi.org/10.1016/j.apenergy.2013.11.032>
- Myers, B. (2018). *Getting started with point cloud data: Revit: Using Point Cloud Data*. Retrieved from <https://www.linkedin.com/learning/revit-using-point-cloud-data/getting-started-with-point-cloud-data>
- Nan, L. (2018, March). *Point Cloud Registration & Reconstruction*. Presented at the Point Cloud Processing 2018, Delft, The Netherlands. Retrieved from [https://3d.bk.tudelft.nl/pdfs/pcp2018/pcp2018\\_LiangliangNan.pdf](https://3d.bk.tudelft.nl/pdfs/pcp2018/pcp2018_LiangliangNan.pdf)
- Odgaard T., Bjarløv SP., Rode C., & Vesterlørkke M. (2015). Building Renovation with Interior Insulation on Solid Masonry Walls in Denmark – A study of the Building Segment and Possible Solutions. *Energy Procedia*, *78*, 830–835. <https://doi.org/10.1016/j.egypro.2015.11.003>
- Overview article Superinsulating materials 12052014.pdf*. (n.d.). Retrieved from <http://www.buildup.eu/sites/default/files/content/Overview%20article%20Superinsulating%20materials%2012052014.pdf>

- Quenard, D. (2013, November 27). OVERVIEW - Superinsulating Materials: A New Era of Insulation Technologies. Retrieved November 6, 2018, from BUILD UP The European Portal for Energy Efficiency in Buildings website:  
<http://www.buildup.eu/en/news/overview-superinsulating-materials-new-era-insulation-technologies>
- Schoor, T. van der. (2013, September). *Strategies for energy efficient restorations*. Presented at the Energy efficient Restoration International Conference 2013. Retrieved from  
<https://research.hanze.nl/en/publications/strategies-for-energy-efficient-restorations>
- Shukla, A., & Sharma, A. (2018). *Sustainability through Energy-Efficient Buildings*. CRC Press.
- Spaceloft-European-Datasheet-EN.pdf*. (n.d.). Retrieved from  
[https://www.aerogel.com/\\_resources/common/userfiles/file/Data%20Sheets/Spaceloft-European-Datasheet-EN.pdf](https://www.aerogel.com/_resources/common/userfiles/file/Data%20Sheets/Spaceloft-European-Datasheet-EN.pdf)
- Technical solutions for energy reduced and renewable energy sources for optimal energy efficient renovation*. (2014, November 20). NeZeR.
- Transition Zero. (n.d.). *Report on Market Assessment and Bottlenecks*. Transition zero.
- van der Linden, A. C., Kuijpers-Van Gaalen, I. M., & Zeegers, A. (2018). *Building Physics*. ThiemeMeulenhoff.
- van Hal, A. (2014). *The merger of Interests 2.0 - The story behind a perspective shift*. Retrieved from <https://brightspace.tudelft.nl/content/enforced/45932-AR0054-M-2017->

4/The%20Merger%20of%20Interests%202.0.pdf?\_&d2lSessionVal=EGGSjX  
SooOXCIVE66yEi0Hd71&ou=45932

VA-Q-TEC. (2018, December 6). *va-Q-vip F Product Data Sheet*. Retrieved from  
<https://www.va-q-tec.com/en/produkte/va-q-vip-f/>

VIP4ALL - Home. (n.d.). Retrieved May 20, 2019, from <https://www.vip4all.com/>

What are Vacuum Insulation Panels? (n.d.). Retrieved June 26, 2019, from Vipa  
International website: <https://vipa-international.org/vacuum-insulation-panels>

# 10 APPENDIX

## Appendix A: Workflow for heat reduction calculation in Rhinoceros

A shoebox model was created with parametrically changeable glazing percentage. The wall surface with the glazing is considered for heat exchange while all other surfaces have been made adiabatic.

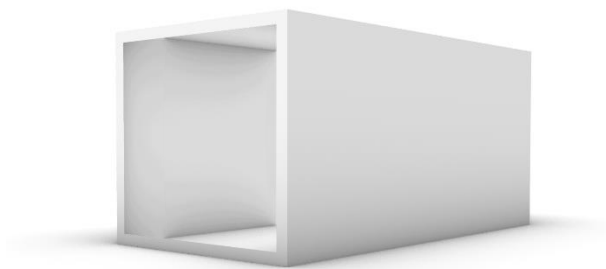
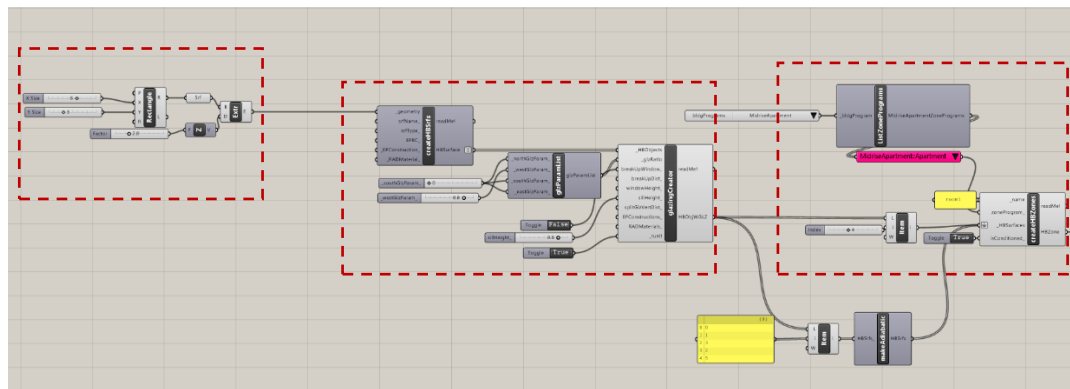

Figure 70 Render of the shoebox model with 80% glazed surface



Create the box

Add glazing based of orientation and percentage

Set zone program and create zone for analysis

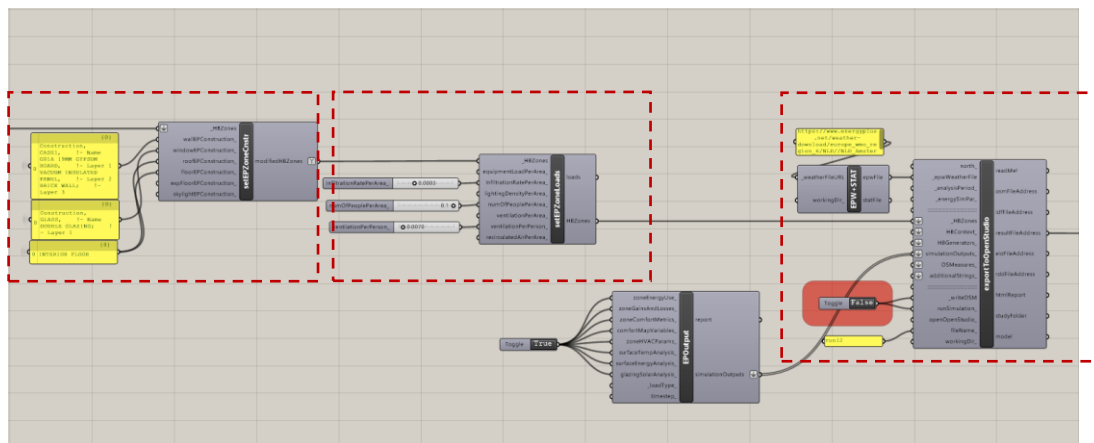

Apply material for each surface

Set zone loads for lighting, ventilation and occupancy

Load weather file and run simulation

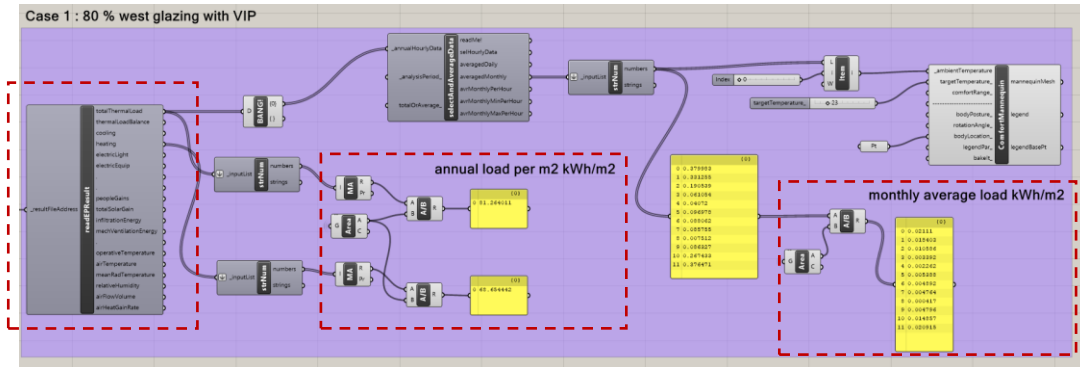



Load result file for processing

Add the hourly value and divide by the area to achieve annual heating load kWh/m<sup>2</sup>



If required, monthly average values can also be calculated

This workflow was followed for simulation of different cases with changing glazing percentage and glass material properties to form a comparative matrix.

## Appendix B : Material Matrix

	Vacuum insulation panel	Aerogel blanket
<b>PERFORMANCE</b>		
Thermal conductivity	0.004 W/mK	0.015 W/mK
Moisture and condensation	Impermeable to air and moisture. If the connection between them is insufficiently sealed and allows for air and vapor transport through the layer, it can create problems	Spaceloft® is water vapour permeable ( $\mu=5$ ), hydrophobic and non-capillary active. Thus a vapour retardant membrane is required
Fire resistance	The core material is non-combustible (fire class A) but the polymer foil barrier is inflammable. The product is approved for general construction purposes.	Classified C-s1,d0 (difficult to ignite, no/hardly smoke and no flaming droplets)
<b>APPLICATION</b>		
Physical form	Rigid panel	Flexible blanket
Thickness	10-40mm x 500/1000mm x 600mm	5mm/10mm X 1470 mm wide
Composition	Vacuumised rigid porous center (powder silica ) and membrane walls	The aerogel component of Spaceloft® is synthetic amorphous (non-crystalline) silica with PET/glass fibre and additives
Finishing	Tough impact material Mesh reinforced mortar or OSB board with plaster board finish	Tough impact layer such as gypsum, wood fibre board, calcium silicate board, cement fibre board etc. or direct plaster of lime, gypsum, clay, sand cement and polymer modified coating on a reinforcing mesh
<b>FIXING</b>		
to the wall	Friction fitting the VIPs with foam sill sealer in order to provide a tight fit and reduce potential puncture from wood splinters, and fitting the VIPs in with table saw milled Extruded Polystyrene (XPS) foam strips  	Blankets should be secured tightly using appropriate mechanical fixings of polymer and/or stainless steel construction to minimise point thermal bridging. Insulation should be butted tightly to ensure continuity of thermal performance and avoid thermal looping.  
<b>SUSTAINABILITY</b>		
life expectancy	25 years	50 years
End of life	The core material can be separated and depending on material can be recycled	Aerogel blankets can be separated into fibre and aerogel. Offcuts can be retained for use in thermal bridging applications or processed into loose-fill insulation. Waste channels exist for the textile component while the silica component can re-used as a particulate insulation in loose fill, mortars, renders, paints etc.
<b>CHALLENGES</b>		
	Cost that is dependent on the core material, durability dependent on a well thought of design, reduce the effect of thermal bridging around the panel, connections to the wall, handling at the site	Preliminary analysis suggest risk of condensation without a vapour retardant

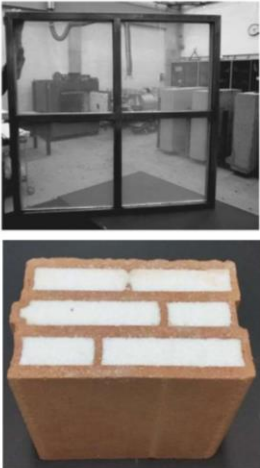

Aerogel granules	Aerogel board	Aerogel plaster
0.019 W/mK	0.016 W/mK	0.028 W/mK
Grains are hydrophobic, casing should be vapour retardant	Hydrophobic with or without vapour retardant . The Magnesium Carrier Board is hydroscopic which means it can take up internal moisture quite safely and without danger of mould	Water vapour permeable, hydrophobic and non-capillary active
Classified C-s1,d0 (difficult to ignite, no/hardly smoke and no flaming droplets)	Classified C-s1,d0 (difficult to ignite, no/hardly smoke and no flaming droplets)	Classified C-s1,d0 (difficult to ignite, no/hardly smoke and no flaming droplets)
Granules	Rigid board	Render
Thickness of the container	10mm x 2400mm x 1000mm	30mm-50mm thickness
Silica gel in which the liquid component is extracted replaced by air by supercritical drying process	The boards are basically aerogel blanket that come finished with Magnesium oxide boards	Hydraulic lime NHL 5, calcium hydroxide, white cement are used as binders with Aerogel granules and light mineral aggregate. water retaining agent, air-entraining agent and hydrophobic agent are added to the mix
Tough impact material. Generally glass or brick	Comes finished with Magnesium oxide board	Requires a reinforcing mesh before the final render (mineral based) can be applied and then painted for finish.
Infill within cavity spaces of glazing or bricks or a custom crafted casing	Once the board is in place, apply pressure to compress the aerogel slightly and use a 3mm to 5mm drill bit to drill pilot holes through the board and into the wall and push the stainless steel / nylon fixings into place.	The premix plaster is prepared and directly sprayed on the surfaces to ensure an even layer. The plaster then require 10 days of curing time before finish can be applied
		
25 years	50 year	20 year
The loose grains can simply be extracted and reused in another application. In case an additive is added to hold the granules, extracting the components is difficult.	Recycled into its main component parts Polyester/ Glass Fibre and Silica Aerogel. The adhesion of MgO board to the blankets can result in wastage of material	It is more difficult to separate aerogel grains from the plaster mix. As a result, the plaster can only be broken into smaller pieces and be used as insulated infills.
Granules should be filled with care such that there are not empty spaces or corners where the material doesn't fit.	Preliminary analysis suggest risk of condensation without a vapour retardant	a long curing time of 10 days makes the plaster difficult to use for interior applications.

## INSTALLATION GUIDE

### Custom finished insulated wall panels

#### Included in the package

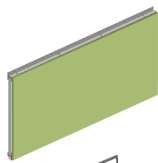

- 15 insulated wall panels

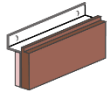

- 6 insulated skirting panel



- 68 fixing screws

#### Additional equipment



- drill machine



- spirit level

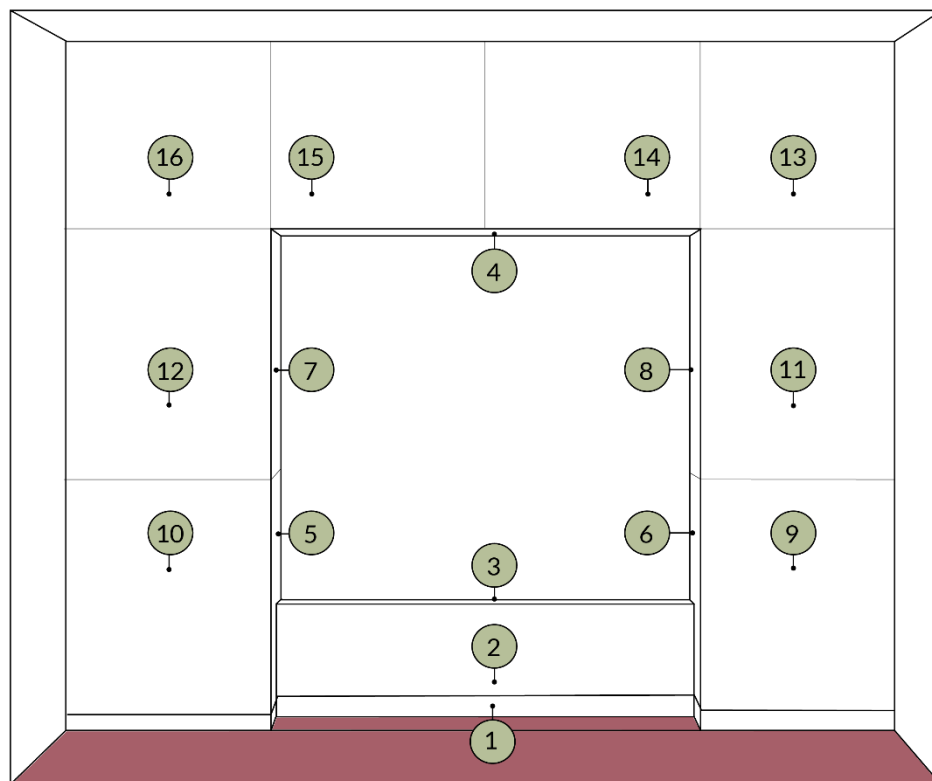

#### Order of installation

- > match number on panel with the number in the drawing for identification
- > start with fixing the skirting panels and then the sill and lintel panels
- > fix bottom piece first, check is leveled, then proceed with upper panels
- > push panels together to ensure tight fit