

# Estimating the (remaining) service life of timber bridges with the use of factor methods

And incorporating these methods in the calculation of the total costs of ownership

by

**Jeroen van de Loo**

to obtain the degree of Master of Science  
at the Delft University of Technology,  
Faculty of Civil Engineering and Geosciences,

## **Author**

Jeroen van de Loo - 4250451  
Master track: Structural Engineering  
Specialization: Structural Mechanics

## **Graduation committee**

Drs. W.F. Gard,	Technische Universiteit Delft
Prof.dr.ir J.W.G. van de Kuilen,	Technische Universiteit Delft
Dr. ir. P.C.J. Hoogenboom,	Technische Universiteit Delft

An electronic version of this thesis is available at <http://repository.tudelft.nl/>.

# Preface

This thesis called 'Using factor methods to estimate the (remaining) service life of timber bridges' is submitted in order to complete the Structural Engineering master track at the Faculty of Civil Engineering and Geosciences at the Delft University of Technology.

The graduation committee that supervised me throughout this research consisted of Prof. dr. ir. J.W.G. van de Kuilen and Drs. W.F. Gard, affiliated to the Biobased Structure and Materials department, and Dr. ir. P.C.J. Hoogenboom, affiliated to the Materials, Mechanics, Management & Design department (3Md). I thank all of them for their guidance and expertise which helped me a lot during this research.

For this research, help has been provided by the municipality of Amsterdam in the form of information and data on their timber bridge inventory. I also thank all the people from the municipality that were in any way involved in helping me with my research.

At last but not least I want to use this preface to thank my family and friends who not only supported me during the writing of this thesis, but throughout my whole time studying at the TU Delft.

*Jeroen van de Loo, Delft, March 2020*

# Summary

Timber bridges are much applied structures in the Dutch landscape. In contrast to the other two most common building materials, concrete and steel, the use of timber is however almost exclusively limited to bridges for lighter traffic, e.g. pedestrians and bicycles. Examples of timber traffic bridges in Germany, Scandinavia and even in the Netherlands, show however that, at least structurally, timber can be perfectly used in the construction of bridges for heavier traffic. Although structurally feasible, there are still a number of doubts and uncertainties that go hand in hand with timber bridges. One of them is the maximum reachable service life. This research focusses on the ability to estimate this service life with the help of so called factor methods.

The service life of a timber element in the Netherlands, with respect to biological decay, is in the basis determined by two main factors: the natural durability of the timber specie, and the moisture and temperature levels of the timber during its service life. In the case of timber bridges, where the timber elements are subjected to the weather, this can be broken down in three main influencing factors, namely:

1. Natural durability of the used timber specie
2. Local climate (Temperature, rainfall and humidity)
3. Detailing of the bridge (Protection against water accumulation)

With these three main influencing factors in mind, factor methods can be used to estimate the service life of bridge elements. These factor methods estimate the service life based on reference situations, and use modification factors to modify these reference situations into the actual situation of the element. In this research two different factor methods have been reviewed in depth: the DuraTB method, developed in Sweden, and the TimberLife method, developed in Australia.

The two factor methods have in this research been compared with each other and after that their usability and accuracy has been tested with the use of two reality checks on existing bridges in Amsterdam. For the reality checks, first an expected bridge condition was determined with the help of the two factor methods. After this the actual condition of the bridge was determined by an in-field visual inspection. Then the expected and the actual conditions were compared in order to obtain insight in the correctness of the service life estimation of the two factor methods.

In addition, the role of factor methods in the processes of service life planning and especially during the calculation of the total costs of ownership (TCO) has been discussed. An example of a TCO calculation has been performed for two bridge designs, in which the focus was put on the incorporation of both the DuraTB and the TimberLife factor methods. Even though this TCO example is not representative from a total cost point of view (since the values of the different costs were guessed), it does show how factor methods can be used in the calculation of these total costs.

# Contents

<b>Summary</b>	<b>ii</b>
<b>1 Introduction</b>	<b>1</b>
1.1 Background . . . . .	1
1.2 Problem statement . . . . .	2
1.3 Research questions . . . . .	3
1.4 Research methodology . . . . .	3
<b>Bibliography</b>	<b>4</b>
<b>I Part I: Literature Study</b>	<b>5</b>
<b>2 Timber - the material</b>	<b>6</b>
2.1 Hardwoods and Softwoods . . . . .	6
2.2 Wood products . . . . .	7
2.3 Moisture content of wood. . . . .	8
2.4 Biological degradation hazards . . . . .	9
2.5 Natural durability . . . . .	10
2.6 Material protection . . . . .	11
<b>3 Timber bridges</b>	<b>16</b>
3.1 Types of timber bridges . . . . .	16
3.2 Connections . . . . .	18
3.3 Protective design . . . . .	19
3.4 Mechanical loads on timber bridges . . . . .	21
3.5 Timber bridge inspection . . . . .	21
<b>Bibliography</b>	<b>22</b>
<b>II Part II: Service life models</b>	<b>23</b>
<b>4 Factor models: Descriptions</b>	<b>24</b>
4.1 Factor methods - General description. . . . .	24
4.2 Japanese factor method . . . . .	25
4.3 Australian factor method . . . . .	30
4.4 Swedish factor method . . . . .	37
4.5 Mechanical performance modelling . . . . .	45
4.6 Markov Chain. . . . .	46
<b>5 Factor models - Comparison</b>	<b>47</b>
5.1 Limit states . . . . .	51
5.2 Reference sources. . . . .	51
5.3 Output . . . . .	53
5.4 Factors influencing the service life . . . . .	54
<b>6 Service life estimation - Proposed approach</b>	<b>59</b>
<b>Bibliography</b>	<b>61</b>
<b>III Part III: Reality checks</b>	<b>63</b>
<b>7 Reality checks</b>	<b>64</b>
7.1 Process description . . . . .	65
7.2 Reality check 1 - Bridge 512 (complete superstructure) . . . . .	66

---

7.3 Reality check 2 - Bridge 526 . . . . .	73
<b>IV Part IV: Service Life Planning</b>	<b>79</b>
<b>8 Service life planning and total costs of ownership</b>	<b>80</b>
8.1 Service life planning . . . . .	80
8.2 Service life planning in the design process . . . . .	81
8.3 Life cycle costs (Total costs of ownership). . . . .	82
<b>9 Example of a TCO calculation</b>	<b>83</b>
9.1 Design alternatives . . . . .	83
9.2 Activity planning . . . . .	84
9.3 Cost estimation . . . . .	85
9.4 Total costs of ownership. . . . .	86
<b>Bibliography</b>	<b>89</b>
<b>Conclusions and future work</b>	<b>90</b>
<b>V Appendices</b>	<b>92</b>
<b>A Calculation of the Dutch climate factors</b>	<b>93</b>
<b>Bibliography</b>	<b>97</b>
<b>B Reality checks:</b>	
<b>Service Life Estimation of bridge 512</b>	<b>98</b>
B.1 Bridge 512. . . . .	98
<b>C TCO Example: Service Life Estimation</b>	<b>105</b>
C.1 Design alternative 1. . . . .	106
C.2 Design alternative 2. . . . .	107

# 1

## Introduction

### 1.1. Background

Timber as a building material is enjoying a significant revival the last few decades. With environmental awareness and sustainability becoming larger parts of the social debate by the day, timber becomes for architects and their clients more and more an interesting alternative for steel and concrete. Timber is, in contrast to steel and concrete, a renewable resource that extracts CO<sub>2</sub> from the air when it grows only to release this when the wood is burned or breaks down biologically. Timber is therefore considered a CO<sub>2</sub> neutral construction material which makes it the perfect material for developers and policy makers to anticipate on the current trend in which CO<sub>2</sub> emissions are considered as one of the main causes of climate change. The increasing popularity of timber can for instance be seen from the fact that high rise buildings are no longer exclusive to steel and concrete, seeing the 85 meter tall timber building Mjøstårnet in Norway, completed in 2019, and the construction of a 73 meter high timber-concrete residential building in Amsterdam, which is expected to be completed in 2021.

For bridges however the trend seems to be the other way around. The Netherlands counts a lot of smaller pedestrian and bicycle bridges made out of timber. These timber bridges are often associated with lots of maintenance works and a low service life compared to for instance steel and concrete bridges. It is for this reason that municipalities often choose to replace their timber bridges at the end of their service life by steel or composite alternatives, which are believed to have a much lower need for maintenance during their life time.

Despite this current trend it can however be expected that in the near future we will also see a revival of timber as a construction material in bridge constructions. Rijkswaterstaat, the organisation responsible for the Dutch infrastructure and waterways, is currently investigating the application of more timber in the Dutch road- and waterworks [3]. Their intention of using more timber has for instance already led to the construction in 2008 of two timber traffic bridges crossing the N7 motorway in Sneek, see figure 1.1.



Figure 1.1: One of the two timber traffic bridges in Sneek [1]

The increased interest in timber as a construction material by for instance Rijkswaterstaat has been greatly influenced by the recent climate objectives set out by the Dutch government. The goal to reduce the CO<sub>2</sub> emissions with 49% in 2030 [7] can for municipalities be a good motivation for an increased use of the CO<sub>2</sub> neutral timber as an alternative to steel and concrete in their building plans, like the construction of new bridges.

With the current national and international emphasis on reducing the CO<sub>2</sub> emissions it seems only a matter of time before these emissions will be a significant factor in the material choice for new bridge designs. However the fact that timber is prone to biological deterioration when it is exposed to weather conditions, and the amount of maintenance and the relatively low service life that goes with it is still making municipalities to often choose for other materials such as steel and composites.

These preconceptions about the life span and maintenance of timber bridges do not always have to be true. When well designed and maintained, timber bridges can reach excellent life spans [2] [4]. In order for timber, as a bridge material, to be fully considered as a worthy alternative for steel and concrete it is important to obtain better insight in its potential life span and in its total costs relative to these other materials.

## 1.2. Problem statement

There are numerous phenomena that are of influence of the service life of a structural component. Table 1.1 gives a list of the most common phenomena according to the Dutch norm NEN-ISO 15686-1 [5]. This master thesis focuses only on the last item on this list: Biological agents. The reason for this is that the general conception about timber in outside use is that the service life is mainly influenced by biological decay, e.g. wood rot.

Table 1.1: List of agents that can affect the service life of construction components according to NEN-ISO 15686-1 [5].

Nature	Class	Examples
Mechanical agents	Gravity	Snow loads, rainwater loads
	Forces and imposed or restrained deformations	Ice formation, expansion and contraction, land slip, creep
	Kinetic energy	Impacts, sand storm, water hammer
	Vibrations and noises	Tunnelling, vibration from traffic or domestic appliances
Electromagnetic agents	Radiation	Solar or ultraviolet radiation, radioactive radiation
	Electricity	Electrolytic reactions, lightning
	Magnetism	Magnetic fields
Thermal agents	Extreme levels of fast alterations of temperature	Heat, frost, thermal shock, fire
Chemical agents	Water and solvents	Air humidity, ground water, alcohol
	Oxidizing agents	Oxygen, disinfectant, bleach
	Reducing agents	Sulphides, ammonia, agents of combustion
	Acids	Carbonic acid, bird droppings, vinegar
	Alkalis (bases)	Lime, hydroxides
	Salts	Nitrates, phosphates, chlorides
	Chemically neutral	Limestone, fat, oil, ink
Biological agents	Vegetable and microbial	Bacteria, moulds, fungi, roots
	Animal	Rodents, termites, worms, birds

Because of biological decay, the condition of timber elements decreases over time till the point where the element is deteriorated so much that it does not fulfil its structural and/or aesthetic purpose any more. When designing a new (or assessing an existing) timber bridge it is therefore of importance to know how this deterioration will develop over time so that the (remaining) service life can be determined or a maintenance plan can be made.

A way of estimating the service life of structural elements is with the use of so called factor methods, of which the general description is given in NEN-ISO 15686-8 [6].

### 1.3. Research questions

The goal of this thesis will be to research how factor methods can be used in the prediction of the service life of timber bridge elements. In addition the role that these factor methods can play during the calculation of the total costs of ownership (TCO) for a new timber bridge will be examined.

Main research question:

- **How can factor methods be used to estimate the (remaining) service life of timber bridges in the Netherlands and can these factor methods be incorporated into the calculation of the total costs of ownership of a timber bridge?**

Sub-questions:

- **To what deterioration phenomena are timber bridges in the Netherlands exposed?**  
Degradation of outdoor timber elements can have multiple biological causes such as varying moisture content, bacteria and fungi, insects, or marine borers. In case of glulam beams also de-lamination can occur. In this research only the main degradation causes for timber elements in the Netherlands will be taken into account.
- **What factors play a role of influence on the service life of timber elements?**  
The service life of a timber element should be dependent on a number of factors. Examples of such factors could be the climate, the way the element is used, etc.
- **Which factor methods can be used to estimate the service life of timber bridges?**  
Several approaches already exist for modelling the behaviour of timber in outdoor applications. The goal is to find (or create) the method that is best suited for estimating the service life of timber bridges in the Netherlands.
- **How can factor methods be of help during the calculation of the total costs of ownership for a newly designed bridge?**

### 1.4. Research methodology

#### *Part I: Literature Study*

A literature study will be done to present theoretical background on timber bridge design and degradation phenomena for outside timber elements and current state-of-art on service life modelling of timber bridges.

#### *Part II: Comparison of different factor methods*

The applicable factor methods found in the literature study will be reviewed in order to find a method best suited to estimate the service life of timber bridges in the Netherlands.

#### *Part III: Reality checks*

The usability and the accuracy of the chosen factor methods will be tested with the help of a number of case studies.

#### *Part IV: TCO calculation example*

An example of a total costs of ownership calculation will be performed in order to show how factor methods can be integrated into this process.



# Bibliography

- [1] Achterbosch Architecten (n.d.). *Figure 1.1*. Retrieved from <https://www.achterboscharchitecten.nl>
- [2] Gilham P.C. (2015). *A New Look At Modern Timber Bridges*. Structures Congress 2015, Portland, Oregon (US)
- [3] GWW-bouw (2019). *Scoren met hout in de GWW*. Retrieved from <https://www.gww-bouw.nl/artikel/scoren-met-hout-in-de-gww/>.
- [4] Mettem C.J. (2011). *Timber Bridges*. Abingdon, UK: Spon Press.
- [5] NEN-ISO (2011). *NEN-ISO 15686-1:2011. Buildings and constructed assets - Service Life Planning. Part 1: General Principles and Framework..* Nederlands Normalisatie-instituut, Delft.
- [6] NEN-ISO (2011). *NEN-ISO 15686-8:2011. Buildings and constructed assets - Service life planning - Part 8: Reference service life and service life estimation..* Nederlands Normalisatie-instituut, Delft.
- [7] Rijksoverheid (n.d.). *Klimaatakkoord*. Retrieved from <https://www.rijksoverheid.nl/onderwerpen/klimaatakkoord>.

# I

## Part I: Literature Study

# 2

## Timber - the material

This chapter will give more information on timber as a construction material, with the focus on biological decay and when and how this occurs. The influence of the timber itself is discussed, just as the influence of external factors such as climate conditions and the way of detailing.

### 2.1. Hardwoods and Softwoods

Trees are divided into two major botanical groups: gymnosperms and angiosperms [1]. The wood that comes from gymnosperms is called softwood while the wood from angiosperms is called hardwood. The difference between the two groups can be found in the cell structure, the leaves (needle-like leaves for softwoods and broad leaves for hardwoods), the mechanical properties and the natural durability against biological decay. In general hardwoods have higher natural strength properties and higher natural durability than softwoods although within both groups these properties vary widely between species, trees and even within a tree itself [9].

Examples of in the Netherlands commonly found angiosperms (hardwoods) are oak and beech trees while pine trees are an example of often found gymnosperms (softwoods).

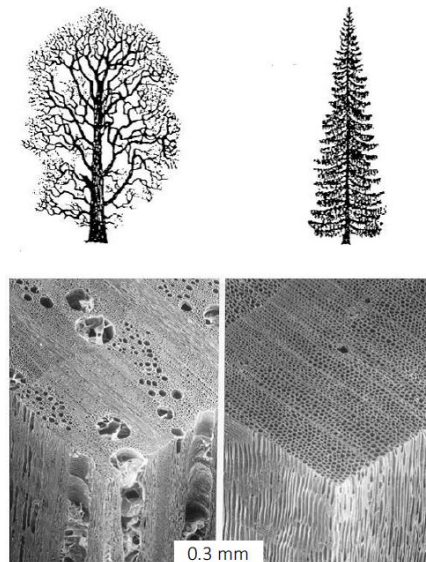

Figure 2.1: Growth patterns and microscopic structures. Left: oak (Hardwood). Right: spruce (Softwood) [1]

### Heartwood and sapwood

Within a tree itself wood can be divided into two zones: the heartwood and the sapwood. The heartwood, which is located in the centre of the cross section, generally only consists of dead cells while in the sapwood, the outer zone, also living cells are present. Heartwood can usually be distinguished from sapwood due to its darker colour, see figure 2.2. Within a tree the properties of the wood differ between the two zones, the natural durability of heartwood is usually much higher than that of sapwood for instance [1].



Figure 2.2: Cross section of a tree with a clear distinction between the darker heartwood and the lighter sapwood [21]

## 2.2. Wood products

For a structural timber element a number of different fabrication choices are available.

### *Solid timber*

The earliest timber bridges were made of solid timber elements [15]. Solid sawn timber elements are cut from logs and their size is thus limited to the tree size of the specific wood species used. Due to the limited cross sectional size, bridges made out of solid timber elements are usually made out of a number of closely spaced solid timber beams with a limited span [15].

### *Mechanically laminated timber*

Because of the limitations in terms of the length and cross sectional size of solid timber elements, people in the beginning of the 19th century started to combine smaller solid timber laminations in order to create beams of bigger lengths and cross sections. At first this combining was done by using mechanical fasteners, creating mechanically laminated timber. These mechanical fasteners, which could be dowels, combine the laminations into one solid cross section [9].

### *Glulam*

At one point, instead of mechanical fasteners, people started using adhesives (glue) to connect the laminations and thus created glue laminated timber, also known as glulam [9]. Glulam elements are made out of multiple layers of timber laminations glued together to form a new larger solid cross section, see figure 2.3. Glulam beams are very well suitable for when large spans need to be crossed, and thus large cross sections are needed, and when curved beams are asked, for instance at arch bridges [19].

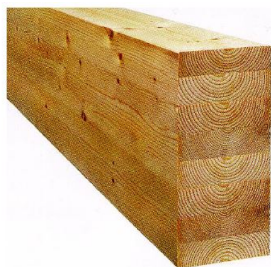

Figure 2.3: Example of a glulam beam [1].

## 2.3. Moisture content of wood

Wood is a capillary-porous material with a hygroscopic cavity system which means that it is able to absorb moisture from the surrounding air. The moisture content of wood,  $u$ , is calculated using formula 2.1 [1]. Oven dry means that the wood contains no water and thus has a moisture content of 0%.

$$u = \frac{m_u - m_{dtr}}{m_{dtr}} * 100 \quad (2.1)$$

where

- $u$  : Moisture content of the wood
- $m_u$  : Mass of the moist wood
- $m_{dtr}$  : Mass of the wood in oven dry condition

Being hygroscopic, wood is able to absorb and discharge moisture from the surrounding air. For each air temperature  $T$  in combination with an air humidity  $\psi$  a corresponding moisture content applies which is called the equilibrium moisture content  $\omega$ . This equilibrium moisture content level is reached within the wood after a certain amount of time.

Starting from the oven dry condition, the first water that is absorbed by the wood is called bound water, since it bounds to the cell walls by hydrogen bonds. The point at which the cells cannot bind any more water is called the fibre saturation point. This point varies between wood species but on average this point is reached at a moisture content of 28% [1]. The water that is absorbed after this point is called free water.

The moisture content has an influence on the mechanical properties of wood and is a key factor in the swelling and shrinking of wood and the development of wood deteriorating processes such as moisture induced cracking and the growth of moulds and fungi.

### Moisture induced cracking

Due to being exposed to rain, snow and changing temperature and humidity the moisture content in outdoor wooden elements constantly changes. In a timber cross section, the moisture content in the centre changes in a lower pace than the moisture content in the outer zones. Because of this difference, unequal deformations want to occur over the cross section which lead to the development of internal stresses [10]. When these moisture induced stresses become larger than the strength of the timber perpendicular to the grain, they will lead to the development of cracks, see figure 2.4.

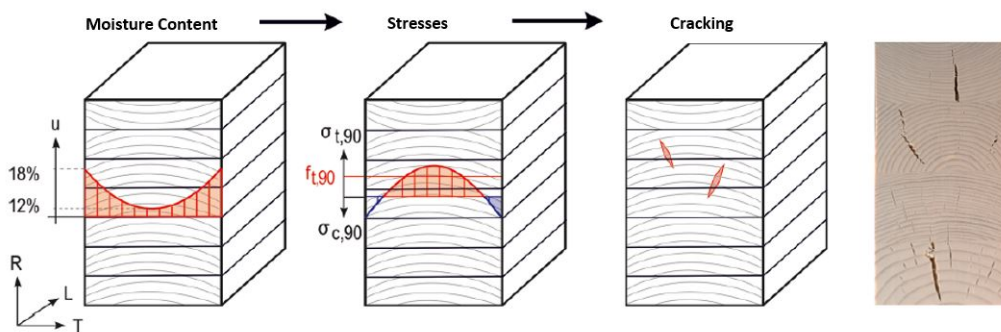

Figure 2.4: Moisture and stress distribution and the development of cracks in a timber cross section due to adsorption [6]

### Biological decay

Besides causing stresses in the wood, moisture is also a key factor in the development of biological wood decaying organisms such as fungi and moulds. Most of these organisms thrive on a relatively high moisture content. Koch et al. [13] state that a moisture content above the fibre saturation point should be avoided in timber elements since from this point fungal decay could start developing. This also applies for when lower moisture contents around 20 to 25 percent are present for an extended period of time.

## 2.4. Biological degradation hazards

As stated above, wood that is used in outdoor applications, and is thus exposed to weather conditions, is vulnerable for a number of biological degradations. In this section the in the Netherlands most common degradation hazards for timber are discussed.

### Fungi and bacteria

Wood deteriorating fungi come in two main groups: Wood destroying fungi and wood staining fungi [1]. Wood staining fungi mainly affect the wood aesthetically by discolouration while wood destroying fungi can greatly influence the strength and mass of the wood in a negative way. The development of fungi is related to a couple of factors like nutrients, water content, temperature, oxygen and PH-level. Eliminating one of these factors from the wood is therefore the often used method to protect the wood from biological decay, for instance by keeping moisture away [3].

#### Wood destroying fungi

There are three main types of wood destroying fungi: brown rot, white rot and soft rot. They differ from each other in exterior appearance and the way they decompose the wood.

Brown-rot fungi grow inside the cell cavities of the wood from where they predominantly break down the cellulose while they lignin stays more or less intact. Due to the cellulose breaking down the wood loses its strength and mass. It also gives the wood a dark brown colour and causes the wood to crack in a deep cubic cracking pattern, see figure 2.5. Most brown-rot fungi attack preferably softwoods, whilst hardwoods are more frequently attacked by white- and soft-rot fungi [1] [3].



Figure 2.5: Typical example of wood degraded by brown rot [1]

White-rot fungi degrade both the cellulose and the lignin in wood. Wood attacked by white rot has a bleached colour and becomes fibrous in texture, see figure 2.6a. In all white rot types, the wood strength properties are reduced to a lesser extent than in brown-rotten wood, since at the same mass loss, lesser cellulose is consumed, and it does not come to cracking or cubical rot [17].

The third type of rot, soft rot, degrades the cellulose, hemicellulose and the lignin inside the wood [17]. Soft rot often develops at wood that has a constantly high wetness, for instance around the water line of poles supporting bridges, see figure 2.6b. Soft rot often leads to erosion of the timber surface [5].



(a) White rot [3]



(b) Soft rot and its eroding effect [5].

Figure 2.6: Examples of white- and soft rot

### *Wood staining fungi*

Moulds, a type of wood staining fungi, grow on the wood surface and cause no or only little damage to the wood components such as lignin or cellulose. This results in discolouration of the wood surface while the wood physical features of the wood remain intact. Nevertheless, mould development is usually a sign that the conditions (temperature and humidity) are favourable for the growth of other more dangerous fungi. Also moulds can cause health problems, especially when growing in indoor environments [1] [17].

Blue stain fungi grow on the wood surface but are also able to penetrate deeply into the wood. Just like with moulds the strength properties of the wood are hardly affected but the presence of blue stain indicates that the growth of worse fungi can follow.

### **Insects**

In the Netherlands, insects and termites cause no significant harm for timber elements [5], therefore they are not further discussed in this report.

### **Discolouration due to weathering**

Another purely aesthetic problem which affects outdoor timber elements is discolouration due to weathering. The combination of sunlight and rain makes that over time timber loses its original colour and becomes greyish. Although structurally this process causes no harm, it can be considered as a type of degradation when aesthetics is an important factor in the choice for timber as a construction material.

## **2.5. Natural durability**

Durability here is used in the sense of the resistance of wood against wood decaying organisms and thus the ability to fulfill its (load bearing) function for the intended service life. The durability of wood is often increased by impregnation of chemicals, wood modification and/or paints and coatings. However wood from itself already has a certain resistance against biological deterioration which is called the natural durability. The natural durability ranges greatly between wood species. In general Hardwoods have higher natural durability than softwoods but within these groups the differences between species are big. Even within a tree itself there are large differences since heartwood for instance has a much higher natural durability than sapwood.

For most common tree species the natural durability has been assessed during tests in laboratories and in the open air. As a result from these tests the wood species are distributed into different durability classes, which in the Netherlands are specified in the European standard EN 350:2016. In this norm the durability against wood-decay organisms of various wood species is ranked into durability classes. It is however stressed that the durability ranking gives no guarantee for the performance of the wood in service since for this many other factors have an influence, such as the principles of good design, climate conditions and maintenance. The natural durability of wood against wood destroying fungi is ranked in a five grade scale, see table 2.1. These durability classes only refer to the heartwood. The sapwood is always regarded as not durable, unless tests have proven otherwise [4].

Table 2.1: Durability classes (DC) of wood and wood-based materials for attack by decay fungi as described in the European standard EN 350:2016 [4]

Durability class	Description
DC 1	Very durable
DC 2	Durable
DC 3	Moderately durable
DC 4	Slightly durable
DC 5	Not durable

## 2.6. Material protection

When used for outdoor applications the natural durability of the wood does not always provide sufficient resistance against decay organisms for the intended service life. In order to still be able to use these wood species in outdoor conditions they need to somehow be protected. For this it is first important to know what circumstances lead to the biological deterioration of wood.

In the Netherlands the main type of wood decaying organisms are different sorts of fungi. For these fungi to develop, the following five conditions need to be met [5]:

1. **A nutrition source needs to be present.** For wood deteriorating organisms the wood is the nutrition source. The presence of other nutrition sources such as dirt can speed up the growth process.
2. **Sufficient oxygen needs to be present.** The fungi do not grow in places with low amounts of oxygen, for instance below the water level.
3. **Enough moisture need to be present over a longer period of time.** As already stated in section 2.3, wood deteriorating organisms are usually unable to develop in wood with a moisture content below 20 percent.
4. **The wood needs to have the right temperature.** The right temperatures vary per fungi type. In general however the Dutch climate is one in which fungi can develop easily.
5. **No substances that are toxic to fungi must be present.** The natural durability of wood species is partly based on by the tree itself produced toxic substances. These substances are partly able to leach away from the wood with water and so the natural durability can decrease over time.

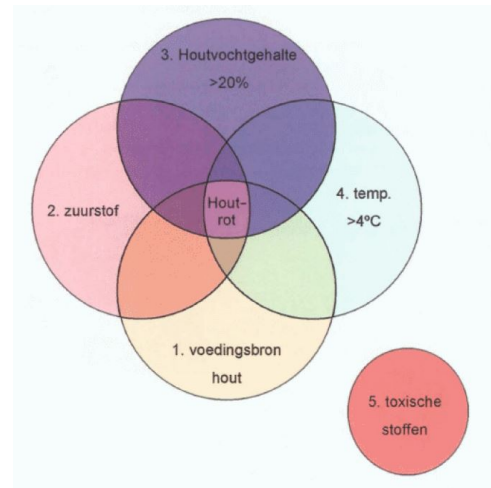

Figure 2.7: Conditions for the development of wood deteriorating Fungi [5].

To prevent biological deterioration from developing only one of these five conditions needs be excluded. Conditions 1 and 4 cannot be prevented when using timber in the Dutch climate. Condition 5 is often made use of by impregnating wood with preservatives which contain substances that are toxic to the deteriorating organisms. Conditions 2 and 3 can be taken into account in the detailing.

### Preservatives

Chemical wood preservatives can be applied with different impregnation techniques. In the early days of wood preservation the main preservatives used were chromated copper arsenate (CCA), pentachlorophenol (PCP) and creosote. However since the 1990s the use of these preservatives has been restricted or banned in most of the EU member states due to health reasons [1]. Nowadays for heavy duty outside application there are two main types of products available, copper-amine based preservatives and creosote. However in the EU creosote as a preservative is under pressure and the allowed use of creosote is limited.

### Wood modification

Another way of increasing the durability of wood is by modifying it. An example of this is the acetylated Acoya wood, which is used in the construction of two timber traffic bridges in Sneek, the Netherlands, see figure 1.1.

### Protective design

Wood can also be protected by assuring that either decay organisms have no access or physical prerequisites for such organisms are inhibited. This means moisture, temperature and oxygen levels are kept below minimum or above maximum for activity or even survival of the respective organisms [2]. Another part of protective design is the selection of building materials that are adequate for the environment the structure will be in. This makes the choice for the wood specie with sufficient natural durability also part of protective design.



As stated earlier, biological wood degrading organisms need a moisture content above 20% to be able to develop in the wood [13]. One of the main goals of protective design is thus to keep the moisture level constantly below this level in order to make the growth of fungi unlikely. For this 'moisture protection' usually three rules are followed [1]

1. Keeping water away from the structure
2. If the first is not possible, removing water from the structure as fast and effective as possible by providing sufficient drainage and ventilation measures.
3. Make sure that wood species with sufficient natural durability are used when permanent humidification cannot be prevented.

Also the way that wood is treated during the construction process is part of protective design. If possible the wood should be installed at the equilibrium moisture content present in the building so that only seasonal variations in humidity have to be taken into account. When no care is taken here, the wood will be prone to cracking after installation.

Below shows a few design principles which protect the timber and can make a significant difference to the life expectancy of components. In section 3.3 a number of protective design measures especially for timber bridges are discussed.

### End grain protection

Water is particularly liable to infiltrate wood in the grain direction. An important protective measure is thus to cover the end grain surfaces so that no water can penetrate, see figure 2.8.



Figure 2.8: End grain protection. Left, timber bridge in Spain without end grain protection of severely decayed main beam. Right, end grain metal covers of projecting exterior beams. [2]

**Separate timber from wet materials**

Timber should be isolated from the ground and from moisture retaining materials or wet surfaces by either an impermeable damp proof membrane or, preferably, by providing sufficient air gaps to prevent absorption or capillary action [18]. Examples shown in figures 2.9 and 2.10.



Figure 2.9: Protection from ground contact. Left, pedestrian bridge with pillars in direct contact with ground. Right, pedestrian bridge in Galicia, Spain, with concrete fundamentals and loadbearing pillars separated from the ground. [2]

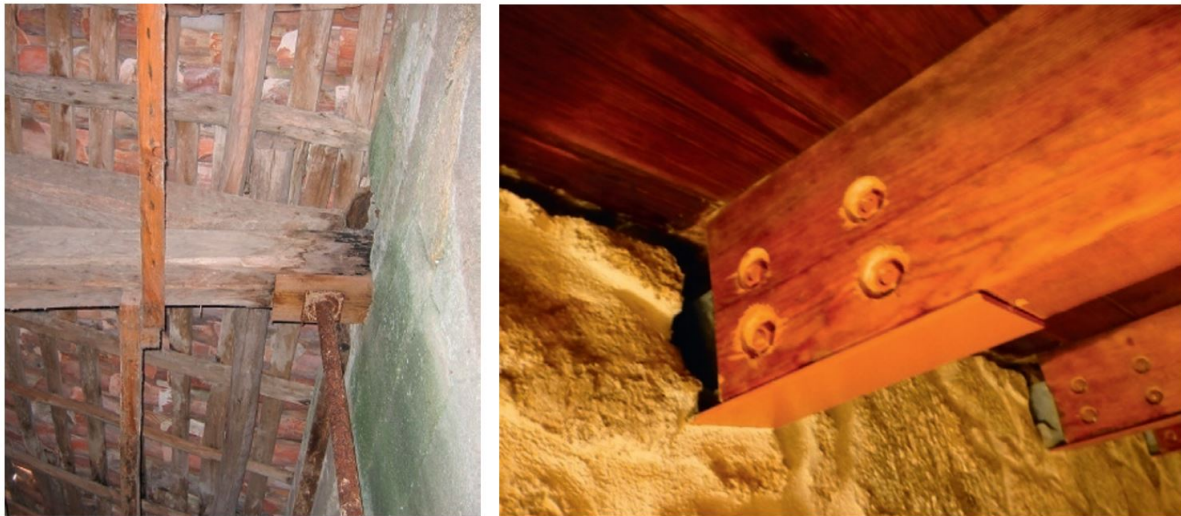

Figure 2.10: Ventilation measures, avoiding direct contact with wet walls. Left, end of beam in direct contact with wet wall. Right, physical separation between end of beam and wet wall that allows drying of wood. [2]

**Avoid water traps**

To avoid water traps, the following points should be incorporated in the design:

- Sufficient slope to horizontal surfaces to prevent water lying on the surface.
- Drainage to ensure that junctions between exposed components and connections do not become water traps



Figure 2.11: Water draining and avoidance of water trapping. Left, decking with good details design to allow dripping rainwater and space between two boards to avoid water accumulations. Right, hand rail in Kristineberg, Sweden: Declined surface but gap between two elements with potential for water trapping. [2]



Figure 2.12: Protection from water accumulation. Left, decking with no correct design due to contact board to board. Right, decking well designed thanks to a good separation between boards that avoid water accumulations. [2]

**Protect timber from wetting**

Protecting the timber from wetting can for instance be achieved by placing (metal) covers on top of beams like in figure 2.13. Wetting of the timber can also occur due to splashing, of which an example is shown in figure 2.14.



Figure 2.13: Effect of covers. Left, end grain joint on railing without cover protection. Right, fence post with traditional copper cover to protect joint area. [2]



Figure 2.14: Protection from splash water. Left, wetting of cladding made from thermally modified wood in north Spain due to splash water — growth of moulds and disfiguring fungi. Right, cladding in north Spain with correct detail design to avoid splash water. [2]

# 3

## Timber bridges

This chapter first gives a subdivision of timber bridges on the basis of the main structural type. After that a number of connection systems often used in timber bridge design will be described together with examples of good protective design measures. The last sections will discuss the actions on timber bridges that are prescribed by Eurocode 1, and some info is given on the inspection of timber bridges.

### 3.1. Types of timber bridges

In this section three important characteristics of timber bridges are discussed, namely the the structural type, the wood product and the deck type. For each characteristic a number of different options are described that will often be encountered in present-day timber bridges. Another important characteristic, the connection system, will separately be discussed in section 3.2.

#### Main structural system

In this research, four main bridge types are distinguished: beam bridges, truss bridges, arch bridges and suspended bridges. Per type a short description will be given below.

##### *Beam bridges*

Beam bridges generally are the simplest and most common type of timber bridges [15]. For relatively small spans they usually consist of a number of longitudinal beams that are simply supported on both ends of the crossing. For larger crossings one or more extra intermediate supports might be needed, see figure 3.1. With beam bridges the deck is usually placed on top of the main beams and can thus, if designed properly, protect these main beams against weather conditions such as rain [9].



Figure 3.1: Two examples of beam bridges, both located in Arnhem. A single span bridge (left) and a bridge with multiple spans (right) [8].

##### *Truss bridges*

The main structural system of a truss bridge usually consists of two trusses that are composed of a top and a bottom chord which are connected by diagonals and posts which leads to a lot of connection points. When placed above the top chord, the deck could protect the trusses against rain. However in most cases, where the clearance below the bridge is of importance, the deck is placed at the height of the bottom chord and thus provides no protection to the main load bearing elements, see figure 3.2.



Figure 3.2: Two examples of truss bridges. In the left picture the deck is placed somewhere halfway the top and bottom chords. The right picture shows a timber bridge near Harderwijk where the deck is positioned at the bottom chord. Also noticeable here are the steel cross beams providing lateral stability to the top chord. [7].

### Arch bridges

Modern timber arches are usually made of glulam beams that are curved in the factory after which they are transported to the building site. The bridgedeck can be placed at the top or at the bottom of the arch, or somewhere in between. This choice is often dictated by the local environment of the bridge [14]. In the design of an arch bridge the choice is often made between a two hinged arch, with two hinged supports, and a three hinged arch with an extra hinge at the top [15], see figure 3.3.



Figure 3.3: A bridge for pedestrians and cyclists consisting of two timber arches crossing the N18 at Lichtenvoorde (left) [8] and a timber arch bridge near Kopenhagen, Denmark (right) [20]. A close look at the connection at the top suggests that this is a three hinged arch.

### Suspended bridges

Suspended bridges can be divided into two different types, namely the suspension bridge and the cable-stayed bridge, see figure 3.4. Although they are different types of load bearing systems they are both characterised by a deck that is supported by steel cables which transfer the forces to two or more towers or masts (for cable stayed bridges only one tower or mast could already be sufficient).



Figure 3.4: Timber cable stayed bridge at Harderwijk for cyclists and pedestrians (left) [20] and a timber suspension footbridge near Arnhem (right) [8].

### 3.2. Connections

For timber bridge constructions, a so called "durable" connection design is of vital importance when aiming for an optimal service life. Badly designed timber bridges that have failed too soon because of biological decay are often found to have failed due to badly designed details with respect to moisture control. For connections it is important to follow the general rules concerning moisture that are previously discussed in section 3.3.

Figure 3.5 shows a number of common details used in jetty constructions that are prone to biological deterioration. These details are also often encountered in smaller timber bridges. The details are described below [5].

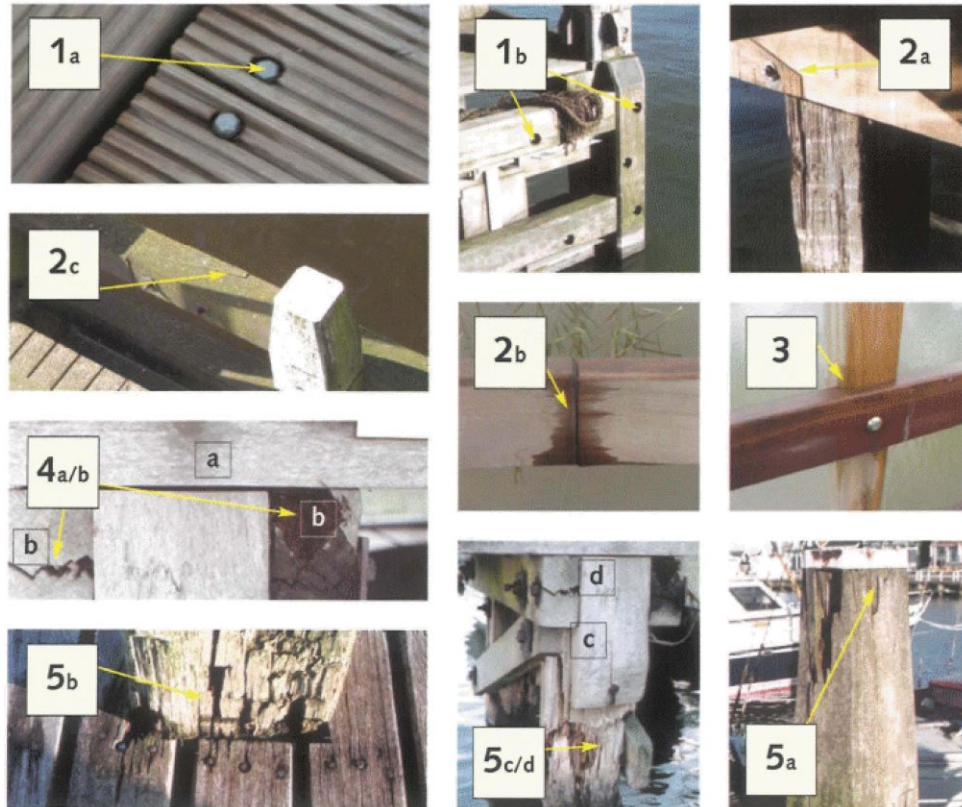

Figure 3.5: Examples of critical details of jetties [5].

#### 1. Milled holes for countersunk bolts

The problem with milled holes needed for bolts is that additional end grain surfaces are created. Especially in case of deck boards this will cause an increased moisture intake when water remains in the holes.

#### 2. Transverse joints

Connections used to increase the length of a timber element. Also in this case the problem is the presence of end grain surfaces. When these surfaces are placed too close to each other a capillary plane is created in which water will be sucked, as can be seen in figure 3.5 2b.

#### 3. Rails with mortise joints

Also here capillary planes are created in which moisture will be sucked in.

#### 5. Poles

Poles have three main places that are prone to biological deterioration. The end grain surface at the top of the pole, 5a, at the level of the decking, 5b, and at the waterlevel, 5c.

These critical details and their durable alternatives are further discussed in the next paragraph.

### 3.3. Protective design

In section 2.6 the main principles of protective design for timber elements has been discussed. In this section a couple of typical protective design measures for timber bridges are shown. As stated in section 2.6 the main goals are to keep water away from the structure and provide sufficient drainage and ventilation to allow for quick drying when water does reach the timber elements.

#### End grain protection

As already stated in section 2.6, an important aspect of protective design is the covering of end grain surfaces of beams and posts. Figure 3.6 shows two pictures of timber bridge posts, one with an open end grain surface and one with the end grain surface covered. The cover should still allow for ventilation of the end grain surface so that any water that gets trapped below is able to escape [5].



Figure 3.6: Left picture shows an example of a bridge post with unprotected end grain surface. On the right a similar bridge post is shown where the end grain surface is covered to prevent water adsorption. (Both bridges located in Pijnacker)

#### Water trapping

Water getting trapped in capillary planes, like in figure 3.5 example 3, should be avoided. An example of how to avoid this is shown in figure 3.7 on the left. With the use of spacers between the two wood surfaces, water and dirt have no change of accumulating between the surfaces and it provides ventilation so that the wood dries faster when wet.



Figure 3.7: Left, railing joint usign spacers to create a gap between the railing post and main beam for drainage and ventilation. Right, railing joint susceptible for water trapping. (Both bridges located in Pijnacker)



## Vegetation

Vegetation on or close to timber elements leads to a long term high moisture content in combination with oxygen. These conditions, which are ideal for the development of fungi, lead to an accelerated deterioration of the timber close to the vegetation. Therefore a situation like in figure 3.8 should be avoided.



Figure 3.8: Example of vegetation growing around a timber pole

## Cladding and covers

Figure 3.9 shows a timber bridge in Germany of which the main structural timber elements are completely covered. The top surfaces are covered with steel covers, while the sides are protected by timber cladding which, besides protecting it, also maintains the timber look of the bridge. This type of protective bridges are often found not only in Germany but also in Scandinavian countries. The protection ensures that the main timber elements can be made of timber species with a lower natural durability, such as some softwoods that are much found in these countries.



Figure 3.9: Fully protected timber arch bridge located in Lohmar, Germany, build in 2014. The main structural timber elements (arches and main girders made from glue laminated spruce) are protected by titanium zinc covers on top and cladding made from larch on the sides [16]

The effect of such protective design measures has been studied in Germany by Koch et al. [13]. In Germany the main structural timber elements of bridges are often structural-protected against precipitation and moisture ingress. In order to show that well protected timber bridges are able to compete with steel and concrete alternatives in terms of durability, Koch et al. initiated a monitoring program to evaluate the efficiency of

these structural protective measures. For the structural-protected timber elements of nine bridges, equipped with measurement systems, the moisture content and ambient climate conditions were measured for 2 years. So far, after measuring one bridge for one and a half year and eight bridges for half a year, the results show that the average moisture level of all nine bridges does not exceed the 20 percent limit. Therefore the conclusion can be drawn that structural-protective measures can keep the moisture level of timber bridge elements below the critical level and can thus increase the service life of timber bridges by preventing the growth of decay fungi.

### 3.4. Mechanical loads on timber bridges

#### Pedestrian and cyclist bridges

In Eurocode 1-2: *Traffic loads on bridges*, the following vertical actions on cycle- and footbridges that need to be taken into account in the design are given:

- a uniformly distributed load,  $q_{fk} = 5 \text{ kN/m}^2$ ,
- a concentrated load,  $Q_{fwk} = 7 \text{ kN}$  (Dutch National Annex),
- loads representing service vehicles,  $Q_{serv}$ .

Also a horizontal force,  $Q_{flk}$ , needs to be taken into account equal to the bigger of the following two values:

- 10 per cent of the total load corresponding to the uniformly distributed load,
- 60 per cent of the total weight of the service vehicle, if relevant.

### 3.5. Timber bridge inspection

Points for attention when inspecting a timber bridge (following from previous chapters):

- Blue stain fungi indicate that the right conditions for the growth of food destroying fungi are present.
- For constructions above water, wood deteriorating fungi develop at places where moisture can accumulate and ventilation is limited. At these places brown- and/or white-rot will develop.
- Soft rot occurs at timber poles at the height of the waterline.
- Rotten wood can at the wood surface be recognised by being white and soft (in case of white rot) or brown and brittle (in case of brown rot).
- White rot mainly appears in hardwoods, while brown rot mainly appears in softwoods.
- The presence of vegetation on or close to timber elements can lead to accelerated deterioration of the timber.

# Bibliography

- [1] Blass H.J., Sandhaas C. (2017). *Timber Engineering - Principles for Design*. Karlsruhe, Germany: KIT Scientific Publishing.
- [2] Brischke C., Humar M., Lorenzo D. (2017). 'Protection by design and maintenance', in Jones D. and Brischke C. (ed.) *Performance of Bio-based Building Materials*. Duxford, UK: Woodhead Publishing, pp. 228-240
- [3] Brischke C., Unger W. (2017). 'Potential hazards and degrading agents', in Jones D. and Brischke C. (ed.) *Performance of Bio-based Building Materials*. Duxford, UK: Woodhead Publishing, pp. 188-203
- [4] CEN (2016). *EN 350:2016. Durability of wood and wood-based products - Testing and classification of the durability to biological agents of wood and wood-based materials*. European Committee for Standardization, Brussels, Belgium.
- [5] CUR (2003). *CUR-rapport 213. Hout in de GWW-sector - "duurzaam detailleren in hout"* Gouda, Stichting CUR.
- [6] Franke B., Muller A., Simon A. (2016). *Holzbrücken - Erkenntnisse zum Feuchteverhalten in den Traggerschnitten aus Langzeitmessungen*. Bautechnik 93, Issue 11. Ernst & Sohn, Berlin, Germany (In German)
- [7] Groot Lemmer B.V. (n.d.). *Figure 3.2*. Retrieved from <https://grootlemmerbruggen.com/vakwerkbrug/>.
- [8] Meerdink Bruggen (n.d.). *Figure 3.1, 3.3, 3.4*. Retrieved from <https://www.meerdinkbruggen.nl/projecten/?term=houten-bruggen>.
- [9] Mettem C.J. (2011). *Timber Bridges*. Abingdon, UK: Spon Press.
- [10] Müller A., Franke B., Schiere M., Franke S. (2017). *Advantages of moisture content monitoring in timber bridges*. 3rd International Conference on Timber Bridges 2017, Skelleftea, Sweden
- [11] NEN (2003). *NEN-EN 1991-2: Actions on structures - Part 2: Traffic loads on bridges..* The Netherlands Standardization Institute, Delft.
- [12] NEN (2011). *Dutch National Annex to NEN-EN 1991-2: Actions on structures - Part 2: Traffic loads on bridges..* The Netherlands Standardization Institute, Delft.
- [13] Koch J., Arndt R.W., Simon A., Jahreis M.G. (2017). *Moisture monitoring of nine protected timber bridges in Germany*. 3rd International Conference on Timber Bridges 2017, Skelleftea, Sweden
- [14] Lebet J.-P., Hirt M.A. (2013). *Steel Bridges*. Lausanne, Switzerland: EPFL Press.
- [15] Ritter M.A. (1990). *Timber Bridges: Design, Construction, Inspection, and Maintenance*. Washington DC, USA.
- [16] Schaffitzel (n.d.). *Figure 3.9*. Retrieved from <https://www.schaffitzel.de/en/bridge-construction/references/289-hoengesberg-de>
- [17] Schmidt O. (2006). *Wood and Tree Fungi - Biology, Damage, Protection and Use*. Springer, Berlin
- [18] Trada (2016). *Designing for durability - part 2: principles of design*. High Wycombe, UK: Exova BM TRADA
- [19] Trada (2019). *Wood Information Sheet - Glued laminated timber*. High Wycombe, UK: Trada
- [20] Wijma Kampen B.V. (n.d.). *Figure 3.3, 3.4*. Retrieved from <https://www.wijma.com/nl/projecten-gww/houten-bruggen>.
- [21] Zukzik (n.d.). *Figure 2.2*. Retrieved from <https://zukzik.com/why-is-heartwood-darker-in-color-than-sapwood/>

# II

## Part II: Service life models

# 4

## Factor models: Descriptions

This chapter gives an overview of existing methods that can be used in the estimation of the service life of timber (bridge) elements. First a general description of the process of factor methods is given based on the European standards NEN-EN 15686-1 and 15686-8 [13], [14]. After that descriptions are given of three different factor methods that are developed for the estimation of the service life of timber (bridge) elements. In addition, also two other non factor methods that can be used for service life estimation are shortly described.

### 4.1. Factor methods - General description

A general description of factor methods can be found in the NEN-ISO 15686 series, the Dutch publication of the international standard ISO 15686 "Buildings and constructed assets — Service life planning". This series discusses service life estimation as a part of the larger process of service life planning. The parts of the series that are involved in service life estimation are shown in figure 4.1.

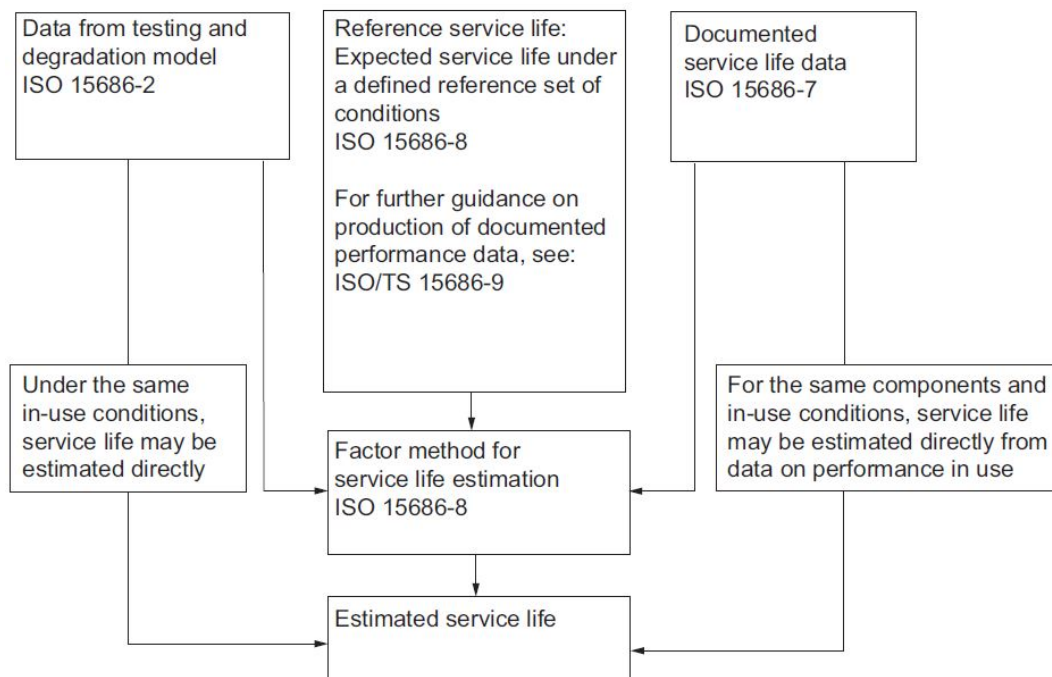

Figure 4.1: Overview of the approaches to service life estimation as described in the NEN-ISO 15686 series. [13].

In an ideal scenario, the service life of a component is predicted by knowing the intended conditions (such as the microclimate), the performance of the component under these conditions, and the construction and maintenance routine. However this data is often not completely available and thus other sources need to be used as a basis of the service life prediction. These sources can for example come from testing (ISO 15686-2), from documented service life data (ISO 15686-7) or from a reference situation (ISO 15686-8), see figure 4.1.

To be used for a specific building, the data from these various sources needs to be adjusted to suit the particular design conditions. This adjustment may be carried out by using a factor method. ISO 15686-8 focusses specifically on the use of factor methods for service life estimation.

The main principle of factor methods is that an Estimated Service Life (ESL) can be calculated by multiplying a Reference Service Life (RSL) with a number of factors, as shown in equation 4.1 [5].

$$ESL = RSL * A * B * C * D * E * F * G \quad (4.1)$$

The values of the factors A-G need to be determined per element or structure and depend on certain conditions such as the material quality, the protection against weather conditions and the outdoor (or indoor) climate.

In a more general way the ISO 15686 factor method can be formulated as follows:

$$ESL = f(RSL, A, B, C, D, E, F, G) \quad (4.2)$$

The following three sections give the descriptions of three different developed factor methods that can be used to estimate the service life of timber bridges. The three methods are respectively developed in Japan, Australia and Sweden.

## 4.2. Japanese factor method

In a study done by Honda and Araki [4], the service life of 72 timber bridges was estimated using a model, based on the factor method, developed by the Japanese Society of Civil Engineers [8].

The JSCE model estimated the service life using the following formulas:

$$ESL = 15 * Y \quad (4.3)$$

$$Y = P * E * S * D * C + M \quad (4.4)$$

In which:

- $ESL$  : is the estimated service life in years.
- 15 : is the reference service life.
- $P$  : is a factor accounting for the wood specie used.
- $E$  : is a factor accounting for the climate conditions .
- $S$  : is a factor accounting for the structural design.
- $D$  : is a factor accounting for any decay preventing detailing applied.
- $C$  : is a factor accounting for any decay preventing execution measures used.
- $M$  : is a factor accounting for any maintenance done.

The reference service life of 15 years is based on experience and counts for the following situation: a girder bridge with a timber deck, made out of cedar with no preservative treatment, situated in an average (Japanese) climate, no use of a roof or any other decay preventing detailing, standard execution process and without any maintenance. In this situation all the factors are equal to 1.

Honda and Araki found, after a first evaluation of 12 timber bridges, that the ESL prediction from formula 4.3 becomes off for bridges with a service life larger than 16 years. Therefore they proposed the following exponential function for the service life estimation with a maximum service life of 50 years, see also figure 4.2:

$$ESL = 7.0 e^{0.73Y} \leq 50 \text{ years} \quad (4.5)$$

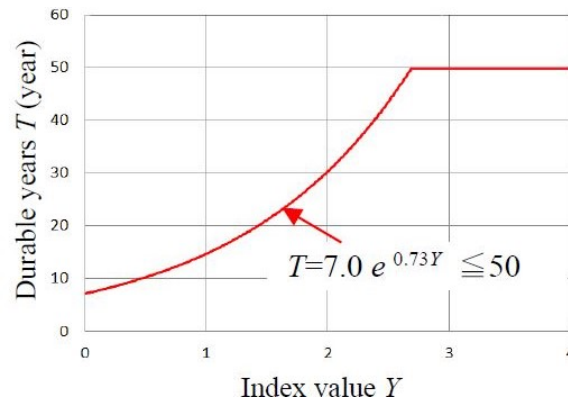

Figure 4.2: Estimated service life as a function of Y [4].

### Factor values

The factors and their formulas are set out in table 4.1. The lists with values for the different factors and sub-factors are shown in table 4.2.

Table 4.1: Factors and sub-factors [4]

Factors	Sub-factors	Formulas
P	P1: Durability of the wood P2: Permeability of the preservative P3: Method of preservative treatment	$P = P_1 + P_2 * P_3$
E	E1: Regional climate conditions E2: Local climate conditions	$E = E_1 * E_2$
S	S1: Existence of a roof S2: Location of deck S3: Main structural style S4: Deck style	$S = S_1 * S_2 * S_3 * S_4$
D	d: Prevention of decay (structural)	$D = d$
C	c: Prevention of decay (execution)	$C = c$
M	m: Conservation action N: Frequency	$M = \sum(N * m)$

For factor P1 a number of often used wood species for timber bridges in Japan were ranked based on their weather resistance, which was found from field pile tests. Factor P2 ranks the same wood species based on their permeability, or the ability to absorb preservatives.

The factors  $S_1 - S_4$  take into account the structural design of the bridge. Historical examples show that roofs are an excellent way to extend the service life of timber bridges. Therefore factor S1 takes into account the presence or absence of a roof. The reason of factor S2 is similar. When the deck is placed on top of the main girders it protects these girders against the weather conditions. The values for S3 are based on the amount and type of connections and elements that belong to the different structural types. A truss bridge has, relative to a girder bridge, a lot of joints and is thus more likely to retain water and development of decay is more likely. Factor S4 is based on the water tightness of the deck and again has to do with the protection of the underlying timber elements against water.

Table 4.2: List of values for the different factors [4] [8].

$P_1$ : Timber specie	
Cypress, Bongossi (Azobe), Zelkova, Japanese cypress, chestnut	1.5
Cedar, bay pine, Larch	1.0
Fir, red pine, Black pine	0.9
Todomatsu, Ezomatsu, Camphor tree	0.8

$P_2$ : Permeability of preservative	
Japanese Cypress	1.1
Cedar, bay pine, fir, Red pine, black pine	1.0
Cypress, zelkova, larch, Scots pine, Todomatsu	0.9
Chestnut, bongoshi, Kunugi, camphor tree	0.8

$P_3$ : Preservative treatment	
Pouring and a surface treatment	1.0
Pouring treatment	0.6
Surface treatment	0.3
No preservative treatment	0

$E_1$ : regional climate	
Climate region 1	1.2
Climate Region 2	1.1
Climate Region 3	1.0
Climate Region 4	0.9
Climate Region 5	0.8

$E_2$ : Local climate	
General local environment	1.0
Moist local environment	0.7

$S_1$ : Presence of roof	
With roof	2.0
Without roof	1.0

$S_2$ : Location of deck	
Deck on top	1.0
Half trough deck	0.8
Trough deck	0.8

$S_3$ : Main structural type	
Girder bridge	1.0
Arch bridge	0.9
Slab bridge	0.8
Truss bridge	0.7

$S_4$ : Deck style	
Steel plate deck, rc deck	1.8
Timber deck (with pavement)	1.5
Timber deck (without pavement)	1.0

$d$ : Decay prevention (Structural)	
Prevention of decay specially considered in design	1.3
Standard design	1.0

$c$ : Decay prevention (execution)	
Prevention of decay specially considered during execution	1.2
Standard Execution	1.0

$M$ : Maintenance	
- Re-preservation of main girder with anti-decay coating. - Replacement of decayed elements	0.3
No maintenance	0.0



Factor E1 is the factor that takes into account the regional climate conditions. In the model developed by the JSCE this climate factor is only a function of the mean annual temperature of the region relative to the national mean annual temperature which is equal to 15.5 degrees Celsius, see table 4.3. Figure 4.3 shows a map of the different climate regions of Japan. The other climate factor, E2, describes the local climate conditions with respect to moistness. For this there are two options: a general local environment or a moist local environment. From the obtained literature it is not clear what exactly is understood with a 'moist' environment.

Table 4.3: Determination of the climate factor E1 [4] [8].

E1:	1.2	1.1	1.0	0.9	0.8
$R_T = T_L/T_A$	$R_T \leq 0.74$	$0.74 < R_T \leq 1.0$	$1.00 < R_T \leq 1.16$	$1.16 < R_T \leq 1.25$	$1.25 < R_T$
$T_L$ = annual mean temperature at bridge location					
$T_A$ = National (Japanese) annual mean temperature (15.5 deg)					

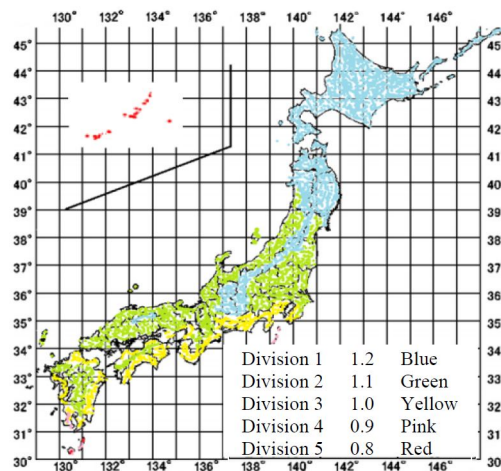

Figure 4.3: Map of Japan showing the different climate regions for factor E1 [4].

Factor D depends on whether decay preventing detailing has been incorporated into the bridge design. It does not rank the detailing but it just takes into account whether it has been applied yes or no.

Factor C depends on whether decay preventing measures have been applied during the execution of the bridge. These are measures such as protecting timber elements from rain by covering them up.

### Reality checks

The prediction formula was determined with the use of 12 timber bridges that got closed or removed because of timber decay. Since for these bridges the actual service life time was known, they could be used to calibrate the prediction formula, see table 4.4.

Table 4.4: Expected and actual service life of 12 existing timber bridges. [8]

Bridge name	Bridge outline	Y value	Expected years	Actual years	Remarks
A: bridge Hokkaido Takikawa	Beimatsu, surface treatment, Arch Bridge (wood floor version)	1.1	17	17	bridge closed
B: bridge Hokkaido Takikawa	Beimatsu, surface treatment, Cable-stayed bridge (wood floor version)	1.2	19	17	Road Closed
K: bridge Kamo City, Niigata Prefecture	Sugi, no preservative treatment, Girder bridge (steel floor version)	1.4	21	22	Removed
N: bridge Toda City, Chiba Prefecture	Bongossi, no preservative treatment, Lower path truss bridge (wooden floor)	1.2	18	16	Road Closed
Q: bridge Karuizawa Town, Nagano Prefecture	Larch, surface treatment, Nakaji style ramen bridge (wooden floor)	1.8	28	24	Removed
R: bridge Shizuoka Prefecture Shimada City	Sugi, no preservative treatment, Girder bridge (wood floor version)	1.0	15	15	Road Closed
T: bridge Shizuoka Prefecture Shizuoka City	Sugi, no preservative treatment, Girder bridge (wood floor version)	1.5	23	20	Road Closed
Y: bridge Fukuyama City, Hiroshima Prefecture	Beimatsu, surface treatment, Lower path truss bridge (wood floor version)	0.7	11	13	Removed
AD: Bridge Kitawagun, Ehime Prefecture	Bongossi, no preservative treatment, Lower path truss bridge (wood floor version)	0.8	13	10	Removed
AJ: Bridge Oita City, Oita Prefecture	Bongossi, no preservative treatment, Lower arch bridge (wood floor version)	1.1	16	13	Removed
F: bridge Hokkaido	Larch (presumed), surface treatment, Girder bridge (Co floor version)	2.7	41	68	In service, but reinforced.
G: bridge Hokkaido	Larch (presumed), surface treatment, Girder bridge (Co floor version)	2.7	41	68	In service, but reinforced.

### 4.3. Australian factor method

Another model that estimates the service life of outdoor timber elements was developed in Australia during an extensive research funded by FWPA (Forest and Wood Products Australia). The research resulted in a technical guide [11] that addresses, among others, service life estimations of timber elements in multiple situations such as in-ground and above-ground decay. Other outcomes of the research are: a draft proposal for an Australian standard which provides calculation procedures for assessing the remaining structural adequacy of timber elements [15], an educational software called 'TimberLife' that provides detailed estimates of service life performance for an extensive range of hazards, and seven detailed technical reports documenting the durability and service life estimation models.

The reports give service life estimation models for a number of deterioration hazards that timber elements are subjected to in Australia. For this thesis the two main interesting hazards are in-ground and above-ground fungal attack which are handled in ManualNo3: Decay in ground contact, and ManualNo4: Decay above ground [20] [21].

#### Service Life

The model is based on the assumed idealised development of decay shown in figure 4.4. This development of decay is characterised by two parameters: a decay rate,  $r$  (in mm/year), and a time lag,  $t_{lag}$  (in years). In the technical guide two limit states are considered:

- **Onset of decay:** This service life refers to an estimate of the mean time taken for the decay to develop to a depth of 2 mm.
- **Need for replacement:** Refers to an estimate of the mean time taken for the decay to develop to a depth of 10 mm.

The decay depth after  $t$  years is given as:

$$d_t = \begin{cases} ct^2, & \text{if } t \leq t_{d0} \\ (t - t_{lag})r, & \text{if } t > t_{d0} \end{cases} \quad (4.6)$$

in which

$$t_{d0} = t_{lag} + \frac{d_0}{r} \quad (4.7)$$

$$c = \frac{d_0}{t_{d0}^2} \quad (4.8)$$

The decay lag,  $t_{lag}$  in years, is assumed to function of the decay rate  $r$ :

$$t_{lag} = 8.5r^{-0.85} \quad (4.9)$$

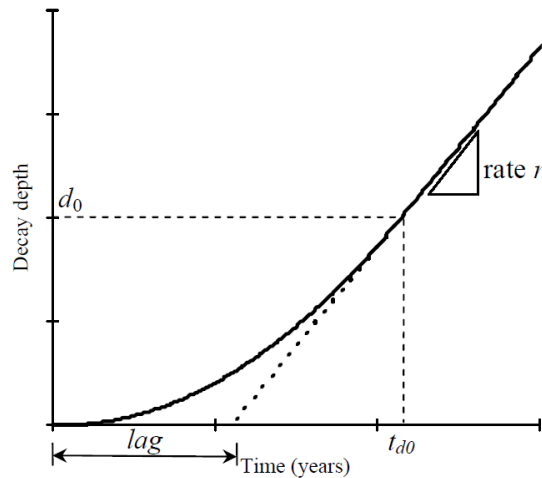

Figure 4.4: Idealised progress of the decay depth over time [21].

For a given time lag  $t_{lag}$  and decay rate  $r$ , and assuming that  $d_0 = 5mm$ , the service life for the two earlier mentioned limit states can be determined as follows:

$$L_S = \left( t_{lag} + \frac{5}{r} \right) \sqrt{\frac{2}{5}} \quad (\text{onset of decay}) \quad (4.10)$$

$$L_R = t_{lag} + \frac{10}{r} \quad (\text{replacement}) \quad (4.11)$$

Both functions are derived from equation 4.6 assuming that  $d_0 = 5mm$  and using  $d = 2mm$  for the onset of decay and  $d_0 = 10mm$  for replacement.

### Design calculations

Part of the research was a proposal for a new Australian standard that will provide design procedures for dealing with timber decay [15]. In the proposal for this standard, called AS1720.5 - Timber Service Life Design Code, the design decay depth is to be determined as follows:

$$d_{design} = d * (1 + \alpha V_d) \quad (4.12)$$

In which:

- $d$  : is the mean decay depth for a chosen design life time, calculated using equation 4.13, which is a simplified version of equation 4.6, see also figure 4.5.
- $V_d$  : is the coefficient of variation of  $d$ . The in the proposal recommended value of  $V_d$  is 2.0.
- $\alpha$  : is a specified parameter related to the target reliability level. The proposed values are:
  - $\alpha = 0.8$  for normal consequences of element failure.
  - $\alpha = 0.4$  for low consequences of element failure.
  - $\alpha = 0.1$  for serviceability considerations.

$$d = \begin{cases} 0, & \text{if } t \leq t_{lag} \cdot \\ (t - t_{lag})r, & \text{if } t > t_{lag} \cdot \end{cases} \quad (4.13)$$

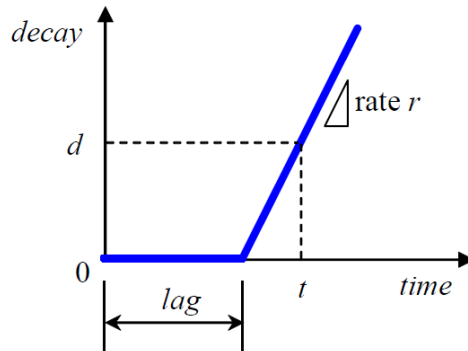

Figure 4.5: Simplified progress of the decay depth over time [15].

### Decay rate $r$

The decay rate  $r$  for a certain timber element surface is calculated as the product of a number of factors that account for the timber specie, geometry and environmental factors:

$$r = k_{wood} k_{climate} k_p k_t k_w k_n k_g \quad (4.14)$$

In which:

- $k_{wood}$  : is a wood parameter,
- $k_{climate}$  : is a climate parameter,
- $k_p$  : is a paint parameter,
- $k_t$  : is a thickness parameter,
- $k_w$  : is a width parameter,
- $k_n$  : is a fastener parameter
- $k_g$  : is a geometry parameter.

It should be noted that the decay rate  $r$  is determined for one **surface** of a timber element. For example: for a simple timber board supported on both ends, the top surface, which is the most exposed to the weather conditions, will have a higher decay rate than the bottom surface and thus the decay rate  $r$  should be separately determined for both surfaces.

### Wood parameter $k_{wood}$

The value for the wood parameter  $k_{wood}$  depends on the durability class in which the used timber specie is ranked. The durability ranking followed is the one set out in the Australian standard AS 5604. The values corresponding to the classes are shown in equation 4.15.

$$k_{wood} = \begin{cases} 0.50, & \text{for durability class 1.} \\ 0.65, & \text{for durability class 2.} \\ 1.15, & \text{for durability class 3.} \\ 2.20, & \text{for durability class 4.} \\ 6.52, & \text{for sapwood.} \end{cases} \quad (4.15)$$

### Climate parameter $k_{climate}$

Figure 4.6 shows a map of Australia divided into four different climate areas. Each zone has its own value for the climate parameter  $k_{climate}$ , see equation 4.16.

$$k_{climate} = \begin{cases} 0.40, & \text{for zone A.} \\ 0.50, & \text{for zone B.} \\ 0.65, & \text{for zone C.} \\ 0.75, & \text{for zone D.} \end{cases} \quad (4.16)$$

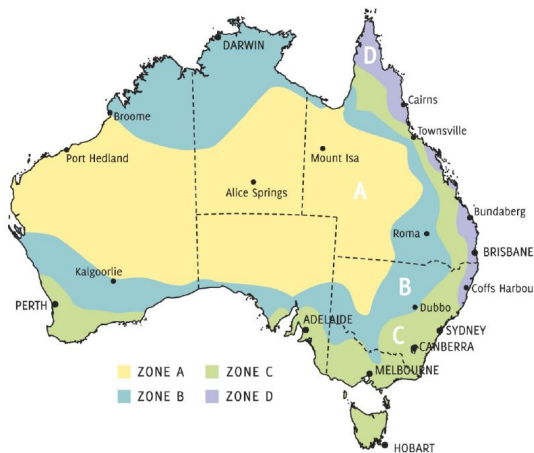

Figure 4.6: Map of Australia divided in four climate zones [21].

Based on tests, the following relationship was found between  $k_{climate}$  and the annual rainfall duration  $t_{rain}$ :

$$k_{climate} = \begin{cases} 0.15t_{rain}^{0.50}, & \text{if } t_{rain} \text{ is in days per year.} \\ 0.03t_{rain}^{0.50}, & \text{if } t_{rain} \text{ is in hours per year.} \end{cases} \quad (4.17)$$

An other outcome of these tests was that there seemed to be no correlation between  $k_{climate}$  and the local mean annual temperature.

### Paint parameter $k_p$

For unpainted wood the value of  $k_p$  is 1.0. For timber elements that are painted the value depends on the durability class of the wood:

$$k_p = \begin{cases} 3.5, & \text{for durability class 1.} \\ 2.0, & \text{for durability class 2.} \\ 1.8, & \text{for durability class 3.} \\ 1.4, & \text{for durability class 4.} \\ 1.3, & \text{for sapwood.} \end{cases} \quad (4.18)$$

### Thickness parameter $k_t$

The thickness parameter accounts for the effect of drying in the transverse direction to the timber grain. When a part of a timber element is not in contact with another element it tends to dry rapidly when it is thin enough. For surfaces in contact with other elements the value of  $k_t$  is 1.0

$$k_p = \begin{cases} 1, & \text{for } t \geq 20mm. \\ 0.5, & \text{for } t \leq 10mm. \\ 0.05t, & \text{otherwise.} \end{cases} \quad (4.19)$$

### Width parameter $k_w$

Bigger width of the element means more restrains on the wood surface during drying and can thus lead to larger and deeper checks on the surface that can subsequently lead to faster decay. For surfaces in contact with other elements the value of  $k_w$  is 1.0

$$k_w = \begin{cases} 1, & \text{for } w \leq 50mm. \\ 2, & \text{for } w \geq 200mm. \\ 1 + \frac{w-50}{150}, & \text{otherwise.} \end{cases} \quad (4.20)$$

### Connector parameter $k_n$

Parameter that accounts for the effect of a connector on the decaying surface. The interface/gap between the connector and its hole would act as a path of moisture entry to enhance the decay progress.

$$k_n = \begin{cases} 2.0, & \text{if a connector is present.} \\ 1.0, & \text{if a connector is not present.} \end{cases} \quad (4.21)$$

### Geometry parameter $k_g$

The geometry factor  $k_g$  is a multiplication of the two sub-factors  $k_{g1}$ , the contact factor, and  $k_{g2}$ , the position factor. These two factors take into account the detailing of the element or connection, and its orientation. These factors were at first based on estimations of experts and were later modified based on construction field data. They are considered as critical factors in the prediction of the decay rate.

**Contact factor  $k_{g1}$ :**

The value of the contact factor  $k_{g1}$  depends on whether the assessed surface is in contact with other structural elements or not. Three options are possible: a non-contact surface, a flat contact surface and an embedded contact surface. Figure 4.7 shows these three options with their corresponding  $k_{g1}$  values.

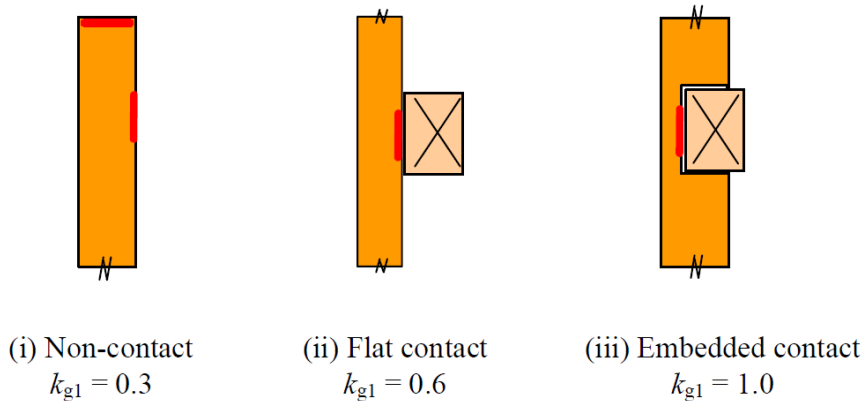

Figure 4.7: Illustrations of non-contact, flat contact and embedded contact surfaces [21].

**Position factor  $k_{g2}$  for non-contact surfaces:**

For non-contact surfaces, the position factor  $k_{g2}$  takes into account the orientation of the member and the surface, and the sheltering effect. The orientation effect is taken into account because of the mechanical degradation caused by the sun.

*(a) For vertical members*

For vertical members the position factor  $k_{g2}$  depends on the orientation of the surface that is being assessed. The following six options are possible: (see also figure 4.8)

- Top (flat)  $k_{g2} = 6.0$
- Top (sloped)  $k_{g2} = 5.0$
- facing north  $k_{g2} = 2.0$
- facing south  $k_{g2} = 1.5$
- facing east  $k_{g2} = 1.5$
- facing west  $k_{g2} = 2.0$

*Non-contact surfaces - Vertical member*

Figure 4.8: The different orientations for factor  $k_{g2}$  for vertical members [21].

*(b) For horizontal members*

For horizontal members the position factor  $k_{g2}$  also depends on the orientation of the surface that is being assessed. In this case the following options are possible:

- Horizontal surface
  - Top of member  $k_{g2} = 3.0$
  - Bottom of member  $k_{g2} = 1.5$
- Vertical side surface (side grain)
  - Sheltered (by decking)  $k_{g2} = 1.0$
  - Exposed to north  $k_{g2} = 2.0$
  - Exposed to south  $k_{g2} = 1.5$
  - Exposed to east  $k_{g2} = 1.5$
  - Exposed to west  $k_{g2} = 2.0$
- Vertical end surface (end grain)
  - Sheltered (by decking)  $k_{g2} = 2.0$
  - Exposed to north  $k_{g2} = 4.0$
  - Exposed to south  $k_{g2} = 3.0$
  - Exposed to east  $k_{g2} = 3.0$
  - Exposed to west  $k_{g2} = 4.0$

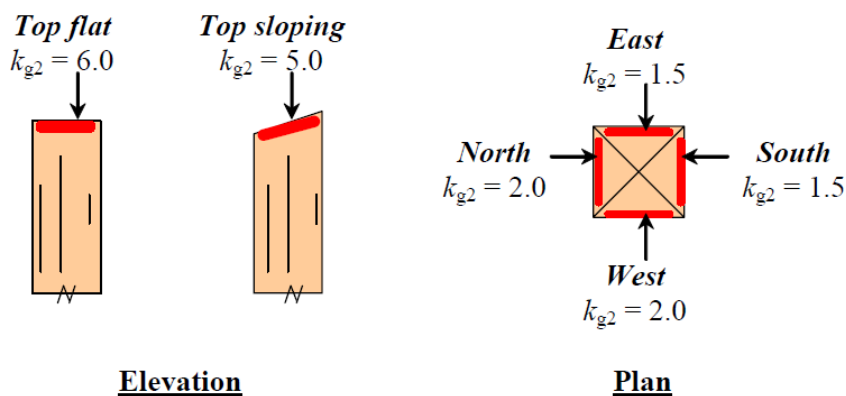
**Position factor  $k_{g2}$  for contact surfaces:**

The position factor  $k_{g2}$  for contact surfaces, both flat and embedded contacts, takes into account the type of material in contact, the presence of a gap, and the gap size and location. The factor  $k_{g2}$  is a multiplication of the factors  $k_{g21}$ ,  $k_{g22}$  and  $k_{g23}$ .

$$k_{g2} = k_{g21} k_{g22} k_{g23} \quad (4.22)$$

The factor  $k_{g21}$  takes into account the material with which the timber element is in contact with:

$$k_{g21} = \begin{cases} 1.0, & \text{when in contact with wood.} \\ 0.7, & \text{when in contact with steel.} \\ 1.0, & \text{when in contact with concrete.} \end{cases} \quad (4.23)$$

The factor  $k_{g22}$  takes into account the orientation of the assessed surface.

$$k_{g22} = \begin{cases} 2.0, & \text{for a horizontal surface facing upwards.} \\ 1.0, & \text{otherwise.} \end{cases} \quad (4.24)$$

The factor  $k_{g23}$  takes into account the presence of a gap together with its size and location. There are three options: (see also figure 4.9)

(a) A continuous member in contact with a continuous member.

$$k_{g23} = 1.0$$

(b) A continuous member in contact with a butted member.

$$k_{g23} = 1.2$$

(c) A butted member.

$$k_{g23} = \begin{cases} 2.0, & \text{when gap size is } \leq 1.0 \text{ mm.} \\ 1.3, & \text{when gap size is } \geq 2.5 \text{ mm.} \\ \frac{3.7}{1.5} - \frac{0.7}{1.5} * \text{gap size,} & \text{otherwise.} \end{cases} \quad (4.25)$$

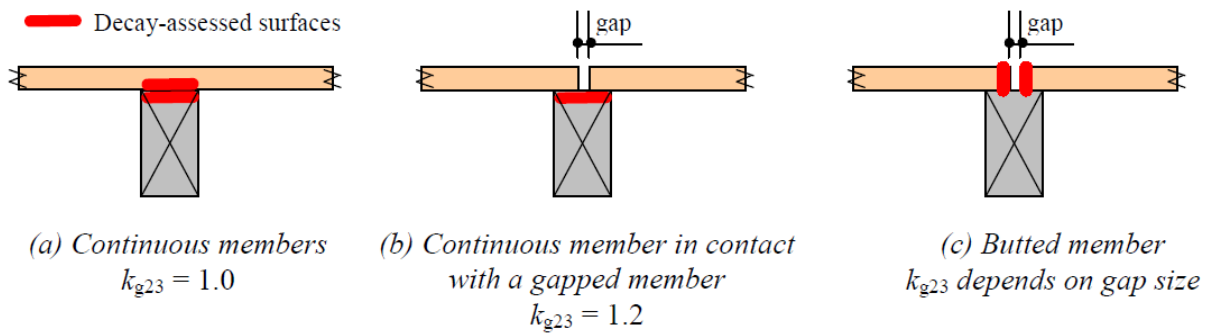

Figure 4.9: Illustrations showing the different options for factor  $k_{g23}$  [21].

### Effect of sealing layers

In the proposal for the Australian standard AS1720.5, an extra parameter was added taking into account the effect of a sealing layer, used as shown in figure 4.10. The effect of such a sealing layer is accounted for by adding an extra time lag to the time lag  $t_{lag}$  determined from equation 4.9. The extra time lag is shown in table 4.5. Three different sealing materials are considered for this. The sealing layer has no effect on the decay rate  $r$ .

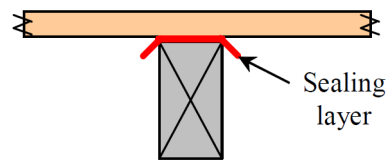

Figure 4.10: Sealing layer placed below the deck [15].

Table 4.5: Extra time lag due to sealing layer [15].

Sealing layer material	Extra lag (years)
Copper naphthenate paste	5
Malthoid DPC	10
Plastic aluminium DPC	10

## 4.4. Swedish factor method

This service life estimation method had been developed within the Swedish DuraTB - Durable Timber Bridges - project. The goal of this project was "to contribute to the development of sustainable timber bridges by making guidelines for moisture design and developing new and improved bridge concepts and details in terms of durability and maintenance aspects" [17].

The method deals with timber in outdoor above ground applications, which is timber in use class 3 according to EN 335 (2013), and considers fungal decay as deterioration mechanism. It is based on the assumption that the service life of a wooden structure with respect to fungal decay is based on the following two main factors:

- **The climatic exposure:** i.e. geographical location, local climate, degree of protection against rain, distance to ground, detailing with respect to moisture trapping and maintenance measures.
- **The material resistance:** different wood species with different kinds of preservation (or without preservation) display different resistance against decay.

The exposure is primarily affected by the design and construction of the bridge and is independent of which wood specie is used, while the resistance is primarily a function of the choice of material.

### Service life

The climatic exposure and material resistance are measured as a dose of which the unit is time (in days). The method can be used to evaluate the durability of individual elements of timber bridges. It states that a selected design solution is acceptable when the cumulative exposure during the intended service life time is smaller than the material resistance.

#### Exposure ≤ Resistance

Mathematically this is shown in equation 4.26.

$$D_{Ed} * SL = D_{Ek,c} \gamma_d * SL \leq D_{Rd} \quad (4.26)$$

In which:

- $D_{Ek}$  : is the characteristic **annual** exposure dose,
- $SL$  : is the intended service life of the element,
- $D_{Rd}$  : is the design value of the resistance dose,
- $\gamma_d$  : is a factor that depends on the severity class.

In the final report of the DuraTB project, Durable timber bridges - Final report and guidelines [17], procedures are set out on how to determine the characteristic annual exposure dose  $D_{Ek}$ , the design resistance dose  $D_{Rd}$  and the severity factor  $\gamma_d$ . When these are all known, the estimated service life can be determined as follows:

$$\text{Estimated service life} = \frac{D_{Rd}}{D_{Ek} * \gamma_d} \text{ (in years)} \quad (4.27)$$

### Limit state

In the research the severity of decay is rated following the decay rating from EN 252 which consists of five decay rankings: 0 (no decay), 1 (slight attack), 2 (moderate attack), 3 (severe attack) and 4 (failure). The design resistance dose, discussed in more detail later on, is based on the point in time at which the wood reaches decay ranking 1 (slight attack), which in the research is also defined as the onset of decay.

Limit state = onset of fungal decay (slight attack)

### Dose response functions

In order to obtain data for the development of timber durability models, field trials with Scots pine sapwood (*Pinus sylvestris* L.) and Douglas fir heartwood (*Pseudotsuga menziesii* Franco) were conducted at 24 test sites in Europe [6]. The specimens were monitored in terms of moisture content, temperature and progress of fungal decay. The decay rating was done following EN 252 which uses the following five rankings: 0 (no decay), 1 (slight attack), 2 (moderate attack), 3 (severe attack) and 4 (failure).

The tests resulted in so called dose-response functions that are able to show the relationship between the mean decay rating and the cumulative dose at a certain moment in time, see figure 4.11. The annual dose  $D$  is a function of two components: a component  $D_u$  which depends on the moisture content  $m_u$  of the wood, and a component  $D_T$  that depends on the temperature  $T$  of the wood. This can be mathematically written as follows:

$$D = f(D_T(T), D_u(u)) \quad (4.28)$$

For  $n$  days the cumulative dose is given by:

$$D(n) = \sum_1^n D_i = \sum_1^n f(D_T(T_i), D_u(u_i)) \quad (4.29)$$

Where  $T_i$  is the average temperature and  $u_i$  the average moisture content of the wood on day  $i$ .

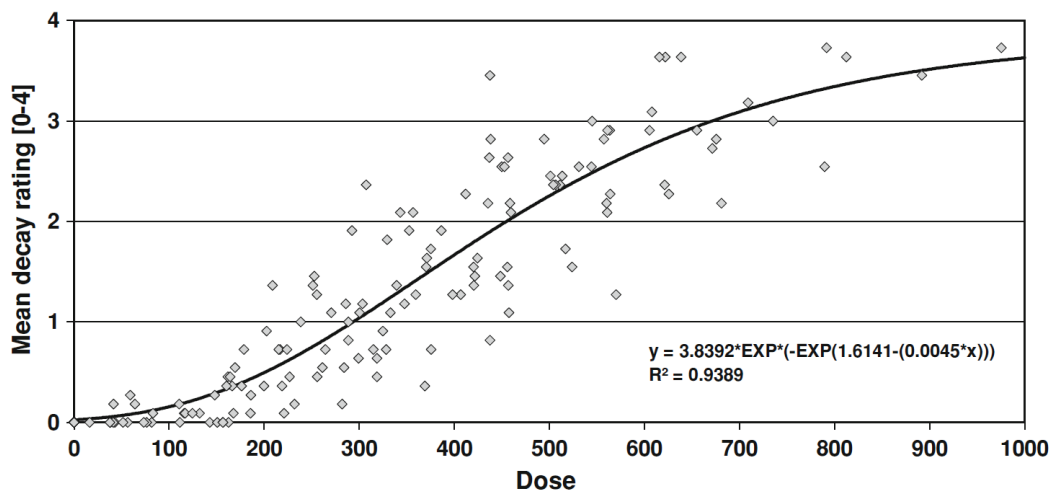

Figure 4.11: Example of a dose response function. This graph shows the relationship between the dose and the decay rating according to EN 252 for Scots pine sapwood test specimens located at 26 different field test sites. Each dot represents the mean decay rating at one exposure site at a certain time of exposure; black line: Gompertz smoothing function [1]

### Annual exposure dose

The annual characteristic exposure dose  $D_{Ek}$  is determined as follows:

$$D_{Ek} = D_{E0} * k_{E1} * k_{E2} * k_{E3} * k_{E4} * c_a \quad (4.30)$$

In which:

- $D_{E0}$  is the annual reference exposure dose depending on the geographical location. The reference exposure dose is determined for a horizontal timber element exposed to outdoor conditions such as rain, relative humidity and temperature, see figure 4.12.
- $k_{E1}$  is a factor accounting for the effect of local climate conditions and driving rain.
- $k_{E2}$  is a factor accounting for the effect of sheltering.
- $k_{E3}$  is a factor accounting for the distance to the ground .
- $k_{E4}$  is a factor accounting for the effect of durable detail design.
- $c_a$  = 1.4, is a calibration factor estimated on the basis of reality checks, safety considerations and expert estimates.

How these factors are determined is described in the final report of the DuraTB study [17] and in a background document written by Isaksson et al. [7].

### Annual reference exposure dose $D_{E0}$

Based on field tests, the annual reference exposure dose has been determined for the reference object shown in figure 4.12. This reference object consists of a horizontally exposed Norway spruce board with no moisture traps. The annual reference exposure dose depends on the climate conditions of the region the bridge is located at. It is a function of the relative humidity, rainfall and temperature of the location. In the DuraTB project multiple ways of determining the exposure dose have been discussed. In the final report the exposure dose has been estimated with the help of the following simplified logistic dose model (SLM) described by Isaksson et al [6]:

$$D = D_u(u) * D_T(T) \quad (4.31)$$

$$D_u(u) = \begin{cases} (u/30)^2 & \text{when } u \leq 30\%. \\ 1 & \text{when } u > 30\%. \end{cases} \quad (4.32)$$

$$D_T(T) = \begin{cases} 0 & \text{when } T < 0^\circ \text{C}. \\ (T/30) & \text{when } 0^\circ \text{C} \leq T \leq 30^\circ \text{C}. \\ 1 & \text{when } T > 30^\circ \text{C}. \end{cases} \quad (4.33)$$

In which:

- $D$  is the exposure dose in days.
- $D_u$  is the component of the dose that takes into account the wood moisture content
- $D_T$  is the component of the dose that takes into account the wood temperature
- $u$  is the moisture content of the wood in %.
- $T$  is the temperature of the wood in ° C.

The wood moisture content and wood temperature are determined using climate data in the form of relative humidity, rainfall and temperature. For the estimation of the moisture content of the wood, a numerical model was developed within the DuraTB program [16] that uses the relative humidity and rainfall as input. The temperature of the wood is assumed to be the same as the air temperature.



Figure 4.12: Reference element for climate exposure – horizontally exposed spruce board without moisture traps [17]

The annual reference exposure dose was calculated for a large number of locations throughout Europe. The result was shown in the form of a contour plot shown in figure 4.13 with the corresponding values listed in table 4.6.

Table 4.6: Annual exposure dose  $D_{E0}$  values for the zones displayed in figure 4.13. Valid for the reference object shown in Figure 4.12.

Zone	Annual exposure dose $D_{E0}$ (days)		Color code
	Mean	Range	
a	66	63-69	
b	60	57-63	
c	55	52-57	
d	49	46-52	
e	43	40-46	
f	37	34-40	
g	32	29-34	
h	26	23-29	
i	20	17-23	
k	15	12-17	
m	9	6-12	

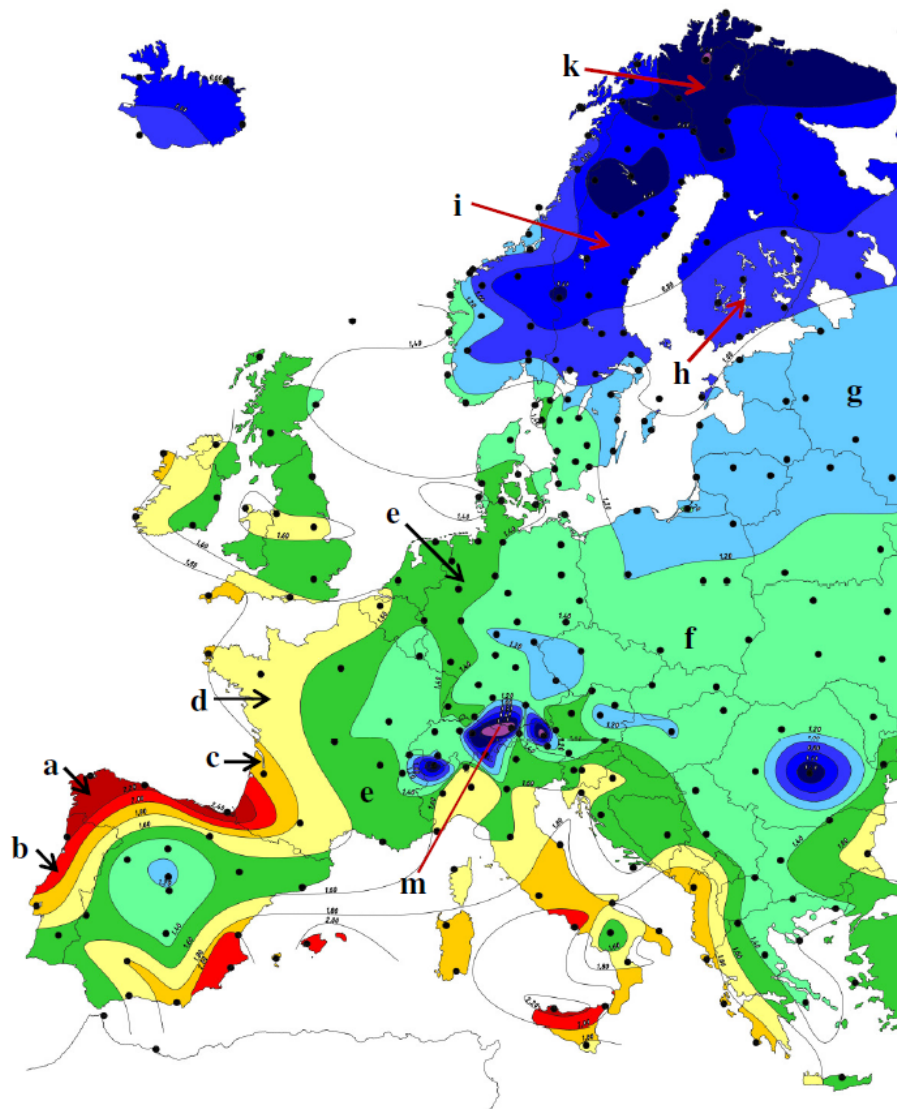

Figure 4.13: European climate zones [17].

### Local climate factor $k_{E1}$

This factor takes into account the expected amount of driving rain and any protection that the surrounding provides against this phenomena. Protection against driving rain can for instance come from adjacent buildings. The values are shown in table 4.7. These values are based on expert opinions, not on experiments. For horizontal rain-exposed surfaces the value should always be taken as 1.0.

Table 4.7: Values for local climate factor  $k_{E1}$  [17]. For horizontal surfaces the  $k_{E1}$  should always be taken as 1.0.

Degree of exposure	Protective effects are present	Driving rain expected at the site	$k_{E1}$
Light	yes	no	0.8
Medium	yes	yes	0.9
Medium	no	no	0.9
Severe	no	yes	1.0

### Degree of sheltering and distance to the ground ( $k_{E2}$ and $k_{E3}$ )

The effect of sheltering against above a timber element is described by the factor  $k_{E2}$ . It is determined by the ratio  $e/d$ , see figure 4.14.

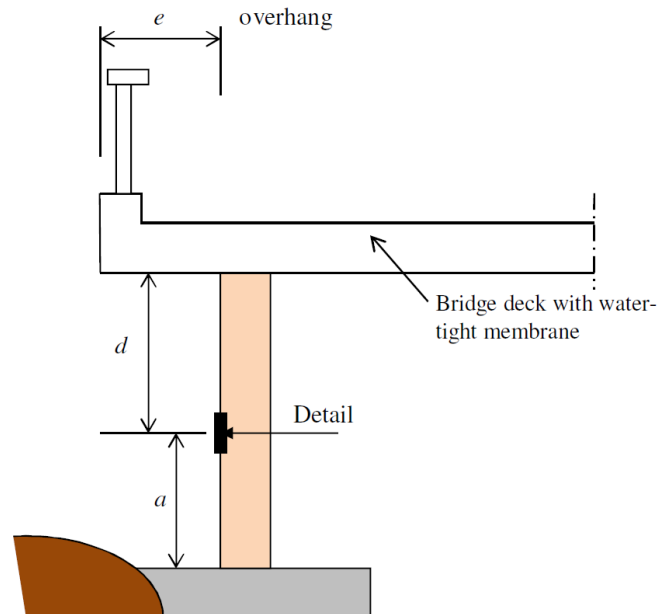

Figure 4.14: Definitions the parameters used for the determination of factors  $k_{E2}$  and  $k_{E3}$  [17].

When sheltering is provided the exposure dose is reduced by factor  $k_{E2}$  which can be calculated according to:

$$k_{E2} = \begin{cases} 1 - 0.2 \frac{e}{d} & \text{if } 0 < \frac{e}{d} \leq 1 \\ 0.8 & \text{if } \frac{e}{d} > 1 \end{cases} \quad (4.34)$$

When elements are placed closer than 400 mm from the ground, an increase of exposure is considered. When the distance is smaller than 100 mm, the element is not considered since durability effects are very uncertain due being almost in ground-contact. The factor  $k_{E3}$  is calculated as follows:



$$k_{E3} = \begin{cases} \frac{700 - a}{300} & \text{if } 100 < a \leq 400 \text{ mm} \\ 1.0 & \text{if } a > 400 \text{ mm} \end{cases} \quad (4.35)$$

### Effect of detail design ( $k_{E4}$ )

The effect of detail design was evaluated based on field tests carried out in the DURA-TB project, where a number of bridge details were exposed outdoors while the moisture content was measured continuously. A ranking was made containing five classes ranging from excellent to poor detail design. This ranking is shown in table 4.8.

Details that differ from the examples shown in table 4.8 need to be assessed by the degree of moisture exposure and related to one of the five classes shown in the table. Important in this assessment is the degree of rain exposure and the possibility of fast drying in order to avoid moisture traps. Also the opportunity for soil and dirt getting trapped in the joints need to be considered.

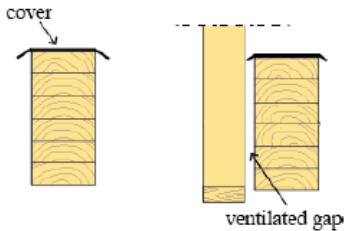
Table 4.8: Ranking of details with respect to exposure and corresponding values for factor  $k_{E4}$  [17].

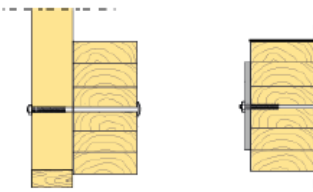
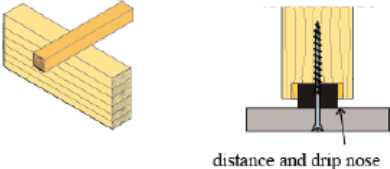
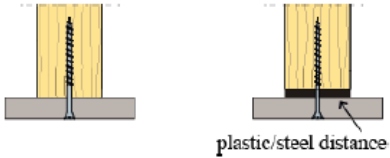
Class	Description	Example	$k_{E4}$
Excellent	Design characterized by excellent ventilation (air gap > 10 mm) and no standing water. For example: a vertical surface without connecting members or with sufficient gap between members <sup>1</sup>		0,8
Good	Design characterized by excellent ventilation but standing water after rain events. For example: horizontal surface without connecting member.		1,0
Medium	Design characterized by poor ventilation but limited exposure to water. For example, vertical contact areas without sufficient air gap.		1,25
Fair	Design characterized by poor ventilation and high exposure to water or end-grain with good ventilation and limited exposure to water. <sup>1</sup> For example: horizontal contact areas and end-grain with sufficient air gap.		1,5
Poor	Design characterized by exposed end-grain with no ventilation and very high exposure to water. For example: end-grain contact area without air gap.		2

### Material resistance dose

The material resistance dose  $D_{Rd}$  is determined as follows:

$$D_{Rd} = D_{crit} * k_{wa} * k_{inh} \quad (4.36)$$

In which:

$D_{crit}$  is the critical reference dose corresponding to the onset of decay, which is rating 1 (slight attack) according to EN 252 (2015).  $D_{crit}$  was evaluated for Scots pine sapwood and douglas fir heartwood and is estimated at 325 days [1].

$k_{wa}$  is a factor accounting for the wetting ability of the tested material, relative to the reference Norway spruce.

$k_{inh}$  is a factor accounting for the inherent protective properties of the tested material against decay, relative to the reference Norway spruce.

Within the DuraTB project the values of  $k_{wa}$  and  $k_{inh}$  for a number of timber species were determined by tests [12]. The resulting values of the material resistance dose  $D_{Rd}$  are shown in table 4.9.

Table 4.9: Material resistance  $D_{Rd}$  for a number of wood species, calculated with equation 4.36. The values of  $k_{wa}$  and  $k_{inh}$  were determined by tests [17]

Wood species	Botanical name	$D_{Rd}$ (in days)	Relative $D_{Rd}^2$
<b>Hardwoods</b>			
Norway maple	Acer platanoides	344	1.06
Aspen	Populus tremula	373	1.15
Birch	Betula pendula	284	0.87
English oak	Quercus robur	1670	5.14
Beech	Fagus sylvatica	313	0.96
Teak	Tectona grandis	3027	9.32
Black locust	Robinia pseudoacacia	2298	7.07
<b>Softwoods</b>			
Norway spruce	Picea abies	325	1.00
Southern Yellow Pine (SYP)	Pinus spp.	727	2.24
Scots pine heart	Pinus sylvestris	856	2.63
Scots pine sap	Pinus sylvestris	304	0.93
Western Red Cedar (WRC)	Thuja plicata	1049	3.23
Juniper	Juniperus communis	1909	5.87
Siberian larch	Larix sibirica	1136	3.50
European larch	Larix decidua	1914	5.89
Douglas fir	Pseudotsuga menziesii	1716	5.28
<b>Modified materials</b>			
Oil-heat treated Spruce	Picea abies	2691	8.28
Oil-heat treated Ash	Fraxinus excelsior	3314	10.20
Thermally modified Scots pine	Pinus sylvestris	2850	8.77
Acetylated SYP (acetyl content: 19 %) <sup>1</sup>	Pinus spp.	3305	10.17
Acetylated Radiata pine (acetyl content: 20 %) <sup>1</sup>	Pinus radiata	3119	9.60
Furfurylated SYP (WPG:50 %) <sup>1</sup>	Pinus spp.	3049	9.38
Furfurylated Scots pine (WPG: 40 %) <sup>1</sup>	Pinus sylvestris	4886	15.03

<sup>1</sup> Weight percent gain of furfurylated wood and acetyl content of acetylated wood according to manufacturer's data.

<sup>2</sup> Relative to Norway spruce.

### Calibration factor $c_a$

The value for the calibration factor  $c_a$  was set on 1.4, based on a number of reality checks.



**Severity class  $\gamma_d$** 

The durability severity class can be seen as a safety factor which takes into account the consequences of a lifespan shorter than estimated. The values of  $\gamma_d$  are shown in table 4.10.

Table 4.10: Different severity classes and corresponding values for  $\gamma_d$  [17].

<b>Severity class</b>	$\gamma_d$
1. Low (e.g. where it is accepted and easy to replace a limited number of components if decay should be initiated within expected service life)	0.6
2. Medium (e.g. when the expected economical and practical consequences are significant)	0.8
3. High (risk for human injuries or loss of lives)	1.0

## 4.5. Mechanical performance modelling

Mechanical performance modelling, which on itself is not a factor method, has been used by van de Kuilen and Gard to estimate the service life of timber structures. Their method is based on the reliability function shown in equation 4.37 [19].

$$Z = R - S \quad (4.37)$$

Where  $R$  is the resistance and  $S$  the load. The method states that both the resistance and the load are time dependent. The assumption is that in time the resistance decreases, due to the load level and degradation processes, and the load increases, due to for instance increasing snow or wind loads. Equation 4.37 then can be written as follows.

$$Z(t) = R(t) - S(t) \quad (4.38)$$

The distribution of  $Z(t)$  over time is shown in figure 4.15.

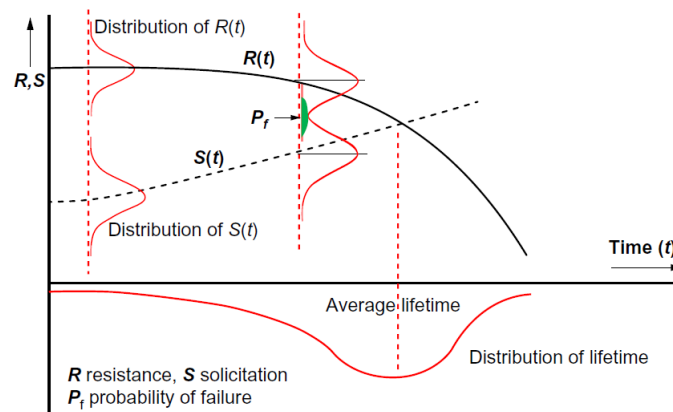

Figure 4.15: Lifetime distribution of structures [19]

van de Kuilen and Gard (2017)

The method is applied by van de Kuilen and Gard to determine the service life of an outdoor glulam beam. Visual inspection of the beam showed that it suffered from fungi decay and delamination cracks. A linear exponential damage accumulation model is used to calculate the degradation due to the load effect, and an assumed constant decay rate is used to calculate the deterioration due to biological decay. One of the results is shown in figure 4.16.

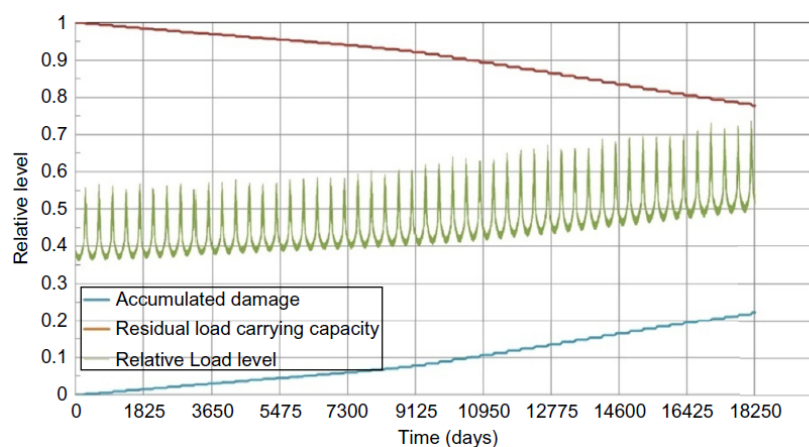

Figure 4.16: Service life calculation for 50 years, load case 2 (dead load + live load + snow load) and biological deterioration 0.5 mm/year with a delay time of 5 years. [19]

## 4.6. Markov Chain

In their article *Deterioration Prediction of Timber Bridge Elements Using the Markov Chain*, Ranjith et al. give the following description of what a Markov process is:

"A Markov process describes a system that can be in one of several (numbered) states, and can pass from one state to another at each time step according to fixed probabilities. If a Markov system is in state  $i$ , there is a fixed probability,  $p_{ij}$ , of it going into state  $j$  at the next time step, and  $p_{ij}$  is called a transition probability."

An example of a Markov process with a typical transition matrix is shown in figure 4.17

Condition state	State 1	State 2	State 3	State 4	Sum
1	0.4	0.3	0.2	0.1	1
2	0	0.5	0.3	0.2	1
3	0	0	0.7	0.3	1
4	0	0	0	1	1

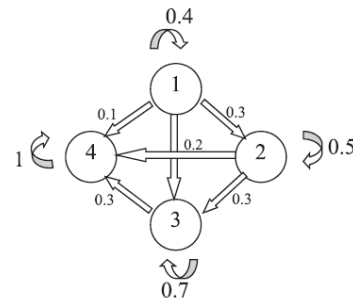

Figure 4.17: Example of a markov process with corresponding transition matrix for a four-stage condition stage [18]

The Markov Chain model can be used in combination with bridge condition data that includes ratings of individual components such as the deck, the main girders and the corbels. The Roads Corporation of Victoria, Australia, for instance uses four condition classes for the rating of timber bridge elements ranging from C1 (good condition) to C4 (bad condition) [18]. Another example is the rating system that the USA's Federal Highway Administration (FHWA) uses for all of their bridges (not just timber) and which exists of nine condition classes going from class 9 (excellent condition) to class 0 (failed condition) [3].

### Research using the Markov Chain

Ranjith et al. 2013 [18]

Ranjith et al. use a stochastic Markov chain model to predict the future condition of timber bridge elements. For this they make use of condition data obtained from the Australian Roads Corporation of Victoria which they used to develop the transition probabilities. A typical set of data for a certain timber bridge is shown in figure 4.11. A timber bridge is divided into eight main elements and the condition of each of these elements can be divided into four condition classes. These condition classes go from C1 (good condition with no decay) to C4 (Heavy rot, decay, splitting or crushing). The percentages in the table in figure 4.11 show what percentage of an element is in a certain condition class.

Table 4.11: Typical data set for a certain timber bridge [18].

Element	Inspection period	Structural identification number	Year of inspection	Year of inspection			
				%C <sub>1</sub>	%C <sub>2</sub>	%C <sub>3</sub>	%C <sub>4</sub>
Deck	2	SN4867	1998	60	40	0	0
			2000	20	60	20	0
Pile	3	SN6997	1999	80	20	0	0
			2002	50	50	0	0
Abutment	4	SN6996	1997	90	5	5	0
			2001	70	0	30	0
Curbs	3	SN3776	1996	100	0	0	0
			1999	75	0	25	0
Railing	2	SN5878	1997	0	0	0	100
			2001	0	0	0	100
Cross beam	3	SN5772	1999	50	50	0	0
			2002	50	50	0	0
Girder	2	SN8970	1998	90	0	10	0
			2000	0	0	100	0
Corbels	4	SN8791	2002	95	5	0	0
			2006	55	26	19	0

# 5

## Factor models - Comparison

In this chapter conclusions will be drawn about the five in chapter 4 described service life models. These conclusions will be based on the information found in the literature study described in chapters 2, 3 and 4, and they will be based on model characteristics such as the required input, the usability, the reliability and the output. Table 5.1 gives a short overview of the five models.

### **Factor methods vs. mathematical methods**

The models are grouped into one out of two types of methods: factor methods and mathematical methods. The Japanese, Australian and Swedish methods are all classified as factor methods. Mechanical performance modelling and the Markov chain are both classified as mathematical method. Table 5.2 gives a short overview of the three factor methods.

Since this research focusses on the use of factor methods, the two mathematical methods described in chapter 4 will not be discussed in more depth in the following chapters.

### **Usability**

An estimation of the service life is something that should be integrated into the design process of any structure, since most design considerations will have an influence on the service life. For timber bridges this is especially important, see chapters 2 and 3 in which the importance of good 'durable' design choices for timber bridges is described.

The usability of a model describes with what ease the model can be used and for which design stage and for what purpose the model is best suited. A designer who is in the early stages of designing a bridge will for instance ask for a different type of model than an engineer who has to say something about the remaining service life of an existing bridge which has already been exposed to some minor (or major) biological damage.

### **Input and output**

The differences in usability described above also reflect on the necessary input and the required output. For the same example used earlier, the designer would want to know what the influence of his or her design choices is on the service life. Therefore his (or her) available input consists of these design choices such as the wood species, the type of connection and/or any protective measures. As output he (or she) will want an estimation of the service life in years and the influence of the design choices on this service life. Since designing is an iterative process during which multiple design options are being assessed, the designer will need for a model that is relatively quick and easy in use so that these different options can be compared without having to make long and difficult calculations at every iteration step.

The engineer who has to assess an existing bridge and has to give an estimation of the remaining service life will have different input available and will also ask for different output. The input will consist of again the bridge design (which is now no longer variable), the current state of the bridge (amount of biological damage) and, if available, the state of the bridge at earlier points in time, documented in inspection reports. The required output will likely be a plot as shown in figures 4.10 and 4.11 showing the decrease in strength of the critical points of the main structural elements.

Table 5.1: Overview of service life estimation methods discussed in chapter 4.

<b>Method</b>	<b>Type of method</b>	<b>Procedure</b>	<b>result</b>
Japanese factor method	Factor method	Reference service life is multiplied by several factors based on e.g. climate, timber specie and design.	An estimated service life for the entire bridge.
Australian TimberLife method	Factor method	For a timber surface, a decay rate and a time lag are determined by multiplying several factors based on e.g. climate, timber specie and design.	A decay rate over time plus a time lag, which can be used to obtain the development of the decay depth over time of a timber surface.
Swedish DuraTB Dose-Response method	Factor method	An annual exposure dose is determined by multiplying a reference exposure dose with several factors based on the climate and design. The material resistance dose is determined by multiplying a reference resistance by factors based on the material properties. The service life is estimated by dividing the material resistance dose by the annual exposure dose.	An estimated service life for the assessed timber bridge element.
Mechanical performance modelling	Mathematical model	The mechanical resistance $R$ of a structure or element is taken as a function of time. The decrease in strength of the wood due to biological deterioration is taken into account by using a decay rate in combination with a time lag.	A function, or plot, of the decreasing mechanical resistance $R$ over time. When combined with a load $S$ (which could be increasing in time) the point in time can be found where $S(t) > R(t)$ and the structure or element fails.
Markov Chain	Mathematical model	Based on data from inspections with a regular interval (e.g. every one or two years) in which bridge elements are ranked on a certain scale (e.g. from 0 (no decay) to 4 (failure)) transition matrices can be made. Such a matrix gives the probability that within the inspection interval an element goes from one scale into the next (e.g. from 0 (no decay) to 1 (light decay)).	An on transition matrices based prediction of the deterioration progress of a timber element over time.

Table 5.2: Overview of the factors used by the models following the factor method.

	<b>Japanese factor method</b>	<b>Australian TimberLife method</b>	<b>Swedish DuraTB method</b>
<b>Use for</b>	Complete bridge	Bridge element or detail	Bridge element or detail
<b>Limit states</b>	Replacement of the entire bridge	Certain amount of decay ingress. Acceptable amount before replacement can be set by engineer/client. E.g. replacement after 10 mm decay ingress	Replacement, corresponding to a decay rating of 1 according to EN 252 (2015)
<b>Reference situation</b>	Cedar timber girder bridge without preservative treatment in an average Japanese climate without any structural or executional protective measures and without any maintenance done.	The method is based on three large scale field tests performed in Australia. These tests used multiple test object configurations and multiple timber species.	Norway spruce board without moisture traps exposed to weather conditions. Used in large scale testing throughout Europe
<b>Timber durability</b>	<p>Factor P1: accounting for the natural durability of the timber specie used</p> <p>Factor P2: accounting for the permeability of the timber</p> <p>Factor P3: depending on the type of preservative treatment used.</p> <p>The three factors are combined as  <math>P = P1 + P2 * P3</math></p>	Parameter $K_{wood}$ : depends on the durability class the timber specie is in.	<p>Factor <math>k_{wa}</math>: accounting for the wetting ability of the tested material, relative to the reference Norway spruce.</p> <p>Factor <math>k_{inh}</math>: accounting for the inherent protective properties of the tested material against decay, relative to the reference Norway spruce.</p>
<b>Climate</b>	<p>Factor E1: environmental climate, based only on the mean temperature of the region.</p> <p>Factor E2: accounts for the moistness of the local conditions.</p>	Climate parameter $k_{climate}$ : depends only on the total annual duration of rainfall (in days per year).	<p><math>D_{E0}</math>: reference annual exposure dose, takes into account both the temperature and the moisture content of the wood.</p> <p>Factor <math>k_{E1}</math>: accounting for local climate and driving rain</p>
<b>Design: Structural style</b>	<p>Factor S1: presence of roof yes or no.</p> <p>Factor S2: location of deck: above or below structural members.</p> <p>Factor S3: main structural type.</p> <p>Factor S4: type of deck.</p>	-	-

<b>Design: Detailing</b>	Factor D: takes into account whether durable design measures have been implemented or not. It considers only two options: either yes, durable details have been used, or no, durable design has not been used.	<p>Thickness parameter <math>k_t</math>: Takes into account the thickness of the timber element. The assumption is that thinner elements tend to dry faster.</p> <p>Width parameter <math>k_w</math>: a bigger width can potentially cause larger and deeper checks.</p> <p>Connector parameter <math>k_n</math>: presence of a connector can act as a moisture entrance.</p> <p>Contact factor <math>k_{g1}</math>: depends on whether the assessed surface is in contact with other structural members or not. This factor is multiplied with a position factor <math>k_{g2}</math> which takes into account the orientation of the surface and, in case of contact, the detailing of the connection.</p> <p>The effect of a sealing layer below the deck is accounted for by an extra time lag.</p>	<p>Factor <math>k_{E2}</math>: takes into account the effect of sheltering.</p> <p>Factor <math>k_{E3}</math>: takes into account the distance to the ground.</p> <p>Factor <math>k_{E4}</math>: takes into account the design of the detail. Details are ranked in one out of five classes rating the detail from excellent to poor with respect to moisture exposure.</p>
<b>Paint</b>	-	Paint parameter $k_p$ : when no paint applied $k_p = 1$ . When paint is applied, the value of $k_p$ is higher than 1, which means faster decay, and depends on the durability class of the timber specie it is applied on.	
<b>Execution</b>	<p>Factor C:</p> <ul style="list-style-type: none"> <li>• Yes, extra measures against decay have been considered during construction.</li> <li>• No, standard execution.</li> </ul>	-	
<b>Maintenance</b>	Factor, M, takes into account the maintenance done.	-	

## 5.1. Limit states

In normal structural design the two main limit states are the ultimate limit state (ULS) and the Serviceability limit state (SLS), where the ULS can be considered to account for the safety while the SLS accounts for the usability and the comfort of a structure.

For durability design these same two limit states can be used. However biological decay phenomena such as fungi affect not only the mechanical properties but also the aesthetic value of timber elements. Consequently the service life of timber elements does not necessarily has to only go hand in hand with the exceeding of the SLS or ULS. The unpleasant look of rotten or stained timber can be a reason for bridge owners to replace elements that, from a structural point of view, are still in good condition.

Aesthetic value is however something that is not easily measured and the accepted amount of visual decay will vary widely between clients. Some clients will attach highly to the visual appearance of their timber structure and will not allow for any sign of biological decay, which can thus lead to the replacement of timber elements long before they reach their structural limit state. On the other side there might be clients who do not care at all about the visual decay and who will replace the timber elements only when the biological decay has developed to the point where the structure is no longer safe.

The two limit states used in the three different factor methods are:

1. **Onset of decay**
2. **Replacement**

However the three factor methods mention different meanings of these limit states.

The **Japanese method** only uses the second limit state, replacement, but they do not link it to a certain amount of biological deterioration. It is just the moment at which a bridge is replaced, for whatever reason.

In the **Australian method** both limit states are used. Onset of decay is linked to a decay depth of 2 mm while replacement corresponds to a decay depth of 10 mm. These two states are however set as examples of limit states that can be used in an early design stage, and the depth corresponding to each limit state can be adjusted per situation. For big maybe slightly over-designed beams, replacement might become necessary at much larger decay depths while for thinner elements 10 mm infiltration depth might already be too much. Also the wishes of the client are of influence. If aesthetics is an important factor in the design then the client might already want to replace certain timber elements as soon as decay occurs or can be seen. In this case both earlier named limit states will occur at the same moment.

The **Swedish method** states that the moment when onset of decay occurs is also the moment to replace the timber element. Onset of decay in this method corresponds to a decay rating of 1 (slight attack) on the 0 to 4 decay scale from EN 252 (2015).

## 5.2. Reference sources

As stated earlier, factor methods usually rely on a certain reference situation for which, due to testing or experience, the service life is known. They are shortly described below.

### Japanese factor method

The Japanese method is based on the following reference situation:

- Bridge type : Girder bridge
- Timber specie : Cedar (no preservative treatment)
- Deck : Cedar timber deck
- Climate : Average Japanese climate (annual mean temperature of 15.5°C)
- Roof : No roof
- Detailing : No durable detailing
- Execution : Standard execution
- Maintenance : No maintenance during the service life



These reference bridge characteristics were chosen because from experience it was known that in Japan these kind of bridges are usually replaced after 15 years. Therefore the reference service life was set to 15 years.

### Australian TimberLife method

The Australian model was developed based on the results of three different large scale field tests performed in Australia.

The first of these field tests consists of a series of L-joint tests initiated in 1987 and performed over a period of 20 years. The test objects were mortise and tenon L-joints as shown in figure 5.1. The tests were performed at 10 different test sites scattered over the east coast of Australia. Multiple wood species were tested. Nine reference species were tested at all 10 sites and 33 more species were installed at one specific site only. For each species, 24 painted and 24 unpainted replicates were installed at each site.

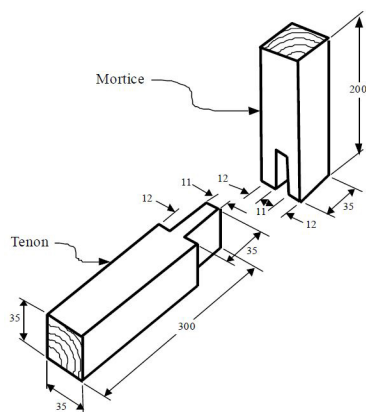

Figure 5.1: Dimensions of the L-joint test objects (left) and photo of one of the test sites (right) [21].

### Swedish DuraTB method

The Swedish model is developed based on the results of multiple large scale field tests performed throughout Europe.

The tested elements were spruce boards, see figure 5.2.



Figure 5.2: Swedish reference situation, spruce board above ground contact.

### 5.3. Output

The three discussed factor methods all provide different types of output. They are described below.

#### Japanese method

The output of the Japanese method is given in the form of an estimated service life of the entire bridge, which is calculated with the use of equation 5.1. No distinction is made between different elements of the bridge.

$$ESL = 7.0 e^{0.73Y} \leq 50 \text{ years} \quad (5.1)$$

#### Swedish DuraTB method

The output of the Swedish factor method is, just as for the Japanese method, given in the form of an estimated service life in years, see equation 5.2. However the Swedish method does give this estimation for a specific bridge element or connection and therefore makes a distinction in the estimated service life for the different bridge elements.

$$\text{Estimated service life} = \frac{D_{Rd}}{D_{Ek} * \gamma_d} \quad (\text{in years}) \quad (5.2)$$

#### Australian TimberLife method

The output of the Australian TimberLife factor method is given in the form of a decay rate  $r$  (in mm/year) and a time lag  $t_{lag}$  (in years), shown in figure 5.3. These are given for specific bridge elements. In contrast to the other two factor methods, the output is thus not given in a specific estimated service life in years. In order to convert this output into an estimated service life, a limit state needs to be set by the user. These limit states are previously described in section 5.1.

The form in which the output of the Australian method is given creates the possibility to show the development of the deterioration of an element over time. This is shown in figure 5.3.

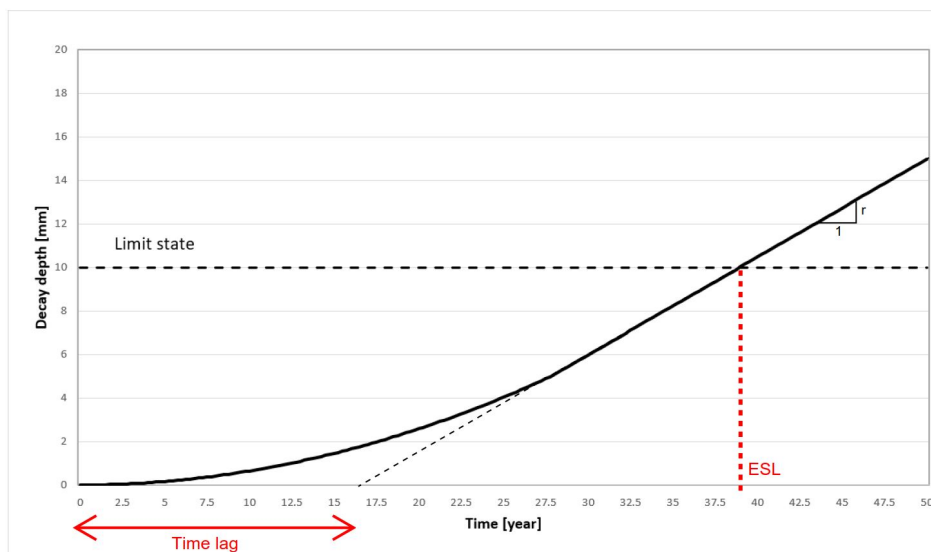

Figure 5.3: Output of the Australian TimberLife factor method [21].

## 5.4. Factors influencing the service life

From the literature study in chapters 2 and 3 it can be concluded that there are three main factors that influence the service life of a timber bridge:

- The natural durability of the used timber specie.
- The climate in which the bridge is situated, i.e. temperature and rainfall.
- The detailing of the elements and connections (with respect to moisture retention.)

Table 5.2 gives an overview of how the three factor methods take these main influences into account. As can be seen from this table, all the methods do take them into account, however in different ways. This section makes a comparison of the influence of the three above mentioned factors between the Swedish and the Australian method. The Japanese method is not taken into account since, unlike the other two methods, it cannot be used to estimate the service life for one element specific.

### 1. Timber durability

The influence of the timber durability factor on the estimated service life is determined with the help of the reference situation shown in figure 5.4. The factor values belonging to this reference situation are shown in tables 5.4 and 5.3. The factors concerning the timber specie are left open since these will variate in this comparison.

Table 5.3: Values of the factors for the reference situation of figure 5.4 for the Swedish method

$k_{wood}$	$k_{climate}$	$k_p$	$k_t$	$k_w$	$k_n$	$k_{g1}$	$k_{g2}$
-	0.77	1.0	1.0	1.3	1.0	0.3	3.0

Table 5.4: Values of the factors for the reference situation of figure 5.4 for the Australian method

$D_{Rd}$ [days]	$D_{E0}$ [days/yr.]	$k_{E1}$	$k_{E2}$	$k_{E3}$	$k_{E4}$	$c_a$
-	43	1.0	1.0	1.0	1.0	1.4

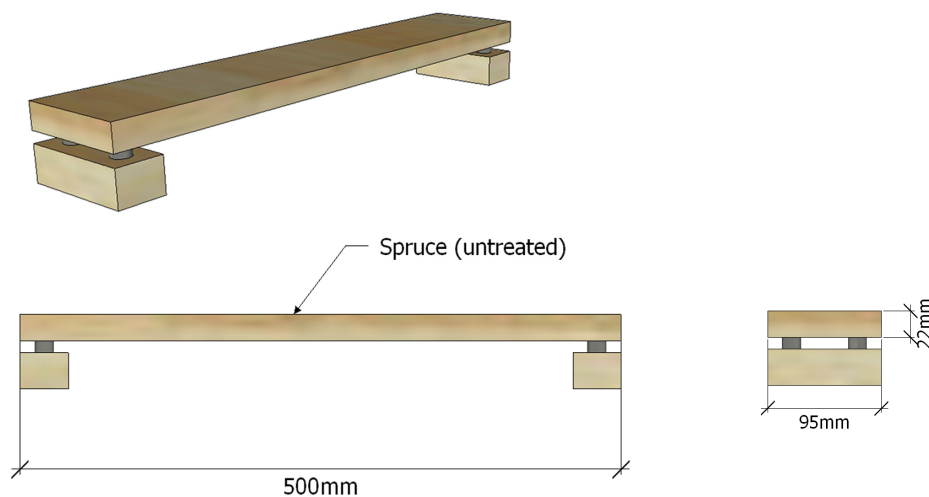

Figure 5.4: Reference situation.

Figures 5.5 and 5.6 show the influence of the timber specie on the estimated service life.

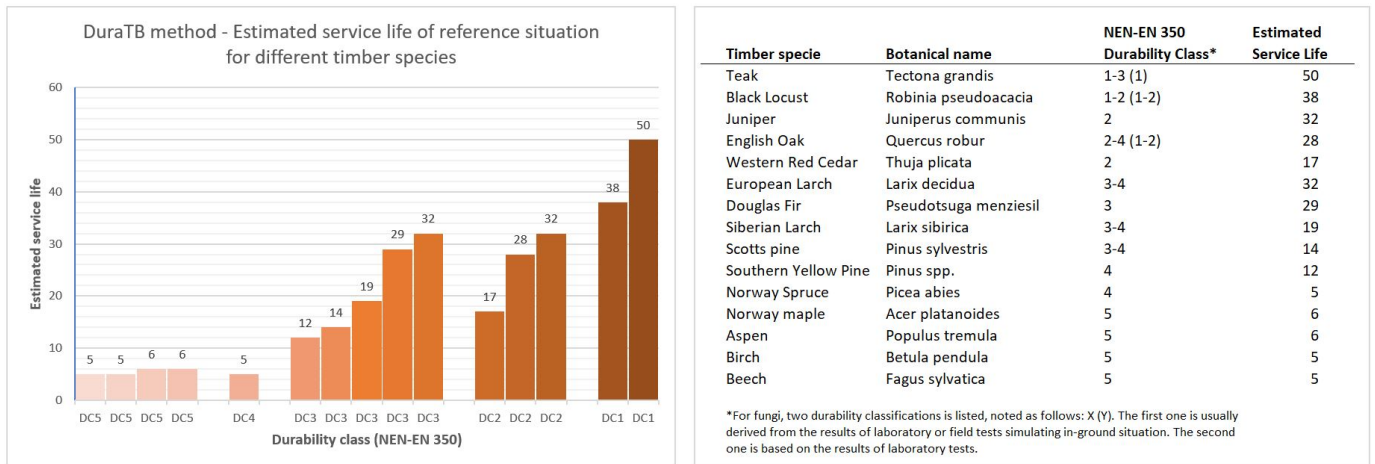

Figure 5.5: Swedish DuraTB method: Influence of timber specie on the estimated service life for the reference situation. This service life corresponds to a rating of 1 (slight decay) on the 0 to 4 decay scale from EN 252, in the Swedish report labelled as 'the onset of decay'.

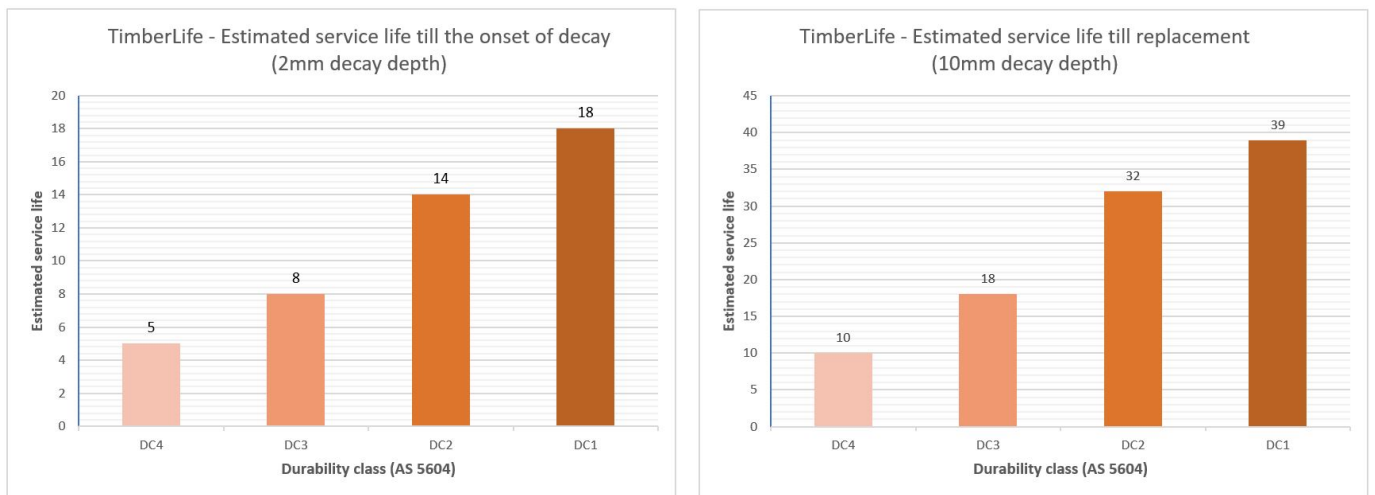

Figure 5.6: Australian TimberLife method: Influence of timber natural durability class on the estimated service life for the reference situation. This service life corresponds to a decay depth of 2 mm (left) and 10 mm (right) labelled as the onset of decay and moment of replacement. The 4 natural durability classes are conform the Australian standard AS 2

## 2. Climate conditions

The second factor of influence is the climate in which the bridge is located. Climatic variables that are of influence on the service life are for instance the air temperature, the relative humidity of the air, the amount of rainfall and the duration of rain events. The three factor methods use different ways of convert (some of) these variables into a climate factor. These different ways are described first.

### Japanese factor method:

In the Japanese research the climate factor is only influenced by the mean annual temperature of the region in which the bridge is located, see table A.1.

Table 5.5: Determination of the climate factor E1 in the Japanese research [4] [8].

E1:	1.2	1.1	1.0	0.9	0.8
$R_T = T_L/T_A$	$R_T \leq 0.74$	$0.74 < R_T \leq 1.0$	$1.00 < R_T \leq 1.16$	$1.16 < R_T \leq 1.25$	$1.25 < R_T$
$T_L =$ annual mean temperature at bridge location					
$T_A =$ National (Japanese) annual mean temperature (15.5°C)					

### Australian TimberLife method:

In the Australian research, the values of the climate parameter  $k_{climate}$  were calculated as a function of the time of rainfall per year as shown in equation A.1 [21].

$$k_{climate} = 0.15 t_{rain}^{0.5} \quad (5.3)$$

With  $t_{rain}$  in days/year.

This means that the only climatic variable that is taken into account is the duration of rain events. So both the intensity of the rain event and the air temperature are not of influence on the climate parameter.

### DuraTB dose response method:

In this method the regional climate is taken into account by the reference annual exposure dose  $D_{E0}$ . Based on European climate data this exposure dose was calculated for the whole of Europe, see figure 4.16 and table 4.6.

The exposure dose is calculated using formulas 4.33 - 4.35. To use these formulas first the moisture content and temperature of the wood need to be linked to the global climate data such as rainfall, relative humidity and temperature. In order to determine the moisture content of the wood several so called exposure models were tested and compared to measured data obtained from experiments. Two of these climate models are shown in figure 5.7. The blue line represents the numerical exposure model which in the end was used to calculate the moisture content, the grey line represents a simple empirical model and the dotted line represents the measured moisture content.

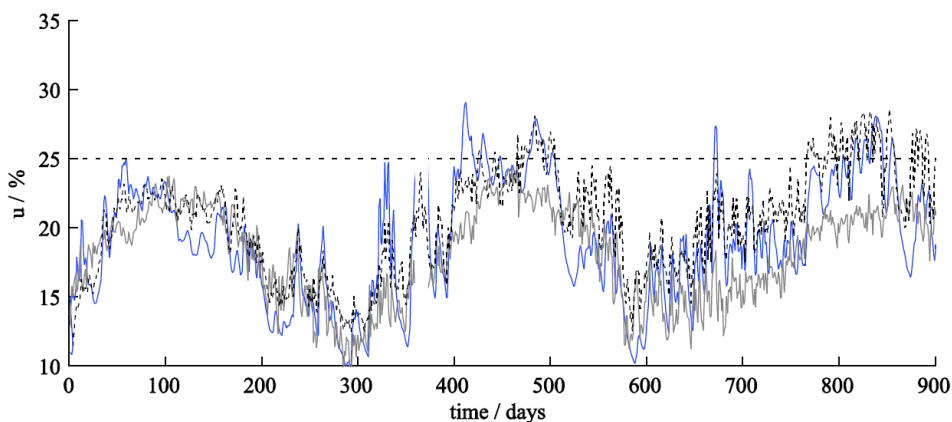

Figure 5.7: Measured average moisture content (dotted) in a Norway spruce board plotted together with the calculated moisture content from the empirical model (grey) and the numerical model (blue) [?].

### Influence on service life

Similar to what is done above for the natural durability factor, the influence of the climate factor on the estimated service life is looked into. This is done by calculating the estimated service life using the same reference situation, the spruce board shown in figure 5.4.

First the value of the climate factors of each of the three factor models has been determined for the Dutch climate. Appendix A shows how these different climate factors have been determined with the help of weather data from the Royal Dutch Meteorological Institute (KNMI). The result is shown in table 5.6.

Table 5.6: Climate factors for the Dutch climate.

Method	Climate factor	Value for Dutch climate	Units
Japanese factor method	$E_1$	1.2	[-]
Australian Timberlife method	$k_{climate}$	0.77	[-]
Swedish DuraTB method	$D_{E0}$	43	[Days/year]

To find out what is the influence of these factors, two fictitious climates are introduced. Table 5.7 shows these two fictitious climates and their climatic properties relative to the Dutch climate. The influence of these climates has been determined for the same reference situation as before shown in figure 5.4. The factor values of tables 5.4 and 5.3 also apply here, except that the climatic factors are now variable instead of the timber specie factors. Figure 5.8 shows the influence of the climate parameter on the estimated service life. It is shown for a timber specie from natural durability class 1 (both NEN-EN 350 and AS 5604).

Table 5.7: The four studied climates and their properties relative to the Dutch climate.

Region	Temp. [°C]	Rel. humidity [%]	rain (amount) [mm/month]	rain (duration) [hours/month]	$k_{climate}$ [-]	$D_{E0}$ [days/year]
1. Netherlands	-	-	-	-	0.77	43
2. Southern Europe	+10	-20	-20	-20	0.61	49
3. Scandinavia	-5	-10	-20	-20	0.61	26

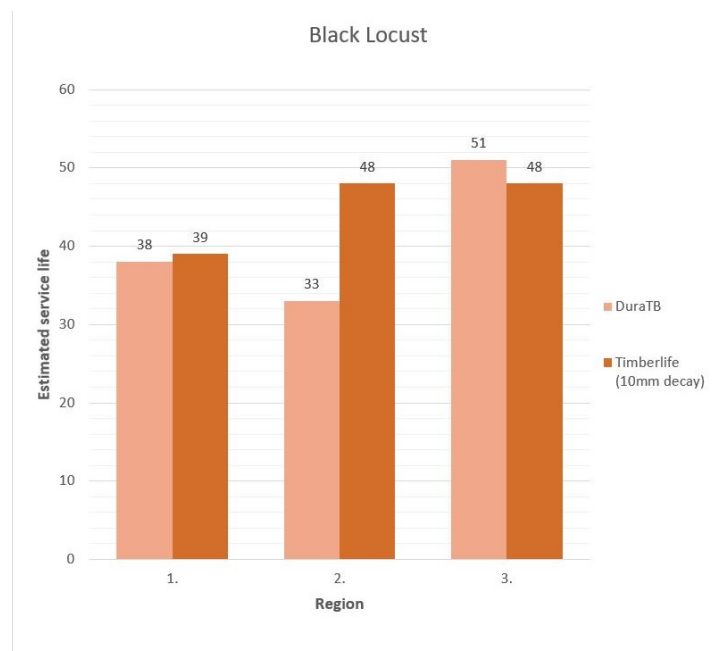

Figure 5.8: Influence of the climate factor on the estimated service life.

**Detail parameters**

The third and last main influencing factor is way of detailing. The influence of this factor is looked into by the hand of the three different post-railing connections shown in figure 5.9.

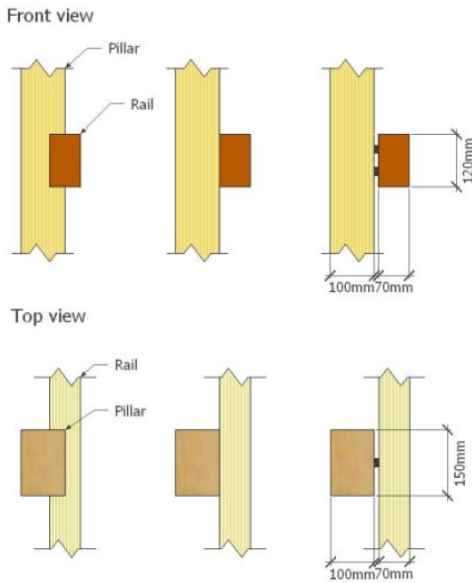

Figure 1.8: The three reference details.

Table 1.8: Values of the factors for the reference situations of figure 1.8 for the Swedish method

Detail	$k_{wood}$	$k_{climate}$	$k_p$	$k_t$	$k_w$	$k_n$	$k_{g1}$	$k_{g2}$
1.	0.5	0.77	1.0	1.0	1.0	1.0	1.0	2.0
2.	0.5	0.77	1.0	1.0	1.0	1.0	0.6	2.0
3.	0.5	0.77	1.0	1.0	1.5	1.0	0.3	2.0

Table 1.9: Values of the factors for the reference situations of figure 1.8 for the Australian method

Detail	$D_{Rd}$ [days]	$D_{E0}$ [days/yr.]	$k_{E1}$	$k_{E2}$	$k_{E3}$	$k_{E4}$	$c_a$
1.	2300	43	1.0	1.0	1.0	2.0	1.4
2.	2300	43	1.0	1.0	1.0	1.25	1.4
3.	2300	43	1.0	1.0	1.0	0.8	1.4

Figure 5.9: The three reference details.

Figure 5.10 shows the estimated service life for the three different railing details shown in figure 5.9.

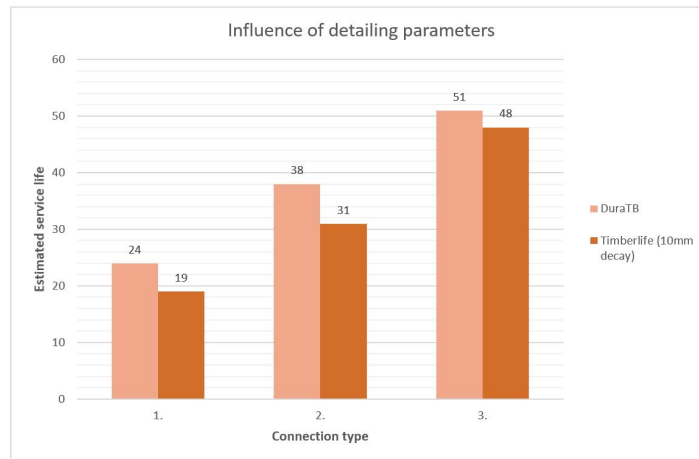

Figure 5.10: Estimated service life for the three different connection types shown in figure 5.9.

# 6

## Service life estimation - Proposed approach

Based on the previous chapters, this chapter gives a proposed approach for the estimation of the service life of timber bridge elements. The proposed approach is shown in the form of a flow chart in figure 6.1. In the following sections the different steps are described in more detail.

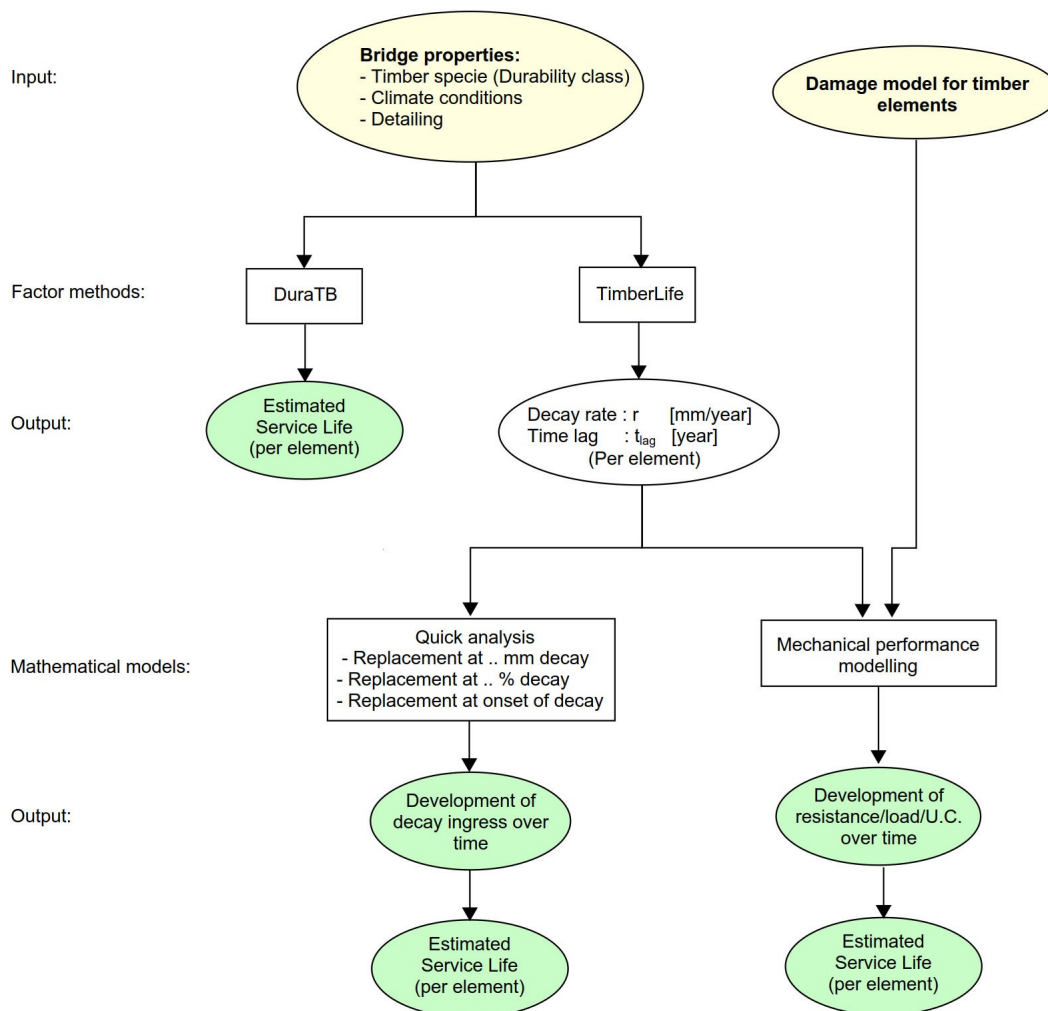

Figure 6.1: Flow chart showing different methods leading to an estimated service life for a timber bridge element.



## Input - Bridge properties

The first step in the process is to gather the necessary input, the bridge properties that are required before being able to fill in the values for the factor methods. For a newly designed bridge these, the properties are relatively easy to require because they follow from the design. The required properties in this case are:

- Applied timber specie and its natural durability class
- The climate in which the bridge will be build. As shown in chapter 5 and appendix A, in whole of the Netherlands can be assumed to have the same climatic conditions.
- The structural design. Especially the detailing.

For the assessment of an existing bridge it can be a bit more difficult, also because more specifications of the bridge need to be known such as the time that the elements have already been in service and any repairs of replacements that have taken place already.

## Factor methods

When the input is obtained it can be used to determine the values of the different factors for both the Swedish DuraTB and the Australian TimberLife factor methods. The values that belong to different properties can be found in the descriptions in chapter 4.

## Factor methods - Output

The two factor methods generate different forms of output. The DuraTB method instantly gives an estimated service life based only on the values of the factors. The TimberLife factor method however gives the output in the form of a decay rate over time (in mm/year) and a time lag (in years). This output first needs to be processed again before an estimated service life is obtained.

## Mathematical methods

The output of the TimberLife method, in the form of a decay rate and time lag, can be processed in two different ways. It can be used in a quick analysis or it can be used as part of the input for the Mechanical performance modelling described in chapter 4.

A quick analysis can be done by setting a limit on the amount of decay intrusion that is acceptable for the concerning timber element. As already described in chapter 4, the Australian report proposes that a timber element should be replaced when a 10 mm intrusion depth is reached. This can however be adjusted to any other value. It makes sense to say that for a very thick beam 10 mm decay intrusion is not as much of a problem as it is for a thin deck board or a piece of railing. Another option is therefore to express the allowable limit in the form of a percentage of the thickness of width of the element. Another option could be to allow no visual signs of decay at all and have the element replaced as soon as the decay has reached for instance 2 mm depth.

Another option for which the decay rate and time lag can be used is as input for Mechanical performance modelling. For this it has to be combined with so called 'damage models' which take into account the damage of a timber element as a result of the loading history and which on themselves do not take into account biological decay. The combination of biological and mechanical deterioration can give a more accurate estimation of the service life of a structural timber element. Mechanical performance modelling is not discussed in more detail in this research.

## Mathematical methods - Output

Doing a quick analysis gives, just like the DuraTB method, a value of the estimated service life for the considered timber element. In addition it also gives the development of the decay over time. The same form of output is obtained when using mechanical performance modelling.

# Bibliography

- [1] Brischke C., Rapp A.O. (2008). *Dose-response relationship between wood moisture content, wood temperature and fungal decay determined for 23 European field test sites.*, Wood Sci. Technol., 42:507-518.
- [2] Brischke C., Thelandersson S. (2014). *Modelling the outdoor performance of wood products — a review on existing approaches.*, Construction and Building Materials 66, 384–397.
- [3] FHWA, U.S. Department of Transportation (1995). *Recording and Coding Guide for the Structure Inventory and Appraisal of the Nation's Bridges.*, Report FHWA-ED-89-044.
- [4] Honda H., Araki S. (2016). *Applied method and estimation of durable years for modern timber bridges.* WCTE 2016, Vienna, Austria
- [5] Hovde P.J. (2005). *The Factor Method - a simple tool to service life estimation.* International conférence on durability of building materials and components, Lyon, France
- [6] Isaksson T., Brischke C., Thelandersson S. (2013). *Development of decay performance models for outdoor timber structures.* Materials and Structures (2013) 46:1209–1225
- [7] Isaksson T., Thelandersson S., Jermer J., Brischke C. (2015). *Service life of wood in outdoor above ground applications: Engineering design guideline – Background document.* Report TVBK-3067. Div. of Structural Engineering Lund University, Sweden
- [8] Japanese Society of Civil Engineers - Timber Bridge Research Subcommittee (2011). *JSCE wood use library 002: Durable years of timber bridges.* (in Japanese)
- [9] Jiang Y., Sinha K.C. (2017). *Bridge service life prediction model using the Markov Chain.* Transportation Research Record 1223
- [10] Koch J., Arndt R.W., Simon A., Jahreis M.G. (2017). *Moisture monitoring of nine protected timber bridges in Germany.* 3rd International Conference on Timber Bridges 2017, Skellefteå, Sweden
- [11] MacKenzie C.E., Wang C.H., Leicester R.H., Foliente G.C., Nguyen M.N. (2013). *Timber service life design guide.* Forest and Wood Products Limited, Victoria, Australia.
- [12] Meyer-Veltrup L., Brischke C., Alfredsen G., Humar M., Flæte P.-O., Isaksson T., Larsson Brelid P., Westin M., Jermer J. (2016). *The combined effect of wetting ability and durability on outdoor performance of wood – development and verification of a new prediction approach.*
- [13] NEN-ISO (2011). *NEN-ISO 15686-1:2011. Buildings and constructed assets - Service Life Planning. Part 1: General Principles and Framework.*. Nederlands Normalisatie-instituut, Delft.
- [14] NEN-ISO (2011). *NEN-ISO 15686-8:2011. Buildings and constructed assets - Service life planning - Part 8: Reference service life and service life estimation.*. Nederlands Normalisatie-instituut, Delft.
- [15] Nguyen M.N., Leicester R.H., Wang C.H., Foliente G.C. (2008). *A Proposal for AS1720.5: Timber Service Life Design Code.* CSIRO Sustainable Ecosystems, Victoria, Australia.
- [16] Niklewski J., Fredriksson M., Isaksson T. (2016). *Moisture content prediction of rain-exposed wood: Test and evaluation of a simple numerical model for durability applications.* Building and Environment 97 (2016) 126-136.
- [17] Pousette, A., Malo, K. A., Thelandersson, S., Fortino, S., Salokangas, L., Wacker, J. (2017). *Durable Timber Bridges - Final Report and Guidelines.*, SP Rapport 2017:25. RISE Research Institutes of Sweden, Skellefteå, Sweden.

- 
- [18] Ranjith S., Setunge S., Gravina R., Venkatesan S. (2013). *Deterioration Prediction of Timber Bridge Elements Using the Markov Chain*. *Journal of Performance of Constructed Facilities*, 27(3), 319–325
- [19] van de Kuilen J.W.G., Gard W.F. (2017). *Mechanical performance modelling*. In *Performance of Bio-based Building Materials* (pp. 522-538)
- [20] Wang C.H., Leicester R.H., Nguyen M.N. (2008). *ManualNo3 - Decay in ground contact*. CSIRO Sustainable Ecosystems, Victoria, Australia.
- [21] Wang C.H., Leicester R.H., Nguyen M.N. (2008). *ManualNo4 - Decay above ground*. CSIRO Sustainable Ecosystems, Victoria, Australia.

# III

## Part III: Reality checks

# 7

## Reality checks

The usability and correctness of the in chapter 6 proposed approach for service life estimation will be verified by performing two reality checks on timber bridges in the city of Amsterdam. The reality checks follow the service life estimation approach that is discussed in chapter 6, but with the focus on the use of the factor methods. Mechanical performance modelling is therefore left out which makes that for the reality checks the approach will become as is shown in figure 7.1.

In order to help this research, the municipality of Amsterdam has provided background documents of their bridges in the form of structural drawings, inspections reports and more.

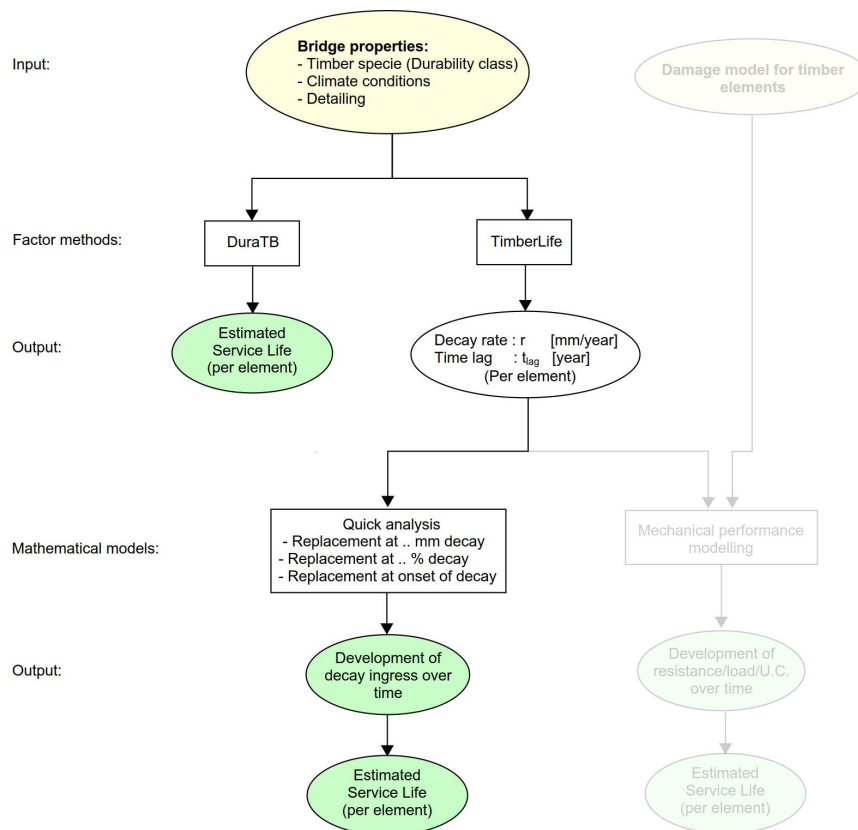

Figure 7.1: Flow chart showing the approach for the service life estimation of the bridges considered in the reality checks. The grayed out part on the right, considering Mechanical Performance modelling, is left out in the reality checks.

## 7.1. Process description

The process of the reality checks consists of three main parts. First the expected bridge condition is determined based on the estimated service life of the elements calculated with the approach shown in figure 7.1. After that, the actual condition of the bridge is determined by an in-field inspection. When both the expected and the actual condition are known, they are compared and conclusions can be drawn.

The three main parts of the reality checks are divided into the following smaller steps: (the pre-inspection preparation follows the steps from figure 7.1)

- **Pre-inspection preparation**

1. Reviewing the available bridge information to obtain the bridge properties.
2. Identifying areas of interest.
3. Estimating the service life of the identified areas of interest

- **DuraTB**

- (a) Determining the values of the different factors for the identified areas of interest
- (b) Calculating the estimated service life for the identified areas of interest

- **Timberlife**

- (a) Determining the values of the different factors for the identified areas of interest
  - (b) Calculating the decay rate  $r$  and the time lag  $t$  for the identified areas of interest
  - (c) Quick analysis: Choosing the amount of decay at which the element should be replaced
  - (d) Quick analysis: Determining the estimated service life
4. Determining the expected bridge condition based on the results of the previous steps.

- **in-field inspection**

- 5 Determining the actual condition: inspection of the bridge.

- **Evaluation of results**

- 6 Findings: How does the expected bridge condition relate to the actual condition?

### Superstructures

The reality checks performed in this chapter only consider the superstructures of the bridges, e.g. the main longitudinal beams, the deck and the railing. The substructure is out of the scope of this report.

## 7.2. Reality check 1 - Bridge 512 (complete superstructure)



Figure 7.2: Bridge 512 (photo from the Amsterdam database)

### Available data

Documents obtained from the Amsterdam database:

- Structural drawings and specifications of the construction of the original bridge in 1967.
- Structural drawings and specifications of the renewal of the bridge in 2005.
- Inspection report from the year 2000.
- Inspection report from the year 2009.

### Step 1: Reviewing the available information

The following information is found from the available documents:

- The bridge is originally built in 1969 and renewed in the year 2005. It functions as a pedestrian bridge.
- The complete superstructure is made out of Azobé, see figure 7.4. The complete superstructure has been renewed in 2005. The timber elements are connected to each other by steel bolts.
- The substructure consists of Azobé timber cross beams, resting on Azobé poles. The timber poles are resting on a concrete foundation. Only the Azobé cross beams have been renewed in 2005.
- A timber gate is located at the centre of the bridge, two water pipes run below the bridge, see figure 7.3.

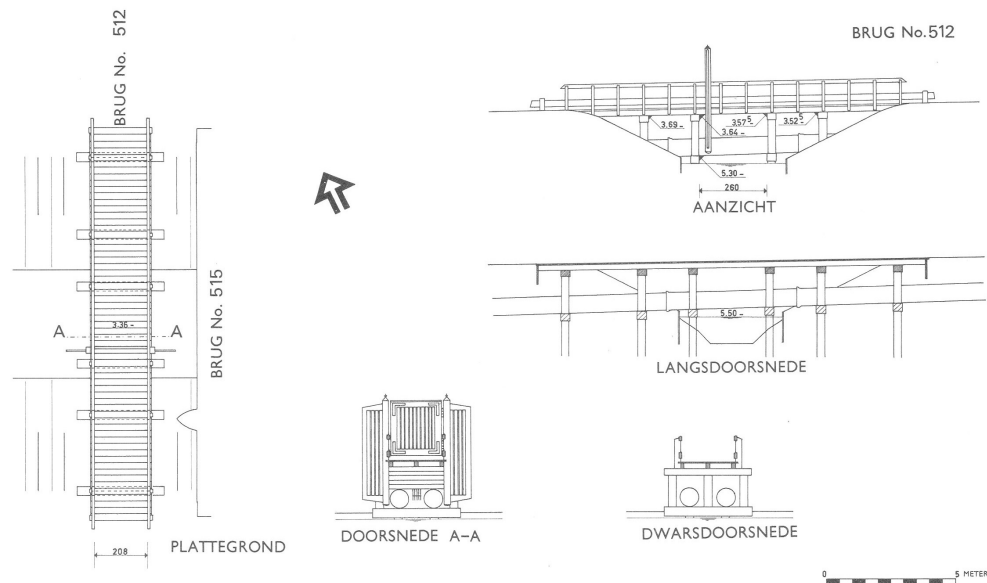

Figure 7.3: Bridge 512 (drawings from the Amsterdam database)

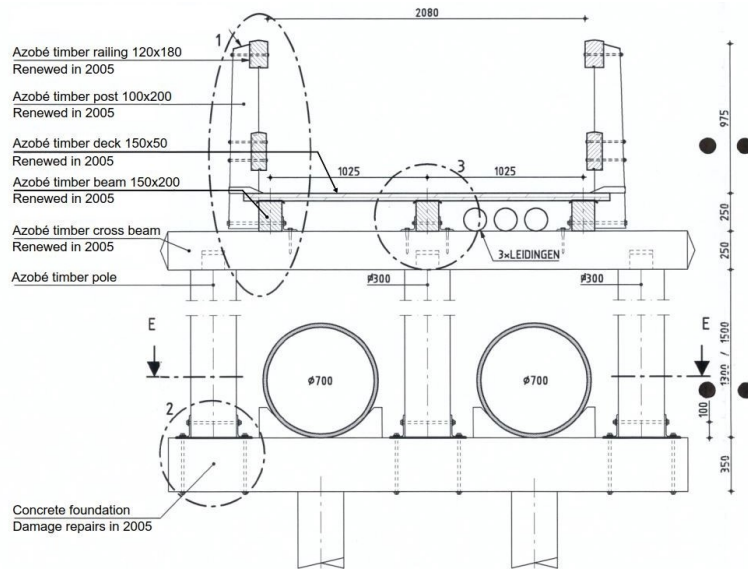

Figure 7.4: Bridge 512 cross section (drawing from the Amsterdam database)

Year of construction	1968
Renovation of the superstructure	2005
Timber specie	Azobé
- Assumed durability class (NEN-EN 350)	D.C. 1
- Assumed durability class (AS 5604)	D.C. 1

**Step 2: Identifying areas of interest**

Wood rot is most likely to start at areas of the bridge where water can easily accumulate. Therefore these areas, usually around connections, are chosen as areas of interest and of these areas the service life will be estimated. Figure 7.5 shows the areas that for this bridge are marked as the areas of interest. The areas are separately described in more detail in annex B.

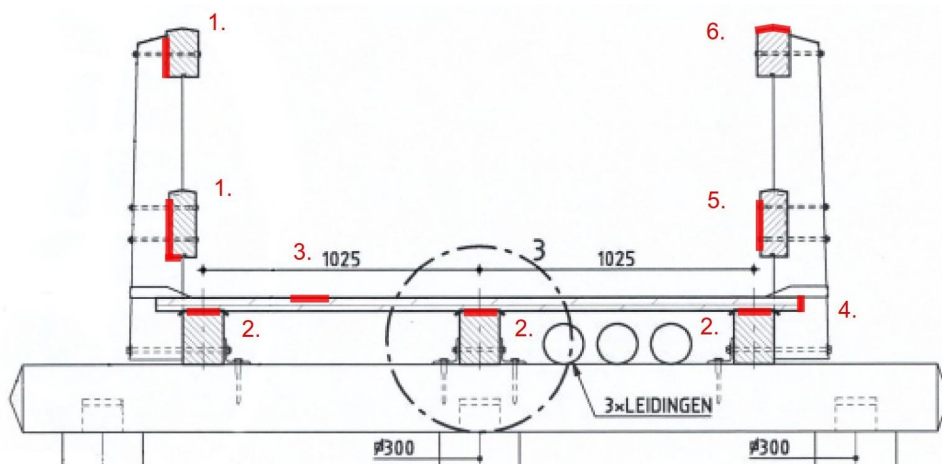

Figure 7.5: Cross section with in red the areas of interest



### Step 3: Estimating the service life of the areas of interest

Figure 7.6 shows the estimated service life of the earlier identified areas, determined with both the DuraTB and Timberlife factor methods. The values of the factors for the different areas are shown in tables 7.1 and 7.2. The steps and calculations leading to the estimated service lives shown in figure 7.6 are shown in more detail in appendix B.

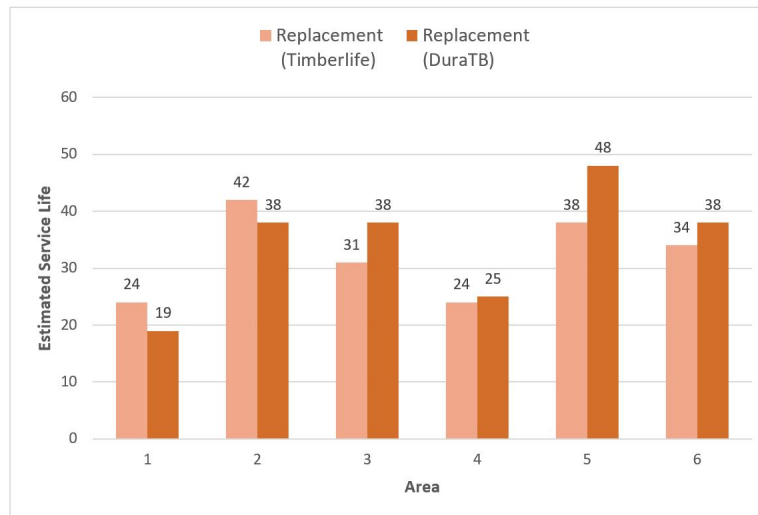

Figure 7.6: The estimated service life of the different zones of bridge 512.

Table 7.1: Bridge 512 - DuraTB

Zone	$D_{Rd}$ [days]	$D_{E0}$ [days/yr.]	$k_{E1}$	$k_{E2}$	$k_{E3}$	$k_{E4}$	$c_a$	ESL [yr.]
1	2300	43	1.0	1.0	1.0	2.0	1.4	19
2	2300	43	1.0	0.8	1.0	1.25	1.4	38
3	2300	43	1.0	1.0	1.0	1.0	1.4	38
4	2300	43	1.0	1.0	1.0	1.5	1.4	25
5	2300	43	1.0	1.0	1.0	0.8	1.4	48
6	2300	43	1.0	1.0	1.0	1.0	1.4	38

Table 7.2: Bridge 512 - Timberlife

Zone	$k_{wood}$	$k_{climate}$	$k_p$	$k_t$	$k_w$	$k_n$	$k_{g1}$	$k_{g2}$	$t_{lag,+}$ [yr.]	r [mm/yr.]	$t_{lag}$ [yr.]	10mm [yr.]
1	0.5	0.77	1.0	1.0	1.0	1.0	1.0	2.0	-	0.77	11	24
2	0.5	0.77	1.0	1.0	1.0	1.0	0.6	2.4	10	0.55	24	42
3	0.5	0.77	1.0	1.0	1.7	1.0	0.3	3.0	-	0.58	14	31
4	0.5	0.77	1.0	1.0	1.7	1.0	0.3	4.0	-	0.77	11	24
5	0.5	0.77	1.0	1.0	2.0	1.0	0.3	2.0	-	0.46	16	38
6	0.5	0.77	1.0	1.0	1.5	1.0	0.3	3.0	-	0.52	15	34

### Step 4: Expected bridge condition

The whole superstructure of the bridge is renewed in 2005, which means that at the time of this research the superstructure elements are in service for 15 years.

Figure 7.7 shows for each area the predicted development of biological decay ingress over time, as predicted by the Australian TimberLife method. With the estimated service lives from figure 7.6, the time lags from table

7.2, and the predicted developments from figure 7.7, it is expected that the bridge is still in a good condition with at most some minor visual signs of decay at areas 1 and 4, e.g. the embedded railing connections and the end grain surfaces of the deck boards.

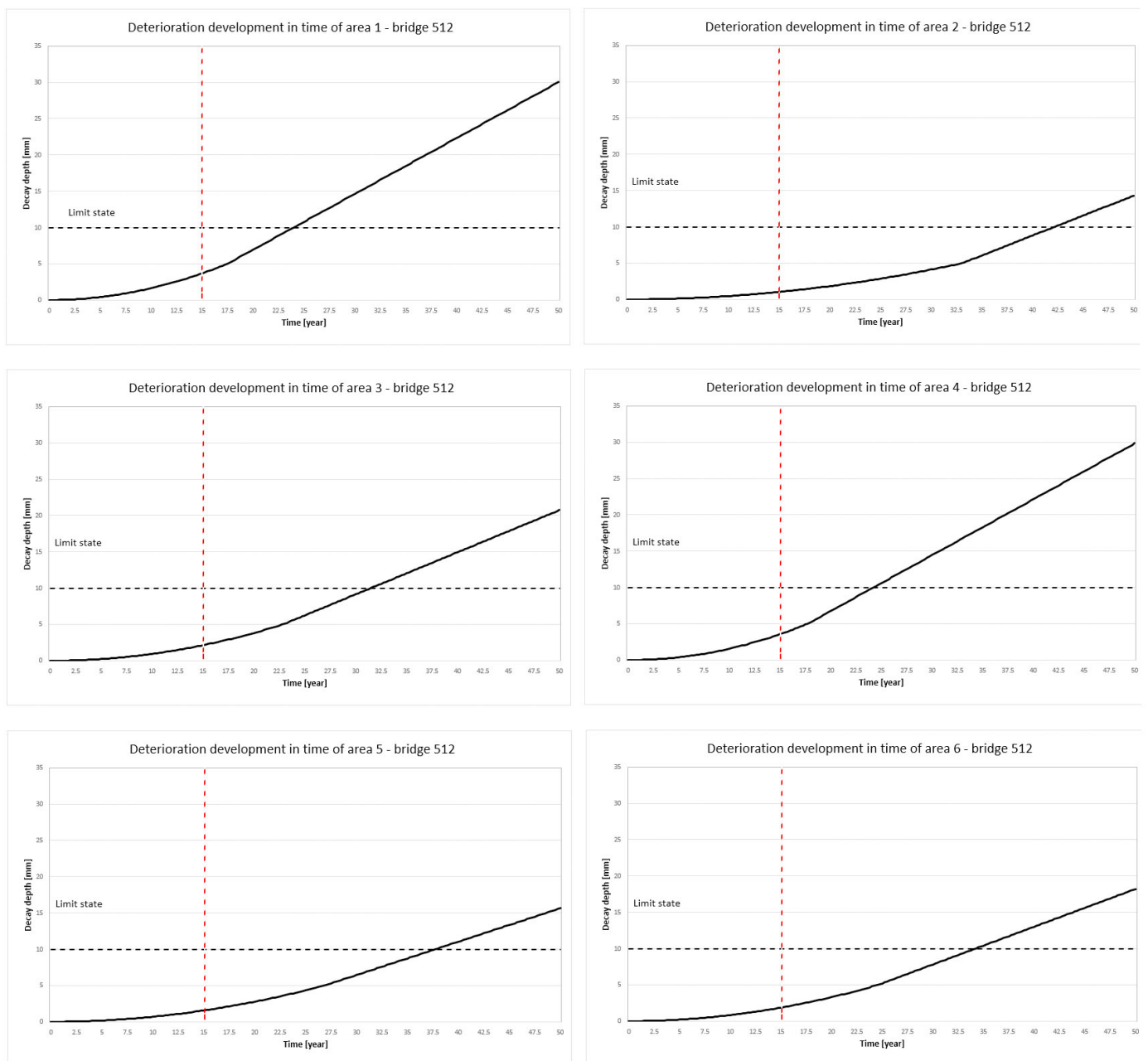

Figure 7.7: The predicted development in time of the decay ingress for the six different areas shown in figure 7.5. The graphs are based on the decay rate and time lag estimated with the Australian Timberlife method. The limit state is chosen as 10 mm decay ingress. The red line marks the current age of the bridge, 15 years.

**Step 5: Inspection - Actual condition**

This section shows the results from the in-field visual inspection of the bridge.

Deck

After 15 years, the Azobé deck is still in a good condition and on the top surface shows no visual signs of decay, see figure 7.8. The end surfaces of most of the deck boards shown no to very little decay. At a few boards however the decay at the end surface is already more developed and can clearly be noticed, see figure 7.9.



Figure 7.8: The top of the timber deck is still in good condition.



Figure 7.9: End grain surfaces of the deck boards are overall still in good condition. A few boards show beginning amounts of wood rot (highlighted with red circles).

### Railing

The railing is completely covered with a layer of paint. The embedded connections between the railing and the railing posts seem after 15 years to still be in good condition and show no visual signs of decay, see figure 7.10. At a few places some paint erosion is found and a large amount of decay is found at the connections between the railing and the two fence posts at the centre of the bridge, figure 7.11.



Figure 7.10: Left: Large parts of the railing, covered with a layer of paint, show no visible decay. Right: Longitudinal connection showing paint erosion but no visible sign of decay.



Figure 7.11: At both sides of the fence the connection between fencepost and bridgerailing shows a significant amount of decay.

### Longitudinal beams

The longitudinal beams below the deck seem to still be in a good condition and shown no signs of visual decay, see figure 7.12.



Figure 7.12: Left: Large parts of the railing, covered with a layer of paint, show no visible decay. Right: Longitudinal connection showing paint erosion but no visible sign of decay.

## Step 6: Conclusions

Overall, as expected, the bridge is still in a good condition and the minor amounts of decay that are present occur at the areas at which were expected to be (areas 1 and 4). The results are shown in table 7.6.

Something that was not expected was the large amount of decay at the connection between the railing and the gate, shown in figure 7.11. Another look at the construction documents from the renovation in 2005 shows that the gate has not been replaced during these works. During the works in 2005 the gate was removed and later again installed on the new timber superstructure. This means that the timber of the gate post is circa 50 years old instead of 15 and thus explains the amount of decay shown in figure 7.11.

Table 7.3: Comparison of the expected service life and the observations from the inspection.

Area	Estimated Service Life [yr.]	Age at inspection [yr.]	Amount of decay observed	As expected?	Strength of comparison	note
1	20	15	None	No	Medium	Small amount of decay was expected
2	40	15	None	Yes	Medium	
3	30	15	None	Yes	Medium	
4	25	15	Little	Yes	Medium	
5	40	15	None	Yes	Medium	
6	35	15	None	Yes	Medium	

### 7.3. Reality check 2 - Bridge 526



Figure 7.13: Bridge 526 (photo from the Amsterdam database)

#### Available data

Documents obtained from the Amsterdam database:

- Structural drawings of the construction of the original bridge in 1938.
- Structural drawings and specifications of the renewal of the bridge in 2003.
- Inspection report from the year 2000.
- Inspection report from the year 2009.

#### Step 1: Reviewing the available information

The following information is found from the available documents:

- The bridge is originally built in 1938 and functions as a pedestrian bridge.
- In 2003, the timber deck and the railing have been renewed.
- After the renewal the deck is made from European oak and the railing from Azobé.
- It is not known if or when the beams below the deck have been replaced since the construction in 1938.

Year of construction	1938
<b>Deck</b>	
Renewed	2003
Timber specie	European oak
- Assumed durability class (NEN-EN 350)	D.C. 2
- Assumed durability class (AS 5604)	D.C. 2
<b>Railing</b>	
Renewed	2003
Timber specie	Azobé
- Assumed durability class (NEN-EN 350)	D.C. 1
- Assumed durability class (AS 5604)	D.C. 1
<b>Longitudinal beams</b>	
Renewed	unknown
Timber specie	Azobé (presumably)
- Assumed durability class (NEN-EN 350)	D.C. 1
- Assumed durability class (AS 5604)	D.C. 1

### Step 2: Identifying areas of interest

Figure 7.14 shows the areas that for this bridge are marked as the areas of interest, where decay is most likely to occur.

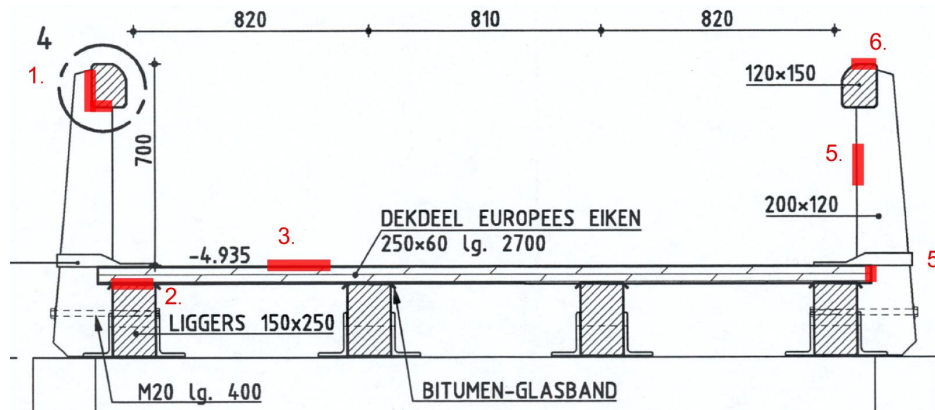

Figure 7.14: Cross section of bridge 526 with in red the areas of interest

### Step 3: Estimating the service life of the areas of interest

Figure 7.15 shows the estimated service life of the areas of interest, determined with both the DuraTB and Timberlife factor methods. The values of the factors for the different areas are shown in tables 7.4 and 7.5. The steps and calculations leading to the estimated service lives shown in figure 7.6 are for this bridge not worked out in more detail since they are similar to bridge 512, for which they are shown in appendix B.

Table 7.4: Bridge 512 - DuraTB

Zone	$D_{Rd}$ [days]	$D_{E0}$ [days/yr.]	$k_{E1}$	$k_{E2}$	$k_{E3}$	$k_{E4}$	$c_a$	ESL [yr.]
1	2300	43	1.0	1.0	1.0	2.0	1.4	19
2	2300	43	1.0	0.8	1.0	1.25	1.4	38
3	1670	43	1.0	1.0	1.0	1.0	1.4	28
4	1670	43	1.0	1.0	1.0	1.5	1.4	18
5	2300	43	1.0	1.0	1.0	0.8	1.4	48
6	2300	43	1.0	1.0	1.0	1.0	1.4	38

Table 7.5: Bridge 512 - Timberlife

Zone	$k_{wood}$	$k_{climate}$	$k_p$	$k_t$	$k_w$	$k_n$	$k_{g1}$	$k_{g2}$	$t_{lag,+}$ [yr.]	r [mm/yr.]	$t_{lag}$ [yr.]	10mm [yr.]
1	0.5	0.77	1.0	1.0	1.0	1.0	1.0	2.0	-	0.77	11	24
2	0.5	0.77	1.0	1.0	1.0	1.0	0.6	2.4	10	0.55	24	42
3	0.62	0.77	1.0	1.0	2.0	1.0	0.3	3.0	-	0.86	10	21
4	0.62	0.77	1.0	1.0	2.0	1.0	0.3	4.0	-	1.15	8	16
5	0.5	0.77	1.0	1.0	2.0	1.0	0.3	2.0	-	0.46	16	38
6	0.5	0.77	1.0	1.0	1.5	1.0	0.3	3.0	-	0.52	15	34

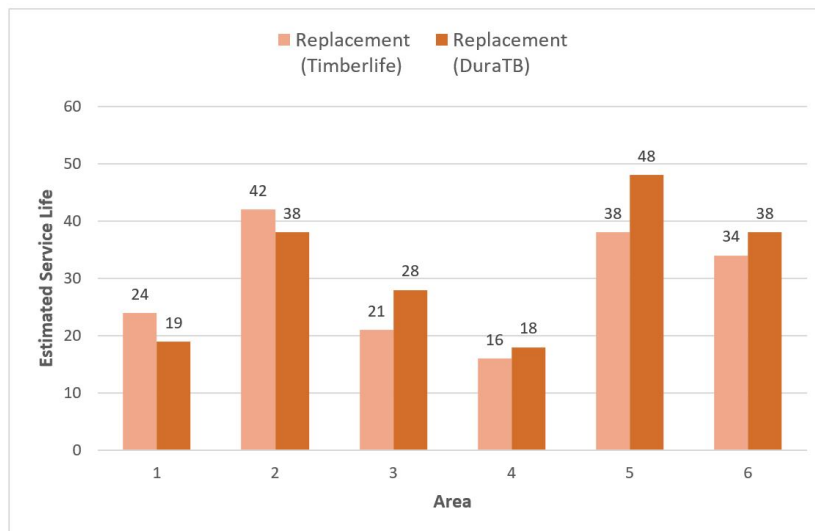

Figure 7.15: The estimated service life of the different zones of bridge 526.

#### Step 4: Expected bridge condition

The deck and the railing of the bridge is renewed in 2003, which means that at the time of this research these elements are in service for 17 years. With the service life estimations from figure 7.15 this means that some parts of the bridge have almost reached their estimated service life and are up for replacement.

Figure 7.16 shows the development of biological decay in time for the European oak deck boards (areas 3 and 4). Notable visual signs of decay are expected to be present at the deck boards, especially around area 4, e.g. the end grain surfaces.

The embedded connections of the railing are expected to already show some minor amounts of visual decay.

Because the age of the longitudinal beams is not known from the obtained information, no expectation can be done for these elements of the bridge.

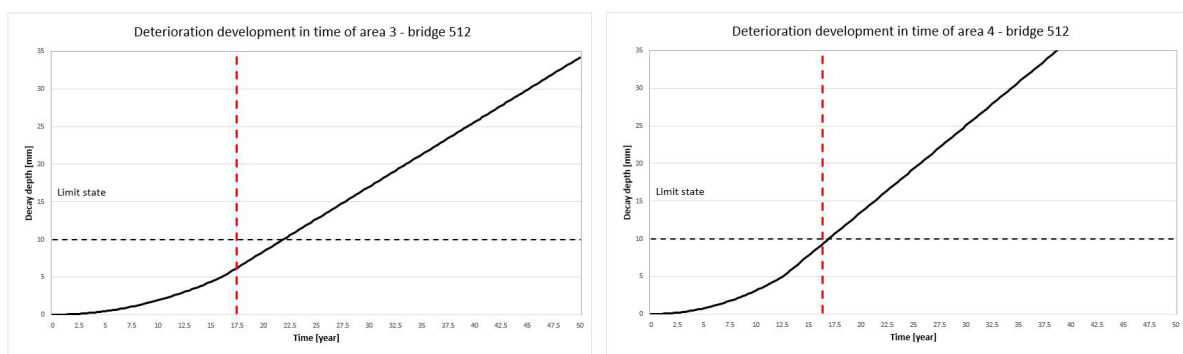

Figure 7.16: The development of the decay depth over time for the deck European oak deck boards (areas 3 and 4). The graphs are based on the decay rate and time lag following from the Australian TimberLife method.



**Step 5: Inspection - Actual condition**

This section shows the results from the in-field visual inspection of the bridge.

Deck

After 17 years, the deck made of European oak is in a bad condition, see figure 7.17. The top surface shows large amounts of decay and at some places temporary reinforcement measures have already been taken. As can be seen in figure 7.18, also the end-grain surfaces of the boards show large amounts of decay.

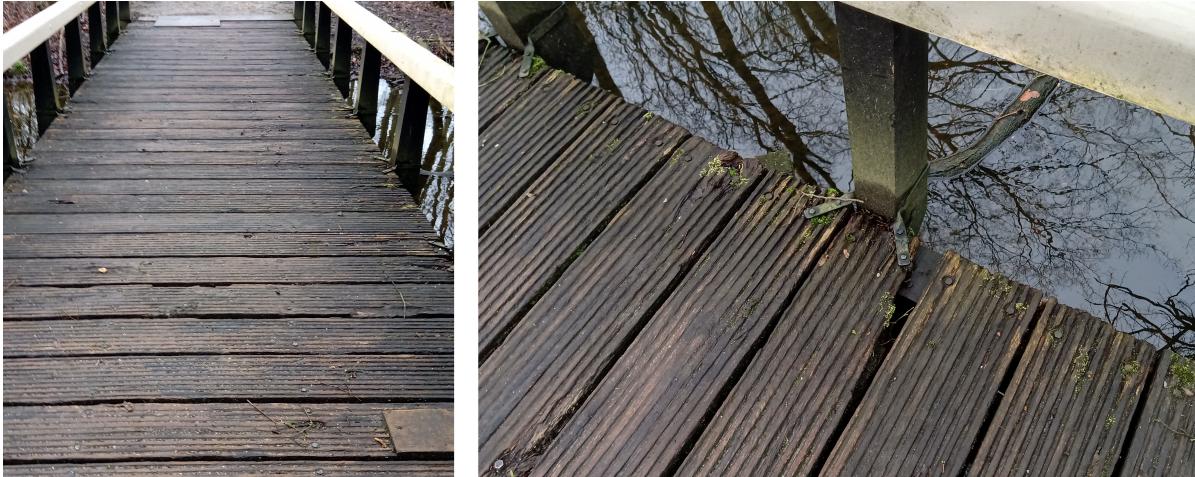

Figure 7.17: The top surface of the deck is in bad condition and shows large amounts of visual decay.



Figure 7.18: End grain surfaces of the deck show large amounts of wood rot.

### Railing

The railing is covered with a layer of paint. The embedded connections between the railing and the railing posts seem after 17 years to still be in good condition and show no visual signs of decay, see figure 7.19.



Figure 7.19: The railing, covered with a layer of paint, shows no visible decay.

### Step 6: Conclusions

The top surface of the bridge deck (European oak) is in a worse state than expected. At the time of the inspection the 17 year old deck is already in need of replacement even though the expected service life of 25 years is not yet reached. Possibly the actual durability class of the used timber was lower than the assumed durability class 2 (both for NEN-EN 350 as AS 5604).

In contrast, the Azobé railing was in a better state than expected. The embedded connections showed little to no visual decay, even though the estimated service life of 20 years is close. This result is similar to the result of the railings found for bridge number 512.

Table 7.6: Comparison of the expected service life and the observations for bridge 526.

Area	Estimated Service Life [yr.]	Age at inspection [yr.]	Amount of decay observed	As expected?	Strength of comparison	note
1	20	17	None	No	High	Small amount of decay was expected
2	40	-	-	-	-	Age at inspection unknown
3	25	17	Large	No	Medium	More decay than expected
4	17	17	Large	Yes	High	
5	40	17	None	Yes	Medium	
6	35	17	None	Yes	Medium	

### European oak

NEN-EN 350 states that, based on either laboratory results or field tests simulating in-ground situations, the natural durability of European oak ranges between durability class 2 and 4. For the service life estimation in this case study, the European oak deck boards were given a natural durability ranking of class 2, both for the European NEN-EN 350 and the Australian AS 5604.

In hindsight this classification has proven to be too optimistic. Redoing the service life estimation for the deck boards (areas 3 and 4) for European oak classified in durability class 3 gives the results shown in tables 7.7 and 7.8. It can be concluded that these estimations lie much closer to the actual situation.

Table 7.7: Values leading to the estimated service life of the European Oak deck boards, using the DuraTB factor method. The European Oak is in this case classified with European durability class 3.

Zone	$D_{Rd}$ [days]	$D_{E0}$ [days/yr.]	$k_{E1}$	$k_{E2}$	$k_{E3}$	$k_{E4}$	$c_a$	ESL [yr.]
3	1150	43	1.0	1.0	1.0	1.0	1.4	19
4	1150	43	1.0	1.0	1.0	1.5	1.4	13

Table 7.8: Values leading to the estimated service life of the European Oak deck boards, using the TimberLife factor method. The European Oak is in this case classified with Australian durability class 3.

Zone	$k_{wood}$	$k_{climate}$	$k_p$	$k_t$	$k_w$	$k_n$	$k_{g1}$	$k_{g2}$	$t_{lag,+}$ [yr.]	r [mm/yr.]	$t_{lag}$ [yr.]	10mm [yr.]
3	1.14	0.77	1.0	1.0	2.0	1.0	0.3	3.0	-	1.58	6	12
4	1.14	0.77	1.0	1.0	2.0	1.0	0.3	4.0	-	2.10	5	9

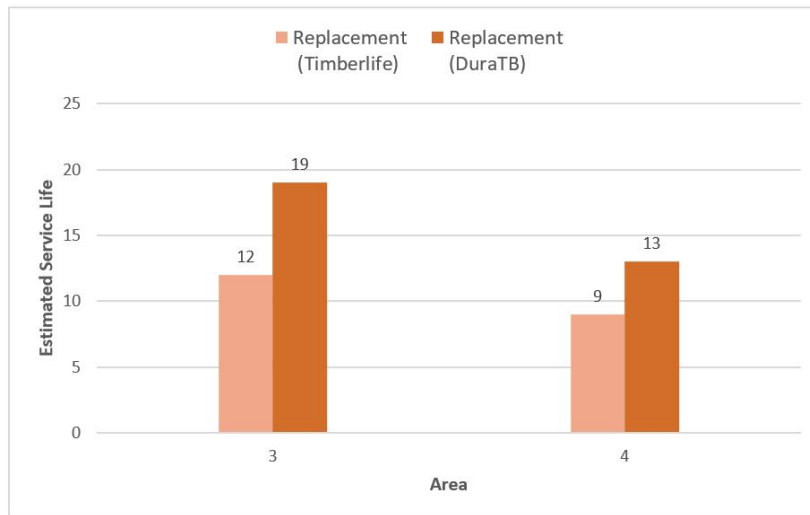

Figure 7.20: Estimated service life of the European oak deck boards classified in durability class 3 instead of class 2.

# IV

## Part IV: Service Life Planning

# 8

## Service life planning and total costs of ownership

### 8.1. Service life planning

NEN-ISO 15686-1 [2] describes service life planning as a design process that seeks to ensure that the service life of a structure or structural component will be equal to or exceeds its design life. Part of a service life planning can be the determination of the life cycle costs and/or the life cycle environmental impact. Life cycle planning can also be used for comparing different design solutions.

The NEN-ISO standard further states that service life planning aids in the decision making concerning specifications and design detailing by estimating how long (each component of) a structure will last. Furthermore it lays a basis for determining the life-cycle costs and the maintenance planning, and the likelihood of early decline can be reduced.

The key principle of service life planning is to demonstrate that the service life of a proposed structure will exceed the design life. The following general principles should guide the process:

- The service life plan should provide sufficient evidence to give reasonable assurance that the estimated service life of a new structure on a specific site, operated as specified in the design brief and with appropriate maintenance and replacement, will be at least as long as the design life.
- The service life of a structure is determined using available knowledge about the service life of each component that is to be used in the building. Service life planning is a process of estimation and/or prediction of future events, and therefore complete accuracy can not be expected.
- If the estimated service life of any component is less than the design life of the building, a decision should be made as to how the essential functions are to be maintained adequately (e.g. by replacement or other maintenance).
- Service life planning should include projections of the needs for, and timing of, maintenance and replacement activities over the life cycle of the building. The projections will be based on data which should be assessed for robustness and reliability, and records of the data sources should be kept.

The following points could be considered in service life planning:

1. The likely performance of the components of the building within the building life cycle in the expected external environment and conditions of occupancy and use.
2. The life-cycle cost and environmental impact of the building over its life cycle.
3. Operating and maintenance costs.
4. The need for repairs, replacements, dismantling, removal, re-use and disposal, and the costs of each;
5. The construction of the whole building, installation of components and the maintenance and replacement of short-life components.

## 8.2. Service life planning in the design process

Service life planning is a task that should be integrated into the building design process, since most design decisions will affect the service life. Service life needs to be considered from the earliest stages of design, when the client brief is being developed. As the design develops in more detail, the service life will need to be estimated in more detail and compared with the required design life identified in the client's brief, to ensure that the predicted service life is adequate.

Service life planning usually requires iterations of the design process to identify the preferred way of meeting the performance and maintenance requirements at an acceptable cost. This iterative process is shown in the flow chart in figure 8.1.

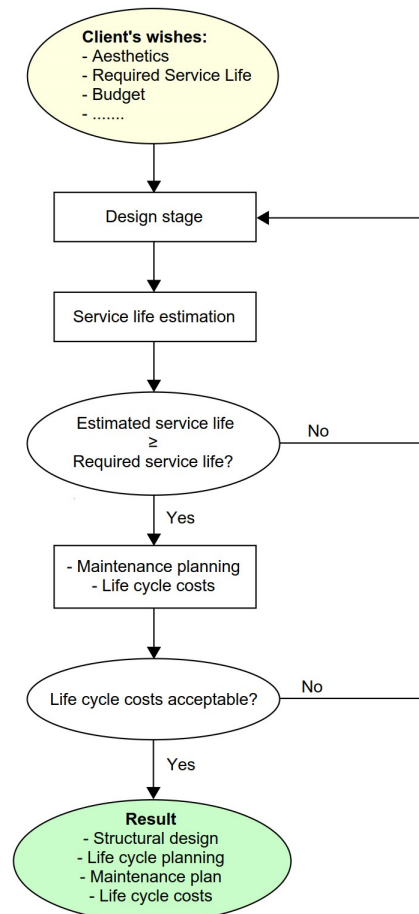

Figure 8.1: Flow chart showing how service life planning can be integrated in structural design.

### Service life estimation

Estimating the service life of a structure and its components is the key task of service life planning. The performance of each component under the expected conditions should be considered while also taking into account the possible failure modes, causes of loss of serviceability, risk of premature failure and their effects on the service life.

In an ideal scenario, for service life prediction, the performance of the component in the intended conditions is known together with other information such as the construction method and the maintenance planning. In practice however this data is not always available and thus an estimate of the service life needs to be made based on reference data of a similar component in similar conditions. This is where service life estimation methods, for instance factor methods, come in play.

### 8.3. Life cycle costs (Total costs of ownership)

As described above, determination of the life cycle costs is an important part of service life planning. Life cycle costs (also called the total costs of ownership) are in the Dutch/European standard ISO 15686-5 described as "the costs of an asset or its parts throughout its life cycle, while fulfilling the performance requirements" [3]. It is an evaluation technique that can be used in the decision making process for investments in (civil) structures.

A LCC analysis takes into account all of the relevant costs which occur throughout the service life of an structure. In general the following main cost categories are:

- Construction costs
- Operation costs
- Maintenance costs
- Disposal costs (end of service life)
- Environmental costs (optionally)

As shown above, it is possible to also take the environmental costs into account when determining the total costs of ownership.

The total costs of ownership are often used as a cost comparison for different alternatives. When using it for this purpose, the analysis can be broken down in the following 5 steps [4], shown in figure 8.2:

1. Establishing the design alternatives
2. Determining the activity planning (maintenance planning)
3. Estimating the costs of the activities
4. Computing the life-cycle costs
5. Analysing the results

During step two an estimation of the service life of the different components is needed in order to determine the planning of major repairs and/or replacements. This is where, for timber bridges, the factor methods discussed in this report can be used. Chapter 11 shows an example of how these factor methods can be used during the calculation of the total costs of ownership.

#### Life cycle cost analysis

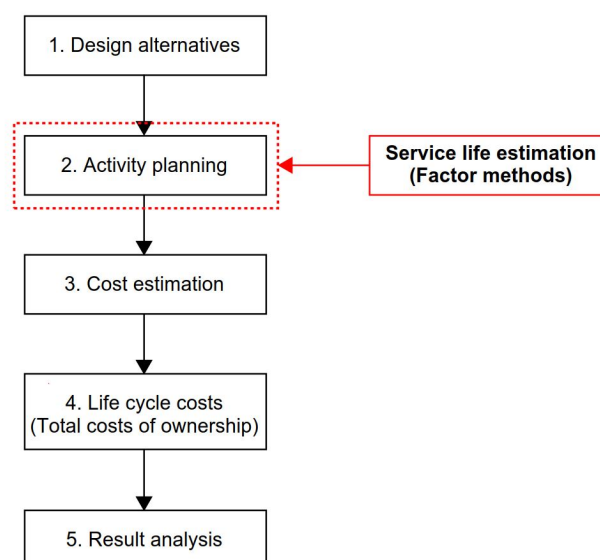

Figure 8.2: Steps in the life-cycle cost analysis

# 9

## Example of a TCO calculation

This chapter shows an example of how service life estimation by factor methods can be implemented in the calculation of the total costs of ownership of a timber bridge. This means that the focus of this example is on the implementation of these factor methods in such a cost analysis, more than on the exactness of the cost analysis. **All the costs used in this example are purely based on educated guesses of the author and are not validated by any other parties.** Therefore the result of this example is **in no way** representative for a real total cost of ownership analysis. What it does show is the steps that are involved in such an analysis, and the way in which the in this report discussed factor methods can be used at the base of this analysis.

The example shows the TCO calculation for two different designs of one bridge. The first design is based on standard bridge design used in 'Het Amsterdamse Bos' while the second design is based on a bridge design with more protective measurements in the detailing. The total costs of ownership of the two different design options have been calculated for three different service lives: 40, 50 and 80 year.

This examples follows the steps shown in figure 8.2.

### 9.1. Design alternatives

This example considers two bridge designs. One with a traditional way of detailing, which can be found a lot around Amsterdam, and the other with a way detailing with the focus on 'protective design'. The example only considers the superstructure of the bridge, e.g. the railing, the deck and the main longitudinal beams. The substructure is assumed to be similar for both bridges and does not need any repairs or replacements during the required service life. The two designs are here described in more detail.

#### Design 1: Traditional

The first bridge design is based on a typical bridge found in 'Het Amsterdamse Bos', an example of which is bridge 512 shown in chapter 7 of this report, see figure 9.1.

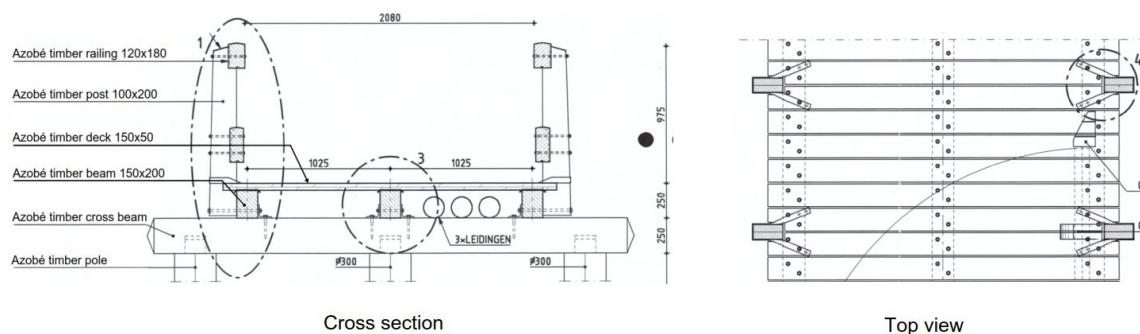

Figure 9.1: Bridge design 1: traditional detailing



### Design 2: Protective design

The second bridge design is based on a more modern design in which protective design measures have been introduced in order to extend the service life of the different elements. Figure 9.2 shows the bridge. The longitudinal beams are at the top protected by steel sheeting.

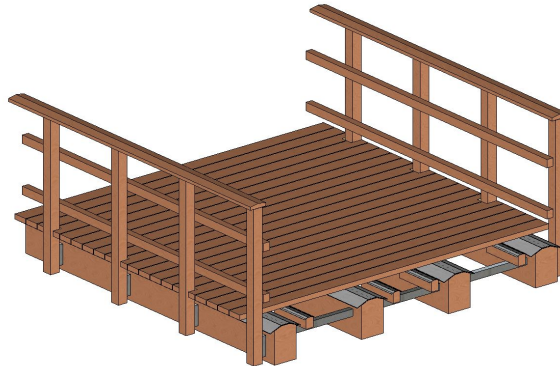

Figure 9.2: Bridge design 2: With protective detailing, based on the durable bridge designs described in the 'Holzbau handbuch - Entwurf von Holzbrücken' [1]

## 9.2. Activity planning

During this step the service life of the different elements is estimated with the help of the factor methods discussed in chapter 6. Based on these service lives, a maintenance planning can be made which includes both the small (often recurring) maintenance activities and the larger (less often recurring) repairs and replacements.

### Service life of elements

As said before, this example only takes into account the superstructure of the bridge. The superstructures of the two design alternatives can be divided into the following three elements: The longitudinal beams, the deck, and the railing. For each of these elements the service life is estimated following the approach described in chapter 6. The results are shown in table 9.1. The steps and calculations leading to these results are shown in Appendix C. Mechanical performance modelling is not used in this example.

Table 9.1: The estimated service life of the different elements.

	Design option 1	Design option 2
<b>Longitudinal beams</b>		
Total replacement	40 years	50 years
<b>Deck</b>		
Total replacement	30 years	30 years
<b>Railing</b>		
Small repairs	20 years	-
Total replacement	40 years	45 years

### Activity planning

The following maintenance activities are taken into account;

- Replacement and repairs
  - Deck replacement
  - Replacement of the longitudinal beams
  - Small railing repairs (removing and replacing few rotten parts)
  - Complete railing replacement
- Cleaning (removing of overgrown vegetation, accumulated dirt, etc.)
- Inspections

The cleaning and inspection of the bridge is given an interval of respectively 1 and 5 years. Table 9.2 shows the interval of which the different activities occur for the two alternative designs and for the required service lives of 40, 50 and 80 years. Where possible, the replacement activities are planned to take place at the same moment, even if that means that some components are replaced before reaching the end of their estimated service life. Another consideration was that in order to replace the main longitudinal beams, also the deck and the railing needs to be removed.

Table 9.2: Intervals of the maintenance activities for the two alternatives for different required service lives.

	40 yr.		50 yr.		80 yr.	
	Option 1	Option 2	Option 1	Option 2	Option 1	Option 2
Cleaning	yr. 1	yr. 1	yr. 1	yr. 1	yr. 1	yr. 1
Inspection	yr. 5	yr. 5	yr. 5	yr. 5	yr. 5	yr. 5
Railing: small repairs	yr. 20	yr. -	yr. 20	yr. -	yr. 20	yr. -
Railing: complete replacement	yr. -	yr. -	yr. 30	yr. 30	yr. 40	yr. 30,50
Deck: complete replacement	yr. 20	yr. 30	yr. 30	yr. 30	yr. 20	yr. 30,50
Beams: complete replacement	yr. -	yr. -	yr. 30	yr. -	yr. 40	yr. 50

### 9.3. Cost estimation

In order to calculate the total costs of ownership, in this example, the initial construction costs and the maintenance costs are taken into account. Table 9.3 shows the values that are used. As stated already, these values are based on educated guesses and have not been validated. The costs for the second alternative are estimated higher than the first alternative due to the more complex design.

The disposal and environmental costs are not taken into account in this example.

Table 9.3: Overview of the costs taken into account in the example. The values are based on educated guesses.

	Design option 1	Design option 2
<b>Initial costs</b>		
Design and construction	€ 120.000	€ 140.000
<b>Maintenance costs</b>		
Cleaning (per execution)	€/ - 300	€/ - 300
Inspection (per inspection)	€/ - 2.000	€/ - 2.000
Azobe railing repairs	€/ - 10.000	€/ - 10.000
Azobe railing replacement	€/ - 20.000	€/ - 20.000
Azobe deck replacement	€/ - 20.000	€/ - 22.000
Azobe main beams replacement	€/ - 25.000	€/ - 28.000

### 9.4. Total costs of ownership

This section gives the results of the TCO calculations performed for the two design options and for the required service lives of 40, 50 and 80 years. It should be noted that price fluctuations (e.g. inflation) have not been taken into account. When multiple replacements take place at the same time, a 10 percent discount has been accounted.

#### 40 year service life

Table 9.4 shows the total costs of ownership for the two design alternatives when the required service life is 40 years. Figure 9.3 shows the development of the maintenance costs for the most economical option (alternative 1) during the service life of 40 years.

Table 9.4: Calculation of the total costs of ownership for the service life of 40 years.

	Alternative 1			Alternative 2		
	Rep.	Costs per rep.	Total costs	Rep.	Costs per rep.	Total costs
Initial			€ 120.000			€ 140.000
Cleaning	40	€/ - 300	€ 12.000	40	€/ - 300	€ 12.000
Inspection	7	€/ - 2.000	€ 14.000	7	€/ - 2.000	€ 14.000
Railing repair	1	€/ - 10.000	€ 10.000	-	€/ - 10.000	€ -
Railing replacement	-	€/ - 20.000	€ -	-	€/ - 20.000	€ -
Deck replacement	1	€/ - 20.000	€ 20.000	1	€/ - 22.000	€ 22.000
Discount	-10 %	€/ - 30.000	€ -3.000	-	€/ - -	€ -
Beams replacement	-	€/ - 25.000	€ -	-	€/ - 28.000	€ -
<b>Total costs of ownership</b>			<b>€ 173.000</b>			<b>€ 188.000</b>
TCO per year			€/yr. 4.325			€/yr. 4.700

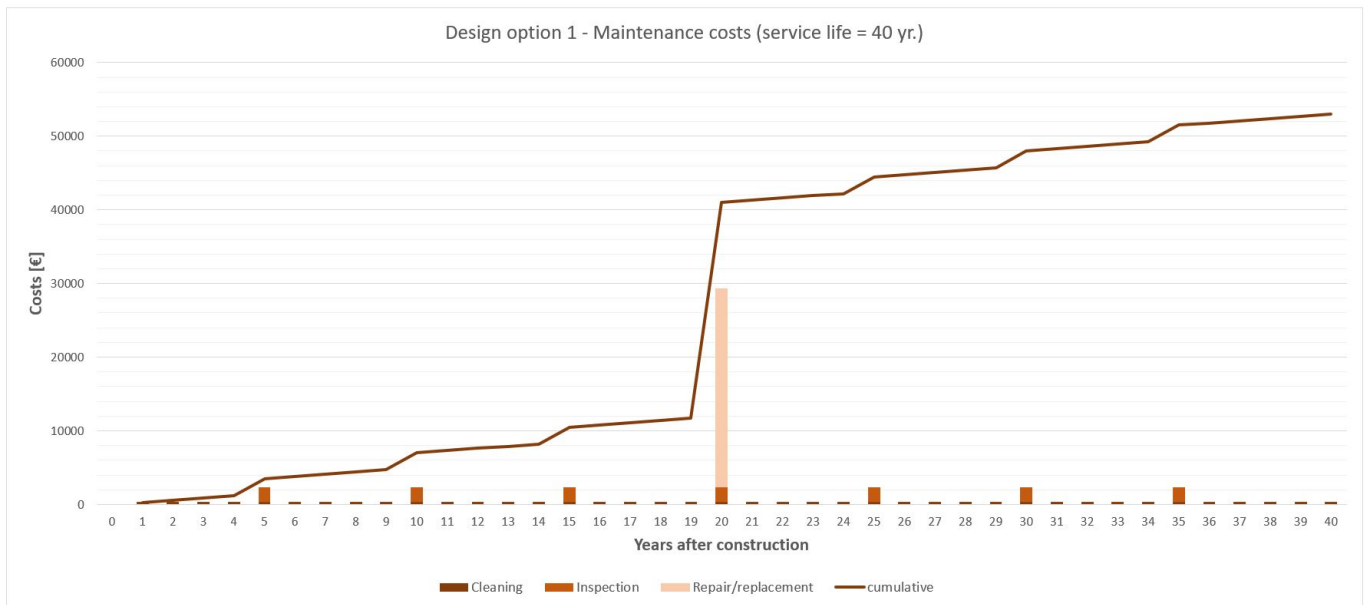

Figure 9.3: Development of the maintenance costs for design alternative 1, during the 40 year service life

**50 year service life**

Table 9.5 shows the total costs of ownership for the two design alternatives when the required service life is 50 years. Figure 9.4 shows the development of the maintenance costs for the most economical option (alternative 2) during the service life of 50 years.

Table 9.5: Calculation of the total costs of ownership for the service life of 50 years.

	Alternative 1			Alternative 2		
	Rep.	Costs per rep.	Total costs	Rep.	Costs per rep.	Total costs
Initial			€ 120.000			€ 140.000
Cleaning	50	€/ - 300	€ 15.000	50	€/ - 300	€ 15.000
Inspection	9	€/ - 2.000	€ 18.000	9	€/ - 2.000	€ 18.000
Railing repair	1	€/ - 10.000	€ 10.000	-	€/ - 10.000	€ -
Railing replacement	1	€/ - 20.000	€ 20.000	1	€/ - 20.000	€ 20.000
Deck replacement	1	€/ - 20.000	€ 20.000	1	€/ - 22.000	€ 22.000
Beams replacement	1	€/ - 25.000	€ 25.000	-	€/ - 28.000	€ -
Discount	-10 %	€/ - 65.000	€ -5.000	-10 %	€/ - 42.000	€ -4.000
<b>Total costs of ownership</b>			<b>€ 223.000</b>			<b>€ 211.000</b>
TCO per year			€/yr. 4.460			€/yr. 4.220

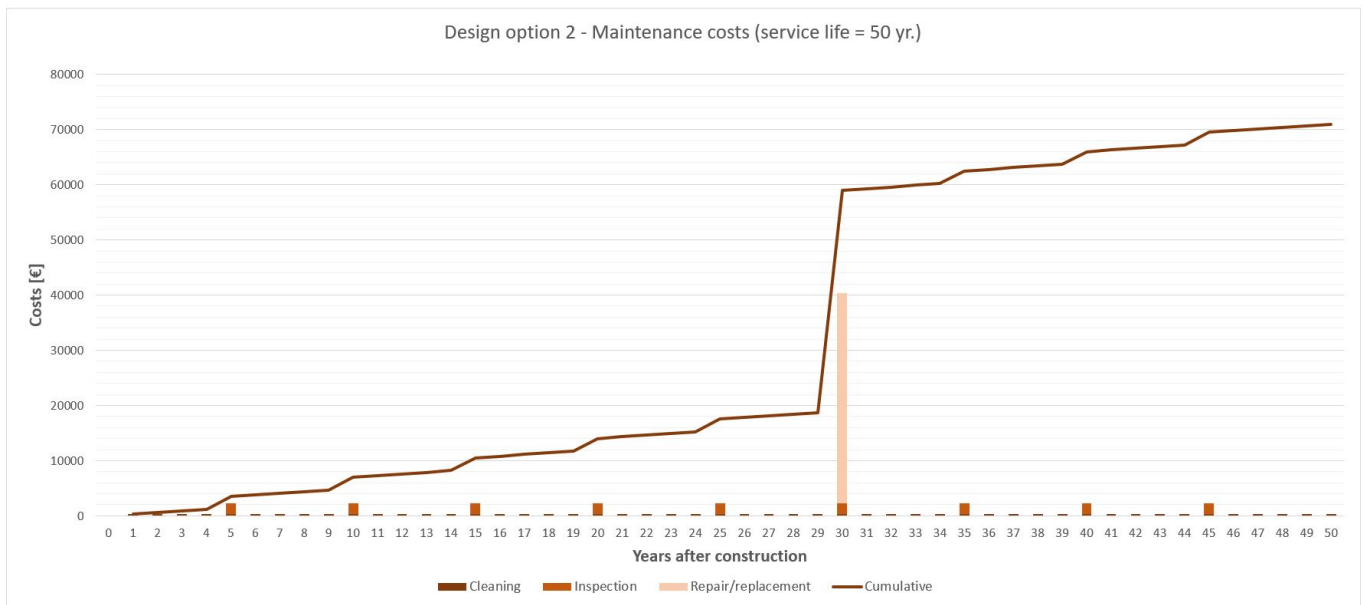

Figure 9.4: Development of the maintenance costs for design alternative 2, during the 50 year service life

### 80 year service life

Table 9.6 shows the total costs of ownership for the two design alternatives when the required service life is 80 years. Figure 9.5 shows the development of the maintenance costs for the most economical option (alternative 1) during the service life of 80 years.

Table 9.6: Calculation of the total costs of ownership for the service life of 80 years.

	Alternative 1			Alternative 2		
	Rep.	Costs per rep.	Total costs	Rep.	Costs per rep.	Total costs
Initial			€ 120.000			€ 140.000
Cleaning	80	€/ - 300	€ 24.000	80	€/ - 300	€ 24.000
Inspection	15	€/ - 2.000	€ 30.000	15	€/ - 2.000	€ 30.000
Railing repair	2	€/ - 10.000	€ 20.000	-	€/ - 10.000	€ -
Railing replacement	1	€/ - 20.000	€ 20.000	2	€/ - 20.000	€ 40.000
Deck replacement	3	€/ - 20.000	€ 60.000	2	€/ - 22.000	€ 44.000
Beams replacement	1	€/ - 25.000	€ 25.000	1	€/ - 28.000	€ 28.000
Discount	-10 %	€/ - 30.000	€ -3.000	-10 %	€/ - 42.000	€ -4.000
Discount	-10 %	€/ - 65.000	€ -5.000	-10 %	€/ - 70.000	€ -7.000
Discount	-10 %	€/ - 30.000	€ -3.000	-	€/ - -	€ -
<b>Total costs of ownership</b>			<b>€ 288.000</b>			<b>€ 295.000</b>
TCO per year			€/yr. 3.600			€/yr. 3.690

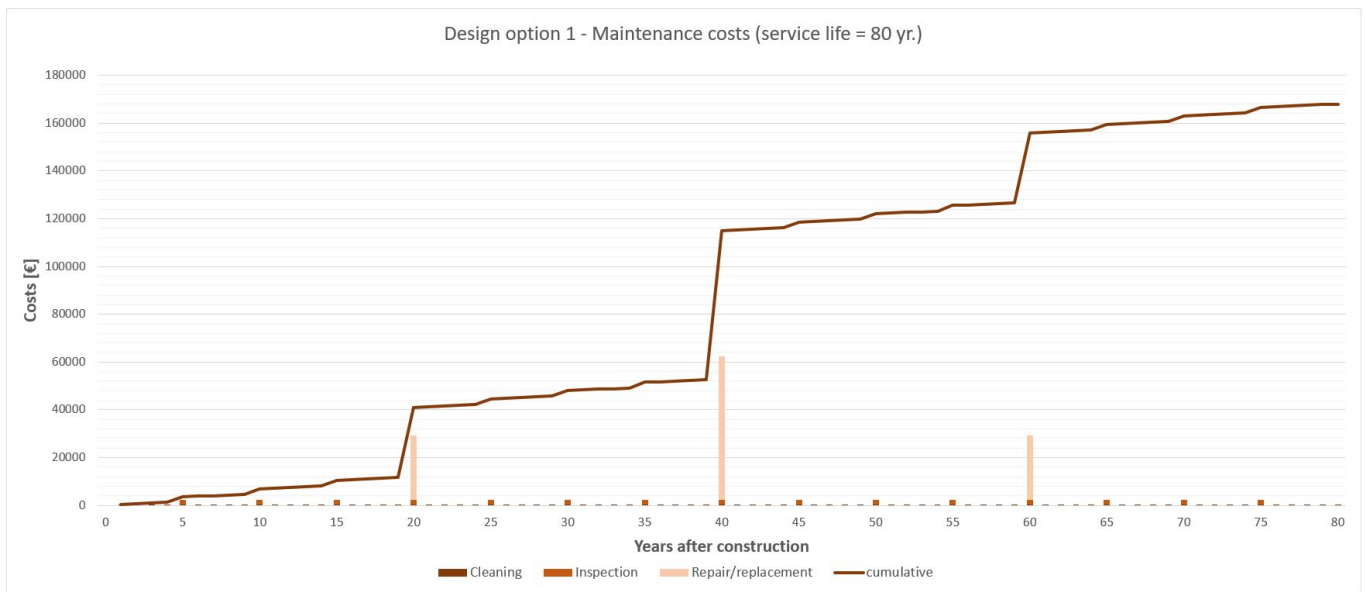

Figure 9.5: Development of the maintenance costs for design alternative 1, during the 80 year service life

# Bibliography

- [1] Informationsdienst Holz (2019). *Entwurf von Holzbrücken*. Holzbau handbuch, Reihe 1, Teil 9, Folge 1. Qualitätsgemeinschaft Holzbrückenbau e.V., Frielzheim, Germany.
- [2] NEN-ISO (2011). *NEN-ISO 15686-1:2011. Buildings and constructed assets - Service Life Planning. Part 1: General Principles and Framework..* Nederlands Normalisatie-instituut, Delft.
- [3] NEN-ISO (2011). *NEN-ISO 15686-5:2011. Buildings and constructed assets - Service life planning - Part 5: Life-cycle costing..* Nederlands Normalisatie-instituut, Delft.
- [4] Office of Asset Management (2002). *Life-Cycle Cost Analysis Primer..* U.S. Department of Transportation, Washington.

# Conclusions, recommendations and future work

## Conclusions

Based on the performed literature research and the examination of the different factor methods, the following conclusions have been formulated:

- Timber bridges in the Netherlands suffer from biological deterioration in the form of wood rot. There is a need for reliable service life estimation models that are able to estimate the service life of timber bridge elements with respect to this deterioration caused by wood rot. Such service life models can for instance follow the factor method approach which can estimate the service life of an element by using reference situations and modification factors.
- Service life models focussing only on this type of biological deterioration following the factor method approach have been developed in Sweden, Australia and Japan. These factor methods are able to take into account the three main factors that are of influence on the development of wood rot and thus on the service life of timber bridge elements: the natural durability of the wood, the climate conditions and the detailing of the bridge.
- A method which is not a factor method and on itself does not take into account biological decay is Mechanical performance modelling. This method uses so called damage functions to determine the accumulated amount of damage in a timber element due to mechanical loading over time.

An approach on how the service life of timber bridge elements can be estimated has been proposed in this research. This proposed approach combines the Swedish and Australian factor methods with quick analysis and mechanical performance modelling in order to create a number of ways to estimate the service life. The usability and accuracy of the approach was tested by performing two reality checks on existing timber bridges in the city of Amsterdam. Based on these reality checks the following has been concluded:

- It was demonstrated that factor methods can be used to estimate the service life of specific elements of a timber bridge. Different areas of interest of an element can be identified and for each element the corresponding values of the different factors can be determined. Based on these factors the service life of each area can separately be estimated.
- For most areas of the two bridges the actual condition matched well with the expected condition that was based on the estimations, especially the elements made out of Azobé.
- For a timber deck made out of European oak the actual condition was however much worse than expected. The reason for this could be found in the natural durability class the European oak boards were ranked in. Based on general conceptions, a natural durability class of 2 was chosen while the oak boards used for the deck should maybe have been classified in a lower class.
- The reality checks showed a difficulty that remains with the service life estimation of timber elements. Within one timber specie the natural durability can vary widely which makes it difficult to appoint a timber specie in a certain durability class without over- or underestimating.

In the last part of this research the role that factor methods can play in the calculation of the total costs of ownership has been examined. An example cost calculation was performed for two design alternatives: one traditional design that is much found in the Netherlands, and the other with a modern design which puts focus on durability by design. From this example the following conclusions are drawn:

- Factor methods can play an important role during the process of calculating the total costs of ownership of a newly designed timber bridge. They can be used to estimate the service life of each single element of the bridge which can then be used as the basis of a planning for minor and major repairs and replacements.

## Recommendations

Based on the literature study, the reality checks and the TCO calculation example, the following recommendation is presented:

- Even though the correctness of the service life estimations will not always be a 100% correct, the use of factor methods can be of great help during the design and plan development process of timber bridges. Not only does it provide the user with an estimation of the service life of a certain timber element, it also shows the user what the influence of certain design choices is on the service life. During the preliminary design stage it can be of great value to use factor methods in order to get insight in what roughly the influence of certain design choices will be on the service life. This is especially valuable for designers or plan makers who lack knowledge on timber as a outdoor structural material.

## Future work

A few recommendations for future research:

- The reality checks in this research considered bridges that were similar to each other in the way of design and used timber specie. In order to validate the correctness of the models for more different bridge designs and timber species, more reality checks are needed that consider a more diverse set of timber bridges.
- The Australian TimberLife factor method shows great potential for engineering purposes due to the fact that it gives its output in the form of a decay rate and a time lag. The underlying assumption here is that biological deterioration starts from the outer layer and slowly makes its way inside. Before this method can be adopted in for instance design standards, this assumption should be verified. A follow up research focussing on this assumption is thus required. This could be done by performing a study that seeks to validate the output of the Australian factor method by inspecting existing timber bridges in more detail than just visual.



# V

## Appendices

# A

## Calculation of the Dutch climate factors

The three factor method models are all based on the climate conditions of the region in which they were developed. In order to see whether the models are also applicable in the Netherlands, the climate data used in the models is compared with weather data of the Netherlands, obtained from the Dutch Meteorological Institute (KNMI) [2].

### Weather data

Weather data of 29 locations in the Netherlands is obtained from the database of the KNMI for the period that ranges from the first day of 2009 to the last day of 2018. The retrieved data consists of the following 4 measurements:

- Daily average temperature (in °C)
- Daily average relative humidity (in %)
- Daily rainfall (in mm)
- Daily duration of rainfall (in hours)

The locations are shown in figure A.2. An example of the weather data is shown in figure A.1.

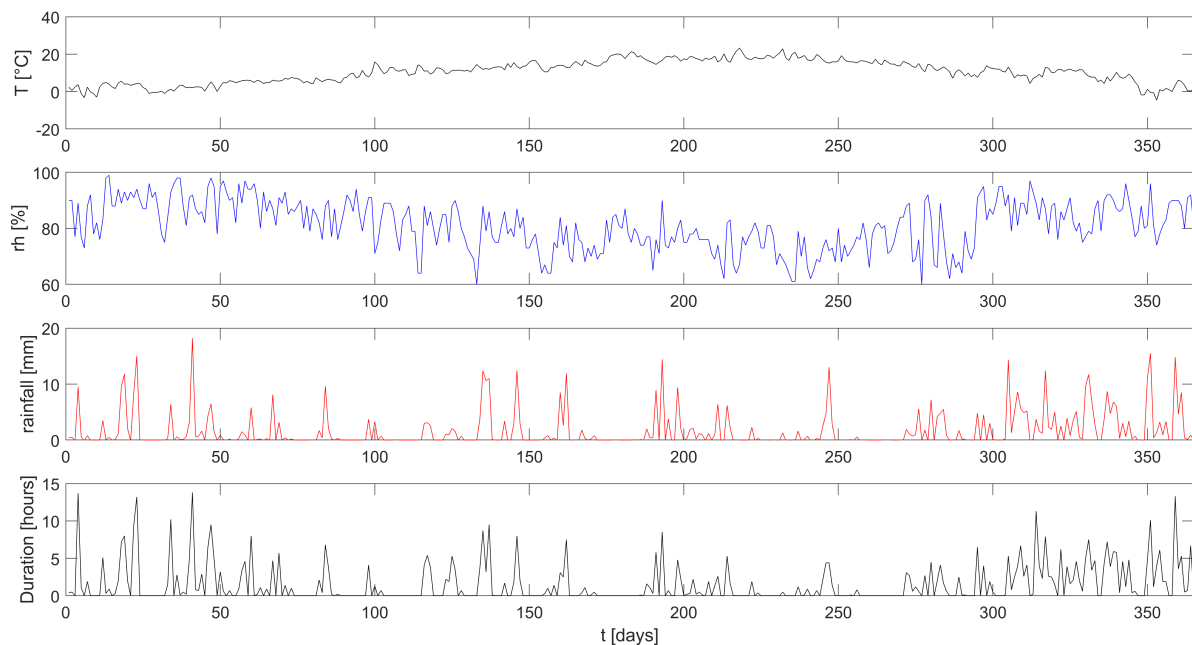

Figure A.1: Weather data measured at weather station De Kooy (Netherlands) in the year 2009.



Figure A.2: Locations of the weather stations from which weather data is obtained.

### Japanese factor method

In the Japanese research the climate factor is only influenced by the mean annual temperature of the region in which the bridge is located, see table A.1. From the obtained weather data it is found that the average yearly temperature for the period of 2009 to 2018 is  $10.5^{\circ}\text{C}$ , which is the average value over all the 29 locations. So according to table A.1:  $R_T = 10.5/15.5 = 0.68$ , which corresponds to **an E1 value of 1.2**.

Table A.1: Determination of the climate factor E1 in the Japanese research [?] [?].

E1:	1.2	1.1	1.0	0.9	0.8
$R_T = T_L/T_A$	$R_T \leq 0.74$	$0.74 < R_T \leq 1.0$	$1.00 < R_T \leq 1.16$	$1.16 < R_T \leq 1.25$	$1.25 < R_T$
$T_L$ = annual mean temperature at bridge location $T_A$ = National (Japanese) annual mean temperature ( $15.5^{\circ}\text{C}$ )					

### Australian TimberLife method

In the Australian research, the values of the climate parameter  $k_{climate}$  were calculated as a function of the time of rainfall per year as shown in equation A.1 [3].

$$k_{climate} = 0.15 t_{rain}^{0.5} \quad (\text{A.1})$$

With  $t_{rain}$  in days/year.

From the weather data obtained from the KNMI, the total yearly rainfall duration has been determined for the 29 weather stations. The yearly rain time for the ten year period between 2009 and 2018 is plotted in figure A.3 for all the 29 weather stations. The average value of all the stations in the ten year period is equal to:

$$t_{rain} = 26.3 \text{ days/year}$$

Which corresponds to a climate parameter value of:

$$k_{climate} = 0.15 * 26.3^{0.5} = \mathbf{0.77}$$

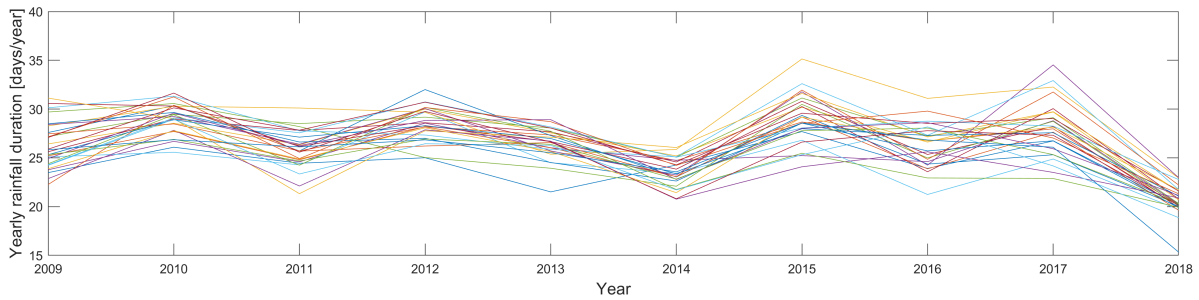

Figure A.3: Plot of the annual total rain duration for 29 weather stations in the period from 2009 till 2018.

### DuraTB dose response method

In this method the regional climate is taken into account by the reference annual exposure dose  $D_{E0}$ . Based on European climate data this exposure dose was calculated for the whole of Europe, see figure 4.16 and table 4.6. For the Netherlands the annual exposure dose is set on 43 days. In this section this value is verified using the climate data obtained from the KNMI.

The exposure dose is calculated using formulas 4.33 - 4.35. To use these formulas first the moisture content and temperature of the wood need to be linked to the global climate data such as rainfall, relative humidity and temperature. In order to determine the moisture content of the wood several so called exposure models were tested and compared to measured data obtained from experiments. Two of these climate models are shown in figure A.4. The blue line represents the numerical exposure model which in the end was used to calculate the moisture content, the grey line represents a simple empirical model and the dotted line represents the measured moisture content.

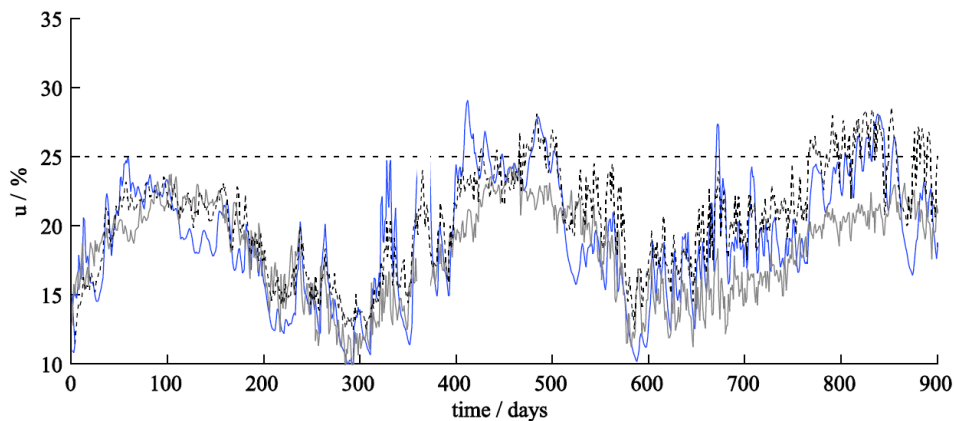

Figure A.4: Measured average moisture content (dotted) in a Norway spruce board plotted together with the calculated moisture content from the empirical model (grey) and the numerical model (blue) [?].

For simplicity the simple empirical exposure model is used to verify the annual exposure dose for the Dutch climate. This model uses the following formula to calculate the wood moisture content:

$$u(\Phi, T) = 10.17 + 0.122\Phi - 0.275T \quad (\text{A.2})$$

In which:

- u : is the moisture content of the wood in %.
- $\Phi$  : is the relative humidity in %.
- T : is the temperature in °C.

Rain is only implicitly considered by setting the relative humidity to 100% during a rain event.

Figure A.5 shows the result of combining the Dutch weather data with equations 5.2 and 4.33 - 4.35. The result shown is the average annual exposure dose for the ten year period from 2009 till 2018, plotted for the 29 data

locations and interpolated for the whole Netherlands.

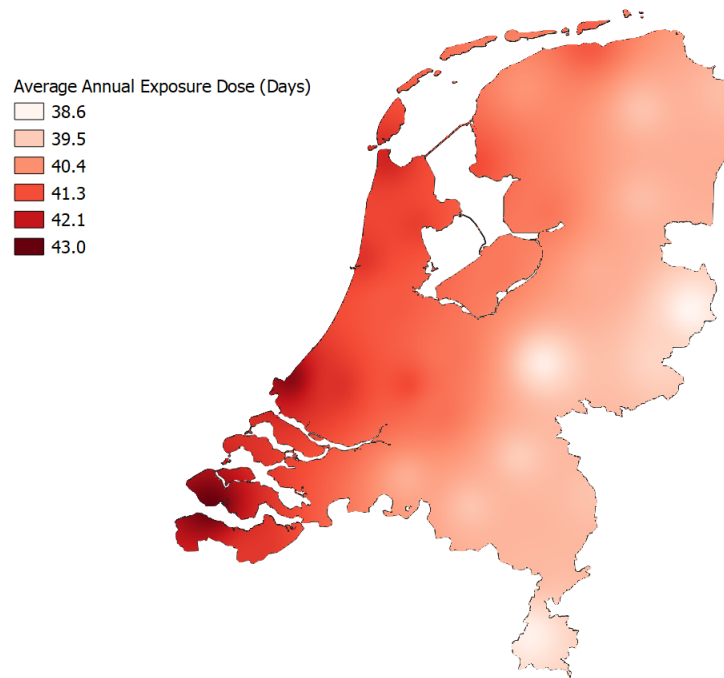

Figure A.5: Average annual exposure dose for the Netherlands. Calculated using the empirical exposure model of equation 5.2.

In the DuraTB project the Netherlands is located in climate zone E, see figure 4.13, which corresponds to a annual exposure dose of 43 days. Based on figure A.5 it can be concluded that this value indeed corresponds to the Dutch climate.

# Bibliography

- [1] Brischke C., Rapp A.O. (2008). *Dose-response relationship between wood moisture content, wood temperature and fungal decay determined for 23 European field test sites.*, Wood Sci. Technol., 42:507-518.
- [2] KNMI, the Royal Dutch Meteorological Institute (n.d.). Weather data obtained from: <https://www.knmi.nl/nederland-nu/klimatologie/daggegevens>
- [3] Wang C.H., Leicester R.H., Nguyen M.N. (2008). *ManualNo4 - Decay above ground.* CSIRO Sustainable Ecosystems, Victoria, Australia.

# B

## Reality checks: Service Life Estimation of bridge 512

This appendix shows the steps and calculation that are taken in order to determine the estimated service life of the different areas of the bridges discussed in chapter 7.

### B.1. Bridge 512

Below shows how the values of the different factors are chosen for the identified areas of interest. A number of factors that are equal for all areas are discussed first. After that the area specific factors are explained.

#### Timber specie: Azobé

The entire superstructure of the bridge is made of Azobé timber. For this example it is assumed that this Azobé timber is classified in natural durability class 1 for both the European standard NEN-EN 350 and the Australian standard AS 5604. This means the following for the values of the corresponding factors:

TimberLife:

Conform equation 4.15, a timber specie which in the Australian standard AS 5604 is ranked in durability class 1, corresponds with a value of the timber factor  $k_{wood}$  of 0.50.

$$k_{wood} = 0.50.$$

DuraTB:

In the DuraTB method the value of the timber durability factor  $D_{Rd}$  is based on tests which are only performed on a limited number of timber species, see table 4.10. Based on the graph of figure 5.4, the value of  $D_{Rd}$  for Azobé is estimated at 2300 days.

$$D_{Rd} = 2300 \text{ days.}$$

#### Climate factors

Appendix A shows how for both the DuraTB and the TimberLife method the values of the climate factors for the Dutch climate are determined. The result is as follows:

TimberLife:

$$k_{climate} = 0.77$$

DuraTB:

$$D_{E0} = 43 \text{ days/year.}$$

## Area 1

The embedded connection between the railing and the railing posts.

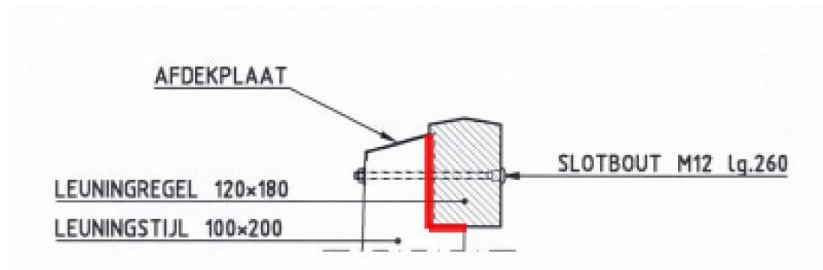

Figure B.1: Area 1: Railing to post connection.

### Timberlife:

- $k_p$  : The railing is covered with a well maintained paint layer, this corresponds to a value of 1.0
- $k_t$  : For a contact surface, the thickness parameter is equal to 1.0
- $k_w$  : For a contact surface, the width parameter is equal to 1.0
- $k_n$  : A value of 1.0 is chosen
- $k_{g1}$  : Conform figure 4.6, an embedded contact surface corresponds to a  $k_{g1}$  value of 1.0
- $k_{g21}$  : Conform equation 4.23, a surface in contact with wood corresponds to a  $k_{g21}$  value of 1.0
- $k_{g22}$  : At the bottom of the connection is a horizontal surface.  $k_{g21} = 2.0$  conform equation 4.24.
- $k_{g23}$  : Contact of two continuous members. Value equal to 1.0 conform figure 4.8.

$$r = k_{wood} k_{climate} k_p k_t k_w k_n k_g = 0.77 \text{ mm/yr.}$$

$$t_{lag} = 8.5r^{-0.85} + t_{lag,+} = 11 \text{ yr.}$$

Years until the in chapter 7 chosen limit state of 10 mm decay ingress is reached:

$$\text{Estimated Service Life} = \frac{10 \text{ mm}}{r} + t_{lag} = 24 \text{ yr.}$$

### DuraTB:

- $k_{E1}$  : No local protective measures, and driving rain is expected to be present. Value is of parameter is equal to 1.0, conform table 4.8.
- $k_{E2}$  : Element is not sheltered. Value of 1.0, conform equation 4.36.
- $k_{E3}$  : Element not close to ground. Value of 1.0 conform equation 4.37.
- $k_{E4}$  : The embedded connection creates a horizontal end grain surface at a place where water will accumulate. The connection is therefore classified as poor which corresponds to a parameter value of 2.0.
- $c_a$  : 1.4

$$\text{Estimated service life} = \frac{D_{Rd}}{D_{Ek} * \gamma_d} \text{ (in years)}$$

$$D_{Ek} = D_{E0} * k_{E1} * k_{E2} * k_{E3} * k_{E4} * c_a = 120 \text{ days/yr.}$$

The value of the severity factor  $\gamma_d$  is kept at 1.0.

$$\text{Estimated service life} = \frac{2300}{120 * 1.0} = 19 \text{ yr.}$$



## Area 2

The connection surface between the main longitudinal beams and the deck boards. The upper surface of the beam is protected by an EPDM-rubber layer, see figure B.2.

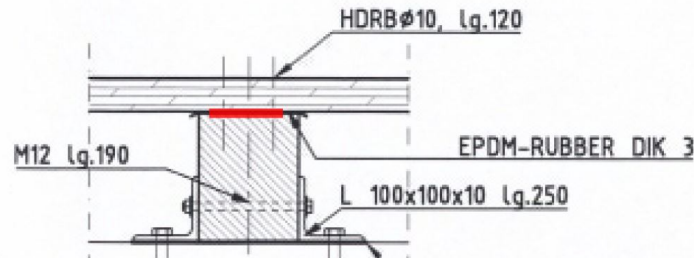

Figure B.2: Area 2: Deck - beam connection.

### Timberlife:

- $k_p$  : No paint, this corresponds to a value of 1.0
- $k_t$  : For a contact surface, the thickness parameter is equal to 1.0
- $k_w$  : For a contact surface, the width parameter is equal to 1.0
- $k_n$  : A value of 1.0 is chosen
- $k_{g1}$  : Conform figure 4.6, a flat contact surface corresponds to a  $k_{g1}$  value of 0.6
- $k_{g21}$  : Conform equation 4.23, a surface in contact with wood corresponds to a  $k_{g21}$  value of 1.0
- $k_{g22}$  : A horizontal upward surface.  $k_{g22} = 2.0$  conform equation 4.24.
- $k_{g23}$  : Contact between a continuous member (beam) and a gapped member (the gaps between the boards). Value equal to 1.2 conform figure 4.8.
- $t_{lag,+}$  : The EPDM-rubber protective layer gives an extra time lag of 10 years, conform table 4.5.

$$r = k_{wood} k_{climate} k_p k_t k_w k_n k_g = 0.55 \text{ mm/yr.}$$

$$t_{lag} = 8.5r^{-0.85} + t_{lag,+} = 24 \text{ yr.}$$

Years until the in chapter 7 chosen limit state of 10 mm decay ingress is reached:

$$\text{Estimated Service Life} = \frac{10 \text{ mm}}{r} + t_{lag} = 42 \text{ yr.}$$

### DuraTB:

- $k_{E1}$  : No local protective measures, and driving rain is expected to be present. Value of parameter is equal to 1.0, conform table 4.8.
- $k_{E2}$  : Element is sheltered by the bridge deck. Value of 0.8, conform equation 4.36.
- $k_{E3}$  : Element not close to ground. Value of 1.0 conform equation 4.37.
- $k_{E4}$  : The flat connection leads to bad ventilation and water is likely to accumulate in the gaps in-between the deck boards. Conform table 4.9 the connection should thus be identified as 'fair'. The protective EPDM-rubber however gives the main beam a bit of extra protection against water and the connection is therefore classified as 'medium', giving it a factor value of 1.25
- $c_a$  : 1.4

$$\text{Estimated service life} = \frac{D_{Rd}}{D_{Ek} * \gamma_d} \text{ (in years)}$$

$$D_{Ek} = D_{E0} * k_{E1} * k_{E2} * k_{E3} * k_{E4} * c_a = 60 \text{ days/yr.}$$

The value of the severity factor  $\gamma_d$  is kept at 1.0.

$$\text{Estimated service life} = \frac{2300}{60 * 1.0} = 38 \text{ yr.}$$

### Area 3

The horizontal top surface of the deck.

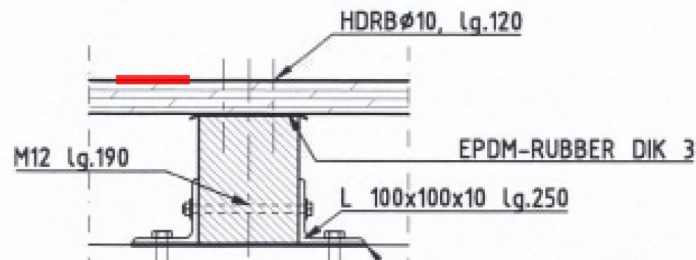

Figure B.3: Area 3: Horizontal top surface of deck board.

#### Timberlife:

- $k_p$  : No paint, this corresponds to a value of 1.0
- $k_t$  : Thickness is 50 mm, value is 1.0 conform equation 4.19
- $k_w$  : Width of the board is 150 mm, value is 1.67 conform equation 4.20
- $k_n$  : A value of 1.0 is chosen
- $k_{g1}$  : Conform figure 4.6, a non-contact surface corresponds to a  $k_{g1}$  value of 0.3
- $k_{g2}$  : Conform figure 1.7, a top surface of a horizontal member corresponds to a value of  $k_{g2}$  of 3.0

$$r = k_{wood} k_{climate} k_p k_t k_w k_n k_g = 0.58 \text{ mm/yr.}$$

$$t_{lag} = 8.5r^{-0.85} + t_{lag,+} = 14 \text{ yr.}$$

Years until the in chapter 7 chosen limit state of 10 mm decay ingress is reached:

$$\text{Estimated Service Life} = \frac{10 \text{ mm}}{r} + t_{lag} = \mathbf{31 \text{ yr.}}$$

#### DuraTB:

- $k_{E1}$  : No local protective measures, and driving rain is expected to be present. Value is of parameter is equal to 1.0, conform table 4.8.
- $k_{E2}$  : Element not sheltered. Value of 1.0, conform equation 4.36.
- $k_{E3}$  : Element not close to ground. Value of 1.0 conform equation 4.37.
- $k_{E4}$  : The horizontal surface is characterised by good ventilation but will have standing water after rain events. The area is therefore classified as 'good', giving it a factor value of 1.0
- $c_a$  : 1.4

$$\text{Estimated service life} = \frac{D_{Rd}}{D_{Ek} * \gamma_d} \text{ (in years)}$$

$$D_{Ek} = D_{E0} * k_{E1} * k_{E2} * k_{E3} * k_{E4} * c_a = 60 \text{ days/yr.}$$

The value of the severity factor  $\gamma_d$  is kept at 1.0.

$$\text{Estimated service life} = \frac{2300}{60 * 1.0} = \mathbf{38 \text{ yr.}}$$

#### Area 4

The end grain surfaces of the deck boards.

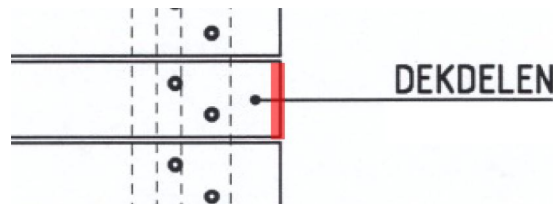

Figure B.4: Area 4: End grain surface of deck board.

#### Timberlife:

- $k_p$  : No paint, this corresponds to a value of 1.0
- $k_t$  : Thickness is 50 mm, value is 1.0 conform equation 4.19
- $k_w$  : Width of the board is 150 mm, value is 1.67 conform equation 4.20
- $k_n$  : A value of 1.0 is chosen
- $k_{g1}$  : Conform figure 4.6, a non-contact surface corresponds to a  $k_{g1}$  value of 0.3
- $k_{g2}$  : Conform figure 1.7, an end-grain surface of a horizontal member corresponds to a value of  $k_{g2}$  of 4.0

$$r = k_{wood} k_{climate} k_p k_t k_w k_n k_g = 0.77 \text{ mm/yr.}$$

$$t_{lag} = 8.5r^{-0.85} + t_{lag,+} = 11 \text{ yr.}$$

Years until the in chapter 7 chosen limit state of 10 mm decay ingress is reached:

$$\text{Estimated Service Life} = \frac{10\text{mm}}{r} + t_{lag} = \mathbf{24 \text{ yr.}}$$

#### DuraTB:

- $k_{E1}$  : No local protective measures, and driving rain is expected to be present. Value is of parameter is equal to 1.0, conform table 4.8.
- $k_{E2}$  : Element not sheltered. Value of 1.0, conform equation 4.36.
- $k_{E3}$  : Element not close to ground. Value of 1.0 conform equation 4.37.
- $k_{E4}$  : The open end-grain surface is characterised by good ventilation and limited exposure to water. Because of the open end-grain surface the area is still classified as 'fair', giving it a factor value of 1.5
- $c_a$  : 1.4

$$\text{Estimated service life} = \frac{D_{Rd}}{D_{Ek} * \gamma_d} \text{ (in years)}$$

$$D_{Ek} = D_{E0} * k_{E1} * k_{E2} * k_{E3} * k_{E4} * c_a = 90\text{days/yr.}$$

The value of the severity factor  $\gamma_d$  is kept at 1.0.

$$\text{Estimated service life} = \frac{2300}{90 * 1.0} = \mathbf{25 \text{ yr.}}$$

## Area 5

The open side surface of the railing.

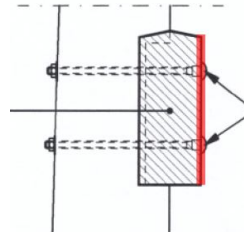

Figure B.5: Area 5: Open side surface of the railing.

### Timberlife:

- $k_p$  : The railing is covered with a well maintained paint layer, this corresponds to a value of 1.0
- $k_t$  : Thickness is 120 mm, value is 1.0 conform equation 4.19
- $k_w$  : Width of the board is 200 mm, value is 2.0 conform equation 4.20
- $k_n$  : A value of 1.0 is chosen
- $k_{g1}$  : Conform figure 4.6, a non-contact surface corresponds to a  $k_{g1}$  value of 0.3
- $k_{g2}$  : Conform figure 1.7, an side surface of a horizontal member corresponds to a value of  $k_{g2}$  of 2.0

$$r = k_{wood} k_{climate} k_p k_t k_w k_n k_g = 0.46 \text{ mm/yr.}$$

$$t_{lag} = 8.5r^{-0.85} + t_{lag,+} = 16 \text{ yr.}$$

Years until the in chapter 7 chosen limit state of 10 mm decay ingress is reached:

$$\text{Estimated Service Life} = \frac{10\text{mm}}{r} + t_{lag} = \mathbf{38 \text{ yr.}}$$

### DuraTB:

- $k_{E1}$  : No local protective measures, and driving rain is expected to be present. Value is of parameter is equal to 1.0, conform table 4.8.
- $k_{E2}$  : Element not sheltered. Value of 1.0, conform equation 4.36.
- $k_{E3}$  : Element not close to ground. Value of 1.0 conform equation 4.37.
- $k_{E4}$  : The open side surface is characterised by good ventilation and limited exposure to water. It is classified as 'excellent', giving it a factor value of 0.8
- $c_a$  : 1.4

$$\text{Estimated service life} = \frac{D_{Rd}}{D_{Ek} * \gamma_d} \text{ (in years)}$$

$$D_{Ek} = D_{E0} * k_{E1} * k_{E2} * k_{E3} * k_{E4} * c_a = 48\text{days/yr.}$$

The value of the severity factor  $\gamma_d$  is kept at 1.0.

$$\text{Estimated service life} = \frac{2300}{90 * 1.0} = \mathbf{48 \text{ yr.}}$$

## Area 6

The sloped top surface of the railing.

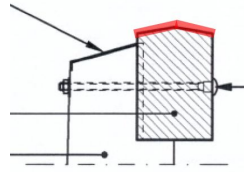

Figure B.6: Area 6: Sloped top surface of the railing.

### Timberlife:

- $k_p$  : The railing is covered with a well maintained paint layer, this corresponds to a value of 1.0
- $k_t$  : Thickness is 180 mm, value is 1.0 conform equation 4.19
- $k_w$  : Width of the board is 120 mm, value is 1.5 conform equation 4.20
- $k_n$  : A value of 1.0 is chosen
- $k_{g1}$  : Conform figure 4.6, a non-contact surface corresponds to a  $k_{g1}$  value of 0.3
- $k_{g2}$  : Conform figure 1.7, a top surface of a horizontal member corresponds to a value of  $k_{g2}$  of 3.0

$$r = k_{wood} k_{climate} k_p k_t k_w k_n k_g = 0.52 \text{ mm/yr.}$$

$$t_{lag} = 8.5r^{-0.85} + t_{lag,+} = 15 \text{ yr.}$$

Years until the in chapter 7 chosen limit state of 10 mm decay ingress is reached:

$$\text{Estimated Service Life} = \frac{10\text{mm}}{r} + t_{lag} = \mathbf{34 \text{ yr.}}$$

### DuraTB:

- $k_{E1}$  : No local protective measures, and driving rain is expected to be present. Value is of parameter is equal to 1.0, conform table 4.8.
- $k_{E2}$  : Element not sheltered. Value of 1.0, conform equation 4.36.
- $k_{E3}$  : Element not close to ground. Value of 1.0 conform equation 4.37.
- $k_{E4}$  : The sloped top surface of the railing is characterised by good ventilation and little standing water after rain events. It is classified as 'good', giving it a factor value of 1.0.
- $c_a$  : 1.4

$$\text{Estimated service life} = \frac{D_{Rd}}{D_{Ek} * \gamma_d} \text{ (in years)}$$

$$D_{Ek} = D_{E0} * k_{E1} * k_{E2} * k_{E3} * k_{E4} * c_a = 60\text{days/yr.}$$

The value of the severity factor  $\gamma_d$  is kept at 1.0.

$$\text{Estimated service life} = \frac{2300}{90 * 1.0} = \mathbf{38 \text{ yr.}}$$

# C

## TCO Example: Service Life Estimation

This appendix shows the steps and calculations performed in order to estimate the service life of the different bridge elements in the TCO example of chapter 11. Only the superstructures of the two alternative bridge designs are taken into account. The superstructures are divided into three main elements: the longitudinal beams, the deck and the railing. For each element the service life is estimated with the use of the approach described in chapter 6, however mechanical performance modelling is left out of this example. The approach is shown in figure C.1. This same approach is used for the estimation of the service lives of the bridges discussed in chapter 7 - Reality checks.

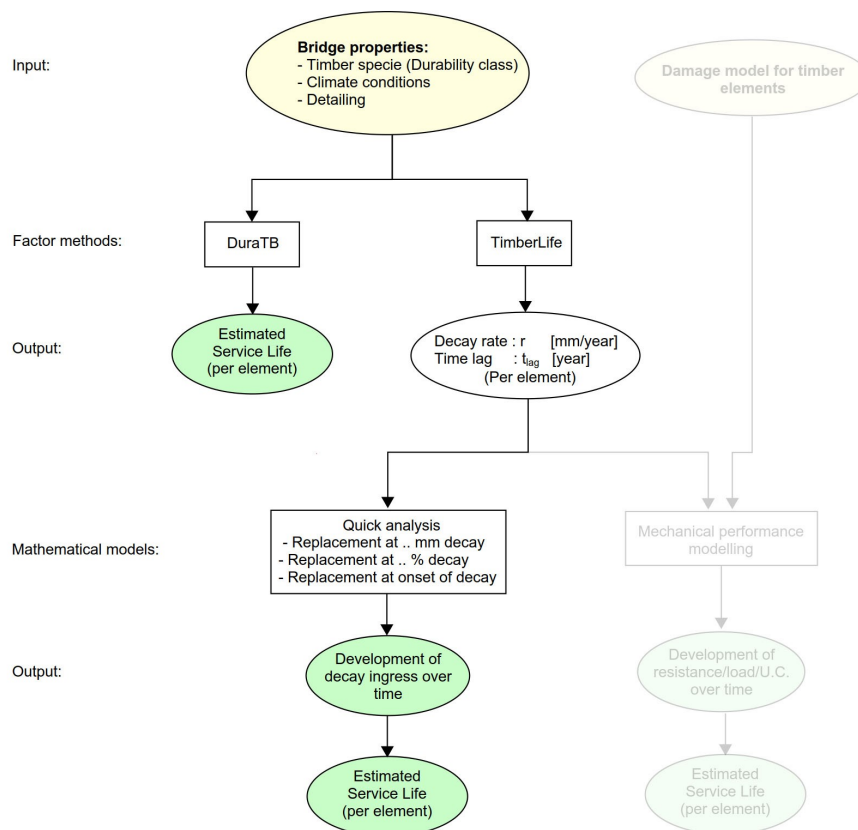

Figure C.1: The approach, described in chapter 6, that is used to estimate the service life of the different elements.

## TimberLife method

The Timberlife factor method is in this example used in combination with a quick analysis, see figure C.1. This means that a limit of the amount of decay needs to be chosen in order to obtain an estimated service life. In this TCO calculation example, the following limit state has been used:

### Replacement at 10 mm decay

This means that when the decay ingress reaches 10 mm, the timber element needs to be replaced.

## C.1. Design alternative 1

The first design alternative is based on the typical timber bridge design that can be found in 'Het Amsterdamse Bos'. An example of such a bridge is bridge 512, which is discussed in chapter 7. The results from the service life estimation of bridge 512, performed in appendix B is also used for the first design alternative in this example. These results are shown in figure C.2.

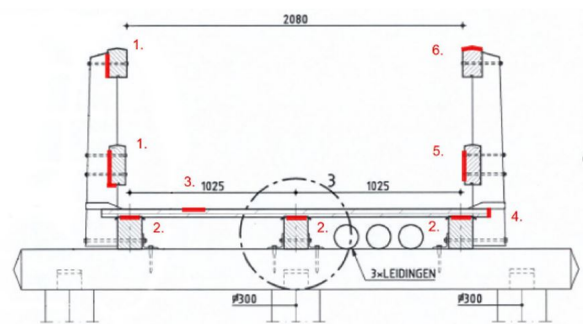
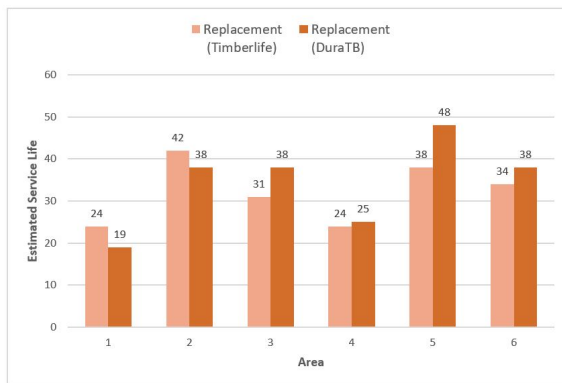

Figure 7.4: Cross section with in red the areas of interest

Figure C.2: The results from chapter 6. The figure shows the cross section of the bridge with the highlighted areas of interest. The graph shows the estimated service life of each of these areas.

## Estimated service lives

Based on figure C.2 the elements are given the following estimated service lives.

### Longitudinal beams

It follows from figure C.2 that after circa 40 years the top surface of the beams suffer from a significant amount of wood rot. The consequence of this is that the deck board can not be properly attached to the main beams any more and/or will come loose, see figure C.3 for an example of a beam that suffers from woodrot at the top surface. The longitudinal beams are therefore considered to have the need to be replaced after 40 years of service.



Figure C.3: Example of a timber longitudinal beam suffering from wood rot at the top surface.

**Deck** Figure C.2 shows that the top surface of the deck has an estimated service life of circa 35 years, while the end grain surfaces only have around 25 years estimated. The consequence of a rotten end grain surfaces at a deck board is not that big, therefore the service life of the total deck is set at 30 years.

**Railing** Figure C.2 shows that at the service life of areas 5 and 6 lies around 40 years. At the location of the embedded connection the service life is however only circa 20 years. This leads to the following:

- Partial replacement/repair of rotten areas around the connetions: 20 years
- Complete replacement of the railing: 40 years

## C.2. Design alternative 2

The second design alternative is based on a more modern timber bridge design which in its detailing is more focussed on durable design. Figure C.4 shows the connections between the longitudinal beams and the deck, and the railing connections. Tables C.1 and C.2 give the values of the different factors together with the estimated service life of the different areas.

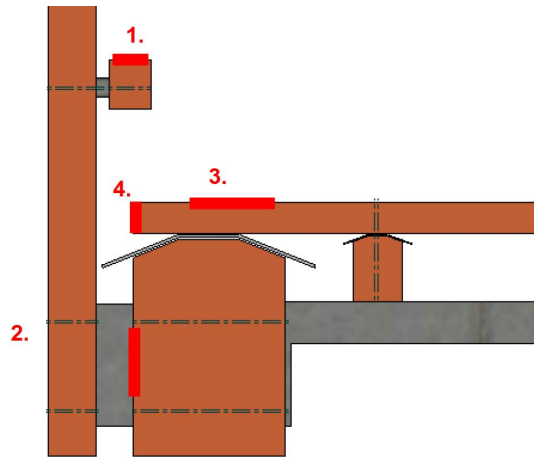

Figure C.4: Example of a timber longitudinal beam suffering from wood rot at the top surface.

Table C.1: Alternative 2 - DuraTB

Zone	$D_{Rd}$ [days]	$D_{E0}$ [days/yr.]	$k_{E1}$	$k_{E2}$	$k_{E3}$	$k_{E4}$	$c_a$	ESL [yr.]
1	2300	43	1.0	1.0	1.0	0.8	1.4	48
2	2300	43	1.0	1.0	1.0	0.8	1.4	48
3	2300	43	1.0	1.0	1.0	1.0	1.4	38
4	2300	43	1.0	1.0	1.0	1.5	1.4	25

Table C.2: Alternative 2 - Timberlife

Zone	$k_{wood}$	$k_{climate}$	$k_p$	$k_t$	$k_w$	$k_n$	$k_{g1}$	$k_{g2}$	$t_{lag,+}$ [yr.]	r [mm/yr.]	$t_{lag}$ [yr.]	10mm [yr.]
1	0.5	0.77	1.0	1.0	1.3	1.0	0.3	3.0	-	0.45	18	39
2	0.5	0.77	1.0	1.0	1.0	1.0	0.6	1.4	-	0.32	22	53
3	0.5	0.77	1.0	1.0	1.7	1.0	0.3	3.0	-	0.58	14	31
4	0.5	0.77	1.0	1.0	1.7	1.0	0.3	4.0	-	0.77	11	24