

Comfortably Rising

Applying passive strategies into
multi-floor residential units

Technical Research Paper

AE Graduation Studio

Bojie Chen

4504402

Research Tutor: Carolin Bellstedt

Architectural Tutor: Mo Smit



Abstract

The high density of the built environment in the informal settlements could cause thermal discomfort, thus hurt the health and resilience of the residents. This is especially true in urban kampungs, Indonesia. As the population rapidly grows inside kampung, its urban tissue becomes overcrowded, worsening the ventilation, temperature, humidity, and daylighting conditions.

This paper is trying to approach principles of the multi-floor residential units which have good thermal comfort conditions in the context of kampung Cigondewah, Bandung.

With the study of the books of Mark Dekay and Snokozy, some strategies focusing on passive cooling are found. Further, with the help of CFD simulating software (Ansys Workbench), the optimized option for ventilation strategies are chosen based on the wind velocity and wind pressure distribution; while the position and measurements of shading strategies could be calculated by using the solar path chart.

The results of the research could serve as the criteria for the design of multi-floor apartment building, which could ensure better interior thermal comfort for the households.

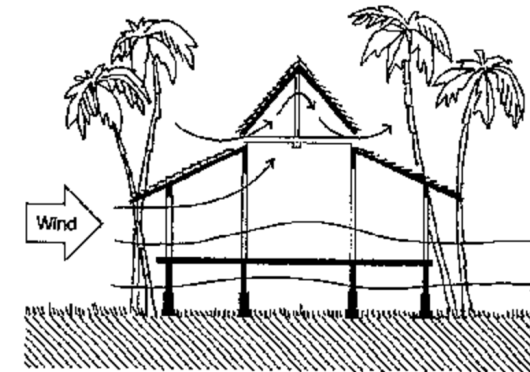

(Lee, 1992)

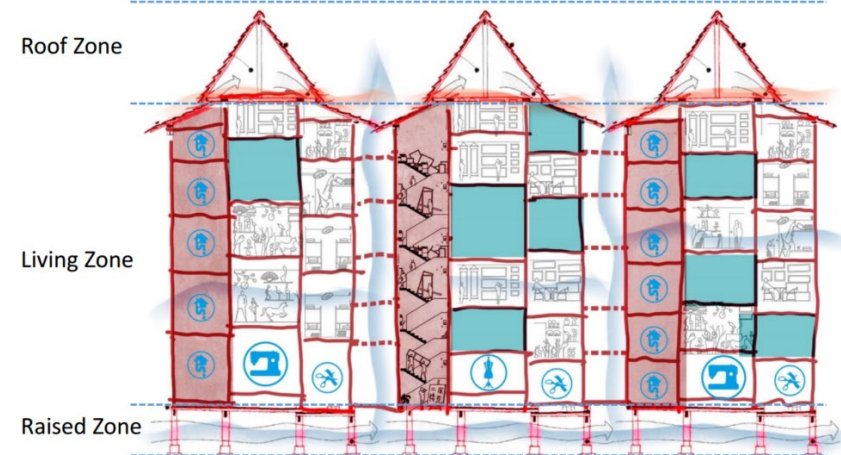

(own drawing, 2016)

?

Table of Contents

Abstract

1. Introduction

- 1.1 Background
- 1.2 Research question
- 1.3 Methods

Chapter 2:

Bandung Climate Research and the Corresponding Passive Strategy

- 2.1 Location and Solar analysis
- 2.2 Temperature, humidity and precipitation.
- 2.3 Wind Direction, velocity, and ventilation
- 2.4 The Standard Effective Temperature and Thermal Comfort Zone
- 2.5 Conclusion

Chapter 3:

Passive Cooling Bundles for the Neighborhoods and the Building

3.1 Neighbor Scale

- 3.1.1 Orientation of Streets and the buildings
- 3.1.2 Breezy Streets and Building Distance
- 3.1.3 Overhead Shadings and Shared Shadings
- 3.1.4 Breezy and Shady Courtyards

3.2 Building Scale

- 3.2.1 Cross ventilation
- 3.2.2 Ventilation Openings Arrangement
- 3.2.3 Stack Ventilation
- 3.2.4 Permeable buildings Combining Stack and Cross Ventilation
- 3.2.5 Rooms Locating Outdoors
- 3.2.6 Shading and insulation for solar radiation

3.3 Conclusion

i

Chapter 4: Passive Strategies Applying to Multi-floor Apartments

4.1 Building Layout Scale:

- 1 4.1.1 Orientation 30
- 7 4.1.2 Distance & Building Length 31
- 7 4.1.3 Size and layout of courtyards 32

4.2 Room Scale:

- 9 4.2.1 Location of the corridors 33
- 11 4.2.2 Layout of stack ventilation 34
- 11 4.2.3 Ventilation Opening size and arrangement 35
- 13 4.2.2 Sizing the sun shading 36

4.3 Conclusion 37

5. Conclusion and Discussion

5.1 Conclusion 40

- 5.1.1 Climate: Challenges and Opportunities 40
- 5.1.2 Passive cooling by ventilation and sun shading 40
- 5.1.3 Application of the strategies 41

5.2 Discussion 41

- 5.2.1 Critical Arguments 41
- 5.2.2 The Potential of the Conclusions 42

1.Introduction

Informal Settlements, often discribed as “slums” or “squatters”, act as important accomodations for the poorer sector of the society (Davis, 2006). As many cities in developing countries facing the rapid urbanization process, the cities growing in size, number, and finance. It becomes rather difficult for the poors to find a decent and affordable housing within urban areas. As a result, low-income groups swarm into the informal settlements within urban areas, which provide cheaper but low-quality housings. This trend leads to the development of informal settlements (Smets, 2014).

Urban Kampung is a typical kind of informal settlement in urban Indonesia. “Kampung” means “village” in Indonesian, which reveals the essence of their formation: the existing village are gradually swallowed by the urban surroundings, leading to a mixed urban context of original village-like tissue and high density in terms of population and built-environment.

The trend of vertical development is an inevitable outcome among urban areas after the ground floor was almost fully occupied. Different from the government and developer-led projects in urban areas, the vertical development in informal settlements is often a self-built process led by the residents themselves. Therefore, the outcomes are often unplanned, which might even make the density problems and thermal comfort condition worse (URBANUS, 2011).

1.1Background:

1.1.1 Growing Density of Population and Urban Tissue

Located in the west Java, Bandung is the third biggest city in Indonesia. The population is 2,470,802 in 2014, with the total population density of 15713 pp/km² (Statistics of Bandung City, 2014). The population is still soaring, as it is estimated that in 2030, the Bandung city will hold more than 4.1 million inhabitants (Smit, 2016), which means that the population density might reach over 26000 pp/km² if the city region doesn't expand.

Bandung is famous for its textile and garment industry, and have been described as the “fashion capital” of Indonesia (Smit 2016). In Bandung Kulon district where Kampung Cigondewah is located, the population density is 22089 pp/km² (Statistics of Bandung

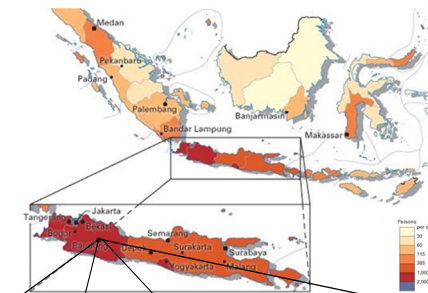
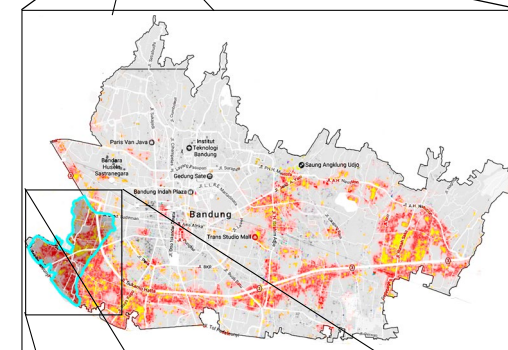
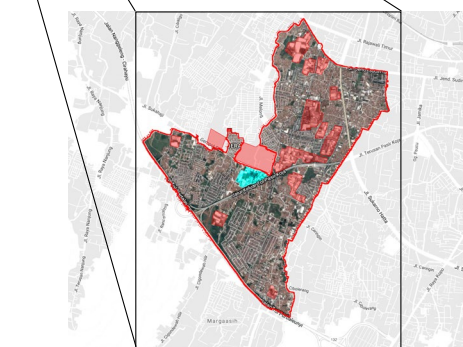

Figure 1.1
Indonesia population density distribution (Own drawing)



Bandung Kulon
Kampung Distribution

Figure 1.2
Urban Kampung distribution in Bandung and Bandung Kulon (Own drawing)



Cigondewah
Factories

Figure 1.3
Factories and Kampung Cigondewah in Bandung Kulon (Own drawing)

City, 2014), much higher than average. From Figure 1.2 and Figure 1.3 we could see that Bandung Kulon is almost fully covered by urban kampung areas, and surrounded by these urban kampungs there are several textile factories. This indicates that urban kampungs often accommodate high population dense than other types of urban tissue.

The reason of the high density in these area is the labor intensity of textile industry. Many workers choose to live around the factories by renting rooms in urban kampungs because of the low rent and the convenient commute (Smit 2016).

1.1.2. Un-planned vertical development

The trend of vertical development is an inevitable outcome in response to the increasing density, especially among the urban areas where the ground floor almost fully occupied. Different from the government and developer-led projects in urban areas, the vertical development in off-grid residential areas is often a self-built process led by the residents themselves (Bredennord, 2014), with lack of planning on neighborhood scale. In kampung Cigondewah, some residents already begin turning their single floor housings to the multi-floor ones by either demolishing the former houses and rebuild a new one, or make the additional part to the existings.

According to an typo-morphology and quality analysis of Housings in Cigondewah that was conducted by students of Bandung Institute of Technology (Figure 1.4), many single floor houses with pitch roofs were initially built before 1980's; while the multi-floor houses were often rebuilt after 1990s; still, there's a particular housing typology of migrant workers which are like small 2-floor apartments. This typology appears after 1990s too, reconstructed from originally private house and turns to rent residential units by the owner (B.Sakina 2015). In his thesis (Figure 1.5), Zichen surveyed some incremental housings and concluded t that the house owners built the upper floors under their own wills (Liu 2016).

When this unplanned vertical development reaches certain degree, the density on the upper floors will make the living condition even poorer. The extreme negative cases are the urban villages in southeast China cities like Shenzhen. In Gangxia village (Figure 1.6), for example, the multi-floor residential buildings have overcrowded layout on both the room scale and the neighbour scale, leading to poor living quality inside (Hang Ma, 2011).

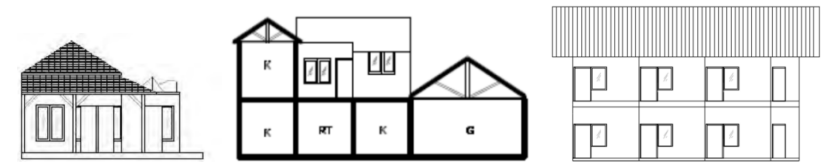

Figure 1.4 Housing typologies: single floor house; multi-floor house, multi-floor worker apartment (B.Sakina, Typomorphology of Housing Cigondewah Bandung, 2015)

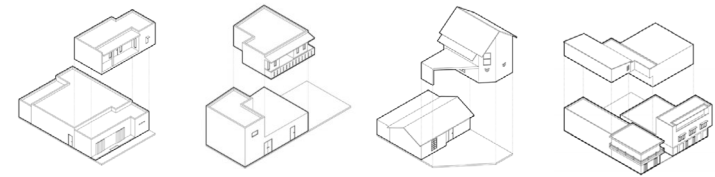

Figure 1.5 Incremental houses (Liu, Incrementality, 2016)



Figure 1.6 Gangxia Village, Shenzhen,(URBANUS, 2011)

1.1.3. Thermal Discomfort and Passive climate strategies

The thermal comfort condition of the residential units is a crucial aspect of the living quality, for it is closely related to the resident's satisfaction with the living condition both physiologically and psychologically (V. Olgyay 1964). Moreover, the thermal condition affects residents' well-being, which is especially evident for children because they are more sensitive and vulnerable to bad thermal conditions. Research shows that the high humidity in Bandung increases the chance for children under 5 years old to get disease like rotavirus diarrhea. (Dwi Prasetyoa 2015, Fabbri 2015)

Generally, Bandung's climate condition is relatively moderate compared to other tropical areas because of its geological location. Nevertheless, it is still not ideal in some periods. Besides, buildings with poor design might led to worse thermal comfort condition indoor than outdoor. Therefore,

Passive design strategies are needed to improve the thermal condition (Figure 1.7).

The passive strategies vary for different climate conditions. To find appropriate strategies, the first step should be the study of the local climate. In the first chapter, the authour will study local climate which target the main climate problems related to thermal comfort based on Szokolay's book *Introduction to Architectural Science: the basis of sustainable design*, thus find the focus of passive design. The second chapter introduces several passive design strategies related to this focus, based on Mark DeKay's book *Sun, Wind & Light: Architectural Design Strategies*.

Figure 1.7 Dark, humid and stuffle interior of a dwelling in Cigondewah (Own Photo, 2016)



1.1.4. Context Analysis

Orientation of Streets and the Buildings

The street orientation of Cigondewah is 20 degree east by north. It generally have NW-SE streets direction that coincide with the main wind direction. The small distance between buildings protects them from direct solar radiant. Nevertheless, as there are some houses locating on the west edge of urban tissue where there's no shared shading from other buildings, where the solar radiation will create a lot of heat gain.

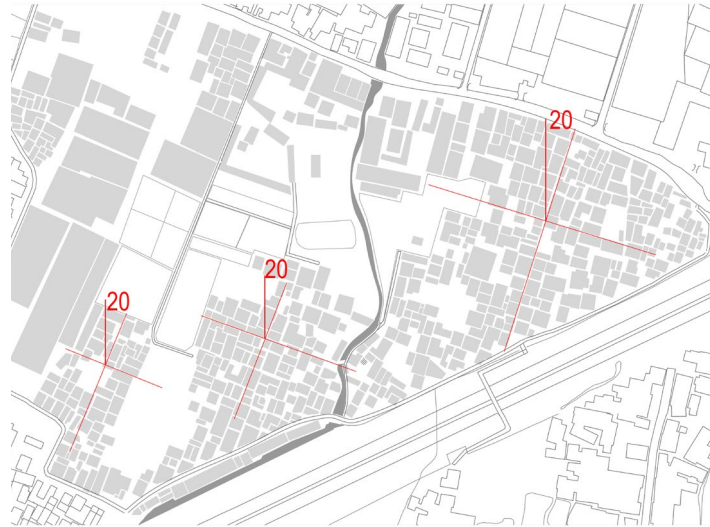

Figure 1.8 existing orientation (Own Drawing,2016)

Overhead Shadings and Shared Shadings

Most buildings have large overhang eaves that provide overhead shadings not only for facades but also for the inbetween spaces (lanes) underneath, therefore the direct sunshine will hardly access the interior (Photo a). On some spot, the eaves are extended for larger semi-outdoor space, which could locate outdoor rooms (Photo b). On the edge of open spaces, the residents built some pergolas as shaded public space. (Photo c).

On the other hand, the small building distance on WE direction also prevent lower solar radiant in the afternoon, though impede the early sun at the same time.



Figure 1.10 Outdoor roomes in Cigondewah (Own Drawing,2016)

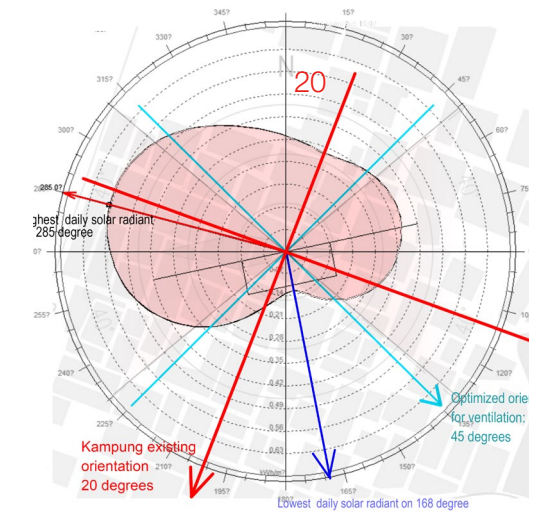

Figure 1.9 Orientations Concerns (Own Drawing,2016)



a b



c

(Own Photos, 2016)

Open spaces and Green space

Besides the crop field and the trees that concentrating in the heart area of Cigondewah, Some open spaces are also interwoven with trees or grass, which also act as cementaries (Photo d) or small parks (Photo e). The public spaces like playground or mosque squares, however, don't have much greens because of their particular functions. Nevertheless, the residents could green the surrounding by planting single tree on the edge of these spaces (photo f).

Breezy Streets & Dispersed buildings

Although having correct orientation, the breezy streets are often blocked because of the high density of the urban tissue on the ground floor. Generally, the size of lanes on NW-SE direction are around 800-1000mm, with high H/W rates and often covered by the eave extensions on the first floor level (Photo g). In some dead end lanes (Photo i), the lane was fully covered by the walls and the eaves, leaving virtually no possibility for ventilation.

The widest and most continuous lane (Photo h) have width between 1100-1400mm, and penetrates the RW12. But since it has N-S direction, it doesn't work well as breezy street.



Figure 1.11. Open Spaces and Green Space
(Own Drawing, 2016)



Figure 1.12. Blocked Tissues and Lanes
(Own Drawing, 2016)



d



e



f



g



h



i

1.1.5. Rumah Susun in Bandung

Rumah Susun means multifloor apartment in Indonesian, which are massively provided in Indonesia during 1990s by government aiming to solve the housing shortage (Bredenoord, 2014). Located in Bandung, the rumah susun Jalan industri was occupied since 1990 (Pak. Nanang, 2016). The project have permeable middle corridors, with some balconies inbetween the room blocks.

Neighbor context:

The orientation of the main facades is west-east, facing a single-floor factory and the a square respectively. The distance with the 9.6m-meters-high buildings on the east is 12.5m, while the distance is 7.6m on the west.

Thermal Comfort

The measurements were taken in the room and in the corridor respectively, showing that the corridor is slightly cooler than the room. Nevertheless, it is still too hot and humid.

Ventilation Strategies

The rooms have opposite vent openings on the facade and in the corridor. In the interviewee room, the opening rate for the living room and the bedrooms is 20.3%. The occupant is very satisfy with the ventilation (Pak Nanang, 2016). Stack effect only happens in the stair shafts, which is not helpful for the overall ventiating strategies.

(Semi-) Outdoor rooms

The inner corridor served as semi-outdoor rooms for residents as public living rooms, as extention of shops, and as green places.

Shadings and Roofs

The building has an integral pitch roof, overhanging 1.2m for each direction. Each windows on west and east facade have independent shadings sizing $0.67 \cdot (H_f - H_s)$, which means there will be direct sunshine in the room before 10:00 and after 15:30 (See 2.2.6). There're few openings on north and west sides, which are shaded by the building block it self.

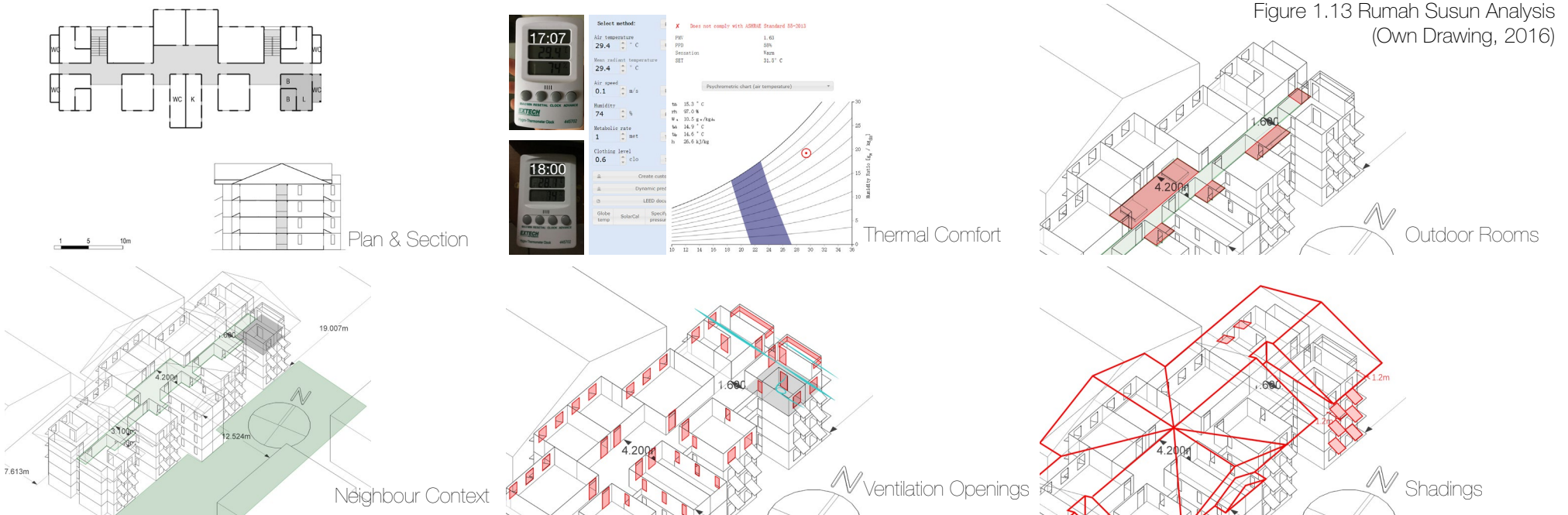

Figure 1.13 Rumah Susun Analysis (Own Drawing, 2016)

1.2 Research question:

What are the most suitable passive design strategies for multi-floor residential units in Bandung, Indonesia?

Sub-Questions:

1. What are the characteristics of the local climate in Bandung?
2. What passive strategies can be applied in this climate situation?
3. How to apply these strategies in multi-floor resident units?

1.3 Methods

Many literatures have been done in regard to these sub-questions respectively. So one of my research methods is the literature study.

Since V.Olgyay published his book *Design with Climate* in 1964, many methods has been developed to investigate the climate characteristics of a certain region and point out the main problems that causes thermal discomfort, often using different Bioclimatic Charts (V. Olgyay, Szokolay, Givoni-Milne). This thesis will use Szokolay's Psychometric Chart.

Further, the passive design strategies are also being summarized and abstracted in response of different climate characteristics. This thesis will depend this part of research on the works of Mark DeKay and Steven Szokolay.

At last, the application of passive design has long history around Indonesia area, which was addressed in Yuan's work (1991); while modern architects, like Charles Correa and Philippe Rahm , also made innovative attempt introducing passive design into tropical modern housing.

Yet, the gap between tropical passive design strategies and their application in multi-floor dwellings in Indonesia still exists. Since there are many differences on the climate characters, the social-economic status and material preferences. Therefore, the thesis will offer a new bridge on this gap.

Chapter 1 is the study of local climate which targets the main climate problems related to thermal comfort, thus find the focus of passive design. This chapter analysis the meter database of Bandung city in 2014. Most of the data (temperature, relative humidity, wind direction, wind velocity, wind frequency, precipitation, and solar path) are from the meteorology station of Husein Airport in Bandung, which can be accessed on Weatheronlin.co.uk. While the solar radiation intensity data is based on the meteorology data of Singapore from Energyplus.com.

The second chapter introduces several passive design strategies related to this focus. The structure and content of this chapter are based on the book *Sun, wind and Light: Architectural design strategies* (third version, Mark DeKay, 2014), which provides full sets of passive strategies related to passive coolings. While some theoretical knowledge are from the book *Introduction to Architectural Science: The Basis of Sustainable Design* (Steven V Szokolay).

In the Third chapter, the author tried to quantify these passive strategies when they are applied in multi-floor residential units. In order to give quantative criteria of the strategies, the author creates a wind channel using the constant west wind with 2.5m/s velocity in the CFD simulation software. The aim was to calculate how different options could affect the wind velocity and wind pressure around the exterior and interior.

The outcome, as a result, could be the principle and criteria for the design later on.

Chapter 2 Climate research and the corresponding Passive strategy

In chapter 2, the weather type of Bandung city will be defined in order to find the essential problems that are affecting or might affect the thermal comfort after the kampung becomes more denser by studying the meteorology data. Furthermore, I will find out the main climate issues by comfortable zone analysis, and define the main focus of the passive climate strategies.

Locating in the Southeast Asia, Bandung has a warm-humid type of climate according to the reports of Atkinson (1954) and Edmonds and Greenup (2002). Nevertheless, the climate is relatively moderate compared to other tropical cities nearby like Jakarta and Singapore. The reason of its special climate is that the landscape is high above the sea level with high volcanic terrains, and the cool climate is the essential reason why Dutch indie government made Bandung as a summer resort area for European travelers since 19th century (LSAI 2006).

Nevertheless, as the urban density grows, the building height and density will create canyon effect, while as the urban vegetation decreased, the climate buffer zone became less effective. As a result, the climate problems related to bioclimatic comfort will be exacerbated (Katia Perini 2014). In urban kampungs like Cigondewah, poor ventilation and high humidity are already threatening both the physiological and psychological well-being of residents, especially of the children (Fabbri 2015, Sanye 2016).

2.1 Location and Solar Analysis

Bandung is located on $6^{\circ} 55' 3''$ S, $107^{\circ} 37' 8.76''$ E, which is near the equator. Its elevation is 768 meters above sea level and is surrounded by high Late Tertiary and Quaternary volcanic terrain (Hasanuddin, 2013). The region of the city receives a large amount of solar radiation every year (Karam M. Al-Obaidin 2014). As figure 2.1 shows, the average annual sum of Global Horizontal Irradiation of the Bandung city is well above 1,800 kWh/sq.m, which is almost twice as it is in Amsterdam (around 1000 kWh/sq.m), Netherlands.

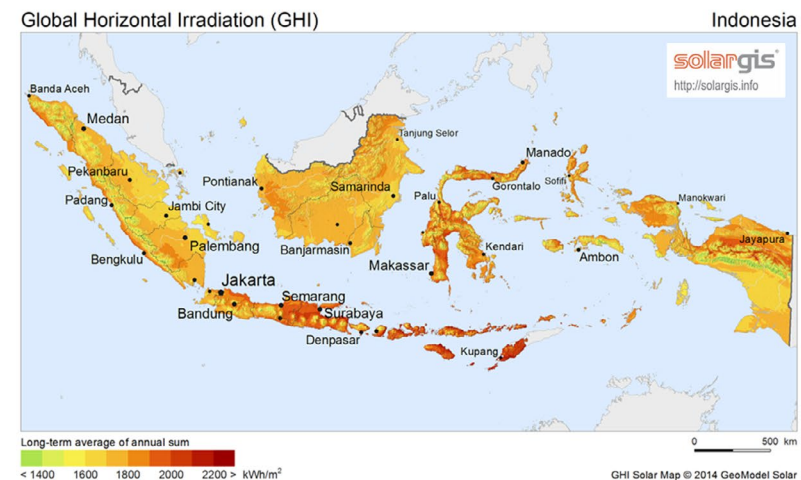
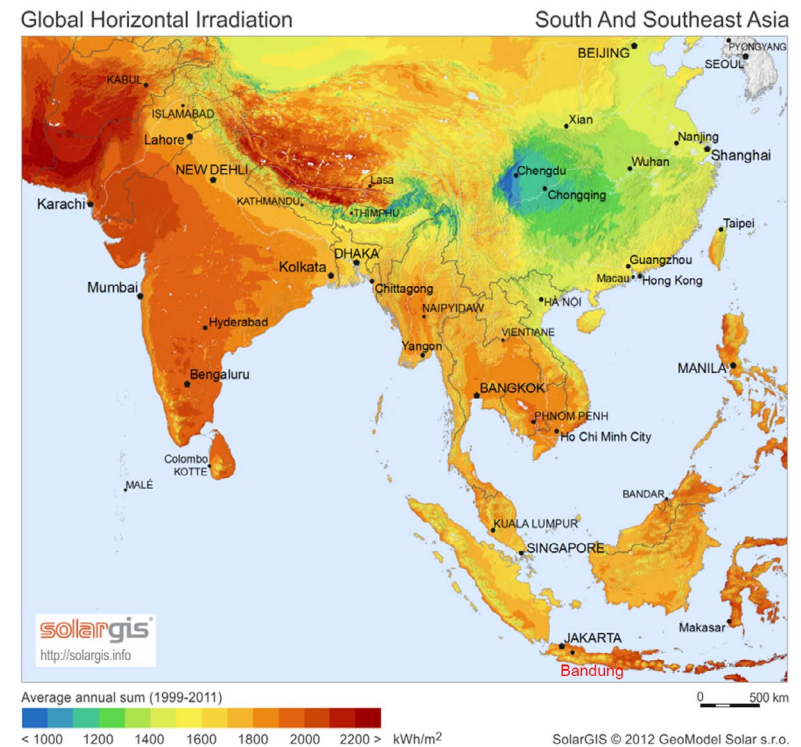

Figure 2.1 Global Horizontal Irradiation in Southeast Asia and Indonesia (Diagrams from solargis.com, 2014)

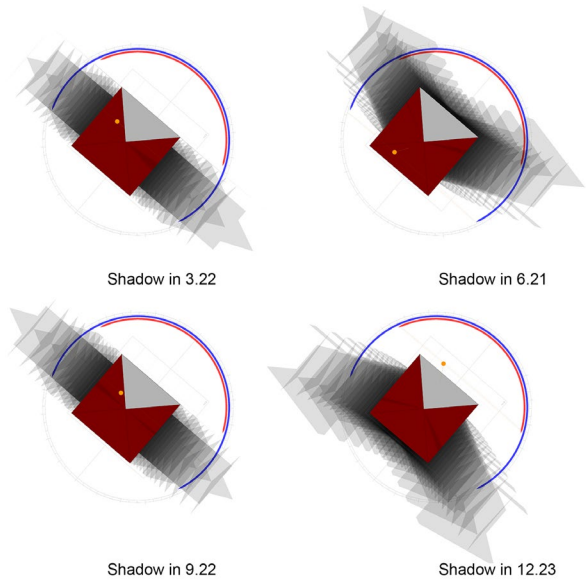

Figure 2.2 Shadow distribution in Singapore (own drawing, 2016)

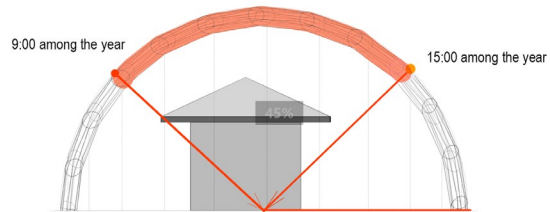

Figure 2.3 Time when the solar altitude is above 45° in Singapore (Own Drawing, 2016)

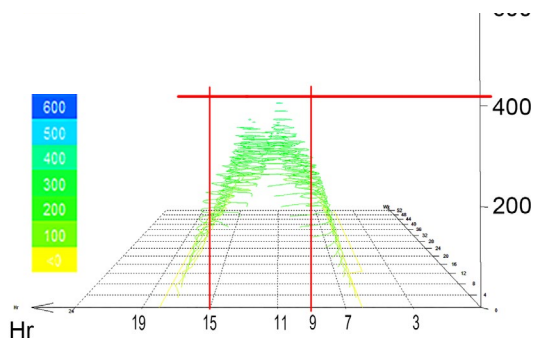

Figure 2.4 Daily Direct solar radiant distribution in Singapore (Own drawing, 2016)

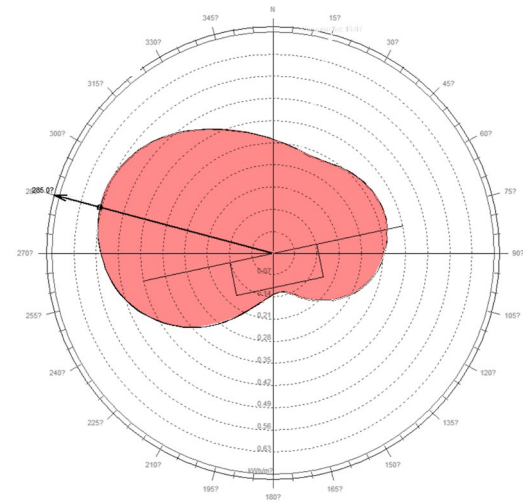

Figure 2.5 Solar radiant on facades in Bandung (Own drawing, 2016)

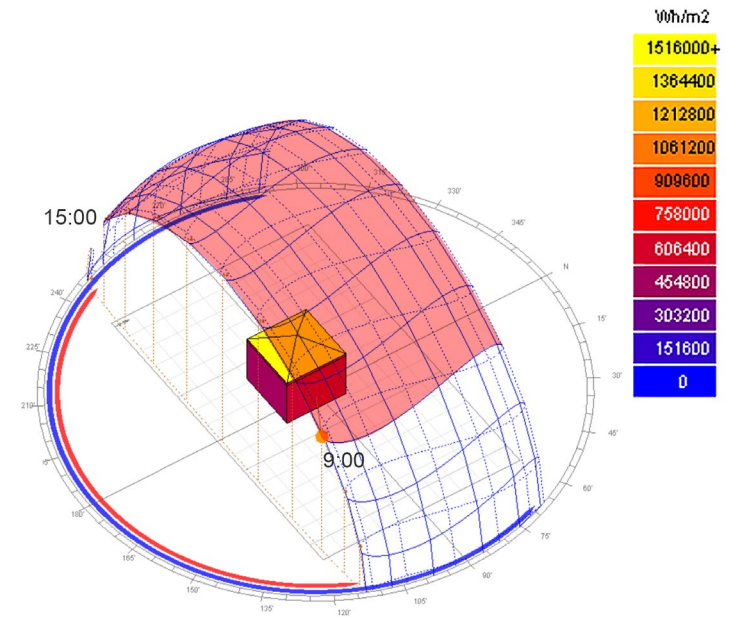

Figure 2.6 Total Annual radiation (Singapore)

Besides, because of the low latitude, the solar radiation mostly comes from above (Figure 2.3 and 2.4). Take another Southeast Asian city Singapore as example¹, According to the local Solar Path Diagram (Figure 2.3), the solar altitude will be higher than 45° from around 10 a.m. to 4 p.m. among all year. This period also has the strongest solar radiation intensity among the whole day, reaching over 400w/sq.m around noon (Figure 2.4). The strong radiation from above draws essential significance on roof insulation, since the heat gain of the roof sometime constitutes 70% of the total heat gain (Karam M. Al-Obaidin 2014). On the other hand, the sun-shading is also important on reducing the direct sunlight. According to figure 2.2, the shadow range in this area is relatively condensed around the contour of the roof, especially for the most sunny hours around 10 a.m. to 4 p.m, which indicates larger overhang of the roof or overhead shadings. Besides, the late afternoon sunshine is still strong, which will heat the west facade. Figure 2.5 shows the annually average daily solar radiant on facades located in Bandung, with the solar intensity data of Singapore.

2.2 Temperature, Humidity and precipitation

Table 2.7 contains the monthly temperature, relative humidity, precipitation and days of raining data in 2014 (Statistic Bandung, 2014, Husein Airport, 2014). Figure 2.8 shows the bar chart of maximum and minimum temperature and the line charts of the average temperature and RH on a monthly base. While Figure 2.9 illustrates the relationship between the precipitation and the days of rain.

The Bandung climate is usually divided into two seasons according to the precipitation: the dry season from March to October, and the rainy season from November to next February.

From table 2.7 and 2.8, one can see that the annual temperature range of Bandung is very small. The difference of monthly average temperature between the hottest month (October) and the coldest month (January)

¹ The location and solar radiation condition of Singapore and Bandung are very similar. Since the weather data file of Bandung is not available, the author use the data of Singapore for the solar analysis instead.

is less than 2°. The daily temperature range, on the other hand, is larger in the dry season with the difference around 10°, especially in August, September and October, while smaller in the rainy season (especially in January and February). The monthly average temperatures are always lower than 25° for the whole year, which is very mild compared to other southeast Asian cities like Singapore. This is because of the higher altitude and surrounding volcanic terrain as was mentioned in previous content.

As for the Relative Humidity, the relatively low RH appears in August, December and January. Comparing to Singapore, the monthly average RH in Bandung is lower especially in cold and dry months. Nevertheless, the lowest average RH in January in Bandung is still well above 75%.

In the following chapter, these climate conditions will be compared to the comfort zone, assessing the thermal comfort status of Bandung city.

2.3 Wind Direction and wind velocity

Figure 2.9 shows the monthly average wind speed in 2014. Figure 2.10 and 2.11 Show the Annual and monthly wind rose in 2016. While Figure 2.12 shows the 2016 annual wind direction distribution on four moments.

According to Figure 2.8 and 2.9, The prevalent wind direction in Bandung is West, on which direction there will be wind all year around. The secondary wind direction is East. The east wind also occurs all year round, but more evident in dry months (From May to August) than in Rainy seasons. While Figure 2.10 shows the difference of wind direction between day and night. Generally, it is more likely to have a west wind in the during the daytime: they are more frequently obtained on 12h and 18h, and the range of direction is relatively concentrated around the west direction; While during the night, more east winds evoke, with wider direction ranges: the 00h and 06h points are more disperse from the southeast to the northeast.

	Jan	Feb	Mar	Apr	May	Jun	Jul	2014 Aug	Sep	Oct	Nov	Dec	Annual
Minimum (C°)	20.2	20.2	20	20.4	20	19.9	19.3	18.8	18.3	19.5	19.9	20.7	19.80
Maximum (C°)	27	27.8	29	29.6	29.4	28.9	28.7	29	30.6	30.9	29.6	29.1	29.10
Average (C°)	22.5	22.9	23.3	23.7	23.5	23.5	23	23.1	23.7	24.2	23.6	23.7	23.40
Relative humidity (%)	76.3	79.5	82.7	87	85.8	81.7	82.4	79	81.9	85.7	87.8	78.2	82.35
Maximum RH(%)*	89	88	92	93	92	89.5	93	90	89	93	94	88.5	90.92
Minimum RH(%)*	64	67	73	80.5	80	75	67	65	74	73	82	65	72.13
Precipitation (mm)	309	88.9	418.7	217.6	177	196	181	119.8	0.6	65	296.5	316.4	198.80
Days of Raining (Days)	27	17	25	22	23	20	15	12	3	11	26	25	18.80
Wind Speed (Km/h)	9.99	12.23	9.27	6.77	6.28	8.12	6.97	7.02	7.59	5.31	5.66	11.03	8.02

* The maximum and minimum RH should be the Average RH in the morning and in the afternoon respectively. But since the hourly data is unavailable, the author take the r

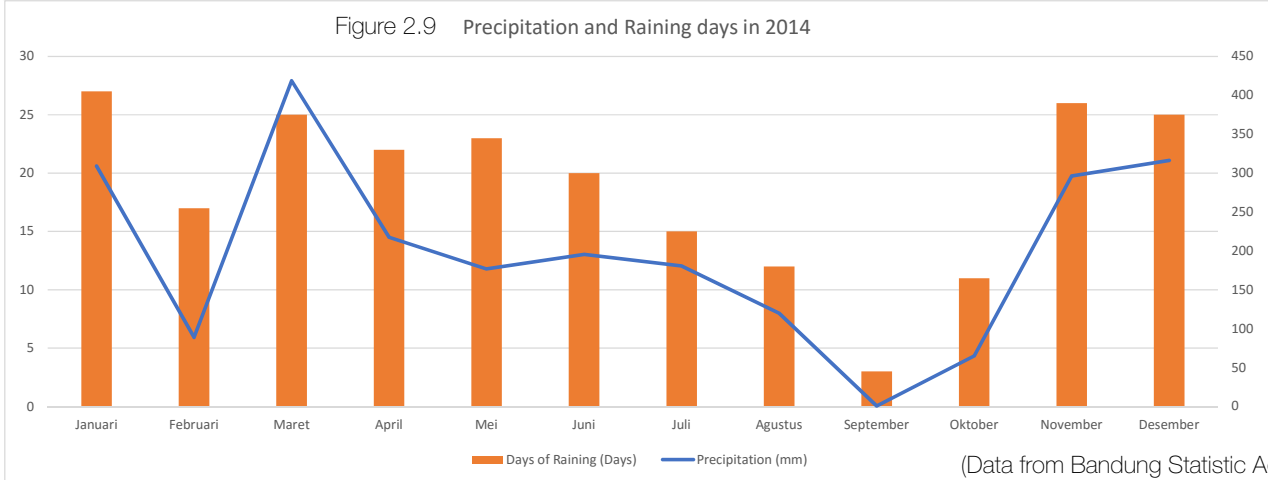
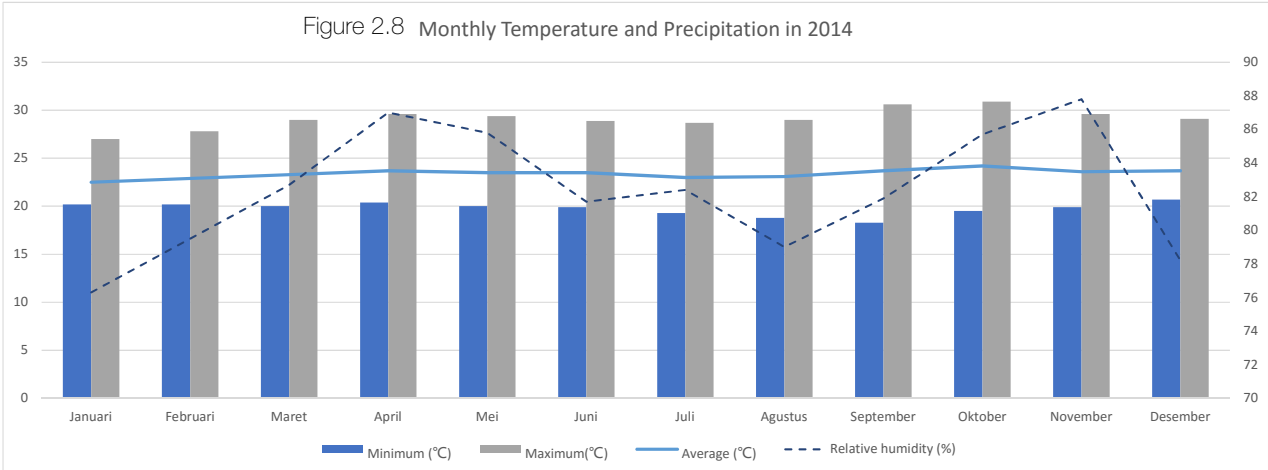

(Data from Bandung Statistic Agency and Weatheronline.com, 2014)

The monthly average wind speed, showed in figure 2.7, ranges from 5.31km/h in October to 12.23km/h in February. Considering the temperature and RH data in Figure 2.5, one could find that some months have very harsh climate with high temperature, high humidity and relatively low wind speed, which will be difficult to remove the extra heat and humidity by ventilation and evaporation (Szokolay 2004).

2.4 The Standard Effective Temperature and Thermal Comfort Zone

The thermal comfort zone is the condition of mind that expresses people's satisfaction with the thermal environment and is assessed by subjective evaluation (ASHRAE 2013), which generally shows the acceptable comfort conditions. Throughout years, different kinds of comfort index² have been created by researchers to take environmental variables such as temperatures, humidity, and wind velocity into consideration on defining thermal comfort (Szokolay 2004).

Standard Effective Temperature

The latest and most widely accepted comfort index is the New effective temperature (ET*)(Gagge 1971), and its standardized version, the SET (Standard Effective Temperature)(Gagge A.P. 1986). ASHRAE 55-2010³ defines SET as:

"the temperature of an imaginary environment at 50% relative humidity, <0.1 m/s average air speed, and mean radiant temperature equal to average air temperature, in which total heat loss from the skin of an imaginary occupant with an activity level of 1.0 met and a clothing level of 0.6 clo is the same as that from a person in the actual environment,

² For example, Houghten and Yagloglou devised the Effective temperature (ET) scale, recognizing the effect of humidity on thermal sensation. (Yagloglou 1923); While Olgyay developed his 'biomatic chart', which shows the comfort zone on a DBT-RH chart, affected by air movement and sun radiation. (V.Olgyay 1962)

³ ASHRAE 55-2010: Thermal Environmental Conditions standard for Human Occupancy, American Society of Heating, Refrigerating and Air-Conditioning Engineers, 2014

with actual clothing and activity level." (ASHRAE 2013).

In author's comprehension, SET is a thermal condition influenced by the different combination of DBT (Dry Bulb Temperature³) and RH (Relative Humidity⁴) in a standard circumstance (1.0 met, 0.6 clo and <1.0m/s air speed). Under this thermal condition, people have the same physiological and psychological feeling as that in the certain temperature on 50%RH.

The SET scale is constructed on the psychrometric chart, tracing the effectively equal temperature of a certain temperature at 50%RH under the certain metabolic rate (met) and clothing insulation (clo). The result is a set of 'SET isotherms', which show sloping lines with gradually increasing gradient from low DBT to high DBT. These lines coincide with the certain DBT on 50%RH curve. The slope shows the influence of RH on the SET: for the same SET, higher DBT can be compensated by lower RH, while as the SET raise up, the influence of RH is increasing.

Thermal Comfort Zone of Bandung Under SET Index

The thermal comfort zone of a certain region can thus be defined as a domain on the psychrometric chart, edged by the highest (T_{high}) and lowest (T_{low}) tolerable SET as well as the AH (absolute humidity⁵) fixed at 12g/kg and 4g/kg (Szokolay 2004).

To find the comfort zone in a certain period (often the hottest and coldest season), The following equation are needed.

$$T_n = 17.6 + 0.31 \times T_{o.av} \quad (\text{Formula 1.1})$$

$$T_{high} = T_n + 2.5 \quad (\text{Formula 1.2})$$

$$T_{low} = T_n - 2.5 \quad (\text{Formula 1.3})$$

(Szokolay 2004)

³ Dry Bulb Temperature (DBT) is the temperature of air measured by a thermometer freely exposed to the air but shielded from radiation and moisture. DBT is the temperature that is usually thought of as air temperature, and it is the true thermodynamic temperature.

⁴ Relative Humidity (RH) is the amount of water vapour present in air expressed as a percentage of the amount needed for saturation at the same temperature.

⁵ Absolute humidity is the measure of water vapor (moisture) in the air, regardless of temperature. It is expressed as grams of moisture per cubic meter of air (g/m³).

Figure 2.11
Annual Wind Direction Histogram and Wind Rose Dec 30 2015 - Dec 28 2016

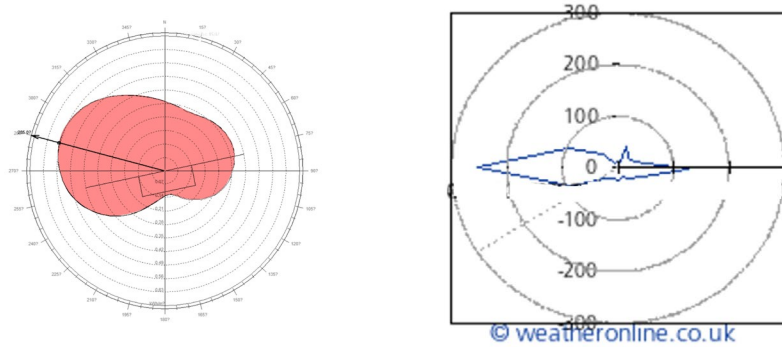
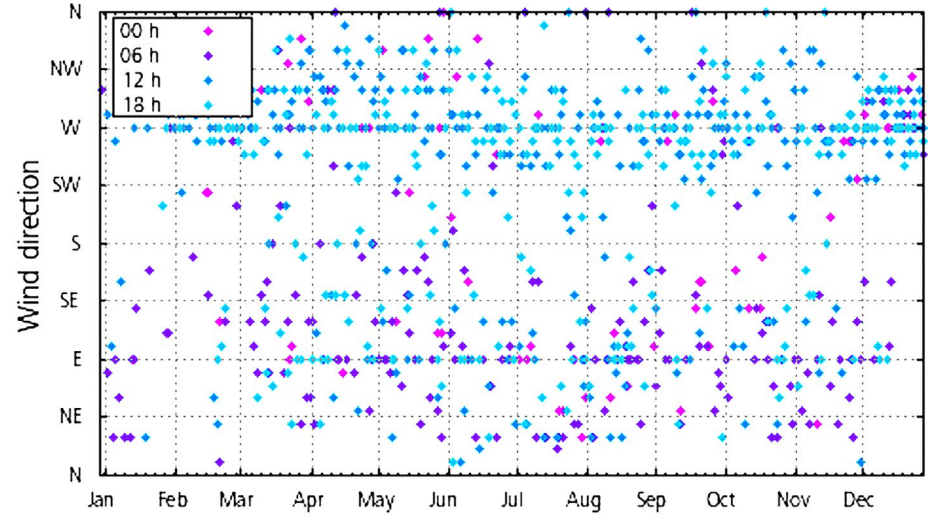
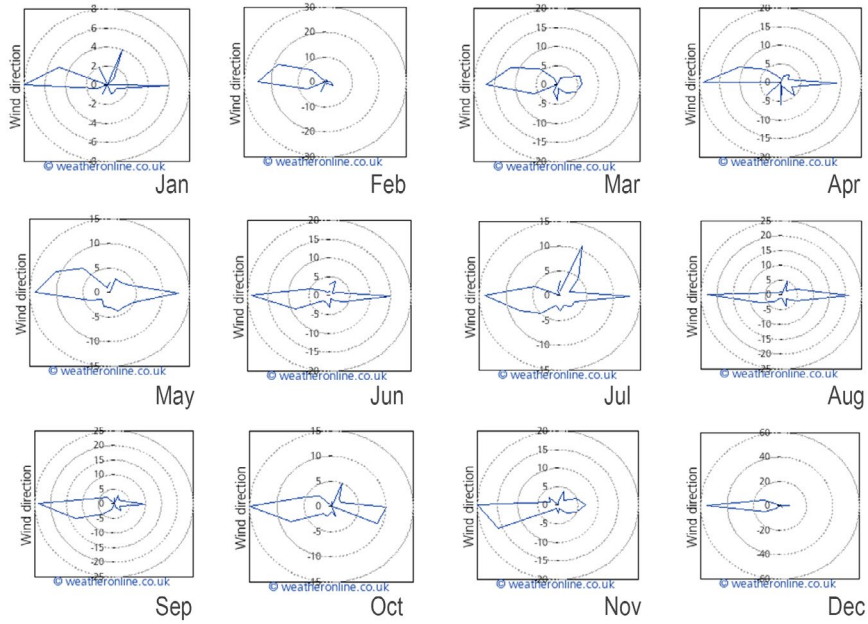

Figure 2.13 Annual Wind Direction Distribution Dec 30 2015 - Dec 28 2016



(Data from Weatheronline.com, 2014)

Figure 2.12 Monthly Wind Rose Dec 30 2015 - Dec 28 2016



(Weatheronline.com, 2014)

Figure 2.10 Temperature and Wind Speed

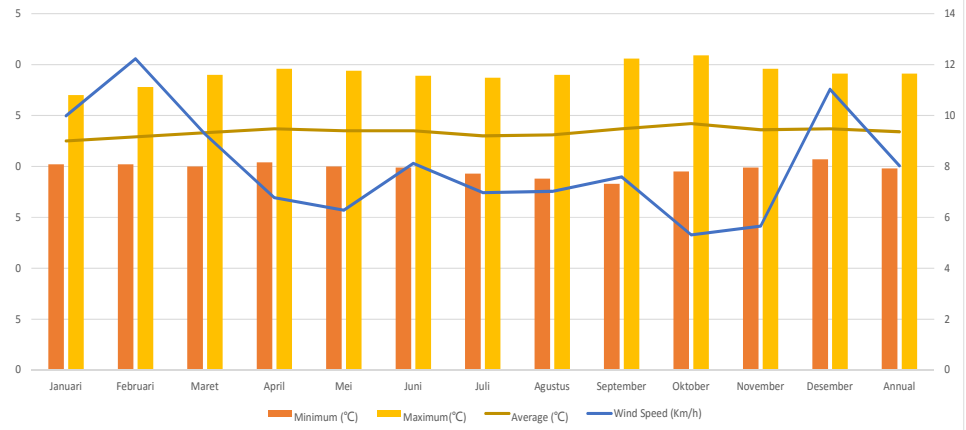

(Data from Weatheronline.com, 2014)

Where:

T_n stands for thermal neutrality temperature

$T_{o.av}$ is the mean temperature of this period.

T_{high} and T_{low} are the highest and lowest tolerable SET in the certain period.

The steps of defining the comfort zone, according to Szokolay's book, are as follow:

- Calculate T_{high} and T_{low} for the certain period of time, and mark them on the RH 50% curve of the psychrometric chart.
- Tracing the corresponding SET isotherms of these two value, defining the boundaries of SET.
- Draw the boundaries of AH on 12g/kg and 4g/kg.

As for Bandung, since the annual difference of air temperature and humidity is very small (See Figure 2.8), The author draws the all year comfort zone based on the climate data of 2014. Here the annual mean temperature $T_{o.av} = 23.4$; $T_n = (17.6 + 0.31 \times 23.4) = 24.85$; $T_{high} = (T_n + 2.5) = 27.35$; $T_{low} = (T_n - 2.5) = 22.35$. The annual Comfort zone is as figure 2.17

Evaluation of Bandung Climate

In order to find appropriate passive strategies, the first essential task is to examine the given local climate. One measure given by Szokolay is to draw the monthly range lines and check the distance of these lines with the given comfort zone: Firstly, mark on the chart two points for each of the 12 month, one using the mean maximum temperature with the afternoon RH and on using the mean minimum temperature with the morning RH; Then connect the two points by a line; The 12 lines thus would indicate the median zone of climatic conditions. And the relationship of these lines to the comfort zone indicates the nature of the climatic problem. (Szokolay 2004)

The monthly range lines of Bandung are shown on the figure 2.17 ,based on the data from Table 2.7. All the lines are well above the

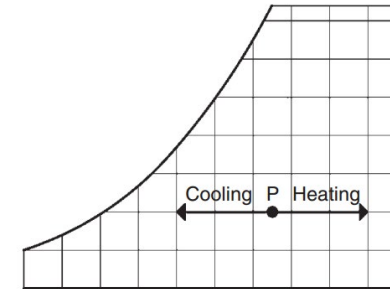

Figure 2.14 Evapourative cooling

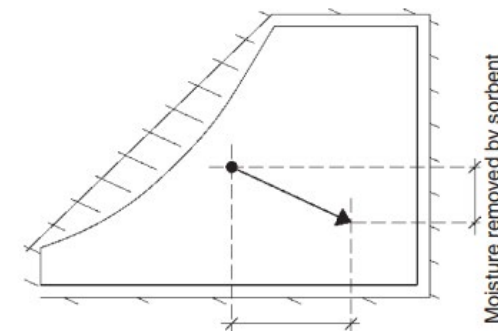

Figure 2.15 Adiabatic Dehumidization
(Figure 2.14 and 2.15 From Szokolay)

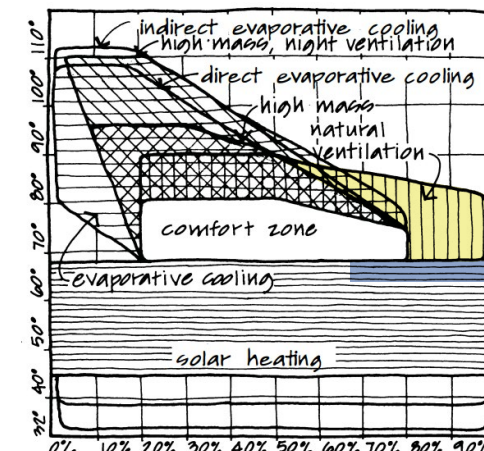
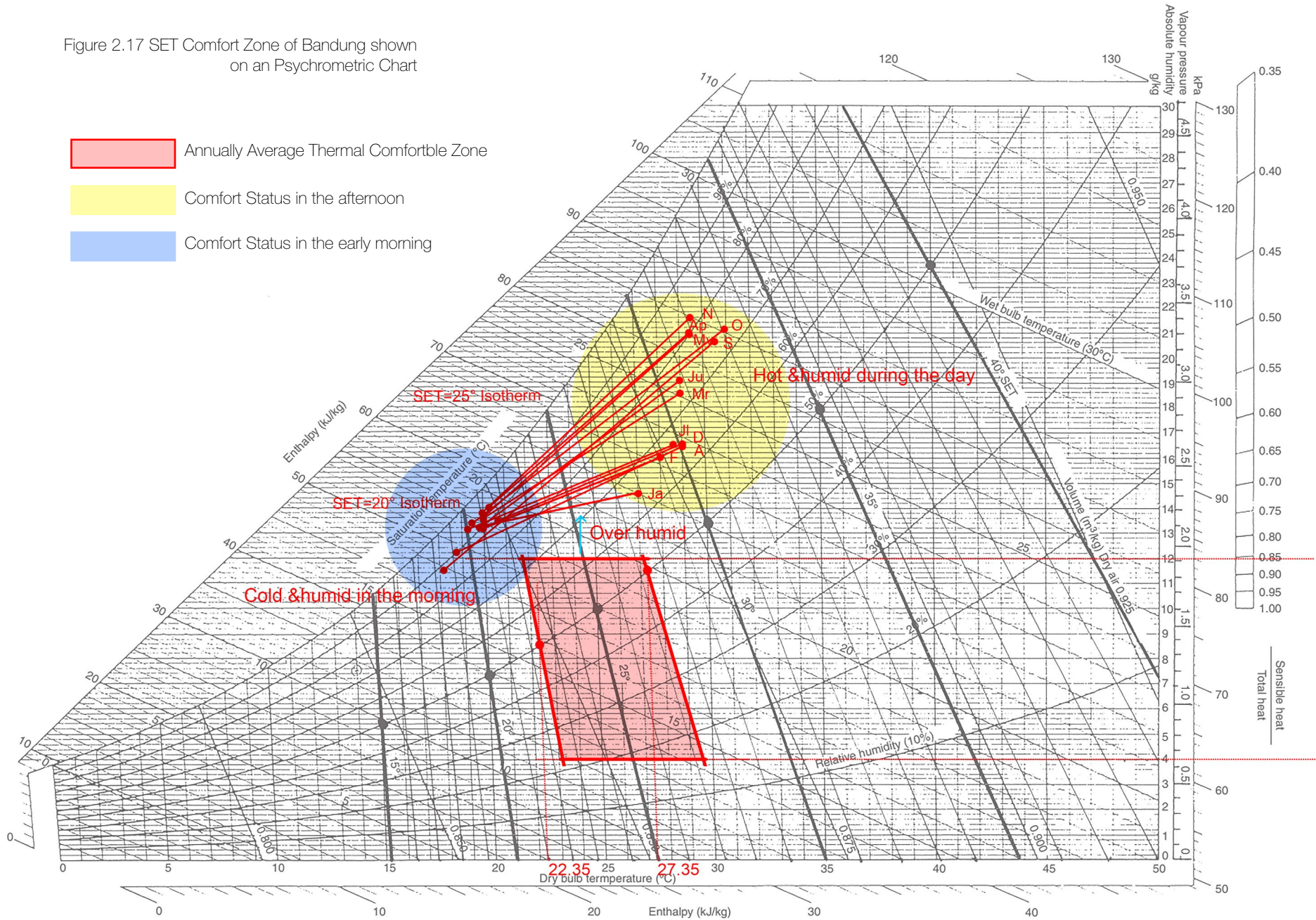

Figure 2.16 Bioclimatic Chart-Design Strategy Zones
(McKay, 2014)

Figure 2.17 SET Comfort Zone of Bandung shown on an Psychrometric Chart



climate zone, indicating that even though Bandung have moderate temperature, the high humidity is bothering all year around. On Figure 2.17, the comfort status is in the blue circle in the morning while in the yellow circle in the afternoon. Generally, the weather will be a little bit cold and humid in the morning, while hot and humid during the day. This result is confirmed by the interviews of Pak Sanye and Pak Dudun in their house, since they all vote “humid” and “cold” in the questionnaire for their morning feeling (Sanye, 2016, Dudun, 2016).

2.5 Conclusion

According to the comfortable zone analysis above, the main task of the passive design in Bandung is dealing with the high humidity. Seen on the psychrometric chart, the current range lines should move towards the bottom right in the morning while moves towards the bottom left during the day, as was shown in Figure 2.17.

While the rightward or leftward moving can be solved by heating and cooling (Seen figure 2.10), the downward moving, which means removing the moisture content in the air, cannot easily be done by passive strategies. In an adiabatic environment (Figure 2.13), if the humidity is removed by chemical sorbents, the process will release heat, causing the rise of the temperature (Szokolay 2004), which is not desirable in an already-hot room.

The indirect way of dealing with humidity is ventilation. When the outdoor air is drier than the indoor condition, ventilation will help replace the humid indoor air by arid fresh air (F.J. Baptista 1999, Szokolay 2004); What's more, air movement with appropriate velocity increases people's satisfaction on thermal condition, thus extend the comfortable zone, making the high humidity tolerable. V.Olgyay indicates this relationship between the air movement and comfortable zone by his bioclimatic charts, While McKay has developed it into “design strategy zones” as Figure 2.14. Research shows that a room with 30 degrees and the air movement velocity of 3m/s gives people the same satisfaction as the room with 22 degrees and 0 air movement (Murali, 2013). Last but

not least, ventilation helps keeping a healthy air quality by replacing the indoor-generated pollutant from the indoor air with the fresh air (Olli A. Seppänen 8.2004), which is crucial in not only domestic dwellings (A. M. FLETCHER 1996, Windisch 2008), but also industrial and industrial facilities like hens-lying buildings(Gustafsson 2005) and factory buildings(Tammy Lundstrom 2002).

Besides, since the requirement of the temperature is different in the morning and during the day, the solar strategy should also be flexible. In the morning, the rooms should have access to the direct sunlight so that it could help heating the indoor climate and reducing the Relative humidity; while during the daytime when the solar radiation is strong, the rooms need well sun shading and insulation from the direct sunshine.

In conclusion, the passive strategies are mainly focusing on **passive cooling**, while the sun shading strategy in the morning should be flexible for direct sunlight.

Chapter 3 Passive Cooling bundles for the neighborhoods and for the building

The last chapter made the conclusion that the passive cooling is needed in the context. Among all the cooling strategies in hot-humid climate area, ventilation and sun-shading are of crucial significant: Sun-shading minimized the solar gain during the daytime, thus drastically reduce the cooling loads; while since evaporative cooling is not working when the moisture content in the air is already high⁶, the ventilation is the primary effective cooling approach in humid areas (Mark DeKay 2014).

In their book **Sun, Wind & Light: Architectural Design Strategies**, M. DeKay and G. Brown offered a sort of passive cooling strategies that related to passive ventilation and sun-shading, which are on both neighbor scale and building scale.

3.1 In Neighborhood Scale

For the whole neighborhood in a hot-humid area, the key point is to hit the balance for cooling and daylighting. Therefore, the key point is the orientation, the layout, and the combination of the streets and the buildings, since they will affect the sun shading, solar gain, wind speeds, and daylight access (Mark DeKay 2014).

3.1.1 Orientation of Streets and the Buildings



The orientation is a balanced result considering prevailing wind direction and the solar radiant. The influence of prevailing wind direction on orientation is rather flexible because the research had proved that “variations in orientation up to 40 degree from perpendicular to prevailing wind do not significantly reduce ventilation” (B. Givoni 1976). Considering the prevailing wind and the secondary wind in Bandung are oppositely from west and east, the acceptable orientation for wind lanes can vary from northwest 40 degrees to southwest 40 degrees (See Figure 3.1).

Considering about the solar radiant, however, the optimal direction is totally different, facing around 78 degrees south by east; while the ⁶ Evaporation of the water will take away the heat from nearby. Nevertheless, the high relative humidity will hamper the evaporation effect (Szokolay 2014). Besides, evaporation will increase the humidity, which will make the situation even worse (M. DeKay 2014).

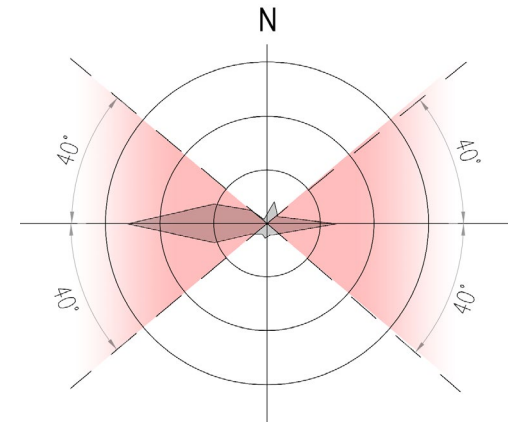

Figure 3.1 Optimal wind orientation (Own drawing, 2016)

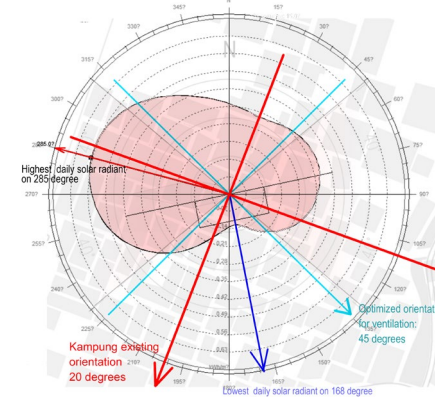

Figure 3.2 Optimum Orientation based on average daily incident radiation (own drawing, 2016)

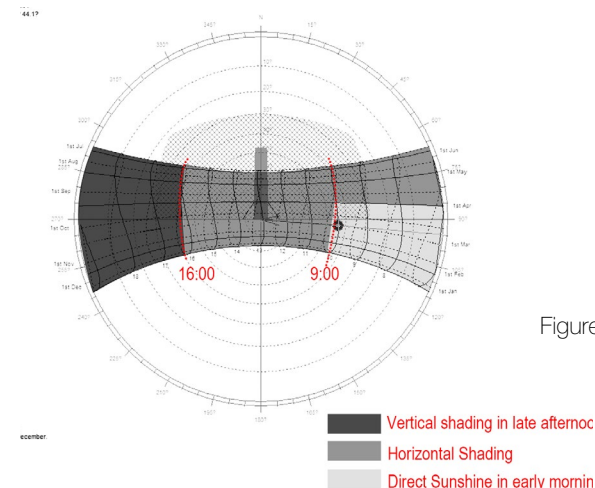

Figure 3.3 Shading demands (Own Drawing, 2016)

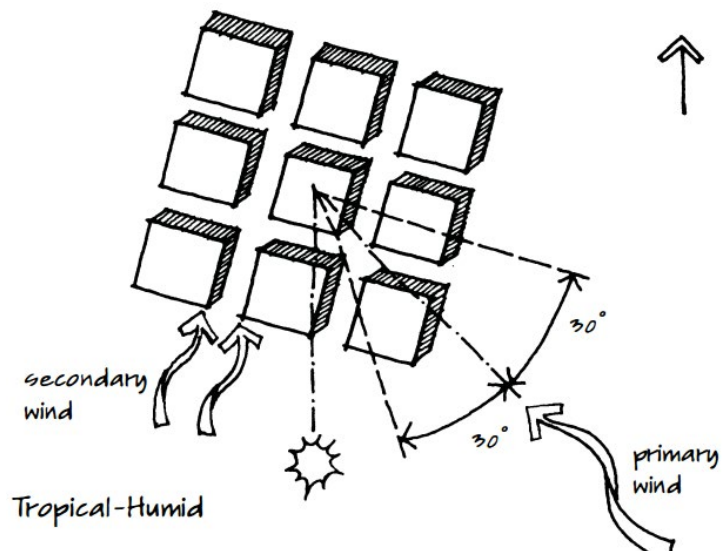

Figure 3.4 DeKay's advise on chosing orientation (Mark DeKay 2014)

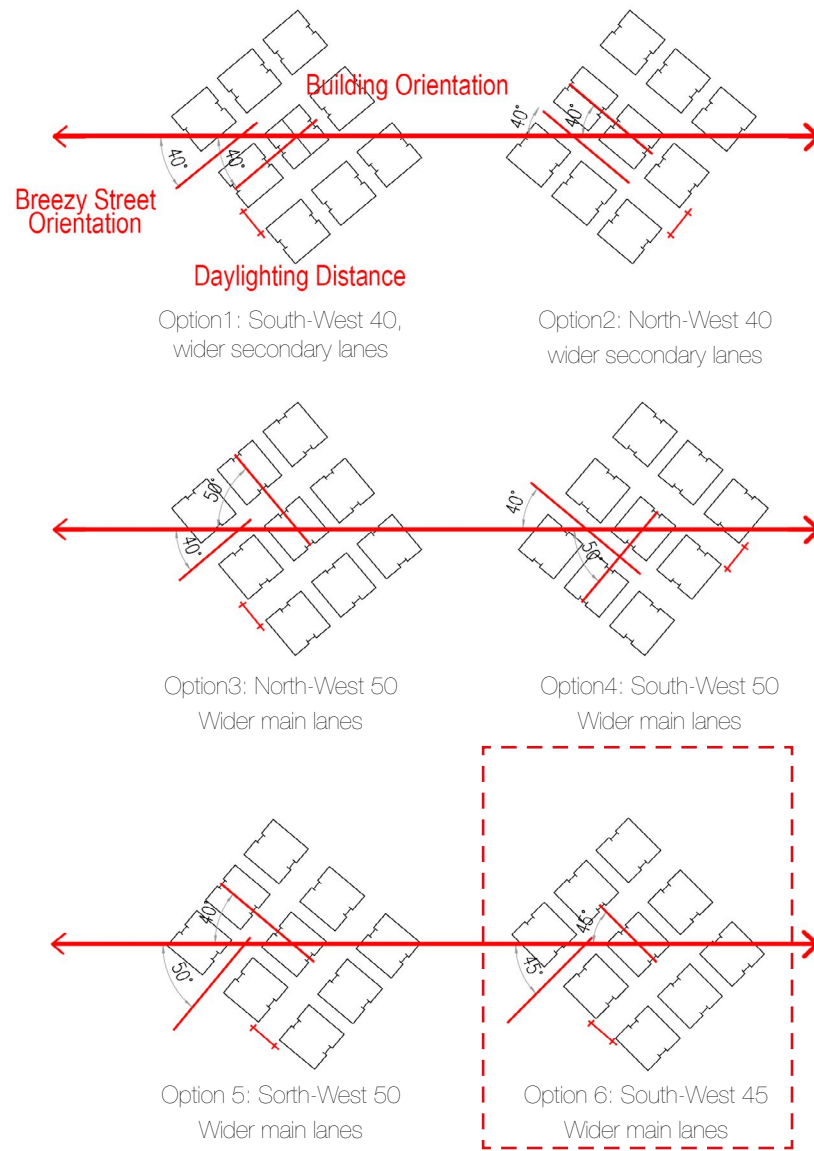

Figure 3.5 Optimal Orientation Considering the prevalent wind direction (Own drawing, 2016)

optimum orientation for ventilation will suffer a lot from the solar radiant in the west (Figure 3.2). In single floor neighbors, the solar radiant can be shaded by shared shading with other buildings, thus the main concern about orientation is wind direction. But when it comes to multi-floor buildings, the upper facades will be severely heated by the sunshine, making the compensation between the two factors more difficult.

The orientation of the building is also crucial for its ventilation and sun shading. To create more drastic wind pressure difference between the wind inlets and outlets, the building air inlets should face towards the prevailing winds and be aware of secondary wind directions, While the air outlets should face away from the prevailing wind (See Figure 3.3).

The optimized orientation for single floor context is shown in figure 3.4. While in Figure 3.5, different situations are listed with different main facade orientation and lane width. Considering the demand of the nature wind for both lanes and buildings, the orientation is set to 45 degrees. The opposite opening is on NW and SE walls respectively, while the late afternoon sunshine is prevented by shared shadings.

3.1.2 Breezy Streets & Building Distance



Breezy Streets serve as wind channels in the neighborhoods to promote air movement. This is important to cool the spaces between buildings and to provide air to buildings for natural ventilation. To achieve the breezy streets, two main factors crucial: Firstly, as was discussed in 2.1.1, the orientation should be alliance with the prevailing wind; Secondly, The layout of buildings should be dispersed, which not only preserve each building's access to breezes but also improve the wind velocity inside the streets (Mark DeKay 2014).

One can tell whether a slice of urban tissue is dispersed or over-dense by checking the Height and Weight ratio (H/W)⁷. Generally, larger H/W, which means higher urban density, creates more shade, cooler daytime street temperatures, less solar gain, lower wind speeds, less daylight

⁷ H/W is the Height to Width ratio of the lane.

access, greater increases in the night time urban heat island, and less night sky cooling. A smaller H/W ratio, which means lower urban density, will have the opposite characteristics (Mark DeKay 2014, pp.119).



3.1.3 Overhead Shadings and Shared Shadings

Overhead shades is a particularly important strategy for shading of pedestrian, of smaller open spaces and of buildings where the height to width ratio admits significant sun, such as the south facade (Mark DeKay 2014, pp 143). Particularly in Cigondewah, overhead shadings are created by the eaves and their extensions, by pergolas, and by the trees. The overhead shadings get rid of direct sunshine from above, creating semi-outdoor space underneath where many public activities happen.

Shared shadings mean buildings being arranged to shade each other and adjacent exterior spaces (Mark DeKay 2014). Since the height to width ratio of lanes in urban kampung is often very high, the shared shading is quite effective, preventing buildings from low altitude solar radiation.

Since the direct sunlight is unwanted during the daytime because of the demands of reducing the solar gain, and since the solar altitude is so high during the day that the overhead shadings are effectively covering the openings (see Figure 3.2), the main taboo of the building opening direction is the large openings on the west. The shading demands on different periods are shown in Figure 3.3.

Besides, as was concluded in 2.5, since the direct sunlight in the morning is welcomed, the building could consider having openings facing to the east and with more flexible sun-shadings that could let in the morning sunshine. The sizing of these shadings are shown in 2.2.6.



3.1.4 Breezy and Shady Courtyards

The courtyards provide outdoor space within a group of building that act as not only provide public space but also micro-climate zone. In hot

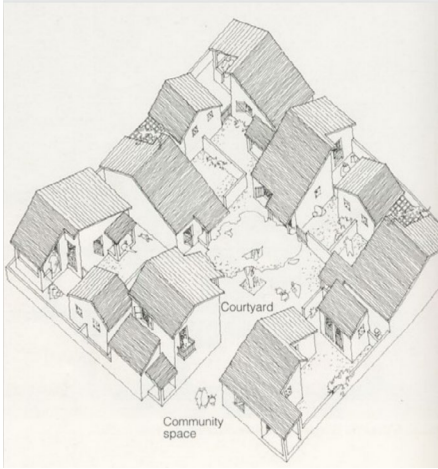

Figure 3.6 Breezy and shady courtyard of incremental housing units in Belapur, India (Chales Correa, 1985)

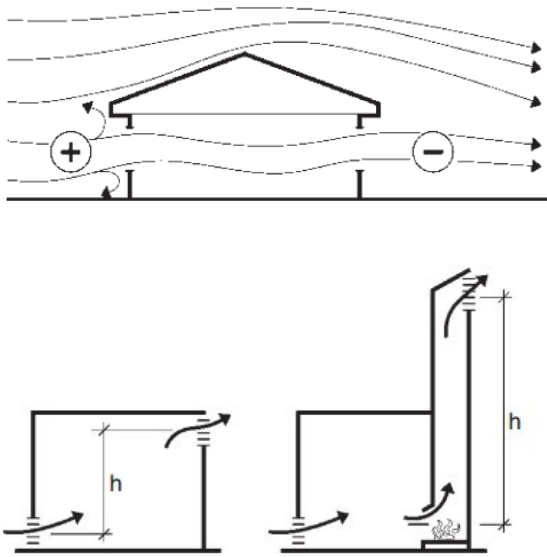
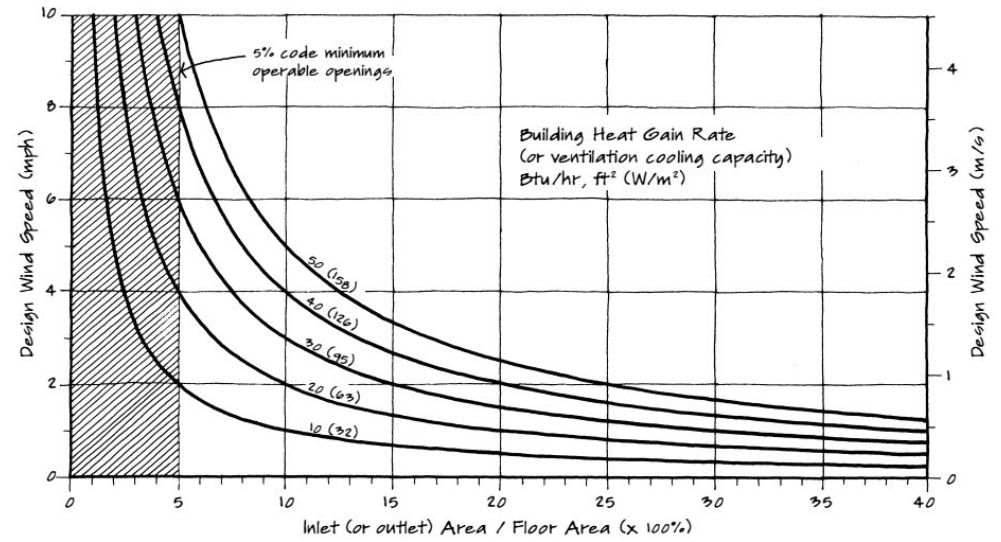

Figure 3.7 Wind effect and Stack effect (Szokolay, 2014)



Sizing Openings for Cross-Ventilation

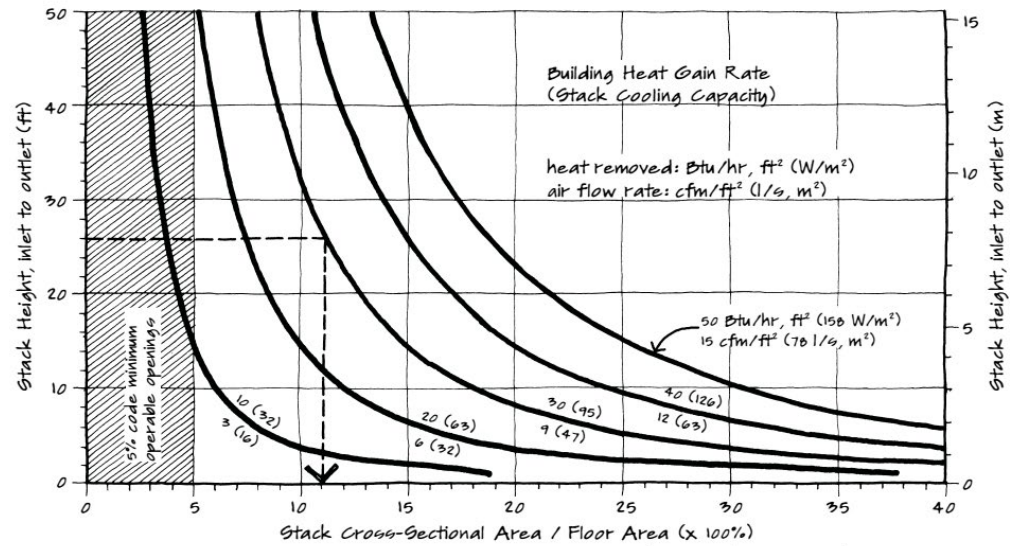

Figure 3.8 Opening size and the effect of Cross Ventilation and Stack ventilation (Mark DeKay 2014)

humid areas, the courtyard should be both breezy and shady. On one hand, the ventilation requires low, wide and permeable. On the other hand, to block the solar radiant, the shady courtyard should be narrower , which contradicts with the ventilation requirement. In general, wider courts that admit the wind, coupled with arcades and layers of shades is optimal in hot-humid climates (Mark DeKay 2014).

In most cases, plants have a notable effect on cooling the surrounding because of the evapotranspiration effect they have and the shading they create. However, the use of plants in high-density hot-humid areas should be carefully designed. Because on one hand, the evapotranspiration effect will increase moisture content in the air; On the other hand, trees and bushes would hamper the air movement.

3.2 The Building Scale

After addressing the neighborhood scale, the building scale will be examined. Passive cooling buildings in hot-humid areas also mainly rely on passive ventilation and sun shading. To improve indoor ventilation, one could develop cross-ventilation and stack ventilation, making full use of nature winds. As for sun shading, it is crucial to prevent the building from the solar radiation from above the head around the noon, and from the west in the late afternoon (see Figure 2.6). Besides, to take full advantage of the outdoor climate, one could also locate some rooms outdoor.

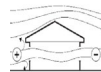

3.2.1 Cross ventilation: the wind drove ventilation

Cross ventilation is the most effective passive ventilation strategy. It is driven by the natural winds that create the wind pressure difference between the windward and the leeward sides of the building, as is shown in figure 3.2 (Szokolay 2004). The efficiency of cross ventilation is related with: a) the areas of the inlets and outlets; b)the wind speed outside; c)the wind direction related to the openings; d) having a relatively unobstructed pathway for the air flow in the room(Mark DeKay 2014, pp. 236).

window height as a fraction of wall height	1/3	1/3	1/3
window width as a fraction of wall width	1/3	2/3	3/3
single opening	12–14%	13–17%	16–23%
two openings in the same wall	—	22%	23%
two openings in adjacent walls	37–45%	37–45%	40–51%
two openings in opposite walls	35–42%	37–51%	47–65%

Figure 3.9 Opening size and the effect of Stack ventilation (Mark DeKay 2014)

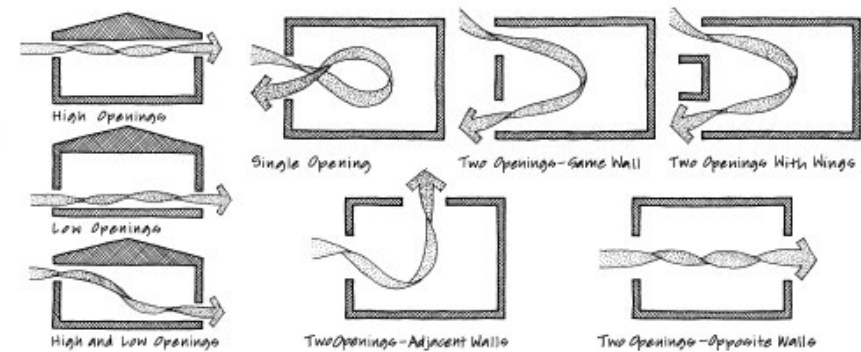

Figure 3.10 Different opening types (Mark DeKay 2014)

The challenge of this strategy is that it only works in presence of winds, and its effect relies on the strength of the wind (Szokolay 2004). This means when there are high humidity, high temperature and low wind velocity, for example in Bandung's October, a more reliable supplement ventilation strategy is needed.



3.2.2 Ventilation Openings Size and Arrangement

The size of air inlets and outlets influenced the effect of both cross ventilation and stack ventilation. As is shown on Figure 3.7, generally the larger the openings are, the better the ventilation is.

Opening arrangement also plays a crucial role in increasing the cross-ventilation in the room. In his research, Melaragno found 3 factors of openings arrangement that influences the air movement significantly. Firstly, the larger the area of wind inlet and outlet are, the larger air movement there will be. Secondly, the position of windows on different walls will significantly affect the ventilation. The rooms that have the openings in one wall gain the air movement with the no more than 23% of the outdoor wind velocity, which will only locate near the windows; The rooms having air inlets and outlets on opposite walls see largest indoor wind velocity, which can reach 65% of the outdoor wind velocity; While openings on adjacent walls encourage both turbulence and air mixing (Figure 3.10), and thus more even wind velocity distribution. Thirdly, the height of windows on the wall decided whether the max wind velocity would appear in people occupied zone, which is usually 0.3 -1.8m above the floor. (Melaragno 1982)

3.2.3 Stack Ventilation



Stack effect occurs when the air inside a vertical stack is warmer than the outside air, or when there is a significant height difference between the low level inlet and high level outlet (Szokolay 2004). The principle of stack ventilation is similar with cross ventilation: it engenders air moving by creating wind pressure difference between the outlets and inlets, which is caused by the difference of either air temperature or wind

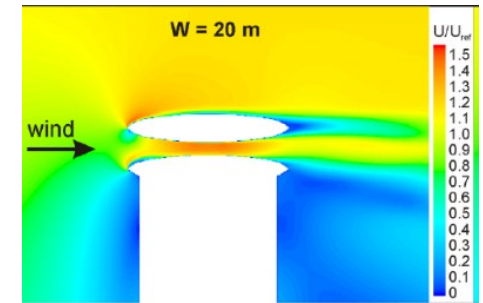

Figure 2.11 Venturi-shaped Roof (Twan van Hooff, 2012)

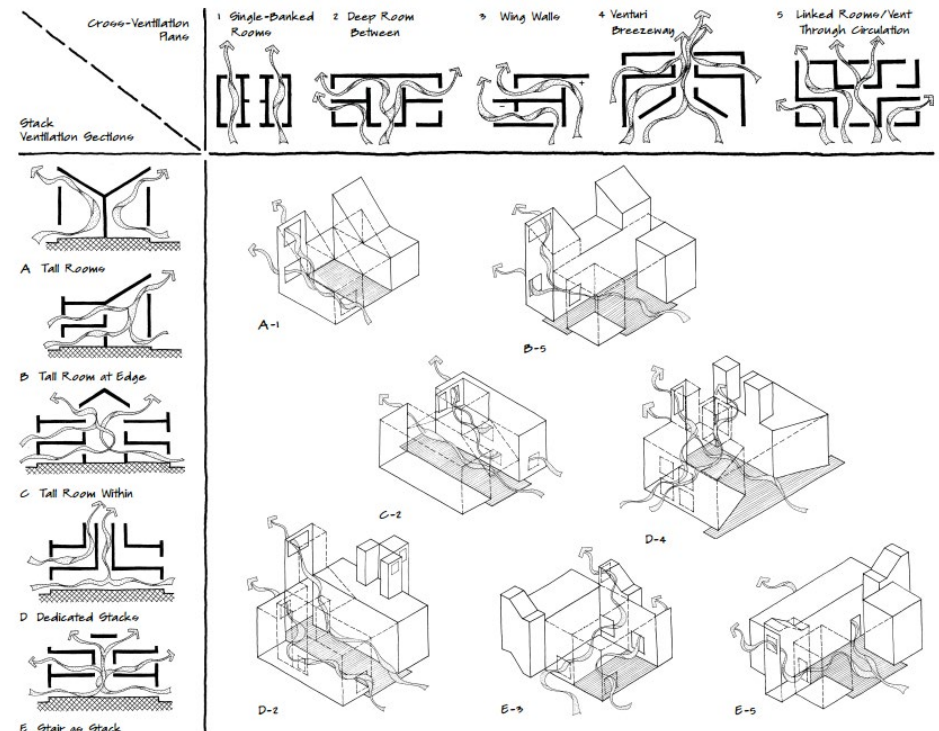

Figure 3.12 Combination of cross ventilation and stack ventilation (Mark DeKay 2014)

speed between the low level and high level.(Jae-Hun Joa 2007) Stack ventilation is more reliable than cross ventilation because it doesn't need wind to create air moving inside. (Mark DeKay 2014)

To enhance the stack ventilation effect, it is crucial to enlarge the pressure difference between the inlets and the outlets. One prevalent strategy is the **solar chimney**, which exposes the upper side of the stack to the solar radiation to heat the air inside, increasing the temperature difference between the bottom and the top (N.K. Bansal, 1993). Another method is the utilize of **Venturi effect** on roofs. Venturi effect is a vacuum effect happens when the air movement on one side of the object is faster than it on another side, which creates a pressure difference between them(T. van Hooffa 2011). The venturi-shape roof allows the wind to partially enter the top of the building to create a vacuum effect which pulls the hot stale air with more effectiveness (communities 2012). See Figure 3.11.



3.2.4 Permeable Buildings Combining Stack and Cross Ventilation

Both cross ventilation and stack ventilation holds their pros and cons. The cross ventilation is generally stronger, while stack ventilation is more reliable. The ideal solution is to combine two strategies together. Combined strategies may also be employed for different rooms in the same building (Figure 3.12). For example, cross ventilation might be used in windward side and upper-level rooms, while stack-ventilation might be used in lee side and lower rooms that have less access to wind (Mark DeKay 2014).

The good examples of combining stack ventilation and cross ventilation have already existed in traditional southeast Asian dwellings. Take Traditional Malay house as the example. On one hand, its facade and interior is optimized for cross ventilation: Its opening rate can reach 50-80% of the facade area, and its partition walls inside are minimized; On the other hand, it utilized stack ventilation by making the roof high and permeable: the air outlets are set between the different parts of roof, so that these outlets can create stack ventilation with lower inlets (Yuan

1991) (Figure 3.15).



3.2.5 Rooms locating outdoors

Instead of taking the nature air into the buildings, one could also locate rooms outdoor, which expand the living space accessing to nature (Mark DeKay 2014). This strategy is often used in the hot-humid area like Bandung city, combining with sun shading strategies creating semi-outdoor living space. For the outdoor climate in many cases is already with mild temperature and breezy winds (see 2.2 and 2.3).



3.2.6 Shading and insulation for solar radiant

In Bandung, the sun is high enough in the sky for the most scorching period of the day that a horizontal structure of overhead elements is effective on shading outdoor spaces, or entire buildings. Therefore, the shading strategy for the building is mainly focusing on overhead shadings just as for neighborhoods, which is often achieved by the large overhang of roofs (Mark DeKay 2014). Moreover, the roofs are also important insulation elements against the huge solar radiation from above (Mark DeKay 2014). In traditional Indonesian and Malay houses, these two main concerns are apparent in the roof typology (Figure 3.15). On one hand, the roofs have large eaves that cover not only all the openings on the facade but also large spaces around the building, creating a layer of outdoor space; On the other hand, the roofs are often made of thick low thermal capacity materials such as thatches, which give the building good insulation against solar radiation (Yuan 1991). To achieve effective overhead shading, the size of the overhangs should be large enough.

On the other hand, Since the solar radiant in the late afternoon is also strong, vertical shadings are also needed. In the high-density situations like urban kampungs, the vertical shadings are often achieved by **Shared Shading**, which means the building volumes shades each other (Mark DeKay 2014). To achieve the shared shading, the north-south lanes should have limited width.

Figure 3.13 and 3.14 shows the way sizing the overhead shading and

shared shading under the solar condition of Bandung. For the North and South direction, The lowest sun altitude appears in Jun 23th in the south (72.6°) and Dec 21st in the north (60.5°). To fully cover the windows on these sides, the size of the Overhead shadings are:

$$S_s = (H_r - H_s) / \tan 72.6^\circ \quad (\text{Fomula 3.1})$$

$$S_n = (H_r - H_s) / \tan 60.5^\circ \quad (\text{Fomula 3.2})$$

Where H_r is the height of the edge of the eave, H_s is the height of the window sill,

Similarly, to prevent the most scorching solar radiant above 45° (See 1.1) during 9:00 to 15:00 in Bandung, There are:

$$S_w = S_e = (H_r - H_s) / \tan 45^\circ \quad (\text{Fomula 3.3})$$

$$= H_r - H_s$$

As for the shared shadings, the distance between buildings are decided by both the shading building height (H_{bw}/H_{be}), the sill height, and the sun altitude. For westward façade, if we want to shade the sunshine after 15:00, there is:

$$D_w = (H_{bw} - H_s) / \tan 45^\circ \quad (\text{Fomula 3.4})$$

While in the east, since the morning could be cold, we can make the direct sunshine possible for the interior (See 1.5), for example during 8:00-9:00. So there is:

$$D_e = (H_{be} - H_s) / \tan 30^\circ \quad (\text{Fomula 3.5})$$

3.3 Conclusion

The passive strategies of ventilation and sun shading in tropical area lies on both neighborhood scale and building scale. On neighborhood scale, the crucial factors are:

1. Orientation of streets and buildings;
2. Distance between buildings;

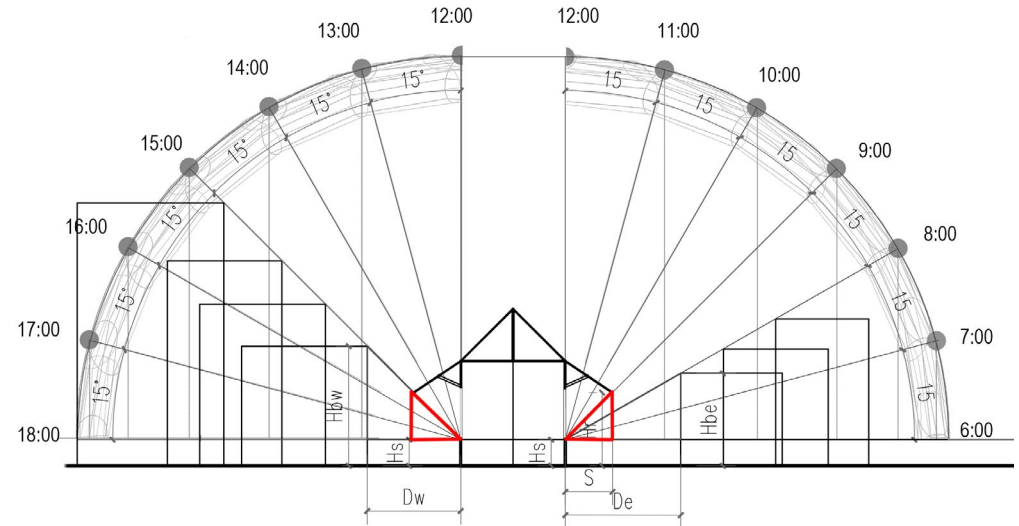

Figure 3.13 Sizing the West-East overhead shading and building distance (Own Drawing, 2016)

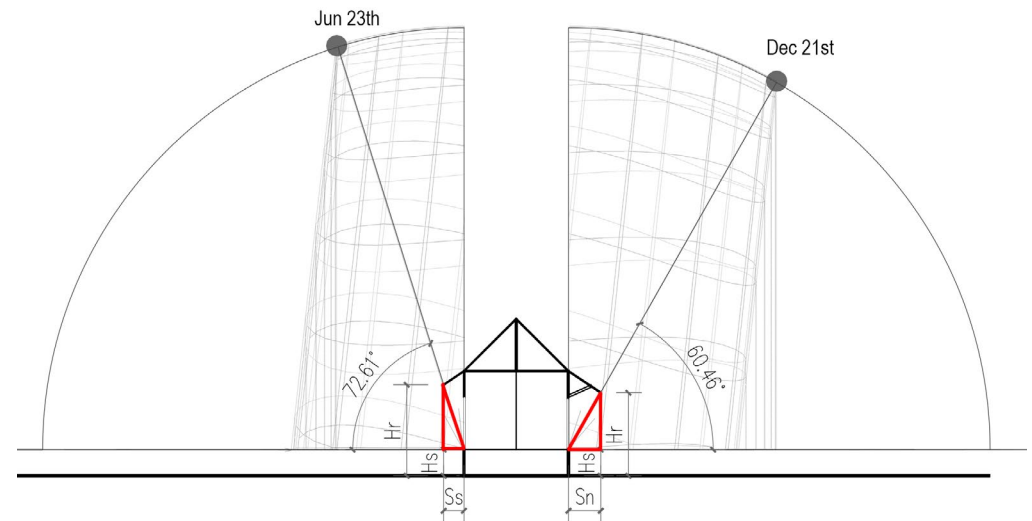

Figure 3.14 Sizing the North-South overhead shading (Own Drawing, 2016)

- 3. Shared shadings of the building masses;
- 4. Courtyards;

On building scale, the crucial factors are:

- 1. Opening arrangement and permeable partitions for cross ventilation;
- 2. Stack ventilation channels that enhance interior air movement;
- 3. Locating (semi-) outdoor space that accessing to the outdoor climate
- 4. Set Horizontal shading for the openings; Avoid the openings on the west facade;
- 5. Solar insulation on the roof and west/east facade;

For the next chapter, the main problem is how to apply these factors to the context- urban kampung in Bandung, and programme - multi-floor housing complex.



1. Thermal insulation:
The Roof is made of thick low thermal capacity materials such as thatches, which gives good insulation against solar radiation.



2. Steep Roof:
The main purpose of the huge degree of the roof might be the heavy precipitation during raining seasons.



3. Roof space:
Served as a insulation layer between the interior and the scorching sun. And



4. Ventilation through the roof joints: To take out the trapped heats.



5. Large Roof Eaves: To prevent the porches and the facads from Solar Radiation, Creating a semi-outdoor space.

1. The roof zone

2. The living zone

- 1. walls with low thermal capacity materials to avoid trapped heats inside the wall.
- 2. High opening rates: In order to facilitate ventilation comfort, the openings in the range of 50%- 80% of the walls is suggested. (rajeh, 1994)
- 3. less partition walls inside: to enhance ventilation

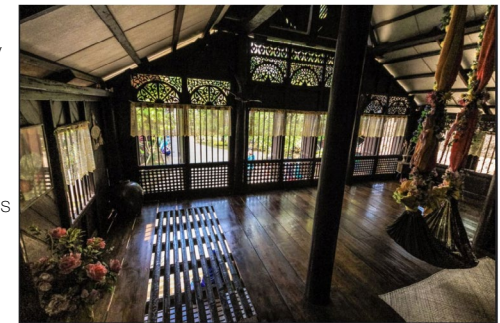

3. The Raised zone

- 1. The building is built beyond the plots so that the interior is detached from the ground. Therefore:
 - a. It prevent rising damp
 - b. It allows the ventilation underneath
- 2. The opening on the floor provide more air exchange between the interior and the beneath.

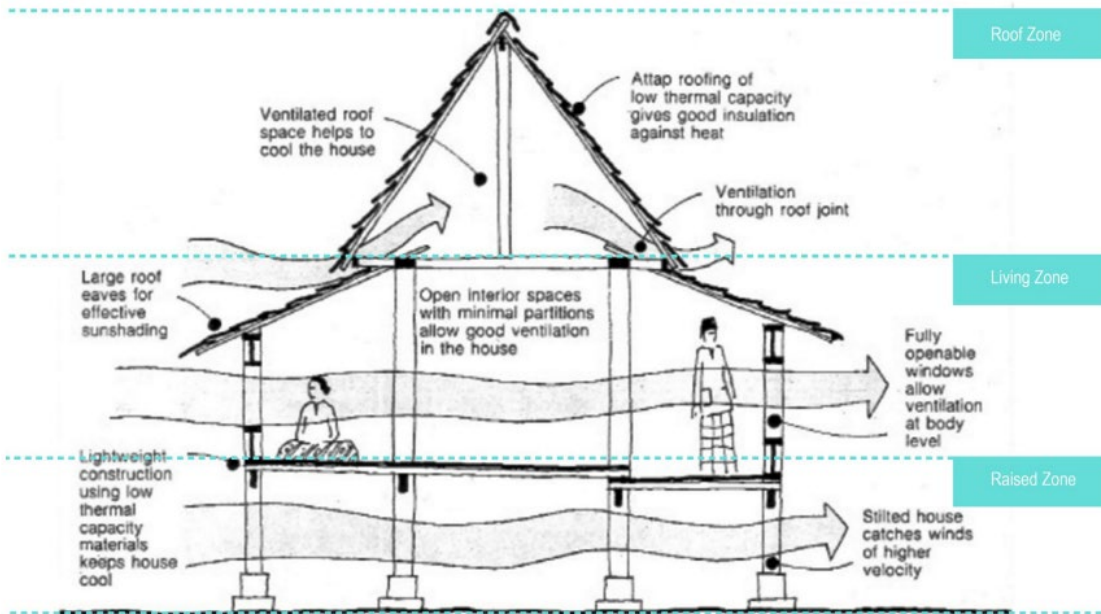
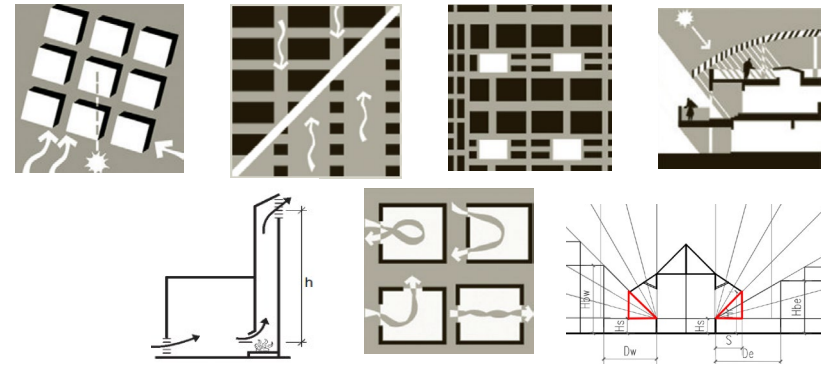

Figure 3.15 Passive strategy Analysis of a Malay house (Developed by author based on the researches of MM.Tahir, I.Usman, A.Che_Ani, M.Surat, N.Abdullah, and M.Nor,2014)

Chapter 4: Application of Passive Strategies in Multi-floor Residential Unit



Unlike the kampung housings in the context, a multi-floor apartments building is relatively independent from the outdoor surrounding in spatial aspect, because it has the public transport and communal spaces within the building, which separate the housings from the urban context. Therefore, the passive strategies could be divided in two spatial scales: the room scale and the building layout scale. The strategies each scale have is slightly shifted compared to the single-floor context like Cigondewah.

The principle of passive cooling strategies of ventilation and sun shadings on each scales remain the same. Nevertheless, some requirements for the passive design strategies are becoming harsh, while others becoming easier. On one hand, the requirement for distance increases because the multi-floor building blocks need larger distances for ventilation and daylighting; It becomes harder to locate (semi-) outdoor rooms because of the limited floor area; And independent horizontal and vertical shadings for the rooms are needed, since it is impossible to achieve the size of a single huge roof (See 2.2.6). On the other hand, one can take advantage of the building height for stack ventilation, which is hardly found in the existing context; The humidity will be lower since the floors are away from the rising damp and flooding on the ground floor.

This chapter will work out the specific dimensional requirements for each passive strategy that is applied to the multi-floor context by using CFD simulations. These dimensional requirements can be used as design criteria later.

On building layout scale, the main focus is on the orientation, the distance, the stack ventilation layout, the location of a corridor and the courtyard. While the room scale strategies is cross-ventilation, which can be optimized by adjusting the measurement of the room as well as the openings.

To make the result comparable, the author set the tested unit as a stack of 12 rooms, which have 3 floors and 4 rooms on each floor. The room size is 4 by 6 meters. The opening size is 1/3 of the facade area, and the sill height is 0.9m. (Figure 4.1)

All the solar analysis is based on Ecotect with the solar radiation data of Singapore; the CFD simulation uses the west wind with an annual average velocity (2.5 m/s)

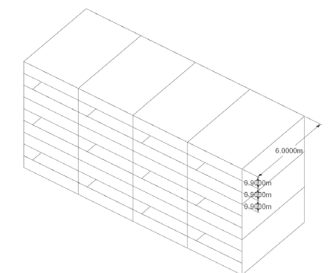

Figure 4.1 Tested unit (own drawing, 2016)



4.1.1 .Orientation

5 orientations are tested, which are: optimum ventilation Orientation (135 and 45 degrees), optimum solar radiant direction (168 degree), Cigondewah orientation 1 (110 degrees), and Cigondewah orientation 2 (20 degrees).

Figure 3.2 shows the total average daily solar gain on the main facades without shading. Solar radiant gain is calculated by the following fomula:

$$R = (i_1 + i_2) * S \quad (\text{Fomula 4.1})$$

where i is the annual average daily solar radiant intensity (kWh/sq.m), which could access from Ecotect analysis; S is the area of N/W facade, which is 129.6 sq m. From the results we could see the sharp predicament between the ventilation and solar radiant: Building would have either better ventilation with higher solar gains, or vise versa.

The author chose the combination of 2 options for the further research. The option with good indoor and outdoor ventilation is 45 degree, but the solar radiation on the main facades is relatively high; while one of the Cigongdewah original orientation (20 degrees) have minimum solar radiation, as well as good ventilation in the W-E lanes. But the ventilation inside the room will be minimal. the combination is the the block with 20 degrees orientation, while the room openings have small twist to 45 degree. this option ensures the minimum solar radiation, good ventilation in between the buildings, and improved ventilation in the room.

Orientation	Solar radiant gain (kwh)	Wind pressure (v= 2.23 m/s)
1 optimum ventilation 1 135°	i1=0.23kwh/sq.m i2=0.51kwh/sq.m R= 95.904 kwh	
2 optimum ventilation 2 45°	i1=0.33kwh/sq.m i2=0.35kwh/sq.m R= 88.128kwh	
3 optimum Solar 168°	i1=0.13kwh/sq.m i2=0.39kwh/sq.m R= 67.392kwh	
4 Cigongdewah 1 110°	i1=0.30kwh/sq.m i2=0.57kwh/sq.m R= 112.752kwh	
5 Cigongdewah 2 20°	i1=0.18kwh/sq.m i2=0.33kwh/sq.m R= 66.096kwh	
6 Combination	Table 4.2 Optimal Orientation (Own Drawing ,2016)	

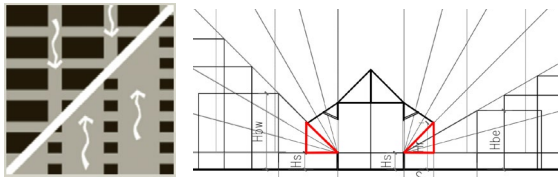

4.1.2 Building Distance

To ascertain the building distance, the main factors are the shared shadings and the ventilation condition for both exterior and the interior. The exterior wind velocity could be directly simulated, while the interior cross ventilation is decided by the pressure difference between the inlets and outlets on the opposite walls. According to figure 2.12, formula 2.2, formula 2.3 and the orientation, if $H_{bw}=H_{be}$, the distance that could shade the whole facades from the direct solar after a certain time could be defined by the formula as below:

$$D(t)_{ns} = H_b \cdot \sin 2\theta / \tan(\theta) \quad (\text{Formula 3.2})$$

$$D(t)_{we} = H_b \cdot \cos 2\theta / \tan(\theta) \quad (\text{Formula 3.3})$$

Where: H_b is the building height on both side of the given building; $\tan(\theta)$ is the solar altitude angle corresponding to the shading time, which could be found in figure 2.12.

In the scenarios on the right, 3 blocks are analyzed, sharing shading after 15:00, 16:00, 17:00 and 18:00 respectively. While result 4 is a block with $D(15:00)$ but have no distance on the perpendicular direction.

The result shows that for the exterior, the orientation ensured the good ventilation in the lanes, which isn't affected much by the distance; on the other hand, the larger the distance, the larger pressure difference, thus better cross-ventilation. Nevertheless, the eastern side of the building saw virtually no pressure difference because of the volumes on the west.

To balance the shared shading, the ventilation, and the necessary density, the option 2 is chosen. Enough insulation and sun shading should be installed on upper floors in case of solar radiant.

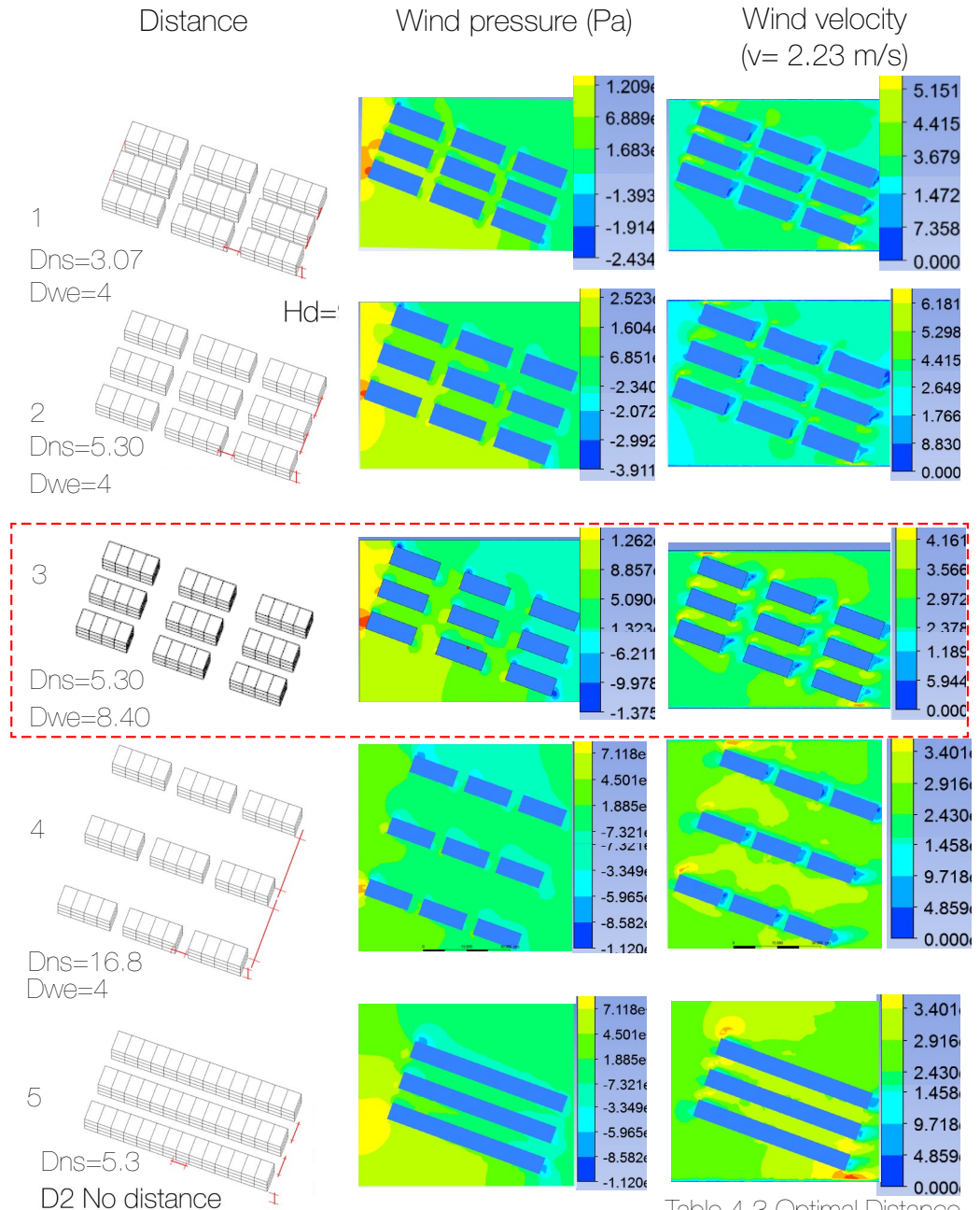

Table 4.3 Optimal Distance
(Own Drawing ,2016)



4.1.3 Courtyard Size and Layout

The courtyards affect the solar gain and the ventilation interior/ exterior. 4 options are given based on the solutions before.

The first option is making the westward courtyard between 3 lines of the building. The large-size courtyard makes larger pressure difference for the surrounding rooms, and ensure the air movement inside the courtyard. But the inner side of the courtyard will lose the shared shading after 15:00, increasing the solar radiation.

Option 2 and 3 show the different orientation of the courtyard. In the option 2, two face-to-face courtyards combined as a larger one. Although the pressure difference is ideal, the air movement inside the west part of the courtyard will be blocked by the building; What's worse, there will be a lot of solar gains both inside the courtyard and on the west side of the building. Option 3 makes all the courtyards towards west, which will severely affect the ventilation around the back rows of the block.

Option 4 is the smaller courtyards between two lines. It will remain the shared shadings inside the courtyard, opening westwards, and doesn't affect the exterior air movement so much. Moreover, it improves the interior ventilation, though changed the ventilation direction in the south wing of the building.

The solution could be the combination between option 1 and 4, involving the 3 kinds of tissues (linear, small courtyards, large courtyards). together.

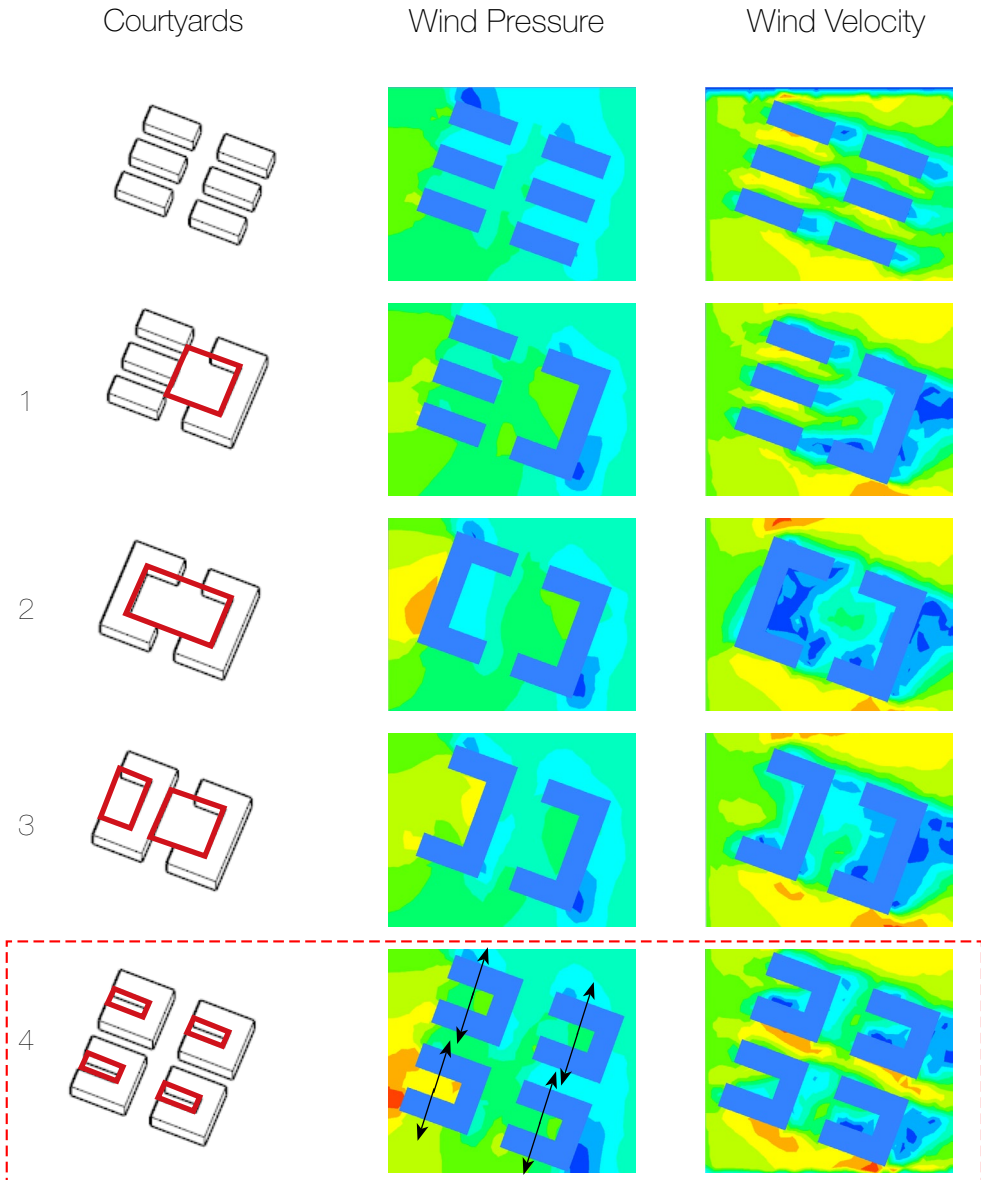
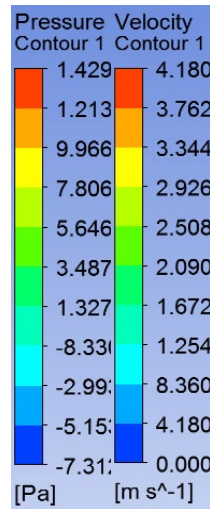

Table 4.4 Optimal Courtyards
(Own Drawing ,2016)



4.2.1 .Corridors Layout

Corridors in the multi-floor units serve not only as transport space but also as horizontal shading and as semi-outdoor rooms. The figures on the right show the location and size of the corridors, the wind pressure inside the courtyard on the section, and the wind velocity on the plan. The courtyard size is based on the research before; the corridor size is 1.5m, which is typical in Rumah Susun projects (See Figure 1.13).

As the additional parts of the building, the size and location of the corridors basically don't affect wind velocity of the courtyard evidently. But for wind pressure distribution, the inner corridors improve the pressure difference between the inner courtyard and the outside. Therefore, it is possible to extend the inner corridors for larger public space.

Considering about the sun shading, larger corridors provide larger overhead shadings during 9:00 to 15:00, and make up the shared shadings after 15:00.

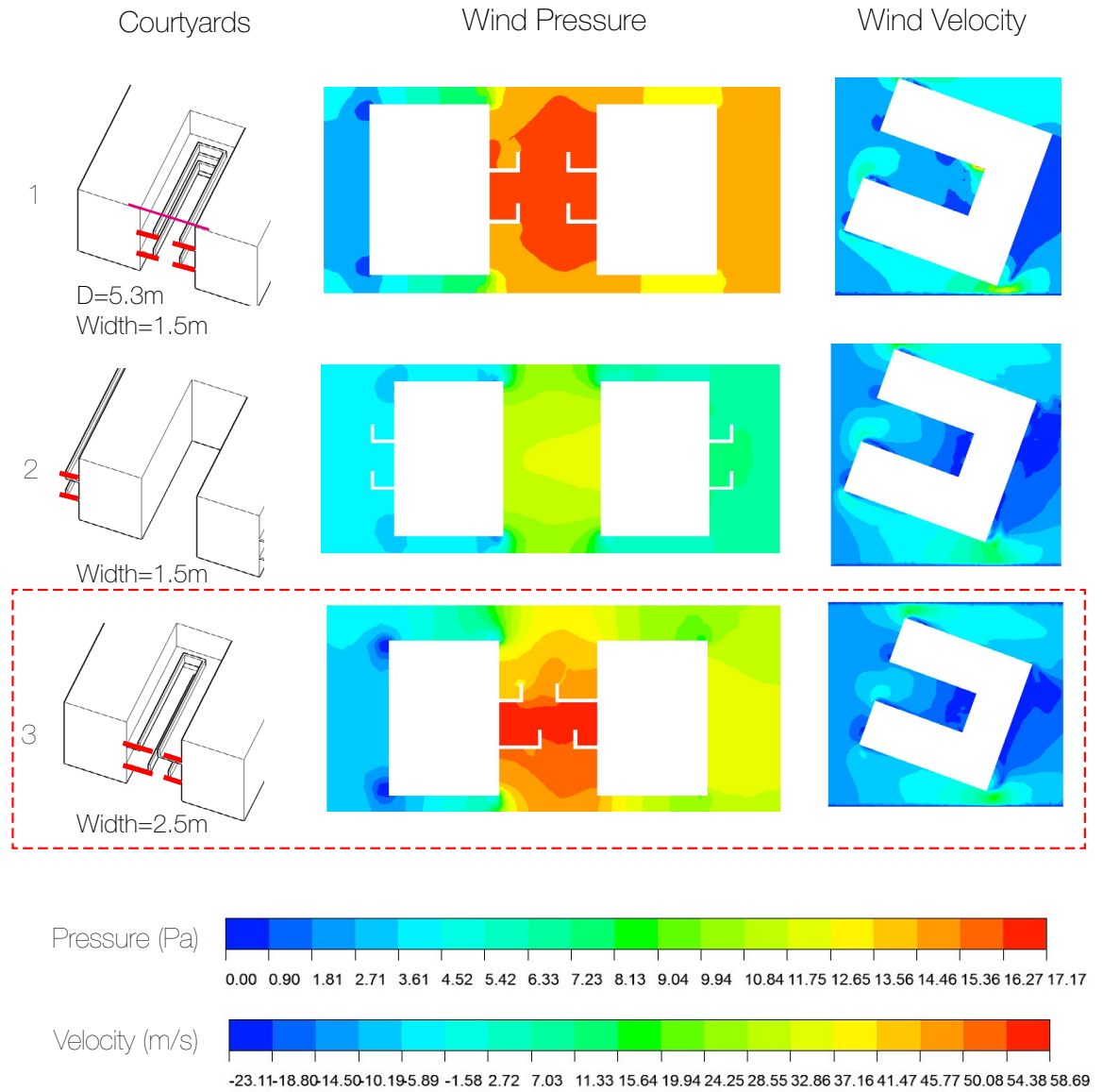
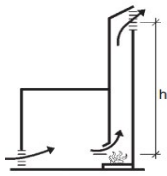

Table 4.4 Corridors Layout
(Own Drawing ,2016)



4.2.2 .Stack Ventilation Layout

Stack ventilation serves as a supplement for insufficient cross ventilation. According to the analysis in 4.1.5, the stack ventilation is needed on the facade on lower wind pressure, where the pressure difference is relatively small.

3 options are analyzed. In option 1, the stack chimneys are set up between every 2 rooms, with the section size of 2 by 2 meters. The chimney created a larger pressure difference between the lower facade and the outlet level on 11m. Considering the heat effect inside the chimneys, the ventilation will be larger. But the size is too large that the chimneys break the facade, blocking the ventilation inlets/outlets, as well as the view to the street.

Option 2 makes the chimneys smaller. But the stack effect will be decreased because of the small section size and small wind shadow they created.

Option 3 creates denser stack chimneys along the facades, ensuring that each stack of rooms has one independent chimney. Besides, the vertical chimneys could combine with the horizontal shadings, as well as make better use of solar radiant.

Pressure (Pa)

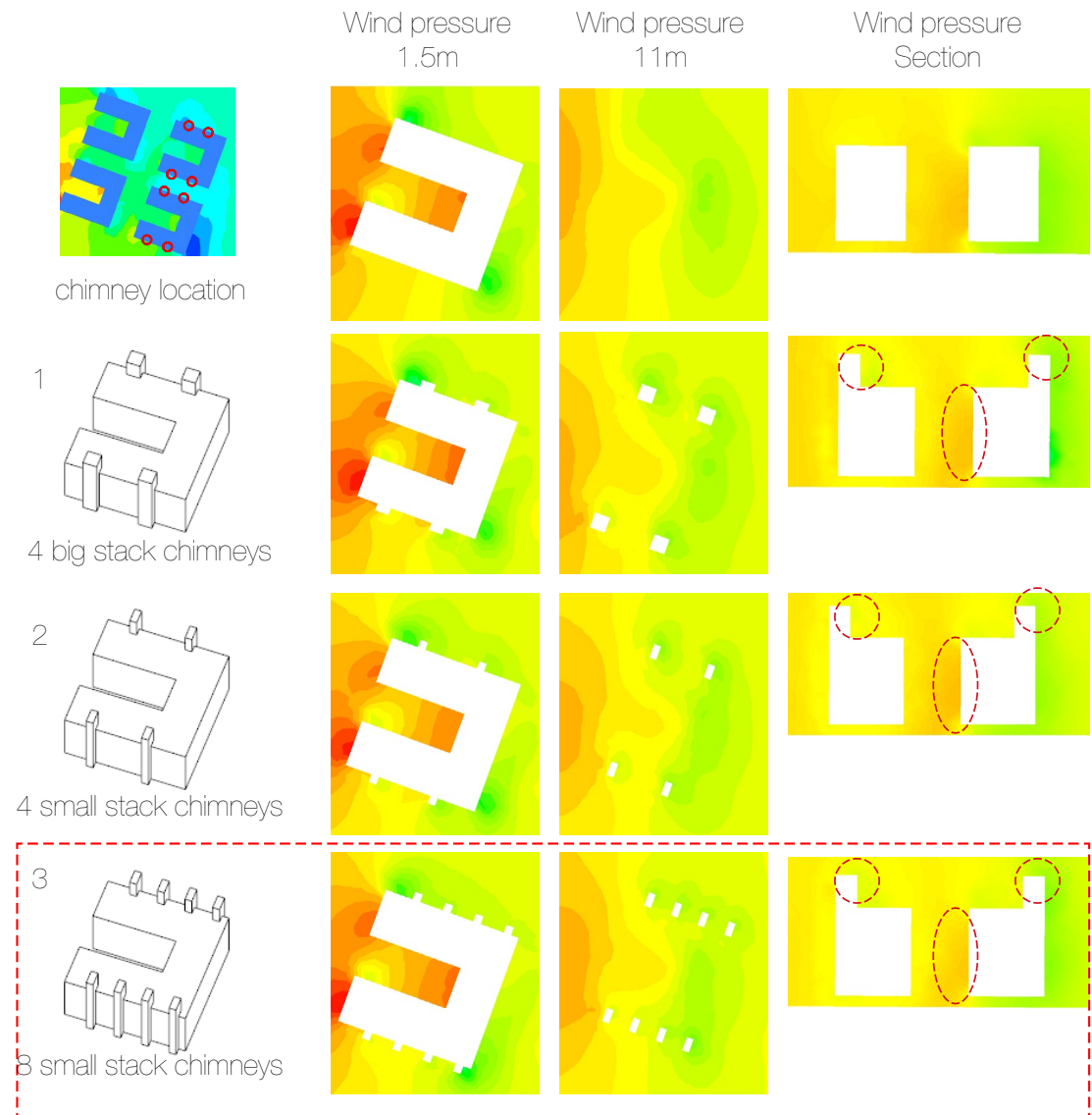
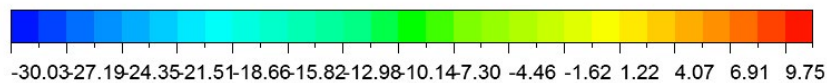

Table 4.5 Stack Ventilation Position
(Own Drawing ,2016)



4.2.3 .Ventilation Opening Size and Arrangement

The following figures show 8 options with different opening sizes and positions. The wind velocity is simulated on the 1.5m level plane and on the section.

The first 4 options discuss the influence of the inlet/outlet size. We could see that when the opening on each facade is larger than 1/6 (Ro=17.9%), the inner ventilation increases little when the opening is becoming larger.

The last 4 options shows that the position of outlets will affect the interior on wind velocity and wind distribution. Although the east corner of the room have largest pressure difference with the inlet,(see 4.1.1), the opening in this position will lead to high speed winds only along the eastern wall; While the better option is the openings in the north corner or on the top of the facade, which give more even wind distribution inside the room.

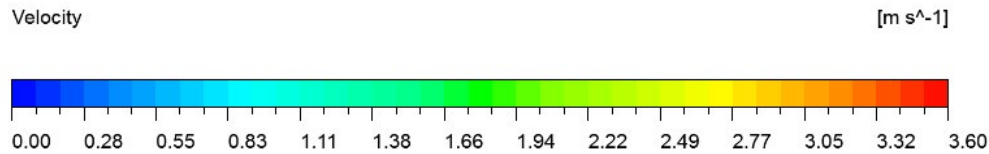
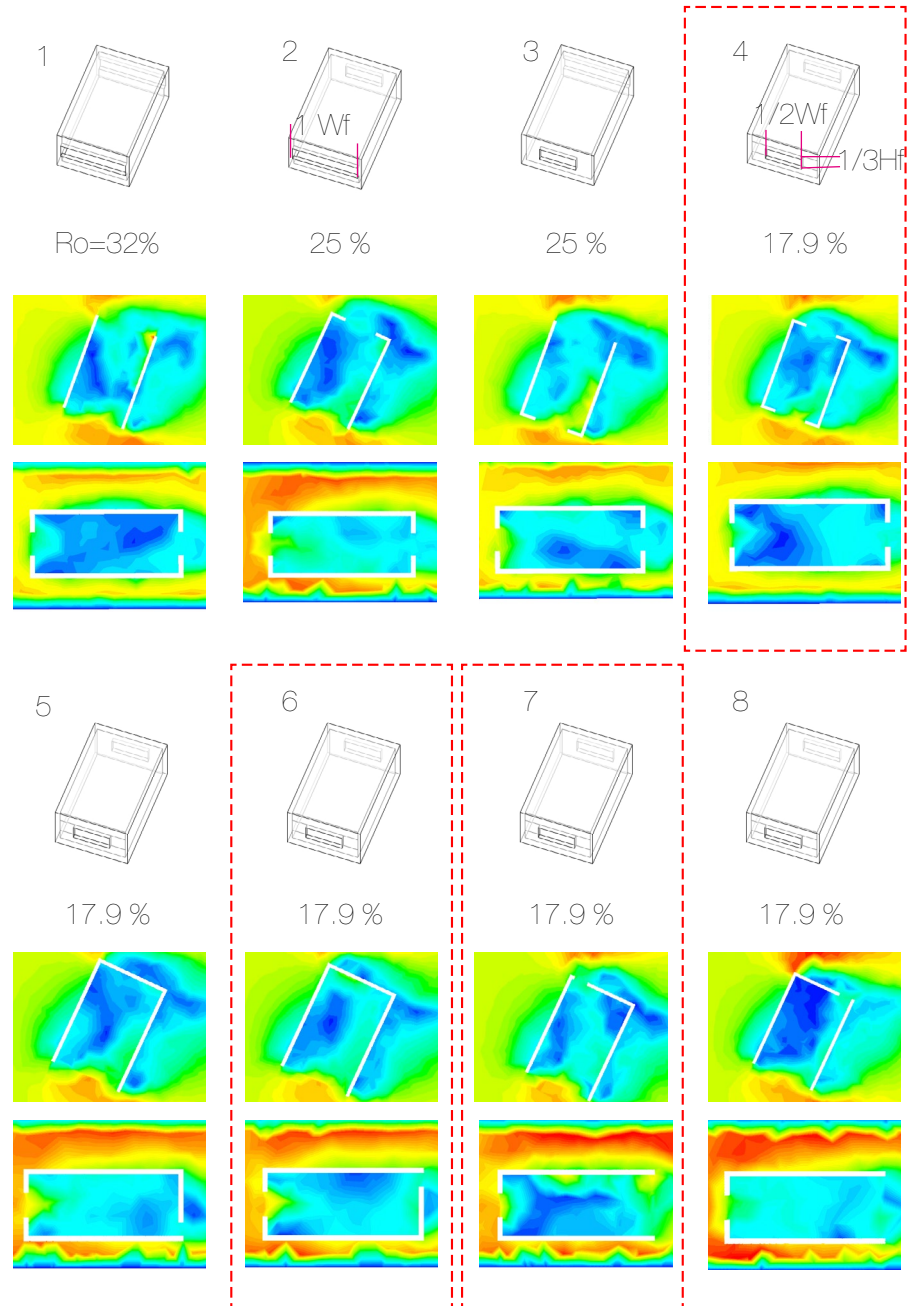
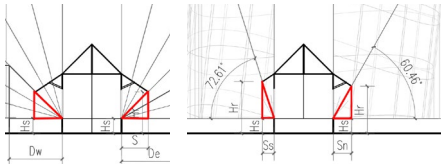

Table 4.6 Ventilation Opening
(Own Drawing ,2016)



4.2.4 .Sizing Sun Shadings

	covering the opening from Corridor	covering whole facade from Corridor	covering the opening With pitch	covering With whole facade With pitch
Hf	2.7	2.7	2.7	2.7
Hs	0.9	0.9	0.9	0.9
H cover	1.8	2.7	1.35	2.25
Due North	1.02	1.53	0.77	1.28
Size on North	0.96	1.44	0.72	1.20
Due South	0.56	0.85	0.42	0.71
Size on South	0.53	0.80	0.40	0.66
Due W/E covering 9-15	1.80	2.70	1.35	2.25
Size on W/E	0.62	0.92	0.46	0.77
Due W/E covering 8-16	3.12	4.68	2.34	3.90
Size on W/E	1.07	1.60	0.80	1.33
Due W/E covering 7-17	6.72	10.08	5.04	8.40
Size on W/E	2.30	3.45	1.72	2.87

Table 4.7 Shading size (own data, 2016)

Table 4.7 shows the independent horizontal shading size on each floor of the main facades based on figure 2.13 & 2.14, and the orientation (20 degrees). According to the calculation based on Figure 2.8 and 2.9, a 1.20m wide pitch shading could provide sun-shading for the whole floor's facade on the northeast facade between 8:00 to 16:00. Similarly, we could find the proper size of shadings on the southwest and the inner corridors, showing on the right.

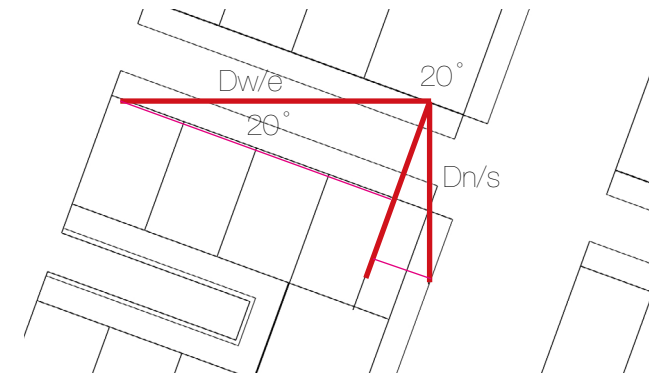

Figure 4.8 Orientation & Angle(Own drawing, 2016)

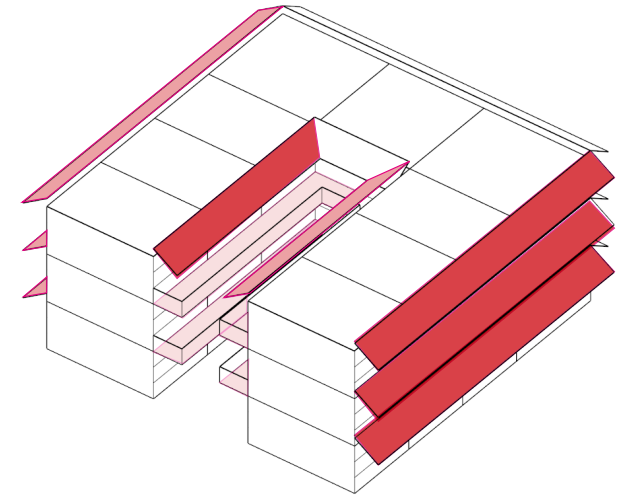

Figure 4.9 Shading Position (Own drawing, 2016)



4.3 Conclusion

1. The existing tissue of Cigondewah already have optimized orientation, thus could be conserved. while the ventilation could be enhanced by other passive strategies.

2. Distance on W-E direction is crucial for ventilation, while for the N-S direction, appropriate reduction of width will increase the wind velocity.

3. Courtyard opening to the prevalent wind could increase the pressure difference between inside and outside the courtyard, thus increase the indoor ventilation.

4. The corridors in the courtyard don't affect the air movement. Moreover, it could increase the pressure difference.

5. Set Chimney on the exterior main facades on the north and south; while modifying the size and distribution so that it could not only combining with horizontal shadings but also better using the solar radiant.

6. For the rooms, the inlet is enough when it is as 1/6 size of the facade. While the outlet should be put either at the corner with the lowest pressure, or on the top of the opposite wall;

7. The proper size of the horizontal shading components will provide shadings between 8:00 to 16:00. The shadings could be adjustable for morning sunlight; While the end of building blocks still need vertical shadings.

Orientation

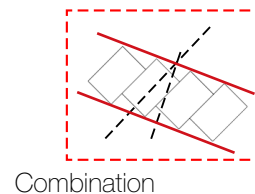
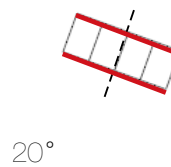
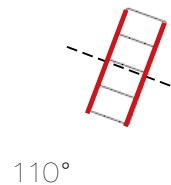
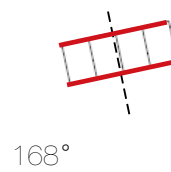
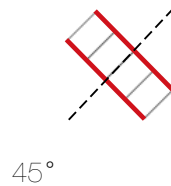
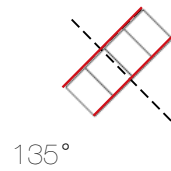

Distance

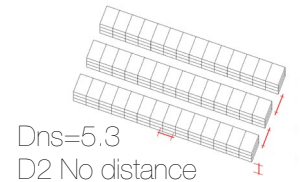
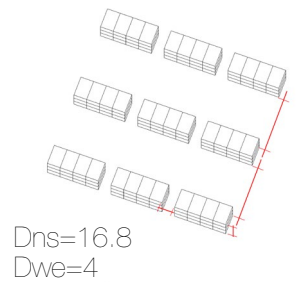
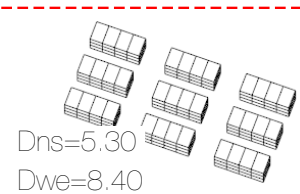
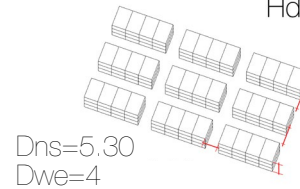
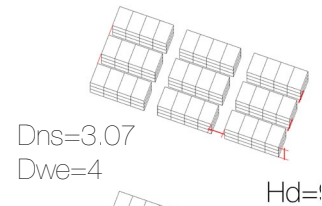

Courtyard

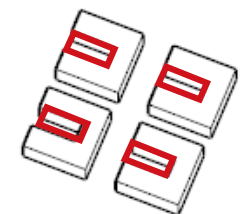
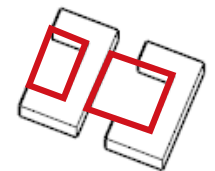
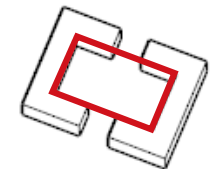
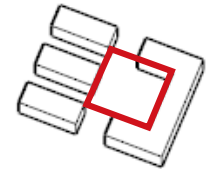
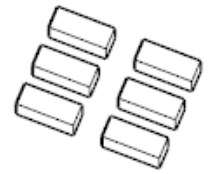

Corridors

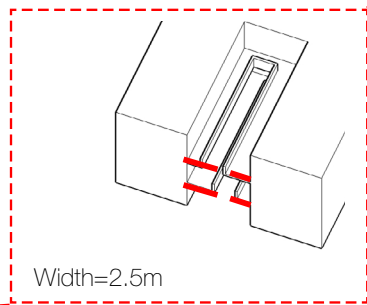
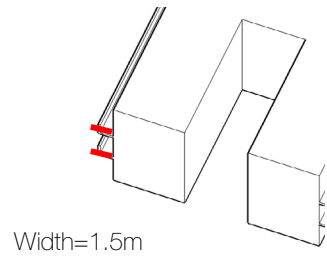
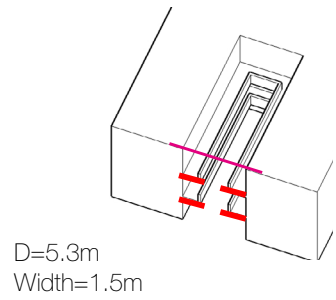

Opening Size

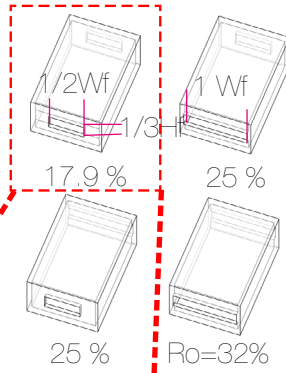

Opening arrangement

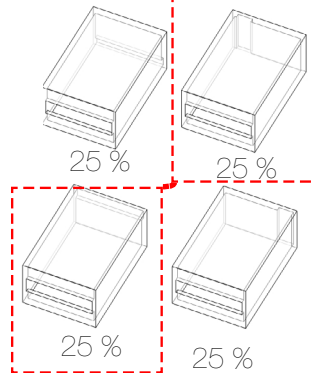

Stack Ventilation

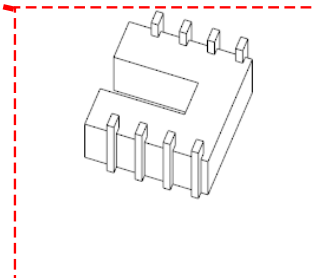
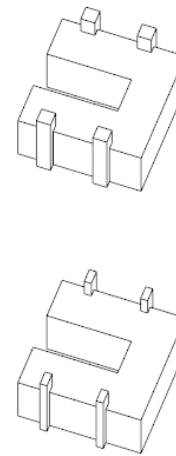

Sun Shading

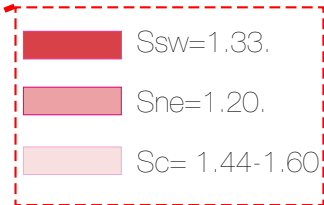
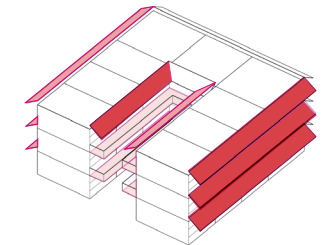

Figure 4.1 Optimized Strategies
(Own Drawings, 2016)

**Chapter 5 Conclusion and Discussion: Basic principles and typology for neighbor scale
and building scale**

5.1 Conclusion

5.1.1 Climate: Challenges and Opportunities

Locating in the southeast Asia, The climate of Bandung is peculiar compared with other tropical cities because of its special geological location. The climate provides not only challenges but also opportunities for the improvement of interior thermal condition.

The challenges are of the solar radiant, the temperature and humidity, and the wind. Because of its low latitude, the solar radiant intensity in Bandung is enormous all year round, which would heat interior severely; The humidity is very high whether it is in rain season or dry season, badly influenced the thermal comfort statues; As for the winds, the prevalent and secondary wind direction is west, which is also the direction with high solar radiant, making it difficult to balance the orientation and direction for different concerns.

As for the Opportunities, firstly, the sun altitude is high from 9am to 3 pm when there is the highest solar radiant among the day, this gives chance to the overhead shadings. Secondly, the temperature is moderate all around the year, making the ventilation cooling easier because the wind temperature does not need to be cooled down. Thirdly, the wind frequency and wind velocity are relatively high compared with other tropical areas, which could be better utilized for the ventilation.

According to the comfortable zone analysis, the passive cooling strategies are needed, which are mainly focusing on passive ventilation and sun shading.

5.1.2 Passive cooling by ventilation and sun shading

The passive cooling rely on the strategies on both neighbor scale and building scale. On a neighbor scale, the ventilation is ensured by the strategies on orientation, distance, and the layout of the courtyards.

	Challenge	Opportunity
Solar	High solar radiant all year round	High solar altitude during scorching time.
Temperature and Humidity	High humidity all year round	Moderate outdoor temperature
Wind	Prevalent wind from west, being the same as worst direction with most solar gain.	Relative high wind frequency and speed

Figure 5.1 Challenge and Opportunities of each climatic factors















	Ventilation Concern	Shading Concern
Neighbor Scale	Orientation  Building Distance  Layout of Courtyards 	Orientation  Building Distance  Layout of Courtyards  Overhead/shared shadings 
Building Scale	Cross ventilation  Openings Arrangement  Stack ventilation  Permeable buildings  (Semi-) Outdoor rooms 	(Semi-) Outdoor rooms  Calculating Shading  Stack Ventilation 

Figure 5.2 Ventilation and Shading related strategies on different scales

While the sun shading depends on the overhead shadings and shared shadings, which are related to the orientation, the distance, the courtyards and the layout of horizontal shadings.

On building scale, there are two main strategies for nature ventilation: cross ventilation and stack ventilation. the optimized option is the permeable buildings combining the two strategies. As for the sun shading, the horizontal and vertical shading components are needed on each floor. Besides, locating outdoor rooms also helps better utilizing the natural ventilation and temperature.

5.1.3 Application of the strategies

The application of the strategies results in both urban and building scales. For urban scale, The optimized urban tissue balanced the orientation and building distances requirements for both ventilation and sun shading. While the courtyards are made for better ventilation, providing space for semi-outdoor rooms.

On building scale, a typology of a multi-floor residential unit is made based on the optimized urban tissue. It is a courtyard dwelling apartment opening the NW side to the street. The corridors are located inside the courtyard, serving as both outdoor rooms and sun shading for the lower floor. On the exterior facades, the horizontal shadings prevent the whole facade from the solar radiation from above the head. To achieve better interior ventilation, the stack chimneys are put along the NE and SW facade, where the pressure difference need to be improved. The rooms have openings rates around 20%, making optimized opening arrangement for wind distribution.

5.2 Discussion:

5.2.1 Critical Arguments

The thesis started with the analysis of climate property and step by step concluded the application of the passive strategies for multi-floor apartment buildings in Indonesia. Although some of arguments in each chapter are not quite convincing because of either sources or methodologies, the research result provide reference value towards further research on passive design in Indonesia.

In the Chapter 2, the climate data of Bandung only covered the year of 2014, which was incomprehensive to show the climatic characteristic of the city. The reason was that the author failed to access the long-term climate data from the meterology station in Bandung. Nevertheless, the shor-term data also shows coherence with the discriptions of bandung climate, which means the analysis is at least a valuable reference for the next steps. Besides, the later researchers who are available to access the long-term climate data will conclude more accurate results by using the methodology in chapter 2.

In the Chapter 4, all the flow simulations are based on a wind channel with steady wind speed of 2m/s. This circumstance, however, it is unreal because the natural wind situation is not steady as they are simulated in the software. Therefore, the simulations could help choosing the better options from others, but they cannot provide exact measurements nor accurate interior wind speed. Yet, the simulation provide a sort of indicating results that show the primary substance of these passive strategies.

Also, because of the limitation of the software, the author failed to simulate the solar-chimney effect in stack-ventilation chimney, which could conclude size of the stack-vent chimney. As the result, the analysis in Chapter 4 only indicated the ideal location, which can be achieved by analyzing wind pressure distribution.

5.2.2 The Potential of the Research Result

The result of the research is a totally top-down solution both on the neighbor scale and building scale. Therefore, the huge gap still lies between the solution and the application of it in the kampung context considering about its informality and unplanned development.

On Neighbor scale, since the existing urban tissue is much denser than the solution (Figure 5.3 and 5.4), the application will inevitably brings about the demolition and reconstruction of existing buildings, which might increase the cost as well as causing inconvenience around the site. Therefore, during the design process a proper approach need to be developed which could replace the existing building scale to a larger scale in a gradual and gentle way, so that the above negative influences could be minimized.

As for building scale, the solution is a congregated multi-floor residential unit, which will be very different from the results of the

current individually vertical development mode. Therefore it calls for the development as groups instead of as individuals. This new process needs the organization and cooperation of communities, as well as the involvement of planners and rulers.

This research result have its specialty in the context, thus is different with former researches on passive design. On one hand, it is different with sustainable housings (Passivehaus) , because it seldom use modern energy facilities. Instead, considering about the social economic situation, all the strategies are applied in low-tech way. On the other hand, even comparing with Correa's Kanchanjunga Apartments in Mumbai, this research result faces more complicated informal settlement context.

In conclusion, the research result could serve as a guidance for the future vertical development of kampung, whilst its feasibility is still largely open to question.

Further more, an relatively gentle approach is to apply the research result merely within building scale, which will exlude the intervention from government and keep the informality and incrementality of the settlement. But the effect of passive design might be little, and the risk of over-density still exists.

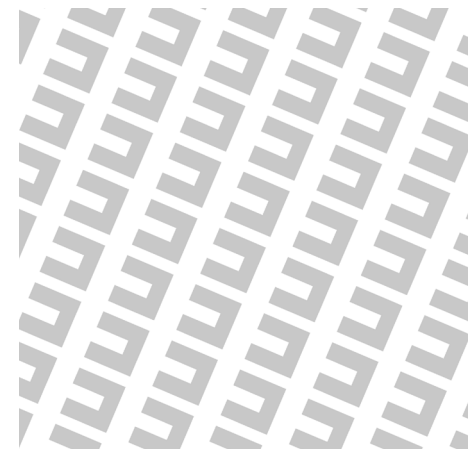





Figure 5.3 Optimized Multi-floor Tissue



Figure 5.4 Existing Tissue

Chapter 2: Passive Cooling Strategies for Neighborhoods And Building Scale

Chapter 1: Bandung Climate research and the corresponding Passive strategy

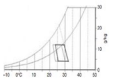
-  1.1 Location and Solar analysis
-  1.2 Temperature and humidity
-  1.3 Wind Direction, velocity, and ventilation
-  1.4 The Standard Effective Temperature and Thermal Comfort Zone

1.5 Conclusion:
Passive cooling:



Sun Shading



Ventilation

2.1 Neighbor Scale



A Orientation of Streets and the buildings



B Breezy Streets and Building Distance



C Overhead Shadings and Shared Shadings



D Breezy Courtyards (Unfinished)

2.2 Building Scale



a Cross ventilation



b Ventilation Openings Arrangement



c Stack Ventilation



d Permeable buildings Combining Stack and Cross Ventilation



e Rooms Locating Outdoors



f Shading and insulation for solar radiation

Research Methods

Climate Database Study; Literature Study

Literature Study

Chapter 3: Passive Strategies applying to multi-floor apartments

3.1 Neighbor scale:

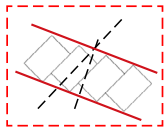

4.1.1 Orientation

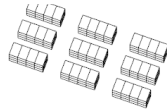

4.1.2 Distance & Building Length

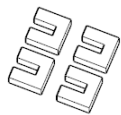

4.1.3 Size and layout of Courtyards

3.2 Building Scale:

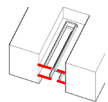

4.2.1 Location of the corridors

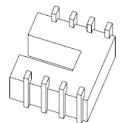

4.2.2 Layout of stack ventilation



4.2.3 Ventilation Opening size and arrangement

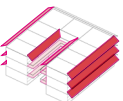

4.2.4 Sizing the sun shading

Chapter 4: Passive Strategies applying to multi-floor apartments

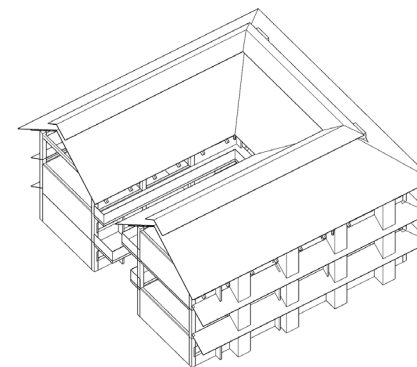
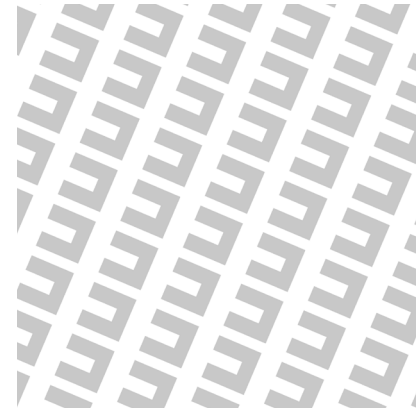

Reference

1. Olli A. Seppänen, W.J.F., Summary of human responses to ventilation. *Indoor Air*, 8.2004. 14(s7): p. 102-118.
2. Wikipedia, Bandung, in Wikipedia. 12.2016.
3. Olgyay, V., *Design with Climate: Bioclimatic Approach to Architectural Regionalism*. 1962, Princeton, New Jersey: Princeton Press.
4. Gagge, A.P., J.A.J. Stolwijk, Y. Nishi, An effective temperature scale based on a simple model of human physiological regulatory response, in *ASHRAE Transactions*. 1971.
5. B.Givoni, *Man, Climate and Architecture*. 1976.
6. Melaragno, M.G., *Wind in architectural and environmental design*. 1982: Van Nostrand Reinhold Co.
7. Gagge A.P., J.A.J.S., Y. Nishi, A standard predictive index of human responses to the thermal environment, in *AHSRAE Transaction*. 1986. p. 709-731.
8. Yuan, L.J., *The Malay House: Rediscovering Malaysia's Indigenous Shelter System*. 1991: Institut Masyarakat.
9. N.K. Bansal, R.M., M.S. Bhandari, Solar chimney for enhanced stack ventilation. *Building and Environment*, 1993. 28(3): p. 373-377.
10. A. M. FLETCHER, C.A.C.P., A. CUSTOVIC, J. SIMPSON, J. KENNAUGH, A. WOODCOCK, Reduction in humidity as a method of controlling mites and mite allergens: the use of mechanical ventilation in British domestic dwellings. *Clinical & Experimental Allergy*, 1996. 26(9): p. 1051-1056.
11. F.J. Baptista, B.J.B., J.M. Randall, J.F. Meneses Greenhouse Ventilation Rate: Theory and Measurement with Tracer Gas Techniques. *Journal of Agricultural Engineering Research*, 1999. 72(4): p. 363-374.
12. Tammy Lundstrom, G.P., Judene Bartley, Jack Cox, Carol Guither, Organizational and environmental factors that affect worker health and safety and patient outcomes. *American Journal of Infection Control*, 2002. 30(2): p. 93-106.
13. Szokolay, S.V., *Introduction to Architectural Science: the basis of sustainable design*. 1 ed. Vol. 1. 2004, Oxford: Architectural Press. 351.
14. Gustafsson, S.N.a.G., Influence of Temperature, Humidity and Ventilation Rate on the Release of Odour and Ammonia in a Floor Housing System for Laying Hen. *CIGR E-Journal*, 2005. 7.
15. LSAI. *An Extremely Brief Urban History of Bandung*. 2006.
16. Jae-Hun Joa, J.-H.L., Seung-Yeong Songb, Myoung-Souk Yeo, Kwang-Woo Kim, Characteristics of pressure distribution and solution to the problems caused by stack effect in high-rise residential buildings. *Building and Environment*, 2007. 42(1): p. 263-277.
17. VDI, methods for the human biometeorological evaluation of climate and air quality for urban and regional planning at regional level. Part1: Climate. *Environmental meteorology*. Vol. 1. 2008, Dusseldorf.
18. Windisch, W., Impact of home mechanical ventilation on health-related quality of life. *European Respiratory Journal*, 2008. 32: p. 1328-1336.
19. T. van Hooffa, b., B. Blockena, , L. Aanenc, B. Bronsemad, A venturi-shaped roof for wind-induced natural ventilation of buildings: Wind tunnel and CFD evaluation of different design configurations. *Building and Environment*, 2011. 46(9): p. 1797-1807.
20. communities, g., *Natural building ventilation, in grassroots communities, g. communities*, Editor. 2012.
21. Hooff, T.v., Numerical analysis of the performance of a venturi-shaped roof for natural ventilation: Influence of building width. *Wind Engineering and Industrial Aerodynamics*, 2012: p. 419-427.
22. ASHRAE, *Thermal Environmental Conditions for Human Occupancy*, in *ANSI/ASHRAE Standard 55-2013* 2013.
23. Hasanuddin Z. Abidin, G., H. Andreas, D. Murdohardono, Y. Fukuda, On causes and impacts of land subsidence in Bandung Basin, Indonesia. *Environmental Earth Sciences*, 2013. 68(6): p. 1545-1553.
24. City, S.o.B., *Density Per Square Of Bandung City In 2008-2014*, S.o.B. City, Editor. 2014.
25. City, S.o.B., *Total Population By Sex And District In Bandung City 2011-2014*, S.o.B. City, Editor. 2014.
26. Jan Bredenoord, P.v.L., Peer Smets, *Affordable Housing in the Urban Global South: Seeking sustainable Solutions*. 2014.
27. Karam M. Al-Obaidin, M.I., Abdul Malek Abdul Rahman, *Passive cooling*

techniques through reflective and radiative roofs in tropical houses in Southeast Asia: A literature review. *Frontiers of Architectural Research*, 2014.

28. Katia Perini, A.M., Effects of vegetation, urban density, building height, and atmospheric conditions on local temperatures and thermal comfort, in *Urban Forestry & Urban Greening*. 2014.

29. M. M. TAHIR, I.M.S.U., A.I. CHE_ANI, M. SURAT, N.A.G. ABDULLAH, , M.F.I. MD.NOR, Reinventing the Traditional Malay Architecture: Creating a Socially Sustainable and Responsive Community in Malaysia through the Introduction of the Raised Floor Innovation in ENERGY, ENVIRONMENT, ECOSYSTEMS, DEVELOPMENT and LANDSCAPE ARCHITECTURE. 2014, Architecture Department, Faculty of Engineering, Universiti Kebangsaan Malaysia.

30. Mark DeKay, G.Z.B., Sun, Wind & Light: Architectural Design Strategies. 3 ed. 2014: John Wiley & Sons.

31. Mark DeKay, G.Z.B., Integrated urban patterns, in Sun, Wind & Light. 2014. p. 138-147.

32. Mark DeKay, G.Z.B., ROOMS: Open Organizations, in Sun, Wind, and Light. 2014. p. 228-229.

33. Mark DeKay, G.Z.B., ROOMS: Location and Orientation, in Sun, Wind, and Light. 2014. p. 250.

34. Solargis, Global Horizontal Irradiation in Southeast Asia and Indonesia. 2014.

35. B.Sakina, T.M.K., Feni Kurniati, Imaniar Sofia, Vika Haristianti, Typomorphology of Housing Cigondewah Bandung - Built Environment Analysis Class. 2015.

36. Dwi Prasetyoa, Y.E., lesje Martizaa, Soenarto Yatib, Correlation between climate variations and rotavirus diarrhea in under-five children in Bandung. *Asian Pacific Journal of Tropical Disease*, 2015. 5(11): p. 908-911.

37. Fabbri, K., Indoor Thermal Comfort Perception : A Questionnaire Approach Focusing on Children. Vol. 6. 2015. 304.

38. Liu, Z., Incrementality: Potential of Incremental Constructions in Indonesia Kampung, in *Msc Architecture Engineering Studio*, BK Delft. 2016, Tu Delft.

39. Mo Smit, S.L., Gideon van Toledo, Paramitha Yanindraputri,

CederickIngen-Housz, HOME AT WORK: Welcome to the Fashion Village! 2016, TU Delft. p. 54.

40. Sanye, P., Interview with Pak aaa, Boje, Editor. 2016.