

# Generating reversible interlocking structures for non-compatible FDM polymers



---

By Thomas van Zeijl

# Abstract

In the field of 3D printing, Multi Material Additive Manufacturing (MMAM) has gained substantial recognition, as it offers interesting new possibilities. MMAM allows the combination of diverse polymers to create products with enhanced, composite properties. However, a significant challenge emerges when chemically incompatible polymers are combined within this technique, which complicates recyclability. This research addresses the issue of connecting these polymers while preserving strength, durability, and the capacity for disconnection, which facilitates efficient recycling at the end of a product's life cycle.

Polymers, while versatile and widely used, often prove to be chemically incompatible due to their distinct chemical compositions and inherent characteristics. This incompatibility becomes a major bottleneck in the field of MMAM, as it obstructs the effective adhesion of polymers to each other. The result is products that are exceedingly challenging to recycle, perpetuating a long-standing issue in the 3D printing domain. Conventional industry solutions, primarily reliant on mechanical interlocking methods, lack the necessary flexibility for disassembly, rendering the materials inseparable and hindering recycling. This issue has long hampered the establishment of a sustainable 3D printing ecosystem.

To conquer this challenge, this research introduces the "Z-pin" connection, a novel reversible interlocking method. The Z-pin method serves as a bridge connecting chemically incompatible polymers and offers an approach that exceeds current alternatives. The introduction of the Z-pin's design helps the joining of different polymers while still facilitating their clean separation when necessary.

The Z-pin method is most novel in its remarkable capacity for disconnection. By subjecting the polymer connection to controlled heating, within a range of 60 to 95 degrees Celsius, this method facilitates the simple, clean, and efficient

separation of materials. Most notably, this process can be executed with basic tools and, in certain scenarios, by manual disassembly.

The developmental process of the Z-pin method comprised three phases. The first phase involved the initial design and evaluation of a range of connection methods. Two methods that demonstrated great potential were selected for further refinement in the second phase. Here, an optimisation process took place, including geometry, print parameters, and material properties. The third phase was dedicated to implementing the enhancements identified in phase two, culminating in a comprehensive and finalized design. This iterative methodology addressed the extensive range of possibilities uncovered during preliminary research.

The research affirms the performance of the Z-pin method over conventional solutions, including the hacksaw and alternating layer methods. The Z-pin method has an impressive tensile strength, positioning it as a contender within the MMAM domain. Furthermore, its straightforward geometry affords scalability and adaptability, enabling it to meet the specific prerequisites of a diverse array of applications.

# Glossary

**AM** - Additive Manufacturing

**CAD** - Computer Aided Design

**Cura** - A slicer developed by the company Ultimaker

**FDM** - Fused Deposition Modeling

**Filament** - Round stock material that is used by FDM printers.

**G-code** - G-code is a set of instructions in a specific format used to control 3D printers and CNC machines for precise movements and actions.

**Interface** - The surface where two materials touch

**MMAM** - Multi Material Additive Manufacturing. A specific kind of 3D printing in which multiple materials are used during the construction of one object.

**PLA** - Polylactic Acid. A rigid polymer. One of the most commonly used materials in FDM printing.

**Slicer** - Software that can create a G-code. When importing a 3D model, this program slices it in thin layers and develops a toolpath, based on input parameters specified by the user.

**Toolpath** - The path that the 3D printer follows while extruding filament in order to create an object.

**TPU** - Thermoplastic Urethane. A flexible polymer.



# Table of contents

<b>1. INTRODUCTION</b>	-	-	-	-	-	-	-	-	-	-	-	-	<b>7</b>
1.1 Introduction	.	.	.	.	.	.	.	.	.	.	.	.	8
1.2 Methodology	.	.	.	.	.	.	.	.	.	.	.	.	8
<b>2. BACKGROUND</b>	-	-	-	-	-	-	-	-	-	-	-	-	<b>11</b>
2.1 FDM	.	.	.	.	.	.	.	.	.	.	.	.	12
2.2 MMAM	.	.	.	.	.	.	.	.	.	.	.	.	13
2.3 Incompatibility	.	.	.	.	.	.	.	.	.	.	.	.	14
2.4 Combining incompatible materials	.	.	.	.	.	.	.	.	.	.	.	.	14
2.5 The materials	.	.	.	.	.	.	.	.	.	.	.	.	16
2.6 Mechanical properties of 3D prints	.	.	.	.	.	.	.	.	.	.	.	.	17
<b>3. DESIGN FRAMEWORK</b>	-	-	-	-	-	-	-	-	-	-	-	-	<b>19</b>
3.1 Recycling	.	.	.	.	.	.	.	.	.	.	.	.	20
3.2 Solutions from literature	.	.	.	.	.	.	.	.	.	.	.	.	22
3.3 Application analysis	.	.	.	.	.	.	.	.	.	.	.	.	25
3.4 Discussion	.	.	.	.	.	.	.	.	.	.	.	.	26
3.5 Define focus	.	.	.	.	.	.	.	.	.	.	.	.	26
3.6 Requirements	.	.	.	.	.	.	.	.	.	.	.	.	27
<b>4. PROBLEM DEFINITION</b>	-	-	-	-	-	-	-	-	-	-	-	-	<b>29</b>
<b>5. DEVELOPMENT AND DESIGN</b>	-	-	-	-	-	-	-	-	-	-	-	-	<b>31</b>
5.1 Disconnection	.	.	.	.	.	.	.	.	.	.	.	.	32
5.2 Connection	.	.	.	.	.	.	.	.	.	.	.	.	36
5.3 Phase 1: Testing of multiple connection methods	.	.	.	.	.	.	.	.	.	.	.	.	40
5.4 Phase 2: Refinement and Selection of Definitive Method	.	.	.	.	.	.	.	.	.	.	.	.	46
5.5 Phase 3: Final design	.	.	.	.	.	.	.	.	.	.	.	.	54
<b>6. EVALUATION</b>	-	-	-	-	-	-	-	-	-	-	-	-	<b>59</b>
6.1 Method	.	.	.	.	.	.	.	.	.	.	.	.	60
6.2 Results	.	.	.	.	.	.	.	.	.	.	.	.	61
6.3 Conclusion	.	.	.	.	.	.	.	.	.	.	.	.	68
<b>7. DISCUSSION AND CONCLUSION</b>	-	-	-	-	-	-	-	-	-	-	-	-	<b>71</b>
7.1 Issues and limitations	.	.	.	.	.	.	.	.	.	.	.	.	72
7.2 Recommendations	.	.	.	.	.	.	.	.	.	.	.	.	72
7.3 Conclusion	.	.	.	.	.	.	.	.	.	.	.	.	73
<b>8. REFERENCES</b>	-	-	-	-	-	-	-	-	-	-	-	-	<b>74</b>
<b>9. APPENDICES</b>	-	-	-	-	-	-	-	-	-	-	-	-	<b>81</b>

# Acknowledgments

After multiple studies, many years and a lot of ups and downs, I am glad to be able to present my masters Thesis, which marks the end of my time as a student at the TU Delft. It's kind of bittersweet, but I'm glad for all the great times I had during these years, and the knowledge I gathered.

I would like to thank a lot of people, but there are not enough pages to mention everybody who added something to my time here, so I'll stick to those who helped during this graduation process and those who went the extra mile to support me.

First of all, I would like to thank my graduation supervisors, Zjenja and Mehmet for all their time, effort and knowledge they contributed to this research. Even through my sometimes incoherent presentations, they always had constructive feedback and were the bumpers to the bowling alley that was the beginning of my process. I tremendously appreciate the amount of meetings we had, which was beyond what I expected after hearing from all my friends about their experiences.

I'd like to thank my parents, for continuing to support me through all my studies, and all my nieces and nephews, and my sister, for not graduating before me - even though I gave you all the opportunity to do so -.

Working on project can be a lonesome business from time to time, but luckily there were always people to share my thoughts with, from my roommate, dear friends and bureau-buddies to those who kept on asking "so, anyway, how's your graduation going?". I thank you all.

# 1. INTRODUCTION

---

In this report the research project that investigated creating a reversible interlocking system for 3D printing incompatible polymers is discussed. An introduction to this goal is given, after which the used methodology is provided.



## 1.1 Introduction

This research aimed to improve the recyclability of polymers that are being used in Multi Material Additive Manufacturing (MMAM). The target was to provide a method of joining two polymers in a manner that allows for disconnection at the end of the products life.

During this research, a look was taken at how polymers are recycled, and in what way a could waste stream be created that allows for recycling. This was used as a foundation for developing a broad spectrum of possible solutions, which were thoroughly tested based on specific requirements. 3D printing is becoming an increasingly big part of the production industry, with MMAM being an upcoming sub-category of this. With its increasing market share, the footprint of this industry becomes ever more important. MMAM can combine many polymers to form products with interesting, combined properties.

Though the pure polymers used in this process are relatively simple to recycle, contamination with other polymers can have disastrous effects on the quality of the recycled material. As not all polymers adhere to each other very well, MMAM uses techniques to join these with mechanical interlocking methods, which prevent the polymers from being able to separate and be recycled. In this report research was done towards a new interlocking method that allows the polymers to be separated when necessary.

In order to understand the fundamentals of this research, it is important to have a basic knowledge of FDM, MMAM and polymers. This can be found in the following paragraphs.

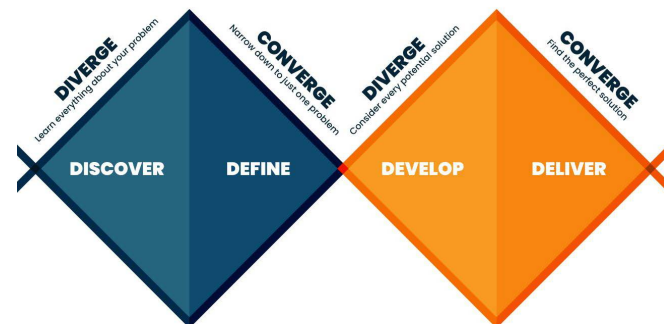

Figure 1: Example of a double diamond approach

## 1.2 Methodology

### 1.2.1 Literature

For the literature research, a double diamond approach (figure 1) was used. First, the project cue was used as a starting point to gain knowledge regarding FDM, polymers and recycling. From this, a broad foundation was formed and many fascinating possibilities and developments were noted. From these, the relevant ones were filtered, narrowing down on knowledge that could be used to create the desired outcome. The chapter “Design Framework” shows the relevant research. In the chapter “Problem Definition” the concluded knowledge gap is stated, and how this research contributes.

### 1.2.2 Designing solutions

Both the disconnection and connection method were primarily developed using knowledge gained during the literature research. A combination of adapting current methods and findings, and examining material properties was used. With this, brainstorming led to a broad spectrum of possible solutions.

The disconnection was chosen by verifying viability of the options with simple tests and selecting the most promising one.

The development of the connection method was separated in three phases, each of which with its own aim.

**The first phase** aimed at designing and evaluating a variety of connection methods, narrowing it down to two with the most potential.

**The second phase** was used to improve on these selected methods by optimizing the geometry of these selected methods, as well as the print parameters involved and determine which would be the definitive method.

**The third phase** was used to implement the improvements found in phase 2 and develop the final design.

This approach was chosen due to the amount of possibilities that was presented during preliminary research, as with this method a broader range of connections could be evaluated.

### 1.2.3 Validating solutions

The testing of the solutions was done on the basis of the requirements which were set for the design. Each of the aforementioned phases ended with an analysis of their performance in the three main criteria, and their performance regarding the disconnection, which was done with the tests as described in chapters 5.1 and 5.2. For both tests, samples with the connection methods were made. All samples were modelled with the same outer dimension, ensuring fair comparisons. The connections on the connective faces differed from sample to sample. The samples were 60x20x4 mm (LxBxW) for the strength test, and 40x20x4 mm (LxBxW) for the disconnection test.

After the final design was chosen, this method was implemented in specific products to validate its applicability beyond laboratory conditions.



## 2. BACKGROUND

---

In this chapter, to better understand the FDM process, an introduction to the matter is presented. Furthermore, the principle of Multi Material Additive Manufacturing and the incompatibility of certain polymers is explored. Hereafter, the materials that were used are described, together with relevant FDM characteristics. Finally, the methodology is explained.





## 2.1 FDM

Fused Deposition Modeling (FDM) is an additive manufacturing (AM) process that involves the layer-by-layer deposition of thermoplastic materials to fabricate three-dimensional objects. To create a 3D printed object, a designer can create their design in a CAD software, building a model that can be imported into a so called “slicer”. This program can translate the model to something a 3D printer can understand; a code called “G-code” (Gao et al., 2021).

The FDM process consists of several key components, including a 3D printer, a heated nozzle, and thermoplastic material filaments. The thermoplastic filament is fed into the printer and guided through the heated nozzle. The nozzle is maintained at an elevated temperature, causing the filament to soften, and become malleable. The softened filament is then extruded onto a build platform according to the instructions provided by the G-code.

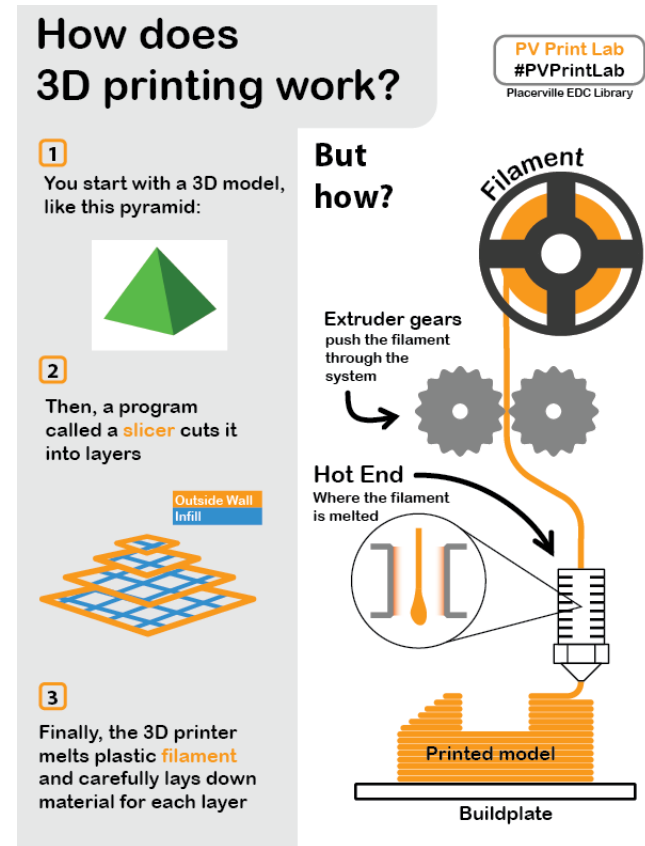

Figure 3: Infographic of the FDM process (u/legocatseyeguy, 2019)

Material extrusion is the fundamental principle underlying the FDM process. As the filament passes through the heated nozzle (figure 4), it undergoes controlled melting. The molten material is then extruded onto the build platform in a predetermined pattern, to form the first layer of the object. Once the layer is complete, either the build platform is lowered, or the print head raised, and the process is repeated for subsequent layers until the entire object is constructed (Rajan et al., 2022). Figure 3 shows the process. With this, a product is constructed that consists of many extruded polymer lines which are “welded” together. Through this, the product is non-homogenous and has anisotropic characteristics, an interesting property that can be used in the design process but should also be considered as a possible weakness (Mesnil et al., 2023) (figure 2).

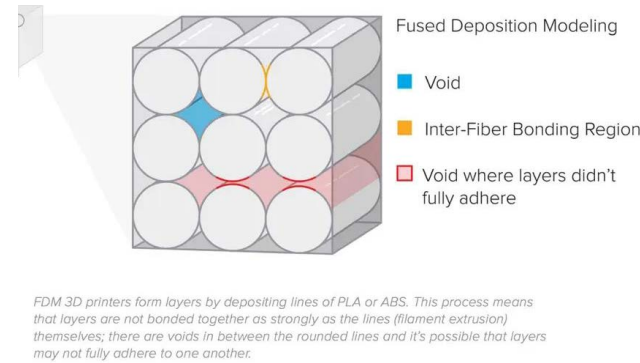

Figure 2: Explanation of the non-homogeneity of FDM prints (Guide to Stereolithography (SLA) 3D Printing, n.d.)

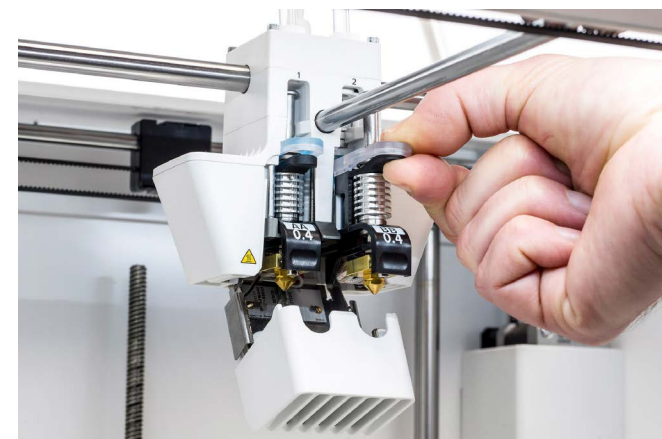

Figure 4: Nozzles of a specific 3D printer (Jakk, 2022)

In the industry, FDM is seeing more and more use, as the possibilities with this production method increase. There is a wide variety of materials that can be used, from durable engineering-grade thermoplastics to general purpose printing, or strong carbon fiber materials (FDM 3D Printing - Fused Deposition Modeling, n.d.). Considering that a 3D printer can be relatively cheap, and operable with minimal training, it is a commonly used method of creating prototypes and proof of concept, personalized products or small batches. With the 3D printing market expanding by 18 to 27% annually (Joshi, 2023), it is a relevant research field in order to have an impact on future production lines, and the recycling of these products. With 68% of the companies using 3D printers stating they use them to produce prototypes, and 59% of using them for proof of concept (Joshi, 2023), these produced products only see a short use, making recyclability of these that much more interesting.

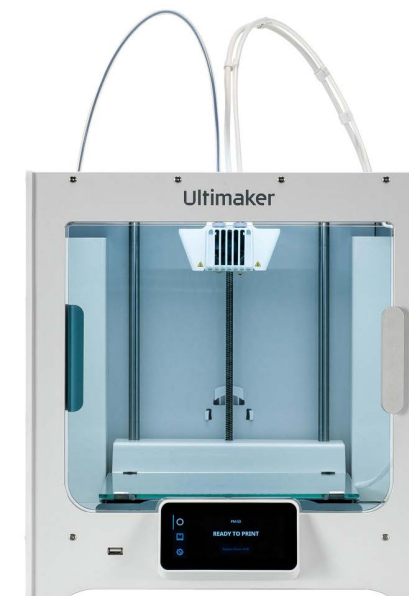

Figure 5: An Ultimaker S3 for MMAM (Jakk, 2022)

## 2.2 MMAM

In some cases, a products functioning depends on the use of multiple materials. As the standard FDM process produces single material parts, we look to Multi Material Additive Manufacturing (MMAM) to solve this problem, eliminating the necessity to involve manual labour into the process (García-Collado et al., 2022). MMAM is the next step in 3D printing in order provide a feasible alternative to common production methods. Printers capable of MMAM have either two or more nozzles or can use one nozzle for multiple filaments (figure 6). The printer used in this research, an Ultimaker S3 (figure 5), works with the multiple nozzle principle (figure 4). Using multiple filaments during the printing process enables a wide range of complex objects with varying properties, colours, or functionalities. At the moment, it is possible to print functional batteries, mechanical actuators and sensors, though in this research we'll only look at applications which use polymers as a base material. MMAM will be useful in the production of soft robotics or rapid prototyping of advanced structures (Team, 2023). More examples of these applications can be found in chapter 3.3, an overview of the relevant industries in appendix B. This technology can be a game changer for some production lines, as increasingly complex products can be constructed without the any human intervention and without additional production steps. At the moment one of the key drawbacks is the reduced adhesion at the joining area, due to materials with different chemical and physical properties (García-Collado et al., 2022) which is where this research focused on and for which at the moment many different possible solutions are being proposed, all with different benefits and drawbacks.

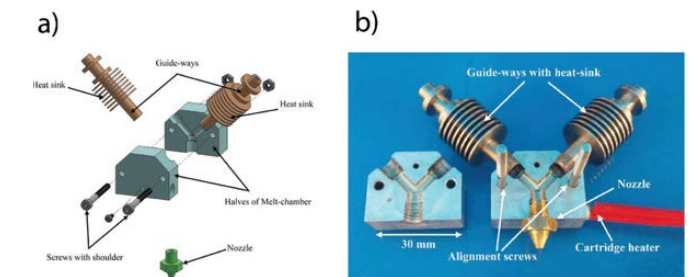

Figure 6: A single nozzle multi-material hotend and nozzle (Rafiee et al., 2020)

### 2.3 Incompatibility

Inherent issues with the finished parts of FDM still exist, with for instance a poor surface finish, limited resolution, slow build speed and bad adherence between printing layers (Zheng et al., 2021). This last issue comes even more in to play when working with dissimilar materials, such as is the case in this research. The strength of the connection between the previous layer and the newly extruded filament is largely based on the forming of polymer chains and intermolecular diffusion between both layers (figure 7), which is significantly less likely to happen between two dissimilar materials, mainly due to chemical differences, but also due to using solid and immiscible materials (García-Collado et al., 2022).

Lopes et al. (2018) shows us that besides the chemical affinity, the difference in mechanical characteristics can be cause for poor interlayer bonding. This can be caused by their difference in thermal contraction and expansion, causing the layers to delaminate during the cooling process, leading to weak areas in the printed part.

### 2.4 Combining incompatible materials

The advantages of using MMAM in production are of significance to a lot of industries, leading to research into solutions for the incompatibility of some the materials seen in figure 8. The strength of the multi-material interface was analysed by Ribeiro et al. (2019), who examined various mechanical interlocking joints. The findings revealed that the macroscopic structure of the interface (mechanical interlock) had a more significant impact on the strength of the interface joint compared to material compatibility. This is something that was observed in a lot of the solutions that have been proposed in the past, most of which rely on mechanical interlocking, an irreversible connection method. In chapter 3.2, the most relevant solutions proposed in literature will be touched upon.

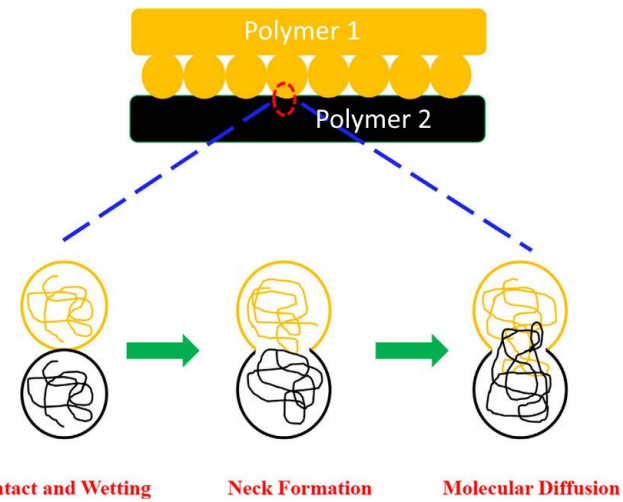

Figure 7: Schematic overview of molecular diffusion between polymers during 3D printing (Rabbi & Chalivendra, 2021)

	PLA	Tough PLA	ABS	Nylon	CPE	CPE+	PC	TPU 95A
PLA	✓	ⓘ	✗	✗	✗	✗	✗	✗
Tough PLA		✓	✗	✗	✗	✗	✗	✗
ABS			✓	✗	✗	✗	✗	ⓘ
Nylon				ⓘ	✗	✗	✗	ⓘ
CPE					✓	✗	✗	✗
CPE+						ⓘ	✗	✗
PC							ⓘ	ⓘ
TPU 95A								ⓘ

Figure 8: Supported material combinations (Castaneda, 2023)



## 2.5 The materials

A broad spectrum of materials that are not chemically compatible exists. A solution that can be applied to all material combinations would be ideal, making implementation and execution much easier for users. When considering the vastly different properties of the polymers, it does seem highly unlikely this will be possible, as for an interactive connection such as the one to be developed, these properties will play an increasingly large role. For this reason, the decision was made to focus solely on one material combination, PLA and TPU, as mentioned in the introduction. If the developed method has any other application cases, this is considered in the discussion.

For this research, the focus was on two specific materials, being PLA and TPU. These materials were chosen because of three specific reasons. First of all, the combination between a flexible and a stiff material offers a lot of opportunities for interesting developments and can be a surrogate for many current products, as can be seen in chapter 3.3.

Secondly, PLA is one of the most used polymers in 3D printing (Hogan, 2023).

Furthermore, PLA is a polymer derived from natural sources like sugarcane and cornstarch, making it a more environment friendly alternative. With an ever growing demand for bioplastics, this market is expected to grow by 19.8% from 2020 to 2027 (3D Printing PLA Market - Global Opportunity Analysis and Industry Forecast (2020-2027), n.d.). As such, knowledge regarding this material is more valuable compared to other less used polymers.

### 2.5.1 PLA

PLA (Polylactic Acid) is a biodegradable thermoplastic polymer derived from renewable resources such as corn starch or sugarcane. It is a popular material in 3D printing due to its environmentally friendly nature and ease of use. PLA offers several advantages, including low toxicity, good strength, and dimensional accuracy, with additional mechanical properties shown in table 1. It has a relatively low melting point, typically around 180-220°C, making it compatible with a wide range of 3D printers. PLA exhibits excellent printability, minimal warping, and produces objects with a smooth surface finish (Joseph et al., 2023). It is commonly used for prototyping,

educational projects, consumer products, and disposable packaging applications (Rajan et al., 2022). Additionally, PLA is compostable under specific conditions, further contributing to its eco-friendly appeal (Hasanov et al., 2021).

### 2.5.2 TPU

TPU (Thermoplastic Polyurethane) is a versatile elastomer with excellent mechanical properties, making it ideal for a wide range of applications. It is a type of thermoplastic that combines the flexibility and elasticity of rubber with the processability of plastic. TPU offers high abrasion resistance, tear strength, and elongation, making it suitable for applications requiring durability and flexibility (Bandur et al., 2008). It has good chemical resistance and can withstand a wide temperature range, with additional mechanical properties shown in table 1. TPU is commonly used in industries such as footwear, automotive, electronics, and sporting goods. In 3D printing, TPU is valued for its ability to create flexible and impact-resistant objects, such as gaskets, seals, and wearable devices (Rajan et al., 2022). It can be printed at temperatures 220–250°C.

Table 1: mechanical properties of TPU and PLA (Brancewicz-Steinmetz et al., 2021)(Ehrmann & Ehrmann, 2021)

	Material	Typical Value
Hardness	PLA	83 (Shore D)
Tensile Modulus [MPa]	PLA	2.346
Yield strength [MPa]	PLA	60
Elongation at break	PLA	5.2 - 10 %
Hardness	TPU	60 (Shore D)
Tensile Modulus [MPa]	TPU	53.7
Yield strength [MPa]	TPU	15
Elongation at break	TPU	318 %

### 2.5.3 Conclusions

The research will focus on developing a method for PLA and TPU. These materials offer a range of interesting applications and as such are widely used in current manufacturing processes, offering an opportunity for a big impact.

## 2.6 Mechanical properties of 3D prints

For this research, the mechanical properties of the finalized method were the main focus, thus warranting a more in depth look at this characteristic of 3D printed parts.

As said before, many parameters influence the mechanical properties of the final part. Much research has been done on this, which can readily be found for implementation in this research.

Second to the parameters, there are multiple factors that can influence the mechanical properties of the final part.

### 2.6.1 Printing parameters

The 3D printing process is highly customizable through the abundance of parameters that can be tweaked in the slicer program to get the desired results. Though there are tens of parameters that can be adjusted, there are some main parameters, which in turn influence a multitude of characteristics of the final product.

The main parameters can be seen as (Domingo-Espin et al., 2015) (Ćwikła et al., 2017)

- Speed (of extrusion and print head movement)
- Temperature (of either the nozzle or the printing bed)
- Line width and thickness
- Pattern (both for infill as for bottom and top layers)

Which in turn, among other things, influence characteristics such as (Huang et al., 2020)

- Mechanical properties
- Surface roughness
- Dimensional accuracy
- Tolerance control

### 2.6.2 Directionality

As the FDM process creates anisotropic materials/parts the three principal directions have a significantly different properties, these being the raster direction, the transverse direction and the build direction. This mainly has a big impact on the elastic modulus and the strength (Huang et al., 2020). Knowing this, prints can be optimized for certain goals. (Arifvianto et al., 2022) found that PLA has the best tensile strength when the

force is applied in line with the extruded filament (figure 9), while TPU has the best bendability when it is rotated with the filament extrusion lines as an axis for the rotation.

### 2.6.3 Surroundings

As stated in – paragraph about parameters – every change has an influence on the final product. Thus, it stands to reason that outside influence can alter the mechanical properties. For instance, gusts of air, high humidity, instable foundations and a deviation of the room temperature can all change the quality of the printed part (Demirtaş & Avcioglu, 2023).

### 2.6.4 Material

The quality of the material can influence the outcome of a print. Some polymers bond with the hydrogen in the air, which can make the material more brittle. At the same time, during the heating process, this water can evaporate, causing small bubbles in a print (Alexandra, 2022). Besides this, the size of the filament should be very accurate. If the printer receives a smaller diameter filament than expected, it will extrude too few of it. As with many polymers, filament will degrade over time due to environmental factors, so storing it properly and using it as soon as possible increases the print quality (Speight, 2020).

### 2.6.5 Conclusions

While developing the method, it is important to create a consistent environment and keep controlled parameters. Not only the geometry determines the final result, but all steps from the design until the production can influence the outcome of this research.

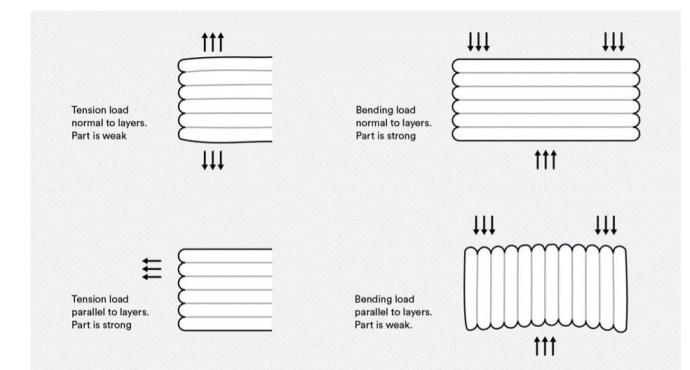

Figure 9: The importance of line directions in 3D printed parts (3D Printing Part Orientation: Why It Matters, n.d.)



# 3. DESIGN FRAMEWORK

---

A broad literature research is done to determine the knowledge gap and the approach that should be taken. Current solutions are touched upon, as well as the current recycling situation.

To develop a connection method for this production method, it was important to keep in mind the final applications. This meant knowing what kind of products might use the design, but also how these can be used. From this the framework was created which guided the requirements for the final design.

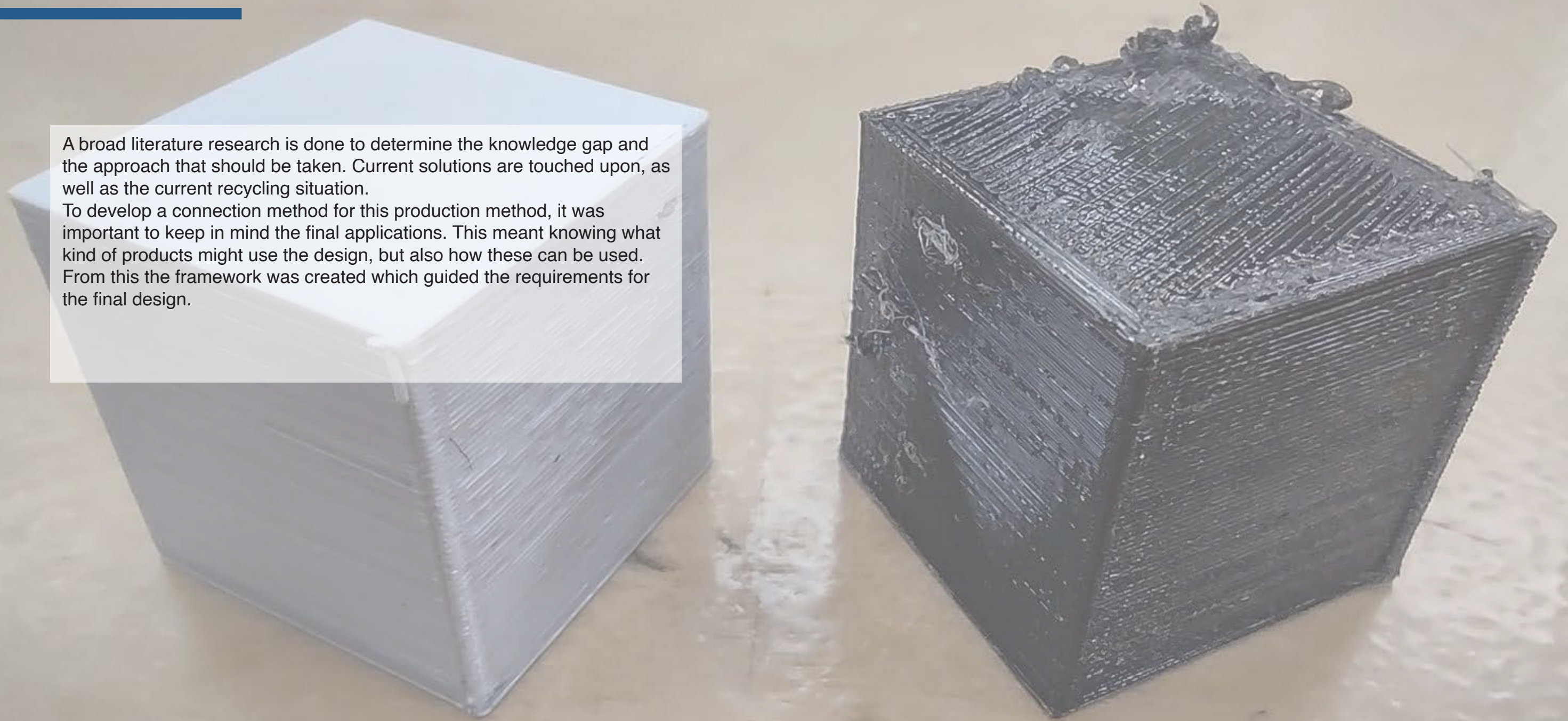



### 3.1 Recycling

The butterfly diagram or circular economy system diagram that can be seen in figure 10 is a well known principle for designers working within the field of sustainability. It shows the continuous flow of materials in a circular economy and exist of two main cycles: the technological cycle and the biological cycle. The technological cycle ensures the continuous circulation of goods and materials via strategies encompassing reuse, repair, remanufacturing, and recycling. Conversely, the biological cycle facilitates the replenishment of natural resources through the restoration of nutrients derived from biodegradable materials to the Earth (The Butterfly Diagram: Visualizing the Circular Economy, n.d.).

In the technical cycle, the preferred order is from left to right, thus recycling being a last resort for products, as it reuses the least of the products value and returns less “energy” than the other options. This being said, this does not mean that we should not optimize our products and methods for recycling. For some applications, this is the only viable option; think of prototypes which can serve no other purpose after production, something that is much applicable to many of the PLA parts that are being printed.

Research has shown that multiple factors influence recycling behaviour in individuals. The most common motivations are moral motivators, in which feelings of pride and altruism are the main ones (Ma et al., 2019) (Vining et al., 1992). Though people might have the best intentions, people are less inclined to participate in a recycling initiative if there is a lack of proper conditions or when the perceived effort increases (Stoeva et al., 2017).

#### 3.1.1 Polymer recycling

With polymers being abundantly used in today’s society, over 320 million tons in 2015 alone (Beckman, n.d.), it isn’t strange that we try to recycle much of it. Still, a lot of it isn’t. Main motivators for this are, for instance, energy, logistics and economical issues (Cruz Sanchez et al., 2017), and the degradation of the quality of the polymers (Mikula et al., n.d.).

The recycling of polymers can be divided into three main categories.

- Mechanical recycling: in which the polymer is reheated and extruded to a new shape. The main issue with this method is the degradation of the polymer chain, leading to reduced characteristics, leading to, for instance, brittle materials. The addition of virgin materials into this process can render

the degradation almost null (Mikula et al., n.d.), with for instance a 50/50 ratio of virgin and recycled PLA there is no noticeable degradation (Zhao et al., 2018).

- Chemical recycling: In chemical recycling, the polymer is de- and reconstructed in a chemical process. This could in theory create an infinite loop, where repolymerisation occurs, without deteriorating the mechanical properties of the polymer. It is cheaper and more efficient than creating new polymers, and it can also deal with contamination of other kinds of polymer, reducing the need for pre-separation (McKeown & Jones, 2020) (Majgaonkar et al., 2021). At the moment of writing, this is not yet done on a big enough scale to implement in any waste stream management system (McKeown & Jones, 2020).
- Composting: Some polymers, like PLA, are bio-polymers. These polymers, like other bio-based products, can be composted. The bio-polymer is ground and composted, which creates compost and CO2 (Cosate de Andrade et al., 2016). In this case perfect separation also is not necessary. Though the composting of PLA sounds like an easy solution, even for this specific conditions are necessary, for which high-rate composting facilities are necessary (Grappling With the

Infamous #7 PLA Recycling Code - McGill Compost, 2022).

In a comparison study done between the three recycling methods by Cosate de Andrade et al., (2016), it was found that for PLA, the order of preference from an environmental point of view is firstly mechanical, secondly chemically and thirdly, a long way down, composting. Figure 11 very clearly shows the impact these methods have on respectively climate change, human toxicity and fossil depletion.

#### 3.1.2 PLA and TPU recycling

From the previous paragraph it was concluded that to have the most impact, this research should strive to develop a method that delivers materials that can be mechanically recycled. Importantly, from conversations with an expert, it became clear that no contamination would be acceptable in the case of mechanical recycling.

PLA and TPU can be recycled without the introduction of virgin materials, but this does create inferior products. After six cycles, TPU can not be used to 3D print (Vidakis et al., 2023). For PLA this is even smaller, at two cycles (McKeown & Jones, 2020). Furthermore, it can be seen that the initial heating that takes place during printing already induces polymer degradation (Zhao et al., 2018).

The aforementioned expert also told that while PLA is being recycled a bit, at the moment, this is much less the case for TPU. The main field in which mechanical recycling is done is the filament industry itself. For PLA, they use waste material from their own production lines. From what can be found, recycled TPU is mainly produced from other products, like old ski boots.

#### 3.1.3 Conclusion

From this research, it was concluded that the method should aim for mechanical recycling, which means that it cannot have any contaminations. In order to ensure people participate in recycling, the effort to perform the necessary steps should be as low as possible. The TPU waste stream that gets recycled is mainly from non-3D printed applications, while PLA is gotten mainly from within the 3D printing industry. Combined with the apparent lack of large scale TPU recycling, the focus should be primarily on the recyclability of the PLA.

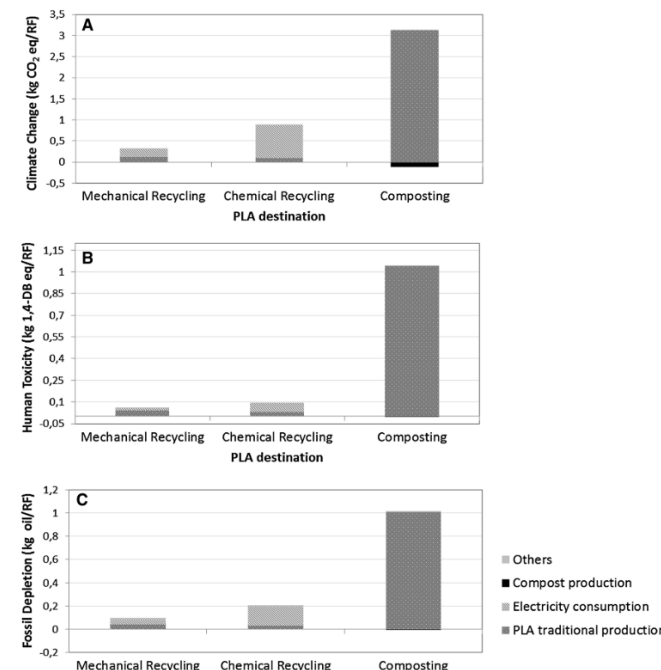
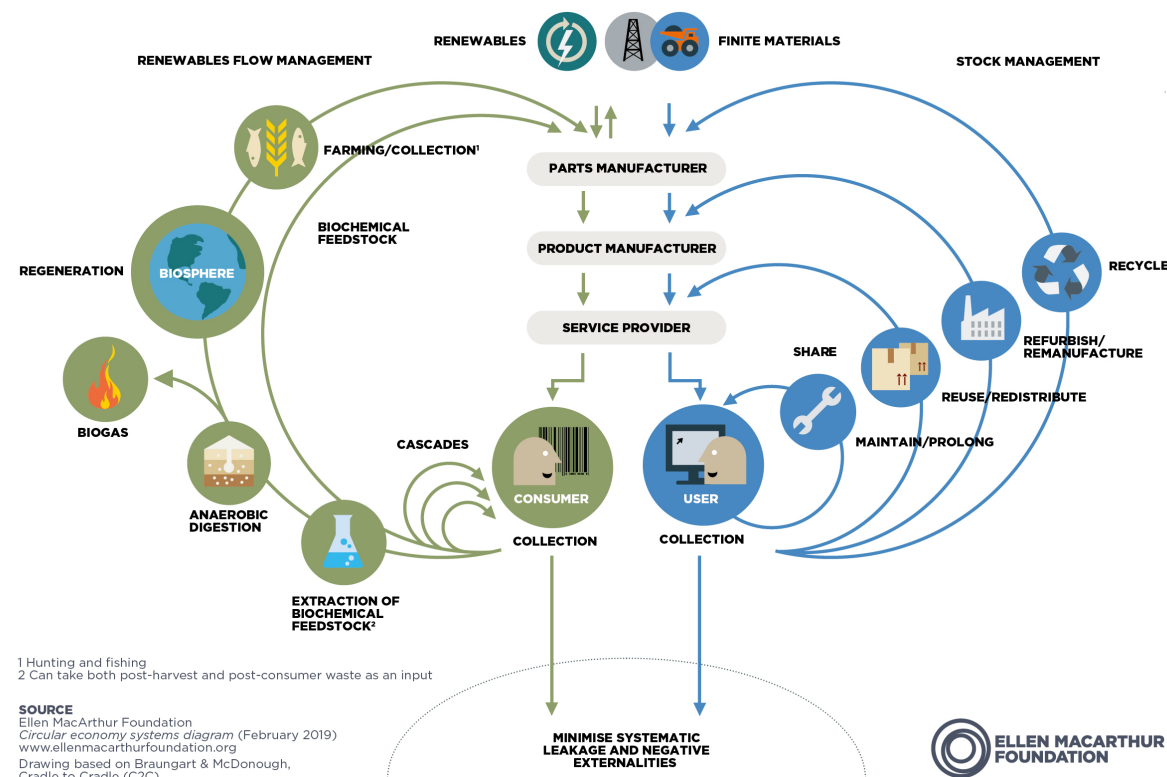

Figure 11: Environmental impacts breakdown of three evaluated PLA destinations (Cosate de Andrade et al., 2016)

Figure 10: The butterfly diagram explaining the continuous flow of a material in a circular economy (Inachai, 2022)



### 3.2 Solutions from literature

As mentioned before, solutions to combine two chemically incompatible materials are already out there and in use, with some implemented in well-known slicers as Cura. These solutions can form a solid foundation for the initial ideation, as these are connection methods that have been proven to work. Tough these were not designed for disconnection, the findings of these researches should be considered nonetheless. The methods mentioned in this paragraph are not the only ones, but a selection of the ones most relevant to this research has been made.

#### 3.2.1 Alternating layer method

The alternating layer method, or “sandwiching” is a connection method which relies on friction. Both materials are printed in an alternating pattern, creating an overlap which can increase the strength of the connection for each layer added (figure 12). For some time, this was the primary connection method within Cura.

Arifvianto et al. (2022) found that due to the materials having different contraction rates during cooling, delamination or cavities can form. Furthermore, using orthogonal layers (0/90 deg) made for a stiffer material. This method is widely applicable and has a relatively high tensile strength, with the ratio TPU/PLA being the limiting factor, as the TPU has the lowest yield strength (Arifvianto et al., 2022).

The strength of this connection is approximately 6.25 MPa, with an overlap of 8mm.

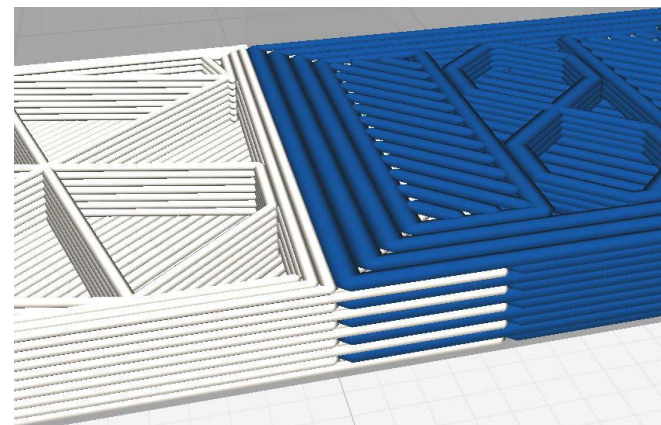

Figure 12: The Alternating layer method, using PLA (white) and TPU (blue)

#### Observations

In order to understand the workings of this connection, some test samples were printed.

This connection can be rather weak in thin samples, as delamination occurs quickly when bending the TPU (figure 13). The less the connection itself bends, the less chance of delamination there is. As a test, vertical PLA connections were inserted into the sandwich structure, which all but eliminated the delamination (figure 14). As an improvement to this method, it is recommend implementing this in your next print when using this method. Thin samples could be separated in order to aid clean disconnection, but pieces thicker than 1.5mm were not able to disconnect cleanly.

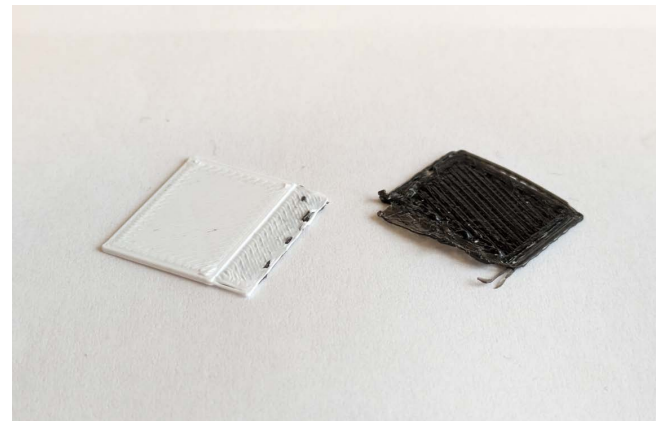

Figure 13: The Alternating layer method, using PLA (white) and TPU (black), can be separated for very thin samples

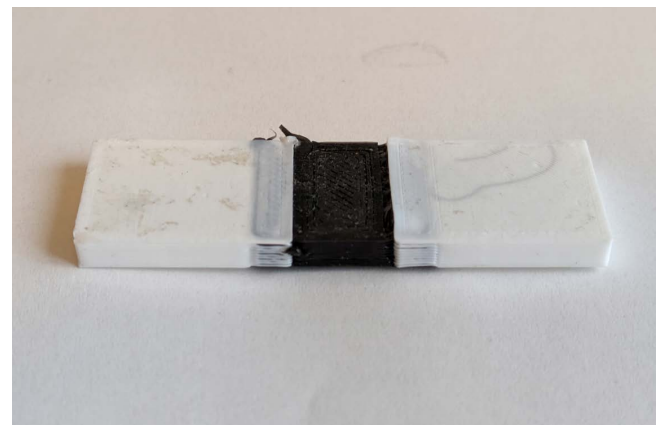

Figure 14: The Alternating layer method, using PLA (white) and TPU (black), can't be separated for most samples

#### 3.2.2 Hacksaw

The hacksaw method was implemented in Cura in the beginning of 2023. This method relies on alternating fingers which extend into the other material and which are turned every x layers by 90 degrees (figure 15). This way, not only are the materials horizontally locked, vertically the materials are strongly connected to themselves in a strong bond as well (Kuipers, 2020). The amount and thickness of the fingers, as well as the depth of penetration into the other part determine the strength of this connection.

The strength of this connection is approximately 5.8 MPa.

#### Observations

In order to understand the workings of this connection, some test samples were printed (figure 17). This method is very stiff, but also very secure. The main concern can be the continuity of the extrusion, which can have some impact on the quality of the TPU part. Furthermore, it is a little slower than the sandwich method.

It was not possible to disconnection the polymers, making the recycling of these parts impossible.

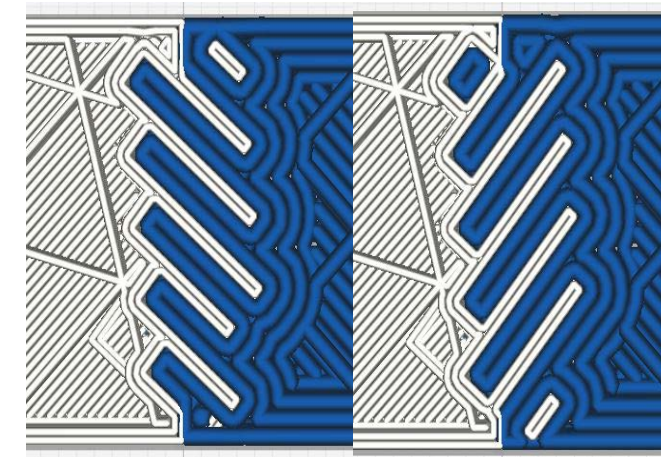

Figure 15: The Hacksaw method, which alternates per layer. Layer 63 (left) and layer 64 (right)

#### 3.2.3 Weaving

With a 3D printer, not all paths have to be planar. Under the right circumstances, one can use non-planar movement (movement in the z-axis) during the printing of a layer to connect layers more tightly together. In a graduation paper from Vlist (2021), this was used to create a joining method which, strength wise, was comparable to the methods in Cura, at 6 MPa. The pathway can be seen in figure 16. For this method, disconnection was not possible.

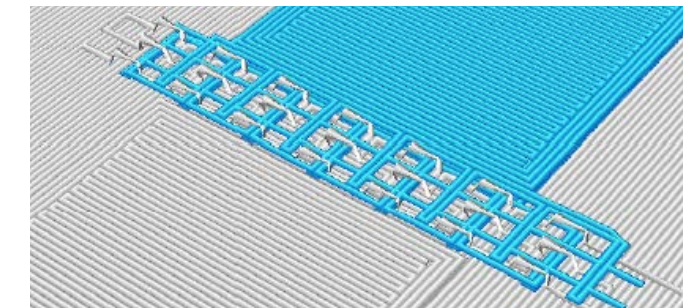

Figure 16: The pathway of the weaving method (Vlist., 2021)

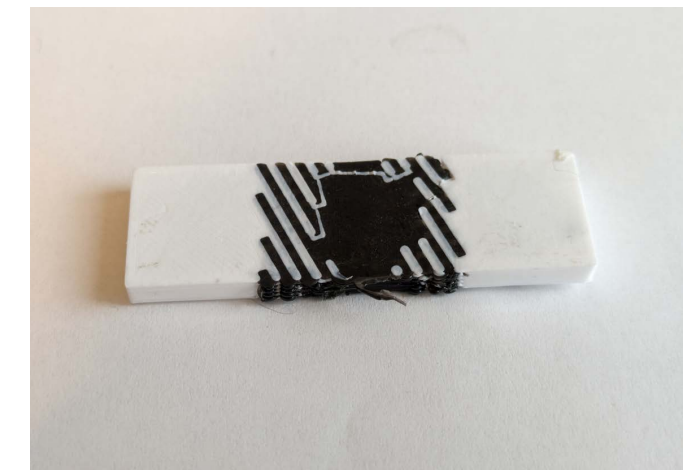

Figure 17: The Alternating layer method, using PLA (white) and TPU (black), can't be separated for most samples



### 3.2.4 Lattice and beads

The lattice and beads method are very comparable methods and are both unique due to the fact that they are the only connection methods which work in a vertical orientation. This connection relies on recepticals in the bottom material, which can be filled with the top material by means of overextrusion (figure 18). With this, they create a connection roughly 3 to 4 times stronger than a simple face to face connection (Kwon et al., 2021). Though the parts could be separated, this could not be done without contaminating the polymers, making it unfit for recycling.

### 3.2.5 Interlaced infill

Interlacing infill is a method that uses the infill as a connection point. By alternating infills, and weaving them together in intricate patterns, they can create strong connection, and even allow for more than 2 materials to be joined (Mustafa et al., 2021). This method can create joints that are as strong as the materials in use. Figure 19 and 20 show an example of this method.

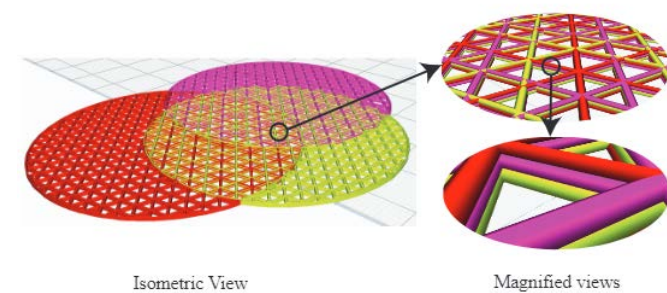

Figure 20: Materials alternating in subsequent layers with the interlaced infill method (Mustafa et al., 2021)

### 3.2.6 Conclusions

A wide variety of solutions is known, with very different approaches. Each of these has their own unique benefit. The one thing that almost all have in common is that it is physically not possible to disconnect them due to the way they are mechanically interlocking. In paragraph 2.1, it was concluded that for proper recycling the polymers should be able to disconnect without contamination, which is not possible with any of the current solution, showing a clear knowledge gap which will be increasingly important with the increased application cases of MMAM in different industries, as mentioned before. Using the findings from these researches regarding the parameters that provide good results, these researches can still be taken into account when designing a new method.

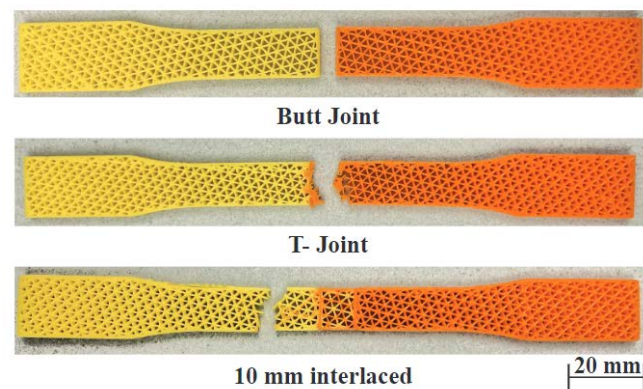

Figure 19: A showcase of the strength of the interlaced infill method (Mustafa et al., 2021)

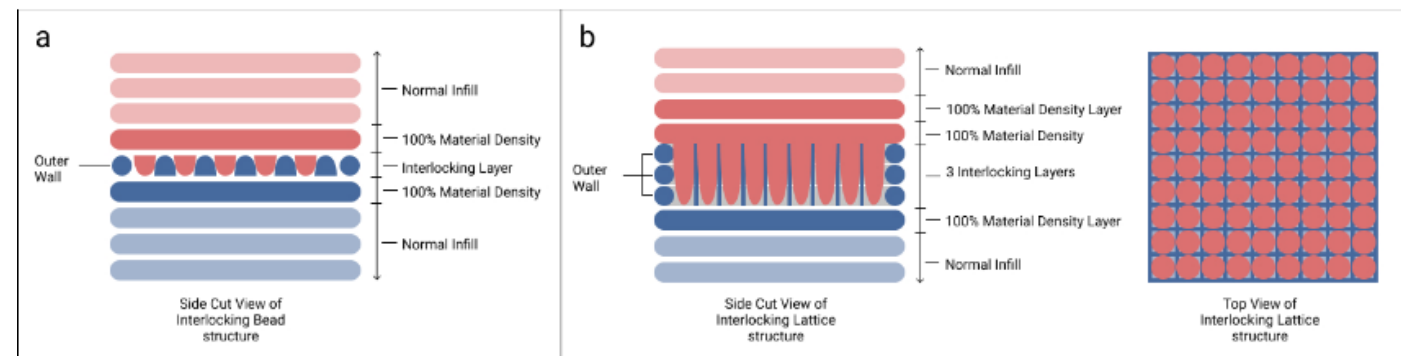

Figure 18: The lattice and beads methods, with the main difference being the depth of the recepticals (Kwon et al., 2021)

## 3.3 Application analysis

Connecting two materials can be done in multiple ways, each being applicable and excelling in certain use-cases. To narrow down the design space, a survey was done in to which product categories and industries could benefit from implementing MMAM with a TPU-PLA combination, and what kind of forces and limitations this would imply. From this, requirements could be created which ensured the viability of the design.

In engineering, there are five main forces to consider (Fairly Fundamental Facts About Forces and Structures, 2023). These are (figure 21 and 23):

- Tensile
- Compressive
- Shear
- Bending
- Torsion

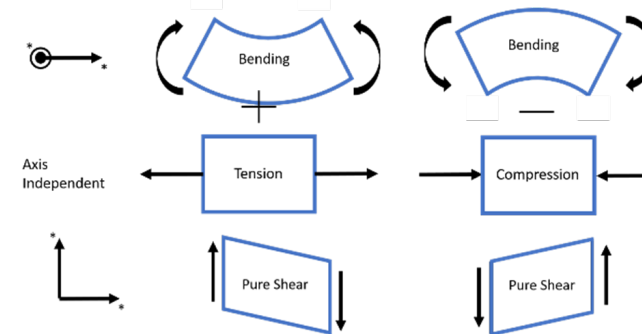

Figure 21: The five main forces (Fairly Fundamental Facts About Forces and Structures, 2023)

Products in which a TPU-PLA connection could be applied were sorted by the main force that this product would encounter (figure 22). What can be seen is that bending is the largest use case, with compression and torsion together in second place. Importantly, many of these products also encounter the other forces, or that same force in multiple directions. As such, it is important the design allows for these motions to still be used,

without risk of failing due to this. The exact forces for these use cases are hard to pin down exactly, as each use case presents its own unique characteristics.

Because of this, the design should deliver an experience and security comparable to the current alternatives.

To meet possible industry demands and address diverse product configurations efficiently, the to be developed method should incorporate a repeatable multi-axial pattern. This choice not only aligns with industry needs for versatility but also ensures the method's adaptability to unexpected challenges and various product shapes and sizes. Not only the product itself, but also the industry in which the method might be used could be of interest. Broader research towards industries that implement MMAM can be found in Appendix B.

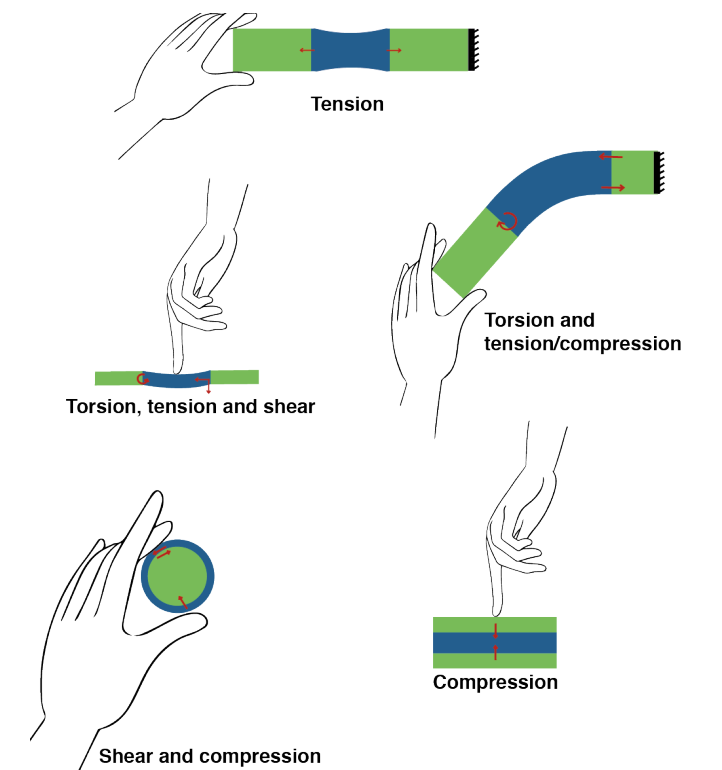

Figure 23: The main forces that will be applied to possible PLA-TPU connections

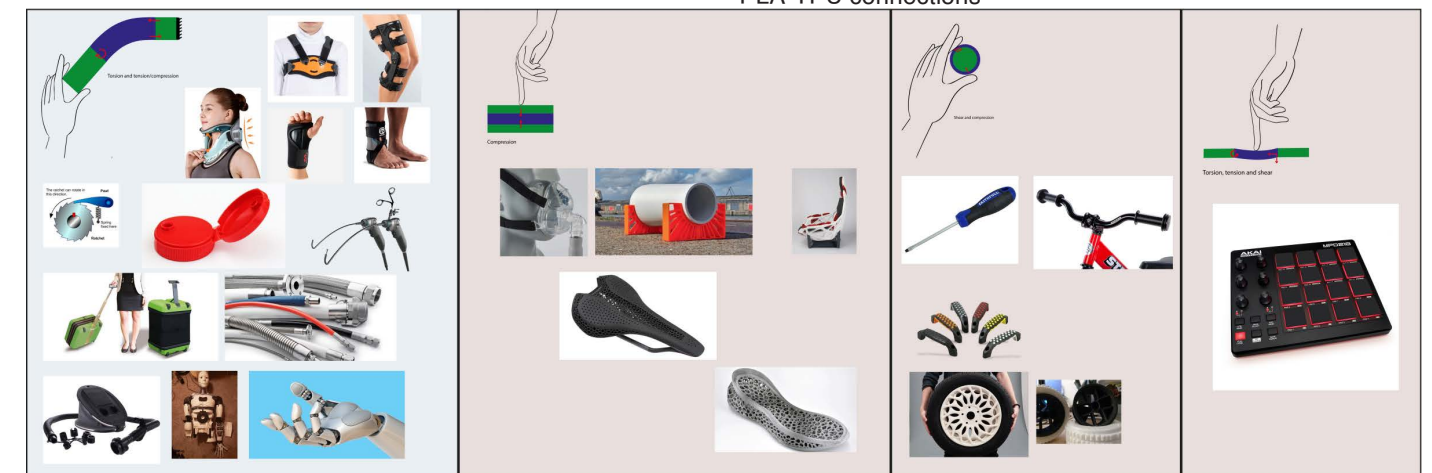

Figure 22: Possible use cases of the PLA-TPU connection, sorted by main applied force

### 3.4 Discussion

From these results it was concluded that many products that could benefit from a PLA-TPU connection rely on the bending properties of the TPU. From this, it was concluded that first and foremost a method should be created that accommodates this, while still considering the other forces. As bending is simply a moment created by a tensile and compression force, the method should have a high tensile strength and be able to withstand the bending forces normally applied. The compressional strength is less of a concern, as this force does not act to separate the two materials.

An interesting opportunity that arose was the possibility to expand this method towards the area of repairability, which can benefit the environmental impact of 3D prints as can be seen in the butterfly diagram. For now, this was beyond the scope of the current project, but it might create an interesting starting point for future research.

It is important to note the threat that might arise with a new connection method that is built to disconnect, being the perceived quality of the connection. It was detrimental to be wary of this and it was important to demonstrate that the quality is comparable to current connection methods being used in the industry.

Progress can only happen when we allow things to change, but within an environment based on gains such as many industries, the resistance should be considered that arises when new developments - especially when they don't immediately benefit the corporation - require a high initial investment. Because of this, and because of sustainability reasons, a solution should not require a change in the hardware of the 3D printers. For the same monetary reasons, print time should not increase significantly, as the famous saying "time is money" is very applicable here.

### 3.5 Define focus

With the insights from previous chapters, the decision was made to have the primary focus on the uncontaminated disconnection of PLA, in contrast to the uncontaminated disconnection of both polymers. The main motivators for this were:

- PLA can be composted or mechanically recycled, and this is happening on some scale at the moment, contrary to TPU.
- As found in chapter 3.1, for the recycling of PLA and TPU, no contamination is allowed. Because of this, the margin for errors is incredibly small. With this focus, we created some leeway in our design space, as contamination of TPU will not be seen as a failure.

As such, this project was successful if a method was found that could deliver a uncontaminated piece of PLA after separation. The uncontaminated disconnection of the TPU was a secondary objective.

### 3.6 Requirements

From the research done so far, we could extract the requirements for a solution that would be viable and desirable. These can be found in table 2.

Table 2: List of requirements for a successful design

	ID	Description	Type	Reason	Source	Means of compliance	Used for
Performance	1.1	The method should connect the two materials such that it can withstand a tensile force comparable to available alternatives	quantitative	The created pieces should not fail while in use and should not be a downgrade from not-seperable options	Application analysis	A tensile test with benchmarks will be performed	assessing viability of the method, concept choice
	1.2	The method can withstand the intended bending without failing and function as good as current alternatives	quantitative	The piece should not start to detach on its own after it gets bend a certain amount of times and should not be a downgrade from not-seperable options	Application analysis	Comparitive tests will be done	assessing viability of the method
	2.1	The PLA can be detached without being contaminated	quantitative	PLA that is contaminated can not be recycled properly	Contact with expert	Disconnected elements show no trace of the other material	assessing viability of the method
	2.2	The detachment can be performed without specialized equipment	qualitative	This method should be very approachable. Recycling should be as easy as possible to gain traction	Chapter: recycling (Stoeva et al., 2017)	The only necessary tools should be tools that can be expected to be present in a place where 3D printing is used	assessing viability of the method
Production	3.1	Method can be performed on the most used dual extrusion printers, without a change in hardware	qualitative	This method should be very approachable. Recycling should be as easy and cheap as possible to gain traction, buying new parts or printers is not sustainable.	Chapter Design Framework	The only changes necessary are in a design or in the slicer	assessing viability of the method
	3.2	The method should not take much longer to print than regular methods	quantitative	This method should be very approachable. Recycling should be as easy and cheap as possible to gain traction	Chapter Design Framework	The method is no more than 5% slower than the hacksaw method	assessing viability of the method
Geometry	4.1	The method should exist of a pattern that can be easily repeated multi-axial	qualitative	This way the method can be implemented in products of different sizes	Application analysis	The method can be repeated in two axis	concept choice



# 4. PROBLEM DEFINITION

---

In previous chapters it was found that MMAM has some big hurdles concerning material compatibility that are slowly being conquered. Through mechanical interlocking, materials can be joined. The downside to this development is the fact that these materials are permanently joined, something that raises questions about the recyclability of the products that are being constructed this way.

In literature, no clear mention is made of any attempts to create a connection between two incompatible materials that can be disconnected for recycling, showing a clear knowledge gap in this area. In this thesis, this knowledge gap will be addressed and filled with relevant expertise. A connection method that is comparable to current alternatives, can cleanly disconnect to allow recycling and is easily implemented in a wide variety of applications will be designed. The design challenge for this thesis as such is:

*“Develop a reversible joining method for chemically incompatible materials for Multi Material Additive Manufacturing equivalent to or surpassing current alternatives and with versatile applicability to create a more sustainable workflow”*





# 5. DEVELOPMENT AND DESIGN

---

In this chapter, the process of developing and deciding on a disconnection method is shown, with as final result a process relying on controlled heating. After this, the considerations and criteria that guided the development of the connection method are outlined by taking a look at the fundamental ways of creating an interlocking connection. After this, the three phases of development of the connection method are shown, with intermediate results that guided the iterative process being presented. The chapter concludes with presenting the final design and results.

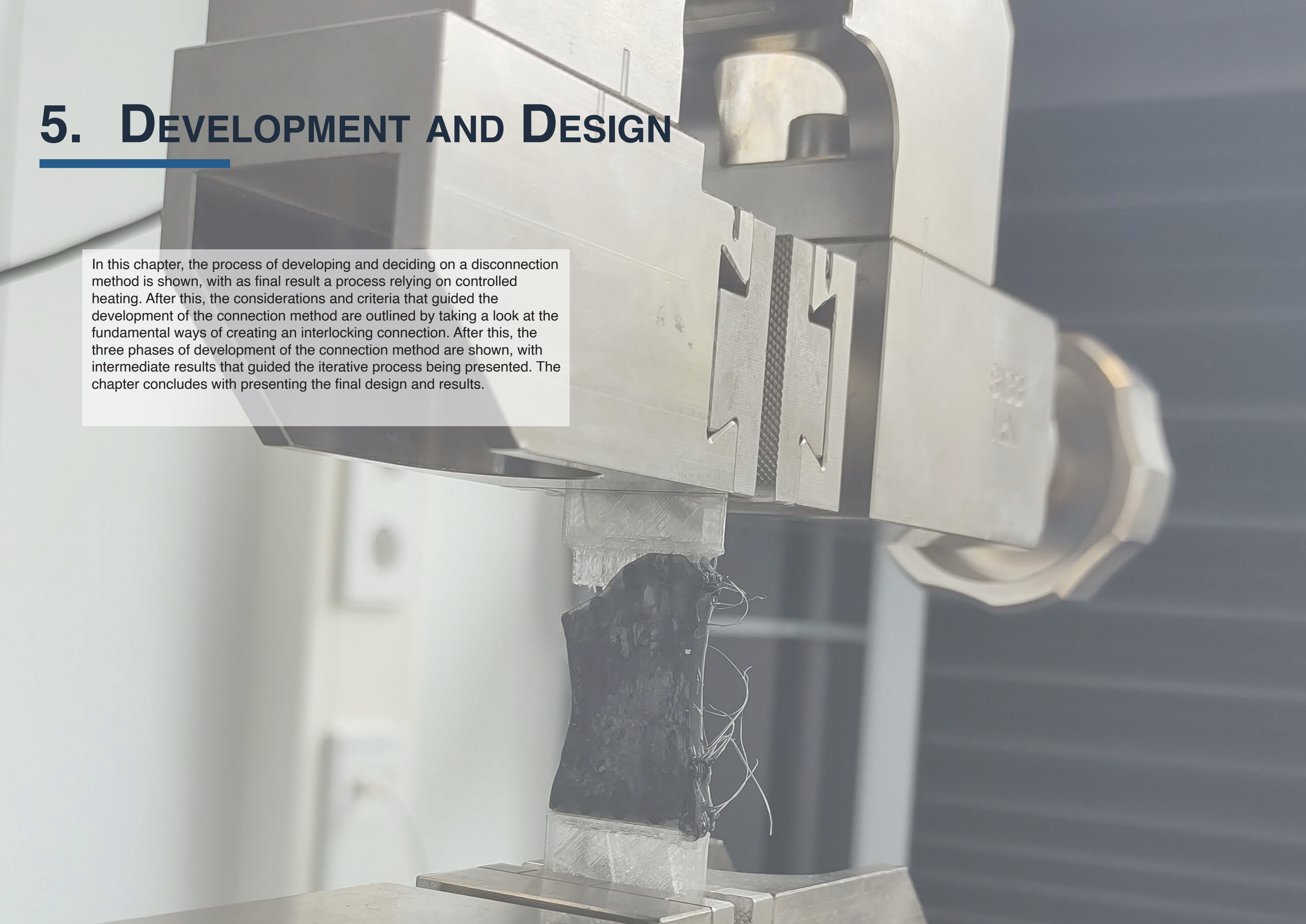



# 5.1 Disconnection

As stated before, the method will be judged on three main factors, being the strength of the connection, the ease of separation and the pattern size. During preliminary research, it was concluded that not the connection, but the disconnection would be the limiting factor for developing a method, as implementing a clean “release” mechanic into a small print would require a high amount of precision and control. Besides this, designing connection methods with no way of disconnecting them would be very counterproductive. As such, first of all the method of disconnection was determined. In the next paragraph, the considered methods are shown, after which the decision for the definitive method is explained.

## 5.1.1 Potential disconnection methods

In order to disconnect two elements that are sturdily connected, two possible changes can be made to the parts.

- Breaking: a part can break in such a way that the connection does not hold anymore, letting the two parts separate.
- Deforming: a part can deform, either temporarily or permanently, disengaging the connection to separate both parts.

These two main separation methods can be accomplished in multiple ways. These approaches are shown in figure 24.

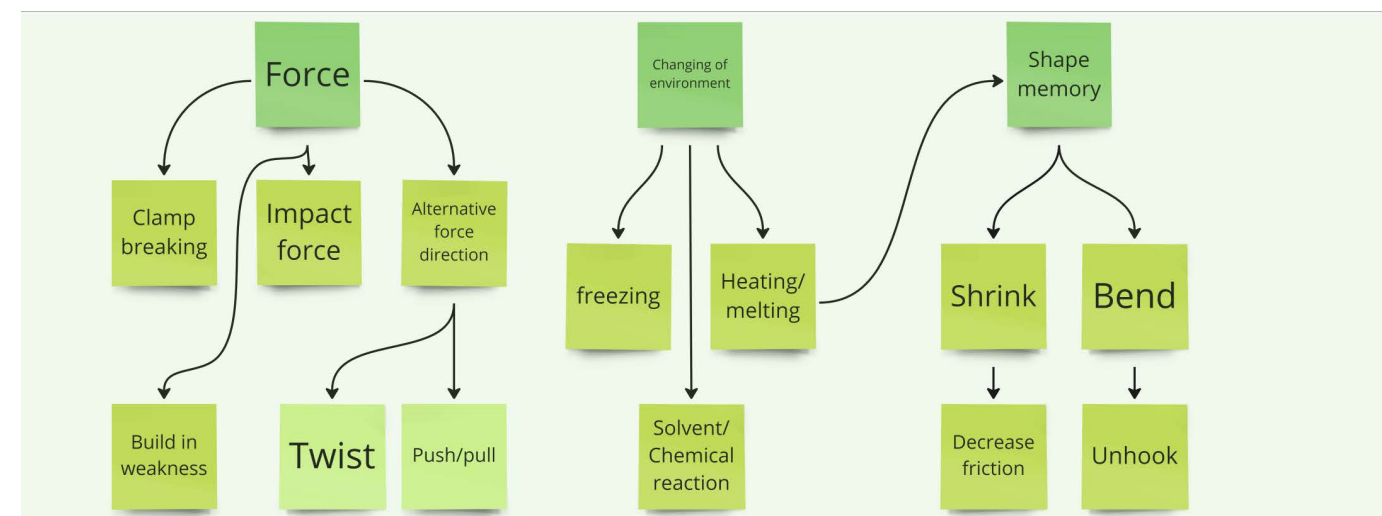

Figure 24: Different approaches to disconnecting two parts from each other

As can be seen, the main categories are methods that rely either on applying force in a certain way, or methods that rely on a change in the environment of the part, with the use of the shape memory effect as a big sub-category.

## 5.1.2 Testing potential disconnection methods

In order to verify the feasibility of these methods, multiple small scale tests were done. It was quickly concluded that almost all force-based methods were not feasible, as either the inherent weakness that was built in to aid disconnection, affected the day to day strength, or limited the range of application.

Regarding the methods relying on the changing of the environment, the option to freeze samples and thus create a situation in which the TPU was brittle was disregarded, as it could potentially lead to small amounts of TPU contaminating the PLA. Using a chemical process could be interesting, as for instance PLA can be composted, a chemical process. Furthermore, there are chemicals that can dissolve the PLA. In the end, it does mean that the PLA is not able to be mechanically recycled, the preferred method. Due to this, the method was disregarded.

This left the heating of the samples and the use of shape memory effect as possible solutions, with no immediate drawbacks.

### Testing of the shape memory method

In the FDM process, the filament is heated above the glass temperature and deposited on a surface. During this, the material is stretched. Depending on print speed, temperature and cooling, a certain amount of tensile strain (residual stress) can thus be stored in the part when it solidifies (Zhang et al., 2022). When we reheat this part, the residual stress is released, as the polymer chains return to their shorter state. Normally, this means the part will shrink in the same direction as it was stretched, but, when multiple layers with different amounts of residual stress are stacked, the movement can be converted into a bend, fold or many other actions (An et al., 2018).

With this principal, attempts were made to create connections that could unhook themselves when heated. Though initial tests were promising and showed that it was possible to control the bending of PLA parts, even at a small scale (figures 25 to 29), all attempts to implement this in combination with TPU surrounding the PLA bore no fruit.

The hypothesis is that due to the encapsulated heat in the surrounding TPU, the residual stress is being dispersed before it can be “activated” later on. Besides this, the friction of the contact surfaces needs to be overcome by the shape memory effect, which for polymers generates a low force. Because of these results, the method was deemed not viable.



Figure 29: Testing the different speeds at which PLA will still adhere to the TPU



Figure 25: Testing the folding and bending of thin PLA samples with different printing speeds



Figure 26: Testing if the shrink force was strong enough to detach a thin piece of PLA, which it was not.



Figure 27: Testing folding in different directions at the same time



Figure 28: Verifying that the PLA can be detached from the TPU with the SM effect.

### 5.1.3 Proposed disconnection method

After some preliminary tests (figure 30 and 31), the heating method was found to be relatively easy and very promising, with a very broad implementation range. This method relies on heating the parts to a certain point, at which the PLA becomes soft and can be pulled away from the TPU.

### 5.1.4 Disconnection method description

Both PLA and TPU are thermoplastic polymers, as are all filaments that a FDM machine uses. These polymers are characterized by being able to be remelted and recast almost indefinitely. This characteristic also means that these materials can be heated to soften them.

The point at which a polymer becomes malleable is called the ‘glass transition temperature’, which gradually builds up to the melting temperature. Before this, we have the Vicat softening point, which is also called the “softening point” of the polymer (Bastida et. al, 1993). Each of these is unique per polymer, which we can use for this method. As can be seen in table 3, for TPU this value lies at 138, while PLA has a value of 44. This means that, if the connection can be heated to somewhere between these values, the PLA will deform, while the TPU does not. Pulling the polymers apart will then separate them.

*In this way, we create a release mechanism that can be triggered by heat, while maintaining full strength under normal conditions.*



Figure 31: Disconnecting heated PLA from TPU

### 5.1.5 Material considerations for disconnection:

There were some important aspects to consider with this disconnection method. First of all, it was detrimental to keep the disconnection in mind when designing. The method relies on exerting a certain amount of force on the connection. As such, there should be a place to grip, clamp or attach something to the object. Furthermore, as the PLA becomes soft, considering what to heat and what not to heat should be done before engaging the disconnection.

This method will only work with materials with a significant difference in their Vicat softening point. As such, this method is best applicable to the PLA-TPU connection, but a PLA-CPE (with a Vicat softening point of 110 degrees) or PETG-TPU (85 degrees) connection could be considered.

Table 3: Relevant PLA and TPU material properties for proposed method

	PLA	TPU
Glass transition temperature [°C]	60	-16
Vicat softening point [°C]	44	138
Melting temperature [°C]	150	210



Figure 30: PLA after being disconnected from the TPU

### 5.1.6 Testing and Validating Concept

We were able to create the desired effect in some test samples that were created, as can be seen in pictures 30 and 31. This was done by submerging the sample in hot water and pulling it apart with pliers. For the testing of the developed methods, a fixed temperature was used, as well as a jig to ensure accurate and repeatable results. Throughout each of the development and validation phases, this was used to ensure the developed connection method did not interfere with the disconnection method in a negative way.

The setup for these experiments can be seen in figures 32 to 34. For any tests considering the disconnection, there were two main criteria on which the samples were tested.

First of all, the contamination of the samples, meaning that there should not be any residue of TPU on the PLA, and preferably neither the other way around.

Secondly, the necessary force when pulling the sample apart. The lower this value, the easier and thus preferable a disconnection will be.

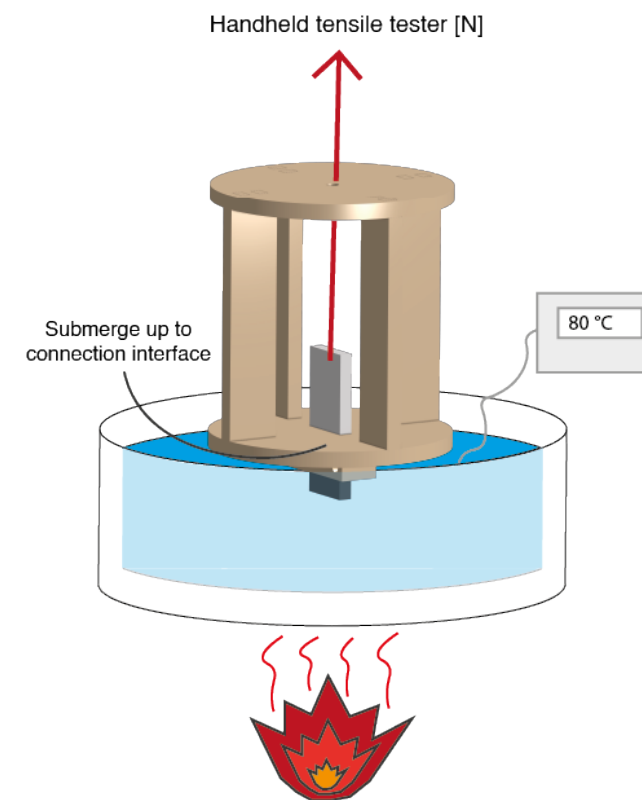

Figure 34: The test setup

Samples were printed with one part PLA and one part TPU. The TPU was clamped, such that the sample could be inserted in the jig. With this installed, the jig with the sample was inserted into the water which had a constant temperature of 80 (+-2) degrees. After 30 seconds, a constantly increasing force was applied by hand, with the use of a force meter. This jig ensured that the force would always be parallel to the direction of the connection. This continued until the PLA disconnected from the TPU, or the elongation was at 300%. At this point, in case the disconnection was successful, the peak force was noted.



Figure 32: The test jig



Figure 33: Clamped samples



## 5.2 Connection

In this chapter, the framework regarding the development of the connection method will be shown as well as the validation of these connection methods. The basic assumptions and the criteria that were used to assess the connections will be explained. Furthermore, the test setup and design approach will be considered. In the end, the data that was found will be analyzed and it will be stated how this will be used to decide the next phase of development.

### 5.2.1 Defining the Framework

The main criteria for the connection methods were, as taken from chapter 3.6

- Strength of the connection
- Ease of disconnection
- Pattern size

### 5.2.2 Starting point and considerations

There were three main types of connection which were of interest (Figure 35):

- Geometrical interlocking: Geometrical interlocking occurs when you can't put together or take apart the separate pieces without doing at least one of the following: (1) lifting the pieces into a higher-dimensional space, (2) changing the shape of at least one object (like bending or stretching it), or (3) cutting at least one piece into two or more smaller pieces. (Estrin et al., 2021)
- Topological interlocking: this is a method where one piece is securely locked within a group of pieces by using the shapes and positions of the surrounding pieces to create constraints that hold it in place. (Williams & Siegmund, 2021)
- Friction

The determined disconnection method will mainly rely on deforming the PLA. Thus, it was deemed that a geometrical interlocking method should be the main focus of the connection development. Furthermore, friction would always be in play and as such could be a secondary way to achieve a better connection. Finally, the slight adhesion between PLA and TPU was considered as essential to create clean boundary layers (the transition layers from TPU to PLA).

From calculations which can be found in appendix A, it was found that the optimal ratio of PLA to TPU in the connection should be 1:4 in an arbitrary connection, if considering the yield strength. This ratio is based on the cross area at the interface between PLA and TPU, and as such does not take into account any possible failures at other points, but it gives a ballpark estimate which can be used as a starting point when optimizing the design.

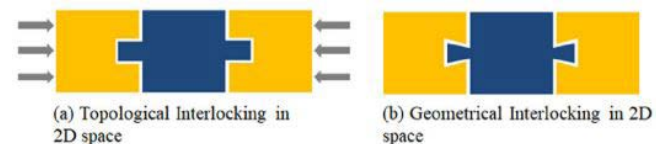

Figure 35: Conceptual examples of topological and geometrical interlocking are illustrated (Estrin et al., 2021)

### 5.2.3 Testing of the connections

As mentioned in the requirements, the specimen should have a strength comparable to available alternatives. This was tested on the tensile testing machine. The test was done twofold, to eliminate variations due to printing defects. If it became clear that a significant deviation between two samples occurred often, the number of tests per parameters could have been increased to create a more reliable result. As can be seen in the results, this was not the case.

#### Shape of the test specimen:

The most common way to test additive manufactured plastics is with a dogbone sample (ASTM D638 - 14) (Tensile Testing for 3D Printing Materials, n.d.) (figure 36). This is because this creates a "forced" breaking point at the thinnest segment. With the tests in this research, a weakest point was already present at the connection between the two materials, so it was less detrimental to force a weak point. Therefore, a rectangular test piece could be used. There were some things that needed to be considered:

- Solid gripping points: The points at which the vices grip need to not dent or slip, thus should be made of solid polymer.
- The stretch of the TPU is not relevant as the focus is at looking at the maximum force the connection can withstand, without taking stretch into account.
- To optimally distribute the force over the whole TPU part of the connection, a solid TPU piece would be ideal. However, in common application, this will hardly ever be done. Next to that, it would diminish the flexibility of the TPU in all directions. Because of this, the TPU was not printed with a 100% infill,

All samples were modelled with the same outer dimension, ensuring fair comparisons. The connections on the connective faces differed from sample to sample. The samples were 60x20x4 mm (LxBxW). The TPU part is placed in the middle, with PLA parts forming the grip surface for the tensile tester. With connections on both sides of the TPU, a symmetry is formed which ensures more accurate testing. (figure 37)

For the tests, a Zwick Proline tensile tester (figure 38) was used to analyse the tensile strength of

the connection. Besides the tensile strength, each sample was analyzed to determine the failure mode, which could help improve the next generation of the connection. Results were analyzed through the use of Microsoft Excel, comparing the different connections in both their regular and heated state.

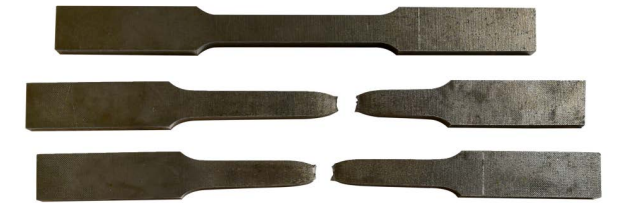

Figure 36: Dogbone tensile test samples (TensileMill CNC, n.d.)

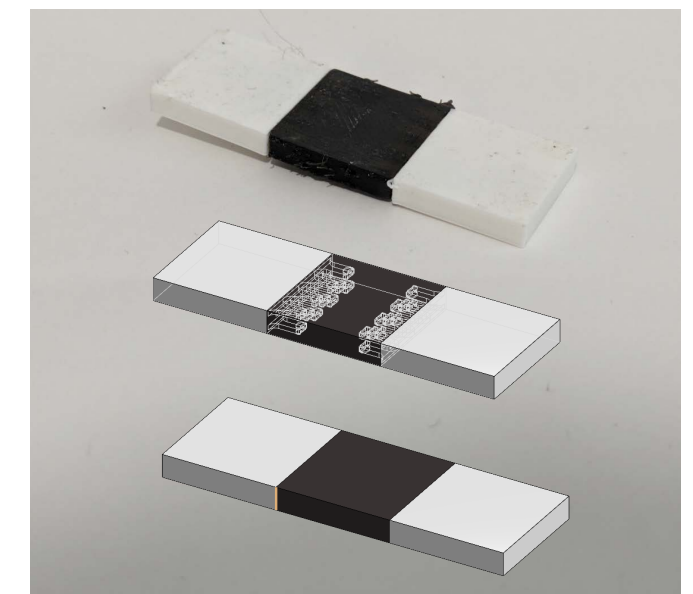

Figure 37: Tensile test sample, from bottom to top: basic outline, inner mechanics, real sample

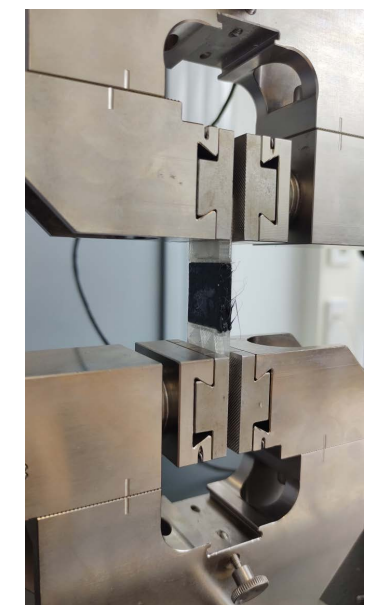

Figure 38: Tensile test setup

### 5.2.4 Printing parameters

To reliably compare the samples, all of them were printed in the same way, with the same parameters. The relevant parameters can be found in table 4. Furthermore, the following factors could have influenced the printing of the samples:

- The samples were printed on an Ultimaker S3
- The 3D printer stood in an encasement, which ensured a constant air temperature.
- Most samples were printed as batches, which can have a slight effect on the layer adhesion and stringing interaction of the TPU. In none of the tests the layer adhesion seemed to have caused serious issue, though the stringing did contaminate the PLA parts in some cases.

Table 4: Sample print parameters

Parameters	Value(s)	
	PLA	TPU
Layer height [mm]	0.2	
Wall Thickness [mm]	1.2	2.4
Nozzle size [mm]	0.4	0.8
Infill density []	15%	30%
Printing temperature [°C]	205	211
Print speed [mm/s]	70	30



# 5.3 Phase 1: Testing of multiple connection methods

## 5.3.1 Introduction to Phase 1

The purpose of this phase was to determine 2 or 3 promising connections which could be researched and improved upon, avoiding the need to take an in depth look at all possible connections. With these tests, the aim was to learn at least the following things:

- What are the failure modes under load?
- In what ways are samples printed, and are all connections printed as intended?
- What forces can the connections sustain, and as such, what can we expect for further improvements?
- Does the disconnection method work as intended?

## 5.3.2 Method

Designing the connection methods was done with the requirements and detachment method in mind. Inspiration was taken from snap fits (Bayern MaterialScience, 2013), carpentry, nature and previous solutions, as stated in chapter 3.2. The main similarity between the designs was the fact that they all needed to be able to “give” when heated, to detach. Nearly all designs employ some kind of bending action to achieve this. With these fundamentals, 40 different connections were designed, which can be ordered in roughly 6 categories, which were based on the geometrical properties. These categories can be seen in figure 39, or in more detail in appendix C. Each has their own ID, which also can be found in appendix C for cross-referencing.

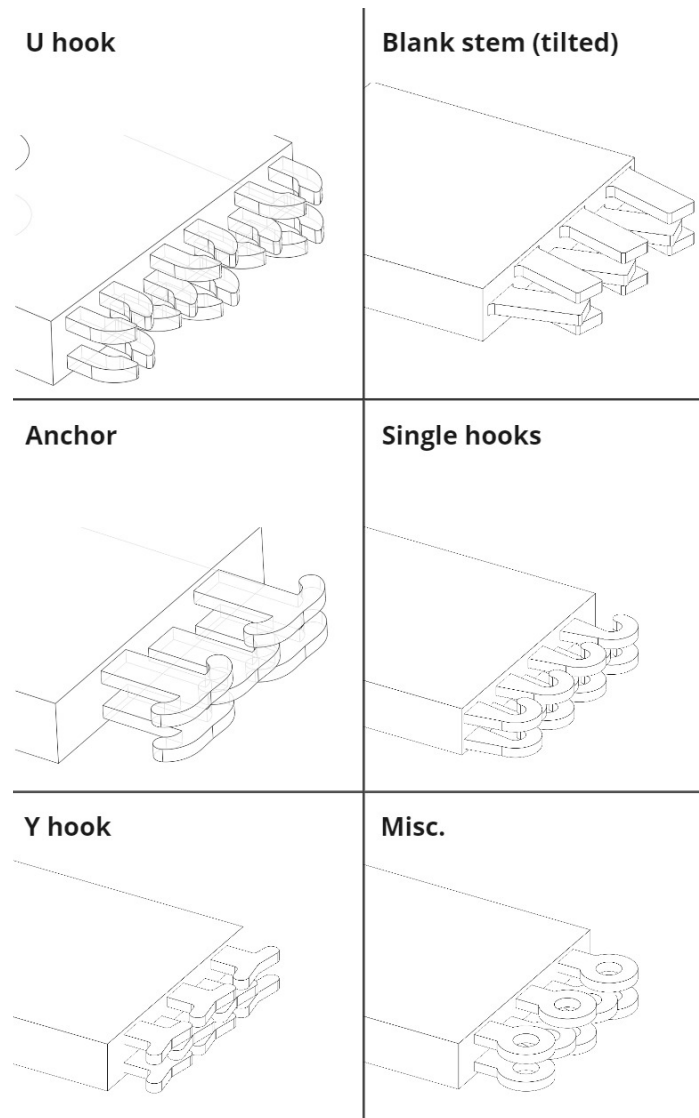

Figure 39: The 6 main design philosophies

## 5.3.3 Results

All samples were tested on their tensile strength and detachment force, using the methods explained in chapter 5.1. In figure 40, the results from both tests can be seen. Here, both yield strength (top graph) and force (bottom graph) are shown. With the force, one can easily compare the samples, but the yield strength gives a more in depth look at how strong each connection is per connective element, as the surface area of the PLA stem is used for the calculation of the yield strength. From this yield strength, no conclusions should be made about the connection strength as a whole, its sole purpose is to illustrate the “efficiency” of the connection per connective element. The samples which were unable to detach were removed from the dataset, which is

the reason not all samples are represented in the graph. From figure 40, looking at the yield strength, there are some clear outliers (samples 34 to 38), which perform very well, with a yield strength well above 20 MPa. These are connections which fall in the “anchor” category. When looking at the overall strength of the samples, these outliers are way less pronounced, or even absent. From this situation, no clear “best” sample can be selected. Looking at the needed force to disconnect (red), these values lie between 22N to 50N and do not seem to be inherently linked to the tensile strength of the sample in cold conditions. Roughly speaking, the heated value is between 7% and 18% of the cold value (figure 41).

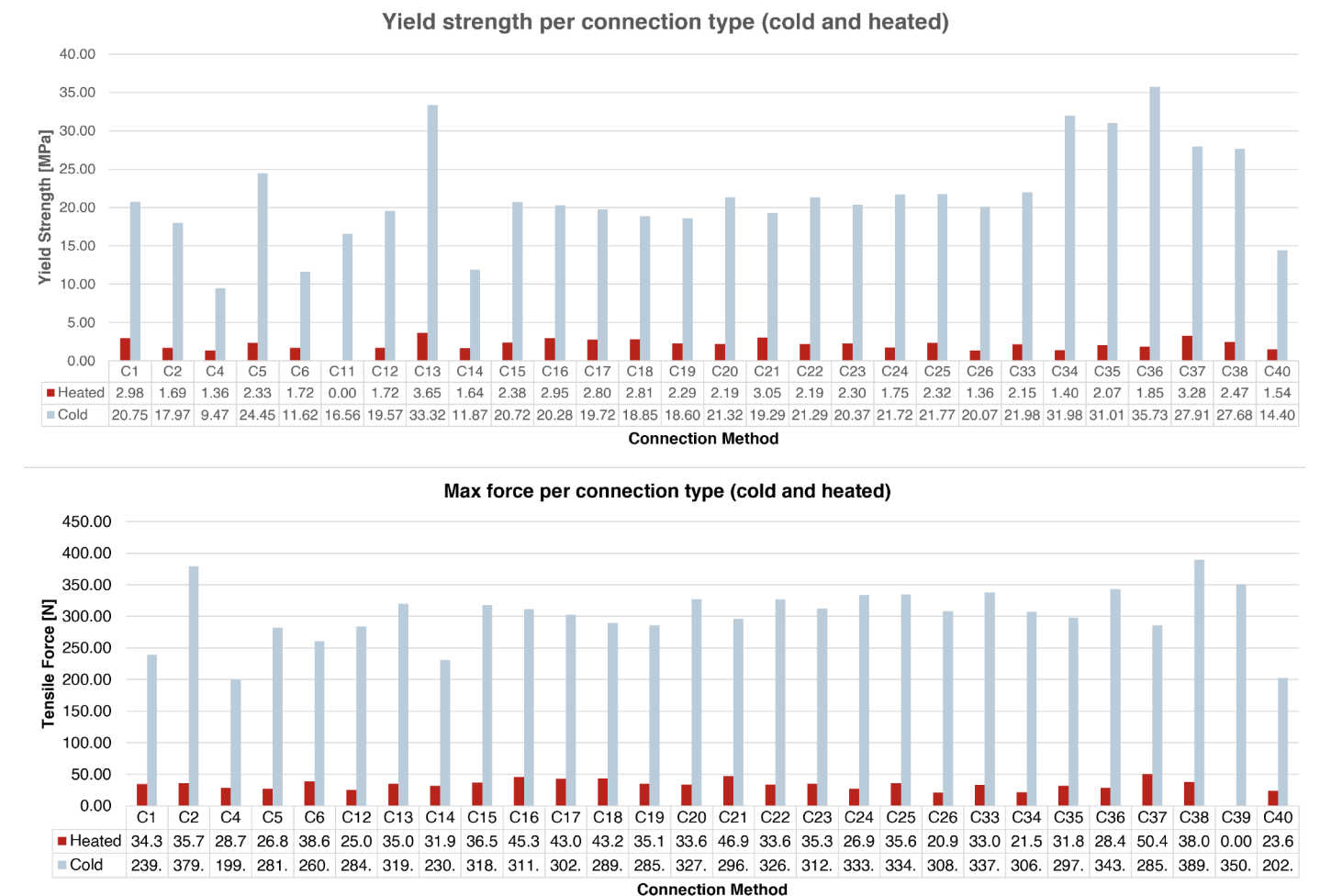

Figure 40: Yield and tensile strength of all connection methods that were able to disconnect. The yield strength is calculated only with surface area of the PLA stems.

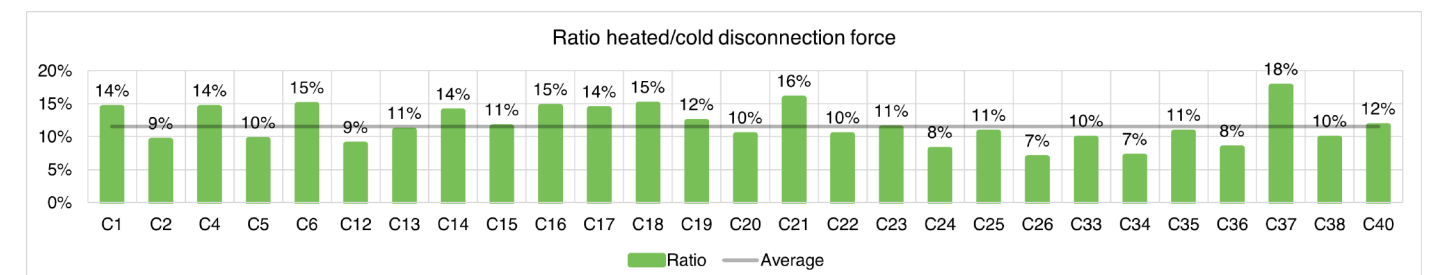

Figure 41: Percentage of force in heated state compared to cold state

### 5.3.4 Observations and Challenges

During the heated detachability tests, it was observed that many of the samples were able to detach cleanly on both sides; the PLA and TPU were able to separate without contamination of either polymer, as can be seen in figure 43. This was a promising result which could indicate the possibility to get back to the original research goal of being able to recycle both polymers.

The hypothesis before starting the tests was that in many cases, the TPU would be the weakest link of the connection, as the material is weaker and previous research seemed to suggest this. Counter to this, nearly all tests showed that the PLA was the failing element in the connection (figure 44). Because of this, connection methods with a higher surface area of PLA at the connection point (the cross section of the stems) showed a better result.

A lot of the samples had issues with the TPU stringing and oozing, which would either interfere with the printing process, or contaminate the PLA (figure 45 and 46). These are known limitations when using TPU in a 3D printer with a Bowden tube, as the retraction is not as accurate as with a direct drive. Implementing an ooze shield or prime tower improved the results marginally.

During the printing process, in many cases the first layer of the connective element would not print as intended due to the poor adhesion of the PLA and TPU. An example can be seen in figure 42. From the second layer of the connective element and onwards, the print corresponded (at least visually) with the sliced model.

Furthermore, we found that the Z-seam caused contamination issues, as this point was very prone to overextrusion, which would wedge itself in between the PLA layers. Preferably, the Z-seam would not be in contact with the PLA, but in Cura, this was very hard to implement.

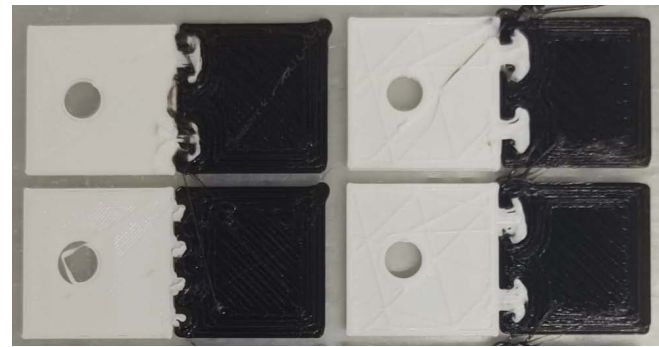

Figure 42: Samples with a failed first layer, different levels of failure



Figure 43: Heated release samples without a trace of TPU contamination



Figure 44: Samples with the PLA failing



Figure 45: Extreme case of oozing and stringing of the TPU



Figure 46: An example of the stringing of the TPU

### Refinement of Criteria and Considerations

As the initial tests showed that the possibility of contamination free disconnection seemed feasible, all connections that could not cleanly be separated were removed from the dataset, which created the graph in figure 47. It can be seen that the “peak performers” from figure 40 are still in consideration, except C2, which means that their performance does not come at the cost of poor disconnection, which could be a logical reason for a connection to be strong. With sustainability being a key factor for this research, being able to recycle both polymers was the ideal outcome.

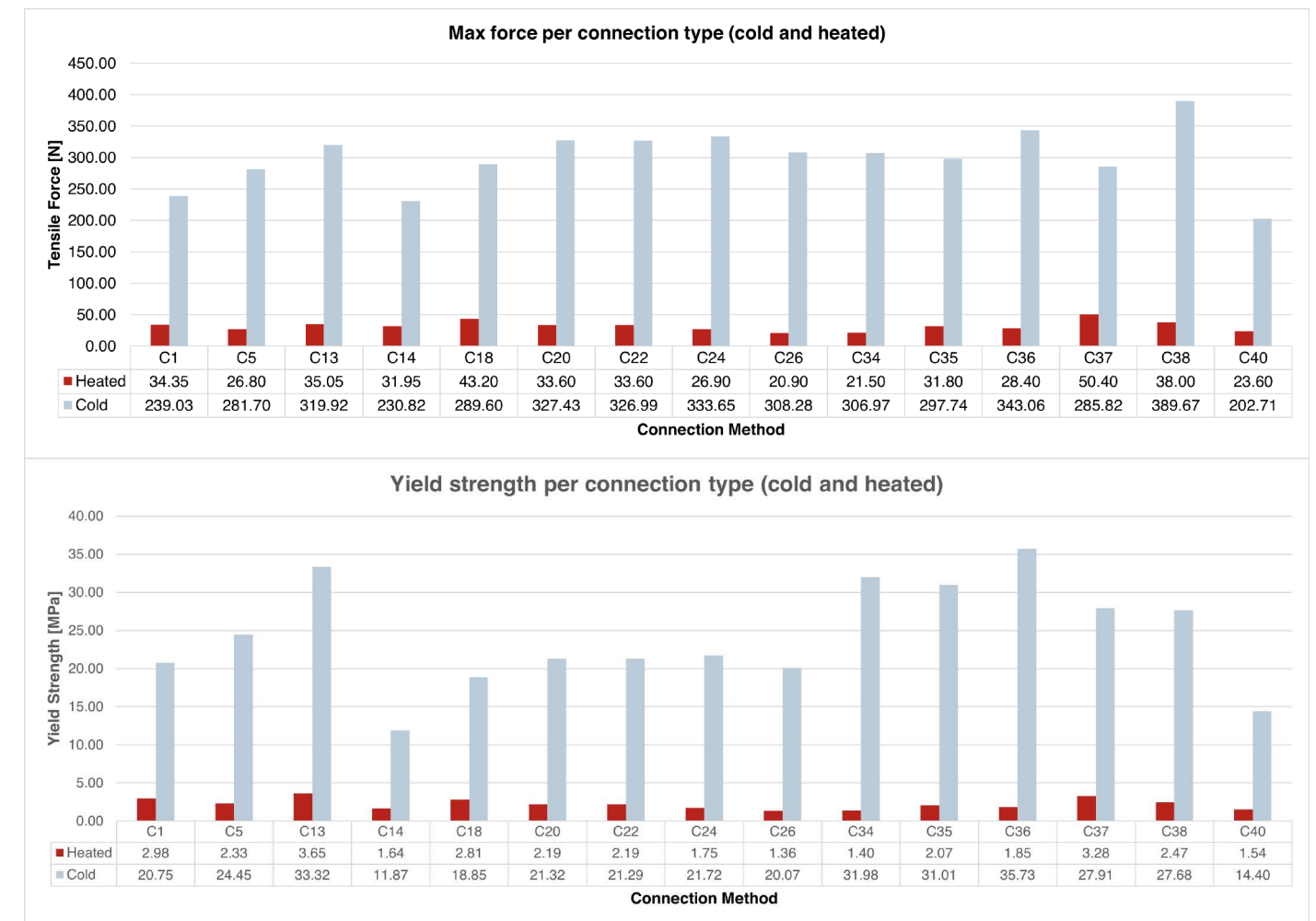

Figure 47: Yield and tensile strength of the connection methods which could cleanly disconnect both PLA and TPU



### Shortlisting of Promising Designs

With these tests, the focus was on finding connections with a high tensile strength under normal circumstances and a low required force to disconnect. The connections which performed best with both criteria were found by filtering the results from figure 47 for all connections that had an above average tensile strength, but below average disconnection force, as well as the connection with the highest overall tensile strength. This yielded the 4 promising connection methods which can be seen in figure 48 and 49. It is clear that type C24, C33 and C36 have a very comparable performance. C38 performs slightly better, with a increase of approximately 17%. The connections C34 and C36 were comparable and could for further research be seen as slight variations of the same design.

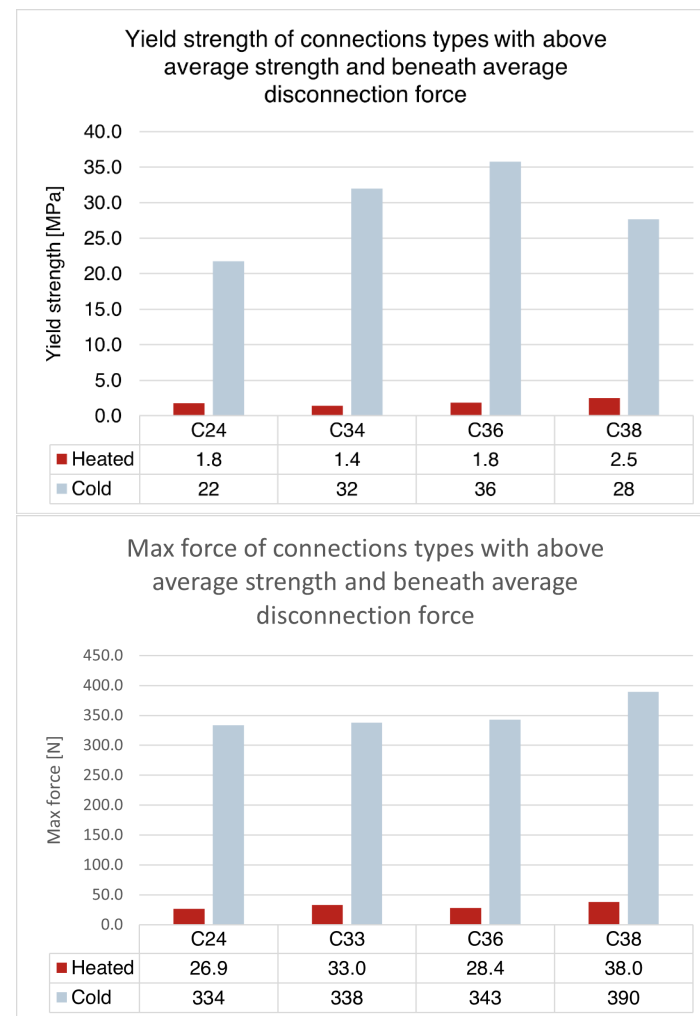

Figure 48: Yield and tensile strength of the most viable designs

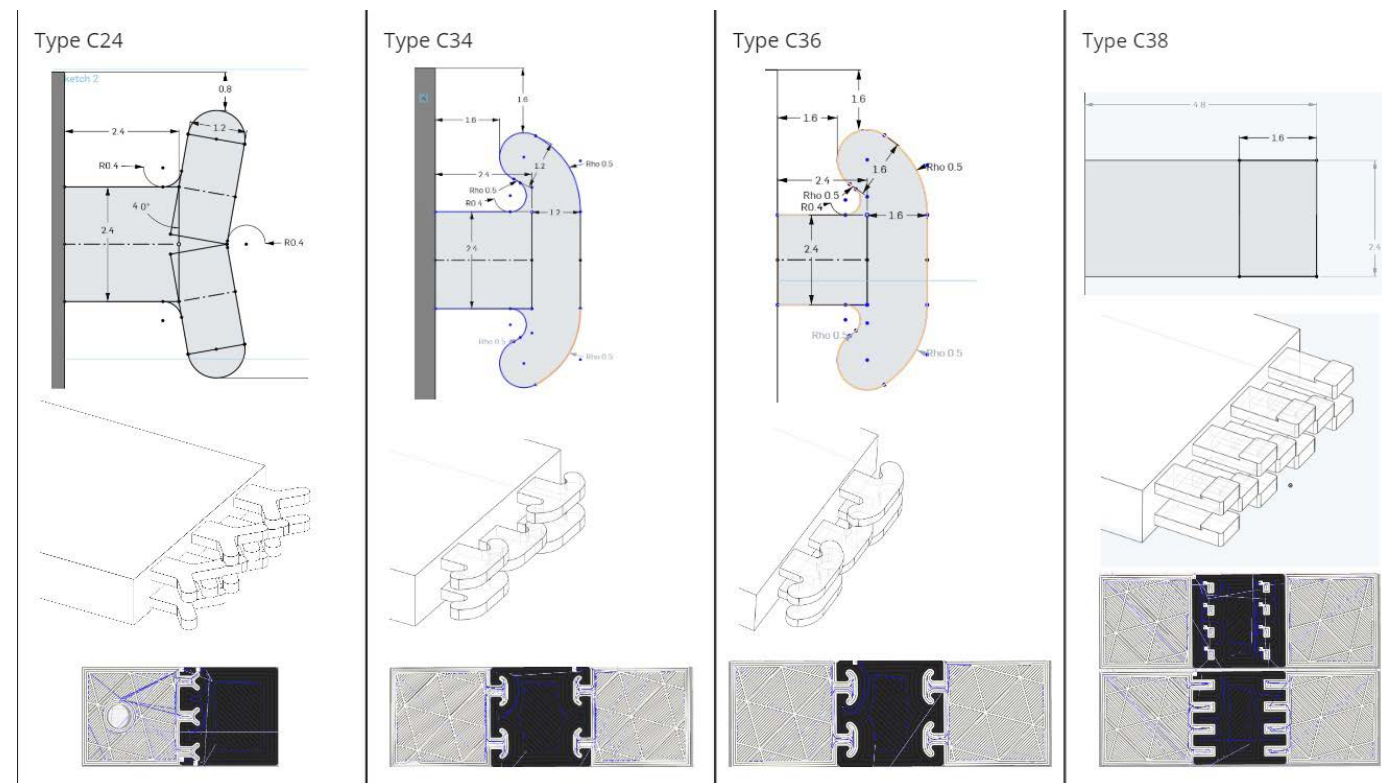

Figure 49: The 4 most promising designs: measurements, implementation and toolpath on relevant layers

### 5.3.5 Conclusion of Phase 1

During this phase, 40 connections were developed in 6 categories. These were analyzed on their strength in normal and heated conditions, their ability to disconnect without contamination and their printability.

During this phase, observations were made regarding the visual results, the measured results and the discrepancies between design and printed sample. From these, some conclusion can be drawn, which will serve as a knowledge base for Phase 2.

In figure 40, there was a clear group of connections that did well for its yield strength. Looking at their tensile strength, this performance did not transfer 1:1. This leads to conclude that these connections are strong as a connective element, but due to their relative size are not able to fit enough of them on a sample to transfer this into a stronger connection when applied in non-standard situations (figure 50 and 51).

It was seen that PLA was in almost all cases the weakest link. This meant either the connective element density or the PLA stem cross section should increase to achieve a better performance. There were serious issues with TPU stringing and oozing, even with a prime tower or ooze shield. As such, these were issues that could best be addressed in a later phase, as changing variables in this phase would make comparisons between the samples impossible.

For some designs, a poor first layer of PLA on the TPU was found. It was determined that the adhesion of the boundary layer was the main reason for this (figure 52). In further iterations, one of the main focus areas was thus decided to be the correct printing of the boundary layer.

The consideration was made that picking designs which were geometrically quite different would accumulate the broadest amount of scientific knowledge. To obtain enough research depth within the given time frame, it was decided only two should be further explored, being the “Anchor” and the “Z-pin” connections. The “Anchor” showed a lot of promise due to the broad geometrical alterations that could still be done with this design, while the “Z-pin” performed exceedingly well in the tensile test and due to its small size was applicable to a lot of real-life scenarios.

Thanks to this initial phase, it could confidently be stated that the designs that were being tested showed great potential and would at least fulfill

the basic requirements that were set at the beginning of this research. As will be shown in the next phases, these requirements were even exceeded.

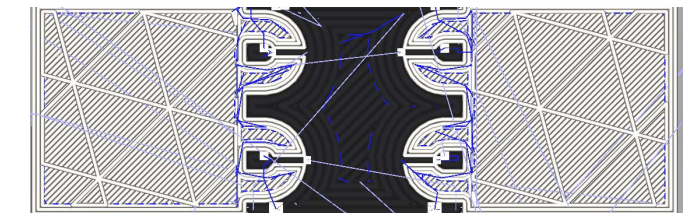

Figure 50: A sample with big connective elements, good for a high yield strength, but not a high tensile strength

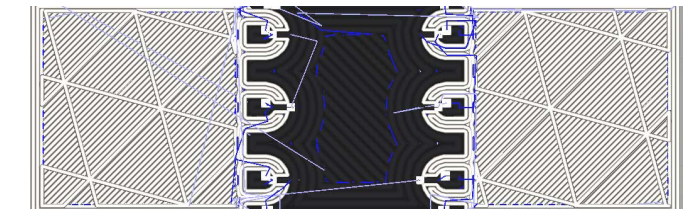

Figure 51: A sample with small connective elements, good for a high tensile strength, but not per se a high yield strength

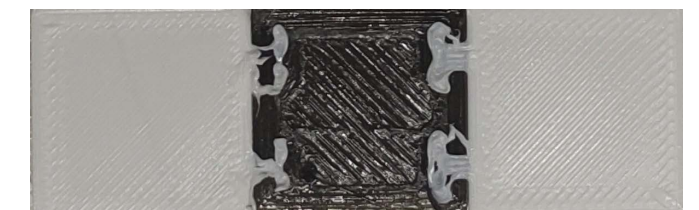

Figure 52: A sample with a poor first layer

# 5.4 Phase 2: Refinement and Selection of Definitive Method

## 5.4.1 Introduction to Phase 2

From the observations made in phase 1, some initial improvements were suggested for phase 2.

First of all, getting the surface area ratio in the right window could improve the tensile strength. Secondly, improving the first layer of the connective element would improve the consistency of the samples, as well as improve the tensile strength and probably the quality of the disconnection. Further focus would be on being able to separate both PLA and TPU cleanly, if possible.

Importantly, in the first phase of the evaluation, for the disconnection tests, a water temperature of 80 degrees was used. In phase two and three, this was changed to 95. During phase one, there was still the potential to use SMP (shape memory polymers) in the release mechanism, but from further tests as mentioned in paragraph 4.1.2, this method proved non-viable. With a temperature of 80 degrees, this SMP could've been activated, and as such this temperature was chosen. Without the necessity to keep SMP in consideration, the temperature could be raised, which positively affected the necessary disconnection force.

Comparing these temperatures resulted in the results as can be seen in figure 53. From these results, it can clearly be seen that shapes that are more complex (the small anchor configuration has roughly twice as much connective elements), or have a shape that needs more transformation (the anchor with a sharper hook has a very acute angle of the hooks) before it can "release" the TPU benefit most from the increased heat. The blank stem, for instance, does not have any significant change in its release force.

These observations initiated further research that was done in this phase. The two designs which were chosen in phase 1 were evaluated and they were improved. Phase 2 would be successful if the answers to the following questions were found:

- Which of the two designs performs best, when testing it against the set requirements.
- How can the printability of the first layer of the connective elements be improved?
- How can the strength of the failure modes that were found in phase 1 be prevented or improved?
- How can it be ensured that everything is printed as intended?
- How can an as low as possible disconnection force be assured?

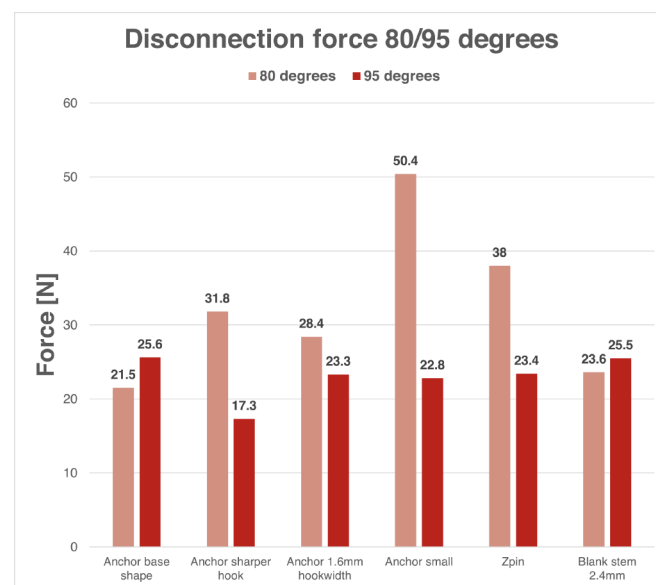

Figure 53: Difference in disconnection force when heated to 80 or 95 degrees

## 5.4.2 Method

### Geometrical Changes

During phase 1, many observations were made regarding the failure modes of the samples and the performance and limitations of the failure modes. With this gathered knowledge, 9 new geometries were designed, in which every geometry had one "new" aspect compared to the basic geometry. This way, not more than one variable was changed and comparisons were possible. In figure 54 and 55, a short overview of these altered geometries can be seen. For a more in depth overview of the implemented changes, see appendix D.

<p><b>A12 - Anchor basic shape</b></p> <p><b>Description:</b> The basic design of the anchor concept</p>	<p><b>A11 - Anchor with dimple</b></p> <p><b>Description:</b> Basic anchor design with a small dimple in the middle. This might give the connective element more flexibility to move when heated for disconnection.</p>
<p><b>A13 - Anchor with extra negative space in the TPU</b></p> <p><b>Description:</b> The PLA part is replicated from the original design, but a cavern behind the connection is created in the TPU part</p>	<p><b>A14 - Anchor hooks with gentler bend</b></p> <p><b>Description:</b> The angle of the bend of the hooks is lower and the hooks overlap in a neater pattern</p>
<p><b>A15 - Anchor with smooth stem transition</b></p> <p><b>Description:</b> There is a fillet from the base to the stem.</p>	<p><b>A16 - Anchor with Zpin</b></p> <p><b>Description:</b> A Zpin has been added at the end of the stem.</p>
<p><b>A17- Anchor with Zpin at edge V1</b></p> <p><b>Description:</b> The connection has a Zpin at the inner edge of the curve towards the hook.</p>	<p><b>A18 - Anchor with Zpin at edge V2</b></p> <p><b>Description:</b> The connection has a Zpin at the inner edge of the curve towards the hook.</p>
<p><b>A19 - Anchor with Zpin at edge V3</b></p> <p><b>Description:</b> The connection has a Zpin at the inner and outer edge of the curve towards the hook.</p>	

Figure 54: Changes in geometry for the "anchor" connection method

<p><b>B10 - Zpin 4mm long</b></p> <p><b>Description:</b> Basic design with a length of 4 mm.</p>	<p><b>B11 - Zpin 3.2mm long</b></p> <p><b>Description:</b> Basic design with a length of 3.2 mm.</p>
<p><b>B12 - Zpin with rounded end</b></p> <p><b>Description:</b> The end of the stem is rounded</p>	<p><b>B13 - Filleted stem</b></p> <p><b>Description:</b> There is a fillet from the base to the stem.</p>
<p><b>B14 - Zpin 0.8mm</b></p> <p><b>Description:</b> The basic Zpin has a depth of 1.6mm. Here this is changed to 0.8mm.</p>	<p><b>B15 - Zpin with 2 layers</b></p> <p><b>Description:</b> The Zpin has two layers, the upper one with an offset of 0.4mm (1 linethickness).</p>
<p><b>B16- Zpin on either side</b></p> <p><b>Description:</b> The stem has a Zpin on either side.</p>	<p><b>B17 - Slit in stem</b></p> <p><b>Description:</b> The stem has a horizontal gap at the 2nd layer.</p>
<p><b>B18 - Curved hollow Zpin</b></p> <p><b>Description:</b> The Zpin has a curved shape with a hollow back</p>	<p><b>B19 - Curved Zpin</b></p> <p><b>Description:</b> The Zpin has a curved shape.</p>

Figure 55: Changes in geometry for the "Z-pin" connection method



### Parameter Changes

From phase 1, observations showed issues during the printing of the samples. This, and some of the issues mentioned in the previous paragraph, could possibly be solved by changing certain settings in the slicer. From literature, settings that could have an impact on these issues were found. Each setting was changed separately, to be able to reliably compare results. Table 5 can be used to see which settings were changed to what values. For a more in depth overview of the reasoning behind this, see appendix E.

Table 5: Alterations in the slicer program "Cura" to improve the printability and strength of the connection methods

	What is changed?	Value
<b>Adjusted speed settings</b>	Wall speed	40/30/20 mm/s
	Top surface speed	40 mm/s
	Bottom surface speed	40 mm/s
	Wall acceleration	250 mm/s <sup>2</sup>
<b>Layerheight</b>	Layerheight	0.25 mm
<b>Higher temperature</b>	Temperature PLA	210
	Temperature TPU	230
<b>Remove small TPU parts that occur under the PLA connective pieces</b>	Cura setting "extra skin wall count"	0
<b>Infill</b>	Infill TPU	100%
<b>Walls</b>	Wall count	3

### 5.4.3 Results

#### Changed geometries

In order to test the changes in geometries and the adjusted parameters, the same tests as in phase 1 were executed. The heated disconnection was only tested for the changed geometry and not for the changed parameters. Through previous experience, it was known that small changes such as the alteration of some parameters would cause would not significantly alter the disconnection force, but a different geometry should always be tested on its ability to cleanly disconnect.

In figures 56 and 57, the results of the tensile and disconnection tests for the "Anchor" and "Z-pin" design are shown. Some important observations were made during testing.

In figure 56, the baseline sample can be seen as the first input, as a way of comparing the new geometries in terms of improvement. The values for the heated release can be seen a being comparable, while almost all new geometries show a value beneath the baseline, indicating a worse performance.

In figure 57, a baseline sample is implemented as well. Here, the heated release is comparable to the baseline value, while almost all geometry changes produce a value above the baseline, indicating successful improvements on the original design.

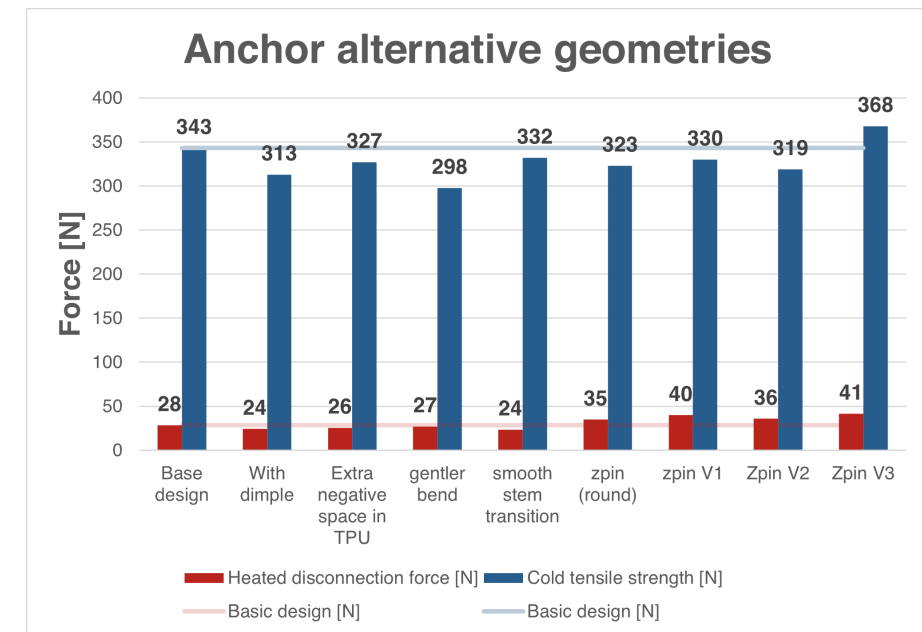

Figure 56: Alternative Anchor geometries tested in both cold and heated state

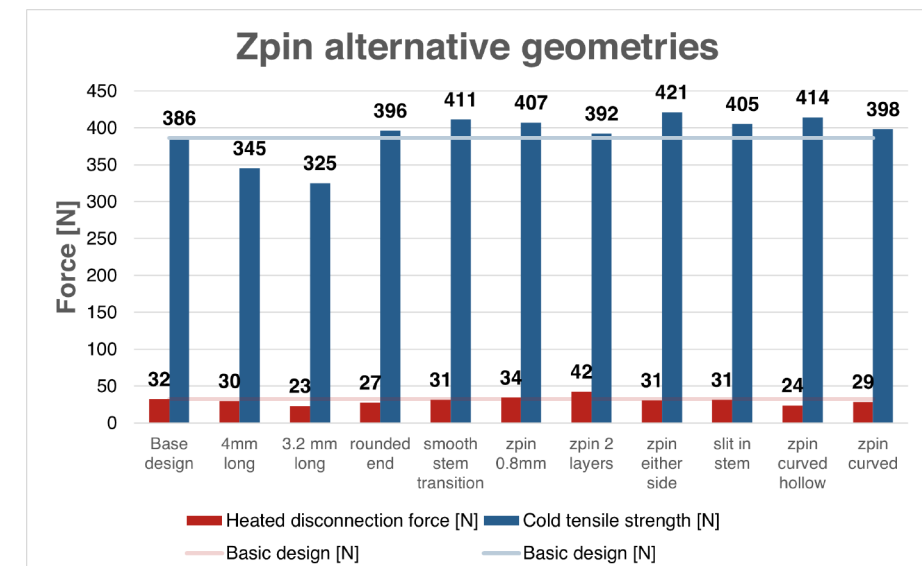

Figure 57: Alternative Z-pin geometries tested in both cold and heated state



### Changed parameters

As stated before, the changed parameters were only tested in the cold tensile test situation. Figure 58 shows the results of these tests. Interestingly, not all parameters have the same consequences for both designs.

As with the graphs for the changed geometries, the first input is a baseline to compare the changes to. It can be seen that all the changes for the anchor connection (green) are above this line, showing an improvement. For the Z-pin, this is about 50/50. Looking further, the largest improvement of 15% can be seen for the Z-pin when increasing the temperature.

Some interesting observations can be made with this graph.

- All the changes improved the tensile strength of the anchor design. We assume this is because the anchor design has a more complex path, which is prone to failing at the first layer. With most of these parameter changes being aimed at more accurate printing, they seem to improve this aspect of the print.
- The Z-pin design has improvements with less of the parameter changes. Presumably, counter to the anchor design, the Z-pin has a relatively easy pathway, which already results in cleaner first layers.

In phase 3, it will be explained which parameter changes were implemented in the final design, and why they were picked.

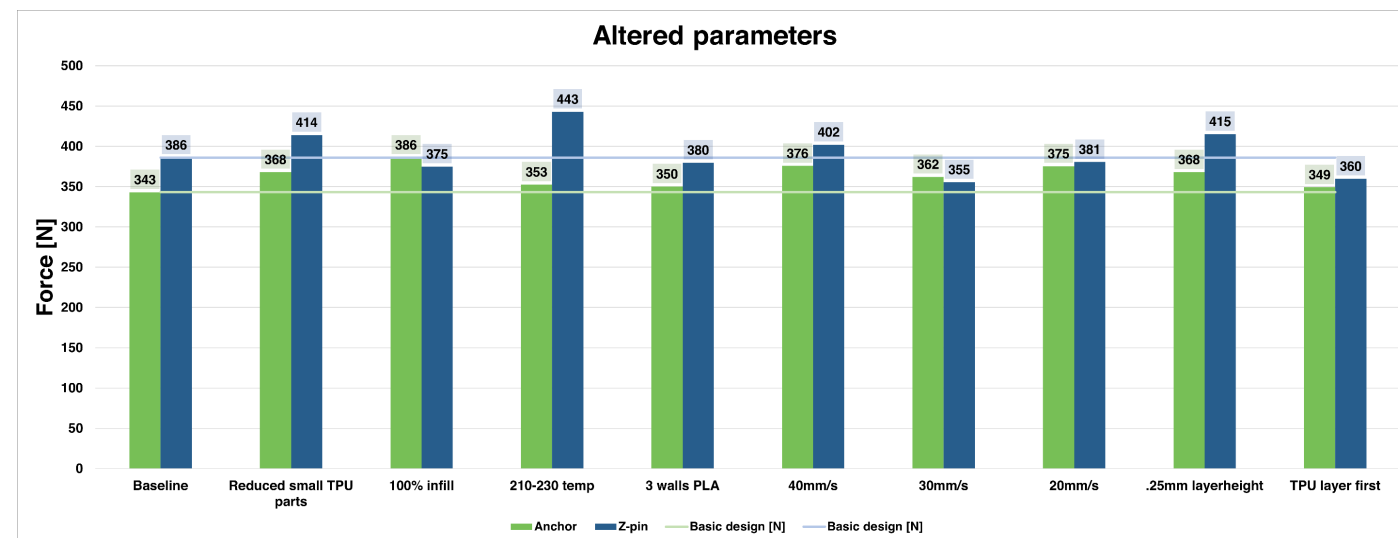

Figure 58: Tensile test results from altered parameters

### 5.4.4 Observations and Challenges

#### Discrepancies between sliced models and printed samples

It was observed that a lot of the samples had first layers which did not correspond to the sliced model. For a select few samples, the test was redone with a very low first layer speed, in order to get a more reliable first layer, as the assumption was that this might have contributed to the bad performance. This showed a slight improvement, but not a significant one. Furthermore, by changing the parameters, the comparison with the baseline design was skewed. It was important to address these discrepancies, as they did have an impact on the strength of the printed sample and might give a skewed view of an otherwise good concept.

In figure 59, the baseline sample can be seen, with its sliced model. Upon inspection, some inherent flaws in the sliced model are visible,

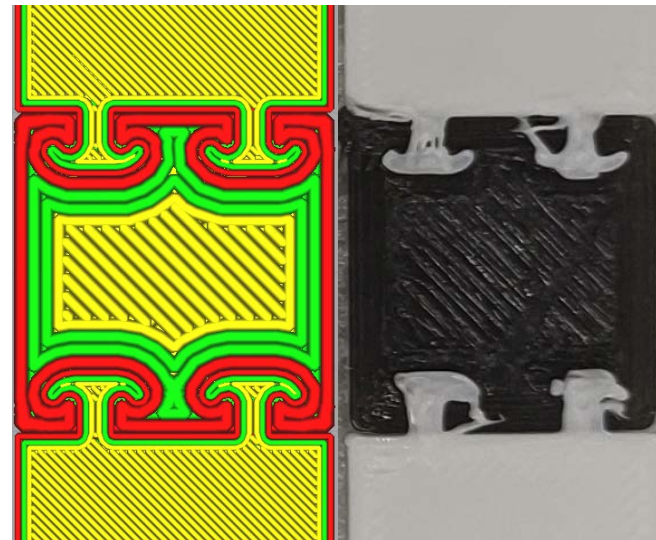

Figure 59: Baseline sample sliced (left) and printed (right)

with the infill not being a neat continuous line, which can cause issues during printing. This same issue is present in many of the other geometries of the anchor method.

Implementing a wall thickness of three lines did help, creating only continuous extrusion in the connective element, which resulted in more accurate prints (figure 60). Interestingly, when looking at figure 58, the increase in tensile strength is only 7N. The same is true for for instance the increase of the temperature, which produced much better first layers (figure 61), but showed only an increase in tensile strength of 10N.

Though many of the samples printed for the testing of the new geometries for the anchor method showed poor first layers, this serves to illustrate that the poor first layers are not the main reason that this geometry performed worse than the Z-pin.

When doing the same comparison for the Z-pin,

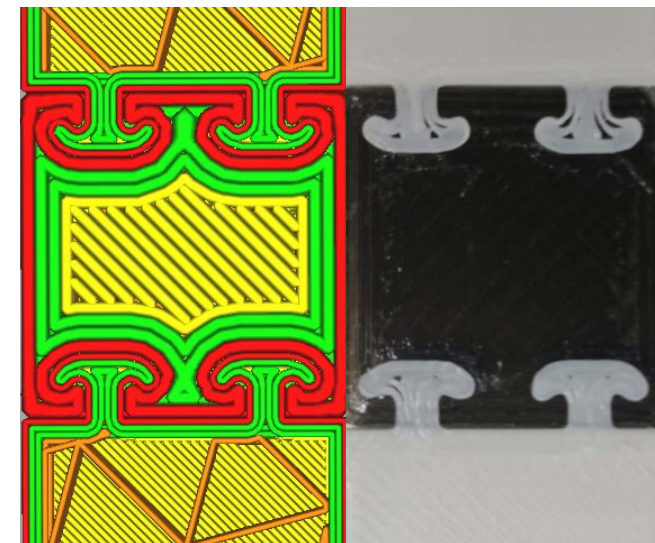

Figure 60: Three wall lines sample sliced (left) and printed (right)

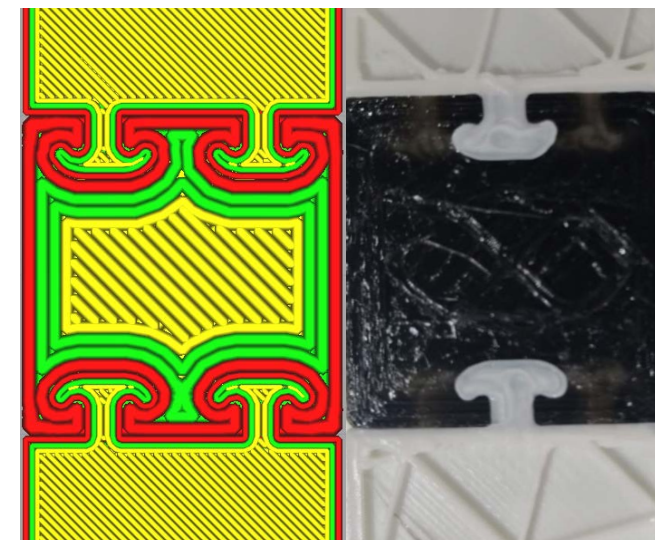

Figure 61: Print temperature 210/230 degrees sample sliced (left) and printed (right)

it can be seen that baseline sample has a relatively neat and “as intended” first layer (figure 62), while the some of the new geometries do have some issues with their first layer, or differ from their intended path (figure 63). Even with this, they still perform better than the baseline sample.

In appendix D and E, all sliced and printed samples for this phase are placed next to each other for comparison.

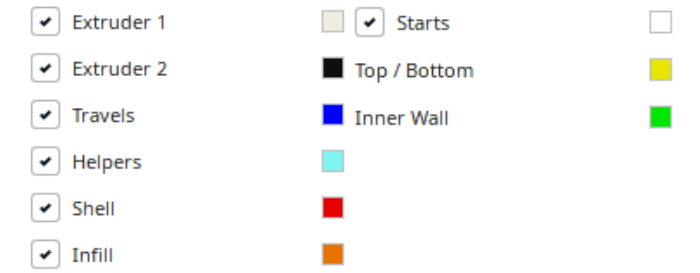

Figure 64: Legend showing the meaning of the colours of the sliced files

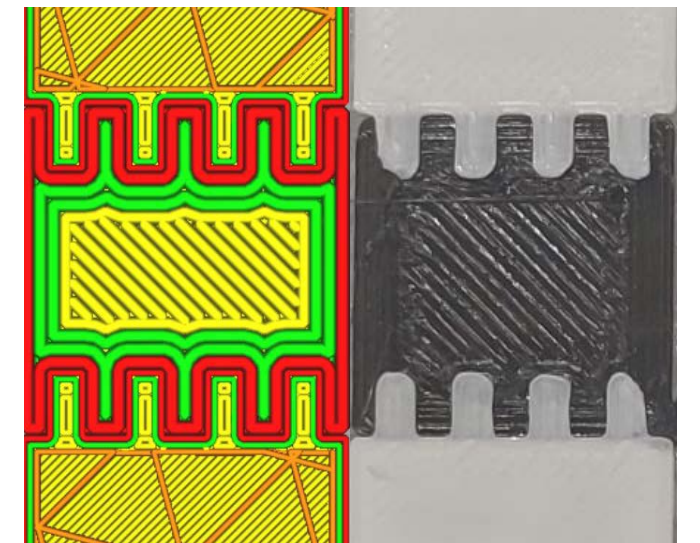

Figure 62: Baseline sample Z-pin sliced (left) and printed (right)

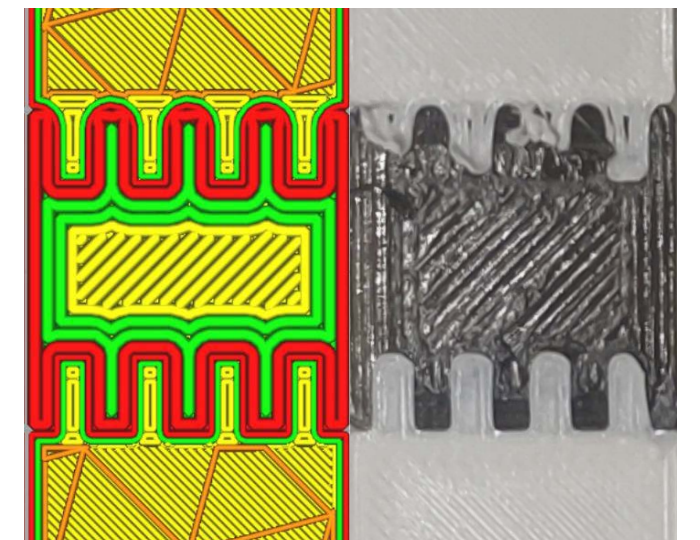

Figure 63: Rounded stem sample Z-pin sliced (left) and printed (right)



- The changes in the geometry of the anchor design failed to provide any reasonable improvement. Except for 1, all of them tested worse than the base design.
- The changes in geometry of the Z-pin design all improved on the base design, with the exception of the shorter stems, which was as expected. This shows that there was still potential hidden in this design direction.
- For both designs, the disconnection tests showed that geometry changes aiming to reduce the necessary force succeeded. But, as can also be seen, the fluctuation in the force is, at most, 12N.
- We can see that during disconnection, all connections are in close proximity of each other, in absolute terms. A high percentage of the force necessary will be due to the friction between the PLA and TPU, which ensures there always is a base force necessary to detach the TPU and PLA.

**Failure mode related observations:**

- During the tensile test, roughly half of the anchor samples failed due to the PLA stem snapping, while the other half failed due to the arms of the anchor bending or shearing, as can be seen in pictures 65 and 67. This was an issue which was hard to fix, as increasing the cross area of the stem or arms would result in a size increase of the whole connective element. It was not reasonably possible to implement this in the size of the sample that was chosen for this research.
- During the tensile test, almost all Z-pin failures were due to the TPU “releasing” the PLA pins. Neither of the polymer parts were ever really damaged (figure 68), as the TPU simply started bending away from the Z-pin under high stress. It was noticed that the bending away always started at one of the short edges of the sample and then released the pins one by one. Figure 68 illustrates this.

**5.4.5 Conclusion**

With the results and observations from the previous paragraph, the decision was made to continue with the Z-pin design as the final pick. This was done by comparing the designs based on the requirements set at the beginning of the evaluation.

**Strength of the connection:**

From figure 69, it can be seen that all the Z-pin designs perform better than the anchor design. Furthermore, the potential seems to be there to improve even more.

**Ease of disconnection:**

Figures 56 and 57 show that in this aspect, both connections perform roughly the same. The only difference, which was not shown in these figures, is that the anchor elongates slightly more before disconnecting (figure 69). In some circumstances, this could be a slight disadvantage.

**Pattern size:**

When comparing the anchor and Z-pin, it can be seen that 5 anchors fit in the sample, while there can be 11 z-pins. Looking at a recommended minimum size of these patterns to use – a triangle configuration of 3 elements to counteract bending of the PLA, figure 70 - , we would be looking at 17x2.6 mm (WxH) for the anchor, and 10x2.8 mm (WxH) for the Z-pin. A clear advantage in width is seen for the Z-pin design. Besides this, the pattern repeats once every 2.4 mm for the Z-pin, compared to 5 mm for the anchor. As such, the Z-pin scales in smaller increments.

During this phase, the Z-pin was selected as the design philosophy to continue with. Slicer parameters which could improve the strength of the connection were found, as well as some geometry changes which could be implemented. Besides this, it was found that changing the design to aid the disconnection of the parts only yielded very small gains. When looking at real life application, it begs the question if this will make a significant enough difference to pursue. In the next phase, this knowledge was used to create a final design which was compared to certain benchmarks.

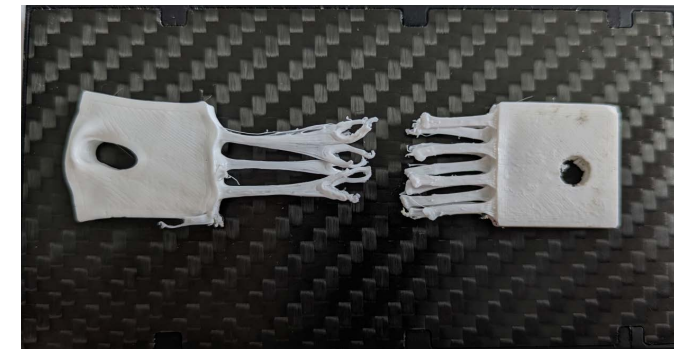

Figure 69: Difference in elongation for anchor (left) and z-pin (right)

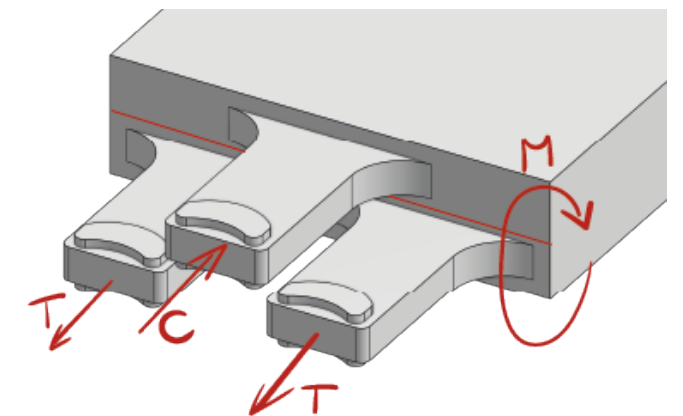

Figure 70: Triangular configuration with T (tension) and C (compression) showing how the moment impacts the connective elements

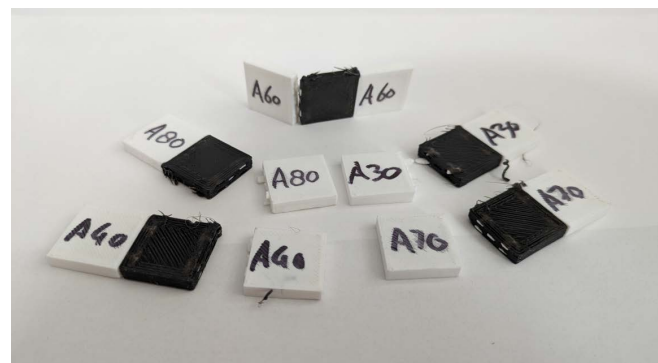

Figure 65: Failure mode of the anchor method during tensile testing

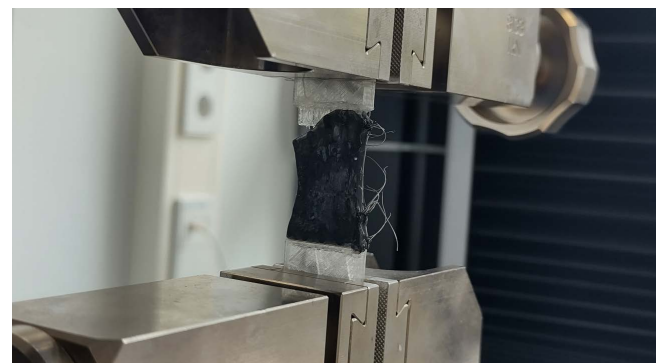

Figure 66: TPU peeling away at the side of a Z-pin sample

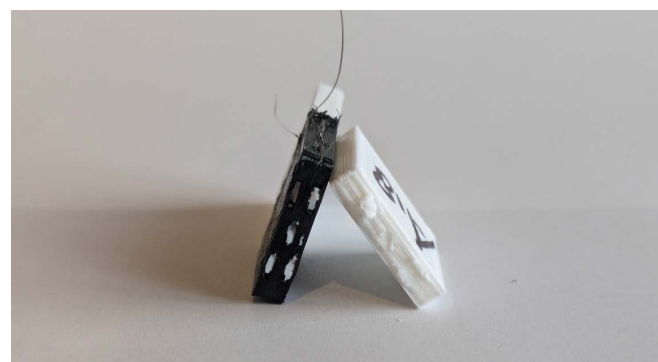

Figure 67: Close up of anchor sample after tensile test



Figure 68: Close up of Z-pin after tensile test

# 5.5 Phase 3: Final design

## 5.5.1 Introduction to Phase 3

The previous phase took a look at improvements in geometry and parameters, and found the best design philosophy to continue with. In this phase, these findings were implemented in a final design, which was tested and compared with a set of benchmarks, providing context about the viability and desirability of this design. During this phase answers to the following questions were found:

- Can a design be created that is a viable alternative for current solutions?
- Can a design be created that is reliable in tensile strength and disconnection?

## 5.5.2 Method

In phase 2, multiple geometrical improvements were found. Those that were implemented in the final design, and the reason they perform well are shown here.

- Smooth stem transition: With this, stress concentrations in sharp corners are reduced, and a smoother print path is created, encouraging more accurate prints, for both the PLA and TPU.
- Z-pin on either side: This can use more of the TPU to keep the PLA part in place. Also, the force is now symmetrical, as it is distributed between both the top and bottom of the stem. Lastly, the bottom pin functions as an adhesion point for the first layer of the stem, which ensures almost perfect first layers.
- Curving the Z-pin: Tests showed a decrease in necessary disconnection force, while the overall tensile strength increased slightly.

Second to this, some parameters were found that could be changed to improve the quality of the print. These are:

- Higher print temperature: The temperature for PLA was raised to 210 degrees, and that of TPU to 230 degrees. The benefit of this is twofold. Firstly, the adhesion is slightly better, improving the first layer. Secondly, this allows the PLA to release more residual stress, which gives it a higher stress capacity when under load.
- Wall count according to the stem width: To ensure that all lines in the stem are printed parallel to the tensile force direction and firmly fixed to the rest of the PLA, the wall count is set to 3.
- Reduced small TPU parts: To ensure that the TPU was extruded continuously, a setting in cura was used, called “extra skin wall count” which was set to 0. With this, the TPU extrusion is significantly neater due to less retraction.

It is good to mention that, although increasing the layer height showed a small improvement, this was deemed undesirable as it also increased the vertical pattern size. The resulting final design can be seen in figure 71.

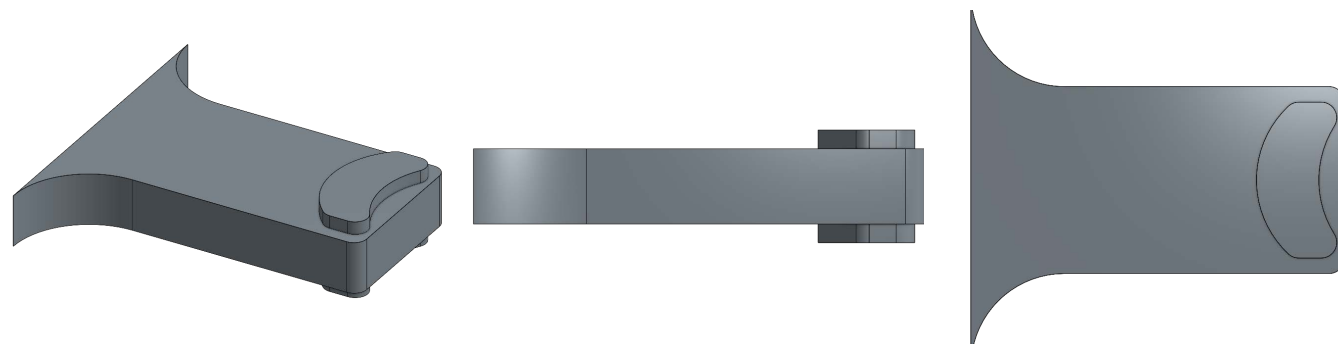

Figure 71: 3 views of the final design

## 5.5.3 Testing and Analysis

The test procedure for the final design was the same as during phase 1 and 2. Figure 73 shows the base design, the design with the new geometry and the design with the new parameters. As can be seen, the results are very good. With only the changed geometry, the tensile strength sees an increase of 43% compared to the base design. With the change of parameters, we get an increase of the tensile strength of 50%. The change in the necessary force to disconnect is negligible.

During the tests, for the first time a very

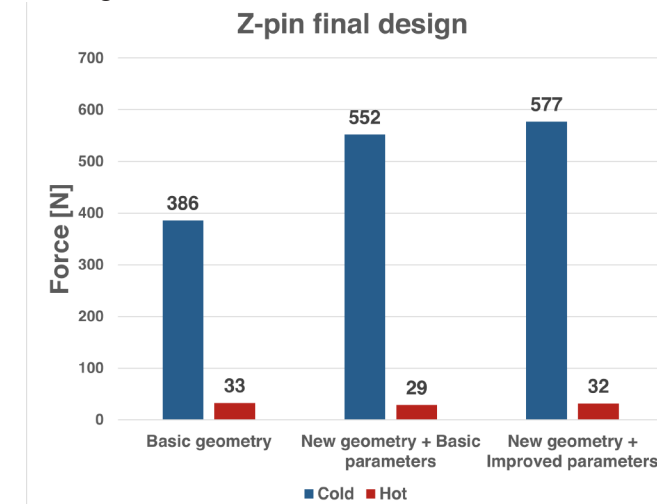

Figure 73: Tensile test results of the final iteration of the Z-pin



Figure 75: An attempt to disconnect the hacksaw and layer method



Figure 72: The process of necking and slipping at one of the short edges

noticeable elongation of the TPU part was seen, with a significant necking effect. This proved in most case to be the reason the piece failed, as it peeled away from the short sides quite drastically, as can be seen in figure 72.

## 5.5.4 Comparison with Benchmarks

In the slicer software “Cura” there are two standard methods to interlock non compatible materials. These are the “hacksaw” and “alternating layers” method. In chapter 3.2, these are explained in detail. To verify that the Z-pin method was a viable alternative to these existing methods, each of them were tested on their tensile performance. In figure 74, one can see the current alternatives in green, with the proposed Z-pin method in blue. A comparison based on their necessary disconnection force is not possible, as the current alternatives are not able to disconnect – figure 75.

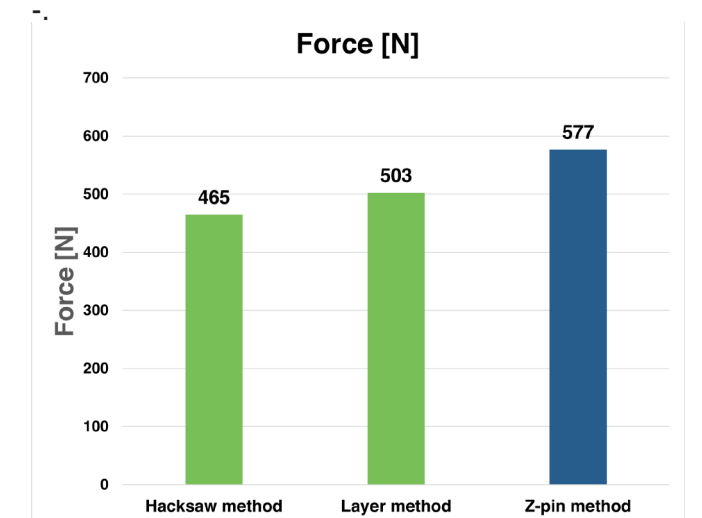

Figure 74: Comparison between Cura benchmarks and the Z-pin



### 5.5.5 Conclusion of Phase 3

In this chapter, numerous improvements were implemented in the geometry of the design and the used print parameters. This new design (figure 76 and 78) showed great improvements in comparison to previous iterations and performed better than the benchmarks in the performed tests, as can be seen in figure 79.

At this moment, there is no industry standard for combining non-compatible polymers that allows for a viable recycling of these materials at the end of life (figure 77). This design fills this gap in knowledge and provides a sustainable solution for this problem by allowing the polymers to be separated by a simple procedure (figure 80).

As for any new technology, for it to be picked up it needs to be able to compete with current solutions, even if it offers other benefits. As such, it is important to see that this design is not inferior in tensile strength or bendability, but exceeds both the current Cura solutions.

With all this mind, the design seems a great alternative for existing solutions. Though this is true, it is important to take note of the limitations of this design, and the boundary cases in which it might or might not be applicable. These will be evaluated in the next chapter.

#### Final results

#### Yield strength of the Z-pin:

7.2 MPa

#### Heated release Yield strength of the Z-pin:

0.4 MPa

Force [N]

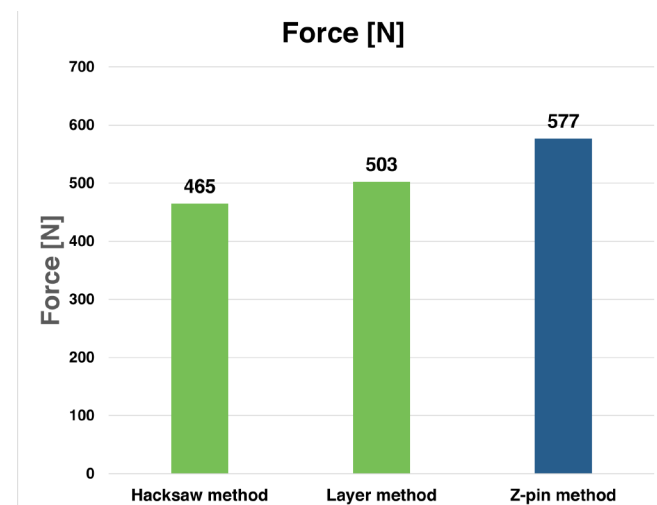

Figure 79: Comparison between Cura benchmarks and the Z-pin

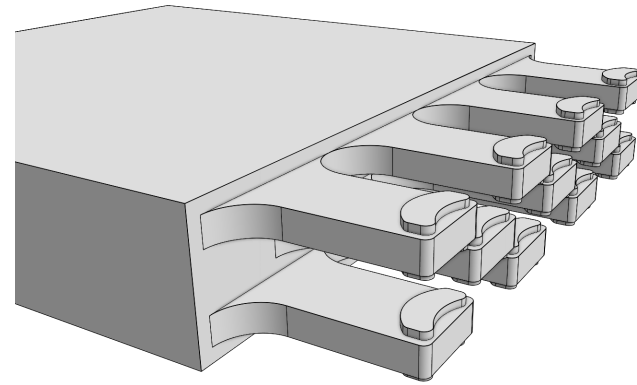

Figure 76: The final design in as implemented on a test sample



Figure 77: The alternating layer method (left), the hacksaw method (middle) and the proposed Z-pin method (right)

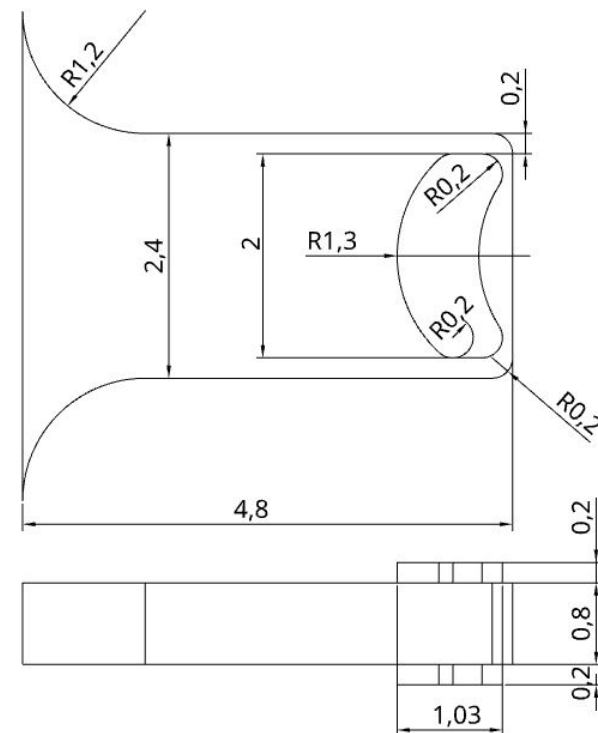

Figure 78: The final design with measurements

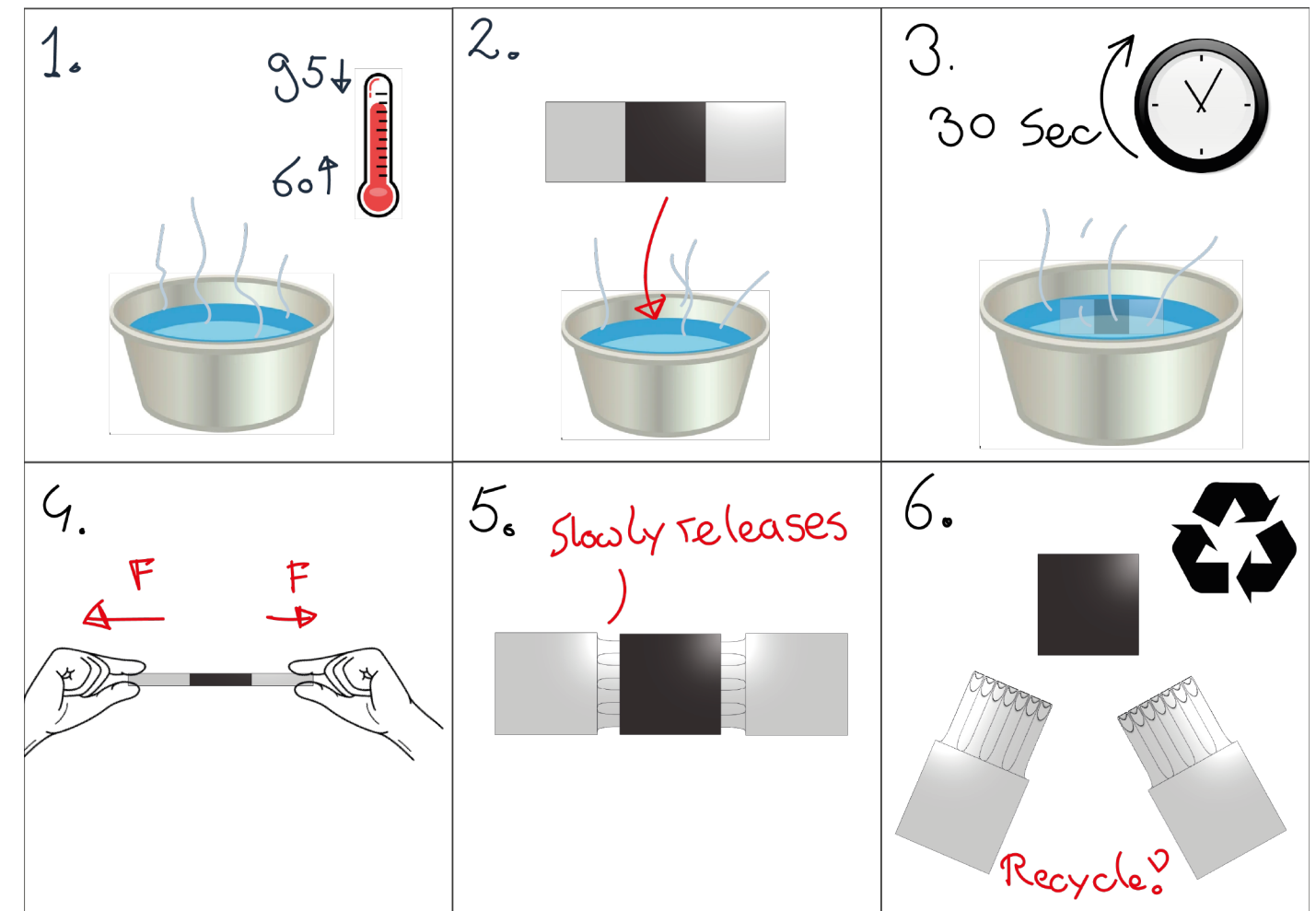

Figure 80: The final proposed disconnection method

# 6. EVALUATION

---

In the previous chapter, an idea was evolved into a working and reliable solution. To compare all results, everything was tested in the same configuration, in a controlled environment.

In this chapter we explored how this method could be applied in a day-to-day environment, in real products. From this, it was possible to show the limitations and boundary cases, as well as ways to implement the method to get specific results. With these findings, this method was taken beyond laboratory conditions and its viability is proven. The chapter is concluded by stating the limitations of the Z-pin connection.

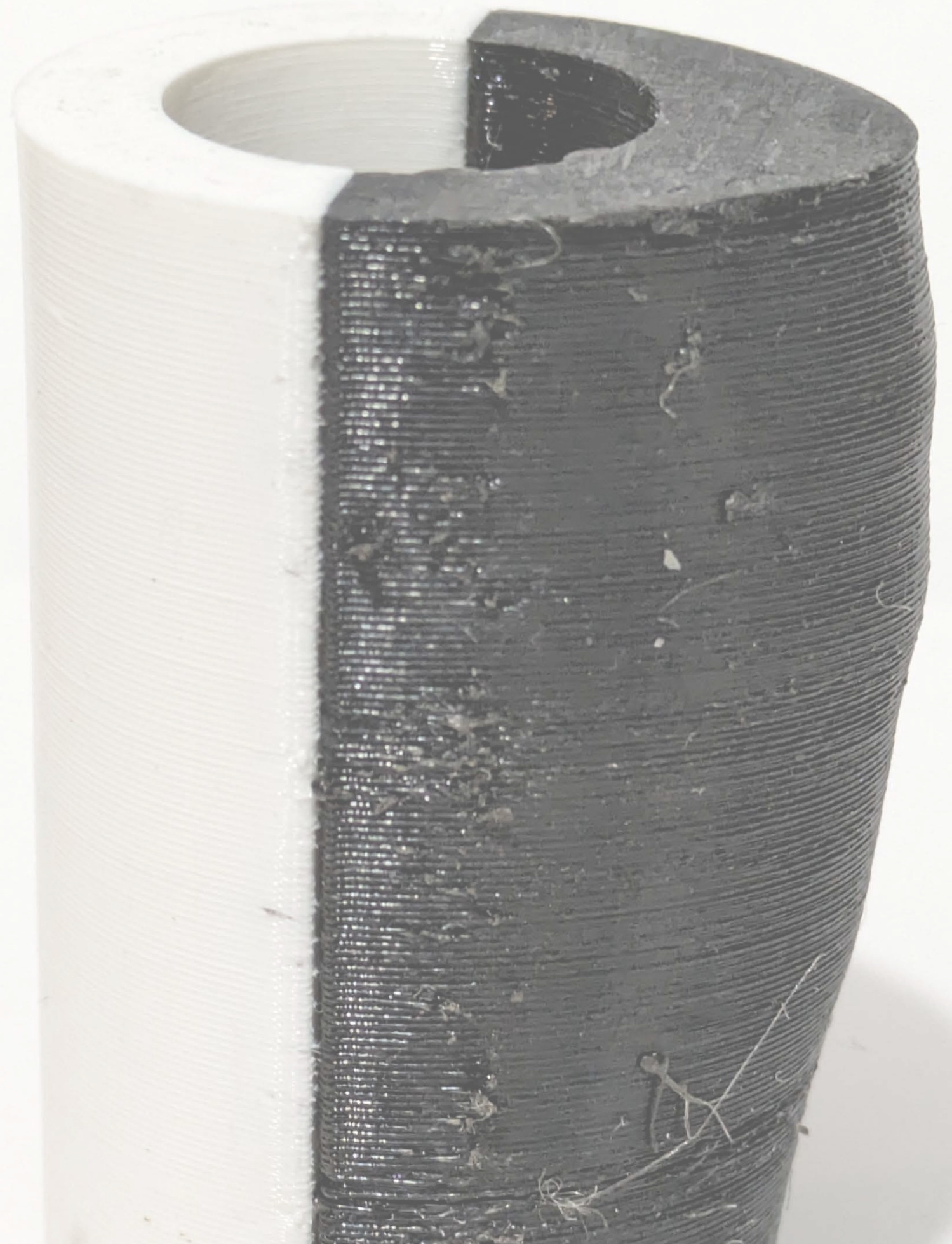



## 6.1 Method

In paragraph 3.3, an overview was created of groups of products that could benefit from a method that could combine TPU and PLA during the FDM process. For reference, this figure can be seen on this page as well (figure 81). If the method that has been developed during this research could be applied in these products, while still performing according to the requirements set initially, it could be concluded that this research has been successful and is a valuable addition to the development of a more sustainable workflow in MMAM.

At the same time, implementing the method in common products was a good method of showing where the limits of this method are. Because of this, products were chosen that not only showcase the desired main force categories, but also situations in which the method is pushed to its limits. These situations were found by trying to deviate as far from the tested setup as possible without altering the intended working principal of the method, and by picking products that had no connective interface that corresponded one to one with the tested setup.

Four distinct showcases were created to test the proposed method.

A brush, with a TPU part in the handle to manage the output pressure. This model shows the ability of the connection to work on a tilted interface, and falls in the bending force group.

A muscle roller, with a TPU outer part to create a softer interface with the body. This model shows the ability of the connection to work in thin walls, in which the TPU is completely wrapped around the PLA and falls in the torsion force group.

A bike handle, where the TPU creates a more ergonomic grip for the user. This model shows the

ability of the connection to work in thin walls, in which the TPU is either partially wrapped around the PLA, or where it is only connected at the short edges of the thin wall. This showcase falls in the pressure force group.

A watch with strap, where the TPU creates a bendable strap and the PLA the case for (for instance) a smart watch. This model shows the ability of the connection to be implemented in thin interfaces while maintaining strength and falls in the bending force group.

These products were qualitatively analyzed, focusing on their printability, the functional strength of the connection when implemented and the separation, the last of which was split in the ease of separation and the cleanliness of the separation.



Figure 81: Possible use cases of the PLA-TPU connection, sorted by main applied force

## 6.2 Results

### 6.2.1 The brush: tilted interfaces

The printed brush can be seen in figure 82. It has a TPU midsection in order to control the pressure that is transferred from the handle to the brushing part.

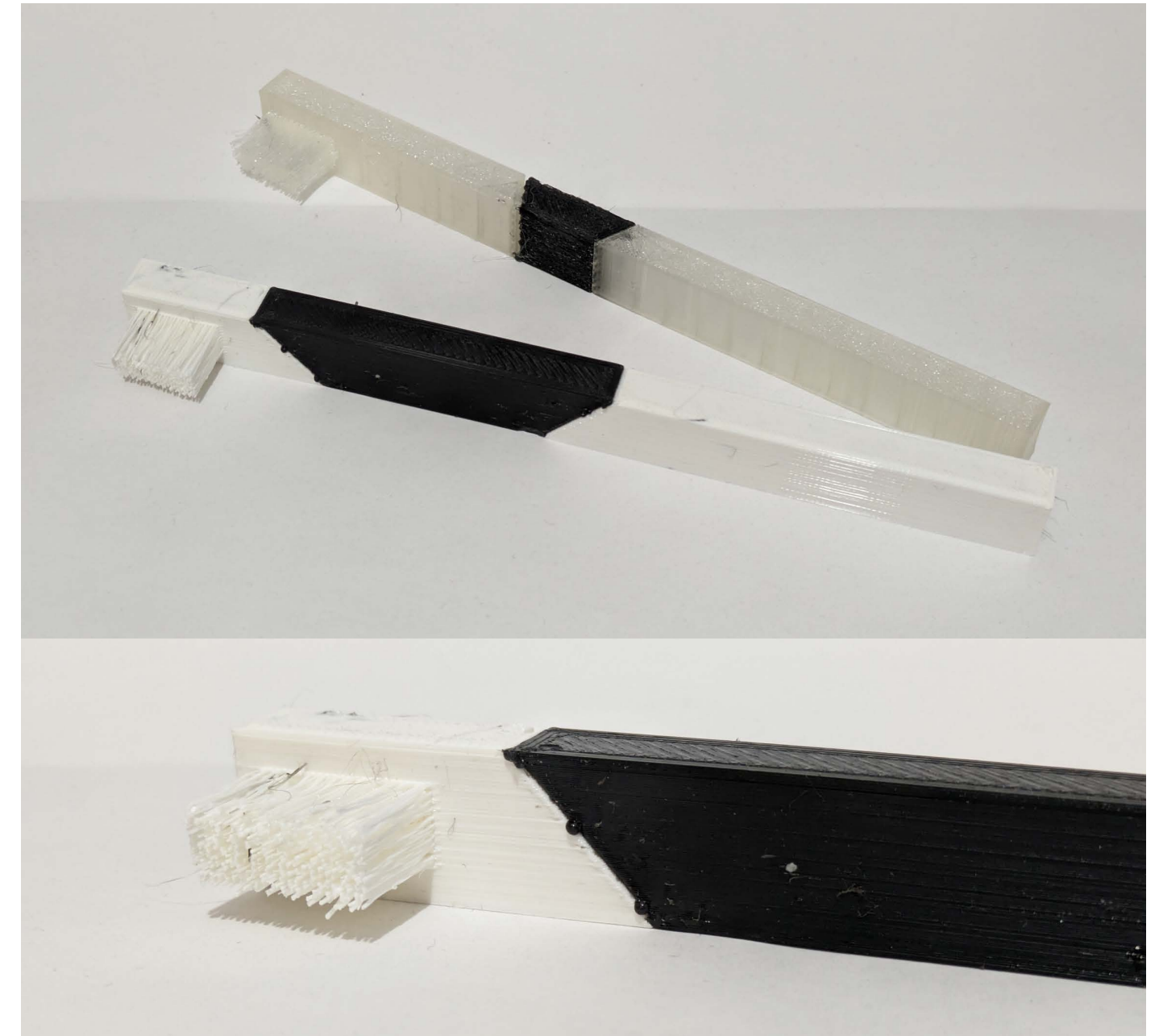

Figure 82: A brush with two types of tilted interfaces

**Boundary case**

Tilted interfaces can be useful to create a different stiffness in two directions in the same plane, for example. Preferably, you always have the connection orthogonal to the interface surface and in line with the force used to disconnect. This specific interface can thus prove to be an issue for two reasons:

- An interface which is rotated around the z-axis will create a connection which is angled away from the direction of the disconnection force, thus increasing the needed force (picture 84).

- An interface rotated around the x or y-axis cannot have its stems orthogonal to the interface, as these would not be printed in the horizontal plane, causing serious weakness through possible delamination the layers when under tension (figure 83). With the connection printed in the XY plane, the amount of TPU underneath will differ from that above the connection, which might cause issues with the quality of the print, or the resulting strength.

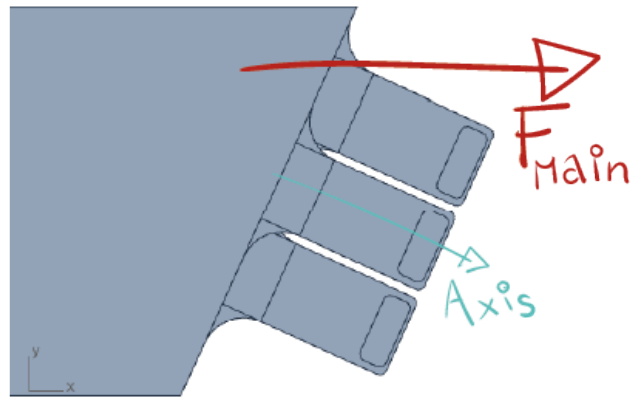

Figure 84: Trouble with disconnecting for interfaces tilted around the Z-axis



Figure 85: The connective elements break more easily due to the acute angle, which increases stress concentrations

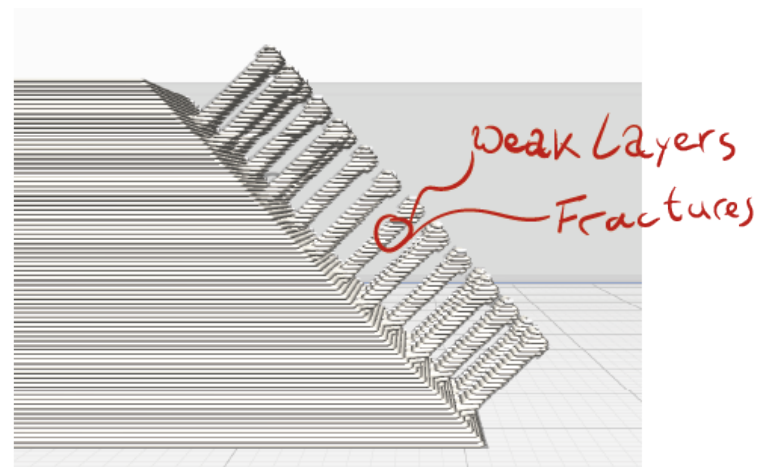
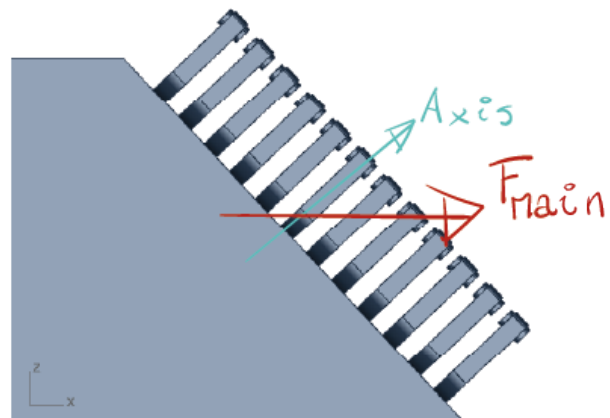

Figure 83: Failure modes for tilted interfaces around the X/Y-axis. Right: The sliced model showing the layers being a fracture risk

**Observations**

**Tilted around Z-axis**

*Design:* Due to the angled connective elements, keep in mind the necessary margin between the connective elements and the wall.

*Printability:* Printability is normal. There are no artifacts that suggest a poor print quality.

*Strength:* All applied forces result in a still functional product. No shortcomings are found.

*Disconnection:* The angled connective elements make disconnecting a harder than normal and less pleasant experience (figure 86 and 87).

**Tilted around X/Y-axis**

*Design:* The maximum acceptable angle should be kept in mind, as at a certain point the connective elements create an angle with the interface that does not allow for TPU anymore.

*Printability:* Printability is normal. There are no artifacts that suggest a poor print quality.

*Strength:* Longitudinal strength seems to be perfectly fine. Bendability is normal, except when bending in the direction of the longer TPU side. The sharp corner between the interface and the connective elements leads to a sudden fracture (figure 85).

*Disconnection:* Functions like normal.

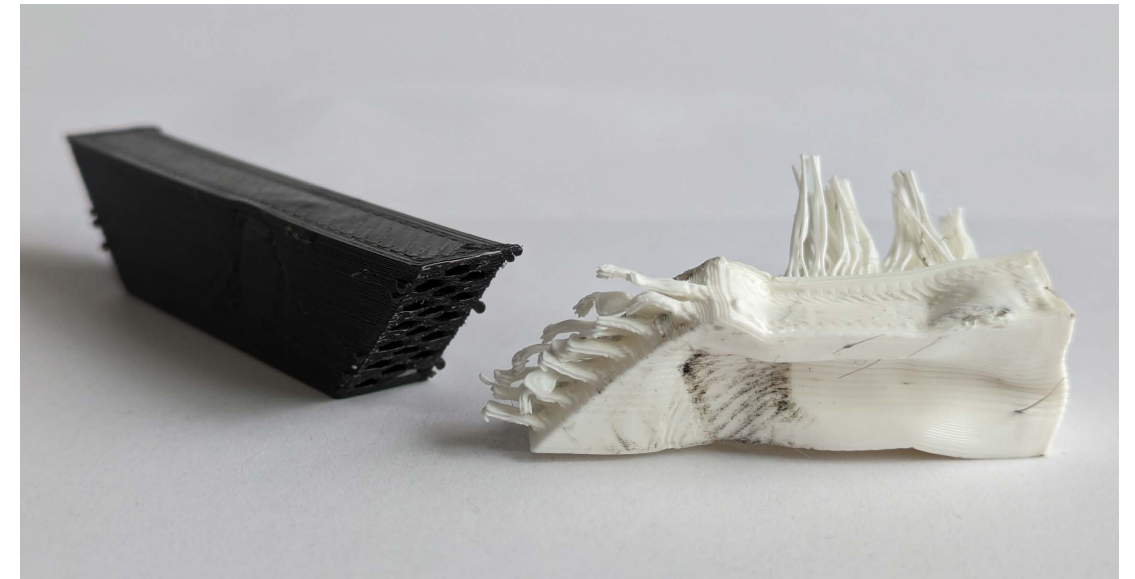

Figure 87: The amount of connective elements and the geometry made disconnection a little harder. A pair of pliers was used

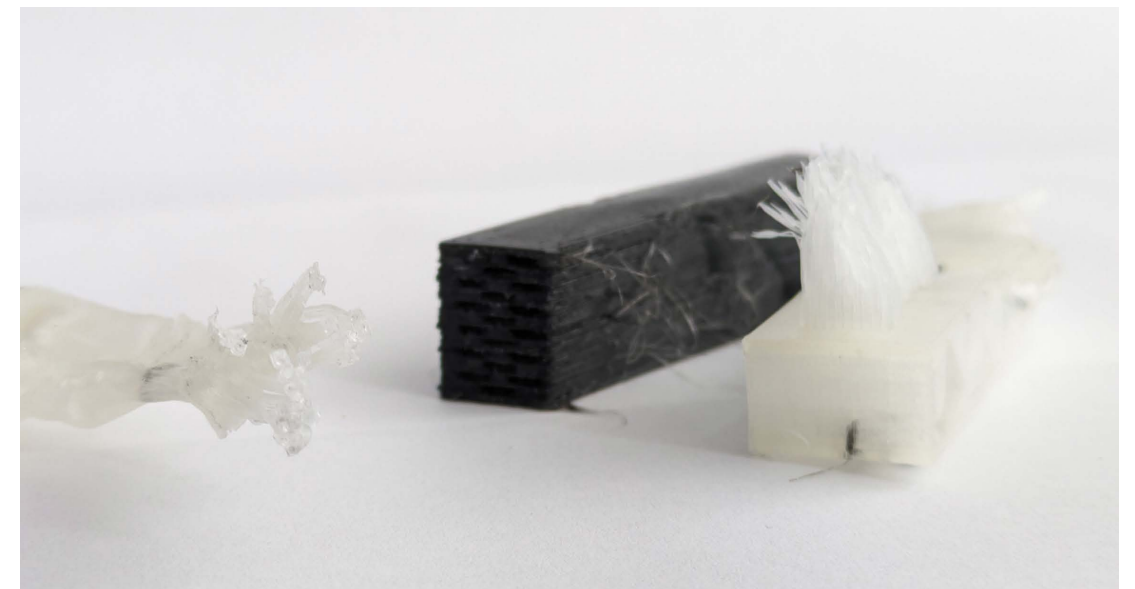

Figure 86: Disconnecting tilted interfaces around the z axis is harder than normal interfaces. We can see the parts are more deformed and the connective elements more elongated than usual



### 6.2.2 Roller and bike handle

The roller can be seen in figure 88. The TPU serves as a soft interaction point with the muscles, while the PLA is used as the bearing for the rolling motion. The bike handle can be seen in figure 89, where the TPU and PLA work together to create a comfortable yet sturdy grip.



Figure 89: A handle for for instance a bike. The flexible TPU accommodates a comfortable grip  
 Figure 88: A muscle roller with a thin wall interface where the TPU surrounds the PLA

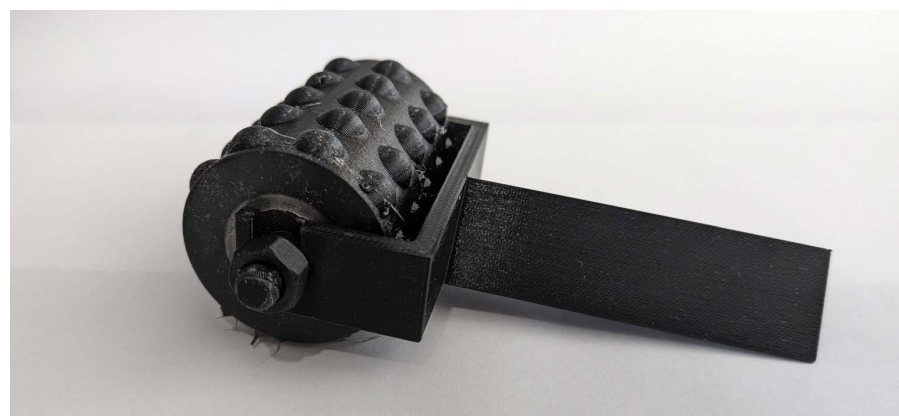

Figure 90: A muscle roller with a thin wall interface where the TPU surrounds the PLA

#### Boundary case

Thin walls are a commonly used phenomenon in for instance boxes, handles, or vases. The inherent issues with these will be that they are quite thin, thus leaving not much space in which to implement a connection. The two main expected issues are:

- The dimensions of the connective element might not fit with the restrictions of the thin-walled design.
- In certain configurations, creating a way to put enough force on the TPU or PLA to commence disconnection might be hard.

#### Observations

##### TPU around PLA

*Design:* Minimal dimensions need to be considered, to accommodate the connective element. These can be a minimum of 2mm, giving the thin wall a minimum thickness of 3.6mm. Furthermore, to allow disconnection, the TPU needs to be able to peel away from the PLA. A seam is necessary (figure 88).

*Printability:* The objects are printable, but due to the surrounding TPU, stringing and oozing is more of an issue than usual.

*Strength:* The connection is plenty strong.

*Disconnection:* Disconnection is quite difficult, as there is no way to pull along the main axis of the connective element. Instead, the TPU needs to be “peeled” off (figure 92), which adds the bending of the TPU as an extra necessary force.



Figure 92: “Peeling” off the TPU from the PLA



Figure 93: Disconnection of the thin walled handle. A clean separation except for the Z-seam overextrusion contamination



Figure 91: Different designs of thin walls with TPU around PLA. Only connections along seam (left), only connections along seam and low infill for TPU (middle), connections all the way around and thick TPU layer (right)



### 6.2.3 Watch case and strap

The watch case with strap can be seen in figure 94 and 95. This products combines a case for a smartwatch and a strap, creating a nicely tied together product.



Figure 95: A watch with a thin interface



Figure 94: A watch with a thin interface

### Boundary case

On some occasions, creating very flexible parts might be what is needed. By keeping the TPU as thin as possible, this can be accomplished. In this case, the main concern is:

- Can a thin interface withstand the bending forces, or will the PLA bend, or fatigue, and break?

### Observations

*Design:* An interface with only one row of connective elements will bend and break easily if not supported in some other way. Using a minimum height of 2.8mm, two rows of connective elements can be implemented, which increases the rigidity immensely.

*Printability:* Printability is perfectly normal.

*Strength:* The strength is perfectly normal, tension as well as bending-wise.

*Disconnection:* Disconnection functions as normal (figure 96).



Figure 96: Disconnected watch straps, which present no issues



## 6.3 Conclusion

The Z-pin connection is applicable in more than just standard situations. Thin walls, flat and tilted surfaces are all possible, but when using the method in non-standard conditions, one should take the connection method in consideration during the design phase.

From the observations, some limitations could be found. These could be seen as boundaries for the Z-pin connection, outside of which no guarantee can be given to its proper functioning. These boundaries were as follows:

- At least two rows of connective elements should be used.
- When printing TPU around PLA, there should be a seam in the TPU, and the TPU is should be slim enough to be bendable to allow “peeling”.
- Thin walls around PLA should have a thickness of at least 3.6mm. Thin walls besides PLA should have a thickness of at least 4.8 mm.
- When designing tilted interfaces, the angle should be as low as possible. Above 20 degrees, the connection loses most of its strength/disconnection becomes troublesome.

With this knowledge, and all knowledge from previous research phases, a guide is created to aid users when applying this method. This can be found in appendix F.

# 7. DISCUSSION AND CONCLUSION

With the design and validation process done, a look is taken at the findings and the limitations of this research are discussed, along with the recommendation and the final take-aways.





## 7.1 Issues and limitations

### Contamination

One of the main objectives of this research was the creation of a contamination free disconnection mechanism. During many of the tests, it was observed that not the connection interface, but other parts of the PLA were contaminated with TPU. Due to stringing and oozing, TPU was being deposited in places it was not supposed to be. Within the current scope, it was not managed to find a solution that mitigated these artifacts.

Another reason for contamination was the Z-seam, which sometimes caused overextrusion, which would get stuck between PLA layers.

### Other printers

During this research, all samples and showcases were printed on the same printer, in the same environment and with the same material brands. Due to this, there is no certainty about how readily this method can be implemented by other people or companies. As mentioned earlier in chapter 3, every small change can have an impact on the final result, and each model of printer has its own characteristics. As such, not all settings as found during this research can be implemented 1:1.

### Geometrical limitations

During the validation with showcases, it was found that there are certain arrangements in which the method does not work or is difficult to implement. Certain dimensional limitations are indicated which can be used as a guideline for designers who want to use the method.

## 7.2 Recommendations

### Different material combinations

As mentioned in chapter 5, there is a possibility that the disconnection can be used for other material combinations as well. Both a PLA – CPE and PETG – TPU combination seem to be viable and there are no indications that the connection method will not be implementable.

### Alternative printer

With one of the main issues being the stringing and oozing of the TPU, it is recommended to verify this research on a MMAM capable printer which has direct drive, instead of a Bowden tube. According to literature, this has a great impact on the printability of TPU.

### Different toolpath

In the end, contamination was still an issue that could not be completely eliminated. Many of the contamination issues could be eliminated with a different toolpath, which is not implementable in most current slicers. It is recommended to put the Z-seam at least 10mm away from any PLA. Furthermore, the strings that occur get dragged over places where PLA is already printed. A method to eliminate this could greatly reduce contamination.

### Forced TPU structure

During this research the primary focus was on the PLA part of the connection, with it being the driving geometry of the connection. For future research, it could be interesting to tweak the TPU area surrounding the PLA, by adding certain structures that can aid disconnection, or prevent the necking that in the end proved to be the weakest link.

## 7.3 Conclusion

This report shows the development of a connection method between chemically incompatible polymers during MMAM which allows for disconnection at the end of their life by applying controlled heat to the object.

The problem was defined as:

*“Develop a reversible joining method for chemically incompatible materials for Multi Material Additive Manufacturing equivalent to or surpassing current alternatives and with versatile applicability to create a more sustainable workflow”*

This was achieved by developing a geometry called the “Z-pin”, which can be repeated in two dimensions. With this a connection can be constructed that can compete with all current alternatives when it comes to strength (figure 97), providing a yield strength of roughly 7.21MPa. Due to its relatively simple shape, the Z-pin can be scaled in length quite easily, providing a way to cater the connection strength and dimensions to each use case.

By applying controlled heating between 60 and 95 degrees Celsius to the prints, it was possible to separate it in its component polymers at the end of life. This could be done with basic tools, or in some cases even by using only the hands.

The method was tried in multiple real-life applications with specific boundary cases to validate its viability, where some limitations were discovered, which could be overcome by slightly altering either length, orientation or positioning of the Z-pin. To make the method easy to use, a guide was developed for users to implement the method into their projects.

With this, a new step has been taken towards a more sustainable workflow for companies and individuals that apply MMAM in their work. This new method provides both the benefits of current implemented solutions and new exciting ways of creating a more sustainable future.

Further steps can be taken to reduce the oozing and stringing of the TPU, which for now is the limiting factor in terms of recyclability. Lastly, more tests can be done on different printers to evaluate different environments for the method and to validate the results that were found.

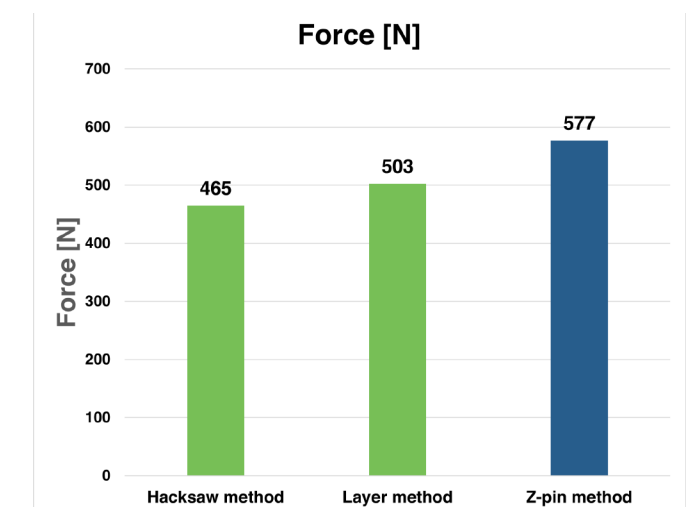

Figure 97: Comparison between Cura benchmarks and the Z-pin method

# 8. REFERENCES

- 3D Printing PLA Market - Global opportunity analysis and industry Forecast (2020-2027). (n.d.). <https://www.meticulousresearch.com/product/3d-printing-pla-market-5152>
- 3D Printing Part Orientation: Why it Matters. (n.d.). <https://www.protolabs.com/resources/blog/considerations-for-3d-printed-part-orientation/>
- Abuzied, H., Senbel, H., Awad, M., & Abbas, A. (2020). A review of advances in design for disassembly with active disassembly applications. In *Engineering Science and Technology, an International Journal* (Vol. 23, Issue 3, pp. 618–624). Elsevier B.V. <https://doi.org/10.1016/j.jestch.2019.07.003>
- Achieving reliable results in tensile testing of plastics. (2018, July 3). [plasticstoday.com. https://www.plasticstoday.com/medical/achieving-reliable-results-tensile-testing-plastics](https://www.plasticstoday.com/medical/achieving-reliable-results-tensile-testing-plastics)
- Alexandra. (2022). The causes of brittle PLA filament and the easy steps to overcome it. *BCN3D Technologies*. <https://www.bcn3d.com/the-causes-of-brittle-pla-filament/>
- An, B., Tao, Y., Gu, J., Cheng, T., Chen, X., Zhang, X., Zhao, W., Do, Y., Takahashi, S., Wu, H. Y., Zhang, T., & Yao, L. (2018). Thermorph: Democratizing 4D printing of self-folding materials and interfaces. *Conference on Human Factors in Computing Systems - Proceedings, 2018-April*. <https://doi.org/10.1145/3173574.3173834>
- Arifvianto, B., Satiti, B. E., Salim, U. A., Suyitno, Nuryanti, A., & Mahardika, M. (2022). Mechanical properties of the FFF sandwich-structured parts made of PLA/TPU multi-material. *Progress in Additive Manufacturing, 7*(6), 1213–1223. <https://doi.org/10.1007/s40964-022-00295-6>
- Bandur, G., Rusu, G., Bull, C., Mărieș, G. R. E., Bandur, G., & Rusu, G. (2008). Influence of Processing Temperature on Some Mechanical-Physical Properties of Thermoplastic Polyurethane Desmopan KA 8377 Used for Injection Moulding of Performance Sport Products *Buletinul Științific al Universității “Politehnica” din Timisoara, ROMÂNIA Seria CHIMIE ȘI INGINERIA MEDIULUI Influence of Processing Temperature on Some Mechanical-Physical Properties of Thermoplastic Polyurethane Desmopan KA 8377 Used for Injection Moulding of Performance Sport Products. In POLITEHNICA” Univ. (Timișoara) (Vol. 53, Issue 67)*. <https://www.researchgate.net/publication/242172243>
- Bayern MaterialScience. (2013). *Snap-Fit Joints for Plastics - A Design Guide [Design Guide]*. Pittsburgh.
- Beckman, E. (n.d.). The world of plastics, in numbers. *The Conversation*. <https://theconversation.com/the-world-of-plastics-in-numbers-100291>
- Brancewicz-Steinmetz, E., Sawicki, J., & Byczkowska, P. (2021). The influence of 3d printing parameters on adhesion between polylactic acid (Pla) and thermoplastic polyurethane (tpu). *Materials, 14*(21). <https://doi.org/10.3390/ma14216464>
- Castaneda, F. (2023). How we test 3D printing material combinations. *UltiMaker*. <https://ultimaker.com/learn/how-we-test-3d-printing-material-combinations/>
- Cosate de Andrade, M. F., Souza, P. M. S., Cavalett, O., & Morales, A. R. (2016). Life Cycle Assessment of Poly(Lactic Acid) (PLA): Comparison Between Chemical Recycling, Mechanical Recycling and Composting. *Journal of Polymers and the Environment, 24*(4), 372–384. <https://doi.org/10.1007/s10924-016-0787-2>
- Cruz Sanchez, F. A., Boudaoud, H., Hoppe, S., & Camargo, M. (2017). Polymer recycling in an open-source additive manufacturing context: Mechanical issues. *Additive Manufacturing, 17*, 87–105. <https://doi.org/10.1016/j.addma.2017.05.013>
- Ćwikła, G., Grabowik, C., Kalinowski, K., Paprocka, I., & Ociepka, P. (2017). The influence of printing parameters on selected mechanical properties of FDM/FFF 3D-printed parts. *IOP Conference Series: Materials Science and Engineering, 227*, 012033. <https://doi.org/10.1088/1757-899X/227/1/012033>
- Demirtaş, M. S., & Avcıoğlu, E. (2023). Ambient relative humidity effects on mechanical properties of FDM 3D printed PLA components. *Physica Scripta, 98*(6), 065923. <https://doi.org/10.1088/1402-4896/acfcf>
- Domingo-Espin, M., Puigoriol-Forcada, J. M., Garcia-Granada, A. A., Llumà, J., Borros, S., & Reyes, G. (2015). Mechanical property characterization and simulation of fused deposition modeling Polycarbonate parts. *Materials & Design, 83*, 670–677. <https://doi.org/10.1016/J.MATDES.2015.06.074>
- Ehrmann, G., & Ehrmann, A. (2021). 3D printing of shape memory polymers. In *Journal of Applied Polymer Science* (Vol. 138, Issue 34). John Wiley and Sons Inc. <https://doi.org/10.1002/app.50847>
- Estrin, Y., Krishnamurthy, V. R., & Akleman, E. (2021). Design of architected materials based on topological and geometrical interlocking. *Journal of Materials Research and Technology, 15*, 1165–1178. <https://doi.org/10.1016/J.JMRT.2021.08.064>
- Fairly Fundamental Facts about Forces and Structures. (2023, March 1). *TeachEngineering.org*. [https://www.teachengineering.org/lessons/view/wpi\\_lesson\\_1](https://www.teachengineering.org/lessons/view/wpi_lesson_1)
- FDM 3D Printing - Fused Deposition Modeling. (n.d.). <https://www.stratasys.com/en/guide-to-3d-printing/technologies-and-materials/fdm-technology/#:~:text=FDM%20Thermoplastic%20Materials&text=A%20significant%20advantage%20of%20FDM,meeting%20the%20most%20demanding%20applications.>
- Gao, X., Qi, S., Kuang, X., Su, Y., Li, J., & Wang, D. (2021). Fused filament fabrication of polymer materials: A review of interlayer bond. *Additive Manufacturing, 37*. <https://doi.org/10.1016/J.ADDMA.2020.101658>
- García-Collado, A., Blanco, J. M., Gupta, M. K., & Dorado-Vicente, R. (2022). Advances in polymers based Multi-Material Additive-Manufacturing Techniques: State-of-art review on properties and applications. *Additive Manufacturing, 50*, 102577. <https://doi.org/10.1016/j.addma.2021.102577>
- gianeco. (2023). CAN PLA BE RECYCLED? Gianeco. Retrieved February 16, 2023, from <https://www.gianeco.com/en/faq-detail/1/13/can-pla-be-recycled>
- Grappling with the infamous #7 PLA recycling code - McGill Compost. (2022, January 14). *McGill Compost*. <https://mcgillcompost.com/resources/grappling-with-the-infamous-7-pla-recycling-code/>
- Guide to Stereolithography (SLA) 3D Printing. (n.d.). *Formlabs*. <https://formlabs.com/blog/ultimate-guide-to-stereolithography-sla-3d-printing/>



- Hainsworth, T.; Smith, L.; Alexander, S.; MacCurdy, R. A Fabrication Free, 3D Printed, Multi-Material, Self-Sensing Soft Actuator. *IEEE Robot. Autom.* 2020, 5, 4118–4125.
- Hasanov, S., Alkunte, S., Rajeshirke, M., Gupta, A., Huseynov, O., Fidan, I., Alifui-Segbaya, F., & Rennie, A. (2021). Review on Additive Manufacturing of Multi-Material Parts: Progress and Challenges. *Journal of Manufacturing and Materials Processing*, 6(1), 4. <https://doi.org/10.3390/jmmp6010004>
- Hogan, M. (2023). 3D Printing with Polymers: The Complete Guide for 2023. Nexa3D. <https://nexa3d.com/blog/3d-printing-with-polymers/#:~:text=PLA%20is%20the%20most%20common,expensive%20and%20difficult%20to%20print.>
- How important is layer height for 3D printing? 3D print better parts with the right layer thickness | Hubs. (n.d.). Hubs. <https://www.hubs.com/knowledge-base/impact-layer-height-3d-print/>
- Huang, J., Chen, Q., Jiang, H., Zou, B., Li, L., Liu, J., & Yu, H. (2020). A survey of design methods for material extrusion polymer 3D printing. *Virtual and Physical Prototyping*, 15(2), 148–162. <https://doi.org/10.1080/17452759.2019.1708027>
- Inchainge. (2022, October 12). The Butterfly Diagram - Inchainge. Inchainge. <https://inchainge.com/knowledge/sustainability/the-butterfly-diagram/>
- Influence of Processing Temperature on Some Mechanical-Physical Properties of Thermoplastic Polyurethane Desmopan KA 8377 Used for Injection Moulding of Performance Sport Products. (2008). *POLITEHNICA*, 53(67).
- Jakk. (2022). Your guide to the Ultimaker S3. Additive-X. <https://additive-x.com/blog/your-guide-to-the-ultimaker-s3/>
- Joseph, T. M., Kallingal, A., Suresh, A. M., Mahapatra, D. K., Hasanin, M. S., Haponiuk, J., & Thomas, S. (2023). 3D printing of polylactic acid: recent advances and opportunities. *The International Journal of Advanced Manufacturing Technology*, 125(3–4), 1015–1035. <https://doi.org/10.1007/s00170-022-10795-y>
- Joshi, S. (2023, July 19). 3D Printing Statistics: 69 facts and trends to follow in 2023. <https://learn.g2.com/3d-printing-statistics>
- Kuipers, T. (2020). Interlocking Print Patterns. [https://www.tdcommons.org/dpubs\\_series/3446](https://www.tdcommons.org/dpubs_series/3446)
- Kwon, N., Deshpande, H., Hasan, M. K., Darnal, A., & Kim, J. (2021). Multi-ttatch: Techniques to Enhance Multi-material Attachments in Low-cost FDM 3D Printing. *Symposium on Computational Fabrication*, 1–16. <https://doi.org/10.1145/3485114.3485116>
- Lopes, L. R., Silva, A. F., & Carneiro, O. S. (2018). Multi-material 3D printing: The relevance of materials affinity on the boundary interface performance. *Additive Manufacturing*, 23, 45–52. <https://doi.org/10.1016/j.addma.2018.06.027>
- Majgaonkar, P., Hanich, R., Malz, F., & Brüll, R. (2021). Chemical Recycling of Post-Consumer PLA Waste for Sustainable Production of Ethyl Lactate. *Chemical Engineering Journal*, 423. <https://doi.org/10.1016/j.cej.2021.129952>
- McKeown, P., & Jones, M. D. (2020). The Chemical Recycling of PLA: A Review. *Sustainable Chemistry*, 1(1), 1–22. <https://doi.org/10.3390/suschem1010001>
- Mesnil, R., Poussard, V., Sab, K., & Caron, J.-F. (2023). On the geometrical origin of the anisotropy in extrusion-based 3d printed structures. *Engineering Structures*, 275, 115082. <https://doi.org/10.1016/j.engstruct.2022.115082>
- Mikula, K., Skrzypczak, D., Izydorczyk, G., Warchoń, J., Moustakas, K., Chojnacka, K., & Witek-Krowiak, A. (n.d.). 3D printing filament as a second life of waste plastics-a review. <https://doi.org/10.1007/s11356-020-10657-8/Published>
- Mustafa, I., & Kwok, T.-H. (2022). Development of Intertwined Infills to Improve Multi-Material Interfacial Bond Strength. *Journal of Manufacturing Science and Engineering*, 144(3). <https://doi.org/10.1115/1.4051884>
- Nath, S.D.; Nilufar, S. An overview of additive manufacturing of polymers and associated composites. *Polymers* 2020, 12, 2719.
- Nozzle diameter and layer height explained. (2022, March 25). Wevolver. <https://www.wevolver.com/article/nozzle-diameter-and-layer-height-explained>
- Pajonk, A., Hoces, A. P., Blum, U., & Knaack, U. (2022). Multi-material additive manufacturing in architecture and construction: A review. *Journal of Building Engineering*, 45, 103603. <https://doi.org/10.1016/j.job.2021.103603>
- Rafiee, M., Farahani, R. D., & Therriault, D. (2020). Multi-Material 3D and 4D printing: a survey. *Advanced Science*, 7(12). <https://doi.org/10.1002/advs.201902307>
- Rajan, K., Samykano, Mahendran, Kadirgama, K., Sharuzi, W., Harun, W., & Rahman, M. M. (2022). Fused deposition modeling: process, materials, parameters, properties, and applications. *The International Journal of Advanced Manufacturing Technology* 2022, 1–40. <https://doi.org/10.1007/S00170-022-08860-7>
- Ribeiro, M., Sousa Carneiro, O., & Ferreira da Silva, A. (2019). Interface geometries in 3D multi-material prints by fused filament fabrication. *Rapid Prototyping Journal*, 25(1), 38–46. <https://doi.org/10.1108/RPJ-05-2017-0107>
- Speight, J. G. (2020). Monomers, polymers, and plastics. In *Handbook of Industrial Hydrocarbon Processes* (pp. 597–649). Elsevier. <https://doi.org/10.1016/B978-0-12-809923-0.00014-X>
- Team, R. (2023, July 13). How is Multi-Material 3D printing done and what can you make with it? Revolutionized. <https://revolutionized.com/multi-material-3d-printing/>
- Tensile Testing for 3D Printing Materials. (n.d.). <https://www.protolabs.com/en-gb/resources/blog/tensile-testing-for-3d-printing-materials/#:~:text=The%20most%20commonly%20used%20and,test%20plastic%203D%2Dprinted%20materials.>
- TensileMill CNC. (n.d.). Tensile sample preparation equipment for Non-Trained CNC machinists. <https://www.tensilemillcnc.com/blog/tensilemill-cnc-mini-super-easy-and-accurate-tensile-sample-preparation-equipment-for-non-trained-cnc-machinists>
- The butterfly diagram: visualizing the circular economy. (n.d.). <https://ellenmacarthurfoundation.org/circular-economy-diagram>
- van der Vlist, K. J. (2021). Joining chemically incompatible materials for fused deposition modeling (Issue March). TU Delft.

- Vidakis, N., Petousis, M., Mountakis, N., David, C. N., Sagris, D., & Das, S. C. (2023). Thermomechanical response of thermoplastic polyurethane used in MEX additive manufacturing over repetitive mechanical recycling courses. *Polymer Degradation and Stability*, 207. <https://doi.org/10.1016/j.polymdegradstab.2022.110232>
- Williams, A., & Siegmund, T. (2021). Mechanics of topologically interlocked material systems under point load: Archimedean and Laves tiling. *International Journal of Mechanical Sciences*, 190, 106016. <https://doi.org/10.1016/j.ijmecsci.2020.106016>
- Zhang, D.; Chi, B.; Li, B.; Gao, Z.; Du, Y.; Guo, J.; Wei, J. Fabrication of highly conductive graphene flexible circuits by 3D printing. *Synth. Met.* 2016, 217, 79–86.
- Zhang, J., Yin, Z., Ren, L., Liu, Q., Ren, L., Yang, X., & Zhou, X. (2022). Advances in 4D Printed Shape Memory Polymers: From 3D Printing, Smart Excitation, and Response to Applications. *Advanced Materials Technologies*, 7(9), 2101568. <https://doi.org/10.1002/admt.202101568>
- Zhao, P., Rao, C., Gu, F., Sharmin, N., & Fu, J. (2018). Close-looped recycling of polylactic acid used in 3D printing: An experimental investigation and life cycle assessment. *Journal of Cleaner Production*, 197, 1046–1055. <https://doi.org/10.1016/j.jclepro.2018.06.275>
- Zheng, Y., Zhang, W., Baca Lopez, D. M., & Ahmad, R. (2021). Scientometric Analysis and Systematic Review of Multi-Material Additive Manufacturing of Polymers. *Polymers*, 13(12), 1957. <https://doi.org/10.3390/polym13121957>
- Zhou, H.; Mohammadi, A.; Oetomo, D.; Alici, G. A Novel Monolithic Soft Robotic Thumb for an Anthropomorphic Prosthetic Hand. *IEEE Robot. Autom.* 2019, 4, 602–609.



# 9. APPENDICES

---





## Appendix A: Ratio calculations

Yield strength of PLA filament: 60 MPa

Yield strength of TPU filament: 15 MPa

If we assume a 50/50 surface area and the polymers would be perfectly homogenously blended, we could roughly assume:

$$\frac{60 + 15}{2} = 37.5 \text{ MPa} \quad (1)$$

But, with the TPU being the weakest, if it is not blended, it will fail at the TPU interface. From this, assuming a break orthogonal to the force, one would get a theoretical yield strength of:

$$\frac{1}{2} * 15 = 7.5 \text{ MPa} \quad (1)$$

If we want an optimised ratio between PLA and TPU, this can be found with the following formula:

$$60*(1 - x) - 15x = 0 \quad (1)$$

*with  $0 < x < 1$*

$$60 - 60x = 15x \quad (2)$$

$$60 = 75x \quad (3)$$

$$x = 0.8 \quad (4)$$

As such, PLA should only be 0.2 of the cross section, giving a ratio of 1:4. This gives a theoretical max yield strength of:

$$0.8*15 = 12 \text{ MPa} \quad (1)$$

$$0.2*60 = 12 \text{ MPa} \quad (2)$$

## Appendix B: Relevant industries

MMAM is a step toward industry 4.0 for many sectors. From reviews it was understood that the sectors that will most likely benefit most from this technology will be:

- Aerospace
- Electronics
- Biomedical
- Construction
- Automobile

### Aerospace

The aerospace sector can benefit hugely from the ability to produce even more lightweight parts, ranging from ceramics and metals, to reinforced composites and polymers (Zheng et al., 2021).

### Electronics

The field of electronics is mainly about the possibility to incorporate sensors and such into a part, during the production process. Besides this, the possibility of creating microelectromechanical systems and creating circuits with nanocomposites (Zhang et al., 2016) seems to be promising. More towards the FFF side of things, a deformable soft robot actuator with embedded sensors was created (Hainsworth et al., 2020).

### Biomedical

The possibilities in the biomedical field are almost limitless, as it stands now. Developing biodegradable drug delivery systems and polymers for cell encapsulation (Nath et al., 2020). Besides this, the possibility to develop tools that have different biological, electrical and mechanical properties can greatly increase to application range of these tools. Lastly, shape memory polymers (SMP) could be used as actuators in smart structures as soft robots and bio-inspired design (Zhou et al., 2019).

### Construction

Pajonk et al. (2022) found that MMAM can be useful in architecture and construction, for instance as a way to create functionally graded transitions between different materials, by adjusting material properties across the volume of an object or by eliminating interfaces and enabling part-count reduction across different materials.

### Automotive

Most of the benefits for the automotive industry can be found in ergonomics and lighter but still safe exterior panels (Zheng et al., 2021).

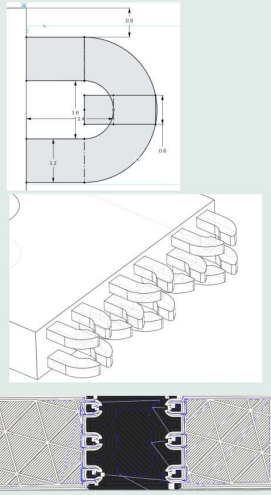
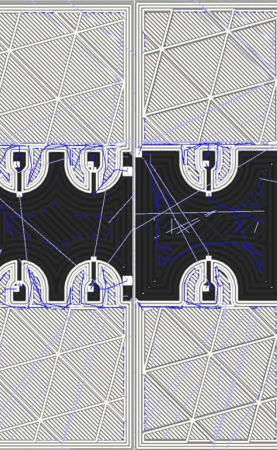
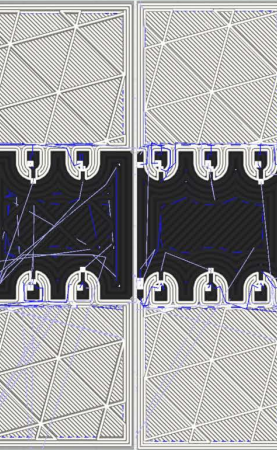
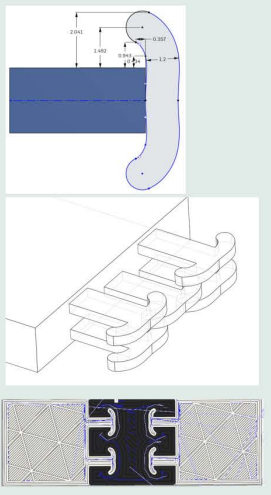
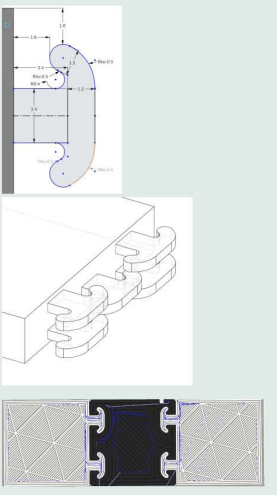
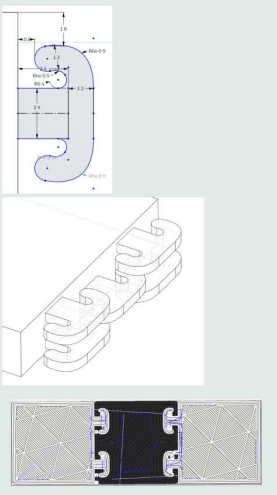
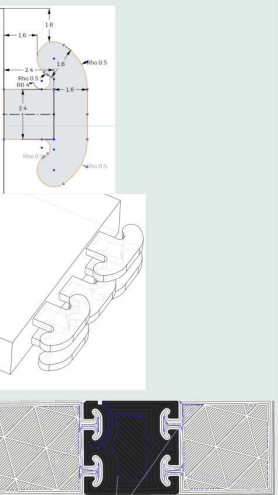
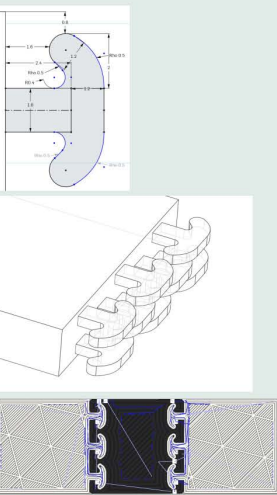
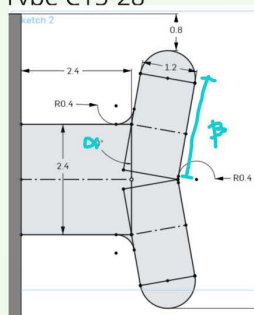
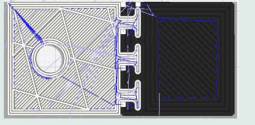
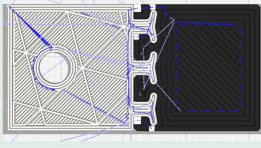
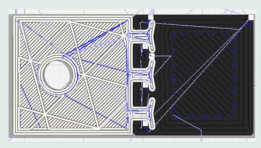
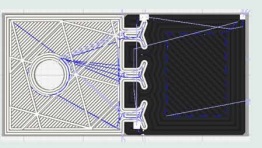
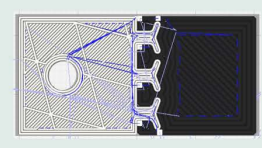
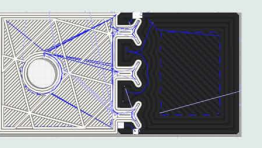
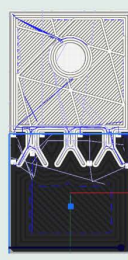
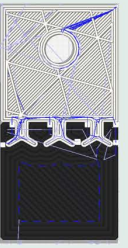
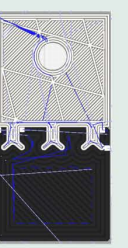
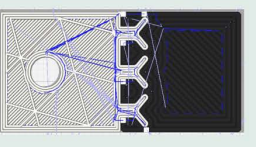
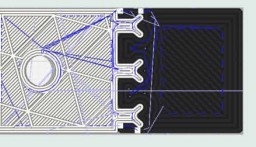
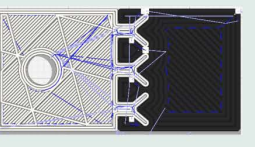
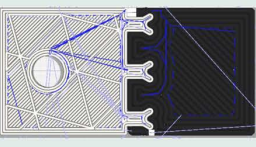
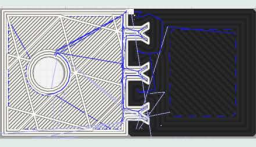

# Appendix C: Connection IDs

<p><b>U hook</b></p>	<p>Type C33</p> 	<p>Type C7</p> 	<p>Type C9</p> 				
<p><b>Anchor</b></p>	<p>Type C13</p> 	<p>Type C34</p> 	<p>Type C35</p> 	<p>Type C36</p> 	<p>Type C37</p> 		
<p><b>Y hook</b> Type C15-28</p>  <p>Variables:  <math>\phi</math> - Angle of arms  <math>L</math> - Length of arms</p>	<p>C15</p> 	<p>C16</p> 	<p>C17</p> 	<p>C18</p> 	<p>C19</p> 	<p>C20</p> 	<p>C27</p> 
<p>C21</p> 		<p>C22</p> 	<p>C23</p> 	<p>C24</p> 	<p>C25</p> 	<p>C26</p> 	<p>C5</p> 

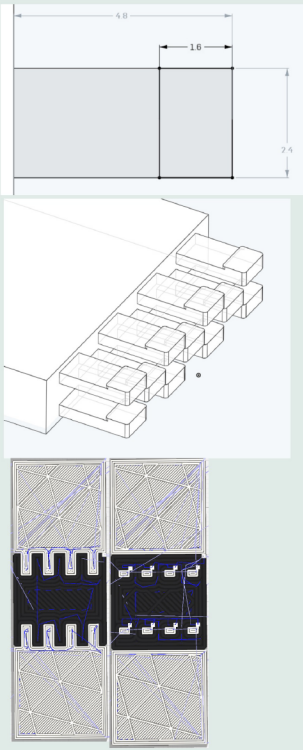
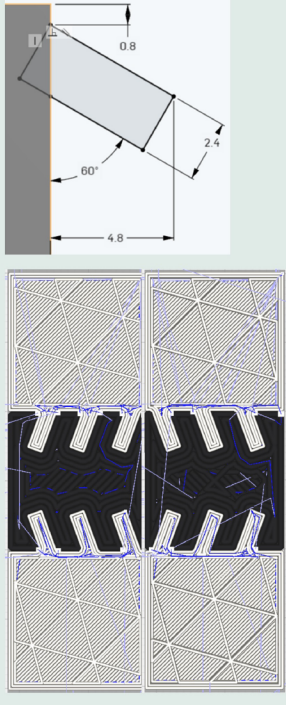
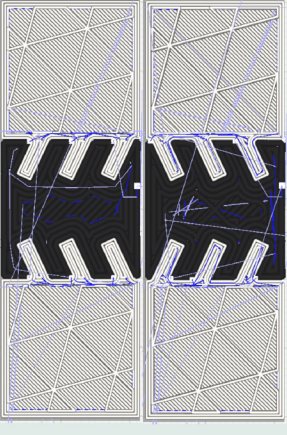
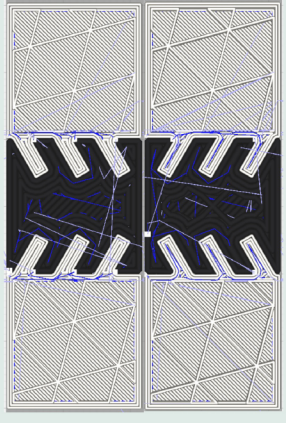
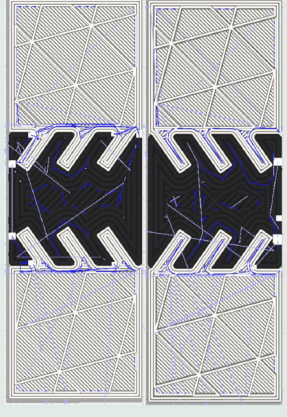
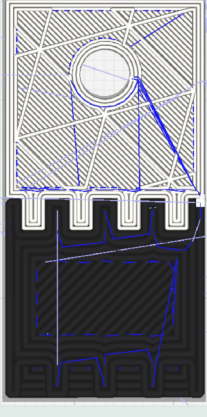
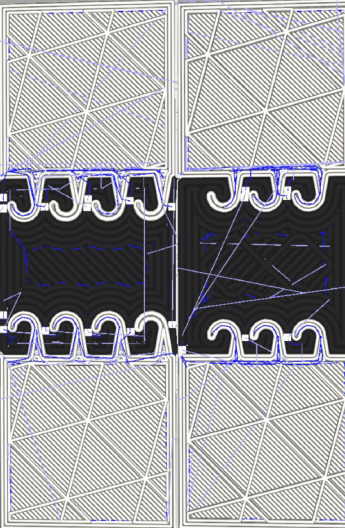
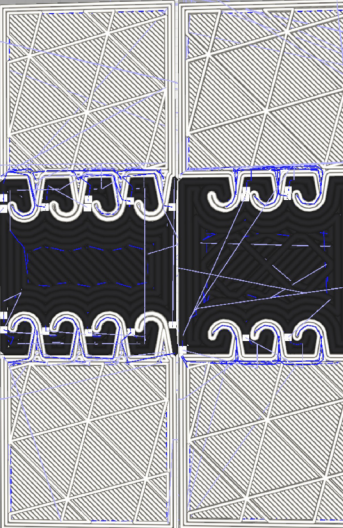
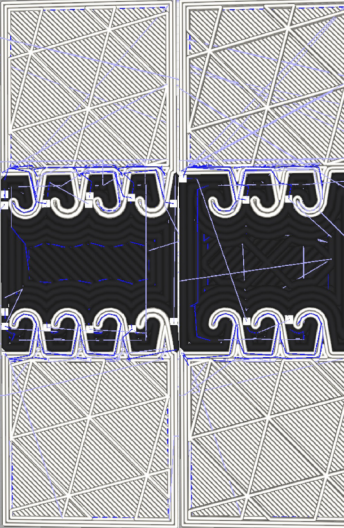
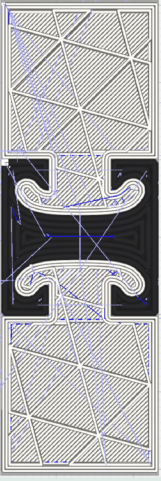
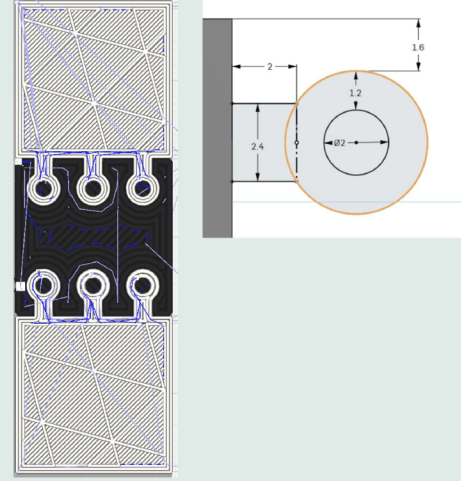

<p><b>Blank stem (tilted)</b></p>	<p>Type C38</p> 	<p>Type C29</p> 	<p>Type C30</p> <p>55 degrees</p> 	<p>Type C31</p> <p>50 degrees</p> 	<p>Type C32</p> <p>45 degrees</p> 	<p>Type C4</p> 	
<p><b>Single hooks</b></p>	<p>Type C10</p> 	<p>Type C11</p> 	<p>Type C12</p> 				
<p><b>Misc.</b></p>	<p>Type C6</p> 	<p>Type C39 &amp; C1</p> 					



# Appendix D: Altered Geometries Phase 2

A12 - Anchor basic shape	A11 - Anchor with dimple	A13 - Anchor with extra negative space in the TPU	A14 - Anchor hooks with gentler bend	A15 - Anchor with smooth stem transition	A16 - Anchor with Zpin	A17 - Anchor with Zpin at edge V1	A18 - Anchor with Zpin at edge V2	A19 - Anchor with Zpin at edge V3
<b>Description:</b> The basic design of the anchor concept	<b>Description:</b> Basic anchor design with a small dimple in the middle. This might give the connective element more flexibility to move when heated for disconnection.	<b>Description:</b> The PLA part is replicated from the original design, but a negative is created in the TPU.	<b>Description:</b> With a gentler bend the stress concentration might be lower. The TPU can be stronger, as the hooks overlap when heated.	<b>Description:</b> There is a fillet from the base to the stem.	<b>Description:</b> A Zpin has been added at the end of the stem.	<b>Description:</b> The connection has a Zpin at the inner edge of the curve towards the hook.	<b>Description:</b> The connection has a Zpin at the inner edge of the curve towards the hook.	<b>Description:</b> The connection has a Zpin at the inner and outer edge of the curve towards the hook.
<b>Reason for design change:</b> -	<b>Reason for design change:</b> A reduction in disconnection force is desirable.	<b>Reason for design change:</b> The negative space in the TPU will allow the PLA to bend out more easily, making disconnection easier when heated.	<b>Reason for design change:</b> With a gentler bend the stress concentration might be lower. The TPU can be stronger, as the hooks overlap when heated.	<b>Reason for design change:</b> A fillet will reduce the stress concentration at the base of the stem.	<b>Reason for design change:</b> A Zpin can greatly increase the tensile strength of the connection.	<b>Reason for design change:</b> A common failure mode was the shearing or splitting of the hooks. This will add a little strength to that part, as well as function as a Zpin.	<b>Reason for design change:</b> A common failure mode was the shearing or splitting of the hooks. This will add a little strength to that part, as well as function as a Zpin.	<b>Reason for design change:</b> A common failure mode was the shearing or splitting of the hooks. This will add a little strength to that part, as well as function as a Zpin.
<b>Sliced model:</b> 	<b>Sliced model:</b> 	<b>Sliced model:</b> 	<b>Sliced model:</b> 	<b>Sliced model:</b> 	<b>Sliced model:</b> 	<b>Sliced model:</b> 	<b>Sliced model:</b> 	<b>Sliced model:</b> 
<b>Printed important layers:</b> 	<b>Printed important layers:</b> 	<b>Printed important layers:</b> 	<b>Printed important layers:</b> 	<b>Printed important layers:</b> 	<b>Printed important layers:</b> 	<b>Printed important layers:</b> 	<b>Printed important layers:</b> 	<b>Printed important layers:</b> 





- Extruder 1
- Extruder 2
- Travels
- Helpers
- Shell
- Infill
- Starts
- Top / Bottom
- Inner Wall

B10 - Zpin 4mm long	B11 - Zpin 3.2mm long	B12 - Zpin with rounded end	B13 - Filleted stem	B14 - Zpin 0.8mm	B15 - Zpin with 2 layers	B16 - Zpin on either side	B17 - Slit in stem	B18 - Curved hollow Zpin	B19 - Curved Zpin
<b>Description:</b> Basic design with a length of 4 mm.	<b>Description:</b> Basic design with a length of 3.2 mm.	<b>Description:</b> The end of the stem is rounded	<b>Description:</b> There is a fillet from the base to the stem.	<b>Description:</b> The basic Zpin has a depth of 1.6mm. Here this is changed to 0.8mm.	<b>Description:</b> The Zpin has two layers, the upper one with an offset of 0.4mm (1 linethickness).	<b>Description:</b> The stem has a Zpin on either side.	<b>Description:</b> The stem has a horizontal gap at the 2nd layer.	<b>Description:</b> The Zpin has a curved shape with a hollow back	<b>Description:</b> The Zpin has a curved shape.
<b>Reason for design change:</b> The basic design is 4.8 mm long. Reducing this length will make the method more broadly applicable.	<b>Reason for design change:</b> The basic design is 4.8 mm long. Reducing this length will make the method more broadly applicable.	<b>Reason for design change:</b> The rounded end will create a smoother path. It will also demonstrate how the shape of the Zpin affects the strength of the connection.	<b>Reason for design change:</b> A fillet will reduce the stress concentration at the base of the stem.	<b>Reason for design change:</b> With this design we can test the impact of the size of the Zpin on the strength of the connection. A smaller Zpin might improve disconnection as well.	<b>Reason for design change:</b> An increase in Zpin height is assumed to increase the strength of the connection. The smaller size of the upper part is to avoid interference.	<b>Reason for design change:</b> An increase in Zpin contact area is assumed to increase the strength of the connection. The reduced upper part is to avoid interference.	<b>Reason for design change:</b> The slit might give the Zpin a place to 'dent' towards when heated for disconnection. This could improve disconnection.	<b>Reason for design change:</b> This design might be easier to detach when heated.	<b>Reason for design change:</b> This design might be easier to detach when heated.
<b>Sliced model:</b> 	<b>Sliced model:</b> 	<b>Sliced model:</b> 	<b>Sliced model:</b> 	<b>Sliced model:</b> 	<b>Sliced model:</b> 	<b>Sliced model:</b> 	<b>Sliced model:</b> 	<b>Sliced model:</b> 	<b>Sliced model:</b> 
<b>Printed important layers:</b> 	<b>Printed important layers:</b> 	<b>Printed important layers:</b> 	<b>Printed important layers:</b> 	<b>Printed important layers:</b> 	<b>Printed important layers:</b> 	<b>Printed important layers:</b> 	<b>Printed important layers:</b> 	<b>Printed important layers:</b> 	<b>Printed important layers:</b> 

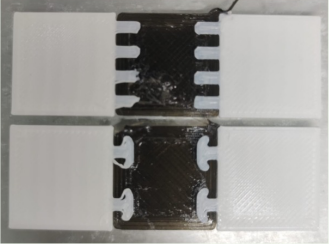
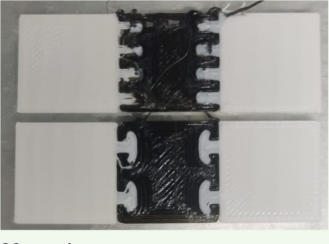
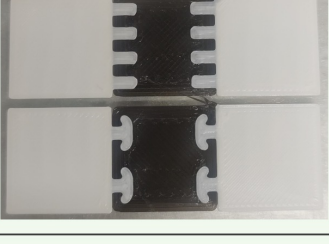
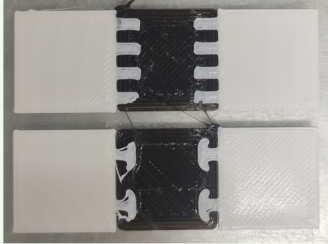

# Appendix E: Altered Parameters Phase 2

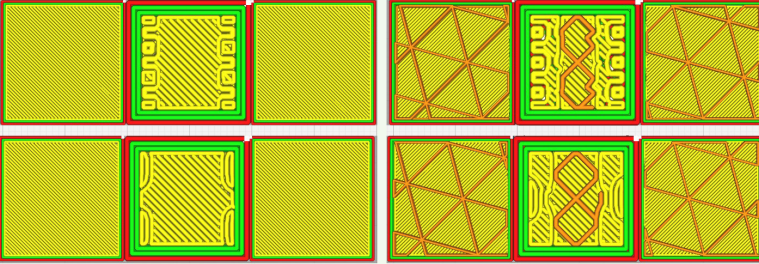
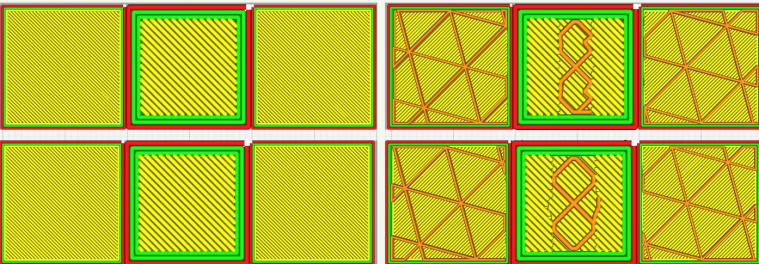
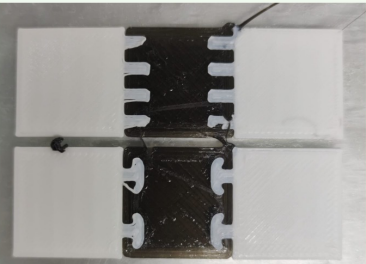
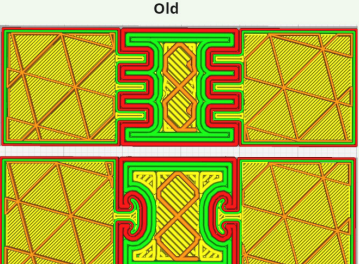
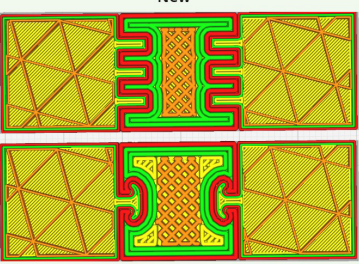
Adjusted speed settings	Change layerheight	Higher temperature	Remove small TPU parts that occur under the PLA connective pieces	100% infill TPU	Walls
<p><b>What is changed:</b> Wall speed: 40/30/20 mm/s Top surface speed: 40 mm/s Bottom surface speed: 40 mm/s Wall Acceleration: 250 mm/s<sup>2</sup></p>	<p><b>What is changed:</b> Layerheight: 0.25mm</p>	<p><b>What is changed:</b> Temperature PLA: 210 degrees Temperature TPU: 230 degrees</p>	<p><b>What is changed:</b> Cura setting "Extra skin wall count": 0</p>	<p><b>What is changed:</b> Infill TPU: 100%</p>	<p><b>What is changed:</b> Wall count: 3</p>
<p><b>Reason for change:</b> Observations showed that first PLA layers on the TPU failed to be printed as intended. With a reduced wall speed and acceleration, the accuracy of these connective elements should increase, as the walls of these elements will support the rest of the connection during printing.</p>	<p><b>Reason for change:</b> A layerheight of .25mm has been proven to increase the tensile strength of 3D printed PLA. <i>(How Important Is Layer Height for 3D Printing? 3D Print Better Parts With the Right Layer Thickness   Hubs, n.d.)</i> <i>(Nozzle Diameter and Layer Height Explained, 2022)</i> <i>(Gurcan et al., 2022)</i></p>	<p><b>Reason for change:</b> An increased temperature is associated with a higher adhesion during printing, as polymers bind more freely and the more fluid material flows better in the previous layer.</p>	<p><b>Reason for change:</b> These small parts were being printed very inaccurately and caused blobs and stringing, which interfered with the PLA. It should be noted that this is not a "basic" parameter, and as such is unique to Cura. The main aim of the change of this parameter is creating a more continuous TPU extrusion.</p>	<p><b>Reason for change:</b> With a higher infill, the TPU becomes less flexibel, which could 'clamp' the PLA tighter</p>	<p><b>Reason for change:</b> The geometry of the connective elements benefits more from more walls. It also adds lines in the tensile direction.</p>
<p><b>Print results</b> 40 mm/s </p> <p>30 mm/s </p> <p>20 mm/s </p>	<p><b>Print results</b> </p>	<p><b>Print results</b> </p>	<p><b>Sliced model:</b></p> <p>Old </p> <p>New </p> <p><b>Print results</b> </p>	<p><b>Sliced model:</b></p> <p>Old </p> <p>New </p> <p><b>Print results</b> </p>	<p><b>Sliced model:</b></p> <p>Old </p> <p>New </p> <p><b>Print results</b> </p>
<p><b>Visual observations:</b> A clear increase in accuracy is visible with a lower printing speed. Not only this, but the risk of PLA stringing seems to decrease as well and no voids a noticable in the layer surface.</p>	<p><b>Visual observations:</b> The print result seems rather comparable to the normal results.</p>	<p><b>Visual observations:</b> The PLA is not perfectly accurate, but there is no sign of peeling or voids.</p>	<p><b>Visual observations:</b> No clear difference from a regular print is visible.</p>	<p><b>Visual observations:</b> No clear difference from a regular print is visible.</p>	<p><b>Visual observations:</b> The anchor has some issues with under-extruding. The Zpin looks about as accurate as a regular print, though the surface seems to be a little bit smoother.</p>

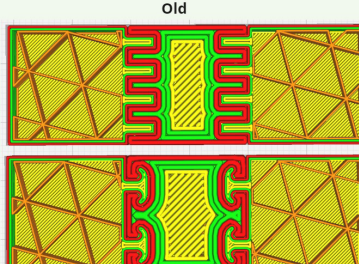
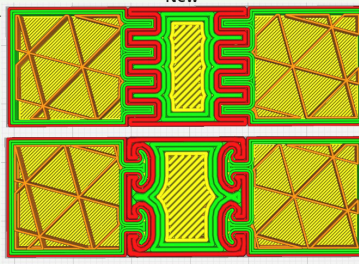
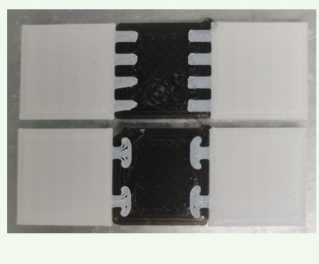

# Appendix F: Guidelines for application

## Guidelines for designing



### Design considerations

**Orientation:** The pins will always be printed in the xy-plane. Vertical connections are not possible.

**Size:** The recommended minimum pin use is 3, in a triangulated shape (two at the tension side of the bending moment axis, one at the compression side, see picture). Due to this, the recommended minimum connection surface area is 2.8x10 mm (HxW).

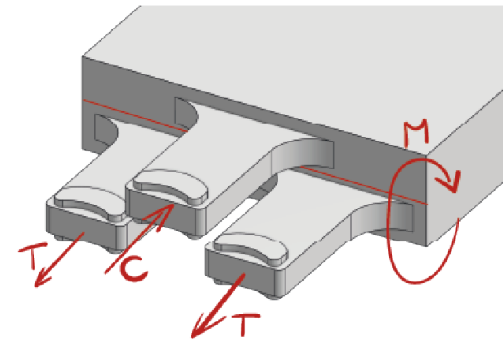

### Special cases

**Thin walls:** Keep in mind that the TPU and PLA will have to detach. If the outer wall is TPU and surrounds the PLA, create a seam so the TPU can be “peeled” away from the PLA. It is also possible to connect the PLA and TPU at the thin surface, but this limits the minimum thickness of the wall to 4.8 mm, as this is the width of 1 connective element.

**Low/flat pieces:** for very flat pieces, it is recommended to strive for a minimum height of 2.8 mm. This way, two layers of pins can be implemented, greatly improving the bending strength.

## Guidelines for slicing



### Pin parameters

**Amount of pins:** It is important to balance the strength of the connection with the ease of separation. Don't blindly implement as many pins as possible, but be mindful of the required strength. Use the graph below for reference.

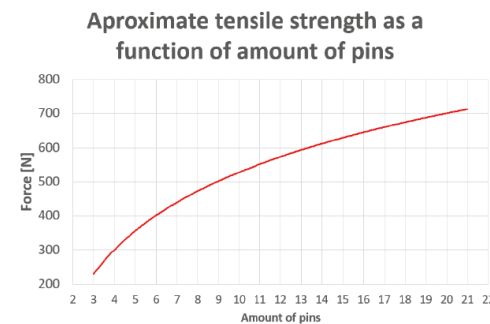

**Size of pins:** Reducing the size of the pins can be a viable option when there is not much TPU in which the pins can be placed (see thin walls), or when a disconnection force is preferred. Use the graph below for an indication of the strength at certain lengths. Steps of .8 mm, a minimum length of 2 mm and maximum length of 5.6 are recommended.

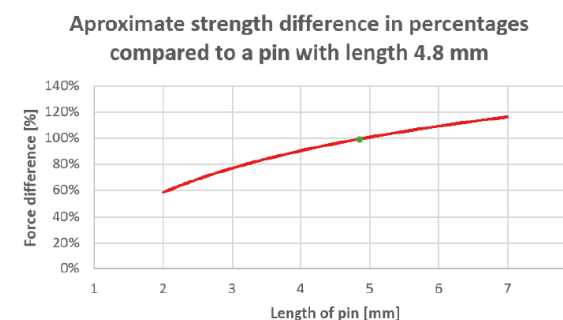

### Special cases

**Thin walls:** With thin walls, the TPU already clamps on PLA. Connective elements are only necessary at the seam of the TPU, once every 2 cm. It might be worth considering using shorter pins, so the disconnection is even easier.

**Angled sides:** Due to the angle, when pulling these pieces apart, the direction of the force is not in line with the axis of the pins. Because of this, less pins would be recommended to ease the disconnection.

## Guidelines for disconnecting



### Heat

**60 - 70 degrees:** use for connections with 9 or less pins, which can be pulled along the axis. Disconnection will be very clean.

**70 - 85 degrees:** use for connections with more than 9 pins, or when the pins are not oriented along the axis of the pull force. Pins might get stringy.

**85 - 95 degrees:** use for connections with many pins, pins not oriented along the axis of the force, or when it is hard to apply a force. Will cause heavy elongation of the pins, disconnection will create heavy deformation in PLA part.

### Pulling apart

**Heating:** submerge the pieces for approximately 1 minute in the water. After this, get them out and ready to detach.

**Tools:** In most cases, the pieces can be detached by hand. In case of a very sturdy connection, non-axial pulling directions or a very high temperature, using pliers might be helpful.

**Direction:** Always try to pull the pieces along the axis of the pins. Wiggling the two parts will help a bit.

### Troubleshoot

**Pieces don't disconnect:** Reheating your piece should help a lot. If this doesn't work, try using a higher temperature. If this fails, it might be that you used too many pins to detach the pieces by hand.

**PLA breaks in the TPU:** Try using a lower temperature and wiggle a bit more. The high temperature might make the PLA too weak. If this does not work, it might be that during printing something went wrong.

# Appendix G: Design brief

DESIGN  
FOR OUR  
future



## IDE Master Graduation

Project team, Procedural checks and personal Project brief

This document contains the agreements made between student and supervisory team about the student's IDE Master Graduation Project. This document can also include the involvement of an external organisation, however, it does not cover any legal employment relationship that the student and the client (might) agree upon. Next to that, this document facilitates the required procedural checks. In this document:

- The student defines the team, what he/she is going to do/deliver and how that will come about.
- SSC E&SA (Shared Service Center, Education & Student Affairs) reports on the student's registration and study progress.
- IDE's Board of Examiners confirms if the student is allowed to start the Graduation Project.

**! USE ADOBE ACROBAT READER TO OPEN, EDIT AND SAVE THIS DOCUMENT**

Download again and reopen in case you tried other software, such as Preview (Mac) or a webbrowser.

### STUDENT DATA & MASTER PROGRAMME

Save this form according to the format "IDE Master Graduation Project Brief\_familyname\_firstname\_studentnumber\_dd-mm-yyyy". Complete all blue parts of the form and include the approved Project Brief in your Graduation Report as Appendix 1 !



family name <u>van Zeijl</u>	Your master programme (only select the options that apply to you):
initials <u>T.</u> given name <u>Thomas</u>	IDE master(s): <input checked="" type="radio"/> IPD <input type="radio"/> Dfl <input type="radio"/> SPD
student number <u>4351002</u>	2 <sup>nd</sup> non-IDE master: _____
street & no. _____	individual programme: _____ (give date of approval)
zipcode & city _____	honours programme: <input type="radio"/> Honours Programme Master
country _____	specialisation / annotation: <input type="radio"/> Medisign
phone _____	<input type="radio"/> Tech. in Sustainable Design
email _____	<input type="radio"/> Entrepreneurship

### SUPERVISORY TEAM \*\*

Fill in the required data for the supervisory team members. Please check the instructions on the right !

** chair <u>Zjenja Doubrovski</u>	dept. / section: _____
** mentor <u>Mehmet Ozdemir</u>	dept. / section: _____
2 <sup>nd</sup> mentor _____	
organisation: _____	
city: _____	country: _____

Chair should request the IDE Board of Examiners for approval of a non-IDE mentor, including a motivation letter and c.v.



Second mentor only applies in case the assignment is hosted by an external organisation.



Ensure a heterogeneous team. In case you wish to include two team members from the same section, please explain why.

comments  
(optional)  
:  
:  
:

### Procedural Checks - IDE Master Graduation

#### APPROVAL PROJECT BRIEF

To be filled in by the chair of the supervisory team.

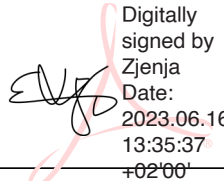
chair Zjenja Doubrovski date 15 - 06 - 1983 signature 

Digitally signed by Zjenja  
Date: 2023.06.16 13:35:37 +02'00'

#### CHECK STUDY PROGRESS

To be filled in by the SSC E&SA (Shared Service Center, Education & Student Affairs), after approval of the project brief by the Chair. The study progress will be checked for a 2nd time just before the green light meeting.

Master electives no. of EC accumulated in total: \_\_\_\_\_ EC  
Of which, taking the conditional requirements into account, can be part of the exam programme \_\_\_\_\_ EC

YES all 1<sup>st</sup> year master courses passed

NO missing 1<sup>st</sup> year master courses are:

List of electives obtained before the third semester without approval of the BoE

name \_\_\_\_\_ date \_\_\_\_\_ signature \_\_\_\_\_

#### FORMAL APPROVAL GRADUATION PROJECT

To be filled in by the Board of Examiners of IDE TU Delft. Please check the supervisory team and study the parts of the brief marked \*\*. Next, please assess, (dis)approve and sign this Project Brief, by using the criteria below.

- Does the project fit within the (MSc)-programme of the student (taking into account, if described, the activities done next to the obligatory MSc specific courses)?
- Is the level of the project challenging enough for a MSc IDE graduating student?
- Is the project expected to be doable within 100 working days/20 weeks ?
- Does the composition of the supervisory team comply with the regulations and fit the assignment ?

Content:  APPROVED  NOT APPROVED

Procedure:  APPROVED  NOT APPROVED

comments

name \_\_\_\_\_ date \_\_\_\_\_ signature \_\_\_\_\_



A Reversible Interlocking System for 3D printing Incompatible Materials project title

Please state the title of your graduation project (above) and the start date and end date (below). Keep the title compact and simple. Do not use abbreviations. The remainder of this document allows you to define and clarify your graduation project.

start date 20 - 03 - 2023 end date 06 - 10 - 2023

**INTRODUCTION \*\***

Please describe, the context of your project, and address the main stakeholders (interests) within this context in a concise yet complete manner. Who are involved, what do they value and how do they currently operate within the given context? What are the main opportunities and limitations you are currently aware of (cultural- and social norms, resources (time, money,...), technology, ...).

In recent years, 3D printing has seen a huge increase in usage and possibilities. An increasing number of products around us are manufactured with the aid of 3D printing. This has an effect on the type of available products and how we use them. For example, products where a significant portion is customized to the need of the user, such as hearing aids, have become widespread. To allow an even greater level of customization, variety and performance, a multitude of variations and innovations have been done in this field. One of these is within the field of FFF and is revered to as multi-material FFF. With this technique, the printer can combine two or more materials, leading to much more complex parts or even full products which embody the characteristics of the used materials. This means that not just the geometry but also the material properties can be tailored to the user. Another benefit of this is the reduction of post-processing time and thus the cost of products, as well as cleaner-looking products with hidden joints.

For this research, we will look at the combination of PLA and TPU, in which TPU is a flexible material that can function, for example, as a joint in a printable part. The issue, and thus the main focus of this research, is the fact that these materials are chemically incompatible, meaning they have close to zero adhesion (Lopes et al., 2018), especially when printed face-to-face (Brancewicz-Steinmetz et al., 2021). This leads to weak connections which will fail easily. Solutions have been proposed in the form of specific parameters which lead to a better result, as Yin et al., (2018) showed that build plate temperature made a significant difference in adhesive force. This still did not create a strong enough bond for many industries to be convinced. In previous research, a mechanical interlocking system was developed to join these two materials together (Van der Vlist, 2021). Though this was a huge improvement over previous methods, the materials could not be separated at the end of life, leading to unnecessary waste. In this research, we will look into a new joining technique which allows for disassembly at the end of life, to create a sustainable workflow.

Previous research has focused on a fixed interlocking system, for example with the sandwich method (Arifvianto et al., 2022) and the non-planar bridge pattern (Van der Vlist, 2021), the latter of which has been implemented in Cura, one of the foremost used slicers.

At the moment there are many promising findings in the field of active disassembly, for instance screws that lose their thread, coils that can turn into springs and clamping washers that can unclamp. More relevant for this project though, are for instance SMP (Shape Memory Polymers) which will change its shape when heat is applied (Zhang et al., 2022). In another field, 3D prints with build-in stress are being created, a technology that allows 3D printed parts to change shape after being printed (An et al., 2018). These techniques have not yet been combined, which could prove to be a valuable addition to the knowledge pool. Almost all active disassembly at the moment focusses on disassembly on the macro level, for instance parts with a snap-fit that can be released. Within this research, the disassembly will be much more on the micro level, where a part might disassemble itself on the layer to layer interface, something which has not been done yet. Furthermore, almost all active disassembly parts at the moment require the additional step of imbedding their "memory" shape after production, which increases production time and cost. Besides this, inspiration could be taken from other disciplines, for instance, Japanese woodworking, which has many ingenious ways of constructing a disassemblable construction.

To ensure the to-be-developed method can be implemented in the design process and therefore in the final products, it is important to consider how applicable the new structures are in a variety of products. Also, we need to ensure its backwards compatibility with the printers currently on the market. The method ideally should be implemented in the software (slicer). Besides this, the method should perform at least as well as the now commonly used sandwich pattern

space available for images / figures on next page

introduction (continued): space for images

**TO PLACE YOUR IMAGE IN THIS AREA:**

- **SAVE THIS DOCUMENT TO YOUR COMPUTER AND OPEN IT IN ADOBE READER**
- **CLICK AREA TO PLACE IMAGE / FIGURE**

**PLEASE NOTE:**

- **IMAGE WILL SCALE TO FIT AUTOMATICALLY**
- **NATIVE IMAGE RATIO IS 16:10**
- **IF YOU EXPERIENCE PROBLEMS IN UPLOADING, COVERT IMAGE TO PDF AND TRY AGAIN**

image / figure 1: \_\_\_\_\_

**TO PLACE YOUR IMAGE IN THIS AREA:**

- **SAVE THIS DOCUMENT TO YOUR COMPUTER AND OPEN IT IN ADOBE READER**
- **CLICK AREA TO PLACE IMAGE / FIGURE**

**PLEASE NOTE:**

- **IMAGE WILL SCALE TO FIT AUTOMATICALLY**
- **NATIVE IMAGE RATIO IS 16:10**
- **IF YOU EXPERIENCE PROBLEMS IN UPLOADING, COVERT IMAGE TO PDF AND TRY AGAIN**

image / figure 2: \_\_\_\_\_

**PROBLEM DEFINITION \*\***

Limit and define the scope and solution space of your project to one that is manageable within one Master Graduation Project of 30 EC (= 20 full time weeks or 100 working days) and clearly indicate what issue(s) should be addressed in this project.

This research will present a method to achieve multi-material products by creating a mechanical bond between PLA and TPU, which will be separable at the end of life. First, we will analyse existing products on how multi-material features are or can be implemented, to get the first requirements for the multi-material products. Then, research and testing will be done on the subjects of interlocking patterns as well as ways of disassembling these patterns. As their will be multiple directions in which to optimise the design, early on in the process a choice will be made to determine the most impactful/relevant application of this method, creating an overview of which characteristics are important to optimize.

The solution will be selected not just for its performance but also for its applicability in a variety of products. Each possible solution will be tested on yield strength, durability, print time and quality, ease of separation and amount of material contamination. To test the concepts, a custom slicer will be created that can implement these in a model that can be used for testing said concepts.

**ASSIGNMENT \*\***

State in 2 or 3 sentences what you are going to research, design, create and / or generate, that will solve (part of) the issue(s) pointed out in "problem definition". Then illustrate this assignment by indicating what kind of solution you expect and / or aim to deliver, for instance: a product, a product-service combination, a strategy illustrated through product or product-service combination ideas, ... . In case of a Specialisation and/or Annotation, make sure the assignment reflects this/these.

The assignment is to develop a method that allows new categories of multi-material 3D printed products, where the bond between PLA and TPU will be reliable yet separable at the end of life. This method will be a valuable addition to the knowledge pool about multi-material printing possibilities and shall be backwards compatible with the hardware that is currently available. A proof of concept will be delivered to present the feasibility and advantages of this method.

**PLANNING AND APPROACH \*\***

Include a Gantt Chart (replace the example below - more examples can be found in Manual 2) that shows the different phases of your project, deliverables you have in mind, meetings, and how you plan to spend your time. Please note that all activities should fit within the given net time of 30 EC = 20 full time weeks or 100 working days, and your planning should include a kick-off meeting, mid-term meeting, green light meeting and graduation ceremony. Illustrate your Gantt Chart by, for instance, explaining your approach, and please indicate periods of part-time activities and/or periods of not spending time on your graduation project, if any, for instance because of holidays or parallel activities.

start date 20 - 3 - 2023 end date 6 - 10 - 2023



Note: I intend to graduate 4 days a week, as I need 1 day to work my job. Besides that, there will be a short holiday during the summer break and some days that I planned in to be free because I already know I will be away these days.



**Personal Project Brief** - IDE Master Graduation

**MOTIVATION AND PERSONAL AMBITIONS**

Explain why you set up this project, what competences you want to prove and learn. For example: acquired competences from your MSc programme, the elective semester, extra-curricular activities (etc.) and point out the competences you have yet developed. Optionally, describe which personal learning ambitions you explicitly want to address in this project, on top of the learning objectives of the Graduation Project, such as: in depth knowledge a on specific subject, broadening your competences or experimenting with a specific tool and/or methodology, ... . Stick to no more than five ambitions.

The ability to be able to create whatever you can imagine is something humanity has been striving for ages. As a person who loves to build and create stuff myself, I connect very strongly to that ambition. With 3D printing, and especially these more and more advanced techniques, producing something becomes increasingly available to a wider audience, leading (hopefully) to many amazing inventions in years to come.

To be able to attribute to this in whatever way possible feels like a great way to both support this progress, as well as get a better understanding of what factors are at play in the AM/CAM industry, both at a micro and a macro level.

During my studies, I have always enjoyed the combination of creativity with logic. The broadness of the tasks that will be required during this project appeals to me greatly. With this project, I hope to showcase my ability to take an idea from its theoretical beginnings, through practical testing, towards a functional product.

At the end of the project, I want to be more advanced in my understanding of the wide spectrum of possibilities that lay within the world of FFF. Besides, I want to sharpen my Grasshopper skills, as I feel that this program is an invaluable asset to designers who intend to work with CAM.

**FINAL COMMENTS**

In case your project brief needs final comments, please add any information you think is relevant.